



PREDICTION  
•  
**PREVENTION**  
•  
MANAGEMENT

The International Network for Acid Prevention

# Global Acid Rock Drainage Guide





# GuideTOC

## From GARDGuide

### Executive Summary

## 1.0 The Global Acid Rock Drainage Guide

### 1.1 Introduction

#### 1.1.1 Acid Rock Drainage

### 1.2 Acid Rock Drainage Management – The Business Case

### 1.3 Scope and Objectives of the Global Acid Rock Drainage Guide

#### 1.3.1 Scope

#### 1.3.2 Objectives

### 1.4 Relation to Other Guides

### 1.5 Approach of the Global Acid Rock Drainage Guide

### 1.6 Application to Mine Phase

### 1.7 The Sustainable Development Approach

### 1.8 Layout and How to Use the Guide

#### 1.8.1 Layout

#### 1.8.2 How to Use the Global Acid Rock Drainage Guide

### 1.9 Chapter References

#### List of Figures

#### List of Appendices

[Top of this page](#)

## 2.0 The Acid Rock Drainage Process

### 2.1 Introduction

### 2.2 Acid Rock Drainage, Neutral Mine Drainage, and Saline Drainage

### 2.3 History of Acid Rock Drainage

### 2.4 The Acid Generation Process

#### Introduction to Coal Mine Drainage

##### C2.1 Introduction

##### C2.2. Pyrite in Sedimentary Strata

##### C2.3 Carbonate Minerals in Coal-bearing Strata

##### C2.4. How Geology Affects Coal Mine Drainage Quality

- 2.4.1 Characteristics of Acid Rock Drainage, Neutral Mine Drainage, and Saline Drainage
- 2.4.2 The Global and Geochemical Sulphur Cycles
- 2.4.3 Acid Rock Drainage Sources
- 2.4.4 The Sulphide Oxidation Process
- 2.4.5 Reaction Products from Sulphide Oxidation
- 2.4.6 Neutralization Reactions
- 2.4.7 The Acid Rock Drainage Process and Migration

2.5 Concluding Statement

2.6 References

List of Tables

List of Figures

### **3.0 Corporate, Regulatory, and Community Framework**

3.1 Framework for Management of Acid Rock Drainage

3.2 Corporate Guidance

3.2.1 Newmont

3.2.2 Rio Tinto

3.2.3 Relationship to Other Requirements and Issues

3.3 Sustainability and Community Considerations

3.4 Global Regulatory Guidance

3.5 Country Regulatory Guidance

3.5.1 Commonalities in the Regulatory Regimes

3.5.2 United States of America and its States

3.5.3 Canada and its Provinces and Territories

3.5.4 Australia, its States and Territories

3.5.5 European Union (EU)

3.5.6 South Africa

3.5.7 New Zealand

3.5.8 Brazil

3.5.9 Indonesia

3.6 Risk Considerations

3.7 References

List of Tables

List of Figures

### **4.0 Defining the Problem - Characterization**

4.1 Introduction

4.2 Site Characterization Approach

- 4.2.1 Mine Life Cycle Phases
- 4.2.2 Sources of Acid Rock Drainage
- 4.2.3 Conceptual Site Model Development

#### 4.3 Components of Site Characterization

- 4.3.1 Geo-environmental Models
- 4.3.2 Source Material Geochemical Characterization
- 4.3.3 Watershed Characterization
  - 4.3.3.1 The Hydrologic Cycle
  - 4.3.3.2 Water Balance
  - 4.3.3.3 Assimilative Capacity of the Receiving Environment
  - 4.3.3.4 Biological Receptors

- 4.4 Summary
- 4.5 References
- List of Tables
- List of Figures

### **5.0 Prediction**

#### 5.1 Introduction

Introduction to CMD Prediction

#### 5.2 Objectives of Prediction Program

#### 5.3 The Prediction Approach

- 5.3.1 Acid Rock Drainage/Metal Leaching Characterization
- 5.3.2 Prediction during Different Phases of the Mine Life
- 5.3.3 Water Quality Prediction

#### 5.4 Prediction Tools

- 5.4.1 Introduction
- 5.4.2 Geological and Lithological Investigations
- 5.4.3 Hydrogeological/Hydrological Investigations
- 5.4.4 Introduction to Geochemical Characterization
- 5.4.5 Sample Storage and Preparation Prior to Analysis
- 5.4.6 Summary of Testing Requirements
- 5.4.7 Physical Characteristics
- 5.4.8 Total and Near-Total Solid-Phase Elemental Concentration
- 5.4.9 Mineralogical Properties
- 5.4.10 Net Acid or ARD Potential
- 5.4.11 Short-Term Leach Tests
- 5.4.12 Laboratory Kinetic Tests

- 5.4.13 Field Methods
- 5.4.14 Data Management
- 5.4.15 Quality Assurance/Quality Control
- 5.4.16 Screening and Evaluation Criteria
- 5.4.17 Reporting

## 5.5 Modeling of Acid Rock Drainage, Neutral Mine Drainage, and Saline Drainage for Characterization and Remediation

- 5.5.1 Introduction
- 5.5.2 Geochemical Modeling
- 5.5.3 Hydrological Modeling
- 5.5.4 Hydrogeological Modeling
- 5.5.5 Gas Transport Modeling
- 5.5.6 Statistical Evaluation

- 5.6 Conclusions
- 5.7 References
- List of Tables
- List of Figures

## **6.0 Prevention And Mitigation**

- 6.1 Introduction
- 6.2 Goals and Objectives of Prevention and Mitigation
- 6.3 Approach to Acid Rock Drainage Prevention and Mitigation
- 6.4 Drivers of Acid Rock Drainage
  - 6.4.1 Physical Factors
  - 6.4.2 Geochemical Weathering Processes
  - 6.4.3 Climate and Physical Environment
- 6.5 Phased Approach
- 6.6 Overview of Best Practice Methods
  - 6.6.1 Avoidance
  - 6.6.2 Re-mining
  - 6.6.3 Special Handling Methods
  - 6.6.4 Additions and Amendment Methods
  - 6.6.5 Water Management Methods
  - 6.6.6 Engineered Barriers
  - 6.6.7 Water Cover Methods
  - 6.6.8 Drained / Sub-Aerial Tailings Deposition Methods
- 6.7 Selection and Evaluation of Alternatives
- 6.8 Design and Construction Considerations
- 6.9 Maintenance and Monitoring Considerations
- 6.10 References

List of Tables  
List of Figures

## 7.0 Drainage Treatment

### 7.1 Introduction

#### 7.1.1 Risk-based approach

### 7.2 Objectives of Mine Drainage Treatment

### 7.3 Mine Drainage Treatment

### 7.4 Drainage Sources, Collection and Management

### 7.5 Mine Drainage Treatment Technologies

#### 7.5.1 Active Treatment Technologies

Aeration systems for treating CMD

#### 7.5.2 Passive Treatment Technologies

History of Passive Treatment

#### 7.5.3 In situ Treatment Technologies

### 7.6 Treatment Residues and Wastes

### 7.7 Recovery of Useful Products

### 7.8 Treatment in the Context of Mine Closure and Post Closure

### 7.9 Evaluation and Selection of Drainage Treatment Technologies

### 7.10 Case Studies

### 7.11 References

List of Tables

List of Figures

## 8.0 Monitoring

### 8.1 Introduction

### 8.2 Objectives of Monitoring

### 8.3 The Acid Rock Drainage Monitoring Approach

#### 8.3.1 Conceptual and Dynamic System Model Development

#### 8.3.2 Risk Based Approach to Monitoring Program Development

#### 8.3.3 Monitoring Program Development

#### 8.3.4 Data Management and Interpretation

#### 8.3.5 Auditing

## 8.4 Monitoring Program Components

8.4.1 Acid Rock Drainage Sources

8.4.2 Pathways

8.4.3 Mitigation Measures

8.4.4 Receptors

8.5 Closure and Long-Term Considerations

8.6 References and Further Reading

List of Tables

List of Figures

List of Photos

## 9.0 Acid Rock Drainage Management and Performance Assessment

9.1 Introduction

9.2 Developing Acid Rock Drainage Management Plans

9.2.1 Sustainability Considerations

9.2.2 Mine Life Cycle Considerations

9.2.3 Acid Rock Drainage Control – a Multidisciplinary Task

9.2.4 ARD Maturity and the Mine-Life Cycle

9.2.5 Design for Closure

9.2.6 Engineering Design Process

9.2.7 Risk Assessment, Management, and Contingency Plans

9.2.8 Monitoring Performance and Assessment of Success

9.3 Implementing the Acid Rock Drainage Management Plan

Mt. Milligan Project Mini Case Study

9.3.1 Integrating Acid Rock Drainage Management into Mine and Process Operations

9.3.2 Management System Roles and Responsibilities

9.4 Long-Term Considerations

9.4.1 Design Horizon

9.4.2 Long-Term Resources

9.4.3 Information/Institutional Knowledge Retention

9.4.4 Changing Standards/Stakeholder Needs and Expectations

9.5 References

List of Tables

List of Figures

## 10.0 Acid Rock Drainage Communication and Consulting

10.1 Introduction

10.2 Why Communicate and Consult about Acid Rock Drainage?



- 10.2.1 Stakeholder Perceptions about Acid Rock Drainage
- 10.2.2 Benefits of Communication and Consultation about Acid Rock Drainage

#### General Information on Metal Leaching and Acid Rock Drainage

### 10.3 Mining Disciplines Involved in Acid Rock Drainage Management and Communication

#### 10.3.1 Integration of Functions

### 10.4 Planning Communication and Consultation on Acid Rock Drainage

- 10.4.1 The Focus of Consulting and Communication
- 10.4.2 Regulatory and Other Requirements for Communication and Consultation
- 10.4.3 Tailor Objectives of Stakeholder Engagement to the Situation at Hand]]

### 10.5 Communication and Consultation about Acid Rock Drainage for each Mining Phase

### 10.6 Good-Practice Principles and Approaches

- 10.6.1 Inclusive Engagement
- 10.6.2 Get in Early
- 10.6.3 Be Respectful to People and Cultural Norms
- 10.6.4 Accessible and Transparent Information
- 10.6.5 Ongoing Feedback and Acknowledgment
- 10.6.6 Dispute Management and Resolution
- 10.6.7 The Principles of Risk Communication

### 10.7 Responsibilities of Regulators

### 10.8 Guidelines for Acid Rock Drainage Reporting

### 10.9 References

#### List of Tables

#### List of Figures

## 11.0 ARD Management in the Future

### 11.1 Introduction

#### 11.1.1 ARD through the Sustainable Development "Lens"

### 11.2 ARD Research and Management - Today and Tomorrow

#### 11.2.1 History and Status of ARD Research and Management

#### 11.2.2 The Future of ARD Research and Management

### 11.3 Stakeholder Roles

#### References

## **Appendices**

### Acronyms

### Glossary



# Main Page

From GARDGuide

## INAP: The International Network for Acid Prevention

INAP is an organization of international mining companies dedicated to reducing liabilities associated with sulphide mine materials.

The International Network for Acid Prevention (INAP) is an industry group created to help meet the challenge of acid drainage. INAP exists to fill the need for an international body which mobilizes acid drainage information and experience. The network was founded in 1998. Since then INAP has become a proactive, global leader in this field.

If you would like an abbreviated introduction to the GARD Guide, there are Executive Summaries in English and Español.

- **Executive Summary in English**
- **Resumen Ejecutivo en Español**
- **Sommaire français**

This PDF of the GARD Guide can be downloaded and printed.

- **The Global Acid Rock Drainage Guide PDF - 125 MB**

## Development of the Global Acid Rock Drainage Guide

The development of the Global Acid Rock Drainage (GARD) Guide is sponsored by INAP with the support of the Global Alliance. The GARD Guide was created through the contributions of many individuals and organizations. A team lead by Golder Associates prepared a draft of the Guide.

The GARD Guide deals with the prediction, prevention and management of drainage produced from sulphide mineral oxidation, often termed “acid rock drainage” (ARD). It also addresses metal leaching caused by sulphide mineral oxidation.

The GARD Guide is intended as a state-of-the-art summary of the best practices and technology to assist mine operators and regulators to address issues related to sulphide mineral oxidation.

The GARD Guide currently has 11 Chapters:

1. The GARD Guide
2. The ARD Process
3. Corporate, Regulatory and Community Framework
4. Defining the Problem - Characterization
5. Prediction
6. Prevention and Mitigation
7. Drainage Treatment

8. Monitoring
9. Management And Performance Assessment
10. ARD Communication And Consultation
11. ARD Management in the Future

This version of the GARD Guide is “Rev 1” and is still a work in progress, as befits an evolving field. All comments are welcome and should be forwarded to:

Mr. Gilles Tremblay/Ms. Charlene Hogan  
 GARD Guide Secreteriate  
[gtrembla@nrca.gc.ca](mailto:gtrembla@nrca.gc.ca) (mailto:gtrembla@nrca.gc.ca)  
[chogan@NRCan.gc.ca](mailto:chogan@NRCan.gc.ca) (mailto:chogan@NRCan.gc.ca)

**Click Here to Leave a Comment** If you are logged in. You do not need to be logged-in to **read the comments**. If you would like to record a comment, but don't have an account, use one of the email addresses just above to request an account.

All comments received will be considered for the next version the GARD Guide.



(<http://www.angloamerican.com/>)

**Links to INAP member companies:**

- Anglo American  
(<http://www.angloamerican.com/>)
- Antofagasta Minerals  
(<http://www.aminerals.cl/>)
- Barrick  
(<http://www.barrick.com/>)
- Freeport McMoRan  
(<http://www.fcx.com/>)
- Kinross Gold Corporation  
(<http://www.kinross.com/>)
- Newcrest  
(<http://www.newcrest.com.au/>)
- Newmont  
(<http://www.newmont.com/>)
- Rio Tinto  
(<http://www.riotinto.com/>)
- Vale (<http://www.vale.com/en-us/Pages/default.aspx/>)
- Xstrata  
(<http://www.xstrata.com/>)



(<http://www.aminerals.cl/>)

(<http://www.barrick.com/>)



(<http://www.fcx.com/>)



(<http://www.kinross.com/>)



(<http://www.newcrest.com.au/>)



(<http://www.newmont.com/>)



(<http://www.riotinto.com/>)



(<http://www.vale.com/en-us/Pages/default.aspx/>)

(<http://www.xstrata.com/>)





# Disclaimer

## From GARDGuide

### Disclaimer and Restrictions on Use

The content of the GARD Guide™ is not intended to be guidance or authority to any person or entity specific to any project of any nature. Any individuals or entities associated with this report disclaim any responsibility or liability to any person or entity that may use any portion or aspect of this report for their specific needs. Each individual or entity interested in any aspect of this report is encouraged to seek out the guidance of a professional engineer or other qualified professional consultant for assistance with respect to their individual and specific circumstances. None of the information contained herein should be relied on in preparation or assessment of any information by any person or entity. Should any person or entity decide to utilize the information in this report for any purposes, they do so at their own risk and consequence. The report is strictly intended to be a culmination of efforts of the authors regarding research and interpretation thereof, and is not directly applicable to any one circumstance or condition.

### Terms and Conditions of Use

Access to and use of INAP's GARD Guide™ web pages, image files and data are subject to the following terms and conditions:

Information from the INAP's GARD Guide™ web site is made available on the internet for non-commercial, personal use. Commercial publication, exploitation, or use of INAP's GARD Guide™ web site on personal or commercial web sites, CD-ROM, or bulletin board systems (BBS) is specifically prohibited.

Subject to the disclaimer and restrictions on use described above, extracts from this publication may be reproduced for non-commercial purposes without permission, provided full acknowledgment is given as follows:

The International Network for Acid Prevention (INAP), 2009. Global Acid Rock Drainage Guide (GARD Guide).<http://www.gardguide.com/>.



# Summary

## From GARDGuide

- Introduction
- Formation of Acid Rock Drainage
- Framework for Acid Rock Drainage Management
- Characterization
- Prediction
- Prevention and Mitigation
- Acid Rock Drainage Treatment
- Acid Rock Drainage Monitoring
- Acid Rock Drainage Management and Performance Assessment
- Acid Rock Drainage Communication and Consultation
- Summary
- References

## Executive Summary

### Introduction

The Global Acid Rock Drainage (GARD) Guide addresses the prediction, prevention, and management of drainage produced from sulfide mineral oxidation, often termed “acid rock drainage” (ARD), “acid mine drainage” or “acid and metalliferous drainage” (AMD), “mining influenced water” (MIW), “saline drainage” (SD), and “neutral mine drainage” (NMD).

This Executive Summary follows the general structure of the full GARD Guide, a state-of-practice summary of the best practices and technologies, developed under the auspices of the International Network for Acid Prevention (INAP) to assist ARD stakeholders, such as mine operators, regulators, communities, and consultants, with addressing issues related to sulfide mineral oxidation. Readers are encouraged to make use of the GARD Guide and its references for further detail on the subjects covered in this Executive Summary. The GARD Guide was prepared with the input and assistance of many individuals and organizations, and their contributions are gratefully acknowledged.

Acid rock drainage is formed by the natural oxidation of sulfide minerals when exposed to air and water. Activities that involve the excavation of rock with sulfide minerals, such as metal and coal mining, accelerate the process. The drainage produced from the oxidation process may be neutral to acidic, with or without dissolved heavy metals, but always contains sulfate. ARD results from a series of reactions and stages that typically proceed from near neutral to more acidic pH conditions. When sufficient base minerals are present to neutralize the ARD, neutral mine drainage or saline drainage may result from the oxidation process. NMD is characterized by elevated metals in solution at circumneutral pH, while SD contains high levels of sulfate at neutral pH without significant dissolved metal concentrations. Figure 1 presents the various types of drainage in a schematic manner.



**Figure 1: Types of Drainage Produced by Sulphide Oxidation**

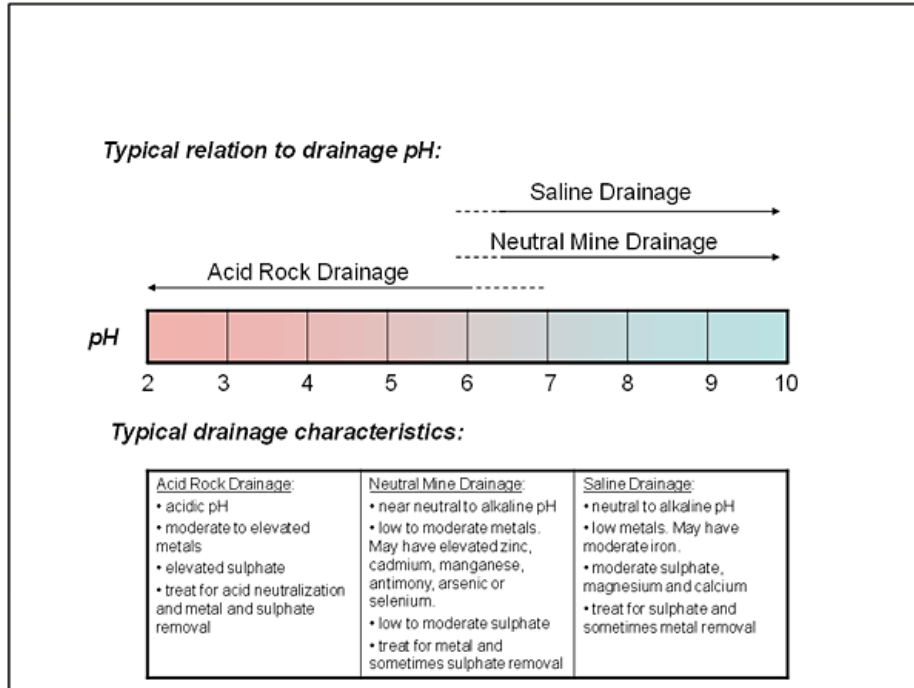

Stopping ARD formation, once initiated, may be challenging because it is a process that, if unimpeded, will continue (and may accelerate) until one or more of the reactants (sulfide minerals, oxygen, water) is exhausted or excluded from reaction. The ARD formation process can continue to produce impacted drainage for decades or centuries after mining has ceased, such as illustrated by this portal dating from the Roman era in Spain (Figure 2).

**Figure 2: Roman Portal with Acid Rock Drainage – Spain**



The cost of ARD remediation at orphaned mines in North America alone has been estimated in the tens of billions of U.S. dollars. Individual mines can face post-closure liabilities of tens to hundreds of million dollars for ARD remediation and treatment if the sulfide oxidation process is not properly managed during the mine's life.

Proper mine characterization, drainage-quality prediction, and mine-waste management can prevent ARD formation in most cases, and minimize ARD formation in all cases. Prevention of ARD must commence at exploration and continue throughout the mine-life cycle. Ongoing ARD planning and management is critical to the successful prevention of ARD.

Many mines will not produce ARD because of the inherent geochemical characteristics of their mining wastes or very arid climatic conditions. In addition, mines that have implemented well founded prediction efforts and, where required, prevention measures and monitoring programs, should also be able to avoid significant ARD issues.

A comprehensive approach to ARD management reduces the environmental risks and subsequent costs for the mining industry and governments, reduces adverse environmental impacts, and promotes public support for mining. The extent and particular elements of the ARD management approach that should be implemented at a particular operation will vary based on many site-specific factors, not limited to the project's potential to generate ARD.

## Formation of Acid Rock Drainage

The process of sulfide oxidation and formation of ARD, NMD, and SD is very complex and involves a multitude of chemical and biological processes that can vary significantly depending on environmental, geological and climate conditions (Nordstrom and Alpers, 1999). Sulfide minerals in ore deposits are formed under reducing conditions in the absence of oxygen. When exposed to atmospheric oxygen or oxygenated waters due to mining, mineral processing, excavation, or other earthmoving processes, sulfide minerals can become unstable and oxidize. Figure 3 presents a simplified model describing the oxidation of pyrite, which is the sulfide mineral responsible for the large majority of ARD (Stumm and Morgan, 1981). The reactions shown are schematic and may not represent the exact mechanisms, but the illustration is a useful visual aid for understanding sulfide oxidation.

Figure 3: Model for the Oxidation of Pyrite (Stumm and Morgan, 1981).

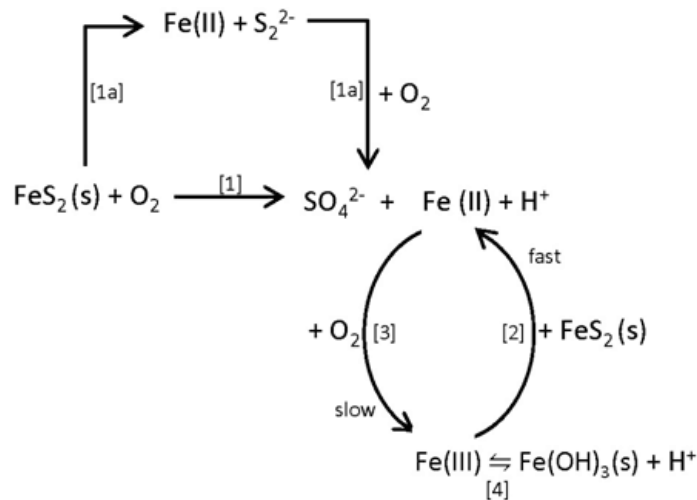

The chemical reaction representing pyrite oxidation (reaction [1]) requires three basic ingredients: pyrite, oxygen, and water. This reaction can occur both abiotically or biotically (i.e., mediated through microorganisms). In the latter case, bacteria such as *Acidithiobacillus ferrooxidans*, which derive their metabolic energy from oxidizing ferrous to ferric iron, can accelerate the oxidation reaction rate by many orders of magnitude relative to abiotic rates (Nordstrom, 2003). In addition to direct oxidation, pyrite can also be dissolved and then oxidized (reaction [1a]).

Under the majority of circumstances, atmospheric oxygen acts as the oxidant. However, aqueous ferric iron can oxidize pyrite as well according to reaction [2]. This reaction is considerably faster (2 to 3 orders of magnitude) than the reaction with oxygen, and generates substantially more acidity per mole of pyrite oxidized. However, this reaction is limited to conditions in which significant amounts of dissolved ferric iron occur (i.e., acidic conditions: pH 4.5 and lower). Oxidation of ferrous iron by oxygen (reaction [3]) is required to generate and replenish ferric iron, and acidic conditions are required for the latter to remain in solution and participate in the ARD

production process. As indicated by this reaction, oxygen is needed to generate ferric iron from ferrous iron. Also, the bacteria that may catalyze this reaction (primarily members of the *Acidithiobacillus genus*) demand oxygen for aerobic cellular respiration. Therefore, some nominal amount of oxygen is needed for this process to be effective even when catalyzed by bacteria, although the oxygen requirement is considerably less than for abiotic oxidation.

A process of environmental importance related to ARD generation pertains to the fate of ferrous iron resulting from reaction [1]. Ferrous iron can be removed from solution under slightly acidic to alkaline conditions through oxidation and subsequent hydrolysis and the formation of a relatively insoluble iron (hydr)oxide (reaction [4]). When reactions [1] and [4] are combined, as is generally the case when conditions are not acidic (i.e., pH > 4.5), oxidation of pyrite produces twice the amount of acidity relative to reaction [1] as follows:

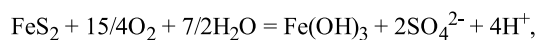

which is the overall reaction most commonly used to describe pyrite oxidation.

Although pyrite is by far the dominant sulfide responsible for the generation of acidity, different ore deposits contain different types of sulfide minerals. Not all of these sulfide minerals generate acidity when being oxidized. As a general rule, iron sulfides (pyrite, marcasite, pyrrhotite), sulfides with molar metal/sulfur ratios < 1, and sulfosalts (e.g., enargite) generate acid when they react with oxygen and water. Sulfides with metal/sulfur ratios = 1 (e.g., sphalerite, galena, chalcopyrite) tend not to produce acidity when oxygen is the oxidant. However, when aqueous ferric iron is the oxidant, all sulfides are capable of generating acidity. Therefore, the acid generation potential of an ore deposit or mine waste generally depends on the amount of iron sulfide present.

Neutralization reactions also play a key role in determining the compositional characteristics of drainage originating from sulfide oxidation. As for sulfide minerals, the reactivity, and accordingly the effectiveness with which neutralizing minerals are able to buffer any acid being generated, can vary widely. Most carbonate minerals are capable of dissolving rapidly, making them effective acid consumers. However, hydrolysis of dissolved Fe or Mn following dissolution of their respective carbonates and subsequent precipitation of a secondary mineral may generate acidity. Although generally more common than carbonate phases, aluminosilicate minerals tend to be less reactive, and their buffering may only succeed in stabilizing the pH when rather acidic conditions have been achieved. Calcium-magnesium silicates have been known to buffer mine effluents at neutral pH when sulfide oxidation rates were very low (Jambor, 2003).

The combination of acid generation and acid neutralization reactions typically leads to a step-wise development of ARD (Figure 4). Over time, pH decreases along a series of pH plateaus governed by the buffering of a range of mineral assemblages. The lag time to acid generation is a very important consideration in ARD prevention. It is far more effective (and generally far less costly in the long term) to control ARD generation during its early stages. The lag time also has significant ramifications for interpretation of test results. Because the first stage of ARD generation may last for a very long time, even for materials that will eventually be highly acid generating, it is critical to recognize the stage of oxidation when predicting ARD potential. The early results of geochemical testing, therefore, may not be representative of long-term environmental stability and associated discharge quality. However early test results provide valuable data to assess future conditions such as consumption rates of available neutralizing minerals.

A common corollary of sulfide oxidation is metal leaching (ML), leading to the frequent use of the acronyms “ARD/ML” or “ML/ARD” to more accurately describe the nature of acidic mine discharges. Major and trace metals in ARD, NMD, and SD originate from the oxidizing sulfides and dissolving acid-consuming minerals. In the case of ARD, Fe and Al are usually the principal major dissolved metals, while trace metals such as Cu, Pb, Zn, Cd, Mn, Co, and Ni can also achieve elevated concentrations. In mine discharges with a more circumneutral character, trace metal concentrations tend to be lower due to formation of secondary mineral phases and increased sorption. However, certain parameters remain in solution as the pH increases, in particular the metalloids As, Se, and Sb as well as other trace metals (e.g., Cd, Cr, Mn, Mo, and Zn).

Figure 4: Stages in the Formation of ARD (INAP, 2009)

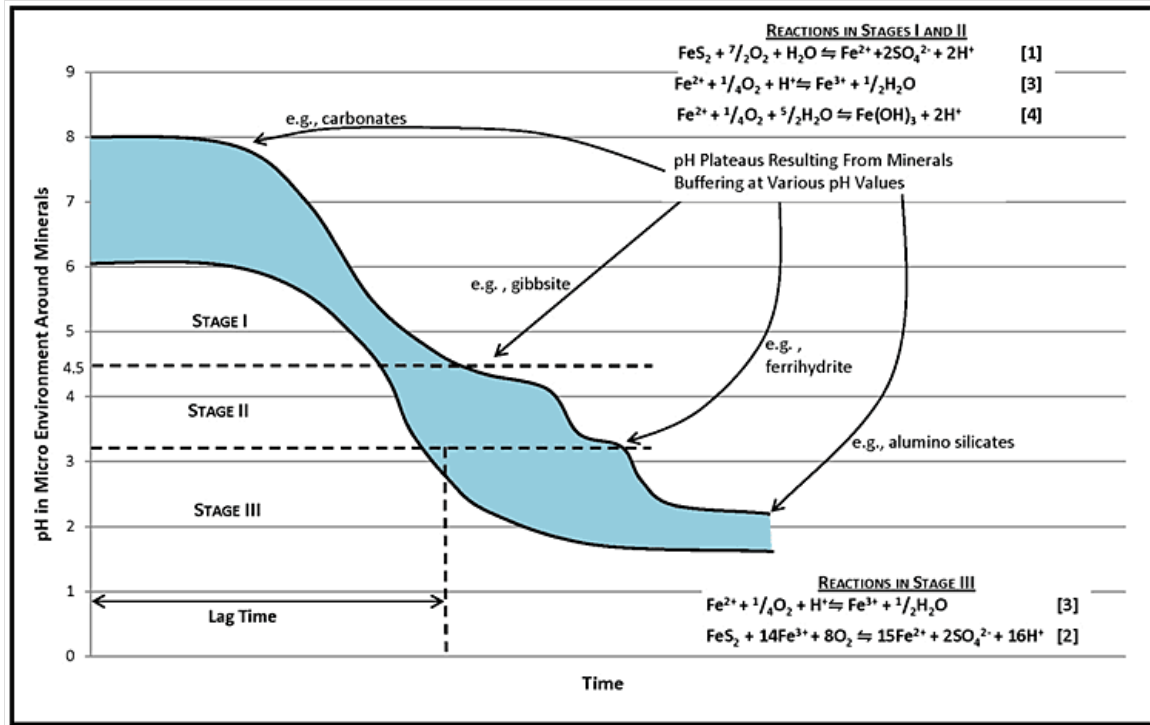

## Framework for Acid Rock Drainage Management

The issues and approaches to ARD prevention and management are the same around the world. However, the specific techniques used for ARD prediction, interpretation of ARD test results, and ARD management may differ depending on the local, regional or country context and are adapted to climate, topography, and other site conditions.

Therefore, despite the global similarities of ARD issues, there is no “one size fits all” approach to address ARD management. The setting of each mine is unique and requires a carefully considered assessment to find a management strategy within the broader corporate, regulatory and community framework that applies to the project in question. The site-specific setting comprises the social, economic and environmental situation within which the mine is located, whilst the framework comprises the applicable corporate, regulatory norms and standards and community specific requirements and expectations. This framework applies over the complete life cycle of the mine and is illustrated conceptually in Figure 5.

**Figure 5: Conceptual ARD Management Framework (INAP, 2009)**

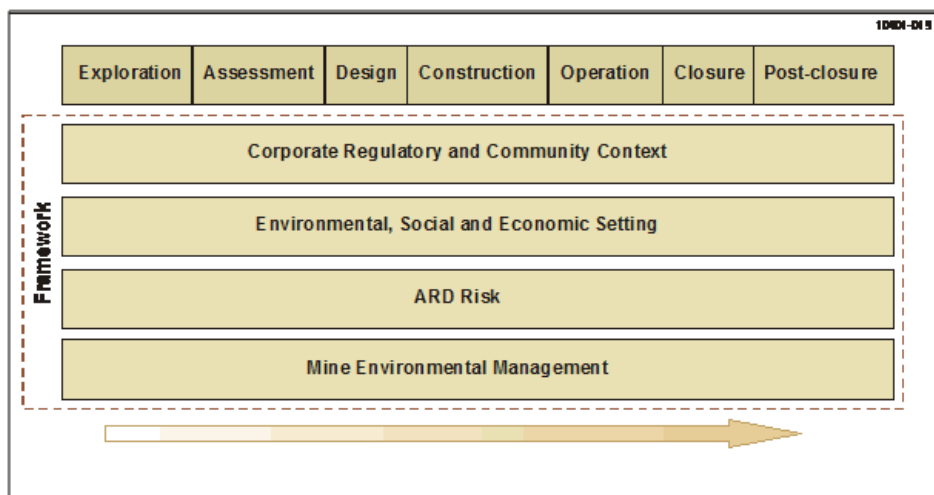

All mining companies, regardless of size, need to comply with the national legislation and regulations pertaining to ARD of the countries within which they operate. It is considered good corporate practice to adhere to global ARD guidance as well, and in many cases such adherence is a condition of funding.

Many mining companies have established clear corporate guidelines that represent the company's view of the priorities to be addressed and their interpretation of generally accepted best practice related to ARD. Caution is needed to ensure all specifics of the country regulations are met, as corporate ARD guidelines cannot be a substitute for country regulations.

Mining companies operate within the constraints of a "social license" that, ideally, is based on a broad consensus with all stakeholders. This consensus tends to cover a broad range of social, economic, environmental and governance elements (sustainable development). ARD plays an important part in the mine's social license due to the fact that ARD tends to be one of the more visible environmental consequences of mining. The costs of closure and post-closure management of ARD are increasingly recognized as a fundamental component of all proposed and operating mining operations. Some form of financial assurance is now required in many jurisdictions.

## Characterization

The generation, release, transport and attenuation of ARD are intricate processes governed by a combination of physical, chemical and biological factors. Whether ARD becomes an environmental concern depends largely on the characteristics of the sources, pathways and receptors involved. Characterization of these aspects is therefore crucial to the prediction, prevention and management of ARD. Environmental characterization programs are designed to collect sufficient data to answer the following questions:

1. Is ARD likely to occur? What type of drainage is expected (ARD/NMD/SD)?
2. What are the sources of ARD? How much ARD will be generated and when?
3. What are the significant pathways that transport contaminants to the receiving environment?
4. What are the anticipated environmental impacts of ARD release to the environment?
5. What can be done to prevent or mitigate/manage ARD?

The geologic and mineralogic characteristics of the ore body and host rock are the principal controls on the type of drainage that will be generated as a result of mining. Subsequently, the site climatic and hydrologic/hydrogeologic characteristics define how mine drainage and its constituents are transported through the receiving environment to receptors. To evaluate these issues, expertise from multiple disciplines is required, including: geology, mineralogy, hydrology, hydrogeology, geochemistry, (micro)biology, meteorology, and engineering.

The geologic characteristics of mineral deposits exert important and predictable controls on the environmental signature of mineralized areas (Plumlee, 1999). Therefore, a preliminary assessment of the ARD potential should be made based on review of geologic data collected during exploration. Baseline characterization of metal concentrations in various environmental media (i.e., water, soils, vegetation and biota) may also provide an indication of ARD potential and serves to document potentially naturally elevated metal concentrations. During mine development and operation, the initial assessment of ARD potential is refined through detailed characterization data on the environmental stability of the waste and ore materials. The magnitude and location of mine discharges to the

environment also are identified during mine development. Meteorologic, hydrological and hydrogeological investigations are conducted to characterize the amount and direction of water movement within the mine watershed(s) to evaluate transport pathways for constituents of interest. Potential biological receptors within the watershed boundary are identified. As a consequence, over the mine life, the focus of the ARD characterization program evolves from establishing baseline conditions, to predicting drainage release and transport, to monitoring of the environmental conditions and impacts.

Despite inherent differences at mine sites (e.g., based on commodity type, climate, mine phase, regulatory framework), the general approach to site characterization is similar:

- Define the quantity and quality of drainage potentially generated by different sources
- Identify surface and groundwater pathways that transport drainage from sources to receptor
- Identify receptors that may be affected by exposure to drainage
- Define the risk of this exposure

Figures 6 and 7 present the chronology of an ARD characterization program and identify the data collection activities typically executed during each mine phase. The bulk of the characterization effort occurs prior to mining during the mine planning, assessment and design (sometimes collectively referred to as the development phase). In addition, potential environmental impacts are identified and appropriate prevention and mitigation measures, intended to minimize environmental impacts, are incorporated. During the commissioning/construction and operation phases, a transition from site characterization to monitoring occurs, which is continued throughout the decommissioning/closure and post-closure phases. Ongoing monitoring helps refine the understanding of the site, which allows for adjustment of remedial measures, in turn resulting in reduced closure costs and improved risk management.

**Figure 6: Overview of ARD Characterization Program by Mine Phase (INAP, 2009)**

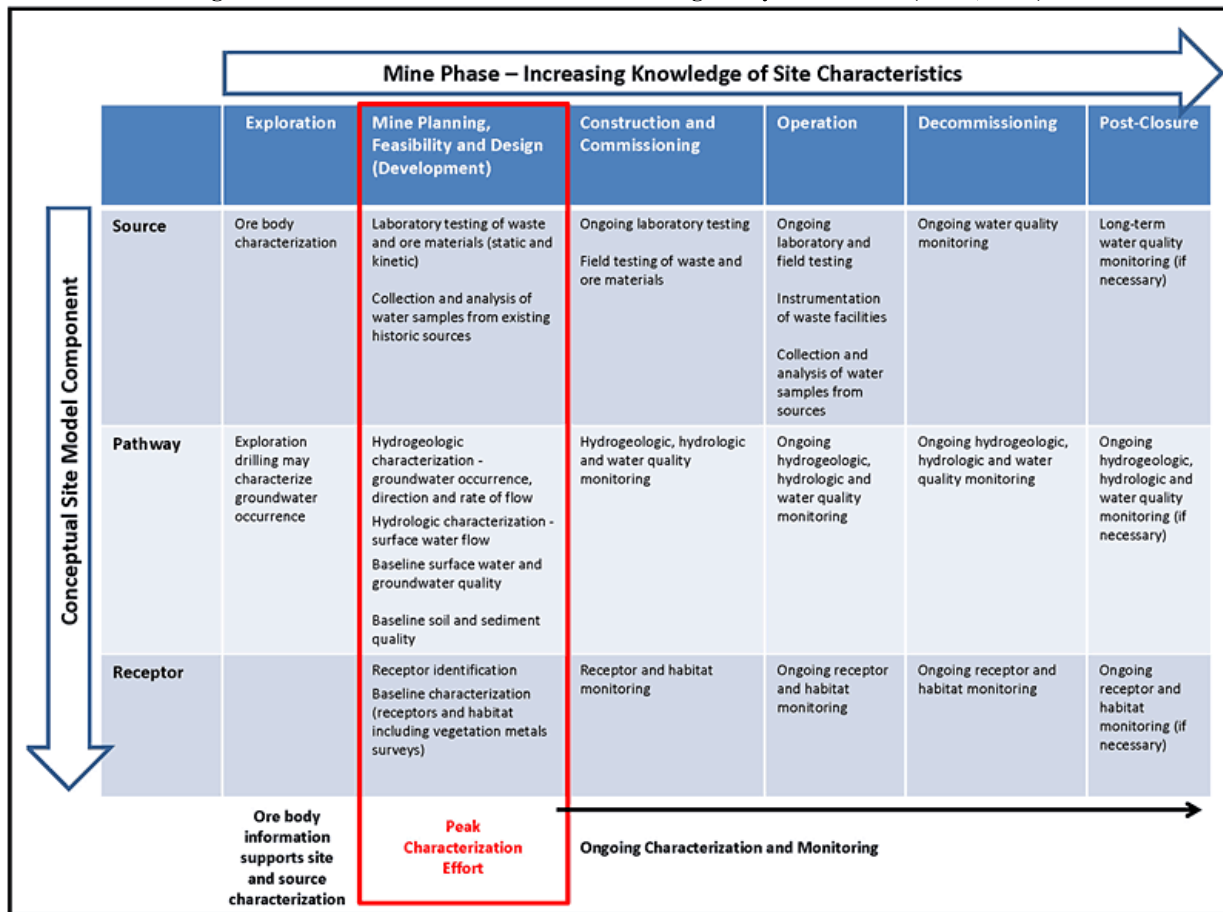

Figure 7: ARD Characterization Program for Individual Source Materials by Mine Phase (INAP, 2009)

Mine Phase – Increasing Knowledge of Source Material Characterization							
	Exploration	Mine Planning, (Pre-) Feasibility and Design	Construction and Commissioning	Operation	Decommissioning	Post-Closure (Care and Maintenance)	
Waste or Facility Type – Potential ARD / NMD / SD Sources	<b>Waste Rock</b>	Drill core descriptions and assay data (petrology and mineralogy)  Block model (quantity of ore and waste)	Laboratory testing of drill core samples – sample selection targets waste <sup>(4)</sup>	Ongoing laboratory testing of drill core or development rock samples <sup>(4)</sup>  Field leach testing (barrels, test pads)	Ongoing laboratory testing <sup>(4)</sup>  Ongoing field leach testing  Collection and analysis of runoff and seepage samples from waste rock facility	Collection and analysis of runoff and seepage samples from waste rock facility	Collection and analysis of runoff and seepage samples from waste rock facility (if necessary)
	<b>Tailings</b>	Review of any historical data	Laboratory testing of pilot plant tailings <sup>(4)</sup>  Analysis of pilot testing supernatant.	Ongoing laboratory testing of pilot plant tailings <sup>(4)</sup>	Ongoing laboratory testing of tailings discharge <sup>(4)</sup>  Collection and analysis of supernatant and seepage samples from TSF	Collection and analysis of supernatant and seepage samples from TSF	Collection and analysis of supernatant and seepage samples from TSF (if necessary)
	<b>Ore</b>		Laboratory testing of drill core samples <sup>(4)</sup>		Ongoing laboratory testing <sup>(4)</sup>	If ore stockpiles exist, collection and analysis of runoff and seepage samples	
	<b>Pit</b>		Laboratory testing of drill core samples – sample selection targets pit walls <sup>(4)</sup>		Field scale leach testing (e.g., wall washing) Collection and analysis of water samples (i.e., runoff, sumps)	Collection and analysis of pit water and pit inflow(s) water samples	Collection and analysis of pit water samples (if necessary)
	<b>Underground Workings</b>		Laboratory testing of drill core samples – sample selection targets mine walls <sup>(4)</sup>		Collection and analysis of water samples (i.e., sumps, dewatering wells)	Collection and analysis of mine pool water samples	Collection and analysis of mine pool water samples (if necessary)

<sup>(4)</sup> Typical laboratory testing components: particle size, whole rock analysis, mineralogy, ABA, static and kinetic leach testing.

## Prediction

One of the main objectives of site characterization is prediction of ARD potential and drainage chemistry. Because prediction is directly linked to mine planning, in particular with regard to water and mine waste management, the characterization effort needs to be phased in step with overall project planning. Early characterization tends to be generic and generally avoids presumptions about the future engineering/mine design, while later characterization and modeling must consider and be integrated with the specifics of engineering/mine design. Iteration may be required as evaluation of the ARD potential may result in the realization that a re-assessment of the overall mine plan is needed. Integration of the characterization and prediction effort into the mine operation is a key element for successful ARD management.

Accurate prediction of future mine discharges requires an understanding of the sampling, testing, and analytical procedures used, consideration of the future physical and geochemical conditions, and the identity, location and reactivity of the contributing minerals. All mine sites are unique for reasons related to geology, geochemistry, climate, commodity, processing method, regulations and stakeholders. Prediction programs therefore need to be tailored to the mine in question. Also, the objectives of a prediction program can be variable. For instance, they can include definition of water treatment requirements, selection of mitigation methods, assessment of water quality impact, or determination of reclamation bond amounts.

Predictions of drainage quality are made in a qualitative and quantitative sense. Qualitative predictions are focused on assessing whether acidic conditions might develop in mine wastes, with the corresponding release of metals and acidity to mine drainage. Where qualitative predictions indicate a high probability of ARD generation, attention turns to review of alternatives to prevent ARD and the prediction program is refocused to assist in the design and evaluation of these alternatives.

Significant advances in the understanding of ARD have been made over the last several decades, with parallel advances in mine water quality prediction and use of prevention techniques. However, quantitative mine water quality prediction can be challenging due to the

wide array of the reactions involved and potentially very long time periods over which these reactions take place. Despite these uncertainties, quantitative predictions that have been developed using realistic assumptions (while recognizing associated limitations) have proven to be of significant value for identification of ARD management options and assessment of potential environmental impacts.

Prediction of mine water quality generally is based on one or more of the following:

- Test leachability of waste materials in the laboratory
- Test leachability of waste materials under field conditions
- Geological, hydrological, chemical and mineralogical characterization of waste materials
- Geochemical and other modeling

Analog operating or historic sites are also valuable in ARD prediction, especially those that have been thoroughly characterized and monitored. The development of geo-environmental models is one of the more prominent examples of the “analog” methodology. Geo-environmental models, which are constructs that interpret the environmental characteristics of an ore deposit in a geologic context, provide a very useful way to interpret and summarize the environmental signatures of mining and mineral deposits in a systematic geologic context, and can be applied to anticipate potential environmental problems at future mines, operating mines and orphan sites (Plumlee et al., 1999). A generic overall approach for ARD prediction is illustrated in Figure 8.



Figure 8: Generic Overview of ARD Prediction Approach (INAP, 2009)

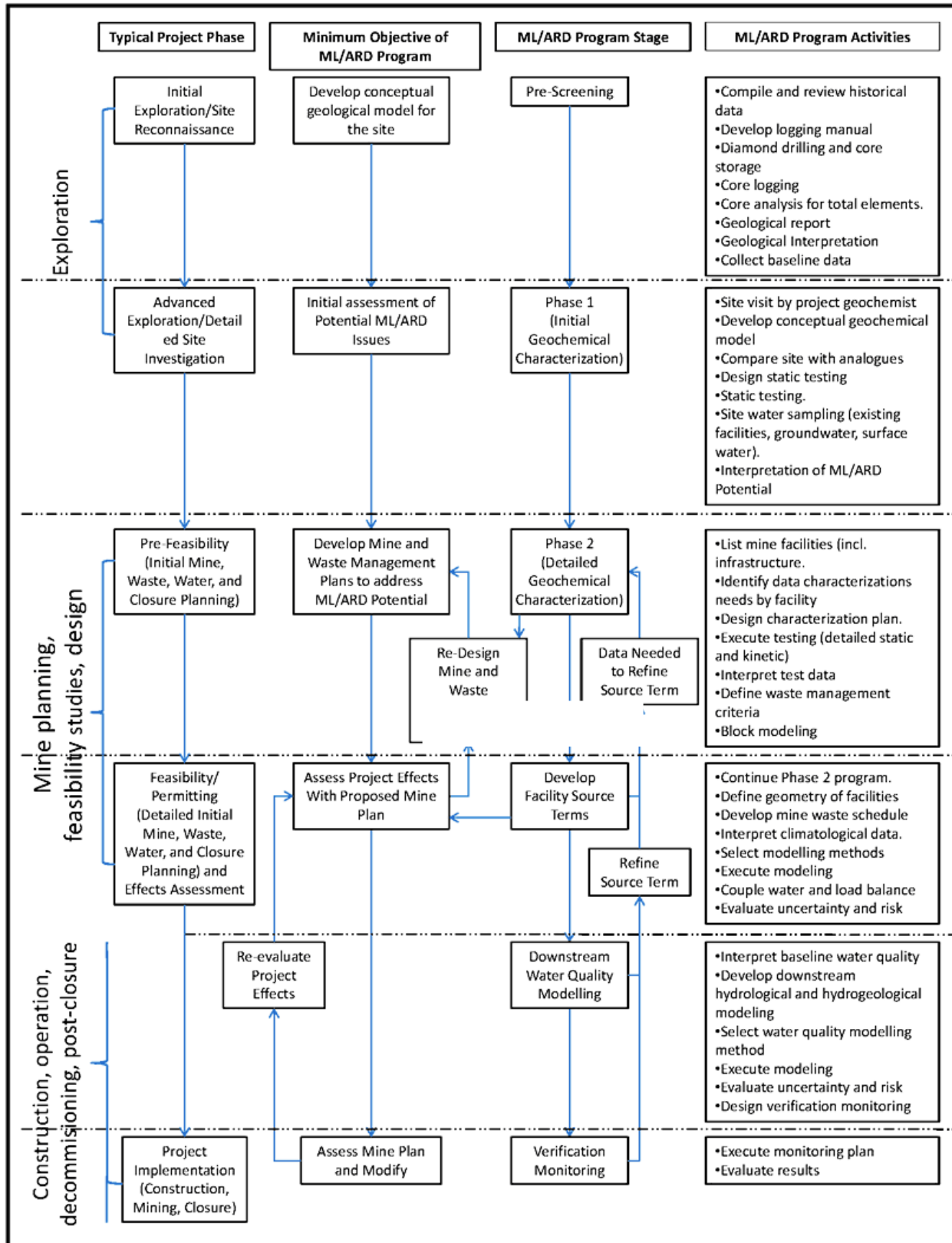

## Prevention and Mitigation

The fundamental principle of ARD prevention is to apply a planning and design process to prevent, inhibit, retard or stop the hydrological, chemical, physical, or microbiological processes that result in the impacts to water resources. Prevention should occur at, or as close to, the point where the deterioration in water quality originates (i.e. source reduction), or through implementation of measures to prevent or retard the transport of the ARD to the water resource (i.e. recycling, treatment and/or secure disposal). This principle is universally applicable, but methods of implementation are site specific.

Prevention is a proactive strategy that obviates the need for the reactive approach to mitigation. For an existing case of ARD that is adversely impacting the environment, mitigation will usually be the initial course of action. Despite this initial action, subsequent preventive measures are often considered with the objective of reducing future contaminant loadings, and thus reducing the ongoing need for mitigation controls. Integration of the prevention and mitigation effort into the mine operation is a key element for successful ARD management.

Prior to identification of evaluation of prevention and mitigation measures, the strategic objectives must be identified. That process should consider assessment of the following:

- Quantifiable risks to ecological systems, human health, and other receptors
- Site specific discharge water quality criteria
- Capital, operating and maintenance costs of mitigation or preventative measures
- Logistics of long-term operations and maintenance
- Required longevity and anticipated failure modes

Typical objectives for ARD control are to satisfy environmental criteria using the most cost-effective technique. Technology selection should consider predictions for discharge water chemistry, advantages and disadvantages of treatment options, risk to receptors, and the regulatory context related to mine discharges.

A risk-based planning and design approach forms the basis for prevention and mitigation. This approach is applied throughout the mine life cycle, but primarily in the assessment and design phases. The risk-based process aims to quantify the long-term impacts of alternatives and to use this knowledge to select the option that has the most desirable combination of attributes (e.g., protectiveness, regulatory acceptance, community approval, cost). Mitigation measures implemented as part of an effective control strategy should require minimal active intervention and management.

Prevention is the key to avoid costly mitigation. The primary objective is to apply methods that minimize sulfide reaction rates, metal leaching and the subsequent migration of weathering products that result from sulfide oxidation. Such methods involve:

- Minimizing oxygen supply
- Minimizing water infiltration and leaching
- Minimizing, removing or isolating sulfide minerals
- Controlling pore water solution pH
- Controlling bacteria and biogeochemical processes

Factors influencing selection of the above methods include:

- Geochemistry of source materials and the potential of source materials to produce ARD
- Type and physical characteristics of the source, including water flow and oxygen transport
- Mine-development stage (more options are available at early stages)
- Phase of oxidation (more options are available at early stages when pH is still near neutral and oxidation products have not significantly accumulated)
- Time period for which the control measure is required to be effective
- Site conditions (i.e., location, topography and available mining voids, climate, geology, hydrology and hydrogeology, availability of materials and vegetation)
- Water quality criteria for discharge
- Risk acceptance by company and other stakeholders

More than one, or a combination of measures, may be required to achieve the desired objective. Figure 9 provides a generic overview of the most common ARD prevention and mitigation measures available during the various stages of the mine-life cycle.

Figure 9: Generic Overview of ARD Prevention and Mitigation Measures (INAP, 2009)

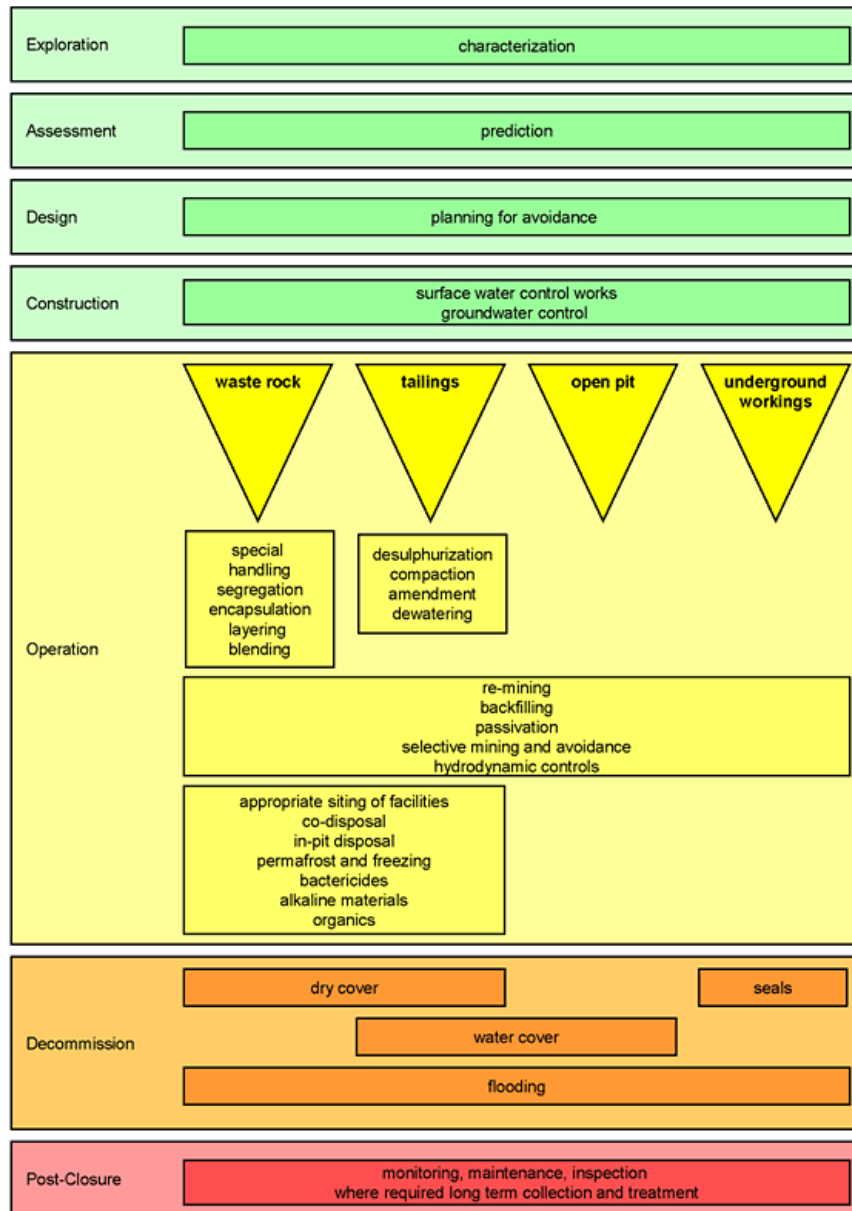

### Acid Rock Drainage Treatment

Sustainable mining requires the mitigation, management and control of mining impacts on the environment. The impacts of mining on water resources can be long term and persist in the post-closure situation. Mine drainage treatment may be a component of overall mine water management to support a mining operation over its entire life. The objectives of mine drainage treatment are varied. Recovery and re-use of mine water within the mining operations may be desirable or required for processing of ores and minerals, conveyance of materials, operational use (dust suppression, mine cooling, irrigation of rehabilitated land), etc. Mine drainage treatment, in this case, is aimed at modifying the water quality so that it is fit for the intended use on or off the mine site.

Another objective of mine water treatment is the protection of human and ecological health in cases where people or ecological receptors may come in contact with the impacted mine water through indirect or direct use. Mine drainage may act as the transport medium for a range of pollutants, which may impact on-site and off-site water resources. Water treatment would remove the pollutants contained in mine drainage to prevent or mitigate environmental impacts.

In the large majority of jurisdictions, any discharge of mine drainage to a public stream or aquifer must be approved by the relevant regulatory authorities, while regulatory requirements stipulate a certain mine water discharge quality or associated discharge pollutant loads. Although discharge quality standards may not be available for many developing mining countries, internationally acceptable environmental quality standards generally still apply as stipulated by project financiers and company corporate policies. The approach to selection of a mine drainage treatment method is premised on a thorough understanding of the integrated mine water system and circuits and the specific objective(s) to be achieved. The approach adopted for mine drainage treatment will be influenced by a number of considerations.

Prior to selecting the treatment process, a clear statement and understanding of the objectives of treatment should be prepared. Mine drainage treatment must always be evaluated and implemented within the context of the integrated mine water system. Treatment will have an impact on the flow and quality profile in the water system; hence, a treatment system is selected based on mine water flow, water quality, cost and ultimate water use(s).

Characterization of the mine drainage in terms of flow and chemical characteristics should include due consideration of temporal and seasonal changes. Flow data are especially important as this information is required to properly size any treatment system. Of particular importance are extreme precipitation and snow melt events that require adequate sizing of collection ponds and related piping and ditches. The key chemical properties of mine drainage relate to acidity/alkalinity, sulfate content, salinity, metal content, and the presence of specific compounds associated with specific mining operations, such as cyanide, ammonia, nitrate, arsenic, selenium, molybdenum and radionuclides. There are also a number of mine drainage constituents (for example, hardness, sulfate, silica) which may not be of regulatory or environmental concern in all jurisdictions, but that could affect the selection of the preferred water treatment technology. Handling and disposal of treatment plant waste and residues such as sludges and brines and their chemical characteristics must also factor in any treatment decisions.

A mine-drainage treatment facility must have the flexibility to deal with increasing/decreasing water flows, changing water qualities and regulatory requirements over the life of mine. This may dictate phased implementation and modular design and construction. Additionally, the post-closure phase may place specific constraints on the continued operation and maintenance of a treatment facility.

Practical considerations related to mine-site features that will influence the construction, operation and maintenance of a mine-drainage-treatment facility are as follows:

- Mine layout and topography
- Space
- Climate
- Sources of mine drainage feeding the treatment facility
- Location of treated water users

A generic range of ARD treatment alternatives is presented in Figure 10.

Figure 10: Generic Overview of ARD Treatment Alternatives (INAP, 2009)

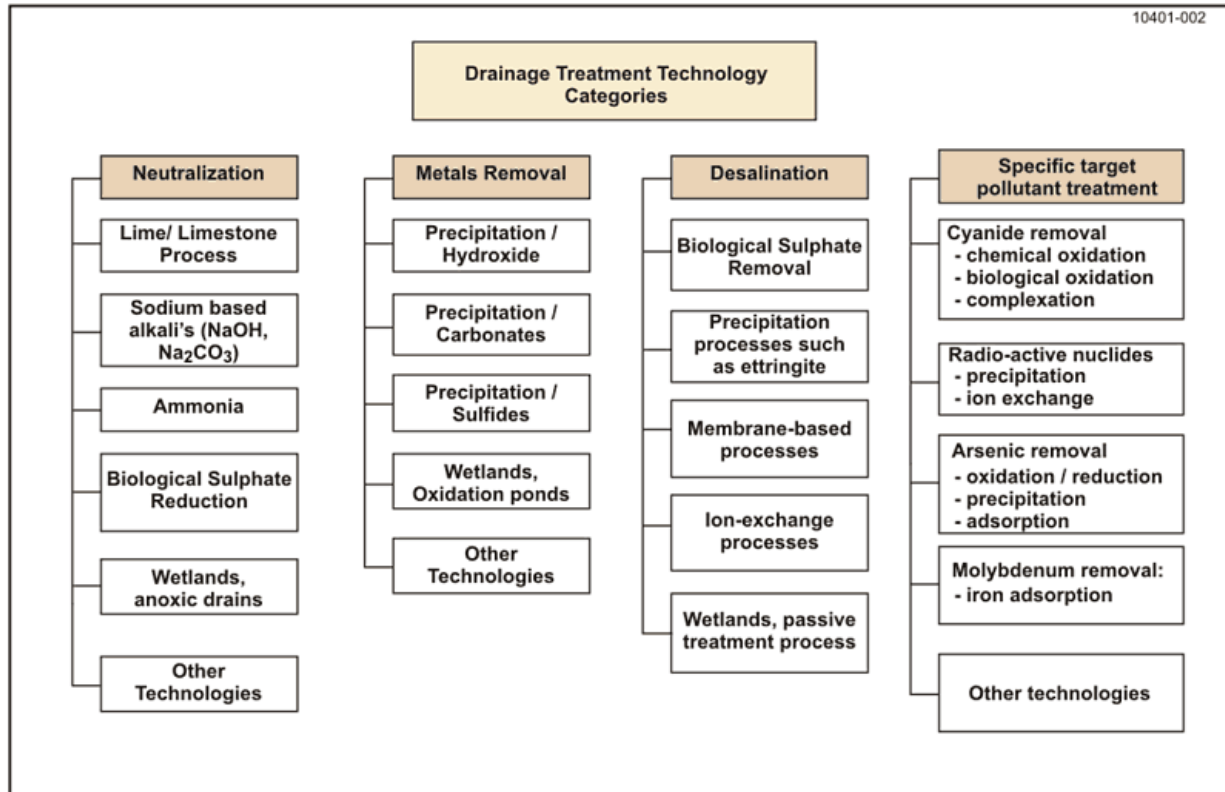

## Acid Rock Drainage Monitoring

Monitoring is the process of routinely, systematically and purposefully gathering information for use in management-decision making. Mine-site monitoring aims to identify and characterize any environmental changes from mining activities to assess conditions on the site and possible impacts to receptors. Monitoring consists of both observation (e.g., recording information about the environment) and investigation (e.g., studies such as toxicity tests where environmental conditions are controlled). Monitoring is critical in decision making related to ARD management, for instance through assessing the effectiveness of mitigation measures and subsequent implementation of adjustments to mitigation measures as required.

Development of an ARD monitoring program starts with review of the mine plan, the geographical location and the geological setting. The mine plan provides information on the location and magnitude of surface and subsurface disturbances, ore processing and milling procedures, waste disposal areas, effluent discharge locations, groundwater withdrawals and surface water diversions. This information is used to identify potential sources of ARD, potential pathways for release of ARD to the receiving environment, and receptors that may be impacted by these releases and potential mitigation that may be required. Because the spatial extent of a monitoring program must include all these components, a watershed approach to ARD monitoring (including groundwater) is often required. Monitoring occurs at all stages of project development, from pre-operational through post closure. However, over the life of a mine, the objectives, components and intensity of the monitoring activities will change. The development and components of a generic ARD monitoring program are presented in Figure 11.

Figure 11: Development of an ARD Monitoring Program (INAP, 2009)

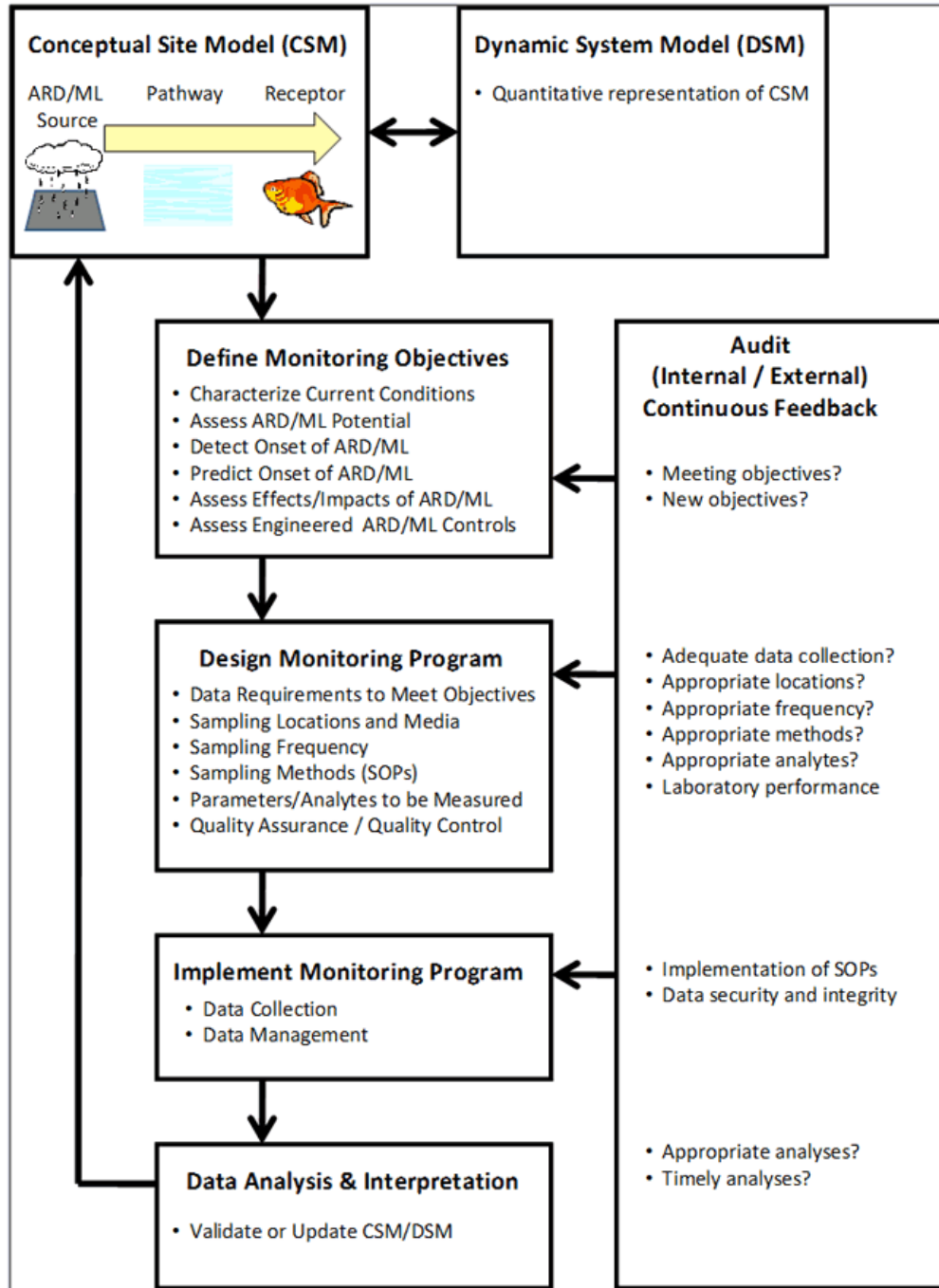

## Acid Rock Drainage Management and Performance Assessment

The management of ARD and the assessment of its performance are usually described within the site environmental management plan or in a site-specific ARD management plan. The ARD management plan represents the integration of the concepts and technologies described earlier in this chapter. It also references the engineering design processes and operational management systems employed by mining companies.

The need for a formal ARD management plan is usually triggered by the results of an ARD characterization and prediction program or the results of site monitoring. The development, assessment and continuous improvement of an ARD management plan is a continuum

throughout the life of a mine. The development, implementation and assessment of the ARD management plan will typically follow the sequence of steps illustrated in Figure 12.

As shown in this figure, the development of an ARD management plan starts with establishment of clear goals and objectives. These might include the prevention of ARD or achieving compliance with specific water quality criteria. This includes consideration of the biophysical setting, regulatory and legal registry, community and corporate requirements and financial considerations. Characterization and prediction programs identify the potential magnitude of the ARD issue and provide the basis for the selection and design of appropriate ARD prevention and mitigation technologies. The design process includes an iterative series of steps in which ARD control technologies are assessed and then combined into a robust system of management and controls (i.e., the ARD management plan) for the specific site. The initial mine design may be used to develop the ARD management plan needed for an environmental assessment (EA). The final design is usually developed in parallel with project permitting.

The ARD management plan identifies the materials and mine wastes that require special management. Risk assessment and management are included in the plan to refine strategies and implementation steps. To be effective, the ARD management plan must be fully integrated with the mine plan. Operational controls such as standard operating procedures (SOPs), key performance indicators (KPIs) and quality assurance/quality control (QA/QC) programs are established to guide its implementation. The ARD management plan identifies roles, responsibilities and accountabilities for mine operating staff. Data management, analysis and reporting schemes are included to track progress of the plan.

In the next step, monitoring is conducted to compare field performance against the design goals and objectives of the management plan. Assumptions made in the characterization and prediction programs and design of the prevention/mitigation measures are tested and revised or validated. “Learnings” from monitoring and assessment are evaluated and incorporated into the plan as part of continuous improvement. Accountability for implementing the management plan is checked to ensure that those responsible are meeting the requirements stipulated in the plan. Internal and external reviews or audits should be conducted to gauge performance of personnel, management systems, and technical components to provide additional perspectives on the implementation of the ARD management plan. Review by site and corporate management of the entire plan is necessary to ensure the plan continues to adhere to site and corporate policies. Additional risk assessment and management may be conducted at this stage to assess the effects of changing conditions or plan deviations. Finally, results are assessed against the goals. If the objectives are met, performance assessment and monitoring continues throughout the mine life with periodic re-checks against the goals. If the objectives are not met, then re-design and re-evaluation of the management plan and performance assessment and monitoring systems for ARD prevention/mitigation are required. This additional effort might also require further characterization and ARD prediction.

The process described in Figure 12 results in continuous improvement of the ARD management plan and its implementation, and accommodates possible modifications in the mine plan. If the initial ARD management plan is robust, it can be more readily adapted to mine plan changes.

Implementing the ARD management plan relies on a hierarchy of management tools. Corporate policies help define corporate or site standards which lead to SOPs and KPIs that are specific to the site and guide operators in implementing the ARD management plan. Where corporate policies or standards do not exist, projects and operations should rely on industry best practice.

## **Acid Rock Drainage Communication and Consultation**

The level of knowledge of ARD generation and mitigation has increased dramatically over the last few decades within the mining industry, academia and regulatory agencies. However, in order for this knowledge to be meaningful to the wide range of stakeholders generally involved with a mining project, it needs to be translated into a format that can be readily understood. This consultation should convey the predictions of future drainage quality and the effectiveness of mitigation plans, their degree of certainty and contingency measures to address that uncertainty. An open dialogue on what is known, and what can be predicted with varying levels of confidence, helps build understanding and trust, and ultimately results in a better ARD management plan.

Communicating and consulting with stakeholders about ARD issues is essential to the company’s social license to operate. Due to the generally highly visible nature of ARD, special measures and skilled people are needed to communicate effectively, and the involvement of representatives from all relevant technical disciplines in a mining company may be required.

## Summary

Acid rock drainage is one of the most serious environmental issues facing the mining industry. A thorough evaluation of ARD potential should be conducted prior to mining and continued through the life of mine. Consistent with sustainability principles, strategies for dealing with ARD should focus on prevention or minimization rather than control or treatment. These strategies are formulated within an ARD management plan, to be developed in the early phases of the project, together with monitoring requirements to assess their performance. The integration of the ARD management plan with the mine operation plan is critical to the success of ARD prevention. Leading practices for ARD management continue to evolve, but tend to be site specific and require specialist expertise.

## References

- International Network for Acid Prevention (INAP), 2009. The Global Acid Rock Drainage Guide. <http://www.gardguide.com>
- Jambor, J.L. 2003. Mine-Waste Mineralogy and Mineralogical Perspectives of Acid-Base Accounting. In: Environmental Aspects of Mine Wastes (Eds.: Jambor, J.L., D.W. Blowes, and A.I.M. Ritchie). Short Course Series Volume 31. Mineralogical Association of Canada.
- Nordstrom, D.K. 2003. Effects of Microbiological and Geochemical Interactions in Mine Drainage. In: Environmental Aspects of Mine Wastes (Eds. Jambor, J.L., D.W. Blowes, and A.I.M. Ritchie). Short Course Series Volume 31. Mineralogical Association of Canada.
- Nordstrom, D.K., and Alpers, C.N. 1999. Geochemistry of Acid Mine Waters. In: The Environmental Geochemistry of Mineral Deposits, Part A: Processes, Techniques and Health Issues (Eds.: Plumlee, G.S., and M.J. Logsdon). Reviews in Economic Geology Vol 6A. Society of Economic Geologists, Inc.
- Plumlee, G.S. 1999. The Environmental Geology of Mineral Deposits. In: The Environmental Geochemistry of Mineral Deposits, Part A: Processes, Techniques and Health Issues (Eds.: Plumlee, G.S., and M.J. Logsdon). Reviews in Economic Geology Vol 6A. Society of Economic Geologists, Inc.
- Plumlee, G.S., K.S., Smith, M.R., Montour, W.H. Ficklin, and Mosier. E.L. 1999. Geologic Controls on the Composition of Natural Waters and Mine Waters Draining Diverse Mineral-Deposit Types. In: The Environmental Geochemistry of Mineral Deposits, Part B: Case Studies and Research Topics (Eds.: Filipek, L.H. and G.S. Plumlee). Reviews in Economic Geology Vol 6B. Society of Economic Geologists, Inc.
- Stumm, W. and Morgan, J.J. 1981. Aquatic Chemistry. Second Edition. New York: John Wiley & Sons.



Figure 12: Flow Chart for ARD Performance Assessment and Management Review (INAP, 2009)

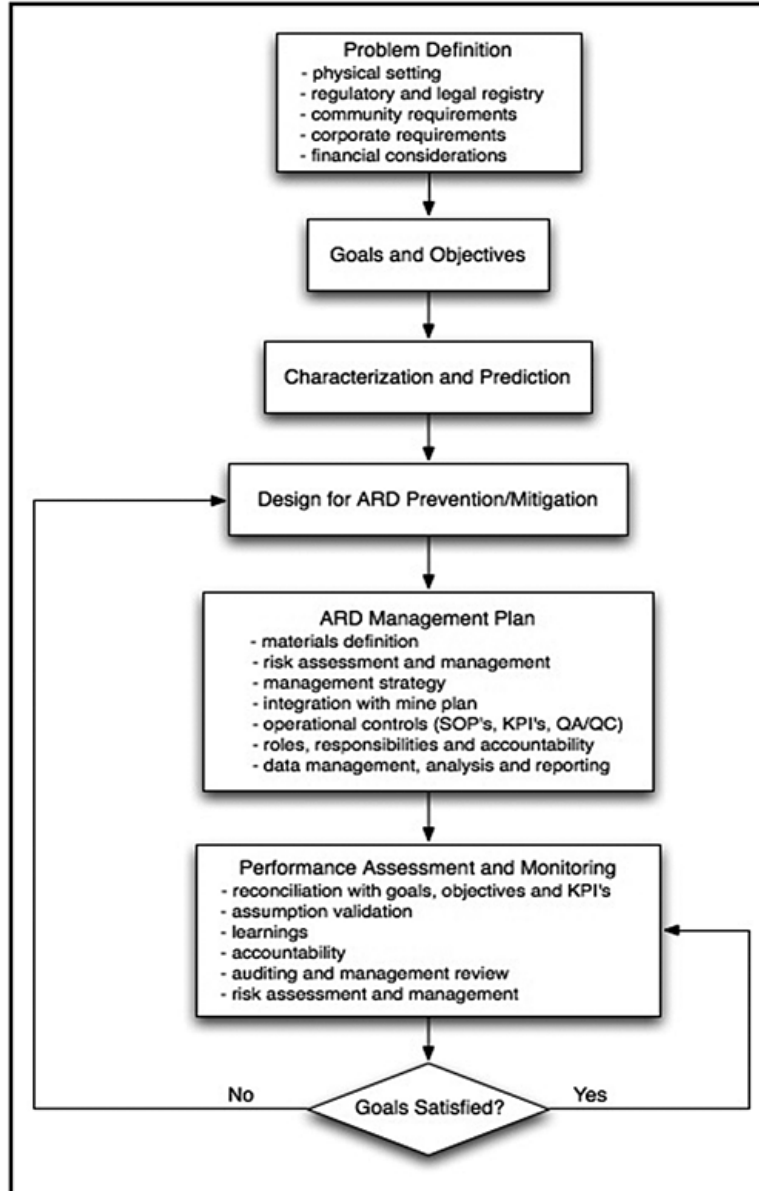

# Resumen

## From GARDGuide

- Introducción
- Formación del Drenaje Ácido de Roca
- Esquema para el Manejo del Drenaje Ácido de Roca
- Caracterización
- Predicción
- Prevención y Mitigación
- Tratamiento del Drenaje Ácido de Roca
- Monitoreo del Drenaje Ácido de Roca
- Manejo del Drenaje Ácido de Roca y Evaluación de Desempeño
- Comunicación y Retroalimentación del Drenaje Ácido de Roca
- Resumen
- Referencias

## Resumen Ejecutivo

### Introducción

La Guía Global de Drenaje Ácido de Roca trata sobre la predicción, prevención y manejo del drenaje producido de la oxidación del mineral sulfuroso, llamado comúnmente “drenaje ácido de roca” (ARD), “drenaje ácido de mina” o “drenaje metalífero y ácido” (AMD), “agua influenciada por minería” (MIW), “drenaje salino” (SD) y “drenaje neutro de mina” (NMD). Este resumen ejecutivo sigue la estructura general de la Guía completa GARD, un resumen del estado de las mejores prácticas y tecnologías desarrolladas bajo el auspicio de la Red Internacional para la Prevención de Ácido (International Network for Acid Prevention – INAP) para auxiliar a personas implicadas con el ARD, tales como operadores de mina, supervisores, comunidades y consultores que tratan cuestiones relacionadas con la oxidación del mineral sulfuroso. Se invita a los lectores a utilizar la Guía GARD y sus referencias para detalles adicionales sobre los temas cubiertos en este Resumen Ejecutivo. La Guía GARD fue preparada con el aporte y ayuda de muchos individuos y organizaciones; sus contribuciones son ampliamente reconocidas.

El drenaje ácido de roca se forma por la oxidación natural de minerales sulfurosos cuando son expuestos al aire y al agua. Las actividades que involucran la excavación de rocas con minerales sulfurosos, tales como la minería de metal y carbón, aceleran el proceso. El drenaje resultante del proceso de oxidación puede ser de neutro a ácido, con o sin metales pesados disueltos, pero siempre con contenido de sulfatos. El ARD resulta de una serie de reacciones y etapas que típicamente proceden de condiciones de pH casi neutras a más ácidas. Cuando los suficientes minerales base están presentes para neutralizar el ARD, se puede presentar un drenaje neutro de mina o drenaje salino del proceso de oxidación. El NMD se caracteriza por metales elevados en solución con pH casi neutro, mientras que el SD contiene altos niveles de sulfatos en pH neutro sin importantes concentraciones de metales disueltos. La Figura 1 presenta los diversos tipos de drenaje de manera esquemática.

**Figura 1: Tipos de Drenaje Producidos por Oxidación de Sulfuros**

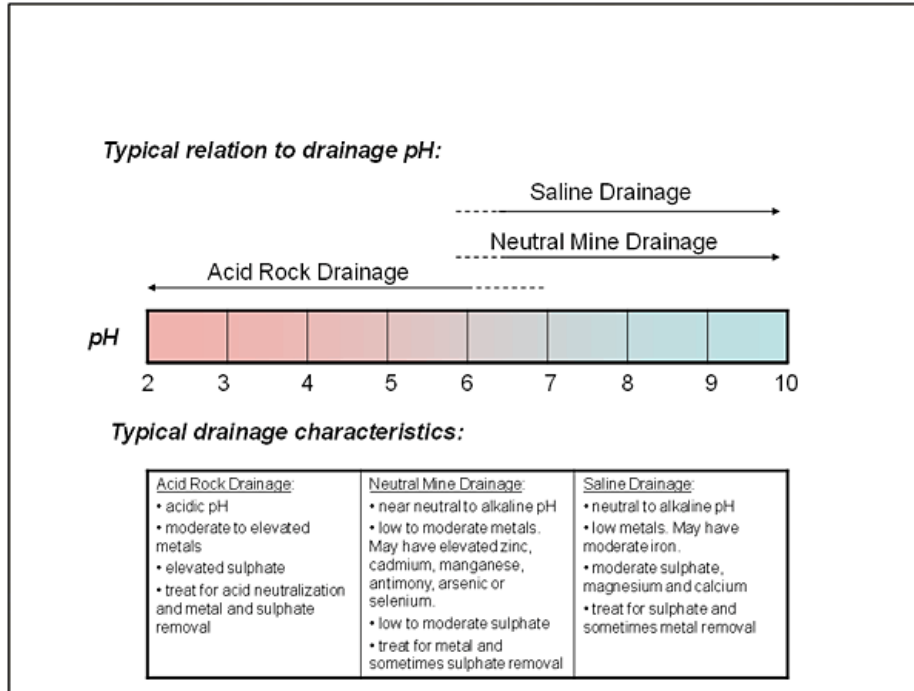

**Figura 2: Portal Romano con Drenaje Ácido de Roca – España**



Parar la formación de ARD una vez iniciado, puede ser un reto, ya que es un proceso que si no se detiene, continuará (y se puede acelerar) hasta que uno o dos de los reactivos (minerales sulfurosos, oxígeno, agua) se agoten o se excluyan de la reacción. El proceso de formación de ARD puede continuar produciendo drenaje impactado por décadas o siglos después que la mina haya cesado, tal como se ilustra en el portal en España, que data de la época Romana (Figura 2).

El costo de la remediación del ARD en minas fuera de operación sólo en Norte América ha sido estimado en diez mil millones de dólares americanos. Minas en particular pueden enfrentar responsabilidades de post-cierre de decenas de cientos de millones de dólares por la remediación y tratamiento del ARD si el proceso de oxidación de sulfuros no se manejó apropiadamente durante la vida de la mina. La apropiada caracterización de la mina, la predicción de la calidad del drenaje y el manejo de los desechos de mina pueden evitar la formación de ARD en la mayoría de los casos y minimizar la formación de ARD en todos los casos. La prevención del ARD debe comenzar en la exploración y continuar a lo largo del ciclo de vida de la mina. Es de suma importancia la continua

planeación y manejo del ARD para la exitosa prevención del ARD. Muchas minas no producirán ARD debido a las características geoquímicas inherentes de sus desechos de mina o a las muy áridas condiciones climáticas. Además, las minas que implementen trabajos de pronóstico bien fundamentados y, cuando procedan, las medidas de prevención y programas de monitoreo, también deberán ser capaces de evitar importantes problemas de ARD.

Una propuesta exhaustiva de manejo de ARD reduce riesgos ambientales y costos posteriores para la industria minera y los gobiernos, reduce impactos ambientales adversos y promueve el apoyo público para la minería. El alcance y los elementos particulares de la propuesta de manejo de ARD que se deben implementar en una operación particular, variará en base a múltiples factores específicos del sitio, no limitándose al potencial del proyecto para generar ARD.

## Formación del Drenaje Ácido de Roca

El proceso de oxidación de sulfuros y la formación del ARD, NMD y SD es muy complejo e involucra a una multitud de procesos químicos y biológicos que pueden variar significativamente dependiendo de las condiciones ambientales, geológicas y climáticas (Nordstrom y Alpers, 1999). Los minerales sulfurosos en los depósitos de mineral se forman bajo condiciones reductoras en la ausencia de oxígeno. Cuando se exponen al oxígeno atmosférico o a aguas oxigenadas debido a la minería, el procesamiento del mineral, excavación u otros procesos de movimiento de tierras, los minerales sulfurosos pueden volverse inestables y oxidarse. La Figura 3 presenta un modelo simplificado que describe la oxidación de la pirita, la cual es el mineral sulfuroso responsable de una gran mayoría de ARD (Stumm y Morgan, 1981). Las reacciones mostradas son esquemáticas y pueden no presentar los mecanismos exactos, pero la ilustración es una útil ayuda visual para entender la oxidación sulfurosa.

La reacción química que representa la oxidación de la pirita (reacción [1]) requiere tres ingredientes básicos: pirita, oxígeno y agua. Esta reacción puede ocurrir tanto abióticamente como bióticamente (ejm.; mediada a través de microorganismos). En este caso, la bacteria como el *Acidithiobacillus ferrooxidans*, que deriva su energía metabólica de oxidación ferroso a hierro férrico, puede acelerar la velocidad de reacción por muchos órdenes de magnitud respecto a los índices abióticos (Nordstrom, 2003). Además de la oxidación directa, la pirita puede ser disuelta y luego oxidada (reacción [1a]).

Figura 3: Modelo para la Oxidación de Pirita (Stumm y Morgan, 1981).

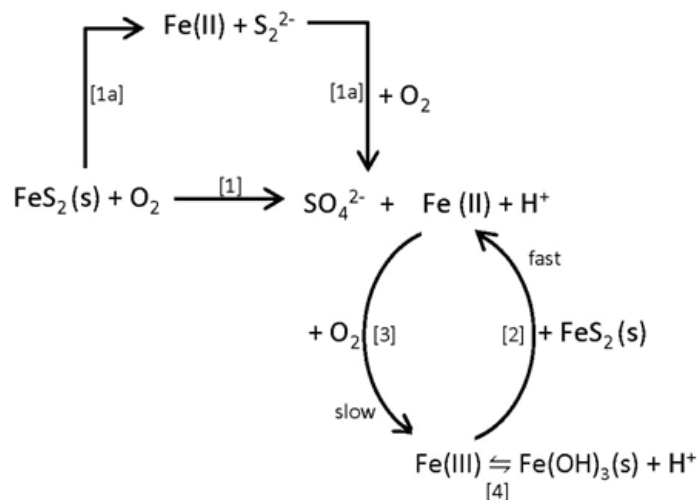

En la mayoría de las circunstancias, el oxígeno atmosférico actúa como oxidante. Sin embargo, el hierro férrico acuoso puede oxidar pirita de acuerdo a la reacción [2]. Esta reacción es considerablemente más rápida (2 a 3 órdenes de magnitud) que la reacción con oxígeno y genera substancialmente más acidez por mol de pirita oxidada. Sin embargo, esta reacción está limitada a condiciones en las que se encuentren cantidades significativas de hierro férrico disuelto (ejm.: condiciones ácidas: pH 4.5 y menores). La oxidación del hierro ferroso por oxígeno (reacción [3]) se requiere para generar y reponer al hierro férrico y se requieren condiciones ácidas para que ésta permanezca en la solución y participe en el proceso de producción del ARD. Como se muestra en esta reacción, se necesita oxígeno para generar hierro férrico del hierro ferroso. También, las bacterias que pueden catalizar esta reacción (fundamentalmente miembros de la *Acidithiobacillus* genus) demandan oxígeno para la respiración aeróbica celular. Así, se necesita de alguna cantidad

nominal de oxígeno para que este proceso sea efectivo cuando se catalice por la bacteria, aunque los requerimientos de oxígeno son considerablemente menores que para la oxidación abiótica.

Un proceso de importancia ambiental relacionado con la generación del ARD, está relacionado con el destino del hierro ferroso resultante de la reacción [1]. El hierro ferroso puede ser removido de la solución en condiciones de ligeramente ácidas a alcalinas mediante oxidación y subsiguiente hidrólisis y formación de un relativamente insoluble (hidr)óxido de hierro (reacción [4]). Cuando las reacciones [1] y [4] se combinan, como generalmente es el caso cuando las condiciones no son ácidas (ejm.: pH > 4.5), la oxidación de la pirita produce el doble de la cantidad de acidez en comparación con la reacción [1] de la siguiente manera:

$FeS_2 + 15/4O_2 + 7/2H_2O = Fe(OH)_3 + 2SO_4^{2-} + 4H^+$ , que es la reacción global más comúnmente utilizada para describir la oxidación de pirita.

Aunque la pirita es por mucho, el sulfuro dominante responsable de la generación de acidez, diferentes depósitos de mineral contienen diferentes tipos de minerales de sulfuro. No todos estos minerales de sulfuro generan acidez cuando se oxidan. Como regla general, los sulfuros de hierro (pirita, marcasita, pirrotita), sulfuros con proporción molar metal/sulfuro < 1, y sulfosales (ejm.: enargita) generan ácido cuando reaccionan con oxígeno y agua. Los sulfuros con proporción metal/sulfuro = 1 (ejm.: esfalerita, galena, calcopirita) tienden a no producir acidez cuando el oxígeno es el oxidante. Por ello, la generación potencial de ácido de un depósito de mineral o un desecho de mina, generalmente depende de la cantidad de sulfuro de hierro presente.

Las reacciones de neutralización también juegan un papel importante en la determinación de las características de composición del drenaje originado de la oxidación de sulfuros. En cuanto a minerales sulfurosos, la reactividad, y en consecuencia la eficacia con que los minerales neutralizantes puedan estabilizar (buffer) cualquier ácido que esté siendo generado, puede variar mucho. La mayoría de los minerales de carbonato son capaces de disolverse rápidamente, haciéndolos efectivos consumidores de ácido. Sin embargo, la hidrólisis del Fe o Mn disueltos tras la disolución de sus respectivos carbonatos y posterior precipitación de un mineral secundario, puede generar acidez. Aunque generalmente más común que las fases de carbonato, los minerales de aluminosilicato tienden a ser menos reactivos y sus neutralizaciones sólo pueden tener éxito en estabilizar el pH cuando más bien las condiciones ácidas han sido logradas. Se ha sabido que los silicatos de calcio-magnesio estabilizan los efluentes de la mina a un pH neutro cuando los índices de oxidación de sulfuros están muy bajos (Jambor, 2003).

La combinación de las reacciones de generación y neutralización de ácido típicamente conduce a un desarrollo en etapas del ARD (Figura 4). Con el paso del tiempo, el pH disminuye a lo largo de una serie de mesetas de pH, regidas por la estabilización de una serie de ensamblajes minerales. El lapso de tiempo para la generación de ácido es una consideración muy importante para la prevención del ARD. Es más efectivo (y generalmente menos costoso a largo plazo) controlar la generación del ARD durante sus etapas tempranas. El lapso de tiempo también consta de ramificaciones importantes para la interpretación de los resultados de las pruebas. Debido a que la primera etapa de generación de ARD puede durar un largo tiempo, aún para materiales que eventualmente serán altamente generadores de ácido, es importante reconocer la etapa de oxidación cuando se predice el potencial de ARD. Los primeros resultados de las pruebas geoquímicas, por lo tanto, no pueden ser representativos de la estabilidad ambiental a largo plazo y la correspondiente calidad de descarga. Sin embargo, los primeros resultados de las pruebas proveen datos valiosos para evaluar las condiciones futuras como los índices de consumo de los minerales neutralizantes disponibles.

Un corolario común de la oxidación de sulfuros es la lixiviación de metales (ML), dando lugar al uso frecuente de los acrónimos “ARD/ML” o “ML/ARD” para describir con más precisión la naturaleza de las descargas ácidas de mina. Los elementos mayores y traza en el ARD, NMD y SD se originan de la oxidación de sulfuros y la disolución de los minerales consumidores de ácido. En el caso del ARD, el Fe y el Al son normalmente los principales metales mayores disueltos, aunque los metales traza como Cu, Pb, Zn, Cd, Mn, Co y Ni también pueden lograr altas concentraciones. En las descargas de mina con un carácter más o menos neutro, las concentraciones de metales traza tienden a ser menores debido a la formación de fases de minerales secundarios y una mayor absorción. Sin embargo, ciertos parámetros permanecen en la solución a medida que el pH aumenta, en particular los metaloides As, Se y Sb, así como otros metales traza (ejm.: Cd, Cr, Mn, Mo y Zn).

Figura 4: Etapas en la Formación del ARD (INAP, 2009)

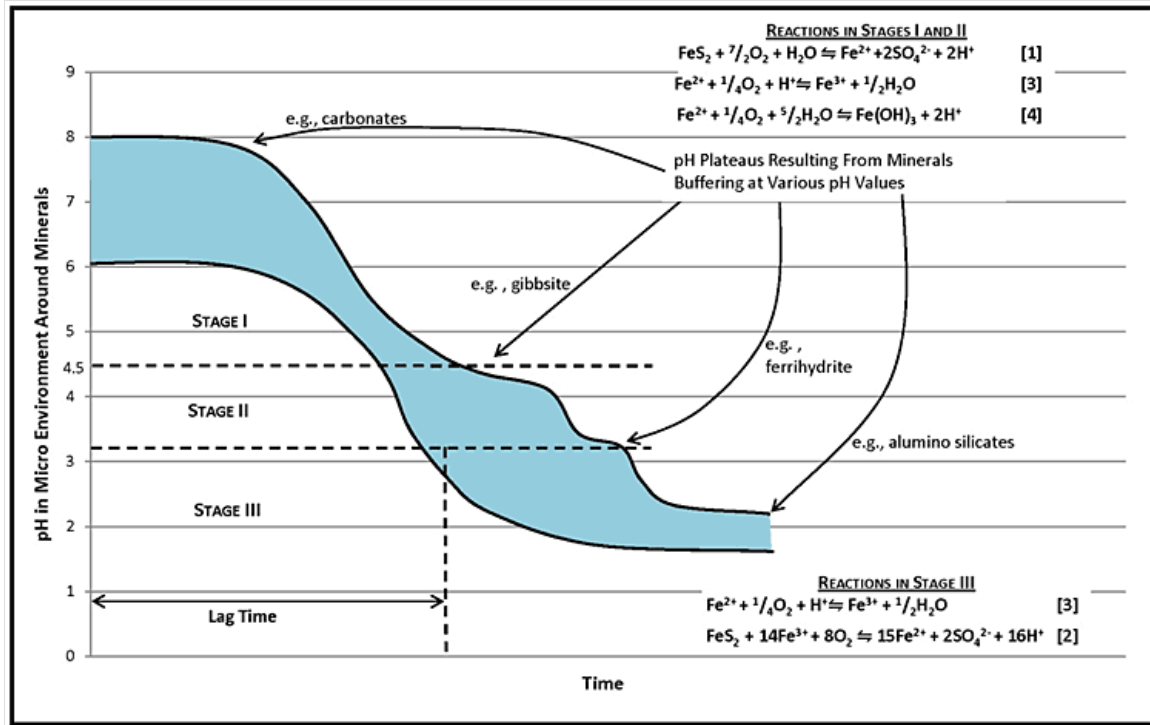

### Esquema para el Manejo del Drenaje Ácido de Roca

Los temas y enfoques sobre la prevención y manejo del ARD son los mismos alrededor del mundo. Sin embargo, las técnicas específicas utilizadas para la predicción, interpretación de los resultados de las pruebas y el manejo del ARD pueden diferir dependiendo del contexto local, regional o nacional y se adaptan al clima, topografía y otras condiciones del sitio.

Por lo tanto, a pesar de las similitudes en los temas de ARD, no existe un enfoque “a la medida de todos” para tratar el manejo del ARD. La conformación de cada mina es única y requiere una cuidadosa evaluación para encontrar una estrategia de manejo dentro del esquema corporativo, regulatorio y de la comunidad que aplique al proyecto en cuestión. La conformación específica del sitio comprende la situación social, económica y ambiental dentro de las cuales la mina está ubicada, mientras que el esquema comprende las normas y estándares corporativos aplicables, así como las expectativas y requerimientos específicos de la comunidad. Este esquema aplica en todo el ciclo de vida de la mina y se ilustra conceptualmente en la Figura 5.

Todas las compañías mineras, sin importar el tamaño, necesitan cumplir con la legislación nacional y las regulaciones relativas al ARD de los países en los que operan. Se considera buena práctica empresarial, añadir las también a la orientación global sobre ARD y en muchos casos, tal adición es una condición para el financiamiento.

Muchas compañías mineras han establecido claros lineamientos empresariales que representan el punto de vista de la compañía acerca de las prioridades que deben tomarse y sus interpretaciones de lo que se considera generalmente la mejor práctica relacionada al ARD. Es necesario tener cuidado y asegurarse de que se cumplan todas las especificaciones de las regulaciones del país, ya que los lineamientos corporativos del ARD no pueden sustituir las regulaciones del país.

**Figura 5: Esquema Conceptual del Manejo del ARD (INAP, 2009)**

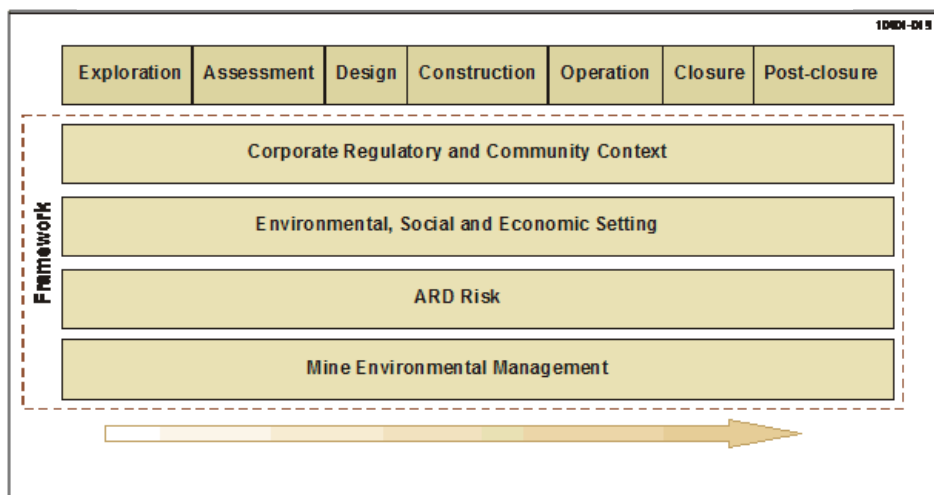

Las compañías mineras operan dentro de las limitaciones de una “licencia social” que, idealmente, se basa en un amplio consenso de todas las partes interesadas. Este consenso tiende a cubrir una amplia gama de elementos sociales, económicos, ambientales y gubernamentales (desarrollo sostenible). El ARD juega un importante papel en la licencia social de la mina, debido a que el ARD tiende a ser una de las consecuencias ambientales más visibles de la minería. Los costos del manejo de cierre y post-cierre del ARD son cada vez más reconocidos como fundamentales componentes de todas las operaciones mineras propuestas y en operación. En algunas jurisdicciones, ahora se requiere de alguna forma de garantía financiera.

## Caracterización

La generación, liberación, transporte y atenuación del ARD son intrincados procesos regidos por una combinación de factores físicos, químicos y biológicos. El hecho que el ARD se convierta en una preocupación ambiental, depende en gran medida de las características de las fuentes, trayectorias y receptores involucrados. La caracterización de estos aspectos es por lo tanto crucial para la predicción, prevención y manejo del ARD. Los programas de caracterización ambiental están diseñados para recolectar la suficiente información para responder a las siguientes preguntas:

1. ¿Es probable que ocurra el ARD? ¿Qué tipo de drenaje se espera (ARD/NMD/SD)?
2. ¿Cuáles son las fuentes del ARD? ¿Cuánto ARD será generado y cuándo?
3. ¿Cuáles son las trayectorias más importantes que transportan los contaminantes al medio ambiente receptor?
4. ¿Cuáles son los impactos ambientales esperados de la liberación del ARD al medio ambiente?
5. ¿Qué se puede hacer para prevenir o mitigar/manejar el ARD?

Las características geológicas y minerales del yacimiento y la roca huésped son los principales controles del tipo de drenaje que será generado como resultado de la minería. Posteriormente, el clima del sitio y las características hidrológicas/hidrogeológicas definen cómo el drenaje de mina y sus constituyentes son transportados a través del medio ambiente receptor hacia los receptores. Para evaluar estas cuestiones, se requiere del conocimiento de múltiples disciplinas, incluyendo: geología, mineralogía, hidrología, hidrogeología, geoquímica, (micro)biología, meteorología e ingeniería.

Las características geológicas de los depósitos minerales ejercen importantes y predecibles controles sobre la firma ambiental de las áreas mineralizadas (Plumlee, 1999). Por lo tanto, se deberá realizar una evaluación preliminar del potencial del ARD, basada en la revisión de los datos geológicos recolectados durante la exploración. La caracterización base de las concentraciones de metales en varios medios ambientes (ej.: agua, tierra, vegetación y biota) también pueden proveer una indicación del potencial del ARD y sirve para documentar las potenciales concentraciones de metal naturalmente elevadas. Durante el desarrollo y la operación de la mina, se refina la evaluación inicial del potencial del ARD a través de los detallados datos de caracterización de la estabilidad ambiental de los materiales minerales y de desecho. La magnitud y la ubicación de las descargas de la mina al medio ambiente también se identifican durante el desarrollo de la mina. Se llevan a cabo investigaciones meteorológicas, hidrológicas e hidrogeológicas para caracterizar la cantidad y dirección del movimiento del agua dentro de la(s) vertiente(s) de la mina, para evaluar las trayectorias de transporte de los componentes de interés. Se identifican los receptores biológicos potenciales dentro de los límites de la vertiente. Como consecuencia, durante la vida de la mina, el punto central del programa de caracterización del ARD evoluciona desde el establecer las condiciones base, a predecir la liberación y transporte del drenaje, a monitorear las condiciones e impactos ambientales.

Pese a las diferencias inherentes a los sitios de mina (ejm.: basado en tipos de materia prima, clima, fase de mina, esquema regulador), el enfoque general para la caracterización del sitio es similar: • Definir la cantidad y calidad del drenaje potencialmente generado por diferentes fuentes • Identificar trayectorias superficiales y subterráneas que transporten el drenaje desde su origen al receptor • Identificar receptores que puedan ser afectados por la exposición al drenaje • Definir el riesgo de esta exposición Las Figuras 6 y 7 presentan la cronología de un programa de caracterización de un ARD e identifican las actividades de recolección de datos típicamente ejecutadas durante cada fase de la mina. El grueso de los trabajos de caracterización ocurre antes del trabajo de explotación minera, durante la planeación, evaluación y diseño (algunas veces llamada fase de desarrollo). Además, se identifican potenciales impactos ambientales y se incorporan apropiadas medidas de prevención y mitigación, con el propósito de minimizar impactos ambientales. Durante las fases de puesta en marcha/construcción y operación, ocurre una transición de la caracterización del sitio al monitoreo, el cual continúa a lo largo de las fases de clausura/cierre y post-cierre. El continuo monitoreo ayuda a refinar el entendimiento del sitio, lo cual permite ajustar las medidas de recuperación, dando como resultado costos de cierre reducidos y mejor manejo de riesgo.

Figura 6: Vista General del Programa de Caracterización del ARD por Fases de la Mina (INAP, 2009)





Figura 7: Programa de Caracterización del ARD para Materiales de Fuente Individual por Fases de la Mina (INAP, 2009)

Mine Phase – Increasing Knowledge of Source Material Characterization							
	Exploration	Mine Planning, (Pre-) Feasibility and Design	Construction and Commissioning	Operation	Decommissioning	Post-Closure (Care and Maintenance)	
Waste or Facility Type – Potential ARD / NMD / SD Sources	Waste Rock	Drill core descriptions and assay data (petrology and mineralogy)  Block model (quantity of ore and waste)	Laboratory testing of drill core samples – sample selection targets waste <sup>(4)</sup>	Ongoing laboratory testing of drill core or development rock samples <sup>(4)</sup>  Field leach testing (barrels, test pads)	Ongoing laboratory testing <sup>(4)</sup>  Ongoing field leach testing  Collection and analysis of runoff and seepage samples from waste rock facility	Collection and analysis of runoff and seepage samples from waste rock facility	Collection and analysis of runoff and seepage samples from waste rock facility (if necessary)
	Tailings	Review of any historical data	Laboratory testing of pilot plant tailings <sup>(4)</sup>  Analysis of pilot testing supernatant.	Ongoing laboratory testing of pilot plant tailings <sup>(4)</sup>	Ongoing laboratory testing of tailings discharge <sup>(4)</sup>  Collection and analysis of supernatant and seepage samples from TSF	Collection and analysis of supernatant and seepage samples from TSF	Collection and analysis of supernatant and seepage samples from TSF (if necessary)
	Ore		Laboratory testing of drill core samples <sup>(4)</sup>		Ongoing laboratory testing <sup>(4)</sup>	If ore stockpiles exist, collection and analysis of runoff and seepage samples	
	Pit		Laboratory testing of drill core samples – sample selection targets pit walls <sup>(4)</sup>		Field scale leach testing (e.g., wall washing) Collection and analysis of water samples (i.e., runoff, sumps)	Collection and analysis of pit water and pit inflow(s) water samples	Collection and analysis of pit water samples (if necessary)
	Underground Workings		Laboratory testing of drill core samples – sample selection targets mine walls <sup>(4)</sup>		Collection and analysis of water samples (i.e., sumps, dewatering wells)	Collection and analysis of mine pool water samples	Collection and analysis of mine pool water samples (if necessary)

<sup>(4)</sup> Typical laboratory testing components: particle size, whole rock analysis, mineralogy, ABA, static and kinetic leach testing.

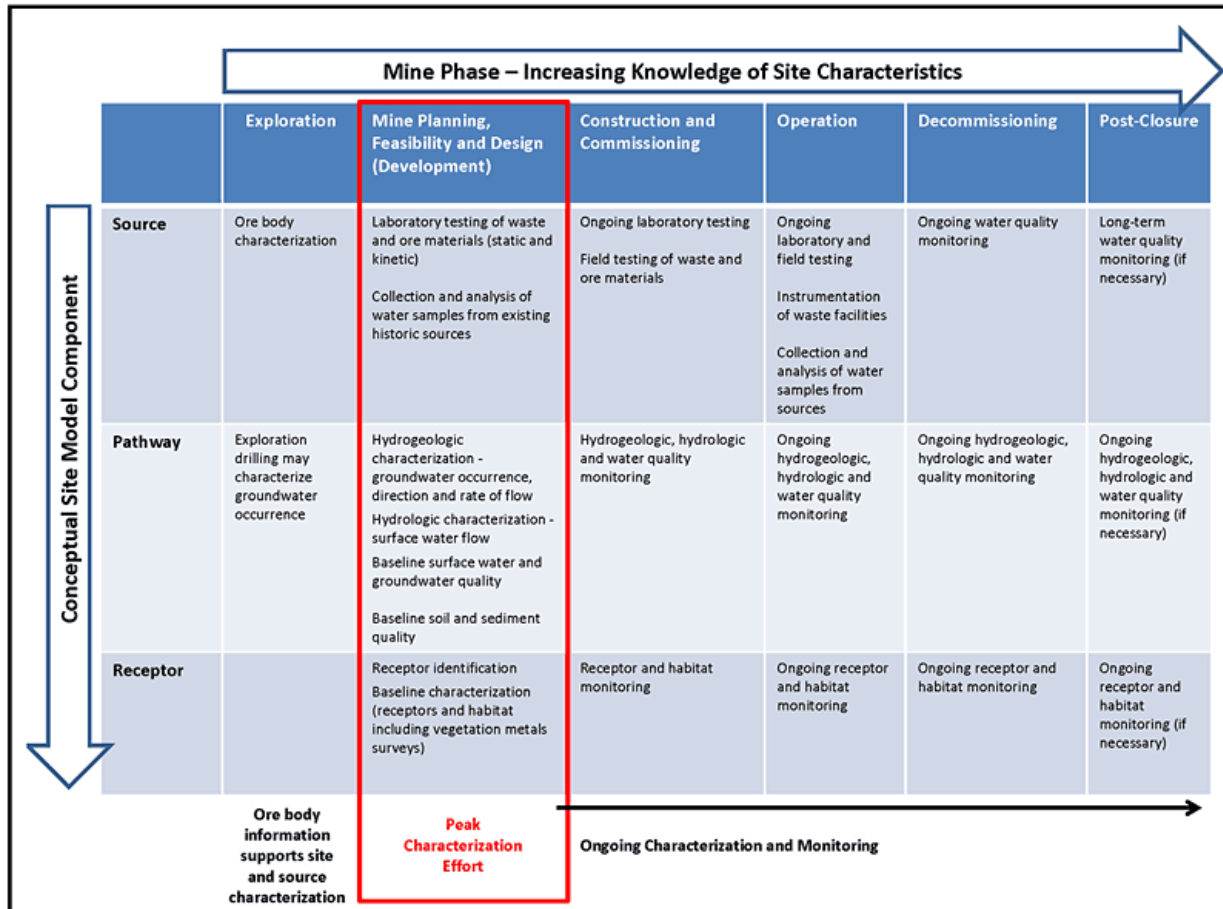
## Predicción

Uno de los objetivos principales de la caracterización del sitio es la predicción del potencial de ARD y la química del drenaje. Ya que la predicción se encuentra directamente ligada a la planeación de la mina, en particular con respecto al manejo del agua y los desechos de mina, los trabajos de caracterización necesitan estar organizados en etapas con la planeación general del proyecto. La caracterización temprana tiende a ser genérica y generalmente evita suposiciones acerca del futuro diseño de la mina/ingeniería, mientras que la caracterización y modelación posteriores deben ser consideradas e integradas con los detalles específicos del diseño de la mina/ingeniería. La iteración puede ser requerida como evaluación del potencial de ARD y puede resultar en la necesidad de una re-evaluación del plan general de la mina. La integración de los trabajos de caracterización y predicción dentro de la operación de la mina son elementos claves para el manejo exitoso del ARD. La exacta predicción de las futuras descargas de la mina requiere el entendimiento de los procedimientos de muestreo, pruebas y análisis utilizados, la consideración de las futuras condiciones físicas y geoquímicas y la identidad, ubicación y reactividad de los minerales contribuyentes. Todos los sitios de mina son únicos por razones relacionadas con la geología, geoquímica, clima, materia prima, método de procesamiento, regulaciones y partes interesadas. Los programas de predicción por lo tanto, necesitan ser elaborados a la medida de la mina en cuestión. También, los objetivos de un programa de predicción pueden ser variables. Por ejemplo, pueden incluir la definición de los requerimientos de tratamiento de agua, la selección de los métodos de mitigación, la evaluación de impacto de la calidad del agua, o la determinación de los costos estimados para la etapa de cierre.

Las predicciones de la calidad del drenaje se hacen en un sentido cualitativo y cuantitativo. Las predicciones cualitativas se enfocan en evaluar en dónde se pudieran desarrollar las condiciones ácidas en los desechos de mina, con la correspondiente liberación de metales y acidez al drenaje de mina. En donde las predicciones cualitativas indiquen una alta probabilidad de generación de ARD, la atención se vuelve a la revisión de alternativas para evitar el ARD y el programa de predicción se reenfoca para auxiliar en el diseño y

evaluación de estas alternativas. Durante las últimas décadas, se han realizado avances significativos en el entendimiento del ARD, con avances paralelos en la predicción de la calidad de agua de mina y el uso de técnicas de prevención. Sin embargo, la predicción cuantitativa de la calidad de agua de mina puede ser un reto debido a la amplia gama de reacciones involucradas y los periodos potencialmente largos sobre los cuales se producen estas reacciones. A pesar de estas incertidumbres, las predicciones cuantitativas que han sido desarrolladas usando suposiciones realistas (en tanto se reconozcan las limitaciones relacionadas), han probado ser de valor significativo para la identificación de las opciones de manejo del ARD y la evaluación de los potenciales impactos ambientales.

La predicción de la calidad de agua de la mina generalmente está basada en una o más de los siguientes:

- Probar la condición de lixiviación de los desechos en el laboratorio
- Probar la condición de lixiviación de los desechos bajo condiciones de campo
- Caracterización geológica, hidrológica, química y mineral de los desechos
- Modelación geoquímica y otras

Los sitios análogos históricos o en operación son también valiosos en la predicción del ARD, especialmente aquellos que han sido minuciosamente caracterizados y monitoreados. El desarrollo de modelos geo-ambientales es uno de los ejemplos más prominentes de la metodología "análoga". Los modelos geo-ambientales, que son aquellos que interpretan las características ambientales de un yacimiento en un contexto geológico, proporcionan una manera muy útil de interpretar y resumir las firmas ambientales de la explotación minera y los yacimientos en un contexto geológico sistemático, y pueden ser aplicados para anticipar los problemas ecológicos potenciales en minas futuras, operantes y sitios fuera de operación (Plumlee et al., 1999). Un enfoque general para la predicción de ARD se ilustra en la Figura 8.

Figura 8: Visa General del Enfoque de Predicción del ARD (INAP, 2009)

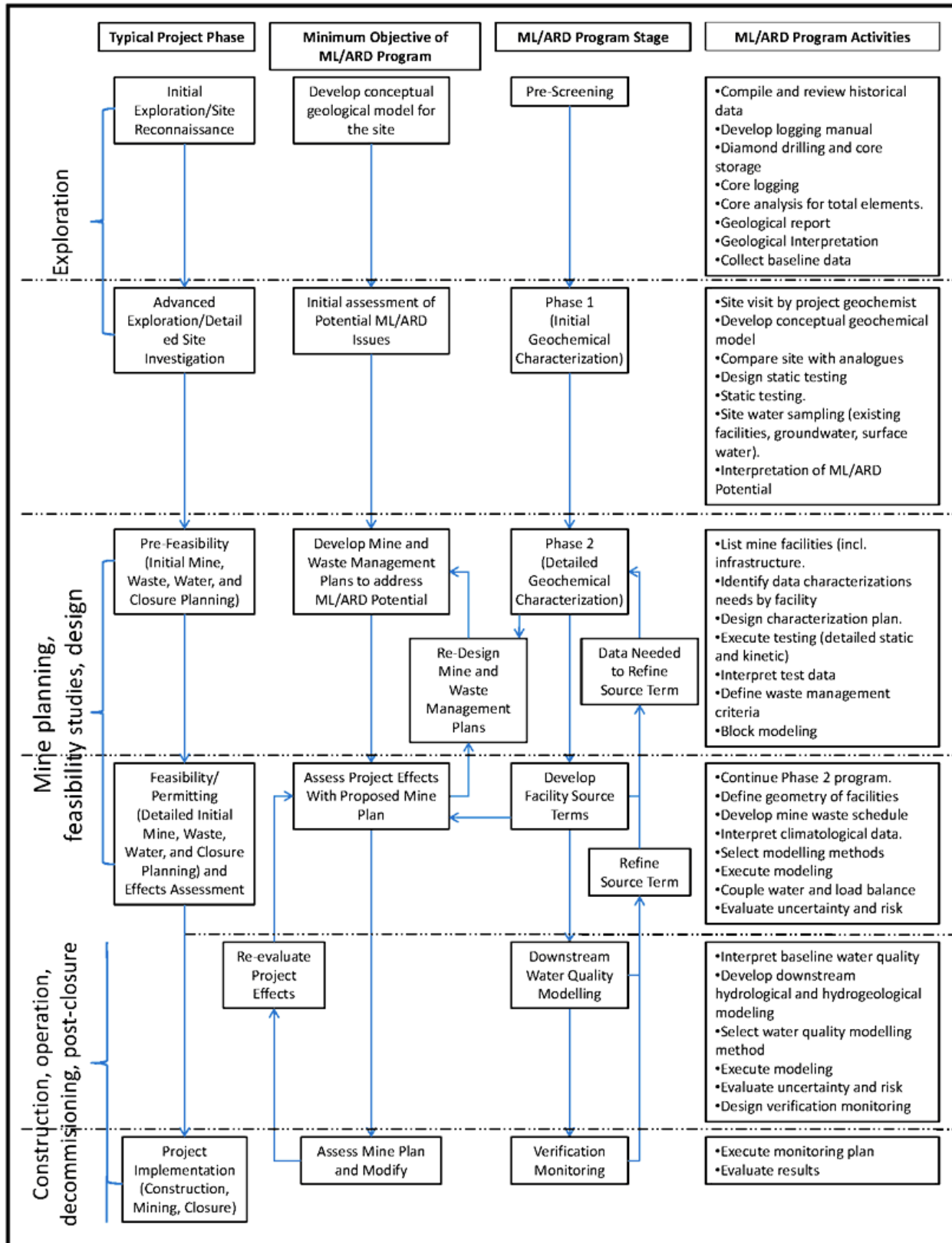

## Prevención y Mitigación

El principio fundamental de la prevención del ARD es aplicar un proceso de planeación y diseño para prevenir, inhibir, retardar o parar los procesos hidrológicos, químicos, físicos o microbiológicos que resulten en los impactos de los recursos de agua. La prevención deberá ocurrir en, o tan cercano al punto donde el deterioro de la calidad del agua se origine (ejm.: reducción de fuente), o a través de la implementación de medidas para prevenir o retardar el transporte del ARD a los recursos de agua (ejm.: reciclar, tratamiento y/o eliminación segura). Este principio es universalmente aplicable, pero los métodos de implementación son específicos del sitio.

La prevención es una estrategia proactiva que supone la necesidad de un enfoque reactivo para la mitigación. Para el caso existente de un ARD que esté impactando de manera adversa al medio ambiente, la mitigación será regularmente el curso inicial de acción. Además de esta acción inicial, se consideran subsiguientes medidas preventivas con el objetivo de reducir futuras cargas contaminantes y así reducir la continua necesidad de controles de mitigación. La integración de los trabajos de prevención y mitigación en la operación de la mina es un elemento clave para el manejo exitoso del ARD. Previo a la identificación de la evaluación de las medidas de prevención y mitigación, se deben identificar los objetivos estratégicos. Ese proceso debe considerar la evaluación de lo siguiente:

- Riesgos cuantificables a los sistemas ecológicos, la salud humana y a otros receptores
- Criterios específicos de la calidad del agua de descarga del sitio
- Capital, costos de operación y mantenimiento de las medidas preventivas y de mitigación
- Logística de las operaciones y mantenimiento a largo plazo
- Longevidad requerida y eventos de contingencias esperados

Los objetivos típicos para el control del ARD son satisfacer los criterios ambientales usando la técnica más rentable. La selección de tecnología deberá considerar las predicciones para la química del agua de descarga, ventajas y desventajas de las opciones de tratamiento, riesgo para los receptores y el contexto regulador relacionado con las descargas de las minas.

Un enfoque basado en los riesgos de planeación y diseño forma la base para la prevención y la mitigación. Este enfoque es aplicado a lo largo del ciclo de vida de la mina, pero fundamentalmente en la evaluación y en las fases del diseño. El proceso basado en los riesgos espera cuantificar los impactos a largo plazo de las alternativas y usar este conocimiento para seleccionar la opción que tenga la combinación más deseable de atributos (ejm.: protección, aceptación regulatoria, aprobación de la comunidad, costo). Las medidas de mitigación implementadas como parte de una estrategia de control efectiva deben requerir una mínima intervención activa y dirección.

Prevención es la clave para evitar una costosa mitigación. El objetivo principal es aplicar los métodos que minimicen los índices de reacción de sulfuros, lixiviación de metales y la subsiguiente migración de productos intemperizados que resulten de la oxidación de sulfuros. Tales métodos involucran:

- Minimizar el abastecimiento de oxígeno
- Minimizar la infiltración de agua y la lixiviación
- Minimizar, remover o aislar los minerales sulfurosos
- Controlar el pH de la solución de agua de los poros
- Controlar la bacteria y los procesos bio-geoquímicos

Factores que influyen en la selección de los métodos anteriores incluyen:

- Geoquímica de materias primas y el potencial de ese material para producir
- Tipo y características de la fuente, incluyendo el flujo de agua y transporte de oxígeno
- Etapa de desarrollo de la mina (se presentan más opciones en etapas tempranas)
- Fase de oxidación (se presentan más opciones en etapas tempranas cuando pH está todavía cercano a neutro y los productos oxidados no se han acumulado significativamente)
- Periodo de tiempo que se requiere la medida de control para que sea efectiva
- Condiciones del sitio (ejm.: ubicación, topografía y huecos de mina disponibles, clima, geología, hidrología e hidrogeología, disponibilidad de materiales y vegetación)
- Criterios de calidad del agua para descarga
- Aceptación de riesgo por parte de la compañía y otras partes interesadas

Se puede requerir más de una o una combinación de medidas para lograr el objetivo deseado. La Figura 9 provee una vista general de las medidas de prevención y mitigación de ARD más comunes disponibles durante las diferentes etapas del ciclo de vida de la mina.

**Figura 9: Visa General de las Medidas de Prevención y Mitigación del ARD (INAP, 2009)**

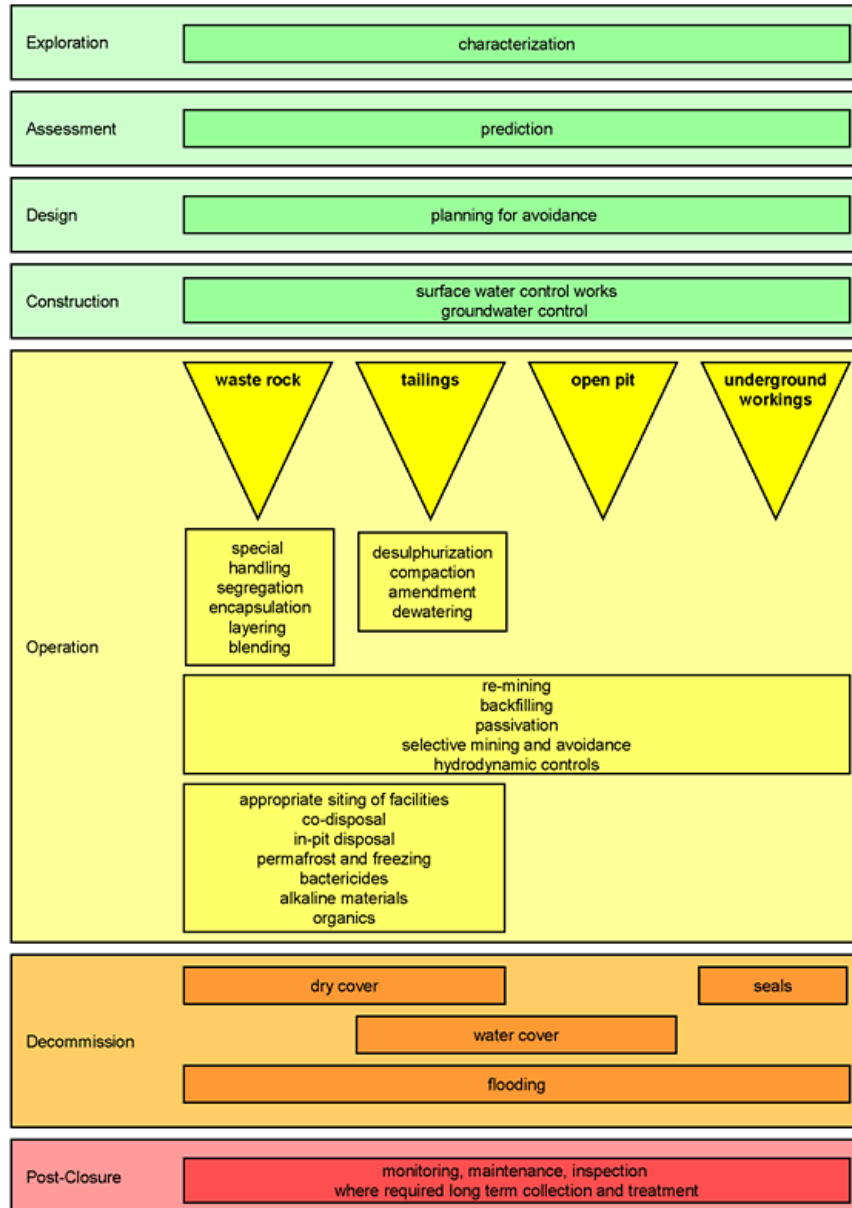

## Tratamiento del Drenaje Ácido de Roca

La minería sustentable requiere la mitigación, el manejo y el control de los impactos de la minería en el medio ambiente. Los impactos de la minería sobre los recursos de agua pueden ser a largo plazo y persistir en la situación de post-cierre. El tratamiento del drenaje de mina puede ser un componente del manejo general de agua de mina para apoyar a la operación de la mina en su vida entera.

Los objetivos del tratamiento del drenaje de mina son variados. La recuperación y el re-uso del agua de mina dentro de las operaciones mineras pueden ser convenientes o requeridos para el procesamiento de minerales, transporte de materiales, uso operativo (suspensión de polvo, sistemas de enfriamiento, irrigación de terrenos rehabilitados), etc. El tratamiento del drenaje de mina, en este caso, está dirigido a modificar la calidad del agua para que sea adecuada para el uso pretendido dentro o fuera del sitio de la mina.

Otro objetivo del tratamiento de agua de mina es la protección de la salud humana y ecológica en casos en donde la gente o los receptores ecológicos puedan estar en contacto con el agua de la mina impactada a través del uso directo o indirecto. El drenaje de

mina puede actuar como medio de transporte para una gama de contaminantes, los cuales pueden impactar los recursos de agua dentro y fuera del sitio. El tratamiento de agua removería los contaminantes contenidos en el drenaje de mina para prevenir o mitigar los impactos ambientales.

En la gran mayoría de las jurisdicciones, cualquier descarga de drenaje de mina a una corriente pública o acuífero, debe ser aprobada por las autoridades reguladoras correspondientes, en tanto los requerimientos reguladores estipulen una cierta calidad de descarga de agua de mina o cargas contaminadas de descargas relacionadas. Aunque los estándares de calidad para la descarga probablemente no estén disponibles para muchos países con minería en desarrollo, generalmente los estándares ambientales internacionalmente aceptados también se aplican conforme a lo estipulado por los financiadores del proyecto y en las políticas de la compañía. El enfoque para seleccionar un método para el tratamiento del drenaje de mina se basa en una comprensión a fondo del sistema y circuitos integrados de agua de la mina y en los objetivos específicos que se deban lograr. El enfoque adoptado para el tratamiento de drenaje de mina será influenciado por un número de consideraciones.

Previo a la selección del proceso de tratamiento, se deberá preparar un claro y entendible comunicado con los objetivos del tratamiento. El tratamiento de drenaje de mina deberá ser siempre evaluado e implementado dentro del contexto del sistema integrado de agua de mina. El tratamiento tendrá un impacto en el flujo y el perfil de calidad en el sistema de agua; por ello, un sistema de tratamiento se selecciona en base al flujo de agua de la mina, calidad del agua, costo y uso(s) final(es) del agua.

La caracterización del drenaje de mina, en términos de flujo y características químicas, deberá incluir las debidas consideraciones de los cambios de temporada y climáticos. Los datos de flujo son especialmente importantes ya que esta información se requiere para evaluar apropiadamente cualquier sistema de tratamiento. De particular importancia son los eventos de precipitación extrema y los deshielos de nevadas que requieren adecuar el tamaño de las pilas de recolección y la tubería y diques asociados. Las principales propiedades químicas del drenaje de mina se refieren a la acidez/alcalinidad, contenido de sulfatos, salinidad, contenido de metal y la presencia de compuestos específicos asociados con operaciones mineras específicas tales como cianuro, amoníaco, nitrato, arsénico, selenio, molibdeno y radionucleidos. También hay un número de constituyentes de drenaje de mina (por ejemplo, dureza, sulfato, sílice) que no son motivo de preocupación ambiental o regulatoria en todas las jurisdicciones, pero eso pudiera afectar la selección de la tecnología del tratamiento de agua preferido. El manejo y la eliminación de los desechos de la planta de tratamiento y los residuos como lodos y salmueras y sus características químicas, también deben ser factores importantes en la toma de decisión de cualquier tratamiento.

Una planta de tratamiento para drenaje de mina debe tener la flexibilidad de tratar con aumento/disminución de flujos de agua, calidad de agua cambiante y los requerimientos regulatorios durante la vida de la mina. Ésto puede establecer la implementación por fases y un diseño modular y construcción. Además, la fase de post-cierre puede poner restricciones específicas en el mantenimiento y operación continua de una planta de tratamiento.

Las consideraciones prácticas relacionadas con las características del sitio de la mina que influenciarán la construcción, operación y mantenimiento de una planta de tratamiento de drenaje son las siguientes:

- Diseño de la mina y topografía
- Espacio
- Clima
- Fuentes de drenaje de mina que alimentan la planta de tratamiento
- Ubicación y usuarios de agua tratada

Una gama genérica de las alternativas de tratamiento del ARD se presenta en la Figura 10.

Figura 10: Vista General de las Alternativas de Tratamiento del ARD

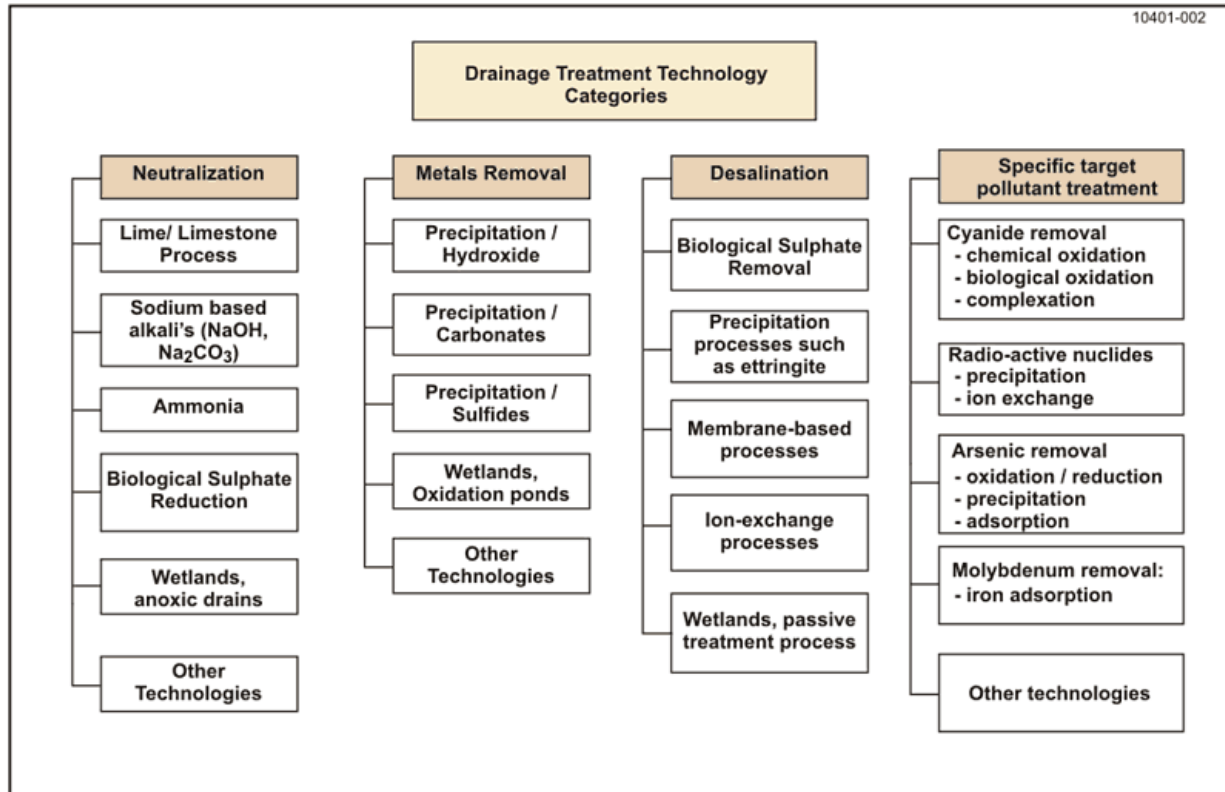

## Monitoreo del Drenaje Ácido de Roca

El monitoreo es el proceso de rutina, sistemático y que deliberadamente recaba información para usar en el manejo-toma de decisiones. El monitoreo en el sitio de la mina tiene como objetivo identificar y caracterizar cualquier cambio ambiental proveniente de las actividades de mina para evaluar las condiciones en el sitio y los posibles impactos para los receptores. El monitoreo consiste de observación (ejm.: registrar información acerca del medio ambiente) e investigación (ejm.: pruebas de toxicidad en donde las condiciones ambientales estén controladas). El monitoreo es de suma importancia en la toma de decisiones relacionadas con el manejo del ARD, por ejemplo a través de la evaluación de la efectividad de las medidas de mitigación y la subsiguiente implementación de ajustes a las medidas de mitigación, según se requiera.

El desarrollo de un programa de monitoreo del ARD inicia con la revisión del plano de la mina, la ubicación geográfica y la fisiografía. El plano de la mina proporciona información de la ubicación y la magnitud de alteraciones de la superficie y el subsuelo, el procesamiento del mineral y los procedimientos de molienda, las áreas de eliminación de desechos, los lugares de descarga de efluentes, las extracciones de agua subterránea y las desviaciones del agua superficial. Esta información es utilizada para identificar las fuentes potenciales del ARD, los posibles trayectos/rutas para descargar el ARD al ambiente receptor y los receptores que pudieran ser impactados por estas descargas, así como la potencial mitigación que se pudiera requerir. Ya que la extensión espacial de un programa de monitoreo debe incluir todos estos componentes, frecuentemente se requiere de una evaluación de la cuenca para el monitoreo del ARD (incluyendo el agua subterránea). El monitoreo se lleva a cabo en todas las etapas del desarrollo del proyecto, desde la pre-operación hasta el post-cierre. Sin embargo, en la vida de la mina, los objetivos, componentes e intensidad de las actividades de monitoreo cambiarán. El desarrollo y los componentes de un programa de monitoreo genérico del ARD se presentan en la Figura 11.

Figura 11: Desarrollo de un Programa de Monitoreo de ARD (INAP, 2009)

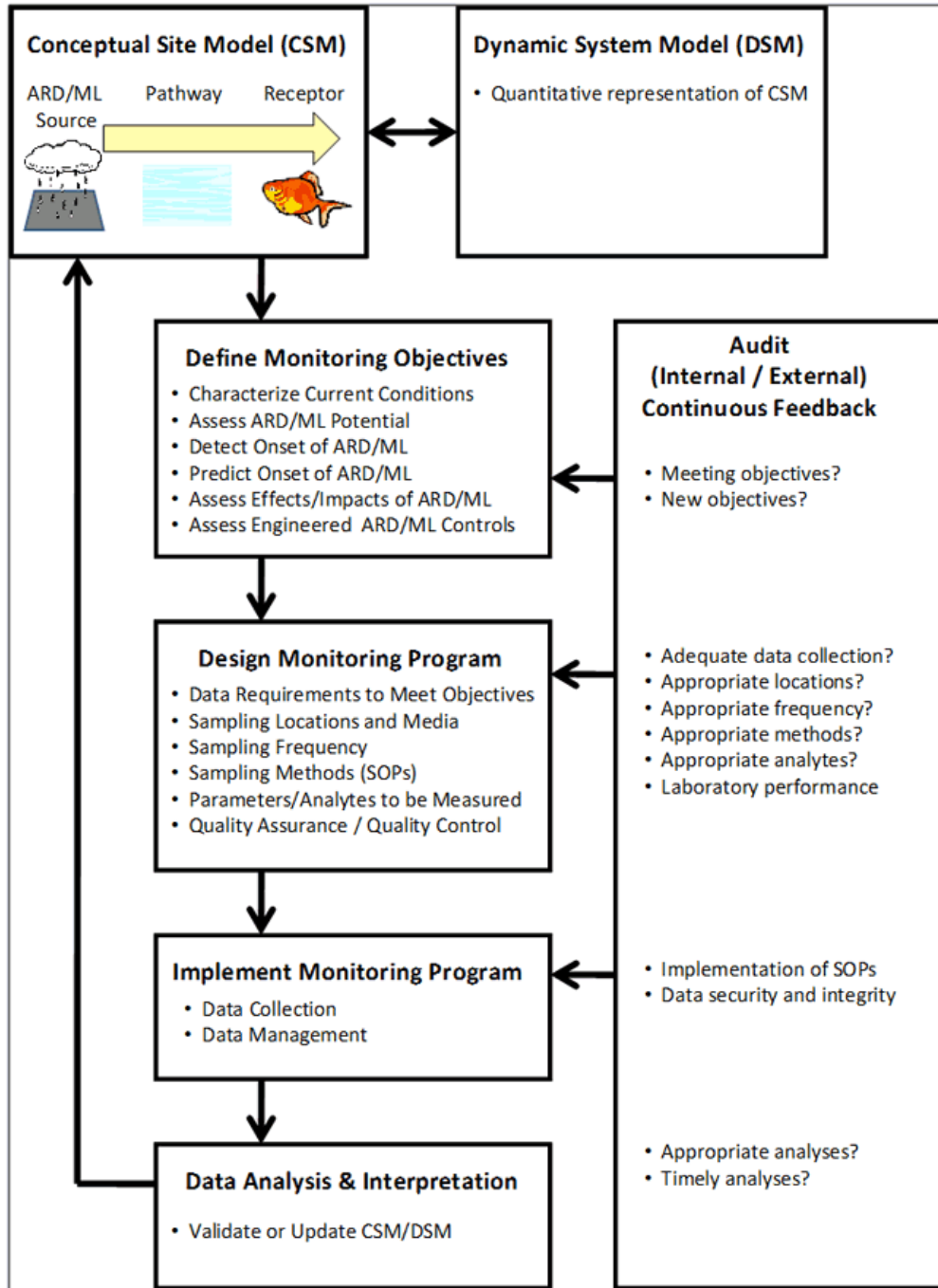

## Manejo del Drenaje Ácido de Roca y Evaluación de Desempeño

El manejo del ARD y la evaluación de su desempeño se describen usualmente dentro del plan de manejo ambiental del sitio o en un plan de manejo del ARD específico del sitio. El plan de manejo del ARD representa la integración de los conceptos y las tecnologías descritas con anterioridad en este capítulo. También hace referencia a los procesos de diseño de ingeniería y a los sistemas de manejo operativos empleados por las compañías mineras.

La necesidad de un plan formal de manejo de ARD usualmente se desencadena por los resultados de un programa de predicción y caracterización del ARD o los resultados de monitoreo del sitio. El desarrollo, evaluación y mejora continua de un plan de manejo de



ARD es una acción continua a lo largo de la vida de una mina. El desarrollo, implementación y evaluación del plan de manejo del ARD usualmente seguirá la secuencia de pasos ilustrados en la Figura 12.

Como se muestra en esta figura, el desarrollo de un plan de manejo de un ARD inicia con el establecimiento de metas y objetivos claros. Éstos pudieran incluir la prevención del ARD o lograr el cumplimiento de criterios específicos de la calidad del agua. Esto incluye la consideración de un planteamiento bio-físico, registro regulador y legal, requerimientos corporativos y de la comunidad, así como consideraciones financieras. Los programas de caracterización y predicción identifican la magnitud potencial del ARD y proveen las bases para la selección y diseño de las tecnologías apropiadas de prevención y mitigación del ARD. El proceso de diseño incluye una serie iterativa de pasos en los que la tecnología de control del ARD es evaluada y luego combinada en un robusto sistema de manejo y control (ejm.: el plan de manejo del ARD) para el sitio específico. El diseño inicial de la mina se puede utilizar para desarrollar el plan de manejo del ARD necesario para una evaluación ambiental. (EA). El diseño final se desarrolla usualmente en paralelo con los permisos del proyecto.

El plan de manejo del ARD identifica los materiales y los desechos que requieren un manejo especial. La evaluación y manejo de riesgos están incluidos en el plan para refinar estrategias pasos de implementación. Para ser efectivo, el plan de manejo de ARD debe estar completamente integrado con el plan de la mina. Los controles operacionales tales como los procedimientos operativos estándar (SOPs), los principales indicadores de desempeño (KPIs) y los programas de aseguramiento/control de calidad (QA/QC) se establecen para guiar su implementación. El plan de manejo del ARD identifica los roles y responsabilidades para el personal operador de la mina. Se incluyen el manejo de datos, análisis y esquemas de reportes para dar un seguimiento al progreso del plan.

En el siguiente paso, se lleva a cabo el monitoreo para comparar el desempeño en el campo contra las metas de diseño y objetivos del plan de manejo. Las suposiciones hechas en los programas de predicción y caracterización y el diseño de las medidas de prevención/mitigación son probadas y revisadas o validadas. Los “aprendizajes” del monitoreo y la evaluación son revisados e incorporados en el plan como parte de una mejora continua. La responsabilidad para implementar el plan de manejo es revisada para asegurar que aquellos responsables cumplan con los requerimientos estipulados en el plan. Se deberán conducir revisiones internas y externas o auditorías para medir el desempeño del personal, los sistemas de manejo y los componentes técnicos para proporcionar perspectivas adicionales en la implementación del plan de manejo del ARD. Es necesaria una revisión del sitio y de la administración corporativa de la planta entera para asegurar que el plan continúe apegado a las normas corporativas y del sitio. En esta etapa, se pueden realizar evaluaciones adicionales de riesgo y manejo para evaluar los efectos de condiciones cambiantes o desviaciones en el plan. Finalmente, se evalúan los resultados contra las metas. Si se cumplen los objetivos, la evaluación del desempeño y el monitoreo continúa a lo largo de la vida de la mina con revisiones periódicas contra las metas. Si los objetivos no se cumplen, entonces se requiere del re-diseño y la re-evaluación del plan de manejo y de los sistemas de evaluación del desempeño y monitoreo para la prevención/mitigación del ARD. Este trabajo adicional también podría requerir de caracterización y predicción de ARD adicionales.

El proceso descrito en la Figura 12 resulta en una mejora continua del plan de manejo del ARD y su implementación, y acomoda las posibles modificaciones en el plan de la mina. Si el plan inicial de manejo del ARD es sólido, puede ser más adaptable a los cambios en el plan de la mina.

Implementar el plan de manejo del ARD depende de una jerarquía de herramientas de manejo. Las políticas corporativas ayudan a definir los estándares corporativos o del sitio, los cuales conducen a SOPs y KPIs que son específicos para el sitio y son guía para los operadores al implementar el plan de manejo del ARD. Cuando no existan políticas ni estándares corporativos, los proyectos y operaciones deberán basarse en las mejores prácticas del sector.

## **Comunicación y Retroalimentación del Drenaje Ácido de Roca**

El nivel de conocimiento de generación y mitigación del ARD se ha incrementado dramáticamente en las últimas décadas dentro de la industria minera, la academia y las agencias reguladoras. Sin embargo, con el propósito de que este conocimiento sea significativo para un amplio rango de interesados generalmente involucrados en un proyecto minero, se debe traducir a un formato que sea fácilmente entendible. Esta retroalimentación deberá comunicar las predicciones de la futura calidad de drenaje y la efectividad de los planes de mitigación, su grado de seguridad y las medidas de contingencia para tratar la incertidumbre. Un diálogo abierto sobre lo que se conoce y lo que se puede predecir con los distintos niveles de confianza, ayuda a construir la comprensión y la confianza y esto resulta a la larga, en un mejor plan de manejo del ARD.

La comunicación y la retroalimentación con las partes interesadas respecto al ARD son esenciales para la licencia social de la compañía para operar. Debido a la generalmente alta naturaleza visible del ARD, se necesitan medidas especiales y gente especializada para comunicarse con efectividad y se requiere del involucramiento de representantes de todas las disciplinas técnicas relevantes en una compañía minera.

## Resumen

El drenaje ácido de roca es uno de los problemas ambientales que enfrenta la industria minera. Una evaluación exhaustiva del potencial de ARD se debe conducir antes del trabajo minero y continuarla a lo largo de la vida de la mina. Consistentes con los principios de sustentabilidad, las estrategias para tratar con el ARD se deben enfocar en la prevención o minimización, preferentemente que el control o tratamiento. Estas estrategias están formuladas dentro del plan de manejo del ARD, para ser desarrolladas en las fases tempranas del proyecto, junto con los requerimientos de monitoreo para evaluar su desempeño. La integración del plan de manejo del ARD con el plan de operación de la mina es de suma importancia para el éxito de la prevención del ARD. Las principales prácticas para el manejo del ARD siguen evolucionando, pero tienden a ser específicas del sitio y requieren expertos en el tema.

## Referencias

- International Network for Acid Prevention (INAP), 2009. The Global Acid Rock Drainage Guide. <http://www.gardguide.com>
- Jambor, J.L. 2003. Mine-Waste Mineralogy and Mineralogical Perspectives of Acid-Base Accounting. In: Environmental Aspects of Mine Wastes (Eds.: Jambor, J.L., D.W. Blowes, and A.I.M. Ritchie). Short Course Series Volume 31. Mineralogical Association of Canada.
- Nordstrom, D.K. 2003. Effects of Microbiological and Geochemical Interactions in Mine Drainage. In: Environmental Aspects of Mine Wastes (Eds. Jambor, J.L., D.W. Blowes, and A.I.M. Ritchie). Short Course Series Volume 31. Mineralogical Association of Canada.
- Nordstrom, D.K., and Alpers, C.N. 1999. Geochemistry of Acid Mine Waters. In: The Environmental Geochemistry of Mineral Deposits, Part A: Processes, Techniques and Health Issues (Eds.: Plumlee, G.S., and M.J. Logsdon). Reviews in Economic Geology Vol 6A. Society of Economic Geologists, Inc.
- Plumlee, G.S. 1999. The Environmental Geology of Mineral Deposits. In: The Environmental Geochemistry of Mineral Deposits, Part A: Processes, Techniques and Health Issues (Eds.: Plumlee, G.S., and M.J. Logsdon). Reviews in Economic Geology Vol 6A. Society of Economic Geologists, Inc.
- Plumlee, G.S., K.S., Smith, M.R., Montour, W.H. Ficklin, and Mosier. E.L. 1999. Geologic Controls on the Composition of Natural Waters and Mine Waters Draining Diverse Mineral-Deposit Types. In: The Environmental Geochemistry of Mineral Deposits, Part B: Case Studies and Research Topics (Eds.: Filipek, L.H. and G.S. Plumlee). Reviews in Economic Geology Vol 6B. Society of Economic Geologists, Inc.
- Stumm, W. and Morgan, J.J. 1981. Aquatic Chemistry. Second Edition. New York: John Wiley & Sons.

Figura 12: Diagrama de flujo para la Evaluación de Desempeño y Revisión por la Dirección (INAP, 2009)

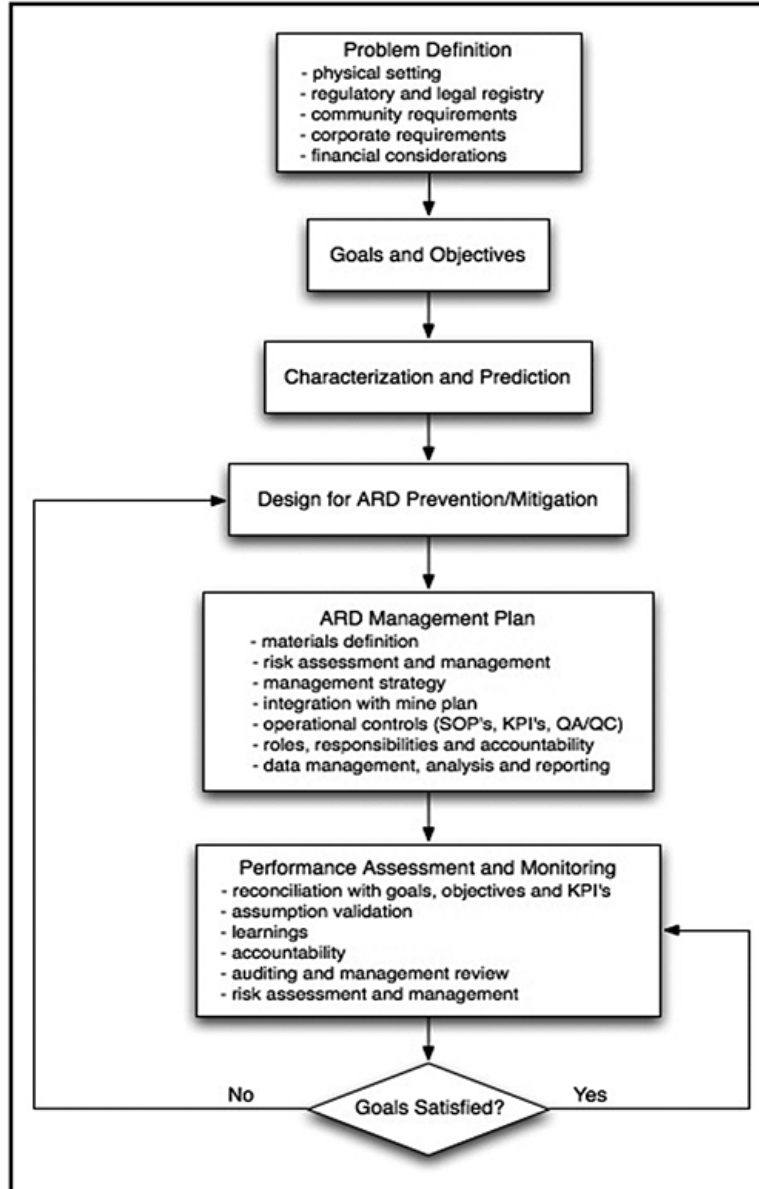

# Sommaire

## From GARDGuide

- Introduction
- La production de drainage rocheux acide
- Cadre de travail pour la gestion du drainage rocheux acide
- Caractérisation
- Prévisions
- Mesures de prévention et d'atténuation des effets
- Traitement du drainage rocheux acide
- Suivi du drainage rocheux acide
- Gestion du drainage rocheux acide et évaluation de sa performance
- Processus de communication et de consultation relatifs au drainage rocheux acide
- Résumé
- Références

## Introduction

Le guide intitulé Global Acid Rock Drainage (GARD) traite des mesures de prévision, de prévention et de gestion des produits de drainage issus de l'oxydation de minéraux sulfurés. Ce processus est désigné par diverses expressions telles que « drainage rocheux acide » (DRA), « drainage minier acide » (DMA) ou « drainage acide et métallifère » (DAM), « eaux touchées par l'exploitation minière » (ETEM), « drainage salin » (DS) et « drainage minier neutre » (DMN).

Le présent sommaire adopte la structure générale établie dans le guide GARD, soit celle d'un sommaire de l'état des meilleures pratiques et technologies élaboré sous l'égide de l'INAP (International Network for Acid Prevention) afin d'aider les parties concernées du domaine du DRA, notamment les exploitants de mines, les organismes de réglementation, les collectivités et les experts-conseils, à résoudre les questions relatives à l'oxydation de minéraux sulfurés. Le lecteur peut avoir accès à des renseignements additionnels sur les sujets abordés dans le présent sommaire en consultant le guide GARD. Celui-ci a été rédigé grâce aux commentaires et à l'aide de nombreuses personnes et organisations. Leur contribution est par la présente reconnue avec vive reconnaissance.

Le drainage rocheux acide est issu de l'oxydation naturelle de minéraux sulfurés qui ont été exposés à l'air et à l'eau. Des activités associées à l'excavation de la roche contenant des minéraux sulfurés, par exemple l'exploitation minière des métaux et du charbon, accélèrent le processus. Les eaux de drainage issues du processus d'oxydation peuvent être de neutres à acides et contenir ou non des métaux lourds dissous, mais elles contiennent toujours des sulfates. Le DRA est attribuable à une série de réactions et d'étapes qui, de manière générale, font passer les conditions d'un milieu de pH presque neutre à des conditions de pH plus acide. Lorsque des minéraux basiques sont présents en quantités suffisantes pour neutraliser les eaux de DRA, le processus d'oxydation peut entraîner le drainage minier neutre ou le drainage salin. Le DMN est caractérisé par des fortes concentrations de métaux en solution à un pH quasiment neutre, tandis que les eaux de DS présentent de fortes concentrations de sulfates à un pH neutre et l'absence de toute concentration importante de métaux dissous. Les schémas de la figure 1 illustrent les divers types de processus de drainage.

Figure 1: Types de drainage provenance de l'oxydation de minéraux sulfurés

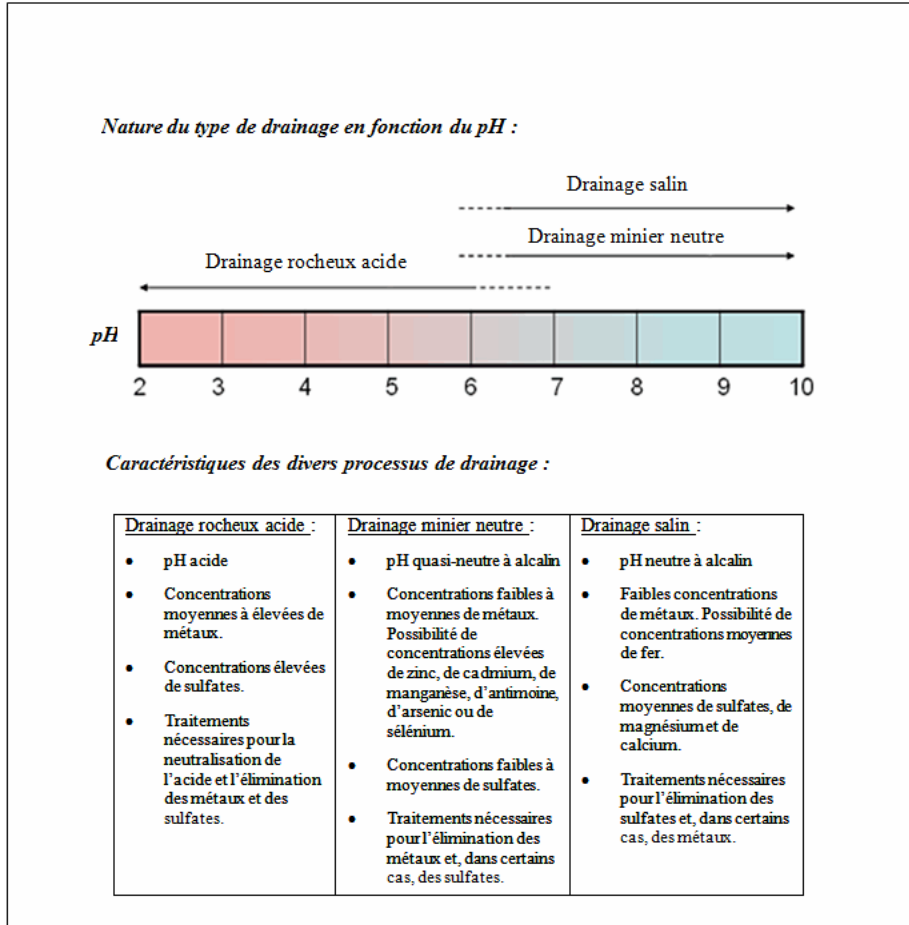

Figure 2: Exemple de drainage rocheux acide à proximité d'une entrée de mine romaine, en Espagne



Une fois que le processus de DRA a débuté, il peut être très difficile de l'interrompre, car c'est un processus qui, en l'absence de toute mesure d'atténuation, se poursuit (et peut même s'accélérer) jusqu'à ce qu'un ou plusieurs des réactifs (minéraux sulfurés, oxygène, eau) s'épuisent ou ne puissent plus participer à la réaction. Le processus de DRA peut se poursuivre pendant des décennies et même des siècles après l'arrêt des travaux d'extraction, ce qu'illustrent bien les conditions à proximité d'une entrée de mine située en Espagne, qui date de l'époque romaine (figure 2).

Les coûts associés aux mesures correctives du DRA dans les mines orphelines d'Amérique du Nord sont estimés à des dizaines de milliards de dollars américains. Les responsabilités de l'exploitant d'une mine qui a fermé ses portes et les travaux visant à corriger le DRA et à traiter les eaux de DRA peuvent entraîner des coûts totalisant des dizaines et même des centaines de millions de dollars si la gestion adéquate du processus d'oxydation des minéraux sulfurés n'a pas été assurée au cours de la durée de vie de la mine.

La caractérisation adéquate de l'aménagement d'une mine, l'élaboration de prévisions valables sur la qualité du processus de drainage et la gestion efficace des rejets miniers peuvent, dans la plupart des cas, prévenir le DRA, et, dans tous les cas, réduire au minimum la production d'eaux de DRA. Les premières mesures pour prévenir le DRA doivent être prises lors des travaux d'exploration et se poursuivre tout au cours du cycle de vie de la mine. La planification et la gestion continues du DRA sont des éléments clés de la prévention de ce processus.

Dans le cas de nombreuses mines, le problème de DRA ne se présente pas, notamment lorsque les propriétés géochimiques intrinsèques des rejets miniers ne favorisent pas son enclenchement ou lorsque les conditions climatiques sont celles d'un milieu très aride. De plus, les exploitants de mines qui ont mis en oeuvre des outils de prévision efficaces et, au besoin, des mesures de prévention et des programmes de suivi, ne devraient pas avoir à résoudre des problèmes de DRA importants.

En adoptant une approche globale pour assurer la gestion du DRA, il est possible de réduire les risques pour l'environnement et les coûts subséquents que doivent assumer l'industrie minière et les gouvernements, de réduire les incidences environnementales nuisibles et de favoriser l'appui du public pour les activités minières. La portée de l'approche de gestion du DRA et ses éléments particuliers qui doivent être mis en oeuvre sur un site minier donné dépendent de nombreux facteurs propres au site et non seulement à ceux associés à la possibilité que l'exécution du projet produise du DRA.

### La production de drainage rocheux acide

L'oxydation des minéraux sulfurés et la production de DRA, de DMN et de DS constituent un processus très complexe, lequel comprend de multiples réactions chimiques et biologiques qui varient grandement en fonction des conditions environnementales, géologiques et climatiques (Nordstrom et Alpers, 1999). Les minéraux sulfurés présents dans les gisements de minerai ont été formés dans des conditions réductrices, en absence d'oxygène. Lorsqu'ils sont exposés à l'oxygène atmosphérique ou à des eaux contenant de l'oxygène, à la suite de travaux d'extraction, de traitement du minerai, d'excavation ou d'autres activités de terrassement, les minéraux sulfurés peuvent devenir instables et s'oxyder. La figure 3 présente un modèle simplifié de l'oxydation de la pyrite, le principal minéral sulfuré responsable du DRA (Stumm et Morgan, 1981). Les réactions sont illustrées sous forme schématique et ne représentent pas nécessairement les mécanismes exacts, mais la figure constitue tout de même un outil efficace pour visualiser et comprendre l'oxydation des minéraux sulfurés.

La réaction chimique de l'oxydation de la pyrite (réaction [1]) exige la présence de trois ingrédients principaux, soit la pyrite, l'oxygène et l'eau. La réaction peut avoir lieu en milieu abiotique ou biotique (c.-à-d. par le biais de microorganismes). Dans ce dernier cas, des bactéries comme *Acidithiobacillus ferrooxidans*, qui tirent leur énergie métabolique de l'oxydation du fer ferreux en fer ferrique, peuvent accélérer la vitesse de la réaction d'oxydation et l'accroître de plusieurs ordres de grandeurs comparativement aux vitesses de réaction en milieu abiotique (Nordstrom, 2003). La pyrite peut non seulement subir une réaction d'oxydation directe, mais elle peut aussi être dissoute et ensuite oxydée (réaction [1a]).

Figure 3: Modèle de l'oxydation de la pyrite (Stumm et Morgan, 1981).

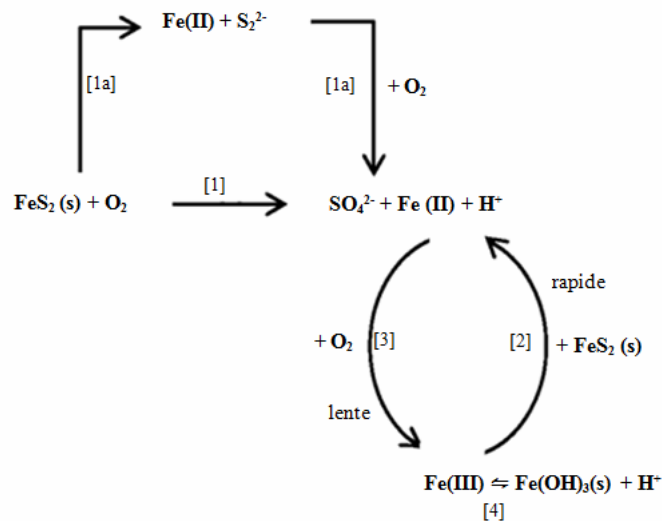

Dans la plupart des circonstances, l'oxygène atmosphérique joue le rôle d'oxydant. Toutefois, le fer ferrique en phase aqueuse peut aussi oxyder la pyrite selon la réaction [2]. Celle-ci est beaucoup plus rapide (de 2 à 3 ordres de grandeur) que la réaction avec l'oxygène et la quantité d'acide produit par mole de pyrite oxydée est grandement supérieure. Cette réaction est cependant restreinte à des conditions dans lesquelles les quantités de fer ferrique dissous

sont importantes (c.-à-d. des conditions acides où le pH est égal ou inférieur à 4,5). L'oxydation du fer ferreux par l'oxygène (réaction [3]) est nécessaire pour produire du fer ferrique et reconstituer les quantités initiales de ce composé et de plus, des conditions acides sont essentielles pour que le fer ferrique demeure en solution et participe au processus de production de DRA. Comme la réaction l'indique clairement, l'oxygène doit être présent pour produire du fer ferrique à partir de fer ferreux. En outre, les bactéries qui peuvent catalyser cette réaction (principalement celles du type *Acidithiobacillus* genus) ont besoin d'oxygène pour assurer la respiration cellulaire aérobie. Une certaine quantité d'oxygène est par conséquent nécessaire pour que le processus soit efficace, et ce, même si des bactéries servent de catalyseurs, mais il faut préciser que la quantité d'oxygène requise est bien inférieure à celle d'une oxydation en milieu abiotique.

Le sort du fer ferreux issu de la réaction [1] constitue un facteur environnemental d'importance en matière de production de DRA. Le fer ferreux peut être extrait d'une solution, dans des conditions de pH légèrement acide à alcalin, par oxydation suivie d'une hydrolyse et formation ultérieure d'un hydroxyde de fer relativement insoluble (réaction [4]). La combinaison des réactions [1] et [4], qui a généralement lieu quand les conditions ne sont pas très acides (c.-à-d. lorsque le pH > 4,5), se traduit par une oxydation de la pyrite qui produit deux fois plus d'acide, comparativement à la réaction [1], selon l'équation suivante :

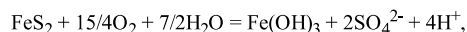

Cette équation représente la réaction la plus couramment utilisée pour décrire l'oxydation de la pyrite.

Bien que la pyrite soit de loin le principal minéral sulfuré responsable de la production d'acide, les divers gisements de minerai contiennent différents types de minéraux sulfurés. Ce ne sont pas tous les minéraux sulfurés qui sont acidogènes lors de leur oxydation. De manière générale, les sulfures de fer (pyrite, marcassite, pyrrhotite), les sulfures où le rapport molaire métal/soufre est inférieur à 1 et les sulfosels (p. ex. l'énargite) produisent de l'acide lorsqu'ils réagissent avec l'oxygène et l'eau. Les sulfures où le rapport molaire métal/soufre est égal à 1 (p. ex. la sphalérite, la galène, la chalcopryrite) ont tendance à ne pas produire d'acide lorsque l'oxydant est l'oxygène. Toutefois, lorsque le fer ferrique en phase aqueuse constitue l'oxydant, tous les sulfures sont acidogènes. Par conséquent, le potentiel acidogène d'un gisement de minerai ou de rejets miniers dépend généralement de la quantité de sulfures de fer présents.

Les réactions de neutralisation jouent aussi un rôle clé dans la détermination des compositions caractéristiques des produits de drainage issus de l'oxydation de sulfures. Tout comme dans le cas des minéraux sulfurés, la réactivité et, conséquemment, l'efficacité des minéraux neutralisants pour tamponner tout acide produit, peuvent grandement varier. La plupart des minéraux carbonatés peuvent se dissoudre rapidement, ce qui en fait d'efficaces neutralisants d'acide. Toutefois, l'hydrolyse du fer (Fe) ou du manganèse (Mn) dissous, issus de la dissolution de leurs carbonates respectifs, et la précipitation subséquente d'un minéral secondaire, peuvent entraîner la formation d'acide. Bien qu'ils soient généralement plus courants que les phases carbonatées, les minéraux aluminosilicatés ont tendance à être moins réactifs que celles-ci et leur effet tampon peut, dans certains cas où les conditions du milieu sont assez acides, permettre seulement la stabilisation du pH. Les données de certaines études indiquent que les silicates de calcium et de magnésium peuvent tamponner les effluents miniers et rendre leur pH neutre lorsque les vitesses d'oxydation des sulfures sont très faibles (Jambor, 2003).

La combinaison des réactions de production d'acide et de neutralisation d'acide se traduit habituellement par un processus de production de DRA par étapes (figure 4). Au fil du temps, le pH diminue en passant par une série de plateaux, en fonction du tamponnage de différents assemblages minéraux. La période précédant le début de la production d'acide constitue un facteur très important en matière de prévention du DRA. Il s'avère beaucoup plus efficace (et généralement beaucoup moins coûteux, à long terme) de maîtriser la production de DRA au cours des premières étapes. La période susmentionnée a aussi des incidences significatives sur l'interprétation des résultats. Puisque la première étape de production de DRA peut être très longue, et ce, même dans le cas de matières pouvant devenir très acidogènes, il est essentiel de clairement identifier l'étape d'oxydation lors de la détermination du potentiel acidogène du DRA. Il est possible que les résultats préliminaires d'essais géochimiques ne soient pas représentatifs de la stabilité environnementale à long terme des formations géologiques visées et de la qualité des effluents connexes. De tels résultats d'essais préliminaires peuvent toutefois constituer des données précieuses pour évaluer des conditions futures et des éléments qui leur sont associés comme les vitesses de neutralisation des minéraux neutralisants disponibles.

Un corollaire est fréquemment établi entre l'oxydation des sulfures et la lixiviation des métaux (LM), ce qui explique que les sigles « DRA/LM » ou « LM/DRA » sont couramment utilisés pour décrire avec plus d'exactitude la nature du drainage minier acide. Les métaux présents à fortes concentrations et les métaux traces issus du DRA, du DMN et du DS proviennent de l'oxydation des sulfures et de la dissolution des minéraux qui neutralisent l'acide. Dans le cas particulier du DRA, ce sont le fer (Fe) et l'aluminium (Al) qui constituent habituellement les principaux métaux dissous à fortes concentrations, mais les concentrations de métaux traces comme Cu, Pb, Zn, Cd, Mn, Co et Ni peuvent aussi être élevées. Lorsque les effluents miniers présentent un pH quasineutre, leurs concentrations tendent à être plus faibles en raison de la formation de phases minérales secondaires et d'un phénomène de sorption plus important. Certains composés restent toutefois en solution lorsque le pH augmente, particulièrement certains métalloïdes comme As, Se et Sb, ainsi que d'autres métaux traces (p. ex. Cd, Cr, Mn, Mo et Zn).

Figure 4: Étapes de production de DRA

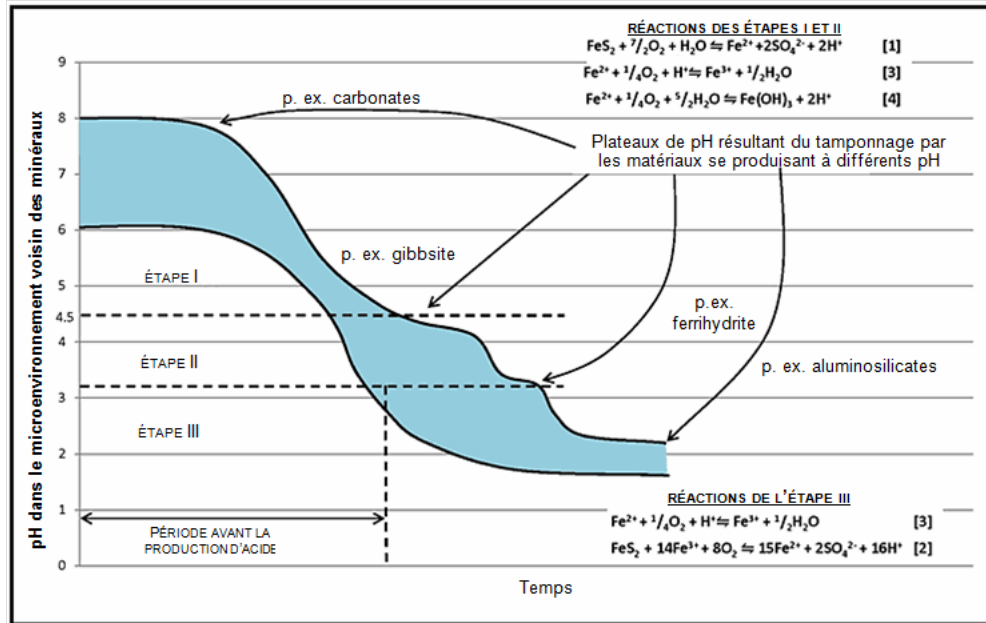

### Cadre de travail pour la gestion du drainage rocheux acide

Les questions et les approches relatives à la prévention et à la gestion du DRA sont les mêmes partout dans le monde. Les techniques particulières servant à réaliser les prévisions de DRA, l'interprétation des résultats d'essais de DRA et la gestion du DRA peuvent toutefois différer selon le contexte local, régional ou national, et il faut habituellement les adapter aux conditions climatiques et topographiques et à d'autres conditions propres au site minier.

Il n'existe donc pas d'approche « uniformisée et universelle » pour la gestion du DRA, et ce, malgré le fait que les questions connexes, à l'échelle internationale, sont de nature semblable. Chaque site minier présente des conditions qui lui sont propres et il faut donc réaliser une évaluation soignée du projet visé afin d'identifier une stratégie de gestion qui peut être intégrée aux cadres plus larges relatifs à la réglementation ainsi qu'à la société d'exploitation et aux collectivités. Les paramètres propres au site comprennent la conjoncture sociale, économique et environnementale dans laquelle l'exploitation de la mine s'effectue, tandis que le cadre de travail comporte, entre autres, les normes réglementaires et celles adoptées par les entreprises qui sont pertinentes, ainsi que les attentes et les exigences particulières des collectivités. La figure 5 illustre un cadre conceptuel de ce type, qui s'applique durant tout le cycle de vie d'une mine.

Les sociétés minières de toutes tailles doivent respecter les lois et règlements relatifs au DRA des pays où elles exploitent des mines. On considère aussi que de bonnes pratiques d'entreprise comprennent le respect de directives de niveau international en matière de DRA, lequel constitue dans de nombreux cas une des conditions liées au financement d'un projet.

Bon nombre de sociétés minières ont adopté des directives claires qui témoignent de leurs priorités en matière de DRA et de leur interprétation des meilleures pratiques connexes. Il faut cependant adopter une approche prudente afin de s'assurer que tous les éléments des règlements nationaux sont respectés, car les directives des entreprises relatives au DRA ne peuvent en aucun cas se substituer aux règlements des différents pays.



**Figure 5: Cadre conceptuel de gestion du DRA**

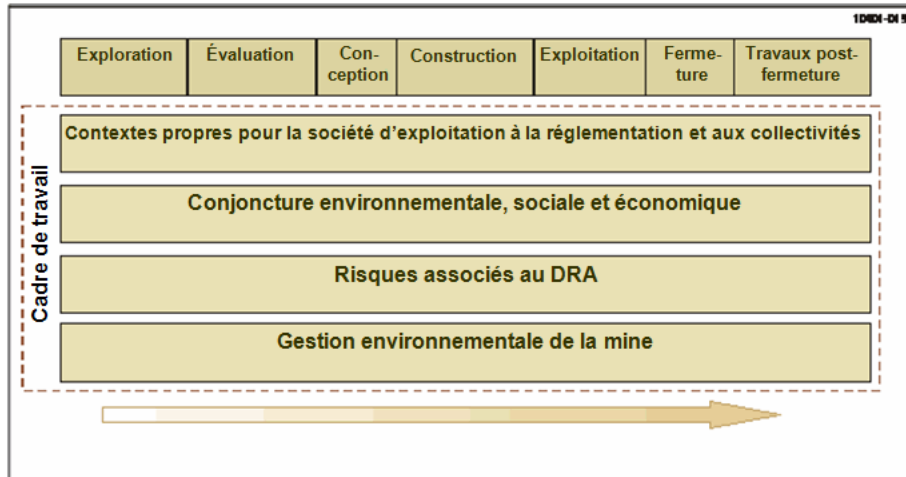

Les travaux des sociétés minières sont exécutés en tenant compte des contraintes d'un « permis d'exploitation social » qui, idéalement, se fonde sur un large consensus regroupant tous les intervenants. La nature même du consensus comporte généralement une vaste gamme d'éléments sociaux, économiques et environnementaux et des éléments de gouvernance (liés au développement durable). Le DRA constitue un élément clé du permis d'exploitation social d'une mine, car ses effets comptent habituellement parmi les répercussions environnementales les plus visibles de l'exploitation minière. Les coûts des travaux de fermeture de la mine et de ceux de postfermeture liés à la gestion du DRA font maintenant partie intégrante du budget de toute mine en exploitation et de tout projet de mine. De nos jours, de nombreux pays et États exigent une quelconque garantie financière ayant trait à ces éléments particuliers.

### Caractérisation

La production de DRA, le drainage et le transport des eaux acides dans l'environnement et l'adoption de mesures d'atténuations correctives en cas de DRA constituent des processus complexes régis par une combinaison de facteurs physiques, chimiques et biologiques. Le fait que le DRA puisse constituer un problème environnemental réel dépend en grande partie des caractéristiques des sources, des voies d'accès et des milieux récepteurs touchés. Il est donc essentiel de pouvoir caractériser ces aspects avant d'effectuer des prévisions et pour faciliter les mesures de prévention et les travaux de gestion du DRA. La nature des programmes de caractérisation environnementale permet de recueillir assez de données pour répondre aux questions de la liste suivante :

1. Quelle est la probabilité que le DRA se produise? Quel type de drainage est prévu (DRA/DMN/DS)?
2. Quelles sont les sources de DRA? Quelles quantités d'eaux de DRA seront produites et à quel moment ou à quelle période le seront-elles?
3. Quelles sont les voies d'accès qui permettent le transport des contaminants jusqu'aux milieux récepteurs?
4. Quelles sont les incidences environnementales prévues du DRA dans l'environnement?
5. Quelles sont les mesures qui peuvent être adoptées afin de prévenir le DRA, d'en atténuer les effets ou d'en assurer la gestion?

Les caractéristiques géologiques et minéralogiques du gisement et de la roche hôte constituent les principaux contrôles géologiques associés au type de drainage qui se produit lors de l'exploitation minière. Par la suite, ce sont les conditions climatiques et les propriétés hydrologiques ou hydrogéologiques du site qui déterminent la manière dont les composants de drainage sont transportés dans le milieu récepteur et jusqu'aux récepteurs. Pour évaluer ces questions, il faut utiliser des connaissances spécialisées de multiples domaines, notamment la géologie, la minéralogie, l'hydrologie, l'hydrogéologie, la géochimie, la microbiologie, la météorologie et divers secteurs du génie.

Les caractéristiques géologiques des gisements minéraux exercent d'importants contrôles prévisibles sur le profil environnemental des zones minéralisées (Plumlee, 1999). Il faut donc baser l'évaluation préliminaire de la probabilité de DRA sur l'examen de données géologiques recueillies durant les travaux d'exploration minière. La détermination des concentrations de référence des métaux dans divers milieux (c.-à-d. les eaux, les sols, les plantes et le biote) peut aussi fournir une indication de la probabilité de DRA; de plus, ces données peuvent être intégrées à des documents sur les possibles concentrations naturelles élevées de métaux. Au cours des travaux d'aménagement et d'exploitation de la mine, l'évaluation initiale de la probabilité de DRA est perfectionnée au moyen de données de caractérisation détaillées sur la stabilité environnementale des rejets et des minerais. La détermination de la nature exacte des effluents miniers dans l'environnement, notamment leur emplacement et l'importance des quantités produites, est effectuée au cours de la phase d'élaboration de la mine. Des études météorologiques, hydrologiques et hydrogéologiques sont réalisées afin de caractériser la quantité d'eau et la direction de leur écoulement dans le ou les bassins versants de la mine, afin d'évaluer les voies d'accès qui permettent le transport des constituants d'intérêt. Les récepteurs biologiques possibles présents au sein du bassin hydrologique sont identifiés. Au cours de la durée de vie de la mine, les travaux du programme de caractérisation du DRA se concentrent donc progressivement sur des éléments différents et passent de la détermination des conditions de référence à la prévision de la nature et du transport des produits de drainage, et par la suite, au suivi des conditions du milieu et des incidences sur l'environnement.

Malgré les différences qui sont propres à chaque site minier (par exemple le type de minerai exploité, le climat, la phase d'exploitation, le cadre de réglementation en vigueur dans le pays), l'approche générale adoptée visant à caractériser le site est semblable et comporte les activités suivantes :

- Déterminer la nature des produits de drainage pouvant provenir de différentes sources ainsi que leur quantité et leur qualité;
- Identifier les voies d'accès des eaux de surface et des eaux souterraines qui permettent le transport des produits de drainage, des sources aux milieux récepteurs;
- Identifier les récepteurs qui pourraient subir les effets de l'exposition aux produits de drainage;
- Déterminer les risques associés à cette exposition.

Les figures 6 et 7 présentent la chronologie des travaux d'un programme de caractérisation du DRA et les activités de collecte de données couramment exécutées au cours de chacune des phases d'une mine. La plupart des efforts de caractérisation sont réalisés avant la phase de l'extraction minière, soit au cours de celle de planification, d'évaluation et de conception de la mine (travaux qui sont parfois désignés par l'expression englobante de phase d'élaboration de la mine). De plus, les incidences environnementales possibles sont identifiées et des mesures adéquates de prévention et d'atténuation des effets, qui visent à réduire au minimum les répercussions environnementales, sont intégrées au programme. Durant la phase de construction et de mise en service et celle de l'exploitation, il y a transition des activités et celles de caractérisation du site sont remplacées par celles du suivi, lesquelles se poursuivent pendant la phase de mise hors service et de fermeture et celle des travaux de postfermeture. Le suivi permet d'affiner les connaissances sur le site, lesquelles servent ensuite à ajuster les mesures correctives et, conséquemment, à réduire les coûts de fermeture du site et accroître l'efficacité de la gestion des risques.

Figure 6: Aperçu du programme de caractérisation du DRA, selon les phases d'une mine

Phases d'une mine – Connaissances accrues des caractéristiques du site						
Composant du modèle conceptuel du site	Exploration	Planification et conception de la mine et études de faisabilité (Élaboration)	Construction et mise en service	Exploitation	Mise hors service	Travaux de post-fermeture
	Source	Caractérisation du gisement	Essais de laboratoire sur les rejets et les minerais (essais statiques et cinétiques)  Prélèvement et analyse d'échantillons d'eau de sources connues	Essais en laboratoire  Essais de terrain sur les rejets et les minerais	Essais en laboratoire et de terrain  Installations pour le suivi des rejets miniers  Prélèvement et analyse d'échantillons d'eau issue des sources	Suivi de la qualité des eaux
Voie d'accès	Les forages d'exploration peuvent aider à caractériser la présence d'eaux souterraines	Caractérisation hydrogéologique – présence d'eaux souterraines, direction de l'écoulement et débit  Caractérisation hydrologique – écoulement des eaux de surface  Données de référence sur la qualité des eaux de surface et des eaux souterraines  Données de référence sur la qualité des sols et sédiments	Suivi des paramètres hydrogéologiques et hydrologiques et de la qualité des eaux	Suivi des paramètres hydrogéologiques et hydrologiques et de la qualité des eaux	Suivi des paramètres hydrogéologiques et hydrologiques et de la qualité des eaux	Suivi des paramètres hydrogéologiques et hydrologiques et de la qualité des eaux (au besoin)
Récepteurs		Identification des récepteurs  Données de référence de caractérisation (récepteurs et habitat, y compris des études sur les métaux présents dans les plantes)	Suivi des récepteurs et de l'habitat	Suivi des récepteurs et de l'habitat	Suivi des récepteurs et de l'habitat	Suivi des récepteurs et de l'habitat (au besoin)
	Les renseignements sur le gisement facilitent la caractérisation du site et des sources	Travaux de caractérisation optimaux	Caractérisation et suivi			

## Prévisions

Les principaux objectifs des travaux de caractérisation du site comprennent entre autres les prévisions relatives aux probabilités de DRA et à la composition chimique des produits du drainage. Comme les activités de prévision sont directement liées à celles de planification de la mine, particulièrement au chapitre de la gestion des eaux et des rejets de la mine, les efforts de caractérisation doivent être exécutés par étapes, parallèlement au déroulement global de la planification du projet. Les activités initiales de caractérisation sont normalement de nature générale et ne reposent habituellement pas sur des hypothèses particulières, en ce qui a trait à la future conception technique de la mine. Les travaux avancés de caractérisation et de modélisation doivent quant à eux tenir compte des éléments spéciaux de la phase de conception technique et y être eux-mêmes intégrés. Pour ce faire, il peut être nécessaire d'utiliser des outils d'itération, car l'évaluation des probabilités de DRA peut mettre en lumière le besoin de réaliser une nouvelle évaluation globale du plan de mine. L'intégration des activités de caractérisation et d'évaluation à celles de l'exploitation minière constitue un élément clé de la gestion efficace du DRA.

La prévision exacte des futurs drainages d'une mine exige une très bonne compréhension des méthodes d'échantillonnage, d'exécution d'essais et d'analyse

employées, l'estimation fiable des futures conditions physiques et géochimiques du milieu, ainsi que la détermination de la nature des minéraux participants, de leur emplacement et de leur réactivité. Chaque site minier possède des caractéristiques qui lui sont propres et qui sont associées à des facteurs géologiques, géochimiques et climatiques, à la nature des produits minéraux et des méthodes de traitement du minerai, au respect des règlements pertinents et aux attentes des parties intéressées. Les programmes de prévisions doivent donc être élaborés sur mesure, en fonction des caractéristiques de la mine, et de plus, leurs objectifs peuvent grandement varier. Ils peuvent par exemple comprendre l'estimation des besoins en matière de traitement des eaux, la sélection de méthodes adéquates d'atténuation, l'évaluation des répercussions sur la qualité de l'eau et la détermination des sommes requises pour assurer la remise en état du site.

Figure 7: Programme de caractérisation du DRA pour des matières issues de sources ponctuelles, selon les phases d'une mine (INAP, 2009)

		Phases de la mine – Connaissances accrues de la caractérisation des matières issues de sources					
		Exploration	Planification et conception de la mine et études de pré faisabilité et de faisabilité	Construction et mise en service	Exploitation	Mise hors service	Travaux de post-fermeture (Entretien et maintenance)
Type d'installations ou de rejets – Sources possibles de DRA/DMN/DS	<b>Stériles</b>	Descriptions de carottes de forage et données sur leurs teneurs (pétrologie et minéralogie)  Modèle de blocs (quantité de minerai et de stériles)	Essais de laboratoire réalisés sur des échantillons de carottes – prélèvement d'échantillons ciblant les stériles <sup>(4)</sup>	Essais en laboratoire sur des échantillons de carottes de forage de développement <sup>(4)</sup>  Essais de lixiviation réalisés sur le terrain (barils, plates-formes d'essai)	Essais en laboratoire <sup>(4)</sup>  Essais de lixiviation sur le terrain  Prélèvement et analyse d'échantillons d'eaux de ruissellement et d'exfiltration issues des installations de stériles	Prélèvement et analyse d'échantillons d'eaux de ruissellement et d'exfiltration issues des installations de stériles	Prélèvement et analyse d'échantillons d'eaux de ruissellement et d'exfiltration issues des installations de stériles (au besoin)
	<b>Résidus miniers</b>	Examen de données historiques	Essais de laboratoire réalisés sur des résidus de l'usine pilote <sup>(4)</sup>  Analyse des liquides sumageants des essais en usine pilote	Essais en laboratoire réalisés sur des résidus de l'usine pilote <sup>(4)</sup>	Essais en laboratoire sur des échantillons d'effluents issus de résidus <sup>(4)</sup>  Prélèvement et analyse d'échantillons de liquides sumageants et d'eaux de ruissellement du parc à résidus	Prélèvement et analyse d'échantillons de liquides sumageants et d'eaux de ruissellement du parc à résidus	Prélèvement et analyse d'échantillons de liquides sumageants et d'eaux de ruissellement du parc à résidus (au besoin)
	<b>Minerai</b>		Essais de laboratoire réalisés sur des échantillons de carottes <sup>(4)</sup>		Essais en laboratoire <sup>(4)</sup>	Si des piles de stockage de minerai existent, prélèvement et analyse d'échantillons d'eaux de ruissellement et d'exfiltration	
	<b>Fosse</b>		Essais en laboratoire réalisés sur des échantillons de carottes – prélèvement d'échantillons ciblant les parois de la fosse <sup>(4)</sup>		Essais de lixiviation de terrain (p. ex. produits de lavage des parois) Prélèvement et analyse d'échantillons d'eaux (c.-à-d. des puisards, des ruissellements)	Prélèvement et analyse d'échantillons d'eaux de la fosse et d'eaux de débit entrant la fosse	Prélèvement et analyse d'échantillons d'eaux de la fosse (au besoin)
	<b>Chantiers souterrains</b>		Essais en laboratoire réalisés sur des échantillons de carottes – prélèvement d'échantillons ciblant les parois des galeries de la mine <sup>(4)</sup>		Prélèvement et analyse d'échantillons d'eaux (c.-à-d. des puisards, des puits d'exhaure)	Prélèvement et analyse d'échantillons d'eaux souterraines de la mine	Prélèvement et analyse d'échantillons d'eaux souterraines de la mine (au besoin)

<sup>(4)</sup> Les essais de laboratoire courants comprennent la détermination de la granulométrie de l'échantillon, l'analyse de la roche totale, la minéralogie, la détermination du bilan acide-base (ABA) et des essais de lixiviation statiques et cinétiques.

Les prévisions relatives à la qualité des produits de drainage peuvent être qualitatives ou quantitatives. Les prévisions qualitatives portent principalement sur l'évaluation des probabilités que des conditions acides se produisent dans les rejets miniers et entraînent par la suite du drainage comprenant des métaux et de l'acide. Si ces prévisions indiquent que les probabilités de DRA sont élevées, les efforts se concentrent sur les solutions permettant de prévenir la production de DRA et l'orientation du programme de prévision est modifiée afin de faciliter l'élaboration et l'évaluation de ces solutions.

Au cours des quelques dernières décennies, des progrès importants ont été réalisés au chapitre de la compréhension du processus de DRA, parallèlement aux avancées effectuées dans les domaines des prévisions de la qualité des eaux de mine et des techniques de prévention connexes. Toutefois, la prévision quantitative de la qualité des eaux de mine peut constituer un défi de taille en raison des très nombreuses réactions participant au processus et, possiblement, des très longues périodes au cours desquelles ces réactions se produisent. Malgré ces facteurs d'incertitude, des prévisions quantitatives ont été élaborées en se basant sur des hypothèses réalistes, tout en tenant compte des éléments limitatifs connexes, et les résultats obtenus se sont révélés très utiles pour identifier des solutions de gestion du DRA et évaluer les incidences environnementales possibles.

Figure 8 : Aperçu général de l'approche adoptée pour les prévisions de DRA (INAP, 2009)

Figure 8: Aperçu général de l'approche adoptée pour les prévisions de DRA (INAP, 2009)

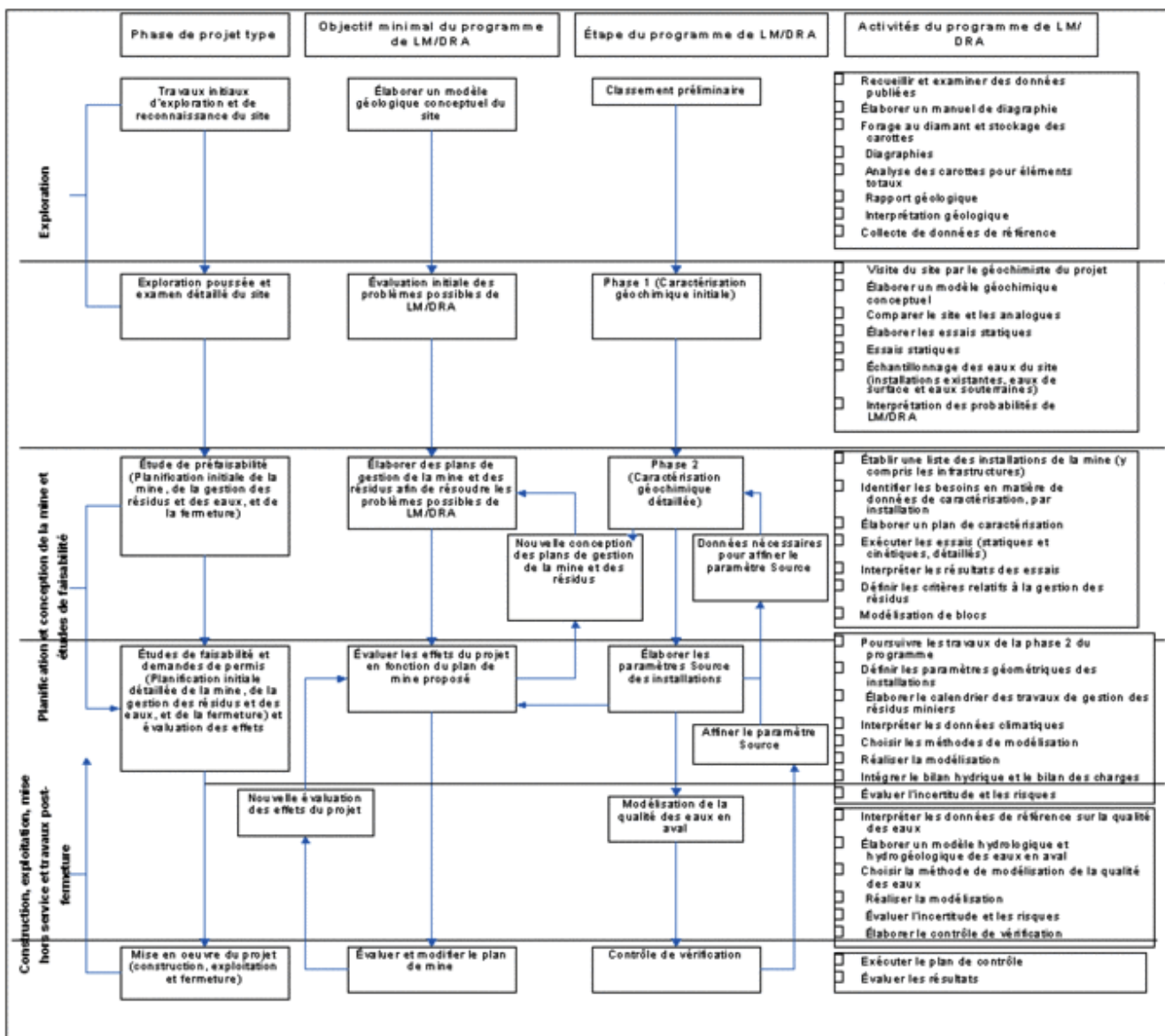

- Les prévisions de la qualité des eaux de mine sont habituellement basées sur un ou plusieurs des éléments suivants :
- Les résultats d'essai de lixiviation réalisés en laboratoire sur des rejets;
- Les résultats d'essais de lixiviation réalisés sur le terrain sur des rejets;
- Les résultats de la caractérisation géologique, hydrologique, chimique et minéralogique des rejets;
- Les résultats d'études de modélisation géochimique et de travaux de modélisation d'autres natures.

Des sites analogues, en cours d'exploitation ou ayant été exploités par le passé, constituent aussi de précieux éléments en matière de prévision du DRA, particulièrement ceux pour lesquels une caractérisation et un suivi poussés ont été réalisés. L'élaboration de modèles géoenvironnementaux représente un des meilleurs exemples de la méthode de « modélisation analogique ». Ces modèles, qui sont en fait des construits permettant d'interpréter les caractéristiques environnementales du gisement de minerai dans un contexte géologique, constituent des outils très utiles pour réaliser l'interprétation et la synthèse des profils environnementaux de gisements et de zones d'exploitation minière, pour un contexte géologique systématique; ils peuvent aussi servir à prévoir des problèmes environnementaux qui pourraient surgir sur les sites de futures mines, de mines en exploitation et de mines orphelines (Plumlee et coll., 1999). La figure 8 présente un aperçu général de l'approche globale adoptée pour les prévisions du DRA.

## Mesures de prévention et d'atténuation des effets

Le principe fondamental sur lequel repose la prévention du DRA consiste à mettre en oeuvre un processus de planification et de conception qui vise à prévenir, inhiber, retarder ou interrompre les processus hydrologiques, chimiques, physiques et microbiologiques qui ont des répercussions sur les ressources hydriques. La prévention doit avoir lieu à l'endroit où se produit la détérioration de la qualité de l'eau, ou à proximité de celui-ci (selon le principe de réduction à la source), ou en mettant en oeuvre des mesures qui permettent de prévenir ou de retarder le transport des produits du DRA jusqu'aux ressources hydriques (c.-à-d. au moyen du recyclage, du traitement ou de la disposition adéquate des produits, ou d'une combinaison de ces solutions). Le principe peut s'appliquer de manière générale, mais les méthodes de mise en oeuvre sont propres à chaque site minier.

La prévention constitue une stratégie proactive qui permet d'éviter l'adoption de l'approche réactive comportant des mesures d'atténuation des effets. Lorsque les conditions existantes de DRA ont des incidences négatives sur l'environnement, la ligne de conduite initiale consiste habituellement à exécuter des mesures d'atténuation. Malgré l'exécution de ces mesures initiales, les mesures de prévention adoptées subséquemment ont souvent pour objectif de réduire les futures charges de contaminants et, par conséquent, les besoins continus en matière de mesures d'atténuation. L'intégration des mesures de prévention du DRA et d'atténuation aux activités d'exploitation de la mine constitue un élément clé de la gestion efficace du DRA.

Avant de pouvoir identifier ou évaluer des mesures de prévention et d'atténuation, il faut déterminer quels sont les objectifs stratégiques pertinents. Le processus doit comporter l'évaluation des éléments suivants :

- Les risques quantifiables pour les écosystèmes, la santé humaine et d'autres récepteurs;
- Les critères relatifs à la qualité des eaux de décharge, qui sont propres au site;
- Les coûts en capital, ceux d'exploitation et ceux d'entretien associés aux mesures de prévention ou d'atténuation;
- La logistique de l'exploitation et de l'entretien à long terme des installations;
- La longévité requise et les modes de défaillances prévus.

Les objectifs usuels, en matière de maîtrise du DRA, visent à respecter les critères environnementaux en utilisant les méthodes les plus rentables. Le processus de sélection des techniques doit tenir compte des prévisions relatives à la composition chimique des eaux de décharge, des avantages et des inconvénients des solutions de traitement, des risques auxquels sont exposés les récepteurs et du contexte réglementaire s'appliquant aux décharges des exploitations minières.

Les décisions en matière de prévention et d'atténuation se fondent sur une approche de planification et de conception basée sur les risques, laquelle s'applique tout au cours du cycle de vie de la mine, mais principalement au cours des étapes d'évaluation et de conception. En se basant sur les risques, le processus vise à quantifier les effets à long terme des options et à utiliser ces connaissances pour choisir celle qui présente la meilleure combinaison de propriétés (p. ex. la capacité de protection, l'acceptation du projet au point de vue réglementaire, l'approbation de la collectivité, les coûts). Des mesures d'atténuation mises en oeuvre dans le cadre d'une stratégie de maîtrise efficace ne devraient nécessiter qu'un minimum d'efforts actifs d'intervention et de gestion.

La prévention constitue l'élément clé qui permet d'éviter l'adoption de mesures d'atténuation très coûteuses. Son principal objectif est d'appliquer des méthodes qui permettent de réduire au minimum la vitesse des réactions auxquelles participent les sulfures, la lixiviation des métaux et la migration ultérieure des produits d'altération issus de l'oxydation de sulfures. Les méthodes de ce type ont notamment les buts suivants :

- Réduire au minimum l'apport d'oxygène;
- Réduire au minimum la présence d'eaux d'infiltration et la lixiviation;
- Éliminer les minéraux sulfurés, réduire au minimum leur présence ou les isoler;
- Maîtriser le pH de l'eau interstitielle;
- Maîtriser les processus bactériens et biogéochimiques pertinents.

Voici une liste de certains des facteurs qui influent sur le choix des méthodes susmentionnées :

- La géochimie des matières issues de la source et les probabilités que ces matières produisent du DRA;
- La nature de la source et ses caractéristiques physiques, y compris l'écoulement d'eau et le transfert d'oxygène;
- L'étape de l'aménagement de la mine (les options sont plus nombreuses lors des premières étapes);
- Le processus et le milieu d'oxydation (les options sont plus nombreuses lors des premières étapes, lorsque le pH est encore quasi-neutre et que

- les quantités accumulées de produits d'oxydation sont faibles);
- La période d'efficacité que doivent présenter les méthodes et la maîtrise des conditions pertinentes;
- Les conditions propres au site (c.-à-d. emplacement, topographie et vides miniers, climat, géologie, hydrologie et hydrogéologie, disponibilité de matières et de plantes);
- Critères relatifs à la qualité des eaux d'effluents miniers;
- Niveau d'acceptation des risques par la société et les autres intervenants.

Il peut être nécessaire d'utiliser plusieurs méthodes pour réaliser les objectifs souhaités. La figure 9 offre un aperçu général des mesures de prévention et d'atténuation des effets du DRA les plus courantes qui peuvent être employées au cours des différentes étapes du cycle de vie d'une mine.

**Figure 9: Aperçu général des mesures de prévention et d'atténuation du DRA (INAP, 2009)**

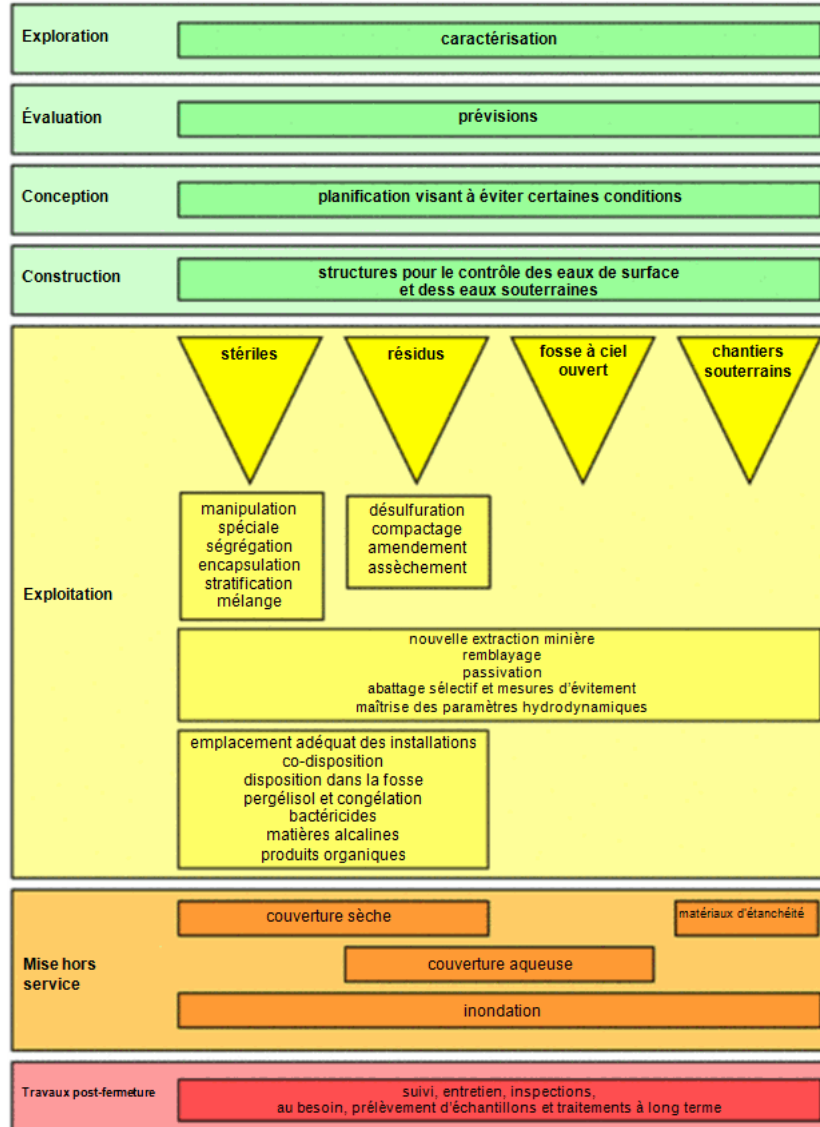

### Traitement du drainage rocheux acide

L'exploitation durable d'une mine exige la mise en oeuvre de programmes visant à maîtriser, gérer et atténuer les effets des travaux d'extraction sur l'environnement. Les incidences de l'exploitation minière sur les ressources hydriques peuvent se poursuivre à long terme, même pendant la phase des travaux post-fermeture. Le traitement des eaux de drainage minier peut constituer un élément des mesures globales de gestion des eaux de la mine au cours de tout le cycle de vie de l'exploitation. Les objectifs d'un programme de traitement du drainage minier sont de nature variée. Il peut être souhaitable ou même obligatoire de récupérer et réutiliser les eaux de mine des chantiers d'exploitation afin, par exemple, de traiter le minerai dans l'usine, de transporter les matières et réaliser divers travaux (élimination des poussières, système de refroidissement de la mine, irrigation des terres remises en état). Le traitement

du drainage minier, dans ce cas particulier, vise à modifier la qualité de l'eau afin qu'elle puisse être utilisée à des fins précises, que ce soit sur le site minier ou hors site.

Les autres objectifs du traitement du drainage minier comprennent la protection de la santé humaine et de la salubrité de l'environnement, lorsque le contact est possible, par utilisation directe ou indirecte, entre des gens ou des récepteurs écologiques et des eaux de mine touchées par les effets du drainage. Le drainage minier peut constituer un milieu de transport de toute une gamme de polluants qui peuvent influencer sur la qualité des ressources hydriques sur le site et hors site. Le traitement des eaux de drainage permettrait d'éliminer les polluants qu'elles contiennent et de prévenir les incidences environnementales connexes ou d'en atténuer les effets.

Dans la plupart des pays et États, tout effluent de produits du drainage minier dans un cours d'eau ou un aquifère public doit être approuvé par l'organisme de réglementation pertinent; d'autre part, ce sont les exigences réglementaires qui stipulent les diverses valeurs associées à la qualité des eaux d'effluents des mines ou aux charges de polluants connexes. Dans de nombreux pays où l'industrie minière est en développement, il est possible qu'aucune norme sur la qualité des eaux ne soit utilisée, mais les responsables du financement du projet et les politiques de l'entreprise garantissent habituellement le respect des normes de qualité de l'environnement adoptées à l'échelle internationale. L'approche à utiliser pour choisir une méthode de traitement du drainage minier repose sur la connaissance profonde du modèle intégré du système de gestion des eaux de la mine et des autres circuits ainsi que sur le ou les objectifs particuliers à atteindre. L'approche globale adoptée dépend d'un certain nombre de facteurs.

Avant de choisir un procédé de traitement, il est essentiel de préparer un document qui énonce clairement les objectifs du traitement. Tout procédé de traitement du drainage minier doit être évalué et mis en oeuvre en tenant compte du système intégré de gestion des eaux de la mine, car il influera sur les débits du système et sur la répartition de la qualité des eaux dans ce dernier. La sélection du procédé de traitement est donc effectuée en se basant sur l'écoulement des eaux de la mine, leur qualité, les coûts connexes et l'utilisation finale de ces eaux.

La caractérisation des eaux de drainage effectuée en fonction des débits et des propriétés chimiques doit tenir compte adéquatement des fluctuations saisonnières et des variations dans le temps. Les données sur les débits sont particulièrement importantes, car elles sont essentielles à la détermination de la capacité de l'usine de traitement. Parmi les autres éléments d'importance, mentionnons les conditions parfois extrêmes liées aux précipitations et à l'eau de fonte de la neige, qui exigent la présence de bassins de retenue, de tuyaux et de fossés de capacité adéquate. Les principales propriétés chimiques d'intérêt, en matière de drainage minier, sont l'acidité et l'alcalinité des milieux, leur teneur en sulfates, leur salinité et leur teneur en métaux. Il faut aussi tenir compte de la présence (ou de l'absence) de composés particuliers associés à des travaux précis de l'exploitation minière, par exemple les cyanures, l'ammoniaque, les nitrates, l'arsenic, le sélénium, le molybdène et les radionucléides. En outre, il est possible qu'un certain nombre de constituants et propriétés du drainage minier (par exemple la dureté de l'eau, la teneur en sulfates et la présence de silice) ne soient pas visés par des règlements ou ne constituent pas un sujet de préoccupation environnementale dans tous les pays et États, mais ils peuvent quand même influencer sur la sélection de la meilleure technique de traitement de l'eau. La manipulation et la disposition des rejets de l'usine de traitement tels que les boues et les saumures, et leurs propriétés chimiques, doivent aussi être considérées lors de prises de décisions sur le traitement.

Les usines de traitement du drainage minier doivent être polyvalentes et avoir la capacité de fonctionner adéquatement lors de hausses ou de diminutions du débit et de variations de la qualité de l'eau, tout en tenant compte des changements apportés aux exigences réglementaires au cours de la durée de vie de la mine. Il faudra donc, dans certaines conditions, mettre en oeuvre le programme par étapes et adopter une approche modulaire lors des travaux de conception et de construction. De plus, les travaux exécutés lors de la phase de postfermeture pourraient imposer des contraintes particulières au chapitre de l'exploitation et de l'entretien des installations de traitement.

Voici une liste des aspects pratiques, associés aux caractéristiques du site minier, qui influent sur la construction, l'exploitation et l'entretien des usines de traitement du drainage minier :

- Le plan de la mine et la topographie du site minier
- L'espace disponible
- Le climat
- Les sources d'eaux de drainage minier qui alimentent les usines de traitement
- L'emplacement des utilisateurs des eaux traitées



Figure 10: illustre un éventail general des possibilités pour le traitement du DRA

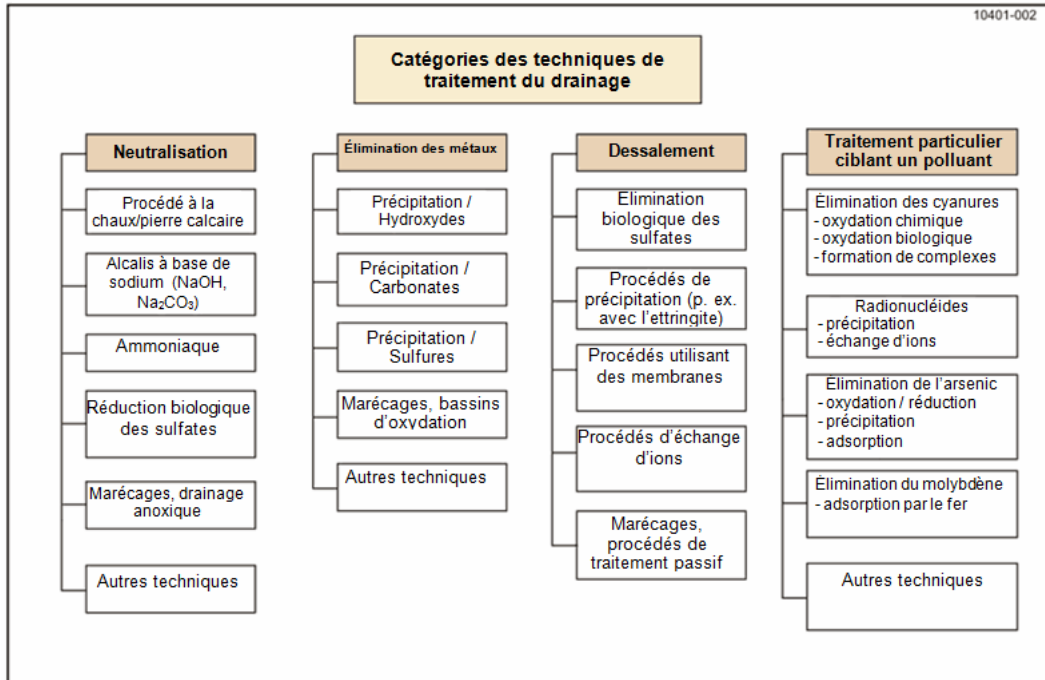

### Suivi du drainage rocheux acide

Le suivi consiste à réaliser la collecte de renseignements de manière répétitive, systématique et pertinente, afin de pouvoir les employer à des fins de gestion et de prise de décisions. Le suivi d'un site minier vise à identifier et caractériser toute modification environnementale causée par les activités minières afin de pouvoir évaluer les conditions propres au site et les incidences possibles sur les récepteurs. Le suivi comporte à la fois l'exécution de travaux d'observation (p. ex. l'enregistrement de données sur l'environnement) et la réalisation d'études (p. ex. des essais de toxicité où les conditions ambiantes sont sous contrôle). Le suivi constitue une étape clé pour la prise de décisions relatives à la gestion du DRA, par exemple lors de l'évaluation de l'efficacité des mesures d'atténuation et, au besoin, de la mise en oeuvre ultérieure des modifications apportées à ces mesures.

La première étape de l'élaboration d'un programme de suivi pour le DRA consiste à examiner le plan de mine, et l'emplacement géographique et le cadre géologique de celui-ci. Le plan de mine fournit des renseignements sur l'emplacement et l'importance des perturbations de surface et de subsurface, les méthodes de concassage, de broyage et de traitement du minerai, les aires de disposition des rejets, ainsi que les endroits où se produisent les effluents, le prélèvement d'eaux souterraines et la déviation des eaux de surface. Ces renseignements servent à identifier des sources possibles de DRA, les voies d'accès qui pourraient permettre aux eaux de DRA d'être libérées dans l'environnement et les récepteurs qui pourraient en subir les effets, ainsi que les mesures d'atténuation qui pourraient être nécessaires. Comme la portée spatiale d'un programme de suivi doit comprendre tous ces composants, il est souvent nécessaire d'adopter une approche globale qui vise le bassin hydrologique (y compris les eaux souterraines). Les activités du programme de suivi sont réalisées à toutes les étapes du développement du projet, depuis les phases précédant l'exploitation jusqu'à celle de postfermeture, mais les objectifs de ces activités, ainsi que leurs constituants et leur intensité, varieront au cours du cycle de vie de la mine. La figure 11 illustre l'élaboration d'un programme général du suivi du DRA et ses principaux éléments.

Figure 11: Development of an ARD Monitoring Program (INAP, 2009)

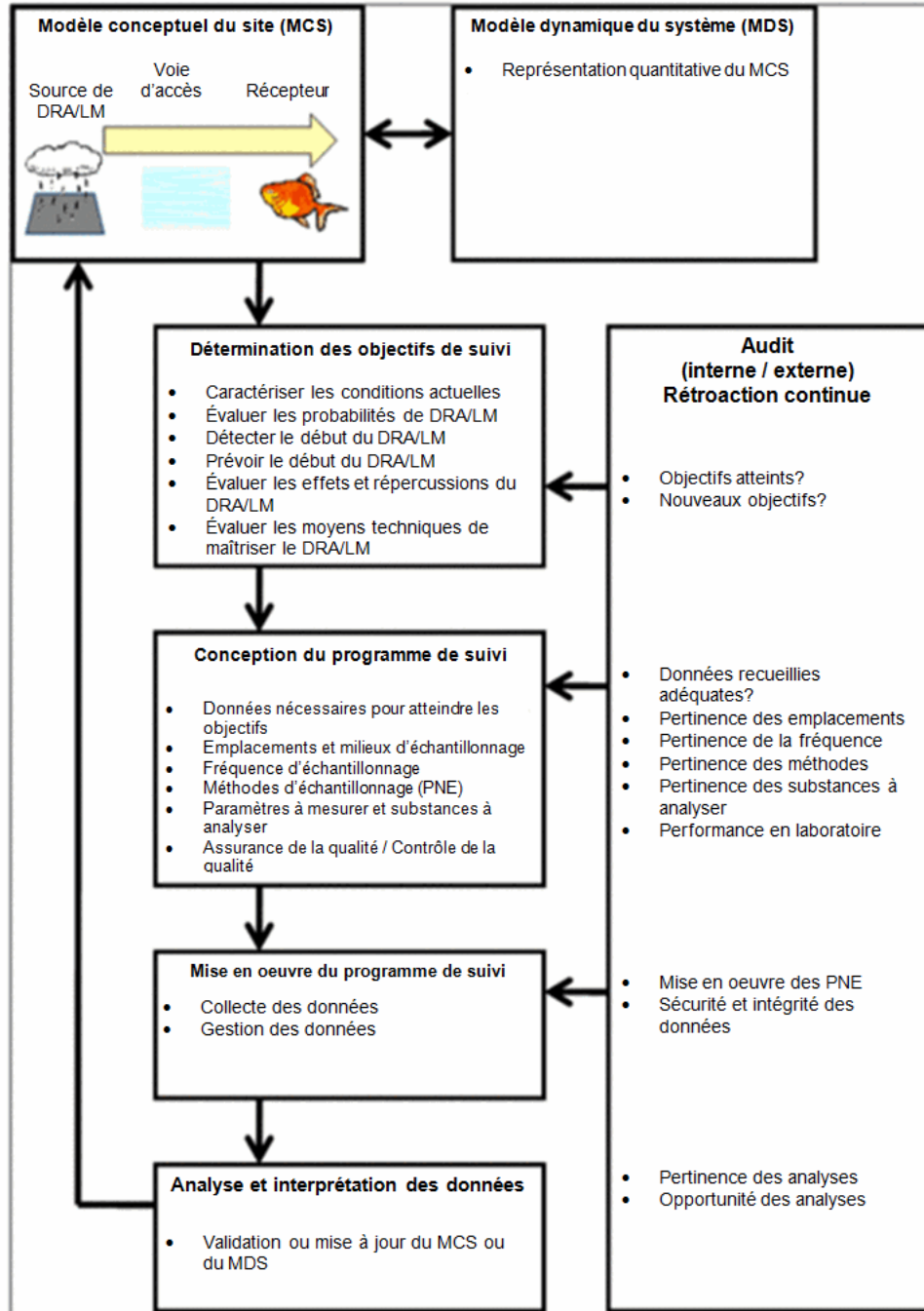

### Gestion du drainage rocheux acide et évaluation de sa performance

La description du processus de gestion du DRA et de l'évaluation de sa performance se trouve habituellement dans le plan de gestion environnementale du site minier ou sinon, dans un plan de gestion du DRA propre au site. Le plan de gestion du DRA représente l'intégration des divers concepts et techniques dont la description apparaît dans les sections précédentes du présent chapitre. Il renvoie aussi aux procédés de conception technique et aux systèmes de gestion de l'exploitation utilisés par les sociétés minières.

L'élaboration d'un plan formel de gestion du DRA est généralement amorcée lorsque les résultats du programme de caractérisation et de prévisions du DRA ou ceux du programme de suivi du site l'exigent. L'élaboration et l'évaluation du plan de gestion du DRA et les mesures connexes d'amélioration continue font partie intégrante d'une démarche globale qui se poursuit tout au long du cycle de vie de la mine. De manière générale, son élaboration, sa mise en oeuvre et son évaluation suivent la série d'étapes illustrée à la figure 12.

Comme l'illustre bien la figure, la première étape de l'élaboration du plan de gestion du DRA consiste à établir des buts et objectifs clairs. Ceux-ci peuvent comprendre la prévention du DRA ou l'atteinte de conditions qui respectent des critères de qualité de l'eau particuliers. Dans le second cas, il faut tenir compte du milieu biophysique, des enregistrements réglementaires et officiels requis, des besoins particuliers de la collectivité et de l'entreprise, ainsi que des contreparties financières. Les programmes de caractérisation et de prévisions permettent de déterminer l'importance que pourraient prendre les problèmes de DRA et servent de base aux processus de sélection et de conception des techniques adéquates de prévention du DRA ou d'atténuation. Le processus de conception comporte une série itérative d'étapes au cours desquelles les techniques de contrôle du DRA sont évaluées puis combinées pour former un plan de gestion robuste pour le DRA et des outils de vérification pour un site minier particulier. Le plan de mine initial peut servir à élaborer le plan de gestion du DRA qui doit être soumis dans le cadre d'une évaluation environnementale (EE), tandis que le plan de mine final est habituellement mis au point parallèlement au processus de demande de permis du projet.

Le plan de gestion du DRA permet de déterminer les matières et les rejets miniers qui exigent un mécanisme de gestion particulier. Des éléments d'évaluation et de gestion des risques sont incorporés au plan afin d'affiner les stratégies et les étapes de la mise en oeuvre. Afin d'être pleinement efficace, le plan de gestion du DRA doit être entièrement intégré au plan de mine. Sa mise en oeuvre est facilitée par l'adoption de contrôles d'exploitation comme les procédures normales d'exploitation (PNE), les indicateurs clés de performance (ICP) et les programmes d'assurance de la qualité et de contrôle de la qualité (AQ/CQ). Le plan de gestion du DRA détermine les rôles, les responsabilités et les obligations de rendre compte des employés de l'exploitation minière. Les progrès réalisés dans le cadre du plan de gestion peuvent être suivis en assurant un système efficace de gestion, d'analyse et de communication des données.

L'étape qui suit consiste à effectuer un suivi en comparant la performance sur le terrain et les buts et objectifs établis lors de la conception du plan de gestion. Les hypothèses émises dans le cadre des programmes de caractérisation et de prévisions et les modèles des mesures de prévention et d'atténuation sont mis à l'épreuve, puis validés ou modifiés. Les « leçons acquises » lors des activités du suivi et d'évaluation sont examinées avant d'être intégrées au plan, dans le cadre du processus d'amélioration continue. Des vérifications sont effectuées afin de s'assurer que les personnes responsables de la mise en oeuvre du plan de gestion respectent les exigences stipulées dans le plan. Des audits internes et externes devraient être réalisés afin de mesurer la performance du personnel, des systèmes de gestion et des composants techniques et de fournir des points de vue supplémentaires sur le processus de mise en oeuvre du plan de gestion du DRA. Les gestionnaires du site minier et de l'entreprise doivent effectuer des examens des résultats des audits afin de s'assurer que les éléments du plan de gestion concordent toujours avec ceux des politiques de l'entreprise et celles relatives au site minier. Des activités additionnelles d'évaluation et de gestion des risques peuvent être exécutées à cette étape particulière afin de déterminer les effets des conditions variables ou des écarts signalés par rapport au plan de gestion du DRA. Finalement, les résultats doivent être évalués en fonction des buts et objectifs établis lors des premières étapes. S'ils ont été atteints, le processus d'évaluation et du suivi de la performance se poursuit au cours du cycle de vie de la mine, au moyen de vérifications périodiques. Dans le cas contraire, il faut entreprendre une nouvelle conception et une nouvelle évaluation du plan de gestion et des systèmes d'évaluation et du suivi visant à prévenir le DRA ou à atténuer ses effets. Ces efforts supplémentaires peuvent aussi exiger de nouveaux travaux de caractérisation et de prévisions du DRA.

Le processus illustré à la figure 12 assure une amélioration continue du plan de gestion du DRA et de sa mise en oeuvre, et de plus, il permet de modifier, au besoin, le plan de mine. Si le plan de gestion initial est robuste, il sera d'autant plus facile de l'adapter aux changements apportés au plan de mine.

La mise en oeuvre efficace du plan de gestion du DRA repose sur un ensemble d'outils de gestion d'importance progressive. Les politiques de l'entreprise servent à établir les normes adoptées par l'entreprise et celles qui s'appliquent au site minier, desquelles découlent les PNE et les ICP propres au site dont se servent les exploitants pour mettre en oeuvre le plan de gestion du DRA. S'il n'existe pas de politiques ou de normes au sein de l'entreprise, la gestion des projets et l'exploitation du site doivent être basées sur les meilleures pratiques de l'industrie.

## **Processus de communication et de consultation relatifs au drainage rocheux acide**

Le niveau des connaissances sur la production du DRA et les mesures d'atténuation de ses effets a grandement augmenté au cours des dernières décennies, que ce soit au sein de l'industrie minière, du milieu universitaire ou des organismes de réglementation. Toutefois, ces connaissances ne peuvent être utiles aux très nombreux intervenants d'un projet minier que si elles sont présentées dans un format qui est facile à comprendre. Les activités de consultation de ce type doivent transmettre des renseignements sur les prévisions relatives à la qualité des futures eaux de drainage et l'efficacité des plans d'atténuation, le degré de certitude qui leur est associé, ainsi que les mesures prévues en tenant compte de cette incertitude. Lorsqu'un dialogue sincère est possible, au chapitre des renseignements connus et de la nature et du degré de confiance des prévisions, il est plus facile d'accroître la compréhension et la confiance, ce qui permet en définitive d'élaborer un meilleur plan de gestion du DRA.

Les entreprises doivent assurer la mise en oeuvre de processus de communication et de consultation relatifs aux questions de DRA avec tous les intervenants, car une telle démarche constitue un élément essentiel de leur permis d'exploitation social. Comme le DRA représente habituellement un phénomène de grande visibilité, il faut s'assurer que les personnes qui doivent communiquer efficacement avec les autres intervenants sont des personnes qualifiées qui emploient des outils spécialisés pour le faire. De plus, il est parfois nécessaire d'impliquer des représentants de tous les domaines techniques pertinents de la société minière dans le processus en question.

## **Résumé**

Le drainage rocheux acide constitue l'un des plus sérieux problèmes environnementaux auxquels doit faire face l'industrie minière. Il faut réaliser une évaluation poussée des probabilités de DRA avant même d'entreprendre l'exploitation minière d'un gisement et poursuivre ces activités tout au long du cycle de vie de la mine. Afin de respecter les principes du développement durable, les stratégies de gestion du DRA doivent principalement porter sur la

prévention du DRA et la réduction au minimum de ses effets plutôt que sur les mesures de contrôle ou de traitement. Les stratégies en question sont définies dans le cadre du plan de gestion du DRA, dont l'élaboration est réalisée au cours des premières phases du projet, parallèlement à la détermination des mesures du suivi nécessaire pour en évaluer la performance. L'intégration du plan de gestion du DRA au plan d'exploitation de la mine constitue un élément crucial du succès du programme de prévention du DRA. Les pratiques de pointe, en matière de gestion du DRA, sont l'objet d'améliorations continues, mais la tendance actuelle consiste à adopter des pratiques qui sont propres aux sites et qui exigent l'apport de personnes possédant des connaissances spécialisées dans ce domaine.

## Références

- International Network for Acid Prevention (INAP), 2009. The Global Acid Rock Drainage Guide. Adresse du site Web : (à déterminer : <http://www.gardguide.com>).
- Jambor, J.L., 2003. « Mine-Waste Mineralogy and Mineralogical Perspectives of Acid-Base Accounting », dans Environmental Aspects of Mine Wastes (éditeurs : Jambor, J.L., D.W. Blowes et A.I.M. Ritchie), « Short Course Series », vol. 31, Association minéralogique du Canada.
- Nordstrom, D.K., 2003. « Effects of Microbiological and Geochemical Interactions in Mine Drainage », dans Environmental Aspects of Mine Wastes (éditeurs : Jambor, J.L., D.W. Blowes, et A.I.M. Ritchie), « Short Course Series », vol. 31, Association minéralogique du Canada.
- Nordstrom, D.K. et Alpers, C.N., 1999. « Geochemistry of Acid Mine Waters », dans The Environmental Geochemistry of Mineral Deposits, Part A: Processes, Techniques and Health Issues, (éditeurs : Plumlee, G.S., et M.J. Logsdon), « Reviews in Economic Geology », vol. 6A, Society of Economic Geologists, Inc.
- Plumlee, G.S., 1999. « The Environmental Geology of Mineral Deposits », dans The Environmental Geochemistry of Mineral Deposits, Part A: Processes, Techniques and Health Issues (éditeurs : Plumlee, G.S., et M.J. Logsdon), « Reviews in Economic Geology », vol. 6A, Society of Economic Geologists, Inc.
- Plumlee, G.S., K.S. Smith, M.R. Montour, W.H. Ficklin et E.L. Mosier. 1999. « Geologic Controls on the Composition of Natural Waters and Mine Waters Draining Diverse Mineral-Deposit Types », dans The Environmental Geochemistry of Mineral Deposits, Part B: Case Studies and Research Topics (éditeurs : Filipek, L.H., et G.S. Plumlee), « Reviews in Economic Geology », vol. 6B, Society of Economic Geologists, Inc.
- Stumm, W., et J.J. Morgan, 1981. « Aquatic Chemistry », 2e édition, New York, John Wiley & Sons.

Figure 12: Organigramme pour effectuer l'examen de la gestion du DRA et de l'évaluation de sa performance

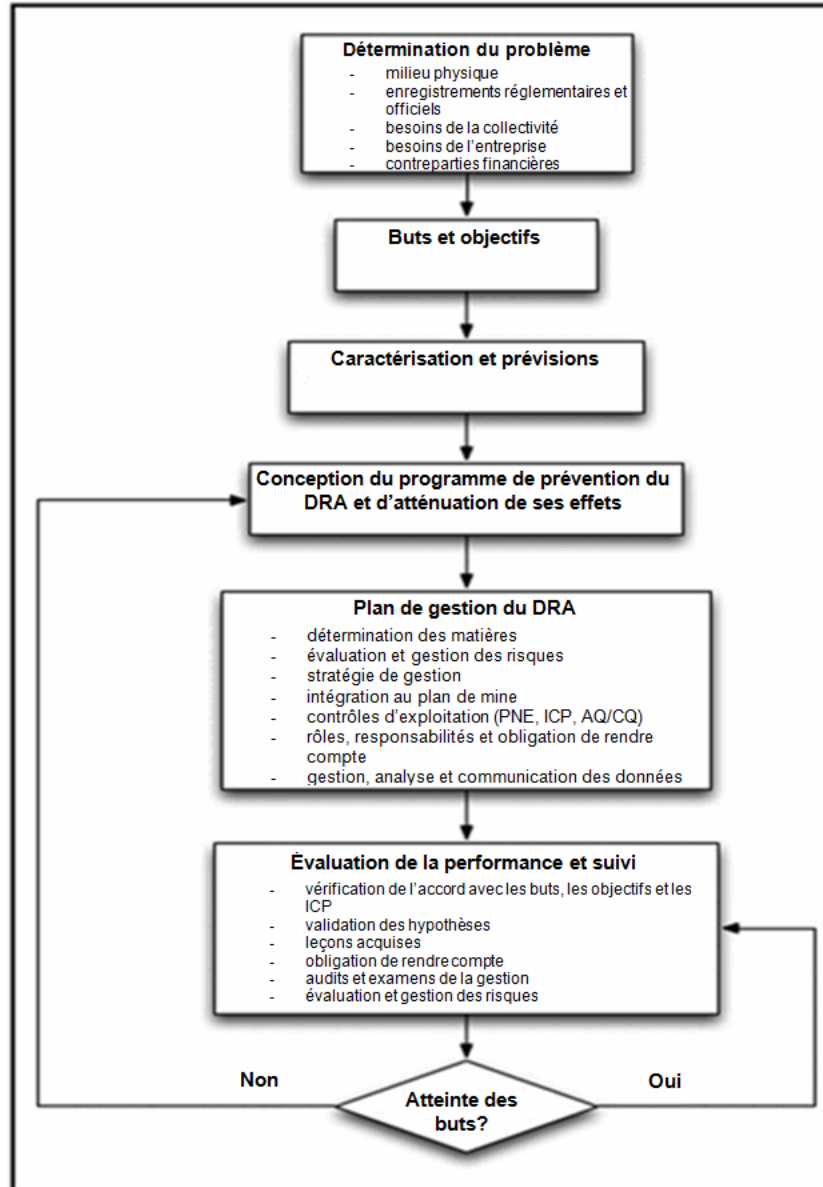

# Acknowledgments

## From GARDGuide

History

Acknowledgments

- INAP Member Companies
- The Global Alliance
- Golder Associates Team Project Management
- Project Champion (Version 0)
- Version 1 Chapter Champions
- Version 0 Chapter Champions
- Version 0 Regional Champions
- Contributing Authors
- GARD Guide Steering and Advisory Committees and Secretariate
- INAP Staff
- Workshops

## History

The production of this Global Acid Rock Drainage Guide (GARD Guide) was initiated in 2007, culminating in the roll-out of Version 0 of the GARD Guide during the 8th International Conference on Acid Rock Drainage (ICARD) held from June 22-26, 2009 in Skellefteå, Sweden. Version 1 was issued during the 9th ICARD held from May 20-24, 2012 in Ottawa, Ontario, Canada. The revision was largely based on comments and feedback received from users. Version 1 included major upgrades of Chapters 4 through 7, as well as numerous changes throughout the document related to updates and corrections.

## Acknowledgments

The GARD Guide was made possible through financial contributions from the International Network on Acid Production (INAP) and the Mining Association of Canada (MAC). The project was developed and initiated by INAP in partnership with the Global Alliance.

Several organizations and many individuals contributed to the development of this GARD Guide. Golder Associates Ltd assembled a team that developed this version of the GARD Guide with the assistance and contributions from INAP member companies and consultants. INAP would like to thank all that contributed to the Guide.

## INAP Member Companies

### Links to INAP member companies:

- Anglo American  
(<http://www.angloamerican.com>)
- Antofagasta Minerals  
(<http://www.aminerals.cl/>)
- Barrick  
(<http://www.barrick.com/>)
- Freeport McMoRan  
(<http://www.fcx.com/>)
- Kinross Gold Corporation  
(<http://www.kinross.com/>)
- Newcrest  
(<http://www.newcrest.com.au/>)
- Newmont  
(<http://www.newmont.com/>)
- Rio Tinto  
(<http://www.riotinto.com/>)
- Vale (<http://www.vale.com/en-us/Pages/default.aspx>)
- Xstrata  
(<http://www.xstrata.com/>)



(<http://www.angloamerican.com/>)



(<http://www.aminerals.cl/>)



(<http://www.barrick.com/>)



(<http://www.fcx.com/>)



(<http://www.kinross.com/>)



(<http://www.newcrest.com.au/>)



(<http://www.newmont.com/>)



(<http://www.riotinto.com/>)



(<http://www.vale.com/en-us/Pages/default.aspx>)

(<http://www.xstrata.com/>)



## The Global Alliance

Acid Drainage Technology Initiative (ADTI), USA ([http://www.aciddrainage.com/adti\\_ms.cfm](http://www.aciddrainage.com/adti_ms.cfm))

Chinese Network for Acid Mine Drainage, China (<http://www.cnamd.net/en/>)

Indonesian Network for Acid Drainage (INAD), Indonesia

Mine Environment Neutral Drainage (MEND), Canada (<http://www.mend-nedem.org/>)

Partnership for Acid Drainage Remediation in Europe (PADRE), Europe (<http://www.padre.imwa.info/>)

South American Network for Acid Prevention (SANAP), South America (<http://sanap.com.br/plus/>)

Sustainable Minerals Institute – Knowledge Transfer (SMI KT), Australia (formerly ACMER)  
(<http://www.jktech.com.au/professional-development>)

Water Research Commission, South Africa (<http://www.wrc.org.za/>)

## **Golder Associates Team Project Management**

Dr. Rens Verburg                      Golder Associates (USA) – Project Director

Mr. Nico Bezuidenhout              Golder Associates (South Africa) – Project Manager

Ms. Shareen Khamisa                Golder Associates (South Africa) – Project Administrator

## **Project Champion (Version 0)**

Mr. Keith Ferguson: Sustainability Engineering (Canada)

## **Version 1 Chapter Champions**

Spanish translation Executive Summary – Mr. Patrick Williamson – Schlumberger Water Services

French translation Executive Summary – Mr. Gilles Tremblay Natural Resources Canada (Canada)

Chapter 4 Characterization – Dr. Stuart Miller – Environmental  
Geochemistry International (Australia)

Chapter 5 Prediction – Dr. Bill Price – Natural Resources Canada  
(Canada)

Chapter 6 Prevention and Mitigation – Dr. Ron Nicholson –  
EcoMetrix (Canada)

Chapter 7 Treatment – Dr. Janice Zinck – Natural Resources Canada



## **Version 0 Chapter Champions**

- Chapter 1 The GARD Guide – Mr. Keith Ferguson – Sustainability Engineering (Canada)
- Chapter 2 The ARD Process – Dr. Rens Verburg – Golder Associates (USA)
- Chapter 3 Corporate, Regulatory and Community Framework - Mr. John Wates - Fraser Alexander (South Africa); Mr. Frank Wimberley - Golder Associates (South Africa)
- Chapter 4 Characterization – Dr. Devin Castendyk - SUNY Oneonta (USA) & Cheryl Ross – Golder Associates (USA)
- Chapter 5 Prediction – Dr Kirk Nordstrom – USGS (USA) & Dr. Rens Verburg – Golder Associates (USA)
- Chapter 6 Prevention and Mitigation – Dr. Ward Wilson – University of British Columbia (Canada) & Dr. Ben Wickland – Golder Associates (Canada)
- Chapter 7 Treatment - Dr. Andre van Niekerk – Golder Associates (South Africa)
- Chapter 8 Monitoring – Dr. Peter Chapman – Golder Associates (Canada) & Cheryl Ross – Golder Associates (USA)
- Chapter 9 ARD Management and Performance Assessment – Dr. Andrew Robertson – Robertson Geotechnical Consultants; Dr. William Pulles - Golder Associates (South Africa) (Canada) & Dr. Dirk van Zyl – University of British Columbia – (Canada)

Chapter 10 ARD Communication and Consultation – Ms. Tisha Greyling – Golder Associates (South Africa)

Chapter 11 ARD Management and Sustainability – Ms. Beth Beloff – Golder Associates (USA) & Mr. Keith Ferguson – Sustainability Engineering (Canada)

## **Version 0 Regional Champions**

Africa Mr. Nico Bezuidenhout – Golder Associates (South Africa)

Australasia Mr. Greg Maddocks – Golder Associates (Australia)

Canada Mr. Ken DeVos – Golder Associates (Canada)

Europe Dr. Bernadette Azzie – Golder Associates (Ireland)

South America Dr. Flavio Vasconcelos – Golder Associates (Brazil)

United States Dr. Rens Verburg – Golder Associates (USA)

## **Contributing Authors**

Mr. Brian Ayers O’Kane Consultants (Canada)

Mr. Stephen Day SRK Consultants (Canada)

Mr. Jim Gusek Sovereign Consulting (USA)

Mr. Les Hulett           Vale INCO (Canada)

Mr. Denis Kemp        Denis Kemp Consulting (Canada)

Dr. Robert Kleinmann   Department of Energy (USA)

Dr. Stuart Miller       Environmental Geochemistry International (Australia)

Mr. Mike O’Kane       O’Kane Consultants (Canada)

Mr. Bryan Ulrich       Knight Piésold & Co (USA)

Mr. Walter Weinig      Golder Associates (USA)

Dr. Paul Ziemkiewicz   University of West Virginia/ADTI (USA)

Dr. Janice Zinck       Natural Resources Canada (Canada)

Mr. Luc Zandvliet      Corporate Engagement Project (USA)

## **GARD Guide Steering and Advisory Committees and Secretariate**

Dr. Clive Bell                   ACMER (Australia)

Mr. Rich Borden               Rio Tinto (USA)

Mr. Charles Bucknam         Newmont (USA)

Mr. Rodolfo Camacho         BHP Billiton (Chile)

Dr. Dave Chambers	Center for Science in Public Participation (USA)
Dr. Terry Chatwin	INAP (USA)
Mr. Meiring du Plessis	Water Research Commission (SA)
Dr. Linda Figueroa	Colorado School of Mines/ADTI (USA)
Mr. Ross Gallinger	IAMGOLD/INAP (Canada)
Ms. Elizabeth Gardiner	Mining Association of Canada/MEND (Canada)
Ms. Charlene Hogan	NRCan (Canada)
Dr. Zhenqi Hu	China University of Mining and Technology (China)
Dr. Adam Jarvis	University of Newcastle (UK)
Dr. David Jones	Australia Department of Environment and Health (Australia)
Mr. Lars-Åke Lindahl	Swedish Mining Association (Sweden)
Dr. Glenn Miller	University of Nevada (USA)
Mr. Peter Moore	Export Development Canada (Canada)
Dr. Bill Price	Natural Resources Canada/MEND (Canada)
Dr. Jos Schaekers	Consultant (SA)
Mr. Gilles Tremblay	NRCan (Canada)

Dr. Harvey Van Veldhuizen      World Bank - MIGA (USA)

Mr. David Williams              US Bureau of Land Management/ADTI (USA)

Dr. Christian Wolkersdorfer      PADRE/IMWA/University of Cape Breton (Canada)

Ms. Jennifer Yang                International Copper Association (China)

Dr. Paul Ziemkiewicz              University of West Virginia/ADTI (USA)

## **INAP Staff**

### **INAP Technical Manager**

The INAP Technical Manager supports the OpCom in co-ordinating and carrying out networking activities, identifying external research providers, facilitating the development of research scopes and budgets, managing individual research projects, and producing publication material. The INAP Technical Manager is:

**Terrence Chatwin** (<mailto:Terrence.Chatwin@inap.com.au>)

2105 Oneida St, Salt Lake City, UT 84109 USA

Tel: +1 801 581 6348

Fax: +1 801 581 5440

### **INAP Home Office**

International Network for Acid Prevention Limited

Level 33, 120 Collins Street

Melbourne, Victoria 3000

## **Workshops**

INAP and the Global Alliance sponsored workshops to review selected portions of Revision 0 of the GARD Guide in Johannesburg (South Africa), Denver (USA), and Vancouver (Canada), Brisbane (Australia), Morgantown (USA), Stockholm (Sweden). These workshops were conducted in partnership with the Water Research Commission (South Africa), U.S. Environmental Protection Agency/Acid Drainage Technology Initiative (ADTI) (USA), and Mine Environment Neutral Drainage (MEND (Canada), Australian Centre for Minerals Extension and Research (Australia), West Virginia Coal Drainage Task Force (USA), and Swedish Association of Mines, Minerals and Metal Producers (SveMin). Over 150 experts attended those workshops. INAP would like to thank all of the workshop attendees for their interest and contributions to the GARD Guide.

# Chapter 1

## From GARDGuide

### 1.0 The Global Acid Rock Drainage Guide

#### 1.1 Introduction

##### 1.1.1 Acid Rock Drainage

#### 1.2 Acid Rock Drainage Management – The Business Case

#### 1.3 Scope and Objectives of the Global Acid Rock Drainage Guide

##### 1.3.1 Scope

##### 1.3.2 Objectives

#### 1.4 Relation to Other Guides

#### 1.5 Approach of the Global Acid Rock Drainage Guide

#### 1.6 Application to Mine Phase

#### 1.7 The Sustainable Development Approach

#### 1.8 Layout and How to Use the Guide

##### 1.8.1 Layout

##### 1.8.2 How to Use the Global Acid Rock Drainage Guide

#### 1.9 Chapter References

##### List of Figures

##### List of Appendices

## The GARD Guide

### 1.1 Introduction

Development of this Global Acid Rock Drainage Guide (GARD Guide) was sponsored by the International Network for Acid Prevention (INAP) with the support of the Global Alliance. It is the property of INAP. Access and use of the GARD Guide is granted by INAP under certain conditions.

This GARD Guide deals with the prediction, prevention, and management of drainage produced from sulphide mineral oxidation, often termed “acid rock drainage” (ARD), “saline drainage” (SD), “acid mine drainage” or “acid and metalliferous drainage” (AMD), “mining influenced water” (MIW), and “neutral mine drainage” (NMD). The GARD Guide also addresses metal leaching caused by sulphide mineral oxidation. While focused on mining, the technology described will be helpful to those practitioners that encounter sulphide minerals in other activities (e.g., rock cuts, excavations, tunnels). Some of the approaches in the GARD Guide are also relevant to issues arising from reactive non-sulphide minerals.

The GARD Guide is intended as a state-of-practice summary of the best practices and technology to assist mine operators, excavators, and regulators to address issues related to sulphide mineral oxidation. The GARD Guide will be of interest to the following:

- Mining and mining service companies
- Governments (national regulatory or land management agencies, IFC, World Bank, regional development agencies etc.)

#### This Version of the GARD Guide

- Version Number: 0.8
- Last Updated: December 13, 2010
- Property of the International Network for Acid Prevention (INAP)
- For further information or to provide comments and contributions to updates of the Guide, please contact: INAP at [terrence.chatwin@inap.com.au](mailto:terrence.chatwin@inap.com.au) (<mailto:terrence.chatwin@inap.com.au>)

- Consultants
- Researchers/Educators/Academia
- Community/Communities of interest
  - Bankers
  - Non-governmental organizations (NGOs)
  - Indigenous Peoples

The GARD Guide is a technical document designed primarily for a scientist or engineer with a reasonable background in chemistry and the basics of engineering with little specific knowledge of ARD. The target audience is adapted from a model developed by the PIRAMID Consortium (2003).

“The document assumes the reader to be a scientist or engineer with a reasonable background in chemistry and the basics of engineering, albeit with no specific knowledge of acid rock drainage. The underlying science and technology of ARD are discussed in sufficient detail that the reader can understand their application, but the discussion stops short of being a formal scientific treatise on the relevant aspects of, for example, geochemical kinetics and solute transport hydrodynamics. Rather, the document guides the reader through the logical framework of ARD management enabling them to quantify the nature of the problematic drainage, and the potential for management that exists on the site, leading to the selection of the most appropriate form of prevention and remediation.”

### 1.1.1 Acid Rock Drainage



([http://www480.pair.com/aturner/gardwiki/index.php/Chapter\\_1#1.1.1\\_Acid\\_Rock\\_Drainage](http://www480.pair.com/aturner/gardwiki/index.php/Chapter_1#1.1.1_Acid_Rock_Drainage))

Acid rock drainage is formed by the natural oxidation of sulphide minerals, together with reactions of the base minerals in the rock, which are exposed to air and water. Activities that involve the excavation of rock with sulphide minerals, such as mining, accelerate the process because such activities increase the exposure of sulphide minerals to air, water, and microorganisms. The drainage produced from the oxidation process may be neutral to acidic, with or without dissolved heavy metals, but such drainage always contains sulphate.

ARD results from a series of reactions and stages that usually progress from near neutral to more acidic pH conditions (see Chapter 2). In addition to ARD, neutral mine drainage or saline drainage may result from the oxidation process where there are sufficient base minerals to neutralize the ARD. NMD is characterized by elevated metals in solution at near neutral pH. SD contains high levels of sulphate at neutral pH without significant metal concentrations and saline drainage’s principal dissolved constituents then are sulphate, magnesium, and calcium ions.

Although the water quality resulting from sulphide mineral oxidation does not lend itself to precise compartmentalization, the accompanying chart illustrates the various types of drainage (Figure 1-1). Neutral mine drainage and saline drainage can occur together (i.e., near neutral pH with elevated metals and sulphate).

The GARD Guide addresses ARD, NMD, and SD where contaminants are released from solid to liquid phase by the oxidation of

sulphide minerals. For simplicity in the GARD Guide, drainage produced by sulphide mineral oxidation is referred to simply as ARD except where specific aspects of ARD, NMD, and SD formation or drainage characteristics are important to the application of a particular technology or management approach. In those cases, the specific terms NMD and SD are used.

**Figure 1-1: Types of Drainage Produced by Sulphide Oxidation**

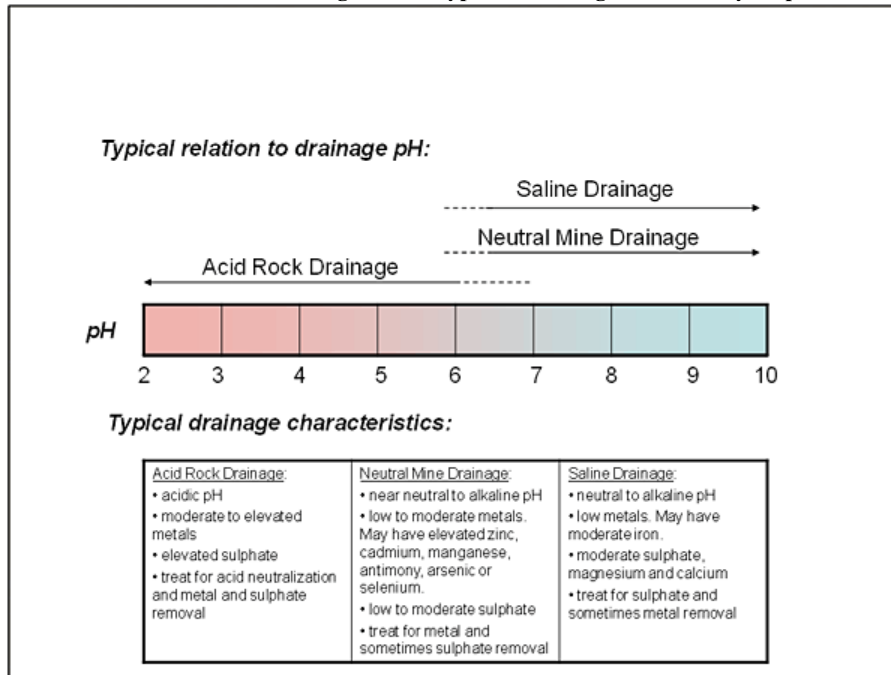

## 1.2 Acid Rock Drainage Management - The Business Case



ARD formation is difficult to stop once initiated because it is a process that, if left unchecked, will continue (and may even accelerate) until one or more of the reactants (sulphide minerals, oxygen, water) is exhausted or no longer available for reaction. The process can continue to produce contaminated drainage from mining and other sulphide bearing rock wastes for decades or even centuries after mining has ceased. In temperate or tropical climates with high rainfall, large volumes of ARD can be produced requiring large and expensive collection systems, treatment plants and civil works (e.g., covers on mine wastes).

The cost of ARD remediation at primarily abandoned and “orphaned” mines in North America has been estimated in the tens of billions of U.S. dollars. Individual mines can face post-closure liabilities of tens to over a hundred million dollars for ARD remediation and treatment if the sulphide oxidation process is not properly managed during the mine’s life.

Put simply, ARD can make a mine project uneconomic and present mine owners with technically challenging and expensive long-term management issues.

Failure to address ARD can impact a company’s “social license to operate” through financial, political, and management issues such as the following:

- Unbudgeted reclamation costs with little or no internal resources (i.e., manpower, equipment, infrastructure, utilities and management) at the time of closure
- Contaminated water resources with adverse impacts on human health, flora, and fauna
- Unbudgeted increases of environmental remediation
- More stringent regulatory requirements which evolved over time



- Loss of corporate image, public acceptance, and stakeholder trust
- Loss of future mining opportunities
- Commitment of corporate resources to a mine that has long since ceased to provide economic value

Proper mine characterization, drainage quality prediction, and mine waste management can prevent in most cases, and minimize in all cases, ARD formation. However prevention of ARD must begin at exploration and continue throughout the mine-life cycle. The mining industry recognizes that continuous ARD planning and management is imperative to successful ARD prevention. Proper planning and management of ARD can prevent environmental impacts from occurring.

Many mines will not produce ARD because of the inherent geochemical nature of their mining wastes or very arid climatic conditions. Also, mines that have implemented well founded prediction and, where required, prevention and monitoring programs should also be able to avoid significant ARD issues. For example, Placer Dome Inc., a large gold and copper mining company, published information on the ARD and metal leaching potential and management plans for its 22 operating and closed mines (Placer Dome Inc, 1998 and 2003). Of the 22 mines, eight (36%) exhibited a potential for ARD and five others (23%) a potential for NMD (metal leaching), requiring that prevention and monitoring plans be developed and implemented. Only three (14%) mines actually produced ARD or NMD where water treatment of drainage was necessary; none of those mines had implemented ARD prevention measures from the start of operations.

“Treating acid drainage once it has occurred, or mitigating environmental impact after it has occurred, is usually an admission that something has gone wrong either in the characterisation, planning, design or operation of a mine. It is Newmont’s belief that acid drainage can be prevented if some key principles are followed throughout the life of a mine, from exploration through to closure.” Paul Dowd, former Managing Director, Newmont Australia (Dowd, 2005)

A comprehensive approach to ARD management, as promoted by the GARD Guide, will reduce environmental risks and subsequent costs for the mining industry and governments, reduce adverse environmental impacts, and build public support for mining. The extent and specific elements of the ARD management approach that should be implemented at a particular mine or project will vary based on the potential to produce ARD and other site-specific factors.

## 1.3 Scope and Objectives of the Global Acid Rock Drainage Guide

### 1.3.1 Scope

The potential for acidic drainage to form from mining has been known since at least 1556 and ARD was observed as early as 1698 associated with coal mining in Pennsylvania (BC Acid Mine Drainage Task Force, 1989).

Research into the process of ARD formation and methods to minimize its impact have been ongoing for more than 50 years. Much progress has been made, in the last 20 years in particular, through a number of research consortiums. As such, there is a considerable scientific and engineering guidance available on ARD through organizations such as INAP, MEND, the British Columbia AMD Task Force (BC AMDTF), the British Columbia Ministry of Energy, Mines and Petroleum Resources (BC MEMPR), ADTI, the Australian Centre for Minerals Extension and Research (ACMER), the South African Water Research Commission (WRC), The South African Department of Water Affairs and Forestry (DWAFF), the Partnership for Acid Drainage Remediation in Europe (PADRE), and other programs. However, this research is generally available through disparate references and is not easily accessible. The research tends to be issue, commodity, or geographically (climate) centred. The objective of this GARD Guide is to consolidate and summarize the current information and to use global thinking on ARD management.

Many examples and case studies of ARD prediction and mitigation have been studied for the last 20 years that buttress and corroborate the more fundamental scientific research. The knowledge gained from both positive and negative field results contributes greatly to current and future ARD management plans and enhances the credibility of consultation processes on ARD. Also, application of ongoing science and engineering research supports continual improvement in ARD management.

This GARD Guide focuses on mining and pertains to ores, wastes (overburden, waste rock and residues/tailings), and mine workings (including in situ mining). The GARD Guide applies to the entire mining industry and all commodities produced by mining, including base metals, coal, iron ore, precious metals, diamonds, and uranium where the ores contain sulphide minerals<sup>[1]</sup>. The GARD Guide is applicable to the complete mine life cycle and to existing and historical ARD issues as well as future mines.

While much of the science in the GARD Guide is more broadly applicable, it does not specifically address the following:

- Acid sulphate soils, although reference is made to approaches and technologies from the acid soil literature where relevant to the management of sulphide mineral oxidation

- Dissolution of sulphate salts (e.g., jarosites and other hydroxyl-sulphates) that are produced by pyrometallurgical or hydrometallurgical processes (However, jarosites or other salts produced as intermediate products during sulphide oxidation under ambient conditions are considered.)

The technology described in the GARD Guide may be of value to those encountering or managing acid sulphate soils and pyrometallurgical or hydrometallurgical sulphate salts.

Additional Web links for organizations:

- MEND <http://www.nrcan-nrcan.gc.ca/mms-smm/tect-tech/sat-set/med-ndd-eng.htm>
- the British Columbia Ministry of Energy, Mines and Petroleum Resources (BC MEMPR) <http://www.gov.bc.ca/empr/>
- ADTI <http://inside.mines.edu/adti/ADTIMAIN.html>
- the *Australian Centre for Minerals Extension and Research* (ACMER) <http://www.acmer.uq.edu.au/index.html>
- the South African Water Research Commission (WRC) <http://www.wrc.org.za/>
- The South African *Department of Water Affairs and Forestry* (DWAF) <http://www.dwaf.gov.za/>
- the Partnership for Acid Drainage Remediation in Europe (PADRE) <http://www.padre.imwa.info/>
- West Virginia Coal Mine Drainage Task Force - <http://wvmdtaskforce.com/>

### 1.3.2 Objectives

The overall objective of the GARD Guide is to collate and facilitate worldwide best practice in prediction, prevention, and mitigation of ARD. It is a reference document for stakeholders involved in sulphide mineral oxidation and related waste management issues.

The GARD Guide has been prepared as a road map through the process of evaluating, planning, design, and management of ARD over the life cycle of mining. The GARD guide has also been prepared as a compendium of the concepts, the techniques, and the processes to be considered in successful ARD management over the mine-life cycle. It provides a broad, but not highly detailed, understanding of ARD technologies and management. However, a comprehensive approach to ARD management will be created where the concepts and guidance in the GARD Guide are translated into site-specific actions.

The GARD Guide is also a “compass” to identify more detailed information on ARD as it lists references for those looking for specifics on ARD technologies and approaches.

The GARD Guide will assist the reader to monitor the evolution of the sulphide oxidation process in mine wastes and identify when involvement of more experienced ARD practitioners is required to address a particular issue.

The GARD Guide is not a design document; design requires a high level of understanding and site-specific knowledge of a particular project or mine. Detailed design of ARD mitigation techniques will continue to be conducted by knowledgeable practitioners.

The following are specific objectives of the GARD Guide:

- Articulate the issues associated with sulphide mineral oxidation
- Improve the understanding of best global practice, customized where necessary for special geoclimatic conditions
- Promote a risk-based, proactive, consistent approach by encouraging planning for and implementation of reduction and control of ARD at the source
- Leverage the world’s ARD expertise and share expertise with developing countries
- Support the ‘Equator Principles’ developed by a consortium of lending institutions and the International Council of Mining and Metals (ICMM’s) objectives by achieving ‘global best practice’ in future mining projects

### 1.4 Relation to Other Guides

There is a considerable body of knowledge on ARD management in the scientific and engineering literature. Many technical documents and guidelines have been produced that summarize certain aspects of the state-of-knowledge and in some cases provide guidelines for managing ARD. In addition, the series of International Conferences on Acid Rock Drainage (ICARD), BC MEND, ACMER, and other conferences regularly review ARD research and management. The ICARD proceedings in particular are valuable summaries of ARD technology and the reader is encouraged to review these proceedings, especially case studies.

### Some Existing ARD Compendia

- Acid Rock Drainage At Enviromine, Enviromine <http://technology.infomine.com/enviromine/ard/home.htm>
- ARD Test Handbook, AMIRA International, May 2002 <http://www.amira.com.au/>
- MiMi – Results and Synthesis Report for Phase 1 1998-2001, MiMi, April 2003
- MiMi – Performance Assessment Main Report, MiMi, December 2004
- Guidelines for Metal Leaching and Acid Rock Drainage at Minesites in British Columbia, Ministry of Energy and Mines, August 1998
- Draft Guidelines and Recommended Methods for Prediction of Metal Leaching and Acid Rock, Ministry of Energy and Mines, 1998
- Draft Acid Rock Drainage Technical Guide Volume 1, British Columbia Acid Mine Drainage Task Force Report, August 1989
- MEND Manuals, MEND, January 2001
- List of Potential Information Requirements in Metal Leaching/ Acid Rock Drainage Assessment and Mitigation Work, MEND Report 5.10E, January 2005 PDF <http://www.mend-nedem.org/reports/files/5.10E.pdf>
- Environmental Regulation of Mine Waters in the European Union, ERMITE <http://www.ncl.ac.uk/environment/research/Ermite.htm>
- Field and Laboratory Methods Application to Overburdens and Minesoils, Industrial Environmental Research Laboratory Office of Research and Developments U.S. Environmental Protection Agency, March 1978 [www.techtransfer.osmre.gov/nttmain/Library/hbmanual/fieldlab/back.pdf](http://www.techtransfer.osmre.gov/nttmain/Library/hbmanual/fieldlab/back.pdf)
- Risk Assessment Framework For the Management of Sulfidic Mine Wastes, Australian Center for Mining Environmental Research, September 1999
- Industry Liaison Officer Report for the Management of Sulfidic Mine Wastes Project, Australian Center for Mining Environmental Research, February 2000 <http://www.acmer.uq.edu.au/publications/handbooks.html>
- Management of Sulfidic Mine Wastes and Acid Drainage, Australian Center for Mining Environmental Research, September 2000
- Manual of Techniques to Quantify Processes Associated with Polluted Effluent Form Sulfidic Mine Wastes, Australian Center for Mining Environmental Research, February 2000
- Comparison of Oxidation Rates of Sulfidic Mine Wastes Measured in the Laboratory and Field, Australian Center for Mining Environmental Research, February 2000
- Management of Sulfidic Mine Wastes – Current Australian Practice and Available Knowledge and Techniques, Australian Center for Mining Environmental Research, May 2000 <http://www.acmer.uq.edu.au/publications/handbooks.html>
- Determining the Toxicity Potential of Mine Waste Piles, USGS, June 2003 <http://pubs.usgs.gov/of/2003/of-03-210/>
- Acid Drainage Technology Initiative, ADTI Workbook Chapters: Introduction (in draft), Mitigation (in draft), Sampling and Monitoring, Pit Lake and Prediction (in preparation)
- On-site and Laboratory Investigations of Spoil in Opencast Collieries and the Development of Acid-Base Accounting Procedures, Usher BH, Cruywagen LM, de Necker E, Hodgson FDI, South African Water Research Commission Report Number 1055/1/03, 2003 <http://www.wrc.org.za/Pages/DisplayItem.aspx?ItemID=7585&FromURL=%2FPages%2FAllKH.aspx%3F>
- Acid –Base Accounting, Techniques and Evaluation (ABATE), Usher BH, Cruywagen LM, de Necker E, Hodgson FDI, South African Water Research Commission Report Number 1055/2/03, 2003 <http://www.wrc.org.za/Pages/DisplayItem.aspx?ItemID=7586&FromURL=%2FPages%2FAllKH.aspx%3F>
- Engineering guidelines for the passive remediation of acidic and/or metalliferous mine drainage and similar wastewaters. European Commission 5th Framework RTD Project no. EVK1-CT-1999-000021 "Passive in-situ remediation of acidic mine / industrial drainage" (PIRAMID). University of Newcastle Upon Tyne, Newcastle Upon Tyne UK. 166pp.) (PIRAMID Consortium (2003) <http://www.ncl.ac.uk/environment/research/PIRAMID.htm>
- ASTM Method E-1915 Standard Test Methods for Analysis of Metal Bearing Ores and Related Materials by Combustion Infrared Absorption Spectrometry, Annual Book of ASTM Standards volume 03.06 (also standard method for humidity cell testing, SPLP (vol 11.04) and MWMP (vol 03.06)) <http://www.astm.org/Standards/E1915.htm>
- Best Practice Guideline Series, South Africa Department of Water Affairs and Forestry, 2006
- Managing Acid and Metalliferous Drainage, Australian Government Department of Industry Tourism and Resources, 2007

Some existing compendia of ARD technology are listed above. The GARD Guide summarizes and references these and other key literature and compendia on the assessment, prediction, control, and management of ARD. It refers the reader to more specialized state-of-the-art guides and summaries where they already exist. INAP has commissioned a separate review of the ARD literature (Wolkersdorfer, 2008).

## 1.5 Approach of the Global Acid Rock Drainage Guide

The GARD Guide is based on a systematic approach to ARD management as shown in Figure 1-2. The approach proceeds from site characterization to preparation, and ultimately implementation of an ARD management plan. It includes a loop for verification and calibration of predictions and assessments as part of evaluating the performance of the ARD management plan.

Figure 1-2: Overall ARD Management Plan

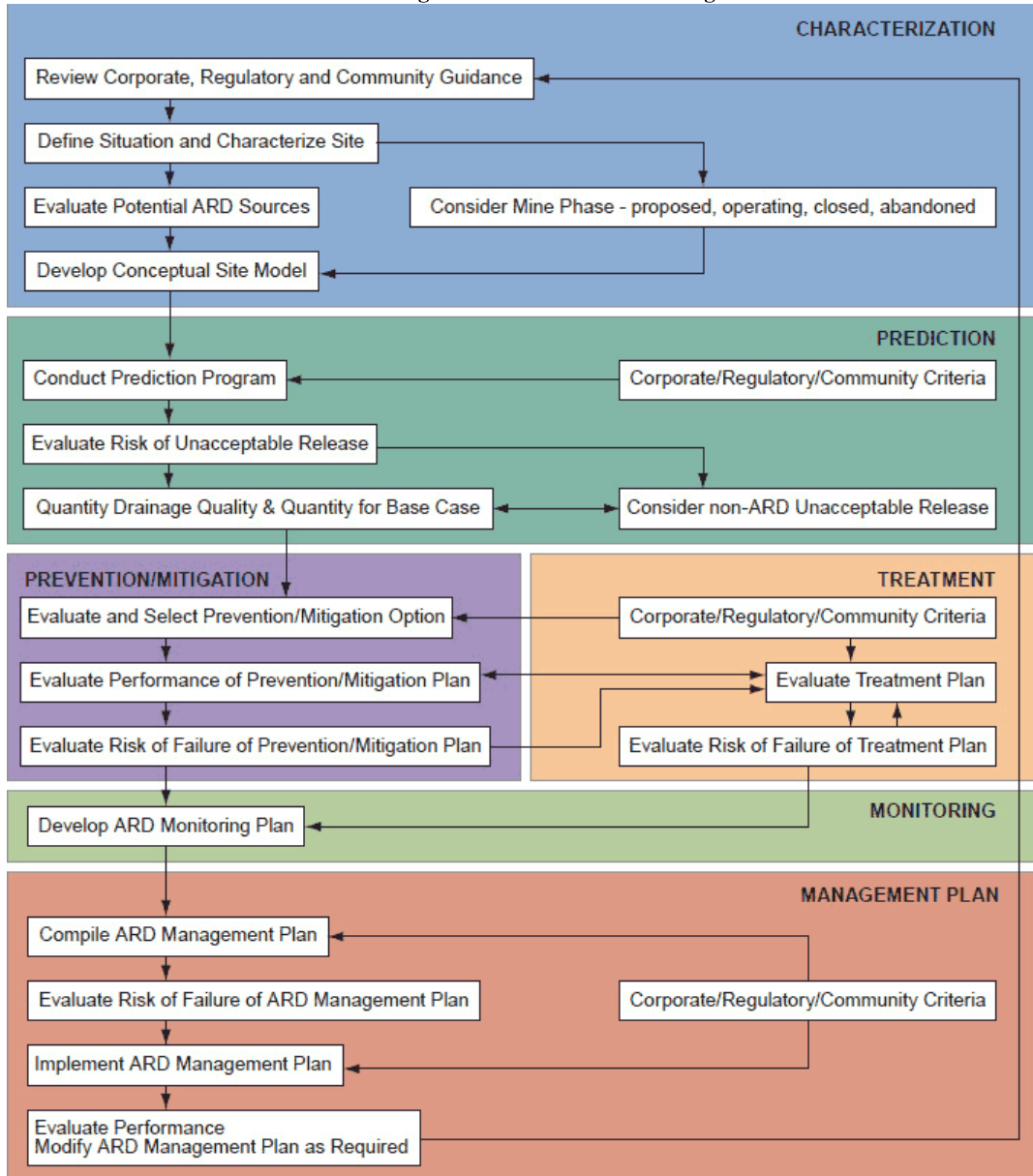

Specific elements of the approach and appropriate technologies are described in more detail in this GARD Guide.

## 1.6 Application to Mine Phase

ARD management is applied at all phases of a mine from “cradle to cradle” as part of an environmental management system (EMS), which

includes a continuous improvement process (Figure 1-3). (The term “cradle to cradle” characterizes the objective to return land used for mining to biologically productive use after mining is finished.)

**Figure 1-3: Applying an Environmental Management System to ARD**

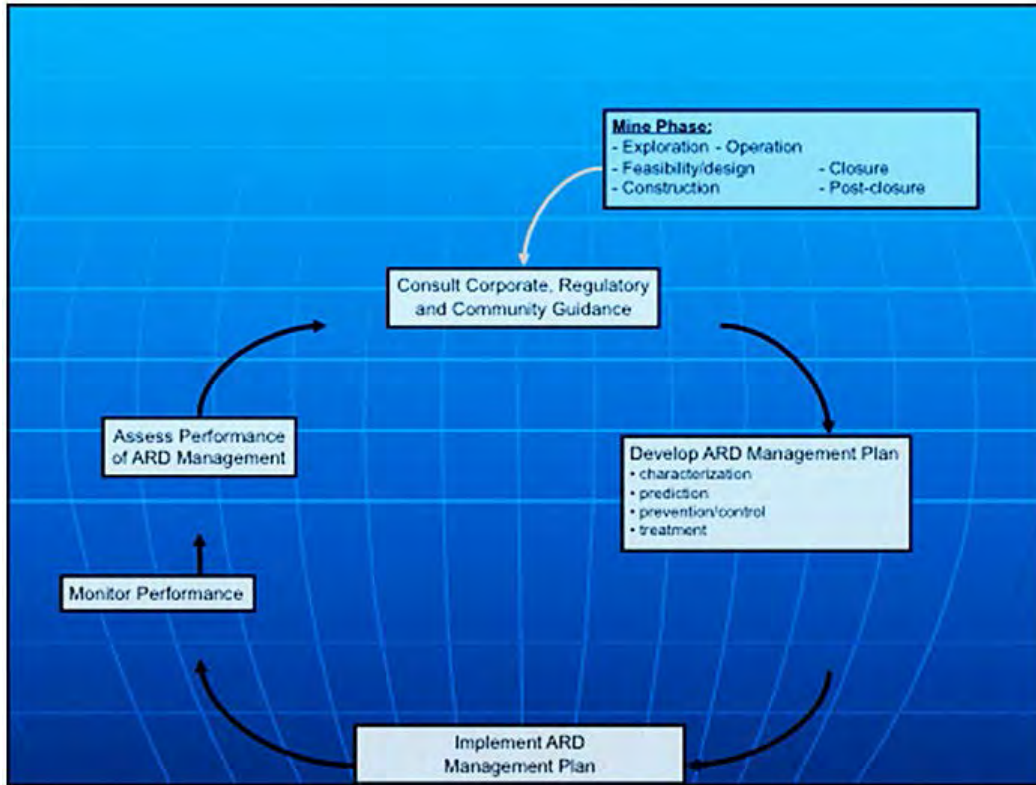

The ARD management plan is based on technical understanding and knowledge but is defined within corporate policies, government regulations, and community expectations. The ARD management plan is based on site characterization and ARD/NMD/SD prediction science and incorporates engineering measures aimed at ARD prevention and control. Water treatment may be included in the plan as a contingency, or as a necessity for existing mines.

Implementation of the ARD management plan requires the use of management systems and communication between stakeholders. The plan’s performance is monitored through a range of metrics usually based on evaluation of mine water quality. The overall performance of ARD management is evaluated against site-specific environmental requirements and the criteria established by corporate policies, government standards, and community expectations. In this way, the ARD management process is a continuous loop.

The level of assessment and planning for each phase of mining varies based on the degree of information available and the extent of rock excavation and the potential environmental impact. For example, relatively little disturbance and excavation of rock containing sulphide minerals usually occurs during exploration. However ARD management plans are required for exploration drilling, bulk samples, and test pits/underground workings. A poorly planned exploration drilling program could cause long-term ARD problems through disturbance of the natural groundwater conditions and provision of new vertical flow paths. In addition, site characterization, including ore and waste characterization and ARD prediction, must begin at the start of mineral exploration.

The approach to ARD management during the phases of mine development is discussed in more detail in Chapter 9.

## 1.7 The Sustainable Development Approach

With its potentially wide-ranging and multigenerational consequences, ARD is an important "sustainable development" or “sustainability” issue. Environmental impacts of ARD can be serious and enduring. Depending on where a mine operates, ARD can also impact the well-being of people surrounding the mine, now and in the future. Poor management of ARD can not only harm the environment but also the mining industry’s reputation and communities’ acceptance of individual mining operations. Applying the concept of sustainable development, on the other hand, offers an opportunity to involve multiple stakeholders in ARD management, improve risk management,

and optimize the socioeconomic and business benefits of a mining operation.

The Minerals, Mining and Sustainable Development (MMSD) Project, an effort initiated by nine of the world's largest mining companies, describes sustainable development as a goal to:

“maximize the contribution to the well-being of the current generation in a way that ensures an equitable distribution of its costs and benefits, without reducing the potential for future generations to meet their own needs” (MMSD, 2002).

In practice, sustainable development requires an integrated, balanced, and responsible approach that accounts for short-term and long-term environmental, social, economic, and governance considerations. The economic benefit derived from mining can be an essential contributor to sustainable development. Environmental and social consequences of ARD detract from this significant benefit unless managed appropriately.

Sustainable development requires that the mining company engage stakeholders and find optimal solutions that minimize risk, maximize benefits to multiple stakeholders, and manage trade-offs. Fundamentally, the company must exercise socially responsible practices. As a particular mining project presents an ARD risk, how can the mining company best limit the risk and satisfy the needs of its stakeholders? Sustainable development requires the following:

- Looking for solutions to ARD issues from a whole-society perspective
- Applying proactive pollution prevention rather than reactive mitigation and treatment
- Implementing ARD prevention and mitigation throughout the whole mine-life-cycle perspective

Application of sustainable development principles to ARD management is discussed further in the GARD Guide (Chapters 10 and 11).

## 1.8 Layout and How to Use the Guide

### 1.8.1 Layout

The GARD Guide is based on a “Wiki” model. Chapters and subchapters are constructed as pages. Internal links are provided for topics where more detail is available. Links to external websites are included to organizations and other more detailed or specific topic references. The application of management technologies is based on the ARD formation process described in Chapter 2. Chapters 3 to 8 build on elements in the ‘knowledge map’ presented in Figure 1-2. Each chapter is “stand alone” with key references and guidance. A **Glossary** of common terms and description of **Acronyms** is available. Each chapter contains tools (e.g., lists, tables, and figures) to assist the reader to apply the knowledge.

Most of the technologies and approaches in the GARD Guide are applicable to generic ARD issues. However, the technologies and approaches may need to be modified to address particular aspects of ARD, such as those related to the following:

- Commodities (coal or hard rock)
- Stage in mine life cycle
- Exploration
- Mine planning, feasibility studies, and design (including environmental impact assessment)
- Construction and commissioning
- Operation
- Decommissioning
- Post-closure
- Mine sources (e.g., in situ leaching, open pit, underground, tailings, waste rock etc.)
- Climate (wet or dry, temperate or hot or cold)
- High/moderate/low technology applications
- Types of drainage – ARD, NMD, or SD
- Sensitive community issues

Information on these special technologies or approaches is provided in the text, side bars, and tables, as appropriate.

Chapter 9, Acid Rock Drainage Assessment and Management, brings the technologies together and discusses their application while describing in more detail the risk approach, engineering design process, and management systems to ARD. The chapter describes how to prepare and implement the ARD management plan. Chapter 10, Communication and Consultation, describes how to communicate ARD issues within and outside an organization. ARD management must be fully incorporated into geological programs, mining, and milling.

so effective communication between disciplines is critical. The chapter also describes the importance of knowledge management given the potential long life of ARD issues. Regulators and local communities must have a clear understanding of the risks of ARD and the effectiveness of approaches proposed to manage it.

Differences in approaches to sustainable development might affect how ARD technologies and management are applied. Sustainable development aspects are briefly discussed in most chapters of the GARD Guide and in more detail in Chapter 11 with respect to the possible future of ARD management. Chapter 11 also identifies research needs and a possible path forward to increase our understanding of ARD genesis, best practice, and management.

## 1.8.2 How to Use the Global Acid Rock Drainage Guide

The GARD Guide contains 11 chapters, including this one. Readers are encouraged to, in the first instance, progress from one chapter to the next because the approach to ARD management is step-wise. Chapter 4, Characterization, in particular is an important step in implementing the ARD management approach because the application of technology must be based on a thorough knowledge of site conditions.

The tools provided in the GARD Guide will help the reader compile information for use by ARD specialist practitioners. The GARD Guide will also support the reader's participation in more detailed scientific investigations and engineering studies at a particular mine site (e.g., identify and collect rock and water samples and review the results of analyses). With the help of the GARD Guide and a site-specific ARD management plan, for example, an environmental coordinator will be able to work with other functional groups at a mine site (e.g., mine, mill, and plant services departments) to assist them in implementing the management plan within the overall mine operations and to monitor the plan's performance.

In general, readers are encouraged to apply the flowcharts and to use the tools in the GARD Guide to address a particular ARD issue. However readers must exercise caution and fully assess the relevance of a tool to their particular situation because ARD issues are often multifaceted and complex; a simple tool, therefore, may not fully apply. References and links in the GARD Guide should be used to access more detailed information on a specific aspect of ARD management relevant to a particular mine project or ARD management issue. An expert ARD practitioner or a suitably qualified person should be consulted in complex cases.

The GARD Guide is also a resource for teaching environmental aspects of mining to science and engineering students.

Finally the GARD Guide is a "living document" and will be updated periodically to reflect the results of ongoing research and advancing knowledge of ARD management technologies. The reader is encouraged to revisit the INAP website to access the most recent version of the GARD Guide and to provide INAP with comments on how the GARD Guide could be improved.

## 1.9 Chapter References

British Columbia Acid Mine Drainage Task Force (BCAMDTF), 1989. Draft Acid Rock Drainage Technical Guide – Volume 1. Prepared by Steffen Robertson and Kirsten (SRK), Vancouver, BC.

Dowd, P.J., 2005. The Business Case for the Prevention of Acid Drainage. Proceedings of the 5<sup>th</sup> Australian Workshop on Acid and Metalliferous Drainage, ACMER, Brisbane, Australia.

Mining, Minerals, and Sustainable Development (MMSD), 2002. Breaking New Ground - The Report of the Mining, Minerals and Sustainable Development Project. Earthscan Publications Ltd., London. <http://www.iied.org/mining-minerals-sustainable-development>

PIRAMID (Passive in-situ remediation of acidic mine/industrial drainage) Consortium, 2003. Engineering guidelines for the passive remediation of acidic and/or metalliferous mine drainage and similar wastewaters. European Commission 5<sup>th</sup> Framework, RTD Project no. EVK1-CT-1999-000021, University of Newcastle Upon Tyne, Newcastle Upon Tyne, UK.

Placer Dome Inc., 1998. It's about our Future, 1998 Sustainability Report. Vancouver, BC.

Placer Dome Inc., 2003. Supplementary Sustainability Information and Technical Data. Vancouver, BC.

Wolkersdorfer, C., 2008. ARD Literature Review. INAP.

## **List of Figures**

Figure 1-1: Types of Drainage Produced by Sulphide Oxidation

Figure 1-2: Overall ARD Management Plan

Figure 1-3: Applying an Environmental Management System to ARD

## **List of Appendices**

Glossary and Acronyms

Units and Conversion Factors

1. † Although coal is not strictly “ore” as the term is used in hard rock mining, the reader should consider that the term “ore” also applies to coal where found in the GARD Guide.





# Chapter 2

## From GARDGuide

### 2.0 The Acid Rock Drainage Process

#### 2.1 Introduction

#### 2.2 Acid Rock Drainage, Neutral Mine Drainage, and Saline Drainage

##### 2.2.1 Definition of Acid Rock Drainage, Neutral Mine Drainage, and Saline Drainage

##### 2.2.2 Natural vs Anthropogenic Drainage

#### 2.3 History of Acid Rock Drainage

#### 2.4 The Acid Generation Process

##### 2.4.1 Characteristics of Acid Rock Drainage, Neutral Mine Drainage, and Saline Drainage

##### 2.4.2 The Global and Geochemical Sulphur Cycles

##### 2.4.3 Acid Rock Drainage Sources

##### 2.4.4 The Sulphide Oxidation Process

##### 2.4.5 Reaction Products from Sulphide Oxidation

##### 2.4.6 Neutralization Reactions

##### 2.4.7 The Acid Rock Drainage Process and Migration

#### 2.5 Concluding Statement

#### 2.6 References

#### List of Tables

#### List of Figures

## 2.0 The Acid Rock Drainage Process

### 2.1 Introduction

Chapter 2 presents an introduction to acid rock drainage (ARD), the history of ARD, and an overview of ARD processes and definitions. This chapter also provides a description of the sulphide oxidation process, including the biological, chemical, and physical factors that govern sulphide oxidation, control migration of ARD, and that modify the compositional characteristics of mine discharges along flow paths. A brief evaluation of receptors and potential impacts resulting from ARD is presented in closing.

### 2.2 Acid Rock Drainage, Neutral Mine Drainage, and Saline Drainage

#### 2.2.1 Definition of Acid Rock Drainage, Neutral Mine Drainage, and Saline Drainage

Throughout this document, the terms acid rock drainage (ARD), neutral mine drainage (NMD), and saline drainage (SD) are used. All three types of drainage can be produced by oxidation of sulphide minerals. In the context of this GARD Guide, ARD, NMD, and SD do not represent consecutive stages in the evolution of mine waters, but instead reflect different end points in terms of water quality that may have different effects on the environment and may necessitate different forms of management.

Figure 1-1 in Chapter 1 provides an overview of the compositional characteristics of each of these drainage types. Although formal guidelines for quantitative definitions of ARD, NMD, and SD are lacking, for the purpose of this GARD Guide, the following approximate thresholds between the three types of mine drainage are applied:

- Above pH 6: NMD and SD; and below pH 6: ARD
- Sulphate concentration of 1,000 milligrams per liter (mg/L): threshold between NMD vs. SD (in accordance with U.S. Geological Survey [USGS] cut-off between fresh water and slightly saline water of 1,000 mg/L TDS [USGS, 2004])

A more detailed description of the characteristics of ARD, NMD, and SD and the factors that control their development is provided in Section 2.4.

A term frequently used as being synonymous with ARD is acid mine drainage (AMD). "AMD" continues to be commonly used, especially where ARD is derived from coal mines. However, use of "acid mine drainage" is discouraged as a general term because it implies that acid drainage originates from mining activities alone. Acid drainage can result from a variety of natural sources and anthropogenic activities; therefore, acid mine drainage is too narrow a descriptor for many situations. For example, highway construction and associated excavations have led to a generation of acid rock drainage in such locations as British Columbia, Pennsylvania, and Northumberland because of exposure of sulphide-bearing mineralized zones. Waste from sand and oil shale extraction in Australia has also been noted to produce ARD on occasion.

Another term that broadly refers to waters that have been impacted by mining or mineral processing facilities is mining influenced water (MIW). This term includes ARD, NMD, SD, and metallurgical process waters of potential concern. In Australia, the term acid and metalliferous drainage (AMD) is used as a synonym for ARD. A key characteristic of most of these waters is that they contain elevated metals that have leached from surrounding solids (e.g., waste rock, tailings, mine surfaces, or mineral surfaces in their pathways). This fact is commonly acknowledged by the phrase "metal leaching" (ML), frequently resulting in acronyms such as ARD/ML.

### 2.2.2 Natural vs Anthropogenic Drainage

The primary process responsible for generation of ARD, NMD, or SD of concern is weathering of sulphide minerals, in particular pyrite. In some cases, the generation of ARD, NMD, or SD may also be due to oxidation of elemental sulphur. Weathering, or oxidation, of pyrite occurs naturally when exposed to atmospheric conditions, either through geologic processes or anthropogenic activities that involve removal of material (e.g., mining, highway construction). Historical records clearly indicate that many mineralized areas contained natural waters with low pH and elevated concentrations of metals and sulphate before the onset of mining, and geographic names such as Rio Tinto (Red River), Rio Agrio (Sour River), Sulphur Creek, Rötzbach (Red Brook) and Copper Creek are testimony to the presence of low pH and elevated metal concentrations.

Mining and other forms of earth moving, however, greatly accelerate the weathering of reactive sulphides because they create conditions that tend to facilitate movement of air and water, expose large volumes of material, increase the surface area of the reactive component, and create the opportunity for colonization by microorganisms that catalyze the oxidation processes in the presence of acidity. As a consequence, the potential environmental consequences of human activities can be significantly more noticeable than those resulting from natural processes.

## 2.3 History of Acid Rock Drainage

Like other human endeavours, mining and the use of mineral resources has resulted in environmental consequences. While organized mining may have originated around 6,000 BC (principally associated with extraction of alluvial gold and flint stone), there is substantial evidence that by the third millennium BC (early Bronze Age) there was contamination resulting from copper mining and smelting in the Iberian Pyrite Belt (Figure 2-1). On a regional scale, the effects of mining and smelting included heavy metal pollution in river water and sediments, increased erosion, and deforestation. Atmospheric pollution present as metal-rich layers in ice cores from Greenland signifies more global effects of these historical mining and smelting activities (Nocete et al., 2005). Similar observations have been made regarding Bronze Age copper mining in Ireland, Great Britain, and Austria.

### Figure 2-1: Roman Portal with Acid Rock Drainage – Spain

As mining progressed throughout the Iron Age, the Roman Empire, and medieval times, the environmental effects of mining continued without controls. Specific references to reactive sulphides and their degradation to acid and salts date from as early as the Roman era, and by the time Georgius Agricola published his seminal and oft-quoted work on mining and metallurgy in the mid-16th century (Agricola, 1556), ARD and its effects on human health and the environment were known. The Industrial Revolution was made possible through, and required extraction of, vast amounts of mineral

**Figure 2-1: Roman Portal with Acid Rock Drainage - Spain**



resources; in particular coal, and the associated water and air pollution became more widespread. Little was done at the time to mitigate these impacts because of a lack of knowledge about the fundamentals of ARD generation, and because not much was known about the consequences of environmental effects in general.

Modern mining has yet again increased the degree of resource recovery (and thereby the potential for ARD generation). However, this resource recovery increase has been accompanied by an increased awareness and understanding of potential environmental consequences and an increased scientific and technical understanding of ARD management tools. As a consequence, organized mining is currently conducted in accordance with a (generally extensive) set of guidelines and regulations aimed at operating in an environmentally responsible manner.

## 2.4 The Acid Generation Process

This section presents a summary of the acid generation process, including the sulphur cycle and its weathering products and the factors that control generation and migration of ARD, NMD, and SD. Potential impacts from ARD, NMD, and SD on specific receptors are also briefly discussed. More detail on the genesis of coal mine drainage (CMD) is presented here: **Introduction to Coal Mine Drainage**.

### 2.4.1 Characteristics of Acid Rock Drainage, Neutral Mine Drainage, and Saline Drainage

The generation, release, mobility and attenuation of ARD, NMD, and SD are complex processes governed by a combination of physical, chemical and biological factors. Whether ARD, NMD or SD enters the environment depends largely on the characteristics of the sources, pathways, and receptors involved. A generalized conceptual model of sources, pathways, and receiving environments is shown in Figure 2-2. These sources, pathways and receiving environments vary by commodity, climate, mine facility, and mine phase. The sources include the mine and process wastes and mine and process facilities that contain reactive sulphide and potentially neutralizing minerals involved in mitigation of acidity. The characteristics and relative abundance of these sulphides and neutralizing minerals, which play a critical role in determining the nature of the discharge being generated, may vary as a function of commodity and ore-deposit type, type of mining, and waste-disposal strategy. The pathways and transport mechanisms are related to climate and seasonal effects and the hydraulic characteristics of the mine or process waste/facility that represents the source. Climate and seasonal effects may determine whether a mine discharge is continuous or intermittent, dilute or highly concentrated, which has an effect on the nature of the drainage. The hydraulic characteristics of a mine or process waste/facility may determine the contact time between solid and solution (e.g., rapid preferential flow vs. gradual matrix flow) or the proportion of mine waste being flushed. The receptors (i.e., the receiving environment) may also alter the nature of the mine drainage. Examples of receiving environments include groundwater, surface water, or wetlands. All of these receiving environments can alter the original characteristics of the mine discharge through a combination of physical mixing, chemical, and biological reaction.

**Figure 2-2: Generalized Conceptual Model of Sources, Pathways and Receiving Environment at a Mine or Processing Site**

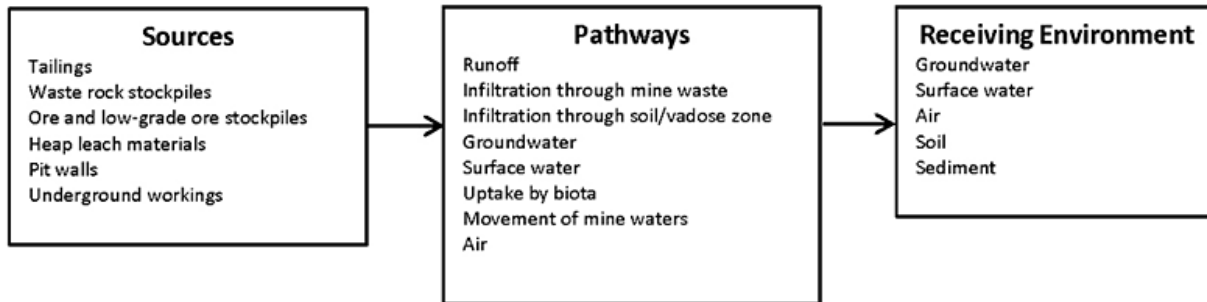

The influence of commodity, climate, mine or process facility, and mine phase on the nature of the mine drainage (ARD, NMD or SD) can be illustrated using Ficklin diagrams or analogue versions. Ficklin diagrams are plots that can be used to interpret variations in mine drainage water chemistry between different deposits (Plumlee et al., 1999). These diagrams were developed in support of the use of geoenvironmental models, which are constructs that interpret the environmental characteristics of an ore deposit in a geologic context. Geoenvironmental models provide a very useful way to interpret and summarize the environmental signatures of mining and mineral deposits in a systematic geologic context. Geo-environmental models can also be used to anticipate potential environmental problems at future mines, operating mines, and orphan sites.

The traditional Ficklin plot is a scattergram in which the sum of the base metals zinc (Zn), copper (Cu), lead (Pb), cadmium (Cd), cobalt (Co), and nickel (Ni) is plotted against pH. These parameters were selected rather than more common metals such as iron (Fe), aluminum (Al), and manganese (Mn) because they have proven the most diagnostic in differentiating between different geologic controls. However, similar plots using parameters other than Zn, Cu, Pb, Cd, Co, and Ni can also be used to demonstrate the effect of commodity, climate, mine facility, and mine phase.

Figure 2-3 shows a Ficklin plot that represents a compilation of data provided in Plumlee et al., (1999) for a wide variety of ore deposit types. Individual data points are not presented, but instead the shaded outline presents the range of major and trace metal concentrations and pH for all deposit types in this publication. Figure 2-4 is a Ficklin analogue, which now shows the range of sulphate concentrations observed in mine waters, also based on data from Plumlee et al. (1999). Superimposed on both plots are the approximate outlines of the ARD, NMD, and SD fields. These outlines should not be construed as representing strict classifications because there are no formal guidelines for quantitative definitions of ARD, NMD, and SD.

**Figure 2-3: Ficklin Diagram Showing ARD, NMD, and SD as a Function of Dissolved Base Metal Concentrations (adapted from Plumlee et al., 1999)**

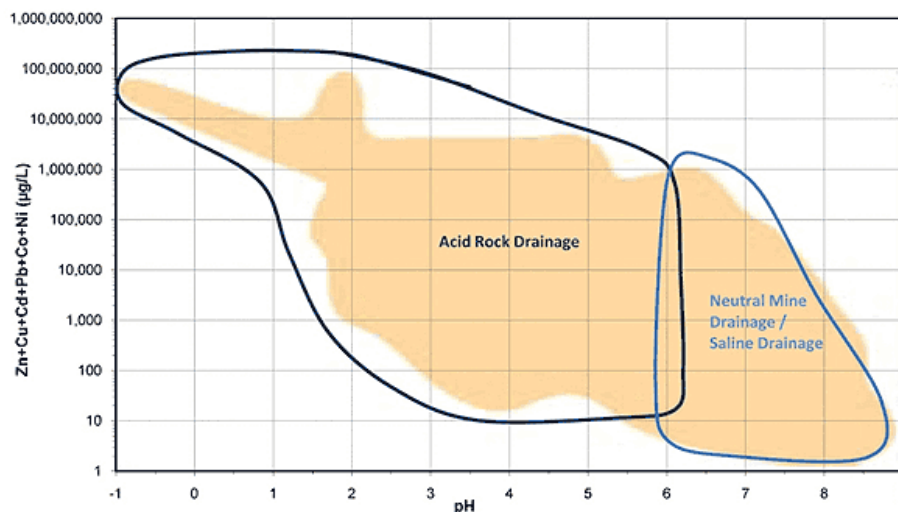

**Figure 2-4: Diagram Showing ARD, NMD, and SD as a Function of Sulphate Concentrations**

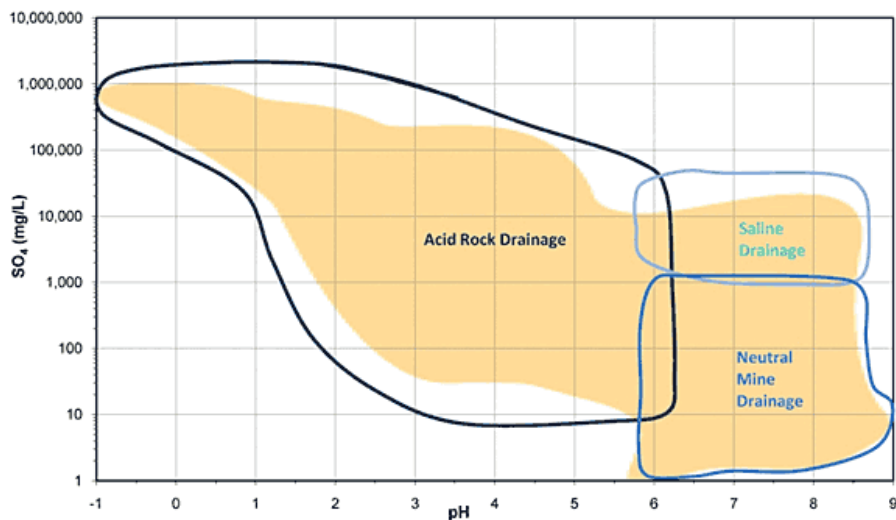

The data compilations presented in Figure 2-3 and Figure 2-4 also include mine water qualities not resulting from sulphide oxidation. However, the fields for ARD, NMD, and SD are drawn so that this nomenclature covers the entire range of water qualities observed, including water types that may deviate from the proper definitions. For example, acidic water with low metal and sulphate levels is captured in the ARD field even though acidic water may not originate from sulphide oxidation but may, for instance, reflect weathering of soils rich in hydrous iron oxides such as laterites.

Typical ore-deposit types most commonly associated with ARD include volcanogenic massive sulphide (VMS) deposits, high sulphidation epithermal deposits, porphyry copper deposits and skarn deposits. Coal deposits also frequently generate ARD. Typical deposit types associated with SD include Mississippi-Valley Type (MVT) deposits, low-sulphide gold-quartz vein deposits, and “clean” skarns. NMD can be generated by a wide variety of ore deposits, depending on the type of alteration and sulphide content, including most types listed for ARD and SD.

Ficklin diagrams can also be used to illustrate a number of principles that govern mine water quality (Figure 2-5). In this figure, a number of trend lines demonstrate the generic effect of increasing pyrite content, increasing base-metal sulphide content, and increasing carbonate content on mine water quality. As portrayed in the diagrams, an increase in pyrite content tends to result in more acidic waters. An increase in base-metal sulphide content tends to result in an increase in trace metal concentrations, and an increase in carbonate content tends to lead to more alkaline waters. However, these trends must be interpreted with caution. For example, some deposits can be carbonate rich but can still generate acidic waters if the acid-buffering carbonates are physically separate from the sulphides, if a reaction barrier of iron (hydr)oxides coats the carbonates and prevents their dissolution, or if the carbonates are associated with metals that release acid when precipitated as hydroxides. Therefore, site-specific evaluation of geochemical and geological characteristics of the ore and mine wastes is required.

**Figure 2-5: Ficklin Diagram Showing Selected Principles that Govern Mine Water Quality (adapted from Plumlee et al., 1999)**

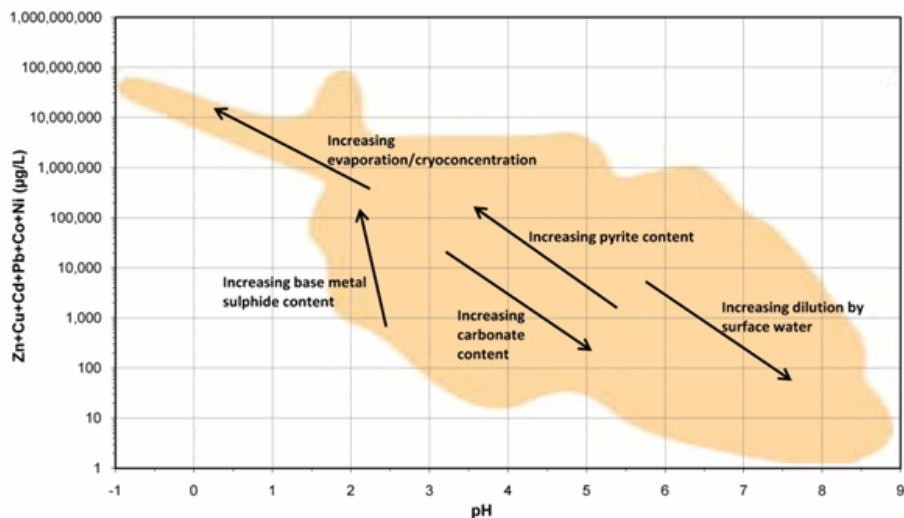

Generic effects of climate are superimposed on Figure 2-5. In very general terms, mine waters from acid generating deposits in arid climates tend to be more acidic and metalliferous due to enhanced evaporation and a greater solid to water ratio during water/rock interaction. Conversely, the greater dilution and reduced solid to water ratio in wetter climates generally leads to mine waters from acid generating deposits with a less acidic and concentrated character. The less common evapoconcentration of mine waters with an alkaline nature (not shown on the figure) tends to result in waters that are more basic, while dilution in wetter climates tends to reduce the alkalinity. Cryoconcentration (i.e., concentration due to freezing) in arctic environments may lead to mine waters with elevated concentrations of trace metals and sulphate. In addition, cryoconcentration tends to increase either the acidic or alkaline nature of the mine effluent. Although climate is a key control on mine water quality, according to Plumlee (1999), the relative shifts in pH and metal content for a given deposit type in different climatic settings are generally of lesser importance than the changes due to the differences in geologic characteristics. Also, the effect of climate on environmental impacts downstream from a mineral deposit should not be ignored. Such effects can be quite significant. For example, downstream dilution is much enhanced in wetter climates relative to dry climates, while seasonal occurrences such as the spring freshet and intense rainfall events can produce short-term high loads of contaminants with potentially dramatic effects on downstream mine water quality.

#### 2.4.2 The Global and Geochemical Sulphur Cycles

Sulphur plays an important role in the formation of ARD, NMD, and SD. Sulphur is a very versatile element that can occur in many different chemical forms and oxidation states. The chemical forms of most importance with respect to mine discharges are elemental sulphur, sulphate (in mineral form as well as aqueous), and sulphide (in mineral form and, to a lesser degree, aqueous and gaseous). The corresponding oxidation states of sulphur in minerals are  $S_0$ ,  $S^{6+}$  and  $S^{2-}$ , respectively. Sulphur speciation, and its associated potential environmental impacts, is therefore strongly related to the reduction-oxidation (redox) properties of the aqueous systems with which it interacts. The oxidation and reduction processes that involve sulphur species tend to be slow unless mediated by microorganisms. However, oxidation of certain sulphide minerals present in mine and process wastes (e.g., pyrrhotite) can be very rapid even in the absence of biotic mediation. In extreme cases, oxidation can result in self-heating and combustion, which necessitates the use of special precautions when handling these materials.

The global cycle of sulphur is characterized by a rather rapid recycling of aqueous forms in water and is also characterized by gases and aerosols in the atmosphere. Sulphur present in reduced form in sulphide minerals is relatively immobile. However, after sulphur is exposed through mining or other earthmoving activities, following oxidation, it can have a significant effect on the receiving environment through formation of ARD, NMD, or SD. A large labile reservoir of sulphate species exists incorporated in sediments and in dissolved form in the world's oceans.

A simplified global sulphur cycle is provided in Figure 2-6 (Stumm and Morgan, 1996), but the quantities presented are approximate at best. In this diagram, the weathering of sulphur-bearing minerals (gypsum and sulphides), volcanic emissions, and the recirculation of sea salt and biogenic gases represent the most important natural segments of the cycle. The global sulphur cycle is strongly affected by anthropogenic inputs. Although the exact quantities and ecological consequences of human contributions are only partially

understood, it is generally accepted that human contributions are significant, particularly on the continental land masses where human activity is concentrated and the impacts of such activity are felt. Major factors in the sulphur cycle are the combustion of coal and petroleum. Other factors include industrial processes such as smelting and refining of sulphide ores, which release sulphur oxides into the atmosphere. These emissions are a substantial contributor to the formation of acid rain, which has had many undesirable effects in Europe, the United States, and Canada. More recent undesirable effects have been seen in nations industrializing at a very rapid rate such as China and India. Human activities also add to the natural flux of dissolved sulphur in river water due to increased erosion and industrial activity.

**Figure 2-6: The Global Sulphur Cycle (Stumm and Morgan, 1996). Global Fluxes in Millions Tons of Sulphur per Year and Inventories in Millions Tons of Sulphur**

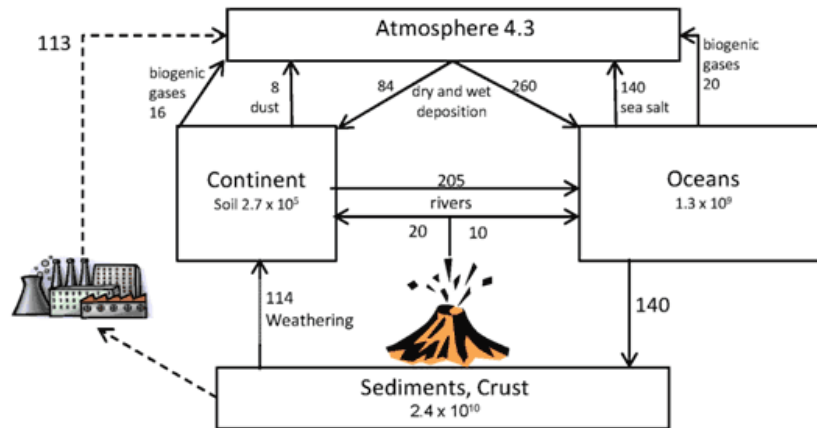

The biogeochemical cycle of sulphur is relatively simple in concept, as illustrated in Figure 2-7, with all components of the cycle being heavily influenced by microorganisms. Most of the sulphur in the earth's sediments and crust is present in the form of primary elemental sulphur and sulphide minerals, which can be oxidized into sulphate through both biotic and abiotic processes. This is the process responsible for formation of ARD, NMD, or SD. Sulphate in soils can be taken up by plants and assimilated into proteins. When plants die and decay, microorganisms mineralize the sulphur in the proteins into hydrogen sulphide or sulphate. The hydrogen sulphide can then be combined with metals to form metal sulphides, or the hydrogen sulphide can be oxidized to elemental sulphur or sulphur dioxide, depending on redox conditions and involvement of biota. In cases where hydrogen sulphide combines with metals, authigenic or secondary sulphide minerals are formed. In the atmosphere, sulphur dioxide may be oxidized and combine with water to form sulphuric acid, which may report to the terrestrial and aqueous environment as acid rain. Direct transformation between sulphate and hydrogen sulphide can be accomplished through a variety of processes that are generally biologically mediated.



**Figure 2-7: The Biogeochemical Sulphur Cycle**

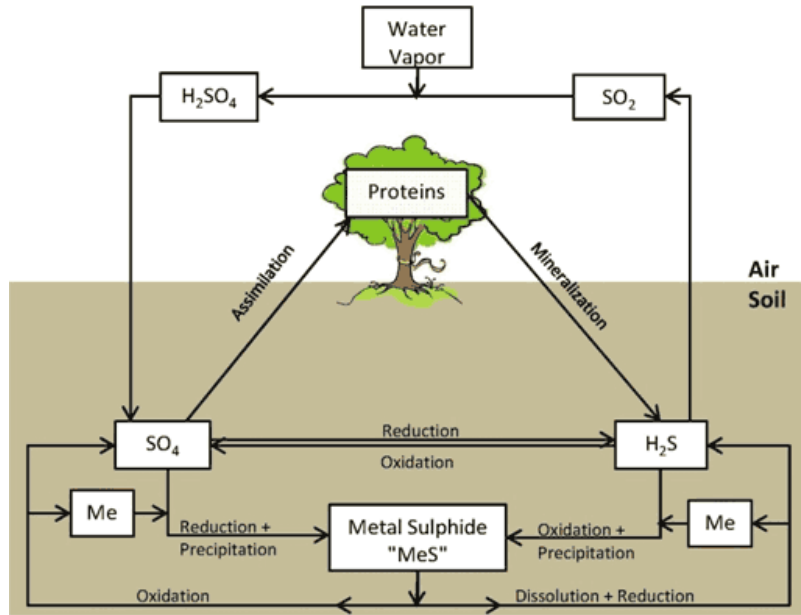

**2.4.3 Acid Rock Drainage Sources**

In the context of this GARD Guide, which focuses on drainages produced by sulphide mineral oxidation, the potential sources for generation of ARD, NMD, and SD are reactive sulphide minerals and their oxidation products. Although other naturally occurring minerals and byproducts from pyrometallurgical and hydrometallurgical processes may generate acidic solutions (e.g., elemental sulfur, jarosites, and other hydroxyl-sulphates such as alunites), these are not discussed in this GARD Guide. The most common sulphide mineral is pyrite [FeS<sub>2</sub>]. Pyrite is the mineral of most relevance from an acid-generation perspective, because its concentration, grain size, and distribution may be the most important factors affecting the production of acidic mine waters (Nordstrom and Alpers, 1999). Other sulphides commonly found in ore deposits are listed in Table 2-1 (Plumlee, 1999). These sulphides may produce ARD, NMD, or SD. Secondary minerals resulting from sulphide oxidation include a complex array of soluble sulphates, hydrous sulphates, hydroxysulphates, metal oxides and hydroxides, clays, carbonates and supergene, and diagenetic sulphides. Some of these secondary minerals may have deleterious effects on water quality because of the release of additional acidity during their formation (e.g., metal (hydr)oxides) or release of stored acidity, sulphate or metals (or both sulphate and metals) during their dissolution (e.g., iron and aluminum hydroxysulphates).

**Table 2-1: Common Sulphides Known or Inferred to Generate Acid when Oxidized (Plumlee, 1999)**

Mineral	Formula
Common sulphides known ( <i>inferred</i> ) to generate acid with oxygen as the oxidant:	
Pyrite, marcasite	FeS <sub>2</sub>
Pyrrhotite	Fe <sub>1-x</sub> S
Bornite	Cu <sub>5</sub> FeS <sub>4</sub>

<i>Arsenopyrite</i>	FeAsS
<i>Enargite/famatinite</i>	Cu <sub>3</sub> AsS <sub>4</sub> /Cu <sub>3</sub> SbS <sub>4</sub>
<i>Tennantite/tetrahedrite</i>	(Cu,Fe,Zn) <sub>12</sub> As <sub>4</sub> S <sub>13</sub> /(Cu,Fe,Zn) <sub>12</sub> Sb <sub>4</sub> S <sub>13</sub>
<i>Realgar</i>	AsS
<i>Orpiment</i>	As <sub>2</sub> S <sub>3</sub>
<i>Stibnite</i>	Sb <sub>2</sub> S <sub>3</sub>
Common sulphides that may generate acid with ferric iron as the oxidant:	
All of the above plus:	
Sphalerite	ZnS
Galena	PbS
Chalcopyrite	CuFeS <sub>2</sub>
Covellite	CuS
Cinnabar	HgS
Millerite	NiS
Pentlandite	(Fe,Ni) <sub>9</sub> S <sub>8</sub>
Greenockite	CdS

The type and distribution of sulphide minerals can vary widely according to the type of ore deposit, nature of the mine waste, and mine stage. Certain types of ore deposits can be devoid of sulphides (e.g., oxide-facies banded iron formation [BIF] deposits) while others contain very substantial amounts of sulphide (e.g., VMS deposits). Similarly, within an individual ore deposit, the distribution of sulphide minerals can range from disseminated evenly throughout the deposit to the sulphides being confined to specific zones. The

distribution depends on the nature of the original ore-forming processes or subsequent alteration. The techniques used to extract and process ores can also significantly affect the type and distribution of sulphide minerals, which in turn has ramifications regarding the nature of corresponding mine discharges. The large volume of waste rock resulting from an open pit mine may have a lower overall sulphide content than the smaller volume originating from an underground mine. This lower overall sulphide content would be due to a greater dilution with rock not directly associated with the mineralization.

A wide variety of mineral processing methods are being used. Some of these methods result in very different types of source materials, especially regarding tailings. For example, where the economic resource is associated with one or more sulphide minerals, its recovery may result in a tailings stream that is low in that particular sulphur mineral association. However, less commonly, where this is not the case, the tailings may represent a material that is concentrated in sulphur relative to the original ore. The type and distribution of sulphide minerals can vary over the life of the mine. This may be due to a change in ore type or processing methodology (or both ore type and processing methodology) over time (e.g., from milling to heap leach as the ore grade decreases or the nature of the ore changes from an oxide-rich to a more sulphidic variant). In addition, because of the ongoing weathering of sulphides, they may become depleted during the life of the mine if sufficiently reactive or, more likely, at some point after mine closure. As illustrated earlier with the various Ficklin diagrams in Section 2.1, all of the above implies that mine drainage generated through sulphide oxidation can show considerable compositional range over the life of the mine as a function of the type of ore deposit and mine or process waste. These site-specific considerations need to be acknowledged before mine development, during operation, and after closure so that they can be accounted for in the identification and implementation of appropriate mine waste and water management practices.

#### 2.4.4 The Sulphide Oxidation Process

The process of sulphide oxidation and formation of ARD, NMD, and SD has been discussed in many references (Stumm and Morgan, 1996; Nordstrom and Alpers, 1999), and only a summary is presented here. Sulphide minerals in ore deposits are formed under reducing conditions in an absence of oxygen. When exposed to atmospheric oxygen or oxygenated waters due to mining, mineral processing, excavation, or other earthmoving processes, sulphide minerals can become unstable and oxidize.

Figure 2-8 presents a model describing the oxidation of pyrite (Stumm and Morgan, 1981). The reactions shown are schematic and may not represent the exact mechanisms, but the illustration represents a useful visual aid for discussing pyrite oxidation.

**Figure 2-8: Model for the Oxidation of Pyrite (Stumm and Morgan, 1981).  
(The numbers in brackets refer to the reactions presented in Section 2.4.4)**

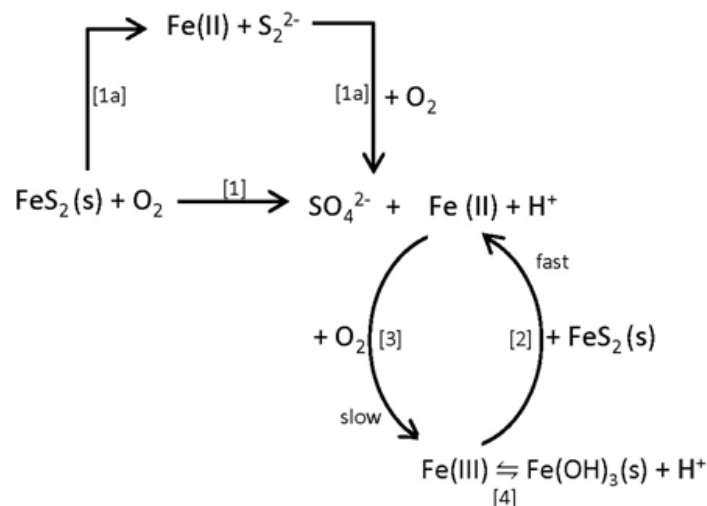

The chemical reaction representing pyrite oxidation requires three basic ingredients: pyrite, oxygen, and water. The overall pyrite oxidation reaction generally is written as:

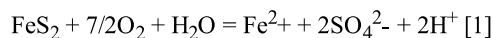

This reaction can occur both abiotically or biotically (i.e., mediated through microorganisms). In addition to direct oxidation, pyrite can also be dissolved and then oxidized (reaction [1a] on Figure 2-8).

Under most circumstances, atmospheric oxygen acts as the oxidant. Oxygen dissolved in water can also result in pyrite oxidation but due to its limited solubility in water, this process is much less prominent. Aqueous ferric iron can oxidize pyrite as well according to the following reaction:

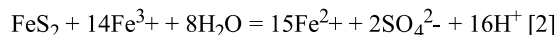

This reaction is considerably faster (2 to 3 orders of magnitude) than the reaction with oxygen and generates substantially more acidity per mole of pyrite oxidized but it is limited to conditions in which significant amounts of dissolved ferric iron occur (i.e., acidic conditions). Therefore, pyrite oxidation is generally initiated through reaction [1] at circumneutral or higher pH, followed by reaction [2] when conditions have become sufficiently acidic (approximately pH 4.5 and lower). A third reaction is required to generate and replenish ferric iron, through oxidation of ferrous iron by oxygen as follows:

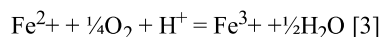

A common misunderstanding is that ferric iron can oxidize pyrite indefinitely in the absence of oxygen. As indicated by reaction [3], oxygen is required to generate ferric iron from ferrous iron. Also, the bacteria that may catalyze this reaction (primarily members of the *Acidithiobacillus genus*) are obligate aerobes (i.e., they require oxygen for aerobic cellular respiration). Therefore, some nominal amount of oxygen is needed for this process to be effective even when catalyzed by bacteria, although the oxygen requirement is less than for abiotic oxidation.

A process of environmental importance related to pyrite oxidation pertains to the fate of ferrous iron generated through reaction [1]. Ferrous iron can be removed from solution under slightly acidic to alkaline conditions through oxidation and subsequent hydrolysis and the formation of a relatively insoluble iron (hydr)oxide. Assuming the nominal composition of ferrihydrite [ $\text{Fe}(\text{OH})_3$ ] for the latter phase, this reaction can be summarized as:

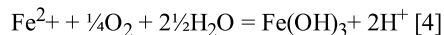

When reactions [1] and [4] are combined, as is generally the case when conditions are not acidic (i.e., pH > 4.5), it can be seen that oxidation of pyrite generates double the amount of acidity relative to reaction [1] as follows:

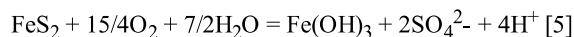

A variety of microorganisms are abundant in mine waters and when conditions become highly acidic they may be the only form of life. Included in the bacterial fauna are iron and sulphur-oxidizing bacteria (e.g., *A. ferrooxidans* and *A. thiooxidans*) These microbes play an important role in sulphide oxidation and in the formation of ARD, NMD, or SD. Due to microbial mediation, many important geochemical reactions take place against thermodynamic expectations (Mills, 1999) because bacteria can couple a thermodynamically unfavourable reaction with a reaction that yields net energy. Rates of reactions, such as iron oxidation, which in turn affects the rate of pyrite oxidation, may be increased by many orders of magnitude relative to the corresponding abiotic rates (Nordstrom and Alpers, 1999; Nordstrom, 2003; Gould and Kapoor, 2003). For example, the oxidation rate of ferrous iron to ferric iron (reaction [3]) can be increased by 5 to 6 orders of magnitude in the presence of iron-oxidizing bacteria. Although the exact reaction mechanism of pyrite oxidation on a molecular level is still under investigation (a recent discussion of the state of knowledge and research is given in Wolkersdorfer [2008]), the rate-limiting step is the production of ferric iron from ferrous iron through microbial catalysis. Figure 2-9 (Robertson and Broughton, 1992) provides a schematic illustration of the normalized relative oxidation rates with and without bacterial mediation as a function of pH.

**Figure 2-9: Schematic Illustration of Normalized Sulphide Oxidation Rates with and without Bacterial Mediations (after Robertson and Broughton, 1992)**

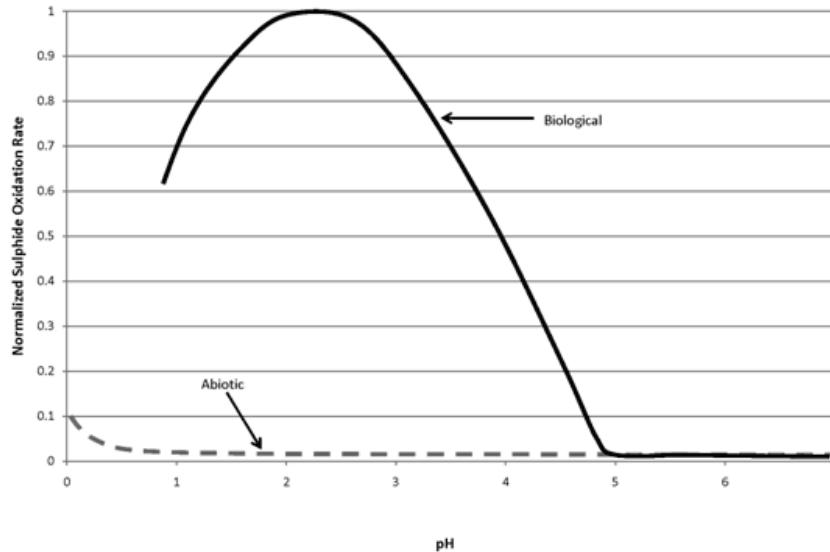

Although pyrite is by far the dominant sulphide responsible for the generation of acidity, different ore deposits contain different types of sulphide minerals, not all of which generate acidity when being oxidized. As a general rule, iron sulphides (pyrite, marcasite, pyrrhotite), sulphides with molar metal/sulphur ratios  $< 1$ , and sulphosalts (e.g., enargite) generate acid when they react with oxygen and water. Sulphides with metal/sulphur ratios  $= 1$  (e.g., sphalerite, galena, chalcopyrite) tend not to produce acidity when oxygen is the oxidant. However, when aqueous ferric iron is the oxidant, all sulphides are capable of generating acidity. Therefore, the amount of iron sulphide present in an ore deposit or mine waste plays a crucial role in determining the characteristics of the mine drainage. While pyrite is the most common source mineral for iron, sulphides such as chalcopyrite and ferrous sphalerite can also act as iron donors. As a result, mine waters originating from such materials tend to be significantly more acidic than discharges from sulphide assemblages that primarily include sphalerite and galena. Oxidation of the sphalerite and galena still occurs, resulting in release of sulphate and trace metals such as zinc and lead, respectively. Should these metals remain in solution, NMD will be generated. Table 2-1 (Plumlee, 1999) provides an overview of sulphide minerals and their known or inferred potential to generate acid when oxidized by either oxygen or ferric iron.

#### 2.4.5 Reaction Products from Sulphide Oxidation

The potential reaction products from sulphide oxidation include acidity, sulphur species, total dissolved solids, and metals. The degree to which these reaction products are being generated and persevere in the receiving environment determines whether ARD, NMD, or SD results.

The production and persistence of acidity largely depends on the nature of the sulphide mineral being oxidized, the reaction mechanism (i.e., oxygen vs. ferric iron as the oxidant), and the presence of acid-consuming minerals. In most ore deposits and mine wastes, sulphide minerals occur in a mineral assemblage that also includes acid-consuming minerals such as carbonates and aluminosilicates. More detail on acid neutralization mechanisms is provided in Section 2.6.6.

The sulphur species generated from sulphide oxidation is sulphate. Under the acidic conditions commonly encountered at some mining sites, dissolved sulphate concentrations can be up to approximately 10,000 mg/L (Figure 2-4). However, in extreme cases, concentrations over 100,000 mg/L have been observed. An example of an extreme case is at the Iron Mountain VMS deposit in California, where pH values may be as low as  $-2$  to  $-3$  (Nordstrom and Alpers, 1999). As conditions become more alkaline, sulphate concentrations are usually governed by the solubility product of gypsum  $[\text{CaSO}_4 \cdot 2\text{H}_2\text{O}]$ , which tends to limit sulphate levels to a few thousand milligrams per litre. Other dissolved sulphur species known to occur in discharges associated with mining activity and during mineral processing are bisulphide ( $\text{HS}^-$ ), sulphide ( $\text{S}^{2-}$ ) and thiosalts (sulphur oxyanions, including polysulphides  $[\text{S}_n^{2-}]$ , sulphoxy anions such as thiosulphate  $[\text{S}_2\text{O}_3^{2-}]$ , polythionates  $[\text{S}_n\text{O}_6^{2-}]$ , and sulphite  $[\text{SO}_3^{2-}]$ ). The thiosalts occupy a metastable position between sulphate and sulphide, and both sulphide and thiosalts will naturally oxidize to sulphate under atmospheric conditions, generating acidity in the process. There is little evidence that dissolved sulphides and thiosalts originate from oxidation of sulphide

minerals in ore deposits or mine wastes. Instead, dissolved sulphide tends to be a by-product of active water treatment at mining sites (for instance, metal precipitation using  $\text{Na}_2\text{S}$  or  $\text{NaSH}$ ). Sulphides can also occur because of interaction between sulphate and organic matter in reducing environments, either in natural settings, active sulphate reducing bacteria (SRB) treatment systems, or in passive treatment systems such as constructed wetlands. Thiosalts usually result from partial oxidation of sulphide minerals during ore processing. The presence of sulphides or thiosalts in process water can be a significant concern in acidification of tailings supernatant and pore water, and can also potentially be of concern in downstream receiving waters.

Total dissolved solids (TDS) concentrations in mine and process discharges are usually directly related to the amount of sulphate, chloride, or bicarbonate present in solution. Although other constituents may also increasingly contribute to TDS when pH decreases and mineral dissolution becomes more effective, sulphate, chloride, or bicarbonate tend to represent the dominant anion contribution to TDS. In the case of alkaline mine discharges (e.g., from kimberlites), alkalinity in the form of carbonate and bicarbonate ions may represent the most important proportion of TDS.

Major and trace metals in ARD, NMD, and SD are sourced from the oxidizing sulphides and dissolving acid-consuming minerals. In the case of ARD, Fe and Al are usually the principal major dissolved metals, with concentrations that can range from 1,000s to 10,000s mg/L. Trace metals such as Cu, Pb, Zn, Cd, Mn, Co, and Ni can also achieve elevated concentrations in ARD, reaching levels from 100s to 1,000s of mg/L (Figure 2-3). In mine discharges with a more circumneutral character, trace metal concentrations tend to be lower due to formation of secondary mineral phases and increased sorption of trace metals onto a variety of sorbents such as metal (oxy)hydroxides, clay minerals, and reactive particulate carbon (Smith, 1999). However, certain parameters remain in solution as the pH increases, in particular the metalloids As, Se, and Sb as well as other trace metals (e.g., Cd, Cr, Mn, Mo, and Zn). The resulting mine or process discharge is NMD, and treatment for these parameters can be challenging. As conditions become even more alkaline, some of these species will precipitate as carbonates or hydroxides (e.g., Zn and Mn) but others may remain in solution (e.g., Cr, As, Se, and Sb) while others (e.g., Al) may become remobilized, such as in alkaline drainages from kimberlite deposits. The mobility (and toxicity) of several environmentally significant trace metals is governed by their oxidation state, for instance for As, Se, uranium (U), and chromium (Cr). Mine waters tend to have an oxidized character, which favours the less mobile arsenic species [As(V)], but enhances the mobility of chromium, selenium, and uranium in the form of [Cr(VI)], [Se(VI)] and [U(VI)], respectively.

#### 2.4.6 Neutralization Reactions

Neutralization reactions play a key role in determining the compositional characteristics of drainage originating from sulphide oxidation. Generic reactions for consumption of acid because of dissolution of carbonate and silicate minerals (using plagioclase as an example) can be written as:

$\text{MeCO}_3 + \text{H}^+ = \text{Me}^{2+} + \text{HCO}_3^-$  [6] (where Me represents a divalent cation, such as calcium or magnesium, but not iron or manganese because these release acidity after subsequent hydrolysis/precipitation)

and

$\text{CaAl}_2\text{Si}_2\text{O}_8 + 8\text{H}^+ = \text{Ca}^{2+} + 2\text{Al}^{3+} + 2\text{H}_4\text{SiO}_4$  [7]

As for sulphide minerals, the reactivity, and accordingly the effectiveness with which these minerals are able to buffer any acid being generated, can vary widely. Most carbonate minerals are capable of dissolving rapidly, making them effective acid consumers. Although generally more common, aluminosilicate minerals tend to be less reactive, and their buffering may only succeed in stabilizing the pH when low values have been achieved. In some cases, when sulphide oxidation rates and flushing rates are very low, certain silicate minerals, in particular calcium-magnesium (Ca-Mg) silicates, have been known to buffer mine effluents at neutral pH (Jambor, 2003).

Hydrolysis of dissolved Fe, Mn, or Al following dissolution of acid-consuming minerals and subsequent precipitation of a secondary mineral according to reaction [4] may generate acidity. As a consequence, the net effect of their dissolution in terms of acid consumption may be significantly less than expected from reactions such as [6] and [7], or they may even generate net acidity at formation of the secondary mineral phase. Examples of such incongruent dissolution reactions that are the equivalents of congruent reactions [6] and [7] are as follows:

$\text{FeCO}_3 + \frac{1}{4}\text{O}_2 + 2\frac{1}{2}\text{H}_2\text{O} = \text{Fe}(\text{OH})_3 + \text{H}^+ + \text{HCO}_3^-$  [8]

and

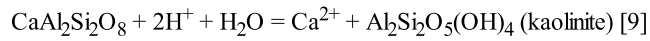

Table 2-2 provides an overview of the ranges of neutralization potential and buffering pH for a number of common minerals. As is immediately obvious, carbonate minerals generate significantly more neutralization potential than silicate minerals, while they also tend to buffer at higher pH values. Effective neutralization, in practice is therefore generally directly related to the abundance of non-Fe/Mn carbonate minerals.

**Table 2-2: Typical NP Values and pH Buffering Ranges for Some Common Minerals (Jambor, 2003; Blowes et al., 2003; BCAMDTF, 1989)**

Group	Formula	Buffer pH	Neutralization Potential Range (kg CaCO <sub>3</sub> /tonne)
Carbonates			500-1,350
calcite, aragonite	CaCO <sub>3</sub>	5.5 – 6.9	
siderite	FeCO <sub>3</sub>	5.1 – 6.0	
malachite	Cu <sub>2</sub> CO <sub>3</sub> (OH) <sub>2</sub>	5.1 – 6.0	
Oxides			
gibbsite	Al(OH) <sub>3</sub>	3.7 – 4.3	
limonite/goethite	FeOOH	3.0 – 3.7	
ferrihydrite	Fe(OH) <sub>3</sub>	2.8 – 3.0	
Jarosite	KFe <sub>3</sub> (SO <sub>4</sub> ) <sub>2</sub> (OH) <sub>6</sub>	1.7 – 2.0	
Aluminosilicates		0.5 – 1.5	
Feldspar Group			
K-feldspar	(K,Na)AlSi <sub>3</sub> O <sub>8</sub>		0.5-1.4
albite (Ab100-Ab50)	NaAlSi <sub>3</sub> O <sub>8</sub>		0.5-2.6
anorthite (An51-An100)	CaAl <sub>2</sub> Si <sub>2</sub> O <sub>8</sub>		5.3-12.5

Pyroxene Group	$(\text{Me})(\text{Si},\text{Al})_2\text{O}_6$		0.5-9.5
Amphibole Group	$(\text{Me})_{7-8}((\text{Si},\text{Al})_4\text{O}_{11})(\text{OH})_2$		0.2-8.1
Mica Group			
muscovite	$\text{KA}_{12}(\text{AlSi}_3\text{O}_{10})(\text{OH})_2$		0.3
biotite	$\text{K}(\text{Mg},\text{Fe})_3(\text{AlSi}_3\text{O}_{10})(\text{OH})_2$		2.7-8.8
Chlorite Group	$(\text{Mg},\text{Fe},\text{Al})_6(\text{Al},\text{Si})_4\text{O}_{10}(\text{OH})_8$		0.8-21.6
Clay Group	$(\text{Me})(\text{Si},\text{Al})_4\text{O}_{10}(\text{OH})_2$		-2.7-29.0
Garnet Group	$(\text{Ca},\text{Mg},\text{Fe},\text{Mn})_3(\text{Al},\text{Fe},\text{Cr})_2(\text{SiO}_4)_3$		1.3-6.3
Apatite Group	$\text{Ca}_5(\text{PO}_4)_3(\text{F},\text{Cl},\text{OH})$		2.7-11.3
Miscellaneous			
talc	$\text{Mg}_3\text{Si}_4\text{O}_{10}(\text{OH})_2$		1.7
serpentine	$\text{Mg}_6\text{Si}_4\text{O}_{10}(\text{OH})_8$		15.1-87.6
epidote	$\text{Ca}_2(\text{Al},\text{Fe})_3\text{Si}_3\text{O}_{12}(\text{OH})$		1.0-3.0
wollastonite	$\text{CaSiO}_3$		440

Me = monovalent, divalent or trivalent cation

The combination of acid generation and acid neutralization reactions typically leads to development of ARD, as illustrated in Figure 2-10 (Broughton and Robertson, 1992). Over time, pH decreases along a series of plateaus governed by the buffering of a range of mineral assemblages. Stage I is characterized by a circumneutral pH range and consumption of acid by carbonate minerals such as calcite according to generic reaction [6]. Reactions [1], [3], and [4] describe the sulphide oxidation process, which results in sulphate release. As this alkalinity is consumed, the pH declines in stages depending on the nature of the neutralizing minerals (Stage II). Generally, at this stage sulphate, acidity, and trace metal levels increase although for some metals (e.g., Cu, Pb), concentrations may be limited by mineral solubility controls. Buffering may be provided by metal hydroxides. At pH values of approximately 4.5 and below, microbially mediated oxidation predominates (reactions [2] and [3]), resulting in a rapid acceleration of acid generation. In Stage 3, final buffering is usually limited to dissolution of silicate minerals (reaction [7]), and solubility controls on trace metal concentrations are largely absent.



Figure 2-10: Stages in the Formation of ARD (after Broughton and Robertson, 1992).

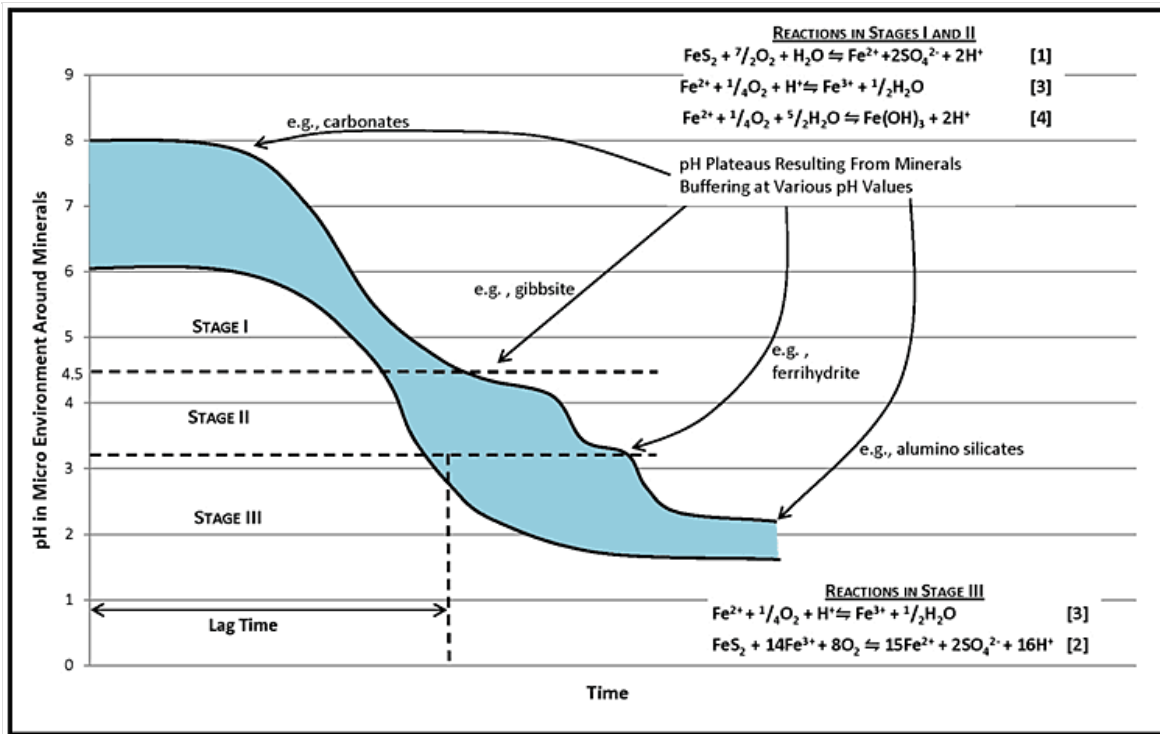

**Note:** The numbers in brackets refer to the reactions presented in Chapter 2.6.4

The lag time to acid generation, as shown in Figure 2-10, is an important consideration in ARD prevention. It is far more effective (and less costly in the long term) to control ARD generation during Stage I than during the subsequent stages. The lag time also has important ramifications for interpretation of test results. It is critical to recognize the stage of oxidation when predicting ARD potential: the first stage may last for a very long time (up to years), even for materials that will eventually be highly acid generating. The early results of geochemical testing, therefore, may not be representative of long-term behaviour and discharge quality.

#### 2.4.7 The Acid Rock Drainage Process and Migration

This section describes the factors that control ARD formation, migration of ARD, and potential impacts of ARD to receptors. The following three aspects of ARD formation and migration are identified and discussed:

- Factors that govern the rate of sulphide oxidation
- Factors that modify the composition of resulting drainage in the mine or process waste
- Factors that modify the composition of drainage after exiting the mine or process waste facility

These three aspects are schematically illustrated in Figure 2-11. The factors that govern the rate of sulphide oxidation are described individually in Section 2.4.7.1 and represent the source term in Figure 2-2. The factors that modify the composition of the resulting drainage both within the mine or process waste and after exiting the mine or process facility are illustrated in Section 2.4.7.2. These factors are represented by the pathways in Figure 2-2. Finally, the receiving environment is discussed in Section 2.4.7.3.

Figure 2-11: Schematic Illustration of Factors that Affect Sulphide Oxidation and Modify Mine Drainage during Transport

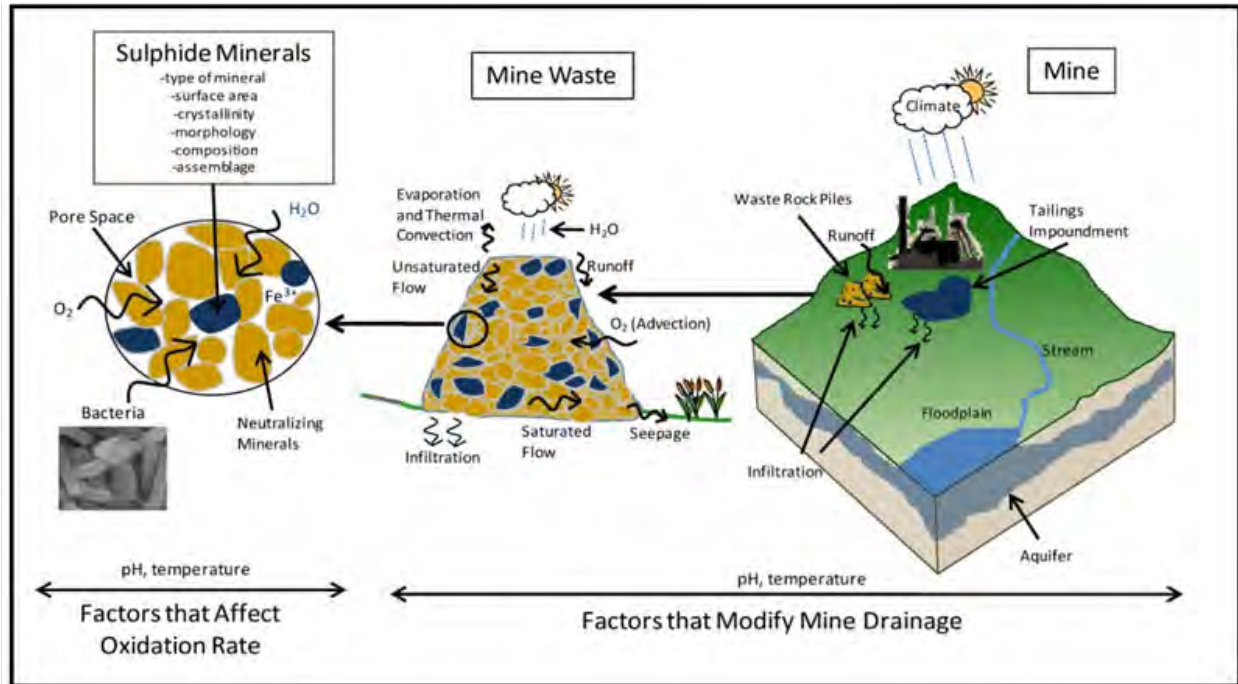

#### 2.4.7.1 Factors directly involved in rate of sulphide oxidation

A large number of factors control the rate of sulphide oxidation. For the purpose of this discussion, these factors are classified as chemical factors, physical factors, and biological factors. However, in reality these aspects form part of a very complicated and interwoven environmental system, and as such don't operate independently but tend to be highly interrelated. Because of this interdependence, the chemical and physical factors are described and summarized simultaneously. While the description of chemical and physical factors also includes some references with regard to biological aspects, more detail on biological factors is provided under separate headings.

##### 2.4.7.1.1 Chemical and physical factors

The principal chemical and physical factors governing the rate of sulphide oxidation include the following:

- Sulphide mineral:
  - Type of mineral
  - Surface area
  - Encapsulation
  - Crystallinity
  - Morphology
  - Assemblage
- Ambient environment:
  - pH
  - Oxidation-reduction (redox) potential
  - Temperature
  - Source of water
- Oxidant:

- Type of oxidant
- Oxygen
- Ferric iron
- Availability of oxidants

The type of sulphide mineral has a significant bearing on oxidation rates. As illustrated in Nordstrom and Alpers (1999) and Plumlee (1999), measured oxidation rates for sulphide minerals vary widely. Although laboratory studies usually agree with the general ranking of sulphides in terms of their reactivity, individual studies can vary considerably in detail when considering observed reaction rates. This disagreement may be due to differences in other aspects related to the sulphide mineral, including surface area, crystallinity, morphology, mineral composition, and sulphide assemblage, all of which can greatly influence resistance to oxidation. The description of these factors in the following paragraphs equally applies to non-sulphides, including acid-consuming minerals such as carbonates and silicates.

Grain size is a fundamental control on the reactivity of waste rock (Smith and Beckie, 2003). Because of the greater surface area available for interaction with oxidizing agents, fine-grained sulphides tend to oxidize more rapidly than their coarser equivalents. A larger surface area can also result from rapid growth of sulphide minerals under highly supersaturated conditions or bacterial activity, which may lead to formation of, for instance, framboidal pyrite (i.e., “raspberry-textured”: agglomerations of many microscopic spherules). Framboidal pyrite is most commonly found in deposits that formed in sedimentary environments such as coal, or colloform (intergrown radiating fibres) textures. In contrast, slower growth in a less supersaturated environment results in euhedral crystals with a smaller surface area, such as the typical cubic form of pyrite. Rapid crystal growth also promotes formation of amorphous rather than crystalline mineral phases. The reactivity of amorphous phases tends to be elevated relative to their crystalline counterparts because of their higher surface energy. The “reactive surface area” (i.e., the portion of the surface area available for chemical reaction) can be considerably less than the surface area measured using standard techniques because of intergranular contacts or inclusion within other minerals. An additional complication in mine and process facilities is that not all exposed surface area is in the flow path of water, thereby further lowering the reactive surface area. The generalized effect of particle size on system reactivity is often counterbalanced by the effect that smaller particle size has on decreasing permeability of the system to oxygen and water.

The composition of the sulphides can also affect oxidation rates. The presence of impurities and defects causes strain in the crystal structure, which in turn diminishes the resistance of the sulphide mineral to oxidation. Sulphides forming part of an assemblage consisting of different sulphide mineral phases can weather preferentially because of galvanic reactions caused by differences in standard electrode potentials of sulphides. This galvanic effect is similar in concept to the galvanic protection applied in many industries that rely on longevity of metals, where sacrificial metals are used to prevent oxidation of the metal of interest (e.g., zinc blocs on steel surfaces). Minerals with lower standard electrode potentials include pyrrhotite, sphalerite, and galena, and these minerals will oxidize preferentially when in electrochemical contact with minerals such as argentite and pyrite, which have higher potentials.

Temperature and the pH of the ambient environment are important controls on the rate of sulphide oxidation. Temperature effects can be described in terms of the Arrhenius equation, which relates chemical reactivity to temperature and activation energy. As a general rule, reaction rates approximately double for every 10°C increase in temperature. However, this generalization needs to be applied with caution, because reaction rates depend on the actual reaction paths (simple vs. complex, homogeneous vs. heterogeneous), reaction order (1st, 2nd, 3rd), and the mechanisms that govern movement of reactants and reaction products (e.g., diffusion). Figure 2-12 (Robertson and Broughton, 1992) presents a schematic illustration of the effect of temperature on abiotic sulphide oxidation rates (normalized) and provides a comparison against the temperature effect on bacterially mediated oxidation.

**Figure 2-12: Schematic Illustration of the Effect of Temperature on Normalized Sulphide Oxidation Rates (after Robertson and Broughton, 1992)**

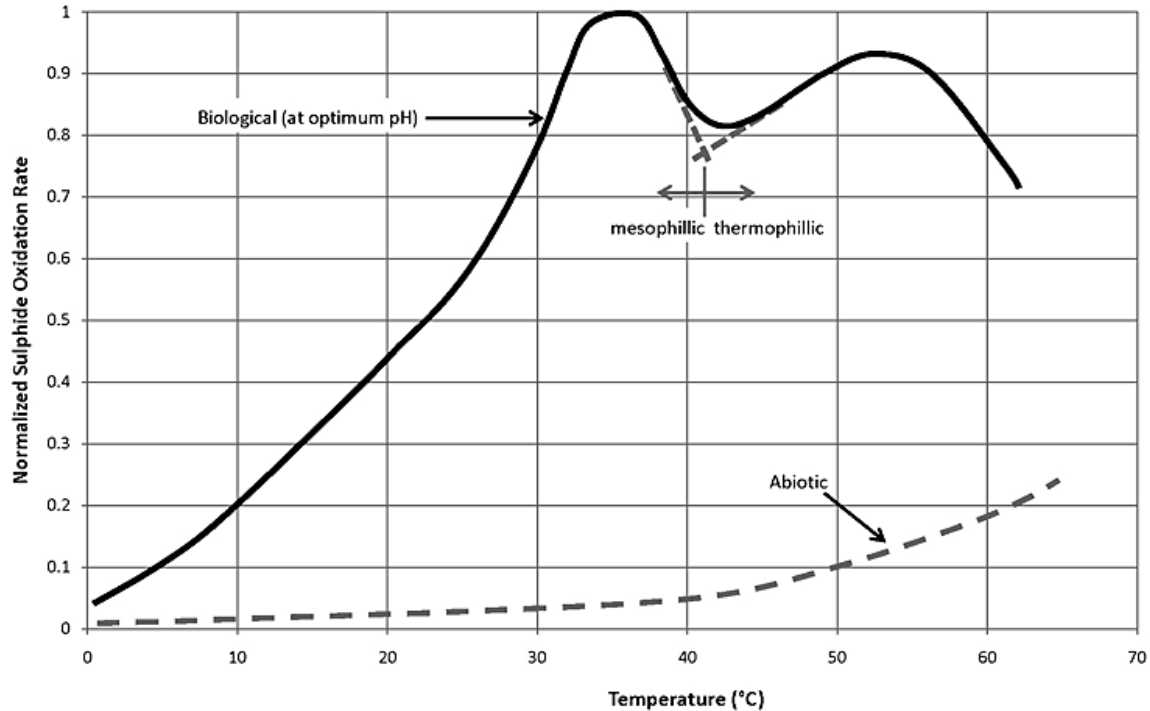

The hydrogen activity (and therefore the pH) features prominently in sulphide oxidation reactions. According to Le Chatelier's principle, for a system at equilibrium, when a condition is changed, the equilibrium will shift in the direction that will reduce, in part, the applied change. For the overall pyrite oxidation reaction [5], this would indicate that pyrite oxidation will decelerate as conditions become more acidic, yet there is little evidence for this occurring in mining materials. One reason for this apparent discrepancy is that the overall reaction as represented by equation [5] does not adequately describe the actual reaction steps and mechanism, which implies that the pH-dependency of the reaction may not be as straightforward as suggested. In addition, at many mine waste facilities, oxidation products are periodically removed by flushing, which allows the oxidation reaction to proceed. The most important effect of pH, however, is that acidic conditions promote the activity of bacteria that can catalyze the various reactions associated with pyrite oxidation. For instance, *A. ferrooxidans* cannot use ferrous iron for metabolic purposes above a pH of approximately 3.5. However, it should be noted that the microenvironment at the reaction site may be very different from what is measured in the bulk aqueous environment because the pH at the pyrite surface, where the bacteria may be active, could be much lower. It is likely that one of the critical catalytic effects that bacteria may have relates to the ability of bacteria to actively maintain a microenvironment at the reaction site that suits their specific metabolic requirements. Measurements of pH, temperature, or redox state in the bulk liquid may therefore not be a reliable indicator of environmental conditions at the reaction site, and care must be taken in reaching conclusions based on these bulk liquid measurements.

The effect of the type of oxidant on the rate of sulphide oxidation is described in Section 2.4.4. In summary, ferric iron accelerates the oxidation of pyrite by approximately 2 to 3 orders of magnitude relative to oxygen. The availability of the oxidant can also have a pronounced effect on pyrite oxidation rates, and, in the case of oxygen, forms the basis for a number of mitigation alternatives.

Ritchie (2003) has demonstrated that the transport of oxygen is the limiting factor in sulphide oxidation rates within mine waste facilities. The principal mechanisms contributing to airflow and oxygen transport include the following:

- Diffusion
- Convection due to a thermal gradient
- Advection due to a wind gradient
- Barometric pumping

Diffusion is usually limited to a near-surface zone of a few meters depth, while convection and barometric pumping have the capability to move air and oxygen to much greater depths. Diffusion and thermally induced convection are largely governed by the reactivity of the mine or process waste and its air permeability, whereas barometric pumping and advection represent external factors whose effect is primarily controlled by only porosity.

Oxygen diffusion is caused by a concentration gradient resulting from oxygen depletion due to sulphide oxidation. Diffusion is described by Fick's Law, which includes a diffusion coefficient that is specific to the properties of the diffusion medium. The degree of saturation within the pore space has a dramatic effect on the value for the oxygen diffusion coefficient, which decreases over approximately 5 orders of magnitude from air to fully saturated conditions. This reduction in diffusivity explains the benefits of maintaining near fully saturated conditions to control sulphide oxidation. An example of a reduction in diffusivity is the use of an overlying water cover or through maintaining saturation within the pore space. Although oxygenated rainwater or pore water represent a potential source of oxygen for sulphide oxidation, this supply is very limited and it cannot be replenished with sufficient efficiency so that it results in the generation of ARD, NMD, or SD. There is increasing evidence that the oxygen present in the water in reactions [1] and [2] partakes in the sulphide oxidation reaction, but this participation is likely to be of negligible importance relative to the control of atmospheric or even dissolved oxygen on the sulphide reaction rate. The degree of oxygen depletion through sulphide oxidation depends on the reactivity of the sulphide minerals. Therefore, oxygen diffusion into waste rock piles tends to be less efficient compared to process tailings because the former are typically less reactive. Conversely, the oxidation front within tailings frequently stalls at a relatively shallow depth (10s of centimetres to several meters), in particular in tailings with significant sulphide content. This is because oxygen is consumed by the reactive sulphides before it can penetrate to greater depths. At some point in time, a steady state may be reached, governed by the rate of oxygen consumption and by the rate of oxygen transport and replenishment. Waste products from coal mining also have a strong oxygen consuming capacity related to the abundant presence of organic material that further depletes oxygen available for sulphide oxidation.

In addition to diffusion of oxygen through the pore space, a second diffusion step is occasionally invoked according to the shrinking core model from Davis and Ritchie (1986). This step involves the diffusion of the oxygen into the unoxidized core of a sulphide particle through an oxidized shell. The shrinking core model has been used successfully to simulate the observed advancement of an oxidation front in mine processing tailings. Figure 2-13 (Wunderly et al., 1996) illustrates this two-stage process for pyrite oxidation in a tailings impoundment, where oxygen diffuses through the bulk pore space, partitions into a water film, and then diffuses into pyrite grains through the oxidized coating formed around the unoxidized core as governed by the oxygen concentration gradient between the particle surface and the unreacted core.

**Figure 2-13: Two-Stage Process for Pyrite Oxidation in a Tailings Impoundment (Wunderly et al., 1996)**

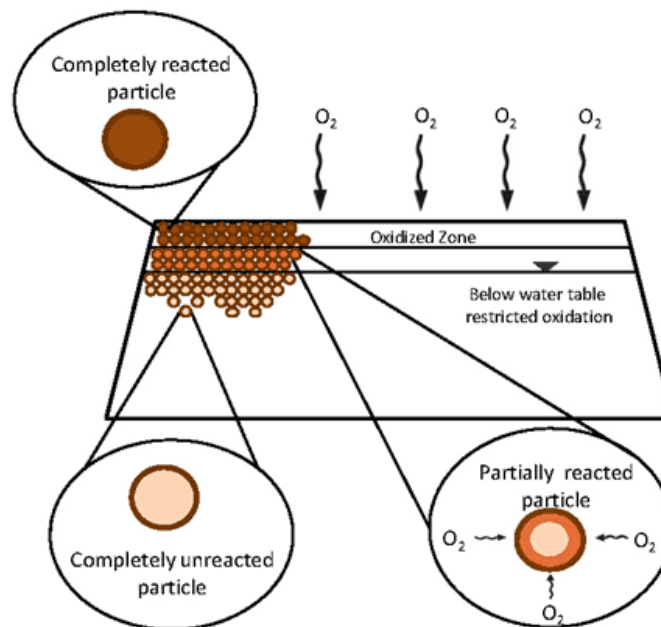

Pyrite oxidation is a strongly exothermic reaction, and the release of heat drives temperature up within waste rock piles, typically up to approximately 70°C. In colder climates or in the winter, this increased temperature can lead to formation of "fumaroles," which may appear as small-scale equivalents of volcanic vents on waste rock facilities and provide evidence that convection indeed can be an important gas transport mechanism. Although the reason for this temperature ceiling is not fully understood, a reasonable hypothesis seems to be that at higher temperatures some of the microbes responsible for the pyrite oxidation perish, after which temperatures decline until the microbial community can be re-established and the process is repeated. The increase in temperature can modify the mechanism for oxygen transfer because of the creation of thermally and density-driven convective air flow. The resulting air movement

draws atmospheric oxygen into the waste rock pile much more efficiently than diffusion, and convection is considered a significant oxygen-supply mechanism, at least for the outer portions of waste rock facilities. When these strongly exothermic reactions occur in coal waste deposits, spontaneous combustion may occur.

Advective air gradients and gas transport can be generated because of wind. Because the time scale for wind velocities is much reduced relative to convective air movement due to temperature gradients, this process is probably of less significance.

Barometric pumping results from changes in atmospheric pressure. The process involved is the compression of the gas phase within a waste rock pile because of an increase in atmospheric pressure, which then allows ingress of atmospheric oxygen. Oxygen egress will occur when the atmospheric pressure declines. The net effect of barometric pumping on oxygen supply and ARD generation is only partially understood and further investigation is required, but it is generally not considered a dominant mechanism.

Based on the considerations presented above regarding availability of oxygen in mine and process waste facilities, Ritchie (1994) coined the concepts of “global oxidation rate” and “intrinsic oxidation rate (IOR),” which describe the overall flux rate of ARD from a waste rock pile and the observed oxygen consumption rate of the waste, respectively. The intrinsic oxidation rate is a measure of the oxidation rate at the mineral surface controlled largely by the reactivity of the sulphide minerals. Ritchie found global oxidation rates to be insensitive to changes in the intrinsic oxidation rate, which suggested that oxygen diffusion is the dominant rate-limiting process for sulphide oxidation, particularly in a newly built pile. With time, convective gas transport will gain access further into the waste rock facility as it ages, but even so, the global oxidation rate will remain approximately constant.

The availability and effectiveness of ferric iron as an oxidant is controlled by the amount of ferric iron present, which in turn is related to the bacterial activity, the pH of the solution, and the residence time of the ferric iron. Acidic conditions and the presence of an active microbial community promote oxidation of ferrous iron to ferric iron. Physical removal mechanisms, such as flushing of contact water, also have an effect on the availability of ferric iron as an oxidant.

#### 2.4.7.1.2 Biological factors

Certain bacteria may accelerate the rate at which some of the reactions involved with sulphide oxidation proceed. Bacteria of the *Acidithiobacillus* species (formerly referred to as *Thiobacillus*) are of particular importance with regard to sulphide oxidation. This is because *A. ferrooxidans* is capable of catalyzing both the oxidation of sulphur and ferrous iron (reactions [1], [2], and [3]), while *A. thiooxidans* can oxidize sulphur only (e.g., reaction [1]). Other members of the *Acidithiobacillus* species are also capable of catalyzing pyrite oxidation, as are certain members of the genera *Sulfolobus* and *Leptospirillum* (Gould and Kapoor, 2003; Mills, 1999). In situations where bacterial acceleration of sulphide oxidation is significant (principally at low pH – see Figure 2-9), the bacterial population density and rate of population growth determine the bacterial activity and the associated rate of acid generation. Population density and growth for bacteria such as *Acidithiobacillus* are functions of the following:

- Carbon availability (in the form of carbon dioxide)
- An electron donor (ferrous iron or sulphur)
- Nutrient availability (i.e., nitrogen, phosphorus for production of biomass)
- Oxygen (promotes growth of aerobic bacteria and is an electron acceptor; kills strictly anaerobic bacteria)
- Temperature (most bacteria demonstrate optimal growth below approximately 70°C)

*A. ferrooxidans* can be characterized as an aerobic autotrophic bacterium (i.e., it requires oxygen and must reduce atmospheric carbon dioxide (CO<sub>2</sub>) to an organic carbon form to generate biomass). *A. ferrooxidans* has a temperature optimum near 35°C and a maximum temperature for growth of 40°C (Gould and Kapoor, 2003). *A. ferrooxidans* is an obligate acidophile: it requires acidic conditions (pH range of 1.0 to 3.5 with an optimum pH near 2.0) to survive. *A. thiooxidans* demonstrates similar characteristics, but is tolerant of a wider range of acidic conditions (pH between 0.5 and 4.0) while its optimum growth temperature is between 25 and 30°C. Figure 2-12 (Robertson and Broughton, 1992) presents a schematic illustration of the temperature effect on bacterially mediated sulphide oxidation rates (normalized) and provides a comparison against the effect of temperature on abiotic oxidation. The principal nutritional requirements for *Acidithiobacilli* (nitrogen, carbon dioxide) are ubiquitous. Sulphur and iron are readily available in mining environments, while only small amounts of phosphorus are required. As a result, sulphur and iron are virtually omnipresent at mining sites, and have been identified in mine effluents of different compositions from quite different mines and in different climatological environments. This implies that microbial mediation of sulphide oxidation is the norm rather than the exception. It must be emphasized that microorganisms are highly efficient at manipulating their immediate environment, either on their own or in a symbiotic relationship with other microorganisms, and that actual reaction site environmental conditions may, therefore, be much more conducive to elevated oxidation rates than would be predicted from measurements in the bulk liquid phase.

#### 2.4.7.2 Factors that modify drainage resulting from sulphide oxidation

This section presents the factors that modify the composition of drainage resulting from sulphide oxidation both within the mine waste and after exiting the mine facility. These factors are described simultaneously because the processes that affect the drainage composition during transport within and outside of the mine or process facility are very similar in concept. Transport of dissolved and particulate constituents takes place along pathways, which are physical or biological conduits that allow movement of these constituents.

As for the sulphide oxidation process, the factors that affect mine drainage composition are classified as chemical factors, physical factors, and biological factors. These aspects form part of a very complicated and interwoven environmental system, and as such don't operate independently but instead tend to be highly interrelated. For the purpose of this discussion, the drainage generated from sulphide oxidation at the grain surface can be ARD, NMD, or SD, depending on the type of sulphide mineral and the reactions taking place in the microenvironment immediately at the grain/water interface.

The transport of ARD, NMD, or SD through and away from the mine or processing facility can take many forms. The pathways of main interest include runoff and overland flow with eventual discharge into surface water and transport via surface water, infiltration through the mine or processing waste facility and into the soil/vadose zone followed by transport in groundwater, uptake by biota, and physical movement of mine waters as part of mine water management (Figure 2-2). This section focuses on the infiltration, surface water, and groundwater pathways.

##### 2.4.7.2.1 Chemical factors

The principal chemical factors that can modify the composition of drainage during transport in the mine waste facility and beyond include the following:

- pH
- Redox conditions
- Chemical composition of drainage
- Secondary mineral formation
- Sorption
- Neutralization reactions
- Photochemistry

The most important chemical control on metal mobility is pH, but the other factors listed above also influence drainage composition. Redox conditions determine the speciation of redox-sensitive species, such as many base and trace metals and sulphur and nitrogen species. Redox conditions can have a pronounced effect on the mobility and toxicity of redox sensitive species. The mobility of constituents of interest may be affected by other species present. For example, complexation with anionic and organic ligands may increase the mobility of base and certain trace metals. A good example of this is the formation of Al-F complexes, which greatly enhances the mobility of aluminum, resulting in much higher dissolved aluminum concentrations than would occur in the absence of fluoride. Similarly, many dissolved organic compounds can promote metal mobility.

Attenuation mechanisms are processes that reduce the mobility and concentration of dissolved constituents in water. The most important attenuation mechanisms include formation of secondary minerals and sorption reactions. A typical attenuation sequence for ARD in surface water is described in Plumlee (1999). As an acidic mine discharge enters a stream, it is progressively diluted, which causes an increase in pH. This leads to precipitation of the typical orange ferric (hydr)oxide colloids and coatings commonly observed in acidic mine effluents. As the pH of the water continues to rise, aluminum and manganese precipitates form, while sorption onto the suspended Fe, Mn, and Al particulates becomes more effective. Other sorbents of potential interest are clay minerals and particulate organic matter. If the pH continues to increase, formation of secondary carbonate minerals may occur, for example, the copper carbonates malachite and azurite frequently encountered. Sulphate removal in such a sequence may occur through formation of Fe/Al hydroxysulphate minerals at low pH or, more commonly, in the form of gypsum if sufficient calcium is present. Most of these processes are reversible. Should conditions change, remobilization of these attenuated trace metals into the water column may occur.

In addition to pH changes because of the mixing of different water types, chemical interaction between water and neutralizing minerals in the solid matrix (waste rock, process tailings, stream sediment, aquifer solids) may also result in a pH increase. The neutralization

mechanisms potentially occurring can be described by such reactions as presented in equations [8] and [9]. Photochemical reactions are of importance with respect to reduction of iron, which may lead to iron rerelease as well as the concomitant release of sorbed metals. Where ARD is contacted with organically enriched water, sulphate reduction processes may occur spontaneously, resulting in depletion of sulphate and an increase in alkalinity and precipitation of trace metals in the form of sparingly soluble sulphides.

ARD, NMD, and SD do not represent consecutive stages in the evolution of a mine water, but instead reflect endpoints in terms of water quality that may have different effects on the environment and may necessitate different forms of management. However, in concept, the above progression presented for the hypothetical surface water describes the potential evolution of ARD to NMD or ARD to SD. In reality, in almost all mine water occurrences this sequence is not brought to completion. If the receiving environment (including the mine or process waste facility) demonstrates a lack of neutralization potential or dilution (or both neutralization potential and dilution), the composition of the original ARD may not change appreciably with distance from the original reactive sulphide grain, and the ensuing acidic contamination can have a large spatial extent. NMD will be the outcome if some of the trace metals are removed from solution, while, according to its definition, SD requires almost complete metal removal. NMD frequently occurs in mine waste environments and surface water and groundwater systems with sufficient readily available neutralization potential to counter the acid being generated, such as many skarns, marine sedimentary strata, and carbonate-hosted replacement deposits. Saline drainage is most commonly associated with deposits that contain little or no sulphide minerals, other than pyrite and sufficient buffering capacity. Examples of such deposits include certain coal deposits as well as “clean” skarns.

#### 2.4.7.2.2 Physical factors

The principal physical factors that can modify the composition of drainage during transport in the mine waste facility and beyond include the following:

- Climate conditions
- Precipitation events
- Water movement
- Temperature

While chemical factors tend to be the most important controls on sulphide oxidation rates and the nature of the resulting discharge (ARD, NMD, or SD), physical factors tend to govern transport of the reaction products and the type and effectiveness of reactions that occur along the flow path.

Climate types (e.g., wet, arid, arctic) and climatic variations (e.g., storm events, seasonal) can have a significant effect on the hydrologic regime within a mine waste and in the receiving environment. Climate types and variations also affect transport of sulphide oxidation products and any changes in drainage composition while being transported. The more water available for transport, the more likely it is that a mine discharge will be generated, and the more likely that this discharge may travel off site and into the receiving environment. Climatic variations may result in transport that is in essence continuous vs. episodic. Therefore, the water balance associated with each climate type and climate variation will be very different, and each will pose its own challenges for water management. The effect of climate type and climate variation on chemical modification of mine drainage is also an important consideration. For example, in drier climates, high evaporation rates tend to increase the acid-buffering capacities of waters draining most rock types. Therefore, a smaller volume of alkaline water in a dry climate may mitigate ARD as effectively as a larger volume of less alkaline water in a wetter climate. Mixing, degree of dilution, and contact time between a mine discharge and the solid matrix (waste rock, process tailings, stream sediment, aquifer solids) are all affected by climate and seasonal events.

Water movement is also affected by the physical characteristics of the mine waste and receiving environment. If water is essentially stagnant, transport of sulphide oxidation products is limited to diffusion, which is a very slow process resulting in a reaction front that may not appreciably move over time. If the water is in motion, these reaction products can move with the velocity of the water in the absence of chemical attenuation mechanisms.

The most important factor involving water movement is the hydraulic conductivity. In principle, the greater the hydraulic conductivity of the source material, the greater the potential for effective transport of the sulphide oxidation products. Similarly, the greater the hydraulic conductivity of the receiving environment (e.g., a fractured vs. a non-fractured medium), the greater the potential for ingress of the mine discharge. Changes in drainage composition along a flow path also depend on the movement of water. Contact time is an important factor, and rapid flow through preferential coarser-grained channels in a waste rock pile will result in a different discharge quality (i.e., likely to be more dilute and less buffered) than gradual flow through the finer-grained matrix. Seepage from process tailings may display geochemical near-equilibrium with the tailings solids because of the extensive contact between tailings pore water and tailings solids before exiting the facility.



The effect of temperature is manifold. Higher temperatures promote evaporation, thereby reducing the amount of transport in liquid form, while also increasing the rates of chemical reactions. Lower temperatures may also prevent water movement (in the case of frozen conditions), while reducing reaction rates or even arresting sulphide oxidation altogether when the subzero environment prevents transport of reactants and reaction products. One of the most dramatic effects of temperature on transport of sulphide oxidation products is during the spring freshet in cold/polar, humid temperate/marine and humid cold/continental climates where snowfall occurs. During the spring melt, very large volumes of water can occur that contain large amounts of oxidation products accumulated during the summer and fall because of the reduced flushing rates. In addition to temperature fluctuation, as governed by external climate and seasonal conditions, sulphide oxidation can result in generation of heat, which may have an effect on transport and modification of mine discharges internal to the mine waste environment.

#### 2.4.7.2.3 Biological factors

The principal biological factors that can modify the composition of drainage during transport in the mine waste facility and beyond include the following:

- Microbial ecology
- Microbial growth kinetics

As explained in Section 2.6.4, biological factors greatly affect the rate of sulphide and iron oxidation because of the catalytic functioning of many different types of microbes. During transport of oxidation products, the importance of these bacteria tends to lessen while that of other types of microorganisms and biota tends to increase.

Bacterially mediated activity of potential importance along flow paths includes reduction of both iron and sulphate. Reduction of iron may lead to release of iron from previously insoluble minerals, such as iron (hydr)oxides, and increased mobility. Conversely, reduction of iron coupled with reduction of sulphate may also lead to formation of insoluble iron sulphide and other metal sulphides if other metal cations are available. Both reaction mechanisms result in release of alkalinity, providing neutralization capacity, and both operate with the greatest efficiency in anaerobic water-saturated environments such as submerged sediments and soils. In particular, the sulphate reduction process forms the basis for use of constructed wetlands and other sulphate-reducing bioreactors for passive and active treatment of ARD. In all of these cases, the type of bacteria (i.e., microbial ecology) and the growth kinetics determine the effectiveness of the various biologically mediated reactions. These biological factors are intrinsically linked to the chemical factors as the nature and type of microorganisms present are directly related to factors such as pH or redox.

Other biological processes that may affect drainage composition along a transport pathway include sorption and ion exchange onto particulate organic matter, direct uptake by plants through roots and leaves, formation of metal (hydr)oxides (aerobic conditions – results in a reduction in pH), formation of metal carbonates (anaerobic conditions – results in a reduction in pH), and filtration by organic substrate.

#### 2.4.7.3 Receiving environment

The final component of the ARD migration process is the receiving environment or receptors (Figure 2-2). The principal receiving environments associated with mine discharges water are groundwater resources, air, soil and sediments. More detail on receiving environment and ARD is presented in Chapter 8. Potential impacts associated with mine discharges are related primarily to sulphate/TDS (ARD, NMD, SD), metals (ARD, NMD) and acidity (ARD). In terms of chemical parameters, therefore, these impacts are not unique to the mining industry, and the toxicological consequences of any of these impacts on the ecological and human receptors identified in Figure 2-2 are usually understood to be the same as if they originated from a non-mining source.

The nature and extent of any impacts is related to the location of a receiving environment relative to the mine release, the degree of sensitivity to the mine release, and the nature of the mine release. The environment has a certain inherent capacity to absorb and sustain a level of ARD release without undergoing significant damage. For example, through natural neutralization, and dilution, it may be possible to contain an ARD plume of a certain magnitude without widespread environmental impact. However, as the reservoir of alkaline material is consumed close to the point of discharge, the ARD plume will migrate further away, resulting in an ever-increasing zone of impact. For a receiving environment with significant acid neutralizing capacity, the extent of the impact will be less than for an environment with little or no buffering ability, and it will take longer for an equivalent impact to manifest itself at any given location. The impact of an SD discharge will be less pronounced than that of an ARD discharge, all else being equal, because of the generally more benign chemical composition of SD. The identification and implementation of mitigation measures are aimed at preventing impact

altogether, or reducing impacts to a level that can be sustained by the receiving environment.

## 2.5 Concluding Statement

During the past two decades, much has been learned about ARD, NMD, and SD and how the reactions responsible for their development might be prevented. The complexity of these reactions and the unique issues associated with each mine and process site do not allow for application of a simple single strategy or a “one-size-fits-all” solution. Instead, each site needs to be examined on a case-by-case basis, leading to implementation of a site-specific ARD management plan from the initial decision to proceed with the mining operation through to post-mining beneficial land use. This plan must be a key focus of the operational, technical and managerial resources at the mine throughout its life cycle. The development of an ARD management plan is described in more detail in Chapter 9 of this GARD Guide.

## 2.6 References

- Agricola, 1556. *De Re Metallica*. Translated by H.C. Hoover and L.H. Hoover, 1950. Dover Publications, New York, NY.
- Berner, R.A., 1984. Sedimentary pyrite formation: An update. *Geochimica et Cosmochimica Acta*, 48(4):605-615.
- Blowes, D.W., Ptacek, C.J., and J. Jurjovec, 2003. Mill Tailings: Hydrogeology and Geochemistry. In: J.L. Jambor, D.W. Blowes and A.I.M. Ritchie (Eds.), *Environmental Aspects of Mine Wastes*, Short Course Series Vol. 31, Mineralogical Association of Canada.
- British Columbia Acid Mine Drainage Task Force (BCAMDTF), 1989. *Draft Acid Rock Drainage Technical Guide – Volume 1*. Prepared by Steffen Robertson and Kirsten (SRK), Vancouver, BC.
- Broughton, L.M., and A.M. Robertson, 1992. Acid Rock Drainage from Mines - Where We Are Now. IMM Minerals, Metals and Environment Conference, February 4-6, Manchester, UK.
- Carrucio, F., Hossner, L.R., and G. Geidel, 1988. Pyritic materials: acid drainage, soil acidity, and liming. In: L.R. Hossner (Ed.), *Reclamation of Surface Mined Lands*, CRC Press, Boca Raton, FL, 1:159-190.
- Casagrande, D.J., Finkelman, R.B., and F.T. Carrucio, 1989. The non-participation of organic sulfur in acid mine drainage generation. *Environmental Geochemistry and Health*, 7:187-192.
- Davis, G.B., and A.I.M. Ritchie, 1986. A model of oxidation in pyritic mine wastes, 1. Equations and approximate solution. *Applied Mathematical Modelling*, 10:314-322.
- Goldhaber, M.B., and I.R. Kaplan, 1982. Controls and consequences of sulfate reduction in recent marine sediments. *Acid Sulfate Weathering*, Soil Science Society of America Special Publication, 10:19-36.

Gould, W.D., and A. Kapoor, 2003. The Microbiology of Acid Mine Drainage. In: J.L. Jambor, D.W. Blowes and A.I.M. Ritchie (Eds.), *Environmental Aspects of Mine Wastes*, Short Course Series Vol. 31, Mineralogical Association of Canada, 203-226.

Jambor, J.L., 2003. Mine-Waste Mineralogy and Mineralogical Perspectives of Acid-Base Accounting. In: J.L. Jambor, D.W. Blowes and A.I.M. Ritchie (Eds.), *Environmental Aspects of Mine Wastes*, Short Course Series Vol. 31, Mineralogical Association of Canada, 117-146.

Kleinmann, R.L.P., and G.R. Watzlaf, 1988. Should the effluent limits for manganese be modified? In: *Proceedings 1988 Mine Drainage and Surface Mine Reclamation Conference*, U.S. Bureau of Mines IC 9184, Pittsburgh, PA, 2:305-310.

Mills, A.L., 1999. The Role of Bacteria in Environmental Geochemistry. In: G.S. Plumlee and M.J. Logsdon (Eds.), *The Environmental Geochemistry of Mineral Deposits, Part A: Processes, Techniques and Health Issues*, *Reviews in Economic Geology* Vol. 6A, Society of Economic Geologists, Inc., 125-132.

Nocete, F., Alex, E., Nieto, J.M., Sáez, R., and M.R. Bayona, 2005. An archaeological approach to regional environmental pollution in the south-western Iberian Peninsula related to Third millennium BC mining and metallurgy. *Journal of Archaeological Science*, 32:1566-1576.

Nordstrom, D.K., 2003. Effects of Microbiological and Geochemical Interactions in Mine Drainage. In: J.L. Jambor, D.W. Blowes and A.I.M. Ritchie (Eds.), *Environmental Aspects of Mine Wastes*, Short Course Series Vol. 31, Mineralogical Association of Canada, 227-238.

Nordstrom, D.K., and C.N. Alpers, 1999. Geochemistry of Acid Mine Waters. In: G.S. Plumlee and M.J. Logsdon (Eds.), *The Environmental Geochemistry of Mineral Deposits, Part A: Processes, Techniques and Health Issues*, *Reviews in Economic Geology* Vol. 6A, Society of Economic Geologists, Inc., 133-160.

Plumlee, G.S., 1999. The Environmental Geology of Mineral Deposits. In: G.S. Plumlee and M.J. Logsdon (Eds.), *The Environmental Geochemistry of Mineral Deposits, Part A: Processes, Techniques and Health Issues*, *Reviews in Economic Geology* Vol. 6A, Society of Economic Geologists, Inc., 71-116.

Plumlee, G.S., Smith, K.S., Montour, M.R., Ficklin, W.H., and E.L. Mosier, 1999. Geologic Controls on the Composition of Natural Waters and Mine Waters Draining Diverse Mineral-Deposit Types. In: L.H. Filipek and G.S. Plumlee (Eds.), *The Environmental Geochemistry of Mineral Deposits, Part B: Case Studies and Research Topics*, *Reviews in Economic Geology* Vol. 6B, Society of Economic Geologists, Inc., 373-432.

Raiswell, R., and R.A. Berner, 1986. Pyrite and organic matter in Phanerozoic normal marine shales. *Geochimica et Cosmochimica Acta*, 50:1967-1976.

Ritchie, A.I.M., 1994. The waste rock environment. In: J.L. Jambor and D.W. Blowes (Eds.), Environmental Geochemistry of Sulfide Mine-Wastes, Short Course Handbook Vol. 22, Mineralogical Association of Canada.

Ritchie, A.I.M., 2003. Oxidation and Gas Transport in Piles of Sulfidic Material. In: J.L. Jambor, D.W. Blowes and A.I.M. Ritchie (Eds.), Environmental Aspects of Mine Wastes, Short Course Series Vol. 31, Mineralogical Association of Canada, 73-94.

Robertson, A.M., and L.M. Broughton, 1992. Reliability of Acid Rock Drainage Testing. Workshop on U.S. EPA Specifications for Tests to Predict Acid Generation from Non-Coal Mining Wastes, July 30-31, Las Vegas, NV.

Rose, A.W. and C.A. Cravotta III, 1998. Geochemistry of coal mine drainage. In: K.B.C. Brady, M.W. Smith and J. Schueck (Eds.), Coal Mine Drainage Prediction and Prevention in Pennsylvania, Pennsylvania Department of Environmental Protection, Harrisburg, PA, 1:1-22. <http://www.dep.state.pa.us/dep/deputate/minres/districts/cmdp/chap01.html>

Smith, K.S., 1999. Metal Sorption on Mineral Surfaces: An Overview with Examples Relating to Mineral Deposits. In: G.S. Plumlee and M.J. Logsdon (Eds.), The Environmental Geochemistry of Mineral Deposits, Part A: Processes, Techniques and Health Issues, Reviews in Economic Geology Vol. 6A, Society of Economic Geologists, Inc., 161-182.

Smith, L., and R. Beckie, 2003. Hydrologic and Geochemical Transport Processes in Mine Waste Rocks. In: J.L. Jambor, D.W. Blowes and A.I.M. Ritchie (Eds.), Environmental Aspects of Mine Wastes, Short Course Series Vol. 31, Mineralogical Association of Canada, 51-72.

Stumm, W., and J.J. Morgan, 1981. Aquatic Chemistry, First Edition. John Wiley & Sons, New York, NY.

Stumm, W., and J.J. Morgan, 1996. Aquatic Chemistry, Third Edition. John Wiley & Sons, New York, NY.

United States Geological Survey (USGS), 2004. Water Science Glossary of Terms.  
<http://ga.water.usgs.gov/edu/dictionary.html#S>

Walkersdorfer, C., 2008. Water Management at Abandoned Flooded Underground Mines – Fundamentals, Tracer Tests, Modelling, Water Treatment. Springer, Heidelberg, Germany.

Wunderly, M.D., Blowes, D.W., Frind, E.O., and C.J. Ptacek, 1996. Sulfide Mineral Oxidation and Subsequent Reactive Transport of Oxidation Products in Mine Tailings Impoundments: A Numerical Model. Water Resources Research, 32(10):3173-3187.

## List of Tables

Table 2-1: Common Sulphides Known or Inferred to Generate Acid when Oxidized (Plumlee, 1999)

Table 2-2: Typical NP Values and pH Buffering Ranges for Some Common Minerals (Jambor, 2003; Blowes et al., 2003; BCAMDTF, 1989)

## List of Figures

Figure 2-1: Roman Portal with Acid Rock Drainage – Spain

Figure 2-2: Generalized Conceptual Model of Sources, Pathways and Receiving Environment at a Mine or Processing Site

Figure 2-3: Ficklin Diagram Showing ARD, NMD, and SD as a Function of Dissolved Base Metal Concentrations (adapted from Plumlee et al., 1999)

Figure 2-4: Diagram Showing ARD, NMD, and SD as a Function of Sulphate Concentrations

Figure 2-5: Ficklin Diagram Showing Selected Principles that Govern Mine Water Quality (adapted from Plumlee et al., 1999)

Figure 2-6: The Global Sulphur Cycle (Stumm and Morgan, 1996). Global Fluxes in Millions Tons of Sulphur per Year and Inventories in Millions Tons of Sulphur

Figure 2-7: The Biogeochemical Sulphur Cycle

Figure 2-8: Model for the Oxidation of Pyrite (Stumm and Morgan, 1981). (The numbers in brackets refer to the reactions presented in Section 2.6.4)

Figure 2-9: Schematic Illustration of Normalized Sulphide Oxidation Rates with and without Bacterial Mediation (after Robertson and Broughton, 1992)

Figure 2-10: Stages in the Formation of ARD (after Broughton and Robertson, 1992).

Figure 2-11: Schematic Illustration of Factors that Affect Sulphide Oxidation and Modify Mine Drainage during Transport

Figure 2-12: Schematic Illustration of the Effect of Temperature on Normalized Sulphide Oxidation Rates (after Robertson and Broughton, 1992)

Figure 2-13: Two-Stage Process for Pyrite Oxidation in a Tailings Impoundment (Wunderly et al., 1996)

# Introduction to Coal Mine Drainage

## From GARDGuide

### Introduction to Coal Mine Drainage

C2.1 Introduction

C2.2. Pyrite in Sedimentary Strata

C2.3 Carbonate Minerals in Coal-bearing Strata

C2.4. How Geology Affects Coal Mine Drainage Quality

## C2.1 Introduction

Coal deposits are found on every continent. Most of these deposits have been or are being mined. China is the world's largest coal producer, while the United States has the world's largest reserves. The other most important coal-producing countries are Australia, India, South Africa, and Russia. Yet the nature of the coal mine drainage (CMD) from the various coal deposits and, indeed, even within the same coal deposits, varies significantly. In part, this is because of climate but also generally the paleoenvironment of the coal deposit – that is, what the region was like when the organic-rich sediment that became the coal was first deposited.

This section discusses why the nature of CMD differs and how it is somewhat different from ARD at most other types of mines. The presentation starts at a very basic level, discussing the nature of sedimentary strata and how mining of these types of deposits is different from mining non-sedimentary (hard rock) ore bodies. Later, in the appropriate chapters, differences between coal and hard rock mining that affect pre-mining prediction of water quality, prevention/mitigation strategies, and water treatment are examined.

The concentrations of iron, manganese, and aluminium are generally very low in natural waters (<1 mg/L) because of chemical and biological processes that cause their precipitation in surface water environments. The same chemical and biological processes remove iron, manganese, and aluminium from contaminated CMD, but the metal loadings from some abandoned coal mine sites are so high that the deleterious effects of these elements persist. Thus, CMD can contain high concentrations of iron, manganese, and aluminium, as well as SO<sub>4</sub>, Ca, Mg, K, and Na. CMD generally contains much lower concentrations of other metals that can be so problematic at metal mines. However, some trace metals can be a cause for concern in certain coal mining areas (e.g., selenium). Drainage from coal refuse disposal sites (the reject material from coal washing or beneficiation plants) is more likely than drainage from coal mines themselves to contain elevated levels of Zn, Ni, and sometimes other potentially toxic metals.

## C2.2. Pyrite in Sedimentary Strata

The principal difference between ARD and CMD is caused by the fact that coal is a sedimentary material. Coal develops from the settling of plant material and subsequent transformation under the pressure of subsequent sedimentary overburden. As most readers of this Guide already know, sedimentary rocks result from the weathering and erosion of other rocks. Streams and rivers transport the sediment to lakes or oceans, or deposit it on nearby floodplains, where it accumulates. On land, these sediments consist mainly of large boulders, cobbles, gravel, sand, and silt. Close to the shore, the deposited sediment is largely sand, silt, and clay. Further away from shore, in deeper water, clays, chemically precipitated calcium carbonate, and the remains of tiny plants and animals (e.g., coral) can accumulate. Over time, these sediment layers are buried by subsequent depositional material, are compacted, and eventually harden into sedimentary rock. Sand beds and beach deposits become sandstone, while finer grained material becomes siltstone or shale (which is cemented clay).

However, since this deposition and compaction is taking place over millions of years, the nature of the deposits at any one spot changes over time. Generally speaking, if the layers have not been disturbed by folding and faulting, the oldest layers are at the bottom. As sea levels rise and fall, near-shore deposits or fresh water sediments may be buried by marine sediments, or vice versa. Further complicating this ancient history are changes caused by regional climate changes, as areas became more or less arid, and the effects of mountain building (due to plate tectonics or volcanic eruptions) and erosion on the nature of the sediment and on the nearby weather patterns.

Strata can also change horizontally. For instance, a given stratum or formation can extend over hundreds of kilometres, but its nature may gradually change over these distances, from cemented gravel (conglomerate), to siltstone (or mudstone), and then to shale, reflecting the decreasing power of water to transport these different size materials away from their source. More rapid facies change is also possible, reflecting topographical features in the paleoenvironment. Also, because sedimentary rocks are formed from fragments of rocks, they are generally weaker than igneous or metamorphic rocks. Often, their strength is determined by how tightly the grains of sediment are stuck together.

In this discussion, an important sedimentary environment has been left out: swamps and wetlands. These represent the transition from terrestrial to lacustrine (lake) or marine deposits and, as one can observe around the world today, wetlands can be quite extensive. Wetlands can be marine, brackish, or fresh water environments and the nature of the sediment can change frequently due to seasonal changes or even large storm events. The sediment that accumulates in swamps is rich in organic matter (peat). When the organic matter is more than 50% by weight or 70% by volume, the compacted sediment is classified as coal; when there is less than 50% by weight or 70% by volume organic matter, the rock is classified as carbonaceous (organic-rich) shale.

Sedimentary strata were originally deposited horizontally, but in many cases, subsequent movement of the earth's crust caused the strata to fold and tilt. As a consequence, many

sedimentary strata, including coal seams, exist today at angles that are not horizontal. This feature is critically significant to how water flows in coal mines and where CMD might emerge.

In general, sedimentary strata tend to have a much simpler mineralogical composition than non-sedimentary mineral deposits. For example, of the common sulphide minerals listed in Table 2.1 of the Guide, only the first, FeS<sub>2</sub>, is commonly found in significant concentrations in sedimentary strata. Importantly, pyrite is commonly found in significant concentrations in organic (carbonaceous) deposits, such as coal and black shale. This is because the decaying organic matter in deltaic and marine wetlands and swamps can lead to the formation of hydrogen sulphide (H<sub>2</sub>S) and then the precipitation of iron monosulphides, which can be buried along with the plant material. Over time, these monosulphides transform into pyrite. The amount of pyrite that may form in sediment is limited by the amount of decomposable organic matter, dissolved sulphate, and reactive detrital iron minerals (Berner, 1984). The iron is a product of mineral weathering upland; iron concentrations are lower in marine sediments than they are in deltaic environments. Generally, sulphate concentrations have the opposite tendency, to the extent that they are often too low in fresh water wetlands to form much H<sub>2</sub>S. As a result, coals and shales that were formed in association with fresh water are generally low in pyrite. In marine sediments, the limiting component is typically the amount of organic matter, so that organic carbon often correlates with the percent sulphur (Goldhaber and Kaplan, 1982; Raiswell and Berner, 1986)

Several types of pyritic sulphur are found in coal and other sedimentary strata, based on the size and structure of the pyrite. Caruccio et al. (1988) provides an extensive review of the different forms, morphologies, and their relative reactivity. Although all of the sedimentary pyrite can oxidize, some forms oxidize faster than others. Figure 1 is a scanning electron microphotograph of one of these forms, framboidal pyrite, which owes its structure to the nature of the original bacterial formation of H<sub>2</sub>S and iron monosulphide. Framboidal pyrite is so small that it typically cannot be observed without magnification. The individual granules of framboidal pyrite are only tenths of a micron in size and so have a very large surface area – typically 2 - 4 m<sup>2</sup>/g – and so are highly reactive. In contrast, some pyrite in coal appears to have been introduced after the peat had been converted to coal, as is evidenced by pyrite coatings on the fracture surfaces, called cleats, in the coal seams. This pyrite reacts at a much slower rate.

In addition to pyrite, other forms of sulphur that are commonly found in sedimentary strata are organic sulphur and sulphate sulphur. Organic sulphur can be present because it was part of the



**Figure 1. A highly magnified image of framboidal pyrite**

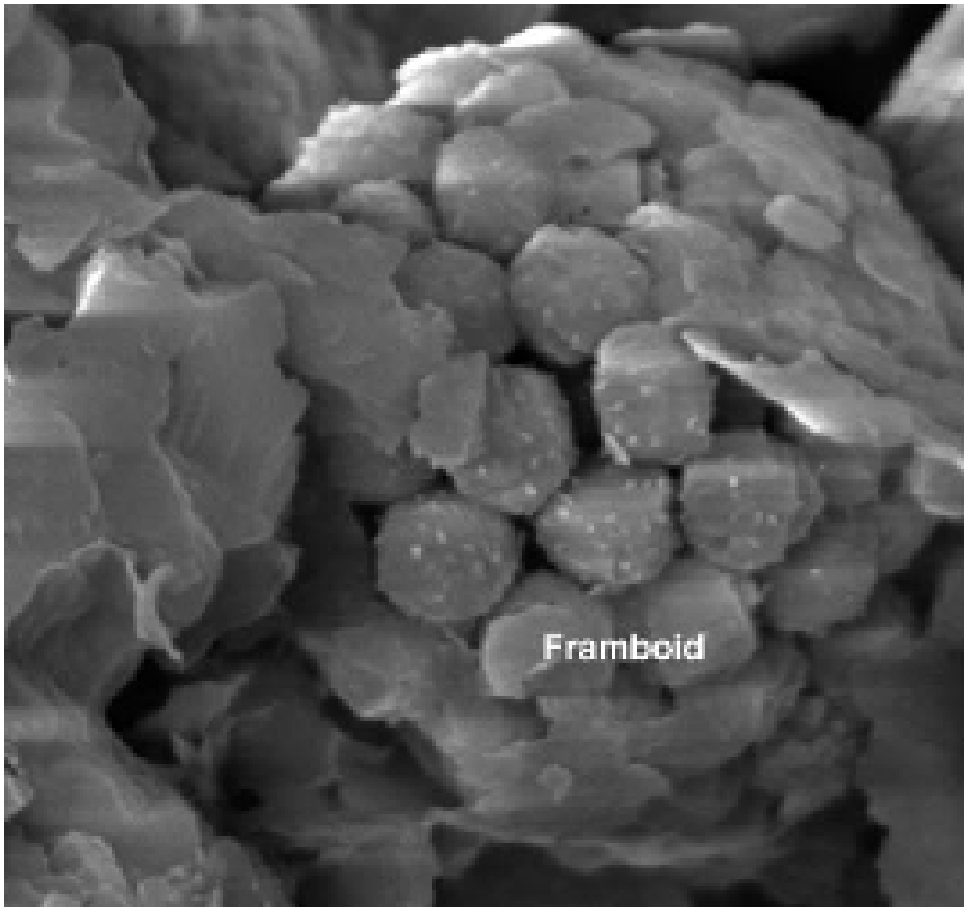

original make-up of the plant material; alternatively, it can represent sulphate that formed complexes with the decaying organic matter, and so became combined with the structure of the coal. Generally, the organic sulphur component is not chemically reactive and has little or no effect on acid producing potential (Casagrande et al., 1989).

Sulphate sulphur is usually only found in relatively minor

quantities in coal and other pyritic rocks, and is commonly the result of weathering and recent oxidation of sulphide sulphur. Some sulphate minerals, like melanterite, can dissolve and form acidity, while others, like gypsum, are not acid producing. Nordstrom (1982) provides a sequential summary of how these sulphate minerals can form. Additional information on their characteristics can be found in Rose and Cravotta (1998).

### **C2.3 Carbonate Minerals in Coal-bearing Strata**

As in hard rock deposits, the nature and quantity of the alkalinity that may be present in the form of mineral carbonates is critical in determining whether ARD will form. The principal carbonate minerals encountered in coal deposits are the minerals calcite (or its rock form, limestone) ( $\text{CaCO}_3$ ), dolomite ( $\text{CaMg}(\text{CO}_3)_2$ ), and siderite ( $\text{FeCO}_3$ ). The presence or absence of calcareous carbonate minerals is extremely important in predicting CMD water quality. These minerals not only neutralize acidic water created by pyrite oxidation, there is also evidence that they actually inhibit pyrite oxidation by buffering the pH at a level where iron, that is released by pyrite oxidation, precipitates as ferric hydroxide rather than oxidizing additional pyrite. Brady et al. (1994) in studies in the southeastern US coal fields showed that the presence of 1-3% carbonate (on a mass-weighted basis) can determine whether a coal mine produces alkaline or acid water. Although pyrite is clearly critical to form acidic CMD, they found that pyrite

concentration only correlated with CMD water quality when calcareous carbonates were largely absent. It is not known if this finding applies to coal deposits elsewhere in the world.

Of the carbonate minerals commonly found in sedimentary strata, the most significant is calcite, which is typically found as a cementing material in sedimentary rocks, a result of secondary emplacement (fracture filling), or as limestone, which is commonly found in marine and fresh water sedimentary strata. Dolomite generally forms after the limey sediment is buried and reflects the replacement of much of the calcium with magnesium. Dolomite is less soluble than calcite or limestone, though it will also neutralize acid and can thus inhibit pyrite oxidation. In some cases, the replacement is not significant enough for the rock to be called dolomite; in such instances, the term dolomitic limestone is used.

Siderite requires reducing environments to form and so it generally represents organic-rich fresh water or mildly brackish paleoenvironments that were too low in sulphate for the iron to precipitate as a sulphide. Siderite is less soluble than dolomite, and is not an effective acid neutralizer because the ferrous iron that is released when siderite dissolves eventually oxidizes and hydrolyzes. As a result, the alkalinity that forms initially when the siderite is dissolved is matched by the acidity that is generated by the eventual precipitation of the iron hydroxide. This becomes significant in prediction of ARD as discussed in Chapter 5. Other minerals listed in Table 2.2 of the Guide are generally not present in high enough concentrations to be relevant in coal mine settings.

## **C2.4. How Geology Affects Coal Mine Drainage Quality**

Coal mining typically involves the disturbance of some of the sedimentary strata that are above, and to a limited extent, below the coal seam(s). At surface mines, all of the overburden strata are excavated and broken up, so all have the potential to affect the quality of the CMD. Moreover, most of the coal is generally removed, and so the effect of the overburden strata may be more important than the characteristics of the coal itself. At underground mines, some of the coal remains behind, often exposed to air and water, and so the amount and nature of the pyrite in the coal is much more important in predicting the quality of the subsequent drainage than the overburden strata, which is only partially fractured and disturbed. However, at either type of mine, the CMD is somewhat affected by all of the disturbed strata.

The nature of sedimentary strata affects the formation of CMD. Coal deposits that formed from fresh water organic-rich sediments, such as most coals found in the western United States, tend to be low in pyrite because there was typically not enough sulphate dissolved in such wetlands to generate H<sub>2</sub>S. In addition, freshwater limestones that may or may not be present in the stratigraphic neighbourhood can provide offsetting alkalinity. Therefore, CMD from fresh water coal deposits may be enriched in sulphate, but if so, it is likely from dissolution of evaporate minerals in the overlying strata rather than from pyrite oxidation.

Deltaic coal deposits are harder to generalize. If the wetland was upper delta, the sulphate

concentrations in the sediment would be relatively low and the amount of pyrite present would therefore also be relatively low. However, lower deltaic wetlands tend to be influenced by tidal forces and therefore brackish. Such an environment is ideal for pyrite formation. In either case, unless the stratigraphy overlying the coal seam represents a substantially different paleoenvironment, there would be little chance for limestone formation, so even a relatively low concentration of sulphide could be problematic. Also, deltaic wetlands are very susceptible to changes in climate, storm events, etc. Consequently, the resultant coal deposit may reflect a highly variable paleoenvironment, with a high ash content and highly variable acid-generating potential.

Wetlands that form near oceans and bays tend to produce coal seams that are relatively high in pyrite. Yet, as discussed above, if marine limestone deposits overlie the coal seams, the alkalinity from the limestone may be enough to neutralize the acidity formed. If this is the case, the CMD will be near-neutral in pH, high in sulphate, and would likely contain some dissolved iron.

ARD from coal mines differs from ARD from metal mines in several ways. Although the pyrite oxidation reactions discussed in Section 2.4.4 in this Guide are the same, the other mineral sulphides typically present at metal ore mines are commonly absent, or if present, are minor components, and so CMD water quality tends to be simpler. In addition, since the rock is generally softer, explosives are used much less at coal mines than at most hard rock mines. Therefore, there is less dissolved ammonia present in CMD, which also simplifies water chemistry since metal-ammonia complexes can be difficult to remove in the water treatment process. As a result, the only cations of concern in CMD are typically iron, manganese, and aluminium, listed in the order in which they are most problematic. Iron is present because it is solubilised by the initial pyrite oxidation reactions. The other two metals are commonly dissolved by the acidic water from other sedimentary strata. Of the three, aluminium is the most toxic to aquatic life, but it readily precipitates at near-neutral pH. Iron is typically present in the highest concentrations. Accordingly, as discussed in Chapter 7, CMD water treatment technology is largely focused on iron removal.

Manganese, however, can be problematic in water treatment because removing it through conventional means (addition of alkalinity combined with aeration) requires a relatively high pH (typically above 10), which, if discharged into streams, could be much more toxic to aquatic life than the manganese itself. Therefore, except where the streams are already acidic and would benefit from the alkalinity, the water has to be re-acidified after the manganese is removed.

# Chapter 3

## From GARDGuide

### 3.0 Corporate, Regulatory, and Community Framework

- 3.1 Framework for Management of Acid Rock Drainage
- 3.2 Corporate Guidance
  - 3.2.1 Newmont
  - 3.2.2 Rio Tinto
  - 3.2.3 Relationship to Other Requirements and Issues
- 3.3 Sustainability and Community Considerations
- 3.4 Global Regulatory Guidance
- 3.5 Country Regulatory Guidance
  - 3.5.1 Commonalities in the Regulatory Regimes
  - 3.5.2 United States of America and its States
  - 3.5.3 Canada and its Provinces and Territories
  - 3.5.4 Australia, its States and Territories
  - 3.5.5 European Union (EU)
  - 3.5.6 South Africa
  - 3.5.7 New Zealand
  - 3.5.8 Brazil
  - 3.5.9 Indonesia
- 3.6 Risk Considerations
  - 3.6.1 Establish the Context (Step 1)
  - 3.6.2 Identify the Risks (Step 2)
  - 3.6.3 Analyze the Risk (Step 3)
  - 3.6.4 Assessment and Prioritization of Risk (Step 4)
  - 3.6.5 Risk Management (Treat the Risk) (Step 5)
  - 3.6.6 Review and Monitor (Step 6)
  - 3.6.7 Risk Priorities
- 3.7 References
  - List of Tables
  - List of Figures

## 3.0 Corporate, Regulatory, and Community Framework

### 3.1 Framework for Management of Acid Rock Drainage

This chapter examines the societal framework for development and operation of mines, and provides guidance on the ARD specific implications of the framework. This framework includes corporate, regulatory, and community elements, as illustrated in Figure 3-1 and Figure 3-2.

**Figure 3-1: Framework for ARD management**

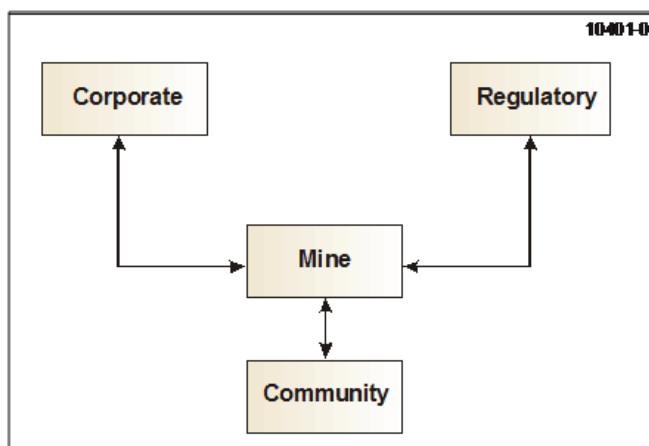

**Figure 3-2: Hierarchical relationship between Global, National and Local Elements of the Framework**

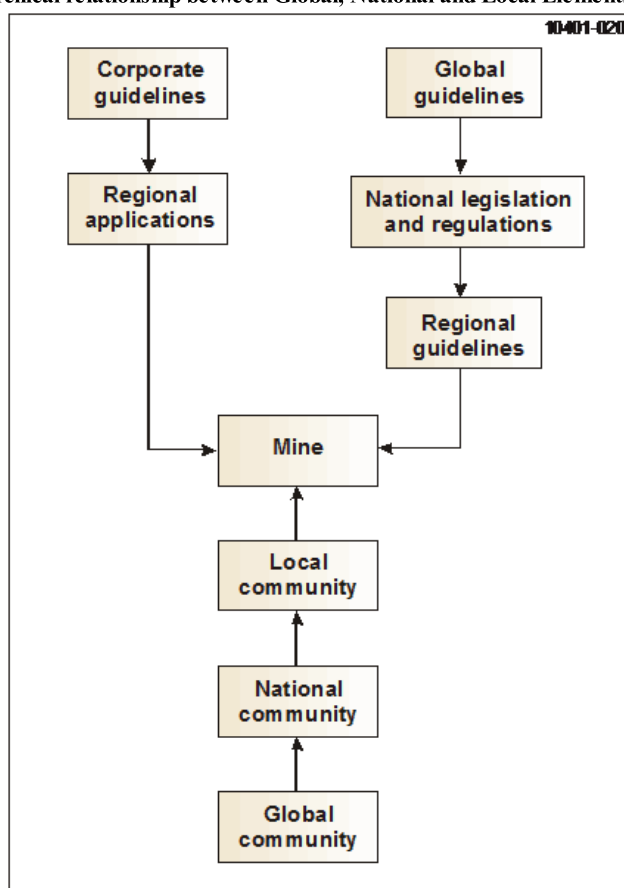

Every mine is established within a “community” that includes all interested and affected parties (Figure 3-2). These may include immediate neighbours, local, regional and national “communities,” and global NGOs in other countries, depending on the setting. Local communities are influential and often the most complex parties to deal with. They are the most directly affected by a mine and may have intricate needs and real and perceived rights, as described in Chapter 10.

The “community” grants and can withdraw the “social license” to operate based on perceptions of performance and the level of trust. Community needs are not always clearly defined and may change over time as socioeconomic conditions change. The operators of the mine, therefore, should remain aware of the changing environment within the community.

The issues and approaches to ARD prevention and management are the same around the world. However, the specific techniques for ARD management, for interpretation of ARD prediction results, and the quantitative endpoints for performance (e.g., water quality standards) may differ depending on the local, regional or country context.

There is, therefore, no ‘one size fits all’ approach to address ARD management at all mine sites. Each mine setting is unique and requires a carefully considered assessment to find a management strategy within the broader corporate, regulatory, and community framework that applies to the mine. The site-specific setting comprises the social, economic, and environmental situation where the mine is located, while the framework comprises the applicable corporate and regulatory norms and standards, and community specific requirements and expectations. This framework applies over the complete life cycle of the mine and is illustrated conceptually in Figure 3-3.

**Figure 3-3: Conceptual ARD Management Framework**

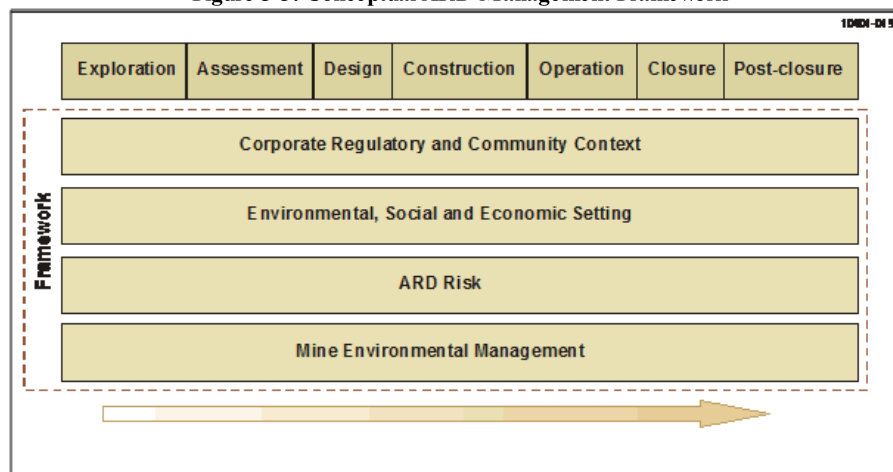

Within this framework:

- All mining companies, irrespective of size, need to adhere to the national legislation and regulations of the countries where they operate. Although mining companies are not obligated to comply with global guidance unless it is a condition of funding, it is considered good corporate practice to adhere to such guidance unless it conflicts with regulations or other mandatory requirements.
- Many mining companies have established corporate guidelines that represent the company’s view of the priorities to be addressed and their interpretation of generally accepted best practice. Such guidelines provide flexibility in approach, given the site-specific nature of ARD.
- Corporate guidelines can be applied in preference to country regulations and global guidelines, provided these corporate guidelines are more comprehensive and expansive and have adopted a precautionary approach. Caution is needed to ensure all specifics of the country regulations are met, as corporate guidelines cannot be a substitute for country regulations.
- Mining companies operate within the constraints of a “social licence” that is based on a broad consensus with all stakeholders to the extent that consensus is achievable. This consensus covers a broad range of social, economic, environmental, and governance elements. ARD plays an important part in the mine’s “social licence” while at the same time stakeholders may not readily understand the associated complexity and uncertainties of ARD.
- The mine often makes commitments regarding ARD that forms the foundation of the “social licence” and should the mine fail to meet its commitments, its “social licence” can be placed at risk. While ARD issues are of a highly technical nature, the consequences of “getting it wrong” should not be underestimated.
- Mining companies should make a commitment to capacity building on ARD issues within the communities where they operate. Mining companies should also solicit regular feedback and reporting on the status of ARD management plans.
- The costs of closure and post-closure management of water quality and ARD are increasingly recognized as a fundamental component of all mining operations. Provision for closure costing is now typically included in new project valuations. Some form of financial assurance (e.g., company provision, bond, letter of credit, trust fund, parental guarantee) is required in most jurisdictions. This financial assurance provides a mechanism to ensure that post-mining conditions will not leave a negative legacy that poorly reflects on mining in general and its social license to operate.

The GARD Guide provides an approach to assessment and planning for ARD management. The GARD guide also focuses on the range of procedures and methodologies that could be considered within the mine-specific setting to produce outcomes that provide an adequate level of certainty that ARD issues will be dealt with satisfactorily over the entire life cycle of the mine. A thorough understanding of the context and setting of each mine is, therefore, required before an appropriate ARD management approach is selected. This understanding requires a thorough assessment and evaluation of the applicable, social, economic, and environmental baselines. Plans, approaches, and the predicted impacts and risks need to be presented to stakeholders, and should be presented in such a way that stakeholders can evaluate the proposed performance of the ARD management plan.

While legal compliance with regional or country regulations is a minimum requirement in all instances, there are additional aspects that often add to these requirements. These additional aspects include the lenders and shareholder requirements, corporate requirements, and the local

community needs.

Adequate project development, implementation resources, and time are needed to consider and integrate requirements and expectations of stakeholders. This is an important phase that is often given insufficient attention and time within the overall project timeline.

Stakeholders are increasingly better informed and more sophisticated in their understanding of ARD and ARD-related issues. The ability to deliver on commitments to manage ARD in the long term will often be scrutinised and followed, resulting in the community holding operators accountable to perform. When established, a level of trust is a valuable element of continued mine success and thus inclusiveness and transparency in actions are important for long-term performance.

The ARD management approach cannot be defined in isolation, and ARD is only one of the environmental issues (sometimes the dominant issue) that a mine must address. Problem analysis and problem solving should be integrated into the overall exploration, mine planning, construction and commissioning, operational, decommissioning, and post-closure processes, which are illustrated in Figure 3-3.

The preceding principles are discussed in more detail in the Sections 3.2 through 3.6.

## 3.2 Corporate Guidance

The mining industry has seen significant development in its approach to sustainability during the past 15 years. Most companies now have a public commitment to a sustainability charter, which articulates the corporate commitment to health, safety, environment, and community (HSEC). Clearly, for the mining industry, the management of ARD and prevention of adverse impacts is a core issue. Beyond the individual corporate commitments, the industry has also cooperated to develop international standards and principles for sustainable development and more specifically ARD management, notably the Mining, Minerals and Sustainable Development (MMSD) project and the International Council on Mining and Metals (ICMM) 10 Principles in the Sustainable Development Framework (ICMM, 2003). Members of the ICMM (and similar organizations) have committed to meeting these principles and to being audited against the standards set forth in these Principles.

Corporate guidance available to address ARD issues can include the following:

- Corporate charter with commitments on performance and consultation
- Commitments to external sustainability principles and metrics (e.g., ICMM and the Global Reporting Initiative [GRI])
- Public targets for environmental performance
- Specific (quantitative) performance criteria that are prescriptive
- Risk assessment protocols and methodologies to develop site-specific performance criteria, for which the methodology is prescriptive rather than the outcome
- Technical guidelines with methodologies to follow for assessment, design, and evaluation of water quality and ARD – similar to this GARD Guide. These are resource documents in which the process is prescribed, but the specific methods or criteria are not prescribed.

Corporate policies and standards differ from company to company. Selected examples of corporate guidance documentation and a perspective on how corporate requirements relate to other requirements follow in Sections 3.2.1 through 3.2.3. The corporate guidance documents that are referred to in these sections represent only a very limited cross section of the many corporate documents that are available, and have been provided here as examples of the type of corporate ARD guidance in existence. The absence of a particular company's guidance documentation from those cited herein therefore does not imply that guidance documentation has not been developed or is not relevant. The intention here is to provide some perspective on the types and ranges of corporate guidance that exist.

### 3.2.1 Newmont

Newmont has developed a guideline document titled Standard ARD Waste Rock Evaluation Methods, dated February 2003 (Newmont Metallurgical Services, 2003). The guideline was developed in response to the state of Nevada's regulations in the early 1990s. Newmont Website (<http://www.newmont.com/>)

The guideline document contains the following guidance:

- Protocols for ARD waste rock evaluations
- Protocols for determination of net carbonate value (NCV)
- Protocols for classification of waste types by NCV
- Protocol for NCV confirmation studies

The appendices to Newmont Metallurgical Services (2003) provide details on analytical test methodologies. The guideline is not prescriptive and can therefore be adopted within the regulatory, community, and environmental context of each Newmont mine. Newmont has integrated its ARD and metal leaching guidance into the stage-gate process for approval of capital expenditures. This method of implementation provides the discipline necessary to ensure that the appropriate level of ARD and metal leaching assessment is completed at each stage of project development.

### 3.2.2 Rio Tinto

Rio Tinto has developed an “environment standard” to ensure risks associated with ARD are effectively identified and managed to prevent or minimise adverse impacts and reduce long-term liabilities and costs. The standard covers all phases of mining from exploration to post-closure and covers implementation and performance measures. It also uses references to many other internal documents such as water use standards, waste management standards, and land use stewardship (Rio Tinto, 2003). In a paper titled "Design and Implementation of a Strategic Review of ARD Risk in Rio Tinto" (Richards et al., 2006), methodologies and major findings of internal reviews are summarized. These reviews were conducted by Rio Tinto as part of its ARD management programme. The purpose of the reviews was to rank hazards at its mines and to assess the performance in key management areas.

The Rio Tinto ARD management programme includes the following:

- A hazard screening protocol, which is used to identify where most of the risks posed by ARD reside within Rio Tinto. The screening protocol was designed to assess all hazards created by the release of sulphide oxidation products, including the formation of acidic soils and saline soils, the release of low pH contact waters, or the release of contact waters (i.e., waters that have contacted mining wastes) with circum-neutral pH but elevated salinity (i.e., total dissolved solids) or metals concentrations. The screening protocol ranks the potential ARD hazard posed by mining based on the physical and chemical setting of each site.
- A risk review protocol, which focuses on how each operation is managing the ARD hazards posed by the ore body and on establishing management measures to reduce the overall financial, environmental, health, and reputational risks. The review protocols are divided into 11 key performance areas that cover all aspects of successful ARD management, including baseline characterization, waste and wall rock characterization, materials management, ARD generation processes, ARD migration pathways and fluxes, potential receiving environments, integrated conceptual understanding, ARD mitigation programs, monitoring and ongoing assessment, management skills, and resources and stakeholder relationships.

The ARD management programme is not prescriptive and can therefore be adopted within the regulatory, community, and environmental context of each Rio Tinto mine.

### 3.2.3 Relationship to Other Requirements and Issues

The specific framework for ARD management at a particular project or mine could be defined using a hierarchy from more general, sometimes aspirational policies, to more specific site requirements, constraints, and opportunities, such as the following:

- Corporate policies, including commitments to sustainability principles (ICMM)
- Corporate standards and guidelines for environmental protection and ARD management
- Global standards and principles (e.g., World Bank and IFC Standards and Equator Principles) and best practices (as defined in this GARD Guide and other ARD guides)
- Country, provincial, or local laws and regulations
- Local communities’ needs, expectations, and aspirations
- Site conditions, including topography, climate, environmental resources, and quality

In the framework discussed above, corporate guidelines do not take precedence over legal requirements, but usually provide further clarification or expansion of the standards that the corporation will follow in addition to or in the absence of other specific requirements. In some instances, corporate guidance might be more stringent than local legal requirements and may address issues that are not covered in the applicable law. Companies following a precautionary approach may also establish additional standards of management of ARD and environmental matters in a particular jurisdiction or geographic region because of anticipated future changes in regulatory requirements.

In addition, companies are also increasingly ascribing to the principle that the practices in the ‘home’ country of the company should be considered where they are more stringent than the local requirements. Corporate governance does not discriminate environmental performance based on a geographical location. Moreover, NGOs, financing institutions, and others judge performance based on the company as whole and not on individual locations. Users of this GARD Guide should be thoroughly conversant with in-country regulatory



requirements. Mining companies entering countries for the first time should be particularly careful to obtain a thorough understanding of the essence of the national, regional, and local laws before starting a new mining project.

Elements of the above hierarchy framework are discussed in more detail below in Sections 3.3 through 3.6.

### 3.3 Sustainability and Community Considerations

The economic benefit derived from mining is an essential contributor to sustainable development but the environmental and social consequences can offset this benefit unless managed appropriately. Appropriate ARD mitigation measures should consider the economic, social, and environmental issues on a global, regional, and local scale. Corporate and global institutional norms and national legislation and guidelines generally provide good global and regional context but sometimes fall short on local context. Local context can only be established through a thorough study and understanding of the economic, social, and biophysical baselines. Of these baselines, the social issues are the most complex and should be dealt with by effective public engagement and consultation using, where possible, local expertise knowledgeable in the customs and traditions (see Chapter 10). ARD and the associated risk are not well understood by the general public, so it is important that the mine operator invests in raising ARD-related awareness and risk communication. Communication of ARD issues is addressed in Chapter 10.

The balance that should be achieved is illustrated in Figure 3-4. The area within the triangle of Figure 3-4 illustrates a domain of results that are all acceptable. The balance point at A, which weighs the social and economic more heavily than the environmental, is equally acceptable as the point of balance at B, which weighs the environmental more heavily. The most suitable point of equilibrium can be identified only through an integrated consultative process involving all stakeholders.

**Figure 3-4: Sustainable Development Balance**

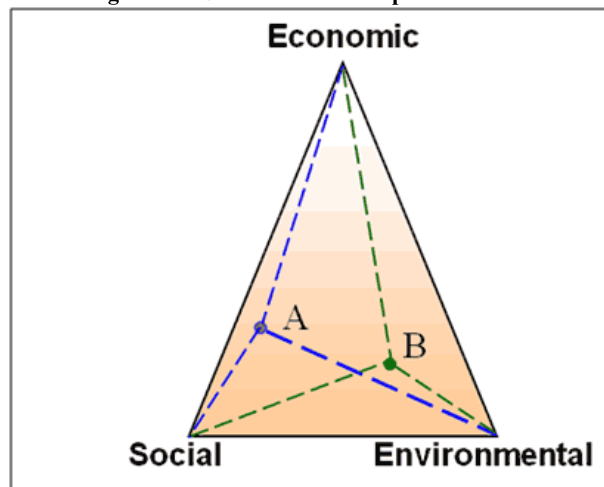

Corporate guidance from multinational companies assists in imbedding sustainability considerations into projects. In addition, sustainability principles are increasingly being reflected in country regulations and processes. For example, the United Kingdom prescribes that planning should be done within the context of the regional Sustainable Development Plan. There are also a number of countries with similar whole-society development frameworks that are not specifically identified by the term “sustainability,” as well as many with spatial development, watershed, air quality, and land management plans, such as typified by catchment management plans in South Africa and regional development plans in Australia. These plans are all of relevance and should be consulted as background. Additional sources are the Environmental, Health and Safety Guidelines for Mining, published by the International Finance Corporation of the World Bank Group in December 2007 (World Bank Group, 2007) and the International Federation of Consulting Engineers (FIDIC) on project sustainability management.

Some mines can have long operational lives, so it is essential to recognize intergenerational changes in the socioeconomic needs and requirements of the affected stakeholders. ARD plans should therefore be flexible and allow for adjustment and continuous improvement over the mine life cycle (see Chapter 9). The development of the ARD management plans for a mine site should begin at an early stage in the mine development (i.e., exploration, project studies, and mine plan development). While the ultimate solution may evolve and differ at the end of the mine life when post-closure land use is selected, a plan should exist from the beginning. Technological progress will improve closure and treatment options and should be integrated into plans. With preparation of an initial plan, the final plan will require less adaptation and be simpler to implement.

Rehabilitation associated with ARD is an important factor that may determine the suitability of the land for future uses. Post-closure land use

will also be dictated by factors that may include regulation, community interests, and economic needs for land. ARD prediction and management is not a precise science so long-term cost implications have uncertainty, which varies depending on the risk of ARD. These considerations should all be met while considering the overall short-term and long-term cost for the mine. Future costs are sometimes underestimated and it is therefore prudent to consider making adequate financial provisions for ARD closure and long-term maintenance.

### 3.4 Global Regulatory Guidance

Global guidance, by definition, can never be mandatory owing to the sovereign nature of the laws applicable to host countries. The global guidance provided by organizations such as the World Bank, International Finance Corporation (IFC) and World Health Organization (WHO), however, provides relevant and applicable standards of practice that should be taken into account for mining projects. Project funding agencies and banks have a particularly strong influence on the standards that mining companies must maintain because they frequently adopt the Equator Principles and their guidelines and standards are a prerequisite for approval and continuation of funding. The IFC Environmental, Health and Safety Guidelines for Mining (World Bank Group, 2007) provides general guidance on the prevention and control of ARD/ML, including the following:

- Design, operation, and maintenance of tailings facilities to internationally recognized standards based on a risk assessment strategy
- Preparation and implementation of ore and waste geochemical characterization, including leaching tests, ARD mapping, and the implementation of ARD preventative actions
- Rigorous impact assessments that must be implemented by suitably qualified professionals
- Mine closure planning and post-closure obligations
- Financial feasibility and closure assurance

The WHO standards identify acceptable levels of human health exposure (WHO, 2005).

Voluntary standards established by industry organisations and associations can also be of assistance, including the following:

- ICMM Principles (ICMM, 2003)
- International Cyanide Management Code (International Cyanide Management Institute [ICMI], 2006)
- Kimberley Process (Kimberley Process Certification Scheme [KPCS], 2008)
- Guidelines For Metal Leaching and Acid Rock Drainage at Mine Sites in British Columbia (Price, 1997)
- Minerals Council of Australia – Enduring Value (MCA, 2006)
- Mining Association of Canada – Towards Sustainable Mining (MAC, 2007)

### 3.5 Country Regulatory Guidance

#### 3.5.1 Commonalities in the Regulatory Regimes

Most countries have environmental legislation, which is generally applicable to ARD, and some countries have specific laws, regulations, and practice guidelines that apply explicitly to ARD. In most regulatory regimes, mining proponents are required at an early stage to address potential environmental risks (including ARD) through an environmental impact study (EIS) and subsequently through environmental management plans (EMPs). EISs and EMPs are developed before the construction of a mine project. This mechanism provides the flexibility for the mining proponent to implement a management plan and environmental performance that match the mine context and that is acceptable to the regulator and affected community.

Other common themes in country legislation and regulations are as follows:

- The impact assessment process required before the issuance of an authorization or permit is generally well defined
- The environmental management plans formulated as part of the authorization process often need to describe how the effects will be managed during the mining operational phase
- The prediction of conditions and planning for mine closure
- The provision of funds for closure and post closure during the operations of the mine
- The ongoing monitoring, review, and continuous improvement, particularly for ARD
- The realization of commitments and requirements specified in permits or environmental impact assessment (EIA) approvals

A comprehensive review of specific requirements of the laws in all the countries where mining occurs is beyond the scope of this GARD Guide. The overview of some country regulatory regimes in Sections 3.5.2 through 3.5.9 provides examples of requirements and guidelines.

### 3.5.2 United States of America and its States

The United States has a complex regulatory system that addresses the entire range of impacts associated with all aspects of mineral development, including water and air quality, reclamation, land use, and final mine closure. While both state and federal agencies may have roles in the permitting process, state and federal regulatory agencies operate under agreements, which attempt to limit duplication and confusion in the mine permitting process.

Mining companies are subject to a combination of federal and state prescriptive standards, discharge limits, authorizations, and permits which must be obtained within a framework of spatial development frameworks and include watershed, air shed, and land development plans.

Federal laws provide a framework allowing states to implement more stringent and comprehensive laws. Often regulatory enforcement for mining, water discharge, and waste management is at the state level. Where states have primacy in mine permitting, they have developed regulatory programs that are at least as stringent as the federal requirements. These regulatory programs have been reviewed and approved by federal agencies such as the U.S. Environmental Protection Agency (USEPA) and Office of Surface Mining (OSM).

Federal laws do have specific limitations on effluent discharges and impacts on receiving water quality. Environmental impacts, reclamation obligations, and post-mining land use issues are often addressed in the environmental reviews required by state and federal laws.

Proponents of new mining projects or expansions of existing mines in the United States with the potential for ARD must comply with a series of federal and state laws and regulations that start with environmental baseline data collection and extend through the life of mine to reclamation and closure. Because of the variability of the climatic, geological, and ecological characteristics in the United States, U.S. federal regulations do not have prescriptive ARD protocols and may rely on other guidance or expertise. In many cases, state regulations have developed more specific and regional-based requirements and guidelines for ARD characterization, prediction, control designs, mitigation, and monitoring than federal regulations.

### 3.5.3 Canada and its Provinces and Territories

Canada consists of 10 provinces and 3 territories. The legislative authority over environmental matters is not expressly allocated to either the federal government or the provincial governments. Generally, the provinces have jurisdiction over provincial lands and matters of a purely local nature, while the federal government asserts jurisdiction over federal lands, navigable waters, nuclear regulatory matters, inter-provincial matters, and international matters. Both federal and provincial governments have produced a formidable array of legislation and supporting regulations dealing with all aspects of the environment. This section summarizes the main federal and provincial legislations and regulations that affect ARD management only and is not intended to be comprehensive of all legislation pertaining to mining or the environment in Canada. Several categories of legislation exist in Canada influencing or affecting ARD evaluation in mining. Broad categories of legislation and guidelines in Canada include the following:

- General ARD guidelines
- Securities rules and legislation for exploration and fund raising
- Closure and mine rehabilitation
- Discharge and operational limits/guidelines
- General environmental legislation

Some of the most relevant legislation, rules, and guidelines are as follows:

- Guidelines and reference materials provided under the Mine Environment Neutral Drainage (MEND) initiative
- Guidelines for Metal Leaching and Acid Rock Drainage at Mine Sites in British Columbia (Price and Errington, 1998)
- Draft Guidelines and Recommended Methods for the Prediction of Metal Leaching and Acid Rock Drainage at Mine Sites in British Columbia (Price, 1997)
- Federal Metal Mining Effluent Regulations (MMER)
- Guidelines for ARD Prediction in the North (Department of Indian and Northern Development [DIAND], 1992)
- Various provincial standards and requirements for water quality discharges
- Various provincial mine closure and financial assurance requirements for mining

Mine closure and rehabilitation guidelines and regulations in Canada are generally quite prescriptive in nature and include evaluation of all aspects of the mine, including waste rock management, tailings disposal facilities, mine and site drainage systems, mine workings, site water quality, and revegetation. The goal of the mine closure and reclamation plan is to leave the site in a condition that will require little or no long-term care and maintenance. As part of this process, it is necessary to demonstrate long-term physical and chemical stability of the materials,

including an evaluation of long-term acid generation potential, metal leaching, potential water quality implications, and treatment requirements. A financial guarantee to cover the costs of reclamation must be posted by the mining company, often in the form of a bond.

Price and Errington (1998) and MEND 5.10E (2005) provide a comprehensive list of the information requirements and factors to consider regarding ARD management. The MEND 5.10E document is more concise and has more recent information on mitigation measures, whereas Price and Errington (1998) give more information on common errors, omissions, and constraints. Price (1997) outlines the proper program planning, test work and the interpretation of the resulting data. Although both Price and Errington (1998) and Price (1997) were developed to guide the mining activities in British Columbia, these documents are widely accepted across Canada, and are required methods under Ontario Regulation 240/00 under Part VII of the Ontario Mining Act relating to mine closure and rehabilitation. The DIAND (1992) Guidelines for ARD Prediction in the North identifies unique aspects of northern climate, geology, topography, and mining practices that should be considered and outlines methods for use in evaluating ARD and ML in the north.

### **3.5.4 Australia, its States and Territories**

State and local governments in the Commonwealth of Australia have legislation and guidelines in place that are relevant to mine site ARD management. The aim of this legislation and guidelines is to protect environmental aspects such as biodiversity, water resources (quantity and quality), landforms, existing and potential future land uses, and cultural and environmental heritage.

The primary means by which state and territory governments regulate ARD is through authorisations required for a mining project. Although the regulatory regime applicable to ARD varies somewhat between jurisdictions, in general they all seek to minimise environmental impacts during operations and after operations seek to achieve sustainable landforms following rehabilitation through the minimization of pollutant release.

Key considerations under state and territory legislation include the following:

- Identification and assessment of ARD risks in the environment and social impact assessment
- Determination of financial bonds based on adequate management of ARD issues post closure
- Management of compliance with national water quality guidelines
- Availability, quality, and use of local and regional water resources

Significant “how to” guidance on the management and prediction of ARD is provided in the Leading Practice Sustainable Development Program for the Mining Industry, Managing Acid and Metalliferous Drainage (Department of Industry, Tourism, and Resources, 2007), published in February 2007 by the Australian Government, Department of Industry, Tourism, and Resources. Although they have been developed specifically for the Australian mining environment, these best practice guidelines are of value to mining companies dealing with ARD elsewhere.

Some Australian states and territories have published sustainable development plans, spatial development plans, and watershed management plans.

### **3.5.5 European Union (EU)**

The European Commission (EC) is responsible for proposing legislation, under which the EU member states need to operate. European legislation is decided together with the European Parliament and the European Council in a so called “co-decision” procedure. Whilst some acts and regulations are put in place by the EC, each EU member state is expected to develop, manage, and incorporate its own environmental protection rules and regulations on mining.

While transposing EU directives into their own national legislation, the member states are free to include additional requirements (e.g., regulate additional substances relevant within their own territory or set higher standards). The member states are not permitted to set standards lower than EC standards because the minimum level of protection afforded should remain the same across the whole EU. According to the EU Treaty, certain areas of law, such as land-use and taxation must be regulated at the most relevant administrative level. EU mining law is therefore based mainly on national or regional laws.

A number of European environmental directives have been put in place in reference to the extractive industry. The most important of these is the Management of Waste from Extractive Industries Directive (i.e. “Mine Waste Directive”) (2006/21/EC). Prior to 2006, waste from the extractive industries fell within the scope of the Landfill of Waste Directive. However, in March 2006, the “Mine Waste Directive” was approved and is now being transposed into national legislation. This directive applies specifically to waste resulting from the extraction, treatment and storage of mineral resources, and the working of quarries. The Mine Waste Directive provides for measures, procedures, and guidance to prevent or reduce as far as possible any adverse effects on the environment, in particular water, air, soil, fauna and flora and

landscape, and any resultant risks to human health, brought about as a result of the management of waste from the extractive industries.

According to the directive, no extractive waste management installation, other than certain installations containing non-hazardous waste from prospecting, inert waste, unpolluted soil, or waste resulting from peat extraction, can operate without a permit issued by the competent authorities. Member states must ensure that operators of the mining waste facility draw up a waste management plan with the objective to prevent or reduce the generation of waste and its negative impact, and to encourage waste recovery through recycling, re-use or recovery. Waste facilities may be of two types according to their potential risks: a waste facility whose failure or incorrect operation would present a significant accident hazard (category A), and all other waste facilities (not category A). For facilities in category A, the competent authority must compile an external emergency plan for the measures to be taken off-site in the event of an accident. The operator must provide a financial guarantee before the beginning of waste processing operations so as to ensure that the provisions of the Directive are complied with and that the financial resources for restoring the site are always available. A mining waste facility is regarded as finally closed when the competent authority conducts a final inspection, studies the reports submitted by the operator, confirms that the site has been restored and gives its approval. After closure, the operator must maintain and monitor the site for as long as the competent authority considers necessary. To date, five supporting decisions have been adopted by the EC to elaborate on the implementation of the Mine Waste Directive. These include the following Commission Decisions:

- Technical guidelines for the establishment of the financial guarantee (2009/335/EC)
- The definition of the criteria for the classification of waste facilities (2009/337/EC)
- The harmonisation, the regular transmission of the information and questionnaire (2009/358/EC)
- The definition of inert waste (2009/359/EC)
- The technical requirements for waste characterization (2009/360/EC)

In order to meet the requirements of this directive, waste will need to be appropriately characterized. The European Committee for Standardization or Comité Européen de Normalisation (CEN), has developed a number of standards and specifications to be published in 2012:

- Technical Report - Characterization of waste - Overall guidance document on characterization of wastes from the extractive industry
- Technical Report - Guidance on sampling of wastes from the extractive industry
- prEN 15875 "Characterization of waste – Static test for determination of acid potential and neutralisation potential of sulfidic waste"
- Technical Report - Characterization of waste – Kinetic testing for assessing acid generation potential of sulfidic waste from extractive industries

Other directives that have some relevance to ARD are discussed briefly below.

The Environmental Impact Assessment Directive (EC, 1997), requires an impact assessment to be carried out by the competent national authority for certain projects, including all mines and quarries above a prescribed size, which have a physical effect on the environment. The assessment must identify the direct and indirect potential effects of the project on the following factors: man, the fauna, the flora, the soil, water, air, the climate, the landscape, the material assets and cultural heritage, and the interaction between these various elements. The assessment is to be carried out before approval can be granted for the project; and the Directive lists the third parties to be consulted in connection with approving the project.

The Water Framework Directive (EC, 2000) is a Community framework for surface and groundwater protection and management. The Framework Directive provides for the identification of European waters and their characteristics, on the basis of individual river basin districts, and the adoption of management plans and programs of measures appropriate for each body of water. There are 6 daughter directives under the Water Framework Directive which have relevance to mine drainage – some of which set environmental quality standards for specific pollutants. In addition, EC Regulation No 166/2006 (EC, 2006b) covers the annual reporting requirements for pollutant releases to water.

The EU Environmental Liability Directive (EC, 2004b) with regard to the prevention and remedying of environmental damage includes requirements for the cost of cleanup and remediation from extractive wastes. Waste facility operators must provide a financial guarantee before the beginning of waste processing operations and must ensure that a plan and financial resources are always available for restoring the site. These plans and the financial resources must periodically be reviewed at least once every 5 years. After closure of a waste activity, the operator must maintain and monitor the site for as long as the competent authority considers necessary.

The Major Accidents Involving Dangerous Substances Directive (2003/105/EC) is based on the Seveso II Directive (96/82/EC), which focussed on protection of the environment, and covered substances considered dangerous to the environment, in particular aquatoxics. The Seveso II directive introduced new requirements relating to safety management systems, emergency plans and land-use planning, and tightened up the provisions on inspections and public information. The scope of the Seveso II directive was broadened in the Major Accidents Involving Dangerous Substances Directive to cover chemical and thermal processing of minerals extracted in mining and quarrying, related storage of dangerous substances and operational tailings disposal facilities.

A BAT (Best Available Techniques) reference document for Management of Tailings and Waste Rock in Mining Activities (EC, 2009) was

adopted in January 2009.

The Integrated Pollution Prevention and Control (IPPC) Directive does not apply to the extractive industry, although some member states have applied their corresponding legislation to mines (e.g., Ireland's national legislation covered mining before the IPPC Directive was adopted at the EU level).

### 3.5.6 South Africa

South African mining law requires the following of the holder of a reconnaissance permission, prospecting right, mining right, mining permit, or retention permit:

- Must consider, investigate, assess, and communicate the impact of prospecting and mining on the environment
- Must manage all environmental impacts in accordance with the environmental management plan or approved environmental management programme
- Must, as far as it is reasonably practicable, rehabilitate the environment affected by the prospecting or mining operations to its natural or predetermined state or to a land use which conforms to the generally accepted principle of sustainable development
- Must be responsible for any environmental damage, pollution or ecological degradation as a result of the reconnaissance prospecting or mining operations and which may occur inside and outside the boundaries of the area to which such right, permit or permission relates
- Must have made prescribed financial provisions for the rehabilitation or management of negative environmental impacts before the Minister approves the environmental management plan

The relevant permits relating to mining, water management, and ARD are as follows:

- A mining permit
- A water use authorisation
- An approved environmental impact assessment

In terms of ARD, the studies in support of the applications for environmental and water-related authorisations will include the following:

- The identification of all potential impacts from the mining operation
- The assessment of these potential impacts in terms of the source of the impact, potential pathways, and potential impact on the receiving water body

The South African Department of Water Affairs and Forestry (DWAF) has published a series of best practice guidelines for water management at mines (DWAF, 2006, 2007). Most of these guidelines provide guidance on pollution prevention and minimisation of impacts, and best management practice relating to general and specific mining activities that is directly applicable to ARD. A specific guideline on impact prediction which relates to ARD will be developed in 2009. These best practice guidelines offer valuable "how to" guidance on the management and prediction of ARD. Although these have been developed specifically for the South African mining environment, these guidelines may be useful to mining companies dealing with ARD elsewhere.

### 3.5.7 New Zealand

In New Zealand, all resource (i.e., land, air, water, and the coast) utilization is managed in accordance with the provisions of the Resource Management Act 1991 (RMA) (New Zealand Government, 1991). ARD is viewed as a contaminant which, if released into the environment, has the potential to affect natural resources. For this reason, the provisions of the RMA apply to ARD.

The release of ARD into the environment would be classified as a discharge under the RMA. Consequently, the RMA identifies the requirements for the discharge of contaminants into or onto land, air, and water.

To ascertain whether an ARD discharge requires a resource consent, it is necessary to consider the provisions of the relevant regional plan. At present, there are no national environmental standards that provide direction regarding discharges of contaminants, so only provisions of regional plans are of relevance. Given the consultative process utilised to develop documents under the RMA, each individual plan's approach can be different even though they are all developed under the framework established by the RMA. This can mean that the type of resource consent required to undertake an ARD discharge depends entirely on which regional plan is involved.

### 3.5.8 Brazil

All mineral exploitation is conducted under federal law. The Ministry of Mines and Energy (DNPM) controls and permits mining activities in the country. A mining title is the instrument granted by the federal authorities to permit exploration or exploitation of a certain mining concession. Mining activities in Brazil are, in general, subject to a set of regulations where the three levels of federal, state, and local authorities have competencies related to assessment of mining and the environment.

The National Environmental Policy regulates environmental protection and can cause action that triggers the remedy of environmental degradation resulting from a mining operation. The construction, installation, expansion, and operation of a facility that uses environmental resources, and may cause environmental degradation, are subject to an environmental licensing process that is managed by the Ministry of Environment (CRA/CEPRAM). Where mining activities are deemed to cause significant impacts to the environment (i.e., impacts to waters, soil, vegetation and air), the environmental agencies require that an EIA and environmental impact report (RIMA) be completed for the proposed mining facility.

The mining policy of Brazil includes the following principles:

- Governmental initiatives for maintenance of the ecological balance, giving special consideration to the protection of cultural heritage
- Control and monitoring the use of surface and groundwater
- Planning and supervision of the use of environmental resources
- Ecosystems protection, the conservation of special protected areas
- Control and zoning of potential or effectively polluting activities
- Incentives for the study and research of technologies aimed at environmental resources protection and use
- Monitoring of environmental quality
- Recovery or protection of degraded or threatened areas
- Environmental education at all levels, including community education, to empower the community for active participation in the defence of the environment

### 3.5.9 Indonesia

The Indonesian legislation related to ARD is the Decree of the State Minister of Environment No. 113 of 2003 (Government of Indonesia, 2003) regarding wastewater standards for coal mines and processing activities. The emphasis in this legislation is that wastewater standards specific to wastewater produced from coal mine activities cannot be exceeded.

The Government of Indonesia, Ministry of Environment, issued a document in 2003 containing guidelines relating to quality standard for water waste in coal mining activities. This guideline prescribes the methods to prevent and handle acid rock drainage by selective placement, bacteria inhibition, soil management, revegetation, stabilization, neutralization of ARD, and handling of ARD passively.

## 3.6 Risk Considerations

Risk assessment is a powerful tool to develop an ARD management plan. It should be applied at each phase of mining in order to:

- Provide a logical and comprehensive basis for decision making
- Provide process transparency to government regulatory agencies and the public
- Inform decision making
- Provide input for priority setting

The risks posed by ARD/ML should be considered on a site-specific basis and the level and depth of the risk assessment should depend on the stage of mine development, hazard associated with the source of the ARD/ML, and the sensitivity of the water resource.

Risk assessment is not only a technical process and therefore the risk identification, analysis and assessment, and the selection of risk management measures should be conducted by a technical team in consultation with stakeholders. Consultation should be used to find an acceptable balance between the environmental and social and economic spheres of sustainable development. Not all risks identified may be considered 'real' by all parties but they should be considered equally and assessed openly if public trust is to be secured. There is likely to be more than one approach that satisfies the risk criteria in all three spheres. The selection of the preferred approach should be done in consultation with the stakeholders.

The geochemistry and risk assessment techniques related to ARD/ML for a new mine development are not as yet calibrated for all situations.

There will therefore be a degree of uncertainty in terms of the confidence in the data collected and the reliability of the analysis and output. For this reason, a precautionary approach and contingency planning should be an integral part of risk assessments of ARD/ML management plans.

The level of acceptable risk will vary from the local, regional, and national communities. In addition, the level of acceptable risk changes over time. Acceptable risks today may not be acceptable in the future.

Risk is defined as the probability that a certain event (hazard) will happen multiplied by the consequence of the event (Equation 3.1).

$$\text{Risk} = \text{Probability} \times \text{Consequence} \text{ Equation 3.1}$$

Lee (1999) provides a risk management procedure for mine sites modified from the Management Advisory Board (MAB), Australian Public Service. Table 3-1 outlines the steps in the process. The risk assessment should be conducted by a team involving site or project staff, technical experts, or risk management specialists. The risk assessment should include the participation, or at least input, from potentially affected communities and relevant regulators.

**Table 3-1 : Risk Management Procedure for Mine Sites (modified from Lee, 1999)**

<b>Step</b>	<b>Name</b>	<b>Description</b>
1	Establish the context	Define policy, purpose, objectives, success criteria, assessment endpoints, and receptors
2	Identify the risk	Define sources, pathways, concerns, and consequences
3	Analyze the risk	Calculations (identify concerns and possible outcomes); certainty and uncertainty
4	Assess and prioritize risks	Compare with criteria; prioritize
5	Manage (treat) the risks	Mitigation, communication; develop and implement contingency and management plans
6	Review and monitor	Risk management plan; continue reviewing and monitoring; assess effectiveness of treatment

### **3.6.1 Establish the Context (Step 1)**

Step 1 involves gathering information on baseline conditions, including geologic and environmental status, sites of cultural and historical interest, and rare flora and fauna. The risk assessment team determines the attitudes of local land and water users toward the mine or project and the perceived risks that it may pose. The team also collects water quality information, initiates geochemical analysis, and identifies constituents of interest (COI). At the conclusion of this step, the team should be able to identify several assessment endpoints, which will be used to guide decision making. These are explicit environmental values to be protected, which have ecological relevance and societal value, and are susceptible to chemical stressors caused by ARD. In the context of an ecological risk assessment, for example, these could include the protection of sport fishing values downstream from a mine site, that are therefore relevant to the site's environmental management goals.



### **3.6.2 Identify the Risks (Step 2)**

Step 2 involves the risk assessment team evaluating preliminary hypotheses about how ecological effects might occur by considering each of the potential sources of ARD, identifying transportation pathways between sources and receptors (i.e., runoff, surface water, and groundwater), formulating a comprehensive list of concerns and consequences associated with potential effects on the assessment endpoint, and estimating the level of risk associated with each effect. This step uses conceptual models of geochemical reactions and drainage transport. At the conclusion of Step 2, the team reports the following data quality objectives (DQOs): (a) define the issues; (b) describe the decisions to be made; (c) list the data inputs needed to make the decisions; and (d) outline how the data will be used in decision making. This information would be used by other project or mine planning teams in their assessments of, for example, waste rock management, open pit mining sequences, and mill tailing management.

### **3.6.3 Analyze the Risk (Step 3)**

Step 3 involves the geochemical characterization of mine and processing units, the hydrologic characterization of flow paths, static and kinetic testing, and predictive geochemical and hydrologic modeling. The information could be used in an engineering reliability assessment of the performance of waste management or treatment schemes. In an ecological risk assessment, the data could be used to (a) define the sources of COIs, their distribution in the receiving environment, and their contact with or co-occurrence with receptors; (b) evaluate chronic and acute response relationships in the receptors (i.e., evidence of exposure); and (c) define the impact of receptor responses on assessment endpoints. Throughout this process, the risk assessment team identifies where flexibility is required to reduce uncertainty given future knowledge development. The assessment also identifies areas where risk can be reduced, and performs sensitivity analyses for various conditions and scenarios. Again this information is reviewed together with other mine planning teams so that results can be integrated into their assessments.

### **3.6.4 Assessment and Prioritization of Risk (Step 4)**

Step 4 involves the risk assessment team estimating the technical hazards (Equation 3.1), which indicates the degree of confidence in estimates, interprets effects on assessment endpoints, estimates outcomes resulting from given consequences, and calculates overall risks. This analysis should also identify social, economic, political, and legal ramifications associated with risks, and prioritizes the risks. The results allow the team to establish the most useful monitoring programs for the assessment endpoints, which are implemented from the construction to post-closure phases. See Lee (1999) for specific methods used in qualitative and quantitative risk calculations.

### **3.6.5 Risk Management (Treat the Risk) (Step 5)**

Step 5 involves the risk assessment team, in conjunction with other mine planning teams, identifying appropriate strategies to deal with the moderate to highest risk events. For new projects or existing mines where ARD/ML is not yet an issue, these strategies could include (a) risk reduction – reduce sources of risk or their likelihood of occurrence or both, and (b) risk avoidance – take a different course of action to avoid negative impact.

For historical mines where ARD/ML is being produced, the strategies could also include (a) impact mitigation – minimize potential impacts by designing physical and chemical barriers along flow paths and implementing contingency planning, regular audits, and internal compliance guidelines (see Chapter 6) and (b) risk co-management – identify how portions of the risk can be managed by various stakeholders including government agencies, or local communities.

In all cases, risk acceptance should be addressed: i.e., the acknowledgement that the residual risk is acceptable viewed through regulatory and sustainability lenses. At this stage, regular and adequate public consultation established with potentially affected groups can greatly reduce the risk associated with any given technical hazard, because the views of the public have influenced the decision process (MMSD, 2002).

### **3.6.6 Review and Monitor (Step 6)**

During Step 6, the team consolidates the risk management aspects together with other project or mine teams into a risk management plan (RMP) to manage various risks from construction through post-closure phases. This plan summarizes the identification and assessment of major risks, various options for treating risks, including the benefits and costs of each option, recommended actions, the implementation plan, and descriptions of monitoring programs. The RMP should be regularly reviewed so that it becomes a living document that evolves as risks change over the mine life. The RMP will be integrated into the overall mine plan, standard operating procedures (SOPs), and environmental management systems (EMS). This is discussed further in Chapter 9.

### 3.6.7 Risk Priorities

The level of detail of the risk assessment and management changes as the mine progresses through the ARD/ML assessment process and the mine development stages. The initial risk assessment might be rather conceptual but will become more comprehensive during the feasibility, detailed design, and operational phases. Risk assessment and management should be specifically applied to the closure plan because of the potential long-term implications of ARD management.

Table 3-2 illustrates the relationship between the relevant ARD/ML management elements and the applicable risk management process. The last column in the table gives an example of the risk assessment tool that might be most appropriate at that stage. The application of risk assessment and risk management is discussed further in Chapter 9.

**Table 3-2: Integrating Risk Approach into ARD/ML Management**

ARD Management	Risk Management Process	Focus Areas for Risk Management			Example Risk Assessment Tools
		Probability	Consequences	Uncertainty	
Characterization	Risk assessment	Sampling	Heterogeneity	Representativeness Testing methods Mineralogy Temporal variability Spatial variability	Potential problem assessment (PPA) Tier approach
Prediction	Risk assessment	Testing interpretation	Seepage characteristics	Assessment criteria Testing duration Particle size effect	Ecological and human health risk assessment
Prevention	Risk management	System malfunction	Seepage characteristics Effluent quality	Waste variability Climatic variability	Engineering reliability analysis (e.g., FMEA)
Treatment	Risk management	System malfunction	Effluent quality	Sample holding time Sample preservation Testing interferences Quantitation limits Treatment effectiveness Influent quality Influent quantity	Engineering reliability analysis (e.g., FMEA)
Monitoring	Risk management	Source characteristics pathway analysis	Assimilative capacity receptors	Sample holding time Sample preservation Testing interferences Quantitation limits Seepage variability Assessment criteria	Ecological and human health risk assessment
Performance assessment /management	Risk management Contingency planning Emergency response	Human error Management error System error	KPIs Effluent quality Receiving water quality	Applicability of performance measures	Management system audit
Communication	Risk communication	Stakeholder views	Stakeholder acceptance	Stakeholder Values	Stakeholder mapping and surveys
Sustainability aspects	Risk acceptance	Impacts and benefits	Environmental social	Sustainability Balance	Sustainability risks and

			economic governance		opportunities assessment
--	--	--	------------------------	--	--------------------------

### 3.7 References

- Department of Indian Affairs and Northern Development (DIAND), 1992. Guidelines for ARD Prediction in the North.
- Department of Industry, Tourism and Resources, 2007. Leading Practice Sustainable Development Program for the Mining Industry, Managing Acid and Metalliferous Drainage. Australian Government.
- Department of Water Affairs and Forestry, 2006. Best Practice Guideline G1: Storm Water Management.
- Department of Water Affairs and Forestry, 2006. Best Practice Guideline G2: Water and Salt Balances.
- Department of Water Affairs and Forestry, 2006. Best Practice Guideline G3: Water Monitoring Systems.
- Department of Water Affairs and Forestry, 2006. Best Practice Guideline H3: Water Reuse and Reclamation.
- Department of Water Affairs and Forestry, 2007. Best Practice Guideline A3: Water Management in Hydrometallurgical Plants.
- Department of Water Affairs and Forestry, 2007. Best Practice Guideline A4: Pollution Control Dams.
- Department of Water Affairs and Forestry, 2007. Best Practice Guideline H4: Water Treatment.
- European Commission, undated. Management of Tailings and Waste Rock in Mining Activities (MTWR). <http://eippcb.jrc.ec.europa.eu/>
- European Commission, 1997. Environmental Impact Assessment Directive (97/11/EC). <http://ec.europa.eu/environment/eia/eia-legalcontext.htm>
- European Commission, 2000. Water Framework Directive (2000/60/EC). <http://eur-lex.europa.eu/LexUriServ/LexUriServ.do?uri=OJ:L:2000:327:0001:0072:EN:PDF>
- European Commission, 2004a. Reference Document on Best Available Techniques for Management of Tailings and Waste Rock in Mining Activities. BREF Code MTWR, July. <http://eippcb.jrc.ec.europa.eu/reference/>
- European Commission, 2004b. Environmental Liability Directive (2004/35/EC). <http://ec.europa.eu/environment/liability/index.htm>
- European Commission, 2006a. Mine Waste Directive (2006/21/EC). <http://ec.europa.eu/environment/waste/mining/index.htm>
- European Commission, 2006b. Regulation NO 166/2006. <http://eur-lex.europa.eu/LexUriServ/LexUriServ.do?uri=OJ:L:2006:033:0001:0017:EN:PDF>
- Government of Indonesia, 2003. Decree of the State Minister of Environment No. 113.
- International Council on Mining and Metals (ICMM), 2003. <http://www.icmm.com/our-work/sustainable-development-framework/10-principles>
- International Cyanide Management Institute (ICMI), 2006. International Cyanide Management Code For The Manufacture, Transport and Use of Cyanide In The Production of Gold (Cyanide Code). <http://www.cyanidecode.org/>
- Kimberley Process Certification Scheme (KPCS), 2008. [http://www.kimberleyprocess.com/home/index\\_en.html](http://www.kimberleyprocess.com/home/index_en.html)
- Lee, M., 1999. Risk Assessment Framework for the Management of Sulphidic Mine Wastes. Australian Centre for Mining Environmental Research (ACMER), September.
- Mine Environment Neutral Drainage (MEND), 2005. List of Potential Information Requirements in Metal Leaching/Acid Rock Drainage (ML/ARD) Assessment and Mitigation Work. MEND Report 5.10E.
- Minerals Council of Australia (MCA), 2006. Enduring Value - the Australian Minerals Industry Framework for Sustainable

Development. <http://www.minerals.org.au/enduringvalue>

Mining Association of Canada (MAC), 2007. Towards Sustainable Mining. <http://www.mining.ca/site/tsmpprogressreport2011/index.html>

Mining, Minerals & Sustainable Development Project (MMSD), 2002. <http://www.iied.org/sustainable-markets/key-issues/business-and-sustainable-development/mining-minerals-and-sustainable-development>

Newmont Metallurgical Services, 2003. Newmont, Standard ARD Waste Rock Evaluation Methods. February 20, Englewood, CO.

New Zealand Government, 1991. Resource Management Act (RMA). Ministry for the Environment.

Price, W.A., 1997. Draft Guidelines and Recommended Methods for the Prediction of Metal Leaching and Acid rock Drainage at Mine sites in British Columbia. British Columbia Ministry of Employment and Investment, April.

Price, W.A., and J.C. Errington, 1998. Guidelines for Metal Leaching and Acid Rock Drainage at Mine sites in British Columbia. Ministry of Energy and Mines, August.

Richards, D.G., Borden, R.K., David, J.W., Blowes, D.W., Logsdon, M.J., Miller, S.D., Slater, S., Smith, L., and G.W. Wilson, 2006. Design and Implementation of a Strategic Review of ARD Risk at Rio Tinto. In: R.I. Barnhisel (Ed.), Proceedings 7<sup>th</sup> International Conference on Acid Rock Drainage (ICARD), March 26-30, St. Louis, MO, American Society of Mining and Reclamation (ASMR), Lexington, KY.

World Bank Group, 2007. Environmental, Health and Safety Guidelines for Mining. International Finance Corporation (IFC), December.

World Health Organization (WHO), 2005. International Health Regulations.

## List of Tables

Table 3-1 : Risk Management Procedure for Mine Sites (modified from Lee, 1999)

Table 3-2: Integrating Risk Approach into ARD/ML Management

## List of Figures

Figure 3-1: Framework for ARD management

Figure 3-2: Hierarchical relationship between Global, National and Local Elements of the Framework

Figure 3-3: Conceptual ARD Management Framework

Figure 3-4: Sustainable Development Balance



# Chapter 4

## From GARDGuide

### 4.0 Defining the Problem – Characterization

#### 4.1 Introduction

#### 4.2 Site Characterization Approach

##### 4.2.1 Mine Life Cycle Phases

##### 4.2.2 Sources of Acid Rock Drainage

##### 4.2.3 Conceptual Site Model Development

#### 4.3 Components of Site Characterization

##### 4.3.1 Geo-environmental Models

##### 4.3.2 Source Material Geochemical Characterization

##### 4.3.3 Watershed Characterization

###### 4.3.3.1 The Hydrologic Cycle

###### 4.3.3.2 Water Balance

###### 4.3.3.3 Assimilative Capacity of the Receiving Environment

###### 4.3.3.4 Biological Receptors

#### 4.4 Summary

#### 4.5 References

#### List of Tables

#### List of Figures

## 4.0 Defining the Problem – Characterization

### 4.1 Introduction

The generation, release, mobility, and attenuation of acid rock drainage (ARD) is a complex process governed by a combination of physical, chemical, and biological factors (see Chapter 2). Neutral mine drainage (NMD) and saline drainage (SD) are governed by similar factors but may or may not involve the oxidation of sulphides. Whether ARD, NMD, or SD enters the environment depends largely on the characteristics of the sources and pathways. Characterization of these features is therefore key to the prediction, prevention, and management of drainage impacted by the products of sulphide oxidation at mine sites.

In this chapter, the term “ARD” refers to drainage types that are affected by the products of sulphide oxidation, including acid, neutral and saline drainage.

Environmental characterization programs are designed to collect sufficient data to answer the following questions:

- Is ARD likely to occur and what are the potential sources?
- What type of chemistry is expected?
- When is likely to start and how much will be generated?
- What are the significant pathways that transport contaminants to the receiving environment and can those contaminants be attenuated along those pathways?

- What are the anticipated environmental impacts?
- What can be done to prevent or mitigate/manage ARD?

Figure 4-1 shows how the information presented in this chapter is integrated with other chapters of the GARD Guide in the development and execution of a site characterization program to address these questions.

**Figure 4-1: Characterization Chapter Road Map**

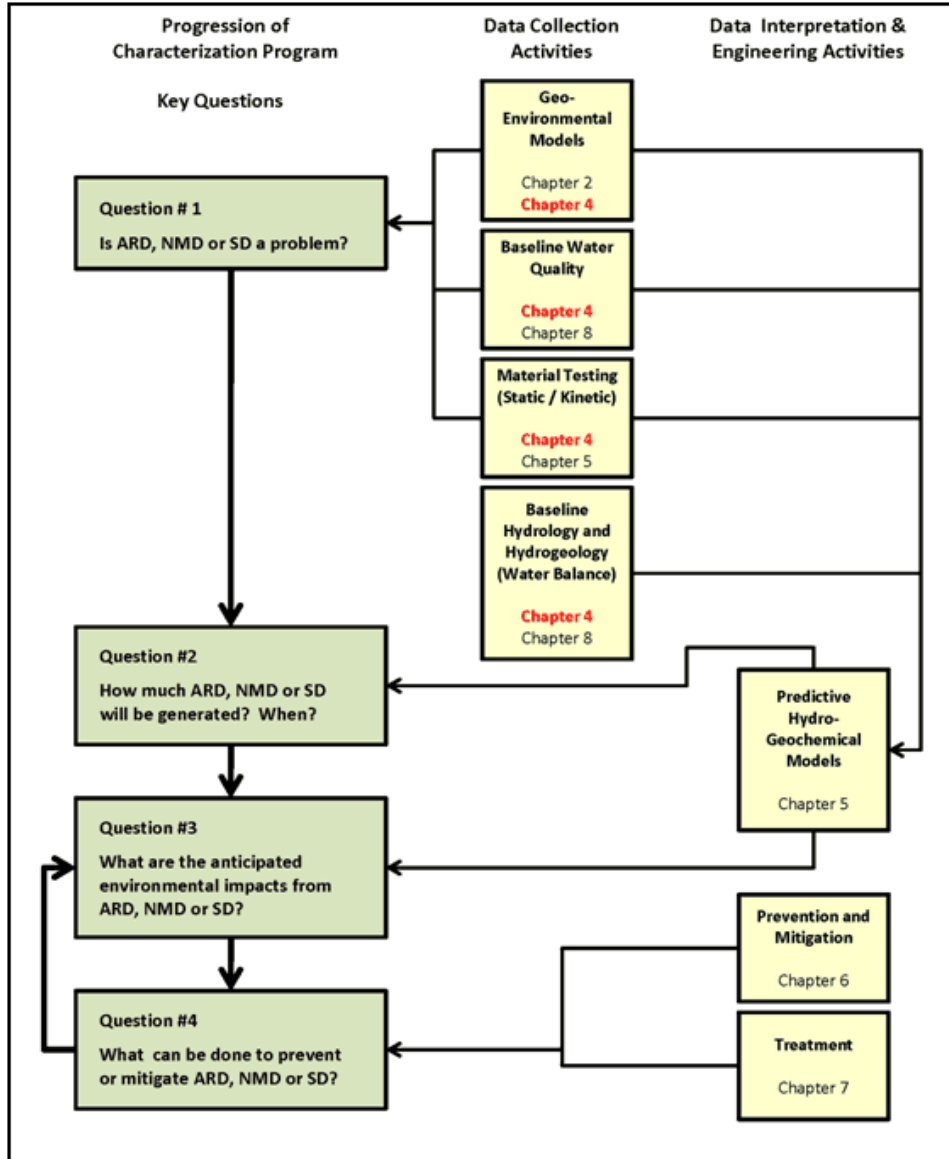

To address these key questions, expertise from numerous disciplines is required, including geology, mineralogy, hydrology, hydrogeology, geochemistry, biology, meteorology, and engineering (Figure 4-2). Fundamentally, the geologic and mineralogic characteristics of the ore body and host rock (or the coal seam and overburden) define the type of drainage generated as a result of mining. The site climatic and hydrologic/hydrogeologic characteristics define whether and how constituents present in mine drainage are transported through the receiving environment to receptors.

Because the geologic and mineralogic characteristics of mineral deposits exert important and predictable controls on the environmental signature of mineralized areas both before mining and during mining (Plumlee, 1999), a preliminary assessment of the potential for ARD is typically made based on review of geologic data collected during exploration. Baseline environmental characterization of elemental concentrations in various media (i.e., water, soils, vegetation, and biota) may also provide an indication of ARD potential and documents

potentially naturally-elevated concentrations in the surrounding environment.

The initial assessment of ARD potential is refined during mine development and operation as detailed characterization data of the waste and ore materials are obtained. During mine development, the magnitude and location of sources of mine and process discharges to the environment are identified. The boundaries of the receiving watersheds are delineated based on topography, defining the site characterization boundary. Meteorologic, hydrological, and hydrogeological investigations are conducted to characterize the amount and direction of water movement within the watershed (i.e., the hydrologic cycle) to evaluate contaminant transport pathways. Potential biological receptors within the watershed boundary are identified. Over the mine life, the focus of the watershed characterization program evolves from establishment of baseline conditions, to prediction of drainage release and transport, to monitoring of the environmental conditions and potential impacts.

This chapter presents the approach and methods typically applied to characterize the release, transport, and fate of constituents present in ARD (i.e., major cations and anions, metals, metalloids, acidity/alkalinity) at a mine site. Despite inherent differences at mine sites (e.g., commodity type, climate, regulatory framework); the general approach to site characterization is similar, as presented in the following sections of this chapter.

## 4.2 Site Characterization Approach

Table 4-1 describes the phases of mine development from exploration through to post-closure. During the early stages of mine development, site-specific information may be limited and therefore a high level of uncertainty is present in site characterization. This uncertainty is reduced as information is obtained during exploration, planning, feasibility and design, and is further reduced during operation and decommissioning.

**Table 4-1: Mine Phase Objectives and Activities**

Mine Phase	Primary Objectives	Typical Activities
<b>Exploration</b>	Discovery and mapping of the extents of an economic ore deposit	Review existing geologic information. Detailed surface reconnaissance (e.g., geologic mapping, geochemical sampling, geophysics) Subsurface investigations (i.e., drilling; exploration pits, adits or shafts)
<b>Mine Planning, Feasibility and Design (Development)</b>	Assess the economic viability of mining and processing	Development of the mine plan and waste management plan Characterization of baseline site conditions Completion of the Environmental and Social Impact Assessment Completion of the Feasibility Assessment Design of mine layout and facilities Mine permitting
<b>Construction and Commissioning</b>	Construction of facilities and infrastructure for operational mine	Construction of mine infrastructure (e.g., power, roads, water ) Construction of metallurgical processing , waste containment and water treatment facilities
<b>Operation</b>	Extraction and processing of ore deposit	Mineral extraction and processing Ore body dewatering Development of waste facilities (waste rock, tailings)
<b>Decommissioning</b>	Site closure - to the extent possible, re-establishment of pre-mining conditions or conditions suitable for post-mining land use	Site reclamation (e.g., regrading, covers) Dismantling of buildings and road decommissioning Ongoing water treatment
<b>Post-Closure</b>	Land use commensurate with owner's desire and adjacent land uses  Management of long-term environmental impacts	Environmental monitoring Site redevelopment Possible water treatment Long-term maintenance of waste storage facilities



Table 4-2 and Table 4-3 present the chronology of a characterization program and identify the data collection activities typically executed during each mine phase. The bulk of the characterization effort occurs before mining during the mine planning, assessment, and design phase (referred to as the development phase throughout this chapter). Identification of potential environmental impacts during this phase and incorporation of appropriate prevention and mitigation measures is intended to minimize environmental impacts and serves as a foundation for the environmental and social impact assessment. During the commissioning/construction and operation phases, a transition from site characterization to monitoring of waste materials and geochemical processes occurs, which continues throughout the decommissioning and post-closure phases. Ongoing monitoring refines the knowledge of the site, allowing adjustments for new technologies that may evolve during the mine life and whose incorporation will reduce closure costs and better manage associated risks.

**Table 4-2: Characterization Activities by Mine Phase**

		Mine Phase – Increasing Knowledge of Site Characteristics					
		Exploration	Mine Planning, Feasibility and Design (Development)	Construction and Commissioning	Operation	Decommissioning	Post-Closure
Conceptual Site Model Component	Source	Ore body characterization	Laboratory testing of waste and ore materials (static and kinetic)  Collection and analysis of water samples from existing historic sources	Ongoing laboratory testing  Field testing of waste and ore materials	Ongoing laboratory and field testing  Instrumentation of waste facilities  Collection and analysis of water samples from sources	Ongoing water quality monitoring	Long-term water quality monitoring (if necessary)
	Pathway	Exploration drilling may characterize groundwater occurrence	Hydrogeologic characterization - groundwater occurrence, direction and rate of flow Hydrologic characterization - surface water flow Baseline surface water and groundwater quality  Baseline soil and sediment quality	Hydrogeologic, hydrologic and water quality monitoring	Ongoing hydrogeologic, hydrologic and water quality monitoring	Ongoing hydrogeologic, hydrologic and water quality monitoring	Ongoing hydrogeologic, hydrologic and water quality monitoring (if necessary)
	Receptor		Receptor identification Baseline characterization (receptors and habitat including vegetation metals surveys)	Receptor and habitat monitoring	Ongoing receptor and habitat monitoring	Ongoing receptor and habitat monitoring	Ongoing receptor and habitat monitoring (if necessary)
		Ore body information supports site and source characterization	<b>Peak Characterization Effort</b>	Ongoing Characterization and Monitoring			

Table 4-3: Source Material Characterization Activities by Mine Phase

Mine Phase – Increasing Knowledge of Source Material Characterization							
	Exploration	Mine Planning, (Pre-) Feasibility and Design	Construction and Commissioning	Operation	Decommissioning	Post-Closure (Care and Maintenance)	
Waste or Facility Type – Potential ARD / NMD / SD Sources	<b>Waste Rock</b>	Drill core descriptions and assay data (petrology and mineralogy)  Block model (quantity of ore and waste)	Laboratory testing of drill core samples – sample selection targets waste <sup>(4)</sup>	Ongoing laboratory testing of drill core or development rock samples <sup>(4)</sup>  Field leach testing (barrels, test pads)	Ongoing laboratory testing <sup>(4)</sup>  Ongoing field leach testing  Collection and analysis of runoff and seepage samples from waste rock facility	Collection and analysis of runoff and seepage samples from waste rock facility	Collection and analysis of runoff and seepage samples from waste rock facility (if necessary)
	<b>Tailings</b>	Review of any historical data	Laboratory testing of pilot plant tailings <sup>(4)</sup>  Analysis of pilot testing supernatant.	Ongoing laboratory testing of pilot plant tailings <sup>(4)</sup>	Ongoing laboratory testing of tailings discharge <sup>(4)</sup>  Collection and analysis of supernatant and seepage samples from TSF	Collection and analysis of supernatant and seepage samples from TSF	Collection and analysis of supernatant and seepage samples from TSF (if necessary)
	<b>Ore</b>		Laboratory testing of drill core samples <sup>(4)</sup>		Ongoing laboratory testing <sup>(4)</sup>	If ore stockpiles exist, collection and analysis of runoff and seepage samples	
	<b>Pit</b>		Laboratory testing of drill core samples – sample selection targets pit walls <sup>(4)</sup>		Field scale leach testing (e.g., wall washing) Collection and analysis of water samples (i.e., runoff, sumps)	Collection and analysis of pit water and pit inflow(s) water samples	Collection and analysis of pit water samples (if necessary)
	<b>Underground Workings</b>		Laboratory testing of drill core samples – sample selection targets mine walls <sup>(4)</sup>		Collection and analysis of water samples (i.e., sumps, dewatering wells)	Collection and analysis of mine pool water samples	Collection and analysis of mine pool water samples (if necessary)

<sup>(4)</sup> Typical laboratory testing components: particle size, whole rock analysis, mineralogy, ABA, static and kinetic leach testing.

## 4.2.1 Mine Life Cycle Phases

### 4.2.1.1 Exploration Phase

The primary objective of exploration is to locate a potentially economic ore body or energy resource. The techniques employed in mineral exploration include literature review, geologic mapping, geochemical sampling (rock, soil, and water sampling), geophysical testing, remote sensing surveys (surface, subsurface, airborne, and satellite), aerial photography, and drilling (SME, 2008). Exploration data are compiled to characterize the ore deposit, including the deposit’s size, grade, mineralization style, and the alteration assemblages present. The exploration geologist maps the lateral and vertical distribution of material types across the deposit. Material types may include distinct lithologies or rock units, ore units, alteration assemblages, coal seam overburden and interburden or soil types that have relatively homogeneous characteristics of importance (e.g., mineralogy, grain size, and porosity) to mineral extraction and processing, waste management, and other uses such as for construction. Three-dimensional digital representations of material types, called block models, are generated from borehole data to develop the economic ore estimation models (see Chapter 5).

If sufficient data are available, geologic block models with an ore evaluation focus can be adapted using ARD potential indicator parameters (e.g., total sulphur and carbonate carbon and ABA results) to provide an early indication of the quantities of potentially acid generating and non-acid generating wastes and the overall ARD potential of the deposit. Determination of parameters such as sulphur and carbon during exploration, therefore, provides significant value at later stages of the project cycle by augmenting the ABA database from the geochemical characterization program.

Exploration data collected to determine the economic value of a mineral deposit also provide information useful in the assessment of environmental impacts from mining. For example, the presence of acid generating and acid neutralizing minerals associated with the ore and host rock can be determined from mineralogical data. Exploration drilling logs are often a source of useful hydrogeologic data. The depth to

water and quantity of water encountered during drilling are information that may be used to characterize groundwater occurrence and flow conditions. Soil, water, and sediment sampling provide information on the occurrence and mobility of trace metals in the watershed. Remote sensing data may provide information on the distribution of secondary minerals formed from weathering of mineral deposits.

Plumlee’s (1999) summary of how the geologic characteristics of a mine deposit affect its environmental signature is reproduced as Table 4-4. Much of this information is obtained during exploration. Seal and Hammarstrom (2003) discuss the application of geoenvironmental models for massive sulphide and gold deposits. Samples collected during the exploration phase (core, rejects and pulps) should be cataloged and saved for potential future use.

**Table 4-4: Geologic Characteristics of Mineral Deposits that Affect Their Environmental Signatures (Plumlee, 1999)**

Characteristic	Type of Control	Explanation
Iron Sulphide Content	Chemical	Oxidation generates acid and supplies ferric oxide, an aggressive oxidant.
Content of Other Sulphides	Chemical	Many (but not all) generate acid during oxidation.
Content of Carbonates, Aluminosilicates and other Nonsulphide Minerals	Chemical	Many of these minerals can consume acid. Iron and manganese carbonates may generate acid under some conditions.
Mineral Resistance to Weathering	Physical	Function of the mineral (different minerals weather at different rates) and the texture and trace-element content of the mineral
Secondary Mineralogy	Chemical & Physical	Soluble secondary minerals can store acid and metals, to be released when the minerals dissolve. Insoluble secondary minerals can armor reactive minerals, thereby restricting access of weathering agents.
Extent of Pre-Mining or Pre-Erosion Weathering and Oxidation	Chemical	Pre-mining oxidation greatly reduces potential for sulphide deposits to generate acid.
Host Rock Lithology	Chemical & Physical	May consume or generate acid. Physical characteristics (porosity, permeability) control access of weathering agents.
Wallrock Alteration	Chemical & Physical	May increase or decrease the host rock’s ability to consume acid. May increase or decrease the host rock’s ability to transmit groundwater. May also increase or decrease resistance to erosion.
Major-, Trace-elements in Deposit and Host Rock	Chemical	Elemental composition of deposit and host rocks are typically reflected in environmental signatures.
Physical Nature of Ore Body (vein, disseminated, massive)	Physical	Controls access of weathering agents.
Porosity, Hydraulic Conductivity of Host Rocks	Physical	Control access of weathering agents.
Presence and Openness of Faults, Joints	Physical	Control access of weathering agents.
Deposit Grade, Size	Physical & Chemical	Control magnitude of natural and mining impacts on surroundings.

#### 4.2.1.2 Mine Planning Phase (Pre-Feasibility, Feasibility and Approval)

To decide whether a project will progress, the economic viability is assessed during the mine planning phase. This phase includes completion

of a number of trade-off, design and prefeasibility studies, including the environmental and social impact assessment (ESIA) and the feasibility study (FS). The ESIA includes an assessment of the potential environmental impacts associated with development of the deposit. Mine design, development of the mine waste management plan and closure planning are incorporated into the ESIA while detailed design and mine permitting follow and are also considered part of the mine planning phase.

During this phase, the intensity of site and source material characterization is usually high. Laboratory testing programs aim to systematically evaluate the environmental stability of waste and ore materials, including the occurrence and nature of sulphide minerals and minerals with neutralization potential and their respective quantities. Intensive baseline monitoring is conducted to characterize existing environmental conditions. This may include establishment of surface water, groundwater, sediment, and climate monitoring stations. The biological receptors within the watershed are identified and their habitats characterized.

Environmental characterization programs need to be integrated with activities of other mine departments to optimize both data collection efforts and the design of the mine facilities. For example, often ARD characterization activities can be combined with geotechnical investigations (e.g., collection of samples for ARD characterization of ultimate pit walls during drilling to evaluate pit wall stability). Optimal siting of waste facilities should integrate information from multiple disciplines, including mining engineering, metallurgy, geochemistry, hydrogeology, hydrology, geology and geotechnical.

When a positive water balance exists in the beneficiation process and depending upon the expected effluent quality, evaluation of water management (e.g., treatment and discharge) may be required to manage excess water if it cannot be contained on the mine property during and after operation.

Characterization during the mine planning phase must be sufficient to allow estimation of any significant long-term costs of ARD management for inclusion in the economic evaluation of the project. It may not be possible to profitably mine some marginally economic ore bodies or coal deposits that have high ARD management and closure costs.

Initial design considerations for mine closure should begin as soon as possible during the mine planning phase. This ensures a “design for closure” approach. Issues such as reduced mine footprint, ARD prevention in waste rock and tailings (and coal refuse), and the avoidance of long-term water treatment should be integrated into the mine design to ensure that the economic model for mine development fully considers the true costs of the whole lifecycle, including post-closure.

If ARD or any other geochemical issue has been identified as a potential concern, then development of an ARD/geochemical block model is usually required during this phase. Integrated with the mine plan, the block model is used to estimate the quantity and production schedule of the identified geochemical waste types. Incorporation of ARD and other geochemical indicator parameters into the block model facilitates consideration of environmental risk in ore development plans, waste production scheduling, and potential segregation of waste as part of an ARD management plan.

#### **4.2.1.3 Construction and Commissioning Phase**

Detailed design typically occurs coincidentally with and subsequent to the ESIA review by regulators, communities and other stakeholders, and the securing of mine permits. Modifications to the ARD management plan may be made as a result of this consultation to reflect stakeholder input and permit conditions. Detailed design transitions into construction of all mine facilities (e.g., mine camp, water treatment plant, and waste storage facilities) and infrastructure (e.g., water, power, and roads) required for operation of the mine and associated mineral processing.

The characterization programs initiated during the mine planning phase are usually continued during this construction and commissioning phase. Ongoing laboratory testing of ore and waste materials may now include testing of samples generated during site excavation activities (e.g., pit pre-stripping and road/tunnel construction). Field-scale testing programs may also be initiated at this time, including large test plots of mine waste and pilot testing of water treatment options. Routine surface water, groundwater, sediment, climate, and biological receptor monitoring programs begin during baseline data collection and continue to be implemented during the construction and commissioning phase. Environmental characterization activities to evaluate the construction of engineering controls intended to prevent ARD migration may also occur during this phase (e.g., field testing of liners placed at the base of waste facilities to ensure design permeability criteria are met).

#### **4.2.1.4 Operational Phase**

The operational phase is usually defined as the start of milling. Note that early mining operations, including pre-stripping of overburden and waste rock, and ore stockpiling at surface mines or during the development of declines, adits or shafts for underground deposits, often begin in the construction phase. The majority of ARD sources resulting from ore extraction and establishment of mine waste facilities are created during the operational phase.

Laboratory and field testing of source materials generally continue during operations to calibrate/validate predictions and validate/modify design of control measures. Testing also supports tracking of waste segregation by ARD potential, if required. Additional testing must be conducted if materials not included and/or fully assessed in the initial characterization programs are encountered during excavation. The waste management plan commonly stipulates specific testing of waste materials to document the composition of waste facilities or, as part of the waste management protocol, to document operational monitoring (e.g., for segregation of waste materials). Source characterization during operations often includes collection of runoff and seepage samples from potential ARD sources. In some cases, instrumentation of waste facilities is required to fulfill specific data needs (e.g., lysimeters or gas monitors within waste rock piles). In general, monitoring of drainage as close to the source as possible is preferred to minimize dilution effects.

Watershed monitoring (i.e., groundwater, surface water, sediment, climate, and biological receptor) continues during the operational phase with a focus on the identification of environmental impacts and compliance with applicable regulations. The quality of water removed in association with dewatering activities should be characterized, even if recycled, to understand the effects on site water quality, and if discharged, the need for treatment.

During the operational phase, source and watershed characterization data collected during operations are reviewed on an ongoing basis and compared to expected conditions and compliance requirements. Trigger levels should be established during this phase that indicate the need to implement contingency measures (e.g., a change or modification to a mitigation measure or engineered source control measure). Trigger levels may be based on predictive models or permit conditions. As needed, the predictive models are updated to reflect measured conditions.

#### **4.2.1.5 Decommissioning Phase**

The decommissioning phase involves activities aimed to reestablish premining conditions (to the extent possible) or conditions suitable for beneficial post-mining land use. Active mining and the activities associated with mining and processing cease (e.g., cessation of dewatering activities, cessation of heap leaching). Site reclamation and rehabilitation activities are often conducted during mine operations (progressive reclamation) but their breadth and intensity increases substantially during the decommissioning phase. The closure measures outlined in the closure plan are revised as needed based on operational experience and are conducted during this phase. If necessary, water treatment facilities continue to operate or passive measures are instituted.

Monitoring continues during the decommissioning phase to assess environmental and geochemical conditions with the view to assessing the performance of the closure plan in meeting targets and/or regulatory requirements, and to identify any need for additional or modified activities. Models are commonly used to predict the performance of closure measures, and data from laboratory and field scale kinetic test work and operational monitoring can be used to calibrate and verify these models for longer term predictions. Additional test work may be necessary or the predictive models themselves may need to be modified.

Water table rebound and surface water inflow during the decommissioning phase present an opportunity to assess actual pit lake or flooded underground mine water quality. Additional data collection and evaluation, including modeling, may be required to refine long-term water quality predictions and assess the need for mitigation measures, including water treatment. The rate of water table rebound is measured to confirm predictions of the time for mine flooding or establishment of a pit lake and its potential consequences (e.g., discharges), including acceptability for post-closure beneficial uses.

#### **4.2.1.6 Post-Closure Phase**

With the advance of mine waste management techniques, the post-closure phase is usually characterized by the absence of a continuous presence of personnel on the mine site, though some operations might require ongoing water management and treatment. During the post-closure phase, land use is commensurate with requirements of permits and expectations from adjacent land users and regulatory agencies. The requirements for post-closure monitoring vary with the post-closure objectives and the remaining facilities. Typically, there is a period of at least five to ten years of performance monitoring over which there is a decreasing frequency of activity, based on achieving the predicted performance for chemical and physical stability. Following performance monitoring, some sites may require longer term monitoring and maintenance of, for example, physical structures such as tailings dams, water retaining structures, or covers. There are a number of management models by which the post-closure monitoring can be achieved (e.g., the company, contractors, regulatory agencies, communities, or research institutions).

### **4.2.2 Sources of Acid Rock Drainage**

The disturbances and wastes resulting from mining and processing are the primary sources of ARD. The methods of extraction include surface

mining (e.g., open pit mining), underground mining, and solution mining. The depth of the deposit, the nature of the mineralization (e.g., disseminated vs. veins), the concentration and amenability to processing of valuable metals, and the cost of waste removal generally dictate whether a resource is extracted using underground or open pit techniques. The solubility of the ore material determines whether heap leaching or in situ solution mining is an option (SME, 2008).

The selection of mining and mineral processing methods defines which sources of ARD are present (Figure 4-2). Both open pit mining and underground mining create features that are potential sources of ARD (e.g., low-grade ore stockpiles, heap leach piles, waste rock facilities, and tailings storage facilities [TSF]). The mine plan and process waste management plan describe the size and location of these facilities. Because waste facility design must consider the potential for these facilities to produce environmental impacts, material characterization and facility design is an iterative process involving multiple disciplines as explained previously. Solution mining changes the geochemistry of the subsurface and has the potential to result in direct ARD impacts to groundwater and impacts to surface water through waste solutions

**Figure 4-2: Major Steps Involved in Extraction Metallurgy of Metals (adapted from SME, 2008)**

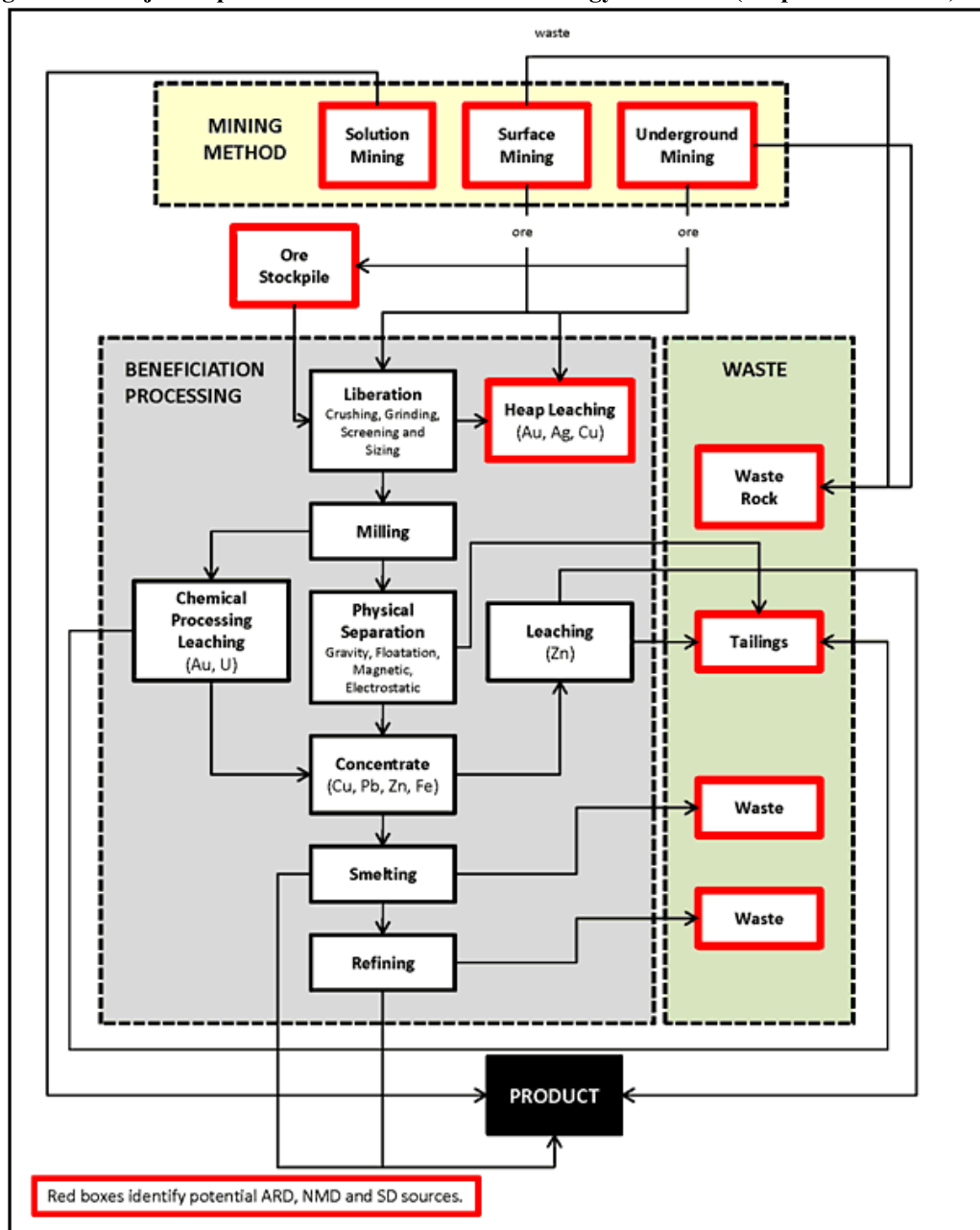

This section describes how the geometry, physical properties, and structure of common mine and process facilities influence or control the

production and pathways of ARD. Conceptual models illustrate the chemical reactions occurring within each facility, as well as the movement of oxygen, heat, and water that govern sulphide oxidation and transport of oxidation products. Additional technical detail on sulphide oxidation and transport of oxidation products is provided in Chapter 2.

#### 4.2.2.1 Surface Mines

Mining of relatively shallow deposits or very large low-grade deposits often employs surface open-pit mining techniques. This typically involves blasting, excavating, loading, hauling of waste rock and ore, with the construction of permanent waste rock storage facilities and temporary (low-grade) ore stockpiles. An open pit is formed by the successive removal of rock from benches as the mine deepens. The ultimate shape of the pit is usually a function of the shape of the ore body, the economics of ore and waste removal and the mechanical characteristics (or strength) of the rock in the pit walls. The ARD potential of the host rock may also be considered in determination of the pit shape to avoid areas with high ARD potential (SME, 2008) or to include areas of high acid neutralizing potential such as limestone.

Open-pit mining may alter surface water and groundwater conditions. Diversion of surface water or dewatering activities to lower the groundwater table may be required to access the ore body. Fractures generated during blasting alter the hydraulic properties of the host rock and may change groundwater flow patterns. Surface water and groundwater quality may also be affected. When sulphides are present within the surrounding rock, dewatering and blasting activities may expose them to atmospheric oxygen, initiating oxidation and acid generation.

##### *Operational Phase*

Figure 4-3 schematically illustrates the primary water pathways and geochemical reactions that occur within an open-pit mine during operations. When necessary, dewatering wells are sited around the perimeter of the pit to lower the groundwater table to beneath low stability rock units and mine working areas. Alternatively, sumps within the pit may be used for dewatering. Precipitation falling within the pit capture zone becomes pit wall runoff, or infiltrates into the unsaturated zone. Infiltration flows downward to the groundwater table or horizontally toward the pit wall, where it discharges as seepage. High-porosity blast-generated fractures within the adjacent rock zone and historical mine tunnels intersecting the open pit provide preferential pathways for groundwater flow and can create a zone of groundwater depression around the pit.

The quality of pit wall runoff and groundwater inflow to the pit is a function of the composition and reactivity of the rocks these waters encounter and the contact time. Sulphides exposed to atmospheric oxygen on the pit walls or blast fractures oxidize, causing generation of acid that may result in ARD. Therefore, if the pit is to be filled and reclaimed after mining is completed, and if mining is proceeding laterally as for a surface coal mine, the backfilling process should be coordinated with excavation to minimize the amount of time that the mineral sulphides are exposed. ARD neutralization may occur due to dissolution of buffering materials, when they are present. Sulphide oxidation products, which accumulate on pit walls and fracture surfaces, are flushed by groundwater or surface runoff. Pit wall runoff may collect in pools where the haul road meets the pit wall. During dry periods, evaporation results in the accumulation of secondary minerals. These soluble mineral phases are flushed during storm events and may release metals, sulphate, and acidity, depending on their characteristics. Ultimately, runoff collects in a shallow pool at the bottom of the pit. Water on the floor of the pit may infiltrate into the groundwater system, evaporate, or be actively removed by pumping from sumps. Infiltrated water mixes with underlying groundwater and may be captured by dewatering wells.

Figure 4-3: Sources and pathways of ARD, NMD, and SD in a Pit during Operation and Closure

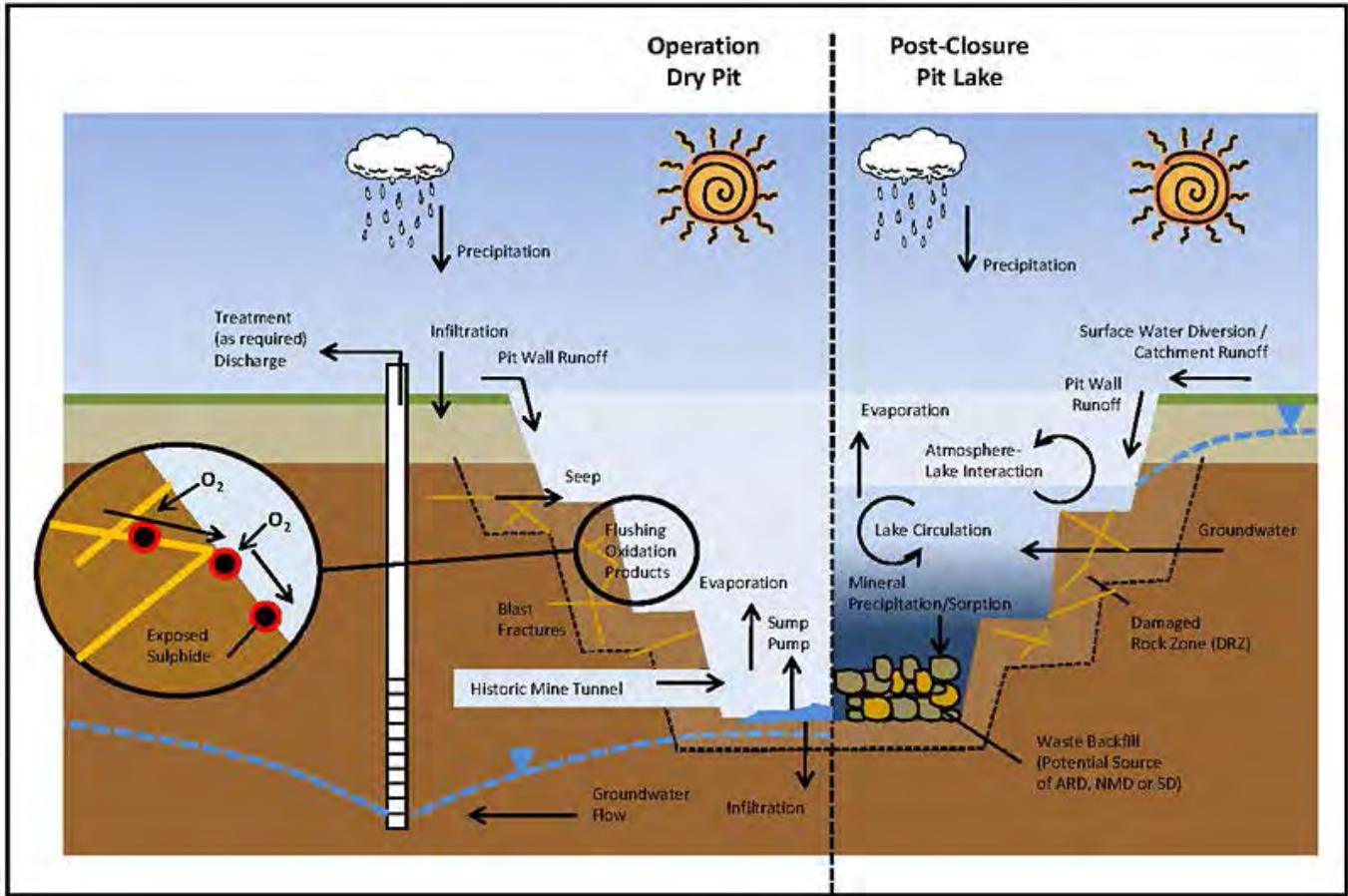

*Decommissioning phase*

At the cessation of mining, a pit lake will form if total water inflow to the pit is greater than water outflow, including evaporation (Figure 4-3).

During the decommissioning phase, dewatering activities typically cease. The groundwater table may rebound to near the premining level and, if the pit has not been backfilled, produce a pit lake that can act as a source to groundwater. In other cases, the pit may develop as a groundwater sink due to low inflow and high evaporative loss.

Filling of the pit may be accelerated by diversion of surface water into the pit. For example, the Island Copper Pit in British Columbia, Canada was flooded with sea water in less than half a year and a similar approach is planned for the Lihir Gold Mine in Papua New Guinea. River water was diverted to accelerate filling of the Kelian Gold mine pit in Kalimantan Indonesia; and the Martha Mine Pit in New Zealand is expected to fill from river water and groundwater over a 5-year period following completion of mining.

Open-pit mines in arid regions with limited surface water resources, low groundwater discharge rates, and high evaporation rates may take tens to hundreds of years to achieve a steady-state lake level, extending lake filling conditions well into the post-closure phase. Alternatively, open-pit mines in such conditions may not contain water at all if the natural groundwater table is below the pit bottom or the evaporation exceeds inflows.

Similar to natural lakes, pit lake water quality may vary seasonally and with depth. Pit lake water quality will be a function of the geochemistry of the wall rock, climatic conditions (i.e., the amount of precipitation and evaporation), the rate and quality of groundwater and surface water inflows, the type and extent of biological activity, and pit limnology (Geller et al., 1998).

Pit lake water quality can present a long-term environmental concern, especially considering the volume of water that some pit lakes contain. Acidic conditions may develop within a pit lake because of the oxidation of sulphides in wall rock, flushing of reactive waste materials backfilled in the pit, the addition of ARD in runoff or groundwater, and the precipitation of iron hydroxide minerals within lake water. An example of a highly acidic pit lake is the Berkeley Pit Lake in Butte, Montana, which has a pH of approximately 2.5 and copper and zinc concentrations of approximately 150 mg/L and 600 mg/L, respectively (Gammons and Duaine, 2006). Fortunately, pit lakes with these extreme characteristics are rare on a global scale and appear to be limited to some porphyry copper deposits with high sulphur contents and



minimal carbonate or other neutralizing lithologies. Abandoned coal mine pits in eastern Germany and Pennsylvania, USA, and uranium mines in central Canada have also developed acidic waters. Neutral to basic waters have developed in pit lakes hosted in limestone deposits, where the dissolution of calcite buffers pit lake pH. Saline waters also occur in pit lakes, particularly in extremely arid environments where the evaporative loss raises the concentration of dissolved solids. In some mine pits in central Australia, hypersaline water can accumulate due to the evapoconcentration of naturally highly saline groundwater inflows. Stratification within pit lakes and the presence of thermoclines and chemoclines may result in waters of very different composition with depth.

Because pit lakes may potentially represent a long-term source of ARD that persists after mine closure, prediction of the quality and environmental impacts of these lakes is a key part of the ARD management plan. If impacts are predicted, mitigative options should be considered, including accelerated flooding, raising the flooded water level, and batch treatment such as nutrient addition to facilitate bioremediation. Selective mining of problematic material from pit walls above the final lake level can also be considered, and as a final option, pumping/treatment may be required.

A pit lake may be incorporated into the site water management plans for post-closure (e.g., Island Copper Mine, Selbaie Mine, and Mt. Milligan Project in Canada). Wastes can be stored in pit lakes where very low oxygen or anoxic conditions essentially prevent sulphide oxidation. Physical (e.g., sedimentation), chemical (e.g., mineral precipitation and sorption), and biological (e.g., sulphate reduction) processes that occur in pit lakes can be used to ameliorate water quality.

Additional references on pit lake characteristics, predictive modeling, remediation and post-closure utilization include Geller and Salomons (1998), Castendyk and Eary (2009), and Bowell (2003).

#### **4.2.2.2 Underground Mining**

Underground mining typically involves blasting, stoping, mucking (excavating), hauling, and where a shaft is used, skipping (vertical haulage) of waste and ore to surface. Where employed, block caving mining methods may create a large mass of fractured rock above the main underground workings. The rubblized zone in some cases may extend all the way to the ground surface. The physical and chemical properties of this large mass of fractured or rubblized rock can be similar to the properties of waste rock.

Similar to open-pit mining, dewatering activities are typically required to remove groundwater from the underground workings, commonly through use of dewatering wells and sump pumps. In some cases, a drainage tunnel can be constructed below the mining level that permits gravity drainage of groundwater to land surface. Mining exposes sulphides present on mine walls or blast fractures to atmospheric oxygen that enters the underground workings through shafts and other openings that intersect the land surface. The underground workings, as well as the ore and waste piles generated by mining, are a potential source of ARD.

##### *Operational Phase*

Figure 4-4 shows the water pathways and geochemical reactions associated with underground mines. Dewatering activities during operations alter groundwater flow paths near the underground workings. Depending on the depth of the workings, the primary source of groundwater inflow into the mine may be from the regional groundwater system (deep mines) or the local groundwater system (shallow mines). The shallow groundwater flow system is recharged by precipitation that falls within the underground working capture zone and infiltrates into the ground. The quality of groundwater inflow is a function of the composition and reactivity of the rock it encounters and the contact time. Oxidation of exposed sulphides in the underground workings (mine walls or blast fractures) results in the accumulation of sulphide oxidation products. During mining, a constant supply of oxygen is maintained through the ventilation system and mine shafts and adits that intersect the land surface. Sulphide oxidation products are flushed by inflowing groundwater. Underground mine water quality may also be affected by chemicals introduced during mining activities (e.g., diesel, nitrogen from blasting residuals, grout, lime dusting) or by materials backfilled into the mine during operations or at closure (e.g., paste tailings, waste rock or borrow material). Groundwater removed as part of dewatering activities may require recycle to the mill process or treatment before discharge to the environment. Although the underground mine is typically a groundwater sink during operations, release of impacted mine water to the environment may occur by infiltration to groundwater or surface discharges at mine openings.

Figure 4-4: Sources and Pathways of ARD, NMD, and SD in Underground Workings during Operation and Closure

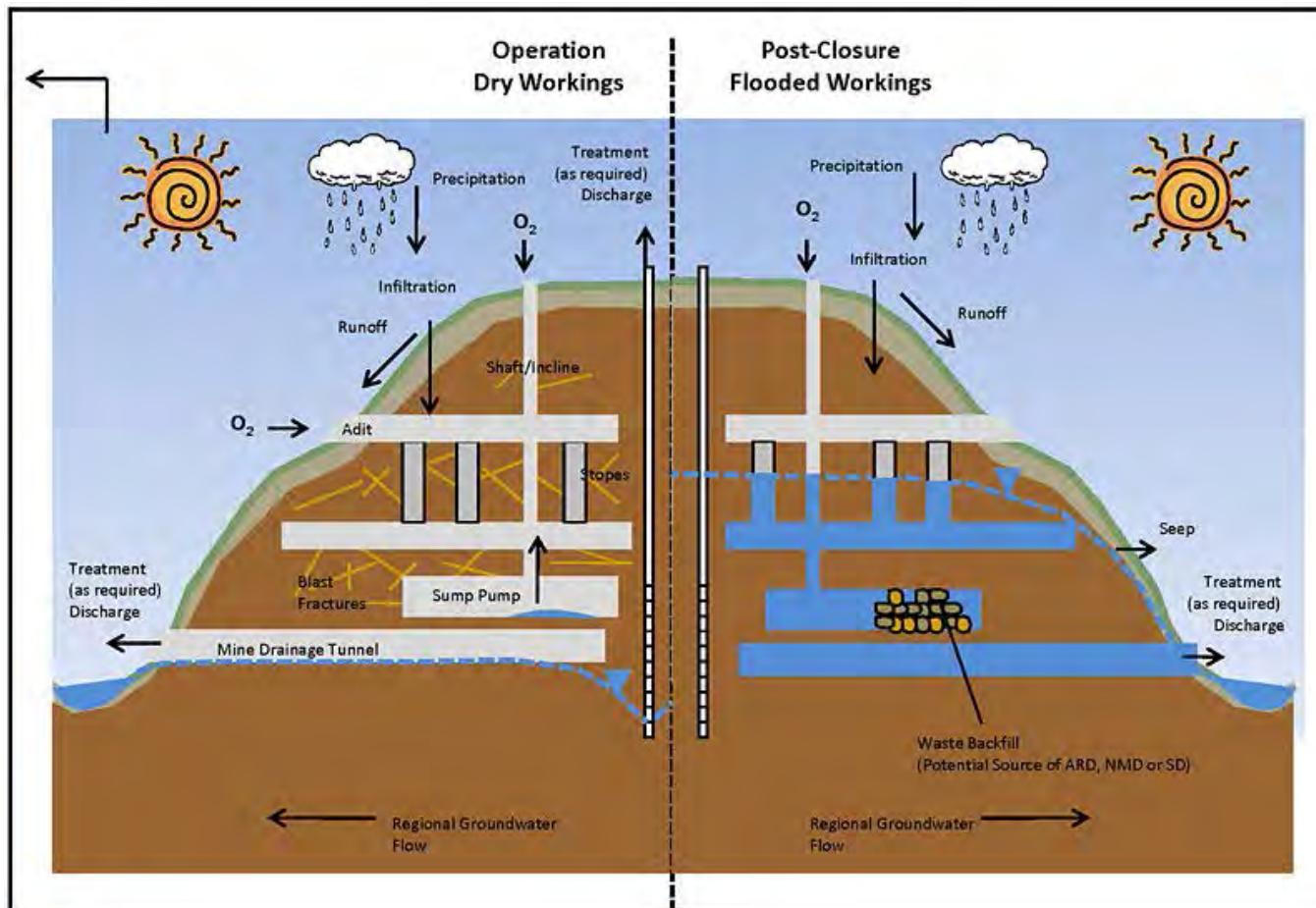

#### Decommissioning phase

At the cessation of mining, dewatering ceases and groundwater inflow into the underground workings may begin to accumulate and flood the workings. The mine workings, due to their elevated permeability and porosity relative to the host rock (even if backfilled during mining), become preferential pathways for groundwater flow. Collapsed or backfilled voids and block cave rubble zones exhibit greater permeability than the surrounding fractured rock and therefore strongly influence groundwater movement. As the water table rebounds, sulphide oxidation products present on mine walls or backfilled waste are flushed, resulting in release of sulphate, metals, and acidity to the mine water while alkalinity from carbonates and other minerals is also introduced to the water. Inundation of sulphide minerals prevents further sulphide oxidation. However, sulphides that remain above the water table represent a long-term source of ARD. As is the case for pit lakes, underground mine pools are frequently stratified (Wolkersdorfer, 2008). In Pennsylvania, USA, water levels in flooded underground coal mines show considerable fluctuation in composition responding to variability in meteoric conditions and local groundwater pumping.

As the water table rebounds, the underground workings may transition from a groundwater sink to a groundwater source. Discharge of mine water to the environment may occur by groundwater or mine openings. In some cases, these openings are plugged to prevent discharge to surface and to further raise the water level (ERMITE-Consortium, 2004).

#### 4.2.2.3 Waste Rock Storage Facilities

Smith and Beckie (2003) provide a comprehensive summary of the hydrologic and geochemical processes occurring in a waste rock pile constructed by the traditional end-tipping from lift heights greater than about 10 m. Figure 4-5 summarizes the water pathways and geochemical reactions associated with this style of waste rock pile. The primary factors controlling the hydrologic characteristics of a waste rock pile are (a) material grain size distribution, and (b) the proportion and spatial arrangement of matrix-supported and matrix-free zones created during construction (Smith and Beckie, 2003).

Figure 4-5: Sources and Pathways of ARD, NMD, and SD in a Waste Rock Pile

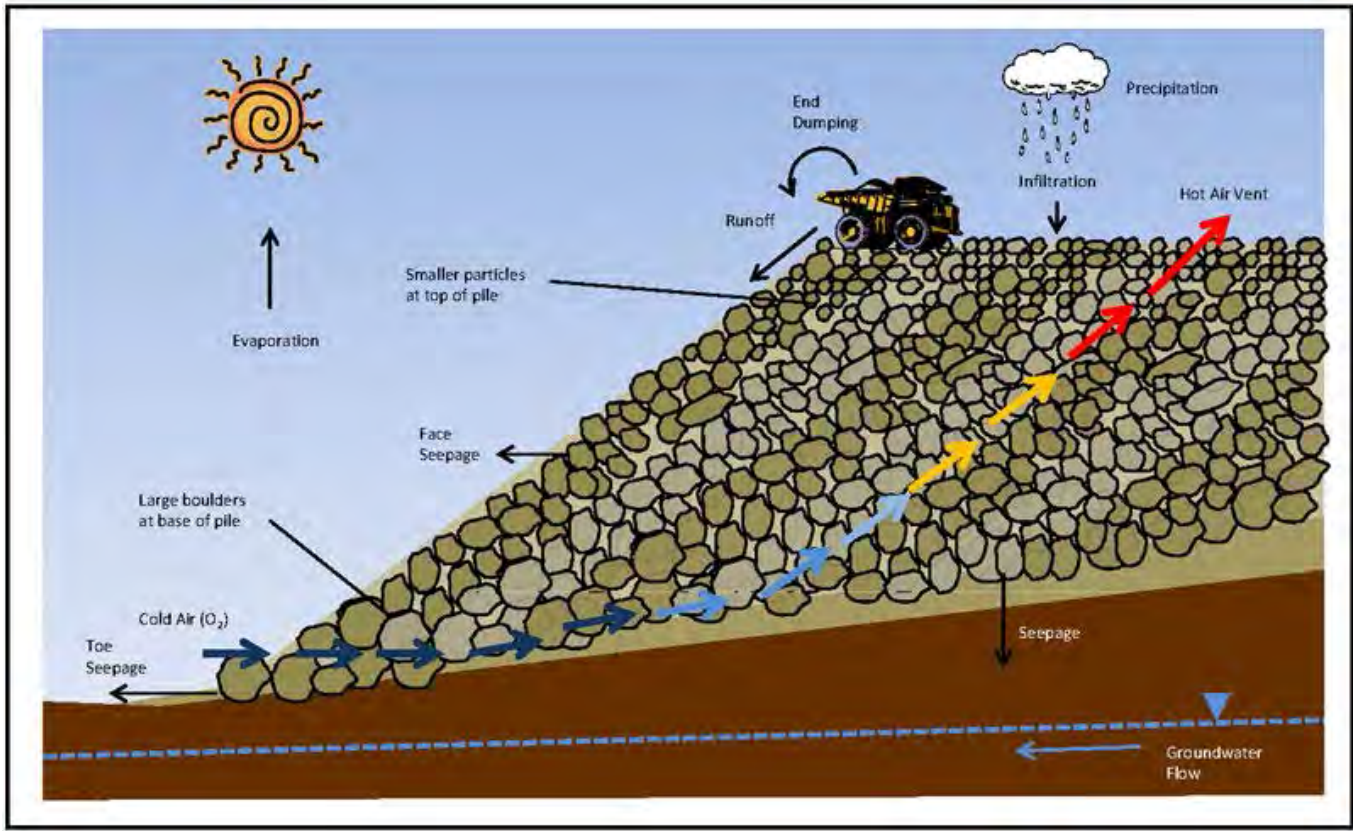

Typically, waste rock is hauled in dump trucks to the disposal site. The loading process and truck vibrations during hauling result in segregation of the rock into layers of similar grain size, a process called sorting. Waste rock dumping from the crest of a steep slope further enhances sorting because large grained material travels further down slope than fine grained material. Consequently, waste rock piles are generally composed of inter-layered beds of coarse grained material and fine grained material inclined at the angle of repose (33 to 37 degree angle). This method of construction creates the following structures that influence water and gas movement within the pile:

- Discrete zones within the pile containing little to no granular material between larger rock fragments
- Sloping surfaces between coarse and fine grained layers
- Internal low permeability pavement surfaces formed by truck movement during pile construction

This method of construction has been standard practice for more than a century. It has been used all over the world and is entirely appropriate if the materials being placed are geochemically inert. However, when rocks are geochemically reactive, this method can promote oxidation and ARD generation, and may result in the need for long-term management.

Many of these facilities, especially large-volume ones, are a legacy of the mining industry due to problems associated with vegetation failure and poor water quality, and require significant effort and cost to mitigate. To address these problems, waste rock piles need to be designed and constructed based on geochemical performance through the application of appropriate geochemical and geotechnical criteria.

The basis for design should be to construct waste piles to control the generation and leaching of sulphide oxidation products through segregation and controlled placement within a waste rock storage facility. Because oxygen is essential for the oxidation process, preventing advective and convective transfer of atmospheric oxygen into the facility and managing the diffusive oxygen flux such that geochemical reaction rates meet design targets that will not adversely effect the environment, are key design considerations. Coupled with the segregation and selective placement of material types with distinct geochemical properties, this may require use of construction and placement methods that include small lifts and prevent particle segregation. Examples of such methods of construction that provide oxidation control are the Martha Mine in New Zealand and the Phu Kham mine in Lao PDR (papers on both are planned for the 2012 ICARD in Ottawa). Further information is presented in Chapter 2, which contains detail on oxygen transport into and within waste rock piles.

Precipitation falling on a waste rock pile will evaporate, flow over the surface of the pile as runoff, or infiltrate into the pile. Saturated conditions may exist within the waste rock pile. Development of a perched water table at the base of the pile may occur because of the

presence of a low permeability layer beneath the pile. Perched water may also be present at higher elevations in a pile because of areas of low permeability created by haul roads. Waste rock seepage may exit along slope faces, at the toe of the pile or may infiltrate into the subsurface underneath the pile.

To prevent infiltration of waste rock seepage into the underlying groundwater system, waste rock piles may be sited in areas where surficial soils have low permeability. Siting such facilities is best accomplished by an assessment of the entire development site to map the levels of permeability for the purposes of determining the optimum location of all facilities. In potentially sensitive areas, drilling, test pitting and geophysical investigation to fully understand the subsurface conditions may be required. In cold climates, permafrost may act as a barrier to the migration of seepage. However, because of the heat generated during sulphide oxidation, the permanence of the permafrost below waste facilities requires evaluation. In some cases, engineered liners may be used as a barrier to seepage migration and drains may be installed to collect drainage.

#### **4.2.2.4 Ore Stockpiles**

Ore stockpiles are essentially temporary storage facilities that are established to provide feed to a processing plant or for direct transfer to markets, such as iron ore and some coal. There can be various grades of ore (e.g., high, medium and low), with the higher grades typically stored for short periods (e.g., 1 month) prior to processing in the mill. In some cases, depending on the economics at that time, lower grade ores may never be processed or may be stockpiled for several years and, hence, should be managed as waste rock. The principles that apply to waste rock dumps (Section 4.2.2.3), therefore may also apply to lower grade ore stockpiles.

High grade or run of mine (ROM) ore may only be stockpiled for a short period and ARD management generally relies on early processing before ARD conditions develop and, in some cases of high reactivity, the capture and treatment of drainage.

Lower grade stockpiles, that may or may not be processed, require careful consideration to ensure allowance is made for closure. Frequently, low grade ore can have a higher ARD risk than waste rock. Therefore, careful planning is necessary to avoid a potential long term liability associated with low grade ore stockpiles.

#### **4.2.2.5 Tailings and Process Refuse Storage Facilities**

Tailings are discharged to surface storage facilities by several methods, including subaerial slurry, subaqueous slurry, paste and dry deposition. The methods of transport and disposal are a function of the water content of the tailings (e.g., thickened and paste tailings may be disposed sub aerially using pipeline transport, whereas fully dewatered tailings are disposed by dry deposition methods, including use of conveyors and trucks) and the topography and placement of the tailings dam. Tailings may be segregated by grain size (e.g., use of cycloning to separate the sand fraction from the slimes) before discharge. Compared to waste rock, tailings are homogenous with a more consistent distribution of acid generating and acid neutralizing minerals. However, if these minerals are associated with a particular size fraction, segregation may occur during deposition, with a higher sulphur content typically occurring near the deposition pipe discharge on the tailings beach. The fine particle size of tailings results in lower permeability to oxygen and water compared to waste rock.

The tailings grain size, disposal method, and deposition history govern the hydrogeological characteristics of a TSF (Blowes et al., 2003). The sulphide content of the tailings and the availability of oxygen will govern the reactivity of sulphidic tailings. Water covers, in the case of subaqueous disposal, act as a barrier to significant oxygen ingress into the tailings. Other tailings design features intended to limit oxygen or water ingress include use of engineered covers and maintenance of a high degree of saturation (e.g., in tailings paste).

In addition to surface disposal, tailings may be disposed in underground workings. Underground disposal may simply fill void spaces or may be designed to provide structural support for ongoing mining. Reagents may be added to increase strength or improve environmental stability before backfill. Addition of a binder (i.e., cement) to acid generating tailings may provide some, although generally limited, neutralization potential and typically reduces water and oxygen permeability. Tailings segregation (e.g., removal of slimes) or dewatering (e.g., for disposal as a paste) may be performed before backfill. Pyrite recovery from tailings in the mill prior to tailings deposition to reduce or eliminate the ARD risk from the bulk of tailings is current practiced at some sites (e.g., Ok Tedi copper and gold mine in Papua New Guinea) and proposed at others (e.g., Paracatu gold mine in Brazil). Pyrite may also be removed to create a non-acid generating cover near the time of mine closure (e.g., Detour Lake Mine in Canada). The small volume of pyrite concentrate that is then produced can be managed and isolated permanently from atmospheric oxygen. In some cases, the pyrite concentrate may have a market value.

Discharges associated with tailings facilities include runoff and seepage for all disposal methods. Runoff and seepage quality are a function of

tailings composition, reactivity, and contact time. Facilities may be sited in areas with low permeability surface soils or an engineered liner may be constructed to prevent migration of tailings seepage. In cold climates, migration of the permafrost into the base of the facility may prevent generation and movement of ARD.

Coal processing typically includes crushing, grinding, and sizing followed by physical separation of pyrite and shale (waste materials) by gravity or floatation. The waste material (locally known as coal refuse, gob, slurry, etc.) from coal beneficiation (also known as coal cleaning, washing, or preparation) generally has a higher acid generation potential than the coal itself because sulphide minerals contained in the coal and waste rock are concentrated in the waste during the coal cleaning process. Coal reject piles, largely consisting of fine-grained shale and pyrite, are typically located near the coal processing plant. Because of the mineral composition, grain size, and high-surface area of these wastes, coal reject piles may be strongly acid generating depending upon their sulphur content (SME, 2008). This waste material is often deposited as a slurry behind a dam, just like tailings. Where it is deposited dry, it should be compacted frequently to minimize the ingress of oxygen. Additional measures may be taken to minimize ARD formation, as discussed in Chapter 6.

Figure 4-6 shows the flow paths and geochemical reactions occurring in a subaqueous TSF as well as the three methods typically employed for dam construction. A dam is first constructed to impound the tailings and supernatant. For stability reasons, tailings dam embankments are commonly designed to be unsaturated and well drained so if they are constructed with sulphide-bearing waste rock or tailings, the tailings dam embankments may be particularly prone to ARD generation. Precipitation onto the surface of the facility contacts the tailings beaches (tailings exposed to atmospheric oxygen), the dam, or falls directly on the tailings pond. During large storm events, discharge through an overflow drain or discharge down the face of the dam may occur. This water may be captured for treatment. Infiltration through the tailings enters into the subsurface or is captured in a seepage collection system. The seepage rate is a function of the permeability of the underlying natural or engineered materials and the infiltration rate through the tailings. During operations, ARD is not normally a concern (except with extremely reactive tailings) because most mill circuits add lime to the tailings. Also, during subaqueous disposal, fresh tailings added to the beaches maintain a relatively high water content for a time. Active management of the tailings pond supernatant (e.g., addition of lime) can be conducted to prevent low pH conditions and mobilization of metals. During post closure, remedial measures that have been designed from the outset are implemented to prevent ARD and improve seepage quality (see Chapter 6).

**Figure 4-6: Sources and Pathways of ARD, NMD, and SD in a Subaqueous Tailings Storage Facility (modified from Blowes et al., 2003)**

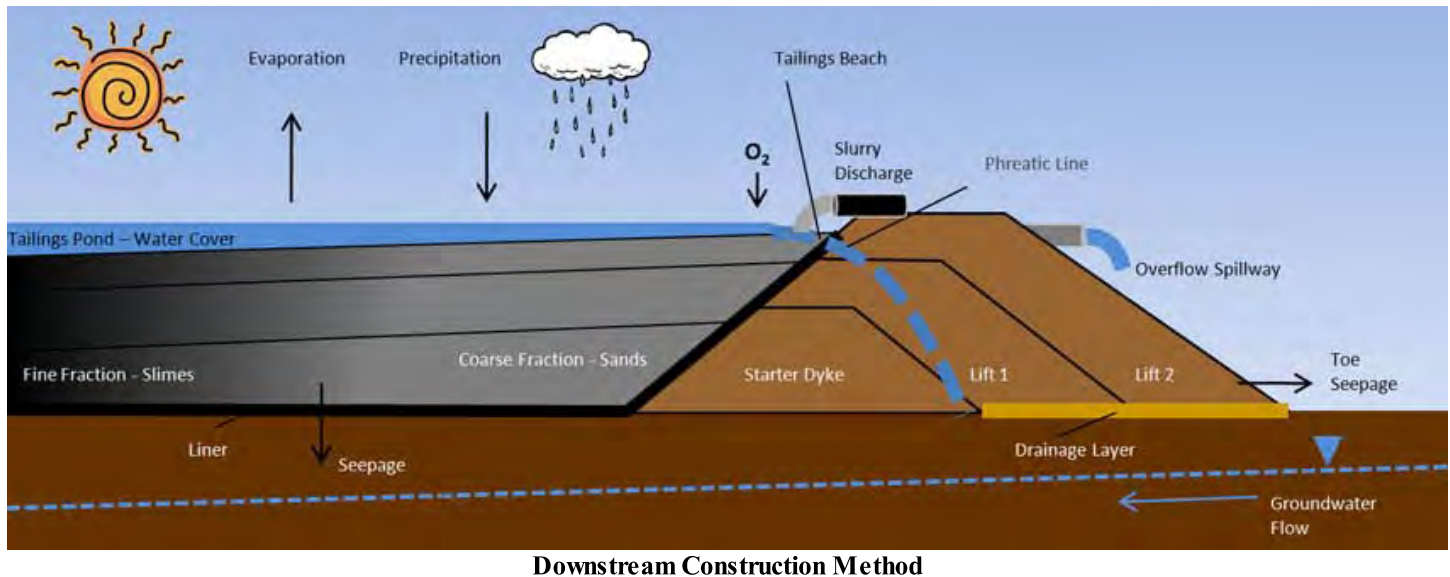

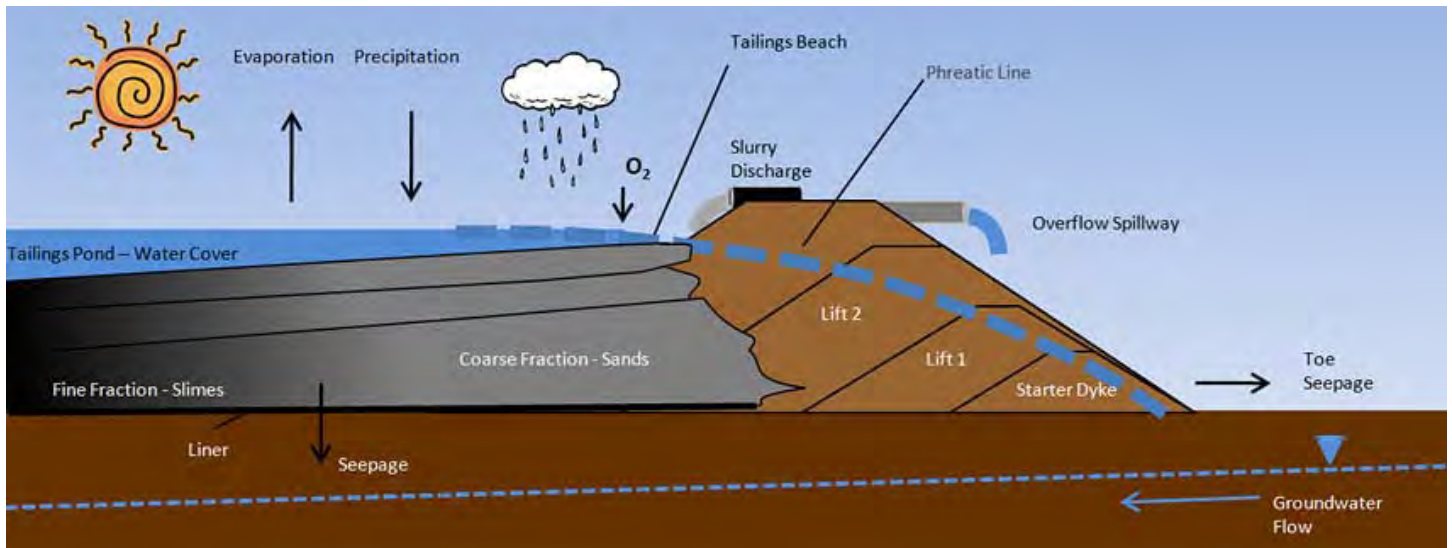

**Upstream Construction Method**

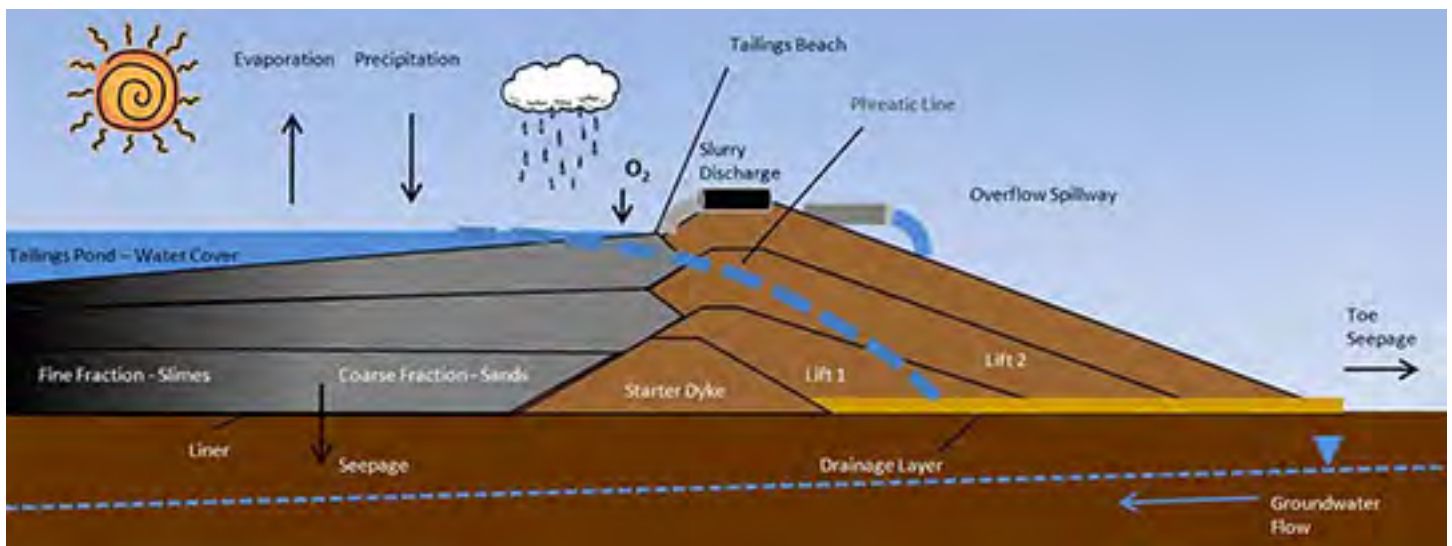

**Centerline Raise Construction Method**

#### 4.2.2.6 Heap Leach Piles

Sulphuric acid/ferric ion leaching and sodium cyanide heap leaching are two metallurgical processes used to extract metals (copper and gold, respectively) from ore material under different conditions. In both leaching processes, cobble-sized or finer grains of ore materials are placed onto lined pads, either directly from the mine or after size reduction. The leaching fluid, applied to the top of the pile, infiltrates through the material, dissolving the ore bearing mineral. The metal-bearing solution (pregnant solution) is collected from the bottom of the pile and processed to recover metals.

Improper handling of both the leach solutions and the pregnant solution can result in the release of acidic or alkaline process solutions to the environment. Leakage through the lined or unlined base of the leach pad could impact groundwater quality, while seepage flowing from the toe of the facilities and direct runoff may impact surface water. When leaching is concluded, the drain down water or rinse water must also be handled properly. Acidic leaching solutions and drainage may precipitate very fine-grained acid-generating secondary minerals such as jarosite and melanterite, onto grain surfaces particularly under dry conditions. During rain events, these secondary minerals will readily dissolve, releasing the stored acidity and metals. Whether these solutions exit the mine waste depends on the climatic and physical characteristics of the mine wastes and the presence or absence of engineering controls (e.g., liner).

Sulphide minerals remaining in the pile after conclusion of leaching can also contribute to acid formation, depending on the residual sulphide mineral content and climatic conditions. If an alkaline cyanide solution is used for ore leaching, some cyanide compounds may remain sorbed to grain surfaces or dissolved in pore waters after leaching concludes. At the cessation of mining, cyanide present in gold heap leach piles can be removed by rinsing or can be allowed to degrade naturally (SME, 2008). Maintenance of the residual alkalinity (pH 10 to 11) from cyanide leaching through the addition of a cover may also provide environmental benefits. Best operating practices from closed heap leach sites in Nevada have demonstrated that preserving the alkaline conditions, which were essential during the cyanide leaching operations, is best achieved by not rinsing the heaps. However, an engineered cover may be needed to limit infiltration of precipitation and prevent natural leaching of alkalinity to a level that could allow ARD, NMD or SD processes to begin depending on the nature of the material.

#### 4.2.2.7 In Situ Solution Mines

Solution mining makes use of a series of injection and recovery wells to circulate a leach solution through an ore zone. Solution mining is applied to extract solids that are easily leached or dissolved. Leach solutions may be acidic, neutral or basic, heated, or unheated. Blasting may be conducted in boreholes before injection to increase the permeability of the ore zone. Solution mining has been used in uranium, copper, manganese, halite, potash, nahcolite, and sulphur mining (SME, 2008).

Solution mining alters groundwater geochemistry and flow paths near the ore zone. In some applications, leach solutions are oxidants and may promote ARD. If not contained, leaching solutions, particularly oxidizing solutions and acids, may degrade local or regional groundwater quality. To avoid groundwater impacts, solution mining requires rigorous evaluation of the groundwater flow system (e.g., flow paths, capture zone analysis) before injection of leach solutions. Characterization of the groundwater system must include hydrogeologic units in hydraulic connection with the ore body and aquifers above and below the ore zone. Disposal of waste solutions may pose a concern for surface water resources.

#### 4.2.3 Conceptual Site Model Development

A conceptual site model (CSM) describes what is known about the release, transport, and fate of contaminants at a mine site. As such, the model includes the following components:

- Sources
- Pathways
- Biological receptors

The CSM describes the sources of potential contaminants, the mechanisms of their release, the pathways for transport, and the potential for human and ecological exposure to these parameters. The most important potential sources of ARD at mine sites are the mine pit (walls, benches and floor), exposures in underground workings, waste rock, ore (including any low grade stockpiles) and process residues (tailings and rejects).

Atmospheric oxygen is essential for oxidation of sulphides and to begin the ARD evolution process. Water is the primary environmental pathway for ARD released from these sources. Transport occurs by groundwater, surface water, or infiltration through the vadose zone. Because water is a primary pathway, aquatic resources generally are the receptor of most interest. In addition to water, human and ecological exposure to contaminants may occur by other pathways, including air (e.g., exposure to wind-blown tailings) or from direct contact with a solid phase mine or process waste (e.g., vegetation in contact with metal-laden soils). Indirect exposure may occur along the food chain (for example exposure of bioavailable metals to animals that graze on vegetation in contact with contaminated soils).

A conceptual site model can be developed at any stage of a mine's life; however, development typically begins in the early phases of a project and is continually validated, revised and updated, as necessary, over the life of the mine as site characterization data and operational monitoring data are collected.

Where regulatory approval for new mine development is required, early involvement by these agencies and other stakeholders, including the local communities, in the development and validation of the model is key, and should be encouraged. Early involvement is needed to establish the hazard considerations for risk assessment (see Section 3.6), as differences in risk tolerance can often be best dealt with through consensus using the evolving site based model.

The principal data requirements of a CSM are shown in Figure 4-7. The ability of the model to accurately describe the release, transport, and

fate of ARD is a function of the amount of available characterization data, which generally is proportional to the mine phase. An example schematic of a CSM is shown in Figure 4-7.

Figure 4-7: Typical Data Requirements of a Conceptual Site Model (CSM)

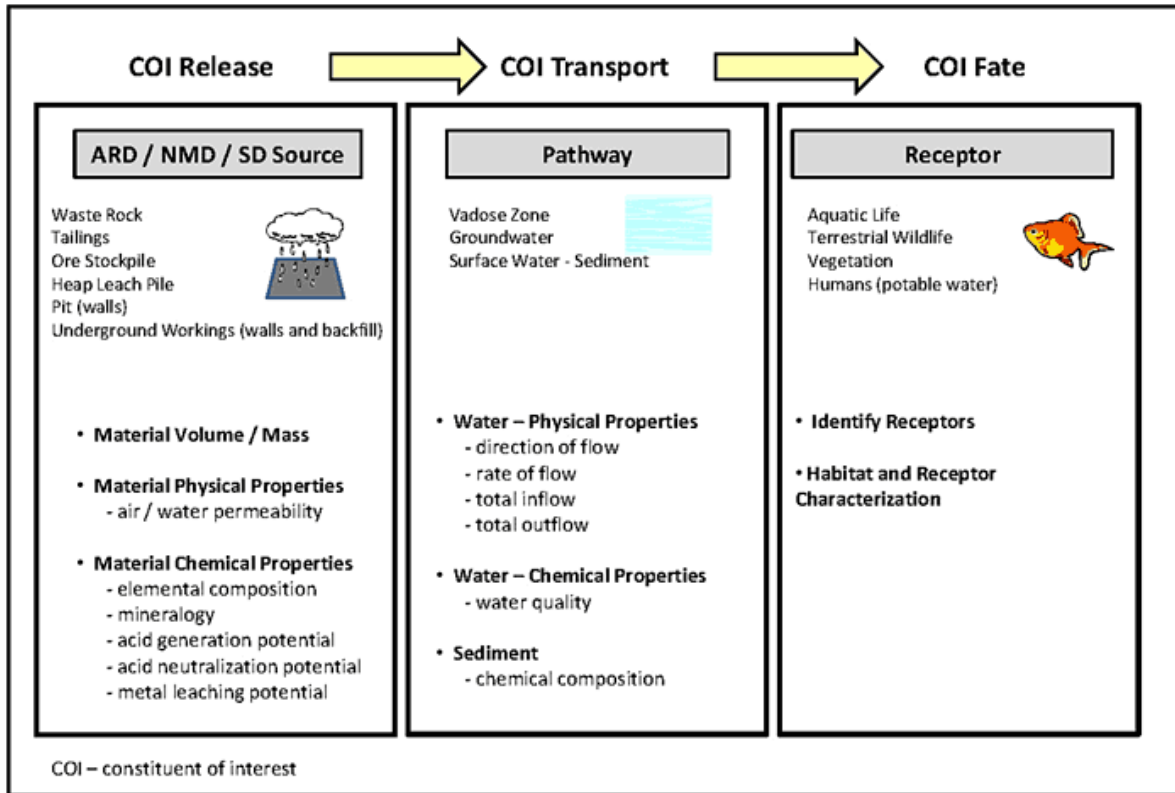

### 4.3 Components of Site Characterization

This section presents a summary of the components and methods commonly used to characterize ARD sources, pathways, and receptors. A comprehensive listing of the tools used in environmental assessments of mining projects, including references and a description of their use, is presented in Plumlee and Logsdon (1999). Price (1997, 2009) presents guidelines for the development of a characterization program, including laboratory testing and interpretation of test results.

An approach for characterization, classification and prediction adopted by Earth Systems is documented in the **Characterization Case Study**.

#### 4.3.1 Geo-environmental Models

A geo-environmental model of a mine deposit is defined as “a compilation of geologic, geophysical, hydrologic, and engineering information pertaining to the environmental behavior of geologically similar mineral deposits prior to mining, and resulting from mining and mineral processing” (Seal et al., 2002). The key elements of the model include deposit type, deposit size, host rock, wall-rock alteration, mining and ore processing method, deposit trace element geochemistry, primary and secondary mineralogy, topography and physiography, hydrology, and climatic effects. Geo-environmental models are empirical data compilations that are best used as guidelines for the potential range of environmental impacts at a site (Seal et al., 2002) and should not be used to predict pH or element concentrations that will develop at a site or in lieu of site characterization (Plumlee, 1999).

Geo-environmental models provide a starting basis for the level of characterization that will be required at a mine site. Additional discussion on geo-environmental models and their use in water quality definition and prediction is presented in Chapters 2 and 5, respectively.



### 4.3.2 Source Material Geochemical Characterization

The primary purpose of geochemical characterization of mine materials is to guide management decisions. Therefore, it is critical that a phased assessment program is carried out to ensure sufficient data are available at all stages of the project cycle (exploration, pre-feasibility, feasibility, construction, operation, closure and post closure). Best practice environmental management can only be achieved through the early recognition of the potential for acid drainage and metal leaching.

Geochemical characterization aims to identify the distribution and variability of key geochemical parameters (such as sulphur content, acid neutralizing capacity and elemental composition) and acid generating and element leaching characteristics. A basic screening level investigation is essential and should commence at the earliest possible stage. The need and scope for detailed investigations will depend on the findings of initial screening. Since some tests, such as leach tests or oxidation rate measurements, require a long time frame to provide the necessary data, it is important to initiate this work well ahead of key project milestones.

Reference to other mining operations in the region, particularly those situated in the same stratigraphic or geological units may provide empirical information on the likely geochemical nature of similar ore types and host and country rocks. Early indications are also provided from exploration drill core, and it is best practice to log key indicators such as sulphide and carbonate type, abundance and mode of occurrence, to analyze samples for total sulphur content as a minimum, and to include key environmental elements (such as carbon, calcium and magnesium as possible analogs for ABA parameters) in drill core assays. Mineralogical investigations should examine the type and mode of occurrence of sulfide and carbonate minerals.

This section outlines sample selection and number of samples required for a geochemical characterization program, and provides an overview of the testing programs and classification procedures. More detail and specific procedures and methods are presented in Chapter 5.

#### 4.3.2.1 Sample Selection

Sample selection is a critical task and must be given careful consideration at all stages of a project. Samples should represent each geological material that will be mined or exposed and each waste type. The number of samples should be based on the project phase but ultimately must be sufficient to adequately represent the variability within each geological unit and waste type.

Although drilling and sampling will focus on ore zones in the exploration and pre-feasibility stages, samples of host and country rock should be increasingly represented as the project develops, so that adequate data are available to produce block models and production schedules by geochemical waste types, where required. The available sources of material for testing are typically related to the phase of mine development. Drill core is the most common material source for geochemical testing during the early stages of mine development. Because exploration drilling programs target discovery and delineation of the ore zone, the selection of samples to characterize waste material must include careful examination of the spatial coverage of the drill core relative to the anticipated extents of the pit or underground workings (Downing and Mills, 2007). Other sources of material for testing that are frequently available include rock chips from borehole drilling, hand samples from outcrops, samples from existing waste facilities, development rock, ore composites, and residues from metallurgical testing.

The project geologist is a valuable resource and should be consulted in the selection of representative samples for testing. Determination of the appropriate disposal methods for wastes generated during exploration necessitates initiation of testing early in the mine life. As mentioned previously, any material with the potential to generate ARD or release contaminants should be characterized. Construction materials for roads and site infrastructure are often quarried from the area around a mining development. The geochemical characteristics of these materials should also be evaluated before construction. Due to the spatial extent of placement, use of construction materials with ARD potential may result in a widespread source of ARD. The potential for land disturbances associated with the construction of mine facilities to expose rock with ARD potential should also be considered.

Selection of representative samples should consider the following:

- Material Type – Individual samples selected for testing should be representative of a single material type (e.g., lithology, alteration type). The exploration geologist should be consulted regarding the initial definition of mine units and material types. Based on the results of the geochemical characterization program, material type classifications may require further refinement. For instance, a classification suitable for mineral extraction may not be sufficient to identify the environmental characteristics and corresponding ore and waste management requirements of the various material types. Construction materials should be included in the characterization program. Ore materials should also be included for prediction of ore stockpile discharges.
- Spatial Representation (x, y, z) – Sample selection should ensure good spatial representation (vertical and horizontal) of the area to be

mined. In practice, sample locations may be restricted to a one-dimensional line defined by a borehole or mine tunnel, or a two-dimensional plane, such as the wall of an open pit or cross section through the deposit. Additional boreholes increase the distribution of sample points and improve the definition of mine units. Because mine plans change, the spatial representativeness of samples should be reassessed throughout operations. For example, if the location of the pit wall changes, additional testing may be required to characterize pit wall runoff. Mining may also extend into areas that were not characterized during feasibility testing and such mining may encounter new materials.

- Compositional Representation – Sample selection should include all major material types and cover the range of pertinent characteristics for each material type (e.g., pH, carbonate, sulphur, and neutralizing potential content). Personnel tasked with sample selection must be familiar with the geological characteristics of the deposit, including rock types, fracture patterns, weathering, alteration, and mineralization.
- Focused (Biased) versus Random Sampling – Use of focused or random sampling depends on the objective of the characterization program. For example, sample selection may target areas with visual sulphides to provide an indication of worst-case drainage quality. Similarly, focused sampling may be more effective in ensuring a sample set with a complete range of compositional characteristics than random sampling. Random sampling may be appropriate during operations in determining the appropriate location for waste disposal (e.g., waste segregation based on total sulphur content). In this context, “random” still implies a rationale-based program, which may be part of a phased program but lacks adequate samples to be geostatistically complete. Ultimately, if a major ARD problem is predicted from earlier phase test work, the waste should be characterized by a geostatistical model, which includes an adequate number of samples as well as a geological interpretation. From this model, one or more key indicators can then be selected for the operations to use in separating materials.

Appropriate sample storage and handling procedures should be defined. Preference regarding the use of weathered or fresh materials for testing must be determined. In either case, the type of material used for testing must be documented. A photographic log of geochemical test samples is recommended.

Standard operating procedures (SOPs) for geological logging and the collection and documentation of sample selection should be developed and followed. SOPs should include quality assurance/quality control (QA/QC) protocols (e.g., collection and analysis of duplicate samples, sample chain of custody procedures, and inclusion of standard samples with known values). Sample size should be large enough to provide material for all potential geochemical tests and sample for archiving purposes. Archived samples should be easily retrievable. If compositing of samples is required, protocols should be defined. Compositing may be useful for identification of the characteristics of a sample representing a larger core interval or rock volume, such as an open-pit mine bench depth or waste zone. However, information on the smaller-scale characteristics may be lost due to the “smearing” of geochemical properties and analytical results. This “smearing” may lead to samples with anomalous qualities not being recognized, even though it may be those materials that govern the composition of a mine or process effluent. In general, it is recommended to collect discrete samples with clearly-defined characteristics. These can be assayed as individual samples or combined to represent mine bench intervals or other mining or waste units (including rocks immediately surrounding underground workings), with selected individual samples used to evaluate variability.

The mine geologic model and the block model may be used in the selection of representative samples. If geochemical testing indicates that special handling of waste materials will be required, the block model may be populated with diagnostic ARD indicator parameters (e.g., total sulphur). In this case, a comprehensive set of samples would be needed to build the geostatistical model.

#### **4.3.2.2 Number of Samples**

The number of samples required for source characterization of each material type depends on the following: (a) the amount of disturbance (i.e., the volume/mass of material extracted or the amount exposed on pit/mine walls or production tonnage as determined by the block model); (b) the compositional variability within a material type; and (c) the statistical degree of confidence that is required for the assessment.

Initial estimates of sample numbers are typically based on professional judgment and experience. The number of samples required commonly increases during each of the early phases of mine development as the knowledge base and project needs develop. Ultimately, for sites characterized as having an ARD potential, a full geostatistical model often provides the basis for control plans where material segregation is part of the mine plan.

Few guidelines are available regarding sample requirements. Table 4-5 provides an example of Australian guidelines for the number of samples during the early phases of the mine life. Although characterization testing is likely to occur during all phases of mine development, the peak of the laboratory testing programs often occurs during the feasibility phase.

**Table 4-5: Australian Guidance on Sample Numbers (adapted from Australian Government Department of Industry, Tourism and Resources, 2007).**

Mine Phase	Number of Samples	Description
Exploration	<p>(1) Prospect Testing – Include sulphur in list of elements being analyzed for all samples tested; include the full range of pathfinder elements as defined by ore deposit/exploration model; collect and record mineralogical data as per exploration/ore deposit model; where the geology of the deposit is known include static testing of at least 3 to 5 representative samples of each key material type (i.e., lithology, alteration type); analysis of ground water and surface water for acidity and representative pathfinder elements.</p> <p>(2) Resource Definition – All samples tested for sulphur and representative samples tested for mineralogy as per ore deposit model. Static testing of at least 5 to 10 representative samples of each key material type. Collect groundwater and surface water data. Surface water and groundwater analysis to include acidity as well representative metal ions.</p> <p>All testing to include QA/QC samples.</p>	<p>By the end of the resource definition phase, there should be adequate information to accurately characterize the ARD potential of the ore body (high and low grade), although further test work will normally be required to characterize the ARD potential of waste rock and ore and hence tailings.</p>
Pre-Feasibility	<p>Static testing of several hundred representative samples of high and low grade ore, waste rock and tailings, the number dependent on the complexity of the deposit geology and its host rocks.</p> <p>All drillhole samples analyzed must include sulphur analysis and identified representative metal ions. Sampling density is dependent on complexity of ore deposit and host rock geology interval of representative drill holes but should be restricted to single rock units or lithologies - include minimums.</p> <p>Kinetic testing of at least 1 to 2 representative samples of each material type.</p> <p>Surface water and groundwater analysis to include acidity as well as pH, EC and representative metal ions, including Al, Fe, Mn.</p> <p>All testing to include QA/QC samples.</p>	<p>Where required, the number of samples must be sufficient to populate a “resource” block model of the ore and host rocks that will be affected by mining with a reliable distribution of NAPP<sup>[1]</sup> data (e.g., acid producing potential (APP), sulphur and acid neutralizing capacity (ANC) (or NPR data) on ore, waste rock and wall rock.</p>
Mine Planning, Feasibility and Design	<p>Where required, additional static testing as required for block waste resource model refinement – increase density of NAPP (or NPR) characterization.</p> <p>Inclusion of confirmatory testing (e.g., NAG testing for comparison to NAPP (i.e. APP, or sulphur, and ANC) for metalliferous deposits; and mineralogy or NPR values).</p> <p>Continuation of kinetic testing.</p> <p>Upgrade drillhole database and waste resource model for</p>	<p>Data set must be sufficient to assess ARD potential to support a management plan. If data are insufficient, additional testing will be required.</p>

	<p>new ore positions.</p> <p>All testing to include QA/QC sample(s). Apply QA/QC to all analyses, not only ore. Include wall rock.</p>	
--	--	--

Statistical analysis of test results is advisable to confirm that a representative data set has been obtained. For example, histograms may be used to ensure that the entire distribution has been captured in sample selection (Runnells et al., 1997) and samples with “extreme” characteristics have not been overlooked. The number of samples will increase as the heterogeneity (e.g., particle size and composition) of a material type increases. For this reason, characterization of process tailings typically requires fewer samples than characterization of waste rock. Sample representativeness must continually be assessed during the mine life. For example, a change in ore type over the mine life may produce process tailings with different characteristics. Operational monitoring (see Chapter 8) should include a program of systematic ongoing tailings testing to identify changes and implement alternative waste management practices, if required.

The goal of material management is to prevent or minimize ARD. Characterization programs must be designed to provide adequate information to make cost-effective, sustainable, and environmentally protective decisions regarding the management and disposal of waste materials. For materials with an uncertain ARD potential, resolution of this uncertainty by additional characterization efforts may not be necessary if a decision is made to manage the waste with the assumption that the material has ARD potential. For example, detailed characterization of the sulphide content of tailings over time may not be necessary if the tailings will be placed in a contained impoundment with a water cover.

#### 4.3.2.3 Testing Program Overview

Laboratory and field testing is conducted to characterize the acid generation and metal leaching potential of mine materials. Geochemical characterization programs typically follow a phased approach, beginning with laboratory testing followed by field testing. The design of most testing programs is dynamic, with each successive phase building on the results of previous phase or phases. A brief summary of the testing approach is provided below, with significantly more detail presented in Chapter 5.

The laboratory phase of a geochemical characterization program will typically include the following analyses:

- Static Tests
  - chemical composition (whole rock and elemental analysis)
  - mineralogical analysis
  - acid base accounting (ABA)
  - net acid generation (NAG)
  - water extraction (batch extraction) tests - with solution assay
- Kinetic Tests
  - humidity cell leach testing
  - column leach testing

Static testing is the first phase of geochemical characterization, and is a precursor to kinetic testing. The objective of static testing is to describe the bulk chemical characteristics of a material. These tests are designed to evaluate the potential of a particular rock type to generate acid, neutralize acid, or leach metals. Static tests provide an indication of the presence of minerals that may generate acid as well as minerals that may act to neutralize any acid formed. In some cases, testing may indicate that a surrogate parameter can be used as an indication of ARD potential (e.g., iron as an indicator of the amount of sulphide, calcium or carbon as an indicator of the amount of neutralization potential) (see Chapter 5 for additional information on the use and interpretation of static tests).

Elemental analysis results are commonly compared to average crustal or mean world soil abundance values as a multiple or geochemical enrichment factor to provide a screening level assessment of elements that are enriched in the sample. A high concentration of a particular element does not necessarily imply that this element will be mobilized in concentrations that may lead to environmental or health impacts, but it does highlight an issue that should be further investigated. An essential component of static testing is mineralogical analysis that, at a minimum, includes identification of all sulphur and carbonate minerals. If possible, mineralogical analysis should be quantitative. A description of how minerals with acid generation and acid neutralization potential occur (e.g., grain size, grain morphology, disseminated, fracture coatings, as inclusions) is also relevant in the assessment of reactivity (i.e., rate of oxidation or dissolution).

ABA analysis typically includes analysis of paste pH, sulphur speciation, neutralizing potential (NP) or acid neutralizing capacity (ANC) and

total inorganic carbon (TIC). Paste pH is used as an indicator of the presence of stored acidity. Sulphur speciation data, which includes information on the presence of non-acid generating sulphur minerals, are used to calculate the acid generation potential of the material. NP and ANC provide estimates of the acid neutralizing potential of a material (NP in the units of tCaCO<sub>3</sub> /kt and ANC in the units of kgH<sub>2</sub>SO<sub>4</sub>/t). TIC is used to calculate the carbonate neutralizing value (CNV) or carbonate NP (Ca-NP), and allows assessment of the fraction of NP or ANC attributed to carbonate mineral phases. In some cases the CNV based on TIC (or even total carbon) can be used as a surrogate to estimate the NP or ANC at a particular site. In combination, results from ABA, NAG, and elemental and mineralogical analysis are used to assess the relative proportions of acid generating and acid consuming materials.

Short-term extraction tests (such as 24-hour batch extraction tests using deionised water) provide information on the short term metal leaching potential. The nature of the sample (e.g., unoxidized vs. oxidized; oxidation products absent vs. oxidation products present), test solution to solid ratio, lixiviant, reaction time, and sample particle size should all be considered in the evaluation and comparison of leach test results.

Although the results of static testing may indicate a potential for acid rock drainage or metal leaching, kinetic testing is commonly required to assess the relative rates of the various ARD and metal leaching reactions occurring, and to provide information on the evolution of ARD over time. Field scale leach tests may be initiated before or during the construction or operational phases of mine development to provide a better representation of material reactivity under ambient site conditions.

Physical properties of the testing materials (e.g., surface area, particle size distribution) are also determined because these properties affect material reactivity and are needed in the scale-up of laboratory and field testing results to represent field scale and operational conditions.

Figure 4-8 shows the typical components and evolution of a geochemical characterization program for selected potential source materials. Any waste, construction, or process stream residues that have the potential to generate ARD must be included in the mine characterization program so that appropriate disposal practices and mitigation measures can be employed. This includes waste rock, ore, process residues, treatment sludges, quarried materials for construction, heap leach residues, hydromet residues, slag etc. Chapter 5 presents detailed descriptions of the laboratory and field scale testing methods and their interpretation for ARD prediction.

**Figure 4-8: Source Material Geochemical Testing Program Components**

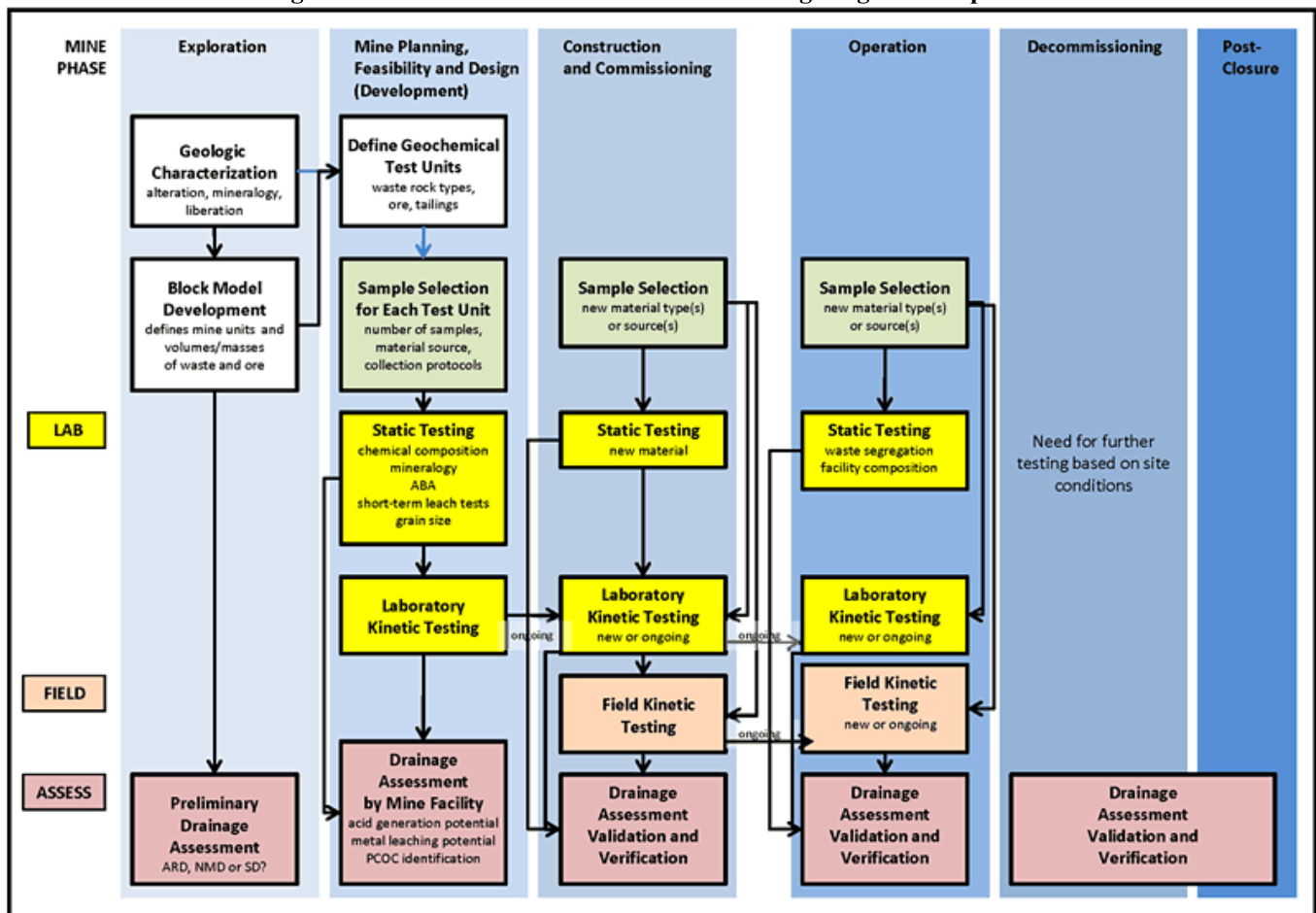

### 4.3.3 Watershed Characterization

Because water is the primary pathway for transport of ARD, the quantity, quality, and movement within the mine's watershed must be characterized. Delineation of the watershed boundary is the first task in watershed characterization. Topographic maps and site reconnaissance are used to determine the surface water boundaries, or divides, that separate the watershed containing the ore deposit from surrounding watersheds. Geographic information systems (GIS) and digital elevation models (DEM) may be used for this task. Groundwater watershed divides are initially assumed to coincide with surface-water divides, with refinements added based on the results of subsequent hydrogeological investigations. The watershed boundary generally defines the site characterization boundary.

Although groundwater watershed divides are typically initially assumed to coincide with surface water divides, groundwater regimes and their boundaries can be complex. When mining in an area with karst, investigations should be conducted very early in the site characterization program to identify karstic limestone features within the watershed boundary. Karst features can be major preferential flow paths which can govern local groundwater regimes and the transport pathways of any seepage from tailings and waste rock containment areas. Siting of mine infrastructure should also consider the presence of major karst features.

#### 4.3.3.1 The Hydrologic Cycle

##### *Climate*

The quantity of water within a watershed is a function of climate. The key components of climatic characterization are precipitation and temperature. Information on the amount, temporal distribution, and form of precipitation (rain or snow) is used in association with temperature data to characterize the quantity and seasonal distribution of recharge to a watershed. These data are used in development of a site wide water balance (see Section 4.3.3.2).

Characterization of the climatic conditions at a site typically begins with identification and review of available regional data. Site-specific climatic data are obtained by installing a meteorological station to record daily values of temperature, precipitation, wind speed, wind direction, and relative humidity. In cold climates, snowpack should be measured. Evaporation pans or empirical equations are used to estimate site evapotranspiration rates.

Site precipitation data are typically compared to regional data collected concurrently to assess the representativeness of the regional data set. Because the period of record for regional data sets is typically longer, these data are often used to estimate the occurrence, frequency, and magnitude of extreme weather events (e.g., floods and droughts). Characterization of these events is needed to assess ARD release, fate, and transport. During dry periods, sulphide oxidation products will accumulate. ARD loading is often greatest during a rain event that follows an extended dry period.

##### *Hydrology*

Hydrologic characterization begins with identification of all surface water features within the watershed (i.e., lakes, streams, and rivers) and points of discharge (i.e., lakes and ocean). Surface water quality, quantity, and direction of flow within the watershed boundaries are characterized. Baseline conditions are characterized before exploration or, more commonly, during the development phase. Monitoring is conducted during the construction and operations phases, and possibly during decommissioning and post-closure phases to assess impacts. Stream flow measurements are required to characterize the amount and rate of flow to evaluate constituent fate and transport and to characterize aquatic habitat. Stream flow is measured by developing a stage (water height) versus discharge relationship and then measuring flow by water elevation (e.g., pressure transducer). The stage-discharge relationship is developed by using a current meter or weirs to measure water flow at various water heights (see Chapter 8). The degree of seasonal variation will dictate the required monitoring frequency. Continuous monitoring systems can be established using data loggers with solar or battery power. These systems characterize changes in flow in response to climatic events. Water quality sampling is conducted to characterize baseline water quality conditions (see Chapter 8). If possible, water quality sampling should precede any land disturbances such as exploration drilling. Multiple sampling events may be required to capture baseline conditions and seasonal variation in water quality related to seasonal variation in flow. The initial water quality survey should be spatially comprehensive, with samples collected throughout the watershed, both upstream and downstream of the ore deposit and future land disturbances. Typically, samples are collected above and below the confluences of each relevant tributary in the watershed, as well as above and below any historical mine features and natural exposures of ARD. This approach allows anomalous high values to be systematically traced to their source. Some of the sampling sites in the initial survey will become part of a long-term monitoring program if and when a mine is developed. With this in mind, siting of sampling locations should consider the locations of future mining features. Sample sites

should be surveyed with a satellite based navigations system such as Global Positioning System (GPS), GALILEO (European Global Satellite Navigation System), or GLONASS (Global'naya Navigatsionnaya Sputnikovaya Sistema [global navigation satellite system]). Because metal concentrations may be naturally elevated in mineralized areas, characterization of baseline conditions is critical in later assessments of water quality impacts related to mining. Baseline data may be used to support establishment of site-specific water quality guidelines based on premining conditions. In the absence of adequate and defensible baseline data, water quality impacts may be erroneously attributed to mining operations or post-closure water quality criteria may be set to unachievable levels. For these reasons, special emphasis is placed on historical mine features and natural sources of drainage. These data may be provided to regulatory agencies in advance of mine development to ensure documentation of premining conditions.

Water quality sampling and flow monitoring continues during the operation phase to evaluate environmental impacts. If lakes are present in the watershed or the watershed discharges to an ocean, characterization and monitoring of these systems may be necessary. Chapter 8 discusses lake and marine water quality monitoring and determination of a lake water balance.

### ***Hydrogeology***

Hydrogeologic characterization includes determination of groundwater occurrence, groundwater quality, current and potential future groundwater usage, and groundwater flow direction and velocity. Characterization of groundwater conditions is required to evaluate constituent fate and transport, to design dewatering operations, assess compliance with regulatory criteria for designated uses (e.g., drinking water), and to site mine and process facilities (e.g., preference for siting waste facilities in groundwater discharge zones over groundwater recharge zones and preference for siting of waste facilities over aquitards rather than aquifers).

Topographic maps, site reconnaissance, and aerial photographs are used to identify areas of groundwater recharge (i.e., hill tops) and groundwater discharge areas (i.e., springs, streams, rivers, ponds, lakes, and wetlands). Information on existing groundwater wells and their use is compiled. Existing geologic information for the watershed is reviewed to evaluate the nature and distribution of aquifers and aquitards. Aquifers are saturated geologic units that readily transmit groundwater (e.g., fractured bedrock, unconsolidated sand, and gravel), whereas aquitards are geologic units that do not transmit significant quantities of groundwater (e.g., unfractured crystalline bedrock, most shales, and clay). In many cases, collection of information on the lithology, stratigraphy, and structural features (e.g., fractures, folds, and faults) of the subsurface will result in an understanding of the distribution of aquifers and aquitards. The geologic data collected during exploration and regional geologic survey data should be included in the assessment of geologic watershed information

Groundwater occurrence and the depth of the water table are determined by drilling and sometimes by geophysics. Shallow exploration boreholes can provide locations to measure the depth to the water table. Exploration drilling logs may also include information on depth to water and volume of water encountered during drilling that can be used in the development of the subsequent field investigations. During the mine development phase, a monitoring well network is established. Groundwater levels are measured to create a potentiometric map for the study area from which groundwater flow directions are determined. Groundwater flows from regions of high hydraulic head (e.g., hill tops) to regions of low hydraulic head (e.g., stream valleys). Hydrostratigraphic cross sections for the site are created showing depth to groundwater, aquifer and aquitard thicknesses, and extents. The location of seeps and springs and their flow rates should be documented.

Laboratory or field testing is conducted to characterize the pertinent hydraulic properties of aquifer units (i.e., porosity and hydraulic conductivity). Hydraulic conductivity is estimated from laboratory testing of drill core samples or from hydraulic testing in the field, including piezometer tests (slug test) or larger scale pumping tests. Because pumping tests provide in situ measurements of hydraulic conductivity averaged over a larger aquifer volume than piezometer tests, pumping tests are often the preferred testing method. Pumping tests also allow for determination of the specific storage and transmissivity of the aquifer. Porosity is determined by laboratory testing or estimated from literature values (Freeze and Cherry, 1979). Groundwater flow velocity is calculated from the hydraulic gradient (determined from water-level data), hydraulic conductivity, and porosity. Groundwater flow velocities are required for evaluation of constituent fate and transport. Characterization of the physical flow system is also required to select an appropriate dewatering system and for dewatering system design. When dewatering wells are employed, the dewatering time is a function of the pumping rate, which is dictated by the number of pumps and pump capacity. Dewatering rates dictate the required capacity of the water treatment plant (if treatment is deemed necessary) and this information is also needed for surface water discharge permits. Numerical modeling software is often used to create a two- or three-dimensional representation of the groundwater flow system, which may be used as a tool in constituent fate and transport and dewatering evaluations. The groundwater model may also be used to define inputs to the water balance (see Section 4.3.3.2 and Chapter 5).

Groundwater quality sampling is conducted at all monitoring wells, seeps, and springs to establish baseline conditions. Monitoring wells are sited upgradient and downgradient of sources of mine drainage. Groundwater quality monitoring continues throughout the operation phase, and as required during the decommissioning and post-closure phases to evaluate environmental impacts. For underground mines, characterization of the hydrogeologic conditions is essential to assess dewatering during operations and flooding at closure. Geologic maps are reviewed to identify structural controls on groundwater flows. Exploration drill holes may be converted to piezometers or for measurement of

groundwater levels or hydrogeologic testing.

#### 4.3.3.2 Water Balance

Climatic, hydrological, and hydrogeologic data are combined to develop a watershed water balance. The water balance is a fundamental component of the environmental impact assessment as it defines the amount of water transporting chemical components and the water available to “dilute” a constituent load released from a source, thereby defining the concentration of a constituent in a water resource. An accurate water balance is, therefore, key to the accurate prediction of constituent concentrations. The water balance is also used to manage site water consumption, predict discharge from water treatment plants, determine design criteria for storm water collection systems, and predict post-mining pit lake filling (if applicable). The water balance describes the hydrologic regime of the watershed. The water balance is an accounting of all water inputs and outputs and changes in storage. For a watershed in which the surface water and groundwater divides coincide and for which there are no external inflows or outflows of groundwater, the water balance is described as follows (Freeze and Cherry, 1979):

$$P = Q + ET + \Delta S \text{ (Equation 4-1)}$$

where P is precipitation, Q is runoff, ET is evapotranspiration, and  $\Delta S$  is the change in storage of the groundwater and surface-water reservoir. A simplified box and arrow representation of the components of a watershed water balance is shown in Figure 4-9. This figure illustrates the interaction between surface water and groundwater resulting in additional components (i.e., overland flow [OF], infiltration to soil and groundwater [IS and IG], and groundwater base flow [B]).

**Figure 4-9: Water Balance Box and Arrow Diagram**

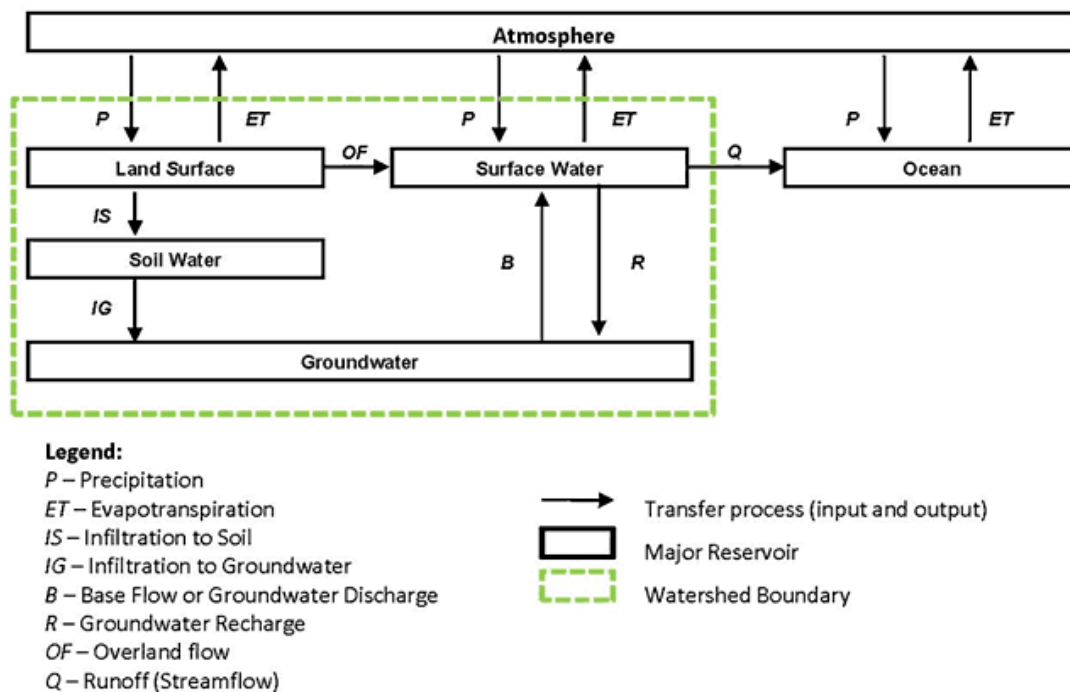

To develop a site wide water balance, each of the water inputs and outputs must be defined using site characterization data. When site data are unavailable, inputs are derived using regional data or established relationships. For example, the precipitation and evapotranspiration inputs may initially be based on regional data and then updated with data from the site meteorological station. The Thornthwaite Method provides a means to estimate monthly ET rates as well as IS and IG values based on average monthly air temperature, latitude, and soil characteristics (Dingman, 2002). The Rational Equation can be used to estimate monthly OF values (Fetter, 2001). Site requirements will dictate the temporal resolution of the water balance. Typically, a daily or monthly time step is applied. Spreadsheet programs, databases, and decision analyses software (e.g., MS Excel, and GoldSim) are well designed for water balance calculations. To evaluate conditions under a range of rainfall events, a multiyear precipitation record is generated. This record typically includes extreme climatic conditions (e.g., droughts and storms) to evaluate the effects of such extreme events. Statistical analysis of historical precipitation records is conducted to determine the frequency and magnitude of extreme events.



#### 4.3.3.3 Assimilative Capacity of the Receiving Environment

The sensitivity of the downstream aquatic life and the ability of the receiving environment to attenuate constituents of potential environmental concern must be characterized to predict the fate and transport of constituents in the environment. The buffering capacity of the receiving environment will affect the fate and transport of acidity and metals present in ARD. For historical mining or natural ARD releases, neutralization of acidity may occur following mixing with alkaline waters or interactions with solid mineral phases. Movement of an acidification front will be slower in a well-buffered system than a poorly-buffered system. The transport of chemical constituents will also be affected by geochemical conditions within the receiving environment, and as such, key geochemical parameters should be measured (i.e., pH and redox). Characterization programs should include collection of solid phase data for stream and lake sediments and aquifer materials that may affect metal transport (e.g., presence of clay and total organic carbon).

#### 4.3.3.4 Biological Receptors

The first step in biological characterization is to identify the receptors within the watershed that may be affected by release of ARD. Biological receptors may include vegetation, aquatic life, terrestrial wildlife, livestock, and humans. Consideration should be given both to current and future use of water resources by humans. During the mine development phase, receptor baseline conditions are characterized, including receptor habitat, when applicable. These studies are completed by ecologists or biologists familiar with the local habitats and biota. During the construction and operation phases, receptor monitoring is conducted to assess impacts. In some cases, potential impacts to receptors are determined indirectly (e.g., monitoring of groundwater quality to ensure drinking water obtained from wells for human consumption and use is not affected). If operational monitoring identifies impacts to biological receptors, the objective of monitoring during the decommissioning phase is to measure recovery in impacted areas. Chapter 8 provides additional detail on receptor characterization and monitoring.

### 4.4 Summary

Development of an ARD characterization program at a mine site is critical to the prediction, prevention, and management of ARD. The development of a site characterization program begins with development of a conceptual site model to identify sources of ARD, pathways for transport, and the receptors within the watershed. This chapter identifies and discusses the common components and data collection activities associated with a mine site characterization program. Because the distinctions between characterization, prediction, prevention and mitigation and and monitoring are loosely defined, the contents of this chapter should be reviewed in association with Chapters 5, 6 and 8.

Identification and characterization of source materials is fundamental to the accurate assessment of whether ARD is likely to occur at a particular mine site. Characterization of materials to assess their ARD and metal leaching potential should begin during the early phases of a mine life and continue through to the end of operation, and possibly into closure. At a minimum, the characterization program should include testing of the mineral resource (i.e., ore) and waste materials (waste rock, coal overburden and process residues). Inclusion of other materials (e.g., construction material) may also be appropriate.

The scope and development of an ARD characterization program is ultimately site specific. In some cases, the precautionary principle may be selected as the preferred or most economical method to address uncertainty in material characterization (e.g., placement of tailings in a lined facility). In all cases, the scope and intensity of the characterization program are determined in an iterative fashion.

### 4.5 References

- Australian Government Department of Industry, Tourism and Resources, 2007. Managing Acid and Metalliferous Drainage, February.
- Blowes, D.W., Ptacek, C.J., and J. Jurjovec, 2003. Mill Tailings: Hydrogeology and Geochemistry. In: J.L. Jambor, D.W. Blowes, and A.I.M. Ritchie (Eds.), Environmental Aspects of Mine Wastes, Short Course Series Vol. 31, Mineralogical Association of Canada, 95-116.
- Bowell, R. (Ed.), 2003. Pit Lake Systems: A Special Issue. *Mine Water and the Environment*, 22(4).

- Burger, H.R., Sheehan, A.F., and C.H. Jones, 2006. Introduction to Applied Geophysics: Exploring the Shallow Subsurface. W.W. Norton & Company, New York, NY.
- Castendyk, D.N., and L.E. Eary, (Eds.), in press. Mine Pit Lakes; Characteristics, Predictive Modeling, and Sustainability. ADTI-MMS Handbook Series Vol. 3, Society for Mining, Metallurgy, and Exploration, Colorado.
- Dingman, S.L., 2002. Physical Hydrology, 2nd edition. Prentice Hall, Upper Saddle River, NJ.
- Downing, B.W., and C. Mills, 2007. Quality Assurance/Quality Control for Acid Rock Drainage Studies.
- ERMITE-Consortium, 2004. Mining Impacts on the Fresh Water Environment: Technical and Managerial Guidelines for Catchment Scale Management. In: P. Younger and C. Wolkersdorfer (Eds.), Mine Water and the Environment, 23(Supplement 1):S2-S80.
- Fetter, C.W., 2001. Applied Hydrogeology, 4th edition. Prentice-Hall, Inc., Upper Saddle River, NJ.
- Freeze, A.R., and J.A. Cherry, 1979. Groundwater. Prentice-Hall, Inc., Englewood Cliffs, NJ.
- Gammons, C.H., and T.E. Duaine, 2006. Long-Term Changes in the Limnology and Geochemistry of the Berkeley Pit Lake, Butte, Montana. Mine Water and the Environment, 25(2):76-85.
- Geller, W., Klapper, H., and W. Salomons (Eds.), 1998. Acidic Mining Lakes – Acid Mine Drainage, Limnology and Reclamation. Springer, Berlin, Heidelberg, New York.
- Hammack, R.W., Love, E.I., Veloski, G.A., Ackman, T.E., and W. Harbert, 2003a. Using helicopter electromagnetic surveys to identify environmental problems at coal mines. Mine Water and the Environment, 22(2):80-84.
- Hammack, R.W., Sams III, J.I., Veloski, G.A., and J.S. Mabie, 2003b. Geophysical investigation of the Sulphur Bank mercury mine Superfund site, Lake County, California. Mine Water and the Environment, 22(2):69-79.
- Plumlee, G.S., 1999. The Environmental Geology of Mineral Deposits. In: G.S. Plumlee and M.J. Logsdon (Eds.), The Environmental Geochemistry of Mineral Deposits, Part A: Processes, Techniques and Health Issues, Reviews in Economic Geology Vol. 6A, Society of Economic Geologists, Inc., 71-116.
- Plumlee, G.S., and M.J. Logsdon, 1999. An Earth-System Science Toolkit for Environmentally Friendly Mineral Resource Development. In: G.S. Plumlee and M.J. Logsdon (Eds.), The Environmental Geochemistry of Mineral Deposits, Part A: Processes, Techniques and Health Issues, Reviews in Economic Geology Vol. 6A, Society of Economic Geologists, Inc., 1-27.
- Price, W.A., 1997. Draft Guidelines and Recommended Methods for the Prediction of Metal Leaching and Acid Rock Drainage at Minesites in British Columbia. Reclamation Section, Energy and Minerals Division, Ministry of Employment and Investment, Smithers, BC.
- Price, W.A., 2009. Prediction Manual for Drainage Chemistry from Sulphidic Geologic Materials. MEND Report 1.20.1, December.
- Runnells, D.D., Shields, M.J., and R.L. Jones, 1997. Methodology for adequacy of sampling of mill tailings and mine waste rock. In: Proceedings of Tailings and Mine Waste 97, Rotterdam, Balkema, 561-563.
- Sams III, J.I., and G.A. Veloski, 2003. Evaluation of airborne thermal infrared imagery for locating mine drainage sites in the Lower Kettle Creek and Cooks Run basins, Pennsylvania, USA. Mine Water and the Environment, 22(2):85-93.
- Seal II, R.R., Foley, N.K., and R.B. Wanty, 2002. Introduction to Geoenvironmental Models of Mineral Deposits. In: R.R. Seal II and N.K. Foley (Eds.), Progress on Geoenvironmental Models for Selected Mineral Deposit Types, U.S. Geological Survey Open-File Report 02-195.
- Seal II, R.R. and J.M. Hammarstrom, 2003. Geoenvironmental Models of Mineral Deposits: Examples from Massive Sulfide and Gold Deposits. In: J.L. Jambor, D.W. Blowes and A.I.M. Ritchie, Environmental Aspects of Mine Wastes, Short Course Series Vol. 31, Mineralogical Association of Canada, 11-50.

Smith, L., and R. Beckie, 2003. Hydrologic and Geochemical Transport Processes in Mine Waste Rock. In: J.L. Jambor, D.W. Blowes and A.I.M. Ritchie, Environmental Aspects of Mine Wastes, Short Course Series Vol. 31, Mineralogical Association of Canada, 51-72.

Society for Mining, Metallurgy, and Exploration, Inc. (SME), 2008. Management Technologies for Metal Mining Influenced Water – Basics of Metal Mining Influenced Water. V.T. McLemore (Ed.).

Swayze, G.A., Smith, K.S., Clark, R.N., Sutley, S.J., Pearson, R.M., Vance, J.S., Hageman, P.L., Briggs, P.H., Meier, A.L., Singleton, M.J., and S. Roth, 2000. Using Imaging Spectroscopy to Map Acid Mine Waste. Environmental Science and Technology, 34:47-54.

United States Geological Survey (USGS), 2008. Bibliography of Geophysical Methods for Characterizing Mine Waste. [http://crustal.usgs.gov/projects/minewaste/geophysics\\_mine\\_pubs.html](http://crustal.usgs.gov/projects/minewaste/geophysics_mine_pubs.html)

Wolkersdorfer, C., 2008. Water Management at Abandoned Flooded Underground Mines – Fundamentals, Tracer Tests, Modelling, Water Treatment. Springer, Heidelberg.

## List of Tables

Table 4-1: Mine Phase Objectives and Activities

Table 4-2: Characterization Activities by Mine Phase

Table 4-3: Source Material Characterization Activities by Mine Phase

Table 4-4: Geologic Characteristics of Mineral Deposits that Affect Their Environmental Signatures (Plumlee, 1999)

Table 4-5: Australian Guidance on Sample Numbers (Australian Government Department of Industry, Tourism and Resources, 2007)

## List of Figures

Figure 4-1: Characterization Chapter Road Map

Figure 4-2: Major Steps Involved in Extraction Metallurgy of Metals

Figure 4-3: Sources and Pathways of ARD, NMD, and SD in a Pit during Operation and Closure

Figure 4-4: Sources and Pathways of ARD, NMD, and SD in Underground Workings during Operation and Closure

Figure 4-5: Sources and Pathways of ARD, NMD, and SD in a Waste Rock Pile

Figure 4-6: Sources and Pathways of ARD, NMD, and SD in a Subaqueous Tailings Storage Facility (modified from Blowes et al., 2003)

Figure 4-7: Typical Data Requirements of a Conceptual Site Model (CSM)

Figure 4-8: Source Material Geochemical Testing Program Components

Figure 4-9: Water Balance Box and Arrow Diagram

1. ↑ NAPP – Net Acid Producing Potential expressed as kg H<sub>2</sub>SO<sub>4</sub> per tonne. Calculated by subtracting acid neutralizing capacity (ANC) from acid producing potential (APP). The Australian Guidelines use NAPP as a measure of the ARD potential. NPR may be used in place of NAPP

# Case Studies Chapter 4

## From GARDGuide

### Geochemical Characterisation in Australia

#### Geochemical Characterisation to Quantify ARD Risk And Facilitate Management at a Gold Mine in Australia

An ARD Geochemical Characterisation case study prepared by Earth Systems Pty. Ltd.

#### Introduction

A waste material characterisation study was carried out during the pre-feasibility stage of an Australian gold mining project. This case study documents how appropriate geochemical characterisation, from sample selection, static and kinetic geochemical testwork, through to integration with a mine block model, forms the basis for quantifying ARD risk and for ARD management planning.

While rock and tailings were the main waste materials to be generated from mining activities, this case study focuses on waste rock only. The approach, however, is equally applicable to tailings, pit wallrock, ore/concentrate stockpiles and heap leach pads.

#### Sample selection and collection

Selection of sufficient and representative waste rock samples for geochemical analysis was a critical part of the characterisation study. Available data on geology (map and cross section), geochemistry (assay), mineralogy and the pit shell were used to identify seven distinct waste rock lithologies. A lithology is defined as a primary rock type that has been altered by a mineralising overprint (protolith plus alteration features). Therefore a single rock type may be represented by multiple lithologies. These may be further sub-divided into degrees of weathering.

An initial 151 waste rock samples were selected from the seven lithologies for static geochemical testwork. These comprised several 1 m interval samples of each lithology, chosen from drill holes across the vertical and lateral extent of the pit shell. If a single lithology contained fresh, partially oxidised or fully oxidised sections, samples were also collected to represent each of these materials. Total S (sulfur) and Total C (carbon) assay data were already available for the entire deposit, and this assisted sample selection by enabling a broad range of S and C values to be chosen. The number of samples collected for each lithology (and weathering sub-category) was proportional to the relative proportion of that lithology within the pit shell that was identified as waste rock.

#### Static geochemical characterisation and ARD risk classification

The following static geochemical parameters were determined for all waste rock samples:

- Total Sulfur;
- Maximum Potential Acidity (MPA, kg H<sub>2</sub>SO<sub>4</sub> / tonne);
- Acid Neutralising Capacity (ANC, kg H<sub>2</sub>SO<sub>4</sub> / tonne);
- Net Acid Producing Potential (NAPP = MPA-ANC, kg H<sub>2</sub>SO<sub>4</sub> / tonne);
- pH after oxidation (NAG pH, pH units);
- Net Acid Generation at pH 4.5 (NAG<sub>4.5</sub>, kg H<sub>2</sub>SO<sub>4</sub> / tonne);
- Net Acid Generation at pH 7.0 (NAG<sub>7.0</sub>, kg H<sub>2</sub>SO<sub>4</sub> / tonne);
- Total Carbon (wt% C) and Total Organic Carbon (TOC, wt% C) (Total C-TOC = Carbonate Carbon wt.%).

Based on these results, samples were classified using AMDact v.2.5 (by Earth Systems) according to their ARD risk into the following categories:

- High potential for acid generation – Category 1 (AG1).
- Moderate/high potential for acid generation – Category 2 (AG2).
- Moderate potential for acid generation – Category 3 (AG3).
- Low potential for acid generation – Category 4 (AG4).
- Unlikely to be acid generating (UAG).
- Likely to be acid consuming (LAC).
- Inconsistent data (ID).

Average static geochemical results and corresponding ARD risk classifications are presented in Table 1 and Figure 1. The majority of waste rock samples were characterised by positive NAPP values and NAG pH below 4.5, corresponding to various acid generating categories.

Several samples with NAG pH values above 4.5, despite positive NAPP values were considered unlikely to be acid generating (UAG). Negative NAPP values generally corresponded to NAG pH values greater than 4.5, indicating that they were likely to be acid consuming (LAC). A relatively close relationship between NAPP and NAG7.0 values for most lithologies indicates that pyrite is the dominant sulfur species.

Samples generally contained relatively low concentrations of Total C and essentially no TOC, and hence Total C values were effectively equivalent to Carbonate C and therefore consistent with the generally low ANC values. Likewise, there was generally a good correlation between measured NAPP values (Table 1) and NAPP values calculated from existing Total Sulfur and Total Carbon values for the same samples. Based on this correlation, NAPP values could be calculated for each 1m interval within the pit shell using the S and C assay data. This calculation was incorporated into the mine block model to create an environmental geochemistry layer. The ARD risk classification system (above) was then applied to the mine block model, based on the calculated NAPP layer, permitting estimation of the annual production of waste rock within each ARD risk category (Figure 2).

**Table 1: Average static geochemical results for the major waste rock lithologies.**

Lithology	n	Average static geochemical characteristics						Proportion of samples in each AMD risk category						
		Total S	ANC	NAPP	NAGpH	NAG4.5	NAG7.0	AG1	AG2	AG3	AG4	UAG	LAC	ID
		wt%	kg H2SO4/t	kg H2SO4/t	pH unit	kg H2SO4/t	kg H2SO4/t							
Lithology 1	34	1.88	15.1	42	3.5	35.1	45.7	14	25	31	14	8	0	8
Lithology 2	27	2.52	11.0	66	3.6	55.3	69.1	23	8	31	19	8	4	8
Lithology 3	26	1.05	45.1	-13	4.9	11.3	15.1	4	8	15	27	38	4	4
Lithology 4	12	0.25	185.7	-178	7.6	0.0	0.8	0	0	0	0	58	17	25
Lithology 5	13	1.68	11.1	40	3.6	31.3	45.0	23	15	23	15	15	0	8
Lithology 6	14	2.38	11.6	61	3.5	41.7	61.9	21	21	21	21	7	0	7
Lithology 7	25	0.31	161.1	-152	7.7	0.3	1.1	0	0	0	20	48	24	8

\* n = number of samples

**Figure 1: NAGpH vs. NAPP for seven waste rock lithologies.**

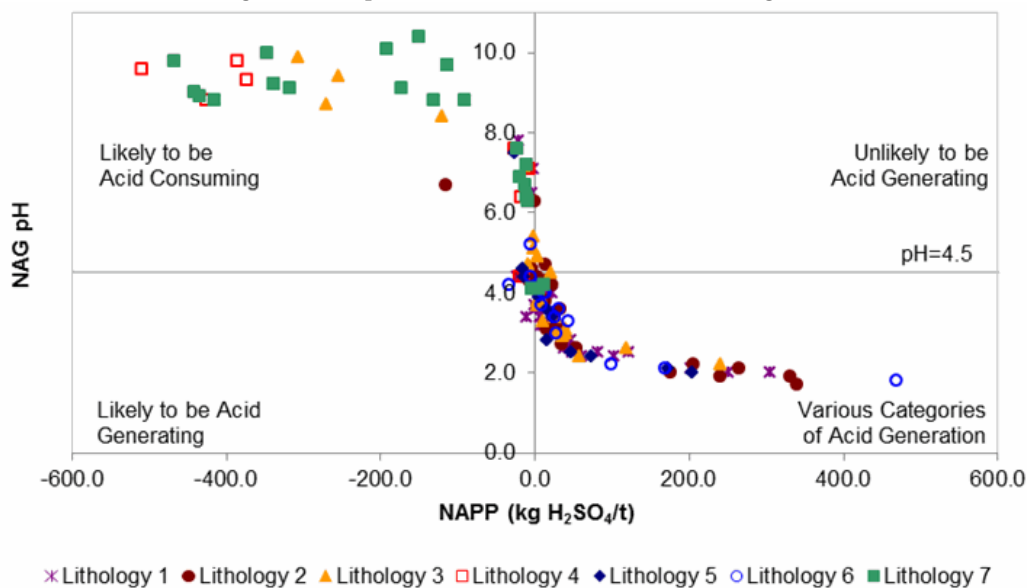

**Figure 2: Annual production of waste rock according to ARD risk classification.**

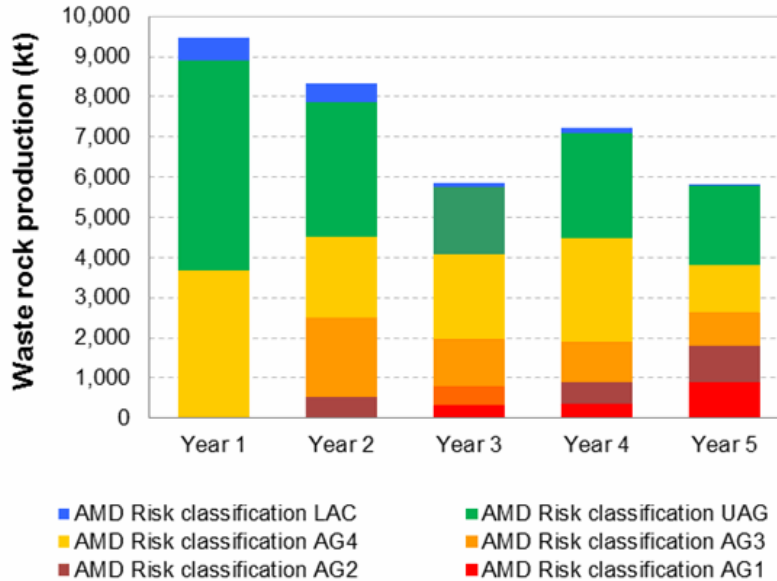

**Kinetic geochemical testwork and estimation of annual acidity generation rates**

Oxygen consumption testwork was conducted on bulk samples of all seven lithologies to clarify pyrite oxidation rates (POR) for the purpose of estimating acidity generation rates from waste rock materials. This approach provides more rapid results than other kinetic testwork methods (eg. column leach, humidity cells) and also has the ability to assess PORs as a function of key controls such as moisture content, oxygen concentration and particle size.

The measured oxygen consumption rate for each bulk sample was assumed to be proportional to the mass of pyrite in the sample and was converted into a POR using the stoichiometric relationship in the complete reaction for pyrite oxidation by oxygen (ie. 3.75 moles of oxygen are consumed to fully oxidise 1 mole of pyrite). This assumes that all sulfur present is in the form of reactive pyrite and that the pyrite oxidation reaction is driven to completion. Oxygen dilution associated with carbon dioxide generation from carbonate dissolution (independently measured) was also taken into account in oxygen consumption calculations.

Despite the broad range in sulfur contents of the bulk samples, the sulfide-normalised PORs for all lithologies were similar and averaged 0.2 wt% FeS<sub>2</sub> / year. These POR units (wt% FeS<sub>2</sub> / year) mean that 0.2 wt% of all pyrite exposed to atmospheric oxygen will be oxidised to form sulfuric acid (H<sub>2</sub>SO<sub>4</sub>) per year. In this form, PORs can be used to produce annual (or monthly) acidity generation rates for any unsaturated sulfidic material, as long as the total mass of the material and its sulfide content are known (see box below).

Acidity generation rate (t H <sub>2</sub> SO <sub>4</sub> /year)	=	Mass of sulfidic material (t)
	x	Pyrite content (wt% FeS <sub>2</sub> )
	x	Pyrite oxidation rate (wt%FeS <sub>2</sub> /year)
	x	1.65 (Stoichiometric factor)

For example, in Year 1 of operations, it was estimated that 3,668 kt of unsaturated waste rock (category AG4) would be produced, with an average 0.9 wt% FeS<sub>2</sub>. For a POR of 0.2 wt% FeS<sub>2</sub> per year, this material can be expected to generate approximately 108 tonnes H<sub>2</sub>SO<sub>4</sub> per year without any ARD management intervention (Table 2). This is equivalent to 29 kg H<sub>2</sub>SO<sub>4</sub> per tonne of waste rock per year. Using this approach, the annual acidity generation loads produced during Years 1 to 5 of mining operations were quantified for all lithologies (see Table 2).

Table 2: Estimated annual acidity generation loads from unsaturated waste rock for Years 1 to 5 in the absence of ARD management strategies. The LAC (likely to be acid consuming) category was disregarded to provide a conservative assessment.

Year	Estimated annual acidity generation (tonnes H <sub>2</sub> SO <sub>4</sub> / year)					
	AG1	AG2	AG3	AG4	Annual Total	Cumulative Total
Year 1	0	0	0	108	108	108
Year 2	0	75	136	59	270	378
Year 3	165	71	80	62	378	756
Year 4	191	79	67	76	413	1,169
Year 5	476	126	60	34	696	1,865

### Development of waste rock designs

Once all of the mine waste rock materials were characterised, classified, scheduled for extraction and assessed for POR and annual acidity loads, management strategies were then formulated to lower the ARD risk, with a better understanding of limitations and resources.

A key conclusion from the data provided above is that the waste rock will require management to minimise or prevent offsite acidity discharges. Slightly more than 50% of the waste rock extracted will be acidity generating. The quantity of acid consuming material is very small and will only be produced in significant quantities in the first 2 years.

Based on material types, acidity generation rates and scheduling limitations, the following key principles of waste rock dump design were developed:

- Avoid end dumping construction techniques.
- Construct thin lifts from AG1-AG4 materials, starting from the base of the dump, optimise moisture addition and ensure maximum compaction to minimise air-entry.
- Encapsulate AG1-AG4 lifts with minimum 15 m thick UAF layers around AG1-AG4 cells to reduce oxygen ingress to diffusion control mechanisms.
- Ensure optimum moisture addition to UAF materials and maximum compaction to minimise air-entry.
- Permit thinly layered dump to grow upwards in thin AG1-AG4 lifts with protective UAF margins.
- Cap AG1-AG4 cells with UAF materials at various stages of dump construction when sufficient material is available, and continue with moisture optimisation and compaction of capping layers during construction.
- Selectively mine and stockpile materials that are LAC (in first 2 years) and utilise as natural alkalinity producing cover materials during the final stages of dump construction to optimise sulfide passivation and thereby progressively lower acidity generation.
- Install a “store and release” cover over the alkalinity producing cover materials in order to lower net percolation into the AG1-AG4 materials.

In combination, all of these approaches are expected to dramatically lower sulfide oxidation rates and acidity flux rates to the stage where natural dilution or possibly passive treatment can deal with the residual acidity release.

# Chapter 5

## From GARDGuide

### 5.0 Prediction

#### 5.1 Introduction

Introduction to CMD Prediction

#### 5.2 Objectives of Prediction Program

#### 5.3 The Prediction Approach

5.3.1 Acid Rock Drainage/Metal Leaching Characterization

5.3.2 Prediction during Different Phases of the Mine Life

5.3.3 Water Quality Prediction

#### 5.4 Prediction Tools

5.4.1 Introduction

5.4.2 Geological and Lithological Investigations

5.4.3 Hydrogeological/Hydrological Investigations

5.4.4 Introduction to Geochemical Characterization

5.4.5 Sample Storage and Preparation Prior to Analysis

5.4.6 Summary of Testing Requirements

5.4.7 Physical Characteristics

5.4.8 Total and Near-Total Solid-Phase Elemental Concentration

5.4.9 Mineralogical Properties

5.4.10 Net Acid or ARD Potential

5.4.11 Short-Term Leach Tests

5.4.12 Laboratory Kinetic Tests

5.4.13 Field Methods

5.4.14 Data Management

5.4.15 Quality Assurance/Quality Control

5.4.16 Screening and Evaluation Criteria

5.4.17 Reporting

#### 5.5 Modeling of Acid Rock Drainage, Neutral Mine Drainage, and Saline Drainage for Characterization and Remediation

5.5.1 Introduction

5.5.2 Geochemical Modeling

5.5.3 Hydrological Modeling

5.5.4 Hydrogeological Modeling

5.5.5 Gas Transport Modeling

5.5.6 Statistical Evaluation

#### 5.6 Conclusions

#### 5.7 References

List of Tables

List of Figures

This is the First Page: Sections 5.1, 5.2, and 5.3

Second Page: Section 5.4 Prediction Tools

Third Page: Sections 5.5, 5.6, and 5.7, Lists of Tables and Figures



## 5.1 Introduction

This chapter presents an overview of the methods available for material characterization and the prediction of drainage water quality, with some guidance as to the usefulness and limitations of the various methods. For more detail, the reader should refer to <http://www.mend-nedem.org/reports/files/1.20.1.pdf> and the other references and links provided in this chapter.

Prediction of drainage chemistry is a critical part of mine planning; particularly water and mine waste management. The primary objective of mine and process water quality prediction is to evaluate the potential for geologic materials and mine and process wastes to generate acid and other constituents of potential environmental concern, and the potential to affect water resources. As an important corollary, the need for and nature of mitigation measures is determined through prediction. Material characterization and prediction of drainage chemistry needs to be synchronized with overall project planning (Price and Errington, 1998).

Prediction during exploration tends to be generic and generally avoids presumptions about future engineering and mine design. Pre-mine material characterization and prediction and modeling of drainage chemistry need to consider the specifics of engineering and mine design. Iteration may be required as results may lead to a revision of aspects of both the prediction program and the mine plan. The timing of the prediction program must be synchronized with the mine development so that the findings of the characterization and prediction efforts can be used for the mine design.

Accurate prediction of future mine discharges requires an understanding of the analytical procedures used and consideration of the future physical and geochemical conditions, external inputs and outputs, and the identity, location and reactivity of the contributing minerals (Price, 2009). All sites are unique for geological, geochemical, climate, commodity extraction, regulatory, and stakeholder reasons. Therefore, a prediction program needs to be tailored to the site in question. Also, the objectives of prediction programs are variable. For example, objectives can include definition of water treatment requirements, selection of mitigation methods, assessment of water quality impact, or determination of reclamation bond amounts.

Predictions of drainage quality are made qualitatively and quantitatively. Qualitative predictions involve assessing whether acidic conditions might develop in mine wastes with the attendant release of metals and acidity to mine drainage. Qualitative predictions have been performed for at least 40 years and although errors have been made, often due to inadequate sampling, the predictions have been successful for many mine sites around the world. Indeed, predictions of whether acidic conditions could develop for high sulphur (often acid producing) and low sulphur (often nonacid producing) are often straightforward. Where qualitative predictions indicate a high probability of ARD production without mitigation, attention quickly turns to reviewing alternatives to prevent ARD and the prediction program is refocused to assist in the design and evaluation of potential success of that program. Significant advances in the understanding of ARD have been made over the last several decades (see Chapter 2), with corresponding advances in mine water quality prediction and use of prevention techniques. However, mine water quality prediction can be challenging because of the wide array of reactions involved and potentially long time periods to cross geochemical thresholds and achieve specific conditions related to ARD, NMD, and SD generation.

The understanding of equilibrium vs. kinetic controls on mineral reactions and their effect on water quality is of particular importance when predicting mine drainage chemistry. Equilibrium conditions are relatively simple to simulate, but might not always be achieved in mine drainage waters under ambient conditions. Conditions governed by rate-limited reactions are common and more difficult to evaluate. However, through the use of state-of-the-art geochemical testing programs, both equilibrium conditions and rate-limited reactions can be assessed.

Despite the uncertainties associated with quantitative estimation of future mine water quality, quantitative predictions developed using a range of realistic assumptions and a recognition of associated limitations have significant value as ARD management tools and environmental impact assessment. From a risk-based perspective, the probability of a certain consequence (i.e., drainage quality) occurring is examined during the testing and prediction stage.

The following approaches have been used for predicting water quality resulting from mining activities:

- Test leachability of waste materials in the laboratory
- Test leachability of waste materials under field conditions
- Geological, hydrological, chemical, and mineralogical characterization of waste materials
- Geochemical modeling

Analog sites or historical mining wastes on the property of interest are also valuable in ARD prediction, especially those that have been thoroughly characterized and monitored for water quality and have many similar characteristics as the site in need of prediction. The development of geo-environmental models is one of the more prominent examples of the “analog” methodology. As described in

Chapter 2, geo-environmental models of a mineral deposit are a compilation of geologic, geochemical, hydrologic, and environmental information pertaining to the environmental behavior of geologically similar mineral deposits. Geo-environmental models are a general guide that will help anticipate potential environmental problems at future mines, operating mines, and orphan sites.

A schematic depiction of the progression in prediction objectives and activities during the development of a hard rock mine is illustrated in Figure 5-1 and discussed in more detail in this chapter. More detail on the prediction of coal mine drainage (CMD) is presented here: **Introduction to CMD Prediction**.

Figure 5-1: Generic Prediction Program Flowchart

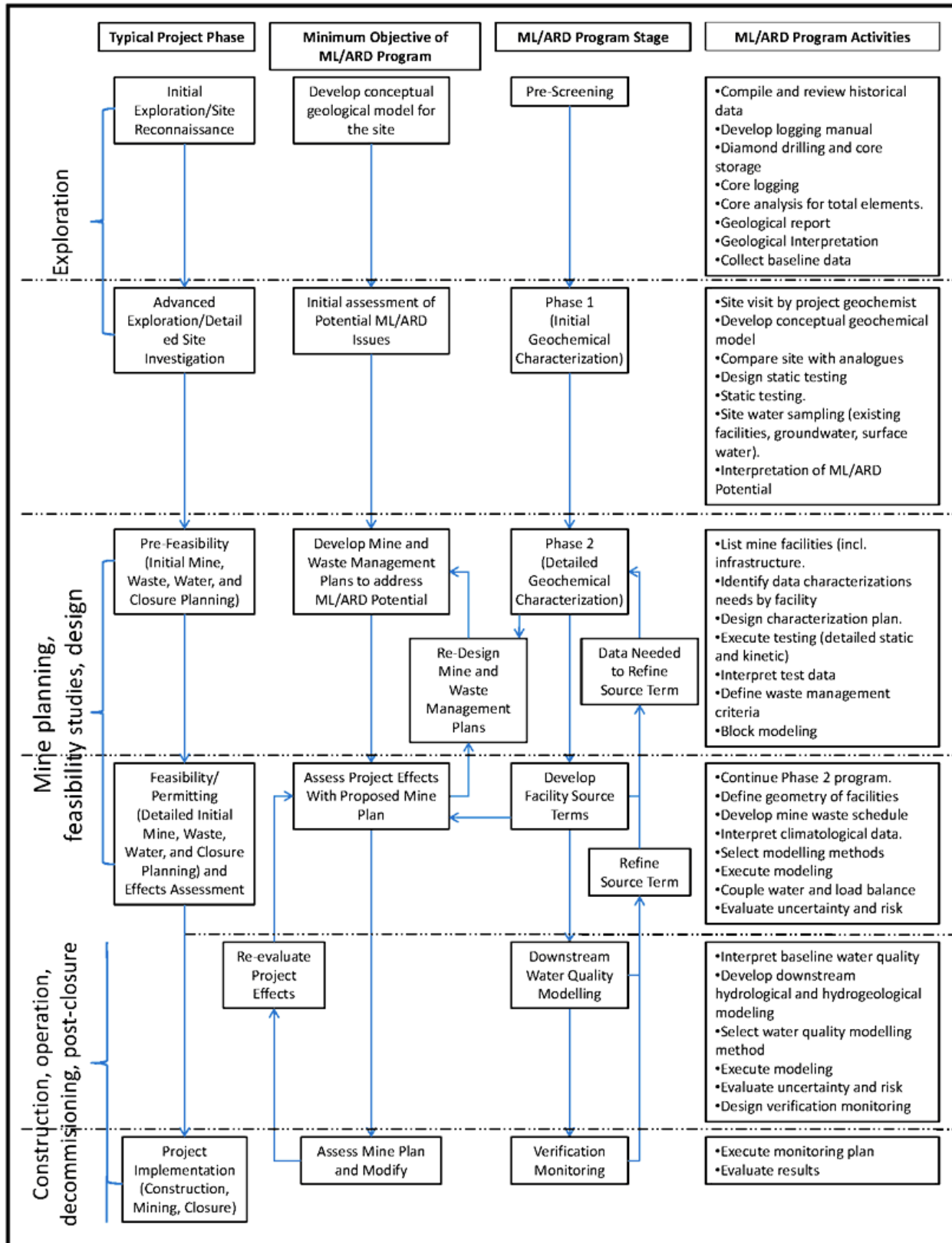

## 5.2 Objectives of Prediction Program

The purpose of a drainage chemistry prediction program is to characterize mine wastes and walls and to anticipate problems so that, if required, impact prevention measures (see Chapter 6) can be implemented in the most cost-effective manner. The objective is to predict drainage chemistry and contaminant loading with sufficient accuracy to ensure mine and mitigation plans achieve the specified environmental objectives (Price, 2009). Adaptive management and contingency plans may be the most cost-effective approach to mitigation.

Predictions occur at different levels of complexity and for different reasons. In the context of pre-mine water quality prediction, the most important questions generally are: Without mitigation, will problematic drainage chemistry be produced from a particular:

- Geological unit?
- Zone of the deposit?
- Mine facility or waste type?
- Particular mining stage or phase?

This set of questions can be answered if an appropriate database on geochemical characteristics is available and a sound understanding of geological and mineralogical conditions has been developed. The strength of the database required depends on the variability and complexity of the contributing chemical species and minerals, the geological units, mine facilities and waste types. For example, a more comprehensive database may be required where there are significant variations in sulphur and carbonate mineral content or if the sulphur and carbonate mineral content are in close balance. The presence of elements, such as selenium (Se) and mercury (Hg), or minerals, such as Fe-carbonate and alunite, whose performance is difficult to predict, may create additional challenges.

Without mitigation, ARD will invariably produce environmental impacts. Where ARD will not occur, the potential for metal release under near neutral pH conditions must still be assessed. Special attention is often placed on trace elements that can be quite soluble at neutral pH such as zinc, cadmium, nickel, antimony, selenium, and arsenic. Whole rock analysis and laboratory kinetic tests can be quite effective in assessing potential near-neutral or alkaline drainage chemistry.

The quantitative prediction of drainage quality is more difficult than establishing whether ARD will be generated. However, in many cases, an accurate quantitative prediction of drainage quality is not required. Instead, it may be sufficient to know for design, operational, or closure purposes whether a particular drainage will meet certain water quality standards, whether it will be ARD, NMD, or SD type water, and what the overall volume will be. Therefore, all prediction efforts (and associated information needs and level of complexity) need to be tailored to the question at hand. As a general rule, the amount of information and sophistication of the water quality prediction approach used must reflect the scale at which the problem is to be addressed, the availability of information, and the level of detail, accuracy, and precision required.

## 5.3 The Prediction Approach

### 5.3.1 Acid Rock Drainage/Metal Leaching Characterization

Figure 5-1 represents an idealized generic overview of a comprehensive ARD/ML prediction program. Application of this approach needs to be customized to account for site-specific aspects. The program, as presented, applies to a project that advances from exploration through to mine closure.

The flowchart in Figure 5-1 assumes that ARD/ML prediction activities are performed at every stage of a project. These activities are coupled with other project planning activities and the level of detail of ARD/ML characterization activities is determined by the stage of the project. Data are accumulated as the project proceeds so that the appropriate information needed to support engineering design is available in a timely manner.

The following six mine phases are identified in the GARD Guide:

- Exploration
- Mine planning, feasibility studies, and design (including environmental impact assessment)
- Construction and commissioning
- Operation
- Decommissioning

- Post-closure

The flowchart focuses on the earlier stages of mine development, a critical period for proactive mine development, when the initial geochemical characterization is usually conducted. The description of mine phases in Figure 5-1 therefore differs slightly from the convention used in the GARD Guide. Both sets of nomenclature are presented.

The major “pillars” of the flowchart are as follows:

- **Typical Project Phase.** Five typical major project phases of the mining cycle are included in Figure 5-1 (initial exploration, advanced exploration, prefeasibility, feasibility/permitting, and project implementation).
- **Minimum Objective of ML/ARD Program.** The overall minimum objective for each project phase of the ARD/ML program is indicated on the flowchart. For each project phase, the minimum objective is typically defined based on the economic assessment of the project. These objectives are described as “minimum” requirements because project managers may choose to meet the objectives of subsequent phases to avoid delays.
- **ML/ARD Program Stage.** This header indicates the level of characterization that is needed to meet the objective.
- **ML/ARD Program Activities.** This element indicates the main types of prediction and characterization activities. All activities are considered cumulative. Activities occurring in earlier phases are continued here as needed to meet future objectives.

If new information becomes available during any one of the stages of the ARD/ML program (e.g., a change in mine plan, or unexpected monitoring results), re-evaluation of earlier stages may be required. These types of iterations are omitted from the flowchart in Figure 5-1 for clarity. An approach for characterization, classification and prediction adopted by Earth Systems is documented in the **Characterization Case Study**.

### 5.3.2 Prediction during Different Phases of the Mine Life

#### 5.3.2.1 Initial Exploration/Site Reconnaissance Phase

During the initial exploration/site reconnaissance phase, the following activities take place: surface geological mapping, geophysical surveys, soil and stream sediment surveys, trenching, and wide-spaced drilling. The information acquired from these activities is used by project geologists to develop a conceptual geological model for the mineral prospect. In the context of managing existing sites, reconnaissance occurs at this stage to obtain historical and site layout information to define subsequent investigations.

The information collected during the initial exploration is not specifically interpreted for ARD/ML potential but becomes the foundation for subsequent evaluations. For example, geological mapping and mineralogical studies should consider the host or country rocks in addition to the ore. A core logging manual should be developed so that logs provide information that can be used for ARD/ML characterization. Core should be suitably stored to be available for future analyses. Rock samples should be analyzed using multi-element scans (including sulphur and carbon) in addition to the suspected commodity elements. Collection of environmental baseline data (soil, sediment, surface water, groundwater, and air) should begin during this phase.

#### 5.3.2.2 Advanced Exploration/Detailed Site Investigation Phase

The advanced exploration/detailed site investigation phase usually involves additional drilling at narrower spacing and, where appropriate, underground development to improve delineation of the ore body, but normally a mine plan has not been developed during this phase. Specific ARD/ML characterization begins early in this phase. The geological model for the project provides a basis for design of a Phase 1 (initial or screening) ARD/ML static test program (Table 5-1 provides more detail on testing methods). The geological model also affords an opportunity for comparing the project to analogs, which may indicate a potential for drainage quality issues, and provides focus for the initial investigation. At this stage, water sampling in the area should include any existing facilities and natural weathering features (e.g., gossan seeps).

Table 5-1 is large enough to require its own page:

**Table 5-1: Methods for Geochemical Characterization (Table 5-1 provides more detail on testing methods.)**

#### 5.3.2.3 Prefeasibility Phase

The prefeasibility phase includes development of initial mine plans (or closure plans for existing sites). During this phase, the results obtained during the Phase 1 program are coupled with the mine, waste, and water management plans to design a detailed Phase 2 ARD/ML characterization program that will lead to development of waste management criteria and water quality predictions. The Phase 2 characterization program will include static chemical and physical testing, mineralogical characterization, and implementation of

laboratory and field kinetic tests specifically designed to answer questions about the geochemical performance of the individual mine and infrastructure facilities. A preliminary waste geochemical block model might be developed during this phase that can be used to initially estimate the quantities of different types of wastes.

#### **5.3.2.4 Feasibility and Permitting Phase**

The feasibility and permitting phases are not distinguished as separate phases in the flowchart because the ARD/ML characterization needs are essentially the same for feasibility and permitting, and the transition from a positive feasibility study to environmental assessment and permitting often occurs rapidly or occurs in parallel and therefore allows little time for additional studies.

The main activity in this phase is the development of source water quality predictions, which are used in the feasibility study (e.g., to determine water treatment requirements) and to evaluate the water quality effects of the project. The predictions are developed by coupling findings of the Phase 2 program with waste schedules and hydrological data for individual facilities. The predictions are used in the internal load balance for the site and as direct inputs to downstream groundwater and surface water effects assessments (see Chapter 8).

The flowchart in Figure 5-1 shows iterative loops from the source term predictions back to the Phase 2 program and show iterative loops from the effects assessment back to the source term predictions because further modeling and testing may be needed to refine water chemistry predictions. The parallel process for mine or closure planning may result in the redesign of some aspects of the mine or closure to address unacceptable effects or costs.

Following completion of an acceptable mine plan, monitoring plans are designed to inform waste management decisions (e.g., analysis of blast hole sample for waste classification) and verify water chemistry predictions (e.g., seep sampling) (see Chapters 8 and 9).

#### **5.3.2.5 Construction, Operational, Closure and Post-Closure Phases**

Prediction is a cradle to grave activity that does not finish when mining starts, but continues during construction, mining and processing, closure and post-closure. Objectives of prediction during mining and processing and each subsequent phase of the mine life are to verify, refine and fill gaps in the predictions from the previous phase. This is achieved through:

- Material characterization
- Monitoring of weathering conditions, drainage chemistry and loadings
- Studies to address information gaps

This section provides an overview of these activities. A more detailed description is provided in Price (2009) (<http://www.mend-nedem.org/reports/files/1.20.1.pdf>). The best time for material characterization is during mining and processing when the materials can be most easily sampled and the information can be used to guide materials handling. Objectives of operational material characterization include:

- Verify, refine and address gaps in the pre-mine characterization
- Segregate materials requiring different disposal or mitigation
- Create an inventory of the composition of materials and the mass and location of different types of material created by mining (e.g., mine walls and waste rock), processing (e.g., tailings), reprocessing (e.g., desulphurized tailings) or during deposition (e.g., tailings sand and slimes)

It is important to conduct operational material characterization for the same reason that mines conduct more detailed characterization to check pre-mine predictions of ore grades. Operational material characterization also fills information gaps that result from a lack of drill core prior to mining at the perimeter or at great depth, a lack of waste rock fines, differences between pilot and large-scale processing facilities, limited tailings samples, and uncertainty regarding the location of final mine walls.

Considerations in sampling and interpretation of analytical results include an identification of the reactive portion of a mine waste, whether segregation occurs during handling and deposition, and whether there is further processing, reprocessing, co-deposition or use of additives (Price, 2005b). Sampling becomes far more difficult once materials are buried (e.g., lower lifts of waste rock) or access is cut off to a portion of a project component (e.g., pit walls or backfilled underground workings). In addition to waste materials produced or surfaces exposed by mining and processing, characterization should be conducted on geological materials used to construct roads, foundations and dams, and stripped as part of mine construction. Sampling and analysis requirements for operational characterization of different materials created by mining are discussed in more detail in Price (2009), Chapters 7, 8 and 9.

Ensuring sufficient time to sample, analyze and act on the results may be a challenge where material characterization is used to segregate materials or verify that mitigation processes, such as desulphurization, have been effective before disposal can proceed. Effective

communication will be needed between the parties responsible for each task where material characterization is used to manage materials that are a potential source of problematic drainage chemistry.

In an effective prediction program, in addition to permit compliance, monitoring is conducted to track trends, inform corrective actions and permit proactive resolution of problems, adaptive management and timely implementation of contingency plans. Monitoring should include measurement of properties and processes that cause mineral instability and changes in drainage chemistry and contaminant loadings. Since weathering processes such as mineral depletion or mine wall collapse may take many years to occur, long-term monitoring will usually be required.

A common target of weathering and seepage monitoring are wastes left exposed for some period of time prior to flooding that have an uncertain time to the onset of acidic weathering conditions. Periodic analysis of solid-phase samples from the surface of project components or field test pads can be used to measure mineral depletion to warn when accelerated flooding may be required. Geochemical and physical heterogeneity of project components may be a challenge when monitoring weathering and drainage chemistry. One solution to the challenge of tracking the performance of materials with different geochemical properties is to construct field test pads from each different material of concern.

Not all prediction questions can be answered prior to mining. Most mines need operational and post-operational studies to address unknowns in mitigation and closure plans. Common reasons for needing operational and post-closure studies include:

- Relatively short-term nature of pre-mine kinetic tests
- Differences between actual materials and weathering conditions at the site and materials and conditions in laboratory tests
- Uncertainty prior to mining about the composition of tailings, tailings sand and slimes, and waste rock fines
- Uncertainty prior to closure about the location of final mine walls, degree of wall collapse, reclamation plans or hydrogeology of the closed site (e.g., rebound in the water table, groundwater chemistry or the height of the water table)
- Operational changes to excavation, processing, waste handling and reclamation plans that change the composition, hydrogeology, size, and location of mine workings and waste materials

There is often great value in continuing pre-mine laboratory kinetic tests and setting up field test pads or monitoring sites on project components to study materials of concern. Prediction of post-closure drainage chemistry should be part of the first mine plan, and should re-occur at regular intervals (e.g., every five years) or whenever there are significant changes to site or project conditions (e.g., changes in drainage chemistry or mine plans). More detailed and accurate material characterization and information regarding site and project conditions at closure will become available as the project develops.

Mine closure may be a difficult time to conduct prediction work and collect data, with facilities being dismantled, staff departing, and equipment removed. Starting to address outstanding closure prediction questions early in the mine life will allow a mine to use its operating facilities, equipment and personnel when initiating and conducting studies, and provide more time to perform the studies and act on the results. Another important consideration in encouraging an early start to closure studies is reduced access after portions of the mine close (Price, 2005b).

After a mine closes, many properties and processes controlling weathering are in flux and there are a number of possible scenarios regarding future drainage chemistry. Many mines need post-closure monitoring and studies to address unknowns regarding future drainage chemistry. Post-closure prediction should continue for as long as there is significant uncertainty regarding environmental behavior of mine materials and a potential need for the proactive resolution of drainage chemistry problems.

Thorough, cradle to grave prediction of drainage chemistry is a relatively new phenomenon. Many older mines lack comprehensive information on operational material characterization of tailings and waste rock, and have no record of the magnitude and disposal location for material with different geochemical properties. Another common omission is a lack of long-term kinetic tests or well-characterized kinetic test samples.

It may not be possible to collect all the missing information and resolve the uncertainty regarding future drainage chemistry. For example, it is generally not feasible to collect an intact sample of the finer size fraction of waste rock buried within large dumps built in several lifts.

### **5.3.3 Water Quality Prediction**

It is important to determine the objectives and the manner in which data will be interpreted when designing a prediction program. Figure 5-2 provides a generalized flowchart that shows the objectives and use of analytical and test results for the prediction of potential water

quality effects (Maest and Kuipers, 2005).

**Figure 5-2: Generalized Flowchart for the ARD Prediction Approach at Mine Sites  
(after Maest and Kuipers, 2005)**

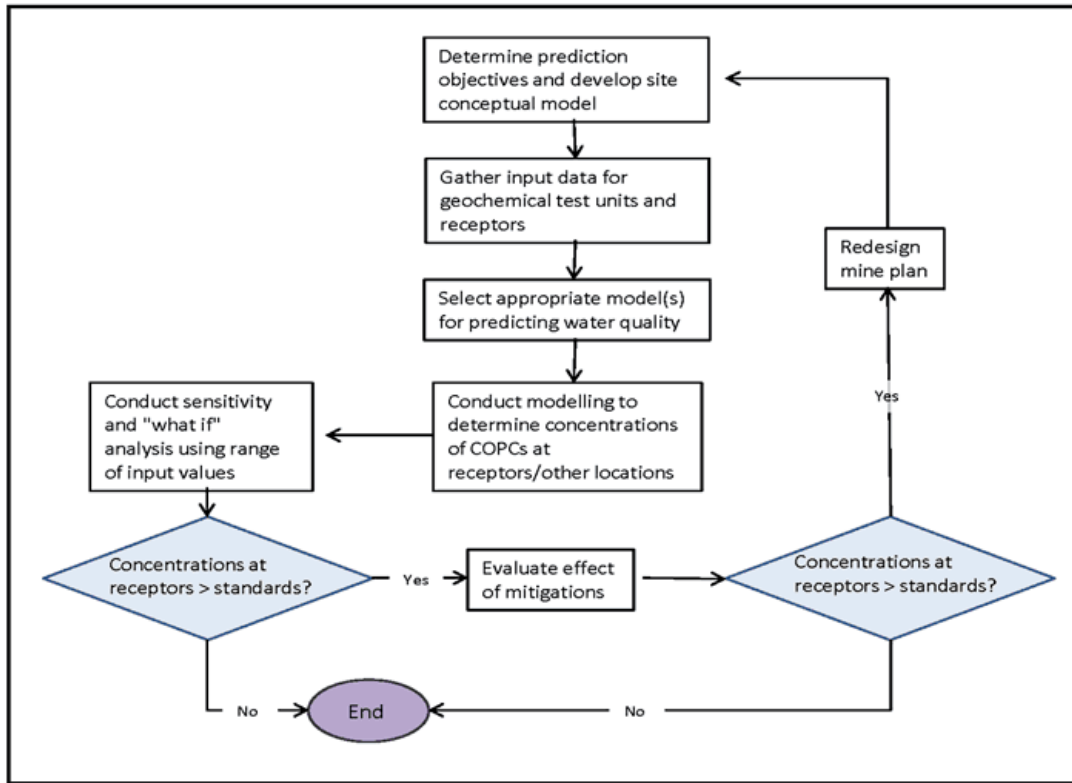

The first step in water quality prediction is to determine the prediction objectives, the importance of which is discussed in the Section 5.1, and set up the site conceptual model discussed in Chapter 4. As site characterization progresses through collection of data (geology, hydrology, mineralogy, and mineral extraction/processing), the conceptual model continues to be refined, and may change as more data become available (Younger and Sapsford, 2006). The core of the conceptual model should be a schematic that shows the major sources of contaminants (e.g., mine portals, open pits, tailings, waste rock piles), the main means of transport (e.g., wind, surface water, groundwater), and the receptors (e.g., atmosphere, lakes, reservoirs, streams, rivers, soils, aquatic biota, terrestrial flora and fauna). Figure 5-3 is an example of a conceptual model in cartoon format, developed for the Iron Mountain Mine (California) and its receiving environment. Figure 5-3 can be made into a schematic (flowchart, flux chart or reservoir chart) with the size of the arrows proportional to flow as shown in Figure 5-4.



**Figure 5-3: Conceptual Model Showing Metal and Acid Source Regions at Iron Mountain and Downstream Transport Pathways to the Sacramento River**

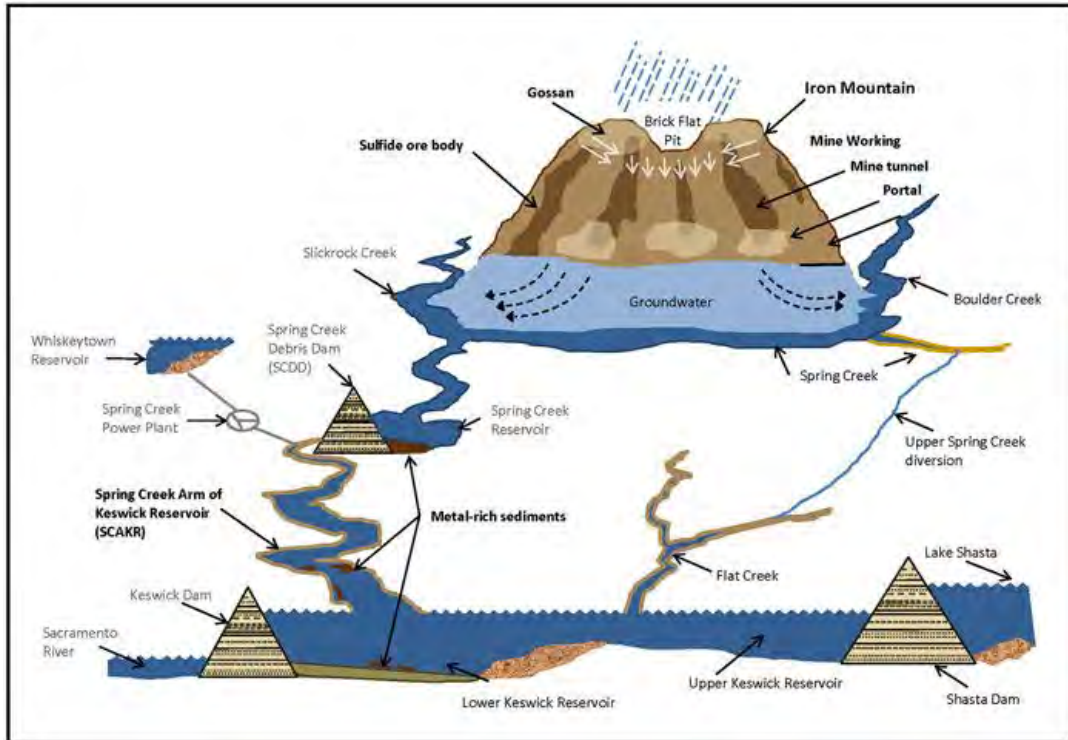

**Figure 5-4: Flowchart for Metal and Acid Source Regions at Iron Mountain and Downstream Transport Pathways to the Sacramento River**

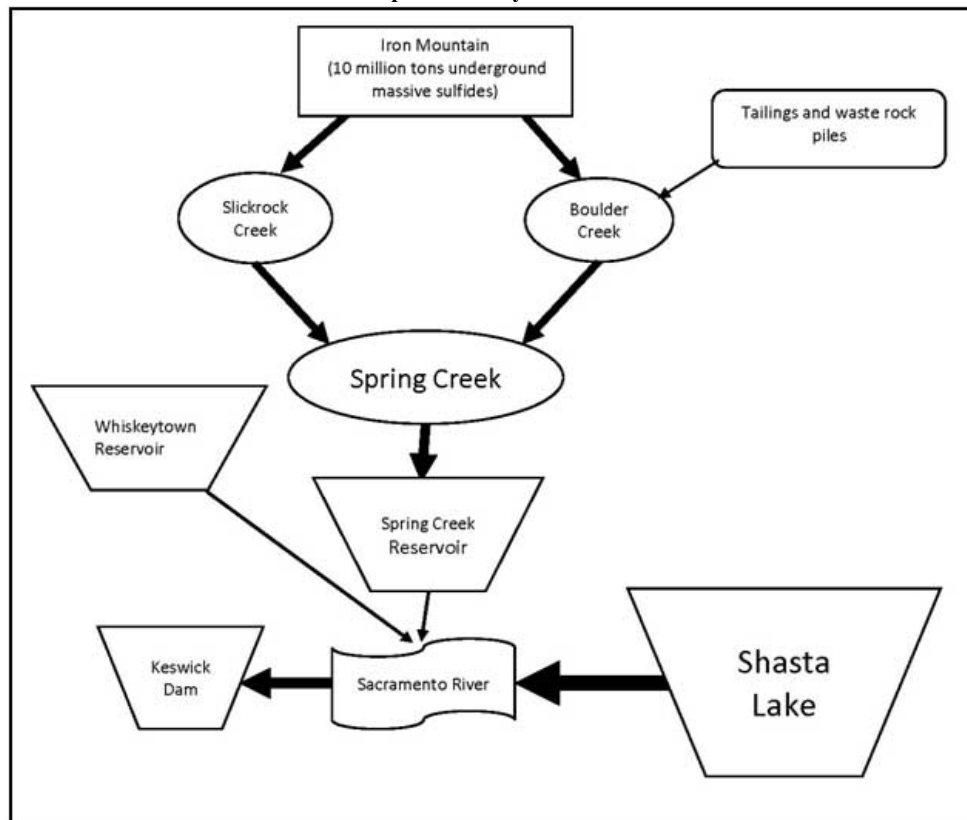

Each reservoir contains a certain mass amount and average concentration of the parameters of interest (acidity, metals, and sulphate in the case of ARD) and each arrow represents a given flux (or load) of those parameters from one reservoir to the next. Because the rates may change (e.g., with hydrologic conditions, irrigation needs, or other uses), a different set of conditions can be shown by both a range of values and a different flowchart with different values for different times of year.

Within each reservoir and flux, geochemical processes, such as precipitation or sorption of metals, result in more dilute solutions. It is within these parts of the flowchart that static/kinetic tests and geochemical modeling can be helpful. For a complex mine site with an open pit, underground workings, waste piles, diversions, and tailings piles, each one of these units should be identified, their rate of weathering and water transport quantified, and the consequences for receiving water bodies determined. A water balance (i.e., a numerical representation of the flowchart) should be developed for the system that takes into account precipitation, infiltration, and evapotranspiration. The effect of extreme events, such as floods and droughts, might also be assessed. For example, the timing and volume of infrequent high precipitation events are important in predicting drainage quality and quantity in quite arid environments.

All geochemical reactions of relevance to water quality prediction should be placed in a hydrogeological context through the flowchart. The main transport pathways can be shown by arrows and by flux numbers where available. Selection of the model to be used for water quality prediction (Figure 5-2) should take into account the prediction objectives.

The hydrogeochemical modeling is conducted using site-specific information to the maximum extent possible. This hydrogeochemical modeling results in prediction of contaminant concentrations at a number of predetermined locations (e.g., compliance points) or receptors. Through use of multiple input values, sensitivity analyses, and “what-if” scenarios, a range of outcomes is generated, bracketing the likely extent of water quality compositions and potential impacts.

Through a comparison of water quality predictions against relevant water quality standards, the need for mitigation measures or redesign of the mine plan can be identified (Figure 5-2). If predicted concentrations meet standards, additional mitigation measures will likely not be required. If, however, predicted concentrations exceed standards, mitigation measures will be necessary and their effectiveness should be evaluated using predictive modeling and active monitoring during and after mine operation. If the proposed mitigation measures are deemed inadequate for meeting standards, a reassessment of mitigation measures and possibly even of the mine design may be required. The prediction process then repeats itself, possibly including development of an improved conceptual model and additional data collection. Clearly, mine water quality prediction is an iterative process that can take place on an ongoing basis throughout the life of a mine, from the exploration phase through post-closure monitoring.



# Chapter 5b

## From GARDGuide

### 5.0 Prediction

#### 5.1 Introduction

#### 5.2 Objectives of Prediction Program

#### 5.3 The Acid Rock Drainage Prediction Approach

##### 5.3.1 Acid Rock Drainage/Metal Leaching Characterization

##### 5.3.2 Description of Phases

##### 5.3.3 Water Quality Prediction

#### 5.4 Prediction Tools

##### 5.4.1 Introduction

##### 5.4.2 Geological and Lithological Investigations

##### 5.4.3 Hydrogeological/Hydrological Investigations

##### 5.4.4 Introduction to Geochemical Characterization

##### 5.4.5 Sample Storage and Preparation Prior to Analysis

##### 5.4.6 Summary of Testing Requirements

##### 5.4.7 Physical Characteristics

##### 5.4.8 Total and Near-Total Solid-Phase Elemental Concentration

##### 5.4.9 Mineralogical Properties

##### 5.4.10 Net Acid or ARD Potential

##### 5.4.11 Short-Term Leach Tests

##### 5.4.12 Laboratory Kinetic Tests

##### 5.4.13 Field Methods

##### 5.4.14 Data Management

##### 5.4.15 Quality Assurance/Quality Control

##### 5.4.16 Screening and Evaluation Criteria

##### 5.4.17 Reporting

#### 5.5 Modeling of Acid Rock Drainage, Neutral Mine Drainage, and Saline Drainage for Characterization and Remediation

##### 5.5.1 Introduction

##### 5.5.2 Geochemical Modeling

##### 5.5.3 Hydrological Modeling

##### 5.5.4 Hydrogeological Modeling

##### 5.5.5 Gas Transport Modeling

##### 5.5.6 Statistical Evaluation

#### 5.6 Conclusions

#### 5.7 References

#### List of Tables

#### List of Figures

First Page: Sections 5.1, 5.2, and 5.3

This is the Second Page: Section 5.4 Prediction Tools

Third Page: Sections 5.5, 5.6, and 5.7, Lists of Tables and Figures

## 5.4 Prediction Tools

### 5.4.1 Introduction

This section describes the main methods of estimating the environmental water-quality consequences of mineral extraction and processing and how these tools could be used to aid in remediation planning and remedial action. These tools build on the approaches described in Chapter 4.

The primary prediction tools discussed in this chapter include the following:

- Geological and lithological investigations
- Hydrogeological investigations
- Geochemical testing methods
  - Laboratory static and short-term methods
  - Laboratory kinetic methods
  - Field methods
- Modelling

#### 5.4.2 Geological and Lithological Investigations

Mineral deposits are categorized according to their temperature of origin, their mineralogy, their lithology, and their structure. These categorizations are the basis for the development of geo-environmental models described in Chapter 2. A thorough understanding of the mineral deposit is critical to the characterization of mine wastes and geologic materials and the prediction of mine drainage quality. This information is typically available from the project geologist. Therefore, the characterization and prediction programs often begin with assembly of geological reports and interviews with the project geologists.

The elements likely to be of concern in water-quality assessments have a source in the rock and minerals that are exposed to weathering because of mining activities. Qualitative predictions on what those elements are can be gained from the rock type, its type and degree of alteration (e.g., hydrothermal, weathering, metasomatic), and the structural controls, including those that affect permeability and surface and groundwater flow. Examples of important geological characteristics that can affect the drainage quality, and hence the characterization program, include the following:

- The presence of a pyrite halo around the mineralized zone
- The role of alteration (e.g., potassic vs. propylitic vs. quartz-sericite-pyrite alteration in porphyry copper deposits) in the presence and distribution of sulphide and carbonate minerals
- Vein vs. disseminated deposit
- The presence and role of faults in displacing mineralized and nonmineralized zones and as conduits for water
- Depth of weathering (e.g., supergene vs. hypogene alteration)
- Sedimentary/stratigraphic sequence of coal deposits

These factors will ultimately determine the chemical composition of the mine drainage source material, which is an important step toward predicting the chemical composition of the mine drainage. An example of geological information that is relevant to ARD prediction and can be gathered by mine geologists during their exploration programs is presented as Table 5-2.

**Table 5-2: Geologists Observations and Logging of Core for ARD Analysis**

Important data relevant to the prediction of ARD can be gathered during the core logging process. Much of this information is already collected by or can be obtained by interviewing exploration geologists. The following summarizes work recommended:

**Quantitative Data:**

- Visual sulphide content (primarily pyrite) with an estimate of accuracy
- Visual carbonate content with an estimate of accuracy

**Semi-Quantitative Data:**

- Mineralogy, grain size, mode of occurrence of sulphides
- Mineralogy, grain size, mode of occurrence of carbonates
- "Fizz" reaction of carbonates (strong, weak, none - powdered and unpowdered)
- Extent of oxidation, if any, of rocks
- Presence of gypsum, barite, graphite or siderite
- RQD or other tests of rock competence
- Limit of oxidation and supergene zones
- Presence of water (depth to water table)
- Rock hardness/competence

**Qualitative Data:**

- Presence of secondary sulphate minerals and identification where possible
- Weathering or slaking potential (unusual observations such as rapid oxidation or weathering) in core as recovered or after storage
- Potential for breakage along fracture planes and for preferential exposure of sulphides and/or carbonates
- Presence of coating on sulphides and carbonates

- Potential problems in collecting samples for analysis and testing (e.g., core loss, concentration of holes near ore versus waste, lack of core at depth, difficulty visually segregating different geological units, differences in specific gravity, biasing by sulphide/carbonate stringers, etc.)
- Observations at outcrops of deposit (sulphide/carbonate content, extent of weathering, staining, coatings, etc.)
- Presence of staining or precipitation in streams or seeps draining the deposit

Quantitative data should be compiled for each drill interval and entered into a geologists log. Semi-quantitative information should be collected periodically through the core when significant changes are noted and could be entered into the "comments" section of log records. Qualitative information relates to unusual conditions that may be encountered while logging or storage of the samples and could be described in a covering memo from the exploration geologist. Geology staff should also advise environmental staff and ARD/ML consultants of any samples submitted for whole rock, metal scans, mineralogical or petrographic analysis as this information is often also relevant to ARD/ML prediction.

### 5.4.3 Hydrogeological/Hydrological Investigations

Contaminants in surface water and groundwater result from hydrologic and geochemical processes. The conceptual site model (as discussed in Chapter 4) of the hydrologic system includes recharge (precipitation, snowmelt, infiltration, minus evapotranspiration), flow paths, and discharge (springs, abstraction boreholes, seeps, portal flow, and base flow to a river or stream). These water fluxes should be estimated (flux-reservoir diagram) and pump tests are usually needed to determine the geohydrological characteristics of aquifer material. Often a potentiometric surface for underground workings, waste piles, and open pit or other excavations needs to be estimated to determine the current or future potential conditions for water flow and changes in direction of that flow. Determining the groundwater table in fractured rock terrain with or without mine voids (i.e., an open pit or underground mine) can be challenging but very useful information, even in a rudimentary form.

### 5.4.4 Introduction to Geochemical Characterization

Geochemical characterization requires careful sampling (Section 4.3.2.1), sample preparation (Section 5.4.5), analysis and testing (Sections 5.4.6 to 5.4.13), data management (Section 5.4.14), quality assurance and control (Section 5.4.15), and data interpretation and use (Section 5.4.16 and 5.5). Sections 5.4.5 to 5.4.16 describe characterization methods and how the test results can be used for prediction of ARD and drainage chemistry. Possible outcomes of geochemical testing include identifying materials suitable for construction uses, as a medium for plant growth, and options for the mining sequence, material handling, waste disposal, and mitigation.

This section represents a high-level overview of available test methods rather than a detailed account of individual procedures, and focuses on the interpretive and predictive value resulting from geochemical tests. Table 5-1 provides a summary description of various test methods used globally and brief discussions of advantages and limitations of the test methods.

Figure 5-5 (Maest and Kuipers, 2005) schematically presents the components of a typical geochemical characterization program aimed at developing water quality predictions and the general sequence in which these components should be conducted. This flowchart in Figure 5-5 provides more detail on the Phase 1 and Phase 2 testing programs illustrated in Phase 1 consists of a screening-level program, while Phase 2 is more detailed. In some cases, a Phase 1 program may be sufficient for mine water and waste management, whereas in more complex settings, a Phase 2 program is generally required. When a Phase 2 program is required, the results from the Phase 1 program are used to identify samples for kinetic testing or additional static testing, such as those identified in Figure 5-1 and Figure 5-5.

Therefore, not all components of the geochemical testing program may be necessary depending on site-specific characteristics and prediction needs. Individual test methods are described in more detail in the Sections 5.4.7 through 5.4.13, and are summarized in Table 5-1. Not all test methods presented in the table are appropriate for evaluation of mine wastes, even though they occasionally are requested by regulatory authorities. Such methods include the Toxicity Characteristic Leaching Procedure (TCLP) and Waste Extraction Test (WET), as explained in more detail in Table 5-1.

**Figure 5-5: Schematic Illustration of Geochemical Characterization Program (modified from Maest and Kuipers, 2005)**

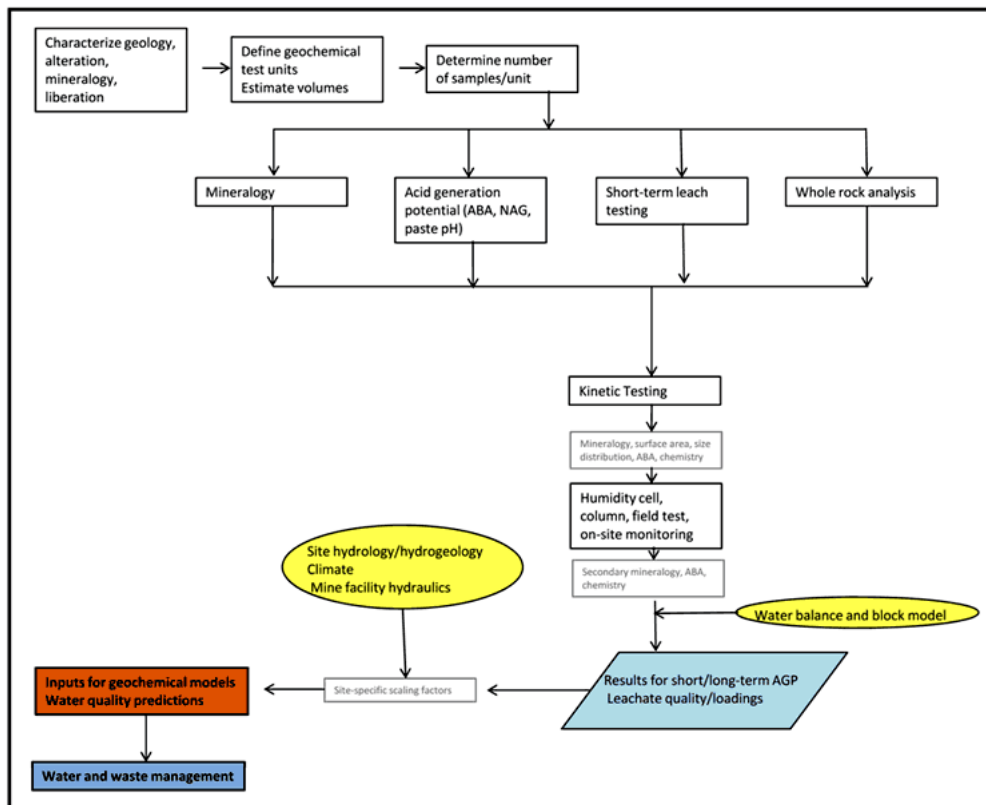

The geochemical characterization program starts with bench-scale testing, which generally involves whole rock analysis to determine chemical composition. In addition, mineralogical examination, evaluation of acid generation potential, and evaluation of metal leachability are used to determine the ARD/ML potential. Detection limits in tests must be low enough to measure contaminants at potential concern levels. Depending on the complexity of the geology and geochemical characteristics of ore and waste rock, the results from the acid generation testing might be combined to develop a 3-dimensional representation of the quantity and geochemical characteristics of ore and waste rock. The information from the whole rock analysis is used to identify categories of rock in support of development of a waste management plan, which aims to handle mining wastes in such a manner as to prevent or minimize environmental impacts (see Chapters 6 and 9).

The next important step in the geochemical characterization program is kinetic testing, which can take the form of laboratory testing, field testing or both laboratory and field testing, supplemented by on-site water quality monitoring. All materials involved in the kinetic testing should undergo a comprehensive characterization before the test begins, including surface area, particle size distribution, mineralogy, chemical composition, acid neutralization potential, and acid generation potential. At the completion of kinetic testing, the interpretive value of the kinetic testing program is greatly enhanced by repeating the determination of mineralogy, chemical composition, and acid generation potential.

In combination with water, and sometimes oxygen flux calculations, the results from the geochemical characterization programs are used to generate predictions regarding short-term and long-term acid generation potential, leachate quality, and loadings from individual waste type units. These predictions can be extrapolated to full-size mine facilities by incorporating a site-specific water balance based on information on hydrology, hydrogeology and climate, and a block model. Use of scaling factors may be required to account for differences in mass, surface area, rock to water ratio and temperature between testing arrangements, and mine facilities. The resulting water quality estimates can be used as inputs to geochemical models to account for geochemical processes that may affect dissolved concentrations such as mineral precipitation and dilution, sorption, and interaction with atmospheric gases. Ultimately, the findings of the geochemical characterization program contribute to development of mine waste and water management plans.

Any water quality prediction program needs to be customized for a particular situation and problem. Depending on the mine phase, commodity, climate, or mine facility, all or a subset of geochemical characterization tests may be required for the prediction effort and, although not indicated in Figure 5-5, multiple iterations may be required. Water transport might outweigh drainage chemistry as the primary factor determining environmental performance in very arid or arctic conditions with limited or infrequent generation of mine discharges. In that case, the primary focus of the program might be on determining site hydrology and hydrogeology, or the hydraulics of the mine facility rather than the range of geochemical characteristics.

Contaminant loading in drainage discharge is usually the primary prediction concern. Other concerns in the prediction of drainage chemistry may be site reclamation, contaminant loss by wind-born sediment and contaminant uptake by flora and fauna. The ARD/ML potential of material that will comprise a growth medium needs to be determined because of its importance for reclamation and contaminant uptake by flora and fauna.

In general, the earlier in the life of a mine, the greater the reliance on use of laboratory tests for water quality prediction. As the mine matures, use of direct field measurements of material geochemistry and from water quality monitoring becomes feasible and is advocated. Accordingly, the comprehensive characterization program presented in Figure 5-5 is most appropriate for proposed operations, while characterization at inactive or orphaned mines would instead focus on observations regarding existing site water and soil quality.

#### 5.4.5 Sample Storage and Preparation Prior to Analysis

Storage and preparation of samples prior to analysis plays an important role in achieving accurate data and needs to be carefully planned. This section provides an overview of these activities. A more detailed description is provided in Price (2009) (<http://www.mend-nedem.org/reports/files/1.20.1.pdf>). The objectives of sample storage and preparation are to preserve properties critical to the prediction of drainage chemistry and provide suitable test material for planned analyses and tests. Before samples are collected, a protocol should be developed that outlines the storage and pretreatment requirements for each type of sample and analysis and test. Every sample should be provided with a name, number and a brief description that can be used to identify the sample in the field, laboratory, and during data evaluation. The sample description should include the following:

- Sampling date
- Sampler's name
- Sampling location (GPS coordinates)
- Area, volume or length over which each individual sample is collected or sub-samples are composited
- Sample size
- Geologic material
- Waste material and project component
- Type of material sampled (e.g., drill core)
- Subsequent treatment, storage, and preparation (e.g., drying and sieving)
- Visual characteristics such as Munsell colour, degree of weathering, mineralogical composition, texture, and particle size distribution

Sample storage conditions should prevent further weathering, especially sulphide oxidation. The most common method to prevent further sulphide oxidation after sampling is drying the sample. Drying temperatures below 40C will ensure most minerals are not altered. Prior to and after drying, samples should be kept cool, and humid storage conditions should be avoided. Where necessary to preserve anaerobic conditions, samples should be stored under nitrogen gas. Freezing can be used to prevent various weathering reactions.

The most common forms of sample preparation are sieving, crushing, and/or grinding. The decision about whether to separate different particle size fractions and crush and/or grind samples depends on the type of sample, logistical constraints, and analysis objectives. Different forms of pretreatment may be required for bedrock (e.g., drill core or chips) versus non-lithified materials (e.g., tailings and waste rock) or measurement of total solid-phase composition versus the soluble chemical species on solid-phase surfaces. Where more than one pretreatment protocol is required, sub-samples can be created using an appropriate method such as a splitter box or coning and quartering.

Sieving may be required to separate the reactive size fraction of non-lithified (particulate) samples. Particulate samples containing stones may be dry sieved into coarser and finer fractions to determine the composition of the more reactive, finer size fraction or to remove particles that are too large for the analysis containers. The weight of each size fraction should be measured, so analytical results can be extrapolated to mine facilities as a whole.

The "reactive" particle size fraction depends on site-specific factors such as the grain size of reactive minerals, previous weathering, and the porosity of the coarse fragments. Based on observations of mineral reactivity made on waste rock with a wide range in grain size, Price and Kwong (1997) recommended that, in the absence of a site-specific evaluation, the minus 2 mm particle size be used as the cut-off for the smallest, more reactive, particle size fraction. The influence of coarse fragments on drainage chemistry increases if coarse fragments break down rapidly, are porous, or the minus 2 mm fraction is unreactive. The assumption that most contaminant releases come from the minus 2 mm fraction may not be correct for historic mine wastes and naturally weathered materials in which weathering has removed reactive minerals from the finer particles.

Many laboratories automatically crush and grind samples to < 74  $\mu\text{m}$  (200 mesh) or < 120  $\mu\text{m}$  (120 mesh) as part of the standard pretreatment without considering whether this will prevent accurate material characterization and the prediction of the drainage chemistry. Whether to crush and grind samples and to what particle size will depend on the sampled material and the proposed analyses and tests. Depending on the laboratory, crushing and grinding to < 74  $\mu\text{m}$  (200 mesh) or < 120  $\mu\text{m}$  (120 mesh) is usually recommended for sub-samples analysis of total elements, sulphur species, neutralization potential and other bulk, whole or total assays. Bedrock samples are often crushed to < 9.5 mm (3/8 inch) or 6.4 mm (1/4 inch) for static solubility water extractions, laboratory humidity cell and column kinetic tests.

Since crushing and grinding creates new particles and surfaces, it should not be conducted on samples of particulate materials prior to sieving, or on sieved particulate material prior to the measurement of surface properties such as rinse pH or soluble constituents produced by surface weathering.

#### 5.4.6 Summary of Testing Requirements

In summary, the evaluation of mine waste ARD/ML potential and prediction of resulting water quality requires an understanding of the following characteristics of the mining wastes and geologic materials:

- Physical characteristics
- Chemical characteristics
- Mineralogical characteristics
- Acid neutralization potential
- Acid generation potential
- Leaching potential



For ease of presentation in this GARD Guide, tests aimed at determining acid generation potential and leaching potential are categorized as follows:

- Laboratory static and short-term methods
- Laboratory kinetic methods
- Field methods

Sections 5.4.7 through 5.4.13 present a brief overview of the components of a comprehensive geochemical characterization program and their significance for mine water quality prediction. Useful references related to static and kinetic testing methods and their interpretation include AMIRA (2002), BCAMDTF (1989), Jambor (2003), Lapakko (2003), Maest and Kuipers (2005), Mills (1999), Morin and Hutt (1997), Price (1997), USEPA (2003), and White et al. (1999).

#### **5.4.7 Physical Characteristics**

The physical characteristic of most significance for water quality prediction is the particle size. Particle size distributions impact both mineral reaction rates and reaction duration by affecting the reactive surface area, the distances between potentially reactive particles, and the porosity and permeability of a solid. Porosity and permeability of a solid are particularly important with regard to movement and transport of air, water, and reaction products from weathering reactions.

The particle size distribution should be measured before any kinetic testing, both for laboratory and field-scale tests. To enable scale-up of test results, estimates of particle size distribution in mine facilities, such as waste rock repositories and heap leaches, are also required. These can be determined from direct measurement or estimated from the blasting plan. The “reactive” surface area of a material (i.e., that portion of the total surface that is actively available for chemical reaction) may be significantly smaller than the surface area as measured by standard techniques.

Permeability, specific gravity, and porosity should be determined in the laboratory for tailing material. The soil water characteristic curve (SWCC) and air entry value for oxygen diffusion might also be determined in the laboratory (see Chapter 6).

#### **5.4.8 Total and Near-Total Solid-Phase Elemental Concentration**

This section provides an overview of the measurement of total and near-total solid-phase elemental concentrations, which has numerous uses and is a valuable part of drainage chemistry prediction. A more detailed description is provided in Price (2009) (<http://www.mend-nedem.org/reports/files/1.20.1.pdf>).

Uses for total solid-phase elemental include:

- Identification of materials with elevated concentrations of constituents of potential concern
- Aid in the selection of samples for kinetic testing and interpretation of the results
- Prediction of the maximum concentration of acid insoluble sulphate and trace metal sulphide minerals in ABA
- Identification of anomalous geochemical conditions
- Verification of lithology and mineralogy

Whole-rock or near-total solid phase elemental analysis should be conducted on all impacted geologic materials. Total element data initially originate from geochemical exploration. More comprehensive data are usually collected as part of pre-mine planning, with data from operational characterization used for verification and filling data gaps. Solid-phase analysis consists of two steps: (1) sample digestion and (2) elemental analysis. More detail on these two components of solid-phase analysis is provided in the next two sections.

##### **5.4.8.1 Sample Digestion**

The purpose of digestion is to release elements from minerals into a phase in which they can be analyzed. Many digestion and analysis methods are acceptable. A hot chemical flux produces a fused glass disk. Combinations of acids produce a liquid solution. Digestion methods vary in their ability to digest different minerals, susceptibility to interference by sample properties such as sulphide content, and detection limits of the subsequent analyses.

Lithium borate fusion completely digests most samples and is recommended if the objective is to measure the total concentration of major mineral forming elements (i.e., whole rock). The resulting fused disk can be analyzed directly by X-ray fluorescence (XRF) or re-dissolved and analyzed by inductively coupled plasma (ICP). Prior analysis is needed to detect samples where elevated sulphide may interfere with the fusion or require additional dilution before the trace element analysis is conducted. Sodium peroxide fusion rather than lithium borate fusion is used when the sulphide mineral concentration is greater than 5%. Four acid (hydrofluoric, perchloric, nitric, and hydrochloric acid) digestion is the most powerful wet acid dissolution procedure in common use and is considered a near total digestion. Although the lower digestion temperature makes it less able to digest silicates than fusion methods, the four acid method is capable of dissolving most metal salts, carbonates, sulphides, silicates, and almost all sulphates and oxides. Three acid digestion differs from four acid digestion by not using hydrofluoric acid, which makes the digestion of silicates less complete but removes operational challenges associated with the use of hydrofluoric acid.

Aqua regia (3:1 mixture of hydrochloric and nitric acids) is an effective solvent for most base metal sulphates, sulphides, oxides and carbonates, but provides only a partial digestion for most rock forming elements and elements of a refractory nature. It is typically less expensive and does not provide as complete a digestion as the four acid method. However, aqua regia provides a good measure of trace elements in most reactive minerals.

#### 5.4.8.2 Elemental Analysis

Inductively coupled plasma (ICP) measurements are made on liquid samples produced by acid digestion. ICP is capable of measuring 40 to 70 elements simultaneously with relatively high level of detection. The standard ICP procedure for near-total solid phase analysis is ICP atomic emission spectroscopy (ICP-AES). ICP mass spectroscopy (ICP-MS) may measure different ionic species and has lower detection limits than ICP-AES. Low detection limits are rarely needed for solid phase and are primarily used for water samples.

Atomic absorption spectroscopy (AAS) measurements are also made on liquid samples produced by acid digestion. AAS is only capable of one element at a time but the equipment is less expensive. AAS with a graphite furnace has similar accuracy to ICP-AES.

The most common use of XRF is to measure major elements (e.g., Al, Ba, Ca, Cr, Fe, K, Mg, Mn, Na, P, Si, and Ti) in a lithium borate fused disk. Trace elements (e.g., As, Ba, Cu, Ni, Sn, Sr, U, W, Zn, and Zr) are measured in an undigested pressed pellet. Major cations are commonly reported as oxide equivalents (e.g., Al<sub>2</sub>O<sub>3</sub> and MgO). Portable and hand held XRF equipment is increasingly being used for field characterization of undigested samples. Primarily developed for exploration, field XRF measurement of selected elements may be used to identify wastes requiring segregation during waste handling (Guerin et al., 2006). The level of detection in field XRF will depend on sample preparation and the type of XRF equipment. Other total element analysis methods include Leco furnace for carbon and sulphur, gravimetric and volumetric methods, and specific ion electrodes. In gravimetric and volumetric methods, elemental concentration is calculated from the amount of reacting species required to completely react with the element of interest.

Detection limits for total and near-total solid-phase elemental analysis vary between laboratories due to differences in sample preparation, instruments, techniques and range in standards. Detection limits vary between samples due to differences in composition and interferences.

#### 5.4.8.3 General Comments

The most commonly used methods are wet acid digestion by four acid and aqua regia, followed by ICP-AES. Where the objective is to determine the concentration of major mineral forming elements, digestion by lithium borate fusion with analysis by XRF or ICP-AES is recommended.

Whole rock and near-total solid phase elemental analysis does not distinguish the form (e.g., mineral) in which the elements exist. Therefore, this analysis is not on its own a measure of potential elemental concentrations in drainage or the threat to the environment; information on the mineralogy, geochemical conditions and drainage chemistry is needed to predict the environmental significance of solid-phase elemental analysis results.

Different methods of digestion and analysis may produce different total solid-phase results from the same sample. Beware when comparing data from different methods. Methods of digestion and analysis and detection limits must be reported when communicating results, to indicate the potential limitations of the data.

#### 5.4.8.4 Calculation of Mineral Concentrations from Elemental Data

Total element data or selective extraction of different solid-phase fractions (Chapter 11) can be used to calculate maximum potential concentrations of individual minerals by assuming elements occur in only that one mineral phase. This technique is used in ABA to determine maximum concentrations of sulphur that could occur as acid insoluble sulphate (e.g., barite and anglesite) or associated with different sulphide minerals (e.g., Zn in sphalerite and Ni in pentlandite) with equations such as the following:

- Barite [BaSO<sub>4</sub>]: % Ba x (32.07/137.3) = % Barite-S
- Anglesite [PbSO<sub>4</sub>]: % Pb x (32.07/207.2) = % Anglesite-S
- Sphalerite [ZnS]: % Zn x (32.07/65.37) = % Zn-S
- Pentlandite [NiS]: % Ni x (32.07/58.7) = % Ni-S

The accuracy of these calculations depends on the accuracy of the assumptions that the element only occurs in one specific mineral phase and the expected elemental composition of the mineral phase. Assuming the elemental composition of the mineral phase is correct, the calculation provides the maximum potential concentration for that mineral phase. Assumptions about the mineral source for specific elements and the elemental composition of mineral phases should be verified using mineralogical tests if these mineral species are potentially important.

Calculation of mineral concentrations from elemental data can range from the relatively simple calculation of individual minerals to complex calculation of an entire mineral assemblage using normative computer programs. Normative calculations produce idealized mineral assemblages from whole rock elemental data, based upon assumptions about the potential mineral phases, order of mineral formation and simplified mineral formulas.

The normative calculation in most common use is the Cross, Iddings, Pirsson and Washington (CIPW) Norm. There are a number of assumptions in the CIPW Norm that deviate from conditions commonly observed in mined geologic materials. These assumptions include no hydrous minerals (e.g., muscovite, hornblende and biotite), ferromagnesian minerals are free of Al<sub>2</sub>O<sub>3</sub>, no weathering or hydrothermal alteration, and limited carbon concentrations. Generic normative calculations are, therefore, unlikely to provide an accurate prediction of the mineral assemblage in mined geologic materials and should never be used without detailed mineralogical testing for each geologic unit to verify their accuracy.

#### 5.4.8.5 Comparison with Concentrations in Non-Mineralized Rock

Comparison with concentrations (mg/kg) in non-mineralized rock (e.g., crustal abundance, composition ranges for specific lithologies and soils) can be used to identify the degree to which trace elements concentrations are elevated. The soluble or leachable proportion of constituents of interest can be determined by combining the results from the chemical analysis with those from leach tests.

One measure of enrichment of elements in whole rock samples is the Geochemical Abundance Index (GAI). The GAI compares the actual concentration of an element in a sample with the median abundance for that element in the most relevant media (such as crustal abundance, soils, or a particular rock type). The main purpose of the GAI is to provide an indication of any elemental enrichment that may be of environmental importance. More detail on the use of the

GAI is presented here: Elemental composition of mineralized rocks.

Other uses of chemical analyses include evaluation of sample representativeness and determination of all or part of the bulk mineralogy. Chemical analyses may also provide a surrogate for acid base accounting parameters (e.g., Ca for NP; total sulphur for AP). Table 5-3 is an example table of results from chemical analysis of various rock types, including a comparison against crustal values.

Table 5-3: Example Chemistry Table

		Ag	Al	Sb	As	Ba	Bi	Ca	Cd	Co	Cu	Fe	Hg	Mo	N	Pb	Se	Zn
		mg/kg	%	mg/kg	mg/kg	mg/kg	mg/kg	%	mg/kg	mg/kg	mg/kg	%	mg/kg	mg/kg	mg/kg	mg/kg	mg/kg	mg/kg
Post Mineral Dykes (n=4)	min	0.10	1.01	0.72	2.00	30.0	0.07	1.55	0.06	12.00	226.0	3.64	0.07	5.00	10.00	1.00	1.90	7.0
	max	1.52	1.72	4.00	12.10	120.0	1.00	9.70	0.25	30.20	3790.0	4.49	5.73	32.40	39.20	2.40	5.40	42.0
	mean	<b>0.69</b>	1.46	<b>2.20</b>	<b>6.75</b>	72.5	<b>0.56</b>	3.87	0.17	17.80	<b>1409.0</b>	4.10	<b>1.70</b>	<b>13.14</b>	22.03	1.53	<b>3.65</b>	22.5
	25th	0.18	1.36	0.98	4.25	52.5	0.15	1.88	0.10	12.75	578.5	3.99	0.39	6.61	12.18	1.00	2.78	13.8
	median	0.56	1.56	2.00	6.45	70.0	0.59	2.11	0.18	14.50	809.5	4.14	0.50	7.57	19.45	1.35	3.65	20.5
	75th	1.07	1.67	3.20	8.95	90.0	1.00	4.09	0.25	19.55	1640.0	4.25	1.81	14.10	29.30	1.88	4.53	29.3
Andesites (n=120)	min	0.04	0.85	0.24	1.00	10.0	0.01	0.94	0.01	9.00	41.6	2.99	0.01	0.50	6.00	0.40	0.60	9.0
	max	13.60	3.74	98.00	932.00	210.0	6.00	7.89	4.30	53.00	5670.0	10.25	5.08	46.50	435.00	230.00	20.20	533.0
	mean	<b>0.75</b>	2.23	<b>3.69</b>	<b>27.52</b>	58.8	<b>0.89</b>	2.62	0.28	<b>31.02</b>	<b>702.0</b>	5.47	<b>0.43</b>	<b>8.07</b>	<b>95.12</b>	5.89	<b>4.36</b>	49.6
	25th	0.19	1.80	0.92	4.38	30.0	0.12	1.89	0.05	28.00	297.0	4.49	0.05	3.00	45.80	1.00	1.90	23.0
	median	0.30	2.22	1.62	7.95	50.0	1.00	2.44	0.25	31.00	523.0	5.32	0.50	4.40	85.90	1.45	3.70	30.5
75th	0.73	2.61	4.00	20.25	72.5	1.00	3.26	0.25	38.00	866.8	6.29	0.50	9.71	121.13	4.00	5.70	48.3	
Stocks (n=105)	min	0.04	0.49	0.19	0.70	10.0	0.01	0.60	0.01	5.00	37.0	2.14	0.03	0.32	1.50	0.30	0.30	11.0
	max	4.10	2.98	27.50	79.50	700.0	4.00	6.09	4.00	59.00	7080.0	9.30	2.00	90.00	115.50	168.50	18.20	273.0
	mean	<b>0.73</b>	1.42	<b>2.62</b>	<b>10.16</b>	107.6	<b>0.64</b>	2.63	0.27	19.46	<b>1093.0</b>	4.87	<b>0.39</b>	<b>10.62</b>	23.39	6.58	<b>3.71</b>	41.7
	25th	0.30	0.98	0.73	3.00	40.0	0.07	2.05	0.08	8.10	605.0	2.98	0.09	1.30	5.00	1.20	1.60	23.0
	median	0.50	1.33	1.00	5.20	70.0	0.48	2.46	0.25	16.70	824.0	4.58	0.50	3.34	13.70	2.50	2.65	30.0
75th	0.87	1.78	3.00	12.00	130.0	1.00	3.04	0.25	31.00	1120.0	6.32	0.50	8.58	32.00	5.00	4.68	42.0	
Continental Crust*		0.08	8.23	0.20	1.80	425.0	0.01	0.15	25.00	60.0	5.63	0.09	1.20	84.00	14.00	0.05	70.0	

Note: Values in bold are greater than average crustal abundance (from Price, 1997)

#### 5.4.9 Mineralogical Properties

Mineralogical analyses measure properties of individual crystalline and amorphous mineral phases and their contribution to geologic materials as a whole. Mineralogical information is an essential component of drainage chemistry prediction because mineralogical properties determine the physical and geochemical stability and reaction rates of geologic materials and mine wastes. This section provides an overview of the determination of mineralogical properties. A more detailed description is provided in Price (2009 - <http://www.mend-nedem.org/reports/files/1.20.1.pdf>).

Information about mineral phases potentially required from a mineralogical assessment includes:

- Type and quantity
- Elemental composition (major components and impurities)
- Grain size, crystal shapes and inclusions
- Spatial distribution and associations
- Surface exposure and deformities
- Mode of formation
- Degree of previous weathering and location, size, abundance and elemental composition of weathering products

The type of mineral phase indicates the major chemical constituents and relative reaction rates under different weathering conditions. Surface exposure, grain size and deformities also affect the rate of weathering. One of the most important uses of mineralogical data is to support selection and design of other tests and interpretation of their results. Mineralogical analysis is usually required for a 'representative' sub-set of the static test samples and each kinetic test sample.

Comprehensive, accurate and precise mineralogical information may be difficult to obtain. Mineralogical techniques differ in speed and accuracy, and the mineral phases, properties and grain sizes they can measure. It is important to use mineralogical techniques capable of providing the required information.

Challenges associated with mineralogical analysis include:

- Many mineralogical analyses only provide qualitative or semi-quantitative data, or measure a very small sample volume
- Important minerals, such as calcite or pyrite, may occur in trace amounts, making it difficult to detect them, and to measure their concentration and chemical composition
- A significant proportion of potentially important minor and trace elements may be present as impurities rather than major structural elements
- Many minerals are solid solutions (i.e. display a compositional continuum between two end-members) and differences in composition significantly impacts their weatherability and contribution to drainage chemistry. (For example, the mineral "plagioclase" ranges in composition from relatively rapid weathering calcic plagioclase [anorthite] to much slower weathering sodic plagioclase [albite]).

The most commonly used mineralogical procedures are:

1. Visual description
2. Petrographic analysis (thin section or polished section)
3. X-ray diffraction
4. Electron microprobe (EM)
5. Scanning electron microscopy/energy dispersive spectroscopy (SEM/EDS)
6. Laser ablation and other specialized methods

At a minimum, one usually needs to conduct the first two procedures and either number 3 or 4. Other methods, such as microprobe, QEMSCAN® and laser ablation, will be used to answer specific prediction questions.

In addition to the choice of procedure, reliable and useful mineralogical information depends on analyzing samples representative of the geochemical variability and material of concern and adequate care in sample storage and preparation prior to analysis. Representative samples are identified from previous analytical work and a good understanding of the deposit geology. More detail on individual techniques is provided in the following sections.

#### 5.4.9.1 Visual Description

Visual descriptions provide information about large-scale mineralogical variability. Visual descriptions will aid in the extrapolation of small-scale microscopic or submicroscopic mineralogical measurements to project components and geological units as a whole.

Visual descriptions usually come from logging drill core. At existing mines, visual descriptions may be made along transects set up along different mine components. Visual descriptions are commonly made with the aid of a hand lens, hydrochloric acid (HCl), and scratchers, and provide valuable information about:

- Rock type
- Geological variability
- Mineral abundance and association
- Mineral alteration and weathering
- Presence of carbonates (HCl fizz)
- Organic C and S

Users of visual descriptions should be aware of the limitations in visual mineral identification and the tendency to include educated guesses, which are not identified as such (e.g., all carbonate is calcite). While it can provide a good start, visual mineral identification will not be sufficiently accurate for most aspects of drainage chemistry prediction. In addition, an assessment of mineral abundance is generally limited to a qualitative estimate (e.g., trace, minor, major). Comparisons between visual estimates and measured values have demonstrated that quantitative assessment of mineral abundance by visual means tends to be approximate at best, even when conducted by experienced practitioners.

#### 5.4.9.2 Petrographic Microscope Analysis

Petrographic microscopes are used to make measurements based on the optical properties of mineral phases in a translucent or opaque, thinly ground (~ 30 µm) slice of material mounted on a glass slide. Most minerals are identified with transmitted plane-polarized light. Sulphide and a few other minerals are identified with reflected light. Thin sections may be created from rock, chips, pulverized or sieved samples. Thin sections should be polished to allow mineral identification with reflected light and subsequent SEM/EDS analysis.

Sample storage should limit oxidation prior to slide preparation and analysis. Friable and fragile materials, such as secondary minerals, clays and weathering products, require impregnation with resins prior to sectioning. Wet or damp samples must be dried prior to impregnation. Drying should not occur at high temperatures because clay-rich materials and certain sulphates react adversely to heat and water. Thin sections may be impregnated with calcium or potassium specific stains to distinguish between calcic and potassium minerals (e.g., feldspars).

Advantages of petrographic versus sub-microscopic mineralogical techniques include the preservation of individual grains and their spatial distribution and the larger field of vision. Petrography is useful for identifying and measuring (Thompson et al., 2005):

- Mineral phase and quantity (vol %)
- Grain size, exposed surface area and surface deformities
- Alteration and weathering features, such as weathering rims and sulphide oxidation
- Association of different mineral phases
- Spatial distribution of mineral phases in, or adjacent to, areas of weakness, such as fractures and veins

The spatial distribution of different mineral phases relative to areas of weakness will indicate their relative exposure in waste rock after excavation and exposure. Weakness may result from minerals that hydrate (e.g., clay alteration minerals) or dissolve (e.g., gypsum), or physical features such as fractures and veins (Price, 1989).

Users of petrographic analysis should be aware of its limitations. The dimensions of a thin section are relatively small and a large number of sections may be required to accurately characterize heterogeneous materials. Petrographers should note grain size limitations, unidentified phases, any uncertainty in mineral identification, potential losses of material during section preparation and recommendations for alternative techniques. Potentially key mineralogical properties that petrographic analysis cannot distinguish are different carbonate species or the identity of mineral phases whose volume is < 0.2-0.5 vol% or < 50 µm for silicates and < 5-10 µm for sulphide grains. The grain size cutoff prevents mineral identification in fine tailings.

Mineral abundance can be estimated semi-quantitatively from a visual scan or quantitatively from a far more time-consuming point counting. Given the potential limitations in mineral identification with petrographic analysis and the lack of automated procedures, point counting is usually better conducted using

SEM/EDX or electron microprobe image analysis.

SEM or Rietveld XRD analysis should be used to confirm results, measure unidentifiable minerals and small grains, and provide more quantitative measurement of mineral abundance. Like most other forms of mineralogical techniques, petrographic analysis is dependent on the skill of the operator. Care should be taken to base mineral identification on the optical evidence and not speculation about the expected composition or theories related to deposit and rock formation.

#### 5.4.9.3 X-Ray Diffraction

X-Ray diffraction identifies mineral phases and measures their quantity from the peaks created by the scattering of radiation by the three dimensional arrays of atoms unique to each minerals. Mineral phases are identified by comparing the locations and intensities of the diffraction peaks with those of mineral reference standards in the International Center for Diffraction Data database. XRD is not limited by grain size and is able to distinguish minerals such as pyrite and marcasite with similar composition but a different crystal structure. XRD has traditionally provided semi-quantitative data.

The two important advantages of Rietveld XRD analysis are the quantitative nature of the data and the low detection limits (Raudsepp and Pani, 2001 and 2003). Rietveld XRD analysis calculates diffraction patterns for each mineral phase from powder XRD data and fits them to the observed powder diffraction pattern. Detection limits for different mineral phases using the Rietveld method may be as low as 0.1 to 0.2 wt%, if there are no overlaps from peaks of other mineral phases (note petrographic estimates of mineral abundance are expressed in vol.%).

The Rietveld method requires that the sample be ground under alcohol to an average particle size of < 5 µm. Alcohol minimizes heat production during grinding, protects the crystal structures of delicate minerals such as micas from damage, and disperses the sample, thereby preventing clumping. A particle size of < 5 µm minimizes micro-absorption and preferred orientation and improves the reproducibility of the diffraction pattern.

Detection limits for mineral abundances depend on:

- XRD instrument, particularly detector sensitivity
- Counting time per point and frequency of analyzed points
- Subjective skill of the operator
- Composition of material, particularly the degree of peak overlap

Potentially important peak overlaps are the main peaks of pyrite and sphalerite, chalcopyrite and calcite, and biotite and illite/muscovite. Other limitations of XRD include an inability to identify the composition of solid solution minerals, fracture coatings, minerals present in trace amounts, and disordered or amorphous minerals such as hydrated sulphates and secondary clay minerals. Phyllosilicate clay mineral species, such as smectite and kaolinite, can be identified by the difference in changes to the interlayer spacing caused by K, Mg, heating and glycol pretreatments. Again, XRD is not a stand alone technique. It needs support of visual and petrographic analysis and occasionally SEM-EDS or electron microprobe.

#### 5.4.9.4 Electron Microprobe

Electron microprobe (EM) accurately measures the elemental composition of selected mineral grains in polished sections, which may be needed to determine the concentration of major or trace constituents.

Electron microprobe may be used to determine the chemical composition of carbonate minerals, especially ankerite and Fe-bearing dolomite, but also other carbonate species, such as siderite, that have a variable composition (solid solution). Where carbonates that are not net neutralizing may be present, microprobe analysis of the chemical composition of selected carbonate minerals is used to measure the proportion that is net neutralizing (Ca and Mg) and not net neutralizing (Fe and Mn) (Frostd et al., 2003).

Measurement of the concentration of trace elements in different mineral phases may be needed to determine the accuracy of assumptions made in interpretation of geochemical results. For example, electron microprobe may be used to measure the proportion of Ba and Pb that occur as acid insoluble sulphate. Measurement of the concentration of trace elements in different mineral phases may also be used to predict conducive conditions for and the relative rate of trace element release, for example, whether Se occurs in sulphide minerals and will be released by oxidative dissolution.

#### 5.4.9.5 Scanning Electron Microscope and Energy Dispersive X-ray Spectrometer

Scanning electron microscopy (SEM) produces a backscattered electron image in which the average atomic number of minerals determines the shade of gray. Silicate minerals with a lower average number appear dark gray, while sulphide minerals with higher atomic numbers are a lighter gray. Portions of the gray-scale can be expanded to differentiate between minerals such as different sulphide minerals with similar average atomic numbers.

Energy dispersive X-ray spectrometry (EDS) measures the elemental composition of small areas of interest and can be used to determine the mineral phase(s) associated with different shades of gray in the SEM image. Major and minor element analysis of polished surfaces by EDS may be semi-quantitative or quantitative.

Used together, SEM/EDS can be used to measure a wide variety of mineral properties:

- Quantification of mineral phases
- Elemental composition
- Grain and particle size distribution and spatial arrangement
- Mineral association
- Number and size of structural deformities and weathering features

Digital image analysis using SEM/EDS software and systems such as quantitative evaluation of minerals by scanning electron microscopy (QEMSCAN®)

and mineral liberation analysis (MLA) can provide automated measurements (Lotter et al., 2002; Gu, 2003). Automated SEM/EDS is a more expensive, but also a more comprehensive, alternative to XRD.

#### 5.4.9.6 Other More Specialized Techniques

There are a number of specialized microbeam mineralogical techniques available that measure smaller depths or areas (e.g., surface alteration or coatings), different oxidation states, isotopes, types of bonding, adsorption modes or with lower detection limits than electron microprobe or SEM/EDS. Examples include:

- Laser ablation ICP-MS
- Proton induced X-ray emission (PIXE)
- Secondary ion mass spectrometry (SIMS)
- X-ray absorption spectroscopy or X-ray absorption near edge structure (EXAFS, XANES)

Laser ablation is used for isotope and elemental analysis of thin layers of weathered, precipitated or included material. Day and Sexsmith (2005) used laser ablation to measure the concentration of selenium in reactive minerals at a coal mine experiencing elevated selenium concentrations in the drainage.

#### 5.4.9.7 General Comments

Mineralogical testing is a required, not an optional, analysis. Mineralogical assessment is generally required for a 'representative' sub-set of static test samples and each kinetic test sample. Mineralogical data will indicate which minerals likely contributed to test results and the likelihood they will contribute similar amounts in the field. Properties of interest will depend on the mineralogical composition, questions raised by other test work and site-specific weathering conditions.

Careful planning is required to obtain mineralogical information at a reasonable cost. As with other analytical procedures, analysis should occur on the materials and compositional fractions of concern. Some information on mineralogy and mineral distribution may already be available in drill logs, exploration reports, metallurgical test work and academic reports. When requesting mineralogical analysis, it is recommended to provide information on sample geochemistry and any other relevant information (e.g., the type of ore deposit) to the mineralogist/petrographer, as this will help determine the protocol for sample preparation and in the interpretation of results. Generally, the more lines of evidence are available, the more accurate the resultant mineral identification.

Recommended mineralogical methods are as follows:

- Mineral abundance - Rietveld XRD and petrographic analysis – may use image analysis with SEM/EDS instead of XRD
- Mineral spatial distribution - Visual plus petrographic analysis or SEM/EDS
- Mineral chemical composition - Electron microprobe or SEM/EDS
- Mineral physical features - Visual plus petrographic analysis and/or SEM/EDS.

The costs of mineralogical analysis generally are similar to those of ABA and less than the costs of kinetic testing. Potential costs associated with inadequate mineralogical understanding are often prohibitive in terms of consultant fees, environmental risks, and delayed regulatory approval. It is important to recognize that the use of mineralogical information in the selection and design of static and kinetic tests and the interpretation of their results can only occur if the mineralogical analysis is completed prior to these activities.

#### 5.4.10 Net Acid or ARD Potential

Two basic types of test are available for determination of the net acid or acid rock drainage (ARD) potential: acid base accounting (ABA), that measures net acid potential through independent determination of acid generating and neutralizing content, and the net acid generation (NAG) procedure, which generates a single value that can be used to indicate the likelihood of net acid generation. On a global scale, use of ABA and paste pH predominates, with the NAG test commonly used in many regions, particularly Australia, New Zealand and SE Asia.

ABA and NAG tests are relatively inexpensive and can be applied to large numbers of samples. The results from these tests can be used for identification of samples requiring additional testing (e.g., kinetic testing) to more definitively determine acid generation potential (AP). In addition, the tests may provide operational screening criteria for mine waste classification and management. However, some differences exist in the ability of the tests to predict acid generation potential. Acid base accounting should always be conducted, while the NAG test may or may not be included, depending on circumstances (for instance, if there is little or no sulphur present or the ABA results indicate a significant excess of NP, the NAG test provides little additional information).

As described in the prediction section for coal mining, ABA methods were initially developed for the coal mining industry and later adapted for use in metal mining. Although all methods incorporate an independent determination of AP and NP, many different protocols are available and in use. Table 5-1 presents the most common methods and summarizes advantages and limitations associated with each type of test. Results from ABA methods need to be interpreted in context with mineralogical information.

In general, the determination of the AP as part of ABA testing is conducted through analysis of one or more sulphur species. The theoretical relationship between sulphur content and AP is as follows:  $AP \text{ (kg CaCO}_3\text{/tonne)}[1] = 31.25 \times S \text{ (\%)}.$

Sulphur species identified generally include total sulphur and pyritic (or sulphide) sulphur. Other sulphur species frequently determined (either through direct analysis or calculated by difference) include sulphate sulphur, organic (or residual) sulphur, and sulphate associated with barite and alunite. The acid potential can be calculated from total sulphur content (the most conservative approach) or the acid potential can be based on the concentration of one or more

sulphur species to provide a more refined estimate of the amount of reactive sulphur present. In the case of coal, it is important to discount the proportion of sulphur associated with organics when determining AP. Similarly, sulphur occurring in the form of non-acid generating sulphate minerals, such as gypsum and barite, should be discounted when information on sulphur speciation is available.

Measurement of AP is often relatively simple and interpretation of results is generally relatively straightforward. However, more interpretation of analytical results is typically needed for tests developed to measure NP because of the widely variable solubilities and reaction rates of potentially neutralizing minerals (e.g., carbonate and silicates), the differences in aggressiveness of the various methods used to determine NP[2], and the different reaction conditions and titration endpoints prescribed for each test. Because the resulting value for the NP is highly sensitive to test protocol and the nature of the NP minerals, it is important that any ABA program makes use of the methodology that is most appropriate for a given objective and application. It is also important that at least one single test method is used throughout the program to ensure that the results are internally consistent. Although perhaps imperfect, the advantage of using "standard" methods for determination of NP, such as the Sobek and modified Sobek methods (see Table 5-1 for description), allows for comparison against a vast body of references values from other sites. The values for AP and NP are combined mathematically to indicate whether a sample has a stoichiometric balance that favours net acidity or net alkalinity.

The net potential ratio (NPR) and net neutralization potential (NNP)[3] are calculated as follows:

$$\text{NPR} = \text{NP}/\text{AP} \text{ and}$$

$$\text{NNP} = \text{NP} - \text{AP} \text{ (kg CaCO}_3\text{/tonne)}$$

Table 5-4 is an example of ABA results, including summary statistics. Figure 5-6 provides an example comparison of NP calculated from total carbon measurements vs. NP using the modified Sobek method. NP is calculated from total carbon using the following formula, which assumes all carbon in the sample occurs as calcite (CaCO<sub>3</sub>):

$$\text{NP (total C)} = \%C \times 83.3$$

When NP is estimated using surrogate analyses (e.g., from total carbon or calcium), results should be reviewed to ensure that these relationships are applicable to all material types and over the full range of NP values observed.

Figure 5-7 compares total sulphur content against sulphide sulphur content. If a quantifiable relationship can be established, then determination of total sulphur may suffice for future purposes. Figures 5-6 and 5-7 are just two of the many graphs that can be used to interpret ABA results.

**Table 5-4: Example ABA Table**

		Paste pH pH units	Total Sulphur %	Sulphate Sulphur %	Sulphide Sulphur %	NP kg/t CaCO <sub>3</sub>	AP kg/t CaCO <sub>3</sub>	NNP kg/t CaCO <sub>3</sub>
Pit A (n = 699)	Minimum	7.6	0.01	0.005	0.01	9	0.15	-189
	25th percentile	8.2	0.62	0.02	0.61	57	19	-38
	Median	8.4	2.18	0.05	2.14	81	68	8
	75th percentile	8.6	3.67	0.08	3.60	98	114.5	54
	Maximum	9.5	9.35	0.18	9.26	222	292	201
Pit B (n=839)	Minimum	7.4	0.002	0.005	0.002	10	0.15	-471
	25th percentile	8.5	0.68	0.03	0.54	40	21	-38
	Median	8.7	1.59	0.05	1.45	56	50	13
	75th percentile	8.9	3.04	0.07	2.91	85	95	45
	Maximum	9.5	18.6	9.68	18.39	294	581	274

Figure 5-6: Example Plot of NP from Total Carbon vs. NP from Modified Sobek

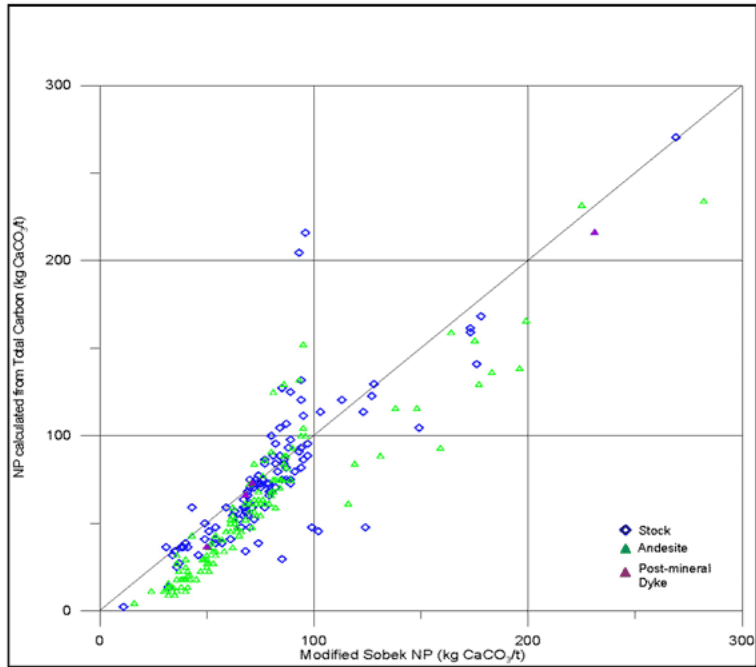
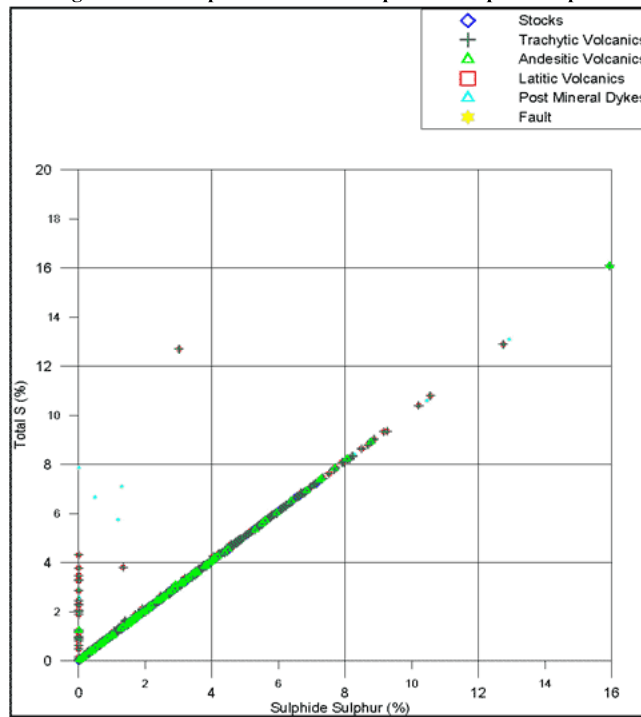

Figure 5-7: Example Plot of Total Sulphur vs. Sulphide Sulphur



The NAG test is used in association with ABA to classify the acid generating potential of a sample. The NAG test involves reaction of a sample with hydrogen peroxide to rapidly oxidize any sulphide minerals. Both acid generation and acid neutralization reactions occur simultaneously and the net result represents a direct measure of the amount of acid generated. A pH after reaction (NAG pH) of less than 4.5 indicates that the sample is net acid generating and the amount of acid is determined by titration and expressed in the same units as ABA.



Several variations of the NAG test have been developed to accommodate the wide geochemical variability of mine waste materials and to address potential interferences. The two main static NAG test procedures currently used are the single addition NAG test and the sequential NAG test. The sequential NAG test may be required for high sulphide sulphur samples to provide a measure of the total acid generating capacity and on samples with high S and high ANC. Specific methodologies are also required for evaluating material with high organic carbon content such as coal rejects and wash plant wastes. Further information on NAG tests and procedures are presented in the AMIRA ARD Test Handbook (AMIRA, 2002).

Figure 5-8 shows how ABA and NAG can be used together to improve prediction confidence, identify uncertain samples and better define cut-off criteria for material classification.

**Figure 5-8: ARD Rock Type Classification Plot Based on ABA and NAG Test**

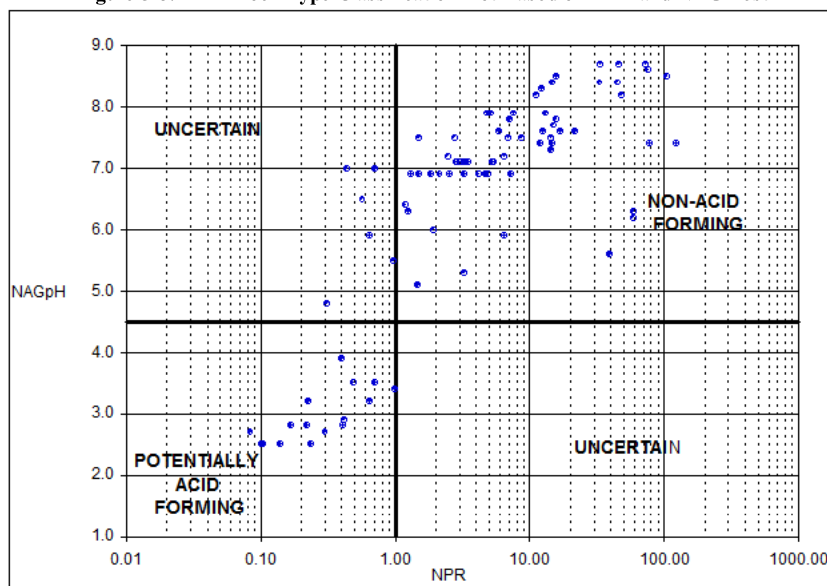

Figure 5-8 is a plot of NPR (an ABA parameter) and NAG pH and identifies four quadrants. Samples with NPR greater than 1 and NAG pH greater than 4.5 plot in the non-acid forming quadrant and samples with NPR less than 1 and NAG pH less than 4.5 plot in the potentially acid forming quadrant. Samples with conflicting ABA and NAG results plot in the “uncertain” quadrants. In the sample set shown in Figure 5-8, six samples plot in the upper left “uncertain” quadrant and follow up testing can be targeted on these samples to confirm the classification. The results also show that all samples with NPR greater than 1 plot in the non-acid forming quadrant and hence a cutoff NPR of 1 is likely to be appropriate for materials represented by the samples in this data set. This type of analysis can be used to develop site-specific criteria for the identification of acid generating rock types and to define an appropriate factor of safety to minimise the risk of misclassification. For example, for material represented in Figure 5-8, an NPR of 1.5 is likely to provide a high factor of safety for classification of non-acid forming material.

Paste pH is a simple, rapid, and inexpensive screening tool that indicates the presence of readily available NP (generally from carbonate) or stored acidity. The outcome of the test is governed by the surficial properties of the solid material being tested, and more particularly, the extent of soluble minerals, which may provide useful information regarding anticipated mine water quality. For example, acidic paste pH values in combination with elevated sulphate sulphur generally suggest the presence of acidic sulphate salts that could cause short-term or long-term water quality issues.

#### 5.4.11 Short-Term Leach Tests

Although protocols for static (or short-term) leach tests vary widely, all tests measure readily soluble constituents of mine wastes and geologic materials. The short-term nature of static leach tests provides a snapshot in time of a material’s environmental stability. Test results depend entirely on the present disposition of the sample (e.g., unoxidized vs. oxidized; oxidation products absent vs. oxidation products present). For reactive rocks (e.g., material that contains oxidizable sulphur), the transient processes that lead to changes in solution chemistry during water-rock interactions develop over periods of time that are much greater than is stipulated in the testing protocols. Therefore, the results from short-term leach tests generally cannot be applied to develop reaction rates and predict long-term mine water quality, but should instead be used to get an initial indication of parameters of constituents of interest. In addition, metal loadings can be calculated from short-term leach tests, as illustrated in Figure 5-9, where loading rates (in milligrams per kilogram [mg/kg]) are compared against initial sulphate content.

**Figure 5-9: Example Plot of Metal Loadings vs. Sulphate Content**

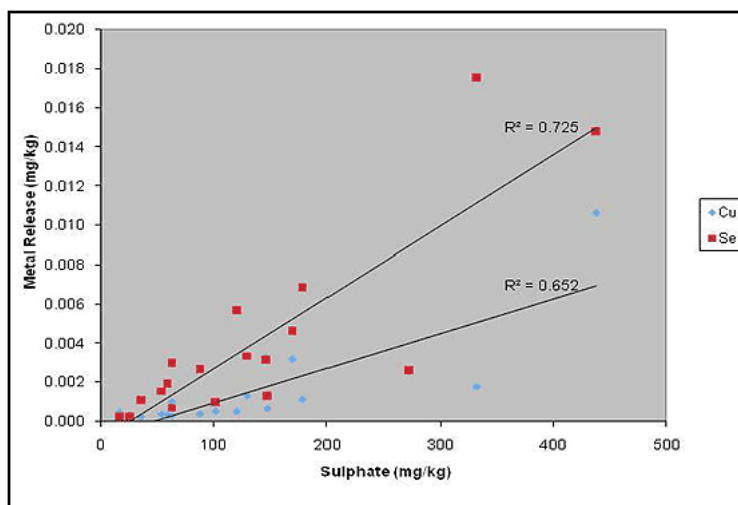

It is important to select the method that most closely simulates the site-specific ambient environment and leaching conditions (e.g., solution to solid ratio, nature of lixiviant, grain size, agitation). In addition, selection of a test method has to take into account the anticipated use of the leach test results (e.g., for prediction of seepage vs. runoff quality, incipient vs. terminal water quality). Regulatory requirements and expectations may also govern selection of a particular methodology. Many jurisdictions have well-defined regulations for evaluation of metal mobility and potential impacts to water resources and in such cases use of a test with regulatory status may be compulsory. In instances where such a test is required but where the mandated protocol has no bearing on site-specific conditions (e.g., the prescribed use of acetic acid in the TCLP test), use of an additional, and more appropriate, alternative short-term leach test is recommended to allow for a more realistic estimate of future mine water quality. Similarly, modifications to standard leach test protocols should be considered to take into account site-specific considerations and improve the tests' predictive ability.

#### 5.4.12 Laboratory Kinetic Tests

Laboratory kinetic testing methods are used to validate and interpret static test methods, and predict long-term weathering rates and the potential for mine wastes and geologic materials to release discharges that may have impacts on the environment. Both acid generation and metal leaching can be evaluated through kinetic testing.

The results from kinetic testing are frequently used in combination with data from static test, mineralogical analyses and geochemical modeling to evaluate geochemical controls on leachate composition and conduct water quality prediction under a range of conditions. Similarly, kinetic testing results are often scaled up and used in combination with water balances for mine facilities to determine loadings and associated potential impacts to the receiving environment. Depending on the end use of the kinetic test results, results may be expressed in terms of leachate quality (mass released/unit leachate volume), mass-based loadings (mass released/total mass/unit time), or surface-area-based loadings (mass released/total surface area/unit time). For loading calculations, a water balance for the test cell and information on the mass and the surface area of the test charge is required. The results of the laboratory tests then need to be scaled to the mass or surface area of the mine waste. Geochemical reactions and reaction rates most commonly monitored throughout the testing include sulphide oxidation, depletion of neutralization potential, and mineral dissolution.

Kinetic testing procedures are complex, time-consuming, and require operator skill to generate consistent results. For any kinetic test conducted, the objectives and limitations of the method used should be acknowledged before starting the program so that it is clear what information will be delivered from the tests conducted. This will ensure accountability and value for efforts and costs expended.

There is no single test that produces all of the chemical information required to evaluate all mine wastes under all conditions of disposal. In all cases, a sample is subjected to periodic leaching and leachate is collected for analysis, but the various methods available may differ in the amount of sample used, the particle size of the sample, effluent sample volume, test duration, degree of oxygenation, or nature of the lixiviant. Therefore, it is important that the objectives of kinetic testing are clearly defined so that an appropriate test method is selected and adjusted to simulate site-specific conditions and the intended use of the data produced. By the same token, conducting standard humidity cell tests (e.g., using the ASTM protocol – see Table 5-1) is very useful to allow comparison with the significant amount of information on kinetic test results available in the literature. A second phase of kinetic testing may be implemented or field testing may be considered if it is decided that tests representing site-specific conditions are required.

The two laboratory kinetic tests in general use are the humidity cell tests (HCT) and column tests. HCTs represent a standardized test under fully oxygenated conditions with periodic flushing of reaction products. No standards are available for column tests, and column tests can simulate different degrees of saturation, including flooded and oxygen-deficient conditions. Column tests are typically larger scale than humidity cell tests. Figure 5-10 is a photo of a typical HCT setup.

**Figure 5-10: Humidity Cells**



HCTs are primarily intended to generate information on weathering rates of primary minerals (e.g., sulphides); information that can be used to estimate the potential for future net-acid conditions. Dissolution rates of readily soluble primary and secondary minerals present at the onset of testing (e.g., gypsum, hydrothermal jarosites) can also be derived from HCT results. In combination with geochemical modeling, HCT leachate results can be, and are frequently, used to make inferences with respect to drainage chemistry, but due to a lack of equilibration with primary and secondary minerals during HCT operation, such an evaluation has to be conducted with caution.

Column tests differ from HCT by having a design that allows contaminants released from primary minerals to precipitate at their natural rates as secondary minerals (Price, 2009). By providing information on the combined effects of primary and secondary minerals, columns provide a more accurate measure of drainage chemistry. Column tests may be modified to simulate the effects of site-specific climate conditions and mitigation measures such as covers and amended mine wastes. Transfer of oxygen, which is not limiting in HCTs but may be in columns, must be understood in column testing. Figure 5-11 is an example of pH and concentration trends and presentation of results from a column or humidity cell test.

**Figure 5-11: Example Plot of Kinetic Test Results**

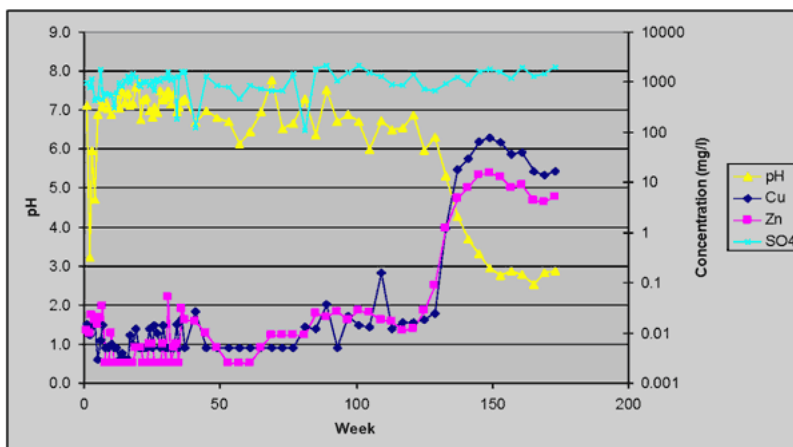

For both HCT and column tests, it is imperative that the test charges be characterized before kinetic testing begins and after kinetic testing has been completed. The information on the test charges may provide important constraints to assist in the interpretation of test results, and may also provide information that can be used for quality control purposes by comparing measured mass removal against calculated mass removal from the leachates.

The required duration of kinetic testing is an area of controversy. The duration of the test depends on the characteristics of the sample and test objective. Although a minimum length of 20 weeks is sometimes referenced, there is little technical basis for the 20-week recommendation. If the objective is to determine whether a sample will generate acid, kinetic tests should be conducted until acidic drainage is produced or until depletion calculations can be used reliably to predict acid generation potential. Another common endpoint for the kinetic testing is when leachate parameters are relatively constant with time.

#### 5.4.13 Field Methods

Field methods to determine acid generation and metal leaching potential range from rapid very small-scale tests to monitoring of full-size mine facilities for extended periods of time. In all cases, the advantage of the field methods is that on-site materials are used and an added benefit is that most field tests allow for evaluation of weathering reactions under ambient conditions, including seasonal effects and discrete events such as intense storms or snowmelt. The greater the amount of material included in the test, the greater the likelihood that a well-designed method will adequately reflect the chemical and

mineralogical composition and physical properties of a mine facility. The larger amount of material will better represent particle size distribution, porosity, hydraulic conductivity, gas ingress, and transport. Disadvantages of field cells are related to the time required to generate reliable field reaction rates, challenges with comprehensive geochemical characterization of the large test charges, problems (especially prior to mining) related to obtaining large sample volumes, and the space needed to test a large number of different material types.

The simplest “field” test is the 5-minute field leaching test (FLT) recently developed by the USGS to simulate the chemical reactions that occur when geological materials are leached by water (Hageman, 2007). The test is considered by the USGS a useful screening procedure that can be used as a surrogate for laboratory leach tests such as the Synthetic Precipitation Leaching Procedure (SPLP), (see Table 5-1).

Wall washing allows for evaluation of runoff quality from an isolated section of in situ rock face after application of a controlled amount of irrigation (Figure 5-12). This wall washing test is considered to represent a very useful order-of-magnitude estimate of contributions from exposed open pit walls or underground mine faces.

**Figure 5-12: Wall Washing**



Pilot cells (Figure 5-13), test piles, test plots (Figure 5-14), or test pads are constructed for long-term monitoring of relatively large quantities of material. Large-scale field columns (field lysimeters), to be operated under natural precipitation conditions, can also be useful.

**Figure 5-13: Test Cells for Waste Rock – Grasberg Mine, Indonesia**



**Figure 5-14: Test Plot for Paste Tailings - Somincor Neves Corvo Mine, Portugal**



Monitoring can be conducted under ambient field conditions, or under controlled conditions, using artificial irrigation. The larger scale relative to laboratory tests results in field test plots having more representative sample dimensions and particle size, in the case of waste rock, and minimizes impacts from boundary effects, sample heterogeneity, and reduced grain size. A comprehensive characterization of the test charge is required. In combination with a good understanding of the water balance for the test pad (achievable through meteorological monitoring or controlled application of infiltration, or both), reaction rates and loadings can be developed for extrapolation to full-scale mine facilities. Longer monitoring durations may be required because of lower field temperatures, intermittent drying, and lower reactivity of field cell test charges relative to the finer-grained materials commonly included in laboratory tests. It may be advantageous to operate field tests during the complete life of mine to identify potential long-term releases.

On-site monitoring of historical and newly-constructed mine facilities (e.g., waste rock pile, tailings impoundment, pit wall and adits) can provide very useful information regarding weathering rates and discharge quality under ambient conditions. By definition, monitoring results of this nature are representative of the facility and existing conditions as a whole, but prediction of future conditions may be hindered by the sluggish rate of reaction relative to smaller scale tests. Also, a comprehensive understanding of chemical and physical material characteristics is not generally feasible, nor is a comprehensive understanding of the water balance, water movement and the role of atmospheric gases. This may limit the interpretive value of direct monitoring of mine facilities for the prediction of future water quality and potential impacts to receptors.

#### **5.4.14 Data Management**

Proper data management is critical to any geochemical characterization and mine water quality prediction effort, and setup and maintenance of a database is an integral component of such a program (Bellefontaine and Price, 2006; Wolkersdorfer, 2008). The primary requirements for a useful and reliable database are that it should be in electronic format, it should be implemented from the beginning of the study, and it should be maintained and augmented throughout all phases of a mining project.

A database should be managed from a central location, with routine backups. The data should be presented in a format that is readily accessible, and appropriate safeguards should be in place to maintain the integrity of the information stored in the database and prevent unauthorized use. Although most databases are designed to store numeric information, increasing use of geospatial data is incorporated by use of geographic information system (GIS). GIS provides a means for integrating and interpreting geochemical data within a geospatial context for land use, climate, topography, or ecosystem. The primary function of a database for geochemical data is to act as a comprehensive data repository that can be used to check and maintain data integrity (see Section 5.4.15 on QA/QC), support data manipulation and data interpretation (including mine planning and material scheduling programs), support and guide water quality and other monitoring programs, enable evaluation of compliance with regulatory requirements, and allow for evaluation of historical trends and prediction of future conditions.

One type of database unique to mining is the so-called block model, which is a 3-dimensional computerized representation of the quantity and characteristics of the pit walls, ore, and waste rock. Historically, block models have been resource focused, and have included information on ore grade, lithology, alteration types, principal minerals, fracture density and orientation, and rock competency, all of which are aimed at optimizing resource recovery. To this end, data from exploration drill holes are subjected to a variety of geostatistical analysis methods, such as kriging to quantify the 3-dimensional distribution of ore throughout the mine. However, increasingly, the same block models and geostatistical techniques are also used for environmental purposes, such as development of waste rock management plans and mine water quality prediction. Results of geochemical characterization programs are incorporated in block models, including inputs such as sulphur and sulphide content, NP, paste pH, NAG pH, NCV, carbon, and carbonate content. The combination of resource and environmental parameters in block models allows for prediction of environmental behaviour of mined materials in time and space and identification of requirements for mitigation actions in time and space. Environmental block models should be developed when a 3-dimensional understanding of ARD potential is required, and should then be maintained and refined throughout the life of mine through the ongoing acquisition of additional data. Examples of use of block models are presented in Figures 5-15 and 5-16. Figure 5-15 shows the ARD potential of a highwall remaining exposed after pit lake formation. Figure 5-16 shows the ARD potential of pit walls at the cessation of mining. In both cases, a block model incorporating ABA parameters formed the basis for the evaluations.

Figure 5-15: Example of Block Model Use: ARD Potential of Pit Highwall Above Final Pit Lake

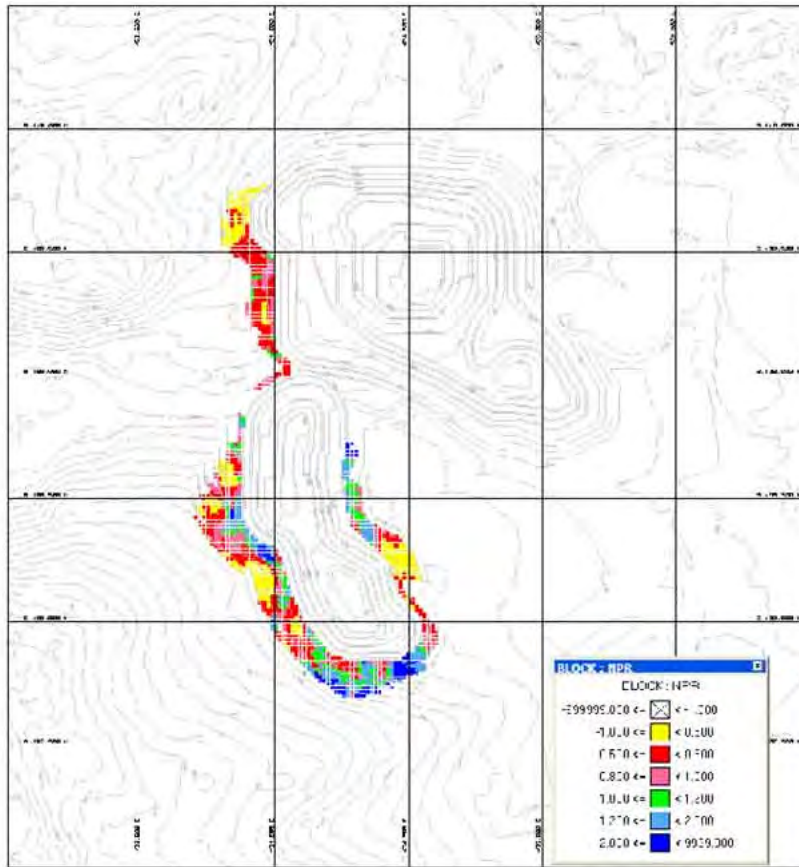
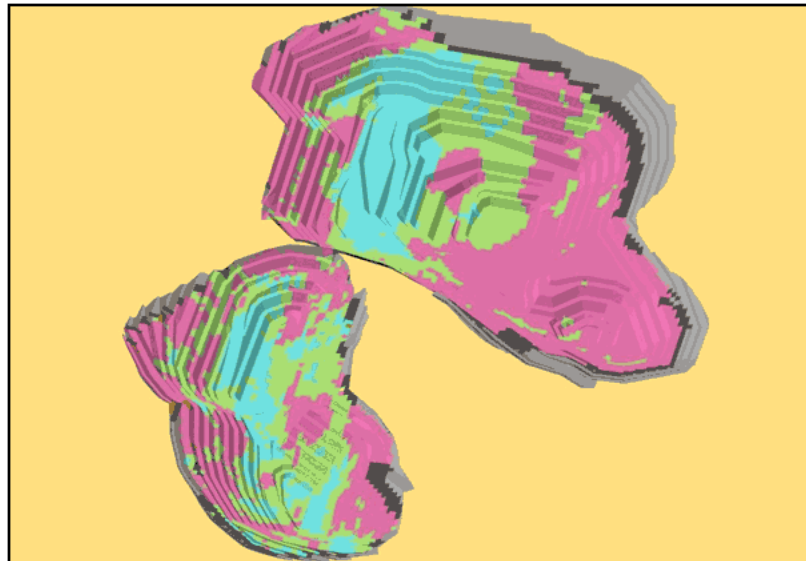

Figure 5-16: Example of Block Model Use: ARD Potential of Pit Wall after Cessation of Mining



#### 5.4.15 Quality Assurance/Quality Control

A rigorous QA/QC program is needed to ensure that geochemical data are reliable and defensible, and that such data can be used for their intended purpose, such as defining the geochemical types and distribution of mine wastes, developing waste management plans, and for mine water quality prediction.

QC is defined as the application of good laboratory practices, good measurement practices, and standard procedures for sampling. QC is also defined as sample preparation and analysis with control points within the sample flow to prevent the reporting of erroneous results. The sampling should include specifications for chain of custody procedures and documentation, sample holding time verification, drying, comminution, storage and preservation, sample labeling, and use of proper sample containers. Physical and chemical tests conducted using appropriate methods and accredited laboratories should produce analytical results with sufficient accuracy and precision for their intended usages. Analytical methods and their repeatability, reproducibility, quantification, and detection limits should meet anticipated requirements (e.g., for classification of geochemical rock types or comparison against water quality standards). Replicate samples, standards, certified reference materials, and blanks should be routinely submitted to ensure and confirm that the analytical results are of acceptable quality. QA is the process of monitoring for adherence to quality control protocols. The DQO of a quality assurance project plan (QAPP) are as follows: accuracy, precision, bias, representativeness, completeness, and comparability. A QAPP will ensure that the proper procedures are established before initiating sample collection and analysis, and that procedures are maintained throughout all stages of a geochemical program. In addition, corrective actions are prescribed through a QAPP. A defensible QA/QC program will add costs to an ARD study, but it will also allow timely correction of errors, saving time and money, and enhance the confidence of operators, regulatory agencies, and other reviewers in assessing the data. A QAPP will help balance the costs of implementing a quality-assured program against the potential liabilities associated with a poorly-designed and executed geochemical characterization program.

The data validation and assessment protocols for geochemical data generated in support of prediction of ARD and metal leaching potential are similar to those used in any type of study that relies on use of analytical results, and the data validation and assessment protocols include a variety of statistical analyses and graphical tools. Geochemical modeling can be useful (e.g., through calculation of the ion balance), while cross checking using results from different types of testing also may provide insight in data quality (e.g., calcium content vs. NP, sulphur content vs. mineralogical composition, measured vs. calculated TDS, NP titration vs. TIC).

#### 5.4.16 Screening and Evaluation Criteria

Screening and evaluation criteria are used to assess whether results from geochemical characterization studies represent a potential impact or risk to a receiving environment at a mine site and to segregate problematic wastes. These criteria can be based on professional and empirical experience, guidance documents, and regulations promulgated for the express purpose of protecting the environment.

Screening and evaluation criteria are commonly used at mine sites for water and mine waste management. Mine waste management involves identification of potentially net acidic or ARD generating (PAG) and non-potentially net acidic or ARD generating (NPAG) waste. PAG material is either acidic or predicted to become net acidic in the future. A material will become net acidic if the rate of acid neutralization is unable to keep pace with the rate of acid generation. This inability to maintain neutral conditions may be due to a decrease in the rate of acid neutralization or an increase in the rate of acid generation, or both. NPAG material is predicted to generate near-neutral or alkaline drainage in the future. Materials will be net neutral or alkaline if the rate of acid neutralization keeps pace with the generation of acid (Price, 2009).

Site-specific operational parameters and threshold values are established for waste classification (i.e., PAG vs. NPAG) based on regulatory requirements, literature, and the geochemical test program. Examples of commonly used operational parameters for waste rock management include the sulphur content (including total and sulphide sulphur), paste pH, NNP, net potential ratio (NPR), NCV, NAG test value, or NAG pH and metal content.

Theoretical relationships, empirical data, and evaluation of analytical and logistical constraints should be used to establish screening or evaluation criteria. For example, if a quantitative relationship can be reliably established between ARD potential and sulphur content, a sulphur cutoff can be determined to segregate between PAG and non-PAG waste rock. Similarly, if a relationship between metal leachability and metal content is identified, a metal concentration cutoff can be established to discriminate between material that will or will not affect receiving water quality. Sometimes a combination of methods is needed to classify problematic material, such as paste, pH, sulphur, and NPR.

Guidance documents are available that provide screening criteria for evaluating geochemical test results, in particular those tests related to prediction of ARD potential: ABA (Price, 2009) and NAG test (AMIRA, 2002). These criteria are generally related to specific values for NNP, NPR, NAG pH, and NCV, and can be used to classify mine wastes and geologic materials in terms of their ARD potential. Special care is required when dealing with mining wastes that exhibit both low sulphur contents and low NP because small changes in analytical results can dramatically affect the calculated NPR and the mine waste classification. Therefore, the screening process should be supported by data from a number of analyses and tests, including the mineralogical composition.

##### 5.4.16.1 Acid Base Accounting Screening Criteria for the Net Acid Potential

An acid pH increases the solubility of most metals (Stumm and Morgan, 1996.) and below pH 3.5, the increased dissolved Fe(III) concentration greatly increases the rate of sulphide oxidation (Williamson et al., 2006). Consequently, criteria used to identify materials with the potential for acidic drainage are a key component of sound environmental and fiscal management. The objective is to be both accurate and cost-effective. Criteria may provide useful short cuts and enable cost-effective prediction, but users always need to evaluate the underlying assumptions and limitations and whether the proposed criteria are compatible with the site-specific conditions.

The following criteria are based on practical and theoretical (scientific) considerations, but it should be noted that a different set of criteria may result from site-specific considerations. A more detailed description is provided in Price (2010).

Under near-neutral or alkaline, oxidized conditions, sulphide oxidation (Reaction 1) and dissolution of acidic sulphate minerals (Reaction 2) may produce acid. If not neutralized (Reaction 3), the acid will lower the pH.

Sulphide (pyrite) oxidation:  $\text{FeS}_2 + \text{O}_2 + \text{H}_2\text{O} \rightarrow \text{Fe}(\text{OH})_3 + 2\text{SO}_4^{2-} + 4\text{H}^+$  (1)

Acid sulphate (melanterite) dissolution:  $\text{FeSO}_4 \cdot 7\text{H}_2\text{O} + \text{O}_2 \rightarrow \text{Fe}(\text{OH})_3 + \text{SO}_4^{2-} + \text{H}_2\text{O} + 2\text{H}^+$  (2)

Acid neutralization by calcite:  $\text{CaCO}_3 + \text{H}^+ \rightarrow \text{Ca}^{2+} + \text{HCO}_3^-$  (3)

The most cost-effective means of predicting whether sulphidic geologic materials are PAG is based on the results of ABA, a series of compositional analyses (static tests) and calculations used to estimate the potential for a near-neutral or alkaline sample to produce acidic drainage if it is exposed to oxygen and water. Acid base accounting consists of:

- Analysis of pH (paste, soil, or rinse pH)
- Analysis of acid generating sulphur species and calculation of acid potential (AP)<sup>[1]</sup>
- Analysis of neutralization potential (NP)
- Calculation of NP/AP (NPR) and NP-AP (NNP)

The pH analysis measures the chemical effect of particle surfaces on drainage pH and indicates if a sample is already able to produce acidic drainage.

The future potential for sulphidic geologic materials with a near-neutral or alkaline pH to produce acidic drainage if exposed to oxygen and water depends on the relative concentration and reaction rates of acid generating sulphur minerals (AP) and neutralizing minerals (NP). The relative magnitude of the NP and AP is indicated by the NP/AP or NPR. AP and NP are reported as kg CaCO<sub>3</sub> equivalents/tonne so they can be compared. A factor of 31.25 is used to convert % S to kg CaCO<sub>3</sub> equivalents/tonne based on the assumption that 1 mole of sulphur produces 2 moles of H<sup>+</sup> (Reaction 1 and 2) and 1 mole of calcite (CaCO<sub>3</sub>) neutralizes 2H<sup>+</sup> (Reaction 3) as follows:

$\text{AP} = 31.25 (\% \text{ sulphide-S} + \% \text{ acid sulphate-S})$

Acid neutralization by calcite:  $\text{CaCO}_3 + \text{H}^+ \rightarrow \text{Ca}^{2+} + \text{H}_2\text{CO}_3$  (4)

Acid neutralization by calcite:  $\text{CaCO}_3 + \text{H}^+ \rightarrow \text{Ca}^{2+} + \text{HCO}_3^-$  (5)

There are two neutralization reactions for calcite. Reaction 4 predominates below pH 6.3. Reaction 5, which requires twice as much NP to neutralize each mole of H<sup>+</sup>, predominates at higher pH. Reaction 4 is assumed in the calculation of AP (%S x 31.25). With reaction 4, an NPR < 1 is required to produce ARD. With reaction 5, an NPR > 2 is required to prevent ARD. Under near-neutral pH conditions, micro-sites with both reaction 4 and 5 are likely to occur. Consequently, the NPR required to generate ARD will be between 1 and 2. This is why the ratio of NP depletion (moles Ca + Mg) to AP depletion (moles sulphate) measured in humidity cells is typically between 1 and 2 (Figure 5-17).

**Figure 5-17: Molar ratio of (Ca+Mg)/SO<sub>4</sub> representing sample specific NPR values (y-axis) versus time in weeks (x-axis) for two humidity cells (from Price, 2010)**

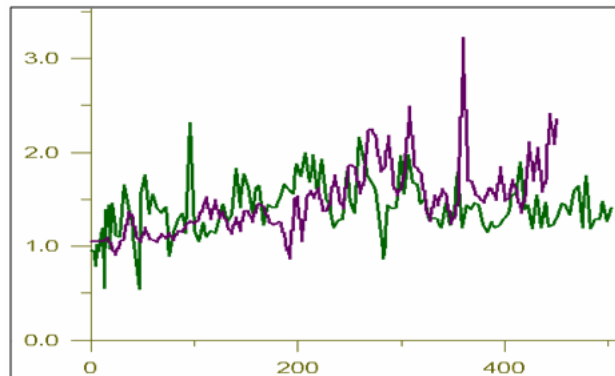

Assuming that the measurements of AP and NP are correct, samples are (Figure 5-18):

- Potentially net acid generating (PAG) if NP/AP < 1
- Not potentially net acid generating (non-PAG) if NP/AP > 2
- Uncertain if NP/AP is between 1 and 2



**Figure 5-18: AP versus NP (from Price, 2010)**

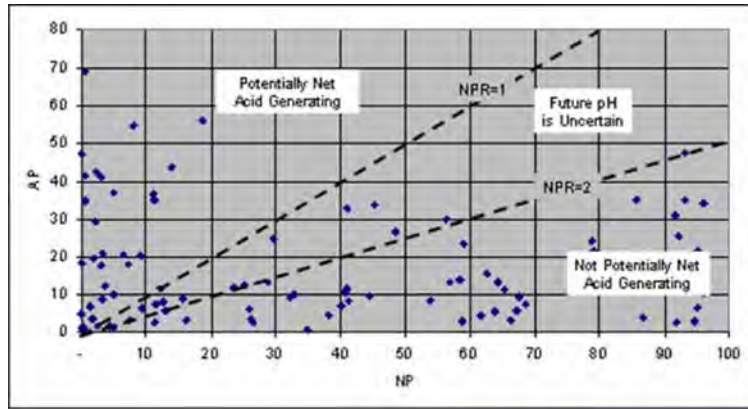

Safety factors may need to be added to these criteria to address limitations in the precision or accuracy in sampling, material handling or prediction of the NP and AP. There are many opportunities for over or under estimating the AP and NP (Price, 2009). For instance, preferential deposition of heavier sulphide minerals may result in a tailings beach having a higher AP than the tailings leaving the processing plant. The exposed AP of waste rock may be higher than predicted by analysis of pre-mine drill core or pre-blast hole chips, if sulphides preferentially report to waste rock fines (Table 5-5). Rock types differ in their surface area and therefore their relative contribution to the overall waste rock composition. If PAG waste rock is highly sericitic, it “opens up” like a book, exposing all its AP. In contrast, non-PAG waste rock with most of the NP may be very hard, with relatively little reactive surface area. The net result is a much lower effective NP/AP ratio than predicted by the relative masses of the two rock types and, consequently, a much greater likelihood for generation of ARD.

**Table 5-5: AP and NP of > 2 mm and < 2 mm waste rock particle size fractions (from Price, 2010)**

	> 2 mm	< 2 mm	< 2 / > 2
AP (kg CaCO <sub>3</sub> /t)	86	257	3.0
NP-Sobek (kg CaCO <sub>3</sub> /t)	32	44	1.4

Oxidation of thiosalts from mineral processing may acidify a tailings water cover (Reaction 6). Oxidation of ammonium (NH<sub>4</sub><sup>+</sup>) from blasting powder, fertilizer and cyanide decomposition may also acidify a tailings water cover (Reaction 7 and Figure 5-19). An initial decline in seepage pH may result from the exchange of cations in the neutral mine drainage for H<sup>+</sup> in acidic organic soils below a waste rock dump (Reaction 8 and Figure 5-20).

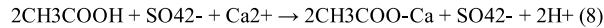
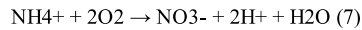
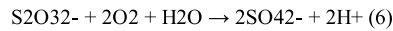

**Figure 5-19: A decline in drainage pH resulting from the oxidation of ammonium (from Price, 2010)**

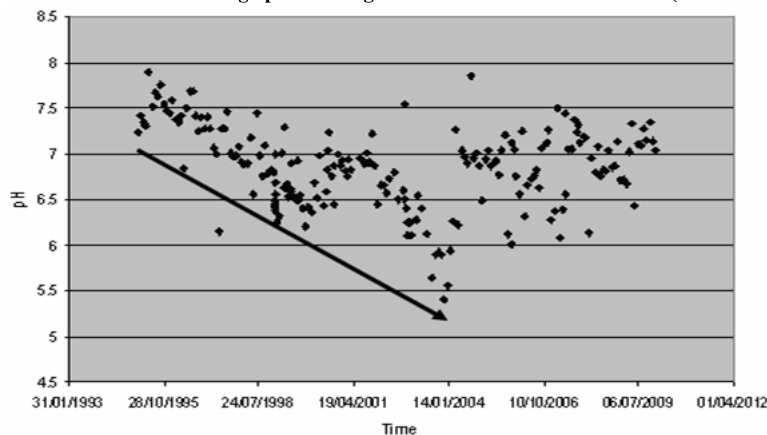

**Figure 5-20: An initial decline in seepage pH from exchange of cations in neutral mine drainage for H<sup>+</sup> in acidic organic soils below a waste rock dump (from Price, 2010)**

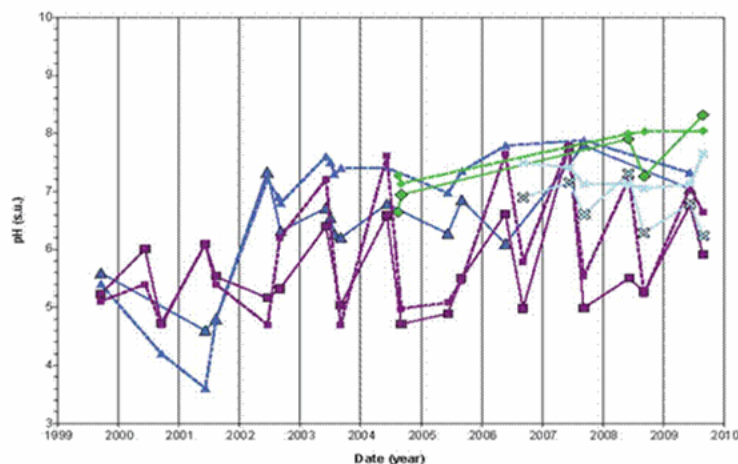

Other sources of acid in addition to sulphide and acidic sulphate minerals include naturally acidic groundwater and runoff from surrounding areas of sulphide mineralization (Price, 2005a).

The criteria for acid generation potential based on the NPR can be summarized as follows:

**Criterion: Sample is PAG if  $NPR < 1$ .** This criterion is true if there are no “errors” in the estimation of effective NP and AP. Possible errors include:

- Acid generated from AP is neutralized by alternative sources in addition to the NP
- At a very low rate of sulphide oxidation, the neutralization capacity of silicates may be underestimated by NP analyses because their reaction is too slow to be completely measured during a relatively short period of acid digestion
- Sulphur minerals containing the sulphur used to calculate the AP may generate  $< 2$  moles of acid per mole of sulphur
- NP and AP measurements are made on whole samples (e.g., drill chips) of material in which NP is preferentially exposed on surfaces, while AP is unavailable within coarse particles

**Criterion: Sample is Non-PAG if  $NPR > 2$ .** This criterion is true if there are no “errors” in the estimation of effective NP and AP. Possible errors include:

- NP is depleted by acid produced in processes other than by acidic sulphate dissolution or sulphide oxidation, which in well-flushed humidity cells can include NP dissolution by the excess water
- NP produces less acid neutralization than calcite or is incapable of maintaining a near-neutral pH
- Sulphide or acid sulphate minerals may generate or release more than 2 moles of acid per mole of sulphur
- NP and AP measurements are made on whole samples (e.g., drill chips) of material in which AP is preferentially exposed on surfaces, while NP is unavailable within coarse particles

**Criterion:  $1 \leq NPR \leq 2$ .** Assuming no errors in the prediction of the effective AP and NP, the maximum NPR capable of generating ARD will be between 1 and 2. The classification of a sample with an NPR between 1 and 2 may remain “uncertain” until the NPR criterion is refined. The ‘minimum’ sulphur content capable of causing ARD depends on the type of sulphur and the magnitude of the NP. Mined rock often has an extremely low NP. For instance, at the East Kemptville Mine in Nova Scotia, humidity cell samples with 0.07 to 0.19% sulphide-S, NPR of 1 to 2 and  $NNP > 0$  produced acidic drainage (Morin and Hutt, 2006). Great care is required when working with materials containing low AP and NP levels because minor variations can significantly alter the predicted and resulting drainage chemistry. A sulphur cut-off should not be used to assess the ARD potential unless the minimum NP value is known. Even low levels of sulphide can produce ARD if the NP is insufficient to neutralize the resulting acid.

The magnitudes of NP combined with humidity cell measurement of NP removal rates provide rough estimates of the time to NP depletion. NP depletion of 2.5 to 5 kg CaCO<sub>3</sub>/tonne/year suggested it would take 36 to 72 years to deplete an NP of 180 kg CaCO<sub>3</sub>/tonne in the backfilled tailings sand in the Snip Mine (Price, 2005b). To support calculations of NP depletion and lag times to acid generation derived from laboratory testing, it is important to set up field test pads as soon as practicable to monitor weathering under field conditions in various geologic materials at the site (Price, 2009).

Observations such as “If this rock was potentially ARD generating, we would have already seen ARD in the dumps, some of which are over 50 years old.” are frequently encountered. However, an absence of ARD after extended periods does not prove it will not occur in the future because depletion of NP may take 10s to 100s of years. For example, it took more than 15 years before acidic drainage was observed at Island Copper, where waste rock contained only a moderate amount of NP (Figure 5-21, Morin and Hutt, 1997).

**Figure 5-21: Seepage pH versus time at the Island Copper Mine (from Morin and Hutt, 1997)**

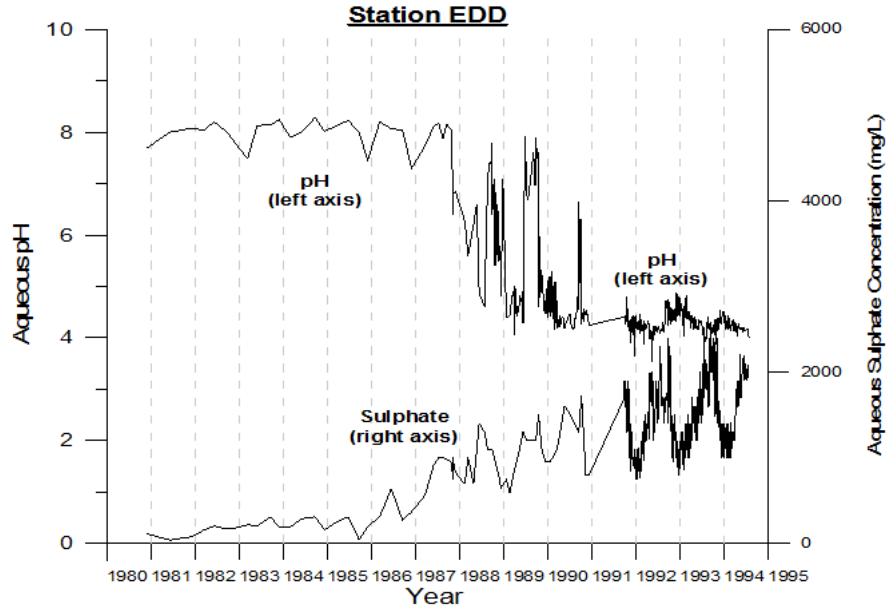

Other considerations regarding ABA criteria are as follows:

- Calculation of AP, NP and NPR typically assumes oxidizing conditions.
- The question is not whether a material generates acid, because everything generates some acid, but whether it will become net acid due to insufficient NP to neutralize the acid.
- The ARD potential of materials with an NPR between 1 and 2 will depend on the fate of alkalinity ( $\text{HCO}_3^-$ ) produced by the  $\text{pH} > 6.3$  neutralization reaction (Reaction 5).
- $\text{NNP} = \text{NP} - \text{AP}$  is additive rather than a ratio, and can therefore not distinguish between materials with an  $\text{NPR} > 2$  and an  $\text{NPR}$  1 to 2. Use of the NNP is not recommended for characterizing the future ARD potential (Figure 5-22).
- Drainage chemistry prediction should still be conducted if the  $\text{NPR} > 2$  because contaminant concentrations at near-neutral or alkaline pH may yet be above environmental guidelines (Stantec, 2004).

**Figure 5-22: NNP versus NPR for a Proposed Cu-Au Mine (from Price, 2010).**

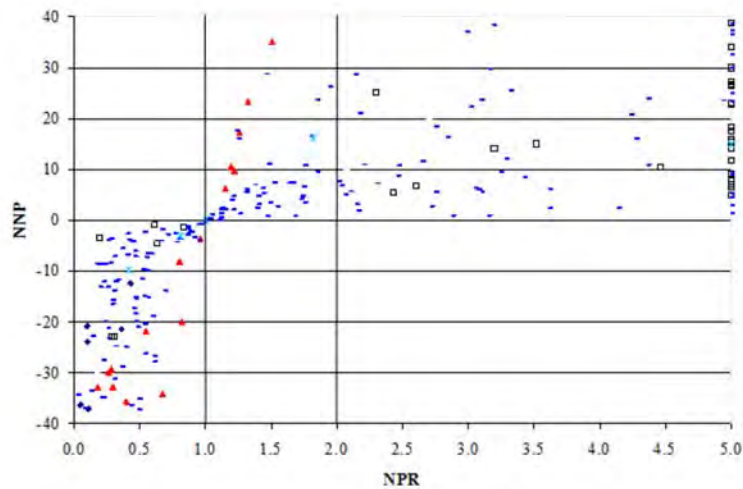

In summary, ABA criteria used to classify materials should be based on practical and theoretical (scientific) considerations. Criteria may provide short cuts, but one always needs to check whether the underlying assumptions or limitations apply to a specific situation. Mineralogical, elemental and humidity cell data are required to check assumptions about chemical species contributing to the ABA parameters and calculation results.

Numerical ABA criteria provided in guidance documents are sometimes misunderstood, used inappropriately and inaccurately described (e.g., the description of guidelines from Price [1997] in Maest et al. [2005]). Always consider the specific situations to which the criteria apply and the details concerning their use.

It is important to recognize that generic ABA criteria cannot substitute for an understanding of the natural environment, the project, the geological materials

and the requirements for protection of human health and the environment. Therefore, development of site-specific criteria is necessary based on measurable parameters and a well-informed assessment of the limitations of the results. Practitioners need to decide what information is required to make an assessment, under what conditions 'short cuts' are permitted, and when conditions deviate from the 'expected'. Sensitivity analyses and risk assessment are required to determine the quality and adequacy of the available information.

#### 5.4.16.2 Net Acid Generation Screening Criteria for the Net Acid Potential

Figure 5-23 is the Australian AMIRA (2002) decision tree for determining acid generation potential. Through use of a combination of results from NAG testing, partial ABA testing, and professional judgment, samples are categorized into a number of classes with a range of ARD potentials.

Figure 5-23: Decision Tree for the Determination of Acid Generation Potential (AMIRA, 2002)

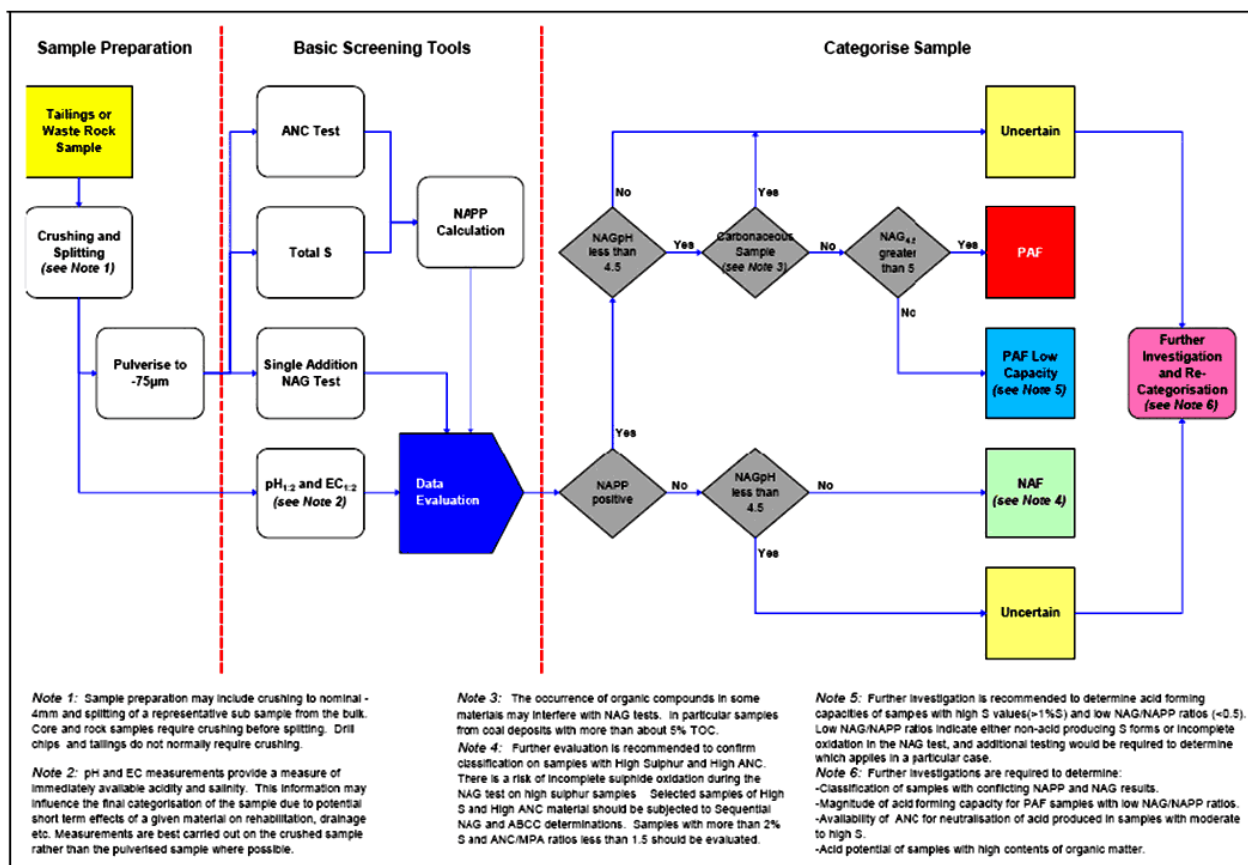

Note 1: Sample preparation may include crushing to nominal -4mm and splitting of a representative sub sample from the bulk. Core and rock samples require crushing before splitting. Drill chips and tailings do not normally require crushing.

Note 2: pH and EC measurements provide a measure of immediately available acidity and salinity. This information may influence the final categorisation of the sample due to potential short term effects of a given material on rehabilitation, drainage etc. Measurements are best carried out on the crushed sample rather than the pulverised sample where possible.

Note 3: The occurrence of organic compounds in some materials may interfere with NAG tests. In particular samples from coal deposits with more than about 5% TOC.

Note 4: Further evaluation is recommended to confirm classification on samples with High Sulphur and high ANC. There is a risk of incomplete sulphide oxidation during the NAG test on high sulphur samples. Selected samples of High S and High ANC material should be subjected to Sequential NAG and ABCC determinations. Samples with more than 2% S and ANC/MPA ratios less than 1.5 should be evaluated.

Note 5: Further investigation is recommended to determine acid forming capacities of samples with high S values (>15%) and low NAG/NAPP ratios (<0.5). Low NAG/NAPP ratios indicate either non-acid producing S forms or incomplete oxidation in the NAG test, and additional testing would be required to determine which applies in a particular case.

Note 6: Further investigations are required to determine:
 

- Classification of samples with conflicting NAPP and NAG results.
- Magnitude of acid forming capacity for PAF samples with low NAG/NAPP ratios.
- Availability of ANC for neutralisation of acid produced in samples with moderate to high S.
- Acid potential of samples with high contents of organic matter.

Notes:

ANC - Acid Neutralizing Capacity  
 NAG - Net Acid Generation  
 NAPP - Net Acid Production Potential  
 PAF - Potentially Acid Forming  
 NAF - Non Acid Forming  
 ABCC - Acid Base Characteristic Curve

#### 5.4.16.3 Other Screening Criteria

No specific NPR value is regulated in the European Union (EU); rather, site-specific values are developed. At some Australasian sites, an NPR value of 3 is conservatively assumed to be the threshold between potential acid generating and nonacid generating mine waste. However, use of a lower ratio is acceptable only if it can be demonstrated, based on site-specific information, that such a value is sufficiently protective. As with all screening criteria, the burden is on the proponent to demonstrate that these criteria are appropriate and defensible based on site-specific considerations.

Worldwide regulatory jurisdictions have adapted criteria for ARD potential, and some have been promulgated into law. When such criteria exist, their application is generally mandatory, unless use of appropriate and defensible site-specific criteria is allowed under the law. The selected criteria can vary and

an understanding of applicable regulations is needed when evaluating results from ABA and NAG tests for the purpose of prediction of ARD potential and identification of mine waste management requirements. Examples of such regulated criteria include an NPR threshold of 3 for nonacid generating waste in New Mexico, an NPR threshold of 1.2 in Nevada, (i.e., 20% excess base), and a three-pronged approach in Quebec based on sulphide content, NNP, and NPR. In Quebec, acid generating material is characterized by sulphide content greater than 0.3%, and, in the absence of confirmatory kinetic testing results, an NNP less than 20 kg CaCO<sub>3</sub>/tonne or an NPR less than 3. Figure 5-24 is an example plot of ABA results in which a number of screening criteria have been included, delineating the boundaries between materials with a different potential for ARD.

Figure 5-24: Example Plot of ABA Results and ARD Criteria

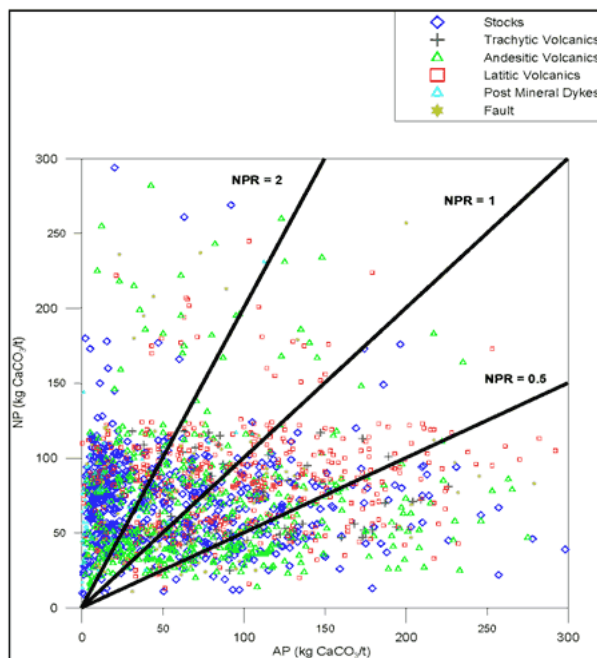

Regulatory criteria also exist for interpretation of results from certain leach tests specifically designed for classification of waste materials and compliance with water quality standards, as indicated in Table 5-1 and on Figure 5-17 (AMIRA, 2002). Examples of such tests include the TCLP, meteoric water mobility procedure (MWMP), and WET tests in the United States, the CEN-series tests in Europe, the Chinese GB tests, and the Brazilian Norma Brasileira Registrada (NBR) tests.

In general, kinetic test results need to be interpreted in the context of all available geochemical information. The following evaluation steps may be of assistance in the assessment of kinetic test results:

- Temporal trends of acidity, alkalinity, sulphate, and pH used to assess rates of acid production and consumption
- Ratio of acid production (using sulphate) vs. acid consumption (using calcium, magnesium, alkalinity) to assess relative rates
- Comparison between observed sulphate generation rate and literature values (Morin, 1997)
- Comparison between observed metal concentrations and water quality objectives (A direct comparison generally should only be used as a screening tool, and should take into account the differences in solid to liquid ratio between the test and the ambient environment.)
- Comparison between kinetic test results and findings from ABA, NAG test, mineralogy, static leach testing, and field water quality
- Comparison between kinetic test results and water quality from analog sites (i.e., geo-environmental approach)
- Geochemical modeling to identify controls on leachate composition
- Development of relationships between sulphate concentrations and those of constituents of interest that can be extrapolated to field conditions through sulphide oxidation modeling or calibrated against field measurements of sulphide oxidation

In the absence of regulatory criteria, and frequently in addition to regulatory criteria, site-specific screening criteria should be developed. These criteria should be based on a thorough geochemical characterization of the material at hand. Results from ABA, NAG testing, mineralogical examination, leach testing, and kinetic testing are used to develop an internally consistent understanding of acid generating potential, culminating in identification of a small number of criteria (generally one or two) that can be used to reliably classify mining wastes and geologic materials according to their ARD potential. To be of value in an operational setting, these criteria need to be based on parameters that can be rapidly determined onsite with a high degree of confidence. Visual methods (e.g., rock type, alteration type, pyrite content) and laboratory determination of total sulphur (Leco), sulphide sulphur (Leco minus weak acid soluble-S), Sobek NP, total carbon (Leco), inorganic carbon (HCl soluble), NCV, and NAG pH are the most commonly used operational waste management tools.

Although development of screening criteria is commonly aimed at identifying the net acid generation potential of a mine waste or geologic material, the process of evaluation of potential environmental impacts should not stop there. The material classified as non net-acid generating should still be assessed for drainage quality. NMD and SD from non net-acid generating material may continue to be a cause for concern even in the case of waste management strategies that include, for example, segregation of PAG from NPAG waste rock or encapsulation of PAG rock by NPAG rock.

#### 5.4.17 Reporting

Reporting is an integral part of an ARD-related study. In addition to including tabulations of analytical results, reported information needs to be presented in a format that provides proper interpretation. This requires calculation of descriptive statistics and use of a variety of graphical representations developed for evaluation of results from ABA, NAG testing, and kinetic testing. Price (2009) or Wolkersdorfer (2008) provide a comprehensive overview of the most commonly used table templates, calculation sheets, and graphs.

These procedures must be documented and submitted as part of the report because the reviewer of an ARD study may not be familiar with all analytical and sampling procedures. Also important is a discussion of QA/QC aspects and their bearing on data reliability and defensibility.

At a minimum, the report needs to contain all predictions of environmental behaviour, including the approach and tools used (e.g., geochemical modeling code, statistical software), assumptions incorporated in the predictions, the prediction results, and a discussion of uncertainties and limitations associated with the predictions. Frequently, a report will also include recommendations for further activities related to data collection or evaluation, an interpretation of results in terms of potential environmental impacts, and an assessment of measures that can be used to prevent, minimize, or mitigate such potential effects.

1. ↑ The acid potential is also referred to as the maximum potential acidity (MPA), expressed in the units of kg H<sub>2</sub>SO<sub>4</sub>/t and calculated as follows:  
MPA (kg H<sub>2</sub>SO<sub>4</sub>/t) = 30.6 x S(%)



# Chapter 5c

## From GARDGuide

### 5.0 Prediction

5.1 Introduction

5.2 Objectives of Prediction Program

5.3 The Acid Rock Drainage Prediction Approach

5.3.1 Acid Rock Drainage/Metal Leaching Characterization

5.3.2 Description of Phases

5.3.3 Water Quality Prediction

5.4 Prediction Tools

5.4.1 Introduction

5.4.2 Geological and Lithological Investigations

5.4.3 Hydrogeological/Hydrological Investigations

5.4.4 Introduction to Geochemical Characterization

5.4.5 Sample Storage and Preparation Prior to Analysis

5.4.6 Summary of Testing Requirements

5.4.7 Physical Characteristics

5.4.8 Total and Near-Total Solid-Phase Elemental Concentration

5.4.9 Mineralogical Properties

5.4.10 Net Acid or ARD Potential

5.4.11 Short-Term Leach Tests

5.4.12 Laboratory Kinetic Tests

5.4.13 Field Methods

5.4.14 Data Management

5.4.15 Quality Assurance/Quality Control

5.4.16 Screening and Evaluation Criteria

5.4.17 Reporting

5.5 Modeling of Acid Rock Drainage, Neutral Mine Drainage, and Saline Drainage for Characterization and Remediation



- 5.5.1 Introduction
- 5.5.2 Geochemical Modeling
- 5.5.3 Hydrological Modeling
- 5.5.4 Hydrogeological Modeling
- 5.5.5 Gas Transport Modeling
- 5.5.6 Statistical Evaluation

- 5.6 Conclusions
- 5.7 References
- List of Tables
- List of Figures

## **5.5 Modeling of Acid Rock Drainage, Neutral Mine Drainage, and Saline Drainage for Characterization and Remediation**

### **5.5.1 Introduction**

Modeling has significant value as a prediction and data management tool and for gaining an understanding of the geochemical, physical, and biological systems at mine and process sites (Oreskes, 2000). In principle, modeling can be applied to all mine and process facilities, including mine portal effluent, subsurface waters (wells or underground workings), waste dumps, process tailings piles, surface waters, pit lakes, and open pits. The type of modeling used depends on both the objectives and the type of source or pathway. A wide variety of codes are available for these various environments, but the critical factors are the quality of their databases of these codes, the inherent assumptions, and, most importantly, the knowledge and experience of the modeler.

Figure 5-25 presents a generalized approach to the development, calibration, and use of a model. The modeling process starts with a strong conceptual model and the mathematical model can then be used to update the conceptual model as necessary. Calibration of the model is a critical part of the overall process.

Figure 5-25: Generalized Model Process

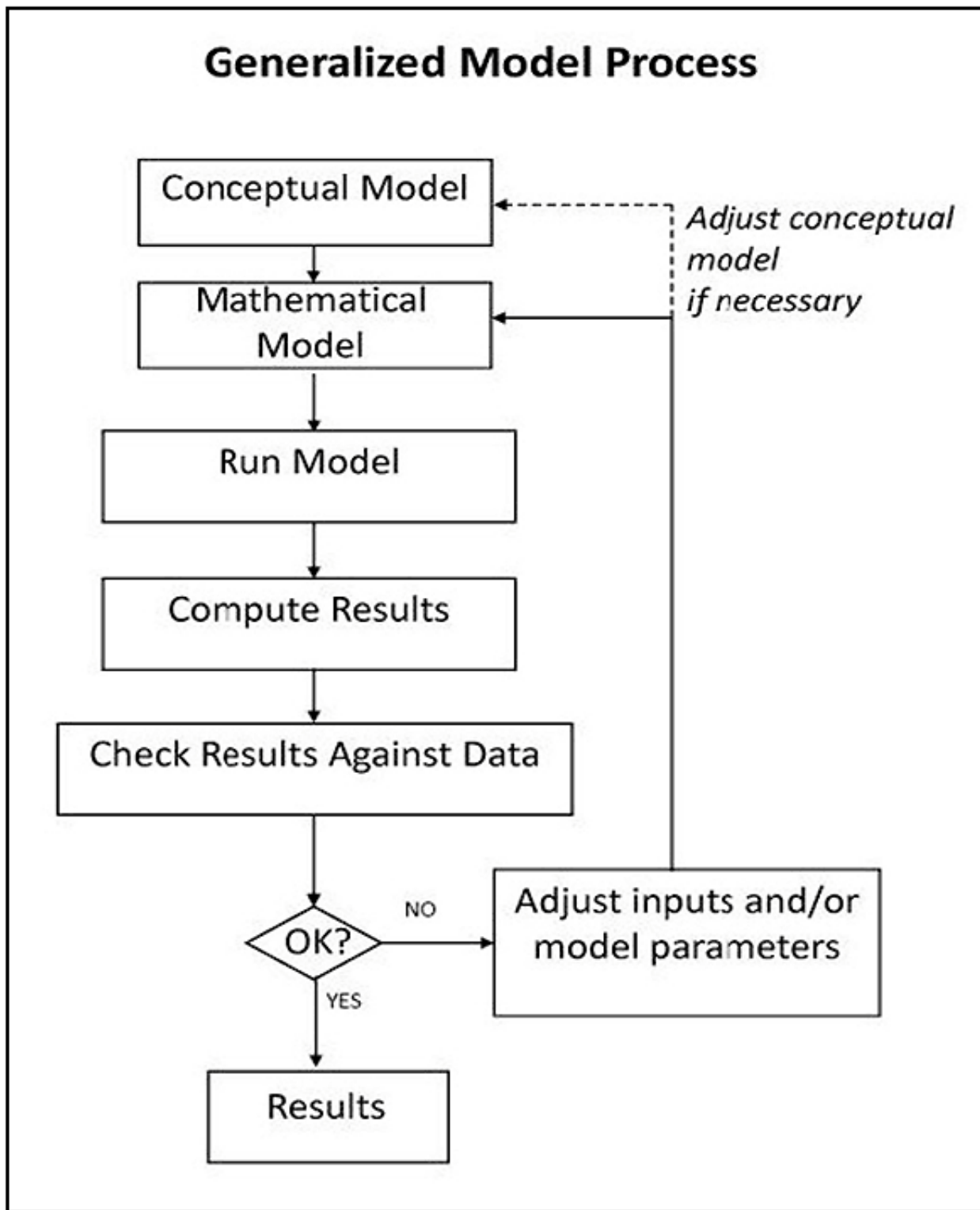

The nature and sophistication of the prediction effort may vary depending on the desired outcome. A prediction exercise aimed at merely answering a “yes/no” question (for example: will the water quality criterion for arsenic be exceeded?) requires less up-front understanding of the system being evaluated, in which case the use of relatively simple modeling tools may suffice. In

contrast, when a more quantitative answer is required (for example: what is the expected arsenic concentration), the complexity of the modeling effort may be quite significant, requiring both a detailed conceptualization of the system being modeled as well as use of advanced modeling codes. Care should therefore be exercised in selecting models so that they suit the need of the application and are compatible with the range and quality of the input data. The use of more sophisticated tools does not necessarily equate to more accurate and precise modeling outcomes. According to Oreskes (2000) and Nordstrom (2004), the current computational abilities of codes and advanced computers far exceed the ability of hydrogeologists and geochemists to represent the physical, chemical, and biological properties of the system at hand or to verify the model results. In light of these considerations, the meaning of “accuracy” and “precision” in the context of mine and process water quality modeling must be reassessed on a case-by-case basis, and numeric analysis needs to be conducted to reflect the uncertainty inherent in predictive modeling. USEPA (2003) recommends the following should be submitted at a minimum to substantiate modeling used for regulatory purposes, regardless of the specific model/code being used:

- Description of the model, its basis, and why it is appropriate for the particular use
- Identification of all input parameters and assumptions, including discussion of parameter derivation (i.e., by measurement, calculation or assumption)
- Discussion of uncertainty
- Sensitivity analysis of important input parameters

The general understanding of geologic materials, mine and process wastes, and the hydrogeochemical factors that govern mine and process water quality continues to advance through the implementation of laboratory and field experiments. In particular those experiments that isolate one variable at a time to identify its effect on overall discharge water quality are of great value. Similarly, ongoing characterization and monitoring of mine and process facilities allows for development of improved scaling factors needed to extrapolate results from smaller scale tests to an operational level. Also, the tools required for geochemical, hydrological, and hydrogeological modeling already exist. Therefore, modeling can be a valuable component of mine water quality prediction and for evaluating management and mitigation options.

Additional detail on geochemical, hydrological, and hydrogeological modeling, including listings of commonly-used codes, can be found here: **Modeling of ARD**.

[Top of this page](#)

### **5.5.2 Geochemical Modeling**

This section describes the conceptual, thermodynamic, and kinetic fundamentals of geochemical modeling and its application to prediction of mine water quality in support of mine site characterization and remediation. The emphasis in this section is on the basic processes that

models attempt to represent with discussions of the usefulness and the limitations of modeling.

Three basic approaches have been used with geochemical data: forward geochemical modeling, inverse geochemical modeling, and geostatistical analyses. Forward modeling is also known as simulating (i.e., potential reactions between rock and water are simulated from initial conditions of a known rock type and composition). Reactions are allowed to proceed in equilibrium or kinetic or combined modes. Changes in temperature and pressure can be invoked, changes in water flow rate can be assessed, and minerals can be allowed to precipitate as they reach equilibrium solubility or dissolve as they become undersaturated. Potential reactions can be simulated to see what the consequences are. This type of modeling is the least constrained. A great many assumptions are either invoked as input data or invoked as dictated by the program that may not apply to the specific system being simulated. This approach assumes the modeler has a significant amount of information on the ability of minerals to maintain equilibrium solubility or their rates of reaction.

Inverse modeling assumes a water flow path is known and that water samples have been analyzed along that flow path. Such data can then be converted into amounts of minerals dissolved or precipitated along that flow path. Several assumptions are still made regarding the choice of minerals and their relative proportions contributing to the water chemistry, but the calculations are constrained with actual data. Inverse modeling can also be done without any recourse to kinetic or thermodynamic data, in which case it represents a relatively simple mass balance calculation. When speciation and thermodynamic and kinetic properties are included for additional constraints, the possible reactions become quite limited and the modeling is much more meaningful.

Geostatistical modeling of geochemical data takes place as part of block model development, and is discussed in more detail in Chapter 4.

Modeling of any type does not lead to a unique solution but the possibilities are more limited with greater amounts of carefully collected field data. Martin et al. (2005) summarized the benefits and limitations of geochemical modeling as follows:

#### Benefits

- Set a ceiling on contaminant levels
- Provide insight into potential future conditions.
- Determine which variables are most important in determining future conditions.
- Assess the effects of alternative approaches to ARD management.
- Assess potential effects of uncertain parameters
- Establish objectives and test conditions for field and laboratory studies
- Integrate available information.

#### Limitations

- Insufficient input data
- Modeling can be challenging and results misinterpreted
- Uncertain and variability of the results
- Difference between modeled and actual field conditions.

Alpers and Nordstrom (1999) and Mayer et al. (2003) provide a review of geochemical models for use in mine water quality prediction.

### **5.5.3 Hydrological Modeling**

Generally, a hydrological model is an analog of a natural or human-modified hydrological system. This generic definition encompasses models of surface-water and groundwater systems. Scientists and engineers commonly use the term hydrological model to refer to models of surface-water systems, and consider hydrogeological models for groundwater systems as a separate subject. This section follows the latter convention, describing hydrological models in the context of surface-water systems.

Hydrological models range from simple algebraic calculations to complex reactive-transport computer codes. Physical analogs, such as stream tables, can also be useful simulations of complex surface-water systems. Hydrological models can be used to predict the fate and transport of mine drainage through a surface-water system, providing important input to human-health or ecological risk assessments. Hydrological models can also be used to estimate the water-quality and water-quantity evolution of pit lakes over time. Hydrological models can be coupled with hydrogeological and geochemical models to incorporate the interaction between surface water and groundwater into the simulation and account for geochemical reactions.

Selection of an appropriate, quantitative hydrological model depends on the type of output that is required and, critically, on the conceptual model of the system being evaluated. A robust conceptual model will identify the important physical and geochemical characteristics of the field-scale system being evaluated. Based on that identification, an appropriate hydrological model can be selected that quantitatively represents those important processes. For complex systems or to assess a range of different types of processes, multiple hydrological models can be applied to predict the fate, transport, and potential impacts of mine discharges.

### **5.5.4 Hydrogeological Modeling**

Hydrogeological models address water flow and contaminant transport below the land surface. As with hydrological models, approaches to hydrogeological simulations range from simple to

complex. The universe of hydrogeological models includes physical and electrical analogs. With the advent of powerful personal computers and high-level programming languages, these approaches are rarely used in current practice.

Much literature exists regarding hydrogeological modeling, as do a number of computer programs. Zheng and Bennett (2002) provide an excellent introduction to the topic of contaminant-transport modeling. Maest and Kuipers (2005) provide a review of hydrogeological models more directly focused on ARD prediction. Three following basic types of hydrogeological models are available, in order from simple to more complex:

1. Analytical models of flow and contaminant transport
2. Analytic element models
3. Numerical models

As a general rule, hydrogeological models should be as simple as possible while still representing the physical system with an adequate degree of precision and accuracy. More complex models should only be selected when project needs dictate, when simpler models are demonstrably not adequate, or when suitable data are available for model parameterization and calibration.

Hydrogeological models are useful tools for predicting the potential generation and resulting impacts of ARD. Models can be used to fill data gaps, either in space or in time. They can also be used to test alternative conceptual models in an iterative process designed to understand the complex natural or human-modified subsurface system.

### **5.5.5 Gas Transport Modeling**

Gas transport, particularly the transport of oxygen into unsaturated waste-rock piles, can be an important process affecting the generation of ARD. Principal modes of oxygen transport include diffusion and advection. Wels et al. (2003) provide a comprehensive overview of the role of gas transport in ARD generation and methods that can be used to model gas transport.

Relatively few models have been developed specifically to address gas transport in the subsurface and the application to ARD-related problems. Modeling the complete set of physical and chemical processes operating within a waste-rock pile requires a multiphase code capable of simulating gas and water flow in the unsaturated zone, chemical interactions with the solid matrix, heat generation and transfer, and chemical mass transfer in the liquid and gas phases.

### **5.5.6 Statistical Evaluation**

The use of statistics can be helpful in finding groupings and correlations among many parameters in a large data set. For instance, water quality results may be grouped into sets that may relate to hydrogeochemical processes. However, caution should always prevail. Statistics is a form of mathematics and supports and helps to understand science and engineering. Statistical results demonstrate correlations or the lack thereof but are nondeterministic. Parameters can correlate but not be deterministically related. Correlated parameters may indicate unknown relationships that were overlooked. Several types of multivariate correlative manipulations using regression techniques are in common use (Davis, 2003), including Principal Component Analysis (PCA), Cluster Analysis (CA), Probability Distributions (PD), and Factor Analysis (FA). These and other techniques often depend on assuming certain characteristics for the data set that are not necessarily correct (e.g., data follow a normal distribution, sufficient data are available to apply statistical tests, and levels of variance are comparable among parameters being correlated). Perhaps the best uses of statistical methods are for reasonable interpolation of spatial or temporal data and for identifying potentially causal parameters that had not previously been recognized.

## 5.6 Conclusions

Mine waste characterization and water quality prediction are integral components of any study related to ARD. As described in this chapter, a standard and structured methodology is used, particularly for new mine development. National regulatory frameworks and global guidelines frequently incorporate elements of this approach. Defensible ARD/ML and water quality predictions are being developed using state-of-the-art techniques by knowledgeable practitioners.

## 5.7 References

Alpers, C.N., and D.K. Nordstrom, 1999. Geochemical Modeling of Water-Rock Interactions in Mining Environments. In: G.S. Plumlee and M.J. Logsdon (Eds.), *The Environmental Geochemistry of Mineral Deposits, Part A: Processes, Techniques and Health Issues*, Reviews in Economic Geology Vol. 6A, Society of Economic Geologists, Inc., 289-324.

AMIRA International, 2002. ARD Test Handbook. Project P387A Prediction & Kinetic Control of Acid Mine Drainage, Ian Wark Research Institute and Environmental Geochemistry International Pty Ltd.

Bellefontaine, K. and W.A. Price, 2006. Environmental Management Plans: A Key Tool in Ensuring Successful Long-Term Environmental Management at Closed Mine Sites with ML/ARD. in *Proceedings of 7th International Conference on Acid Rock Drainage*, St.

Louis, Missouri, March 26-30.

Block, F., Tarantino, J., Hornberger, R., Brady, K., Donovan, J., Sames, G., and W. Chisholm, 2000. Overburden sampling considerations. In: R.L.P. Kleinmann (Ed.), Prediction of Water Quality at Surface Coal Mines, National Mine Land Reclamation Center, West Virginia University, Morgantown, WV, 140-167.

Brady, K.B.C., 1998. Groundwater chemistry from previously mined areas as a mine drainage quality prediction tool. In: K.B.C. Brady, M.W. Smith and J. Schueck (Eds.), Coal Mine Drainage Prediction and Prevention in Pennsylvania, Pennsylvania Department of Environmental Protection, Harrisburg, PA, 9:1-21.

Brady, K., and R.J. Hornberger, 1990. A Manual for Premining Prediction of Coal Mine Drainage Quality. Pennsylvania Department of Environmental Resources, Harrisburg, PA.

Brady, K.B.C., Hornberger, R.J., and G. Fleeger, 1998. Influence of geology on post-mining water quality: Northern Appalachian Basin. In: K.B.C. Brady, M.W. Smith, and J. Schueck (Eds.), Coal Mine Drainage Prediction and Prevention in Pennsylvania, Pennsylvania Department of Environmental Protection, Harrisburg, PA, 8:1-92.

Brady, K., Perry, E., Beam, R., Bisko, D., Gardner, M., and J. Tarantino, 1994. Evaluation of acid-base accounting to predict the quality of drainage at surface coal mines in Pennsylvania, USA. In: Proceedings of the International Land Reclamation and Mine Drainage Conference, U.S. Bureau of Mines SP-06A-94, Pittsburgh, PA.

Brady, K.B.C., Shaulis, J.R., and V.W. Skema, 1988. A study of mine drainage quality and prediction using overburden analysis and paleoenvironmental reconstructions, Fayette County, Pennsylvania. In: Proceedings of the Mine Drainage and Surface Mine Reclamation Conference, U.S. Bureau of Mines IC 9183, Pittsburgh, PA, 33-43.

British Columbia Acid Mine Drainage Task Force (BCAMDTF), 1989. Draft Acid Rock Drainage Technical Guide, Vol. 1, August.

Caruccio, F.T., and G. Geidel, 1982. The geologic distribution of pyrite and calcareous material and its relationship to overburden sampling. In: Proceedings of The Role of Overburden Analysis in Surface Mining, U.S. Bureau of Mines IC 8863, Wheeling, WV, 2-12.

Davis, J.C., 2003. Statistics and Data Analysis in Geology. Wiley International, New York, NY.

Day, S. and K. Sexsmith, 2005. Prediction of selenium leaching. In: W.A. Price and K.



Bellefontaine (eds.) Challenges in the Prediction of Drainage Chemistry. Proceedings of 12th British Columbia MEND Metal Leaching and Acid Rock Drainage Workshop, Vancouver, British Columbia, November 30 - December 1.

Erickson, P.M., and R.S. Hedin, 1988. Evaluation of overburden analytical methods as means to predict post-mining coal mine drainage quality. In: Proceedings of the Mine Drainage and Surface Mine Reclamation Conference, U.S. Bureau of Mines IC 9183, Pittsburgh, PA, 11-19.

Frostad, S., W.A. Price and H.G. Bent, 2003. Operational NP Determination – Accounting for Iron Manganese Carbonates and Developing a Site-Specific Fizz Rating. In: Proceedings of Sudbury 2003: Mining and the Environment Conference, Sudbury, Ontario, May 24-29.

Geidel, G., Caruccio, F.T., Hornberger, R., and K. Brady, 2000. Guidelines and recommendations for use of kinetic tests for coal mining (AMD) prediction in the eastern U.S. In: R.L.P. Kleinmann (Ed.), Prediction of Water Quality at Surface Coal Mines, National Mine Land Reclamation Center, West Virginia University, Morgantown, WV, 99-139.

Grube, W.E., Smith, R.M., Singh, R.N., and A.A. Sobek, 1973. Characterization of coal overburden materials and minesoils in advance of surface mining. In: Proceedings of Symposium on Mined Land Reclamation, NCA/BCR, Pittsburgh, PA, 134-151.

Gu, Y, 2003. Automated Scanning Electron Microscope Based Mineral Liberation Analysis - An Introduction to JK/MRC/FEI Mineral Liberation Analyser. Journal of Minerals & Materials Characterization & Engineering. 2(1): 33-41.

Guerin, F., Wilson, S and R. Nicholson, 2006. Optimizing In-Pit Disposal of Problematic Waste Rock Using Leaching Tests, Portable XRF, Block and Mass Transport Models. In: Proceedings of 13th British Columbia - MEND Metal Leaching/Acid Rock Drainage Workshop, Challenges with Open Pits and Underground Workings. Vancouver, British Columbia, November 29-30.

Hageman, P.L., 2007. U.S. Geological Survey field leach test for assessing water reactivity and leaching potential of mine-wastes, soils, and other geologic and environmental materials. U.S. Geological Survey Techniques and Methods, Book 5, Chapter D3. <http://pubs.usgs.gov/tm/2007/05D03/>

Hammack, R.W., 1987. Evolved gas analysis – a new method for determining pyrite, bicarbonate, and alkaline earth carbonates. In: Proceedings of the 8th West Virginia Surface Mine Drainage Task Force Symposium, Morgantown, WV.

Hornberger, R.J., and K.B.C. Brady, 1998. Kinetic (leaching) tests for the prediction of mine drainage quality. In: K.B.C. Brady, M.W. Smith and J. Schueck (Eds.), Coal Mine Drainage Prediction and Prevention in Pennsylvania, Pennsylvania Department of Environmental Protection, Harrisburg, PA, 7:1–54.

<http://www.dep.state.pa.us/dep/deputate/minres/districts/cmdp/chap07.html>

Hornberger, R.J., Brady, K.B.C., Scheetz, B.E., White, W.B., and S.C. Parsons, 2005. ADTI-WP2 Leaching Column Method for Overburden Analysis and Prediction of Weathering Rates. In: Proceedings of the West Virginia Surface Mine Drainage Task Force Symposium, Morgantown, WV.

<http://wvmdtaskforce.com/proceedings/05/Hornberger.pdf>

Jambor, J.L., 2003. Mine-Waste Mineralogy and Mineralogical Perspectives of Acid-Base Accounting. In: J.L. Jambor, D.W. Blowes and A.I.M. Ritchie (Eds.), Environmental Aspects of Mine Wastes, Short Course Series Vol. 31, Mineralogical Association of Canada, 117-146.

Lapakko, K.A., 2003. Developments in Humidity-Cell Tests and Their Application. In: J.L. Jambor, D.W. Blowes and A.I.M. Ritchie (Eds.), Environmental Aspects of Mine Wastes, Short Course Series Vol. 31, Mineralogical Association of Canada, 147-164.

Leavitt, B., Skousen, J., and P. Ziemkiewicz, 1995. Effects of siderite on the neutralization potential in the acid-base account. In: Proceedings of the 16th West Virginia Surface Mine Drainage Task Force Symposium, Morgantown, WV.

Lotter, N.O., P.J. Whittaker, L. Kormos, J.S. Stickling and G.J. Wilkie, 2002. The development of process mineralogy at Falconbridge Limited and application to the Raglan Mill. In: Proceedings of the 34th Annual Meeting of the Canadian Mineral Processors, Ottawa, Ontario, January 22-24.

Maest, A.S., and J.R. Kuipers, 2005. Predicting Water Quality at Hardrock Mines: Methods and Models, Uncertainties and State-of-the-Art. Earthworks, Washington, DC.

Martin, J., Wiatzka, G., Scharer, J., and B. Halbert, 2005. Case Studies that Illustrate the Benefits, Limitations and Information Requirements of Geochemical Modelling. In: Proceedings of the 12th Annual British Columbia – MEND ARD/ML Workshop, November 30 and December 1, Vancouver, BC.

Mayer, U., Blowes, D.W., and E.O. Frind, 2003. Advances in Reactive-Transport Modeling of Contaminant Release and Attenuation from Mine-Waste Deposits. In: J.L. Jambor, D.W. Blowes and A.I.M. Ritchie (Eds.), Environmental Aspects of Mine Wastes, Short Course Series Vol. 31, Mineralogical Association of Canada, 283-302.

Mills, C., 1999. Acid Rock Drainage at Enviromine.  
<http://technology.infomine.com/enviromine/ard/home.htm>

Morin, K.A. and N.M. Hutt, 1997. Environmental Geochemistry of Minesite Drainage: Practical Theory and Case Studies. MDAG Publishing, Vancouver, BC.

Morin K.A. and N. M. Hutt, 2006. Is There a Solid-Phase Sulphide Level Below Which No ARD is Possible? MDAG Internet Case Study #21,  
[www.mdag.com/case\\_studies/cs21.html](http://www.mdag.com/case_studies/cs21.html).

Noll, D.A., Bergstresser, T.W., and J. Woodcock, 1988. Overburden Sampling and Testing Manual. Small Operator's Assistance Program, Pennsylvania Department of Environmental Resources, Harrisburg, PA.

Nordstrom, D.K., 2004. Modeling Low-Temperature Geochemical Processes. In: H.D. Holland and K.K. Turekian (Eds.), Treatise on Geochemistry, Vol. 5, Surface and Ground Water, Weathering and Soils, Elsevier Ltd.

Oreskes, N., 2000. Why predict? Historical perspectives on prediction in earth science. In: D. Sarewitz, R.A. Pielke Jr. and R. Byerly Jr. (Eds.), Prediction: Science, decision making, and the future of nature, Island Press, Washington, DC, 25-40.

Perry, E., 2000. Mine drainage prediction, a summary of concepts and processes. In: R.L.P. Kleinmann (Ed.), Prediction of Water Quality at Surface Coal Mines, National Mine Land Reclamation Center, West Virginia University, Morgantown, WV, 168-194.

Price, W.A., 1989. Factors Affecting Vegetation Establishment at the Kitsault Minesite. Ph.D. Thesis, Department of Soil Science, University of British Columbia. p 416.

Price, W.A., 1997. Draft Guidelines and Recommended Methods for the Prediction of Metal Leaching and Acid Rock Drainage at Mine sites in British Columbia. BC Ministry of Employment and Investment.

Price, W.A. and Y.T.J. Kwong, 1997. Waste Rock Weathering, Sampling and Analysis: Observations from the British Columbia Ministry of Employment and Investment Database. in Proceedings of Fourth International Conference on Acid Rock Drainage, Vancouver. Volume 1, p 31-46.

Price, W.A. and J. Errington, 1998. Guidelines for Metal Leaching and Acid Rock Drainage at Minesites in British Columbia, British Columbia Ministry of Energy and Mines. p. 86.

Price WA, 2005a. Case Studies of ML/ARD Assessment and Mitigation: Placement of the Sulphurets Waste Rock in Brucejack Lake. MEND Report 9.1b.

Price WA, 2005b. Case Studies of ML/ARD Assessment and Mitigation: Snip Gold Mine. MEND Report 9.1c.

Price, W.A, 2009. Prediction Manual of Drainage Chemistry from Sulphidic Geologic Materials. Mend Report 1.20.1 (December 2009)

Price, W.A, 2010. Acid Base Accounting Criteria Used in Prediction of Drainage Chemistry. International Mine Water Association (IMWA) 2010 Symposium, Sydney, Nova Scotia, September 5 - 9, 2010

Raudsepp, M. and E. Pani, 2001. Quantitative Phase Analysis of Tailings and waste Rock using the Rietveld Method and X-ray Powder Diffraction Data. In: W.A. Price (ed.) New Developments, Different Aspects of Prediction and the Use of Water Covers as a Mitigation Strategy. Proceedings of 8th Annual British Columbia MEM - MEND Metal Leaching and ARD Workshop, Vancouver, British Columbia, November 28-29.

Raudsepp, M. and E. Pani, 2003. Application of Rietveld Analysis to Environmental Mineralogy - Chapter 8. In: J.L. Jambor, D.W. Blowes and A.I.M. Ritchie (eds.) Environmental Aspects of Mine Wastes. Mineralogical Association of Canada Short Course Series, volume 31.

Rymer, T., and A. Stiller, 1989. Sampling for sulfur – how much is enough? *Minelands*, 1(1):3-4.

Shaw, S., 2005. Case Studies and Subsequent Guidelines for the Use of the Static NAG Procedure. In: Proceedings of the 12th Annual British Columbia – MEND ARD/ML Workshop. November 30 and December 1, Vancouver, BC.

Skousen, J.G., Renton, J., Brown, H., Evans, P., Leavitt, B., Brady, K., Cohen, L., and P. Ziemkiewicz, 1997. Neutralization potential of overburden samples containing siderite. *Journal of Environmental Quality*, 26(3):673-681.

Skousen, J., Perry, E., Leavitt, B., Sames, G., Chisholm, W., Cecil, C.B., and R. Hammack, 2000. Static tests for coal mining acid mine drainage prediction in the eastern U.S. In: R.L.P. Kleinmann (Ed.), Prediction of Water Quality at Surface Coal Mines, National Mine Land Reclamation Center, West Virginia University, Morgantown, WV, 73-98.

Skousen, J.G., Sencindiver, J.C., and R.M. Smith, 1987. A review of procedures for

surface mining and reclamation in areas with acid-producing materials. In: Proceedings of the 8th West Virginia Surface Mine Drainage Task Force Symposium, Morgantown, WV.

Skousen, S.W., Miller, S., and R. Smart, 2006. Advances in acid rock drainage (ARD) characterization of mine wastes. In: R.I. Barnhisel (Ed.), Proceedings of the 7th International Conference on Acid Rock Drainage (ICARD), St. Louis, MO, 2098-2119, American Society of Mining and Reclamation (ASMR), Lexington, KY.

Sobek, A.A., Schuller, W.A., Freeman, J.R., and R.M. Smith, 1978. Field and Laboratory Methods Applicable to Overburdens and Minesoils. U.S. Environmental Protection Agency 600/2-78-054, Washington DC.

Stantec Consulting Ltd., 2004. Review of Water Quality Issues in Neutral pH Drainage: Examples and Emerging Priorities for the Mining Industry in Canada. MEND Report 10.1

Stewart, W., Schuman, R., Miller, S., and R. Smart, 2009. Development of prediction methods for ARD assessment of coal process wastes. In: Proceedings of the 8th International Conference on Acid Rock Drainage (ICARD), June 22-26, Skellefteå, Sweden, in prep.

Stumm, W. and J.J. Morgan, 1996. Aquatic chemistry, 3rd ed. New York: John Wiley & Sons, Inc.

Tarantino, J.M., and D.J. Schaffer, 1998. Planning the overburden analysis. In: K.B.C. Brady, M.W. Smith, and J. Schueck (Eds.), Coal Mine Drainage Prediction and Prevention in Pennsylvania, Pennsylvania Department of Environmental Protection, Harrisburg, PA, 5:1-9.

Thompson, A., Price, W.A., Dunne, K. and J. Jambor, 2005. Guidelines for the Determination of Mineralogy and Mineralogical Properties. In: W.A. Price and K. Bellefontaine (eds.). Challenges in the Prediction of Drainage Chemistry. Proceedings of 12th British Columbia MEND Metal Leaching and Acid Rock Drainage Workshop, Vancouver, British Columbia, November 30 - December 1.

United States Environmental Protection Agency (USEPA), 2003. EPA and Hard Rock Mining: A Source Book for Industry in the Northwest and Alaska. EPA 910-R-99-016.

West Virginia University, 1971. Mine spoil potentials for water quality and controlled erosion. U.S. Environmental Protection Agency OWP 14010 EJE, Washington, DC.

Wels, C., Lefebvre, R. and A.M. Robertson, 2003. An Overview of Prediction and Control of Air Flow in Acid-Generating Waste Rock Dumps. In: Proceedings of the 6th

International Conference on Acid Rock Drainage (ICARD), Cairns, Australia.

White III, W.W., Lapakko, K.A., and R.L. Cox, 1999. Static-Test Methods Most Commonly Used to Predict Acid-Mine Drainage: Practical Guidelines for Use and Interpretation. In: G.S. Plumlee and M.J. Logsdon (Eds.), *The Environmental Geochemistry of Mineral Deposits, Part A: Processes, Techniques and Health Issues*, Reviews in Economic Geology Vol. 6A, Society of Economic Geologists, Inc., 325-356.

Williamson, M.A., C.S. Kirby and J.D. Rimstidt, 2006. Iron Dynamics in Acid Mine Drainage. In: R.I. Barnhisel (ed.) *Proceedings of the Seventh International Conference on Acid Rock Drainage*, St. Louis, Missouri, USA, May 31-June 4, 2006. American Society of Mining and Reclamation (ASMR).

Wolkersdorfer, C., 2008. *Water Management at Abandoned Flooded Underground Mines*. Springer, Heidelberg.

Younger, P.L. and D.J. Sapsford, 2006. Acid Drainage Prevention Guidelines for Scottish Opencast Coal Mining: the Primacy of the Conceptual Model. In: R.I. Barnhisel (Ed.), *Proceedings of the 7th International Conference on Acid Rock Drainage (ICARD)*, St. Louis, MO, American Society of Mining and Reclamation (ASMR), Lexington, KY.

Zheng, C., and G.D. Bennett, 2002. *Applied Contaminant Transport Modeling*. Wiley-Interscience, New York, NY.

## **List of Tables**

Table 5-1: Methods for Geochemical Characterization

Table 5-2: Geologists Observations and Logging of Core for ARD Analysis

Table 5-3: Example Chemistry Table

Table 5-4: Example ABA Table

Table 5-5: AP and NP of > 2 mm and < 2 mm waste rock particle size fractions (from Price, 2010)

## **List of Figures**

Figure 5-1: Generic Prediction Program Flowchart

Figure 5-2: Generalized Flowchart for the ARD Prediction Approach at Mine Sites (after

Maest and Kuipers, 2005)

Figure 5-3: Conceptual Model Showing Metal and Acid Source Regions at Iron Mountain and Downstream Transport Pathways to the Sacramento River

Figure 5-4: Flowchart for Metal and Acid Source Regions at Iron Mountain and Downstream Transport Pathways to the Sacramento River

Figure 5-5: Schematic Illustration of Geochemical Characterization Program (modified from Maest and Kuipers, 2005)

Figure 5-6: Example Plot of NP from Total Carbon vs. NP from Modified Sobek

Figure 5-7: Example Plot of Total Sulphur vs. Sulphide Sulphur

Figure 5-8: ARD Rock Type Classification Plot Based on ABA and NAG Test

Figure 5-9: Example Plot of Metal Loadings vs. Sulphate Content

Figure 5-10: Humidity Cells

Figure 5-11: Example Plot of Kinetic Test Results

Figure 5-12: Wall Washing

Figure 5-13: Test Cells for Waste Rock

Figure 5-14: Test Plot for Paste Tailings – Somincor Neves Corvo Mine, Portugal

Figure 5-15: Example of Block Model Use: ARD Potential of Pit Highwall Above Final Pit lake

Figure 5-16: Example of Block Model Use: ARD Potential of Pit Wall after Cessation of Mining

Figure 5-17: Molar ratio of  $(Ca+Mg)/SO_4$  representing sample specific NPR values for two humidity cells

Figure 5-18: AP versus NP (from Price, 2010)

Figure 5-19: A decline in drainage pH resulting from the oxidation of ammonium (from Price, 2010)

Figure 5-20: An initial decline in seepage pH from exchange of cations in neutral mine drainage for  $H^+$  in acidic organic soils

Figure 5-21: Seepage pH versus time at the Island Copper Mine (from Morin and Hutt, 1997)

Figure 5-22: NNP versus NPR for a Proposed Cu-Au Mine (from Price, 2010)

Figure 5-23: Decision Tree for the Determination of Acid Generation Potential (AMIRA, 2002)

Figure 5-24: Example Plot of ABA Results and ARD Criteria

Figure 5-25: Generalized Model Process

# Table 5-1

From GARDGuide

Table 5-1: Methods for Geochemical Characterization

Return to: 5.3.2 Description of Phases

Test Type	Test Methods and Description	Use in Geochemical Characterization and Water Quality Prediction	Advantages	Limitations
Grain Size	Sieve	Predict reactivity on basis of available surface area	Relatively rapid, less expensive	Little information on fine fraction No information on "reactive" fraction
	Hydrometer		Information on fine fraction	More time consuming, more expensive No information on "reactive" fraction
	BET method		Sophisticated technique Information on "reactive" fraction through measurement of total and specific surface area	Time consuming and expensive Requires specialized equipment and personnel
Chemical Composition	Digestion using various acids for analysis by multiple quantitative techniques (ICP-AES, ICP-MS, AAS, NAA)	Determines total potential load of constituents to environment.	Comparison against site-specific baseline values and reference geologic materials Surrogate for and confirmation of ABA parameters (e.g., Ca, S) Surrogate for and confirmation of mineralogical composition Evaluation of sample set representativeness	Instrument-specific interferences Volatilization Elevated detection limits due to dilution
	Preparation of bead/powder sample for semi-quantitative analysis by XRF			
	Portable equipment (XRF)			
Paste pH/Paste Conductivity	Mixture of solution and solid in desired ratio (typically 1:1 to 5:1) followed by pH/electrical conductivity measurement	Determines potential short-term effect of surficial/soluble salts on water quality	Quick, inexpensive, easy to perform in field and laboratory Can be useful monitoring test for operational mine waste management	Lack of ability to predict long-term conditions Measures stored acidity
	<b>Sobek Method</b> AP commonly from total sulphur NP by boiling, HCl to pH 0.8-2.5	<b>All Methods:</b> Establish overall acid generating and acid neutralizing capability of a material through independent determination Identification of the need for and samples that require kinetic testing	<b>All Methods:</b> Most techniques well established Generally relatively fast and inexpensive Provide operational screening criteria for mine waste classification and management	<b>All Methods:</b> Provide no information on relative rates of acid generation and neutralization Assume NP and AG sulfur or minerals are completely available for reaction Can over- or under-estimate AG or NP depending on method used NPR cannot be calculated in the absence of sulphur and sulphide Acid addition dependent on a subjective fizz test which can affect accuracy
	<b>Modified Sobek (Lawrence Method)</b> AP from sulphide sulphur NP at ambient temperature for 24 hours near boiling, HCl to pH 2.0-2.5		Prevent over-estimation of NP or AP relative to Sobek method Widely used	
	<b>Lapakko</b> NP at ambient temperature up to 1 week, H2SO4 to pH 6.0			



<b>Acid Base Accounting (ABA)</b>	<b>BC Research Inc. (BCRI) Initial</b> NP at ambient temperature for 16-24 hours, H2SO4 to pH 3.5			
	<b>Sobek Siderite Correction</b> as Sobek, but with H2O2	Accounts for complete oxidation of soluble metals during titration	ASTM draft method uses sulphuric acid Requires no fizz test Uses pH to determine acid addition requirements Negative values indicate stored acid	
	<b>Net Carbonate Value (NCV), %CO2</b> NCV = ANP + AGP, where AGP = -1.37[(total sulphur) - (residual sulphur after pyrolysis)] ANP = 3.67[(total carbon) - (carb on after HCl digestion)] (=see TIC)	Developed by Newmont Negative ANP and positive AGP must be corrected to zero Negative NCV indicates acid generation potential Confirm NCV classification using BC Research Confirmation on zone composites	Standardized as ASTM E-1915 Waste rock composites characterized with metallurgical suite for ores Several options for sulphide confirmation depending on mineralogy Classification system limits uncertainty	Requires carbon-sulphur sophisticated combustion-infrared instrumentation similar to Sobek Results require conversion for comparison against data from other ABA tests in order to differentiate methods Metal carbonates overestimate ANP Does not account for silicate buffering or stored acidity
	<b>Acid Buffering Characteristic Curve (ABCC)</b> Titration of sample with acid while continuously monitoring pH	Provides an indication of the portion of the NP that is readily available for neutralization Used principally in Australia Similar in nature to the BCRI Initial test	Can be used to identify minerals responsible for neutralization by comparing against ABCCs for reference minerals Well suited for measuring actual NP vs. total NP Represents a less conservative method of measuring NP	Only feasible to do on selected samples due to long test time Limited basis for comparison against results from more "traditional" ABA tests due to limited use to date
	<b>Total Inorganic Carbon (TIC)</b> TIC = (total carbon) - (carbon after HCl digestion)		Measures NP associated with carbonates only	Only provides carbonate fraction of NP Can only be used in concert with total NP results Will include carbonates that do not contribute NP (e.g., siderite) Not suitable for materials with low NP
	<b>Sulphur Analysis</b> (total S, pyritic S, sulphide S, organic S, sulphate S, residual S) Analysis requires selective digestion of ground sample and measurement of sulphur by infrared or titration after combustion Removal of non-sulphide and/or targeted sulphide minerals to determine sulphur species	Potential of samples to generate acid Used as part of ABA testing	Distinguishes between sulphur forms and allows identification of "reactive" sulphur species	Does not confirm the identity of the sulphur-bearing mineral(s) Can overestimate or underestimate reactive sulphur content
	<b>Chromium Reducible Sulphur</b> Targets acid-volatile sulphur, elemental sulphur and pyrite sulphur through HCl digestion	Used principally in acid sulphate soils investigations. CRS is also useful for sulphide analysis in coal and coal reject materials	Considered a very reliable method for measuring low-level sulphur concentrations Only measures sulphide minerals	Limited basis for direct comparison against results from more "traditional" ABA tests
	<b>Total Actual Acidity (TAA)</b> Titration of KCl extract to pH 5.5 with NaOH		Can define actual acidity in low-pH samples that have oxidized	
<b>Total Potential Acidity (TPA)</b> Heating of KCl extract with H2O2 and titration to pH 5.5 with NaOH				
<b>Single addition NAG</b> Reaction with H2O2, measurement of the NAG pH and titration to pH 4.5	<b>All Methods:</b> Establishes overall acid generating capability of a material through	<b>All Methods:</b> Evaluates net acid-base balance Generally relatively fast and	<b>All Methods:</b> Does not distinguish between AP and NP	

<b>Net Acid Generating (NAG)</b>	and pH 7.0 with NaOH	simultaneous reaction of acid generating and acid neutralizing components Identification of the need for and samples that require kinetic testing Used in conjunction with ABA or stand alone field test when calibrated	inexpensive Provides operational screening criteria for mine waste classification and management Greatly reduces false positive and false negative ABA results Confirmation results for unreactive materials In combination with ABA improves prediction reliability and range of uncertainty	Potential interferences in presence of organic carbon and copper May underestimate ARD potential in high-sulphide material due to incomplete oxidation (Sequential NAG addresses this limitation) Quality of H <sub>2</sub> O <sub>2</sub> may vary: some H <sub>2</sub> O <sub>2</sub> brands required pre-treatment for NAG test use	
	<b>Sequential NAG</b> Multi-stage repeat of single-addition NAG tests until NAG pH is greater than 4.5				Overcomes incomplete oxidation in high-sulphur samples Can provide qualitative estimate of approximate lag time to acid generation
	<b>Extended Boil and Calculated NAG</b> As single addition NAG, but accounts for potential effect from organic matter Extended boiling and assay of the NAG solution for S, Ca, Mg, Cl, Na and K				Accounts for potential effect from organic matter
	<b>Kinetic NAG</b> As single addition NAG but with monitoring of temperature and pH during reaction with H <sub>2</sub> O <sub>2</sub>				Provides qualitative estimate of reaction kinetics and lag time (i.e., weeks, months, years)
<b>Mineralogical Composition</b>	<b>Visual/Optical Microscopy</b> Hand lens, binocular microscope	<u>All Methods:</u> Identify primary and secondary minerals that could affect acid generation potential and contact water quality With increasing sophistication of techniques, also information on texture, mineral composition and morphology to evaluate mineral reactivity and availability for weathering reactions that can affect acid generation and leaching potential	<u>All Methods:</u> Provide information on acid generating potential and NP, availability of minerals for weathering Corroborate lithologic information Essential for understanding of geochemical controls on contact water quality and as inputs to geochemical model simulations	Qualitative	
	<b>X-ray diffraction (XRD)</b> Qualitative or semi-quantitative (Rietveld) analysis			Semi-quantitative at best High detection limit ~1% Capable of identifying crystalline minerals only	
	<b>Petrographic analysis</b> Reflection or transmission petrographic microscope			Requires sophisticated instrumentation and specialized personnel for interpretation	
	<b>SEM/EDS</b> Electron beam scan for mineral identification			Surpasses combustion-infrared methods in quantifying trace sulfide mineral concentrations	
	<b>Electron microprobe</b> Like SEM but optimized for chemical analysis				
	<b>Portable equipment (PIMA)</b> Infrared analyzer			Portable Particularly suited for hydrated minerals	Not capable of identifying all minerals
	<b>SPLP (Synthetic Precipitation Leaching Procedure)</b> US EPA Method 1312	<u>All Methods:</u> Measures readily soluble constituents of mine and process wastes	<u>All Methods:</u> Provides indication of short-term leaching of soluble constituents.	<u>All Methods:</u> Provides no information on transient processes and long-term conditions.	

<p>20:1 solution to solid Deionized water or dilute sulphuric/nitric acid to pH 4.2 or 5.0 &lt; 9.5 mm 18 ± 2 hours Variant: <b>Standard Test Method for Shake Extraction of Mining Waste by the Synthetic Precipitation Leaching Procedure</b> ASTM D 6234</p>		Identifies readily dissolvable constituents	Only simulates short-term interaction High liquid to solid ratio may underestimate leachability Grain size reduction may increase reactivity
<p><b>TCLP (Toxicity Characteristic Leaching Procedure)</b> US EPA Method 1311 20:1 solution to solid ratio acetic acid/acetate buffer &lt; 9.5 mm 18 ± 2 hours</p>	Used to determine if waste is hazardous under RCRA Intended to simulate municipal landfill containing organic wastes	Applicable standards available	Use of acetic acid/acetate buffers not appropriate for mining applications, Short list of metals evaluated
<p><b>Meteoric Water Mobility Procedure (MWMP)</b> 1:1 solution to solid ratio reagent-grade water &lt; 2 inch &lt; 48 hours</p>	Same as for SPLP Primarily used in Nevada	Quasi-dynamic test More realistic than SPLP due to higher solid to solution ratio, longer duration and coarser material Applicable standards available	Weaker lixiviant than acidified SPLP
<p><b>California Waste Extraction Test (WET)</b> 10:1 solution to solid ratio dilute sodium citrate solution &lt; 2 mm 48 hours</p>	Intended to simulate municipal landfill containing organic wastes Primarily used in California	Lower liquid to solid ratio and longer test duration than SPLP and TCLP Applicable standards available	Use of sodium citrate not appropriate for mining applications
<p><b>Modified Test for Shake Extraction of Solid Waste with Water</b> 4:1 solution to solid ratio reagent-grade water adjusted to pH 5.5 with carbonic acid 18 hours</p>	Same as for SPLP	Lower liquid to solid ratio than SPLP	
<p><b>British Columbia Special Waste Extraction Procedure (BC SWEPE)</b> 20:1 solution to solid ratio acetic acid &lt; 9.5 mm 24 hours <b>Modification for mining wastes</b> 3:1 solution to solid ratio dilute hydrochloric acid</p>	Similar to TCLP for normal procedure Similar to SPLP and ASTM for modified procedure	Modified: lower solution to solid ratio than SPLP and ASTM	Intended to simulate municipal landfill containing organic wastes Same as for SPLP
<p><b>NAG Test with Leachate Analysis</b> 100:1 solution to solid ratio 15% H<sub>2</sub>O<sub>2</sub> solution &lt; 75 µm Until boiling or effervescing ceases</p>	Can be used to determine total potential loading or release of metals after complete oxidation of reactive sulphides	"Short-cut" to conditions representative of complete sulphide oxidation	Leachate contains all reaction products from sulphide oxidation High solution to solid ratio Significant grain size reduction
<p><b>Characterization of Waste - Leaching - Compliance Test for Leaching of Granular Materials and Sludge</b> EN 12457 1 One stage test 2:1 solution to solid ratio &lt; 4 mm EN 12457-2 One stage test 10:1 solution to solid ratio &lt; 4 mm</p>	<u>All European Union (EU) Methods:</u> Basic characterization: obtain information on leaching behavior and characteristics Compliance: determine whether waste complies with specific reference values	<u>All European Union (EU) Methods:</u> Test protocol is adjusted based on information needs and site-specific conditions Applicable standards available (expressed as loadings)	Same as for SPLP

Short-Term Leach Tests	EN 12457-3 Two stage test 2:1 and 8:1 solution to solid ratios < 4 mm EN 12457-4 One stage test 10:1 solution to solid ratio < 10 mm All Methods: distilled/demineralized/deionized water 24 hours			
	<b>Characterization of Waste - Leaching Behavior Tests - Up-flow Percolation Test</b> CEN/TS 14405 10:1 solution to solid ratio < 10 mm demineralized water duration as needed	Used to determine leachability of a waste under hydraulically dynamic conditions (EU)	Test can be used to establish the distinction between various release mechanisms (e.g., first flush vs. steady state leaching)	Same as for MWMP Test developed for landfills
	<b>Characterization of Waste - Leaching Behavior Tests - Influence of pH on Leaching with Initial Acid/Base Addition</b> CEN/TS 14429 10:1 solution to solid ratio at least 8 individual solutions of different pH using nitric acid or sodium hydroxide covering the range pH 4-12 95% < 1 mm 48 hours	Used to determine influence of pH on waste leachability and buffering capacity (EU)	Leachate analyzed for inorganic constituents (as opposed to prCEN/TS 15364) pH is allowed to fluctuate after initial addition of acid or base Allows evaluation of buffering capacity	Same as for SPLP Test developed for landfills
	<b>Characterization of Waste - Leaching Behavior Tests - Influence of pH on Leaching with Continuous pH-Control</b> EN 14997 10:1 solution to solid ratio at least 8 individual solutions of different pH using nitric acid or sodium hydroxide covering the range pH 4-12 95% < 1 mm 48 hours	Used to determine influence of pH on waste leachability (EU)	Leachate analyzed for inorganic constituents (as opposed to prCEN/TS 15364) pH is maintained at constant value after initial addition of acid or base Allows evaluation of leachability under constant pH	Same as for SPLP Test developed for landfills
	<b>Characterization of Waste - Leaching Behavior Tests - Acid and Base Neutralization Capacity Test</b> CEN/TS 15364 10:1 solution to solid ratio at least 8 individual solutions of different pH using nitric acid or sodium hydroxide covering the range pH 4-12 95% < 1 mm 48 hours	Used to determine final pH of a waste as well as assess consequences of external influences (carbonation, oxidation) on the final pH (EU)		Same as for SPLP Test developed for landfills Leachate only analyzed for pH
	<b>Lixiviação de Resíduos</b> NBR 10005 16:1 solution to solid ratio acetic acid < 9.5 mm 24 hours	Used to determine if mine waste is hazardous under solid waste regulations (Brazil) Intended to simulate municipal landfill containing organic wastes	Applicable standards available	Use of acetic acid not appropriate for mining applications
	<b>Solubilização de Resíduos</b> NBR 10006 4:1 solution to solid ratio deionized water grain size not specified 7 days	Used to evaluate potential for impacts to groundwater by comparison against groundwater quality standards (Brazil)	Applicable standards available Lower solution to solid ratio and longer duration than SPLP	Same as for SPLP
				2014-10-21

	<p><b>Test Method Standard for Leaching Toxicity of Solid Wastes - Roll Over Leaching Procedure</b> GB5086.1-1997 10:1 solution to solid ratio deionized/distilled water &lt; 5 mm 18 hours</p>	Used to determine if mine waste is hazardous under solid waste regulations by comparison against Integrated Wastewater Discharge Standards (China)	Applicable standards available	Same as for SPLP
	<p><b>Test Method Standard for Leaching Toxicity of Solid Wastes - Horizontal Vibration Extraction Procedure</b> GB5086.2-1997 10:1 solution to solid ratio deionized/distilled water &lt; 3 mm 24 hours</p>	Used to determine if mine waste is hazardous under solid waste regulations by comparison against Integrated Wastewater Discharge Standards (China)	Applicable standards available	Same as for SPLP
	<p><b>Sequential Extraction</b> Variety of methods using different extractants to evaluate leachability from targeted fractions of mine waste Methods may vary depending on analyte of interest and target fraction of interest</p>	To evaluate associations between constituents of interests and different fractions of the solid Allows for determination of the labile portion of the solid phase	Understanding associations of constituents with different fractions of the solid assists in understanding geochemical conditions under which they may be released to the environment	Involved procedure Many reagents Most reagents not uniquely selective to targeted fraction Use of some reagents precludes analysis of certain constituents No applicable standards
Long-Term Leach Tests	<p><b>Humidity Cell Test (HCT)</b> ASTM D5744-96 0.5:1 or 1:1 solution to solid ratio deionized water different dimensions for &lt; 6.3 mm and &lt;150 µm weekly cycle of 3-day alternating dry air and wet air followed by leach generally 20-week minimum but can run longer weekly analysis of diagnostic ARD parameters (e.g., pH, SC, Fe, SO<sub>4</sub>, Eh, Ca, Mg, alkalinity) generally less-frequent analysis for comprehensive metals and major ions</p>	To determine long-term weathering rates (sulphide oxidation, dissolution of neutralizing minerals, trace metal release) under oxygenated conditions To evaluate lag time to acid generation To provide reaction rates for geochemical modeling	Standardized test Provides kinetic and steady-state leaching information and is recommended test for determination of weathering rates of primary minerals	Not suitable for evaluation of saturated materials Grain size reduction may increase reactivity Potential for channel flow High leaching rate can affect reaction kinetics due to higher pH and undersaturation with secondary minerals
	<p><b>Column Test</b> variable solution to solid ratio generally deionized water, groundwater or natural precipitation generally &lt; 25 mm variable dimension, but generally larger than HCT leaching cycles can vary and include maintaining water over sample, alternate flooding and draining, and recirculating leachate</p>	As above, but can simulate leaching in variably saturated or oxygen-deficient conditions To simulate environmental performance of amended mine wastes and/or cover designs	Frequently closer to field conditions than HCT Can simulate different degrees of saturation Can simulate remedial alternatives Simulates combined weathering of primary and secondary minerals	Not standardized Potential for channeling through preferential flowpaths Grain size reduction may increase reactivity Without entire load of weathering products from primary minerals, reaction rates for primary minerals and extent of secondary precipitation cannot be measured
	<p><b>Wall Washing</b> 1L rinse of 1 × 1 m surface area distilled water</p>	<p><u>All Methods:</u> To estimate short and long-term potential of mine materials to generate acid and leach metals using on-site materials</p>	Rapid Measures leachate quality from in situ material Can be repeated to obtain temporal component	May be difficult to establish accurate mass balance due to loss of solution
	<p><b>US Geological Survey Field Leach Test (FLT)</b> 20:1 solution to solid ratio deionized water &lt; 2 mm 5 minutes</p>		Can be performed in the field Rapid and inexpensive method to characterize chemical reactivity and water-soluble fraction Field screening method that can be used as surrogate for SPLP due to	Same as for SPLP

<b>Field Tests</b>	<a href="http://pubs.usgs.gov/tm/2007/05D03/">http://pubs.usgs.gov/tm/2007/05D03/</a>		similarity in approach and results	
	<p><b><i>Field Cells/Test Pads/Mine Facilities</i></b>          Monitoring of increasingly larger volumes of mine wastes          Ambient precipitation or irrigation          Degree of grain size reduction required decreases with increasing size of test          Test duration months to years</p>		<p>Test are conducted under actual field conditions          Can collect samples after transient events          Larger sample size results in enhanced test charge representativeness          With increasing test size, effects from grain size reduction, sample heterogeneity and preferential pathways reduced          With increasing test size, empirical results increasingly directly applicable to mine facility</p>	<p>Comprehensive characterization of test sample may not be feasible          Complete understanding of water balance may not be feasible          Complexity of tested system may limit interpretive and predictive value of observations</p>



# Introduction to CMD Prediction

## From GARDGuide

- C5.1 Introduction
- C5.2 Overburden Sampling Considerations
- C5.3 Predictive Factors Other than Overburden Analysis
- C5.4. Acid Base Accounting (ABA)
- C5.5 Other Static Tests
- C5.6 Kinetic Tests

## C5.1 Introduction

The greatest difference in approach and technology between hard rock and coal mining lies in the area of prediction. The underlying differences (geology, economics, regulations, etc.) between the two all come into play. As discussed in Section 2A, coal deposits are very different from most other mineral deposits. Except in completely new coal districts, the nature of sedimentary rock makes it relatively easy to predict where the coal can be found. Exploration is not generally an important issue; instead, property rights and land access to the coal seam(s) are more likely to determine where a coal mine is placed.

This section starts by discussing overburden sampling, which is critical for prediction of CMD quality at surface mines, less significant at longwall operations, and even less significant at other underground coal mines, where the nature of the coal seam and the immediately adjacent strata dictate eventual water quality. This section only introduces the concepts and some of the challenges that must be considered. However, representative sampling is critical: to quote Block et al. (2000), “precise analyses performed on an unrepresentative sampling plan will, at best, accurately characterize that unrepresentative population.” Failure to accurately predict post-reclamation water quality is probably more often due to an inadequate sampling strategy than to poor analytical techniques.

The following section discusses other important approaches to predicting post-mining water quality; valuable information is provided by water quality at adjacent mine sites and pre-mining water quality. Overburden analysis, otherwise known as static testing, focusing principally on acid-base accounting is examined next. Finally, kinetic tests, which are much more typically used in hard rock mining operations, but are sometimes warranted at coal mines as well, are examined.



## C5.2 Overburden Sampling Considerations

The objective of an overburden sampling program is to provide statistically valid estimates of the pyrite and carbonate content of the overburden strata. At surface mines, the entire overburden continuum is important. At underground operations, the coal seam and the strata immediately surrounding the coal seams are most important, while strata further away from the seam being mined may be undisturbed by the mining process and therefore irrelevant. In either case, the amount of rock being sampled compared to the amount of rock being mined is minimal, and therefore there must be a fair degree of consistency or at least a consistent trend that can be generalized across the entire site. With the exception of deltaic deposits, sedimentary rock is usually relatively consistent (laterally pervasive) on the scale of a mine site. However, there are exceptions. Brady et al. (1988) documented five surface mines operating near each other on the same seam in Fayette County, PA, USA, that were generating markedly different water: both acidic and alkaline CMD. He found that there were abrupt lateral changes in geology which caused some sites (the ones with alkaline CMD) to have calcareous shale strata while the acid generating sites did not. However, this is unusual. Limestone, if present, will be fairly consistent in carbonate content. Sandstone or shale, if calcareous (e.g., calcite cement) at more than one sampling location, will likely be equally calcareous across the site (Caruccio and Geidel, 1982; Tarantino and Schaffer, 1998).

Pyrite content in sedimentary strata is somewhat more variable (Rymer and Stiller, 1989). Channel sandstones are especially variable, due to changes in flow rates over time and area. Ideally, by collecting samples of each geological unit at various random locations across the prospective mine site, consistency in the amount of pyrite and carbonate minerals in that unit across the site and their relative proportions in each unit can be assessed.

Overburden samples are usually collected by air rotary or core drilling; augering is not recommended. When drilling with an air rotary rig, rock chips are collected as opposed to cores, which introduces one additional variable to consider. Samples from one unit can be contaminated with rock chips dislodged from another, depending on the sampling procedures being followed and the type of rotary rig being used. This effect can be minimized (Block et al. 2000; Noll et al. 1988), but in general, cores provide better samples than rock chips.

Because these holes are being drilled almost exclusively for overburden sampling (exploration drilling is usually not required), there may be a tendency to drill as few holes as possible to minimize costs. For example, in Pennsylvania, the absolute minimum is two sample points, with one additional hole requested for every 40 ha (100 acres) to be mined. However, the standard practice in Pennsylvania is to require 6-7 holes for every 40 ha being mined, though this ratio is sometimes reduced if there is information available from adjacent mine sites. Where predictions are more challenging due to geology (e.g., deltaic coal deposits are notoriously hard to assess, as discussed in Section 2A), operators will typically drill more holes. For example, at one site, the ratio was about one hole per ha (Brady et al. 1994).

Weathering results in the near-surface depletion of pyrite and carbonate minerals, and, if not considered, can lead to erroneous conclusions on the nature of a given geological unit (Figure 1).

The depth of this depletion varies with the lithology and the climate, but unless the site and the strata are both flat, rock that is weathered in this manner at one location will be buried deeper and unweathered elsewhere on the same site. Generalizing that the unit is relatively inert based on the weathered sample, or that alkalinity is present in the unit across the site, based on a sample taken from the unweathered unit, could lead to errors.

**Figure 1. Depletion of near-surface (at this site, the top 5 m) total sulfur at a prospective coal mine site. Samples should be collected from both the weathered and unweathered material.**

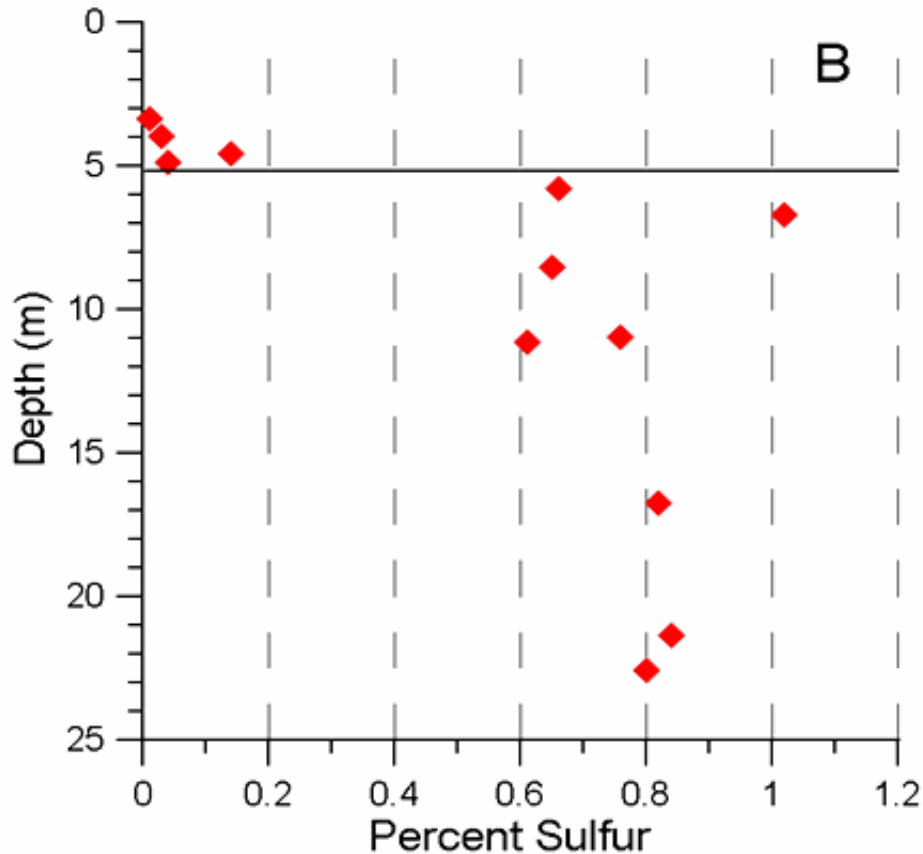

The drill holes should be located to provide as much useful information as possible. So holes should be placed to align with planned mining phases, with at least one hole in the initial mining phase. Also, at least one hole should be located at the maximum highwall height, and at least one hole should be located at an area of much less cover, to account for the effects of weathering (Block et al. 2000)

Underground mine operations must consider the pyrite content of the coal and adjacent strata that will be left behind when mining is completed. Since pyrite varies more than carbonate content, more intensive sampling will likely be necessary to predict post-closure water quality. However, predicting the eventual post-closure water table is even more important since that will determine if there will be a post-mining discharge.

The preceding discussion applies to horizontal variability. Vertical variability is almost a certainty, regardless of the geology. All distinct geologic units should be sampled separately and thicker units should be sampled at every change in appearance or, if the rock appears to be consistent, at every 1-1.5 m. If interbedding makes it impossible to sample individual units, then samples may have to be aggregated and averaged. Weathered strata should be sampled separately from rock that appears to be unweathered. More information on this topic is readily available (e.g., Block et al. 2000; Tarantino and Schaffer 1998).

However, overburden analysis uses only a portion of the samples taken from a given interval. Acid-base accounting (ABA) typically requires only 1 g for sulfur analysis and 2 g for the NP test. Thus, changes in the geochemistry within the vertical extent of the sample introduce another potential source of error, which is typically resolved by crushing the entire sample (or, if from a core, a longitudinal half of the core interval) and then using a riffle or splitter to obtain a representative sample.

### **C5.3 Predictive Factors Other than Overburden Analysis**

Groundwater reflects the mineralogy of rocks and soils that the water has contacted and so can be used to confirm the presence of carbonates in mine site overburden (Perry, 2000). Brady (1998) suggests that alkalinity concentrations should exceed 50 mg/L in deeper groundwater if there are significant amounts of neutralizing minerals present. Further, if the ground water samples are alkaline but overburden samples do not indicate that calcareous rocks are present, the overburden sampling may not adequately represent the site. However, his study also showed that groundwater quality cannot be used to estimate the amount of pyrite, since it only oxidizes upon exposure to the atmosphere. Brady (1998) observed that sulfate concentrations were unrelated to the amount of pyrite present.

Water quality from mining operations at adjacent sites is generally more useful. Large areas can be accurately predicted to be either acid producing or non-acid producing, since their geology is similar. The most obvious examples are most of the coal mines in the western United States, where because the deposits are associated with fresh water paleoenvironments, there is very little pyrite in the coal or overburden. Similar trends can be observed in most coal mining regions where an extensive coal seam is being mined and the overburden is reasonably consistent. However, exceptions do exist, as documented by Brady et al. (1988) and discussed earlier. Nonetheless, the water quality at adjacent mines is often an accurate predictor of water quality at a proposed site. Brady (1998) documents numerous examples that demonstrate the usefulness of this technique and how it has been applied. He states that, "Groundwater quality from previously mined areas, when available and used properly, can be the best mine drainage quality prediction tool in the tool box." That is because it already represents many of the variables that cannot be assessed in the laboratory, no matter how many samples are analyzed. As a result, when the results of predictive tests seem to contradict each other, water quality at adjacent mines should be given precedence (Brady, 1988).

## **C5.4. Acid Base Accounting (ABA)**

ABA is one of the standard means of overburden analysis characterized as a static test, since it ignores the effect of time-related factors such as weathering. It owes its ancestry to a mine soil classification system developed to determine how much agricultural lime should be added to support plant growth (Skousen et al., 2000). West Virginia University researchers recommended that sulfur profiles and neutralization capacities be determined for all strata down to and immediately underlying the coal seam to be mined (West Virginia University, 1971) and the ABA methodology was subsequently described by Grube et al. (1973). Sobek et al. (1978) presented the field and laboratory procedures in more detail. Subsequent passage of the Surface Mining Control and Reclamation Act in the U.S. virtually required its use since there were no other tools available at the time to characterize overburden material prior to disturbance (Skousen et al., 2000).

If pyrite is not the dominant form of sulfur present, then the actual amount of pyrite can and should be determined. For example, coal mining sites in the western U.S. sometimes generated relatively high acid potential values in the laboratory even though they contained virtually no pyrite. Organic sulfur (which is complexed within the plant material that makes up the coal and does not produce significant amounts of acidity) in the coal, and non-acid forming sulfate salts such as gypsum, are measured in a total sulphur assay. Therefore pyritic sulfur, rather than total sulfur should be measured at sites where the nature of the total sulfur present is unknown.

Initial simple use of ABA in the eastern and mid-western U.S. was not as accurate as hoped. A U.S. Bureau of Mines study (Erickson and Hedin, 1988) of sites that were not easy to predict (sites that were clearly dominated by high NP or AP values were intentionally excluded) generated the data shown in Figure 2.

**Figure 2. Sites where actual water quality exactly matched predicted water quality should fall on or near the blue line; any square in the upper left or lower right quadrants represented completely erroneous predictions. Thus, if accuracy is defined as merely predicting whether the CMD would be acidic or not, predictions were correct only about 2/3 of the time for these sites.**

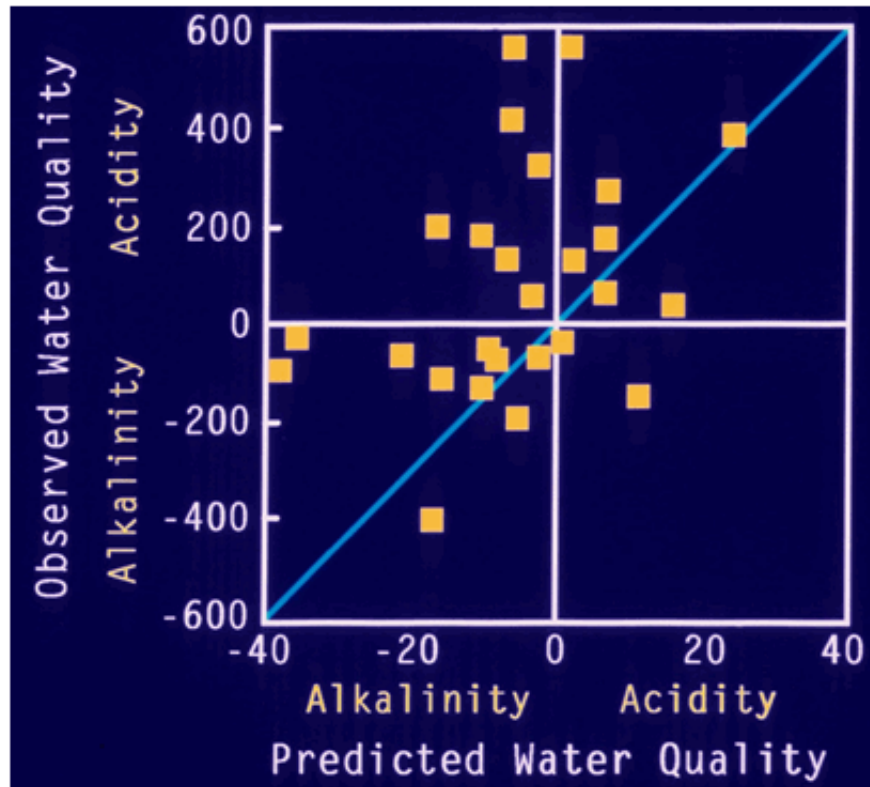

Although comparison of results for individual rock units worked well in the laboratory, water quality predictions done by multiplying the NNP values by the thickness of the units and the area represented by each core sample being analyzed were often inaccurate. Brady and Hornberger (1990) suggested that ABA only be used qualitatively (acid vs. non-acid) and that NP would have to significantly exceed MPA to produce alkaline water. The Pennsylvania Dept. of Environmental Protection showed that an NNP value of 12 tons per 1,000 tons effectively separated sites that produced non-acidic CMD from those that did not. NNP values between 0 and 12 produced both acid and alkaline sites; these were interpreted as sites that can only be permitted if special procedures are used to prevent acid generation. Sites with NNP values less than 0 were likely to produce acidic CMD (Brady et al. 1994). Alternatively, a ratio of NP:AP (NPR) can be used. A ratio less than 1 represented a likely acid producer while a ratio greater than 2 would be alkaline; ratios between the two are variable and will likely require some alkaline amendments or special handling.

Figure 3. A graph of some mine sites operating in Pennsylvania in the early 1990s, revealing how an NNP cutoff value of 12 tons per 1000 tons can be used to predict sites where alkaline drainage will be produced.

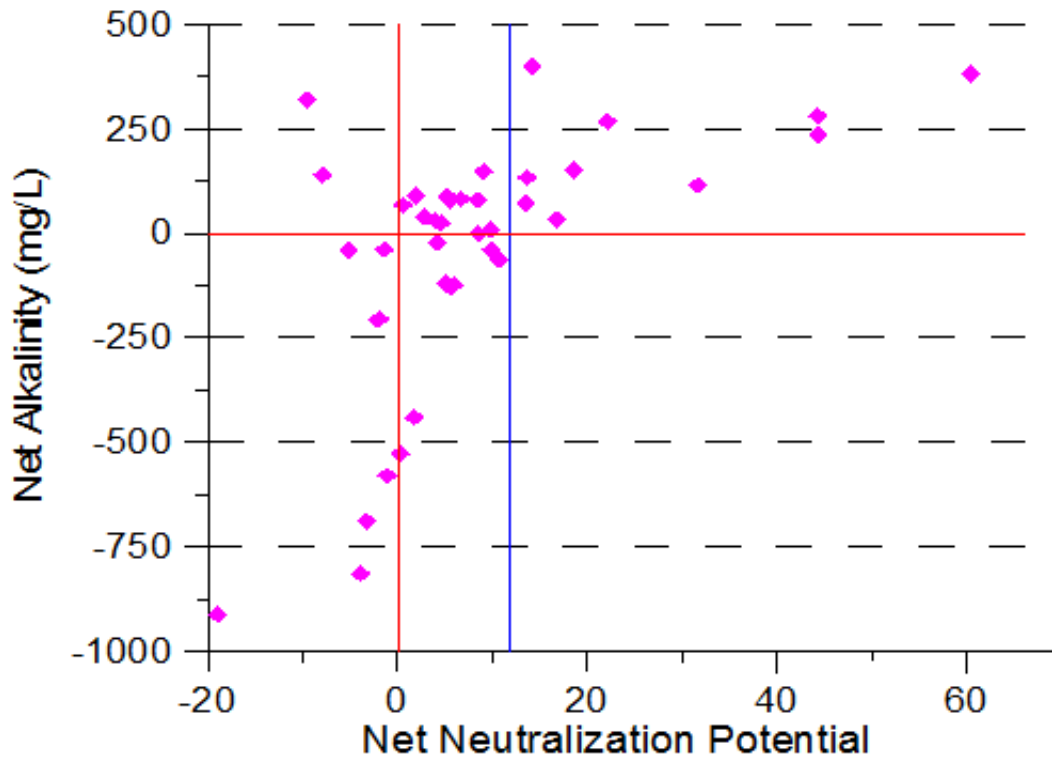

Siderite (iron carbonate), if present, affects the NP determinations at some sites since it is measured in NP determinations even though it produces neither acidity nor alkalinity. The alkalinity initially generated as the carbonate dissolves is neutralized by the acidity generated as the  $\text{Fe}^{3+}$  hydrolyzes. Leavitt et al. (1995) proposed a modified method to determine NP. This modified ABA methodology was subsequently assessed by Skousen et al. (1997) and found to effectively compensate for the errors introduced by siderite while dramatically reducing variability in NP determinations among analytical laboratories. In general, this modified version of ABA is now the accepted standard method for CMD.

### C5.5 Other Static Tests

Other methods to predict CMD water quality have been suggested, though none have yet displaced the modified ABA method. These include ABA down-hole prompt gamma ray spectroscopy wireline logging (Skousen et al., 2000), which is a field technique, and evolved gas analysis (Hammack, 1987; Skousen et al., 2000). Both of these approaches are relatively expensive compared to ABA.

However, a modified version of the NAG test is becoming common in the southeastern US and may someday displace ABA analysis. As discussed in Section 5.4.4.6.1 of this Guide, the NAGtest is an Australian approach to static testing of non-organic rock strata that is useful in assessing the ARD potential of prospective hard rock mining operations. It can differentiate the effects of forms of sulfur and siderite. However, the presence of organic material (e.g. coal) in

sedimentary strata made it inappropriate for predicting CMD quality. Recently, Stewart et al. (2006) modified the method to extend it to coal mining operations and have recently tested it, using coal washery reject material (coal refuse) (Stewart et al., 2009).

## **C5.6 Kinetic Tests**

Kinetic tests (e.g., leaching columns, humidity cells) are discussed in more detail in Section 5.4.4.7 of this Guide. As stated there, the fundamental concept is to simulate the cyclic wetting, drying, and flushing that occurs over time at every mine site. Their chief advantage is that they can be used more quantitatively than static tests, to simulate the relative rates of acid generation and alkaline production, the relative concentrations of net acidity, metals and sulfate concentrations, and the potential value that would be gained by alkaline amendments (Perry, 2000). However, kinetic tests are much more expensive and time consuming than static tests.

Before making a decision regarding kinetic testing, readers are encouraged to consult Geidel et al. (2000) and Hornberger and Brady (1998). Several researchers, as part of the U.S. Acid Drainage Technology Initiative (ADTI), have been developing a standard kinetic test procedure (Hornberger et al., 2005: <http://wvmdtaskforce.com/proceedings/05/Hornberger.pdf>) The U.S. Environmental Protection Agency and the ASTM may designate this procedure as an official standard method in 2009 or 2010.

# Modeling of ARD

## From GARDGuide

[Back to Chapter 5.5.1 Introduction](#)

### Contents

- 1 Appendix 5-A
  - 1.1 Introduction
  - 1.2 Approaches to Geochemical Modeling
  - 1.3 Role of Thermodynamic and Kinetic Data
  - 1.4 Scale-up Considerations
  - 1.5 Examples of Major Codes
  - 1.6 Hydrological Modeling
  - 1.7 Hydrogeological Modeling
  - 1.8 Gas Transport Modeling
  - 1.9 Considerations Regarding Predictive Modeling of Effluent Quality

## Appendix 5-A

### Introduction

#### *Geochemical Modeling*

This section describes the conceptual, thermodynamic, and kinetic fundamentals of geochemical modeling and its application to prediction of mine water quality in support of mine site characterization and remediation. The emphasis in this section is on the basic processes that models attempt to represent with discussions of the usefulness and the limitations of modeling.

In principle, geochemical modeling can be applied to all mine and process facilities, including mine portal effluent, subsurface waters (wells or underground workings), waste dumps, process tailings piles, surface waters, pit lakes, and open pits. The type of modeling used depends on both the objectives and the type of source or pathway. A wide variety of codes are available for these various environments but the critical factors are the quality of their databases, the inherent assumptions, and, most importantly, the knowledge and experience of the modeler.

Three basic approaches have been used with geochemical data: forward geochemical modeling, inverse geochemical modeling, and geostatistical analyses.

Forward modeling is also known as simulating (i.e. potential reactions between rock and water are simulated from initial conditions of a known rock type and composition). Reactions are allowed to proceed in equilibrium or kinetic or combined modes. Changes in temperature and pressure can be invoked, changes in water flow rate can be invoked, and minerals can be allowed to precipitate as they reach equilibrium solubility or dissolve as they become undersaturated. Potential reactions can be simulated to see what the consequences are. This type of modeling is the least constrained. A great many assumptions are either invoked as input data or invoked as dictated by the program that may not apply to the specific system being simulated. This approach assumes the modeler has a significant amount of information on the ability of minerals to maintain equilibrium solubility or their rates of reaction.

Inverse modeling assumes a water flow path is known and that water samples have been analyzed along that flow path. Such data can then be converted into amounts of minerals dissolved or precipitated along that flow path. Several assumptions are still made regarding the choice of minerals and their relative proportions contributing to the water chemistry, but the calculations are constrained with actual data. Inverse modeling can also be done without any recourse to kinetic or thermodynamic data, in which case it represents a relatively simple mass balance calculation. When speciation and thermodynamic and kinetic properties are included for additional constraints, the possible reactions become quite limited and the modeling is much more meaningful.

Modeling of any type does not lead to a unique solution but the possibilities are more limited with greater amounts of carefully collected field data. Martin et al. (2005) summarized the benefits and limitations of geochemical modeling as follows:

#### **Benefits**

- Provide insight into potential future conditions
- Determine which variables are most important in determining future conditions
- Assess the effects of alternative approaches to ARD management
- Assess potential effects of uncertain parameters
- Establish objectives and test conditions for field and laboratory studies
- Integrate available information

#### **Limitations**

- Insufficient input data
- Modeling can be challenging and results misinterpreted
- Uncertain and variability of the results



- Difference between modeled and actual field conditions

## Approaches to Geochemical Modeling

### *Speciation*

One of the most fundamental types of geochemical modeling is speciation modeling. “Speciation” refers to the distribution of chemical components or elements among the different possible forms or species. Aqueous speciation is the distribution of chemical components among dissolved free ions, ion pairs and triplets, and other complexes. This concept is important because research has shown that a number of processes, including mineral precipitation and dissolution, biological uptake and toxicology, and sorption are all affected by speciation.

Some species, such as redox species, have to be determined analytically. This is because most geochemical modeling codes erroneously assume that redox equilibrium is maintained while, in reality, disequilibrium among redox species is the rule, not the exception. In particular, dissolved iron is usually present in high concentration in ARD and can exist as the reduced ferrous iron or as the oxidized ferric iron. For an accurate evaluation of iron speciation, chemical analysis rather than speciation modeling is required. In NMD and SD, dissolved iron is largely absent due to formation of sparingly-soluble ferrihydrite or similar iron oxyhydroxide minerals. Solid speciation is the distribution of chemical components among various solid phases. For example, iron can precipitate from ARD as goethite, jarosite, schwertmannite, or ferrihydrite. Identifying these phases would constitute solid speciation.

Aqueous speciation results are used in a variety of modeling objectives that include modeling of saturation-index calculations for mass-transfer, modeling of mineral precipitation and dissolution, modeling of adsorption and desorption, and reactive-transport modeling.

### *Mass Transfer (precipitation, dissolution, gas transfer)*

Modeling of mineral precipitation and dissolution and gas-transfer reactions can take place conceptually in one of three possible systems: equilibrium state, steady-state, or transient state. The equilibrium state assumes the system under investigation is isolated from any external exchanges of energy or mass. Although an unrealistic concept, equilibrium state is actually quite practical because many reactions approximate equilibrium even though there are gradients in water pressure or temperature. For example, in many groundwaters, calcite and gypsum quickly reach their equilibrium solubility. Even with gradients in CO<sub>2</sub> pressure or mixing with other sources of sulphate, these minerals adjust to maintain saturation and the assumption of equilibrium may be valid. In addition, even when geochemical reactions of interest do not reach equilibrium rapidly, such reactions may achieve equilibrium over the time scale of the modeling simulation (i.e. the life of a mine and beyond). Therefore, the majority of geochemical modeling can be conducted under the assumption of equilibrium conditions.

### *Reactive Transport (Coupled Models)*

Reactive-transport models that can be applied to simulation of ARD, NMD, and SD are generally the subject of active research, although several have been applied with considerable success. The idea is to couple flow models with chemical reaction models to determine the effects of flow on reactions and vice versa, including the effects of dispersion. Such modeling is relatively straightforward for streams and rivers because the flow path is not only visible but measurable. Considerable effort has been made to develop quantitative reaction-transport models for streams affected by acid mine drainage (Kimball et al., 1994; Runkel et al., 1996). Progress in surface-water reactive-transport modeling has now advanced to the point where it can guide remediation decisions for complex mine sites (Runkel and Kimball, 2002; Kimball et al., 2003).

Reactive-transport modeling for groundwater has also progressed substantially over the last two decades and many of the recent codes have been applied to mine sites. Three general types of coupled models can be distinguished: those that model the groundwater only, those that model the unsaturated zone only, and those that model both. The most recent overview by Mayer et al. (2003) provides the theoretical foundations for groundwater reactive-transport modeling, methods of coupling flow with reaction, the various codes that have been used in mined environments, and case studies. An excellent example of combining laboratory testing of waste rock material with field measurements and modeling of small- to medium-scale test plots of actual mine wastes to predict the consequent water quality over the short term and the long term in a very sensitive environment is in progress at the Diavik mine site near Yellowknife, Northwest Territories, Canada (Blowes et al., 2007). This investigation may be one of the first to combine lab-scale tests, field tests, and modeling, supported by the detailed characterization of the rock and mineral composition and their weatherability.

## Role of Thermodynamic and Kinetic Data

Thermodynamic and, for some models, kinetic data are part of the basic input to codes that compute reactions and simulations for water-rock interactions. For some reactions, these data are known accurately and precisely; for others they are non-existent or poorly known. Thermodynamic measurements and evaluations are part of ongoing research. Sometimes the conclusions of a modeling study can be greatly affected by these databases and their uncertainties and sometimes not. Rarely are modeling results evaluated from the point of view of the basic data, which reflects a general lack of QA/QC common to many modeling efforts.

## Scale-up Considerations

Drainage quality prediction is made challenging by a number of factors that range in scale from small to large. Small-scale factors that influence drainage quality are related to reactions at the water-rock interface in the aqueous, gas and solid phase. Information on reactive surface area and reaction rates generally is limited. On a large scale, geology, climate, mining method, mineral processing method, and waste management practices vary within and amongst operations. Variability of these large-scale factors implies that it may not always be feasible to apply information from one site to another. However, advances are being made in this respect, for instance, through the use of geo-environmental models that present unifying principles which link mine water quality to the nature of the ore deposit, climate, and type of mine waste.

Water quality prediction typically necessitates the extrapolation of laboratory-scale results to operational scale. This extrapolation must address factors such as differences in particle size, climate conditions, water and gas transport, and duration (i.e., how these variables affect drainage composition over decades, centuries or longer). Although the construction of instrumented, large-scale mine waste test cells has increased significantly in recent years and is expected to yield valuable data, little information is currently available describing the effects of these variables on well-characterized mine wastes over extended periods of time. Use of models therefore is required to bridge the gap between laboratory results and operational conditions (USEPA, 2003).

## Examples of Major Codes

Some of the more popular codes used primarily for groundwater geochemistry but also for mining-affected sites are shown in Table A-5-1 below. More detail on geochemical modeling, modeling codes and associated uses and limitations is presented in Alpers and Nordstrom (1999), Mayer et al. (2003), and Maest and Kuipers (2005). Section XXX on hydrogeological models in this Appendix also provides additional information.

**A-5-1: Summary of Geochemical Modeling Codes**

Codes	Type	Reference
PHREEQC, PHAST	USGS codes: mass transfer and reactive-transport	Parkhurst and Appelo (1999), Parkhurst et al. (2004)
SOLMINEQ.GW	USGS code: mass transfer and high temperature	Perkins et al. (1990)
WATEQ4F	USGS code: speciation and low-temperature only	Ball and Nordstrom (1991)
MINTEQA2	EPA supported code: speciation and mass transfer	USEPA (1999)
MIN3P	Waterloo code: saturated and unsaturated flow	Mayer et al. (2002)
TOUGH-AMD	Quebec code: gas and energy transfer without reaction	Lefebvre et al. (2002)
RETRASO	Barcelona code: unsaturated and saturated flow and reaction	Saaltink et al. (2002)
SULFIDOX	ANSTO code: gas and energy transfer	Ritchie (2003)
CRUNCH	Bern/LBL code: unsaturated and saturated flow and reaction	Steeffel (2000)
Geochemist's Workbench	University of Illinois code: mass transfer, saturated flow	Bethke (1994, 1996)
EQ 3/6	Lawrence Livermore National Laboratory code: mass transfer and reactive transport	Wolery and Daveler (1992)

## Hydrological Modeling

### Introduction

In a general sense, a hydrological model is an analog of a natural or human-modified hydrological system. This generic definition encompasses models of surface-water and groundwater systems. Scientists and engineers more commonly use the term hydrological model to refer to models of surface-water systems, and consider hydrogeological models for groundwater systems as a separate subject. This section follows the latter convention, describing hydrological models in the context of surface-water systems. Hydrogeological models and their applications are presented in Section XXX.

Hydrological models range from simple algebraic calculations to complex reactive-transport computer codes. Physical analogs, such as stream tables, can also be useful simulations of complex surface-water systems. Hydrological models can be used to predict the fate and transport of mine drainage through a surface-water system, providing important input to human-health or ecological risk assessments. Hydrological models can also be used to estimate the water-quality and water-quantity evolution of pit lakes over time. Hydrological models can be coupled with hydrogeological and geochemical models to incorporate the interaction between surface water and groundwater into the simulation and account for geochemical reactions.

Selection of an appropriate, quantitative hydrological model depends on the type of output that is required and, critically, on the conceptual model of the system being evaluated. A robust conceptual model will identify the important physical and geochemical characteristics of the field-scale system being evaluated. Based on that identification, an appropriate hydrological model can be selected that quantitatively represents those important processes. For complex systems or to assess a range of different types of processes, multiple hydrological models can be applied to predict the fate, transport, and potential impacts of mine discharges.

### *Data Needs*

In common with all models, the output from a hydrological model is only as reliable as the data that are used to generate the model. Typical data requirements for many hydrological models include:

- Precipitation, either local or distributed across a region
- Evaporation from surface-water bodies such as lakes and rivers
- Potential or actual evapotranspiration from vegetated areas and bare land
- Surface slope and land cover
- Channel slope, width, depth, and roughness for calculations of stream flow or conveyance capacity
- Concentrations of chemical constituents. These may be determined from on-site monitoring programs, laboratory or field-scale testing programs, or estimated using geochemical models

Simple quantitative models of surface-water flow such as the United States Natural Resource Conservation Service (formerly known as the Soil Conservation Service [SCS]) curve-number method (SCS, 1972) may only require a few of the before listed data elements. More detailed models, for instance those that incorporate reactive transport (e.g., Runkel and Kimball, 2002), may require additional information regarding the kinetics of reactions considered in the simulation.

Governmental agencies in many countries collect regional precipitation and evaporation data that may be used for hydrological models. Precipitation data are commonly collected with the greatest frequency through meteorological measuring stations. Evaporation data, such as pan evaporation measurements, generally are collected with less frequency. Some mine sites also collect these types of data on a local scale that can be used to refine the regional data sets.

Care must be taken if combining different types of data from different locations. The locations should be similar in terms of latitude, elevation, overall climatic zone, and cloud cover for the combined data set to be reliable. If this is not the case, statistical methods have been developed to estimate precipitation at a special site from a known precipitation network.

### *Water-Balance and Mixing-Cell Models*

Water-balance models apply the principle of conservation of mass to quantitatively track inflows and outflows from the various components of a conceptual model. Mass and concentration of ARD-related constituents can be incorporated into this approach through mixing-cell models. The hydrologic elements of a conceptual model, such as surface-water reservoirs, open pits, and groundwater basins, can be represented as a series of simulated reservoirs. The connections between the reservoirs, such as the creeks or groundwater flow paths, can be represented by quantitative estimates of capacity or flow. Concentrations of individual constituents can be tracked along with water quantity to calculate the transfer of chemical mass and mathematically mixed in the model to evaluate changes in concentration over time in the reservoirs.

Water-balance and mixing-cell models can be implemented in standard spreadsheets. More complex water-balance or mixing-cell models, incorporating additional physical or chemical processes, can be addressed by using dynamic system simulators such as GoldSim™ or STELLA™.

### *Rainfall Runoff Models*

Appendix A of USEPA (2003) describes the basic approaches to modeling runoff processes based on precipitation inputs. Runoff can be thought of as the excess precipitation after processes such as infiltration and surface abstraction are evaluated. The most commonly applied model to estimate the volume of runoff is the SCS curve-number method (SCS, 1972). The SCS curve-number method involves estimating the vegetation and land-cover characteristics of a watershed or mine facility, looking up the resulting curve number, and then applying that number along with precipitation information to develop the runoff volume for a storm event.

The unit-hydrograph method of runoff determination may be more appropriate for many mine sites. The method is also described in SCS (1972). A hydrograph relating runoff to precipitation is developed for a unit precipitation volume over an area, for example 1 inch or 1 centimeter of rainfall. The unit hydrograph is then used to estimate runoff from storms of greater or lesser intensity.

Water quality in well-mixed rivers and streams can be predicted using a code such as QUAL2K developed by the USEPA (Chapra et al., 2007). QUAL2K represents a modernized version of QUAL2E (Brown and Barnwell, 1987). QUAL2K is programmed in the Visual Basic for Applications language and executed within the Microsoft Excel spreadsheet environment. The program can simulate 1-dimensional flow, changes in water quality along the flow path, and chemical interactions with bed sediments.

Distributed-parameter rainfall-runoff models are more appropriate for larger watersheds with heterogeneous flow characteristics. SWAT2000 (Neitsch et al., 2002) is a distributed-parameter model developed by the Agricultural Research Service of the U.S. Department of Agriculture to simulate runoff and water quality in large, complex watersheds. SWAT2000 and similar models break a complex watershed into hydrologic sub-units, each with a uniform set of characteristics. Flow and water quality are calculated for each sub-unit, then aggregated to provide predictions at a complex watershed scale.

### *Pit Lake Modeling*

Pit lake formation and the evolution of water quality can be simulated using a water-balance approach or with complex numerical codes. Water balance models can be used to quantify the inflows to the pit lake as the pit fills after mining and dewatering ceases. Potential inflows include direct precipitation over the surface area of the lake, runoff entering the pit lake from the surrounding watershed, and groundwater inflow through the walls and floor of the pit. Outflows may include direct evaporation from the lake surface, groundwater outflow, and potentially surface-water discharges if a spill elevation is reached.

A chemical composition can be assigned to each inflow and outflow to extend the water-balance model to include ARD-related impacts. For example, wall-washing results can be used to estimate the mass input of chemical constituents from seepage or overland flow coming in contact with reactive portions of the pit wall. Geochemical speciation models can be used to predict the resulting chemical quality of water in the pit.

Rainfall-runoff models can be used to develop the surface-water inflow portions of the water balance. Groundwater inflow can be estimated using simple analytical equations (Marinelli and Niccoli, 2000). The solution to drawdown in a large-diameter pumping well presented by Papadopoulos and Cooper (1967) is often used to approximate the groundwater inflow to a mine pit, and can also be used to estimate recharge to the pit lake. Cimen (2001) and Aryafar (2007) present additional analytical solutions that can be useful in pit-lake studies.

Complex numerical models can also be used to estimate the groundwater inflow to a pit lake. SEEPW (Ref) and FEFLOW (WASY, XXXX) are finite-element, variably-saturated flow models that have been applied to this problem. MODFLOW2005 (Ref), including the LAK package, is a modular, 3-dimensional, finite-difference model that can be used to simulate the groundwater components of pit-lake evolution. Complex models such as these, however, require more data for parameterization and calibration than the simpler approaches. Selection of more complex simulation approaches should only be made if the conceptual model and project needs require the additional computational burden.

An alternative to geochemical models for the prediction of pit-lake quality is a code such as CE-QUAL-W2 developed by the U.S. Army Corps of Engineers Waterway

Experiment Station (Cole and Buchak, 1995). CE-QUAL-W2 is suitable for applications to rivers, lakes, reservoirs, and estuaries.

#### *Watershed Models*

Watershed models are used to simulate the hydrologic cycle, including surface water, groundwater, and the interactions between the two, at the basin or watershed scale. Watershed models can be used to predict ARD impacts on downstream users and the evolution of ARD-related water quality through a flow system. Furman (2008) summarizes the mathematics and computational tools used to simulate coupled surface and subsurface flow processes.

Watershed models can be data-intensive and numerically complex. The most widely used watershed models are:

- MIKE SHE, developed by the Danish Hydraulic Institute (DHI) in Denmark
- HEC-HMS, developed by the U.S. Army Corps of Engineers Hydrologic Engineering Center
- WMS (Watershed Modeling System), a graphical interface developed by Environmental Modeling Systems, Inc. for a number of modules including HEC-HMS, CE-QUAL-W2 and other codes

## **Hydrogeological Modeling**

#### *Introduction*

Hydrogeological models address water flow and contaminant transport below the land surface. As with hydrological models, approaches to hydrogeological simulations range from simple to complex. The universe of hydrogeological models includes physical and electrical analogs. With the advent of powerful personal computers and high-level programming languages, these approaches are rarely used in current practice. Accordingly, this discussion of hydrogeological models will focus on quantitative, mathematical approaches to subsurface water flow and contaminant transport.

A large body of literature exists regarding hydrogeological modeling, as do a number of computer programs. Zheng and Bennett (2002) provide an excellent introduction to the topic of contaminant-transport modeling. Maest and Kuipers (2005) provide a review of hydrogeological models more directly focused on ARD prediction. Other references are provided in the discussion below.

Three basic types of hydrogeological models are available, in order from simple to more complex:

1. Analytical models of flow and contaminant transport
2. Analytic element models
3. Numerical models

As a general rule, hydrogeological models should be as simple as possible while still representing the physical system with an adequate degree of precision and accuracy. More complex models should only be selected when project needs dictate, simpler models are demonstrably not adequate, and suitable data are available for model parameterization and calibration.

Hydrogeological models are useful tools for predicting the potential generation and resulting impacts of ARD. Models can be used to fill data gaps, either in space or in time. They can also be used to test alternative conceptual models in an iterative process designed to understand the complex natural or human-modified subsurface system.

Figure 5-19 in Chapter 5 of this GARD Guide presents a generalized approach to the development, calibration, and use of models, including hydrogeological models. The quantitative modeling process starts with a strong conceptual model, and the quantitative model can then be used to update the conceptual model as necessary. The majority of the effort for a hydrogeological model goes into the calibration phase of the process, sometimes also referred to as inverse modeling.

#### *Data Needs for Model Parameterization*

##### *Basic Flow and Transport Models*

As model complexity grows, the data requirements for model parameterization and calibration also increase. Basic data requirements for any groundwater flow and contaminant-transport model include:

- Saturated hydraulic conductivity
- Specific yield or storativity
- Effective porosity (for calculations of contaminant transport)

##### *Unsaturated-Zone Models*

Simulating flow and transport in the unsaturated zone typically requires additional information regarding the flow characteristics of the unsaturated porous medium. Unsaturated hydraulic conductivity is a function of the saturated hydraulic conductivity and the degree of saturation of the porous medium. Additional data requirements for unsaturated-zone models include the parameters for the function describing the relationship between saturation, matric suction, and unsaturated hydraulic conductivity.

##### *Sorption and Retardation Factors*

Interaction between the aquifer matrix and dissolved constituents can be an important process for ARD-related hydrogeological models. Many contaminant-transport models simulate this interaction through the use of a retardation factor.

The retardation factor is the ratio between the apparent velocity of the contaminant front and the pore velocity of moving groundwater (Fetter, 1993). In its simplest form, the retardation factor is calculated using a distribution coefficient appropriate for a linear adsorption isotherm. More complex forms of the retardation factor can be derived using different adsorption isotherms and assumptions.

Models incorporating retardation thus require additional data, including:

- Bulk density of the aquifer matrix
- Distribution coefficient or other parameters defining the adsorption isotherm
- Rate constants for non-equilibrium sorption models

### *Reactive-Transport Models*

As discussed in Section XXXX under geochemical modeling, detailed evaluation of the evolution of ARD-related constituent concentrations over time and space in an aquifer may require the use of a reactive-transport model. These types of models allow the simulation of reactions between the dissolved constituents and the aquifer matrix and reactions between the dissolved species themselves. Relative to the more basic hydrogeological models, additional data are necessary to apply these models, including:

- Non-equilibrium rate constants describing the reactions between dissolved constituents
- Proportionality constants or functions describing the solubility controls on individual species under consideration

Steeffel et al. (2005) and Mayer et al. (2003) provide overviews of reactive-transport models and their associated data requirements.

### *Data Collection*

The field data most commonly obtained in support of hydrogeological modeling are the saturated hydraulic conductivity and storage coefficients (specific yield or storativity). Saturated hydraulic conductivity can be measured on core samples in the laboratory, by using single-well slug tests, or by using multiple-well, long-term pumping tests.

Slug tests and pumping tests provide better estimates of saturated hydraulic conductivity at the field scale than laboratory tests. Pumping tests conducted with one or more pumping wells in combination with at least one additional observation well can also provide data regarding the storage coefficients. Butler (1998) provides an extensive description of the design and performance of slug tests. Kruseman and de Ridder (2000) describe the design and performance of pumping tests.

The relationship of unsaturated hydraulic conductivity to moisture content can be measured in the field or laboratory, and the resulting data can be fitted to a number of equations. Stephens (1995) provides a detailed description of data collection and analysis related to unsaturated-zone hydrology.

### *Other Data Sources*

Unsaturated hydraulic conductivity characteristic curves can be estimated by several methods. RETC (van Genuchten et al., 1991) and ROSETTA (Schaap, 2003?) are programs that can be used to estimate unsaturated flow characteristics from more commonly available data. SoilVision (SoilVision Systems, XXXX) contains a database of measured unsaturated hydraulic conductivity characteristic curves in addition to a number of algorithms to calculate unsaturated flow characteristics.

Adsorption-isotherm distribution coefficients for a number of metals are tabulated in Stenge and Peterson (1989). Values are included for three different pH ranges and a range of sorbent (organics, oxides, clays) contents.

### *Analytical Models*

Analytical models are relatively simple methods for simulating groundwater flow and contaminant transport. These models are formulated as closed-form equations that can be solved directly without the use of numerical methods. Transient or steady-state solutions for groundwater flow and contaminant transport with simple retardation factors in one, two or three dimensions are available.

Because of their simplicity, data needs are relatively minor for analytical models. Homogeneous, isotropic flow conditions are typically assumed. Analytical models can be useful for screening-level evaluations. They can also be used for more definitive assessments of groundwater flow and contaminant transport if the assumptions are judged to be valid or insufficient data are available to warrant a more complex approach.

One useful analytical model for the prediction of ARD-related transport is the Ogata and Banks (1961) solution to the advection-dispersion equation. Domenico and Schwartz (1990) extended that solution to include a retardation factor based on a linear adsorption isotherm. The Domenico and Schwartz (1990) model can be implemented in a spreadsheet format and adapted to a wide variety of problems.

STANMOD (Simunek et al., 2003) is a public domain set of analytical solutions to the advection-dispersion equation in one, two or three dimensions. A variety of previously published solutions, already in the public domain, are included in STANMOD.

### *Analytic Element Models*

Analytic element modeling takes advantage of the principle of linear superposition to solve groundwater flow and contaminant transport problems in more complex systems than can be addressed by analytical models. Haitjema (1995) provides the basic theoretical framework for the analytic element method and describes its use.

GFLOW (Haitjema Software, 2007) is a groundwater flow model that implements the analytic-element method. PhreFlow (Jankovic and Barnes, 2001) is a public domain analytic-element model of 3-dimensional groundwater flow and contaminant transport. WhAEM2000 (Kreamer et al., 2007) is a public domain and open source general purpose groundwater flow modeling system, with strengths in representing regional flow systems, and ground water/surface water interactions. It was initially designed to facilitate capture zone delineation.

### *Numerical Models*

Numerical models use iterative processes to solve the equations of groundwater flow and contaminant transport in complex domains. Flow and transport under saturated, unsaturated, or variably-saturated conditions in heterogeneous, anisotropic systems with various boundary conditions can be simulated using these methods. Numerical models can also require a substantial amount of data regarding parameters and for input to the simulation.

Two numerical solution schemes, finite-difference and finite-element, are widely used in hydrogeological models (Wang and Anderson, 1982). Finite-difference models employ a rectangular discretization scheme to divide the model domain into individual cells, within which flow characteristics such as hydraulic conductivity are assumed to be uniform. Finite-element models employ either a triangular or rectangular discretization scheme to divide the model domain into individual elements of uniform characteristics.

As a general rule, finite-difference models are more computationally efficient for a given problem compared to finite-element models. Finite-element models can be fitted more closely to irregular boundaries and can handle internal boundaries such as mine pits, underground workings, or faults with less numerical instability than finite-difference models. The choice of numerical solution scheme and computer code should be driven by the conceptual model, project requirements, and available computer resources.

The MODFLOW family of computer codes (e.g., MODFLOW2005, Ref) contains examples of finite-difference models. MODFLOW, originally released by the USGS in 1988 and upgraded periodically since then, is probably the most widely used hydrogeological model in the world.

Finite-element models are exemplified by FEFLOW (WASY, XXXX). FEFLOW is a commercially available code that can be applied to a broad range of variably-saturated flow and transport problems. Compared to MODFLOW it has more capabilities for modeling mine water problems because the original program code was derived from a mining background.

Many other finite-difference and finite-element models suitable for application to ARD-prediction problems are available. Maest and Kuipers (2005) tabulate the capabilities for a range of models.

*Commonly Available Models*

Table A-5-2 summarizes the characteristics of several numerical model computer codes that are widely used and can be applied to problems of ARD-related contaminant transport. Some models are freely available in the public domain, while others are proprietary products distributed by commercial companies. Table A-5-2 is organized by computer program and by graphical user interface (GUI). More information on GUI use and characteristics is presented below.

*Unsaturated-Zone Models*

Unsaturated-zone models are often used to assist with predicting the formation and transport of ARD within and through waste-rock dumps and unsaturated process tailings impoundments. Commonly used unsaturated-zone models include HELP (Schroeder et al., 1994), HYDRUS (Simunek et al., 2007), UNSATH (Fayer, 2000), and VADOSE/W (GeoSlope International, 2002). HELP and UNSATH are available in the public domain, as is the 1-dimensional version of HYDRUS.

*Fracture-Flow Models*

The majority of hydrogeological models are strictly valid for simulating flow and transport through continuous porous media only. However, some ARD problems occur in subsurface systems dominated by flow and transport through discrete fractures or fracture networks. Even if flow and transport are primarily through fractures, porous-medium models may be adequate if the fracture density is great and the fracture aperture is small. Some models allow a dual-porosity formulation that can represent the flow through a fracture network as well as flow through the porous media between fractures.

If the assumption of flow through continuous porous media is not valid, models that represent the physics of fracture flow should be considered. Two such models are FRACMAN (Golder, 2007) and FRACTRAN/FRAC3DVS (University of Waterloo, 2004).

*Density-Dependent Flow and Transport*

Most contaminant-transport models are based on the assumption that concentrations are relatively dilute and the density of groundwater is not significantly different from fresh water. Groundwater that is heavily impacted by ARD, however, can have sufficiently large concentrations of metals, sulfate, and other species that the density effects are significant. If the conceptual site model indicates that density effects are important, a model capable of accounting for variability in density should be selected.

SEAWAT2000 (Guo and Langevin, 2002) is one such model, developed by the USGS to simulate 3-dimensional, variable-density groundwater flow in porous media. It was developed by combining MODFLOW and MT3DMS into a single program that solves the coupled flow and solute-transport equations.

*Reactive-Transport Models*

Most contaminant-transport models incorporate relatively simple reactions describing interaction between dissolved constituents and the aquifer matrix. These reactions are implemented in the form of retardation factors using one of several adsorption isotherms. Interactions between dissolved constituents are typically not considered.

**Table A-5-2: Hydrogeological Models and Graphical User Interfaces for those models**

GUI		Groundwater Vistas	Groundwater Modeling Systems	Visual MODFLOW	Argus ONE	PMWIN	Description
FLOW	SEEP2D		x				A 2D finite-element groundwater model designed to be used for such as cross-sections of earth dams or levees
	MODAEM		x				Analytic element model for simple flow and transport conditions
	MODFLOW 88	x				xXx	MODFLOW is a 3D, cell-centered, finite difference, saturated flow model developed by the USGS
	MODFLOW 96	x			x	xXx	MODFLOW is a 3D, cell-centered, finite difference, saturated flow model developed by the USGS
	MODFLOW 2000	x	x	x	x	xXx	MODFLOW is a 3D, cell-centered, finite difference, saturated flow model developed by the USGS
	MODFLOW 2005	x		x			MODFLOW is a 3D, cell-centered, finite difference, saturated flow model developed by the USGS
	FEMWATER		x				3D finite-element model used to simulate density-driven flow and contaminant transport in saturated and unsaturated zones
	ART3D		x				A three-dimensional analytic reactive transport model
	MODPATH	x	x	x	x		A particle tracking code used with MODFLOW assuming that contaminants are transported by advection

SOLUTE TRANSPORT	PATH3D	x					General particle tracking program for calculating ground-times in steady-state or transient, 2 or 3D flow fields
	PMPATH					xXx	Particle tracking
	MOC3D				x	xXx	3D method-of-characteristics ground-water flow and tra with MODFLOW-96
	MT3D	x	x	x	x	xXx	Simulation of single-species transport via advection, disp chemical reactions
	MT3DMS	x	x	x	x	xXx	Simulation of multi-species transport by advection, disper chemical reactions of dissolved constituents
	PHT3D			x		x	A reactive transport model coupling MT3DMS and PHR
	RT3D	x	x	x		x	An advanced multi-species reactive transport model deve Pacific Northwest National Laboratory
	SEAM3D		x				Reactive transport model to simulate complex biodegrad multiple substrates and multiple electron acceptors
	SEAWAT 2000	x		x	x		Simulation of 3D, transient, variable-density ground wate
	MODFLOW-SURFACT	x		x			Enhanced simulation capabilities and robust solution meth complex saturated/unsaturated flow and transport
	MODFLOWT	x					Version of MODFLOW that includes modules for simula transport
	SWIFT	x					3D model to simulate groundwater flow, heat, brine and t
	UTCHEM		x				A multi-phase flow and transport model ideally suited for simulations
CALIBRATION	MODFLOW 2000	x	x				Parameter inversion option built into MODFLOW 2000
	UCODE	x	x			x	Developed by the USGS, UCODE is a universal inverse parameter estimation problems
	PEST	x	x	x		x	A model-independent, non-linear parameter estimator to interpretation, model calibration, and predictive analysis
	Stochastic	x	x				Parameter inversion using Monte Carlo or Latin Hypercu
	Modac	x					An inverse model that calculates a K for every cell in the layers) using starting heads as the calibration target
	Automated Sensitivity	x					Automated sensitivity analysis that can be used for initial parameter sensitivity

OPTIMIZE	Somos	x					Optimization modules to aid in optimally managing water
	Brute Force	x					Optimization based on plume containment
	MODOFC	x					MODOFC is designed to allow the user to create and so problems for hydraulic control in groundwater systems
	MGO	x		x			Optimizes groundwater management and remedial strateg physical, environmental and budgetary constraints
GRAPHICS	GIS	Import, export	Import, export	Import, export	Import, export		
	AutoCAD	Import, export	Import	Import, export			
	Registered images	Import	Import	Import		Import	
	Surfer	Import, export		Import		Import, export	
	EQuIS	Import					
	Slicer	Export					
	Earth Vision	Import, export					
	EVS	Import, export					
	Tecplot	Export					
	Prop. 3D Visualization		yes	yes			
Local Mesh Refinement?	yes	yes	no	no	yes		

If reactions between dissolved constituents, or precipitation and re-dissolution of individual constituents are important processes, reactive-transport models may be necessary to adequately represent the hydrogeological system. PHAST and PHT3D are two potential choices for this type of model.

PHAST (Parkhurst et al, 2004) simulates multi-component, reactive solute transport in three-dimensional saturated ground-water flow systems. The flow and transport calculations are based on a modified version of HST3D (Kipp, 1997) that is restricted to constant fluid density and constant temperature. The geochemical reactions are simulated with the geochemical model PHREEQC, which is embedded in PHAST.

The publicly-available code PHT3D (Prommer, 2002) couples MT3DMS and PHREEQC and therefore works within the MODFLOW scheme. PHT3D provides the highest level of coupling between constant density flow and fully reactive-transport codes. Because PHT3D couples MT3DMS with PHREEQC, it cannot be used simultaneously with SEAWAT2000, which also uses MT3DMS to couple MODFLOW.

Models available for fully coupled reactive flow and transport with density effects are severely limited. PHWAT (Mao et al., 2006) incorporates PHREEQC-2 into SEAWAT and provides the necessary capabilities. However, the model is still in development and not available commercially. It can simulate multi-component reactive transport with variable density groundwater flow.

#### Graphical User Interfaces

The raw input files for many hydrogeological models, including MODFLOW, are quite user-unfriendly. Model inputs are typically via multiple text files using line-entry and array format. Large models can be quite difficult to manage. Fortunately, several GUIs have been developed that are user-friendly and simplify the process of developing, calibrating, and using hydrogeological models.

In general, GUIs provide Windows-based interfaces that simplify pre- and post-processing for MODFLOW and other hydrogeological models. Several GUIs provide interfaces



with AutoCAD, Geographic Information Systems (GIS), SURFER (Golden Software, 2002) or other graphical programs to directly input material properties and boundary conditions as well as visualize model outputs.

GUIs also provide interfaces with add-on modules such as calibration and optimization routines, including UCODE and PEST. Some GUIs provide interfaces with these codes in addition to the inverse-modeling routines contained within MODFLOW. Further, a suite of optimization codes can be used to evaluate a variety of hydrologic issues related to groundwater pumping, plume management, cost effectiveness, and receptor management for contaminated areas.

Local Mesh Refinement (LMR) provides the ability to create submodels within a regional model. While submodels cannot be used simultaneously with a regional model, they can be used to refine calibration or predictions within a smaller area after solving the regional model. Some GUIs provide this function while others do not

Table A-5-3 provides a comparison of capabilities of five widely used GUIs:

- Groundwater Vistas (Environmental Simulations Inc., 2007)
- Groundwater Modeling System (GMS; Environmental Modeling Systems Inc., 2007)
- Visual MODFLOW (Schlumberger Water Services, 2007)
- Processing MODFLOW for Windows (PMWIN; Chiang, 2005)
- Argus Open Numerical Environments (ONE; Argus Holdings Ltd., 1997)

Argus ONE is an open environment for creating GUIs adapted to specific models. The USGS and others have developed interfaces within Argus ONE for a number of hydrogeological models. The other 4 GUIs are distributed as packages with their respective models included in the distribution.

#### *Model Calibration*

Calibration of a hydrogeological model is an application of inverse modeling. Model calibration is the process of selecting parameter values, inputs, and boundary conditions such that model output matches related observed data with an acceptable degree of accuracy and precision.

Calibration can be a major portion of the effort required to complete the modeling phase of a project. The level of calibration required for a particular model depends on the type and amount of data available in combination with project needs. Hill and Tiedemann (2007) present suggested guidelines for effective model calibration along with a description of the calibration process. Vrugt et al. (2008) review the state of the science with respect to inverse modeling of subsurface flow and transport properties.

A number of computer programs have been developed to automate the calibration process for particular hydrogeological models. More recently, model-independent inverse-modeling programs have been developed that can be applied to a broad range of forward models. Two such programs that have been widely accepted are UCODE (Poeter et al, 2005) and PEST (Doherty, 2004). Both UCODE and PEST have been incorporated into several GUIs to speed the model-calibration process.

## **Gas Transport Modeling**

#### *Introduction*

Gas transport, particularly the transport of oxygen into unsaturated waste-rock piles, can be an important process affecting the generation of ARD. Principal modes of oxygen transport include diffusion and advection. Wels et al. (2003) provide a comprehensive overview of the role of gas transport in ARD generation and methods that can be used to model gas transport.

#### *Data Needs*

Data required to model gas transport are similar to the data needed for equivalent modeling of water flow and transport in the subsurface. The permeability of the porous media is an important consideration. Because permeability to gas is a function of the degree of saturation of the pore space, moisture content is also important.

Permeability and moisture-content measurements can be made in the field or the laboratory. Measurements of moisture content are reasonably straightforward using established methodologies. Field measurements of air permeability using pneumatic pumping tests are described by Baehr and Hult (1991) and are conceptually similar to groundwater pumping tests used to determine aquifer characteristics. Stonestrom and Rubin (1989) describe laboratory air-permeability measurements.

#### *Model Selection*

Relatively few models have been developed specifically to address gas transport in the subsurface and the application to ARD-related problems. Modeling the complete set of physical and chemical processes operating within a waste-rock pile requires a multi-phase code capable of simulating gas and water flow in the unsaturated zone, chemical interactions with the solid matrix, heat generation and transfer, and chemical mass transfer in the liquid and gas phases.

Several general-purpose, multi-phase simulation programs have been developed that could be applied to these types of problems. The TOUGH family of codes (Pruess et al., 2004) was developed at Lawrence Berkeley National Laboratories and has been applied to a wide range of complex, multi-phase problems. TOUGH-AMD (Lefebvre et al., 2001) is an adaptation of TOUGH to address ARD-related issues. TOUGHREACT (Xu et al., 2004) was developed as a comprehensive non-isothermal multi-component reactive fluid flow and geochemical transport simulator to investigate acid-mine drainage and other problems.

Groundwater flow models can be adapted to simulate air flow using appropriate transformations of variables and parameter formulations. Massman (1989) shows how groundwater solutions can be modified for gas-flow problems. This type of adaptation would not be appropriate to model the most complex multi-phase, reactive-transport problems, but may be adequate to address many issues of importance to the prediction of ARD generation.

## **Considerations Regarding Predictive Modeling of Effluent Quality**

As discussed throughout Chapter 5 of the GARD Guide and this Appendix, the principal objective of mine and process water quality prediction is to evaluate the potential for geologic materials and mine and process wastes to generate acid and contaminants and affect water resources. As an important corollary, the need for and nature of mitigation measures is determined through prediction.

The nature and sophistication of the prediction effort may vary depending on the desired outcome. A prediction exercise aimed at merely answering a “yes/no” question (for

instance: will the water quality criterion for arsenic be exceeded?) requires less up-front understanding of the system being evaluated, in which case while use of relatively “crude” modeling tools may suffice. In contrast, when a more quantitative answer is required (for instance: what is the expected arsenic concentration?), the complexity of the modeling effort may be quite significant, requiring both a detailed conceptualization of the system being modeled as well as use of advanced modeling codes.

It should be noted that use of more sophisticated tools does not necessarily equate to more accurate and precise modeling outcomes. According to Oreskes (2000) and Nordstrom (2004), the computational abilities of codes and advanced computers currently far exceed the ability of hydrogeologists and geochemists to represent the physical, chemical and biological properties of the system at hand or to verify the model results. In light of these difficulties, the meaning of “accuracy” and “precision” in the context of mine and process water quality modeling must be re-assessed on a case-by-case basis, and numeric analysis needs to be conducted to reflect the uncertainty inherent in predictive modeling. Accordingly, USEPA (2003) recommends the following should be submitted at a minimum to substantiate modeling used for regulatory purposes, regardless of the specific model/code being used:

- Description of the model, its basis, and why it is appropriate for the particular use
- Identification of all input parameters and assumptions, including discussion of parameter derivation (i.e., by measurement, calculation or assumption)
- Discussion of uncertainty
- Sensitivity analysis of important input parameters

Having said all that, despite the limitations identified throughout this chapter, modeling and prediction have significant value as management tools and for gaining an understanding of the geochemical, physical and biological systems at mine and process sites (Oreskes, 2000). There is little doubt that the understanding of geologic materials, mine and process wastes and the hydrogeochemical factors that govern mine and process water quality will continue to advance through the implementation of laboratory and field experiments. In particular those experiments that isolate one variable at a time to identify its effect on overall discharge water quality will prove of great value. Similarly, ongoing characterization and monitoring of mine and process facilities will allow development of improved scaling factors needed to extrapolate results from smaller-scale tests to an operational level. Lastly, the tools required for geochemical, hydrological and hydrogeological modeling already largely exist. With an increased comprehension of the factors that govern the generation of ARD, NMD or SD, modeling and prediction efforts will become increasingly reliable.



# Chapter 6

## From GARDGuide

### 6.0 Prevention And Mitigation

- 6.1 Introduction
- 6.2 Goals and Objectives of Prevention and Mitigation
- 6.3 Approach to Acid Rock Drainage Prevention and Mitigation
- 6.4 Drivers of Acid Rock Drainage
  - 6.4.1 Physical Factors
  - 6.4.2 Geochemical Weathering Processes
  - 6.4.3 Climate and Physical Environment
- 6.5 Phased Approach
- 6.6 Overview of Best Practice Methods
  - 6.6.1 Avoidance
  - 6.6.2 Re-mining
  - 6.6.3 Special Handling Methods
  - 6.6.4 Additions and Amendment Methods
  - 6.6.5 Water Management Methods
  - 6.6.6 Engineered Barriers
  - 6.6.7 Water Cover Methods
  - 6.6.8 Drained Tailings Deposition Methods
- 6.7 Selection and Evaluation of Alternatives
- 6.8 Design and Construction Considerations
- 6.9 Maintenance and Monitoring Considerations
- 6.10 References
- List of Tables
- List of Figures

### Case Studies for Chapter 6

## 6.0 PREVENTION AND MITIGATION

### 6.1 Introduction

The most recent and widely accepted methods for the prevention and mitigation of ARD (see Chapter 1 for definition) are presented in this Chapter. Discussions include the principles and objectives for prevention and mitigation and definitions and terms, suitability and applications, expectations and limitations, and primary references. While this chapter focuses on environmental technologies, regulatory, social, economic, and sustainability issues must always be managed within the applications of all prevention and mitigation techniques.

As discussed in Chapter 2, sulphide mineral oxidation occurs naturally as part of the sulphur cycle. In the context of ARD management during mining, the goal of mitigation measures is often to maintain or control the rate of sulphide mineral oxidation so that ARD formation is prevented or reduced to minimal or acceptable levels. Absolute prevention of ARD may require that all reactive sulphide bearing minerals remain virtually isolated from atmospheric oxygen. However, absolute prevention of ARD may not always be required for protection of environmental quality.

The basic approaches to prevent ARD are similar at coal mines and hard rock mines: reducing oxygen ingress and reducing the flow of water that can act as a transport medium for oxidation products. Coal mines may make use of low-permeability covers, or selectively place pyritic material high in the backfill so that it will not be exposed to ground water. Pyritic material can also be mixed with alkaline strata or some added alkaline material or by-product (e.g., fly ash, steel slag), to neutralize acidity and inhibit high rates of pyrite oxidation that can occur when the pH gets low enough to permit iron-oxidizing bacteria and ferric oxidation of pyrite to become significant (Brady et al., 1990; Perry and Brady, 1995; Rich and Hutchison, 1990; Rose et al., 1995; Skousen and Larew, 1994; Smith and Brady 1998; Wiram and Naumann, 1995). These latter techniques have also been applied with some modifications at hard rock mines, as will be discussed later in this chapter.

The implementation of methods for prevention and mitigation depends on the mine development stage, deposit type, geochemistry, climatic regime, terrain (or topography), surface water, geology, groundwater, and aquatic and terrestrial ecosystems. Material availability, land management and land use requirements, receptors, risk, cost, maintenance, sustainability and regulatory requirements will also influence the approach selected.

It is important to recognize that the science and engineering of ARD management, especially related to prevention and mitigation, are evolving. There are no off-the-shelf solutions that can be applied at all sites that will guarantee acceptable water quality through prevention of ARD or leaching of soluble constituents from mine rock, tailings or other mine materials. Therefore, the planning for and management of mine material handling and storage should be considered in a risk-based framework. While a risk-based approach should apply to other aspects of ARD such as prediction, as discussed in Chapter 5 of this Guide, it is especially relevant to the planning and implementation of prevention and mitigation methods that will inevitably have unique features and issues that are associated with site-specific and mine-specific conditions.

Prevention and mitigation of ARD is an exercise in water quality management. One important feature of managing water quality associated with mine materials is delay times between implementation of remedial activities and observed or measured water quality from a facility such as a mine rock stockpile or a tailings impoundment. Delay times between implementation and monitoring or measurement of effects often result in the need for long periods of monitoring or testing to determine the outcomes of implemented methods. There is a growing foundation of long-term studies and case histories for prevention and mitigation strategies in the literature and in practice at many operations. With the exception of water covers that are relatively well understood, the scientific and engineering community are on an ongoing learning curve for many of the other ARD management approaches. Therefore, prevention and mitigation planning should be undertaken with due consideration of key uncertainties and appropriate management of risks to achieve the desired outcomes. While it is not practical to wait years or decades to confirm successful performance of proposed waste management methods, adaptive management techniques are needed and appropriate to respond to unexpected responses while maintaining environmental protection and cost control.

An understanding of delayed responses to test conditions or mitigation activities is important to anticipate potential outcomes and to correctly interpret data collected from tests or full-scale facilities. In some cases, delays can result from chemical behavior. The time to deplete neutralization potential (NP) and to the onset of low-pH conditions is an obvious example of such delays. In this case, we understand the process of NP depletion and with the appropriate data, the depletion times can be estimated even if test results did not exhibit depletion.

There are other, more subtle, changes that can also occur over time that can represent delays as well. For example, Rinker et al. (2003) showed that neutral drainage from humidity cell tests of mine rock from a nickel deposit exhibited delays of 20 to 50 weeks before exhibiting nickel concentrations that exceeded 0.01 mg/L. In that case, the elevated nickel values were triggered by a pH shift from 8 to 7.5. After recognizing the mechanism that was responsible for the increased nickel, the process and the outcome can be accounted for and therefore managed as required. Similar delays in metal release were observed in field-scale mine rock pile tests at a copper-zinc mine in South America. The test piles had been operating for four years with relatively low metal concentrations in the drainage. A shift in pH from 7.5 to 6.3 resulted in the release of copper and zinc concentrations in the tens of mg/L range in the drainage samples.

Although delays from chemical processes like those described in the previous paragraph can occur, the more common causes of delays are generally related to the hydraulics of rock piles and tailings facilities, or a combination of hydraulics and chemical reactions. The hydraulics or hydrology of mine rock piles and tailings deposits are relatively well understood and can be evaluated with proven science and engineering principles. Combining the hydraulic and chemical behavior is somewhat more complex, but conceptual models can be developed and translated to quantitative models or calculations as discussed in Section 5.5. Nonetheless, the monitoring of such facilities to assess performance of mitigation measures is not always straight forward. For example, it is not easy to measure leaching or water quality effects in a field-scale rock pile. Therefore, it is often necessary to collect and monitor drainage at the base of the pile. Depending on the size of the pile, this could represent years of delay between the changes that may occur in the pile and those observed in the drainage. The processes would therefore normally be modeled to better understand the expected water quality and timeframe for anticipated changes, and the modeling results would guide the monitoring program.

This chapter emphasizes examples and case histories in an attempt to assist the reader in understanding approaches to prevention and mitigation strategies that have been applied and for which performance data are available.

## 6.2 Goals and Objectives of Prevention and Mitigation

Prevention is a proactive strategy that obviates the need for the reactive approach to mitigation. Mitigation will be the usual initial course of action for an existing case of mine drainage that is adversely impacting the environment. Despite this initial action, subsequent preventative measures may also need to be considered in the context of reducing future contaminant load, and thus reducing the ongoing need for mitigation controls. For example, the amount of seepage requiring treatment may be reduced if the current source strength is reduced.

For both prevention and mitigation, the strategic objectives must be identified because, to a large extent, these strategic objectives will define the control methods that need to be used. The process of identifying the strategic objectives should consider the following:

- Quantifiable risks to ecological systems, human health, and other receptors
- Site-specific discharge water quality criteria
- Capital, operating, and maintenance costs of mitigation or preventative measures
- Logistics of long-term operations and maintenance
- Required system longevity

- Risk of system failure and identification of potential modes of failure

ARD/ML prevention is the key to avoid costly mitigation. ARD, NMD, and SD are all the result of natural weathering processes that occur under atmospheric conditions. The primary goal of the prevention is to stop contaminated drainage from leaving the mine site at its source by minimizing reaction rates, leaching, and the subsequent migration of weathering products from mine waste to the environment.

A typical objective for ARD control is to satisfy environmental criteria using the most cost-effective technique. Technology selection should consider predictions for discharge water chemistry, advantages and disadvantages of treatment options, risk to receptors, and the regulatory context, including permitted discharge water quality (see Chapter 9).

### **6.3 Approach to Acid Rock Drainage Prevention and Mitigation**

Prevention of ARD can be achieved through a risk-based planning and design approach that is applied throughout the mine life cycle. However, prevention is primarily accomplished in the assessment and design phases. The prevention process aims to quantify the long-term impacts of alternatives and to use this knowledge to select the option that has the least impact. Mitigation measures implemented as part of an effective control strategy should require minimal active intervention and management.

The primary approach to the prevention and mitigation of ARD is to apply methods that minimize the supply of the primary reactants for sulphide oxidation, and/or maximize the amount and availability of acid neutralizing reactants. These methods may involve one or more of the following:

- Minimizing oxygen supply because of diffusion or advection
- Minimizing water infiltration and leaching (water acts as both a reactant and a transport mechanism)
- Minimizing, removing, or isolating sulphide minerals
- Controlling pore water solution pH
- Maximizing availability of acid neutralizing minerals and pore water alkalinity
- Controlling bacteria and biogeochemical processes

Factors influencing selection of the above methods include the following:

- Geochemistry (i.e., sulphide/carbonate content and reactivity) of source materials and the potential of source materials to produce ARD
- Type and physical characteristics of the source, including water flow and oxygen transport
- Mine development stage – (More options are available at early stages.)
- Phase of oxidation – (More options are available at early stages when pH may be near neutral and oxidation products have not significantly accumulated.)
- Time period for which the control measure is required to be effective
- Site conditions – location, topography, and available mining voids, climate, geology, hydrology and hydrogeology, availability of materials, and vegetation
- Criteria for discharge
- Risk acceptance by company and stakeholders

In general, more options and more effective options are available earlier in the mine life, as indicated in Figure 6-1. More than one measure, or a combination of measures, may be required to achieve the desired objective.

Figure 6-1: Options and Effectiveness with Time (TEAM NT, 2004)

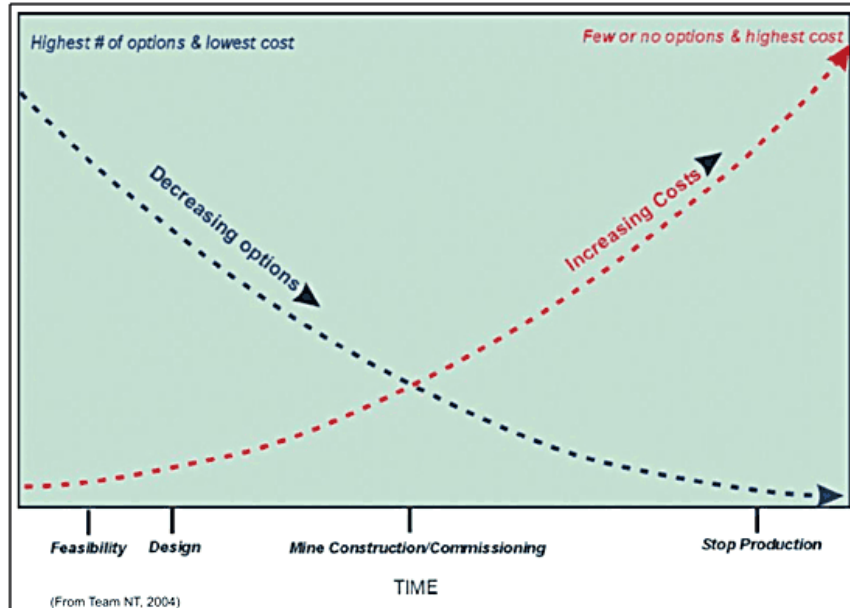

## 6.4 Drivers of Acid Rock Drainage

The primary drivers of ARD can be classified in three distinct categories of physical factors, geochemical weathering processes, and climate and physical environment. Each is described below in Sections 6.4.1 through 6.4.3.

### 6.4.1 Physical Factors

The structural nature and physical environment of the ARD source material influences selection of the most appropriate method(s) for prevention and mitigation. Typical mining and non-mining related sources of ARD are reviewed in Chapter 4. Specific mining related examples include the following:

- Waste rock – coarse, highly permeable unsaturated porous overburden material (boulder to sand size) deposited in the mine pit or as rock piles above the natural topography
- Tailings and coal refuse – fine, variably saturated or unsaturated porous material (clay to sand size) derived from ore processing or beneficiation, generally deposited in engineered impoundments
- Spent ore and heap leach residues
- Open or filled pits, containing rock debris, massive and fractured rock
- Underground mine structures, shafts, drifts, and stopes
- Block cave rubble zones (can be transitional between waste rock and fractured rock medium characteristics)

The structural nature and physical environment of each source must be described with respect to the water table, seepage and flow, degree of saturation, oxygen, heat, and solutes to provide a detailed level of understanding of how geometry, hydraulic properties, and structure influence control mechanisms, behavior, and performance. For example, Figure 6-2 illustrates processes that occur within a waste rock dump and are influenced by structure. By necessity, solutions to prevent or mitigate ARD will therefore be site specific.

Figure 6-2: Waste Rock Pile Structure and Processes (Wilson, 2008b)

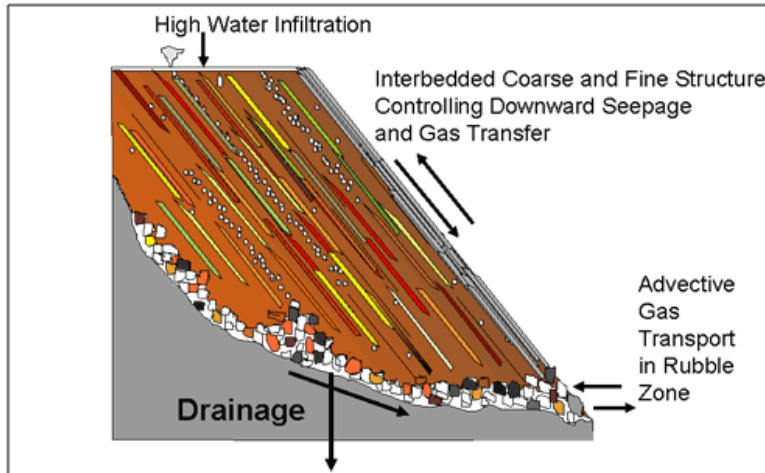

### 6.4.2 Geochemical Weathering Processes

Factors that control the generation of ARD and other mine drainages (see Chapter 1) are described in Chapter 2. The integration and coupling of ARD factors must be used to assess the best approach to prevention and mitigation of ARD. Controls may be targeted at each aspect of the ARD generation process.

### 6.4.3 Climate and Physical Environment

A physical environment is formed when water and energy budgets are coupled with the terrain, landforms, surface topography, soils, stratigraphy and geology, surface hydrology, hydrogeology, and flora. Together these factors comprise an “earth system” and need to be considered in developing the most suitable methods for prevention, control, and mitigation of mine discharges.

For example, in open pit hard rock mines, most of the mine wastes are typically stored on the surface and exposed to atmospheric conditions. Because the main source of mine drainage is meteoric water, local climate has a direct influence on the selection of prevention and mitigation methods for ARD. The Köppen system (Peel et al., 2007) is a well known method for climate classification. Methods for prevention and mitigation that are suitable in a tropical humid climate, such as Borneo, Indonesia, may fail in a dry climate such as the Pilbara region of Western Australia or the polar climate in the Northwest Territories of the Canadian Arctic.

#### Sample Climate Classification (Köppen system)

- Tropical humid
- Dry
- Mild mid - latitude
- Severe mid - latitude
- Polar
- Highland

## 6.5 Phased Approach

A phased approach to the implementation of methods for prevention, control, and mitigation is recommended. Experience based on direct observation is of great value for decision analysis (adaptive management) and the design of systems for prevention and mitigation.

For example, longer-term data for some ARD methods (e.g., water covers) are now available. As discussed in Section 6.1, time frames associated with mine life cycles are decades and sometimes centuries, so the time frames required for the verification of prevention and mitigation methods may be long.

Therefore, assessment, design, testing and refinements should take place at all phases of the project although varying in intensity of effort. During exploration, activities are minimal and a screening assessment of a few representative samples for ABA would be adequate. During project planning, the effort should be consistent with the advancement of the project, with preliminary efforts at the scoping stage to identify possible risks and issues, to more advanced and intensified assessment and identification of preferred ARD management options for various mine components.

#### Scientific Method

- Question
- Hypothesis
- Experiment
- Analysis
- Conclusions

These concepts have been articulated in Chapters 1 and 5 and are illustrated in Figures 1-2 and 5-1. Figure 6-3 builds on Figure 5-1 with an emphasis on the development of prevention and mitigation strategies and plans. Because of the site-specific nature of methods and the evolving nature of scientific



understanding and engineering experience, there is a need for continuous feedback, assessment and refinement at the various stages of mine planning, development, operations and decommissioning.

**Figure 6-3: Adaptive Management Approach to Prevention and Mitigation of ARD**

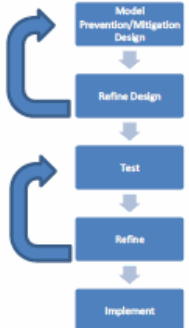
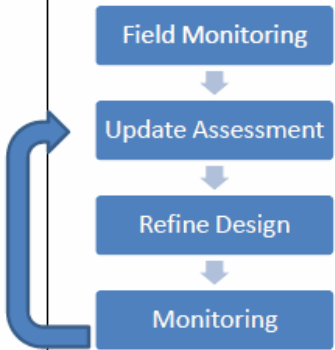
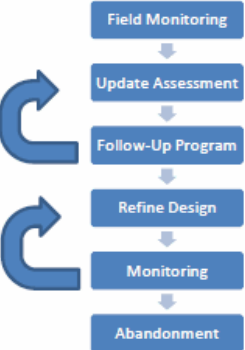
Project Phase	Minimum Objectives	Activities
Exploration	Conceptual Geological Model	Screening assessment of ARD
Mine Planning - Scoping/Pre-Feas/Feasibility	Conceptual ARD Model for Site/Project Preliminary ARD Assessment Follow Through Assessment Develop Conceptual ARD Management Plan  	Waste Characterization Lab Tests - Limited Materials Preliminary Predictions  Additional Waste Testing Confirmation Refinement  Scale-up Tests  Preliminary ARD Plan Model Mitigation Scenarios Test Mitigation  Refine Designs  Finalize Mitigation Plans
Construction		Implement ARD Management Plan
Operation		Monitor  Re-assess  Refine  Monitor
Decommissioning and Closure		

The observational approach based on scientific methods is the most appropriate approach. The ARD prevention plan should be as robust (based on scientific and engineering methods) and flexible as possible so that it can be adapted based on observed performance. Figure 6-4 illustrates adaptive management and implementation using a phased approach, which begins with the development of hypotheses and conceptual designs based on site characterization and problem definition. The phased process can begin and enter at any stage of mine development. The key step is to develop a system design that leads to the basis for analysis and the capacity to make decisions. The process should include a staged approach that allows ongoing analysis, verification, and improvement in system design. Regional and local experience at nearby mines, where available, should also be used to minimize redundant investigations and to optimize the most successful methods for prevention and control. The phased approach leads to development of a monitoring and

maintenance program that reinforces and improves system design and performance.

**Figure 6-4: Adaptive Management Implementation by Phased Approach**

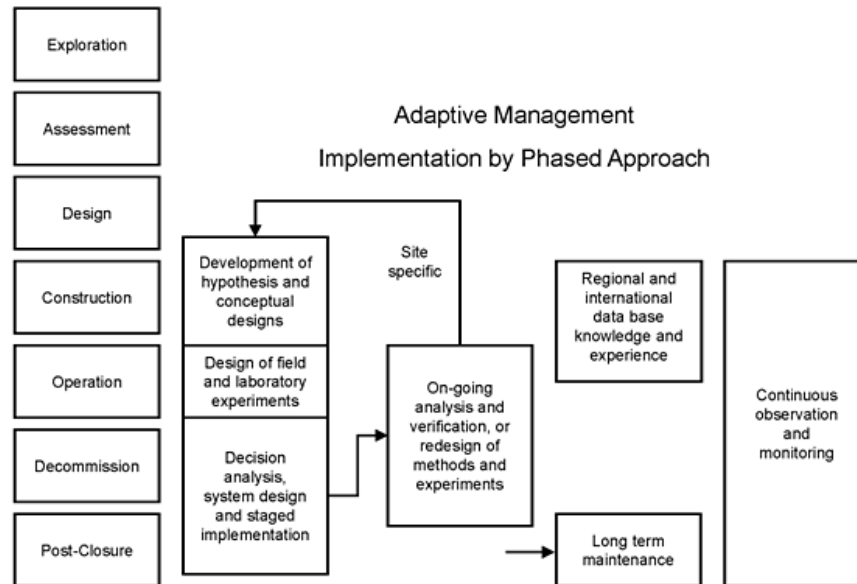

## 6.6 Overview of Best Practice Methods

This section presents a summary of the methods available for prevention and mitigation of mine drainage, as shown in Figure 6-5. The purpose of this section is to provide an overview of best practice methods. Detailed design manuals, such as MEND (2001), MEND (2004a) and DWAF (2007), are provided in the reference section.

Technically, “prevention” implies plans or activities before the fact that will result in no undesirable effects as a result of mine waste management. For example, direct deposition of unweathered sulphide tailings under water during operations to prevent acid generation and metal leaching may be considered a preventive action. “Mitigation” can be applied to prevent the occurrence of ARD or as a corrective action to an existing condition. For instance, oxidized acidic tailings can be flooded to mitigate water quality effects by preventing future acid generation, but soluble metals may be released from past oxidation. Because some methods can be applied during the planning stages as true “prevention” strategies as well as corrective strategies for existing conditions to mitigate ARD and water quality impairment, the prevention and mitigation methods have not been separated in the following discussion. However, where appropriate, cautionary notes have been added in the text to indicate where performance of particular methods may differ when applied to fresh, newly deposited materials versus historic, previously exposed materials with soluble loads of acidity and/or other constituents. For example, flooding of both fresh non-oxidized and pre-acidified tailings can be beneficial. However, as mentioned above, the pre-acidified tailings will need to be managed appropriately to account for the acid and metals that will be flushed from the tailings and the time that will be required before the overlying water quality approaches the desired criteria or target concentrations.

Figure 6-5: Methods for Prevention and Mitigation of ARD

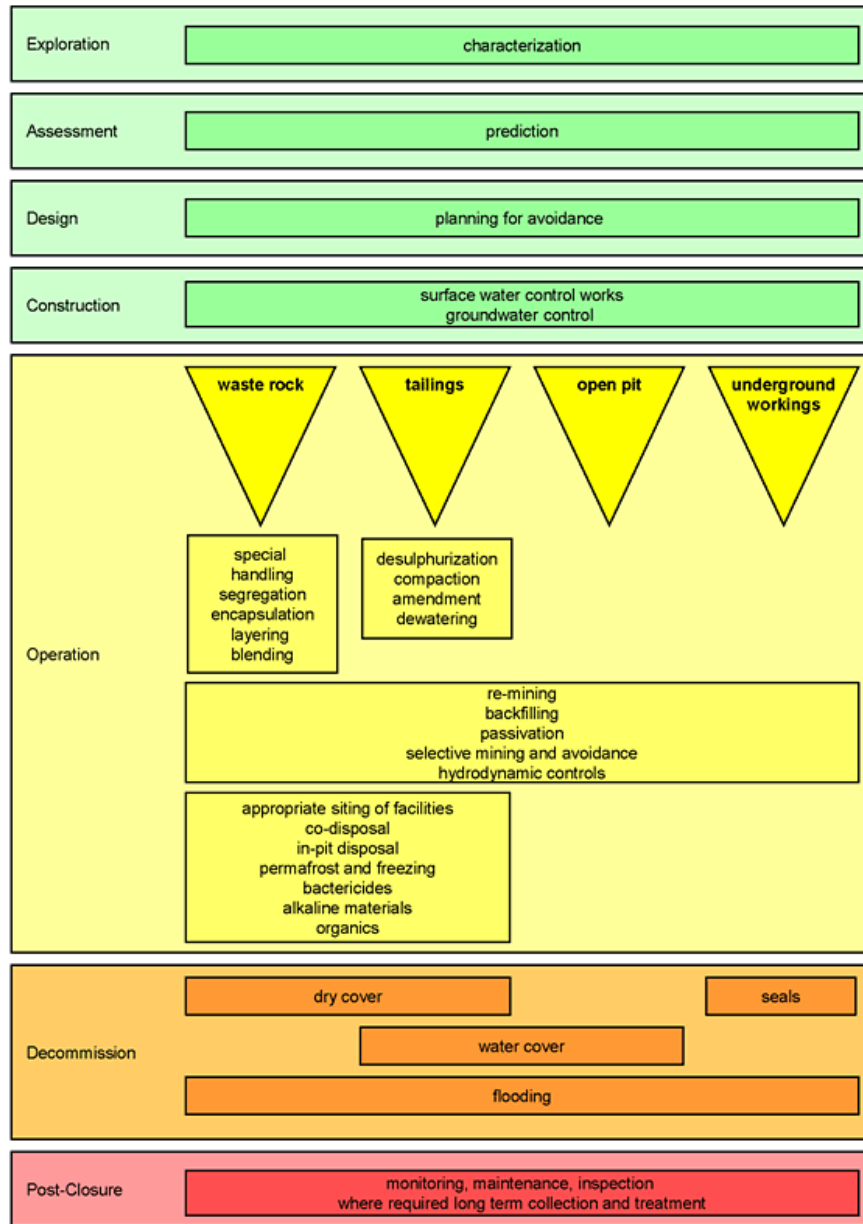

### 6.6.1 Avoidance

Sites that generate ARD with a high solute load and concentrations of contaminants can incur significant long-term ARD treatment costs that can impair the economic success and, in some cases, the viability of a project. Measures for ARD prevention, mitigation, and treatment must therefore be included in evaluation of mine lifecycle costs, both for processing wastes that are derived from the ore and overburden or waste rock that must be stripped to access the ore. The result of this overall assessment may be a decision not to mine a particular rock mass at some mines, or to mine in a manner that might initially be thought to be more costly (ADTI, 1998).

**Early avoidance of ARD problems is a best practice technique that may be achieved through integrating the results of characterization and prediction, described in Chapters 4 and 5, with mine planning, design, and waste management strategies.**

Avoidance is not synonymous with non-development in mining. Avoidance includes the decision not to extract a particularly reactive rock type that will be too difficult to manage in the future. This may require the development of mine designs that avoid or work around difficult rock types through alteration of mine access, inclines, stopes, and open pit designs.

## 6.6.2 Re-mining

Historical legacy sites that are currently generating ARD are some of the most difficult to remediate because significant volumes of reactive wastes may need to be managed or even moved. However, sometimes abandoned surface or underground mines can be re-mined to remove valuable material that remains. Re-mining provides opportunities to improve waste disposal systems and reduce or remove sulphide minerals.

Re-mining methods used include the following:

- Excavation and milling of waste rock and tailings deposits
- Covering and burial of existing waste piles with new benign waste
- Push-back of existing pits walls to excavate and process reactive rock, leaving lower grade non-reactive wall rock
- Excavating areas previously mined by room-and-pillar methods, extracting the reactive rock along with the remaining commodity (e.g., coal), also called “daylighting”
- Re-handling wastes and moving them to improved storage facilities

Typically, at coal mines, re-mining and reclamation reduce acid loads by:

1. decreasing infiltration rates
2. covering acid-producing materials
3. removing the remaining coal which at many sites is the source of most of the pyrite.

However, re-mining can also expose pyritic overburden strata and so can actually degrade water quality unless supplemental abatement measures, such as alkaline addition, are used (Hawkins, 1998). Therefore, an assessment of re-mining options should consider the potential long-term costs for mitigation and treatment of drainage versus the potential for increased recovery of resources. At many sites, the value gained from extraction can finance further opportunities to mitigate ARD (PaDEP, 1998 Chapter 17).

## 6.6.3 Special Handling Methods

Specialized handling procedures for mine waste products, including tailings and waste rock, are often adopted as part of a strategy to minimize ARD. This is often the first step in implementing the ARD management plan. The handling procedures are based on the result of the ARD prediction program (Chapter 5). Special handling approaches are discussed in this chapter and in Chapter 9.

### 6.6.3.1 Incorporation in Mine Plan

Mine waste handling may be incorporated into mine planning to minimize exposure of materials to atmospheric conditions and minimize the volume of material left on surface at closure. Examples of common practices include the following:

- Use of tailings backfill for underground support. This method can also reduce overall costs compared to conventional hydraulic backfill.
- Subaqueous disposal of reactive wastes in mine voids, including placing mining wastes into open pits and underground workings. The economic feasibility of this practice is highly site specific, but is fairly common, and the approaches are well developed. Mined-out pits can provide a void for storage of tailings, waste rock, or seepage water. Pits provide the potential for long-term geologically stable containment while traditional impoundments often require monitoring and maintenance to ensure stability of the constructed embankments over the long term.
- In-pit disposal of tailings or waste rock may be combined with other strategies, such as subaqueous or underwater disposal, alkaline addition, cover technologies, and sulphate reduction, which are described later in this chapter.
- Minimization of the waste footprint to reduce capping and revegetation costs, or to reduce the surface area exposed to precipitation and oxidation.
- Avoidance of placing waste storage facilities near sensitive receiving environments or regionally significant aquifers.

### 6.6.3.2 Segregation

Segregation of waste rock (also referred to as selective handling) involves physical separation of PAG and NAG materials (MEND, 2001). While segregation on its own does not prevent ARD, it is often a necessary step within the mitigation plan. PAG materials may be used or placed in engineered configurations to minimize impacts to the receiving environment. Commonly, one attempts to either ensure that PAG material is kept completely saturated (to minimize exposure to air) or to minimize surface and groundwater contact with PAG materials while maximizing water contact with alkalinity generating materials. Segregation of ore and waste is standard mining practice, and similar techniques may be used to separate waste types (see Chapter 9). The development of an ARD management plan that involves segregation generally proceeds as follows:

- The mine waste plan is developed based on detailed geochemical characterization using procedures defined in Chapters 4 and 5 and appropriate models (i.e., block models for open pits).
- Waste management and operational monitoring programs are established to identify and segregate materials before handling, transport, and deposition.
- Special handling procedures are developed, such as cellular construction of waste piles or purpose-built repositories for reactive materials with

system design to provide isolation and sealing (e.g., subaqueous disposal of reactive wastes or storage of PAG rock within tailings impoundments). Waste rock lifts might be compacted or covered with thin layers of lower permeability material to inhibit infiltration and oxygen transfer.

At coal mines, the PAG material is typically placed on a pad of non-reactive rock so that it is elevated above any fluctuating water level in the pit. The material should be compacted and treated with alkaline material to neutralize the acid-producing potential, capped with a layer of low permeability material, and then covered with non-acid-producing material and topsoil to reduce water and air movement into the reactive rock. Further information on special handling at coal mines may be found in Perry et al. (1998: <http://www.dep.state.pa.us/dep/deputate/minres/districts/cmdp/chap14.html>), Skousen and Ziemkiewicz (1996), and Hawkins (2004).

### 6.6.3.3 Tailings Desulphurization

The concept of desulphurization of tailings to prevent ARD has been considered since the early 1990s (Bois et al., 2004). The concept is based on the separation of non-economic sulphide minerals into a low-volume stream, leaving the majority of the tailings with a low sulphur content that will be less reactive and preferably non-acid generating. The two tailings streams can then be managed differently. The high-sulphur material can be selectively deposited in the tailings pond to remain submerged in water during operations and post closure. Alternatively, the high-sulphur tailings can be managed to ensure that they will be covered by the low-sulphur material after closure if assessment shows that this approach is considered protective of water quality during operations and in the long term. In any case, there will be a need to manage the high-sulphur tailings that presumably will represent only a small fraction of the total tailings volume produced during the operation.

Desulphurization can be achieved in different ways, depending on the ore type and metallurgical process used to extract economic minerals from the ore. A separate flotation circuit or additional flotation cells to increase sulphide removal in the mill can be constructed. Bois et al. (2004) showed that metal mine tailings containing about 20% S could be separated by flotation, into materials containing 0.5% S and 43% S. Hesketh et al. (2010) also demonstrated sulphur removal by flotation technology and achieved a low sulphur tailings with 0.22% S that was non-acid generating with a net neutralization potential (NNP) of 25 kg-CaCO<sub>3</sub>/t.

Sulphur separation was used at a mill that processed nickel sulphide ore in Canada. The sulphur was initially removed to lower the sulphur content in coarse-grained tailings that were used for mine backfill. The fine fraction or cyclone overflow was utilized as a low-sulphur cover material on existing high-sulphur tailings (Martin and Fyfe, 2011).

Sulphur separation can also be achieved as an objective of metallurgical processing of ore, for porphyry copper ores, for example. Metallurgical separation of sulphur in ore can be used to increase efficiency of copper recovery producing a “rougher” tailings with a low sulphur content and a “cleaner” tailings with a high sulphur content. Examples of such metallurgical processes have resulted in low-sulphur tailings that contain less than 0.03% S with a positive NNP and will not generate acid. The corresponding high-sulphur tailings stream can contain on the order of 5 to 10% S, and would typically represent less than 10% of the total tailings mass. At a proposed copper mine in Central America, the high sulphur tailings will be deposited under water into the pond within the tailings impoundment during operations and then will also be covered by low-sulphur tailings at the end of the operation (AMEC, 2010).

Depyritized tailings with non-acid generating or acid consuming characteristics may be stored in large-volume repositories. Relatively clean tailings materials may also be used for other prevention and mitigation methods, such as soil covers (Sjoberg-Dobchuk et al., 2003). The acid generating characteristics of the depyritized tailings should be verified to ensure that it is not acid generating before it is used as a cover material.

In general, the feasibility of this sulphide separation option depends on the characteristics of tailings and therefore must be assessed for site-specific conditions. The flotation processes must be sufficiently effective to remove enough sulphide minerals to render the remaining tailings as non-acid generating. The cost of the process may be offset by the production of a relatively clean tailings material that can potentially be used to provide a final cover layer, rather than having to mine or import material from elsewhere (MEND, 2001; Bussière, 2007; Strathcona Case Study).

### 6.6.3.4 Compaction and Physical Tailings Conditioning

Control of physical properties of tailings may be accomplished by methods including thickening, filtration, compaction, and gradation control. The purpose of conditioning is to improve physical properties, such as reduction of hydraulic conductivity, to limit the ARD process. For example, a decrease in porosity may result in a decrease in both hydraulic conductivity and oxygen diffusion. Figure 6-6 (Aubertin, 2005) illustrates the relationship between the coefficient of oxygen diffusion and degree of saturation for soils or porous media. It illustrates that oxygen diffusion rapidly decreases by 3 to 4 orders of magnitude as the degree of saturation increases above 85%. The concept described here has been successfully implemented at a number of sites, including the multi-layered cover design at the Les Terrains Aurifères (LTA) site in Quebec, Canada described by Bussière (2007). This case was also reported as a MEND study and can be found on the web site <http://www.mend-nedem.org/>.

Figure 6-6: Coefficient of Diffusion versus Degree of Saturation for Saturated Porous Media (from Aubertin, 2005)

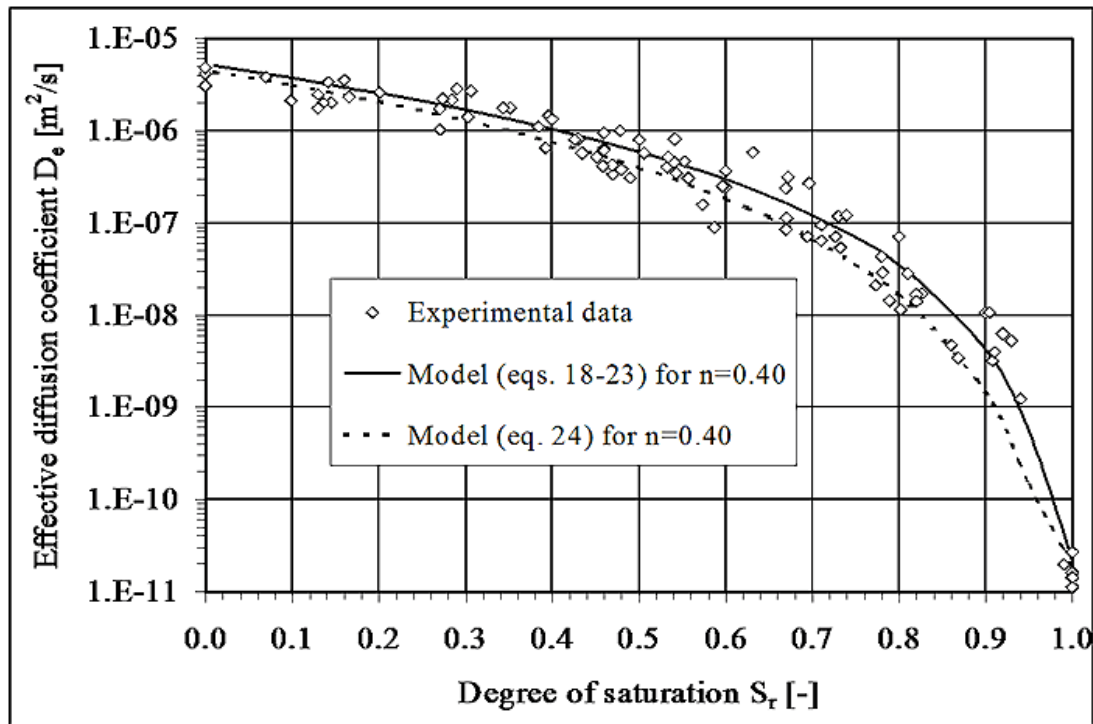

Traditional disposal of tailings slurry to impoundments by hydraulic deposition typically produces a beach of coarser material near the spigot and finer materials further from the spigot. The beach materials are usually above the water table and are unsaturated and therefore prone to oxidation. Sulphide segregation may occur on beaches due to the higher specific gravity of pyrite versus other non-sulphide minerals including carbonates. Finer tailings tend to have lower permeability, water retaining capacity and resistance to air entry, and are more likely to be saturated. However, finer materials are often unconsolidated and prone to liquefaction and settlement that make reclamation more difficult.

For geotechnical reasons, the embankments for tailings impoundments are generally designed to be well drained and unsaturated. Construction of embankments with sulphide-bearing tailings may pose significant ARD risks compared to construction with inert materials.

Several methods are available to improve physical properties of tailings (Bussi re, 2007). Tailings can be thickened (removal of water) to produce a non-segregating material or paste (ACG, 2006). Selection of thickening technology depends on tailings geochemical and physical characteristics and must be reviewed on a site by site basis. Compaction of placed materials will decrease oxygen diffusion and void ratios, decrease water permeability, increase water retention, and increase saturation levels. Installation of wick drains or blast densification can achieve the same result, depending on the tailings deposit.

Layering tailings deposits with clean or low sulphur layers may decrease oxygen gradients and limit oxygen diffusion. Tailings gradation and fines content may be adjusted to create fine layers that maintain high saturation (Figure 6-7) and restrict oxygen flow to underlying sulphide-bearing coarser layers. This method of layering is best implemented as a closure approach to create a cover, and may be achieved through controlled tailings discharge management and deposition planning.

### 6.6.3.5 Encapsulation and Layering

Encapsulation and layering involves placing acid producing and acid consuming materials (typically waste rock) in geometries designed to control or limit ARD. The effectiveness of the encapsulation and layering is governed by availability of materials, the general balance between acid producing and acid neutralizing materials, the type and reactivity of acid-consuming material, deposit geometry, the nature and flow of water through the deposit, and chemical armoring of alkaline materials (MEND, 1998a and 2001; Miller et al., 2003 and 2006). Layering of waste rock and tailings materials is discussed below in Section 6.6.3.7.

Encapsulation has been applied for acidic historic tailings that were moved to expand a pit at a gold mine in the Timmins region, Ontario Canada. The acidic Pamour tailings were relocated in 2006 (**Pamour Case Study**). The tailings were placed on a layer of neutral tailings containing excess carbonate minerals and covered by similar material. Experimental studies were also completed to evaluate final water quality and results were reported in MEND, 2010.

**Figure 6-7: Example Waste Rock Encapsulation Strategy**

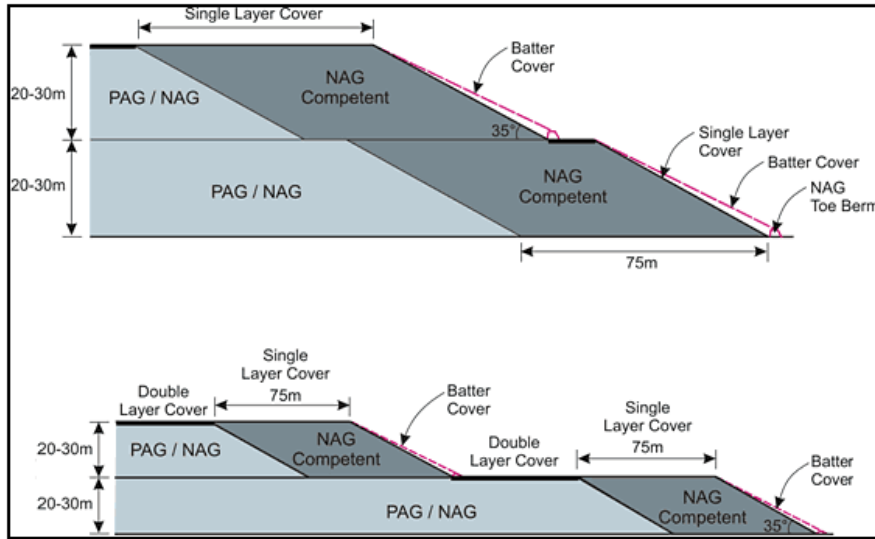

**6.6.3.6 Blending**

Blending is the mixing of waste rock types of varying acid generation and neutralization potential to create a deposit that generates a discharge of acceptable quality. The effectiveness of blending as an option depends on the availability of materials and the mine plan, the general stoichiometric balance between acid producing and acid neutralizing materials, geochemical properties, reactivity of waste rock types, flow pathways created within the deposit, and the extent of mixing and method of blending. Homogeneous and thorough mixing is generally required to achieve maximum benefit (MEND, 1998a and 2001). Evidence from field trials indicates limited success with mixing of waste rock types using haul trucks, but better mixing of waste rock with limestone was achieved using a conveyor system and stacker (Miller et al., 2006).

Operational experience indicates that, for effective blending of PAG rock with limestone, it is essential that all size fractions within the blend be at least acid-base neutral (i.e., NPR (ANC/MPA) of at least 1). Since the run of mine particle size of limestone is generally coarser than PAG rock, the acid base balance or NPR of the bulk waste rock needs to be greater than one. Experience with rock types at Freeport (Indonesia) and Ok Tedi (Papua New Guinea) indicates that well-mixed PAG and limestone rock needs to have a bulk NNP of more than 150 kg CaCO<sub>3</sub>/t (or net acid production potential (NAPP) of less than 150 kg H<sub>2</sub>SO<sub>4</sub>/t). The actual blend will depend on site factors and particle size distribution for each rock type.

**6.6.3.7 Co-disposal**

Co-disposal is the disposal of waste rock with tailings. Co-disposal can take several forms, which vary depending on the degree of mixing, as summarized in Table 6-1 (Wickland et al., 2006).

**Table 6-1: Forms of Co-Disposal (from Wickland et al., 2006)**

Co-disposal Type	
Homogeneous mixtures - Waste rock and tailings are blended to form a homogeneous mass – “paste rock.”	Increasing degree of mixing  ↑
Pumped co-disposal – Coarse and fine materials are pumped to impoundments for disposal (segregation occurs on deposition).	
Layered co-mingling – Layers of waste rock and tailings are alternated.	
Waste rock is added to a tailings impoundment.	
Tailings are added to a waste rock pile.	
Waste rock and tailings are disposed in the same topographic depression.	

Co-disposal has the potential to limit ARD as follows:

- Co-disposal of highly reactive waste rock within saturated tailings impoundments
- Layered co-mingling of thickened tailings and waste rock
- Thorough mixing of paste or filtered tailings with waste rock to create “paste rock”

In each case, loadings of leaching products can be reduced as a result of restricted access to oxygen as well as reduced flow rates through the deposit

compared to conditions within a typical waste rock pile.

For ideal mixing, the void space of waste rock particles are filled with finer tailings particles which typically have a higher moisture content, thereby limiting the transport of oxygen and water relative to deposits of waste rock alone. Amendment of tailings with alkaline materials is possible, and co-disposed materials will have a lower rate of ARD production than only blending of waste rock types. Benefits and considerations for co-disposal are listed in Table 6-2.

**Table 6-2: Benefits and Considerations of Co-Disposal**

Additional Benefits	Considerations
<ul style="list-style-type: none"> <li>▪ Minimization of footprint or volume required for disposal</li> <li>▪ Physical stability</li> <li>▪ Possible use as cover material</li> <li>▪ Possible elimination of the tailings dam</li> <li>▪ Creation of an elevated water table within deposits</li> </ul>	<ul style="list-style-type: none"> <li>▪ Waste production schedule and sequencing</li> <li>▪ Proportions of waste rock to tailings, or strip ratio</li> <li>▪ PAG/NAG ratio</li> <li>▪ Erodibility of gap graded mixtures</li> <li>▪ Methods for mixing and placement with respect to maximum particle size</li> <li>▪ Limitations on future re-mining of tailings</li> </ul>

Pumped co-disposal of coarse and fine coal beneficiation wastes has been implemented at coal mines in the United States, Australia, and Indonesia since the 1990s (Williams et al., 1995), though pumped co-disposal typically results in a segregated deposit. Co-disposal is used in South African coal operations where coal slurry is placed within a dam constructed of coarse reject. Mixing waste rock and tailings for blended co-disposal and paste rock at operating hard rock mines appears promising, but is in the research stage and, as of 2012, has not been implemented at full scale.

**6.6.3.8 Permafrost and Freezing**

Permafrost or ice covers approximately 25% of the earth’s surface, and the mine operator may take advantage of cold conditions to control weathering and drainage. Permafrost is generally defined as ground that remains below 0° Celsius for more than 2 years. The term permafrost does not imply ice or water content.

Freezing of materials to control acid generation has been used as a strategy to control ARD at several northern sites (MEND, 2004b). However, it should be noted that chemical activity does not stop at 0° Celsius, and freezing point depression, caused by higher concentrations of dissolved solids in water, may result in unfrozen water in mine waste materials at temperatures well below freezing.

Periodic warming of the surface during summer periods in zones of permafrost results in thaw within an upper “active zone.” Strategies for limiting chemical weathering may include a cover that prevents penetration of the active zone into PAG materials so that the PAG materials remain frozen (MEND, 2009).

Tailings deposition planning may be optimized to promote freezing during winter months and limit thawing during summer months. Thermal analysis is required to predict long-term freezing of reactive materials. Experience has shown that tailings will freeze on cold sites, such as at the Nanisivik Mine, Nunavut, Canada (Claypool et al., 2007).

As a general rule, permafrost encapsulation requires approximately -8° Celsius mean annual air temperature. One possible limitation of relying on freezing alone is the potential for climate change associated with global warming (MEND, 2001 and 2004b).

**6.6.4 Additions and Amendment Methods**

Methods for use of amendments and additions are described below in Sections 6.6.4.1 through 6.6.4.4.

**6.6.4.1 Passivation**

Passivation is the treatment of reactive rock surfaces to limit release of leaching or oxidation products by creating a chemically inert and protective surface layer. Few systematic studies have been performed, especially at the field scale, and operational use of passivation techniques is essentially non-existent.

Under EPA’s Mine Waste Technology Program, MSE Technology Inc (MSE) conducted three comparative evaluation studies to evaluate several ARD passivation and microencapsulation technologies. Laboratory-based weather accelerated conditions were studied for two commercial technologies. This work indicated that the KEECO treatment (see below for more detail) was successful in preventing or delaying ARD with the initial consequence of generating very high pH levels. This work also indicated that the MT2 EcoBond treatment (see below for more detail) delayed the onset of ARD.

A field multi-cell evaluation of four treatment technologies (KEECO, potassium permanganate, EcoBond, and lime) indicated that the potassium permanganate and



lime technologies were able to prevent or delay ARD formation. An evaluation demonstration of four technologies on an open-pit mine highwall indicated that all treatments reduced the concentrations of SO<sub>4</sub><sup>2-</sup> removed and reduced the mobility of metals from the highwall.

Several of the technologies that have undergone investigation are discussed in more detail in the following sections.

### ***Potassium Permanganate***

A potassium permanganate based passivation technology was developed by DuPont (DeVries, 1996) and is owned by University of Nevada, Reno (UNR). The pyritic rock surfaces are first rinsed with a solution of lime, sodium hydroxide, and magnesium oxide at a pH >12, followed by treatment with potassium permanganate. The overall reaction generates a manganese/iron/magnesium surface, which is resistant to further oxidation and substantially reduces the ARD generation. Pilot-scale experiments have shown that passivation with potassium permanganate can substantially reduce contaminant release for more than 5 years, but the long-term stability of this treatment still needs to be established. Treatment of freshly mined surfaces has shown the greatest success, and requires the lowest consumption of reagents compared to treatment of aged reactive rock surfaces, which often have high acidity and contain an oxidation rind that limits the effectiveness of passivation (Miller and Van Zyl, 2008).

### ***Phosphate Coatings***

Application of soluble phosphate together with hydrogen peroxide generates an inert surface layer. The hydrogen peroxide oxidizes pyrite and produces ferric iron, which reacts with the phosphate to produce a surface-protective coating of ferric phosphate on pyrite surfaces. Evangelou (1998) proposed an alternative coating technique involving the formation of an iron oxide/silica coating on pyrite surfaces.

The application of phosphate fertilizers was proven to be an effective short-term method. However, the results of long-term field trials demonstrate that coarsely granulated waste rock was not coated by secondary phosphate solid phases and that amendment by phosphate rock or phosphate fertilizer did not improve leachate quality compared to the unamended waste (Mauric et al., 2011).

Laboratory experiments (Harris and Lottermoser, 2006) demonstrated that the application of bulk industrial chemicals (potassium permanganate and water-soluble phosphate fertilizer Trifos, Ca(H<sub>2</sub>PO<sub>4</sub>)<sub>2</sub>) to partly oxidized, polyminerallic mine wastes can inhibit sulphide oxidation and metal and metalloid mobility. Chalcopyrite and galena were found to be abundantly coated with metal, metal-alkali and alkali-phosphate. The technique was ineffective at suppressing oxidation of arsenopyrite and preventing the release of arsenic from mine waters.

### ***Combined Phosphate and Thiocyanate Treatment***

Combined phosphate and thiocyanate treatment has been presented as an effective coating technology (Olson et al., 2005) to prevent ARD generation. Thiocyanate at low concentrations is a strong and selective inhibitor of microbial iron oxidation, which prevents severe ARD generation that lessens the effectiveness of phosphate in precipitating Fe and Al phosphate coating on pyrites. The technology was tested at the Red Dog zinc-lead mine in northwestern Alaska on sulphidic waste materials at a kg scale in laboratory humidity cell and column leach tests and at 600-ton scale in field trials (Olson et al., 2005). Thiocyanate addition reduced ARD generation by 50% or more compared to untreated sulfidic waste. Low dosages of phosphate materials combined with thiocyanate treatment reduced ARD generation beyond that was achieved with thiocyanate alone.

### ***High-pH Aluminum Waste***

Treatment of acid generating pyritic rock surfaces with high-pH aluminum waste (ITRC, 2008) offers certain benefits that can not only neutralize acidic rocks but also provide a passivation layer for the remaining rock. In this treatment, waste from aluminum smelters, which generally has a high pH, is mixed with either the acidic waste rock or an acid drainage solution. The resulting precipitate on the rock surface serves to limit further oxidation of reactive surfaces.

### ***Ecobond™***

Metal Treatment Technologies (MT2) has developed a proprietary phosphate-based solution, which aims to generate a stable and insoluble ferric-phosphate coating on the acid generating rock. The technology forms a stable iron phosphate complex on acid generating rock that is intended to resist hydrolysis and prevent further oxidation.

### ***Silica Micro-Encapsulation (SME)***

Klean Earth Environmental Company (KEECO) has developed a proprietary silica microencapsulation treatment to coat acid generating rock surfaces. The silica treatment was found to prevent acid generation for over six years (Eger and Antonson, 2002, 2004; Eger and Mitchell, 2007).

## **6.6.4.2 Alkaline Materials**

A relatively common approach to mitigation of ARD is the control of solution pH by the addition of alkaline materials. Methods for use of alkaline materials include blending with waste rock, amendment of tailings, placement of alkaline material above or below wastes as liner or cover materials, and treatment of drainage (BC AMD, 1989; PaDEP, 1998, Chapter 13; Miller et al., 2003 and 2006; and Taylor et al., 2006).

Addition of alkaline materials can control ARD, provided intimate blending can be achieved; this is often a difficult task. The effectiveness of the method is dependent on the pathways of movement of water through the system, degree of mixing, and the nature of the contact between acidic rock and the alkaline materials. If the mixture is not homogeneous and there is not good contact between the materials, then localized “hot spots” of acid generation may occur.

The type, purity, reactivity, availability, and proportion of the alkaline material are also important. Common additives at metal mines include limestone (CaCO<sub>3</sub>) and lime (CaO or Ca(OH)<sub>2</sub>). Liquid forms are considerably diluted relative to solid forms and have limited longevity, but may provide better penetration of the acid generating mine waste.

At coal mines, limestone is often the least expensive and most readily available source of alkalinity. It has a neutralization potential (NP) between 75 and 100% of CaCO<sub>3</sub> equivalent, and is safe and easy to handle. On the other hand, it has no cementing properties and cannot be used as a barrier or low-permeability material. Fluidized Bed Combustion (FBC) ash generally has NP values between 20 and 40% of CaCO<sub>3</sub> equivalent, and tends to harden into a cement after wetting (Skousen et al., 1997a). Other power-generation ashes, like flue gas desulfurization (FGD) products, may also have significant NP, which can represent suitable alkaline amendment materials (Stehouwer et al., 1995). Kiln dust, produced by lime and cement kilns, contains similar NP levels as FBC ash, but also contains 50 to 70% un-reacted limestone. Kiln dust absorbs moisture and hardens upon wetting (Rich and Hutchison, 1994), and is widely used as a stabilization and barrier material at coal mines in the US.

Steel slags, when fresh, have NP values from 45 to 90% of CaCO<sub>3</sub> equivalent. Steel slag can be used as an alkaline amendment as well as a medium for alkaline recharge trenches. Slags are produced by a number of processes, so care is needed to ensure that candidate slags are not prone to leaching metal ions like Cr, Mn, and Ni. Potential sources of alkaline material should be checked by a complete analysis (see Chapter 5) to evaluate the possibility of adverse effects on leachate water quality.

Use of alkaline materials overlying acid generating mine waste can provide a long-term source of alkalinity, may lead to formation of a “chemical cap” (i.e., a hardpan) at the interface between alkaline and acid generating material, and may produce a passivating coating on the surface of acid generating particles. However, the effectiveness of this approach depends on the solubility of the neutralizing agent and the flux of infiltrating water available to carry the alkalinity down to the underlying sulphidic waste. Use of alkaline materials underneath acid generating mine waste may result in formation of a passivating coating on the surface of alkaline particles, thus reducing considerably the effectiveness of this strategy. Benefits and limitations of alkaline amendments are summarized in Table 6-3.

**Table 6-3: Benefits and Limitations of Alkaline Amendments**

<b>Configuration</b>	<b>Benefits</b>	<b>Limitations</b>
<ul style="list-style-type: none"> <li>▪ Liquid amendment</li> </ul>	<ul style="list-style-type: none"> <li>▪ Excellent initial control of solution pH</li> <li>▪ Versatile - allows localized treatment</li> <li>▪ Proven to work</li> </ul>	<ul style="list-style-type: none"> <li>▪ Time - alkaline materials are consumed by even pH-neutral water</li> <li>▪ Readily flushed from storage facility</li> <li>▪ Cost and availability of reagents</li> <li>▪ Particle size and release of alkalinity</li> <li>▪ Effort for mixing or blending</li> </ul>
<ul style="list-style-type: none"> <li>▪ Layering</li> </ul>	<ul style="list-style-type: none"> <li>▪ Easy to implement and manage</li> </ul>	<ul style="list-style-type: none"> <li>▪ Difficult to obtain mixing of alkaline and acid leachate due to preferential flow</li> </ul>
<ul style="list-style-type: none"> <li>▪ Encapsulation and Alkaline Cover</li> </ul>	<ul style="list-style-type: none"> <li>▪ Easy to implement and manage</li> <li>▪ Versatile and allows localized treatment</li> </ul>	<ul style="list-style-type: none"> <li>▪ Cost and availability of material</li> <li>▪ Time and release rate of alkalinity</li> <li>▪ Alkaline materials are consumed by pH neutral water</li> </ul>
<ul style="list-style-type: none"> <li>▪ Blending</li> </ul>	<ul style="list-style-type: none"> <li>▪ Excellent pH control</li> <li>▪ Proven to work</li> </ul>	<ul style="list-style-type: none"> <li>▪ Cost of mixing and blending</li> <li>▪ Availability of materials</li> </ul>

#### 6.6.4.3 Examples of Alkaline Materials Applications

##### *Limestone, CaCO<sub>3</sub>*

Rotary drum stations have been used in West Virginia to grind limestone into a powder form before application into acidic streams (Zurbuch, 1984; 1996).

##### *Kiln dust*

Rich and Hutchison (1990; 1994) reported a successful operation where 2% lime kiln dust was added to refuse at a coal preparation plant in West Virginia. The kiln dust prevented acid formation and it improved the strength of the refuse pile by absorbing moisture from the filter cake, allowing easy access for large haulage trucks. At that time, eight preparation plants in the eastern USA were using this technique.

## ***Steel Slag***

Extensive reclamation efforts at the Broken Aro Mine in Ohio, USA utilized slag beds receiving both ARD and clean water (Rose, 2010). The slag beds were used in combination with diversion of surface water, vertical flow ponds, settling ponds and other technologies to remediate contaminated waters (Lavery et al., 2007). The slag beds were found to contribute large amounts of alkalinity. Similar success of slag bed utilization was reported at the Huff Run watershed in Ohio (Hamilton et al., 2007).

### **6.6.4.4 Use of Organic Matter**

Organic materials can be mixed directly with wastes to consume oxygen and promote metal reduction in an anoxic environment by naturally occurring bacteria. Bacteria can reduce available sulphate and create insoluble metal sulphide precipitates in the presence of suitable organic substrates. Examples of organic substrates include sewage sludge, municipal landfill waste, and pulp and paper waste. Similar concepts are described as a passive treatment method in Chapter 7. The method is limited by exhaustion of organic materials. Use of organics as part of a cover design is discussed in Section 6.6.6.2.3. A possible concern in using organic matter is that the reducing conditions generated can dissolve precipitated iron and manganese hydroxides. The latter, especially, can be problematic at coal mines.

### **6.6.4.5 Bactericides**

In limited circumstances, anionic surfactants (the active cleansing surfactants used in detergents and shampoo) can be used to control bacteria that extract energy from the oxidation of iron, and thereby control the rate of pyrite oxidation (Kleinmann and Crerar, 1979; Kleinmann et al., 1981). The effectiveness of anionic surfactants was found to be short term and repeated application of chemicals was required (Loos et al., 1989).

The bacteria can thrive in the very acidic water because they are protected from it by a phospholipid cytoplasmic membrane. This greasy coating allows the internal enzymes of the bacteria, which require a near-neutral pH, to function normally in an acid environment (Langworthy, 1978; Ingledew, 1982). At low concentrations, anionic surfactants induce seepage of the H<sup>+</sup> into the bacteria, which slows down iron oxidation by decreasing the activity of the pH-sensitive enzymes. Slightly higher surfactant concentrations kill the bacteria (Kleinmann, 1979, 1998).

Anionic surfactants have been successfully used in combating ARD from coal refuse, reducing acid generation by 60 to 95%. They work best on fresh, pyritic materials like the reject material from coal preparation plants. There, surfactant solutions are applied to refuse conveyor belts or sprayed by trucks onto the coal refuse 3 to 4 times a year (Rastogi, 1996). The surfactants can also be applied to older coal refuse piles, but there will be a lag period before their benefit is observed as acid already formed has to be washed out (Kleinmann and Erickson, 1981, 1983). However, applying them to sites that have already been reclaimed is ineffective because the surfactants bind to soil and dirt.

Anionic surfactants have occasionally been used at surface mines, including metal mines (Parisi et al., 1994), but often the effects at such sites have been minimal and/or short-lived. Surfactants, therefore, are not considered to represent a permanent solution to ARD. Eventually, the compounds either leach out of the rock mass or break down.

[Top of this page](#)

## **6.6.5 Water Management Methods**

Methods for water management include diversion of site surface drainage and groundwater. Water acts as a transport mechanism and as a reactant. However, the amount of water required for sulphide oxidation is virtually always present in excess, except in extremely arid environments. The primary role of water management is to reduce infiltration and thereby reduce the volume of affected drainage and potentially the contaminant loading. It is generally more cost effective to treat smaller volumes of more concentrated water than larger volumes of less concentrated water that still fails to meet discharge standards. Water management should be assessed at the local watershed scale (DWAF, 2006).

### **6.6.5.1 Hydrogeological and Hydrodynamic Controls**

Hydrogeological controls for groundwater systems include both barriers and higher permeability features. The objective of hydrogeological controls is to control the flow of groundwater. The use of hydrodynamic control options is site specific and depends on site conditions, including climate, topography, geology, hydrology, and hydrogeology.

An example of hydrogeological containment is disposal of tailings in an open pit with a pervious surround. A granular filter layer is placed between the pit wall and the low-permeability tailings to provide a high hydraulic conductivity pathway for regional groundwater flow. Because the tailings have a lower hydraulic conductivity than the surrounding granular layer, groundwater preferentially flows around, rather than through, the tailings (e.g., Rabbit Lake Mine, Collins Bay, Saskatchewan, Canada). This can reduce the constituent loadings from the tailings pore water to the surrounding groundwater and thereby to the surface water environment.

### **6.6.5.2 Dewatering**

Dewatering involves lowering the hydraulic head to change the hydraulic gradient. Clean upgradient groundwater can be collected before encountering reactive wastes. Examples include pit dewatering to reduce seepage into pits and shallow groundwater collection ditches upgradient of tailing ponds and waste rock piles. The collection of contaminated water using groundwater pumping is considered part of treatment (see Chapter 7). Conventional hydrogeology science can be applied to design control measures, such as well spacing and pumping rates.

### 6.6.5.3 Diversion

Control of surface water can minimize flow through PAG materials and thereby reduce the volume of ARD. Surface water diversion may include upstream ditching or impervious channels to divert drainage around impacted areas. Drainage works must be sized based on catchment hydrology, including snowmelt and storm events, and will typically require ongoing maintenance (because of debris accumulating, sloughing, and animal activity) to ensure long-term performance. Therefore, the best long-term solution may involve selecting storage sites that minimize the need for surface diversion (ADTI, 1998).

In contrast, alkaline recharge trenches (Caruccio et al., 1984) are surface ditches that are intentionally constructed to allow water to slowly infiltrate into the coal mine backfill. Trenches can improve water quality at down-gradient seeps by causing the water to flow through alkaline material before it infiltrates. Early research used relatively small trenches to divert the surface water that naturally collected during precipitation events. These demonstrated minimal benefits since water movement into the backfill was limited by rainfall and the water did not move uniformly through the backfill (Caruccio and Geidel, 1989). More recent applications of this technology used water pumped from ponds into the alkaline trenches to greatly accelerate the movement of alkalinity into the backfill (Ziemkiewicz et al., 2000).

Exploration boreholes can be a source of groundwater flow that can be controlled by proper grouting following drilling. Hydraulic mine seals (discussed in Section 6.6.5.5) emplaced in underground workings are another way in which groundwater can be manipulated. Conventional grouting methods can be applied to fractured rock, but complete sealing may be difficult because water can still migrate using alternative lower permeability pathways. Grouting may also result in the build-up of large pressure-heads that have safety implications in underground mines, especially where the host rock contains karst features. French drains and soil-bentonite-slurry cut-off walls may be used at surface mines.

At many sites that have been successfully inundated, the volume of water being discharged can sometimes be large. Reducing the rate of surface infiltration may be required. Much of the surface water may enter the underground coal mine through subsidence-induced fractures that have intercepted streambeds and are partially or even completely draining the streams. These small fractures are often hidden from view by stream sediment. Hand-held geophysical instruments can be used to locate the areas where significant amounts of water are flowing underground. Small holes can be drilled or hammered into the stream less than 1 m into the rock beneath the sediment, and used to inject grout beneath the streambed. The intent is not to seal the entire fracture, but rather to seal cracks that have reached near to the stream and serve as water conduits, draining the stream into the mine (Ackman and Jones, 1991). The approach has restored 85 - 100% of stream flow and has been used to reduce infiltration into active mining operations. For more detail regarding this method, click here: [Reduction of Surface Infiltration](#)

Control of groundwater in discharge areas can be challenging to achieve and maintain. A drainage system may help to keep a mine pit relatively dry, especially at coal mine sites where water is infiltrating through the high wall. This is particularly important when the pit floor contains acid-forming materials, and when this pyritic material cannot be completely inundated when the mine is closed. Pipes or French drains have been used.

PAG waste materials should not be placed in a groundwater discharge zone (DWAF, 2006; ADTI, 1998; and TEAM NT, 2004). Soil covers may divert water and limit infiltration, and are discussed in Section 6.6.7.

### 6.6.5.4 Flooding

Flooding of underground or surface mine voids with water has the potential to significantly inhibit the supply of oxygen so that ARD production is not a concern (see Section 6.8.7.1). The scientific basis for the approach is also provided in MEND (2001). However, caution must be used with flooding of previously oxidized wastes because stored oxidation products may be dissolved during the initial inundation of pits, wastes, or workings. Flooding can release soluble products to the flood water and therefore provisions may be required to adjust pH to neutralize acidity or to mitigate unacceptable concentrations of other constituents.

Factors to be considered for flooding include the status of the mine plan and schedule of waste production, potential for mobilization of stored oxidation products, availability of open workings or pits, and capacity to store waste products (note that mined material will increase in volume by approximately 25% to 30% [swell factor]). ARD from block caves and glory holes may be difficult to manage as access may be restricted. However, flooding may be possible depending on bottom drainage conditions.

In humid and temperate climates with a positive water balance, flooding of underground and open pit operations will typically occur after closure. Consideration should be given to the potential soluble products that may be dissolved into the flooding waters, and implementation of mitigation strategies may be required. Mitigation may depend on the expected outflow pathways from the mine void(s). Outflow directly to surface water may require different considerations than outflow through subsurface pathways. There may be ongoing contributions of loadings from zones that will remain above the expected final water level in the mine opening(s). Water quality effects should be predicted (see Chapter 5) in order to assess the potential risks and to develop water management strategies, if required, after flooding.

There are examples of flooding to mitigate ARD and metal leaching as reported by MEND (1995) for in-pit disposal practices. One example cited was the potential relocation of weathered nickel-rich mine rock, that had elevated soluble nickel levels, to a mined-out pit at a uranium mine. The rock has been subsequently relocated in the pit, covered by a one-meter layer of till and flooded. Water quality in the pit is expected to be acceptable at closure.

Flooding after closure has also been selected as a preferred option for tailings at a number of sites. One of the best known success stories is represented by the reclamation of pyritic tailings in the Elliot Lake uranium district of Ontario, Canada (DES, 2011). Several tailings impoundments operated from the 1950s to the 1990s when decommissioning was completed. One of these, the Denison tailings management area, serves as a good example of reclamation by flooding (**Denison Case Study**). Acid generating tailings that were located in low-lying areas and in former lakes were flooded by constructing and raising dams to develop a water cover. Acidity from the tailings was treated as necessary to attain neutral pH prior to discharge. The acidity, and therefore

the need to treat and consequent lime demand, declined over several years. Most flooded tailings in the Elliott Lake district no longer require treatment for control of pH or metals.

Occasionally, water discharges from stratified mine pools. The water quality may then initially be acceptable as the infiltrating surface waters tend to be less dense than the more stagnant and concentrated water beneath. This stratification may become a concern if the deeper water reaches the level of the discharge.

#### **6.6.5.5 Seals**

When decommissioning an underground mine, knowledge of the areas within the mine that are geochemically most reactive and knowledge of water ingress and discharge locations will enable design and implementation of a rational ARD management plan aimed at controlling the flow of water to minimize water quality deterioration. This process would involve construction of seals and also perhaps reinforcing of some areas in advance of flooding to accommodate water flow. Use of seals and reinforcements is a good example of prevention and minimization by design.

Hydraulic seals limit movement of air and water through mine workings. Seals can be used to promote flooded conditions. Flooding of mine workings may generate considerable hydraulic heads and, therefore, require rigorous engineering design. An example case study for underground mine flooding is described in Lang (2007) for the Millennium Plug installed at the Britannia Mine in British Columbia, Canada. For the Britannia Mine, a concrete plug was placed within a tunnel to prevent effluent from being released to the environment, and caused flooding of the mine to prevent oxygen entry and further acid generation. The plug also resulted in water storage within the mine that served as a reservoir prior to treatment.

Sealing of drifts, adits (horizontal), and stopes (angled mine workings) is common when decommissioning an underground mine. Seal construction may include brick and mortar walls to contain concrete pumped between the seals. Horizontal seals or plugs can be left with through piping that may be opened to allow drainage of mine waters, if necessary. Where safety of workings is a concern for the construction of seals, particularly in old mine sites, concrete seals can be placed remotely through drill holes. Seals at active mines are rarely constructed remotely.

Three common and successful approaches to constructing seals include pressure grouting of adjacent ground, increasing the length of the seal to increase the seepage flow path length, and installation of secondary seals (ADTI, 1998 and ERMITE, 2003).

[Top of this page](#)

### **6.6.6 Engineered Barriers**

Engineered barriers can be applied to either cover waste or to provide a bottom barrier or liner, each with their own unique performance requirements. From an ARD mitigation purpose, covers are typically designed to limit the ingress of water and oxygen into the underlying waste. Liner systems are typically designed to act as a barrier for contaminant flow from the overlying waste into the receiving environment.

#### **6.6.6.1 Liners**

There are a multitude of low-permeability materials, ranging from synthetic to geosynthetic to natural, that can be utilized in liner systems. There are also a multitude of liner system designs that can be applied. The combination of the design and the materials will determine the leakage rate of the liner system.

Given the relatively high cost of liner systems, it is important to quantify the performance requirements of the liner system so that the design and required materials can be optimized in terms of cost. Risk-based approaches are typically used to quantify the required liner performance against the risk of downstream receptor impact. It is also important to evaluate the robustness of the liner materials (durability, compatibility and life expectancy) against the geochemical characteristics of the drainage that will report to the liner system.

#### **6.6.6.2 Dry Cover Methods**

Dry covers are typically earthen, organic, or synthetic materials placed over mine wastes. The term “dry” cover is used to contrast them from water or “wet” covers, which are discussed in Section 6.6.7. The primary purpose of placing dry covers over reactive waste material is to minimize ARD and ML production and to minimize its transport. In addition, dry covers can also be designed to provide a suitable rooting zone for vegetation, and have minimal erosion through design of stable landforms.

Performance criteria for a given dry cover should be developed on a case-by-case basis, with due consideration of the short-term and long-term impacts on the receiving environment at a particular site (O’Kane and Wels, 2003). The objective is to determine the appropriate level of control (e.g., oxygen ingress and/or net percolation) required by the cover system. Figure 6-8 puts forward a methodology for developing site-specific performance criteria for a dry cover designed to control ARD/ML and/or gas fluxes. The methodology links the predicted performance of a cover system to groundwater, surface water, and air quality impacts.

Figure 6-8: Flow Chart for the Dry Cover Design Process (adapted from O'Kane and Wels, 2003)

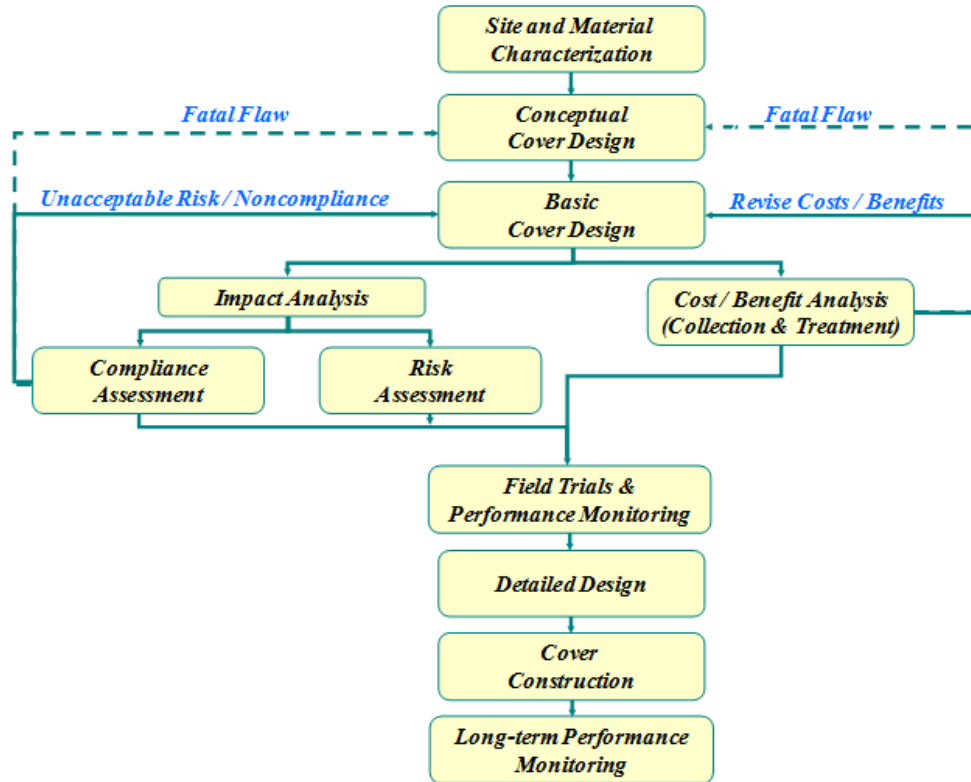

In the long term, dry cover systems must interact with climate, hydrology, human activity, vegetation, animals, and settlement of underlying material. Figure 6-9 which is a tri-linear plot of climate classification, rainfall, and temperature, provides general guidance on appropriate cover types for climates ranging from arid to high rainfall and tropical to polar. Oxygen barrier covers with low water permeability prevent oxygen entry by maintaining high water saturation. These covers are best suited to climate regimes where the potential evapotranspiration to precipitation ratio is less than 1.0. It is difficult to maintain saturation in dry climates where the potential evapotranspiration ratio is greater than 1.0; therefore, the design objective for the cover becomes the minimization of infiltration through water diversion, runoff and shedding, or store and release mechanisms. It is recommended that substantial caution be used when selecting a particular dry cover design based on “annual” criteria for characterizing the climate at a site. Numerous sites exist where precipitation exceeds potential evaporation on an annual basis; however, the site may experience hot, dry months where evaporation greatly exceeds rainfall. These dry summer conditions can make it difficult to design a cover system that meets all objectives throughout the year. In many instances, where the potential evaporation exceeds precipitation on an annual basis, the site might experience high intensity and short duration rainfall conditions, which may exceed the storage capacity of the cover material. Particular caution is required when there is potential for consecutive significant rainfall events, which limit the time frame for evapotranspiration to remove moisture from the previous event and therefore increase the net percolation (MEND, 2004a).

For the purposes of this guide, dry covers are divided into the following categories: soil covers (Section 6.6.6.2.1), alkaline covers (Section 6.6.6.2.2), organic covers (Section 6.6.6.2.3), covers of sulphide-bearing but net neutralizing materials (Section 6.6.6.2.4), and synthetic covers (Section 6.6.6.2.5). It should be noted, however, that organic and synthetic materials are often a component of a multi-layer soil cover. Gas barriers are briefly described in Section 6.6.6.2.6, while vegetation and landform design in relation to dry covers are discussed in Sections 6.6.6.2.7 and 6.6.6.2.8, respectively. Monitoring is briefly discussed in Section 6.6.6.2.9 and in more detail in Chapter 8; however, specific details on performance monitoring for dry covers are included in Section 6.6.6.2.9.

**Figure 6-9: Covers and Climate Types (modified from Holdridge et al., 1971 by Wickland and Wilson)**

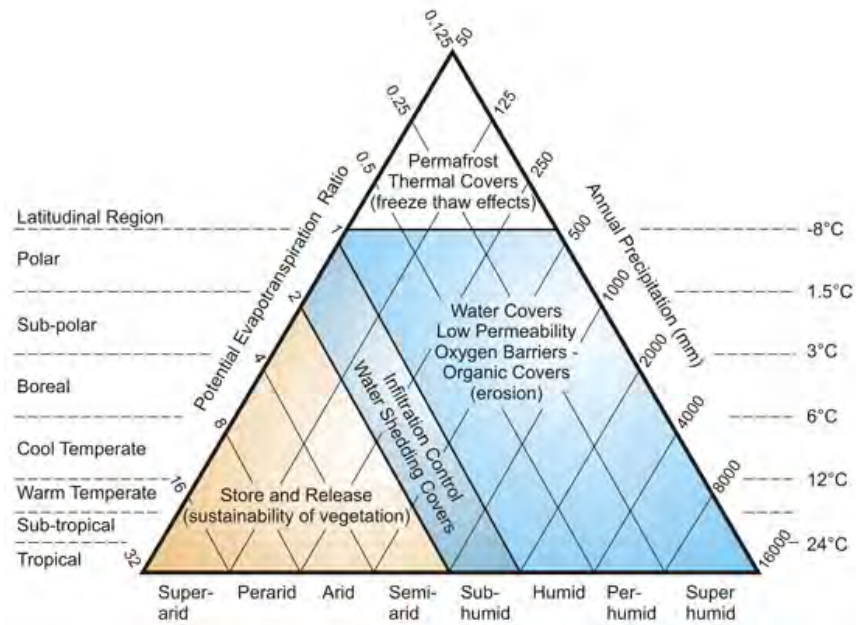

#### 6.6.6.2.1 Soil Covers

Soil covers generally involve the use of granular earthen materials placed over mine wastes (MEND, 2001). The objectives of a soil cover will vary from site to site, but generally include (i) dust and erosion control; (ii) chemical stabilization of acid-generating mine waste (through control of oxygen or water ingress); (iii) contaminant release control (through improved quality of runoff water and control of infiltration); and/or (iv) provision of a growth medium for establishment of sustainable vegetation (MEND, 2004a).

The following definitions are provided for clarification of terminology:

##### *Dry Covers Nomenclature*

- Alkaline Covers – Cover systems designed to release alkalinity to infiltrating waters. Alkalinity generally consists of dissolved carbonate species that are derived from the dissolution of limestone ( $\text{CaCO}_3$ ).
- Dry Covers – Cover layer(s) consisting of earthen or synthetic materials in contrast to “wet” covers that involve water.
- Organic Covers – Covers consisting of organic material that may act as a reductant (electron donor) that can scavenge or remove oxygen and possibly drive other reducing reactions such as sulphate reduction.
- Soil Covers – Cover layer(s) constructed with natural earth materials that can include mine rock.
- Store and Release Covers – Cover system that is constructed to reduce net infiltration by storing moisture during higher precipitation periods and releasing moisture via evapotranspiration in dryer periods.
- Sulphide – Net Neutral – Cover material that may contain sulphide minerals as well as excess NP to prevent net acid production. There are many examples of tailings with such properties. Such a layer can scavenge oxygen and prevent further oxygen ingress.
- Synthetic Covers – Cover systems constructed with synthetic layers such as geosynthetic clay layers, various plastics or bitumen. The primary objective of such covers is to reduce net infiltration.

Key factors to consider in the design of a soil cover include:

- The climate regime at the site
- The reactivity and texture of the mine waste material
- The geotechnical, hydrologic, and durability properties of economically available cover materials
- The hydrogeologic setting of the waste storage facility
- Long-term erosion, weathering, and evolution of the cover system

Another key factor is that performance of a soil cover on a sloping surface can be much different compared to that on a horizontal surface. The ability of soil covers to function as oxygen ingress and water infiltration control will be different than that predicted by idealized one-dimensional numerical models (Boldt-Leppin et al., 1999). The difference in performance relates to site climate conditions, the slope length and angle, and hydraulic properties of the cover materials (Bussiere, 2007). Some documented case studies of “soil cover failures” are in fact a result of the soil cover being designed for a horizontal surface while being constructed on a sloping surface.

Soil store and release covers perform best in wet/dry climates with high potential evaporation equal to 2 or 3 times precipitation. These covers generally consist of a monolithic layer of well-graded granular material placed with sufficient moisture storage capacity to limit percolation of meteoric waters to the

underlying waste material. At many sites, a chemically inert run-of-mine waste material can be used to construct a store and release cover over mine wastes to reduce or control ARD production. Despite the perceived simplicity of constructing such a cover, a gap- or well-graded material will segregate when haul trucks are used to place the material (MEND, 2001). Angle-of-repose coarse layers form, which increase water infiltration and act as preferential flow paths with flow and storage characteristics different from the rest of the cover layer. Following cover placement, the material may have to be mixed to ensure that a homogeneous layer has been created. An “enhanced” store and release cover can be created by compacting the upper waste material first (Christensen and O’Kane, 2005). The compacted waste layer “holds” infiltrating meteoric waters within the overlying cover material for an increased period of time during wet periods, providing the opportunity for evapotranspiration and thus reduces the amount of runoff, and can decrease oxygen concentrations and increase the capacity for dissolution of carbonate minerals (Strock, 1998). The stored water is evaporated back to the atmosphere, rather than reporting as net percolation into the underlying waste material.

Single soil layers were also used in North America for revegetation of mining wastes and it was hoped that they would reduce ARD. However, in general, they were not effective. Engineered multi-layer soil covers for ARD control became popular in the 1990s with the development of the science of unsaturated media that enabled prediction of evaporation from soil cover systems (e.g., the SoilCover Model). Multi-layer systems in wet climates often include a relatively loose layer for vegetation roots, a compacted fine grained layer that maintains a high moisture content to reduce oxygen transfer, and a coarser capillary break that prevents upward migration of soluble salts from the underlying mine wastes. In general, compacted clay rich barrier cover designs function best in wet tropical and temperate climates. An example of a recently designed multi-layer soil cover for reactive mine waste is the one constructed over the backfilled open pit at the Whistle Mine near Sudbury, Ontario, Canada (Ayles et al., 2007).

Multi-layer soil covers may also include a capillary barrier to maintain a tension saturated layer within the cover system and thus mitigate oxygen ingress. A fine-textured material placed between an underlying and overlying coarse-textured material can result in a capillary barrier for downward as well as upward moisture migration from the “sandwiched” layer (MEND, 2004a). The lower hydraulic conductivity of the fine-textured layer (usually compacted), combined with the lower capillary barrier, also provides a control on net percolation to the underlying waste material. The design of a capillary barrier is dependent on the contrast between the hydraulic properties of both the coarse and fine materials. Capillary barriers, unlike compacted clay barriers, do not rely solely on a low hydraulic conductivity layer to restrict moisture movement into the underlying material. Processes that increase hydraulic conductivity, such as desiccation and freeze/thaw cycling, do not necessarily decrease the effectiveness of a capillary barrier (MEND, 2004a).

Often in the design and construction of a multi-layer soil cover system, the focus of the design is on the barrier layer. While the importance of the barrier should not be discounted, neither should the importance of the overlying growth medium (Ayles et al., 2004). The growth medium layer serves as protection against physical processes, such as wet/dry and freeze/thaw cycling, as well as various chemical and biological processes. An inadequate growth medium layer will not properly protect the barrier layer, leading to possible changes in its performance (see INAP, 2003). One of the most common factors leading to failure of multi-layer soil cover systems is an inadequate thickness of growth medium material over the lower hydraulic conductivity layer (e.g., Rum Jungle in the Northern Territory, Australia). One key factor to consider during the design of a multi-layer cover system is the available water holding capacity of the growth medium layer to ensure that plant demands for soil water can be satisfied under drier climatic conditions, thus minimizing the potential for root penetration and desiccation of the barrier layer.

The longevity of a soil cover design should be evaluated in relation to site-specific physical, biological, and chemical processes that will alter as-built performance and determine long-term performance (Figure 6-10). It is noted, however, that in many respects the impact of biological and chemical processes specific to a site on long-term cover performance can only be evaluated from a qualitative perspective. In contrast, many of the physical processes affecting long-term performance are quantifiable using state-of-the-art technology, provided that adequate materials characterization data are available. Recent reviews based on 10 to 15 years of cover performance data indicate that covers may limit, but do not stop, infiltration and sulphide oxidation (Wilson, 2008a; Wilson et al., 2003; and Taylor et al., 2003). However, the achieved reduction in oxidation (and attendant ARD and metal leaching) may be sufficient to meet design goals and at a minimum can reduce water treatment requirements.



Figure 6-10: Conceptual Illustration of Processes Affecting Long-Term Performance of Soils Covers (from INAP, 2003)

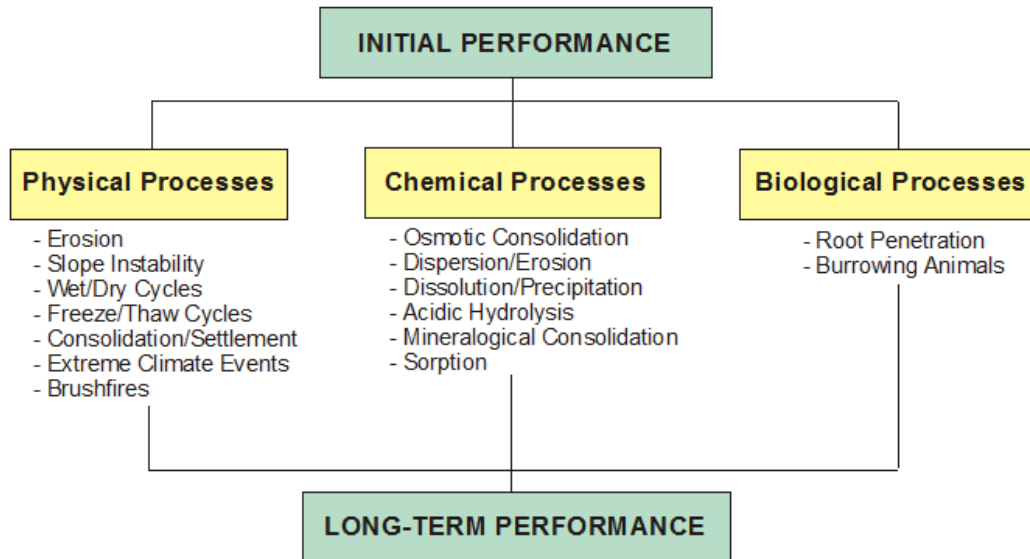

Examples of soil cover designs are shown in Figure 6-11 (MEND, 2001). Considerations for use of soil covers are listed in MEND (2001) as well. The simplest case (i.e. the base method cover system design) is typically evaluated first during the conceptual and/or preliminary cover system design phase, and then complexity added until the desired design objectives are met. In general, increasing complexity in the design of a cover system implies increased cover system performance, but would also typically entail increased costs and a more difficult cover system to construct. Note, however, that an increase in performance is not necessarily true for all climate conditions. For example, a store and release cover in arid or semi-arid climate conditions can provide the same level of control on net percolation as compared to a cover system with a low hydraulic conductivity barrier layer or a capillary barrier cover system (MEND, 2004a). Considerations for use of soil covers are listed in Table 6-4 and an excellent similar compilation is provided in MEND (2004a).

Figure 6-11: Sample Soil Covers Designs (from MEND, 2001)

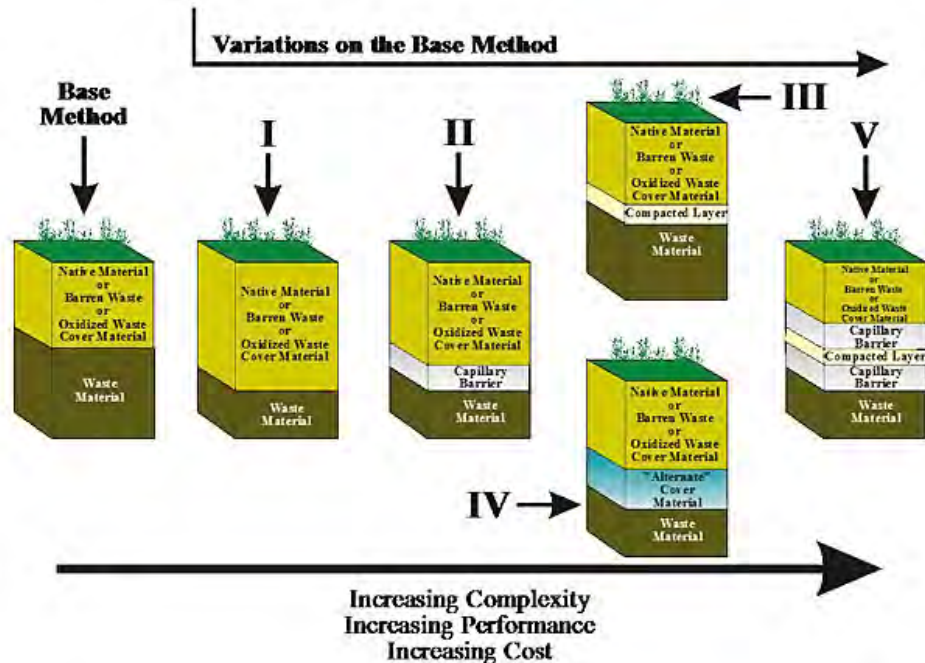

Table 6-4: Considerations and Limitations of Soil Covers

Considerations	Limitations
<ul style="list-style-type: none"> <li>▪ Climate – wetting, drying, freezing, thawing</li> <li>▪ Type and performance of waste (such as surface settlement), reactivity of wastes</li> </ul>	<ul style="list-style-type: none"> <li>▪ Soil covers do not stop infiltration and may not stop acid drainage.</li> <li>▪ Permeability of water infiltration barriers may increase with time</li> </ul>

- Surface water flow and erosion
- Topography
- Hydrogeological setting and basal flow
- Availability of cover materials
- Construction quality control and maintenance
- Design of landforms - final land use

when subjected to climate and vegetation.

- Oxygen barrier covers are especially vulnerable to relatively small imperfections in the cover – such as differential settlement, holes caused by animal burrows, desiccation cracking, – that effectively render permeable an otherwise sealed area.
- Soil covers may be prone to erosion and long-term maintenance requirements
- Soil covers may be vulnerable to vegetation, animal, and human activity including vehicle traffic

#### 6.6.6.2.2 Alkaline Covers

The addition of alkaline materials to mine wastes has been described in Section 6.6.4.2. This section addresses alkaline covers. Alkaline cover materials, such as limestone, placed over PAG materials can increase alkalinity of infiltration, thereby providing pH control (see Section 6.8.3.6 and Section 6.8.4.2). Alkaline infiltration may react with and generate a surface coating on sulphide bearing materials that isolates sulphide minerals (Miller et al., 2003) and form a hardpan (i.e., “chemical barrier”) at the contact between the alkaline material and the reactive mine waste. Use of the method must consider climate, availability of alkaline materials, geometry and reactivity of alkaline materials, and time of consumption. Infiltration through a limestone cover may transport sufficient alkalinity to neutralize the uppermost portion of the underlying waste and thus increase the effective cover thickness and slow the oxygen flux to reactive sulphides deeper in the profile. An example of the use of alkaline material in a cover is provided in the **Benambra Case Study**.

#### 6.6.6.2.3 Organic Covers

The addition of organic matter to mine waste has been addressed in Section 6.6.4.3. Organic materials can also be used to cover PAG wastes to provide some or all of following:

- A saturated layer that serves as a physical barrier to oxygen
- An oxygen consuming layer – (Decomposition of organic material may create a large biological oxygen demand [note: may need replenishment])
- Chemical inhibition – (Decomposition products and compounds within the organic material may inhibit the growth and metabolism of acidifying bacteria)
- Chemical amelioration – (Organic compounds may create conditions that support the reductive dissolution of iron oxides and subsequent precipitation in the form of sulphides thus reducing acid production by ferric iron [see Chapter 2])
- A carbon source for sulphate reducing bacteria
- Limitation of water infiltration by lowering hydraulic conductivity

Organic materials have included pulp and paper residues, sewage sludge, bark, sawdust, sanding dust, fiberboard, pulpwood, deinking residues, peat, compost and carbonaceous matter, or waste rock rich in organic matter.

Organic covers have been shown to reduce acidity but without stopping ARD (**Case Study Organic Covers**). Limitations to the process include availability of organic materials for cover, longevity (organic materials will become resistant to decomposition with time), and climate (humid climates may be required to maintain anaerobic conditions in the organic medium). Another example of the use of organic matter in a cover is provided in the **Benambra Case Study**.

#### 6.6.6.2.4 Covers of Sulphide-bearing but Net Neutralizing Materials

Mineral wastes that contain sulphides, but which have an excess of neutralizing potential, can be used for covers that will consume oxygen but not contribute to ARD generation. For further information see Section 6.6.3.3 on the use of depyritized tailing covers.

#### 6.6.6.2.5 Synthetic Covers

Use of synthetic materials to cover wastes can dramatically reduce infiltration. Synthetics include different types of plastics (polyethylene (PE), high density polyethylene (HDPE), chlorinated polyethylene (CPE), chlorosulphonated polyethylene (DuPont trade mark HYPALON), polyvinyl chloride (PVC), linear low-density polyethylene (LLDPE), geosynthetic clay liners (GCLs), and geomembranes impregnated with bitumen. A review of many types of synthetic covers is presented in MEND (2002). Synthetics are often subject to degradation by sunlight and must be protected with an earthen cover material. GCLs consist of a ~1 cm layer of sodium bentonite sandwiched between two geotextiles or glued to a geomembrane. Prior to selecting a GCL product, chemical compatibility with the overlying cover soil must be confirmed to prevent cation exchange with the bentonite layer, which can lead to substantial increases in the hydraulic conductivity of the GCL (Meer and Benson, 2007). A suitable bedding material layer (for example sand) must be laid in advance of application of the synthetic layer to prevent puncturing by underlying rock. Similarly, the synthetic layer must be carefully covered with a protective overlying layer before adding the final growth substrate or rock mulch layer. A slope stability analysis is recommended when a synthetic layer is incorporated in a multi-layer soil cover placed on relatively steep slopes. Sample configurations of synthetics in soil covers are illustrated in Figure 6-12. Benefits and disadvantages of synthetic covers are listed in Table 6-5.

At the Upshur Mining Complex in West Virginia, Meek (1994) reported covering a 20-per hectare (ha) spoil pile with a 39-mil PVC liner. This treatment

reduced acid loads by 70%.

One of the earliest HDPE covers was installed on a 46-ha tailings facility at the Poirier Mine (**Poirier Case Study**) site in Northwest Quebec, Canada in 2000 (Lewis et al., 2000). The cover has reduced acidity and metal loadings and decreased seepage from the tailings. A similar size cover system was installed on the Normetal (**Normetal Case Study**) reactive tailings in Northern Quebec, Canada. (Hofton and Schwenger, 2010).

Construction of a bitumen cover on mine rocks piles and over a partially backfilled, shallow pit at a former copper mine at Mount Washington, British Columbia, Canada was initiated in 2009 (Murphy, 2010). The historic mine operation was abandoned in the mid-1960s and copper loadings to the downstream environment were considered to have affected salmon spawning. The bitumen membrane was covered by 1 m of local till for protection. The four-hectare cover was estimated to cost about \$4M CND (in 2007 \$).

A GCL cover system was constructed over tailings at the Kam Kotia, abandoned copper zinc mine site (near Timmins, Ontario, Canada) over the period of 2006 to 08 (Hamblin, 2010). Mining occurred between 1943 and 1944 and again between 1961 and 1972, resulting in the deposition of almost 7 M tonnes of acid generating tailings over 500 ha, much of which did not represent an engineered impoundment. The 80 ha GCL multi-layer cover was estimated to cost \$16.5 M Cdn (2008) or about \$200,000 per ha. The cover system consisted of a GCL membrane over the existing granular material on the tailings and in order, overlain by 0.15 m of clay, 0.6 m of granular fill with a 0.15 m layer of topsoil at surface.

**Figure 6-12: Sample Configurations of Synthetics in Soil Covers**

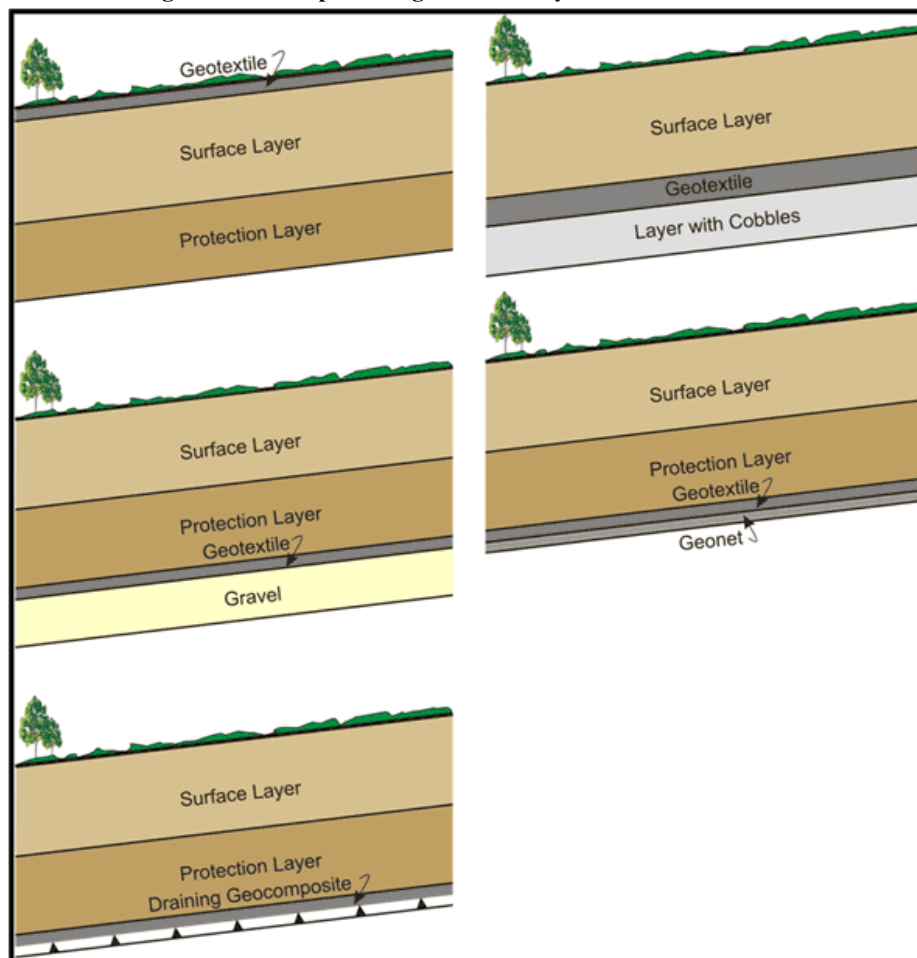

**Table 6-5: Benefits and Disadvantages of Synthetic Covers**

Benefits	Disadvantages
<ul style="list-style-type: none"> <li>▪ Low permeability</li> <li>▪ Easy to install</li> <li>▪ Resistant to chemical and bacterial attack</li> </ul>	<ul style="list-style-type: none"> <li>▪ High cost</li> <li>▪ Costly depending on distance between site and the product supplier</li> <li>▪ Possible limited design life - on the order of 50 to 100 years</li> <li>▪ Requires proper bedding and protective cover</li> <li>▪ Geotechnical stability concerns for steep slope applications</li> <li>▪ Vulnerabilities include:                             <ul style="list-style-type: none"> <li>▪ Sun light</li> <li>▪ Puncture by surface traffic</li> <li>▪ Cracking and creasing</li> </ul> </li> </ul>

	<ul style="list-style-type: none"> <li>▪ Difficulties in seaming</li> <li>▪ Uplift pressure from contained fluid or gases</li> <li>▪ Degradation due to low acidity conditions / cation exchange for GCLs</li> <li>▪ Differential settlement of underlying materials</li> <li>▪ Thermal expansion and contraction (high thermal coefficient)</li> </ul>
--	---

#### 6.6.6.2.6 Gas Barriers

Flooding of underground mine workings with deoxygenated air (e.g., nitrogen) could prevent ARD, but applications are relatively rare. Mine ventilation is controlled during operation and any post-closure investigations must consider safe work procedures for confined spaces. For example, atmospheric levels of radon may increase (e.g., Lisheen Mine, Ireland). See Chapter 8 for reference to the extreme safety hazards posed by deoxygenated air as illustrated by fatalities in a sampling shed at the Sullivan Mine in British Columbia, Canada.

#### 6.6.6.2.7 Vegetation

Establishment of vegetation is often included as a criterion for closure. The purpose of the vegetative cover may include erosion control, enhancement of evapotranspiration as part of a store and release cover system, re-establishment of sustainable ecosystems, and satisfaction of requirements for post-closure land use, including regulatory requirements and visual appeal. Depending on leaf area index, vegetation may increase the evapotranspiration rate up to a maximum equal to the potential evaporation rate provided an unlimited supply of soil water is available to the plant roots. The function of vegetation for store and release covers is important as it can substantially reduce the net percolation of meteoric waters to the underlying waste compared to a bare surface condition. The overall performance of the vegetation cover is dependent on the cover density, the species composition, and the available rooting depth. Generally, a diverse vegetative community that mimics or replicates the existing native communities in the surrounding area will provide the best long-term cover performance. A cover that is too thin will not only limit the volume of water that can be stored during wet periods, but will also limit the types of vegetation that can become established.

Effects of vegetation must be considered in engineered soil cover design with respect to ARD. Vegetation may physically alter cover systems by way of holes because of roots, tree throw, or blow down, and may uptake and transport contaminants from below the soil cover. Root penetration of cover systems may effectively bypass capillary break layers and provide a pathway to the surface ecosystem. Root exudates and decomposition products create soil structure that increases the permeability of clays. This may have undesirable consequences for water penetration and gas exchange. In many cases, however, an underlying barrier cover layer can be protected provided the growth medium or protective cover layer is thick enough to provide sufficient available water for plant growth. A properly designed growth medium (thickness and moisture retention characteristics) is more important to the long-term integrity of an underlying low permeability layer, than the properties and characteristics of the low permeability layer itself. One of the most common reasons for failure of a low permeability layer (i.e. eventual increase in permeability) is an inadequate growth medium layer, where inadequate generally implies insufficient thickness.

Long-term maintenance requirements must consider effects of vegetation. Vegetation growth will increase organic content of the cover, and its decay will consume oxygen (see Section 6.8.6.3).

Many jurisdictions encourage the use of local or native species to ensure ecological continuity with surrounding areas and minimize care and maintenance. However, seed of native species may not be readily available or they may be costly. Also, native species may be difficult to establish and lack the grazing resistance and erosion control properties of agronomic species.

#### 6.6.6.2.8 Landform Design

The long-term integrity of dry cover systems must consider the effects of climate and extreme climatic events, hydrology, animals, vegetation, and biogeochemistry. The closure landform will evolve or develop into a condition that is in steady-state harmony with its surroundings. The rate of evolution and the desired end point must be included as goals for reclamation. Cover systems that shed water might increase the potential for erosion and therefore the specified physical design parameters (e.g., slope angle and length) must take into account the variability of the local climate (MEND, 2007a). Some ongoing maintenance may be required for at least a period of time after closure.

#### 6.6.6.2.9 Performance Monitoring of Dry Cover Systems

Historically, dry cover system performance was evaluated by water quality analyses of seepage discharged from the waste storage facility. This approach empirically describes a waste storage facility through monitoring of its cumulative effect at the base (Morin and Hutt, 1994). In addition, for sites actively generating ARD, monitoring gaseous oxygen and temperature profiles can also serve as a tool for the evaluation of cover system performance because the profiles indicate the internal behaviour of the a waste storage facility (Harries and Ritchie, 1987). Although these monitoring techniques have their merits, it may take tens of years before a considerable change is measured inside or downstream of the waste storage facility due to the drain-down effect and complete oxidation of sulphidic minerals.

Direct measurement of field performance is the state-of-the-art methodology for measuring performance of a cover system. Field performance monitoring can be implemented during the design stage with test cover plots (e.g., MEND, 2007a; Aubertin et al., 1997; O’Kane et al., 1998a) 2014-10-21

construction of the full-scale cover (e.g., O’Kane et al., 1998b; Ayres et al., 2007). Direct measurement of field performance of a cover system is the best method for demonstrating that the cover system will perform as designed. The main objectives of field performance monitoring are to (MEND, 2004a):

- Obtain a water balance for the site
- Obtain an accurate set of field data to calibrate a numerical model
- Develop confidence with all stakeholders with respect to cover system performance
- Develop an understanding for key characteristics and processes that control performance

In terms of a field test plot trial scale, cover system field performance monitoring systems should be designed to measure most of the components of the water balance as well as oxygen ingress rates, as shown schematically in Figure 6-13. This includes meteorological monitoring, monitoring of moisture storage changes, and monitoring of net percolation, surface runoff, erosion, and vegetation (MEND, 2004a). For field performance monitoring for a full-scale cover system, a recommended minimum level of monitoring would include meteorological monitoring (i.e. determination of potential evaporation rates), site-specific precipitation, cover material moisture storage changes, watershed or catchment area surface runoff, vegetation, and erosion (MEND, 2004a).

**Figure 6-13: Conceptual Schematic of the Components of a Field Performance Monitoring System (from MEND, 2004a)**

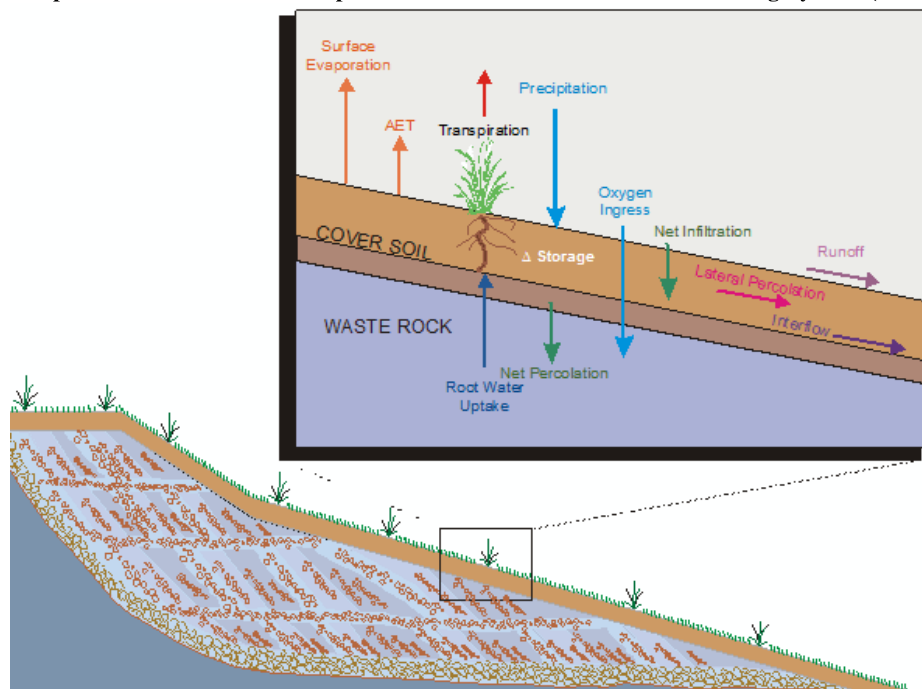

### 6.6.7 Water Cover Methods

Disposal of acid generating materials below a water cover is one of the most effective methods for limiting ARD generation. In water, the maximum concentration of dissolved oxygen is approximately 30 times less than in the atmosphere. More importantly, the transport of oxygen through water by advection and diffusion is severely limited relative to transport in air. For example, the diffusive transfer of oxygen in water is on the order of 10,000 times slower than diffusive transfer in air. Results of field and laboratory testing have confirmed that submergence of ARD generating materials is one of the best available methods for limiting ARD generation over the long term (MEND, 2001). Other mechanisms associated with water covers include sulphide reduction by bacteria, metal hydroxide precipitation, and development of sediment layers, which inhibit interaction between tailings and overlying waters.

Water covers can be attained in various ways. There are examples of sulphide materials deposited in natural water bodies to take advantage of physically stable, depositional environments. Mined out pits are also being used for under water deposition and storage of sulphide tailings (MEND, 1995). In other cases, engineered structures are used to raise or control water levels. Water covers can be developed at closure as discussed for the uranium mines in the Elliot Lake district of Canada (Section 6.6.5.4) or deposition under water can be achieved during operation such as that at the Louvicourt Mine in Quebec, Canada (MEND, 2007b) and at the Voisey’s Bay Nickel Mine in Labrador, Canada. Some operations have comprehensive programs for long-term subaqueous deposition of sulphide tailings. Vale’s Thompson tailings basin has been in operation since 1955 with underwater disposal of tailings and plans for raising the water levels in the basin as required to an expected closure in 2030 (Cochrane, 2012).

#### 6.6.7.1 Subaqueous Disposal

Water covers limit the exposure of PAG materials to oxygen. Example configurations for subaqueous tailings disposal are shown in Figure 6-14. Generally, sufficient depth of water over the PAG material must be provided to account for mixing of the water column and to prevent resuspension of wastes by

wind or wave action. Water covers may not be suitable for material that has already appreciably oxidized. The “cut off” point at which this distinction is made will be mine-waste specific. General processes for water covers are illustrated in Figure 6-15. Sediment layers can help isolate subaqueous wastes and adjustment of water cover chemistry is also possible.

**Figure 6-14: Subaqueous Tailings Disposal**

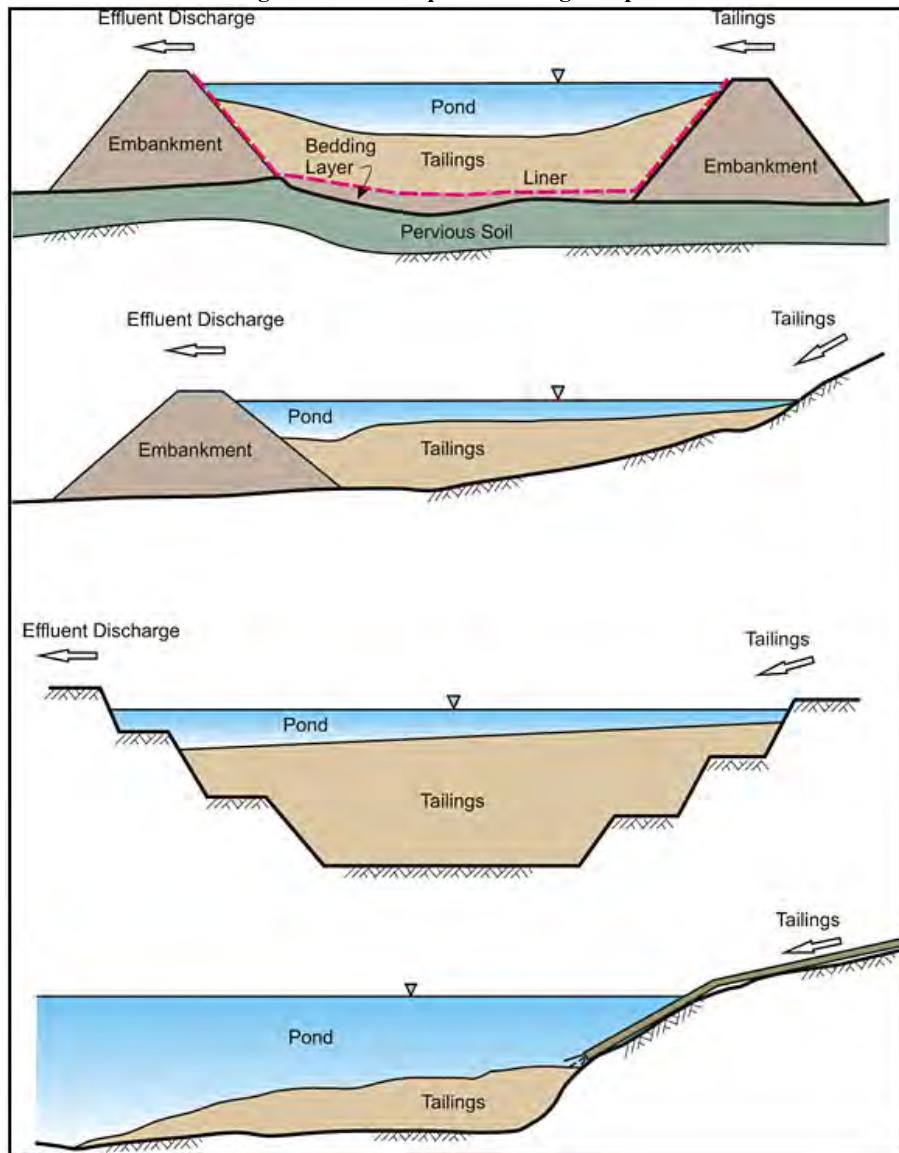

**Figure 6-15: Water Cover Processes**

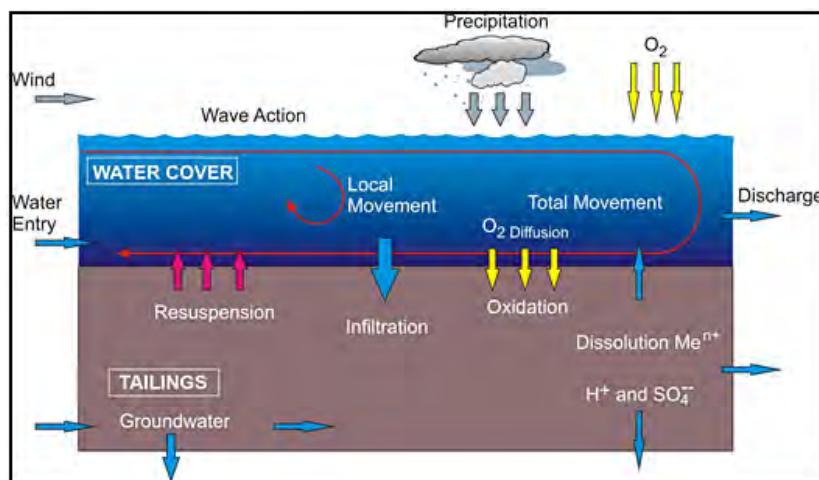

Requirements for a water cover include a climate with a positive water balance, long-term physical stability of containment facilities and outlet structures (with sufficient capacity to handle extreme events), and water depth sufficient to prevent resuspension by wind and wave action. Designs must consider the potential for periods of extended drought and exposure of previously saturated material. The considerations for a water cover are summarized in Table 6-6. While only shallow water covers are needed to effectively prevent oxygen diffusion, a thicker cover (typically from 1 to 3 metres deep) is needed if preventing resuspension of fine tailings due to wave action is a consideration. MEND (1998b) provides a thorough guide for the design of subaqueous impoundments. An example of a permanent water cover, augmented by alkaline amendment and organic matter, is provided in the **Benambra Case Study**.

A distinction is made between use of natural water bodies or flooded mining voids and engineered tailings dams and manmade lakes. Table 6-6 presents a high-level overview of possible factors that could be considered in the evaluation of subaqueous disposal; this overview is not meant to be comprehensive. The proposed use of natural water bodies in particular may require extensive studies of baseline conditions and potential impacts, as well as legislative action. For example, in Canada special amendment to a regulation is required to use “fish-bearing water bodies” for storage of mine wastes.

**Table 6-6: Some Considerations for Subaqueous Disposal**

Considerations for Use of Natural Water Bodies (lakes or oceans)	Considerations for Engineered Water Retaining Structures (dikes and dams, pits, underground workings)
<p><b>Proximity to Mine</b></p> <ul style="list-style-type: none"> <li>▪ Water level</li> <li>▪ Tides and currents</li> <li>▪ Other lake uses</li> <li>▪ Regulatory environment</li> <li>▪ Potential toxicity of wastes including metal leaching, reagents and metals from the milling process</li> <li>▪ Residue from blasting processes as a potential nutrient source</li> <li>▪ Potential increase in turbidity</li> <li>▪ Potential effects on local flora and fauna including commercial and recreational fisheries</li> <li>▪ Potential loss of habitat</li> <li>▪ Natural mixing processes</li> <li>▪ Lake water chemistry</li> </ul>	<p><b>Dams and Dikes</b></p> <ul style="list-style-type: none"> <li>▪ Detailed design of embankment and spillway required</li> <li>▪ Measures required to control seepage</li> <li>▪ Geotechnical, maintenance, and inspection requirements of dikes, dams, and hydraulic structures required to maintain a water cover</li> <li>▪ Hydrogeology and hydrology, - a reliable water source is required to maintain flooded conditions, even during drought</li> <li>▪ Potential risks to downstream receptors of catastrophic failure and release of retained water and/or wastes</li> </ul> <p><b>Pits and underground workings</b></p> <ul style="list-style-type: none"> <li>▪ Potential mobilization of stored oxidation products upon flooding</li> <li>▪ Potential leaching of metals from flooded materials</li> <li>▪ Resulting pit lake chemistry</li> <li>▪ Potential oxidation of materials above the water line</li> <li>▪ Continuity with other underground workings</li> </ul>

### 6.6.7.2 Partial Water Cover

The partial water cover concept involves an elevated water table that maintains saturation throughout the bulk of the tailings profile (Bussière, 2007; Ouangrawa et al., 2006). A surface pond does not extend to the embankment or dykes along the perimeter of the tailings impoundment, but a small pond may be maintained in the centre to maintain an elevated water table over the entire region of the tailings impoundment.

The objective of the partial water cover is to minimize the higher risk of structural failure associated with having a water cover and pond adjacent to the embankment wall, while maintaining saturation through enough of the waste to limit the maximum extent of oxidation that will occur. The partial water cover

method is well suited for operations where two types of tailings are being generated: the high sulphur concentrate produced by desulphurization (see Section 6.6.3.3) that is stored at depth and the non-acid generating tailings that are used as cover above the level of the pond (Sjoberg-Dobchuk et al., 2003). A partial water cover is also well suited to the case where the underlying non-oxidized tailings have sufficient neutralizing capacity to assimilate the entire acid load that is produced from the overlying rind of unsaturated tailings. A key design consideration is to raise the water table above the acid generating material by placing non-acid generating material as a cover, controlling the water level by the pond spillway elevation, or both placing non-acid generating material and controlling the water level.

Use of the partial water-cover method must consider climate, topography, hydrology and hydrogeology, the residual neutralizing capacity of unoxidized tailings, and the water characteristic retention curve of the tailings material. A case study is provided for the Lupin Mine in Nunavut, Canada (**Lupin Case Study**).

### **6.6.7.3 Wetland Covers**

A wetland or bog cover includes soil, vegetation, and water overlying acid generating wastes. Soil ameliorates extreme climatic drying events and vegetation helps prevent erosion. Water limits oxygen ingress and plants offer passive treatment opportunities (ERMITE, 2003). The most critical operational aspect of using wetlands and bogs as covers is that oxygen depleted and reducing conditions are maintained at the base of the cover profile, thus not only protecting underlying unoxidized material but also creating the potential for precipitation of existing ARD products as sulphides. MEND (1993) provides a comprehensive case study of wetland covers.

### **6.6.7.4 Attenuation**

Attenuation measures are discussed in Chapter 7.

### **6.6.7.5 Streamflow Regulation**

Control of surface water flow and drainages that discharge to adjacent receiving water bodies must satisfy compliance criteria established by regulatory agencies and internal corporate standards. In most cases, criteria are defined in terms of concentrations for specified parameters (e.g., pH, acidity, alkalinity, metals, sulphate, and major ions), streamflows, and environmental loadings. Concentrations may also be defined based on periods for high flow and low flow.

Assessment of mine drainage often involves development of a comprehensive water balance (i.e., both surface and groundwater) combined with mass loadings. Key components of a surface water balance include precipitation (both daily and hourly), evapotranspiration, runoff, infiltration, and drainage rates from surface structures (i.e., waste rock). Surface water management is controlled most strongly by precipitation, which is highly responsive within short time periods and can be easily monitored with instruments and flow gauges. Contamination of groundwater resources and the migration of plumes to surface water streams are frequently overlooked and can only be evaluated based on an understanding of groundwater hydrogeology and chemical analyses (see Chapter 8).

Stormwater management associated with extreme climatic events is often the most important issue for peak flow prediction, design of impoundment storage capacity, freeboard, spillways, flow concentrations, and diversion channels. Design inadequacies and failure of surface water management systems generally occur during extreme events so designs are based on storm return periods and hydrologic assessments. In many cases, it is better to use multi-staged designs based on operational flow rates supported with bypass spillways and diversion channels to handle extreme high-flow conditions. Criteria for bypass flow must be established based on risk, peak loadings, and downstream dispersion and dilution. Designs need to minimize the risk of severe erosion and structural stability of major containment facilities, especially after closure.

### **6.6.7.6 Water Recycle and Reuse**

Minimization of water use and water losses is a critical objective, especially in arid climates. Key design options include minimizing process water discharged to tailings (i.e., thickening), use of low permeability liners and barriers, recycling of process waters along with any contaminated discharges and seepage to the mill, and the use of surface water retention ponds for evaporation (climate permitting). Treatment sludges are also frequently discharged to tailings impoundments and may be sent to voids for deep disposal in pit lakes for long-term management.

Salt budgets may also be critical at arid sites for pit lakes and surface impoundments where a negative water balance because of low precipitation and high evaporation can cause evapoconcentration or hyper saline conditions to develop with time.

## **6.6.8 Drained / Sub-Aerial Tailings Deposition Methods**

Two legs of the “ARD Tetrahedron” (air and water) can be disrupted if fine-grained pyritic tailings can be dewatered and consolidated. Creating a low-water content paste is one method of tailings management that has been used to accomplish this goal as well as to maximize the amount of solids that can be stored in a given tailings storage facility. However, the energy and machinery involved in paste tailings production and placement is expensive and a certain amount of water must remain in the tailings to allow pipeline transport. De-watering tailings passively with little additional equipment is an attractive alternative.

Sub-aerial tailings deposition (more specifically, thin-layer sub-aerial deposition) is a methodology for mineral waste management which has proven successful in a number of sites in environmentally sensitive areas of the western U.S.A., Canada and in the Pacific Rim. Since about 1990, the method has been used to place tens of millions of cubic meters of tailings in an environmentally acceptable manner. The method involves the sequential deposition of



tailings slurry in thin layers around the perimeter of the tailings facility. As each layer is deposited, particle settlement, desiccation, and consolidation occur in four distinct stages as detailed below and in Figure 1:

- In Stage 1, the slurry is in a super-saturated condition with solid particles completely suspended in the fluid. There is minimal intergranular contact and a hydrostatic pore pressure distribution is present, resulting in an unstable condition which requires agitation for particles to remain in suspension.
- Stage 2 begins where the slurry has been initially deposited in a super-saturated plastic condition under water. As the solid particles settle, low intergranular contact is established and bleeding of surface water has started, with further release of liquid induced by drainage and/or evaporation. Loading of the settled deposit will result in formation of excess pore pressures which will slowly dissipate with seepage.
- Stage 3 is characterized by increased in-place density by means of application of underdrainage, which causes further consolidation and dissipation of positive pore pressures.
- Stage 4 develops as the drained deposit is allowed to air-dry and consolidate. This consolidation can be quite significant and results from the development of negative or suction pressures in the deposit as air is entrained within the soil structure. The resultant layer of air-dried waste is a stable, partially-saturated mass which has a lower permeability and greatly increased resistance to liquefaction under seismic loading. The most significant attribute of the slurry's transformation from Stage 1 to Stage 4 is the increase in the dry density of solids. For example, a gold tailings slurry initially at a solids content of 42% increases in dry solid density from approximately 0.83 kg/L (52 pounds per cubic foot [pcf]) to nearly 1.6 kg/L (100 pcf) merely by allowing settlement, drainage and air-drying in relatively thin layers prior to deposition of a fresh layer of tailings.

**Figure 6-16: State of Solids during Deposition and Consolidation (L); Stage 4 Photo (R)**

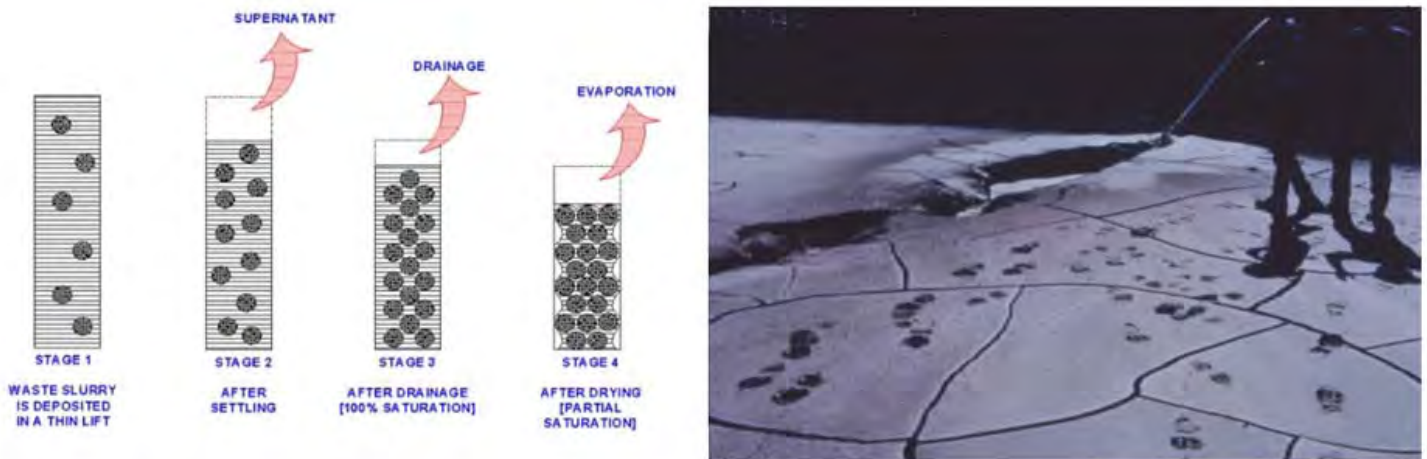

As the drying process continues and the moisture content has been reduced to approximately 20%, the dry density shows little increase with continued drying. In practice, once this point has been reached, a new layer of tailings is added and the cycle begins again.

Figure 6-17: Schematic Plan View, TSF with Three Depositional Zones

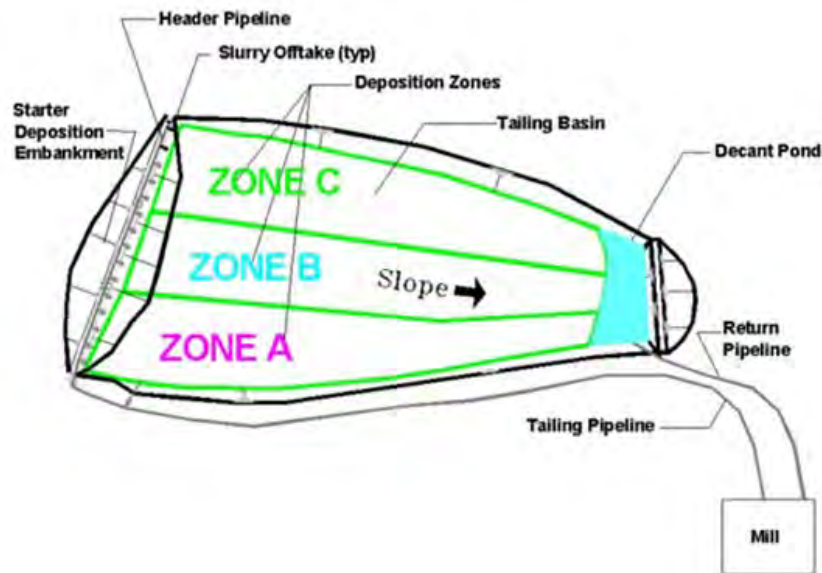

In order to achieve Stage 4 conditions, air-drying of the thinly-deposited (100 to 150 mm) layer of tailings is typically facilitated through a systematic rotational waste discharge strategy. Note that even though the tailings material in Figure 1 (R) is probably finer than 74 microns (<200 mesh), foot traffic is possible within several weeks of cessation of deposition. Vehicular traffic to conduct closure activities (e.g., placement of cover soils, liners, or soil amendments for revegetation) is also possible shortly after Stage 4 conditions are observed on the tailings surface (Reisinger et al., 2001).

If the tailings are very fine grained, thin-layer sub-aerial deposition techniques can create a tailings mass that is relatively impermeable with little entrained moisture. In fact, it can be demonstrated that the low permeability of the consolidated tailings materials in the initial lifts could allow regulating agencies to consider the tailings themselves as a "liner" in a double-liner configuration. A drainage blanket beneath the tailings would be included in the design as a leach collection and detection system. Consequently, the design should require only one geosynthetic liner (beneath the drainage blanket) to satisfy a double-liner requirement.

If the tailings contain significant concentrations of reactive sulfides, the relative impermeability of the tailings mass created with sub-aerial placement techniques should also suppress ARD formation, either in the toe seepage (which should be minimized) or runoff from the revegetated surface. Retrofitting existing tailings impoundments that have been designed as sub-aqueous facilities is also possible (Filas and Zmudzinski, 1993). Inserting wick drains or implementing other passive methods that relieve the pore pressure in saturated tailings has also been considered (Brown and Greenway, undated).

In summary, the thin-layer sub-aerial tailings deposition method may provide a cost-effective minimum energy and equipment tailings management technology. Advantages of the technology include:

- increased stored densities
- reduced seepage losses
- reduced ARD generation
- increased ease of surface reclamation at closure and
- improved embankment stability.

More economical upstream construction may be feasible with sub-aerial deposited tailings. In short, this technology fully embraces the concept of storing solids, not water, and in doing so, can better avoid ARD problems during operation and post closure.

## 6.7 Selection and Evaluation of Alternatives

No universal solution exists for the prevention, control, and mitigation of ARD, NMD, and SD. While submergence is clearly the most geochemically-stable approach, subaqueous disposal of tailings and waste in natural water bodies, such as lakes or marine environments, can be contentious. The applicability of technologies to ARD sources and phase of mining is shown in Figure 6-18.

Specific evaluation of methods for prevention and mitigation of ARD requires a clear definition of objectives and defined purpose. The specific environmental technologies and options that will work best will be site specific, often governed by climatic considerations. The applicability of several methods described in the preceding sections is summarized in Table 6-7. Some methods have been demonstrated to be effective at sites around the world while others have had limited demonstration. This is a simple summary only in order to broadly categorize the technology. Some technologies may have been demonstrated in a few climate type but could be applicable to others. As discussed throughout this Guide, site-specific considerations should be

assessed during the evaluation of any ARD prevention technology.

Water covers are a proven technology from a geochemical perspective but are sustainable only in climates with a positive water balance (i.e., precipitation > evaporation). In climates with a suitable water balance, geotechnical and long-term hazards with respect to stability, extreme storms and floods, spillways, erosion, and other natural hazards such as seismic events must be considered.

**Figure 6-18: Prevention and Mitigation Evaluation of Alternatives**

<b>Prevention and Mitigation Evaluation of Alternatives</b>	
<b>Characterization and Prediction of ARD/NMD/SD</b>	•see Chapters 4 and 5.
<b>Define Purpose</b>	<ul style="list-style-type: none"> <li>•includes specific water quality targets, as required by regulatory environment, licensing commitments, or an assessment of risk to human and ecological receptors</li> <li>•criteria for decision are defined</li> <li>•see Chapter 3 for guidance on regulatory frameworks</li> </ul>
<b>Compilation of Options</b>	•overview of available technologies
<b>Pre-Screening</b>	<ul style="list-style-type: none"> <li>•definition of criteria</li> <li>•scoping level decision</li> </ul>
<b>Review and Comparison of Options</b>	Prepare matrix of methods and characteristics to capture synergistic effects of multiple prevention and mitigation measures, including: <ul style="list-style-type: none"> <li>•costs</li> <li>•benefits</li> <li>•effectiveness</li> <li>•reliability and service life</li> <li>•sustainability, requirements for long term treatment and maintenance</li> <li>•acceptability to stakeholders, public and regulators</li> <li>•risks associated with failure or non-compliance effects</li> </ul>
<b>Decision and Planning for Implementation</b>	<ul style="list-style-type: none"> <li>•review of decision criteria with respect to matrix of methods</li> <li>•decision</li> </ul>

**Table 6-7: Summary of Prevention and Mitigative Measures and Climate Considerations**

<b>Oxygen Limiting</b>	
<b>Widely Demonstrated</b>	<b>Limited Demonstration</b>
<ul style="list-style-type: none"> <li>▪ Submergence (all climates except B)</li> <li>▪ Water covers (A, C, D)</li> <li>▪ In-pit disposal (all climates)</li> <li>▪ Elevated water table (A,C, D)</li> <li>▪ Mine backfilling (all climates)</li> <li>▪ Membrane covers (all climates)</li> </ul>	<ul style="list-style-type: none"> <li>▪ Oxygen consuming cover (all climates)</li> <li>▪ Saturated soil cover (A, C, D)</li> </ul>
<b>Water Limiting</b>	
<b>Widely Demonstrated</b>	<b>Limited Demonstration</b>
<ul style="list-style-type: none"> <li>▪ Diversion (all climates)</li> <li>▪ Store and release covers (B)</li> </ul>	<ul style="list-style-type: none"> <li>▪ Low permeability covers in wet climates (A, C, D)</li> </ul>

<ul style="list-style-type: none"> <li>▪ Membrane covers (all climates)</li> </ul>	<ul style="list-style-type: none"> <li>▪ Paste Tailings (C,D)</li> </ul>
<b>Geochemical</b>	
<b>Widely Demonstrated</b>	<b>Limited Demonstration</b>
<ul style="list-style-type: none"> <li>▪ Segregation (all climates)</li> <li>▪ Avoidance (all climates)</li> <li>▪ Tailings desulphurization (C)</li> <li>▪ Encapsulation (coal) (C)</li> </ul>	<ul style="list-style-type: none"> <li>▪ Alkaline covers (all climates)</li> <li>▪ Passivation (all climates)</li> <li>▪ Blending (all climates)</li> <li>▪ Encapsulation (metal) (A,C)</li> </ul>

**LEGEND: (Climate Classification by Köppen system)**

- |                                 |                                     |
|---------------------------------|-------------------------------------|
| (A) Tropical humid              | (D) Continental severe mid-latitude |
| (B) Dry                         | (E) Polar                           |
| (C) Temperate mild mid-latitude | (H) Highland                        |

In-pit disposal and mine backfill might be preferred in some situations, but this method of disposal usually only becomes available after or well into the mine operating phase.

In many cases, more than one approach or method will be required. For example, sulphide separation combined with water covers, elevated water table, and barrier covers may prove to be the best combined system for a given tailings impoundment.

Cost and economic viability must be evaluated similar to the other criteria for environmental and social settings. Cost estimates are almost always site-specific. Standard engineering approaches are used to develop capital and operating cost estimates to evaluate options and to assist in selecting a technology. Detailed design of an ARD prevention or mitigation technology involves preparing a detailed cost estimate. The specific approaches and methods used to cost ARD prevention and mitigation technologies are beyond the scope of the GARD Guide, but are described in standard engineering text books. Site-specific pre-construction cost estimates and actual as-built construction costs may be found in the proceedings from the major ARD conferences and other sources.

However, in general, cover systems for tailings and waste rock deposits are often costly. Although costs vary widely, soil covers costs can range from about \$25,000 to \$100,000 (USD) per hectare (ha); heavily dependent upon the proximity of borrow sources for the soil cover material. The application of synthetic and complex multi-layer covers can easily double this cost and therefore those technologies are usually applied at smaller sites. Figure 6-19 as an example, summarizes relative costs of a few technologies for a particular site: capillary barrier cover (i.e., covers with capillary barrier effects (CCBE)), desulphurization covers, and water covers. As shown here, desulphurization may be the most attractive alternative of the three options for this particular site depending upon the consideration of other factors (e.g., ease of application and environmental and social requirements).

**Figure 6-19: Comparative Costs for Capillary Barrier Cover (CCBE), Complete and Partial Desulphurization and Water Cover (Bussiere and Wilson, 2006)**

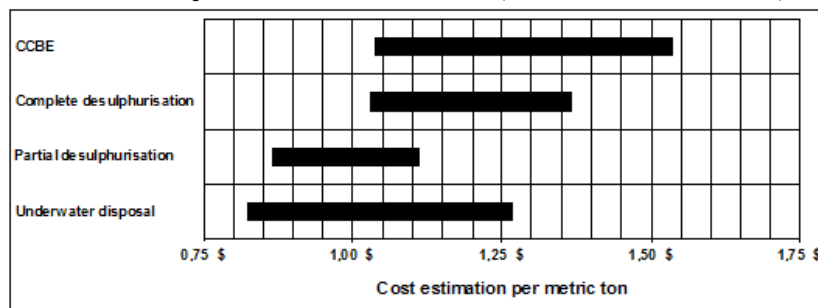

Data requirements for detailed design of prevention and mitigation strategies include detailed site characterization, such as topography and physical setting, geology, hydrogeology and hydrology, climate, materials availability and mine development sequence, and detailed characterization of source materials, including type, geochemistry, volume, and reactivity. Evaluation of alternatives as part of the preparation of the overall ARD management plan is discussed further in Chapter 9.

## 6.8 Design and Construction Considerations

Design of prevention and mitigation measures will likely require some analytical or numerical modeling (or both analytical and numerical modeling) to predict both geochemical and physical performance (see Chapter 5). The time frame and scheduling of the implementation of control measures becomes

important when PAG materials have a limited time to the onset of ARD production.

Construction must consider site location and transportation logistics, use and availability of local material types, quality control and quality assurance, including as-built inspection and reporting, and ongoing monitoring, maintenance, and reporting requirements. Construction quality control programs are critical to the success of any prevention and mitigation measure.

## 6.9 Maintenance and Monitoring Considerations

Effective maintenance and monitoring programs must follow selection and implementation of any technical method for prevention or mitigation. Monitoring demonstrates achievement of objectives and maintenance ensures engineering integrity of the design. Monitoring is discussed in more detail in Chapter 8.

## 6.10 References

- Acid Drainage Technology Initiative (ADTI), 1998. Handbook of Technologies for Avoidance and Remediation of Acid Mine Drainage. J. Skousen, A. Rose, G., Geidel, J., Foreman, R., Evans, W. Hellier, and members of the Avoidance and Remediation Working Group, National Land Reclamation Centre, West Virginia University, Morgantown, WV.
- Ackman T.E., and J.R. Jones, 1991. Methods to identify and reduce potential surface stream water losses into abandoned underground mines. *Environmental Geology and Water Sciences*, 17(3):227-232.
- Amec, 2010. MINA DE COBRE PANAMÁ PROJECT FEED STUDY - EXECUTIVE SUMMARY, MINERA PANAMA, S.A. ([http://www.inmetmining.com/Theme/Inmet/files/Section%200-Executive%20Summary\\_FinalFEED\\_31%20March.pdf](http://www.inmetmining.com/Theme/Inmet/files/Section%200-Executive%20Summary_FinalFEED_31%20March.pdf))
- Aubertin, M., Industrial NSERC Ecole Polytechnique – UQAT Chair, 2005. Unpublished presentation.
- Aubertin, M., Bussière, B., Barbera, J.M., Chapuis, R.P., Monzon, M., and M. Aachib, 1997. Construction and instrumentation of in situ test plots to evaluate covers built with clean tailings. In: Proceedings of the 4th International Conference on Acid Rock Drainage (ICARD), May 31-June 6, Vancouver, BC, 715-730.
- Australian Centre for Geomechanics (ACG), 2006. Paste and Thickened Tailings – A Guide, 2nd Edition. R.J. Jewell and A.B. Fourie (Eds.), Nedlands, Western Australia, Australia.
- Ayres, B.K., O’Kane M., and S.L. Barbour, 2004. Issues for consideration when designing a growth medium layer for a reactive mine waste cover system. In: Proceedings of 11th International Conference on Tailings and Mine Waste, October 10-13, Vail, CO.
- Ayres, B., Lanteigne, L., Smith, Q., and M. O’Kane, 2007. Closure planning and implementation at CVRD Inco’s Whistle Mine, Ontario, Canada. In: Proceedings of Mine Closure 2007 Conference, October 16-19, Santiago, Chile.
- Bois, D., Poirier, P., Benzaazoua, M., and Bussière, B. A, 2004. Feasibility Study on the Use of Desulphurized Tailings to Control Acid Mine Drainage. Proceedings 2004 – 36th Annual Meeting of the Canadian Mineral Processors, January 20-22, 2004, Ottawa (Ontario), pp. 361-380.
- Boldt-Leppin, B., O’Kane, M., and M.D. Haug, 1999. Soil covers for sloped surfaces of mine waste rock and tailings. In: Proceedings of the Tailings and Mine Waste Conference, January 24-27, Fort Collins, CO, 393-403.
- Brady, K., Smith, M.W., Beam, R.L., and C.A. Cravotta, 1990. Effectiveness of the use of alkaline materials at surface coal mines in preventing or abating acid mine drainage: part 2 - mine site case studies. In: J. Skousen, J. Sencindiver and D. Samuel (Eds.), Proceedings 1990 Mining and Reclamation Conference, West Virginia University, Morgantown, WV, 227-241.
- Broman, P.G., Haglund, P., Mattsson, E. 1991. Use of sludge for sealing purposes in dry covers-development and field experiences. Vol. 1: P515-528. In Proceedings of the Second International Conference on the Abatement of Acidic Drainage, Montréal, Québec. Sept. 16-18.
- Brooks, W., 2011. Minera Panama SA, Personal Communication.
- Brown, B.S., and G. Greenway, updated. Field Experience in the Use of Wick Drains to Consolidate Soft Tailings. Downloaded from: <http://www.infomine.com/library/publications/docs/brown.pdf>, May 20, 2013.
- British Columbia Acid Mine Drainage Task Force (BC AMD), 1989. Draft Acid Rock Drainage Technical Guide. BiTech Publishers Ltd., Vancouver, BC.
- Bussière, B., 2007. Colloquium 2004: Hydrogeotechnical properties of hard rock tailings from metal mines and emerging geoenvironmental disposal

practices. *Canadian Geotechnical Journal*, 44:1019-1052.

Bussière, B. and G.W. Wilson, 2006. Cover Design Manual for Peru. CIDA - Percan project.

Cabral A., Lefebvre, G., Burnotte, F., Proulx, M.F. 1997. Use of Deinking Residues as Cover Material in the Prevention of AMD Generation at an Abandoned Mine Site. Vol. 3: P1109-1123. In *Proceedings Fourth International Conference on Acid Rock Drainage*, Vancouver, B.C. May 31-June 6.

Caruccio, F.T., Geidel, G., and R. Williams, 1984. Induced alkaline recharge zones to mitigate acid seeps. In: *Proceedings National Symposium on Surface Mining, Hydrology, Sedimentology and Reclamation*, University of Kentucky, Lexington, KY, 43-47.

Caruccio, F.T., and G. Geidel, 1989. Water management strategies in abating acid mine drainage - Is water diversion really beneficial? In: *Proceedings Multinational Conference on Mine Planning and Design*, University of Kentucky, Lexington, KY, 167-172.

Christensen, D. and M. O'Kane, 2005. The use of "enhanced" moisture store and release cover system over reactive mine waste in arid and semi-arid climates. *Proceedings of the 2005 National Meeting of the American Society of Mining and Reclamation*, Breckenridge CO, June 19-23, 2005.

Claypool, G., Cassie, J., and R. Carreau, 2007. Reclamation of Frozen Sulphidic Tailings Area – Nanisivik Mine, Northern Canada. In: *Proceedings of the 2nd International Seminar on Mine Closure*, October 16-19, Santiago, Chile. Australian Centre for Geomechanics, Nedlands WA, Australia.

Cochrane, T, R.V. Nicholson, A. Small and P. Babulic, 2012. In: *Proceedings of the 9th International Conference on Acid Rock Drainage*, Ottawa, May 20-26, 2012.

DES (Denison Environmental Services) 2011. Elliot Lake Reclamation <http://www.denisonenvironmental.com/en/decommissioning/denison/>.

Department of Water and Forestry, Republic of South Africa (DWAF), 2006. Best Practice Guideline – H3: Water Reuse and Reclamation. Pulles, Howard & de Lange Inc.

Department of Water and Forestry, Republic of South Africa (DWAF), 2007. Best Practice Guideline – H2: Pollution Prevention and Minimization of Impacts.

DeVries, N.H.C., 1996. "Process of Treating Iron-containing Sulfide Rocks and Ores." U.S. Patent No. 5587001. <http://www.patentstorm.us/patents/5587001/fulltext.html>.

Eger, P., and D. Antonson. 2002. "Use of Microencapsulation to Prevent Acid Rock Drainage," report to MSE Technology Applications, Minnesota Department of Natural Resources, St. Paul, Minn.

Eger, P., and D. Antonson. 2004. "Use of Microencapsulation to Prevent Acid Rock Drainage," St. Paul, Minn.: Minnesota Department of Natural Resources.

Eger, P., and P. Mitchell. 2007. "The Use of Microencapsulation to Prevent Acid Rock Drainage," presented at Mining and the Environment IV Conference, Sudbury, Ontario, Canada, October 19–27.

ERMITE (Environmental Regulation of Mine Waters in the European Union), 2003. Technical and Managerial Guidelines D6. P.L. Younger and C. Wolkersdorfer (Eds.).

Evangelou, V.P., 1998. Pyrite Chemistry: the key for abatement of acid mine drainage. In: Geller, A., Klapper, H., Salomons, W., editors. *Acidic Mine Lakes: Acid Mine Drainage, Limnology and Reclamation*. Berlin: Springer. p. 197-222.

Faulkner, B.B., and J.G. Skousen, 1994. Treatment of acid mine drainage by passive treatment systems. In: *Proceedings of the International Land Reclamation and Mine Drainage Conference*, U.S. Bureau of Mines SP 06A-94, Pittsburgh, PA, 250-257.

Filas, B.A., and G.L. Zmudzinski, 1993. Improving Fine Refuse Reclamation Potential by Managed Slurry Deposition. Presented at the Society for Mining, Metallurgy, and Exploration, Inc. (SME) annual meeting, Reno, Nevada, February 15-18, 1993.

Germain, D. Normand Tassé, and Johanne Cyr 2003. Treatment of Acid Mine Effluents Using a Wood-Waste Cover. *Proceedings of the 6th International Conference on Acid Rock Drainage (ICARD)*, Cairns, Australia, 12-18 July 2003, Australian Institute of Mining and Metallurgy, Melbourne.

Germain, D., Normand Tassé, and Johanne Cyr 2010. The East Sullivan Mine Site: Merging Prevention and Treatment of Acid Mine Drainage. Presentation in *Proceedings of the 16th Annual BC-MEND ML/ARD workshop*, Vancouver, BC., December 2-3, 2009, W.A. Price and K. Bellefontaine (Eds.)  
2014-10-21

- Hamblin, C. 2010. The Rehabilitation of the Kam Kotia Mine Site: An Exercise in Cover Construction and Water Management.
- Hamilton, J., Gue, J and Socotch, C. 2007. The use of steel slag in passive treatment design for AMD discharge in the Huff Run watershed restoration. Proc. Amer. Soc. of Mining and Reclamation, Gillette, WY, June 2-6, 2007, p. 272-282.
- Hammack, R.W., and G.R. Watzlaf, 1990. The effect of oxygen on pyrite oxidation. In: Proceedings of the American Society for Surface Mining and Reclamation, Charleston, WV, 1:33-41.
- Harries, J.R., and A.I.M. Ritchie, 1987. The effect of rehabilitation on the rate of oxidation of pyrite in a mine waste rock dump. Environmental Geochemistry and Health, 9:27-36.
- Harris, D.L. and Lottermoser, B.G., 2006. Evaluation of phosphate fertilizers for ameliorating acid mine waste. Applied Geochemistry, 21, p. 1216-1225.
- Hawkins, J.W., 1994. Assessment of contaminant load changes caused by re-mining abandoned coal mines. In: Proceedings of the International Land Reclamation and Mine Drainage Conference, U.S. Bureau of Mines SP 06A-94, Pittsburgh, PA, 20-29.
- Hawkins, J.W., 1998. Re-mining. In: K.C. Brady, M.W. Smith and J.Schueck (Eds.), Coal Mine Drainage Prediction and Pollution Prevention in Pennsylvania, PA DEP, Harrisburg, PA, 17:1-6.
- Hawkins, J.W., 2004. Predictability of Surface Mine Spoil Hydrologic Properties in the Appalachian Plateau. Ground Water, 42(1):119-125.
- Hesketh, A.H., Broadhurst, J.L., and Harrison, S.T.L., 2010. Mitigating the generation of acid mine drainage from copper sulphide tailings impoundments in perpetuity: A case study for an integrated management strategy. Minerals Engineering, 23 (2010), p. 225-229.
- Hofton, T. and R. Schwenger. 2010. Geomembrance Cover on Nonmetal Reactive Tailings – A Case Study. Presentation in Proceedings of the 16th Annual BC-MEND ML/ARD Workshop, Vancouver, British Columbia, December 2-3, 2009. W.A. Price and K. Bellefontaine (Eds.)
- Ingledeew, W.J., 1982. Thiobacillus ferrooxidans the bioenergetics of an acidophilic chemolithotroph: Biochimica et Biophysica Acta, Vol. 683, pp. 89-117.
- International Network for Acid Prevention (INAP), 2003. Evaluation of the Long-term Performance of Dry Cover Systems, Final Report. O'Kane Consultants Inc., (Eds.), Report No. 684-02, March.
- ITRC, 2008. Mining Waste Issues in the United States: A White Paper, January.
- Julien M. R., M. Lemieux, J. Cayouette and D. Talbot, Performance and Monitoring of the Louvicourt Mine Tailings Disposal Area, [http://www.minem.gob.pe/minem/archivos/file/dgaam/publicaciones/cursos\\_cierreminas/02\\_T%C3%A9cnico/06\\_Coberturas/TecCover-L06\\_Water%20cover-Louvicourt.pdf](http://www.minem.gob.pe/minem/archivos/file/dgaam/publicaciones/cursos_cierreminas/02_T%C3%A9cnico/06_Coberturas/TecCover-L06_Water%20cover-Louvicourt.pdf)
- Kelly, D. P., and A. P. Wood, 2000. Reclassification of some species of Thiobacillus to the newly designated genera Acidithiobacillus gen. nov., Halothiobacillus gen. nov. and Thermithiobacillus gen. nov. International Journal of Systematic and Evolutionary Microbiology, 50:511-516.
- Kleinmann, R.L.P., 1979. The biogeochemistry of acid mine drainage and a method to control acid formation. Ph.D Thesis, Princeton University, Princeton, NJ.
- Kleinmann, R.L.P., 1982. Method of control of acid drainage from exposed pyritic materials. U.S. Patent 4,314,966.
- Kleinmann, R.L.P., 1998. Bactericidal control of acidic drainage. In: K.C. Brady, M.W. Smith, and J. Schueck (Eds.), Coal Mine Drainage Prediction and Pollution Prevention in Pennsylvania, PA DEP, Harrisburg, PA, 15:1-6.
- Kleinmann, R.L.P., and D.A. Crerar, 1979. Thiobacillus ferrooxidans and the formation of acidity in simulated coal mine environments. Geomicrobiology Journal, 1:373-388.
- Kleinmann, R.L.P., Crerar, D.A., and R.R. Pacelli, 1981. Biogeochemistry of acid mine drainage and a method to control its formation. Mining Engineering, 33:300-306.
- Kleinmann, R.L.P., and P.M. Erickson, 1981. Field evaluation of a bactericidal treatment to control acid drainage. In: D.H. Graves (Ed.), Proceedings of the Symposium on Surface Mining Hydrology, Sedimentology and Reclamation, University of Kentucky, Lexington, KY, 325-329.
- Kleinmann, R.L.P., and P.M. Erickson, 1983. Control of acid drainage from coal refuse using anionic surfactants. U.S. Bureau of Mines RI 8847, Pittsburgh, PA.
- Lang, B., 2007. <http://www.cerm3.mining.ubc.ca/millennium.htm>

- Langworthy, T.A., 1978. Microbial life in extreme pH values. In: D.J. Kushner (Ed.), *Microbial Life in Extreme Environments*, Academic Press, NYC, NY, 279-315.
- Lavery, B., McCament, B and Farley, M.E., 2007, Performance of steel slag and other passive treatment systems at the Broken Aro mine in Little Racoon Creek, Ohio. Proc., WV Surface Mine Drainage Task Force Symposium, April 2007, p. 57-83.
- Levićán, G.P., Bruscella, M.M., Guacunano, C.I., Bonnefoy V., Holmes, D.S., and E. Jedlicki, 2002. Characterization of the petI and res Operons of *Acidithiobacillus ferrooxidans*. *Journal of Bacteriology*, 184(5):1498-1501.
- Lewis, B.A., R.D. Gallinger, and M. Wiber, 2000. Poirier Site Reclamation Program. ICARD, Proceedings of the 5th International Conference on Acid Rock Drainage, Vol II.
- Lindsay, M.B.J., Blowes, D.W., Condon, P.D., Ptacek, C.J., 2011. Organic carbon amendments for passive in situ treatment of mine drainage: Field experiments. *Applied Geochemistry*, 26, p. 1169-1183.
- Martin, J. and J. Fyfe, 2011. Innovative Closure Concepts for Xstrata Nickel Onaping Operations, Presentation in Sudbury 2011, Mining and the Environment International Conference V, 25-30 June 2011, (<http://www.sudbury2011.ca/2007Presentations/Presentations/Session%20%20-%20A/2%20Jeff%20Martin.pdf>)
- Mauric, A. and Lottermoser, B.G., 2011. Phosphate amendment of metalliferous waste rocks, Century Pb-Zn mine, Australia: Laboratory and field trials. *Applied Geochemistry*, 26 (2011), 45-46. p. 45-56.
- Meek, F.A., 1994. Evaluation of acid prevention techniques used in surface mining. p. 41-48. In: Proceedings, International Land Reclamation and Mine Drainage Conference, 24-29 April, USDI, Bureau of Mines SP 06B-94, Pittsburgh, PA.
- Meer, S.R. and C.H. Benson, 2007. Hydraulic conductivity of geosynthetic clay liners exhumed from landfill final covers. *Journal of Geotechnical and Geoenvironmental Engineering*, 133(5):550-563.
- Mine Environment Neutral Drainage Program (MEND), 1993. Panel Wetland – A Case History of Partially Submerged Pyritic Uranium Tailings Underwater. Report 3.12.2, CANMET.
- Mine Environment Neutral Drainage Program (MEND), 1995. Review of In-Pit Disposal Practices for the Prevention of Acid Drainage - Case Studies, Report 2.36.1, CANMET.
- Mine Environment Neutral Drainage Program (MEND), 1998a. Blending and Layering Waste Rock to Delay, Mitigate or Prevent Acid Rock Drainage and Metal Leaching: A Case Study Review. Report 2.37.1, CANMET.
- Mine Environment Neutral Drainage Program (MEND), 1998b. Design Guide for the Subaqueous Disposal of Reactive Tailings in Constructed Impoundments. Report 2.11.9, CANMET.
- Mine Environment Neutral Drainage Program (MEND), 2001. Prevention and Control. Volume 4. Manual 5.4.2d. G.A. Tremblay and C.M. Hogan (Eds.), CANMET.
- Mine Environment Neutral Drainage Program (MEND), 2002. A Review of Non-Traditional Dry Covers. Report 2.21.3b, Natural Resources Canada.
- Mine Environment Neutral Drainage Program (MEND), 2004a. Design, Construction and Performance Monitoring of Cover Systems for Waste Rock and Tailings. Report 2.21.4, Natural Resources Canada.
- Mine Environment Neutral Drainage Program (MEND), 2004b. Covers for Reactive Tailings Located in Permafrost Regions Review. Report 1.61.4, Natural Resources Canada
- Mine Environment Neutral Drainage Program (MEND), 2007a. Macro-Scale Cover Design and Performance Monitoring Manual. Report 2.21.5, Natural Resources Canada.
- Mine Environment Neutral Drainage Program (MEND), 2007b. Assessing the Long Term Performance of a Shallow Water Cover to Limit Oxidation of Reactive Tailings at Louvicourt Mine. Report 2.12.2, Natural Resources Canada.
- Mine Environment Neutral Drainage Program (MEND), 2009. Mine Waste Covers in Cold Regions. Report 1.61.5a, Natural Resources Canada.
- Mine Environment Neutral Drainage Program (MEND), 2010. Evaluation of the Water Quality Benefits from Encapsulation of Acid-Generating Tailings by Acid-Consuming Tailings – December.
- Miller, G., and D. Van Zyl, 2008. Personal communication.



- Miller, S., Rusdinar, Y., Smart, R., Andrina, J., and D. Richards, 2006. Design and Construction of Limestone Blended Waste Rock Dumps – Lessons Learned from a 10-Year Study at Grasberg. In: R.I. Barnhisel (Ed.), Proceedings of 7th International Conference on Acid Rock Drainage (ICARD), March 26-30, St. Louis, MO, American Society of Mining and Reclamation, Lexington, KY.
- Miller, S., Smart, R., Andrina, J., Neale, A., and D. Richards, 2003. Evaluation of Limestone Covers and Blends for Long-Term Acid Rock Drainage Control at the Grasberg Mine, Papua Province, Indonesia. In: Proceedings of 6th International Conference on Acid Rock Drainage (ICARD), July 12-18, Cairns, QLD, Australia, AusIMM, 133-141.
- Morin, K.A., and N.M. Hutt, 1994. An empirical technique for predicting the chemistry of water seeping from mine-rock piles. In: Proceedings of the Third International Conference on the Abatement of Acidic Drainage, Pittsburgh, Pennsylvania, USA, April 24-29, Volume 1, p.12-19.
- Murphy, M. 2010. Mount Washington Remediation – Four Hectares of Bituminous Liner. Presentation in Proceeding of the 16th Annual BC-MEND ML/ARD Workshop, Vancouver, British Columbia, December 2-3, 2009. W.A. Price and K. Bellefontaine (Eds).
- Nawrot, J.R., Conley, P.S., and J.E. Sandusky, 1994. Concentrated alkaline recharge pools for acid seep abatement: principles, design, construction and performance. In: Proceedings International Land Reclamation and Mine Drainage Conference, U.S. Bureau of Mines SP 06A-94, Pittsburgh, PA, 382-391.
- Nicholson, R.V., I. Ludgate, E. Clyde and M. Venhuis, 2012. The Successful Reclamation of Acid Generating Tailings in the Elliot Lake Uranium District of Canada: A Good-News Case, In Proc. 9th ICARD, May, Ottawa, Canada.
- Northern Territory Minerals Council (Inc.) and the Mines and Petroleum Management Division of the Northern Territory Government (TEAM NT), 2004. TEAM NT: Technologies for Environmental Advancement of Mining in the Northern Territory: Toolkit. D.R. Jones and M. Fawcett (principal authors).
- O’Kane, M., and C. Wels, 2003. Mine waste cover system design – linking predicted performance to groundwater and surface water impacts. In: Proceedings of 6th International Conference on Acid Rock Drainage (ICARD), July 12-18, Cairns, QLD, Australia, AusIMM, 341-349.
- O’Kane, M., Porterfield, D., Haug, M.D., and M. Endersby, 1998a. The design and implementation of the field test plots at BHP Iron Ore, Mt. Whaleback – a soil cover system for an arid climate. In: Proceedings, 1998 SME Annual Meeting & Exhibit, March 9-11, Orlando, FL.
- O’Kane, M., Wilson, G.W., and S.L. Barbour, 1998b. Instrumentation and monitoring of an engineered soil cover system for mine waste rock. Canadian Geotechnical Journal, 35:828-846.
- Olson, G.J., Clark, T.R., and Mudder, T.I., 2005. Acid Rock Drainage Prevention and Treatment with Thiocyanate and Phosphate Containing Materials. 2005 National Meetings of the American Society of Mining and Reclamation, Breckenridge, CO, June 19-23, 2005. Published by ASMR, 3134 Montavesta Rd., Lexington, KY 40502. P. 831-841.
- Ouangrawa, M., Molson, J., Aubertin, M., Zagury, G., and B. Bussière, 2006. The Effect of Water Table Elevation on Acid Mine Drainage from Reactive Tailings: A Laboratory and Numerical Modeling Study. In: R.I. Barnhisel (Ed.), Proceedings of 7th International Conference on Acid Rock Drainage (ICARD), March 26-30, St. Louis, MO, American Society of Mining and Reclamation, Lexington, KY.
- Parisi, D., Horneman, J., and V. Rastogi, 1994. Use of bactericides to control acid mine drainage from surface operations. In: Proceedings of the International Land Reclamation and Mine Drainage Conference, U.S. Bureau of Mines SP 06B-94, Pittsburgh, PA, 319-325.
- Pennsylvania Department of Environmental Protection (PaDEP), 1998. Coal Mine Drainage Prediction and Pollution Prevention in Pennsylvania. K.B.C. Brady, M.W. Smith and J. Schueck (Eds.), Harrisburg, PA, <http://www.dep.state.pa.us/dep/deputate/minres/districts/cmdp/main.htm>
- Perry, E.F., and K.B.C. Brady., 1995. Influence of neutralization potential on surface mine drainage quality in Pennsylvania. In: Proceedings 16th Annual Surface Mine Drainage Task Force Symposium, West Virginia University, Morgantown, WV.
- Perry E., Holland L., Evans R., Schueck J., and D. Maxwell, 1998. Chapter 14 - Special Handling Techniques in the Prevention of Acid Mine Drainage. In: K.B.C. Brady, M.W. Smith and J. Schueck (Eds.), Coal Mine Drainage Prediction and Pollution Prevention in Pennsylvania, Harrisburg, PA. <http://www.dep.state.pa.us/dep/deputate/minres/districts/cmdp/chap14.html>.
- Peel, M.C., Finlayson, B.L., and T.A. McMahon, 2007. "Updated world map of the Köppen-Geiger climate classification". Hydrology and Earth Systems Sciences, 11:1633-1644.
- Peterson, H. R. Beckie, B. Harrison, K. U. Mayer, and L. Smith, 2012. Rapid transition from neutral to acidic drainage in a waste rock test pile at the Antamina Mine, Peru, In: Proceedings of the 9th International Conference on Acid Rock Drainage, Ottawa, May 20-26, 2012.
- Pierce, W.G. 1992. Reclamation of Sulphide Tailings using Municipal Solid Waste Compost: Literature Review and Recommendations. CANMET, Ottawa, Project NEDEM 2.25.1(a).

- Pierce, W.G., Belzile, N., Wiseman, M.E., Winterhalder, K. 1994. Composted Organic Wastes as Anaerobic Reducing Covers for Long Term Abandonment of Acid-Generating Tailings. Vol. 2: P148-157. In Proceedings International Land Reclamation and Mine Drainage Conference and Third International Conference on Abatement of Acidic Drainage. Pittsburgh, PA. April 24-29.
- Pulles, W., 2008. Best Practice Guideline G5: Water Management Aspects for Mine Closure. Department of Water Affairs and Forestry, December
- Rastogi, V., 1996. Water quality and reclamation management in mining using bactericides. *Mining Engineering*, 48(4):66-71.
- Reardon, E.J., Moddle, P.M., 1985. Suitability of Peat as an Oxygen Interceptor Material for the Close-out of Pyritic Uranium Tailings: Column Studies. *Uranium*, 2: 83-110.
- Reisinger, R.W., D.R. East, A.H. Gipson, J.E. Valera, and J.A. Gorman, 2001. Reclamation of the Big Springs sub-aerial tailings facility, Nevada. In: *Tailings and Mine Waste '01 Proceedings*. Eds.: Taylor & Francis - A. A. Balkema, Publishers.
- Rich, D.H. and K.R. Hutchison, 1990. Neutralization and stabilization of combined refuse using lime kiln dust at High Power Mountain. p. 55-59. In: *Proceedings, 1990 Mining and Reclamation Conference*, 23-26 April 1990, West Virginia University, Morgantown, WV.
- Rich, D.H., and K.R. Hutchison, 1994. Coal refuse disposal using engineering design and lime chemistry. In: *Proceedings International Land Reclamation and Mine Drainage Conference*, U.S. Bureau of Mines SP 06A-94, Pittsburgh, PA, 392-399.
- Rinker, M.J., R.V. Nicholson, M.A. Venhuis and B. Swarbrick, 2003. Implication of Non-Acidic Metal Leaching on Mine Rock Management at Nickel Mine in Permafrost Terrain: Mine Rock Evaluation. In *Proceeding Sudbury 2003 Mining and the Environment conference*. Sudbury, Ontario 25-28 May.
- Rose, A.W., Phelps, L.B., Parizek, R.R., and D.R. Evans, 1995. Effectiveness of lime kiln flue dust in preventing acid mine drainage at the Kauffman surface coal mine, Clearfield County, Pennsylvania. In: *Proceedings American Society for Surface Mining and Reclamation*, Gillette, WY, 159-171.
- Rose, A.W., J. Stalker, and L. Michaud. 1996. Remediation of acid mine drainage within strip mine spoil by sulfate reduction using waste organic matter. p. 321-335. In: *Proceedings, Thirteenth American Society for Surface Mining and Reclamation Conference*, May 18-23, 1996, Knoxville, TN.
- Rose, A.W., 2010. *Advances in Passive Treatment of Coal Mine Drainage 1998-2009*. National Meeting of the American Society of Mining and Reclamation, Pittsburgh, PA Bridging Reclamation, Science and the Community June 5 - 11, 2010. R.I. Barnhisel (Ed.) Published by ASMR, 3134 Montavesta Rd., Lexington, KY 40502.
- Sjoberg-Dobchuk, B., Wilson, G.W., and M. Aubertin, 2003. Evaluation of a Single-Layer Desulfurised Tailings Cover. In: *Proceedings of 6th International Conference Acid Rock Drainage (ICARD)*, July 14-17, Cairns, QLD, Australia, AusIMM.
- Skousen, J., Bhumbra, D., Gorman, J., and J. Sencindiver, 1997a. Hydraulic conductivity of ash mixtures and metal release upon leaching. In: *Proceedings American Society for Surface Mining and Reclamation*, Austin, TX, 480-495.
- Skousen, J.G., Hedin, R., and B.B. Faulkner, 1997b. Water quality changes and costs of remining in Pennsylvania and West Virginia. In: *Proceedings American Society for Surface Mining and Reclamation*, Austin, TX, 64-73.
- Skousen, J., and G. Larew, 1994. Alkaline overburden addition to acid-producing materials to prevent acid mine drainage. In: *Proceedings International Land Reclamation and Mine Drainage Conference*, U.S. Bureau of Mines SP 06B-94, Pittsburgh, PA, 375-381.
- Skousen, J.G., Sencindiver, J.C., and R.M. Smith, 1987. A Review of Procedures for Surface Mining and Reclamation in Areas with Acid-Producing Materials. EWRC 871, West Virginia University, Morgantown, WV.
- Skousen, J., and P. Ziemkiewicz, 1996. *Acid Mine Drainage Control and Treatment - 2nd edition*. National Research Center for Coal and Energy, National Mine Land Reclamation Center, West Virginia University, Morgantown, WV.
- Smith, M.W., and K.B.C. Brady, 1998. Alkaline addition. In: K.B.C. Brady, M.W. Smith and J. Schueck (Eds.), *Coal Mine Drainage Prediction and Pollution Prevention in Pennsylvania*, PA DEP, Harrisburg, PA, 13:1-13.
- Sobek, A.A., Benedetti, D.A., and V. Rastogi, 1990. Successful reclamation using controlled release bactericides: two case studies. In: *Proceedings American Society for Surface Mining and Reclamation*, Charleston, WV, 1:33-41.
- Splitdorf, D., and V. Rastogi, 1995. Ten year results from bactericide-treated and reclaimed mine land. In: *Proceedings American Society for Surface Mining and Reclamation*, Gillette, WY, 471-478.

- SRK Consulting, 2008. Mount Washington Mine Remediation – Executive Summary, Report to Tsolum River Partnership, SRK-1CT001.001, January.  
[http://www.tsolumriver.org/pictures/Executive%20Summary\\_Mt%20Wash\\_Final.pdf](http://www.tsolumriver.org/pictures/Executive%20Summary_Mt%20Wash_Final.pdf)
- Stehouwer, R., Sutton, P., Fowler, R., and W. Dick, 1995. Minespoil amendment with dry flue gas desulfurization by-products: element solubility and mobility. *Journal of Environmental Quality*, 24:165-174.
- Strock, N., 1998. Reclamation and revegetation. In: K.B.C. Brady, M.W. Smith and J. Schueck (Eds.), *Coal Mine Drainage Prediction and Pollution Prevention in Pennsylvania*, PA DEP, Harrisburg, PA, 12:1-5.
- Taylor, G., Spain, A., Nefiodovas, A., Timms, G., Kuznetsov, V., and J. Bennett, 2003. Determination of the Reasons for Deterioration of the Rum Jungle Waste Rock Cover. ACMER, Brisbane.
- Taylor, J.R., Guthrie, B., Murphy, N.C., and J. Waters, 2006. Alkalinity Producing Cover Materials for Providing Sustained Improvement in Water Quality from Waste Rock Piles. In: *Proceedings of the 7th International Conference on Acid Rock Drainage (ICARD)*, March 26-30, St. Louis, MO, American Society of Mining and Reclamation, Lexington, KY.
- Ulrich, B, D.R. East and J. Gorman, 2000. *Subaerial Tailings Deposition – Design, Construction and Operation for Facility Closure and Reclamation*. Tailings and Mine Waste '00. A. A. Balkema Publishers (Editor).
- United States Environmental Protection Agency (USEPA), 2003. *EPA and Hardrock Mining: A Source Book for Industry in the Northwest and Alaska*. Prepared by EPA Region 10 with the technical assistance of Science Applications International Corporation.
- Wickland, B.E., Wilson, G.W., Wijewickreme, D., and B. Klein, 2006. Design and evaluation of mixtures of mine waste rock and tailings. *Canadian Geotechnical Journal*, 43:928-945.
- White, W., and A. Tang, 2010. Mount Washington Mine Remediation Project – Construction Phase. BC Mine Reclamation Symposium, September, Comox, BC.
- Williams, D.J., Gowan, M., and P. Keefer, 1995. Practical Co-Disposal Deposition. In: *Proceedings of 7th Australian Coal Preparation Conference*, Mudgee, New South Wales, Australia, 371-383.
- Wilson, G.W., 2008a. Why are we still struggling with ARD? Sixth Australian Workshop on Acid and Metalliferous Drainage, April 15-18, Burnie, Tasmania.
- Wilson, G.W., 2008b. Permission given for use in GARD Guide. ACMER, Brisbane.
- Wilson, G.W., Williams, D.J., and E.M. Rykaart, 2003. The Integrity of Cover Systems - An Update. In: *Proceedings of 6th International Conference on Acid Rock Drainage (ICARD)*, Cairns, QLD, Australia, AusIMM, 445-452.
- Wiram, V.P., and H.E. Naumann, 1995. Alkaline additions to the backfill: A key mining/ reclamation component to acid mine drainage prevention. In: *Proceedings 16th Annual Surface Mine Drainage Task Force Symposium*, West Virginia University, Morgantown, WV.
- Younger, P.L., 1997. The longevity of mine water pollution – a basis for decision making. *Science of the Total Environment*, 194/195:457-466.
- Ziemkiewicz, P., Donovan, J., Frazier, J., Daly, M., Black, C., and E. Werner, 2000. Experimental injection of alkaline lime slurry for in-situ remediation of an acidic surface mine aquifer. In: *Proceedings 21st Annual Surface Mine Drainage Task Force Symposium*, West Virginia University, Morgantown, WV.
- Zurbuch, P.E. 1984. Neutralization of acidified streams in West Virginia. *Fisheries* 9:42- 47.
- Zurbuch, P.E. 1996. Early results from calcium carbonate neutralization of two West Virginia rivers acidified by mine drainage. In: *Proceedings, Seventeenth West Virginia Surface Mine Drainage Task Force Symposium*, April 2-3, 1996, Morgantown, WV.

## List of Tables

- Table 6-1: Forms of Co-Disposal (from Wickland et al., 2006)
- Table 6-2: Benefits and Considerations of Co-Disposal
- Table 6-3: Benefits and Limitations of Alkaline Amendments
- Table 6-4: Considerations and Limitations of Soil Covers
- Table 6-5: Benefits and Disadvantages of Synthetic Covers

Table 6-6: Some Considerations for Subaqueous Disposal

Table 6-7: Summary of Prevention and Mitigative Measures and Climate Considerations

## List of Figures

Figure 6-1: Options and Effectiveness with Time (TEAM NT, 2004)

Figure 6-2: Waste Rock Pile Structure and Processes (Wilson, 2008b)

Figure 6-3: Adaptive Management Approach to Prevention and Mitigation of ARD

Figure 6-4: Adaptive Management Implementation by Phased Approach

Figure 6-5: Methods for Prevention and Mitigation of ARD

Figure 6-6: Coefficient of Diffusion versus Degree of Saturation for Saturated Porous Media (from Aubertin, 2005)

Figure 6-7: Example Waste Rock Encapsulation Strategy

Figure 6-8: Flow Chart for the Dry Cover Design Process (adapted from O’Kane and Wels, 2003)

Figure 6-9: Covers and Climate Types (from Holdridge et al., 1971)

Figure 6-10: Conceptual Illustration of Processes Affecting Long-Term Performance of Soil Covers (from INAP, 2003)

Figure 6-11: Sample Soil Covers Designs (from MEND, 2001)

Figure 6-12: Sample Configurations of Synthetics in Soil Covers

Figure 6-13: Conceptual Schematic of the Components of a Field Performance Monitoring System (from MEND, 2004a)

Figure 6-14: Subaqueous Tailings Disposal

Figure 6-15: Water Cover Processes

Figure 6-16: State of Solids during Deposition and Consolidation (L); Photo (R)

Figure 6-17: Schematic Plan View, TSF with Three Depositional Zones

Figure 6-18: Prevention and Mitigation Evaluation of Alternatives

Figure 6-19: Comparative Costs for Capillary Barrier Cover (CCBE), Complete and Partial Desulphurization and Water Cover (Bussiere and Wilson, 2006)



# Case Studies Chapter 6

## From GARDGuide

1. Pamour Tailings – Encapsulation
2. Lupin Tailings – Elevated Water Table Covers for Reactive Tailings
3. Strathcona Tailings – De-Sulphurized Tailings Cover
4. Poirier Tailings – HDPE Synthetic Cover
5. Normetal Tailings – HDPE Membrane Cover
6. Denison Tailings – Reclamation by Flooding Post Closure
7. East Sullivan mine site – Organic Covers
8. Benambra Mine Site - Alkaline Covers

### 1. Pamour Tailings – Encapsulation

A historic gold tailings impoundment in the Timmins area, Ontario, Canada is sulphide bearing with moderate to high carbonate contents. Expansion of an open pit required relocation of a tailings stack (T1). During milling, the tailings were separated into a sulphide concentrate and a carbonate-rich flotation tailings and were placed in different locations within the T1 stack. The sulphide concentrate tailings were on surface and exposed to the atmosphere for decades and therefore had developed acidic pore water within the near-surface tailings. Relocation planning included investigations to mitigate existing acidic pore water as well as ongoing acid generation. The selected option included the relocation and deposition of the acidic sulphide concentrate tailings onto a nearby high-carbonate tailings stack (T2) followed by a cover composed of the remaining high-carbonate tailings from the relocated T1 stack. This encapsulation approach was investigated extensively to minimize the risk of acidic leachate. An investigation was also completed to evaluate the quality of pore water that would evolve when acidic waters migrated down through the high-carbonate tailings and the results were presented in MEND Report 2.46.1 (2010).

The tailings in both the T1 and T2 stacks were characterized in the field during the options investigation. Samples of the sulphide concentrate and carbonate-rich T1 tailings were collected from multiple depths and at several locations. The solids and soluble (pore water) products were analyzed in all samples. Acid base accounting (ABA) was complemented by total sulphur and sulphide-sulphur analyses as well as carbonate contents to illustrate AP/NP values for the carbonate-rich tailings and to quantify available NP in the stack below the sulphide concentrate layer.

The acidity in the existing pore water represented only a small portion of the AP. The AP/NP balance clearly showed that there was adequate NP to consume all acidity in low-pH pore water as well as all AP that could be generated in the sulphide concentrate layer if all of the remaining sulphide reacted to form sulphuric acid.

The investigation of mitigated water quality was completed in two phases. The initial phase included batch studies that added acidic tailings to neutral carbonate-rich tailings, after which pore water was extracted and analyzed. The second phase included column studies involving acidic tailings overlying neutral tailings, which were completed over a one-year period with field-like infiltration rates. Samples of pore water were collected within the neutral tailings and column drainage was collected at the base of the column and analyzed. The results showed that concentrations of most soluble constituents in the neutralized pore water were attenuated or mitigated to low values as waters migrated through the neutral tailings. Field monitoring was conducted to follow the performance of the encapsulated tailings.

### Reference

Mine Environment Neutral Drainage Program (MEND), 2010. Evaluation of the Water Quality Benefits from Encapsulation of Acid-Generating Tailings by Acid-Consuming Tailings – December.

## **2. Lupin Tailings – Elevated Water Table Covers for Reactive Tailings**

The Lupin former gold mine in Nunavut, about 400 km NE of Yellowknife, NT, Canada operated from 1982 and closed in the mid-2000s. The tailings were potentially acid generating. Tailings were deposited over a 600-ha area in multiple shallow cells that were originally small lakes and were contained by multiple small dams. The closure concept for the tailings included construction of “dry covers” between 0.6 to 1.6 m thick with the added design feature that the final water table in each tailings cell would occur within the cover layer as described in MEND (2004). With the water table above the tailings surface, the raised water table provides an “effective” water cover to prevent sulphide oxidation. The cover design therefore was a hybrid system that represented a dry cover with no standing water within the tailings cells while maintaining submerged conditions for the sulphide tailings. Although this concept was implemented at a mine site in permafrost terrain, permafrost was not a necessary aspect of the design and adaptation is possible at other sites with an appropriate water balance and topography.

Deposition of tailings in cells provided an opportunity for progressive reclamation that started in 1995. The cover material consisted of esker sands. There was no need for low-permeability materials to prevent infiltration of water or ingress of oxygen. The elevated water table above the tailings represented the design feature that prevented oxidation and generation of ARD. The cover system, however, included a second feature to complement and maintain the raised water table. The surface layer was composed of coarse granular material that reduces evaporation and promotes infiltration to maintain an elevated water table.

While it is commonly accepted that a water cover in a pond, for example, should have a thickness of 1 to 3 m in order to avoid physical resuspension of tailings, the depth below the water table can be minimal because any water cover thickness is effective at limiting oxygen access and there is no potential for mixing within a porous medium. Therefore, the design criteria for a raised water table above the tailings surface can include a minimum depth below the water table and the thickness of the cover is constrained only by the preference to avoid free water over the cover layer surface.

### **Reference**

Mine Environment Neutral Drainage Program (MEND), 2004. Covers for Reactive Tailings Located in Permafrost Regions Review. Report 1.61.4, Natural Resources Canada

## **3. Strathcona Tailings – De-Sulphurized Tailings Cover**

The Strathcona tailings facility, near Sudbury, Ontario, Canada has an active area of 100 ha and has been operating since 1968. For the first two decades, the nickel tailings with a sulphur content of 15% S, mainly as pyrrhotite, were discharged as an unsegregated slurry in cells within an impoundment. When tailings were exposed to the atmosphere with no further addition of fresh tailings slurry, the surface material oxidized rapidly, producing acidity, soluble metals and a visible crust, or hard pan, of iron hydroxide. Tailings management alternatives were considered in the early 1990s and the preferred option was to use the scavenger tailings with a sulphur content of less than 1% to cover the high-sulphur tailings. Lime kiln dust or reject material from lime production was also added to the low-sulphur tailings to increase the carbonate NP as well as the NP/AP ratio. The high-sulphur tailings fraction with 30% S was deposited underwater in the Oxidation Pond that is also an integral part of the water treatment system for the mining complex in the Onaping area. The low-sulphur cover placement was initiated in 1995.

The low-sulphur tailings cover is produced as the cyclone overflow from the scavenger flotation units that generate a sandy material for mine backfill. The overflow contains the fine-grained fraction referred to as slimes and therefore has the value-added property of moisture retention capacity. The high-moisture retention acts to reduce oxygen ingress due to low values for the gas diffusion coefficient.

The low-sulphur tailings slimes cover was evaluated through modelling to determine the appropriate thickness required to protect the underlying high-sulphur tailings from oxidation. A minimum cover thickness of 1.5 m was selected as being

adequate as an oxygen barrier based on the degree of moisture retention or saturation anticipated in the lower zone of the cover layer. The desulphurized tailings cover was almost completed by the summer of 2011.

Interim assessment of the cover layer has shown that the sulphur content is consistently less than 1% S and that the NP/AP ratios ranged between 1.4 and 12. The lime demand for water treatment in the adjacent oxidation pond has decreased substantially since the cover construction was initiated. The lime demand in the pond, however, represents other possible sources of acidity and therefore does not directly reflect the performance of the desulphurized tailings cover.

#### **4. Poirier Tailings – HDPE Synthetic Cover**

The Poirier Mine was an underground copper-zinc operation that opened in 1965 and closed in 1975, producing about 5 million tonnes of tailings containing between 6 and 20%S. A reclamation options assessment was initiated in 1996 for the surface oxidized and acid generating tailings. The preferred option that was accepted by the regulators was the construction of a HDPE membrane over the 46-ha tailings impoundment with a protective earth materials cover over the membrane. The objective of the cover was to reduce long-term loadings of acidity and metals from the tailings to the adjacent environment by limiting infiltration into the tailings that contained substantial loads of soluble oxidation products as a result of more than 20 years of exposure since the mine closed.

A follow-up study with four years of performance data showed that the loadings of acidity and metals from the tailings impoundment were reduced to small percentages of pre-reclamation values (Maurice and Wiber, 2004). The water table in the tailings had declined to elevations near the base of the tailings as a result of limited infiltration to recharge the subsurface water. The outflow from the tailings had also declined in response to the decrease in the water table.

#### **Reference**

Mauric, A. and Lottermoser, B.G. Phosphate amendment of metalliferous waste rocks, Century Pb-Zn mine, Australia: Laboratory and field trials. *Applied Geochemistry*, 26 (2011), 45-46. P. 45-56.

#### **5. Normetal Tailings – HDPE Membrane Cover**

The underground Normetal Mine operated from 1937 to 1975, producing more than 10 million tonnes of sulphide-bearing tailings that were deposited over a 60-ha area. An HDPE membrane was placed over 56 ha of the tailings in 2005-06. The objective of the membrane cover system was to reduce oxygen and water infiltration into the tailings, thereby reducing acidity and metal loadings to the environment.

The cover system included 0.3 m of clay till on membrane slopes and 0.5 m of clay on flatter membrane surfaces. Rip-rap was also placed on slopes as added protection and for stabilization. Toe drains were installed at the base of tailings slopes below the membrane to collect and divert tailings seepage to desired locations. Surface drainage networks were constructed to collect and divert non-contact waters. The exposed clay cover layer was re-vegetated. Construction was completed in September 2006.

In the first two years after construction, the water table decreased an average of about 6 cm per month resulting in a reduction of tailings seepage flow from 150 to 103 L/min. The downstream conditions improved over that time, showing increases in pH and decreases in concentrations of acidity and metals. The pH increased from 3.0 before reclamation to 6.8 in 2009. Concentrations of iron decreased from a high of 300 mg/L to values near 10 mg/L and zinc declined from a high near 7 mg/L to values near 0.2 mg/L over the same period. The overall cover performance was considered to be successful to 2009 with plans to complete detailed monitoring to 2011. One technical issue noted was partial blockage of seepage drain pipes by iron precipitates and organic “slime” thought to have resulted from iron-oxidizing bacteria. Mitigation of the precipitate formation was being considered.



## 6. Denison Tailings – Reclamation by Flooding Post Closure

The Elliot Lake Uranium Mining District in Ontario was one of several early sources of uranium in Canada. Many of the Elliot Lake mines ceased operation in the early 1960s. Some mines, however, operated until the early 1990s producing almost 200 million tonnes of tailings before closure. The Denison Mine operated from 1957 to 1992, producing about 60 million tonnes of tailings that were stored in two tailings management areas (TMA).

### Description of Denison Mine TMA

Elliot Lake is 30 km north of Lake Huron and 130 km west of Sudbury on the Canadian Shield, a region of exposed Precambrian rock that mantles a large area across Canada. The Denison property is located about 11 km north of Elliot Lake and is within the Serpent River watershed that drains to Lake Huron (Figure 1). The underground mine began operation in 1957 and continued production until 1992. The mill was located on site and the original production rate of 5,000 tonnes per day was increased to 6,350 tonnes per day in 1977 and 13,600 tonnes per day in 1982. More than 60 million tonnes of ore were processed over the life of mine and the tailings were stored in two tailings management areas (TMAs), TMA1 and TMA2 (Figure 2). The combined area of the TMAs is 280 ha.

Figure 1: Location of the Denison Mine

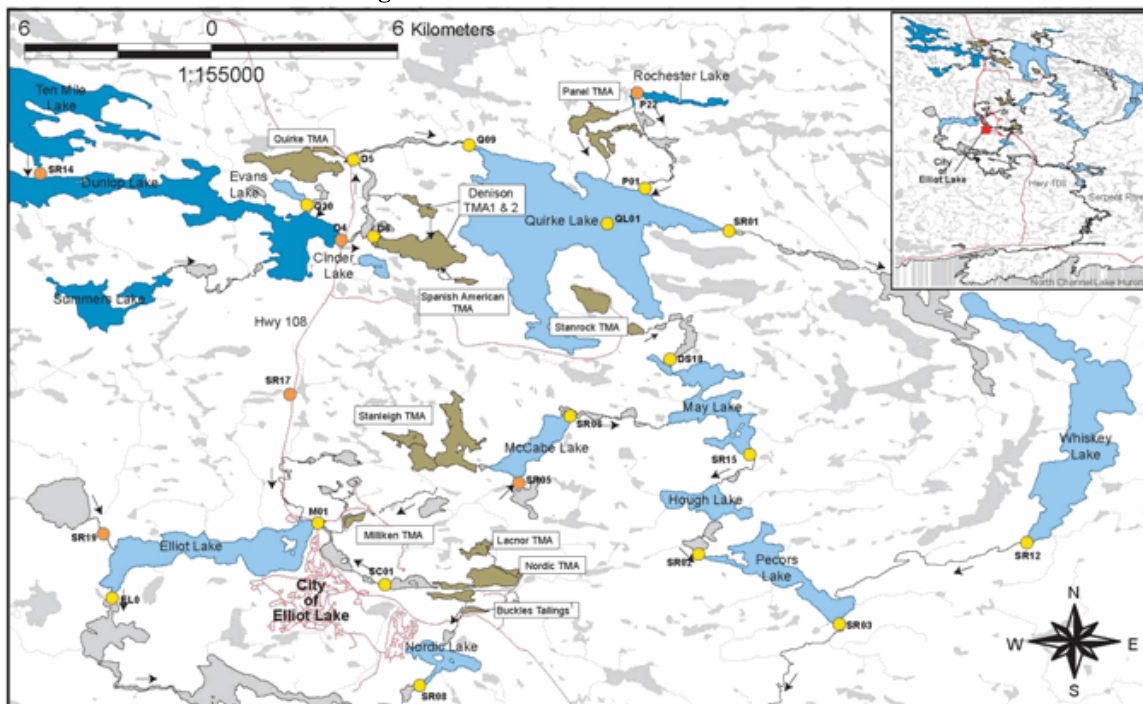

The TMAs were originally lakes that had dams constructed at lower sections of the perimeters in order to increase capacity. Tailings deposition was typical with low density slurry delivery to the impoundments. Spigotting resulted in the development of long beach areas near the spigot and ponds where fines settled near the dams.

**Figure 2: Configuration of the Denison Tailings Management Area**



The Denison tailings were typical of those from the Elliot Lake ore body. The ore was a Precambrian conglomerate similar to the gold deposits in South Africa. The uranium grade was on the order of 0.2% U. Pyrite was an accessory mineral with typical sulphide contents in the range of 5 to 10 % S. The ore was milled with a sulphuric acid leach process that removed any potential carbonate or other neutralizing minerals. The only neutralization potential (NP) in the tailings originated from residual traces of carbonate minerals in the lime that was used to neutralize the tailings prior to deposition in the TMAs. Studies of other tailings deposits in the region suggested that the NP of Elliot Lake tailings was less than 0.1% CaCO<sub>3</sub> or 1 kg CaCO<sub>3</sub>/t (Dubrovsky et al., 1985).

Acidic water in the Denison tailings was recognized in the 1980s and water treatment plants were constructed to manage the effluents from each of the TMAs separately. The treatment systems were designed for pH control as well as for the removal of radium-226, a daughter isotope of uranium that has a prescribed effluent release limit of 0.37 Bq/L (10pCi/L).

### The Decommissioning Concept

The proposed decommissioning plan for the TMAs was based on the concept of mitigation to lessen the need for active management in the long term, in accordance with the principles developed by the federal nuclear regulatory agency. While the decommissioning plan considered all mine facilities and infrastructure, the tailings represented the main focus for water quality effects, and therefore, is the focus of this discussion.

Pyrite oxidation and ongoing acid generation in exposed on-land tailings was identified as the key concern with the need to develop chemical stability for the protection of water quality in the long term. Therefore, flooding and permanent underwater storage of the existing tailings was selected as the preferred closure option at Denison, as well as several other TMAs at Elliot Lake. Although dams were in place to contain tailings in TMA1 and 2, they were generally not suited to raise water levels sufficiently to flood the beached tailings. Flooding was achieved through a combination of modest dam

raises and upgrades to hold water at appropriate elevations, as well as the relocation of some beached tailings to lower elevations. Some beached tailings in TMA2 were relocated to TMA1 and some were sent underground. Some drainage redirection in the watershed was also required to have a positive water balance and to maintain a water cover on TMA1.

A cornerstone of the decommissioning plan for Denison, and for other TMAs at Elliot Lake, was the follow-up monitoring plan that consisted of three tiers of surveillance. These included a range of physical scales from the footprint of the tailings facility to the greater watershed that receives water from most of the TMAs.

### Water Quality Before And After

Acidic conditions had developed in the beached tailings in TMA1 and TMA2. The acid conditions were observed in the effluent from the Denison tailings. More detailed investigations at other Elliot Lake TMAs showed that the shallow tailings pore waters were commonly characterized by pH values less than 3 with elevated sulphate and acidity, iron and other metals (Dubrovsky et al., 1985). In fine-grained tailings, the acidic zones were generally limited to the top few metres of tailings while in coarser and well-drained tailings acid zones had developed to depths of 10m. At Denison, about 1.7Mm<sup>3</sup> of the most acidic tailings in TMA2 were relocated during decommissioning with about 50% sent to underground workings and 50% to TMA1. During relocation, lime was added to the acidic tailings to raise the pH.

The acidity loads generated in the TMAs can be estimated from the quantities of lime and/or sodium hydroxide used in the treatment plants that receive runoff and seepage from the tailings. Prior to flooding TMA1, typical lime consumption was on the order of 4,000 tonnes of CaO per year (Figure 3a). Lime consumption declined dramatically during the decommissioning process by three orders of magnitude (99.9%). Similarly in TMA2, sodium hydroxide consumption prior to decommissioning was on the order to 1.5 t/a, which declined to zero post decommissioning (Figure 3b).

**Figure 3: Lime and Sodium Hydroxide Consumption at TMA1 and TMA2 at the Denison Mine**

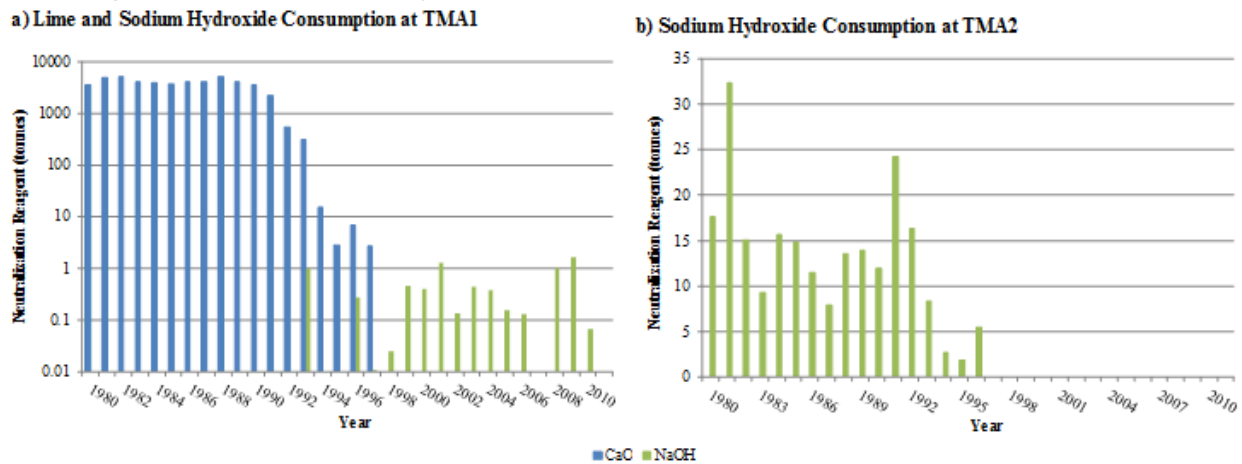

Water quality of the influent to the water treatment plant reflects the effects of flooding to some extent as shown for sulphate, acidity and iron concentrations in Figure 4. All parameters that were elevated prior to flooding exhibit decreases after flooding. The differences do not appear as dramatic as those for lime use, primarily because the chemistry of the tailings basin water was altered by in-situ lime addition prior to reporting to the treatment plant. Part of the overall trend in pyrite oxidation at TMA1 is exhibited by the concentrations of sulphate in the treated water, as shown in Figure 5, that were typically in the 1,500 to 2,000 mg/L range prior to decommissioning and declined to the 20 to 100 mg/L range after flooding. The lower concentrations of sulphate are expected to persist for an extended period because of the presence of gypsum ( $\text{CaSO}_4 \cdot 2\text{H}_2\text{O}$ ) in the tailings that dissolves and releases sulphate to pore water. Subsequently, sulphate in the pore water is released to the overlying water as a result of diffusion at the water-tailings interface. In the tailings at the Denison site, gypsum originated from two sources: it formed when the sulphuric acid ( $\text{H}_2\text{SO}_4$ ) in the leach solution was neutralized with lime ( $\text{CaO}$ ) and in the oxidized tailings when sulphuric acid was produced by pyrite oxidation and reacted

with available calcium.

The effects of decommissioning are also observed in the Serpent River, immediately downstream of the Denison effluent discharge as shown in Figure 6. While the pH values have become more consistently in the range of 6.5 to 7.5, the sulphate, acidity and iron concentrations have all declined to low levels. For example, prior to 1994, sulphate concentrations as high as 1,000 mg/L were commonly measured in the river while the average value from 2010 to 2011 is less than 20 mg/L.

Quirke Lake is the largest water body immediately downstream of the Denison TMAs in the Serpent River chain of lakes with a volume of 803.0Mm<sup>3</sup> and an annual average outflow of 183Mm<sup>3</sup>/a. Quirke Lake also receives treated effluent from the other TMAs that were also decommissioned and flooded at about the same time as the Denison TMAs. In the 1960s, Quirke Lake had pH values near 4 as a result of early milling practices that did not include complete neutralization of mill process water prior to tailings discharge. Neutralization of tailings was implemented in the 1970s and the pH in Quirke Lake increased. The water quality at the outlet of Quirke Lake from the late 1980s to 2011 is summarized in Figure 7. The pH was typically in the range of 5 to 6 in the early 1990s and has since increased to values consistently near 7. The concentrations of sulphate have declined from about 200 mg/L in 1991 to less than 50 mg/L in 2011. Similarly, concentrations of acidity and iron have declined since decommissioning of the Denison and other upstream TMAs.

Figure 4: Water Quality in the Influent to the TMA1 Treatment Plant

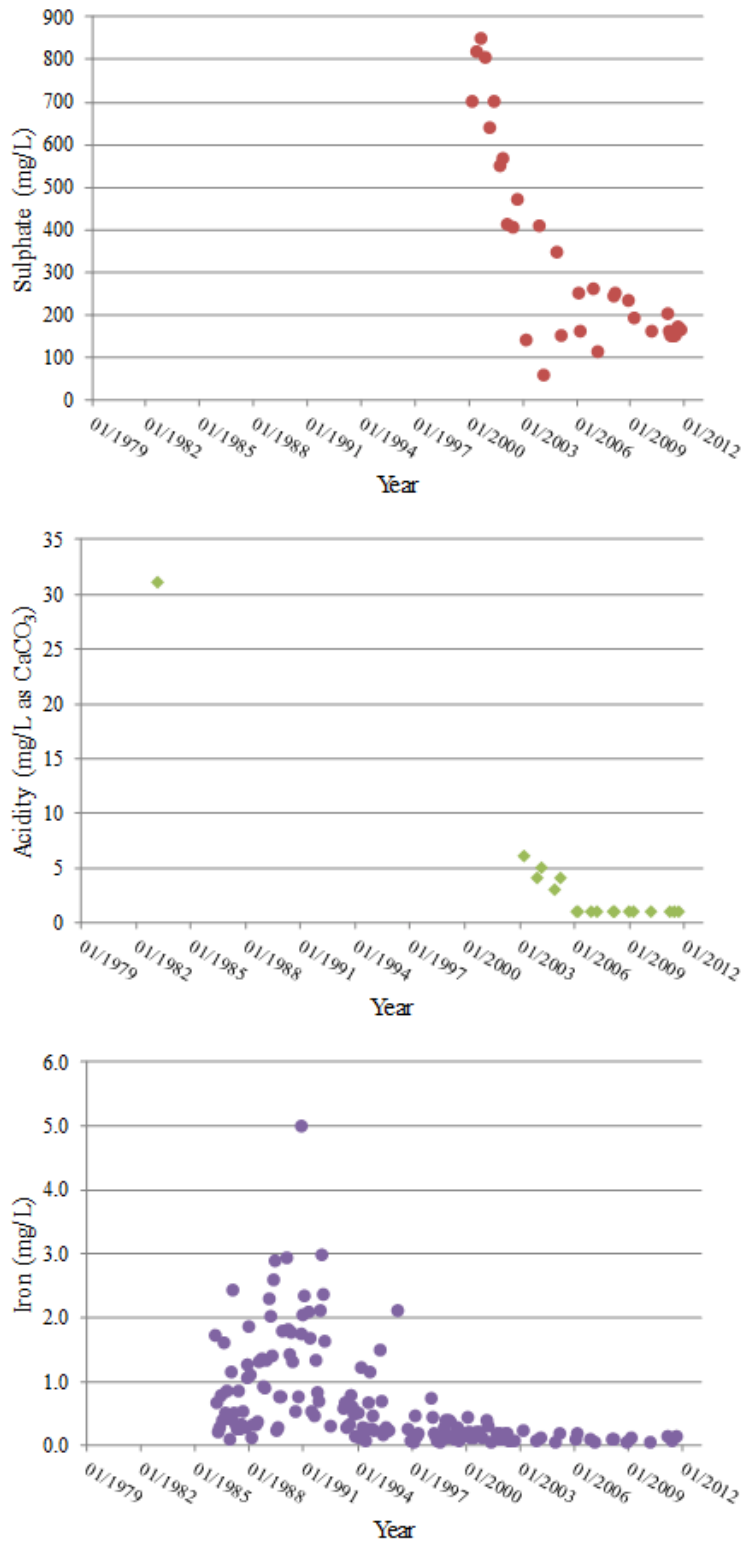

Figure 5: Sulphate Concentrations in Effluent from the TMA1 Treatment Plant

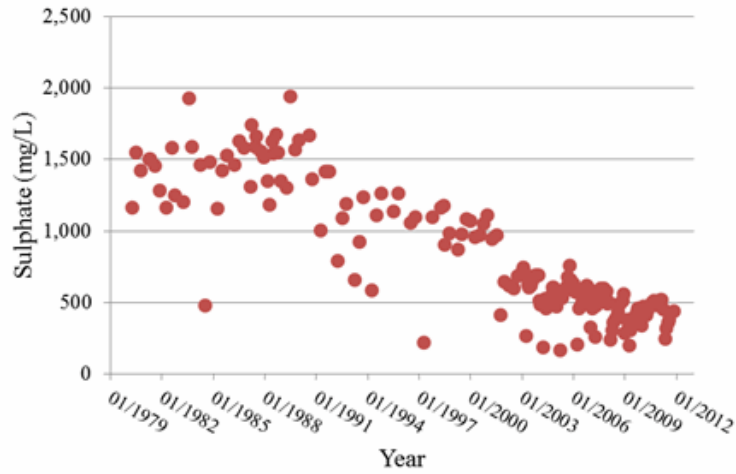
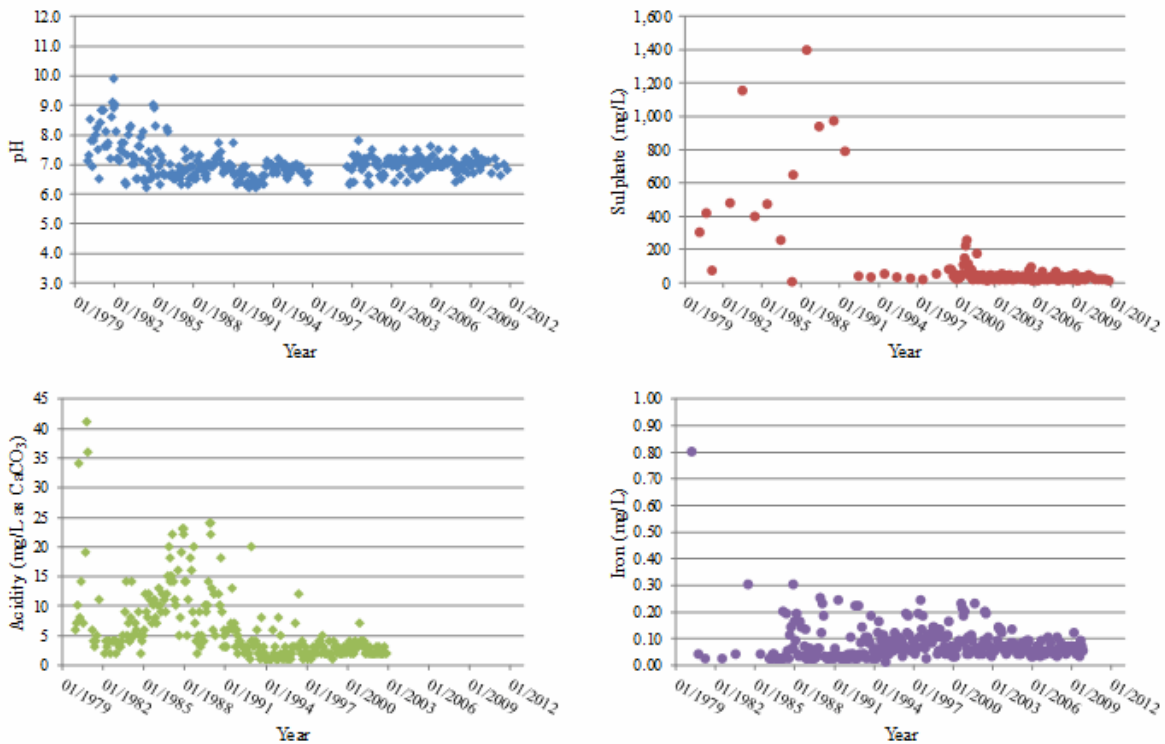
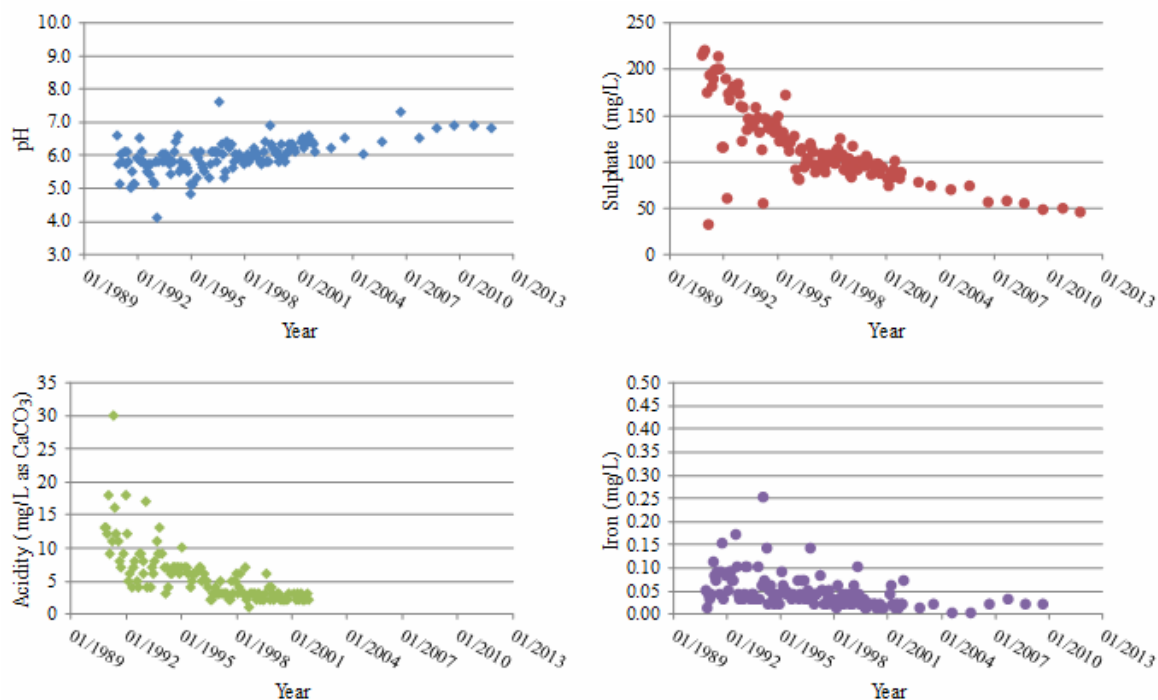

Figure 6: Water Quality in the Serpent River Downstream from the Denison Effluent Discharge



**Figure 7: Water Quality in Quirke Lake Outflow**



## Conclusion

The uranium mines in Elliot Lake were developed and operated over decades at a time when environmental effects from sulphide oxidation and acid generation on water quality were not clearly understood. Planning for decommissioning and mitigation of acid generation was therefore only considered in the late stages of operation, prior to mine closure. During closure planning, sulphide oxidation and tailings acidification were recognized as the most important influences on future water quality and ecological health of the watershed. The implementation of effective mitigation strategies for potentially acid generating tailings produced excellent results for water quality improvement at the individual TMAs and in the watershed, overall. The case study of the Denison TMA and results for other flooded TMAs in the Serpent River Watershed represent excellent examples of the reversibility of environmental effects from mining operations that were not initially designed to mitigate acid generation. The commitment by Denison Mines Inc. and other former uranium mine operators at Elliot Lake has clearly demonstrated that historic mines need not represent a negative environmental legacy for future generations.

## References

- Blair, R.D (1981). Hydrogeochemistry of an Inactive Pyritic Uranium Tailings Basin, Nordic Mine, Elliot Lake, Ontario M.Sc. Thesis, Department of Earth Sciences, University of Waterloo, Waterloo, ON, Canada.
- Dubrovsky, N.M., J.A. Cherry, and E. J Reardon (1984). Geochemical Evolution of Inactive Pyritic Tailings in the Elliot Lake Uranium District. Department of Earth Sciences, University of Waterloo, Waterloo, ON Canada.
- Ludgate, L., Morrell, R., Knapp, R.A. and Kam, S.N. (1997). Decommissioning of Denison Mines Tailings Management Areas. Proceedings of the Fourth International Conference on Acid Rock Drainage, Volume II, pp. 917-933, May 13-June 6, 1997, Vancouver, British Columbia.
- Moffatt, D. and M. Tellier (1978). Radiological Investigations of an Abandoned Uranium Tailings Area. J. Envir. Qual., 7(3).

## **7. East Sullivan mine site – Organic Covers**

A mixture of organic materials (sawdust and sewage sludge) was emplaced into a mine spoil backfill to stimulate microbial growth and generate an anoxic environment through sulphate reduction (Rose et al., 1996). The results of the organic matter injection process caused no change in water pH, about a 20% decrease in acidity and a similar decrease in Fe, Mn, and Al. The results indicate that the process works, but improvements in organic material injection and the establishment of a reliable saturated zone in the backfill are needed for maximum development.

The nature of the organic material used to prevent the oxidation of sulfidic mine tailings is varied. Forestry wastes have been laid down since 1984 at the East Sullivan mine site in north-western Québec (Germain et al., 2003).

The wood waste cover on the East Sullivan mine tailings serves several functions. The cover is considered to act as a prevention method for potential ARD production. The organic matter consumes oxygen and therefore acts as an oxygen barrier. The wood waste also promotes higher infiltration rates and therefore maintains a higher water table in the tailings than would occur without the cover. The higher water table is considered to be protective of the reactive tailings if oxygen does migrate through the cover. In addition, the cover has had a role in water treatment. Water collected in perimeter ponds is pumped onto the wood waste cover with the intent of removing soluble sulphide oxidation products, such as iron and other metals, and to neutralize the water with alkalinity produced by decomposition of the organic matter (Germain, et al., 2010).

A field-scale experiment was conducted at the Greens Creek Mine on Admiralty Island, Juneau, Alaska, USA to evaluate various organic carbon sources (peat, spent-brewing grain, municipal biosolids) as amendments for passive treatment of tailings in pore water (Lindsay et al., 2011). The field experiment proved that the technique can effectively limit the transport of sulphide mineral oxidation products in mine tailings impoundments. The experiment reported that the amendments containing a large proportion of labile organic carbon compounds should be used sparingly, as rapid development of reducing conditions can lead to enhanced mobilization of iron and associated trace elements.

### **References**

Germain, D. Normand Tassé, and Johanne Cyr 2003. Treatment of Acid Mine Effluents Using a Wood-Waste Cover. Proceedings of the 6th International Conference on Acid Rock Drainage (ICARD), Cairns, Australia, 12-18 July 2003, Australian Institute of Mining and Metallurgy, Melbourne.

Germain, D., Normand Tassé, and Johanne Cyr 2010. The East Sullivan Mine Site: Merging Prevention and Treatment of Acid Mine Drainage. Presentation in Proceedings of the 16th Annual BC-MEND ML/ARD workshop, Vancouver, BC., December 2-3, 2009, W.A. Price and K. Bellefontaine (Eds.).

Lindsay, M.B.J., Blowes, D.W., Condon, P.D., Ptacek, C.J. Organic carbon amendments for passive in situ treatment of mine drainage: Field experiments. Applied Geochemistry, 26 (2011), p. 1169-1183.

Rose, A.W., J. Stalker, and L. Michaud. 1996. Remediation of acid mine drainage within strip mine spoil by sulfate reduction using waste organic matter. p. 321-335. In: Proceedings, Thirteenth American Society for Surface Mining and Reclamation Conference, May 18-23, 1996, Knoxville, TN.

## **8. Benambra Mine Site - Alkaline Covers**

### **Rehabilitation and Post-Closure Monitoring and Performance at the Benambra Base Metal Mine Site in Australia**

A Closure and Rehabilitation case study prepared by Earth Systems Pty. Ltd.



## Site History

The Benambra Mine Site in south-eastern Australia was operated as an underground base metal mine from 1992 to 1996. During operations, 927,000 tonnes of ore was processed on site to produce copper and zinc concentrate, and nearly 700,000 tonnes of sulfidic tailings from the process plant was delivered by pipeline to a nearby tailings dam. The tailings are dominated by pyrite (65 wt.%), with lesser amounts of quartz (13 wt.%) sphalerite (1-8 wt.%), dolomite (4-5 wt.%) and chalcopyrite (1-2 wt.%).

The mining company was liquidated in 1996 and the site is now managed by the state government of Victoria, Australia. A detailed rehabilitation strategy was developed for the tailings dam, process plant site, geological core storage facility and road network. The rehabilitation strategy aimed to restore the environment to as near pre-mining conditions as possible, in accordance with industry best practice and stakeholder, community and legislative requirements. The key environmental risk was the potential for ARD generation from the tailings dam (Earth Systems, 2003) which is therefore the focus of this case study.

## Description

The tailings dam was engineered as a competent water-retaining structure. Prior to rehabilitation, the dam contained about 160 ML of supernatant water, with near-neutral pH and elevated concentrations of dissolved metals (zinc, arsenic, copper, lead, and manganese) and sulfate. Due to the irregular bathymetry of the tailings surface, the supernatant water depth varied from 0 to 8 m. Prior to rehabilitation, the supernatant water was treated with hydrated lime (calcium hydroxide;  $\text{Ca}(\text{OH})_2$ ) on several occasions as required to achieve suitable water quality for off site discharge. The residual metal hydroxide precipitates arising from these treatment activities remained in the tailings dam but progressively began to dissolve, with acidic catchment inputs releasing metals back into the water column, over subsequent months after treatment. Seepage from the dam wall, flowing at around 1 L/s, was also affected by ARD. This water was characterised by slightly acidic pH, elevated zinc, manganese, copper, lead and arsenic, and high sulfate concentrations. The source of this ARD was attributed to the presence of sulfidic rocks in the dam wall rather than the tailings. This is based on the water chemistry and low flow rates observed, and effectively saturated condition of the tailings.

## Rehabilitation

The primary objective of site rehabilitation was to manage ARD in the tailings dam by creating a permanent water cover over the tailings, with a minimum 2 m depth, and utilising passive treatment systems for long-term water quality control, as follows:

- Diversion channels around the tailings dam were removed and original creek alignments were reinstated in the upstream catchment, to direct water back into the tailings dam to maintain the permanent water cover.
- A spillway was constructed to allow controlled overflow and ensure long term stability of the dam wall. Long term climate and water balance modelling was conducted to determine the required spillway elevation to maintain the

**Plate 1. Aerial view of the Benambra tailings dam at completion of rehabilitation works.**

permanent water cover of at least 2 m.

- The tailings were redistributed to remove irregularities in the bathymetry and ensure a consistent water cover across the tailings surface.
- The levelled tailings were then covered with a layer of limestone sand to minimise wave-based re-suspension of tailings in the water column and therefore minimise the potential for oxidation of sulfidic material near the water surface.
- Organic matter layers (jute matting and sawdust) were installed above the limestone sand to promote sulfate reducing bacterial activity, in order to convert existing metal hydroxide precipitates into relatively stable metal sulfide complexes and lower sulfate concentrations in the supernatant water. Furthermore, the organic matter was intended to further minimise the potential for sulfide oxidation by inhibiting the migration of dissolved oxygen from the water column into the tailings.
- The tailings dam perimeter was revegetated to permit a constant supply of organic inputs to the tailings dam via leaf litter. This was aimed to promote ongoing sulfate reducing bacterial activity, to convert any residual metal hydroxides to sulfides and further reduce sulfate concentrations, in the long term.
- Passive alkalinity addition systems were installed in the upstream catchment to raise the naturally acidic pH of creek water to near-neutral levels prior to entering the tailings dam, to minimise acidity addition to the tailings dam water.
- The dam wall was strengthened by creating a 4:1 (H:V) downstream batter slope to maintain geotechnical stability in the event of a “maximum credible earthquake”.
- An anaerobic vertical upflow wetland was installed to passively treat seepage from the base of the dam wall. The wetland has a design life of 20-30 years, after which maintenance will be required if ARD-affected seepage continues to emanate from the dam wall.



### **Monitoring**

The water monitoring program during rehabilitation involved the collection of in-situ water quality data and samples for laboratory analysis. At the completion of rehabilitation, a remote monitoring system was installed at the tailings dam to continuously monitor rainfall, surface water level and key water quality indicators (pH, temperature and electrical conductivity), in order to monitor the effectiveness of rehabilitation and provide early warning of potential water quality issues. Results from the monitoring system were compared with field results collected manually during the first 12 months post rehabilitation, to confirm the reliability of the system. Sensor calibrations are checked quarterly (rainfall gauge six monthly) or as required. Seepage water quality and flow rate has also been monitored (manually) on a regular basis to verify the performance of the constructed wetland system.

### **Results**

Key findings from the surface water monitoring before and after rehabilitation were:

- A minimum water cover of .

**Plate 2. View of the vertical upflow anaerobic wetland that was constructed for passive treatment**



2 m over the tailings material has been maintained.

- The pH was elevated at around 8.5-9.0 due to water treatment during rehabilitation, but has subsequently stabilised at near-neutral to slightly alkaline values.
- Dissolved metal concentrations have decreased by around 85-95% following rehabilitation. For example, copper concentrations decreased from 2.4 mg/L to 0.03 mg/L, lead decreased from 1.95 mg/L to 0.001 mg/L, manganese decreased from 1.3 to around 0.1-0.2 mg/L, zinc decreased from above 1 mg/L to around 0.1-0.2 mg/L, and arsenic decreased from 0.068 mg/L to 0.001 mg/L.
- Similarly, there has been an 80-90% reduction in sulfate concentrations, from 1600 mg/L to less than 200 mg/L following rehabilitation. Trends in salinity have been similar to those observed for sulfate.
- Detailed review of the sulfate data, taking into account the effects of dilution and evaporation in the dam, indicates no evidence of sulfate addition associated with ARD generation.

**Key findings from the seepage water monitoring before and after rehabilitation were:**

- There has been no apparent increase in seepage flow rates from the dam wall.
- The pH has increased from slightly acidic (5.6-6.0) values to near-neutral values (6.3-7.1) and salinity has progressively decreased following wetland installation.
- A comparison of dissolved metal concentrations before and after wetland installation indicates a decrease of around 85-95% for copper, lead, zinc and arsenic (generally below detection limits). These metals are effectively converting to stable metal sulfide precipitates in the wetland.
- Unlike copper, lead, zinc and arsenic, the precipitation of manganese requires oxidising conditions. This is effectively occurring in the receiving creek line, within 1 km of the wetland overflow, where dissolved manganese drops from around 10 mg/L to less than 0.5 mg/L.

**Conclusions**

- There has been substantial improvement in surface water quality in the tailings dam post rehabilitation.
- The permanent minimum water cover of 2 m over the tailings is providing an effective long-term solution to water quality control in the tailings dam.
- Passive alkalinity addition systems, including a limestone sand layer over the levelled tailings, have maintained near-neutral to slightly alkaline pH in the dam.
- Addition of organic matter to the dam has promoted sulfate reducing bacterial activity and generated at least a 75% reduction in its soluble sulfate load since the completion of rehabilitation activities. This sulfate reduction is improving water quality by promoting metal sulfide precipitation, and concomitantly contributing alkalinity to the surface water.
- Decreasing soluble copper concentrations have gradually permitted algal growth which has in turn

encouraged water birds to the dam. Faeces from water birds is introducing new organic matter and phosphorus to the system, which is further encouraging sulfate reducing bacterial activity and probably metal phosphate precipitation, ultimately improving water quality.

- Continued vegetation growth around the dam perimeter will promote a self-sustaining biological remediation system within the dam (via passive carbon addition) and ensure long-term passive water treatment through natural biological processes.
- The anaerobic wetland and downstream oxidation processes are combining to effectively treat ARD seepage from the dam wall.

## **Reference**

Earth Systems (2003). Geochemical study of the Benambra Tailings Dam, Eastern Victoria. Prepared for Department of Primary Industries – Minerals and Petroleum Division. Earth Systems, Melbourne, Australia.



# Chapter 7

## From GARDGuide

### 7.0 Drainage Treatment

#### 7.1 Introduction

##### 7.1.1 Risk-based approach

#### 7.2 Objectives of Mine Drainage Treatment

#### 7.3 Mine Drainage Treatment

#### 7.4 Drainage Sources, Collection and Management

#### 7.5 Mine Drainage Treatment Technologies

##### 7.5.1 Active Treatment Technologies

Aeration systems for treating CMD

##### 7.5.2 Passive Treatment Technologies

History of Passive Treatment

##### 7.5.3 In situ Treatment Technologies

#### 7.6 Treatment Residues and Wastes

#### 7.7 Recovery of Useful Products

#### 7.8 Treatment in the Context of Mine Closure and Post Closure

#### 7.9 Evaluation and Selection of Drainage Treatment Technologies

#### 7.10 Case Studies

#### 7.11 References

#### List of Tables

#### List of Figures

### Case Studies for Chapter 7

## 7.0 Drainage Treatment

### 7.1 Introduction

The objectives and approach to treatment of the different mine water types depend on the category of mine water and the degree of treatment required.

The consideration of drainage treatment technologies covers the range of applications to the following:

- Different commodities, including coal, diamond, iron, gold, uranium, and precious and base metals
- Different phases of mining, including exploration, feasibility (assessment and design), construction, operation, decommissioning, and post closure

#### 7.1.1 Risk-based approach

A risk assessment should evaluate all aspects of the treatment process using a standard Failure Modes and Effects Analysis (FMEA) approach, which evaluates risk based on consequence and likelihood.

There are five main areas that should be assessed: influent, treatment system, effluent, byproduct management, and site conditions.

Risks to be assessed for the influent can include, for instance, influent flow rates (excessively high and/or variable), contaminant concentrations (exceed type and concentration predicted), and influent pH. The treatment risks to be evaluated can include mechanical

This chapter contains an overview of the following topics related to mine drainage treatment:

- Objectives of and approach to mine drainage treatment
  - Risk-based approach
- Drainage sources, collection and management
- Treatment technologies including:
  - Active treatment
  - Passive treatment
  - Active/passive hybrids
  - In situ treatment
- Treatment residues and waste
- Recovery of useful byproducts
- Drainage treatment during mine closure and post closure
- Selection of appropriate treatment technology

failure, power failure, plugging of substrate, piping or ditches, armouring of reactants, failure of reagent delivery system, failure of process control components, inadequate design volume of holding ponds, scaling of plant components, and shutdown due to labour disruption. Effluent management risks may include failure to meet compliance (total or dissolved metals, pH, etc.), effluent toxicity test failure, change in permit requirement, and inability to meet receiving environment water quality. Sludge management risks can include low sludge density, lack of appropriate on site disposal, off-site transportation and disposal issues, poor sludge stability (chemical mobilization, physical instability), sludge pond access risks (human/fauna), and dusting (airborne contamination). Risks of final site conditions must also be assessed, such as the risk of natural disasters to the treatment system (e.g., earthquake, excessive precipitation).

## 7.2 Objectives of Mine Drainage Treatment

The objectives of mine drainage treatment are varied and may include one or more of the following:

- Recovery and reuse of mine water within the mining operations for processing of ores and minerals, conveyance of materials, and operational use (e.g., dust suppression, mine cooling, and irrigation of rehabilitated land). Most mining operations include the management of water on the mine site and manage associated water infrastructure. The mine water balance requires management of different demands and sources for water volume and water quality. Mine drainage treatment, in this case, is aimed at modifying the water quality so that the treated effluent is fit for the intended use on the mine complex or site. Where multiple water sources are available it is typically less costly to keep the water sources separate to reduce the volume of water to be treated. This option is particularly true when off-site run-off water can be diverted away from the mine and waste facilities to reduce water volume needed to be treated.
- Protection of human health in situations where people may come in contact with the impacted mine water through indirect or direct use of mine water drainage.
- Environmental protection, specifically related to mining water impacts on surface water and groundwater resources. Mine drainage may act as the transport medium for a range of pollutants, which may impact on-site and off-site water resources. Water treatment would remove the pollutants contained in mine drainage to prevent or mitigate environmental impacts.
- Useful and potentially saleable products may be recovered from mine drainage. It is unlikely that by-products recovery would be a sole driver to the installation of a water treatment facility. However, when commodity prices are high, the recovery of saleable products will improve the financial viability of mine drainage treatment projects.
- Regulatory requirements may stipulate a mine water discharge quality or associated discharge pollutant loads. Any discharge of mine drainage to a public stream or aquifer must be approved by the relevant regulatory authorities. Discharge quality standards may not be set for many developing mining countries, but internationally acceptable environmental quality standards may still apply as stipulated by project financiers and company corporate policies.
- Mine water is a valuable resource and much of the world is facing water stress. The beneficial use of mine water to satisfy the needs of a variety of mining and non-mining water users can be a key driver supporting the installation of mine drainage treatment facilities. There is an increasing number of mine drainage treatment projects aimed at supplying treated mine water to neighbouring communities and industries around mines.
- Sustainability of mining will require the mitigation, management, and control of mining impacts on the environment. In many cases, the mining impacts on water resources are long term and persist in the post-closure situation. Mine drainage treatment may be a component of overall mine water management to support a mining operation over the mine's entire life and enhances post-closure and sustainable use of the mine property long after the ore deposit is depleted.

## 7.3 Mine Drainage Treatment

The approach to mine drainage treatment is based on an understanding of the integrated mine water system and circuits and the specific objective (or objectives) to be achieved. A generic mine water system diagram is shown in Figure 7-1 to demonstrate the point that treatment may be introduced at several different points or locations on a mining project and to illustrate different purposes and objectives.

Figure 7-1: Generic Mine Water System Indicating Potential Position for Drainage Treatment Facility

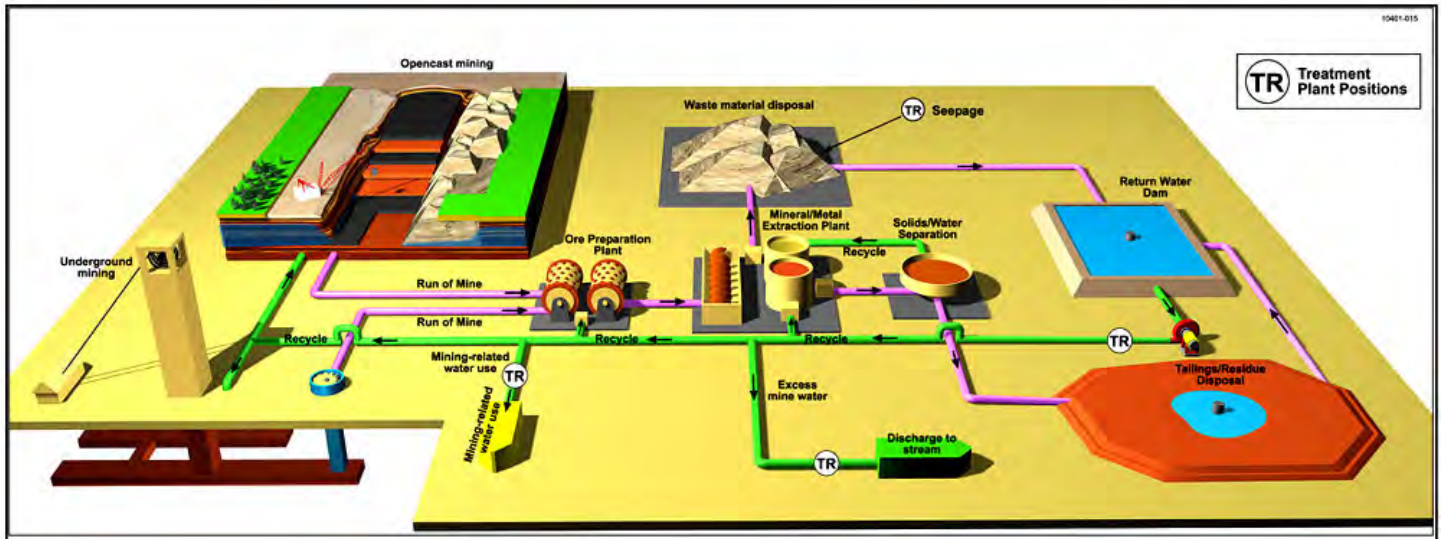

The generic location for a mine drainage treatment facility includes the following:

- A selected mine water stream originating from a process or facility discharging high concentrations and loads of pollutants
- A water stream dedicated to some mining-related water use, which may require a specific water quality
- A return water stream to render the recycled water fit for use in the mining or minerals processing operation
- A point or diffuse discharge stream to a natural watercourse or aquifer

Mine drainage treatment projects are executed within the overall hierarchy of mine water management, which generically includes the following steps:

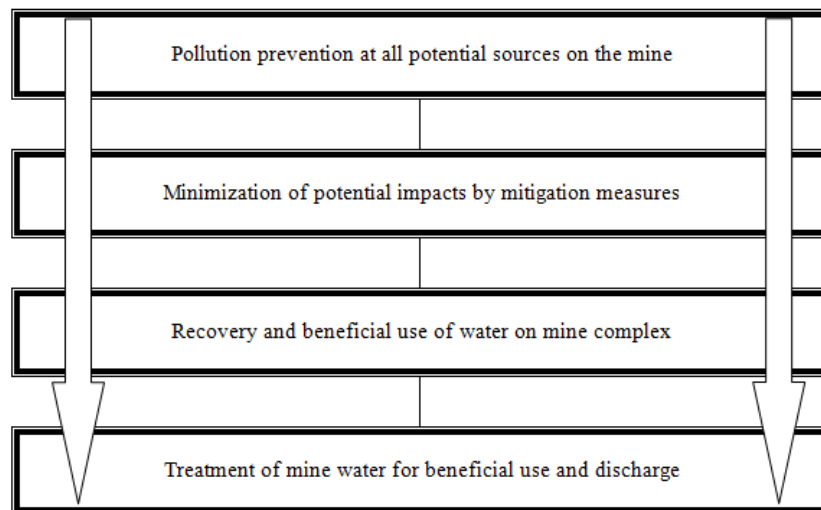

This approach adopted for mine drainage treatment will be influenced by a number of considerations related to the following:

- Before selecting the treatment process, a clear statement and understanding of the objectives of treatment should be prepared. Mine drainage treatment must always be evaluated and implemented within the context of the integrated mine water system. Treatment will affect the flow and quality profile in the water system; therefore, the sized treatment system is selected based on mine water flow, water quality, cost, and ultimately water uses.
- Characterization of the mine drainage in terms of flow and key properties of ARD, NMD, or SD should include careful consideration of temporal and seasonal changes. Flow data are especially important because this information is required to properly size any treatment system. Particular concern should be taken to account for extreme precipitation and snowmelt events to ensure that the collection ponds and related piping and ditches are adequately sized and maintained. The key properties of mine drainage relate to acidity and alkalinity, sulphate content, salinity, metal content, microbiological quality, and the presence of specific compounds associated with specific mining operations, such as cyanide, ammonia, nitrate, arsenic, selenium, molybdenum, and radionuclides. Coal mine drainage (CMD) typically contains iron, aluminum, and manganese in significant concentrations. Other metals are usually only present in trace concentrations, and as mentioned in Chapter 2, these are usually removed in the process of meeting the typical CMD standards for manganese. There are also a number of properties of the mine-drainage constituents (e.g., hardness, sulphate, and silica) that may not be of regulatory or environmental concern in all jurisdictions currently, but that could affect the selection of the preferred water treatment technology.



- Different stages of mining and how the mine water system and water balance will change over the life of a mine. A mine drainage treatment facility must have the flexibility to deal with increasing and decreasing water flows, changing water qualities, and regulatory requirements. This may dictate phased implementation and modular design and construction of a treatment facility. Additionally, the post-closure phase may place specific constraints on the continued operation and maintenance of a treatment facility.
- Commodity-specific water aspects related to compounds present in the mine drainage (e.g., presence of radionuclides in the case of uranium mining). Some mining or processing operations may introduce extraneous chemicals and reagents into the water circuits. Reagents from one minerals processing plant (e.g., copper recovery) may be detrimental to another minerals processing plant (e.g., phosphate recovery).
- Practical mine site features, which will influence the construction, operation, and maintenance of a mine drainage treatment facility, including the following:
  - Mine layout and topography
  - Space
  - Climate
  - Sources of mine drainage feeding the treatment facility
  - Location of treated water users
- Handling and disposal of treatment plant waste and residues, such as sludges and brines

## 7.4 Drainage Sources, Collection and Management

There are several main types of drainage that may require treatment before discharge from a site: acidic drainage, neutral drainage, and saline drainage. Each type of drainage, while distinct in its typical composition and chemistry, can typically be treated using similar, if not, identical treatment technologies. Chapter 2 provides more detail on the compositional characteristics of these mine waters. Certain mine waters, for instance from coal operations, may contain specific constituents that are challenging to treat, such as selenium. When certain constituents are absent, for instance iron in neutral drainage, chemical treatment of other parameters is often more difficult.

Drainage sources include waste rock dumps, tailings impoundments, haulage roadways, milling areas, contaminated surface, and underground mine workings. One of the most critical steps in any site treatment strategy is the water management plan. A critical component of treatment systems design is the flow rate. By decreasing annual flows requiring treatment, this will decrease operating and capital costs for the system. The key to an effective water management plan is to divert clean water and concentrate contaminated waters requiring treatment.

The objectives of a water management system are (Aubé and Zinck, 2009):

- To ensure diversion of all attainable uncontaminated waters using ditches and berms on upper water catchment areas
- To ensure capture of all contaminated waters
  - If contaminated waters come in contact with clean water, the clean water becomes dirty and volumes of water to be treated increase
  - Prevent release of contaminated water
- To minimise footprint and contact
  - Smaller waste storage and processing areas will minimise contact and result in more clean water
  - Covered waste piles prevent contamination

The water management system components and infrastructure pose engineering and operational challenges because of the variable flow rates and the corrosive or scaling nature of mine drainage. The considerations in the development of a mine drainage collection and conveyance system include the following:

- Properties of mine drainage, including corrosiveness, scale/precipitate forming potential, solids deposition, organic fouling, and plugging
- Dealing with variable mine drainage flows and qualities as dictated by climatic and seasonal changes and by the different stages of the life of the mine (The sizing of collection ponds and ditches is particularly critical where combined snow or precipitation events can combine to over top and cause failure of these facilities)
- The size of the collection ponds and ditches may be defined by the regulatory requirements (i.e., to meet a 24-hour 100-year precipitation event)
- Site and route selection based on consideration of topography, geotechnical conditions, and climate
- Selection of appropriate materials of construction
- Engineering features, including pretreatment before conveyance, pumping installation, and piping systems
- Operational aspects related to access, regular cleaning, monitoring, typical failures, and risks
- Maintenance aspects, particularly ease of cleaning

Mine drainage diversion, collection and conveyance systems are critical components of any treatment project. Appropriate basis of design must be developed and integrated into the overall treatment project. Surge ponds may be a valuable feature in the case of highly variable mine drainage flows and pollutant loads. This will afford some protection against surcharging the treatment system. It is typically not economical to build very large raw water retention ponds nor is it economical to build small ponds and very large treatment plants. Optimum sizing of both must be done together to determine best cost/efficiency ratio. Examples exist of failed projects because of the neglect of the design, operation and maintenance of the mine drainage collection infrastructure.

## 7.5 Mine Drainage Treatment Technologies

A wide spectrum of drainage treatment technologies has been developed, proven, and applied to many different applications. The generic range of mine drainage treatment technologies is reflected in Figure 7-2. The description of the different drainage treatment technologies in this section will be framed in the context of current best practice of proven technologies.

Mine drainage treatment technologies can be broadly classified into active treatment, passive treatment, and in situ treatment as described in Table 7-1. The selection of the appropriate category of mine drainage for a specific application is influenced by the aspects summarized in Table 7-1

Figure 7-2: Generic Range of Drainage Treatment Technologies

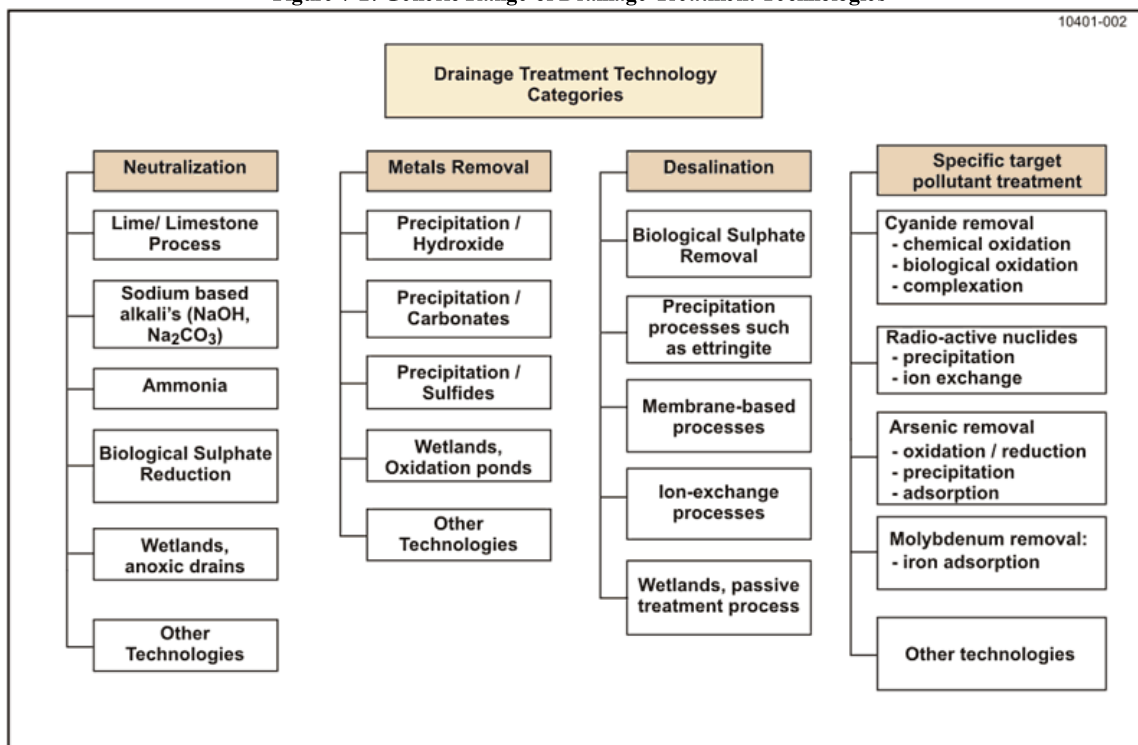

Table 7-1: Qualitative Comparison of Different Categories of Treatment

Feature / Characteristic	Active Treatment	Passive Treatment	In Situ Treatment
1. Application to phase of mining	Most appropriate to exploration and operational phases because it requires active control and management. Closure and post-closure applications mainly associated with large flows.	Most attractive to the closure and post-closure phases, because it requires only intermittent supervision, maintenance, and monitoring of self-sustaining processes.	Appropriate to the exploration and operational phases because it requires ongoing operation and maintenance.
2. Operational involvement	Active and ongoing plant operations and maintenance systems and personnel.	Constant operations not required, but regular maintenance essential.	Active and ongoing operational personnel required, but permanent presence on site not required.
3. Operational inputs and materials	Requires chemicals, operations staff, maintenance staff, electrical power, continuous and/or regular monitoring.	Self sustaining processes, periodic maintenance, intermittent monitoring. May require replacement or supplement of materials at low frequency.	Requires chemicals, operations staff, intermittent field maintenance, electrical power and low frequency monitoring.
4. Supply of power	Electrical and mechanical energy sources.	Natural energy sources of gravity flow, solar energy and bio-chemical energy.	Electrical and mechanical energy sources.
5. Management and supervision requirements.	Ongoing management engagement, constant facility supervision.	Low level management engagement and low frequency intermittent supervision.	High frequency supervision, but no permanent site presence required.

6. Range of application: <ul style="list-style-type: none"> <li>▪ Flow rates</li> <li>▪ Constituents of interest</li> </ul>	Application to all flow rates, especially high flow rates and any constituent of interest.	Mainly applied to low flow rates and acidity, metals, and sulphate removal.	Large spectrum of volume and flow applications, mainly to deal with acidity and metals removal.
7. Treated water quality	Treatment process can be purpose built to deal with spectrum of treated water requirements.	Treated water quality poorer and more variable than other options.	Treated water quality lower and more variable than active treatment process.
8. Waste sludge and brine production.	Waste sludge and brine are produced, depending on level of treatment, requiring disposal.	No brine production, but longer term liability to deal with accumulated pollutants in wetland sludge.	Sludge and waste production accumulated in situ, may pose long term environmental liability.
9. Capital investment cost	High capital investment and periodic capital replacement required.	Moderate capital investment with periodic reinvestment to replace depleted wetlands media.	Low capital investment typically to deal with a short term problem.
10. Operating and maintenance cost	High operating and maintenance cost, with some potential for cost recovery by sale of product water, metals and by-products.	Low operating cost.	Moderate operating costs, but chemical usage may be high due to process inefficiency.

The costs of each ARD treatment system based on neutralization (in terms of the reagent amount and cost, capital investment, and maintenance of the dispensing system) and sludge disposal should be evaluated to determine the most cost effective system. The U.S. Office of Surface Mining has developed a software package, AMDTreat, which can be used to decide among the various options. AMDTreat can be downloaded at: <http://amd.osmre.gov/>. Where possible, users should apply local reagent prices rather than the default values. Another tool available is the Excel based ABATES program (<http://www.earthsystems.com.au/resources/acid-drainage/>) developed by Earth Systems for acid-base accounting and reagent requirements and treatment costs.

An excellent tool that can be used to decide which treatment process should be selected is the Acid Drainage Decision Tree (Figure 7-3) developed by Jack Adams (pers.comm.) of the University of Utah. Depending upon a range of factors, including influent flow rate, pH, acidity, alkalinity, the presence of iron, sulphate and other contaminants, the appropriate treatment process can be selected.

Figure 7-3: Acid Drainage Decision Tree

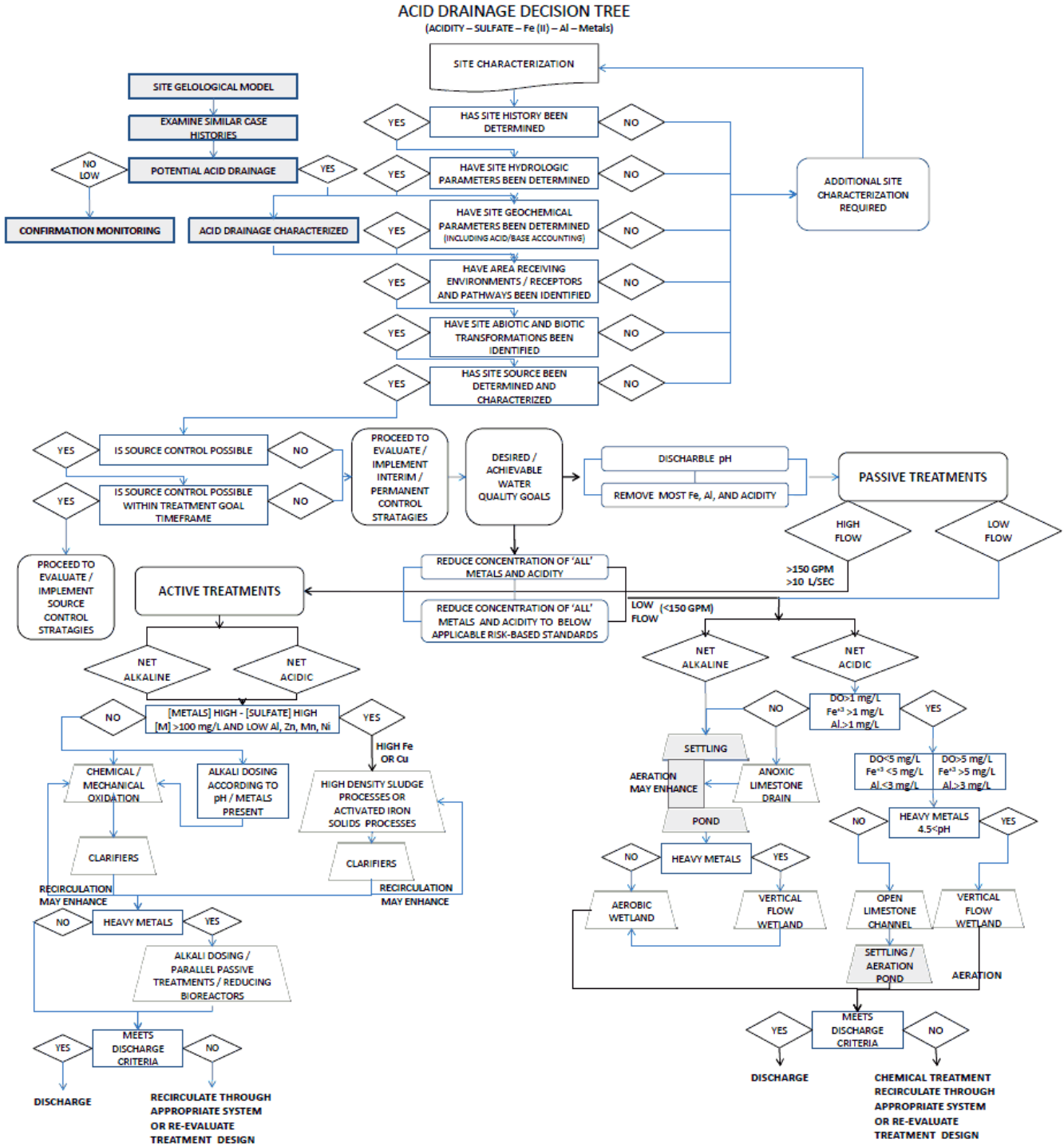

### 7.5.1 Active Treatment Technologies

Active treatment refers to technologies requiring ongoing human operations; maintenance, and monitoring based on external sources of energy (electrical power) using infrastructure and engineered systems.

Active treatment technologies include aeration, neutralization, which often includes metal precipitation, metals removal, chemical precipitation, membrane processes, ion exchange, and biological sulphate removal.

### 7.5.1.1 Aeration

Since the principal contaminant is often dissolved ferrous iron, a key aspect of treating ARD is aeration. Only about 10 mg/L of oxygen can dissolve in water, so if there is more than about 50 mg/L of Fe<sup>2+</sup>, the water must be aerated. Even at lower Fe<sup>2+</sup> concentrations, aeration increases the level of dissolved oxygen and promotes oxidation of iron and manganese, increases chemical treatment efficiency, and decreases costs. Aeration also drives off dissolved CO<sub>2</sub>, which is commonly present in mine water coming from underground. This increases the pH and can significantly reduce reagent use. To view photos of aeration systems, click here: **Aeration systems for treating CMD.**

Aeration can be done before or during treatment, using gravity or mechanical aeration/ mixing devices. In-line systems that use Venturi-based jet pumps and static mixers can be a cost-effective alternative since the air and neutralizing agent can both be introduced into the same jet pump orifice, increasing operational efficiency (Ackman and Kleinmann, 1984, 1991). If there is at least 20 psi (1.4 × 10<sup>5</sup> Pa) of excess systemic water pressure (e.g., the water is being pumped to the treatment site), these simple in-line systems do not require additional power. Otherwise, a small amount of power can operate an aeration device.

The primary cost of aeration is in the blower power consumption. For example, a 40-HP blower operated 24 hours per day for a year will cost about \$18k/yr in power consumption at \$0.07/kWh. A second cost is in the mixing system, as proper aeration requires that a high-shear radial impeller be used to break-up the air bubbles and increase the surface area for oxygen dissolution. These mixers typically draw more than twice the power than would an axial agitator used solely to maintain the precipitates in suspension (Zinck and Aube, 2000).

A hidden cost is also included in the dissolution of carbon dioxide from air, which will increase lime consumption and sludge production. Although air contains only 0.03% carbon dioxide, the dissolution rate of CO<sub>2</sub> is considerably faster than that of oxygen. If aeration is not necessary, these additional lime costs and associated additional sludge disposal costs must also be considered (Zinck and Aube, 2000).

The capital costs of aeration include the purchase price of a blower, the air distribution system, and the radial agitator. Often a second blower is added as a backup, and either a separate building is constructed or a room is insulated for sound due to the high decibels put out by a blower.

### 7.5.1.2 Neutralization/Hydrolysis

The key considerations in selecting an appropriate neutralization agent and integrated process configuration for a specific mine water treatment application include the following:

- Materials handling, including road/rail transport, bulk storage, make up, and dosing
- Classification of alkali material as a dangerous or hazardous material requiring special precautions in handling and personnel safety
- Availability and reliability of supply
- Efficiency as neutralizing agent and active ingredient/component of bulk material
- Process implications such as increasing propensity for scaling/coating/clogging of equipment /pipelines/instrumentation
- Infrastructure and equipment investment cost of alkali material handling, storage, make up, and dosing facilities

Neutralization and hydrolysis are key aspects of ARD treatment and many different alkali materials and different process configurations are employed. A list of commonly applied alkali compounds and materials is in Table 7-2.

**Table 7-2: Alkali Materials and Compounds Applied to ARD Treatment**

Alkali Compound/Material	Alkali Requirements (ton/ton of acidity) <sup>1</sup>	Neutralisation Efficiency (% of applied alkali used) <sup>2</sup>	Relative Cost (\$ / tonnes bulk) <sup>3</sup>
Limestone, CaCO <sub>3</sub>	1.00	30 - 50	10 – 15
Hydrated lime, Ca(OH) <sub>2</sub>	0.74	90	60 – 100
Un-hydrated (quick) lime, CaO	0.56	90	80 – 240
Soda ash, Na <sub>2</sub> CO <sub>3</sub>	1.06	60 - 80	200 – 350
Caustic soda, NaOH	0.80	100	650 – 900
Magna lime, MgO	0.4	90	Project specific
Fly ash	Material specific	-	Project specific
Kiln dust	Material specific	-	Project specific
Slag	Material specific	-	Project specific

<sup>1</sup> The alkali requirement is expressed relative to CaCO<sub>3</sub> and reflects the amount of alkali required per unit of acidity (expressed as CaCO<sub>3</sub>).

<sup>2</sup>Neutralization efficiency estimates the relative effectiveness of the chemical in neutralizing ARD acidity. For example, if 100 tons of acid was the amount of acid to be neutralized, then it can be estimated that 82 tons of hydrated lime would be needed to neutralize the acidity in the water (100(0.74)/0.90).

<sup>3</sup>Price of chemical depends on the quantity being delivered. Bulk delivery prices and small quantity delivery prices will differ. These prices are approximate and generally reflect the market in January 2009. Prices will vary significantly around the world and over time.

Selection of an alkali material depends on the following:

- Secondary impacts associated with the use of a specific alkali residual on treated mine water quality such as ammonia content (aquatic environmental, eco-toxicity impacts), and increased salinity
- Cost of alkali material
- Treatment objectives, specifically the removal of metals

#### 7.5.1.2.1 Lime

Hydrated lime (Ca(OH)<sub>2</sub>) is typically procured in bulk powder form. Lime can be added either as a controlled dispersion of powder into the water or as a lime slurry. Hydrated lime is particularly useful and cost effective in large-flow, high-acidity situations where a lime treatment plant with a mixer/aerator is constructed to help dispense and mix the chemical with the water (Skousen and Ziemkiewicz, 1996). Lime slurry piping requires careful design and maintenance due to the tendency of the lime to congeal in the piping system under certain conditions.

Lime neutralization in a high density sludge (HDS) process configuration is the industry standard for impacted mine water neutralization for of the following reasons:

- Relative low cost of lime
- Efficient use of lime
- High density of waste sludge requiring a smaller site for disposal
- Scale control on treatment plant structures, pipelines, equipment, and instrumentation
- Good solids/water separation
- Robust process, able to treat variable flows and acidity/metals loadings

Lime neutralization/hydrolysis in an HDS process configuration is the most established and widely practiced ARD treatment technology. A number of variations and innovations to the original HDS treatment process concept have been developed and implemented. The basic HDS process configuration is shown in Table 7-3.

The key features of some of the commonly applied HDS process variations are shown in Figure 7-4.

**Table 7-3: Comparative Table Different HDS Process Configurations**

<b>Process Parameters</b>	<b>Conventional HDS</b>	<b>Cominco Process</b>	<b>Geco Process</b>	<b>Staged-neutralization</b>	<b>Tetra (Doyon) Process</b>
ARD feed point	Mix tank	Mix tank	Sludge conditioning tank	First stage	Sludge conditioning tank
Sludge recycle point	Sludge conditioning tank	Separate sludge/lime mix tank	Sludge conditioning tank	Upstream stages	Sludge conditioning tank and separate sludge/lime mix tank
Lime slurry feed point	Sludge conditioning tank	Separate sludge/lime mix tank	Rapid mix tank	Downstream stages	Separate sludge/lime mix tank
Aeration, air injection	Neutralization reactor	Neutralization reactor	Neutralization reactor	Upstream stages	Neutralization reactor
Polymer addition point	Upstream of thickener	Upstream of thickener	Upstream of thickener	Upstream of thickener	Upstream of thickener
Solids separation device	Gravity thickener	Gravity thickener	Gravity thickener	Gravity thickener	Gravity thickener

**Figure 7-4: Basic HDS Process Configuration**

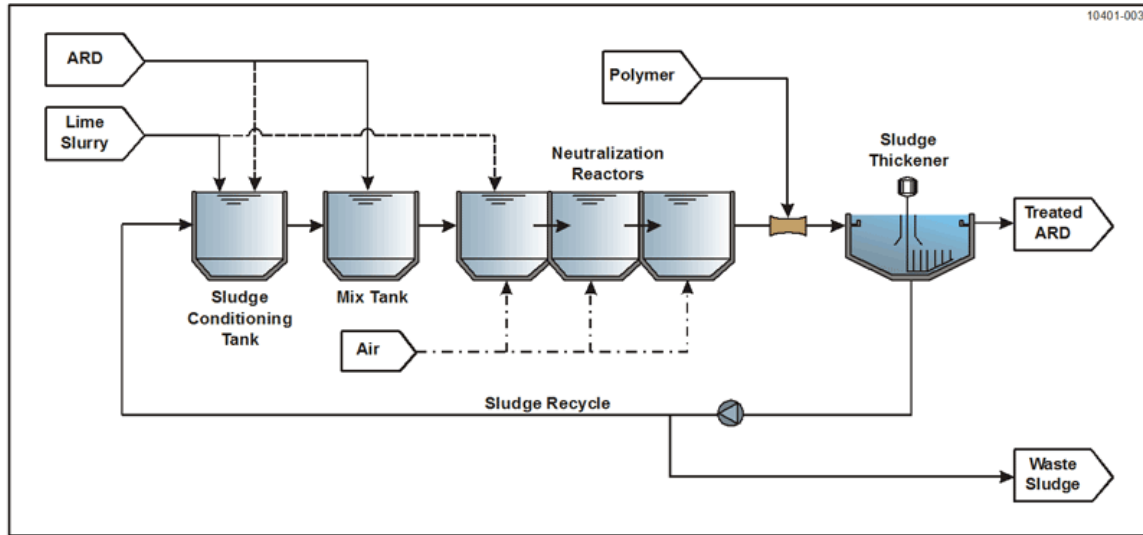

The selection of the most appropriate lime neutralization process is site and project specific and will depend on the following:

- Flow rate and acidity/metals loadings
- Efficiency of lime usage
- Sludge settling and solid/liquid separation characteristics
- Waste sludge density and disposal site size (volume) constraints
- Sludge stability (residual neutralization capacity)
- Treated water quality
- Capital investment
- Operating and maintenance cost

Table 7-4 lists the relative performance of some lime neutralization processes based on a few selection criteria.

**Table 7-4: Selection Criteria for Lime Neutralization Processes**

Selection Criteria	Conventional HDS	Cominco Process	Geco Process	Tetra (Doyon) Process	Staged-neutralization
Efficient lime utilization	X	XX	XX	XX	XXX
Waste sludge density	X	XX	XX	XX	XXX
Sludge viscosity	XXX	XX	XX	XX	X
Sludge stability	XXX	XX	XX	XX	X
Treated water quality	XX	XX	XX	XX	XX
Legend	X	= good			
	XX	= better			
	XXX	= best			

The process principles for the Geco, Tetra, and Staged Neutralization treatment processes are similar and based on intermediate and final pH adjustment. Staged neutralization is better suited to the treatment of ARD with a high iron and sulphate content.

The capital costs of the treatment process are directly dependent on influent flow rate. Figure 7-5 shows the relationship between flow rate and capital cost based on actual treatment plant capital costs (Aubé, 2011)

**Figure 7-5: Relationship between Flow Rate and Treatment Plant Capital Cost**

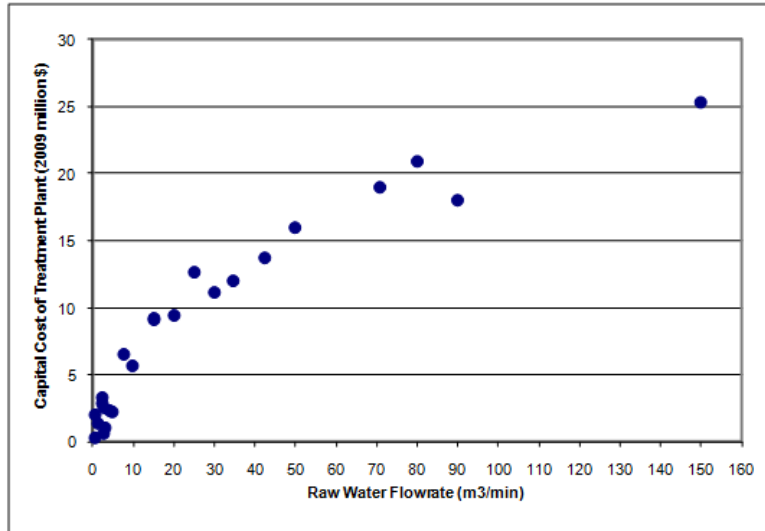

Hydrated lime is less cost effective if a very high pH is required to remove ions such as Mn, which is a common problem in CMD. Operators of lime treatment systems often increase lime application as Mn levels increase in the water. However, due to the kinetics of lime dissolution, increasing the lime rate increases the volume of unreacted lime that enters the metal flocculation pond. An additional complication is that it is relatively easy to over-treat CMD with hydrated lime, which can result in a pH that is high enough to cause aluminum to redissolve. If the treated water still has a pH above 9 once the iron hydrolyzes and settles, regulatory authorities will typically insist that the alkaline water be re-acidified to at least pH 9 unless the receiving stream is acidic. Using an in-line system (mentioned in Section 7.5.1.1), may allow an operator to better regulate lime usage in such circumstances. An example of an HDS lime neutralization system is provided in the Brukunga Case Study.

**7.5.1.2.2 Limestone**

Limestone has been used for decades to raise pH and precipitate metals in CMD (Deul and Mihok, 1967; Mihok, 1970). It has the lowest material cost and is the safest and easiest to handle of the ARD chemicals. It is useful when the only contaminants of concern are iron and aluminum, as is often the case in CMD. Unfortunately, its successful application is limited due to its low solubility and tendency to develop an external coating, or armour, of Fe(OH)<sub>3</sub> when added to ARD. Limestone, when simply placed into mine water, should be very fine grained (a high particle surface area/ volume ratio). The goal is for the limestone to dissolve before it becomes armoured. When pH is low and the metal concentrations are also relatively low, finely-ground limestone may be dumped into drainage directly (limestone sand application) or limestone gravel may be ground into powder by water-powered rotating drums (limestone drum stations) and metered into the drainage. Sand-sized limestone has also been placed in a large cylindrical tank and mixed with the ARD which is introduced into the bottom of the tank; these are called diversion wells (Faulkner and Skousen, 1995; Arnold, 1991). Diversion wells use the power of the drainage to fluidize (form a suspension) the limestone. The limestone particles rub against each other vigorously, which allows dissolution without armoring. Limestone has also been used to treat CMD in anaerobic (e.g., anoxic limestone drains) and aerobic environments (e.g., open limestone channels). These are covered in more detail later in this chapter, as part of passive treatment.

A novel integrated limestone/lime neutralization process was developed at the South African Council for Scientific and Industrial Research (CSIR) (Geldenhuys et al., 2001), as shown in Figure 7-6. The integrated limestone/lime process incorporates the following three process steps:

**Figure 7-6: Integrated Limestone / Lime Neutralization Process**

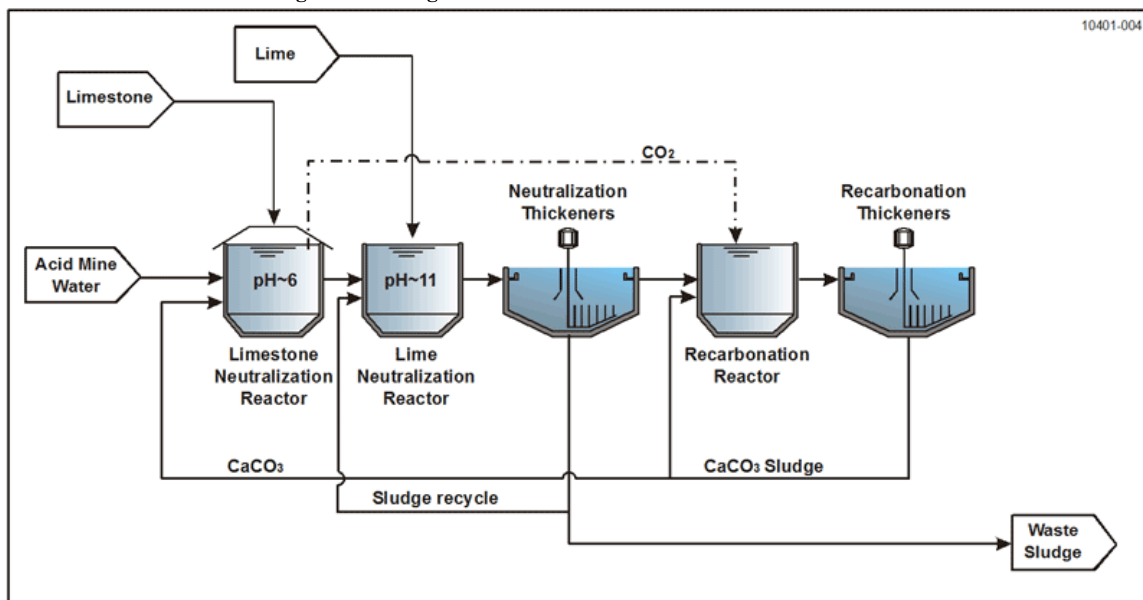



- Pre-neutralization using relatively inexpensive limestone
- Lime neutralization to a pH target, which is dictated by the treatment targets such as specific metals removal (This step is also designed to precipitate gypsum.)
- Re-carbonation and pH adjustment using the CO<sub>2</sub> generated in the first process step

The benefits of the integrated limestone/lime process relate to the efficient use of relatively inexpensive alkali materials and reuse of alkali sludge produced in the process.

Many process streams within mineral processing facilities are highly alkaline (i.e., waters from flotation plants). Therefore, excess process waters from the flotation plant could be mixed with ARD for neutralization.

### 7.5.1.2.3 Other Forms of Alkali Addition

At sites where it is not possible to provide as much supervision as the use of hydrated lime requires, pebble quicklime (CaO) has often been used, in conjunction with the Aquafix water treatment system. This device is powered by the force of the stream, using a water wheel concept (Jenkins and Skousen, 2001). The advantage of this approach is the amount of maintenance and manpower is much less than is required for a hydrated lime treatment plant, though it is still greater than is required for a passive treatment system. The amount of chemical added is dictated by the movement of a water wheel, which causes a screw feeder to dispense the chemical. The hopper and feeder can be installed in less than an hour. This system was initially used for small and/or periodic flows with high acidity because CaO reacts very quickly. Recently, water wheels have been attached to large silos for relatively high flow/ high acidity situations.

Caustic soda (NaOH) is available commercially as a concentrated liquid or as water soluble pellets. It is generally only used in remote locations (e.g., where electricity is unavailable), and in low flow, high acidity situations, especially where long- term ARD treatment may not be necessary or where Mn concentrations are high. Caustic soda is very soluble in water, disperses rapidly, and raises the pH of the water quickly. It should be applied at the surface of ponds because the chemical is denser than water. The major drawbacks of liquid NaOH for CMD treatment are its relatively high cost. Liquid NaOH is also extremely caustic and therefore potentially dangerous to anyone who comes in contact with it. A third drawback, at least in winter, is that it has a relatively high freezing point (≈ 14°C), which has caused problems at some sites.

Soda ash (Na<sub>2</sub>CO<sub>3</sub>) is generally only used to treat CMD in remote areas with low flow and low amounts of acidity and metals. Selection of Na<sub>2</sub>CO<sub>3</sub> for treating ARD is usually based on convenience rather than chemical cost. Soda ash comes as solid briquettes, and is gravity fed into water by the use of bins or barrels. The number of briquettes to be used each day is determined by the rate of flow and quality of the water being treated. One problem with the bin system is that the briquettes absorb moisture, causing them to expand and stick to the corners of the bin. This prevents the briquettes from dropping into the stream. For short-term treatment at isolated sites, some operators use a much simpler system, employing a wooden box or barrel with holes that allows water inflow and outflow. The operator simply fills the barrel with briquettes on a regular basis and places the barrel in the flowing water. However, this system offers less control of the amount of chemical used.

### 7.5.1.3 Metal Removal

As discussed in Chapter 2, the metals content of mine drainage varies significantly depending on the following:

- Geology and geochemistry of the mine environment
- Specific ore being mined
- pH and oxidation/reduction potential of the mine water which governs the solubility of metals
- Source of mine water (e.g., drainage from underground workings, runoff from open pit workings, seepage from waste rock dumps, drainage from mill tailings and ore stock piles, spent ore piles from heap leach operations)
- Climatic conditions

The classical approach to metals removal is based on chemical precipitation, formation of solids particles containing the metal precipitates, and separation of the solids from the mine drainage. Metals [M] can form a number of insoluble compounds with anions, such as:

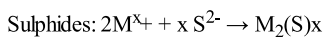
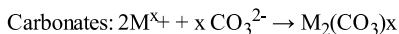
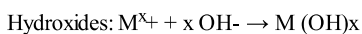

The solubility of metal hydroxides can be used to illustrate the point. Many metals have an amphoteric property, with decreasing solubility up to a threshold pH, above which the metal solubility increases again because of the formation of soluble complexes. The pH corresponding to the theoretical thermodynamic and minimum solubility of some selected metal hydroxides is shown in Table 7-5.

**Table 7-5: Theoretical Minimum Metal Hydroxide Solubility pH**

Metal	pH Corresponding to Minimum Metal Hydroxide Solubility/L
Ferric iron, Fe <sup>3+</sup>	~ 3.5

Antimony, Sb <sup>2+</sup>	~ 4.2
Aluminum, Al <sup>3+</sup>	~ 4.5
Lead, Pb <sup>2+</sup>	~ 6.5
Copper, Cu <sup>2+</sup>	~ 7.0
Ferrous iron, Fe <sup>2+</sup>	~ 8.0
Zinc, Zn <sup>2+</sup>	~ 8.5
Nickel, Ni <sup>2+</sup>	~ 9.3
Cadmium, Cd <sup>2+</sup>	~ 10.0
Manganese, Mn <sup>2+</sup>	~ 10.6

Metals removal by precipitation typically involves alkali addition to a target pH for selective removal of the metal of interest. It may also be advisable to pre-oxidize the metal (or metals) before precipitation where a metal can exist in more than one oxidation state. This will assist precipitation because the more oxidized form of some metals has a lower solubility. This is, however, not true for compounds of chromium, selenium, and uranium, which are more soluble in oxidized form.

A common approach to enhance removal of specific metals is the use of chemical pre-treatment or co-precipitation strategies, such as the following:

- Aeration can be used to improve removal of iron and manganese
- In low-iron containing waters, iron may be added to co-precipitate or adsorb certain metals onto ferric hydroxide precipitates. This process achieves lower effluent concentrations than would be achieved solely based on the solubility of the pure metal hydroxide
- Chemical reduction or oxidation can be used to alter the valence state of a target metal and enhance its removal. Examples of chemical reduction or oxidation include arsenic, selenium, and chromium

The key considerations in selecting an appropriate reagent for metal precipitation include:

- Materials handling considerations, including road/rail transport, bulk storage, make up, and dosing
- Classification of the reagent as a dangerous or hazardous material requiring special precautions in handling and personnel safety
- Availability and reliability of the supply
- Infrastructure and equipment investment cost of reagent handling, storage, make up, and dosing facilities
- Cost of reagent
- Treatment objectives

The specific process arrangement for metals removal is the same as for neutralization – and is often in a lime/HDS configuration with additional chemical feed and control systems. The primary differences are the potential pre-treatment requirements, operation at an elevated pH, and the possible need to reduce the treated effluent pH with acid or carbon dioxide to meet effluent discharge pH requirements.

After chemical treatment, the treated water will typically be directed into sedimentation ponds or mechanical thickeners so that the precipitating metals suspended in the water can precipitate and settle out. The metals generally precipitate from impacted water as a loose, open-structured mass of tiny grains called ‘floc’, which aggregates and settles out as a yellow, orange, or red sludge. Since CMD normally contains little in the way of potentially toxic contaminants, this sludge is generally non-hazardous, with the exception of those higher selenium contents. However, CMD sludge cannot be allowed to flow into the receiving stream since it would make the bottom of the stream inhospitable to fish, insect larvae and other benthic organisms. The sludge in the settling ponds must be periodically pumped out and disposed of, since sufficient residence time, which is dictated by pond size and depth, is important for adequate metal precipitation. The amount of metal floc generated by neutralization depends on the quality and quantity of water being treated, which in turn determines how often the ponds must be cleaned.

Sludge disposal options include: (1) leaving the material submerged in a pond indefinitely; (2) pumping or hauling sludge from ponds to abandoned deep mines or to pits dug on surface mines, or simply placing it onto the land surface; and (3) dumping sludge into refuse piles. CMD sludge is often disposed in abandoned deep mines or to pits dug on surface mines to take advantage of its excess alkalinity (due to unconsumed hydrated lime) but this is only appropriate if the environment that the sludge is being placed into is not acidic. If the sludge is exposed to sufficiently acidic water, the sludge can dissolve, neutralizing the pH somewhat but increasing the dissolved metal content. Sludge dewatering can be a cost effective alternative when the alternative is pumping or trucking sludge that is 80-95% water. CMD sludge pumped onto the surface of land and allowed to age and dry is generally a good strategy for disposal, since, in its oxidized and dried condition, the sludge can become crystalline and part of the soil. ARD sludge has also been dewatered and contained using geotextile products.

Selenium content and potential leaching from treatment sludge is in general not an issue as Se in its oxidized form does not readily report to the sludge. In a MEND study which examined seventeen treatment sludges from coal, base metal, precious metal, and uranium treatment operations, the concentration of Se leached was below regulated limits for all samples tested (Zinck et al., 1997).

#### 7.5.1.4 Chemical Precipitation for Sulphate Removal

The desalination treatment technologies most applicable to mine drainage target sulphate salts. Mine water may contain a wide range of anionic species, but sulphate is typical of many mine drainages and often represents the primary contaminant. Consequently, sulphate removal is an important treatment objective and is also often key to the reduction of TDS.

Some sulphate is removed by gypsum precipitation during neutralization reactions if lime, limestone, or another calcium source is added during water treatment. In addition, a number of precipitation processes have been developed for specific application to high sulphate content mine waters, including the following:

- Barium sulphate process
- Ettringite ( $\text{Ca}_6\text{Al}_2(\text{SO}_4)_3(\text{OH})_{12}\cdot 26\text{H}_2\text{O}$ ) precipitation process

The barium sulphate process is based on the addition of a barium salt to re-precipitate sulphate. The insoluble barium sulphate sludge is separated and removed from the main stream process. This barium is recovered from the sulphate sludge and recycled to the main stream process.

The barium sulphate process has not been developed past the development of a pilot scale demonstration process. While this process is very effective, it is challenged by the following:

- The use of an environmentally toxic compound as a treatment reagent
- Generation and handling of a toxic and hazardous gas ( $\text{H}_2\text{S}$ )
- Requirement for thermal regeneration and recycle of the barium reagent

Barium carbonate and barium hydroxide have been tested by CANMET-MMSL in Canada. (Zinck et al., 2007).

Two variations of the ettringite precipitation process (SAVMINTM and cost-effective sulphate removal [CESR]) have been developed and demonstrated. The ettringite process is based on the addition of aluminum hydroxide in a high pH environment resulting in precipitation of ettringite (a hydrated calcium aluminosulphate mineral), as shown below:

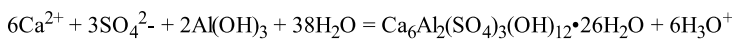

The simplified process flow diagram of the SAVMIN™ process is shown in Figure 7-7.

**Figure 7-7: Simplified SAVMIN Process Diagram**

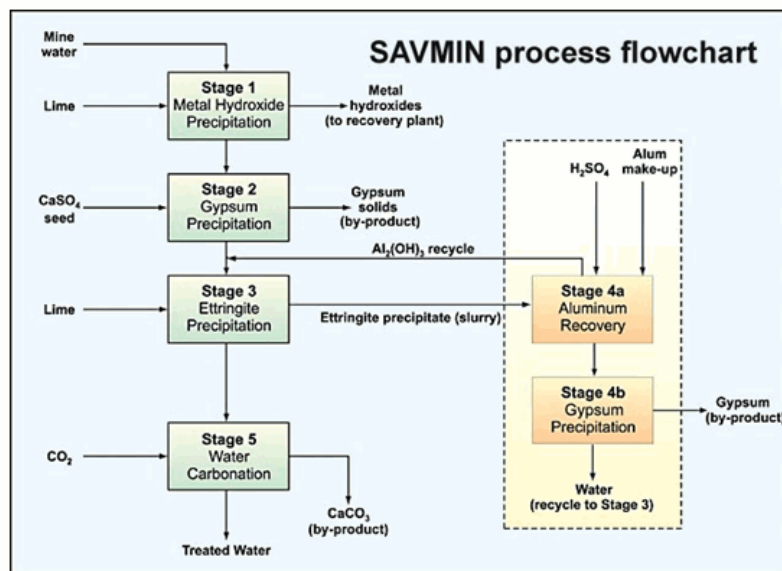

The CESR process is similar in concept but CESR uses a proprietary chemical derived from the cement industry to precipitate ettringite. It has the benefit of not requiring the decomposition of ettringite or the recycling of reagents.

While these processes have been demonstrated, neither has been applied to mine drainage projects for full-scale installations to date.

### 7.5.1.5 Membrane Treatment

A wide range of membrane treatment technologies exist to treat brackish and saline waters such as mine drainage. The application of these membrane technologies to mine drainage is challenging because of scaling and fouling potential. Mine drainage typically contains several compounds with a scaling and fouling potential such as metals, sulphate, and carbonate. The application of membrane desalination processes to mine drainage also typically results in the production of sludge and brine streams. In recent years, however, a number of high recovery membrane desalination processes have been developed, constructed, and operated at mine sites.

The concept of a high recovery membrane desalination process is shown in Figure 7-7. The primary features of the mainstream membrane desalination process include the following:

- Pretreatment with lime to remove metals and supersaturated gypsum (this is essential to limit the membrane scaling potential of the mine drainage)

- Pretreatment to remove residual suspended solids
- Pretreatment by adjusting the pH to a nonscaling regime and adding anti-scalant reagent
- Membrane treatment typically accomplished using spiral wound reverse osmosis (RO) or nano-filtration (NF) membranes
- Post treatment (a simple process that may only involve stabilization using an alkali such as lime)

Figure 7-8: Conceptual High Recovery Membrane Desalination Process

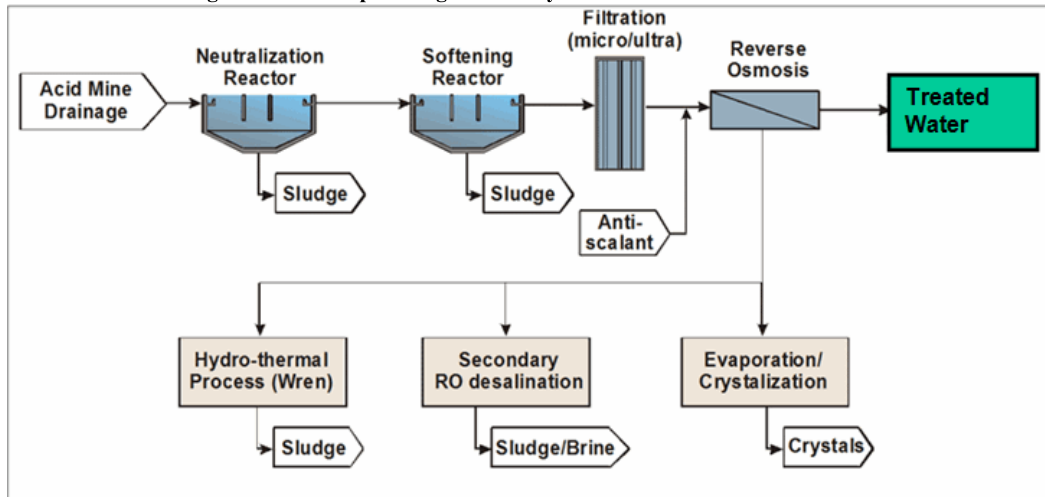

A single pass membrane treatment process will typically achieve only a clean water recovery of 60% to 70% for mine waters. The membrane process still leaves a substantial brine stream, which requires treatment. Methods to treat the brine are discussed in Section 7.6. The following two approaches exist to further increase the clean water recovery and decrease the need for brine handling and disposal:

- The brine stream can be desaturated by lime treatment which destroys the anti-scalant action and precipitates any supersaturated salts. A second stage higher pressure RO/NF process is then used to recover more clean water.
- The brine stream can be further concentrated by conventional thermal evaporation/crystallization treatment. These techniques are capital intensive and require substantial energy.

A further variation of the membrane desalination process involves the use of tubular RO type membranes. The slurry precipitation and recycle reverse osmosis (SPARRO) process was developed and holds potential as shown in Figure 7-9.

Figure 7-9: Concept SPARRO Process Flow Diagram

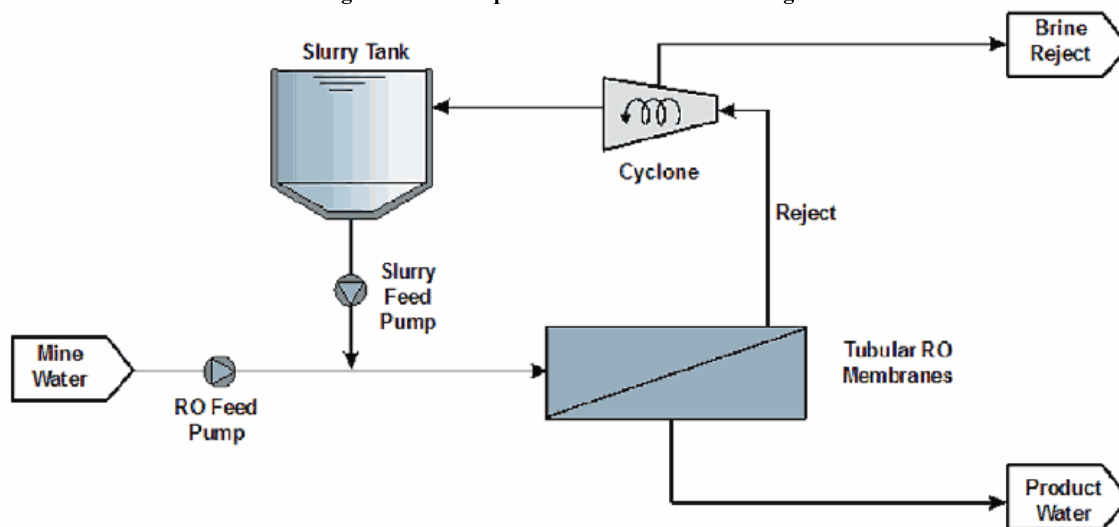

The concept of the SPARRO process is based on the protection of the membrane surfaces by providing a slurry suspension onto which the precipitation products can form. High water recoveries were achieved by a demonstration scale plant (Pulles et al., 1992).

In principle, other membrane processes such as electrodialysis reversal (EDR) can also be applied to mine water desalination. No full-scale EDR desalination plants, however, are known to exist in the mine water industry for the large-scale desalination of mine drainage.

### 7.5.1.6 Ion Exchange

One of the older ion exchange processes used by mining companies is the copper cementation or precipitation process. In this process, waste galvanized cans were burnt to remove the zinc coating or other metallic iron was placed in a copper containing stream, which was typically leach solution from a waste or low-grade ore pile. Copper in solution would plate on the surface of the iron metal and in doing so would exchange electrons with the underlying iron, oxidizing the iron and reducing the copper to the metallic state. This process created a higher-value product from a waste product (precipitate copper from waste cans) and would reduce somewhat the toxicity of the solution to fish (exchanging  $\text{Cu}^{2+}$  for  $\text{Fe}^{3+}$  ions), as shown in the following reaction:

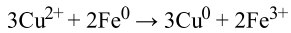

This process has been used to treat copper containing solutions from abandoned mine sites in the United States and it is a process that is amenable to use by artisan miners in developing countries, provided the influent copper concentration is quite elevated (i.e., greater than approximately 20 mg/L).

A novel ion exchange process, GYPCIX®, was developed for high sulphate type mine drainage. The process requires pretreatment to remove metals, which may interfere and decrease the efficiency of the downstream ion exchange process resins. The GYPCIX® conceptual flow diagram is shown in Figure 7-10. The cation resin exchanges  $\text{Ca}^{2+}$ ,  $\text{Mg}^{2+}$ , and other cations (i.e., metal ions) by the following reaction:

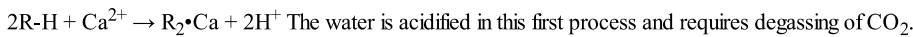

The anion resin exchanges  $\text{SO}_4^{2-}$ ,  $\text{Cl}^-$ , and other anions by the following reaction:

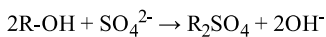
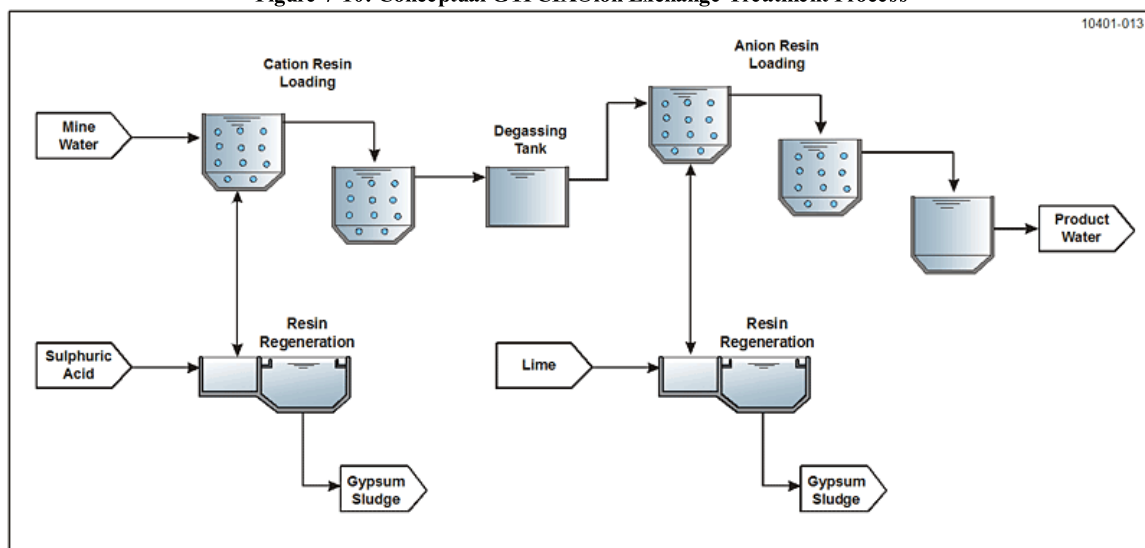

Figure 7-10: Conceptual GYPCIX® Ion Exchange Treatment Process



The product water is near neutral and may require stabilization before distribution or discharge. The resin regeneration requires sulphuric acid and lime, thus producing mainly gypsum as waste sludge. The GYPCIX process has been demonstrated on a small scale, but no commercial operations exist in the mining industry.

A number of natural ion-exchange materials, such as zeolites (a class of aluminosilicate minerals), have been demonstrated to have treatment potential. Few full-scale operating treatment facilities using natural ion-exchange materials exist.

### 7.5.1.7 Biological Sulphate Removal

Biological sulphate removal has been used by mining companies at several locations around the world. Many variations of the process have been developed. The generic biological sulphate removal process configuration is shown in Figure 7-11.

**Figure 7-11: Generic Biological Sulphate Removal Process Configuration**

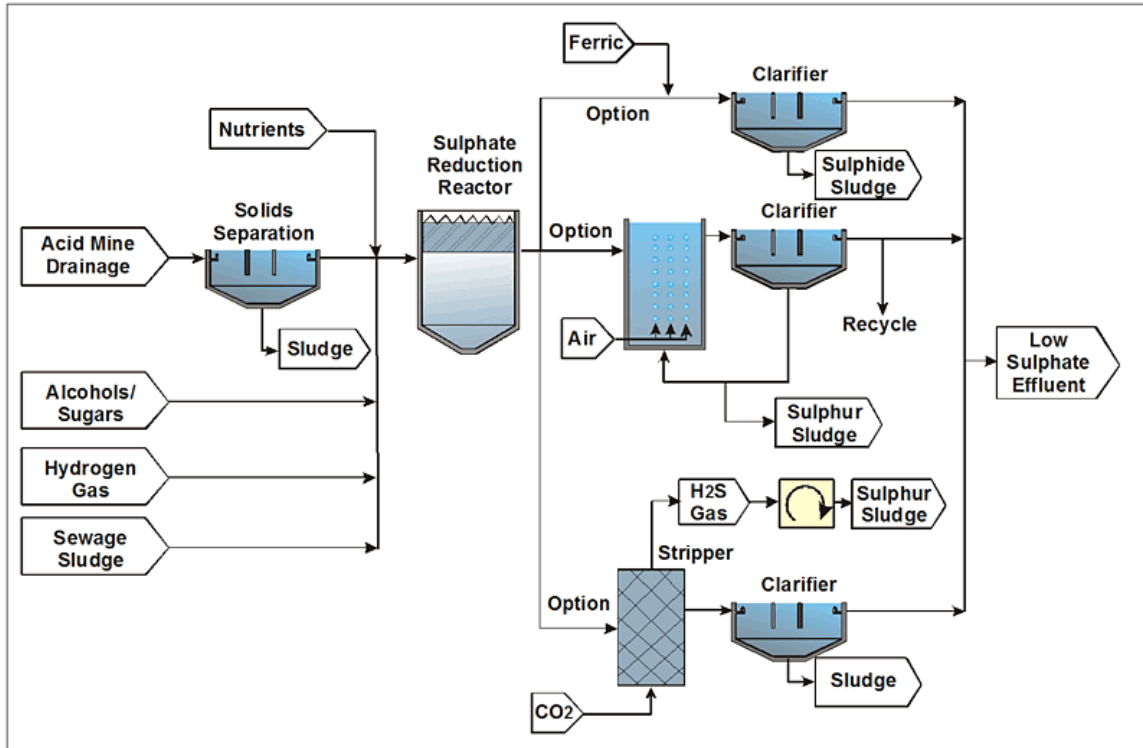

The key features of the biological sulphate removal process include the following:

- Pretreatment to remove metals by precipitation as sulphides, hydroxides, or carbonates
- Dosing of an electron donor and carbon source such as alcohol, sugar, H<sub>2</sub> gas, and even complex substrates such as sewage sludge
- Addition of nutrients, including sources of nitrogen, phosphate, potassium, and trace minerals
- Sulphate reduction in an anaerobic reactor which converts sulphate to sulphide. The process is mediated by sulphate reducing bacteria (SRB), which uses preferred substrates such as fatty acids, alcohols, and H<sub>2</sub> gas. The bacterial population includes a consortium of other organisms such as fermenting bacteria and methanogens, some of which help to hydrolyze and ferment complex carbons to readily available substrates for the SRBs

The biological sulphate reduction part of the process has been researched and demonstrated by a number of companies. This part of the overall treatment train can be considered as proven technology. The further handling and treatment of the sulphide rich effluent can be done in a number of different ways, as shown in Figure 7-11. A ferric salt (or ferric sludge) can be dosed to precipitate the sulphide; a ferric sulphide sludge is then generated, which may require special care in disposal and the associated anion may increase salinity of the treated water, as follows:

- The sulphide can be partially oxidized to sulphur in a carefully controlled micro-aerobic environment. The sulphur is separated as a potentially saleable by-product
- The sulphide is stripped and converted to sulphur in a side stream process. The substitution of H<sub>2</sub>S by CO<sub>2</sub> results in an increase in carbonate alkalinity and potential precipitation of carbonates such as calcite

The criteria for selecting an appropriate mine water desalination technology are listed in Table 7-6, with an indication of the relative performance of different technologies.

**Table 7-6: Criteria for Selecting an Appropriate Mine-Water Treatment Desalination Technology**

Selection Criteria	Mine Drainage Treatment Technology			
	Chemical Precipitation	Membrane Treatment	Ion Exchange	Biological Sulphate Removal
Proven technology on commercial scale	Proven with many demonstration scales, large commercial plants	Proven, with several large commercial plants	Demonstrated on pilot scale, no large commercial plants	Proven, with a limited number of commercial plants
Specialized application	General application to high metals, high SO <sub>4</sub> mine water	General application, but with appropriate pre-treatment	Demonstrated for CaSO <sub>4</sub> type waters, with	Specialized application to high SO <sub>4</sub> mine waters

			appropriate pre-treatment	
Water recovery	High water recovery > 95%	High water recovery > 90%	High water recovery not confirmed	Very high water recovery > 98%
Waste sludge/brine production	Large waste sludge production	Sludge and brine production	Large waste sludge production	Small waste sludge production
Potential byproducts recovery	Potential for CaSO <sub>4</sub> recovery	Potential, but not demonstrated	Potential for CaSO <sub>4</sub> recovery	High potential for Sulphur recovery
Chemicals dosing	High chemicals dosing	Limited chemicals dosing	High chemicals dosing	Process depends on carbon source dosing
Energy usage efficiency	Moderate energy usage	High energy usage	Moderate energy usage	Moderate energy usage (heating of anaerobic reactors)
Reliable and robust performance	Robust process	Process good performance, but sensitive to pre-treatment	IX process performance and resin recovery subject to interference	Biological process sensitive to toxics, fluctuating feed water quality and environmental conditions
Capital investment cost (per m <sup>3</sup> /day capacity)	\$ 300 – 1,250 (see note)	\$500 – 1,000	See note	\$800 – 1,500
Operations and maintenance cost (\$ per m <sup>3</sup> treated)	\$0.2 – 1.5/m <sup>3</sup> (see note)	\$0.5 – 1.0/m <sup>3</sup>	See note	\$0.7 – 1.5

*Note: The cost information on chemical precipitation and ion exchange processes is indicative since no full scale commercial installations exist.*

The cost of treating mine waters in cold and remote sites (i.e., arctic regions) could be higher by a factor of 2 or more because of expensive transportation and storage requirements of reagents. These sites are usually accessed by air or ice roads and the treatment systems are installed and operated indoors, requiring construction and maintenance of heated buildings. At closed mining sites, possibilities for seasonal operations should be investigated and applied where possible.

### 7.5.1.8 Sulphide Precipitation

Sulphide precipitation works under the same basic principle as hydroxide precipitation. The precipitation process converts soluble metal compounds into relatively insoluble sulphide compounds through the addition of precipitating agents, such as the following:

- Sodium sulphide (Na<sub>2</sub>S)
- Sodium hydrosulphide (NaHS)
- Ferrous sulphide (FeS)
- Calcium sulphide (CaS)

Sulphide precipitation is an effective alternative to hydroxide precipitation. Over a broad pH range, sulphides (S<sup>2-</sup>, HS<sup>-</sup>) are extremely reactive with heavy metal ions. Sulphide precipitation can be used to remove lead, copper, chromium (VI), silver, cadmium, zinc, mercury, nickel, thallium, antimony, and vanadium from wastewaters. The precipitation reaction is generally induced under near neutral conditions (pH 7.0 to 9.0). In a way that is similar to hydroxide precipitation, metal-sulphide precipitates must be physically removed from solution (through coagulation, flocculation, and clarification, or filtration), leaving a metal-sulphide sludge.

In addition, sulphide precipitation is sometimes used in water treatment following conventional lime treatment to reduce concentrations of residual metals, particularly cadmium. This is successful because of the ability of sulphide to reduce metal concentrations to much lower values than can be achieved by precipitating metals as hydroxides with lime, although the metals precipitated are not recovered as they report to the lime sludge. Some of the advantages of sulphide treatment include effective metal removal for most metals, low retention time requirement, and reduced sludge volumes. The disadvantages of sulphide treatment are significant and include potential for toxic hydrogen sulphide gas emissions and residual sulphide in treatment effluent. Also, the soluble sulphide process may result in odour problems and the complexities of the systems frequently result in higher capital and operating costs than lime treatment.

### 7.5.2 Passive Treatment Technologies

Passive treatment refers to processes that do not require regular human intervention, operations, or maintenance. It should typically employ natural construction materials, (e.g., soils, clays, and broken rock), natural materials (e.g., plant residues such as straw, wood chips, manure, and compost) and promote the growth of natural vegetation. Passive treatment systems use gravity flow for water movement. In some arid climates, it might also include use of evaporation or infiltration (e.g., soil amelioration and neutralization) of small volumes of ARD.

Pulles et al. (2004) defined a passive treatment system as:

*“A water treatment system that utilizes naturally available energy sources such as topographical gradient, microbial metabolic energy, photosynthesis and chemical energy and requires regular, but infrequent maintenance to operate successfully over its design life”*

Gusek (2002) also defined passive treatment as:

*“... a process of sequentially removing metals and/or acidity in a natural-looking, man-made bio-system that capitalizes on ecological and geochemical reactions. The process does not require power or chemicals after construction, and lasts for decades with minimal human help”.*

A truly passive system should also function for many years without a major retrofit to replenish materials, and should be able to function without using electrical power. Benning and Otte (1997) describe a volunteer passive system at an abandoned lead-zinc mine in Ireland that has apparently been functioning unattended for over 120 years. Similar volunteer systems are likely to be found functioning at some level of efficiency in most historical mining districts. Attempts to reproduce the beneficial effects observed at such volunteer wetlands in the eastern U.S. led to the use of passive treatment technology at mine sites.

Gusek (2008) provides an excellent summary of the history of passive treatment as applied to ARD and CMD in the US. The pioneering work of a group of researchers at Wright State University over thirty years ago documented water quality improvements in a natural Sphagnum bog in Ohio that was receiving low-pH, metal-laden water. Complementing this research, a group at West Virginia University found similar results at the Tub Run Bog. Subsequently, researchers, practitioners and engineers focused on developing the promising technology of using constructed wetlands to treat acid drainage. Since the term ‘wetland’, carried legal and regulatory challenges and does not quite describe structures like anoxic limestone drains or successive alkalinity producing systems, the term ‘passive treatment’ was adopted. More detail on the history of passive treatment can be found here: **History of Passive Treatment**

Most elements can be treated in a passive treatment process as outlined in Figure 7-12, which is the periodic table for passive treatment elements developed by Gusek and Waples (2009).

**Figure 7-12: Periodic Table for Passive Treatment**

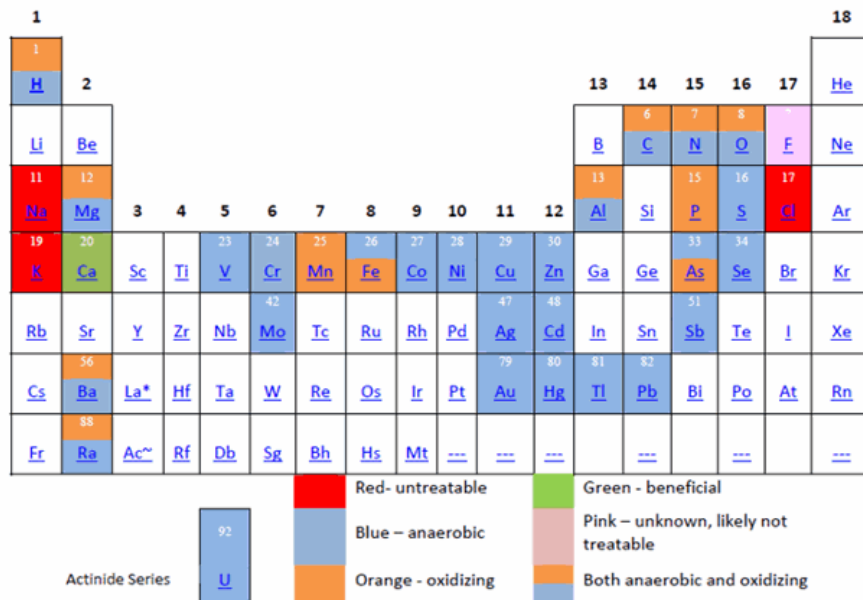

The generic categories of passive treatment systems are detailed in Table 7-7.

**Table 7-7: Generic Categories of Passive Treatment Systems**

Passive Treatment Technology	Application Niche in Mine Drainage
Aerobic wetlands	Net alkaline drainage
Anoxic limestone drains (ALD)	Net acidic, low Al <sup>3+</sup> , low Fe <sup>3+</sup> , low dissolved oxygen drainage
Anaerobic wetlands	Net acidic water with high metal content
Reducing and alkalinity producing systems (RAPS)	Net acidic water with high metal content
Open limestone drains (OLD)	Net acidic water with high metal content, low to moderate SO <sub>4</sub> .

The proven application of passive treatment technology is to the low-flow range. Most successful passive treatment projects are treating less than 1,000 m<sup>3</sup> per day. The largest documented passive treatment system has been treating approximately 6,500 m<sup>3</sup> per day since 1996 with limited maintenance (Gusek et al., 2000, 2007).



Hedin et al. (1994a) developed a decision support flow sheet to assist in the selection of an appropriate passive treatment technology. This was further refined by the PIRAMID Consortium as shown in Figure 7-13 (PIRAMID Consortium, 2003). Gusek (2008) further updated the decision tree to include a wider range of chemistries for mining-influenced water as earlier versions primarily focused on iron and magnesium (Figure 7-14).

Figure 7-13: Selection of Passive Treatment Technology Chart

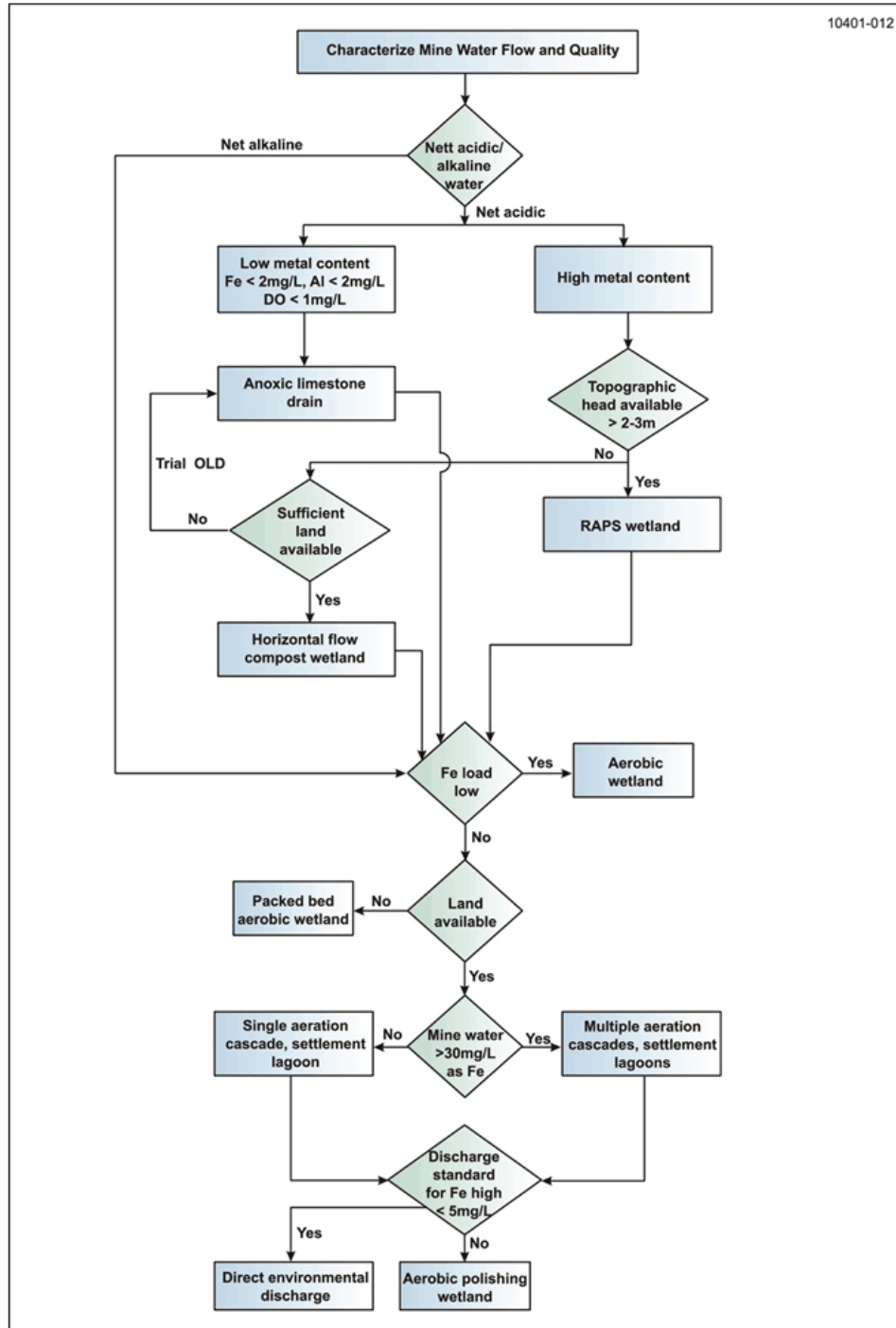
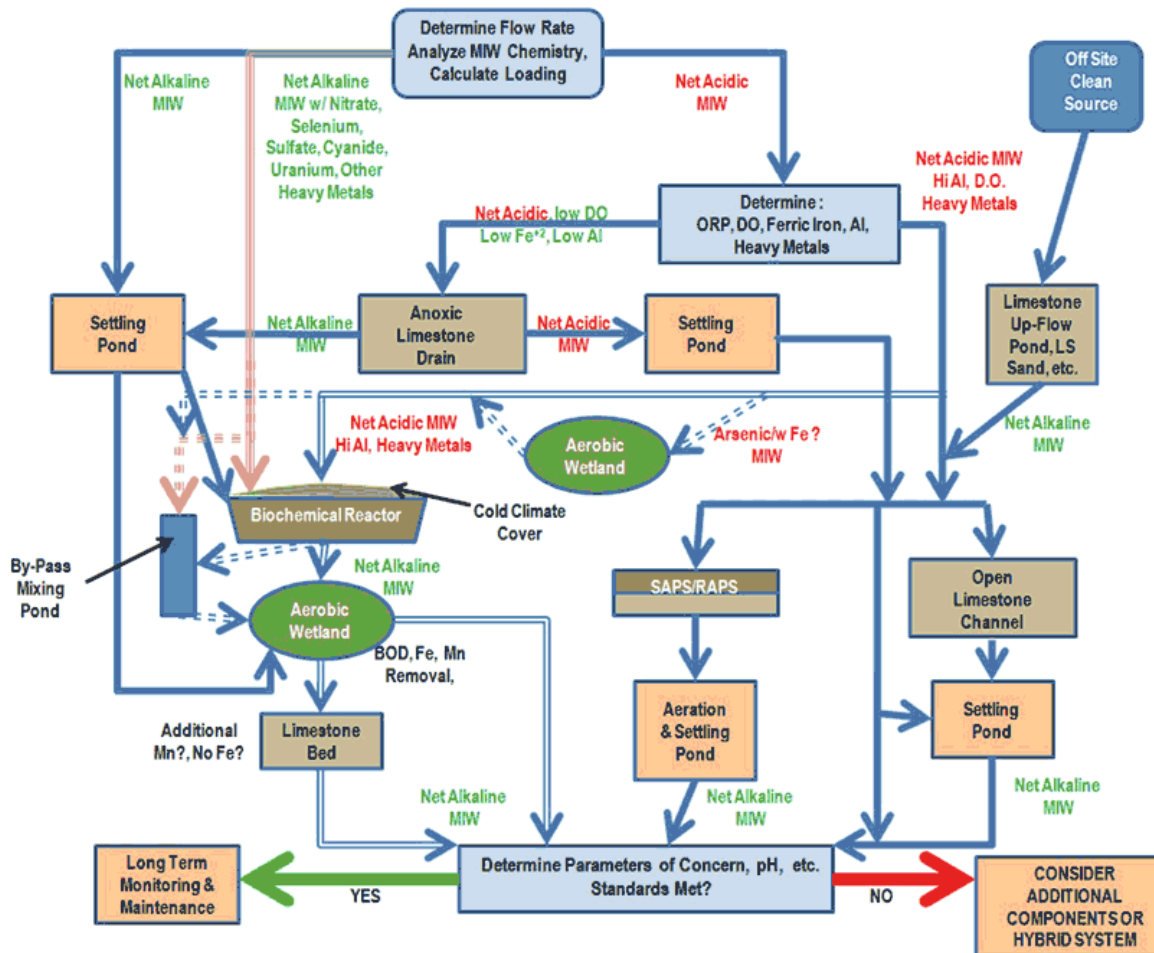

Figure 7-14: Selection of Passive Treatment Technology Chart



The mechanisms of metal removal and retention in passive treatment systems are varied and include:









- Oxidation
- Precipitation as hydroxides and carbonates under aerobic conditions
- Precipitation as sulphides and hydroxy-sulphate (aluminum special case) under anaerobic conditions
- Complexation and adsorption onto organic matter
- Ion exchange with organic matter
- Uptake by plants (phyto-remediation)

The environmental conditions in the different passive treatment systems will dictate the dominant metals removal mechanisms. Experience in Australia suggests that passive treatment is more effective if the acidity loading is less than approximately 150 kg/day.

The precipitation of iron as hydroxides and carbonates may also assist in the removal of additional pollutants. Several ionic species, such as arsenic and molybdenum, co-precipitate or adsorb onto ferric hydroxides. There is evidence that some of these reactions can be microbially facilitated (LeBlanc et al., 1996).

Sections 7.5.2.1 through 7.5.2.7 provide a brief overview of the principal passive treatment technologies. Figure 7-15 presents photographs of the main components of passive treatment systems (from Gusek, 2008).

Figure 7-15: Selected Passive Treatment Components (Gusek et al.)

<p>Aerobic Wetland</p>		<p>Anoxic Limestone Drain photo credit: www.wvu.edu/~agexten/landrec/land</p>	
<p>Aeration and Settling Pond</p>		<p>Sulfate Reducing Bioreactor (AKA Biochemical Reactor – [BCR])</p>	
<p>Successive/ Reducing alkalinity producing systems (SAPS/ RAPS) photo credit: www.wvu.edu/~agexten/landrec/</p>		<p>Open limestone channels (OLCs) photo credit: www.wvu.edu/~agexten/landrec/</p>	
<p>Limestone beds</p>		<p>Limestone Sand (semi-passive)</p>	

### 7.5.2.1 Aerobic Wetlands

Aerobic wetlands provide the environmental conditions for removal of suspended solids and selected metals using the following features:

- Relatively shallow water depths to allow aeration of the mine drainage
- Cascades to further enhance aeration
- Configuration and layout to promote favourable hydrodynamic flow conditions (prevent short circuiting)
- Wetlands vegetation to assist in aeration of the substrate (wetlands vegetation has the capability to maintain aerobic conditions around the root/rhizome area and can also promote favourable flow conditions)
- Sufficient residence time to allow the treatment reactions to take place
- Space for the settling and accumulation of the metal precipitates and solids
- Layout and screening against wind mixing and re-suspension of settled solids
- Promote algal growth to further increase the pH and facilitate manganese oxidation and precipitation
- Piping and hydraulic controls to manage the water levels in individual wetlands cells

As mentioned previously, aeration can be enhanced passively by simply cascading the ARD down a rock-lined channel or over a dam to encourage splashing and turbulence. Mine impacted water that contains less than 50 mg/L of dissolved iron and relatively low concentrations of manganese can often be treated simply using this form of aeration, followed by a pond or wetland for metal floc settling, if there is enough change in elevation to produce the required turbulence. No chemical addition is needed and the water can be discharged safely without adversely affecting receiving streams. If the iron concentrations are higher, additional aeration steps can be incorporated into the design by inserting additional turbulence between the ponds or wetland cells. Since enhanced iron oxidation and hydrolysis are the keys to most

ARD and CMD passive treatment systems, such turbulence steps are routinely added between wetland cells. For sites where the iron loading is particularly high, or where the change in elevation is minimal, supplemental aeration may be necessary. At such sites, semi-passive systems have been constructed using gravity-, wind-, and water-powered aeration or neutralization processes, as well as some devices that require external electrical power, may be used to provide supplemental aeration. This is still often less expensive than conventional chemical treatment.

Aerobic wetlands consist of *Typha* and other wetland vegetation typically planted in shallow water depths (<30cm), in relatively impermeable sediments comprised of soil, clay, or mine spoil. Aerobic wetlands promote metal oxidation and hydrolysis, thereby causing precipitation and physical retention of Fe, Al, and Mn oxyhydroxides, much like sedimentation structures. Successful metal removal depends principally on the dissolved metal concentrations, dissolved oxygen (DO) content, pH, net acidity/alkalinity of the mine water, and the retention time of the water in the wetland. The pH and net acidity/alkalinity of the water are particularly important because pH influences both the solubility of metal hydroxide precipitates and the kinetics of metal oxidation and hydrolysis. Therefore, aerobic wetlands are best used in conjunction with water that is net alkaline; the wetland serves primarily as a metal-floc collection and retention structure. The wetlands must be designed properly to optimize sedimentation and to provide for sludge storage. The vegetation enhances physical filtration of suspended metal particles and colloids; direct metal uptake by the plants is usually only a significant factor when the metal concentrations are already very low.

Some aerobic systems have been constructed by planting *Typha* rhizomes in soil or alkaline spoil obtained onsite, while others have been planted simply by spreading *Typha* seeds, with good plant growth after two years. However, it is best to use a mixture of appropriate emergent vegetation since this will allow the wetland to survive better in times of stress. For the same reason, the wetland cells should not be of uniform depth, but should include shallow and deeper areas and a few deep (1 to 2 m) spots. Most rooted aquatic vegetation cannot tolerate water depths greater than 50 cm, and require shallower depths for propagation. However, varying the depth will help promote wetland diversity (with respect to both plants and animals) and will help the wetlands survive droughts and storm events.

Some of the aerobic systems that have been constructed to treat alkaline mine water have little emergent plant growth and are better termed ponds than wetlands. In fact, typically, since sludge can be pumped from a pond, a pond is typically placed before the wetland cells to remove much, if not most, of the iron hydroxide. This pond is usually sized for an 8 to 24 hour retention time (often encompassing as much surface area as the wetland cells that follow it) and is typically 1.5 to 2.5 m deep. To account for the accumulation of iron, the value of 0.17 g of iron per cm<sup>3</sup> can be used, so that the required detention time will be available for a predetermined time (i.e. its design life). It is recommended that the freeboard of aerobic wetlands/ponds be constructed at about 1 m to allow for the removal of iron. Observations of sludge accumulation in existing wetlands suggest that a 1-m freeboard should be adequate to hold 20 to 25 years of iron oxyhydroxide accumulation. Some of these iron precipitates have been characterized for potential recycling as pigment (Kairies et al., 2001 and Hedin, 2002).

Often, several wetland cells and/or ponds are connected by flow through a v-notch weir, lined railroad tie steps, or down a ditch. Use of multiple cell/ponds can limit the amount of short-circuiting, and aerates the water at each connection. If there are elevation differences between the cells (as discussed above, to increase dissolved oxygen), the interconnection should be designed to dissipate kinetic energy and avoid erosion and/or the mobilization of precipitates in the next cell. Spillways should be designed to pass the maximum probable flow. Spillways should consist of wide cuts in the dike with side slopes no steeper than 2H:1V, be lined with non-biodegradable erosion control fabric and a coarse riprap, if high flows are expected (Brodie, 1991). Proper spillway design can preclude future maintenance costs associated with erosion and/or failed dikes. If pipes are used, small diameter (< 30 cm) pipes should be avoided because they can plug with litter and FeOOH deposits. Pipes should be made of PVC or PE, or coated for long-term stability. More details on the construction of aerobic wetland systems can be found in Hammer's *Creating Freshwater Wetlands* (1992). The floor of the wetland cell may be sloped up to a 3% grade. If a level cell floor is used, then the water level and flow will be controlled by the downstream dam spillway and/or adjustable riser pipes.

Hedin et al. (1994a) reported typical removal rates of 10 to 20 gd<sup>-1</sup>m<sup>2</sup> for iron, and 0.5 to 1.0 gd<sup>-1</sup>m<sup>2</sup> for manganese. Several groups have attempted to develop models that more effectively estimate the performance of treatment systems, especially for iron removal. Watzlaf et al. (2001, 2004) were able to model a system consisting of an aerobic pond, an aeration cascade, and a wetland using only the temperature-adjusted abiotic rate of iron oxidation. They found that the overall performance and the performance of certain sections of the system fell within the 10 to 20 gd<sup>-1</sup>m<sup>2</sup> range, but that the performance of some sections was outside of that range. Their model indicated that pH was the key factor limiting the rate of removal.

Kirby et al. (1999) used the same factors but included the effect of bacterial iron oxidation to model a set of 17 ponds. They found that the relative importance of the biotic and abiotic mechanisms was determined mainly by pH, with the abiotic path predominating at the higher pH values. They suggested that pH and temperature are the most important variables for determining iron oxidation rates, and therefore, iron removal rates. However, little can be done to control temperature in a passive treatment. The work by Kirby et al. (1999) suggests that increasing pH from 6.1 to 6.4, for example, greatly enhances oxidation, whereas doubling dissolved oxygen (as long as oxygen is sufficiently high stoichiometrically to oxidize metals), pond volume, or retention time has considerably less impact on oxidation rates.

Dempsey et al. (2001) found that oxygen transfer was rate limiting in one system, and that the amount of catalytic reaction provided by ferric hydroxide was the determining factor at a second site. While heterogeneous catalysis apparently plays a significant role in iron oxidation, it is difficult to increase concentrations of iron solids in a completely passive system. Such catalysis could be quite important in semi-passive or active treatment systems.

However, overall, it appears that the original estimate of Hedin et al. (1994a) of 10 to 20 gd<sup>-1</sup>m<sup>2</sup> remains a convenient pre-construction rule-of-thumb for estimating pond and wetlands sizes for iron removal. Studies undertaken since their publication tend to support the findings in the majority of cases (Younger et al., 2002 and Watzlaf et al., 2004). Recently, however, Kruse et al. (2009) suggested that hydraulic retention time rather than surface area should be used to design such systems.

The layout and slope of aerobic wetlands should be designed to minimize disruption of the natural conditions when the wetland sludge is removed and substrate is replaced, while maintaining the above engineering considerations. Any habitat value should reflect the potential uptake of toxic metals to birds, riparian mammals, and amphibians while enhancing the aesthetic quality of the project.

Many aerobic wetland systems have enjoyed long-term success and cost effectiveness. However, there have also been many failures, which have been very damaging to their perceived effectiveness. In general, systems that were not effective or failed were undersized, improperly designed, or both. The key, as with all water treatment systems, is to understand the limitations of each unit's operation, to have reasonable expectations, and to use conservative sizing criteria to attain specific water quality goals. Even undersized passive systems can be useful, discharging water with significantly lower concentrations of metal contaminants than were present in the inflow drainage. These improvements in water quality have significantly decreased the costs of subsequent water treatment at active sites, and deleterious impacts

that discharges from abandoned sites have on receiving streams and lakes.

### 7.5.2.2 Anaerobic Wetlands and Biochemical Reactors

Anaerobic systems primarily rely on chemical and microbial reduction reactions to precipitate metals and neutralize acidity. The water infiltrates through thick, permeable organic material that becomes anaerobic due to high biological oxygen demand. Several other treatment mechanisms function beyond those in aerobic wetlands, including metal exchange reactions, formation and precipitation of metal sulphides, microbially-generated alkalinity due to reduction reactions, and continuous formation of carbonate alkalinity due to limestone dissolution under anoxic conditions. Since anaerobic wetlands produce alkalinity, their use can be extended to poor quality, net acidic, low pH, high Fe, and high dissolved oxygen (>2 mg/L) ARD. Microbial mechanisms of alkalinity production are of critical importance to long-term ARD treatment. When wetlands receive high acid loads (>300 mg/L), the pH-sensitive microbial activities are eventually overwhelmed. Therefore, like their aerobic counterparts, anaerobic wetlands are most successful when used to treat small ARD flows and/or ARD that has moderate water quality.

The ARD treatment mechanisms for anaerobic biochemical reactors (BCRs) (also referred to as compost reactors) are based on alkalinity addition using the following two mechanisms:

- Sulphate reduction, which converts  $\text{SO}_4^{2-}$  into  $\text{H}_2\text{S}$  in an organic rich environment devoid of oxygen, releases alkalinity as a by-product as follows:

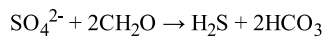

- Limestone and dolomitic material react to neutralize acidity as follows:

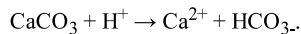

Carbonate material also suppresses fermentation bacteria, which are required in the bacterial consortium, but are not desirable in quantity, since fermentation by-products can lower the pH.

The key features of an anaerobic biochemical reactor are:

- A substrate bed containing a varied blend of natural material (e.g., wood chips, crushed limestone, plant residue, grass cuttings, hay, straw, manure, and compost)
- A surface pond (at least 150 mm deep), which floods the substrate bed and limits oxygen ingress into the BCR
- Mine water flow distribution and collection system to promote a plug flow pattern (typically configured vertically) with limited risk of short circuiting or dead zones
- Flow and level control devices to control the water level and to prevent substrate from being exposed to the atmosphere
- Higher plant life may be present to assist with organic material supplementation, as a wildlife habitat and for aesthetic appearance. However, vegetation may need to be suppressed in BCRs with a relatively thin (< 750 mm) substrate layer because the oxygen infusion from the plant activity can impact the establishment of geochemical reducing conditions.

BCRs constructed in the 1990s were typically horizontal plug-flow cells that resulted in a significant amount of mine water flow across the cell surface. These were often referred to as compost wetlands (Hedin et al., 1994). The current common practice is to use a vertical flow configuration with untreated water introduced at the top of the cell and treated water collected from the bottom.

The mechanisms of metals removal vary depending on the specific metal, but mechanisms of metals removal are a combination of the following:

- Sulphide precipitation
- Oxidation/hydrolysis (on the BCR surface if iron is present)
- Carbonate precipitation
- Absorption onto organic matter

A key advantage of BCRs is that the organic matter is typically found locally, as is the consortium of bacteria that populate the substrate. Common animal manure (browsing animals like cows, sheep, or goats are preferred) provides the bacterial inoculum for these units.

BCRs are typically followed by aerobic cells. Systems are typically comprised of two BCRs to facilitate long-term maintenance (all flow is temporarily directed to one BCR, while the other is being retrofitted) feeding into a single multiple-compartment aerobic wetland.

### 7.5.2.3 Anoxic Limestone Drains

Anoxic limestone drains (ALDs) are buried cells or trenches of limestone into which anoxic water is introduced (Figure 7-16). The ALD must be sealed so that the inputs of atmospheric oxygen are minimized, and the accumulation of  $\text{CO}_2$  within the ALD is maximized. This is usually accomplished by burying the ALD under 1 to 3 m of clay. Plastic is sometimes placed between the limestone and clay as an additional gas barrier. In some cases, the ALD has been completely wrapped in plastic before burial (Skousen and Faulkner, 1992). This can also help keep clay and dirt from entering the pore volume from the bottom and sides of the excavation.

**Figure 7-16: Anoxic Limestone Drain Design**

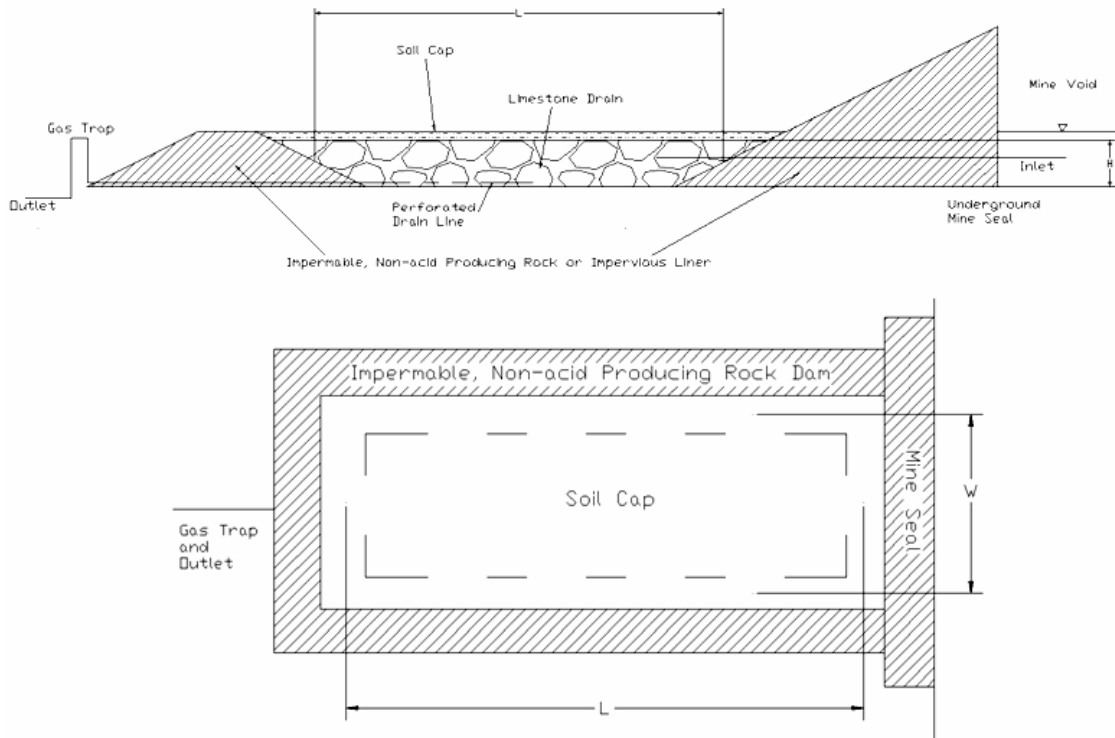

The limestone dissolves in the acid water, raises pH, and adds alkalinity. Under anoxic conditions, the limestone does not coat or armour with Fe hydroxides because  $\text{Fe}^{2+}$  does not precipitate as  $\text{Fe}(\text{OH})_2$  at an acid or circum-neutral pH. In addition to little or no dissolved oxygen and  $\text{Fe}^{3+}$ , aluminum concentrations must also be low: less than 2 mg/L. An ALD in western Pennsylvania that received 21 mg/L of aluminum completely clogged in eight months.

Limestone with higher  $\text{CaCO}_3$  content (> 80%) dissolves faster than limestone with a higher  $\text{MgCO}_3$  or  $\text{CaMg}(\text{CO}_3)_2$  content ( $\approx 50\% \text{CaCO}_3$ ) (Watzlaf and Hedin, 1993). The limestone used in most successful ALDs contains 80 to 95%  $\text{CaCO}_3$ . Most effective systems have used 5- to 20-cm-sized limestone. Some systems constructed with fine and small gravel limestone have failed, apparently because of plugging problems.

The ALD should be designed to inundate the limestone with water at all times. Clay dikes within the ALD or riser pipes at the outflow of the ALD will help ensure inundation. Also, the ALD discharge should be equipped with a plumbing trap to prevent air from entering the system. Finally, a pond must be constructed down-gradient to capture all of the iron that will precipitate once the neutralized water contacts the atmosphere. Typically, this pond is followed by additional ponds or wetlands to further enhance water quality. The dimensions of ALDs vary considerably. Narrower ALDs have the advantage of minimizing short-circuiting, but present a small cross-section perpendicular to the flow and thus may be more prone to clogging. Wider ALDs may be less likely to suffer significant permeability reductions (clogging) but may allow short-circuiting to occur. Site conditions will often dictate the dimensions of the ALD.

Faulkner and Skousen (1994) reported both successes and failures among 11 ALDs treating mine water in West Virginia. In all cases, water pH was raised after ALD treatment but three of the sites had pH values <5.0, indicating that the ALD was not fully functioning. When working correctly, the pH values of water in ALDs should be at least 6.0. Water acidity in these drains decreased 50 to 80%, but Fe and Al concentrations in the outflow, unfortunately, also decreased. Ferric iron and Al precipitate as hydroxides at this pH; reductions in dissolved Fe and Al indicate that some coating or clogging of limestone likely occurred.

Thus, longevity of treatment is a major concern for ALDs, especially in terms of water flow through the limestone. Unless there is no  $\text{Fe}^{3+}$ , dissolved oxygen, or Al present, eventual clogging of the limestone pore spaces with precipitated Al and Fe and/or gypsum is predicted at many sites (Nairn et al., 1991). Selection of the appropriate water and environmental conditions is critical for long-term alkalinity generation in an ALD. Like wetlands, ALDs may be a solution for ARD treatment for specific water conditions or for a finite period, after which the system must be replenished or replaced.

Tracer studies indicated that while ALDs approximate plug-flow systems, some short-circuiting occurs, and dead areas do exist. Calculated retention times, using 49% porosity, were in fairly good agreement with the median retention times of the tracer tests (Watzlaf et al., 2004). Water quality data determine the applicability of an ALD and flow data provide the basis for sizing an effective ALD for the desired design life. Approximately 15 hours of contact time between mine water and limestone in an ALD is necessary to achieve a maximum concentration of alkalinity. In order to achieve 15 hours of contact time within an ALD, 2,800 kg of limestone is required for each L/min of mine water flow. For example, an ALD that discharges water with 300 mg/L of alkalinity (the maximum sustained concentration thus far observed in an ALD effluent), dissolves 1,750 kg of limestone (90% calcium carbonate) in ten years, per each L/min of mine water flow. Therefore, a limestone bed should contain 6,200 kg of limestone for each L/min of flow (equivalent to 26 tons of limestone for each gallon per minute of flow). This assumes that the ALD is constructed with 90%  $\text{CaCO}_3$  limestone rock and has a porosity of 49%. The calculation also assumes that the original CMD does not contain  $\text{Fe}^{3+}$  or Al. The presence of these ions could result in faster rates of limestone dissolution due to the generation of acidity during hydrolysis. More importantly, they have the potential to limit limestone dissolution and cause a significant reduction in permeability that could very well lead to failure (as previously discussed). For a more detailed discussion

of limestone dissolution rates, see Cravotta and Watzlaf (2002).

To summarize, the success of ALDs depends on the following:

- Iron must be in the reduced ferrous (Fe II) form because ferric iron (Fe III) will armour the limestone material (if not, use a RAPS, as described in Section 7.5.2.3)
- No free oxygen ( $< 1$  mg/L) must be present; otherwise iron (Fe III) precipitation will take place (see RAPS in Section 7.5.2.4, if water is oxygenated)
- Low mine water aluminum concentration ( $< 2$  mg/L) because any aluminum hydroxide precipitates will clog the limestone bed
- A vent for excess CO<sub>2</sub> formed in the ALD

#### 7.5.2.4 Reducing and Alkalinity Producing System Wetlands

If the water contains dissolved oxygen or ferric iron, a reducing and alkalinity producing system (RAPS) will function better than an anoxic limestone drain. RAPS are similar in construction to an anaerobic BCR, but the function of a RAPS is to reduce ferric iron to ferrous in a thin organic layer (as opposed to a much thicker substrate layer in the BCR) and then neutralize the acidity in a limestone layer installed beneath the organic layer. Sulphate reduction also takes place, which generates alkalinity, and can precipitate some metals as sulphides. However, alkaline addition in RAPS is dominated by the limestone dissolution pathway. The acid neutralization potential afforded by a RAPS ranges from 35 to over 400 mg/L CaCO<sub>3</sub>. Sulphate reduction contributes an average of 28% (with a range of 5 to 51%) of the total alkalinity produced. The rate of alkaline addition for a single RAPS unit is about 40 to 60 gd<sup>-1</sup>. The rate of alkaline addition for a second RAPS unit in a series is about 1/2 to 1/3 of the rate of the first unit.

This type of system was first implemented at Galax, Virginia, in the late 1980s to treat highly acidic, high-iron water emerging from an abandoned pyrite mine (Hendricks 1991). In 1991, a second system of this type was constructed to treat water being discharged by a coal processing waste landfill near Norton Virginia (Duddleston et al., 1992). The term "successive alkalinity producing system (SAPS)", indicating that more than one of these units could be used in series to treat very highly acidic water, was applied to these systems by Kepler and McCleary (1994), who demonstrated a successful application at the Howe Bridge site in NW Pennsylvania. The Kepler and McCleary application received widespread notice, and use of these systems expanded rapidly thereafter. Similar systems have also been referred to as vertical flow systems, vertical flow ponds, or vertical flow wetlands. Chemically, biologically, and physically, these systems behave similarly, and are all referred to here as RAPS since most applications involve just a single system followed by an oxidation pond to precipitate and settle iron from the alkalinity-buffered RAPS effluent.

A typical design involves a sedimentation pond or aerobic wetland to precipitate any suspended ferric hydroxide that may be present. This is followed by the RAPS, which is constructed by placing a layer of limestone (0.6 to 1.2 m thick) on the bottom of an excavated area. A network of perforated pipes is placed in the lower portion of this limestone layer. Organic material (0.15 to 0.6 m thick), which typically has been composted, is placed above the limestone, and serves as the nutrient source for the iron- and sulphate-reducing bacteria. The composted organic material lies beneath 1-3 m of water (Figure 7-17; the water pressure helps force the water through the organic layer).

Figure 7-17: Profile view of a reducing and alkalinity producing system (RAPS) (not to scale)

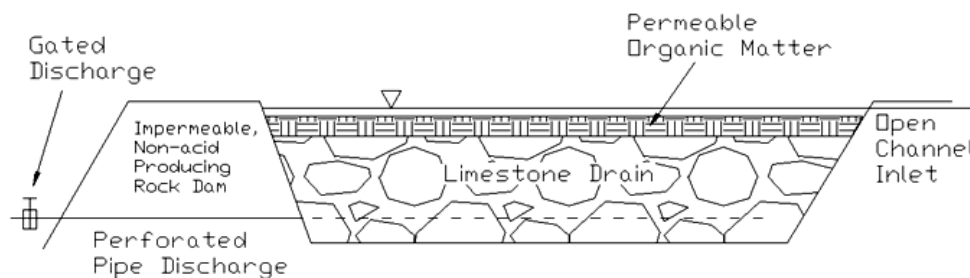

RAPS are now more common than ALDs for treatment of CMD because they are appropriate for water that contains dissolved oxygen or ferric iron, which can armour the limestone in an ALD. It is thought that RAPS may also be more resistant to plugging by aluminum than ALDs because of their larger cross sectional area and higher available head pressures (Watzlaf and Hyman, 1995). The Howe Bridge RAPS treated water for 11 years before being replaced. After 11 years, it was still able to pass 50% of the influent water through the compost and limestone layers. However, this system received less than 0.2 mg/L of aluminum. It appeared that the progressive reduction in permeability was due to the lack of a preliminary sedimentation pond; iron hydroxides precipitated on top of the compost layer, with an eventual accumulation of more than 15 cm of iron sludge on top of the compost. Reduced permeability can also result from storm-mobilized silt and other solids, as well as precipitation of metal sulphides within the organic layer. Thus, continued monitoring of the actual performance of these systems is warranted.

Kepler and McCleary (1997) described a flushing mechanism that they reported allowed RAPS to resist clogging by aluminum. However, field experiments conducted by Watzlaf et al. (2003, 2004) indicated that, although it appears that significant solids are being flushed out, the actual amount is only a minor component of what apparently precipitated in the system, based on water quality records. So, if aluminum is present at significant concentrations in the mine water, this alkalinity-adjusting method should be avoided because of potential plugging.

### 7.5.2.5 Open Limestone Drain

Open limestone drains (OLDs) are designed to introduce alkalinity into the dissolution of exposed limestone in the bottom and sides of a limestone drain. Past assumptions held that limestone armoured or coated with Fe or Al hydroxides ceased to dissolve. Ziemkiewicz et al. (1994, 1997) reported that armoured limestone was still somewhat effective (50 to 90%, compared to unarmoured limestone), and that seven OLDs in the field reduced acidity in ARD by 4 to 62% compared to a 2% acid reduction in a sandstone channel. They suggested that OLDs would be useful in abandoned mine reclamation projects where one-time installation costs can be incurred and regular maintenance is not possible.

Long channels of limestone can be used to convey ARD to a stream or other discharge point. Based on flows and acidity concentrations, cross sections of stream channels (widths and heights) can be designed with calculated amounts of limestone (which will become armoured) to treat the water. However, the design and operation of the limestone drain require special attention to accommodate the inevitable armouring and coating of the limestone. The following features in open limestone drain are recommended:

- Steep drain slopes of > 20%
- High flow velocities to scour settled solids and clean precipitates from the limestone surfaces
- Ability to periodically flush the OLD and clear accumulated precipitates and solids

### 7.5.2.6 Passive Sulphate Removal

A special category of passive treatment technology has been specifically developed to achieve high rates of sulphate reduction and ultimately sulphate removal as elemental sulphur. While anaerobic wetlands do incorporate a degree of sulphate reduction, rates are low and these wetlands are without a dedicated oxidative process to remove the sulphides as elemental sulphur. An integrated passive mine water treatment process has been developed in South Africa (Pulles et al., 2004) using integrated and managed passive treatment (IMPI). The IMPI technology has not been applied to many full-scale and permanent treatment sites. Passive sulphate removal uses the same fundamental treatment mechanisms at work in an anaerobic wetland, but with some of the following novel features:

- The Degrading Packed Bed reactor is filled with a specific sequence of selected organic materials, designed to hydrolyze ligno-cellulosic materials. The objective is to sustainably produce volatile fatty acids (VFA) to drive the sulphate reduction process.
- The sulphide oxidizing reactors (primary and secondary) are intended to partially oxidize the H<sub>2</sub>S to sulphur, with limited impacts on the VFA concentrations.
- The sulphate reduction reactor relies on the upstream generation of adequate and suitable readily biodegradable compounds, such as VFAs to support the sulphate reducing bacteria.

### 7.5.2.7 Alkaline Leach Beds

Alkaline leach beds are ponds or cells filled with limestone or steel slag. Like OLDs, they have occasionally been used to improve water quality at abandoned mine sites. The alkalinity is added up-gradient of significant concentrations of dissolved metals. Ideally, slightly acidic water with no metals is introduced into limestone-filled ponds. The limestone dissolution adds 50 to 75 mg/L of alkalinity as CaCO<sub>3</sub> to the water. The alkalinity buffers the stream and mitigates the effects of ARD entering downstream. At several sites where limestone-filled alkaline leach beds have been installed, fisheries have been re-established.

In situations where large metal and acid loads enter downstream, the upstream water must be charged with greater levels of alkalinity. Steel slag, a by-product and waste from the making of steel, contains high levels of alkalinity that are released into water. Alkaline leach beds can be filled with steel slag, which can generate much higher alkalinities in water (as much as 2,000 mg/L as CaCO<sub>3</sub>). Sites where these high alkalinities are generated must be carefully selected, because water that is too alkaline can be toxic to aquatic life.

### 7.5.2.8 Manganese Oxidation Beds

Manganese oxidation beds (MOBs) appear similar to alkaline leach beds but they are positioned as the final step in a successful passive treatment system of CMD. MOBs support the growth of a bacterial/algal consortium. The initial precipitation of MnO<sub>2</sub> or similar compounds is slow, but is apparently aided by the bacterial activity. Because MOBs are intended to facilitate manganese oxidation, the limestone cannot be completely inundated; the general rule is "one should be able to easily walk across a MOB without getting your feet wet". Both research and experience have indicated that the bacterial/algal organisms are naturally occurring and will typically colonize the bed within six to eight weeks (Brant and Ziemkiewicz, 1997, Rose et al., 2003). Once the bacteria oxidize the manganese and induce manganese oxide precipitation, the mineral surface catalyzes additional manganese oxidation (auto-catalysis). The algae employ the MnO<sub>2</sub> formed to provide hold-fasts to rocks in the flowing water and appear to facilitate manganese removal.

MOBs only function as a polishing step in a passive treatment system because they are only effective after virtually all of the iron has been removed, since dissolved Fe<sup>2+</sup> chemically reduces manganese, causing it to re-dissolve. Also, while MOBs allow manganese to be inexpensively removed at circum-neutral pH, manganese is sometimes only regulated as a surrogate for other more toxic metals, as stated in the CMD section of Chapter 2. Where that is the case, the presence of such metals may argue against the emplacement of a MOB unless the removal of those metals has also been addressed.



### 7.5.2.9 Design of Passive Treatment System Components

Gusek (2008) provides a detailed overview of the testing required to design a passive treatment system, which is summarized below. If the chemistry of the acidic drainage is complex or unique, the initial phase of the passive treatment evaluation might occur in the laboratory. As with any treatment process design, the composition of the water to be treated, the nominal flow rates and seasonal variations, and the target effluent levels must be clearly defined.

**Initial Feasibility Testing:** Typically, locally-available and plentiful candidate substrate materials for BCR systems are evaluated in the laboratory, involving testing, utilizing about 30 to 60 grams of different substrate materials in culture bottles immersed in drainage samples. The tests take about six to eight weeks. Aerobic testing is typically conducted simultaneously by monitoring effluent behaviour over time under aerobic conditions (algae inoculum) without substrate. A typical algae inoculum may include pond scum or algae growths from natural wetland sites near the project. Indicative measurements during proof-of-principle testing include pH, oxidation reduction potential (ORP), conductivity, substrate/water color, and odour (Gusek, 2008). These studies are static rather than flow-through experiments and are typically developed to test the suitability of the candidate substrate materials or inoculum in a passive treatment component and determine whether removal of a contaminant by microbial processes in a wetland with a known substrate composition is possible.

**Bench Scale Testing:** To conduct effective bench-scale tests, approximately 100 kg of substrate are operated in the field for at least three months utilizing a typical range of dissolved metals concentration in the influent. This approach begins to simulate the typical kinetic chemical reactions that might occur at a larger scale. Site-specific loading factors and substrate hydrology/permeability characteristics are determined during bench-scale testing.

**Pilot-Scale Testing:** Successful bench-scale testing supports the construction of pilot-scale systems utilizing tonnes of substrate. These systems are typically operated for at least a year before full-scale system design is finalized. If possible, pilot system cells are sized to be integrated into the overall, operational passive system design.

### 7.5.2.10 Passive Treatment System Performance

Generally, operational problems with passive treatment systems can be attributed to inadequate design, unrealistic expectations, pests, inadequate construction methods, and/or unanticipated perturbations (e.g., extreme storm events, long droughts). If properly designed and constructed, most passive treatment systems function very well with a minimum amount of attention and money. However, the specific performance and useful life of passive treatment systems are difficult to predict with a high level of confidence. The treatment kinetics and efficiency of such systems are influenced by site-specific environmental conditions, flow conditions and patterns, complex natural organic material, water chemistry, and seasonal variability. It is therefore important to pilot test such technologies before full-scale implementation and to use conservative design criteria and performance estimates.

Design and operation of passive treatment systems must take into account seasonal variations and specifically cold climate winter conditions. All biochemical and microbial reaction rates decrease as temperatures drop. Freezing conditions will impact passive treatment system performance, and can cause the system to fail. Care must be taken in applying generic design criteria to such cold winter operating conditions. Precautions can be taken in the case of some passive treatment facilities (such as anoxic limestone drains and RAPS) to insulate the treatment unit against the extremes of winter temperatures. However, the mine drainage temperature may still decrease during winter and impact the treatment efficiency. Pilot testing over a full year or more should provide data on efficiency changes in response to depressed mine water temperatures, if they can be anticipated to occur.

Limited information is available from full-scale treatment processes operated for a sustained period of time on the removal efficiencies for some contaminants. Younger et al. (2002) compiled a summary of postulated passive treatment removal mechanisms, which has been enhanced and modified based on the prevailing wisdom and experience regarding these systems in Table 7-8.

**Table 7-8: Postulated Removal Mechanisms of Metals and Mining-related Pollutants in Passive Treatment Systems**

Parameters	Postulated Removal Mechanisms	
	Aerobic Wetlands	Anaerobic Wetlands
Arsenic	Oxidation to form $\text{AsO}_4^{3-}$ , adsorption to ferric oxides	Reduction to $\text{As}^{3+}$ , precipitated as a number of sulphides
Cadmium	-	Precipitation as a sulphide
Chromium	-	Reduction of $\text{Cr}^{6+}$ to $\text{Cr}^{3+}$ , precipitated as hydroxide
Copper	Oxidation in alkaline environment, precipitation as carbonate	Reduction and precipitation as sulphide
Cyanide	Photolytic conversion, bacterial oxidation to $\text{NH}_3$ and $\text{N}_2$	Reduction and decomposition to $\text{NH}_3$ and $\text{CO}_2$
Lead	Oxidation in alkaline environment, precipitation as carbonate	Precipitation as a sulphide

Nickel	-	Precipitation as a sulphide
Zinc	Precipitation as a carbonate	Precipitation as a sulphide

The removal of these contaminants takes place simultaneously with the mainstream processes of removal of acidity, iron, sulphate, and aluminum, if present. The available information on the removal rates of the non-ferrous metals and other mine water parameters is growing, but site-specific verification is highly recommended. System designers must account for the potential for portions of a passive system to lose effectiveness, to determine where uncontrolled release may occur, and must allow for the long-term depletion of neutralizing material, such as limestone chips.

Probably the most common maintenance problem is stability in the dike and spillway. Reworking slopes, rebuilding spillways, and increasing freeboard can all be avoided by proper design and construction using existing guidelines for such construction.

Pests can plague wetlands with operational problems. Rodents such as muskrats can burrow into dikes, causing leakage and potentially catastrophic failure problems, and can also uproot significant amounts of cattails and other aquatic vegetation. Muskrats can be discouraged by lining dikes and slopes with chain link fence or riprap to prevent burrowing (Brodie, 1990). Beaver dams can cause water level disruptions and can seriously damage vegetation. They are very difficult to control once established. Small diameter pipes traversing wide spillways (three-log structure) and trapping have had limited success in beaver control. Large pipes with 90-degree elbows on the upstream end have been used as discharge structures in beaver-prone areas (Brodie, 1991). Otherwise, shallow ponds with dikes and shallow slopes toward wide, rip-rapped spillways may be the best design to deter beaver populations. Insects, such as the armyworm, with their appetite for Typha, have devastated monocultural wetlands (Hedin et al., 1994a). The use of a variety of plants in a system will minimize such problems. Mosquitoes can breed in wetlands where mine water is alkaline. In southern Appalachia, mosquito fish (*Gambusia affinis*) have been introduced into alkaline-water wetlands to control mosquito populations (Brodie, 1990).

#### 7.5.2.11 Concluding Comments on Passive Treatment

Characterization of influent water quality and quantity, including seasonal variation, is important prior to the selection and development of a passive treatment system (Hyman and Watzlaf, 1995). The presence or absence of periodic events, such as spring flushes of deposited metal salts from within the mine area, may influence the selection and sizing of passive systems.

Aerobic ponds and wetlands can be very effective for the removal of iron from net alkaline mine water, especially CMD. It appears that the original estimate of Hedin et al. (1994a) of 10 to 20  $\text{gd}^{-1} \text{m}^{-2}$  remains a convenient pre-construction rule-of-thumb for estimating pond and wetlands sizes. Recent studies have provided insight into the factors that control the overall processes, and these approaches may be used to fine-tune sizing criteria. As stated earlier, aeration can be used to sparge  $\text{CO}_2$  and increase pH, which can significantly increase iron oxidation rates, thereby reducing the size of aerobic ponds and wetlands needed for iron removal.

ALDs can effectively treat net acidic mine water with a pH below 5.0. At this pH, ferric iron and aluminum concentrations will be very low. Intercepted ground water is typically low in dissolved oxygen, and often contains partial pressures of  $\text{CO}_2$  higher than atmospheric levels, which allows for development of alkalinity concentrations greater than 100 mg/L as  $\text{CaCO}_3$ . Near maximum levels of alkalinity (usually between 150 and 300 mg/L) can be achieved with 15 hours or more of contact time. ALDs are tolerant of both ferrous iron and manganese, because they remain soluble within the ALD. However, the presence of ferric iron, and particularly aluminum, can reduce permeability of the ALD by precipitation of these metals within the voids in the limestone. In the absence of ferric iron and aluminum, ALDs have continued to perform well with no obvious seasonal variation or long-term reduction in effectiveness.

At mine sites where the appropriate water quality criteria were met and the ALD was sized properly, effective treatment of mine drainage occurred, provided that the ALD was followed by ponds and/or wetlands for iron oxidation, precipitation, and settling. At these sites, it is projected that the ALD will be effective for the designed lifetime of 25 to 30 years and, in some cases, well beyond. ALDs offer an effective means of introducing alkalinity into net acidic waters that contain neither ferric iron nor aluminum. The presence of either of these ions will reduce permeability of the ALD by precipitation, which will cause premature failure by clogging. In the absence of these ions, ALDs have continued to perform well with no obvious seasonal variation or long-term degradation. Near maximum levels of alkalinity (usually between 150 and 300 mg/L) can be achieved with 15 hours or more of contact time. ALDs are tolerant of both ferrous iron and manganese. ALDs must be viewed as a unit operation, not a standalone remediation technique, and must be followed by a pond and wetland for iron oxidation, precipitation, and settling.

Alkaline addition in RAPS is dominated by the limestone dissolution pathway. The rate of alkaline addition for a single RAPS unit is about 40 to 60  $\text{gd}^{-1} \text{m}^{-2}$ . Rates for the second RAPS in a series fall off to about 1/2 to 1/3 of the rate of the first system. Much of the variability in performance can be attributed to influent water quality and detention time. As with ALDs, RAPS should be viewed as unit operations, not stand-alone technologies. They must be preceded by a pond/wetland to precipitate iron and other settleable solids. As with ALDs, RAPS must also be followed by a pond and wetland for iron oxidation, precipitation, and settling.

Finally, care should be taken to obtain sufficient water quality data, including seasonal variation, before designing and developing a passive treatment system. Site and funding constraints may limit the applicability of passive techniques for some mine drainages. However, for those drainages with appropriate water quality and land availability, passive treatment systems continue to perform very well.

#### 7.5.3 In situ Treatment Technologies

In situ treatment of mine drainage can be undertaken in many different ways and configurations. This section is limited to a brief discussion that includes the following:

- Spreading of alkaline material across mining impacted land and mine waste

- In pit water (pit lake) treatment
- Organic covers of mine land and mining waste
- Permeable reactive barriers (i.e., organic-rich material, zero-valent iron)

In situ treatment of acidic mine water by injection of alkaline lime slurry to disturbed mine land, spoils, and mining waste has met with mixed success for mine drainage. The challenges to practical mine-scale applications include the following:

- Flow and transport characteristics of the mine waste material, described as pseudokarstic aquifer due to the presence of interconnected preferential flow paths
- Introducing the lime slurry (or any other alkaline solution) in a manner that will ensure distribution and effective contact with acid producing zones or water bodies
- The scale of such operations and the preparation of infiltration beds or trenches, which do not blind or suffer from ponding

Full-scale trials have been conducted in West Virginia surface coal mines (Donovan et al., 2000) with some success. Pit lake treatment typically involves the spreading and dispersion of an alkali material across the accumulated water surface. The challenge is to effectively bring the alkali material into contact with the large water body. Available approaches are as follows:

- Approach 1 - Spreading of the alkali material in a powder or slurry form across the full aerial extent of the pit lake. This relies on the even spreading of the alkali material and sufficient mixing and contact time between the alkali material and the pit lake. Unreacted alkali material will accumulate on the pit floor, together with associated neutralization reaction products such as metal precipitates.
- Approach 2 - Abstracting the pit water and pumping/flowing the water across or through an alkali mix device for blending and dissolution of alkali material. The pit water and alkali blend stream is then returned to the pit for completion of the neutralization reactions, precipitation of metals, and dispersion of the alkali material.
- Approach 3 – Adding alkali material in the early stages of pit flooding as water is entering the pit or workings.

The challenges to in situ pit water treatment include the following:

- Effective contact between alkali material and pit water
- Efficient use of available alkali material
- Long-term dissolution of precipitated metals from the sludge layers
- Poor control of the pH and redox conditions in all parts of the pit lake to achieve the target treatment objectives

## 7.6 Treatment Residues and Wastes

All mine drainage treatment technologies produce some residues (e.g., sludge, brines, and spent media) or emissions (e.g., gasses). These residues and emissions contain the elements and compounds removed from the mine drainage and the additives and supplements dosed in the treatment process. No consideration of mine drainage treatment technologies is complete without an understanding of these residues and emissions as it relates to the following:

- Relative production in terms of volumes and masses
- Typical characteristics in terms of chemical composition (e.g., hydroxide, sulphide, and NP) and physical properties (i.e., consistency, volatility, and dewater ability)
- Hazardous classification and rating
- Potential environmental impacts
- Disposal options

The treatment residues can be broadly classified into the following two categories:

- Sludge, which is a slurry or dewatered cake containing precipitates of diverse composition
- Brines, which contains soluble salts in high concentrations

### 7.6.1 Sludge Management

Sludge management is an escalating concern as the inventory of sludge continues to increase and the stability of the sludge under various disposal conditions is poorly understood. As such, the management and disposal of these mining wastes requires careful consideration and planning.

#### 7.6.1.1 General Considerations

To design the most appropriate sludge management strategy for a site, several factors need to be considered. The principal considerations are the mass of sludge produced, whether the mine is operating or closed, dewatering ability of the sludge, sludge density (moisture content), sludge volume, chemical and physical stability, sludge composition, disposal location availability, and economics (Zinck, 2006). The ability of a sludge to dewater may limit the options available. Sludges that can dewater without mechanical assistance will not only reduce the area required for disposal, but also make it more attractive for reuse options. The ability of sludge to dewater depends on its particle size, morphology, and surface charge. As a particle deviates from a spherical shape, the surface area per unit volume increases, resulting in reduced settleability and decreased dewatering rate. These characteristics are linked directly to the water treatment process that generates the sludge and to the raw water chemistry (Zinck, 2005).

### 7.6.1.2 Sludge Disposal

Various options available for sludge disposal are reviewed below.

#### *Pond disposal*

Sludge management involves three principal steps, namely solid-liquid separation, sludge dewatering, and disposal. Many sites utilize settling ponds as an efficient sludge management option. The sludge is pumped to a settling pond where solid-liquid separation, dewatering and, in many cases, disposal occur simultaneously. Issues associated with pond disposal are minimal. Wind resuspension and dusting present problems at some sites, particularly in arid or northern regions. Due to the large requirement for space, land use can be a challenge for some sites. Due to the thixotropic nature of sludges (viscosity decreases as shear strength increases), pond failure could present some concerns, although generally not to the same extent as with tailings impoundments. In a pond environment, either with or without a water cover, the degree of metal leaching is expected to be minimal, as the excess alkalinity available in the sludge is enough to sustain a moderate pH for decades, even centuries (Zinck et al., 1997). Sludge disposal in a pond environment can be either subaerial or subaqueous. In a subaerial environment, the sludge is exposed to weathering conditions. Sludge cracking due to moisture loss at the surface is prevalent, causing an increase in surface water infiltration. Under these conditions, sludge dewatering occurs at the surface while the majority of the sludge at depth is still very moist. The desiccated surface may be reclaimed (Zinck, 2006).

#### *Codisposal with Tailings*

The practice of co-mixing tailings with treatment sludge for disposal involves injecting the treatment sludge into the tailings slurry prior to discharge to the impoundment. Typically, the sludge to tailings ratio is less than 1:20. Here the sludge serves to fill void spaces within the tailings, in theory reducing the potential for water or air infiltration and the hydraulic conductivity of the mixture. This method of disposal could be an effective option provided that the tailings are either non-acid generating or that tailings oxidation is prevented. However, if the tailings undergo oxidation and commence acid generation, the likelihood for sludge dissolution and metal mobilization is high (Zinck, 2006).

#### *Sludge as a Cover over Tailings*

The application of wet and dry covers to prevent acidic drainage is widely adopted. Wet covers provide a barrier that minimizes oxygen contact with potentially acid generating material and, except for minor oxygen dissolved in the water, precludes contact with atmospheric oxygen completely. Some of the issues related to the application of a sludge cover on tailings are cracking and preferential channelling. Therefore, sludge needs to be disposed in a manner by which the particles will not segregate, such that the sludge and the underlying tailings remain saturated (Zinck, 2006).

#### *Sludge Disposal with Waste Rock*

Disposing sludge with waste rock has several of the same potential benefits as disposal with tailings, including utilization of excess alkalinity to offset acid generation and filling of void spaces. This practice of disposing treatment sludge in waste rock piles is being adopted at some sites. While results (Coleman et al., 1997) show that sludge is not effective as a capping material, this method was found to be a low-cost final disposal option because the sludge filled pore spaces and voids within the waste rock pile.

#### *Disposal in Underground Mine Workings*

Disposal of treatment sludge into underground mine workings has several benefits that make it an attractive sludge management option. The deposition of sludge into underground mines reduces the footprint required for disposal sites (landfills and impoundments), eliminates the potential for surface water pollution, reduces the potential for subsidence, and improves the aesthetics of the local area. Also, in acidic mine workings, the underground disposal could have the additional benefit of reducing the acidity of the mine water. This practice involves pumping or trucking sludge to boreholes, which are drilled into underground inactive mines. Some of the factors that need to be considered in this disposal option include:

- Site availability and access
- Mine capacity, void space, configuration
- Sludge properties (e.g. viscosity)

This method is very attractive from an economic and environmental standpoint. However, like most disposal options presented, this is clearly site specific. Sludge with high iron content can most probably be disposed of this way economically. Disposal of sludge with high Cd, Zn, or Ni content in this manner may or may not be economic or environmentally acceptable depending on the contact effectiveness and ratio between the sludge and acidic mine water, the alkalinity of the sludge, and the acidity of the mine drainage (Aubé, 2004 and Aubé et al., 2005).

#### *Disposal in Pit Lakes*

Disposal in an abandoned open pit is typically one of the most economical solutions for sludge storage, if a pit is within a reasonable pumping distance from the treatment plant. Many companies frequently take advantage of open pits available on site as an appropriate short or long-term sludge disposal option. Some excellent work on this option has been described by McNee et al. (2003) and McNee (2004).

## 7.6.2 Brine Management

Brine disposal is much more challenging, and the disposal options include the following:

- Incorporation into a mine waste or tailing stream

- Irrigation and potential cultivation of salt resistant plants
- Solar evaporation ponds, possibly with some wind-assisted features
- Discharge and dilution in a sanitary sewer
- Mechanical evaporation and crystallization
- Beneficial use in the cultivation of halophilic (“salt loving”) algal species of commercial value

## 7.7 Recovery of Useful Products

A paradigm shift has taken place in the handling and management of treatment residues, such as sludges and brines. The recovery of useful and saleable products is now researched and actively pursued. The recovery of useful products from the treatment process waste streams may include the following:

- Metals recovery
- Supplements for mine land rehabilitation and revegetation, such as  $\text{CaSO}_4 \cdot 2\text{H}_2\text{O}$
- Alkali recovery, such as  $\text{CaCO}_3$
- Building and construction related materials, such as gypsum
- Beneficial use of brine in the cultivation of halophilic organisms, such as algae containing high  $\beta$ -carotenes and other nutritional supplements
- Recovery of saleable products, such as sulphur and magnesium salts
- Agricultural use (e.g., fertilizer)
- Supplement in cement manufacturing
- Gravel from sludge
- Metal adsorbents in used industrial wastewater treatment
- Pigment (ferrihydrite) (Hedin, 1988, 2002)

For a detailed discussion on reuse options for ARD treatment sludge refer to Zinck (2005). Research and development work in this area are ongoing. The incentives driving the recovery of byproducts include the following:

- Reduction of waste sludge and brine products, which require perpetual handling and disposal with associated long-term environmental liabilities
- Generation of a revenue stream to partly or fully offset the ongoing treatment cost
- Contribution to the long-term sustainability of mine water treatment projects

The key aspects of successful byproducts recovery in the treatment of mine drainage are as follows:

- The target byproducts must be selectively removed by minimizing the co-precipitation of compounds that would degrade the quality of by-products.
- By-products recovery, as a project objective, will have an impact on the mainstream treatment process in terms of unit treatment, process selection, and sequence of treatment processes.
- Chemicals (reagents) dosing to the mainstream treatment process must take into account the impact on the potential for and composition of by-products.

## 7.8 Treatment in the Context of Mine Closure and Post Closure

The approach to mine drainage treatment during and after closure of mining operations must be placed in context with respect to the following factors:

- Changes in mine drainage flow and quality
- Climate change over the long term
- Long-term operations and maintenance
- Capital replacement cost
- Non-mining water user requirements
- Involvement from non-mining stakeholders

Mine drainage volumes requiring treatment may increase or decrease after mine closure. The opportunities for consumptive on-mine water usage decrease after closure, potentially resulting in increased excess mine drainage volumes. On the other hand, completion of rehabilitation work after closure may decrease the ingress of water into old mining operations, resulting in decreased excess mine drainage.

Management and support for long-term post-closure operation and maintenance of mine drainage treatment facilities may be limited. Passive treatment technologies are therefore considered more beneficial in the post-closure situation than active treatment technologies, where applicable.

Mine planners should consider post-closure water treatment system land requirements in the design of tailings storage facilities and mine waste dumps so that space is available, when needed, and post-closure water treatment does not become a major design constraint that forces the implementation of active treatment technologies. For example, a waste rock dump might be configured in a way that leaves adequate room at the toe for collection and passive treatment of residual seepage. A similar design protocol should be followed for tailings dams and other long-term mine waste facilities that may generate drainage in some cases in perpetuity.

The design life of post-closure treatment facilities should be based on geochemical model predictions of the long-term mine drainage flow and quality.

Replacement of capital infrastructure and equipment items must be taken into account for continued post-closure treatment. Mine drainage flows and associated pollutant loads are typically projected to continue for a considerable period after mine closure. In some cases, this long-term projection for continued treatment may even require a re-evaluation of the appropriate treatment approach and technology as research and technology development take place.

Communities and other non-mining economic activities may rely on the long-term availability of mine drainage. Such reliance is not necessarily negative because the transfer of mine drainage treatment facilities to a third party may assist in the sustainability of a post-mining situation. For instance, the Emalahleni Local Municipality in South Africa receives a substantial part of their drinking water supply from a mine water reclamation plant (Gunther et al., 2008).

The early involvement of non-mining stakeholders to identify and implement post-closure beneficial and economic use of mine drainage will assist in developing appropriate treatment infrastructure.

## 7.9 Evaluation and Selection of Drainage Treatment Technologies

The evaluation of alternative drainage treatment technologies and the selection of an appropriate technology for a specific application require consideration of many of the following factors:

- Technical factors:
  - Scale of project
  - Location and accessibility of project
  - Location within the overall mine water cycle and circuits
  - Raw water composition and flow rate
  - Fit into the life cycle of the mine
  - Proven technology
  - Treated water quality requirements
  - Reliable performance
  - Risks related to implementation
- Operational factors:
  - Operations manpower and labour requirements
  - Process control and automation
  - Utility requirements (e.g., electrical power and water)
  - Chemicals and reagents requirements
  - Maintenance
  - Logistics and communications
- Environmental factors:
  - Residual impacts of treated water discharge
  - Climatic conditions
  - Waste disposal
  - Land use impacts
  - Regulatory approvals
- Financial factors:
  - Capital investment
  - Capital replacement costs
  - Operations and maintenance (O&M) costs
- Management factors:
  - Negotiating with regulators and other stakeholders
  - Defining decision process
  - Funding for all phases of mining
  - Negotiating for unexpected resources requirements
  - Maintaining companies' credibility and good standing
- Social Factors:
  - Community acceptance and involvement

A life cycle financial model approach is typically applied to evaluate the treatment project financial implications, including the following:

- Production and management of wastes and emissions
- Potential for by-product recovery
- Sustainability during active mining and post-closure phases

## 7.10 Case Studies

The following case studies are provided to demonstrate some of the technologies highlighted in this chapter.

1. The Argo Tunnel - Pulsed Limestone Bed Treatment
2. Bisbee No. 7 stockpile – BioSulphide process
3. Equity Silver – High Density Sludge Treatment Plant
4. Keystone Mine – Constructed Wetlands

The Interstate Technology and Regulatory Council (ITRC) in the USA also has compiled several very useful case studies on their website:

[http://www.itrcweb.org/miningwaste-guidance/case\\_studies.htm](http://www.itrcweb.org/miningwaste-guidance/case_studies.htm)

## 7.11 References

- Ackman, T.E., and R.L.P. Kleinmann, 1984. In-line aeration and treatment of acid mine drainage. In: D.H. Graves (Ed.), Proceedings Symposium on Surface mining Hydrology, Sedimentology and Reclamation, University of Kentucky, Lexington, KY, 29-34.
- Ackman, T.E., and R.L.P. Kleinmann, 1991. An in-line system for treatment of mine water. *International Mine Waste Management News*, 1(3):1-4.
- Adams, J. 2008. Personal communication to Dr. Terrence Chatwin, INAP, September 2008.
- Arnold, D.E., 1991. Diversion wells - A low-cost approach to treatment of acid mine drainage. In: Proceedings 12th West Virginia Surface Mine Drainage Task Force Symposium, Morgantown, WV.
- Aubé, B, Clyburn, B. and Zinck, J. 2005. Sludge Disposal in Mine Workings at Cape Breton Development Corporation, In Proceedings of Mining and the Environment: Securing the Future, Sweden.
- Aubé, B. 2004. Sludge Disposal in Mine Workings at Cape Breton Development Corporation. MEND Ontario Workshop, Sudbury. May 26-27, 2004, CD-ROM.
- Aubé, B. and Zinck, J. 2009. Mine Drainage Treatment: A Detailed Review of Active Treatment Options, Advantages and Challenges. Short Course presented at the 8th International Conference on Acid Rock Drainage, June 2009, Sweden.
- Benning, B.A., and M.L. Otte, 1997. Retention of metals and longevity of a wetland receiving mine leachate. In: Proceedings of 1997 National Meeting of the American Society for Surface Mining and Reclamation, Austin, TX, 43-46.16.
- Brant, D.L., and P.F., Ziemkiewicz, 1997. Passive removal of manganese from acid mine drainage. In: Proceedings 14th Meeting of the American Society for Surface Mining and Reclamation, Austin, TX, 741-744.
- Brodie, G.A., 1990. Treatment of acid drainage using constructed wetlands: experience of the Tennessee Valley Authority. In: Proceedings National Symposium on Mining, Lexington, KY, 77-83.
- Brodie, G.A., 1991. Achieving compliance with staged aerobic constructed wetlands to treat acid drainage. In: Proceedings National Meeting of the American Society for Surface Mining and Reclamation, Princeton, WV, 151-174.
- Brown, M., Barley, B., and H. Wood, 2002. *Minewater Treatment, Technology, Application and Policy*. IWA Publishing, London, UK.
- Cohen, R.R.H., and S.W. Staub, 1992. Technical manual for the design and operation of a passive mine drainage treatment system. U.S. Bureau of Land Management and U.S. Bureau of Reclamation.
- Coleman, M.M.D., T.J. Whalen and A. Landva. 1997. Investigation on the Placement of Lime Neutralization Sludge on Acid Generating Waste Rock, In: Proceedings of the Fourth International Conference on Acid Rock Drainage, May 31 – June 6 1997, Vancouver, Canada. Vol 3, pp. 1163-1175.
- Cravotta III, C.A., and G.R. Watzlaf, 2002. Design and performance of limestone drains to increase pH and remove metals from acidic mine drainage. *Handbook of Groundwater Remediation using Permeable Reactive Barriers*, Elsevier Science, New York, NY, 19-66.
- Crear, Robert. 2001. Engineering And Design Precipitation/ Coagulation/ Flocculation. Department of the Army EM 1110-1-4012. U.S. Army Corps of Engineers. CECW-ET Washington, DC 20314-1000. Manual 15 November 200. No. 1110-1-4012.
- Dempsey, B.A., Roscoe, H.C., Ames, R., Hedin, R., and B.H. Jeon, 2001. Ferrous oxidation chemistry in passive abiotic systems for treatment of mine drainage. *Geochemistry: Exploration, Environment, and Analysis*, 1(1):81-88.
- Deul, M., and E.A. Mihok, 1967. *Mine Water Research: Neutralization*. USBM RI 6987.
- Donovan, J.J., Fazier, J., Ziemkiewicz, P.F., Daly, M., Black, C., and E. Werner, 2000. Experimental injection of alkaline lime slurry for in-situ remediation of an acidic surface mine aquifer. In: Proceedings 5th International Conference on Acid Rock Drainage (ICARD), May 21-24, Denver, CO, Society for Mining, Metallurgy, and Exploration, Inc., Littleton, CO, 2:1001-1115.

- Duddlestone, K.N. E. Fritz, A.C. Hendricks, and K. Roddenberry. 1992. Anoxic cattail wetland for treatment of water associated with coal mining activities. p. 249-254, In: Proceedings, 1992 National Meeting of the American Society for Surface Mining and Reclamation.
- Faulkner, B.B., and J.G. Skousen, 1994. Treatment of acid mine drainage by passive treatment systems. USBM SP 06A-94, 250-257.
- Faulkner, B.B., and J.G. Skousen, 1995. Effects of land reclamation and passive treatment systems on improving water quality. *Green Lands*, 25(4):34-40.
- Geldenhuys, A.J., Maree, J.P., de Beer, M., and P. Hlabela, 2001. An Integrated Limestone/Lime Process for Partial Sulphate Removal. Conference on Environmentally Responsible Mining in South Africa, CSIR, Pretoria, South Africa.
- Gerber, D.W., Burris, J.E., and R.W. Stone, 1985. Removal of dissolved iron and manganese ions from water by a sphagnum moss system. In: Proceedings Wetlands and Water Management on Mined Lands, Pennsylvania University, University Park, PA, 365-372.
- Girts, M.A., Kleinmann, R.L.P., and P.M. Erickson, 1987. Performance data on Typha and Sphagnum wetlands constructed to treat coal mine drainage. In: Proceedings 8th Meeting of the West Virginia Surface Mine Drainage Task Force Symposium.
- Gunther, P., Naidu, T., and W. Mey, 2008. Emalahleni mine water reclamation project-key learnings. Water Institute of Southern Africa, May, Sun City, South Africa.
- Gusek, J., 1998. Three case histories of passive treatment of metal mine drainage. In: Proceedings 19th West Virginia Surface Mine Drainage Task Force Symposium, Morgantown, WV.
- Gusek, J., 2002. Sulphate-Reducing Bioreactor Design and Operating Issues: Is This the Passive Treatment Technology for Your Mine Drainage? National Association of Abandoned Mine Land Programs, September 15-18, Park City, UT.
- Gusek, J.J., 2008. Passive Treatment 101: An Overview of the Technologies. 2008 U.S. EPA/National Groundwater Association Remediation of Abandoned Mine Land Conference, October. Denver, CO.
- Gusek, J.J. and J.S. Waples (2009). A Periodic Table of Passive Treatment for Mining Influenced Water. In: Proceedings of the 8th International Conference on Acid Rock Drainage (ICARD), June 22-26, Skellefteå, Sweden.
- Gusek, J., Mann, C., Wildeman, T., and D. Murphy, 2000. Operational results of a 1200 gpm passive bioreactor for metal mine drainage, West Fork, Missouri. In: Proceedings of 5th International Conference on Acid Rock Drainage (ICARD), May 21-24, Denver, CO, Society for Mining, Metallurgy, and Exploration, Inc., Littleton, CO, 2:1133-1137.
- Gusek, J., Wildeman, T., and D. Reisman, 2007. Development of Modern Sulfate Reducing Bioreactors for Treatment of Mine Waters.
- Hammer, D.A., 1992. Creating Freshwater Wetlands. Lewis Publishers, Boca Raton, FL.
- Hedin, R.S., Nairn, R.W., and R.L.P. Kleinmann, 1994. Passive Treatment of Coal Mine Drainage. Information Circular 9389, Bureau of Mines, United States Department of the Interior, Pittsburgh, PA.
- Hedin, R.S., Nairn, R.W., and R.L.P. Kleinmann, 1994a. Passive Treatment of Coal Mine Drainage. USBM IC 9389.
- Hedin, R.S., 1988. Potential recovery of iron oxides from coal mine drainage. In: Proceedings 19th Meeting of the West Virginia Surface Mine Drainage Task Force Symposium.
- Hedin, R.S., 2002. Recovery of marketable iron oxide from mine drainage. In: Proceedings National Meeting of the American Society of Mining and Reclamation, Lexington, KY, 517-526.
- Hedin, R.S., Hyman, D.M., and R.W. Hammack, 1988. Implication of sulfate-reduction and pyrite formation processes for water quality in a constructed wetland. US Bureau of Mines IC 9183, 382-389.
- Hedin, R.S., Watzlaf, G.R., and G.R. Nairn, 1994b. Passive treatment of acid mine drainage with limestone. *Journal of Environmental Quality*, 23(6):1338-1345.
- Hendricks, A. C. 1991. The use of an Artificial Wetland to Treat Acid Mine Drainage. In Proceedings of the International Conference on the Abatement of Acidic Drainage. Montreal, Canada. September 1991.
- Howard, E.A., Emerick, J.E., and T.R. Wildeman, 1989. The design, construction and initial operation of a research site for passive mine drainage treatment in Idaho Springs, Colorado. In: D.A. Hammer (Ed.), *Constructed Wetlands for Wastewater Treatment*, Lewis Publishers, Ann Arbor, MI, 761-764.
- Huntsman, B.E., Solch, J.G., and M.D. Porter, 1978. Utilization of Sphagnum species dominated bog for coal acid mine drainage abatement. In: Abstracts 91st Annual Meeting of the Geological Society of America, Toronto, ON, 322.
- Huntsman, B.E., Kleinmann, R.L.P., and T.O. Tiernan, 1985. Hydrologic and geochemical considerations in maintaining man-made wetlands constructed for acid mine drainage abatement. In: Proceedings Wetlands and Water Management on Mined Lands, Pennsylvania University, University Park, PA, 375.



- Hyman, D.M., and G.R. Watzlaf, 1995. Mine drainage characterization for the successful design and evaluation of passive treatment systems. In: Proceedings 17th Annual Conference of the Association of Abandoned Mine Lands, French Creek, IN, 170-185.
- Jenkins, M., and J. Skousen, 1993. Acid mine drainage treatment with the Aquafix System. In: Proceedings 14th West Virginia Surface Mine Drainage Task Force Symposium, West Virginia University, Morgantown, WV.
- Jenkins, M. and J. Skousen, 2001. Acid mine drainage treatment costs with calcium oxide and the Aquafix Machine. *Green Lands* 31: 46–51.
- Kalin, M., Fyson, A., and M.P. Smith, 1996. Passive Treatment Processes for the Mineral Sector. In: Proceedings 2nd International Symposium on Waste Processing and Recycling in the Mineral and Metallurgical Industries, Vancouver, BC, 363-376.
- Kairies, C.L., Watzlaf, G.R., Hedin, R.S., and R.C. Capo, 2001. Characterization and resource recovery potential of precipitates associated with abandoned coal mine drainage. In: Proceedings National Meeting of the American Society for Surface Mining and Reclamation, Albuquerque, NM, 278-279.
- Kepler, D.A., 1995. Successive alkalinity-producing systems (SAPS). In: Proceedings 10th West Virginia Surface Mine Drainage Task Symposium.
- Kepler, D.A., and E.C. McCleary, 1994. Successive alkalinity-producing systems (SAPS) for the treatment of acid mine drainage. USBM SP 06B-94, 195-204.
- Kepler, D.A., and E.C. McCleary, 1997. Passive aluminum treatment successes. In: Proceedings 12th West Virginia Surface Mine Drainage Task Symposium.
- Kirby, C.S., Thomas, H.M., Southman, G., and R. Donald, 1999. Relative contributions of abiotic and biological factors in Fe(II) oxidation in mine drainage. *Applied Geochemistry*, 14:511-530.
- Kleinmann, R.L.P., 1985. Treatment of Acidic Mine Water by Wetlands. USBM IC 9027, 48-52.
- Kleinmann, R.L.P., Tiernan, T.O., Solch, J.G., and R.L. Harris, 1983. A low-cost, low-maintenance treatment system for acid mine drainage using Sphagnum moss and limestone. In: Proceedings National Symposium on Mining, University of Kentucky, Lexington, KY, 241-245.
- Kruse, N.A.S., Gozzard, E., and A.P. Jarvis, 2009. Determination of hydraulic residence times in several UK mine water treatment systems and their relationship to iron removal. *Mine Water and the Environment* (in press).
- Leblanc, M., Achard, B., Othman, D.B., Luck, J.M., Bertrand-Sarfati, J., and J.C. Personne, 1996. Accumulation of arsenic from acidic mine waters by ferruginous bacterial accretions (stromatolites). *Applied Geochemistry*, 11:541–554.
- McIntyre, P.E., and H.M. Edenborn, 1990. The use of bacterial sulfate reduction in the treatment of drainage from coal mines. In: J. Skousen, J. Sencindiver and D. Samuel (Eds.), Proceedings Mining and Reclamation Conference and Exhibition, 2:409-415.
- McNee, J.J. 2004. The Implications of Sludge Deposition to the Physical and Geochemical Evolution of a Pit Lake, MEND Ontario Workshop, Sudbury. May 26-27, 2004, CD-ROM.
- McNee, J.J. , J. Crusius , A.J. Martin; P. Whittle; R. Pieters; T.F. Pedersen. 2003. The Physical, Chemical and Biological Dynamics of Two Contrasting Pit Lakes: Implications for Pit Lake Bio-Remediation Proceedings of the Sudbury 2003 Mining and the Environment Conference, 25-28 May 2003, Sudbury, ON, Canada. Laurentian Univ., Sudbury, ON. Centre for Environmental Monitoring, ISBN: 0-88667-051-9. CD-ROM, pp.16
- Mihok, E.A., 1970. Mine Water Research: Plant Design and Cost Estimates for Limestone Treatment. USBM RI 7368.
- Nairn, R.W., Hedin, R.S., and G. Watzlaf, 1991. A Preliminary review of the use of anoxic limestone drains in the passive treatment of acid mine drainage. In: Proceedings 12th Annual West Virginia Surface Mine Drainage Task Force Symposium, Morgantown, WV.
- Nawrot, J., 1990. Mine drainage treatment through enhanced biological sulfate reduction within wetlands. In: J. Skousen, J. Sencindiver and D. Samuel (Eds.), Proceedings Mining and Reclamation Conference and Exhibition, 2:353-364.
- PIRAMID Consortium, 2003. Engineering guidelines for the passive remediation of acidic and metalliferous mine drainage and similar wastewaters. European Commission 5th Framework RTD Project EVK1-CT-1999-000021, University of Newcastle Upon Tyne, Newcastle Upon Tyne, UK.
- Pulles, W., Juby, G.J.G., and R.W. Busby, 1992. Development of the Slurry Precipitation and Recycle Reverse Osmosis (SPARRO) Technology for Desalination Scaling Mine Water. IAWPRC Specialized Conference on Membrane Technology in Wastewater Management, Cape Town, South Africa.
- Pulles, W., Coetser, L., Heath, R., and R. Muhlbauer, 2004. Development of high-rate passive sulphate reduction technology for mine waters. In: Proceedings of IMWA Conference, September 19-23, University of Newcastle, UK, 253-265.
- Rose, A.W., Shah, P.J., and B. Means, 2003. Case studies of limestone-bed passive systems for manganese removal from acid mine drainage. In: Proceedings National Meeting of the American Society for Mining and Reclamation, Billings, MT, 1059-1078.
- Sencindiver, J.C., and D.K. Bhumbra, 1988. Effects of cattails (Typha) on metal removal from mine drainage. In: Proceedings Mine Drainage and Surface Mine Reclamation, USBM IC 9183, 1:359-369.

- Simmons, J., Ziemkiewicz, P., and D.C. Black, 2002. Use of steel slag leach beds for the treatment of acid mine drainage. *Mine Water and the Environment*, 21(2):91-99.
- Skousen, J., and B. Faulkner, 1992. Preliminary results of acid mine drainage treatment with anoxic limestone drains in West Virginia. In: *Proceedings 13th West Virginia Surface Mine Drainage Task Symposium*.
- Skousen, J., and P. Ziemkiewicz, 1996. *Acid Mine Drainage Control and Treatment*, 2nd Edition. National Research Center for Coal and Energy, National Mine Land Reclamation Center, West Virginia University, Morgantown, WV.
- Spratt, A.K., and R.K. Wieder, 1988. Growth responses and iron uptake in Sphagnum plants and their relations to acid mine drainage (AMD) treatment. In: *Proceedings Mine Drainage and Surface Mine Reclamation*, USBM IC 9183, 1:279-286.
- Stark, L.E., Stevens, H., Webster, H., and W. Wenerick, 1990. Iron loading, efficiency, and sizing in a constructed wetland receiving acid mine drainage. In: J. Skousen, J. Sencindiver and D. Samuel (Eds.), *Proceedings Mining and Reclamation Conference and Exhibition*, 2:393-401.
- Stone, R.W., and B.J. Pesavento, 1985. Micro-and macro-biological characteristics of wetlands removing iron and manganese. In: *Proceedings Wetlands and Water Management on Mined Lands*, Pennsylvania State University, University Park, PA, 373.
- Turner, D., and D. McCoy, 1990. Anoxic alkaline drain treatment system, a low cost acid mine drainage alternative. In: *Proceedings National Symposium on Mining*, University of Kentucky, Lexington, KY, 73-75.
- Watzlaf, G.R., and R.S. Hedin, 1993. A method for predicting the alkalinity generated by anoxic limestone drains. In: *Proceedings 14th West Virginia Surface Mine Drainage Task Force Symposium*.
- Watzlaf, G.R., and D.M. Hyman, 1995. Limitations of passive systems for the treatment of mine drainage. In: *Proceedings 17th Association of Abandoned Mine Lands Conference*, 186-199.
- Watzlaf, G.R., Kairies, C.L., and K.T. Schroeder, 2003. Flushing of metals from reducing and alkaline producing systems. In: *Proceedings American Society of Mining and Reclamation*, Billings, MT, 1425-1426.
- Watzlaf, G.R., Schroeder, K.T., and C.L. Kairies, 2001. Modeling of Iron Oxidation in a Passive Treatment System. In: *Proceedings National Meeting of the American Society for Surface Mining and Reclamation*, Albuquerque, NM, 626-638.
- Watzlaf, G.R., Schroeder, K.T., Kleinmann, R.L.P., Kairies, C.L., and R.W. Nairn, 2004. The Passive Treatment of Coal Mine Drainage. DOE/NETL-2004-1202.
- Wieder, R.K., and G.E. Lang, 1982. Modification of acid mine drainage in a freshwater wetland. In: *Proceedings Symposium on Wetland of the Unglaciated Appalachian Region*, West Virginia University, Morgantown, WV, 45-53.
- Wildeman, T.R., and L.S. Laudon, 1989. Use of wetland for treatment of environmental problems in mining/non-coal mining applications. In: D.S. Hammer (Ed.), *Constructed Wetlands for Wastewater Treatment – Municipal, Industrial, and Agricultural*, Lewis Publishing, Chelsea, MI, 221-231.
- Wildeman, T., Machener, S., Klusman, R., Cohen, R., and P. Lemke, 1990. Metal removal efficiencies from acid mine drainage in the Big Five constructed wetland. In: J. Skousen, J. Sencindiver and D. Samuel (Eds.), *Proceedings Mining and Reclamation Conference and Exhibition*, 2:425-433.
- Wildeman, T.R., Spotts, E., Schafer, W., and J. Gusek, 1994. Characterization, management and treatment of water for metal-mining operations. Short course, Meeting of the American Society for Surface Mining and Reclamation, Pittsburgh, PA.
- Younger, P.L., 2000. The adoption and adaptation of passive treatment technologies for mine waters in the United Kingdom. *Mine Water and the Environment*, 19:84-97.
- Younger, P.L., Banwart S.A., and R.S. Hedin, 2002. *Mine Water: Hydrology, Pollution, Remediation*. Kluwer Academic Publishers, Dordrecht, The Netherlands.
- Ziemkiewicz, P.F., Skousen, J., and R.J. Lovett, 1994. Open limestone channels for treating acid mine drainage: a new look at an old idea. *Green Lands*, 24(4):36-41.
- Ziemkiewicz, P.F., Skousen, J., Brant, D.L., Sterner, P.L., and R.J. Lovett, 1997. Acid mine drainage treatment with armored limestone in open limestone channels. *Journal of Environmental Quality*, 26:1017-1024.
- Zinck, J. *Disposal, Reprocessing And Reuse Options For Acidic Drainage Treatment Sludge*. 2006, 7th ICARD, March 26-30, 2006, St. Louis MO. Published by ASMR, 3134 Montavesta Rd., Lexington, KY 40502.
- Zinck, J., Fiset, J.F., and W. Griffith, 2007. Chemical Treatment Options for Effective Sulphate Removal from Acidic Drainage and Process Water. *Mining and the Environment*, October 20-27, Sudbury, ON.
- Zinck, J. 2005. Review of Disposal, Reprocessing and Reuse Options for Acidic Drainage Treatment Sludge. CANMET Report 04-007 CR prepared for

MEND (Report 3.42.3 )

Zinck, J.M. and B.C. Aube. 2000. Optimization of lime treatment processes. CIM Bulletin, Vol. 93 No. 1043, September 2000.

Zinck, J.M. and W.F. Griffith, 2000. An Assessment of HDS-Type Lime Treatment Processes-Efficiency and Environmental Impact In: 5th International Conference on Acid Rock Drainage, Denver, Colorado, May 21-24, 2000.

Zinck, J.M., Wilson, L.J., Chen, T.T., Griffith, W., Mikhail, S. and Turcotte, A.M., 1997. Characterization and Stability of Acid Mine Drainage Treatment Sludges. Mining and Mineral Sciences Laboratories Report 96-079 (CR), MEND Report 3.42.2, May.

## List of Tables

Table 7-1: Qualitative Comparison of Different Categories of Treatment

Table 7-2: Alkali Materials and Compounds Applied to ARD Treatment

Table 7-3: Comparative Table Different HDS Process Configurations

Table 7-4: Selection Criteria for Lime Neutralization Processes

Table 7-5: Theoretical Minimum Metal Hydroxide Solubility pH

Table 7-6: Criteria for Selecting an Appropriate Mine-Water Treatment Desalination Technology

Table 7-7: Generic Categories of Passive Treatment Systems

Table 7-8: Postulated Removal Mechanisms of Metals and Mining-related Pollutants in Passive Treatment Systems

## List of Figures

Figure 7-1: Generic Mine Water System Indicating Potential Position for a Drainage Treatment Facility

Figure 7-2: Generic Range of Drainage Treatment Technologies

Figure 7-3: Acid Drainage Decision Tree

Figure 7-4: Basic HDS Process Configuration

Figure 7-5: Relationship between Flow Rate and Treatment Plant Capital Cost

Figure 7-6: Integrated Limestone / Lime Neutralization Process

Figure 7-7: Simplified SAVMIN Process Diagram

Figure 7-8: Conceptual High Recovery Membrane Desalination Process

Figure 7-9: Concept SPARRO Process Flow Diagram

Figure 7-10: Conceptual GYPCIX® Ion Exchange Treatment Process

Figure 7-11: Generic Biological Sulphate Removal Process Configuration

Figure 7-12: Periodic Table for Passive Treatment

Figure 7-13: Selection of Passive Treatment Technology Chart

Figure 7-14: Selection of Passive Treatment Technology Chart

Figure 7-15: Selected Passive Treatment Components

Figure 7-16: Anoxic Limestone Drain Design

Figure 7-17: Profile view of a reducing and alkalinity producing system

# Case Studies Chapter 7

## From GARDGuide

1. The Argo Tunnel - Pulsed Limestone Bed Treatment
2. Bisbee No. 7 stockpile – BioSulphide process
3. Equity Silver – High Density Sludge Treatment Plant
4. Keystone Mine – Constructed Wetlands
5. Brukunga Pyrite Mine Site - High Density Sludge Lime Neutralization

### 1. The Argo Tunnel - Pulsed Limestone Bed Treatment

(Demonstration)

#### Background

The Argo Tunnel is located in Idaho Springs, Clear Creek County, Colorado, approximately 30 miles west of Denver. The tunnel was constructed to provide drainage and transportation for several connected gold mines. The tunnel continues to drain acidic mine water at an average rate of 280 gallons per minute. The environmental media affected are surface water and, to a much lesser extent, groundwater.

#### Treatment Applied

A conventional lime water treatment plant was constructed in 1998 and has been operating continuously. Primary contaminants include acidity and a host of heavy metals, including aluminum, copper, iron, manganese and zinc.

A pilot treatment system was operated and studied periodically from 2004 through 2007 by the United States Geological Survey (USGS) Leetown Science Center utilizing a pulsed limestone bed treatment system at 230 L/min.

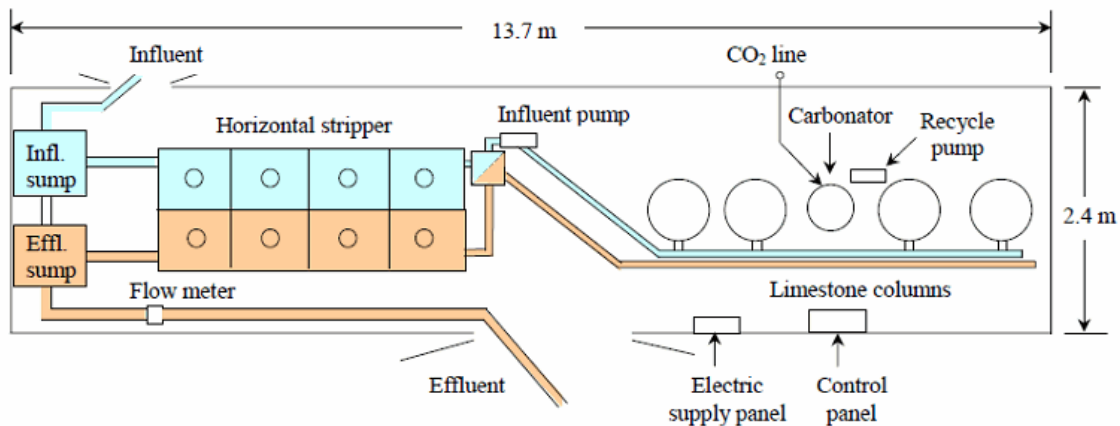

#### Performance

Metals removal for iron and aluminum was >98%. Copper had removals of 50 to >99%, while zinc had removals from 5 to 65%. Manganese concentrations were generally unaffected. The effluent of the limestone reactor required post-treatment with lime to raise the pH high enough to remove zinc and manganese to dischargeable levels. The sludge from the limestone/lime treatment scheme had settled volumes that were 60% of the lime treatment alone.

#### Reference

Sibrell, P. L., T. R. Wildeman, M. Friemuth, M. Chambers, and D. Bless. 2005. "Demonstration of a Pulsed Limestone Bed Process for the Treatment of Acid Mine Drainage at the Argo Tunnel Site." Abstract. [www.epa.gov/aml/news/argo.htm](http://www.epa.gov/aml/news/argo.htm).

## 2. Bisbee No. 7 stockpile – BioSulphide process

### *Background*

The Copper Queen Mine closed in the 1970s after nearly one hundred years of mining. One of the major issues at this site was drainage from a large ore stockpile (No. 7). This drainage was optimal for BioSulphide treatment due to its flow rate and copper concentration. The plant was commissioned in 2004.

### *Treatment Applied*

BioteQ and Phelps Dodge have a Joint Venture to use the process to recover copper at Bisbee, Arizona. The fully commissioned BioSulphide® plant recovers copper from dump drainage. The resulting concentrate (50% Cu) reports to the Miami smelter for profitable water treatment. The plant has a design capacity of 3.6 tonnes Cu/day

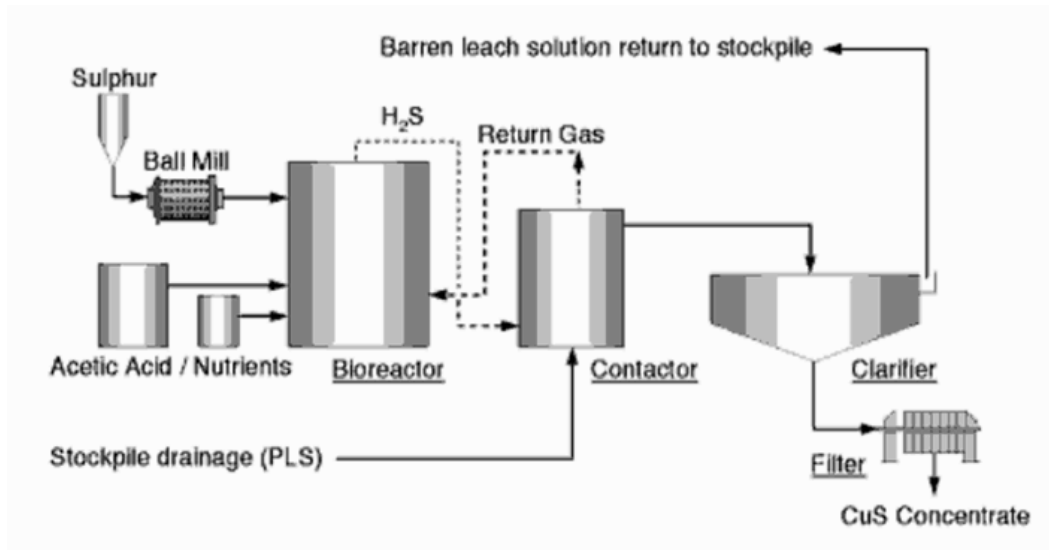

### *Performance*

The feed water to the plant contains 0.5 to 2 g/L iron and 340 mg/L copper at a pH of 2.2. After treatment, the effluent contains less than 1 mg/L copper and iron. The plant is currently recovering more than 2 tonnes Cu per day.

## Reference

Nelson L. Ashe, Ian McLean, and Max Nodwell. 2008. "Review of Operations of the Biosulphide® Process Plant at the Copper Queen Mine, Bisbee, Arizona". In Hydrometallurgy 2008 - 6th International Symposium - Honoring Robert Shoemaker. Editors Courtney A. Young, Patrick R. Taylor, Corby G. Anderson - 2008 - Technology & Engineering - 1186 pages

### 3. Equity Silver – High Density Sludge Treatment Plant

#### Background

The Equity Silver mine is a former open pit and underground mine, located 35 kilometres southeast of Houston in north central British Columbia. The Equity Silver mine operated from 1980 to 1994 and then closed due to depletion of the economic resource. The mining occurred from three open pits and a small underground mine. Copper, silver and gold were extracted through a conventional mill flotation circuit plus a cyanide leach circuit.

Shortly after the mine opened, acidic drainage was found to be occurring from the oxidization of sulphide minerals contained in the mined rock. Equity Silver's original low density sludge process was unable to handle the usually large runoff events so a new high density sludge (HDS) plant was commissioned to treat acidic drainage post closure.

#### Treatment Applied

Installation of a conventional high density plant was completed in 2004 at a cost of \$10M. The 600 m<sup>3</sup>/h water treatment plant started up in December 2004, with placement of the treatment sludge in an abandoned pit. The plant was designed for full automation and remote control.

Parameters	Design Feed	Permit Limits
pH	2.4	6.5 to 9.5
Acidity	13,500	
Al (mg/L)	650	0.5
Cu (mg/L)	280	0.05
Fe (mg/L)	2000	0.3
Zn (mg/L)	350	0.2
SO <sub>4</sub> (mg/L)	12,500	
Cd (mg/L)	1.2	0.01
As (mg/L)	2.5	0.05

### *Performance*

The effluent discharge consistently meets regulatory compliance.

<b>Treatment Statistics</b>	<b>2008</b>	<b>2007</b>
Lime(t)	4,014	7,290
Drainage treated (m <sup>3</sup> )	793,459	1,629,420
Average acidity (mg/L)	9,004	8,404
Sludge produced (m <sup>3</sup> )	99,240	125,930
Water discharges (m <sup>3</sup> )	1,476,793	3,836,848

### *Reference*

Goldcorp. 2008. Sustainability Report. [http://csr.goldcorp.com/docs/2008\\_report.pdf](http://csr.goldcorp.com/docs/2008_report.pdf)

## **4. Keystone Mine – Constructed Wetlands**

### *Background*

The Keystone Mine was owned by Silver King Mines Inc., of Salt Lake City, Utah. The mine produced mainly copper from 1923 to 1925 and includes two adits and 2,000 ft of drifts and crosscuts in an area of 15 acres. The extraction of large quantities of ore from the mine resulted in extensive development of the underground workings. These workings discharge two miles upstream of the confluence with Lake Shasta, with copper, cadmium, and zinc the constituents of concern.

### *Treatment Applied*

The typical metal concentrations and ranges of discharge are shown below.

<b>Constituent</b>	<b>Concentration</b>	<b>5 gpm discharge [kg/year]</b>	<b>10 gpm discharge [kg/year]</b>
<b>pH</b>	2.9–3.8	NA	NA
<b>Copper</b>	2–13 mg/L	20–130	40–260
<b>Cadmium</b>	3–21 mg/L	30–210	60–420
<b>Zinc</b>	0.02–0.12 mg/L	0.2–1.2	0.4–2.4

<b>Iron</b>	9–140 mg/L	90–1,400	180–2,400
-------------	------------	----------	-----------

In 1989, a constructed wetlands treatment system was commissioned. It consists of a vertical flow of water treated using anaerobic conditions at the base to precipitate heavy metals as sulphides. The technology is designed to treat the drainage in perpetuity. The system uses a ditch design with a topsoil substrate. The retention time through the 4200 square meter (1 m deep) system is 0.3 days at a flow rate of 8600 L/minute. The treatment system was constructed for \$2M US. Operation and maintenance (O&M) are estimated at \$10,000 per year indefinitely.

### **Performance**

The constructed wetlands system has an efficiency of 90%. Details of its performance are presented below.

<b>Constituent</b>	<b>Concentration (mg/L)&gt;</b>	<b>Quantity removed in a 5 gpm discharge (kg/year)&gt;</b>	<b>Quantity removed in a 10 gpm discharge (kg/year)&gt;</b>
<b>Copper</b>	0.2–1.3	18–117	36–234
<b>Cadmium</b>	0.3–2.1	27–189	54–378
<b>Zinc</b>	0.002–0.012	0.18–1.1	0.36–2.2
<b>Iron</b>	0.9–14	81–1,260	62–2,160

### **References**

Robert S. Hedin, Robert W. Naim, and Robert L. P. Kleinmann. . Passive Treatment of Coal Mine Drainage. U.S. Dept. of the Interior, Bureau of Mines, 1994 - Technology & Engineering - 35 pages. <http://www.hedinenv.com/pdf/ptcmd.pdf>

ITRC website - retrieved on May 5, 2012 from - [http://www.itrcweb.org/miningwaste-guidance/cs22\\_24\\_keystone\\_rising.htm](http://www.itrcweb.org/miningwaste-guidance/cs22_24_keystone_rising.htm)

Top of this page

## **5. Brukunga Pyrite Mine Site - High Density Sludge Lime Neutralization**

### **Improved ARD Treatment With A High Density Sludge (HDS) Lime Neutralization System At The Brukunga Pyrite Mine Site, South Australia**

An ARD Treatment case study prepared by Earth Systems Pty. Ltd.

#### **Site history**

The Brukunga pyrite mine is located approximately 40 km east of Adelaide in the Mount Lofty Range of South Australia. Pyrite and pyrrhotite were mined from 1955 to 1972 to supply feedstock for sulfuric acid production for the South Australian fertiliser industry. In August 1977 the South Australian State Government accepted responsibility for rehabilitation of Brukunga, with the Department of Manufacturing, Innovation, Trade, Resources and Energy (DMITRE) currently tasked with the management and remediation of the site.

Acid Rock Drainage (ARD) has been a significant issue at the Brukunga mine as a result of the oxidation of pyrite and pyrrhotite within the waste rock piles, tailings and pit highwall. This process continues to generate acidic water, characterised by pH values from of 2.5 to 2.9 and elevated acidities ranging from 2,500 to 12,000 mg/L CaCO<sub>3</sub>. ARD contains sulphate concentrations ranging between 6,000 and 10,000 mg/L, and elevated soluble Fe, Al and Mn concentrations, which comprise the key constituents of the metal acidity. An average of approximately 2.0 tonnes of H<sub>2</sub>SO<sub>4</sub> acidity is generated by the site each day. It has been conservatively estimated that acidity generation



will continue for hundreds of years, and unless a comprehensive remediation strategy is implemented, water treatment in perpetuity is the only option for environmental protection.

Since 1980, the ARD affected seepage from the tailings storage facility and mine site have been directed to collection ponds, and then pumped to a central water treatment facility. The original water treatment plant commissioned by the State Government in 1980 was a low-density sludge (LDS) lime neutralization system, designed to treat a maximum of 20kL/h of ARD affected water.

The capacity of the treatment plant was often exceeded, by up to 25KL/h, due to high flows in the mine creek during high intensity rainfall events. In 2003, to assist with improved mine water management, a river diversion system was installed to divert unpolluted water from above the mine away from the sulfidic waste materials. Improvements in the treatment plant were also designed and implemented.

### **Treatment plant upgrade**

In 2004 the South Australian Government commissioned an upgrade of the LDS plant. The key objectives of the WTP upgrade included:

- Improve the hydraulic capacity of WTP to better manage heavy rainfall events.
- Improve the neutralization and precipitate settling capacity of WTP to effectively treat the higher acidity loads reporting to the plant following construction of the clean water diversion system around the mine.
- Minimise sludge volumes produced at the plant in order to reduce pumping, storage, dewatering and handling costs.
- Improve the quality of discharge water by enhancing the oxidation of soluble Fe<sup>2+</sup> and Mn<sup>2+</sup> within the plant.
- Optimise water treatment to minimise operating costs.

The objectives of the WTP upgrade were met by transforming the existing LDS plant to a High Density Sludge (HDS) system, and installing additional hydraulic capacity with HDS capability. The HDS conversion strategy involved recirculating treatment precipitates (sludge) back into untreated ARD prior hydrated lime addition.

The advantages of using the HDS approach include:

- Ability to deal with mine waters characterised by high acidity.
- A substantial reduction in sludge volume resulting from increases in sludge density from 2-6 wt.% solids up to 40 wt.% solids.
- Reduced sludge management costs.
- Slightly reduced reagent costs.
- Ability of HDS precipitates to settle faster minimises sizing requirements for thickeners/clarifiers.

Detailed chemical testwork was conducted on site to identify the optimum operating parameters for the HDS upgrade.

### **HDS plant operational parameters**

Results from the testwork and a site water balance identified the following process variables for the new HDS system:

- Total HDS treatment capacity: 50kL/h.
- Sludge recycle rate: 10-15kL/h.
- Recycled sludge and raw ARD residence time in Reactor 1: 10-15 minutes.
- Overflow pH of ARD/sludge mix from Reactor 1 = 4-7 pH units.
- Target pH in Reactor 2 using hydrated lime slurry addition is ~10.
- Recycled sludge, raw ARD and lime slurry residence time in Reactor 2: 15 minutes.
- Aeration rate in Reactor 2 = 110 m<sup>3</sup>/h.
- Recycled sludge, raw ARD and hydrated lime residence time in Reactor 3: 15 minutes.
- Aeration rate in Reactor 3 = 110 m<sup>3</sup>/h.
- Anionic polymer flocculant addition to Reactor 3 overflow prior to thickener.
- Target pH = 9.2-9.5 in supernatant overflow from thickener.
- Sludge density: 25-40 wt% at base of thickener unit; and >50 wt% after dewatering in the drying ponds.

The HDS plant at Brukunga has been consistently meeting its design objectives both in terms of treated water quality and sludge density for the past 7 years.

### **The future**

While the total volume of sludge produced at Brukunga has decreased substantially, the total tonnage remains unchanged and hence issues associated with its management and safe storage continue. Approximately 3.0-4.0 tonnes (dry basis) of gypsum-rich sludge are produced for every tonne of hydrated lime (dry basis) added in the plant. Hence, an estimated 2,000-3,000 tonnes of dry sludge are generated annually and disposed against the highwall at the mine site (Figure 1). The mine site currently hosts close to 60,000 tonnes of dry sludge

material. Each additional 100 years of water treatment can be expected to add a further 200,000-300,000 tonnes of relatively soluble gypsum-rich sludge to the mine site.

While treatment in perpetuity can often represent the lowest cost option for dealing with ARD on a Net Present Value basis, it sustains residual risk for the South Australian Government associated with the obligation for unfailing treatment in perpetuity and a growing stockpile of unstable metalliferous sludge.

To better manage these risks and community expectations, DMITRE has engaged in a process to devise a comprehensive remediation strategy for the site. A key aim of rehabilitation is to devise and implement a strategy that supersedes the need for perpetual treatment.

**Figure 1: Dry treatment sludge stored against the highwall at the Brukunga mine site.**





# Aeration systems for treating CMD

From GARDGuide

**Photo 1. A 25° gravity-based cascading aeration flume (photo courtesy of Mike Kaufman, Chemstream, Inc.)**



**Photo 2. Conventional neutralization (a lime slurry and a flocculant being added near the rear of the photo) and mechanical aeration of coal mine drainage (photograph by Terry Ackman)**



**Photo 3. Static mixers being used to aerate coal mine drainage after in-line neutralization neutralization using jet pumps; at this site, replacing a conventional water treatment facility with an in-line system was highly cost effective (photograph by Terry Ackman)**



**Photo 4. A commercial 15 horse-power (11,000 watts) aeration device (a Maelstrom Oxidizer) installed at a passive treatment site to aerate water flowing from an underground coal mine (photograph by Don Budeit, Environmental Solutions, Inc.)**

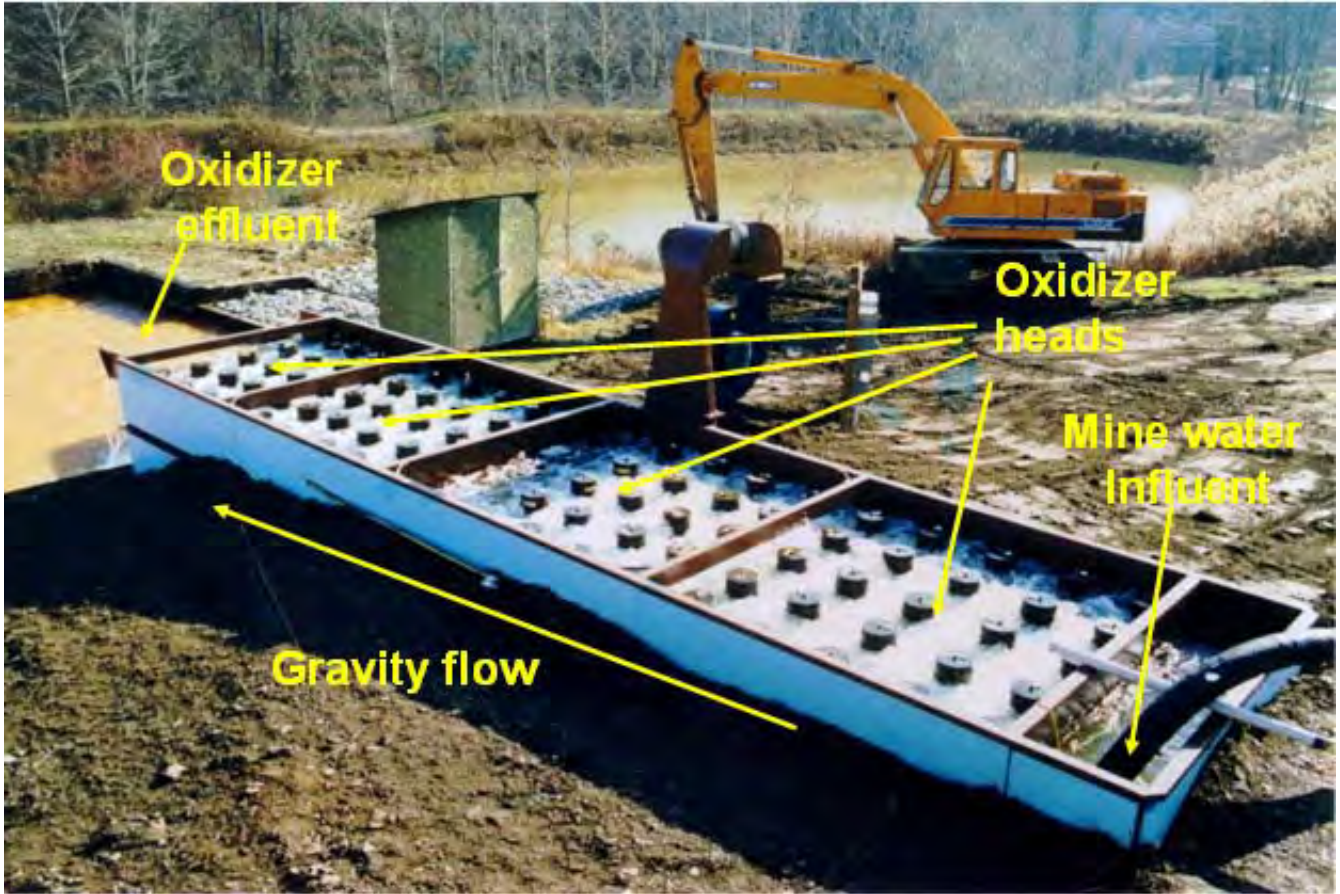

Retrieved from "[http://www.gardguide.com/index.php?title=Aeration\\_systems\\_for\\_treating\\_CMD](http://www.gardguide.com/index.php?title=Aeration_systems_for_treating_CMD)"

---

- This page was last modified 19:26, 31 May 2011.

# Chapter 8

## From GARDGuide

### 8.0 Monitoring

- 8.1 Introduction
- 8.2 Objectives of Monitoring
- 8.3 The Acid Rock Drainage Monitoring Approach
  - 8.3.1 Conceptual and Dynamic System Model Development
  - 8.3.2 Risk Based Approach to Monitoring Program Development
  - 8.3.3 Monitoring Program Development
  - 8.3.4 Data Management and Interpretation
  - 8.3.5 Auditing
- 8.4 Monitoring Program Components
  - 8.4.1 Acid Rock Drainage Sources
  - 8.4.2 Pathways
  - 8.4.3 Mitigation Measures
  - 8.4.4 Receptors
- 8.5 Closure and Long-Term Considerations
- 8.6 References and Further Reading
- List of Tables
- List of Figures
- List of Photos

## 8.0 Monitoring

### 8.1 Introduction

Monitoring is the process of routinely, systematically, and purposefully gathering information for use in management-decision making. Mine site monitoring characterizes environmental changes from mining activities to assess conditions on the site and possible impacts to receptors. Monitoring includes both observation (e.g., recording information about the environment) and investigation (e.g., manipulative studies such as toxicity tests where environmental conditions are controlled). Monitoring to assess the effectiveness of mitigation measures to minimize the effects of environmentally-detrimental processes such as ARD and implementation of adjustments to mitigation measures as required is an example of the use of monitoring in management decision making.

Development of an ARD mine site monitoring program begins with review of the mine plan, the geographical location, and the geological setting. The mine plan provides information on the location and magnitude of surface and subsurface disturbances, ore processing and milling procedures, waste disposal areas, effluent discharge locations, groundwater withdrawals, and surface water diversions. This information is used to identify sources of ARD, potential pathways for release of ARD to the receiving environment, receptors that may be impacted by these releases, and potential mitigation that may be required. Because the spatial extent of a monitoring program must include all these components, a watershed (including groundwater) approach to ARD mine site monitoring is often required. Monitoring occurs at all stages of project development, from preoperational until post closure; however, during the life of a mine, the objectives, components, and intensity of the monitoring activities will change.

This Chapter 8 presents guidelines and tools for establishing a monitoring program at mine sites with a potential for ARD, NMD, and SD. General aspects of monitoring are discussed first with monitoring specific to ARD sources discussed later in this chapter. Generic guidance provided in this chapter can be used to develop site-specific monitoring approaches for assessing contamination, effects, and impacts. The guidance provided is intended to promote a monitoring program that will satisfy a company's corporate responsibilities and commitment to sustainable mining, regulatory needs, stakeholder desire for relevant and useful information, and management requirements for relevant and meaningful information to support environmentally appropriate and cost-effective decision-making. Figure 8-1 outlines the chapter organization. The objectives and development of a monitoring plan are discussed first followed by a discussion of monitoring within each of the components.



**Figure 8-1: Monitoring Chapter Organization**

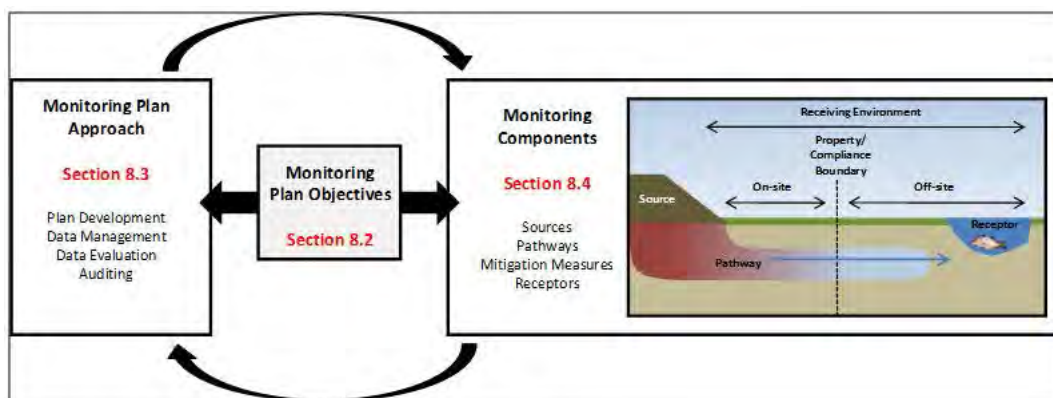

## 8.2 Objectives of Monitoring

Monitoring allows a mining company to measure success in meeting corporate goals pertaining to sustainable mining, continuous improvement of environmental and social performance, and minimizing environmental impacts. Monitoring requirements may also be imposed by regulatory authorities as a condition to develop, operate, or decommission a site. Mine permits outline specific data collection and reporting protocols, often with a focus on points of discharge to the receiving environment. Monitoring commitments may also be made to stakeholders or lending agencies as part of the “social license” to operate a mine or as a condition of funding. Many communities have representatives who are very interested in reviewing environmental monitoring plans and data. Fundamentally, corporate responsibility, regulatory compliance, or stakeholder agreement may be the primary objective(s) of a monitoring program; however, the underlying goals or purpose of the information obtained from these programs are often to protect human health and the environment.

Well defined objectives must be established at the start of a monitoring program. Specific objectives pertaining to environmental protection from ARD release may include the following:

- **Characterization of Current (Baseline) Conditions** – This monitoring is designed to characterize baseline environmental conditions (physical, chemical, and biological) against which to measure changes resulting from mining. Ecosystems are not totally free of COIs before a disturbance. For example, metals and metalloids occur naturally in the environment (e.g., water and sediment) and in biological tissues, particularly in mineralized areas (i.e., where mining occurs). Baseline conditions may also be affected by historical mining or other anthropogenic activities unrelated to mining. During baseline monitoring, areas particularly sensitive to changes are identified.
- **Confirmation of ARD Potential** – This monitoring takes place during the development phase and involves solid phase analyses and leach testing (static and kinetic) being conducted to assess the ARD potential of waste and ore materials (see Chapters 4 and 5). These tests may continue during operation. Monitoring is conducted to confirm the potential for ARD derived from the testing program.
- **Detect or Predict Onset of ARD** – This monitoring is designed to detect the onset or predict future release of ARD as early as possible to allow implementation of mitigative measures. Monitoring may include direct or indirect measures of ARD release (e.g., direct - collection and analysis of waste material seepage and runoff; or indirect - measurement of temperature and oxygen profiles within a waste rock facility as a measure of sulphide oxidation). Monitoring data may be required to validate or calibrate predictive models (see Chapter 5).
- **Verification of Expected Behaviour** – This monitoring during operations is designed to confirm the expected environmental behaviour of mine materials, as determined from characterization and prediction efforts (see Chapters 4 and 5). Monitoring allows for detection of unexpected behaviour so appropriate corrective actions can be taken.
- **Assess Fate and Transport of Constituents** – This monitoring is designed to characterize physical or geochemical conditions to evaluate the rate of movement of COIs through the receiving environment.
- **Assess Impacts to the Receiving Environment** – This monitoring is designed to characterize current conditions to evaluate impacts to the environment. A distinction should be noted between effects, basically alterations which may or may not be harmful (e.g., changes in water or sediment quality) and impacts, which are environmentally harmful. Impacts adversely affect the utility, viability, and productivity of a population of organisms, not just individual organisms. However, in the case of humans or endangered species, impacts would also apply to individual organisms.
- **Environmental Management** – This monitoring is designed to assess the performance of waste management practices, including engineered designs to reduce, prevent, control, or treat ARD and strategies put in place for proper waste disposal (e.g., waste rock segregation).

Monitoring objectives may change during the life of a monitoring program. Objectives should be reviewed and updated, as required, as part of the audit process (see Section 8.3.5). A statement of clear objectives is required to direct and focus a monitoring program and to avoid expensive and unnecessary data collection efforts.

## 8.3 The Acid Rock Drainage Monitoring Approach

The monitoring program implemented at a mine site is determined by the monitoring objectives. Effective monitoring balances comprehensiveness, necessity, and monetary costs. The monitoring program is site-specific and takes into consideration the phase of project development and the sensitivity of the

surrounding environment and community. This Section 8.3 presents the steps in development of a monitoring program (Figure 8-2).

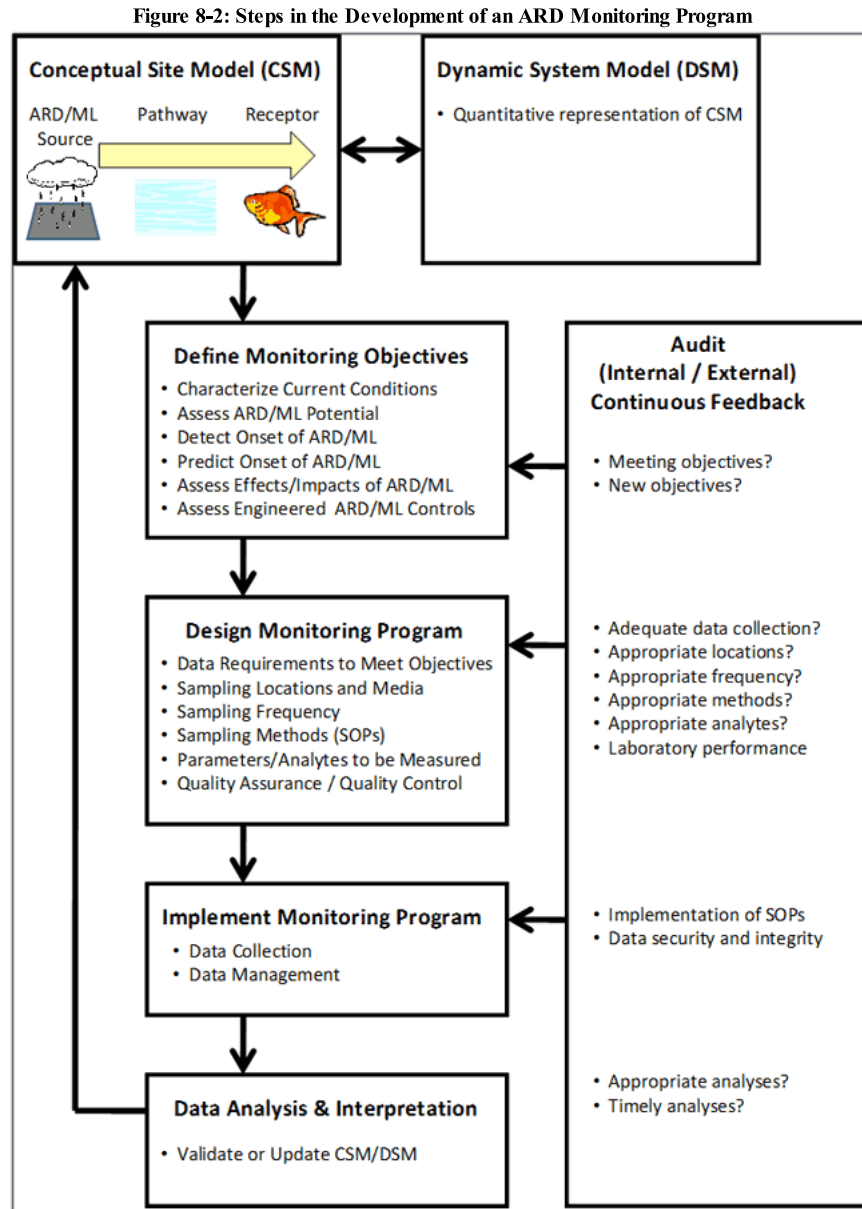

### 8.3.1 Conceptual and Dynamic System Model Development

The conceptual site model (CSM) (see Chapter 4 and Figure 4-4) provides the framework for development of an ARD monitoring program. The CSM is a hypothesis that incorporates site data to assess future or current environmental impacts from a mining operation. The CSM integrates geologic, hydrologic, chemical, biological, and climatic information to describe the release, transport, and fate of constituents at a mine site. It should involve both temporal and spatial components and should be reviewed and agreed to by regulatory agencies and other stakeholders before beginning field or laboratory studies. Environmental conditions at similar sites can assist in identifying potential shortcomings and pitfalls and help focus the CSM as much as possible. CSMs are dynamic and should be updated as additional project information becomes available.

The CSM is used to identify the ARD sources, pathways, and receptors for inclusion in the monitoring program (Table 8-1).

**Table 8-1: Monitoring Sources, Pathways, and Receptors**

Source - Chemical	Pathway - Physical	Receptor - Biological
Waste rock	Air	Aquatic life
Tailings	Vadose zone	Terrestrial wildlife
Ore stockpile	Groundwater	Vegetation
Heap leach pile	Surface water - sediment	Humans
Underground workings (walls)		
pit (walls)		

The primary sources of ARD are mine and process waste, ore, and the disturbances resulting from ore extraction. The primary pathway to the environment for constituents (acidity, metals and metalloids) released from these sources is water. Transport may occur by way of groundwater, surface water, or infiltration through the vadose zone. Sediment and air pathways are typically of lesser importance. Because water is the primary pathway for metals and acidity, aquatic resources are generally the primary receptor of interest.

The CSM provides the framework for development of a dynamic system model (DSM). The DSM integrates the components of the CSM (i.e., sources, pathways, and receptors) and identifies their inter-relationships. The DSM quantifies the processes that control the release (e.g., sulphide oxidation), transport, and uptake of COIs. Because of the importance of water with respect to all of these processes, a site-wide water balance is a primary component of the DSM. The DSM is calibrated to current conditions and then used to predict constituent fate and transport. DSM may also be used to evaluate the effectiveness of mitigative measures. The DSM will highlight uncertainties and data gaps and therefore can be used to identify key components of the monitoring program. The monitoring program may include collection of data to verify or improve the accuracy of model predictions. Sensitivity analyses may be conducted to identify key input parameters to the DSM for inclusion in the monitoring program.

### 8.3.2 Risk Based Approach to Monitoring Program Development

A mine site monitoring program will include monitoring of both on-site facilities and the receiving environment. On-site monitoring will include monitoring of facilities identified as having the potential to generate ARD (i.e., sources). The scope of the source monitoring program, including frequency and extent, should follow a risk-based approach that considers the probability and consequences of ARD generation at a source.

A risk-based approach to monitoring evaluates the relationships between the ARD sources, the organisms that live in the environment that receives the ARD products, and the pathways that link the discharge source to the organisms to determine the potential for exposure. Risk (or exposure) can only exist if a stressor (or source), pathway, and receptor coincide (Figure 8-3). In this risk-based approach, the receiving environment is viewed as an ecosystem and the effluent is considered in relationship to that ecosystem. This means that the resident organisms, their habitat and ecology, and nature of how they are exposed to the stressor (or stressors) all need to be considered.

**Figure 8-3: Conceptual Risk-Based Approach - Relationships Between the Contaminant Source, the Receptor, and the Pathway that Connects them**

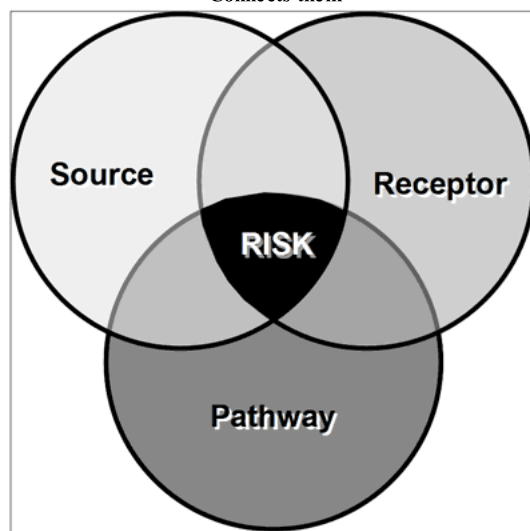

A risk-based environmental effects monitoring program seeks to identify the following:

- The pathways by which organisms may become exposed to an effluent
- The extent to which these organisms are likely to be exposed
- The effect or impact that exposure is likely to have on these organisms

### 8.3.3 Monitoring Program Development

Development of an ARD monitoring program begins with an assessment of the likelihood that waste and ore materials will generate acid and leach metals. Source material characterization methods and the interpretation of characterization results are discussed in Chapters 4 and 5, respectively.

Water is often the focus of ARD monitoring programs because of its role in both the release and transport of ARD, its frequent beneficial use (e.g., drinking water and irrigation), and its function as a habitat for aquatic receptors. Monitoring programs include collection of data to assess water quality and movement. Water quality data are collected to evaluate compliance with standards and fate and transport. Water quality standards are defined as follows: “A water quality standard defines the goals of a water body by designating the use or uses to be made of the water, establishing criteria necessary to protect those uses, and preventing degradation of water quality through antidegradation provisions” (USEPA, 2003). Because water use may include human consumption or aquatic habitat, or both, water quality monitoring also provides information on possible impacts to receptors.

ARD monitoring programs often include collection of data to evaluate the sulphide oxidation process. Because there may be a lag time to the onset of ARD at a mine site, prudent environmental management includes an assessment of the stage of potential or actual ARD.

Development of a monitoring program must consider the climatic conditions at a particular site. The occurrence and distribution of rainfall at a site will dictate decisions regarding the timing of water sample collection. For example, in arid regions, collection of water samples may be scheduled to occur concurrent with rainfall events instead of at equally spaced intervals over time. Also, in arid regions, groundwater may be the primary constituent pathway and therefore the focus of water monitoring. Climatic conditions will also affect the rate of evolution of ARD (i.e., ARD evolution may be slower at low precipitation sites and in cold climates) which will affect decisions regarding the frequency and locations of sample collection.

This Section 8.3 presents the information included in a mine monitoring program applicable to all components of the CSM (i.e., ARD source, pathway, mitigation, and receptor). This mine monitoring information is typically included in the sampling and analysis plan (SAP) or QAPP for a site. Detailed discussions specific to monitoring of each component are presented in Section 8.4.

#### 8.3.3.1 Data Requirements

The data collection activities required to fulfill the monitoring objectives must first be identified. These will define the media that will be sampled (e.g., water, gas, or sediment). Table 8-2 lists activities common to ARD monitoring programs and the rationale for each activity.

**Table 8-2: Common ARD Monitoring Components**

Type	Information	Rationale
Climatic	Rainfall	water balance input
	Evaporation	water balance input (pit)
	Temperature	water balance
	Humidity	water balance
	Wind direction	assess ARD process
	Wind speed	assess ARD process
	Snowpack	water balance
Hydrology	Surface water flow	calculation of contaminant loading
		aquatic habitat assessment
		site or facility water balance input
	Surface water quality	characterize in situ conditions (baseline)
		assess ARD/ML source/process
		evaluate COI fate and transport
		habitat information for receptor exposure and effect/impact assessment
	Sediment quality	characterize in situ conditions (baseline)
		evaluate COI fate and transport
habitat information for receptor exposure and effect/impact assessment		
Hydrogeology	Groundwater flow	evaluate COI fate and transport
		site or facility water balance input
		characterize in situ conditions (baseline)

	Groundwater quality	evaluate COI fate and transport assess ARD/ML source/process
Biological	Aquatic receptors	characterize baseline conditions assess COI exposure and effects/impact
	Habitat	receptor exposure and effects/impact assessment
Geochemical	Chemical composition	assess ARD/ML potential
	ABA	assess ARD/ML potential
	Leach testing	assess ARD/ML potential
	Mineralogy	assess ARD/ML potential
Gas	Gas transfer	assess ARD process

ML – metal leaching

COI – constituent of interest

#### 8.3.3.2 Statistical Considerations

Fulfillment of the objectives of the monitoring program will include use of appropriate statistical and other data analyses. To assess effects or impacts, exposure (i.e., downgradient) data are compared to reference (i.e., upgradient) data to determine if there is a difference. Compliance monitoring may require that mean or peak concentrations not exceed a certain limit within a prescribed confidence limit. This Section 8.3.3.2 presents statistical concepts relevant to the design of an ARD monitoring program. Monitoring design should include evaluation of the statistical methods that will be used in data analysis.

Sample Variation - Determination of sample variation is key to design of an efficient monitoring program. The three forms of sample variation are as follows:

- Spatial – measurable differences between stations
- Temporal – measurable differences within a station between sampling periods
- Instantaneous – measurable differences within a station during the same sampling period (includes “real” variation as well as analytical and field errors)

Variation is determined by taking multiple samples (over time, space, or both time and space) and examining their frequency distribution. Collection of single samples assumes no instantaneous variability. Collection of replicate samples is required to assess instantaneous variability. Differences between sites (spatial variation), the fundamental basis of an impact assessment, can be determined only when differences within a site (instantaneous variation) are known.

Frequency Distribution - Sample variance and the shape of the frequency distribution must be considered in monitoring program design because sample variance and the shape of the frequency distribution determine the number of samples needed to reach a predetermined confidence level for estimates of mean and peak values. Selection of appropriate statistical procedures depends on the nature of the distribution.

Stratification – Strata are factors that may influence the mean or variance of a parameter and may be evident by a bimodal or multimodal frequency distribution. Efficient sampling designs are stratified according to the dominant pattern of variation. For example, monitoring of ARD impacts to a stream may be seasonal or flow related.

Autocorrelation - Autocorrelation (serial dependence) must be considered to determine optimal sampling frequency, especially when mean concentrations are required. Accurate determination of the mean with the fewest number of samples requires that the sampling frequency be low enough so that each sample is independent of the previous sample. For systems with low autocorrelation, sampling frequency must be high enough to achieve the desired confidence limits of the mean. High frequency sampling should be conducted during preliminary studies to determine the degree of autocorrelation. These data will also indicate the duration of peak or minimum values, which may be of interest in assessing environmental effects or impacts.

At mine sites where ARD is occurring, or suspected of occurring, an intensive preliminary sampling program that includes the steps listed in Table 8-3 is recommended (MEND, 1990).

**Table 8-3: Preliminary Intensive Sampling Program**

Step	Evaluation	Description
1	Preliminary stratification	Identification of all factors that might influence the mean or variance of ARD parameters. Selection of temporal and spatial strata.
2	Cofactors	Identification of factors that may influence the mean and variance of the data for inclusion in monitoring program (e.g., flow).

3	Instantaneous variation	Collection of 4 to 6 replicate samples for each strata (temporal or spatial).
4	Autocorrelation	Collection of numerous samples within each time stratum to evaluate short-term temporal variation and lag time between independent samples. Continuous monitoring of key parameters (pH and electrical conductivity) to correlate with other ARD parameters measured at shorter time intervals.
5	Frequency distribution and variance	Using the time interval between independent samples (Step 4), collect a minimum of 30 random samples during each time stratum to determine the frequency distribution (more than 30 samples are typically required for non-normal distributions).
6	Monitoring design optimization	Using the preliminary data and defined control criteria (e.g., confidence limits) optimize the monitoring program. Strata identified in Step 1 should be evaluated and reduced to those with unique means, variances and/or frequency distributions. Evaluate cofactor and variable/variable relationships to identify reduction in parameters. Determine sampling frequency from autocorrelation data.

#### 8.3.3.3 Sampling Locations

Collection of samples at the potential source of ARD provides information on the onset of ARD and the magnitude of constituent loading to the environment. Section 8.4.1 describes the types of samples (e.g., seepage, runoff, or supernatant) typically collected at different ARD sources.

Designs of receiving environment sampling locations for impact studies must consider the approach that will be used to determine if a measurable impact has occurred as a result of mining activities (Table 8-4). These approaches vary in the selection of premining or reference monitoring locations.

**Table 8-4: Impact Assessment Sampling Location Designs**

No.	Design Type	Name	Description
1	Spatial	Control-Impact (CI) or Upgradient-Downgradient	Spatial comparison between reference sites (upgradient) and potentially impacted sites (downgradient)
2	Temporal	Before-After (BA)	Temporal comparison between premining (baseline) and mining data
3	Spatial-Temporal	Before-After-Control-Impact (BACI)	Include both spatial and temporal comparisons (combination of 1 and 2)
4	Spatial	Gradient	Spatial comparisons along an identifiable contaminant gradient

The most robust study designs include a temporal and spatial component (i.e., Before-After-Control-Impact [BACI]) to compare nonimpact versus potentially impacted areas. Study designs that include control/reference stations (i.e., Control-Impact [CI] and BACI) are enhanced by the inclusion of multiple reference stations (MEND, 1997). Upgradient-downgradient designs are typically employed at mine sites to evaluate ARD release from primary sources.

Reference areas or locations serve as additional benchmarks (to baseline data) against which to compare sites exposed to COIs. Characterization of reference sites must be adequate enough to distinguish potential ARD effects from natural variability or trends at the regional scale, or both. Typically, reference areas or locations represent “the optimal range of minimally impaired conditions that can be achieved at sites anticipated to be ecologically similar” and should be acceptable by local stakeholders and appropriately represent reference conditions (Krantzberg et al., 2000).

The media to be sampled (e.g., solids, water, or biological) and methods of sample collection will influence the selection of sampling locations. Selection of sampling locations should consider the following (if applicable):

- Inclusion of compliance monitoring locations stipulated in permits and inclusion of upgradient stations as early warning of effects or impacts
- Colocation with historical sampling locations to allow for direct comparison and evaluation of temporal trends
- Colocation of samples for different media (e.g., sediment, water, benthic macroinvertebrates, plankton, or periphyton) as required for data analysis
- The number of locations required to ensure characterization of spatial variability
- Safe and easy access during all sampling periods

#### 8.3.3.4 Sampling Frequency

Determination of the appropriate sampling frequency for ARD monitoring must consider temporal variability in acidity and metal release from sources related to climatic conditions. During prolonged dry periods or freezing conditions, sulphide oxidation products will accumulate within source materials. These dry periods are characterized by having sufficient water available to support sulphide oxidation, but insufficient water to flush the products of these reactions.

“First flush” events (e.g., the first rainfall after a prolonged dry period, snowmelt, or a period of thawing) are generally characterized by high acidity and high metal loading. Runoff and seepage quality from ARD sources therefore will not only be a function of the composition of materials, but also the water contact time, precipitation or snowmelt event duration, position in hydrograph, and time since last flushing event.

Determination of sampling frequency must consider the climatic conditions at the mine site. For example, in low precipitation environments, seepage from waste rock piles may be intermittent. Seepage collection may therefore need to occur concurrent with rainfall events. Natural springs may also flow intermittently and therefore the timing of flow and water quality monitoring may be dependent on rainfall events.

Hysteresis Effect – Hysteresis describes the cyclic relationship between concentration and flow (rising versus stable or falling hydrograph). Accumulated sulphide oxidation products are flushed with the first flush event. Concentrations increase as infiltrating water contacts more surfaces. If flow stabilizes, concentrations will remain stable or decrease as stored oxidation products decline. Eventually, concentrations decrease with steady or rising flows due to declining reserves. At the end of the cycle, the source material is well rinsed and continued flushing only carries the ARD products being generated at the time (Figure 8-4). Maximum ARD loads are therefore generated during moderate to high flows that follow low flow periods (MEND, 1990).

Figure 8-4: Waste Stockpile Seepage Water Quality Hysteresis

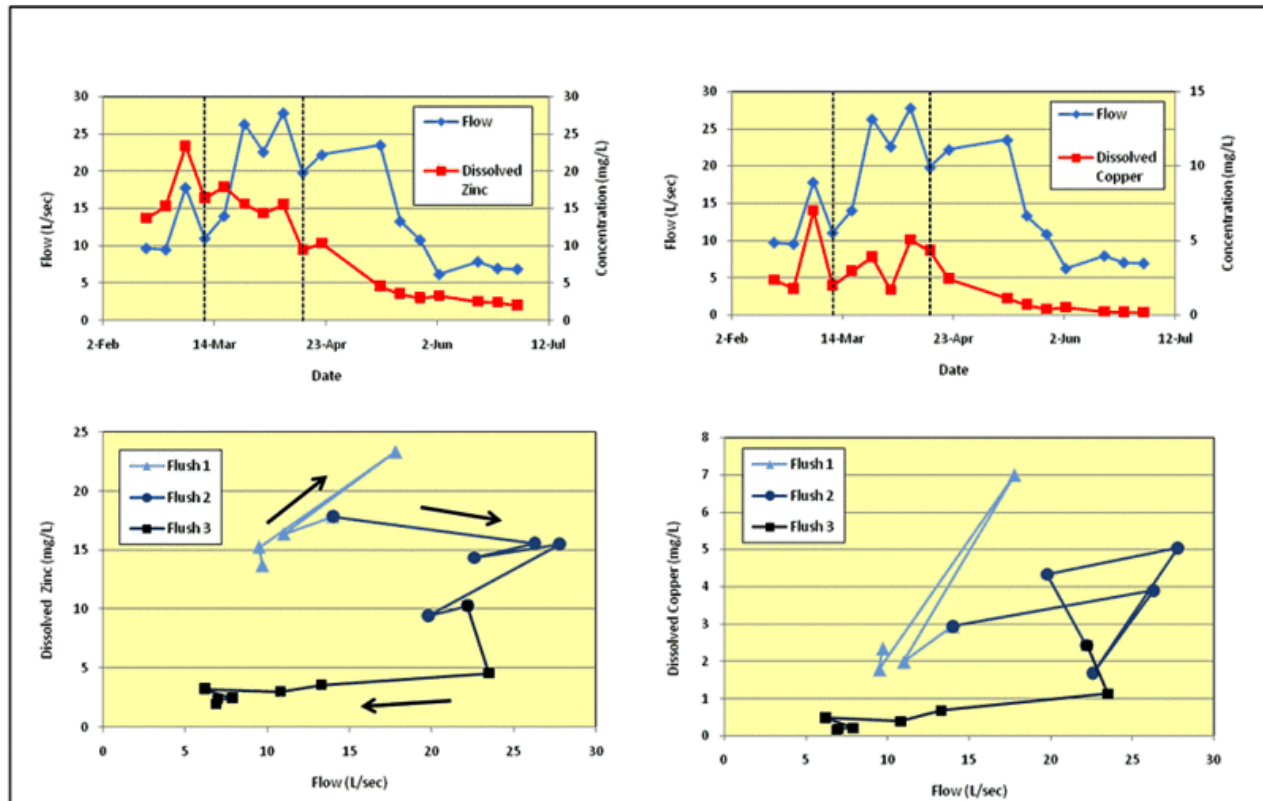

Although fixed frequency sampling is often stipulated in mine permits for water quality and flow monitoring, fixed frequency may not satisfy the monitoring objectives, particularly if accurate mean or peak concentration values are required. Sampling frequency design should be based on the monitoring objectives that indicate the required accuracy of mean and peak values. The required accuracy level is based on the magnitude of the minimum changes or differences (i.e., variance) that must be detected (MEND, 1990). Accurate monitoring of peak concentrations may require intensive monitoring. The required accuracy, and therefore number of samples required, should consider the environmental risk associated with a short-term peak value.

“Efficient sampling programs are stratified according to the dominant pattern of variation in the data” (MEND, 1990). Seasonal stratification for monitoring of ARD sources is often appropriate. To capture the first flush event, the monitoring start date must be flexible and determined by the on-site operator. When monitoring ARD release to a stream, a flow-stratified frequency may be adopted. This method is appropriate when accurate determination of annual loading is required.

Continuous monitoring of water quality parameters or flow is a tool that should be considered to determine accurate average and peak values. Due to the hysteresis effect, a continuous monitoring device may be the only way to capture peak concentrations because peak concentration is a function of recent weather conditions as well as immediate rainfall and flow conditions (MEND, 1990). When possible, continuous measurement of ARD indicator parameters using probes (e.g., pH and electrical conductivity) represents the most accurate measurements of peak and average values. Although this approach may not be suitable for measurement of metals, correlations may be developed. Continuous measurements of water levels using a transducer allow for creation of a continuous flow record. For continuous monitoring devices, the time period over which data are read, averaged, and reported must be determined. At remote sites, installation of continuous monitoring devices may not be practical because of the possibility of breakdown, theft, or vandalism. System design

must consider these issues. In such instances, employment of local personnel to perform monitoring activities may be an expedient alternative.

Monitoring frequency should consider the degree of autocorrelation. For both flow and water quality, slower changes in groundwater in comparison to surface water quality result typically in a shorter time period between surface water measurements than groundwater measurements. Increased frequency may be appropriate for groundwater wells located adjacent to surface water when groundwater levels show a surface water influence.

Baseline Data Collection - The potential for seasonal variability in background water quality, because of acidity and metal releases associated with historical mining or natural conditions (mineralized areas), should be considered during the baseline data collection.

The timing of sampling events should consider not only the potential for variability in ARD release, but also variability in receptor sensitivity (e.g., ARD release during early stages of fish development).

### 8.3.3.5 Sampling Methods and Protocols

Selection of appropriate sampling methods and protocols will depend on data requirements and will consider factors such as site specific characteristics, permit requirements, and required accuracy and precision. Written SOPs should be developed and available for reference. SOPs ensure the following:

- Implementation of a uniform approach and methodology
- Continuity with changing personnel
- Use of standard field forms
- Inclusion of QA/QC procedures (e.g., decontamination)
- Use of correct sampling equipment
- Adherence to corporate health and safety requirements

Table 8-5 lists SOP references for typical data collection activities.

**Table 8-5: Monitoring Activity Guidance**

Monitoring Activity	Guidance Reference	Web Link
Water Quality Sampling	ISO 5667 - <i>Water Quality Sampling - Part 3: Guidance on the Preservation and Handling of Water Samples</i> (ISO, 2003)	<a href="http://www.iso.org/iso/iso_catalogue/catalogue_tc/catalogue_detail.htm?csnumber=33486">http://www.iso.org/iso/iso_catalogue/catalogue_tc/catalogue_detail.htm?csnumber=33486</a>
	USGS - <i>National Field Manual for the Collection of Water-Quality Data</i> (USGS, variously dated)	<a href="http://pubs.water.usgs.gov/twri9A">http://pubs.water.usgs.gov/twri9A</a>
	ANZECC/ARMCANZ - Australian Guidelines for Water Quality Monitoring and Reporting (ANZECC and ARMCANZ, 2000)	<a href="http://www.mincos.gov.au/publications/australian_guidelines_for_water_quality_monitoring_and_reporting">http://www.mincos.gov.au/publications/australian_guidelines_for_water_quality_monitoring_and_reporting</a>
	ACMER - <i>A Guide to the Application of the ANZECC/ARMCANZ Water Quality Guidelines in the Minerals Industry</i> (Batley et al., 2003)	<a href="http://www.acmer.uq.edu.au/publications/attachments/WQGTableofContents.pdf">http://www.acmer.uq.edu.au/publications/attachments/WQGTableofContents.pdf</a>
Water	USEPA - <i>Sampling</i>	<a href="http://www.ecy.wa.gov/programs/wq/wastewater/method_1669.pdf">http://www.ecy.wa.gov/programs/wq/wastewater/method_1669.pdf</a>



Quality Sampling - Low Level Metals Analysis	<i>Ambient Water for Trace Metals at EPA Water Quality Criteria Levels</i> (USEPA, 1996)	
Groundwater Sampling	<b>USEPA - Ground-Water Sampling Guidelines for Superfund and RCRA Project Managers</b> (Yeskis and Zavala, 2002)	<a href="http://www.epa.gov/tio/tsp/download/gw_sampling_guide.pdf">http://www.epa.gov/tio/tsp/download/gw_sampling_guide.pdf</a>
	<b>ISO 5667 - Water Quality Sampling - Part 18: Guidance on Sampling of Groundwater at Contaminated Sites</b> (ISO, 2001)	<a href="http://www.iso.org/iso/iso_catalogue/catalogue_tc/catalogue_detail.htm?csnumber=29025">http://www.iso.org/iso/iso_catalogue/catalogue_tc/catalogue_detail.htm?csnumber=29025</a>
	<b>NEPC - Schedule B (2) Guideline on Data Collection, Sample Design and Reporting</b> (NEPC, 1999) (includes information on soil sampling)	<a href="http://www.ephc.gov.au/nepms">http://www.ephc.gov.au/nepms</a>
	<b>AS/NZS - Water Quality Sampling, Part 11: Guidance on Sampling of Groundwaters</b> (AS/NZS, 1998)	<a href="http://infostore.saiglobal.com/store/details.aspx?ProductID=387183">http://infostore.saiglobal.com/store/details.aspx?ProductID=387183</a>
Surface Water Sampling	<b>ISO 5667 - Water Quality Sampling - Part 6: Guidance on Sampling of Rivers and Streams</b> (ISO, 2005)	<a href="http://www.iso.org/iso/iso_catalogue/catalogue_tc/catalogue_detail.htm?csnumber=34815">http://www.iso.org/iso/iso_catalogue/catalogue_tc/catalogue_detail.htm?csnumber=34815</a>
Gas Transfer	<b>MEND - Field Procedures Manual Gas Transfer Measurements</b> (MEND, 1993)	<a href="http://www.mend-nedem.org/reports/files/7.5.pdf">http://www.mend-nedem.org/reports/files/7.5.pdf</a>
Tailings Monitoring	<b>MEND - Field Sampling Manual for Reactive Sulphide Tailings</b> (MEND, 1989)	<a href="http://www.mend-nedem.org/reports/categories-e.aspx?cat_id=10">http://www.mend-nedem.org/reports/categories-e.aspx?cat_id=10</a>
Receptor Monitoring	<b>APHA/AWAA/WEF - Standard Methods for the Examination of</b>	<a href="http://www.apha.org/">http://www.apha.org/</a>

	<i>Water and Wastewater</i> (23rd Edition) (APHA/AWAA/WEF, 2007)	
	ASTM - <i>Annual Book of ASTM Standards - Section 11 - Water and Environmental Technology</i> (ASTM, 2007)	<a href="http://www.astm.org/index.shtml">http://www.astm.org/index.shtml</a>

### 8.3.3.6 Analytes

For all chemical analyses, the monitoring program should identify the analytes for all media of interest (e.g., water, sediment or mine waste) at each sampling location. The parameters typically of most relevance for water samples collected for ARD monitoring programs are the following: pH, (acidity or alkalinity, or both), electrical conductivity, and sulphate and metals of interest as determined for a particular site during characterization (Chapter 4). Sulphate, pH, and electrical conductivity are indicator parameters that are used to monitor the onset of ARD, as described in Chapters 2 and 4.

Determination of the analytes for water quality samples should consider the following:

- Relevant regulatory guidelines (e.g., aquatic life, potable water, antidegradation)
- COIs identified during predictive geochemical testing (see Chapter 4 and Chapter 5)
- Requirements for predictive geochemical modeling (i.e., comprehensive chemical analyses)
- Inclusion of analytes for QA/QC evaluations (e.g., major ions for calculation of ion balances)
- Inclusion of analytes that modify toxicity (e.g., pH, hardness, dissolved organic carbon)
- Analytical holding times (at remote sites, transport and analysis of samples within acceptable holding times may not be feasible)
- Appropriate parameter state (e.g., dissolved, total or total recoverable metals analysis; free, weak acid dissociable [WAD], or total cyanide analysis)
- Inclusion of chemicals introduced during mineral processing or extraction (e.g., nitrogen species from blasting agents)
- Inclusion of in situ field analyses (e.g., pH, redox, electrical conductivity, temperature, alkalinity, dissolved oxygen, turbidity)
- Inclusion of radiological parameters
- Cofactor or variable/variable relationships opportunities to reduce the analyte list

Water sampling SOPs should include information on appropriate sample containers, preservation methods, and storage times.

Guidelines for selection of parameters in receiving waters for early identification of a release are listed below (Maxfield and Mair, 1995):

- Fate and Transport – Are mobile (i.e., unlikely to be retarded in surface water and groundwater), stable, and persistent
- Baseline Conditions - Do not exhibit significant natural variability in background concentrations
- Analysis – Are easy to detect and not subject to significant sampling and analytical interferences
- QA/QC – Are common laboratory or field contaminants

### 8.3.3.7 Laboratory Selection

Laboratory selection is a primary consideration in successful implementation of a monitoring program because of the laboratory's role in generation of an accurate and defensible data set. Issues for consideration in laboratory selection include the following:

- Location (shipping costs and sample delivery within holding times)
- Reporting limits (Reporting limits must be low enough to allow comparison to applicable guidelines/standards.)
- Scope of services (water analyses, geochemical testing)
- QA/QC (laboratory SOPs, level of QA/QC reporting)
- Service (turn-around times, electronic reporting, report customization, and responsiveness)
- Accreditation
- Cost

On-Site Laboratory Analyses – Two advantages of on-site analysis are favorable economics and improved decision-making capabilities due to rapid turn around. The required analytical precision and accuracy must be considered in the selection of any laboratory, including the decision to analyze samples in-house. An in-house laboratory may not be capable of analyzing key ARD parameters to the required levels of detection.

Analytical accuracy has sometimes been overemphasized as a priority in ARD monitoring. In reality, the day to day variations occurring in surface water are usually much greater than the results from an on-site laboratory versus a commercial laboratory (MEND, 1990). On-site analysis often allows for increased

sampling frequency. Verification of on-site results can be achieved by submission of split samples to an accredited commercial laboratory. For some monitoring objectives, use of an on-site laboratory may not be appropriate (e.g., analysis of samples requiring high precision and low detection limits, sample analysis for regulatory reporting).

#### 8.3.3.8 Quality Assurance/Quality Control

The reliability of assessments made from a data set depends on the accuracy of the data set. To ensure collection of data of known and defensible quality, QA and QC operating procedures are implemented. Elements of a QAPP and specific information included for each are listed below (USEPA, 2001):

- Project Management – specific roles and responsibilities of the project team, personnel qualifications and training requirements, DQO, and performance criteria
- Data Generation and Acquisition – SOPs for data collection, measurement and analysis, sample handling and custody, analytical methods, laboratory and field quality control activities (e.g., blanks, duplicates, laboratory control samples) and required control limits and corrective actions, instrument calibration and maintenance, and data management
- Assessment and Oversight – components and schedule for performance audits, response actions for deficiencies and nonconforming activities
- Data Validation and Usability – criteria for data review and validation

For water quality analyses, selection of a laboratory and appropriate analytical methods to achieve the required reporting limits is an important step in generation of a useful data set. When project requirements include very low trace metal reporting limits, appropriate field procedures must be employed to avoid sample contamination. The USEPA provides guidance on collection of ambient water samples using ultra-clean techniques for low-level metal analysis (USEPA, 1996).

#### 8.3.3.9 Health and Safety

Health and safety factors must be considered in the design and implementation of the monitoring program. For example, sampling should not be mandated (by managers or by regulatory authorities) when such activities could pose a danger to human health. It is mandatory nowadays that environmental managers develop and provide a budget for a health and safety plan before sampling is initiated.

Personnel tasked with collection of samples from source areas, in particular waste rock piles, should be aware of the potential for oxygen deficient conditions because of sulphide oxidation and carbonate neutralization reactions. Climatic conditions, including temperature differentials between air and waste rock facilities and sharp drops in barometric pressures, have resulted in outflows of oxygen-depleted air from a waste pile. Sampling locations should be sited in areas where there are no limitations to the mixing of out-flowing gases with the surrounding area. Further information on the air quality hazards associated with waste rock stockpiles is presented in Phillip et al. (2008) who describe the incident at the Sullivan Mine in British Columbia, Canada. Sampling of coal waste piles may require establishment of specialized health and safety protocols to address burning waste or the potential for spontaneous combustion. Similarly, facilities that are conducive to generation of hydrogen sulphide (H<sub>2</sub>S) gas (e.g., treatment systems that include use of sulphate reduction) should be approached with caution.

### 8.3.4 Data Management and Interpretation

Data management procedures for a project are included in the QAPP and should include standard recordkeeping procedures, document control, and the approach for electronic storage and retrieval. Procedures must ensure data accessibility to users without compromising data security and integrity. The data management system should be capable of integrating various file formats (e.g., photos, drawings, and laboratory data) and information from different disciplines (e.g., hydrology, hydrogeology, and water quality). Use of a database with a GIS interface is recommended.

Ongoing data evaluation is required to assess data quality and provide feedback to environmental management systems. Reasons for ongoing data evaluation include, but are not restricted to the following:

- Statistical analysis to identify changes in environmental conditions (e.g., a change in water or sediment quality) relative to baseline or background conditions

(see Section 8.3.3.2).

- Evaluation of water quality trends to identify the onset of ARD. Graphical tools should be employed to evaluate temporal trends and to ensure early identification of any anomalous results. Frequent assessment and trend analysis of ARD indicator parameters (i.e., pH, SO<sub>4</sub>, alkalinity, and metals of interest) is required to ensure early identification of the onset of ARD.
- Evaluation of water quality trends to determine the need for additional monitoring locations or increase/decrease in sampling frequency.
- A tiered monitoring approach may be adopted with respect to sampling locations, frequency, or analytes. This approach may include establishing trigger levels for key parameters. If a tiered monitoring approach has been agreed upon, ongoing data management is essential to ensure appropriate implementation of tiering. For example, water quality monitoring may include measurement of indicator parameters (e.g., sulphate, pH, and electrical conductivity) to identify the onset of ARD followed by inclusion of additional metals following establishment of ARD. For parameters with water quality guidelines, a trigger level may be established at a value below the water quality guideline to provide an early warning of possible future exceedances.

- Regular updates to the DSM to assess performance with respect to predictions.

Figure 8-5 shows seepage water quality data from two waste rock dumps over a six-year period. These graphs illustrate the onset of ARD, characterized by declines in pH and increases in metal and sulphate concentrations. Seepage pH remained near neutral for a number of years before acidic conditions were established. The water quality data in Figure 8-5 show that alkalinity, as opposed to pH, may be a better early time indicator of the onset of ARD. At this site, the downward trend in alkalinity is evident before the downward trend in pH. These graphs further demonstrate the importance of frequent monitoring to capture seasonal variability in water quality conditions and the use of graphical techniques to identify anomalous values (see zinc data in Figure 8-5).

**Figure 8-5: Waste Rock Seepage Water Quality Trends (pH, Alkalinity, SO<sub>4</sub>, Cu, and Zn)**

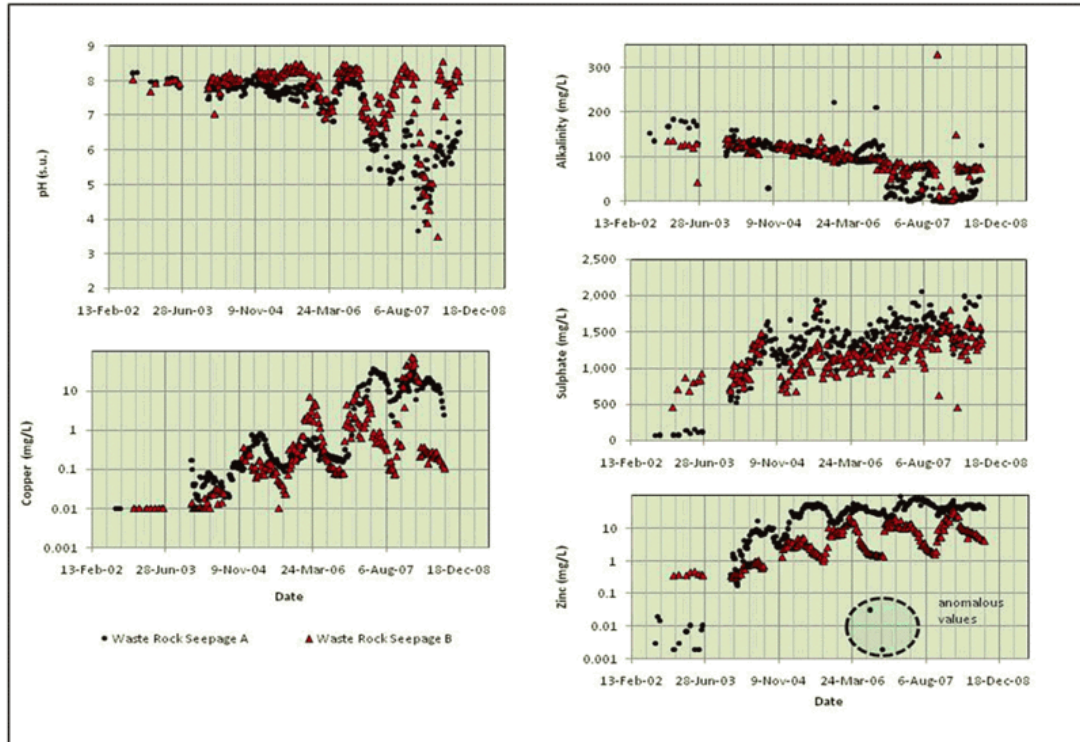

### 8.3.5 Auditing

ARD monitoring requirements will evolve over a mine's life. Regular review of the monitoring program is required to ensure that objectives are being fulfilled. The components and schedule for program audits are included in the project QAPP. Audits may be performed by internal or external personnel; using both internal and external personnel is desirable. Periodic external audits by third parties allow for a "fresh look" by someone who is removed from day-to-day activities. Evaluation of laboratory performance should be included in audits.

## 8.4 Monitoring Program Components

Source and pathway monitoring determines the level of contamination present in the receiving environment. A "contaminant" is defined in this GARD Guide as a substance not normally present (e.g., low pH) or as a substance present above background or reference levels (e.g., a metal or metalloid). To determine whether or not that contamination is capable of causing an effect, the interactions between exposure (from COIs) and effects to receptors of potential concern are evaluated. If effects are shown to occur, or if effects may occur, then a determination must be made as to whether or not those effects could become impacts.

An effect is defined as an alteration to a valued ecosystem component (VEC) that can be positive, negative, or neutral (e.g., Cu and Zn are essential metals that can have positive as well as negative effects on biota, depending on concentration). An impact is an effect that adversely affects the productivity or

viability of a VEC community or population of VEC organisms. The possibility of impacts is the primary focus of monitoring, not effects to individual organisms, except in the case of endangered species or humans, where a greater level of protection of individuals may be required.

In terms of ARD, the focus is on the following four primary potential adverse effects, when of sufficient severity, can result in population-level impacts:

- Lowered pH
- Increased sulphate ion concentrations
- Increased concentrations of bioavailable metals and metalloids
- Precipitation of metal hydroxides (reduced habitat and oxygen supply)

#### **8.4.1 Acid Rock Drainage Sources**

The primary focus of ARD source monitoring is typically to provide an early warning of ARD release. In Sections 8.4.1.1 through 8.4.1.3 a number of individual potential sources for ARD and specific monitoring requirements are described.

##### **8.4.1.1 Mine Workings**

Sulphide minerals exposed to the atmosphere in underground workings and open pits are a potential source of ARD. During operations, dewatering programs (removal of groundwater with wells and sumps) minimize groundwater interaction. When mining ceases, flooding of mine workings may flush stored oxidation products from pit and mine walls. Backfill materials (e.g., waste rock and tailings) may also contribute metals and acidity to a mine pool or pit lake.

Hydrogeologic site conditions must be considered in the development of a monitoring program for underground workings. Below-drainage (i.e., fully flooded) mines tend to have a finite life for acid mine drainage discharge whereas acid mine drainage from above-drainage (partially flooded mines) may persist for decades, or longer, depending upon the exposure and reactivity of acid generating walls (Demchak et al., 2004). Peak contaminant concentrations generally occur during the first flush because of the rinsing of accumulated sulphide oxidation products. During water table rebound, underground workings may transition from a groundwater sink to a groundwater source.

An understanding of the pit lake water balance is required to determine if a pit lake will form and if the pit will be a hydrologic source or sink.

Water Quality Monitoring – During operations, collection of sump and dewatering well samples provides a direct assessment of ARD. During pit flooding, collection of samples from the mine pool, surface expressions, and within the pit lake provides source characterization.

A chemocline or thermocline may develop in open pits and underground workings. Collection of water quality samples to assess the presence of a chemocline and evaluate changes in chemistry with depth may be appropriate.

Hydrologic Monitoring – During operations, dewatering volumes and information to estimate the size of the void created by mining (i.e., volume of material removed) should be recorded. This information is used to estimate time to water table rebound following cessation of dewatering activities. During water table rebound, water levels within the pit, underground workings, or dewatering wells are monitored to evaluate the rate of water-table rebound. This water-level information is required to estimate the timing and location of possible discharges to the environment (e.g., water discharge from underground adits or shafts or discharge from a pit lake).

ARD Process Monitoring – Wall washing tests may be conducted to provide data on sulphide oxidation rates and metal leaching from mine and pit walls (Photo 8-1) (Price, 1997).

**Photo 8-1: Collection of a Wall Washing Sample from a Pit Face**



**8.4.1.2 Waste Rock Piles**

Waste rock piles are typically described as heterogeneous, consisting of a mixture of rock types with variable ARD potential and a range of particle sizes. In some cases, operational characterization (e.g., total sulphur and NP analysis) of waste rock may be conducted to segregate waste rock on the basis of ARD potential. Precipitation is the primary water source moving through this waste. Typical components of a waste rock monitoring program are listed in Table 8-6.

**Table 8-6: Components of Waste Rock Pile Monitoring Program**

Objective	Data Collection	Method/Instrument	Reference
ARD/ML leaching - water quality	Pore water - unsaturated Zone	Pressure-vacuum (suction) lysimeters	
	Pore water - saturated zone	Piezometers/wells	
	Runoff	Weirs	
	Seepage	Weirs/wells	
Water flow	Precipitation	Rain gauge	
	Infiltration rate	Gravity lysimeter	(ACMER, 2000) Method P-001
	Water permeability	Infiltration/slug tests	
	Moisture content	Neutron probe	
		Time-domain Reflectometry (TDR)	
	Matric suction	Tensiometer	
		Thermal conductivity Sensor	
	Soil-water characteristic curve	Laboratory test	
Unsaturated (saturated) Hydraulic conductivity	Laboratory test		
ARD/ML process	Temperature (profile)	Thermistor strings	(ACMER, 2000) Method P-002 (probe installation) and P-003
	Oxygen (profile)	Well gas ports	(ACMER, 2000) P-006

	Air Permeability	Porosity	(MEND, 1993)
	Oxygen Diffusion	Well gas ports	(MEND, 1993)
	Particle size distribution	Sieve analysis	

**Water Quality Monitoring** - Collection and analysis of water samples provides a direct assessment of the onset or magnitude of ARD within a waste rock facility. Collection of water samples may include seepage (typically collected at the toe of the pile), runoff, and pore water from within the pile. Pore water samples are collected using lysimeters or piezometers from the unsaturated and saturated portions of the pile, respectively. Lysimeters may also be used to measure water volumes to calculate infiltration rates (Photo 8-2). A seasonally stratified sampling program is appropriate for collection of water samples.

**Photo 8-2: Waste Rock Lysimeter in an Arid Climate**



**Hydrologic Monitoring** – The range of particle sizes in a waste rock pile complicates measurement or estimation of infiltration. Water infiltration through waste rock is a combination of matrix flow and preferential flow. Best practices for instrumentation of waste rock piles to quantify key infiltration processes are still in development; however, the parameters of most interest in characterization of hydrogeologic conditions are moisture content, matric suction, soil-water characteristic curves, and unsaturated hydraulic conductivity (Smith and Beckie, 2003). Infiltration is measured directly through installation of lysimeters within the pile.

**ARD Process Monitoring** - Waste rock monitoring may also include collection of data to evaluate the rate or status of ARD for predictive evaluations. The availability and transport of oxygen to reactive sulphides controls the rate of sulphide oxidation. Therefore, prediction of the rate of sulphide oxidation within a waste rock stockpile requires an understanding of gas transfer mechanisms within the pile (i.e., diffusion and advection) (see Chapter 2 for more detail on the ARD process). To define gas transfer, the following bulk physical parameters must be measured: thermal conductivity, gas diffusion coefficient, and gas permeability. MEND (1993) and ACMER (2000) provide information on field procedures for instrumentation and collection of data to evaluate gas transfer Table 8-6.

**Figure 8-6: Sprint Thaw Stream Concentration and Loading Trends (March 23 to June 22)**

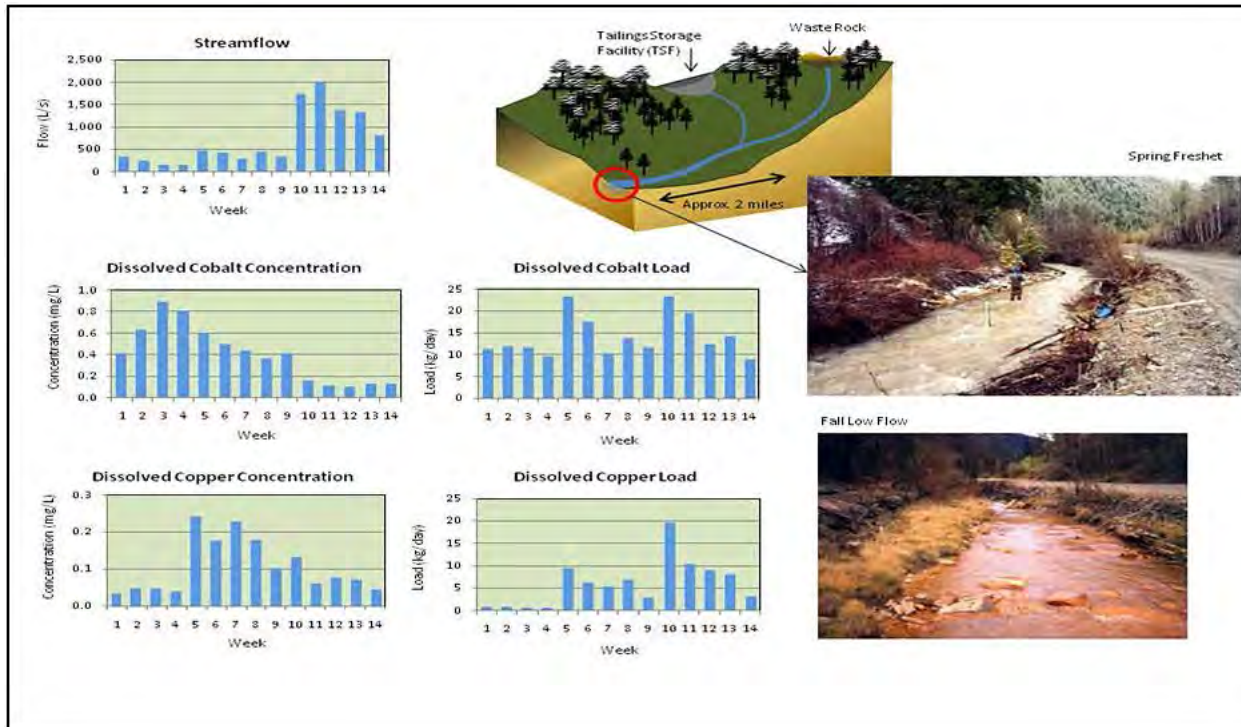

Pyrite oxidation is an exothermic reaction that consumes oxygen. Measurements of temperature and oxygen profiles within a waste rock pile provide an indirect means to assess the rate of sulphide oxidation within a waste rock facility after ARD is well established. This method is applicable provided the pile does not contain other oxidizable material (e.g., carbonaceous material).

**8.4.1.3 Tailings Storage Facility**

Tailings are discharged to storage facilities by three methods: subaerial slurry, subaqueous, or dry deposition. Compared to waste rock, tailings are homogenous with a more consistent distribution of acid generating and acid neutralizing materials; however, if associated with a particular size fraction, segregation may occur during deposition. The fine particle size of tailings results in low permeability to oxygen and water.

Spatial differences in sulphide reactivity and pore water quality must be considered in the design of a TSF monitoring program. Tailings moisture content is a primary control on the rate of oxygen diffusion into tailings and therefore the rate of sulphide oxidation. Sulphide oxidation is typically restricted to the uppermost tailings exposed to the atmosphere. Shallow acidic pore water may be neutralized as it migrates downward through the tailings. Tailings pore water quality is therefore typically highly variable with depth. The time for acidic seepage to emanate from the base of sulphide tailings will be a function of both the reactivity of the tailings (i.e., the relative rates and amount of acid generation by sulphide oxidation and acid neutralization by dissolution of minerals with buffering capacity) and the travel time through the tailings. The duration of effects from sulphide oxidation from tailings can range from decades (e.g., tailings with a low sulphide content and shallow water table in the tailings) to centuries (e.g., tailings with a high sulphide content and deep water table) (Blowes et al., 2003). Typical components of a tailings monitoring program are listed in Table 8-7.

**Table 8-7: Components of Tailings Storage Facility Monitoring Program**

Objective	Data Collection	Method/Instrument
ARD/ML leaching water quality	Pore water- unsaturated zone	Core sample extraction (e.g., centrifugation, pressurised consolidation – squeezing, pore water displacement)
	Pore water – saturated zone	Suction lysimeters
	Runoff	Weirs
	Seepage	Weirs/wells
	Water cover (subaqueous disposal)	
Water flow	Hydraulic conductivity	Estimated from grain size, slug tests or pumping tests
	Hydraulic head	Water level measurement in piezometers/wells pond elevation (subaqueous disposal)



	Air permeability	Porosity
ARD/ML process	Moisture content	Neutron probe
	Pore gas O <sub>2</sub>	Well gas ports
Time domain reflectrometry (TDR)		

**Water Quality Monitoring** - Collection and analysis of water samples provides a direct assessment of the onset or magnitude of ARD within the tailings. Collection of water samples from a tailings impoundment may include (sample types may not be applicable to all TSF designs) tailings slurry water from the point of discharge, tailings pore water, tailings pond supernatant (subaqueous disposal), tailings seepage (embankment or from collection drains), and tailings runoff.

Different methods may be used to collect tailings pore water from the unsaturated and saturated zones (Table 8-7). Collection of pore water samples with depth allows evaluation of current conditions and also allows the progression of acidification fronts through the tailings. Differences in geochemical conditions at depth may result in enhanced mobility of some constituents (e.g., reductive dissolution resulting in arsenic release). Therefore, water quality results from shallow pore water or tailings pond supernatant may not identify all COIs. Collection of tailings pond supernatant should also consider the potential for vertical stratification.

Determination of the analyte list should consider inclusion of beneficiation process chemicals (e.g., cyanide). If the TSF is used for codisposal of other waste materials, inclusion of additional analytes may be appropriate.

During operations, milling processes can produce thiosalts, especially from pyrrhotite ores. These thiosalts usually report to tailings and can be the source of additional concerns related to the further oxidation to sulphate, which both lowers the pH and consumes oxygen. Tailings from these reactive ores should be monitored for thiosalt presence and for the associated oxidation of these thiosalts and its potential effect on tailings water quality and the environment (see Chapter 2 for additional information on thiosalts).

In the case of subaqueous disposal in a lake or the marine environment, additional monitoring requirements are related to sediment quality and smothering of sediments and the potential for lateral and vertical distribution (i.e., upwelling) of tailing-related water.

**Hydrogeologic Monitoring** - The hydrogeologic conditions within a TSF are controlled by tailings grain size and depositional history. Measurements of hydraulic head and hydraulic conductivity can be used to estimate the rate of water movement through the tailings. Geochemical characteristics of the pore water may also serve as tracers to estimate the rate of water movement (Blowes et al., 2003).

**ARD Process Monitoring** – Tailings solids sampling and analysis may be conducted during operations to characterize changes in the waste composition and acid base accounting. Data collection to support predictive sulphide oxidation modeling and verification and for performance monitoring of mitigation measures (e.g., covers) may include moisture content profiles, porosity, and pore gas oxygen concentrations.

## 8.4.2 Pathways

The goals of pathway monitoring may include characterization of current conditions, assessment of fate and transport of COIs, and estimation of contaminant loading. Surface water and groundwater are the primary pathways of interest for impacts from ARD sources.

Mine discharges may include both controlled releases of effluent (e.g., water treatment plant effluent discharge) and more diffuse releases (runoff and seepage from waste facilities). ARD discharge occurs within the mine property boundary where initial mixing with surface water or groundwater occurs. The COI may eventually migrate to the property or compliance boundary and beyond.

### 8.4.2.1 Surface Water (Streams and Sediment)

**Water Quality** – BACI (see Table 8-4) is the preferred monitoring location design for stream water quality monitoring. Exposure stations should be sited near ARD sources or effluent discharges where complete mixing is achieved. Collection of multiple samples along the width of the stream will allow for an assessment of within-station variance and the degree of mixing. Evaluation of the transport of COIs downstream of a source requires collection of samples upstream and downstream of surface water inflows.

Flow-stratified sampling is often appropriate. Figure 8-6 shows stream flow and concentration trends (dissolved copper and cobalt) downstream of multiple ARD sources (TSF and waste rock). These data illustrate that concentration trends for parameters may differ, resulting from differences in both source release and transport within the receiving environment (i.e., differing degrees of attenuation).

Collection of samples can be conducted manually or with automatic programmable samplers. Manual collection allows immediate determination of field parameters and submission of samples for analysis. Programmable samplers allow collection of multiple samples over time and can be used to capture unpredictable events (e.g., storm flush). The potential for damage to the automatic sampler during flood events should be considered when siting the equipment. The effects of a delay between sample collection and analysis are a potential disadvantage of automated samplers. Collection of grab samples is appropriate for fully mixed systems. Composite samples (e.g., flow weighted) can be collected if complete mixing has not been achieved.

Diel (24-hour) sampling may be required to characterize within-station variance for some parameters. Dissolved concentrations of some trace metals exhibit

consistent and substantial diel variations, particularly in streams with neutral to alkaline pH values. Daily changes in water temperature and pH and their effect on metal sorption are the most likely cause of observed diurnal metal cycles. Metal concentrations typically show increasing trends during the night and decreasing trends during the day (e.g., Cd, Mn, and Zn), primarily related to changes in water pH related to respiration vs. photosynthesis of aquatic plants. However, the opposite trends have been observed for arsenic (USGS, 2003). In the case of ARD, such behaviour is generally not observed due to the acidic nature of the solution and the relatively minor changes relative to the overall metals load.

**Flow** – Measurements of stream discharge are required to calculate chemical loading, and such measurements should be conducted concurrent with water quality sampling. Instantaneous stream discharge measurements are made by dividing the width of a stream into sections and measuring the cross sectional area and average water velocity using a current velocity meter (Photo 8-3). Total river discharge is estimated by summing the discharge within each subsection where the discharge within each subsection is the product of the subsection width, midpoint depth, and average velocity. A stage-discharge relationship (curve) can be developed to convert water level measurements (from a gauge or transducer) to streamflow. Approximately 10 stage/discharge measurements, taken over a range of flows, are typically required to establish a stage-discharge curve (MEND, 2001). Characterization of high flows to capture the high end of the stage-discharge curve may require sampling during precipitation events. Safety aspects associated with sampling during high-precipitation events should be taken into account. Streamflow monitoring locations should be sited in areas with the following characteristics: relatively straight channel, uniform bed elevation, nonturbulent flow, and close proximity to staff gauge/transducer.

**Photo 8-3: Stream Discharge Monitoring Using a Current Meter**



The accuracy of discharge measurements in mountain streams using traditional methods (e.g., weir or current velocity meter) is reduced because of the exclusion of the contribution from the hyporheic zone (subsurface volume of sediment and porous space adjacent to a stream through which stream water readily exchanges). The hydrology of mountain streams is complex. Variability in streambed topography, resulting in variation in stream water slope, influences the potential energy distribution at the boundary between the stream and subsurface. Changes in pressure distributions on the channel bed cause surface water to flow into and out of the bed. Individual flowpaths of exchange can range in scale from centimeters to tens to hundreds of meters with travel times from minutes to years (Harvey et al., 1996). Tracer tests have been used to estimate the following hydrologic properties in mountain streams: velocity, travel time, groundwater inflow, and mixing of solutes (USGS, 1997). Selection of a conservative tracer is key to the success of tracer dilution tests. Guidance for the design of stream discharge tracer studies is presented in Kilpatrick and Cobb (1985).

Weirs, either as temporary or permanent installations, are also used to estimate streamflow. A weir is an overflow structure built perpendicular to an open channel axis to measure the rate of the flow of water. When properly constructed and operated, flow is estimated by measuring the head of water above the crest of the weir. The shape of the crest overflow governs the relationship between head measurement and discharge. Common weir types include rectangular, V-notch, and Cipoletti (trapezoidal) weirs. Guidelines for the appropriate use of weirs and their maintenance are provided in the Water Management Manual (U.S. Department of the Interior – Bureau of Reclamation, 2001).

Accurate flow measurements are essential to evaluating chemical loading. Measurement of electrical conductivity, in association with flow measurements, may allow for identification of anomalous flow measurements (Wolkersdorfer, 2008).

**Sediment** – Because of the tendency for sediment to act as a metal sink, and conversely a source of metal release and toxicity to aquatic life, river and lake sediment monitoring is often a component of impact assessment. Sampling locations should target fine-grained depositional zones. The vertical accumulation of COIs is affected by bioturbation, bioirrigation, sedimentation rates, and turnover events. Recommended depths of sample collection are variable; however, typically samples are collected up to a depth of approximately 10 to 15 centimeters to encompass the zone within which most burrowing animals live. Consistency in sample collection depth between events is critical for meaningful comparisons of temporal data. Grab or core sampling methods can be used; core sampling provides greater precision for sample depth. Sample collection should avoid periods of disturbance (i.e., high flows or seasonal turnover events). Sample analysis typically includes chemical analysis (metals and sulphides; sulphides are particularly important with respect to possible sediment toxicity testing), grain size, total organic carbon, and wet/dry weight. Sequential extraction or acid volatile sulphide (AVS) analyses may be performed if information on metal phases is required for toxicity or bioavailability assessments. The grain size fraction used for chemical analysis must be defined.

Collection of pore water samples is less common, but may be required for detailed toxicity studies. In situ sampling methods (e.g., suction or dialysis samples) provide better representation of the anoxic conditions typically present than do laboratory methods such as centrifugation (Chapman et al., 2002).

#### 8.4.2.2 Lake Monitoring

Monitoring design to assess impacts to lakes must consider the following characteristics that affect water quality and constituent fate and transport (Hem, 1992).

Figure 8-7: Solute Transport and Thermal Stratification in Lakes

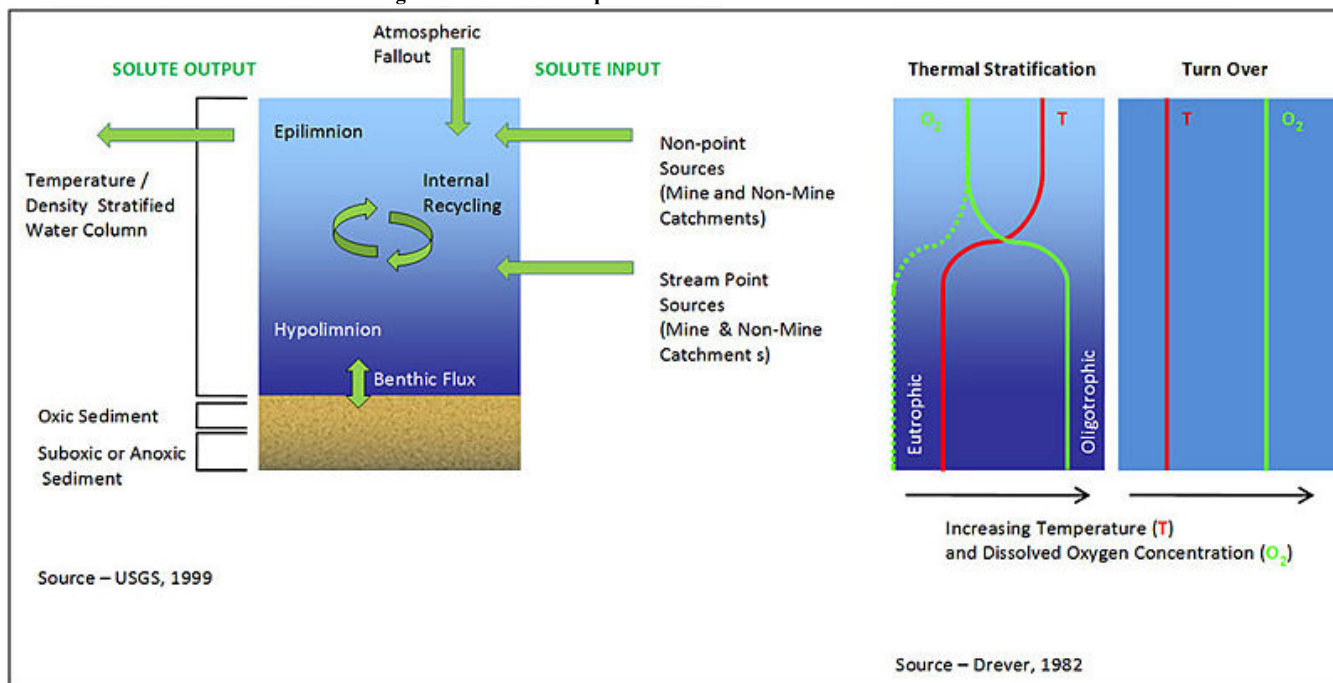

- Retention Time – In comparison to streams, the longer retention time in a lake provides more time for kinetically slow reactions to come closer to completion.
- Degree of Mixing – Incomplete mixing in a lake may result in significant spatial variability in water quality.
- Evaporation – In closed basin lakes, constituent concentrations will increase due to evaporation.
- Thermal Stratification – Heating of the upper water layer during warm periods results in stratification because of the relationship between water density and temperature. Thermal stratification separates warm lighter surface water (epilimnion) from cold heavier bottom water (hypolimnion). Minimal solute exchange between the layers may result in thermal and chemical stratification and the development of a thermocline/chemocline. Stratification can also cause oxygen depletion at depth because of atmospheric isolation and oxygen consumption by biochemical processes. A change to cooler temperatures may result in lake turnover (mixing) and a change to more uniform water quality conditions, including more uniform dissolved oxygen concentrations.

The physical, chemical, and biological conditions within a lake will affect the transfer of metals between the water and sediment phases. If the CSM identifies metal loading to lake bed sediments as a concern, identification of the primary mechanisms responsible for metal transfer between the aqueous phase (water column or sediment pore water) and solid phase (sediments) within the lake and the geochemical conditions driving these reactions may require collection of specific data.

Lake monitoring may include the collection of water quality samples. The degree of mixing within a lake will dictate requirements for spatial collection of samples. Collection of depth profiles of key parameters (e.g., temperature, dissolved oxygen, electrical conductivity) will provide information on the degree of stratification and the need for collection of depth stratified samples.

Evaluation of temporal water quality trends necessitates collection of proper baseline data or monitoring of reference lakes, or both. Without appropriate reference (and background) measurements, water quality changes due to other factors (acid rain, climate change) may be incorrectly attributed to mine operations. Monitoring of background drainages outside of the mine catchment may be required to evaluate other sources of loadings. Temporal comparisons of lake water quality should be made with samples taken during the same season. To assess metal loadings to a lake, data collection to calculate a loading budget may be more appropriate than in-lake water quality measurements. Measurement of inflow and outflow water quality and flow allows for determination of the lake as a constituent source or sink. Data indicative of accumulation of a COI within the lake could trigger collection of data on likely sinks (sediment and aquatic organisms).

#### 8.4.2.3 Marine Monitoring

For coastal sites, marine monitoring may be required if the CSM indicates a potential for ARD release to this environment. The physical (e.g., tidal and ocean currents) and chemical (e.g., high ionic strength, chemical gradients) dynamics of the marine system result in very site-specific approaches to monitoring. Biological monitoring may be the most efficient way to evaluate ARD impacts (MEND, 1990). For submarine tailings disposal, monitoring to evaluate the spatial extents of dispersion of the tailings plume is often required.

#### 8.4.2.4 Groundwater

BACI (see Table 8-4) is the preferred monitoring location design for groundwater monitoring. Information on the site geology, topography, and hydrology (including wetlands) should be reviewed to develop a conceptual model of groundwater flow directions before siting monitoring wells. Land surface topography is used to assess the general direction of groundwater flow and identify areas of groundwater recharge and discharge. Topographical highs are recharge areas where groundwater flow is directed downward. Groundwater discharges at topographical low areas to springs, lakes, wetlands, or streams.

The monitoring well network is designed to provide information on groundwater quality and groundwater flow (direction and velocity). Siting of monitoring wells should consider the following:

- Groundwater Flow – A minimum of three groundwater level measurements from the same aquifer are required to determine groundwater flow direction. Calculation of groundwater velocity requires information on the hydraulic gradient (calculated from water-level measurements) and the hydraulic properties of the aquifer (porosity and hydraulic conductivity [K]). Hydraulic conductivity can be estimated using a variety of laboratory or field testing methods (e.g., estimated from grain size, laboratory falling-head permeameter tests, slug testing, and pump testing). Tracer studies can also be used to characterize groundwater flow. Numerical models may be used as a tool in the evaluation of groundwater flow.
- Impact Well Siting – Wells sited to assess impacts to groundwater quality from a source must consider groundwater flow directions and velocity. Wells sited to provide an early warning of impacts should not be placed too far downgradient or at too great a depth (Richards et al., 2006). Spatial monitoring well coverage must consider all three dimensions. The potential for mining activities to change groundwater flow patterns or water-table depth should also be evaluated to determine well screen elevations (e.g., dewatering wells, ponded water conditions in a TSF).
- Groundwater Quality – Fate and Transport – Characterization of aquifer solids (e.g., neutralization potential, cation exchange capacity) may provide useful data for groundwater fate and transport assessments, specifically in the evaluation of metals attenuation or acidity neutralization. The sequence of pH buffering reactions that occur during migration of an acidic plume is well documented in areas affected by mining activity and described in Blowes and Ptacek (1994), Stollenwerk (1994), and Brown et al. (1999).
- Geophysical Methods may also be used to assess the migration of an ARD plume and may be used as a tool in siting wells at sites where ARD contamination exists (MEND, 2001).
- Springs – Baseline characterization of site hydrogeology should include a survey of seeps and springs. Collection of water quality and flow measurements may be included in baseline and operational monitoring.
- Monitoring Frequency – A fixed frequency sampling program is typically employed for groundwater monitoring (e.g., monthly groundwater level measurements and quarterly groundwater quality sampling). Continuous water-level measurement using transducers may be appropriate (e.g., monitoring of groundwater level decline associated with dewatering operations).
- Well Construction – Use of acid or sulphate resistant materials in the construction of ARD monitoring wells may be appropriate (e.g., use of PVC or stainless steel screens instead of a mild steel or use of sulphate resistant grout).

#### 8.4.2.5 Groundwater/Surface Water Interactions

Investigative monitoring may be required to identify groundwater discharge of COIs to surface water. Synoptic sampling involves collection of samples from multiple locations during a short period of time to provide a “snapshot” of conditions and identify sources and sinks to the water resource of interest. Synoptic stream sampling involves collection of surface water quality samples and flow measurements along a flow path synchronous with flow velocity to track loading and identify sources and sinks. This technique is often used to identify groundwater COI sources.

Following identification of areas of groundwater seepage, seepage meters can be used to calculate seepage rates or collect seepage samples for chemical analysis. The basic concept of the seepage meter is to cover and isolate part of the sediment-water interface with a chamber open at the base and to measure the change in the volume of water contained in a bag attached to the chamber over a measured time interval.

#### 8.4.2.6 Climate

Collection of site climatological data is important to develop site-wide water balance. Installation of precipitation gauges to collect daily rainfall data and evaporation pans provide data for calculation of net infiltration. Wind speed, wind direction, relative humidity, and temperature data may also be compiled if a comprehensive evaluation of site specific conditions is required. In cold climates, snowpack may be measured to evaluate hydrologic conditions during spring thaw.

### 8.4.3 Mitigation Measures

The following are examples of typical monitoring requirements for evaluation of the effectiveness of engineering controls designed to control or mitigate ARD releases:

- Water Treatment (Passive and Active) – Water-quality monitoring of treatment influent and effluent samples is standard practice. Passive treatment systems may require more frequent monitoring during certain climatic conditions to ensure consistent performance (e.g., periods of high flow or extreme ambient temperatures).
- Cover Performance – Cover designs to prevent or reduce sulphide oxidation are designed to limit oxygen transfer or water infiltration into a waste material. Monitoring designs to evaluate the effectiveness of cover performance are the same as those employed to evaluate ARD processes within a waste material and are described in Section 8.4.1.
- Liner Performance – Waste facilities may be lined to prevent migration of seepage into groundwater. Groundwater monitoring wells may be sited adjacent to waste facilities to provide early warning of COI release because of liner failure.

The mitigation measures implemented at a particular site will dictate the monitoring required to evaluate performance. Additional information mitigation measures monitoring is provided in Chapter 6.

### 8.4.4 Receptors

Receptor monitoring is conducted to identify any changes in biota attributable to mining. Metal or acidity release to the receiving environment may alter population dynamics or alter the community composition of an ecosystem. Receptor monitoring is designed to detect changes in species composition (the presence or absence of taxa within an area), abundance or distribution of plants and animals, or both. Unlike water quality monitoring, which provides information on environmental conditions at a point in time, biological monitoring provides an indication of environmental conditions over time.

Figure 8-8 shows the steps in the development of a biological monitoring program. At the start of a biological monitoring program, receptors in potentially affected areas are identified. Selection of receptors for inclusion in the monitoring program considers the following: predicted COIs, range of biota exposed, toxicological implications of exposure to specific biota, and potential for recovery following mitigation (e.g., recolonization, reproductive potential).

**Figure 8-8: Steps in the Development of a Biological Monitoring Program**

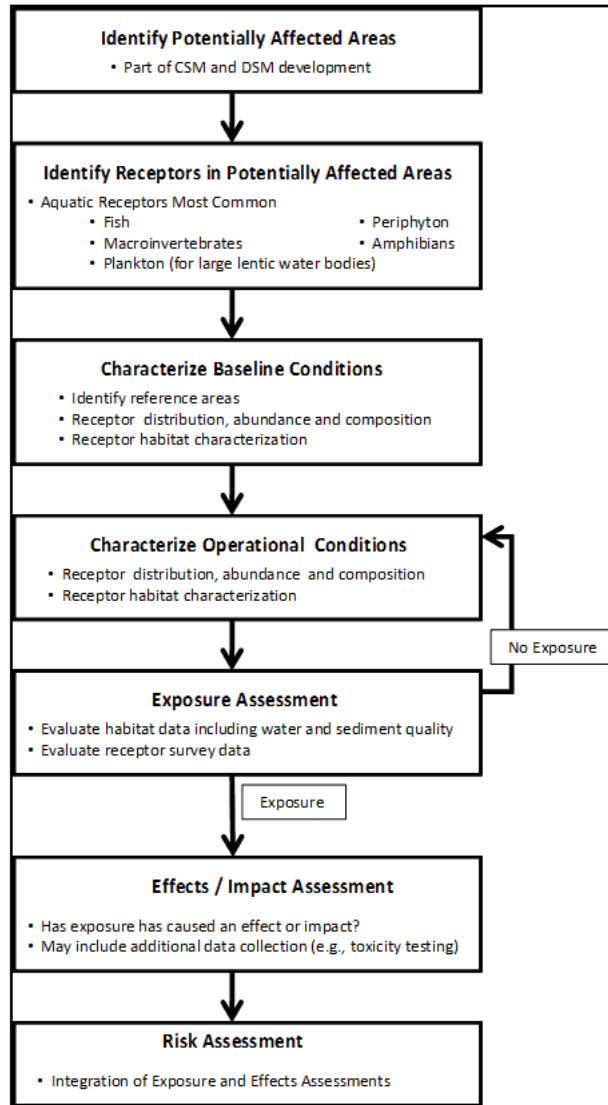

Assessment and measurement endpoints are defined for each biological receptor. An assessment endpoint is the explicit expression of the environmental value that is to be protected (e.g., survival, growth, and reproduction of major aquatic communities). A measurement endpoint is the measurable ecological characteristic that is related to the assessment endpoint (e.g., actual determinations of survival, growth, and reproduction using laboratory or other tests or field observations, or both).

Fish and benthic macroinvertebrates are often selected to measure effects from ARD (Photo 8-4, Photo 8-5, and Photo 8-6). Fish are selected for monitoring because of their economic value, public perception (impacts are often visible and well understood by the public), and their use as an indicator of possible impacts to lower trophic levels. Reduced pH or trace metals can affect behavioural, respiratory, and other physiological fish functions. Fish population characteristics (e.g., length and weight relationships, age structure, sex ratio, fecundity, and growth) and tissue metal concentrations are common metrics (MEND, 2001).

**Photo 8-4: Benthic Macroinvertebrate**



**Photo 8-5: Benthic Macroinvertebrate Sampling with a Hess Sampler**



**Photo 8-6: Fish Survey Using Nets**



Benthic macroinvertebrates are small animals without backbones that inhabit bottom substrates and are retained by mesh sizes  $\geq 200$  to 500 micrometers ( $\mu\text{m}$ ). Benthic assemblages are comprised of a range of organisms that exhibit variability in their tolerance to impacts (e.g., sedimentation and metals) (USEPA, 2003). Reduced density, reduced taxa richness, or a shift from sensitive to tolerant benthic taxa are all indicators of impacts. Reasons to include benthic macroinvertebrates in monitoring programs include their sessile nature, their use as indicators of water quality and habitat conditions, and they are a

food source for fish, an indirect measure of ARD impacts to fish populations.

#### 8.4.4.1 Establishment of Baseline Conditions

The CSM identifies areas that may be affected by ARD release. Monitoring is conducted to establish baseline ecological conditions within these areas at both reference and exposure stations. Reference and exposure aquatic monitoring stations should be sited in areas with similar physical and ecological characteristics to minimize the potential for differences because of natural confounding factors (e.g., current velocity, depth, substrate, dissolved oxygen). The first aquatic monitoring station should be located within the mixing zone near the point of ARD release. Additional downstream stations are sited at increasing fixed intervals. The final monitoring location should be beyond the point of potential environmental impacts. Co-location of water quality and sediment sampling stations may be appropriate.

Habitat, a consideration in the selection of sampling locations, should be characterized at all locations. Information requirements for aquatic habitats are shown in Table 8-8 (USEPA, 2003). Determination of relevant information will be receptor dependent.

**Table 8-8: Aquatic Habitat Information Requirements for Biological Monitoring**

Habitat	Information
Stream	Gradient, width and depth, pool frequency, substrate composition, streambank erosion, flow characteristics, temperature, and dissolved oxygen
Lake or reservoir	Depth, surface area, littoral zone area, aquatic vegetation, and substrate composition
Riparian zone	Width, percent cover and composition of vegetation by strata, and estimated shaded area by season

#### 8.4.4.2 Sample Collection

Site conditions, receptors of potential concern, and assessment endpoints will dictate sample collection protocols. General guidelines for benthic macroinvertebrate and fish monitoring include MEND (1997), Environment Canada (2002), and USEPA (2003).

#### 8.4.4.3 Data Evaluation - Exposure Assessment

Habitat (including water and sediment quality) and biological monitoring data are evaluated to determine if receptors have been exposed to COIs. The exposure assessment attempts to answer the following questions:

- Are COIs elevated?
- Could biomagnification occur? Biomagnification is only relevant for a very few organic substances (e.g., the organic form of mercury - methyl mercury), but not for inorganic metals or metalloids.
- How does environmental fate of a COI affect receptor exposure?

Confirmation of exposure triggers an effects assessment.

#### 8.4.4.4 Data Evaluation - Effects Assessment

The effects assessment attempts to answer the following questions:

- Are COIs biologically available? The bioavailability, bioaccessibility, and bioreactivity of the COI are determined. Bioavailability can be estimated for metals by modelling (e.g., the Biotic Ligand Model [BLM]) (Paquin et al., 2000) or laboratory testing.
- Are COIs toxic? The magnitude of any toxicity associated with exposure to COIs is assessed. Such information is typically determined from toxicity tests with well-established standard test organisms.
- Are resident communities altered? Alteration of resident community structure is assessed by identifying and enumerating assemblages, and using both univariate and multivariate analyses to determine similarities and differences from reference areas and baseline conditions.
- Are COIs causative? Investigation of causation involves additional or more extensive studies as appropriate to site-specific circumstances (e.g., spiked toxicity tests, toxicity identification evaluation [TIE], contaminant body residue [CBR] analyses, tests with resident organisms, and in situ bioassays).



#### 8.4.4.5 Risk Characterization

Combining exposure and effects assessments differentiates contamination from pollution (“pollution” is defined here as contamination that results in adverse biological effects). Including both toxicity testing and assessment of any alterations to resident communities differentiates effects from impacts. Exposure and effects assessments are integrated to determine whether or not significant effects are occurring or are likely to occur. In addition, the nature, magnitude, and areal extent of effects on the selected assessment points are described. The COIs that may be causing or substantially contributing to such effects are identified to the extent possible.

The results for each line of evidence are compiled and interpreted separately. Subsequently, they are combined and integrated, including uncertainty and best professional judgment, to establish a weight of evidence for assessing risks. Risks of adverse effects can generally be considered in the following four categories:

- Negligible – similar to those for baseline or reference conditions, or both
- Moderate – minor or potential differences compared to baseline or reference conditions, or both
- High – major or significant differences compared to baseline or reference conditions, or both
- Uncertain – requiring further study (determined on a case- and site-specific basis)

The latter two categories would also involve determination of causation, specifically answering the question as to whether or not any observed biological effects are due to ARD-associated contaminants and, if so, which contaminants and at what concentrations.

### 8.5 Closure and Long-Term Considerations

During the decommissioning phase, current environmental conditions are compared to the predictive models to assess the need for long-term monitoring. Because there may be significant lag times to the onset of ARD, the absence of ARD issues during operations does not negate the possibility of ARD conditions occurring following mine closure. If ARD releases have not occurred during operations, a reduction in monitoring frequency is typically appropriate.

If operational monitoring identified impacts to biological receptors, the objective of monitoring during decommissioning and post closure is to measure recovery in impacted areas.

Access to remote sites may be an issue during the closure and decommissioning phases. For these sites, remote monitoring techniques may be employed.

It is common in monitoring for potential ARD effects to continue well into the post-closure phase because ARD can become evident after a considerable latent period. The frequency of post-closure monitoring is typically reduced relative to the frequency during operations so post-closure often might be only once or twice per year, depending on the predictions for ARD occurrence for a particular site. Guidance on when to cease monitoring is provided in Chapter 9.

### 8.6 References and Further Reading

Australian Center for Mining Environmental Research (ACMER), 2000. Manual of Techniques to Quantify Processes Associated with Polluted Effluent from Sulfidic Mine Wastes. A.M. Garvie and G.F. Taylor (Eds.), Australian Center for Mining Research, February, Kenmore, Queensland, Australia.

Australian and New Zealand Environment and Conservation Council (ANZECC) and Agriculture and Resource Management Council of Australia and New Zealand (ARMCANZ), 2000. Australian Guidelines for Water Quality Monitoring and Reporting. National Water Quality Management Strategy No. 7, October.

American Public Health Association / American Water Works Association / Water Environment Federation (APHA/AWAA/WEF), 2007. Standard Methods for the Examination of Water and Wastewater, 23<sup>rd</sup> Edition. Washington, DC.

American Society for Testing and Materials (ASTM), 2007. Annual Book of ASTM Standards, Section 11. Water and Environmental Technology, Vol. 11.06, West Conshohocken, PA.

Batley, G.E., Humphrey, C.L., Apte, S.C., and J.L. Stauber, 2003. A Guide to the Application of the ANZECC/ARMCANZ Water Quality Guidelines in the Minerals Industry. Australian Center for Mining Environmental Research (ACMER), September.

Blowes D.W., and C.J. Ptacek, 1994. Acid neutralization mechanisms in inactive mine tailings. In: J.L. Jambor and D.W. Blowes (Eds.), Short Course Handbook on Environmental Geochemistry of Sulfide Mine-Wastes, Waterloo, ON, 271–292.

Blowes, D.W., Ptacek, C.J., and J. Jurjovec, 2003. Mill Tailings: Hydrogeology and Geochemistry. In: J.L. Jambor, D.W. Blowes and A.I.M. Ritchie (Eds.), Environmental Aspects of Mine Wastes, Short Course Series Vol. 31, Mineralogical Association of Canada, 95-116.

Brown, J. G., Glynn, P.D., and R. L. Bassett, 1999. Geochemistry and reactive transport of metal contaminants in ground water, Pinal Creek Basin, Arizona. U.S. Geological Survey Water-Resources Investigations Report 99-4018A, 1:141-153.

- Chapman, P.M., Wang, F., Germano, D.D., and G. Batley, 2002. Porewater testing and analysis: The good, the bad and the ugly. *Marine Pollution Bulletin*, 44:359-366.
- Demchak, J., Skousen, J., and L.M. McDonald, 2004. Longevity of acid discharges from underground mines located above the regional water table. *Journal of Environmental Quality*, 33:656-668.
- Environment Canada, 2002. Metal Mining Guidance Document for Aquatic Environmental Effects Monitoring. June.
- Harvey, J.W., Wagner, B.J., and K.E. Bencala, 1996. Evaluating the reliability of the stream tracer approach to characterize stream-subsurface water exchange. *Water Resources Research*, 32(8):2441-2451.
- Hem, J.D., 1992. Study and Interpretation of the Chemical Characteristics of Natural Water. United States Geological Survey Water-Supply Paper 2254.
- International Standards Organization (ISO), 2001. Water quality – Sampling – Part 18: Guidance on sampling of groundwater at contaminated sites. ISO 5667-18:2001(E).
- International Standards Organization (ISO), 2003. Water quality – Sampling – Part 3: Guidance on the preservation and handling of water samples. ISO 5667-3:2003(E).
- International Standards Organization (ISO), 2005. Water quality – Sampling – Part 6: Guidance on sampling of rivers and streams. ISO 5667-6:2005(E).
- Kilpatrick, F.A., and E.D. Cobb, 1985. Techniques of Water Resources Investigations of the United States Geological Survey – Chapter A16 – Measurement of Discharge using Tracers. USGS Publication, United States Government Printing Office, Washington, DC.
- Krantzberg, G., Reynoldson, T., Jaagumagi, R., Painter, S., Boyd, D., Bedard, D., and T. Pawson, 2000. SEDS: Setting environmental decisions for sediment management. *Aquatic Ecosystem Health Management*, 3:387-396.
- Maxfield, S.L., and A. Mair, 1995. Chapter 18 – Strategic Design of Groundwater Monitoring Programs for Inorganics. In: B.J. Scheiner, T.D. Chatwin, H. El-Shall, S.K. Kawatra and A.E. Torma (Eds.), *New Remediation Technology in the Changing Environmental Arena*, Society for Mining, Metallurgy, and Exploration, Inc., Littleton, CO, 133-138.
- Mine Environment Neutral Drainage Program (MEND), 1989. Field Sampling Manual for Reactive Sulphide Tailings. Prepared by Canect Environmental Control Technologies Limited, MEND Project 4.1.1, November.
- Mine Environment Neutral Drainage Program (MEND), 1990. Monitoring Acid Mine Drainage. Prepared by Emily Robertson and Steffen Robertson and Kirsten (B.C.) Inc., MEND Project 4.7.1, August.
- Mine Environment Neutral Drainage Program (MEND), 1993. Field Procedures Manual Gas Transfer Measurements Waste Rock, Heath Steele New Brunswick. Prepared by Nolan, Davis and Associates (N.B.) Limited, MEND Report 1.22.1a, May.
- Mine Environment Neutral Drainage Program (MEND), 1997. Guideline Document for Monitoring Acid Mine Drainage. Prepared by Terrestrial & Aquatic Environmental Managers (TEAM) Ltd. and SENES Consultants Ltd., MEND Project 4.5.4, October.
- Mine Environment Neutral Drainage Program (MEND), 2001. MEND Manual – Volume 2 – Sampling and Analysis. G.A. Tremblay and C.M. Hogan (Eds.), MEND Project 5.4.2b, January.
- National Environment Protection Council, 1999. Schedule B (2) Guideline on Data Collection, Sample Design and Reporting. National Environment Protection (Assessment of Site Contamination) Measure 1999, December.
- Paquin, P.R., Santore, R.C., Wu, K.B., Kavvadas, C.D., and D.M. Di Toro, 2000. The biotic ligand model: a model of the acute toxicity of metals to aquatic life. *Environmental Science and Policy*, 3(1):175-182.
- Phillip, M., Hockley, D., and B. Dawson, 2008. Sullivan Mine Fatalities Incident: Preliminary Technical Investigations and Findings. In: L.C. Bell, B.M.D. Barrie, B. Braddock and R.W. McLean (Eds.), *Proceedings 6<sup>th</sup> Australian Workshop on Acid and Metalliferous Drainage*, April 15-18, Burnie, Tasmania, 193-208.
- Price, W.A., 1997. Draft Guidelines and Recommended Methods for the Prediction of Metal Leaching and Acid Rock Drainage at Minesites in British Columbia. Reclamation Section, Energy and Minerals Division, Ministry of Employment and Investment, Smithers, BC.
- Richards, D.G., Borden, R.K., Bennett, J.W., Blowes, D.W., Logsdon, M.J., Miller, S.D., Slater, S., Smith, L., and G.W. Wilson, 2006. Design and implementation of a strategic review of ARD risk in Rio Tinto. In: R.I. Barnhisel (Ed.), *Proceedings of the 7<sup>th</sup> International Conference on Acid Rock Drainage (ICARD)*, March 26-20, St. Louis, MO, American Society of Mining and Reclamation (ASMR), Lexington, KY.
- Smith, L., and R. Beckie, 2003. Hydrologic and Geochemical Transport Processes in Mine Waste Rock. In: J.L. Jambor, D.W. Blowes and A.I.M. Ritchie (Eds.), *Environmental Aspects of Mine Wastes, Short Course Series Vol. 31*, Mineralogical Association of Canada, 51-72.

Standards Australia and Standards New Zealand (AS/NZS), 1998. Water Quality – Sampling – Part 11: Guidance on Sampling Groundwaters. AS/NZS 5667.11:1998.

Stollenwerk, K.G., 1994. Geochemical interactions between constituents in acidic groundwater and alluvium in an aquifer near Globe, Arizona. *Applied Geochemistry*, 9:353-369.

United States Department of the Interior – Bureau of Reclamation, 2001. Water Measurement Manual – A Water Resources Technical Publication. U.S. Government Printing Office, Washington, DC. [http://www.usbr.gov/pmts/hydraulics\\_lab/pubs/wmm/](http://www.usbr.gov/pmts/hydraulics_lab/pubs/wmm/)

United States Environmental Protection Agency (USEPA), 1996. Method 1669, Sampling Ambient Water for Trace Metals at EPA Water Quality Criteria Levels. Office of Water, July.

United States Environmental Protection Agency (USEPA), 2001. EPA Requirements for Quality Assurance Project Plans. EPA/240/B-01/003, March.

United States Environmental Protection Agency (USEPA), 2003. EPA and Hardrock Mining: A Source Book for Industry in the Northwest and Alaska. Region 10, Seattle, WA.

United States Geological Survey (USGS), 1997. Use of tracer injections and synoptic sampling to measure metal loading from acid mine drainage.

United States Geological Survey (USGS), 2003. Diurnal variation in trace-metal concentration in streams. USGS Fact Sheet FS-086-03, December.

U.S. Geological Survey, variously dated. National field manual for the collection of water-quality data: U.S. Geological Survey Techniques of Water-Resources Investigations, Book 9, chaps. A1-A9. <http://pubs.water.usgs.gov/twr9A>

Wolkersdorfer, C., 2008. Water Management at Abandoned Flooded Underground Mines – Fundamentals, Tracer Tests, Modelling, Water Treatment. Springer, Heidelberg.

Yeskis, D., and B. Zavala, 2002. Ground-Water Sampling Guidelines for Superfund and RCRA Project Managers. United States Environmental Protection Agency, EPA 542-S-02-001.

## List of Tables

- Table 8-1: Monitoring Sources, Pathways, and Receptors
- Table 8-2: Common ARD Monitoring Components
- Table 8-3: Preliminary Intensive Sampling Program
- Table 8-4: Impact Assessment Sampling Location Designs
- Table 8-5: Monitoring Activity Guidance
- Table 8-6: Components of Waste Rock Pile Monitoring Program
- Table 8-7: Components of Tailings Storage Facility Monitoring Program
- Table 8-8: Aquatic Habitat Information Requirements for Biological Monitoring

## List of Figures

- Figure 8-1: Monitoring Chapter Organization
- Figure 8-2: Steps in the Development of an ARD Monitoring Program
- Figure 8-3: Conceptual Risk-Based Approach - Relationships Between the Contaminant Source the Receptor and the Pathway that Connects them
- Figure 8-4: Waste Stockpile Seepage Water Quality Hysteresis
- Figure 8-5: Waste Rock Seepage Water Quality Trends (pH, Alkalinity, SO<sub>4</sub>, Cu, and Zn)
- Figure 8-6: Spring Thaw Stream Concentration and Loading Trends (March 23 to June 22)
- Figure 8-7: Solute Transport and Thermal Stratification in Lakes
- Figure 8-8: Steps in the Development of a Biological Monitoring Program

[Top of this page](#)

## List of Photos

- Photo 8-1: Collection of a Wall Washing Sample from a Pit Face
- Photo 8-2: Waste Rock Lysimeter in an Arid Climate
- Photo 8-3: Stream Discharge Monitoring Using a Current Meter
- Photo 8-4: Benthic Macroinvertebrate
- Photo 8-5: Benthic Macroinvertebrate Sampling with a Hess Sampler
- Photo 8-6: Fish Survey Using Nets

# Chapter 9

## From GARDGuide

### 9.0 Acid Rock Drainage Management and Performance Assessment

#### 9.1 Introduction

#### 9.2 Developing Acid Rock Drainage Management Plans

##### 9.2.1 Sustainability Considerations

##### 9.2.2 Mine Life Cycle Considerations

##### 9.2.3 Acid Rock Drainage Control – a Multidisciplinary Task

##### 9.2.4 ARD Maturity and the Mine-Life Cycle

##### 9.2.5 Design for Closure

##### 9.2.6 Engineering Design Process

##### 9.2.7 Risk Assessment, Management, and Contingency Plans

##### 9.2.8 Monitoring Performance and Assessment of Success

#### 9.3 Implementing the Acid Rock Drainage Management Plan

##### 9.3.1 Integrating Acid Rock Drainage Management into Mine and Process Operations

##### 9.3.2 Management System Roles and Responsibilities

#### 9.4 Long-Term Considerations

##### 9.4.1 Design Horizon

##### 9.4.2 Long-Term Resources

##### 9.4.3 Information/Institutional Knowledge Retention

##### 9.4.4 Changing Standards/Stakeholder Needs and Expectations

#### 9.5 References

##### List of Tables

##### List of Figures

## 9.0 Acid Rock Drainage Management and Performance Assessment

### 9.1 Introduction

The management of ARD and the assessment of its performance are usually described within the site environmental management plan or, in the case of a significant ARD issue, in a site-specific ARD management plan. The ARD management plan represents the integration of the concepts and technologies described in the previous chapters of this GARD Guide. It also references the engineering design processes and operational management systems employed by mining companies.

The need for a formal ARD management plan is usually triggered by the results of a characterization and prediction program (Chapters 4 and 5) or the results of site monitoring (Chapter 8). For a mine project, the corporate staff coordinating the environmental input into a feasibility study are most likely to identify the requirement for an ARD management plan, while for an operating mine site, the environmental superintendent is most likely to identify the need for the plan or an update to an existing plan.

The development, implementation, and assessment of the ARD management plan will typically follow the sequence of steps illustrated in the flowchart in Figure 9-1. This sequence is similar to that illustrated in Figure 1-2 in Chapter 1; however, the ARD management plan provides more detail and it also provides performance assessment and monitoring.

The comprehensive approach outlined in this chapter for the development and contents of an ARD management plan assumes that ARD is a significant issue for a mine project, operating or closed site. Only some elements of the approach contained in this chapter may be applied where ARD is a lesser issue.

**Figure 9-1: Flowchart for Performance Assessment and Management Review**

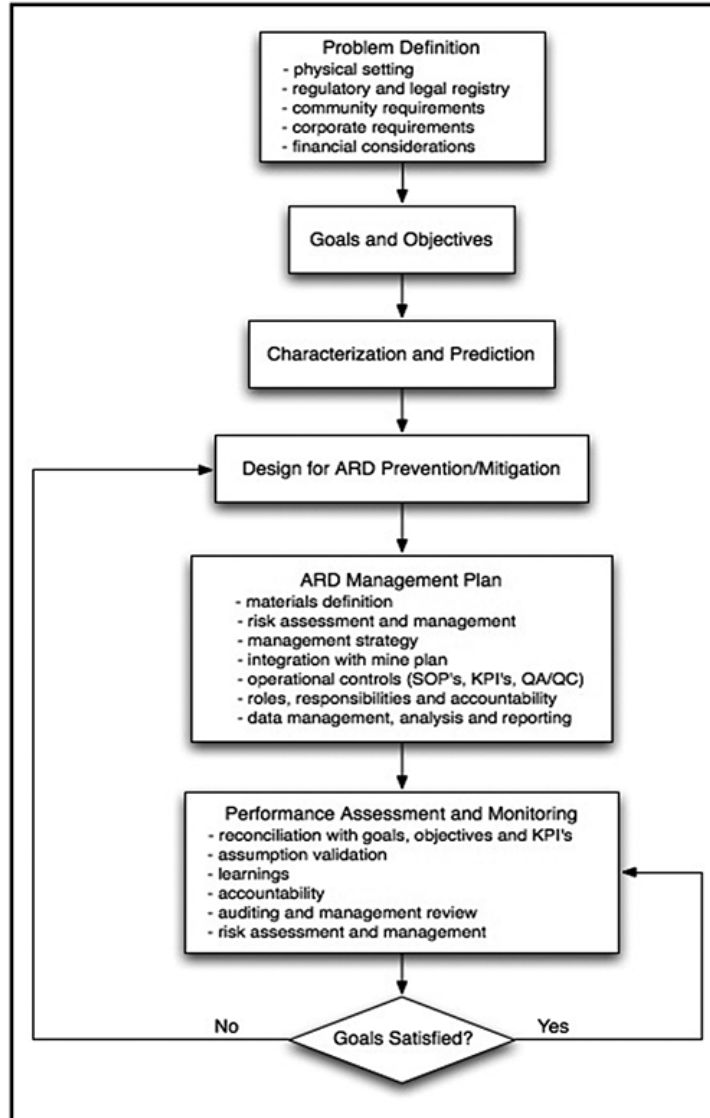

Characterization is the first step for the development of an ARD management plan, as shown in Figure 9-1. Characterization also includes consideration of the biophysical setting (e.g., CSM as described in Chapter 4), regulatory and legal registry, community and corporate requirements, and financial considerations. Clear goals and objectives are then established for the management plan. These goals and objectives might include the prevention of the development of acidic seeps and runoff or the meeting of specific water quality criteria. Characterization and prediction programs (as discussed in Chapters 4 and 5) identify the potential magnitude of the ARD issue and provide the basis for the selection and design of appropriate ARD prevention and mitigation technologies (Chapters 6 and 7). The design process includes an iterative series of steps in which ARD control technologies are assessed and then combined into a robust system of management and controls (ARD management plan) for the specific site. The initial mine design is used to develop the ARD management plan needed for an environmental assessment (EA). The final design is usually developed in parallel with project permitting.

The ARD management plan identifies materials and wastes for special management. Risk assessment and management are included in the plan to refine strategies and implementation steps. To be effective, the ARD management plan must be fully integrated with the mine plan. Operational controls such as SOPs, key performance indicators (KPIs) and QA/QC programs are established to guide the implementation. Roles, responsibilities, and accountabilities for mine operating staff to implement the ARD management plan are identified. Data management, analysis, and reporting schemes are developed to track progress of the plan.

In the next step of the ARD management plan, monitoring is conducted to assess the field performance compared to the design goals and objectives of the management plan. Assumptions made in the characterization and prediction programs and design of the prevention and mitigation plan are tested and revised or validated. “Learnings” from monitoring and assessment are assessed and incorporated into the plan as part of continuous improvement. Accountability for implementing the management plan is checked to ensure that those responsible are fully adhering to elements of the plan. Internal and external reviews, or audits, are often conducted of performance, management systems, and technical components to provide additional perspectives on the implementation of the ARD management plan. Review by site and corporate management of the entire plan is necessary to ensure that the plan continues to adhere to site and corporate policies. Further risk assessment and management is conducted at this stage to assess the effects of changing conditions or plan deviations. Finally, results are assessed against the goals. If the goals are met, performance assessment and monitoring continues throughout the mine life, with periodic rechecks against the goals. If the goals are not met, then redesign and re-evaluation of the management plan and performance assessment and monitoring systems for ARD prevention and mitigation are required. This additional work might also include further characterization and prediction assessments.

The process described in Figure 9-1 results in continuous improvement of the ARD management plan and implementation of the plan, and accommodates changes in the mine plan that is especially likely to occur at times of rising or falling metal prices. If the initial ARD management plan is robust, it can be more readily adapted to changes in the mine plan.

Implementing the ARD management plan relies on a hierarchy of management tools, as illustrated in Figure 9-2. Corporate policies help to define corporate or site standards, which lead to SOPs and KPIs that are specific to the site and guide operators in implementing the ARD management plan. Where corporate policies or standards do not exist, projects and operations should rely on industry best practice.

**Figure 9-2: Hierarchy of Management Tools**

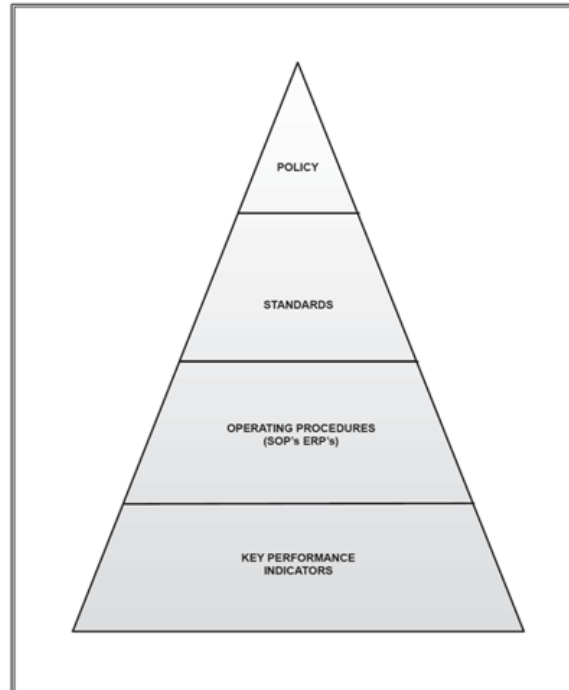

In summary, the development, assessment, and continuous improvement of a site-specific ARD management plan is a continuum throughout the life of a mine.

## 9.2 Developing Acid Rock Drainage Management Plans

The development of an ARD management plan requires a multidisciplinary approach that considers a number of site specific considerations. These considerations are discussed in Sections 9.2.1 and 9.2.2 below.

### 9.2.1 Sustainability Considerations

The ARD management plan should consider the following sustainable development principles:

- Commitment to regulatory requirements and corporate policies
- Engagement of stakeholders in the planning and implementation of the ARD management plan to understand their expectations (see Chapter 10). The stakeholders of the ARD management include those internal and external to the mining operation (e.g., mining personnel, nearby communities, regulatory agencies, NGOs) and the mining company shareholders (because of the potential long-term economic impacts).
- Environmental protection during all stages of the mine life cycle, especially during post closure
- Adoption of a risk-based ARD management approach in a timely manner
- Economic considerations with respect to the cost of ARD management plan implementation
- Well-being of nearby communities during and following operations. Special attention should be given to social aspects of the communities such as access to specific sites of spiritual importance.
- Transparency in the planning and implementation of the ARD management plan
- Mine life-cycle considerations of environmental and community impacts and costs
- Continuous improvement of ARD management throughout operations
- Consideration of and integration with post-mining land use objectives and plans

The underlying concept is to evaluate, understand, and maximize the contributions that mining makes to sustainable development. Application of these concepts may

result in the “bar being set higher” than conventional environmental permitting considerations. Instead of accepting mitigation of impacts, the application of sustainability concepts strives to maintain or improve overall community conditions. This approach has been accepted in a number of recent mining projects (e.g., Gibson, 2005) and presents some specific challenges for ARD management (see Chapter 10).

The Australian Department of Industry, Tourism and Resources (DITR) has developed a series of handbooks as part of their Leading Practice Sustainable Development Program for the Mining Industry that demonstrate a commitment to sustainable development through integration of environmental, economic and social aspects through all phases of mineral production (DITR, 2006-2008).

### 9.2.2 Mine Life Cycle Considerations

Table 9-1 describes mine life cycle considerations for the development of an ARD management plan for various sources of ARD. Aspects of mine life-cycle considerations include characterization and prediction for new, operating, and closed mines and selection of ARD control technology. Characterization is divided between source investigation and source performance. This division of source investigation and source performance is done to distinguish between the characteristics of the potentially acid generating materials and how the materials will behave when placed in an on-site facility.

The project knowledge base is improved throughout the mine life cycle (e.g., Currey, 2008). Lessons learned from pilot tests, large-scale implementation, and monitoring are used to improve the designs and application so that the ARD management plan can provide efficient and effective environmental protection.

**Table 9-1: Mine Life Cycle Considerations for the Development of ARD Management Plans**

	<b>Project For New Mine</b>	<b>Operating Mine</b>	<b>Closed Mine (Without Management Plan)</b>	<b>Comments</b>
<b>Characterization &amp; Prediction</b>				
<b>ARD sources</b>	Limited until mine developed, other than usually minor sources that result from exploration programs.	Mine workings, waste rock piles, tailings deposit, infrastructure built from waste rock, spillages along conveying routes, wind-blown or stormwater-transported material, sediments in dams and watercourses and ore stockpiles.	Mine workings, waste rock piles, tailings deposit, infrastructure built from waste rock, spillages along conveying routes, wind-blown or stormwater-transported material, sediments in dams and watercourses.	Number and size of waste piles and extent of mine workings increase during mining life cycle. Risk also exists for interactions with sources on adjacent mines through inter-mine hydrological connections.
<b>ARD maturity</b>	Not started.	Mine workings and waste rock piles may be mature. Tailings immature or early stage of ARD evolution due to reduced permeability and high water content. Maturity of fugitive sources (spillage, windblown, sediments) may vary.	Mine workings, waste rock piles, tailings and fugitive sources all mature for surface drainage. Tailings yield to groundwater may be immature. Relevance of off-site sources from inter-mine flow depends on circumstances.	Maturity depends on time of exposure to air and moisture.
<b>Information available for characterization and prediction</b>	Drill core, samples from trenches and road cuts. Static and lab and field kinetic cell tests. Good mining geology understanding for source modeling. Important to integrate ARD data collection with mineral resource exploration drilling and sampling.	Drill core plus abundant rock exposures for sampling/testing. Field kinetic cell tests; field reconnaissance; lab tests, including leach extraction of aged waste; drainage water quality monitoring results. Good mining geology understanding and operating records for source and deposits modeling.	Field reconnaissance, drainage water quality monitoring, drilling and trenching to obtain aged samples for lab characterization, including leach extraction testing. Generally, poor geology and operating records for source and deposit modeling for historical mines. Variable historical plans & records of mining activities and depositional history for residue deposits.	Field reconnaissance includes color change observations and paste pH and conductivity testing of wastes. Direct sampling and testing of ARD becomes possible.
<b>ARD model calibration</b>	Calibration against experience at mines with similar deposit	Calibrate against mine mapping and placement records, results	Possibly limited mine waste management records for	Need for modeling and prediction reduces as ARD conditions mature.

	geology, mineralogy and mine development. Possibly lower reliability.	from lab & field test cells, reconnaissance tests and early stage drainage water quality.	characterization and modeling but good reconnaissance test results and drainage water quality for calibration.	However long-term predictions necessary for post closure monitoring and maintenance plan development and determination/establishment of any post-closure financial provisions.
<b>ARD Control Technology Selection And Management Plan Design</b>				
<b>Selection of ARD control technology</b>	All options applicable to the ARD mineral type and site specific conditions may be considered. 'Design for closure' and state-of-the-art practices can be applied to all mine elements. Provision can be made for appropriate management practices and optimization of use of mined materials. Able to maximize 'prevention' controls.	Options constrained for existing development and waste deposits. Future mining and ARD control measures can be optimized to most cost effectively implement ARD control and a desired closure condition. Can optimize use of suitable waste remaining to be mined. Possible increasing reliance on migration and collection and treatment controls although regular review of management plans will identify new 'prevention' controls.	Options severely constrained by methods of prior mining, waste rock piles and tailings site selection and deposit designs. Drainage collection and groundwater migration control might be difficult. Possible large accumulation of ARD products in waste deposits. Relying generally on migration controls and collection and treatment although 'prevention' principles can be incorporated into cover design.	Control measures involving best site selection, and materials handling to maximize prevention of ARD generation are possible only for new mines. Control of ARD for mines later in their lives is increasingly dependent on ARD migration controls (e.g., covers and in situ reactive barriers) and collection and treatment.

The opportunity for investigations and the information available for source and deposits modeling differ during the life cycle of a mine. At the start of exploration and mine design, there might be limited information on the nature of future potential ARD sources. Mine design and layout and characterization and prediction are based on laboratory testing that usually cannot be fully verified through field measurements and observations. However, there is the opportunity for both gathering information and for optimizing the selection and application of ARD control technologies through judicious interpretation of available test results, professional experience, and comparison with analogue sites. State-of-the-art practices and designs therefore can be incorporated into the ARD management plan. As the mine develops, the temporal behaviours of the exposed mineralized rock, mine, and process wastes become apparent.

Initiating development of an ARD characterization and management plan for an operating mine has reduced potential for using deposit characterization as a source of data because most of the delineation drilling will have been completed. However historical core libraries may be available and these can be invaluable in assessing ARD potential for an existing mine. Ore and waste can be mapped, sampled, and characterized as it is mined and processed. For an operating mine, many of the mine and process waste facilities will have already been sited and partly developed, thereby limiting the potential application of ARD prevention strategies. Depending on the age of the mine, best practices as documented in this GARD Guide may not have been applied throughout mine development. The existing developments must be investigated and characterized to determine the extent to which they represent potential ARD sources. The design of existing facilities may constrain the range of ARD technologies that are technically and economically viable.

Monitoring existing mine-waste facilities and mine voids (open pit, underground mine) provides valuable data on geochemical reaction rates under field conditions. Geochemical reconnaissance surveys, leach testing, and drainage water quality monitoring provide data for understanding the evolution and quality of ARD and maturity of these systems. The value of this post hoc information can be substantially enhanced if the depositional history of these facilities has been properly recorded (see Chapters 4 and 5).

Mine designs and operating practices can often be modified to incorporate ARD prevention strategies during operations that are then applied for the remainder of the mine life. The overall mine management plan should incorporate the ARD management strategy so that the final site condition at mine closure is consistent with closure objectives. There are more likely to be personnel and equipment resources available for both investigation/characterization and implementation of the management plan during mine operation than after decommissioning.

Where mines have closed without adequate consideration of ARD management, there is a need to forensically investigate all elements of the mine and process development (mine, waste rock piles, process tailings deposit, and infrastructure in which mine and process wastes were placed). Information relevant to ARD sources and characterization might not be available and a program of drilling and trenching with sampling, field reconnaissance, laboratory testing with leach extraction testing, and monitoring of ARD discharges from mine waste deposits is often required. ARD from waste deposits might have occurred.

At closed sites, the ARD generation process in mine workings and wastes may be evolving, depending on when mining ceased. In arid climates and wastes containing higher carbonate mineral content, that evolution may proceed slowly. Drainage patterns in arid climates will also be different than those in wetter climates (e.g., compared to freshet effects in temperate climates). Therefore, characterization must consider and assess the stage of the ARD process.

ARD control options are limited, both technically and financially, by the physical constraints of the closed mine. Materials required for ARD control, such as cover materials, might not have been stockpiled from disturbed land or from appropriate selectively handled and placed waste and it may be necessary to disturb additional



areas to develop borrow sources. Access, personnel, and equipment resources may be limited in remote locales. Disturbance of mature oxidizing mine waste can release large loads of ARD products and relocation and disturbance of such material must be done with appropriate caution and safeguards.

### 9.2.3 Acid Rock Drainage Control – a Multidisciplinary Task

The development of an ARD management plan requires the integration of a number of technical disciplines. Some of the disciplines most commonly required are listed in Table 9-2.

In addition to the specialists listed in Table 9-2, there are numerous other skilled personnel involved in plan development and implementation. These include drillers and excavation samplers for procurement of samples, laboratory technicians skilled in mineral and ARD characterization testing, monitoring instrumentation technicians, and technicians and supervisors responsible for facility construction, rock placement, water management, water quality sampling, covers installation, and revegetation.

Often project development staff at the corporate level develops the mine plan during the feasibility stage of a project. Environmental and ARD specialists need to work closely with mine planners and metallurgists to identify opportunities to prevent ARD and to ensure ARD management is fully integrated into the mine plan and feasibility study. For example, opportunities to segregate NAG and PAG waste rock and tailing may become apparent during project design. Implementation of segregation requires that mine planners and metallurgists integrate ARD considerations into their feasibility activities. Figure 9-3 shows an open pit bench plan developed during the feasibility phase of a mine project. Results of ARD block modeling are integrated with ore and waste block modeling to show how segregation of NAG and PAG waste rock can be achieved at the individual mine bench level. These plans and other more detailed plans will be used by mine operations staff to define shovel cuts and haul truck destinations. Figure 9-4 illustrates the overall segregation of various waste rock units based on their ARD potential and physical characteristics.

**Table 9-2: Technical Disciplines Involved in the Development of an ARD Management Plan**

<b>Discipline</b>	<b>Typical Involvement</b>
Geology	To define the geological distribution of rock types and mineralogy, for developing the geological model on which the geochemical zones and their characterization are developed.
Mineralogy	To identify minerals that control the oxidation and neutralization potential and products.
Geochemistry	To evaluate the oxidation and neutralization processes, dissolution, and solubility controls that determine mine water quality, modeling of ARD, and the determination of ARD control requirements.
Mining engineering and planning	To develop the mining methods and schedules for waste extraction and ore placed in stockpiles and waste rock dumps, and for integration of the ARD management plan into mining operations.
Mineral processing/metallurgy	To determine the characteristics of the heap leach, milled wastes or tailings and the control technologies that can be applied in processing to minimize ARD potential.
Analytical chemistry	To support mine and metallurgical operations by implementing proper test methods for sample handling.
Water treatment	To design water treatment plants to remove deleterious constituents in ARD and supervise water treatment plant operations.
Geotechnical engineering	To design pit slopes and waste storage facilities such as tailings dams and waste rock piles, covers, and erosion stability of the post closure drainage system and landforms.
Social sciences	To ensure effective and open communication with stakeholders and to ensure that their concerns are integrated into the management plan.
Hydrogeology	To evaluate groundwater inflows to underground and open pit mines and groundwater flows that have contact with ARD sources.
Hydrology and limnology	To determine flood flows and water balance required for design water management facilities.
Soil sciences	To design and implement surficial soils (covers) in the closure landscape to facilitate growth of self sustaining vegetation.
Agronomy/botany forestry	To evaluate sustainable vegetation to meet the management plan and closure objectives.
Biology/ecology	To evaluate ecological impacts of residual surface and groundwater contamination and establish conditions for ecosystems of restored lands that meets operating and closure objectives.
Environmental law	To determine the regulatory requirements that the mine needs to comply with
Accounting and financial management	To estimate and monitor costs, and make appropriate provisions for funding the management plan and sustain post-closure monitoring and maintenance requirements.
Contract management	To ensure that ARD management plan issues and measures are incorporated into all relevant contracts that the mine enters into with suppliers and contractors.
Project management and supervision	To manage and supervise all aspects of management plan development and implementation, including long-term post closure activities, where applicable.

Senior management	To ensure management plan adherence, implementation and continuous improvement are incorporated into the key performance indicators of all relevant personnel.

Figure 9-3: Open Pit Bench Plan Developed During the Feasibility Phase of a Mine Project

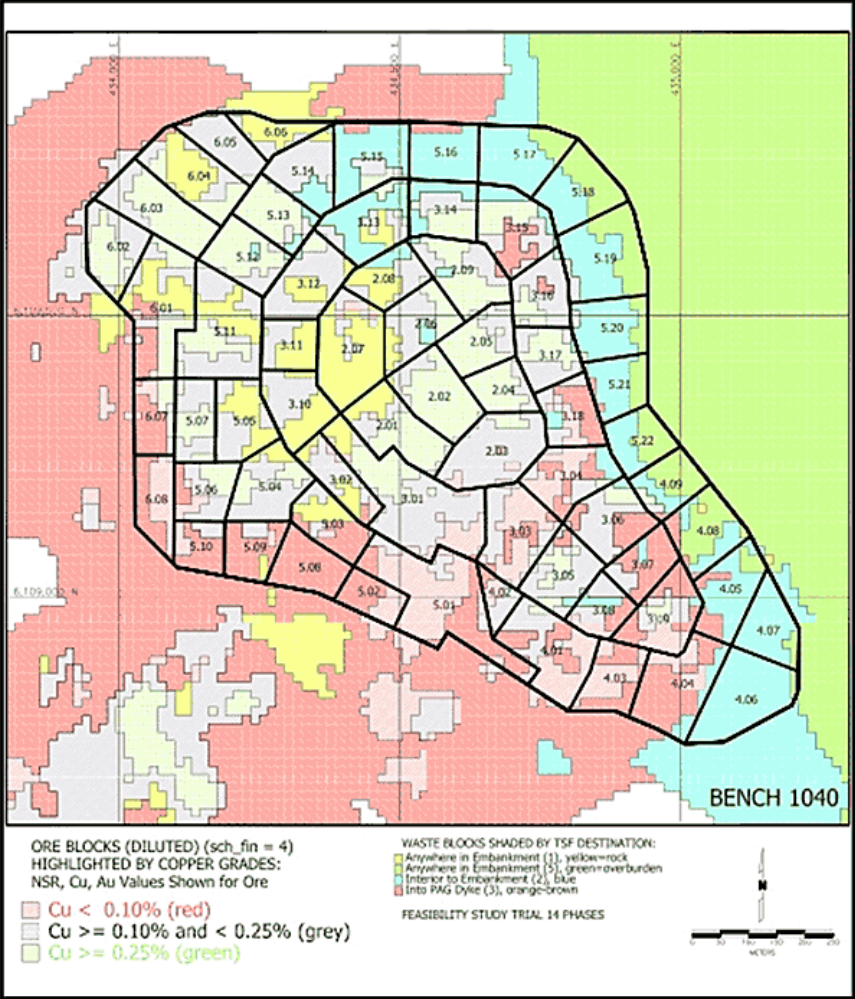

**Figure 9-4: Overall Segregation of Various Waste Rock Units Based on their ARD Potential and Physical Characteristics**

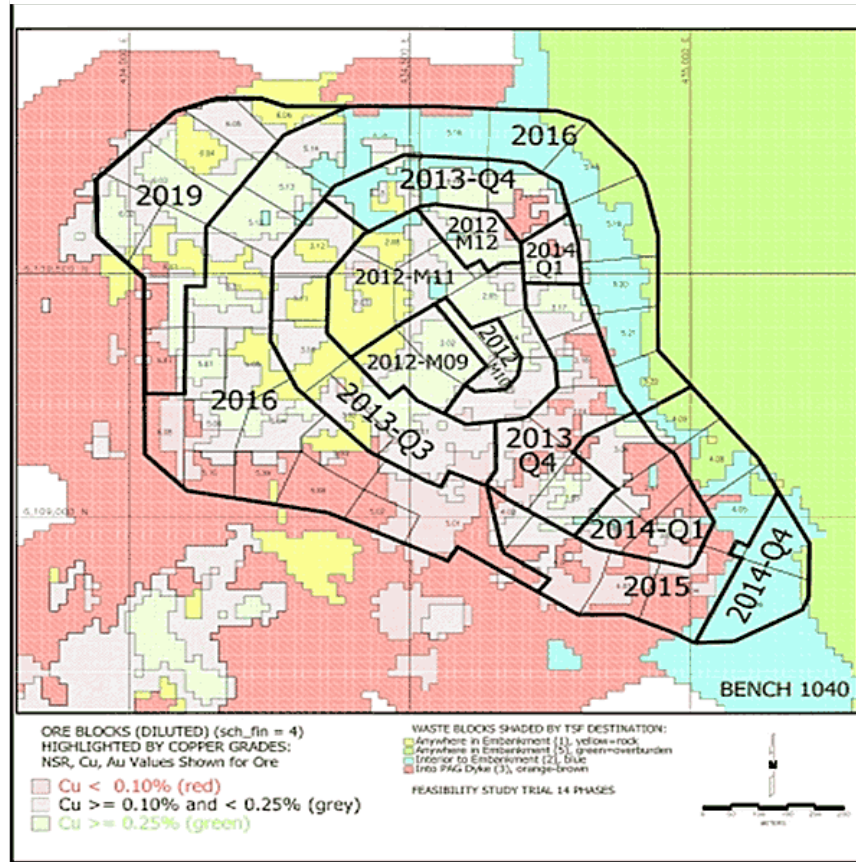

#### 9.2.4 ARD Maturity and the Mine-Life Cycle

The time to onset of ARD conditions often depends on the geochemical and physical characteristics of the ARD sources and may take many years. For highly reactive sources, the maximum ARD load (concentration of contaminants and flows) may occur during the operating stage of the mine life. For others, the maximum ARD load may develop some time after mine closure.

Minimizing sulphide oxidation, preferably to extremely slow or negligible rates, by implementing ARD prevention measures, is the principal goal of the ARD management plan.

#### 9.2.5 Design for Closure

The concept of “design for closure” should be applied in the design of all mine and process facilities that have an ARD potential. Design for closure requires that the full mine-life cycle, from development to closure, be considered in the design of the mine components so that the desired mine closure conditions are achieved. Design for closure should also consider the potential, practical, and financial implications of temporary halting of operations or of early closure of the mine.

An example of the design for closure principle follows: If waste is placed above water and allowed to oxidize during the mine life then, at the time of mine closure, the waste material could contain large quantities of oxidation products. Subsequent placement below water could result in the release of large quantities of acidity and soluble metal contaminants, possibly rendering the subaqueous placement uneconomic or environmentally unacceptable. Applying “design for closure” at the time of initial waste storage facility design recognizes the need to place wastes underwater before there is significant oxidation and accumulation of oxidation products.

With an ARD management plan in place, the fundamental objective of performance assessment and monitoring is to determine the effectiveness of that plan rather than simply the evolution of the ARD process.

#### 9.2.6 Engineering Design Process

In concept, the engineering design process evaluates a range of technologies or control measures to identify the most effective and cost-effective option (or options)

that will meet objectives. The expected performance of these alternatives or options can be evaluated using modeling and other approaches, and the outcomes can be compared to the site-specific goals and objectives. Cost estimates and other aspects (e.g., security of approach, risk, ease of implementation) are assessed to compare the different alternatives or options and thereby select the preferred option for implementation. This is an iterative process that may require a series of cycles of analyses, alternative technologies, and prediction to arrive at the preferred alternative.

Selecting technologies or control measures is dependent on the site conditions, including climate, geochemical characteristics of rock materials, and site topography. At some sites, the concerns may be focused on only one issue, such as potential ARD seepage from a tailings or mine rock facility. At other sites, a wide range of ARD concerns may have to be addressed, such as potential seepage from waste rock piles, runoff from process tailings embankments, runoff from mineralized pit slopes, and discharge from underground mine workings.

When only one concern is identified, there may be only a very limited number of applicable control measures to consider. Technologies can be identified for source control, migration control, and treatment options. For example, the technologies for preventing ARD seepage from a waste rock pile can include waste rock segregation and selective placement, encapsulation of waste rock to limit infiltration, and addition of lime to delay the onset of ARD until a cover can be constructed (see Chapter 6).

During the selection process of the control technologies, conceptual designs are developed for each technology option. The design process is iterative because a conceptual design is developed and then updated as more information becomes available or more detailed site information is obtained. Each of the technologies should be considered and then evaluated, first using qualitative screening based on advantages and disadvantages of each. The remaining technologies should then be evaluated using, for example, site-specific modeling or cost estimation. The result is the selection of a preferred technology or group of technologies that can be combined to satisfy the goals of the ARD management plan.

When there are multiple sources of ARD, the technologies or control measures for each source should be listed. Alternatives or options are then developed by combining a series of appropriate technologies. Conceptual designs are developed for each alternative so that site-specific modeling and cost estimation can be completed. Each alternative is screened using qualitative and quantitative approaches. Experienced engineers and scientists should work together in a team to accomplish this task because the complexity can increase dramatically with multiple sources, technologies, and alternatives. The outcome of this process is a plan for all the potential ARD sources, including the preferred alternatives or options that will satisfy all the goals.

#### **9.2.6.1 Evaluation and Selection of Preferred Option**

As described in Chapter 6, there are many technologies that may be considered for ARD control in the design of each of the mine components. For example, both the process tailings and waste rock may be placed below water (water covers) or stored in drained piles under dry covers of various types.

The combinations of control technologies that address all components are “options” for an ARD management plan. Various combinations of alternative control measures may be considered in a number of “options.” There are typically many advantages and disadvantages for each option identified.

A number of decision tools have been developed to assist the selection process. One is the Multiple Accounts Analysis (MAA) (Robertson and Shaw, 2004; Shaw et al., 2001). The method involves the following three basic steps:

1. Identify the impacts (benefits and costs) to be included in the evaluation
2. Quantify the impacts (benefits and costs)
3. Assess the combined or accumulated impacts for each option, and compare these with other alternatives to develop a preference list (ranking, scaling, and weighting) of the alternatives

The risk associated with each ARD management option is an important consideration and should be embodied in the assessment of values for indicators.

#### **9.2.7 Risk Assessment, Management, and Contingency Plans**

Risk assessment is widely used in the mining industry to identify and evaluate risks and develop risk management strategies and contingency plans. The basic process is described in Chapter 3. This Section 9.2.7 discusses two approaches for risk assessment that might be applied to evaluating the potential success of the ARD management plan: a failure mode and effects analysis (FMEA) and environmental risk assessment (ERA). FMEA may be best suited for engineering designs and potential consequences that may result from a failure, while an ERA focuses more directly on potential environmental effects.

##### **Failure Mode and Effects Analysis**

Haines (2004) describes a FMEA as a method that is “widely used for reliability analysis of systems, subsystems, and individual components of systems.” FMEA constitutes an enabling mechanism to identify the multiple paths of system failures. A prerequisite for an effective risk assessment process is to identify “all conceivable failure modes of a system.” A team of cross-disciplinary experts is required to construct an effective FMEA. The team should ideally include a representative that can speak for the interests of the local community (see Chapter 10). Dushnisky and Vick (1994) describe the FMEA process as applied to mining projects.

Multiple FMEAs may be performed on ARD management during a mine’s life cycle, especially as new information becomes available, projects expand, or new technologies develop. It is essential, though, to perform a risk assessment, FMEA, or other risk assessment approach to identify the selected alternative or option for ARD management.

A small team of experts representing various stakeholders should be assembled for a one or two day facilitated workshop to perform the FMEA. The experts should also represent different disciplines associated with the ARD management plan and they should have the same basic knowledge and understanding about the site conditions. The boundaries of the FMEA should be established before the workshop in terms of their physical and temporal extent. For example, the physical boundaries may include a single facility on a mine site, such as a waste rock facility or the whole mine site. Temporal boundaries may include the life of the mine plus a 20-year, or longer, post mining period. It is also useful to identify some conceptual failure modes before the workshop.

During the risk workshop, a full list of realistic failure modes is identified and described using a matrix where failure mode, effects of failure, likelihood of failure, consequences, and confidence in analysis must be identified. Failure likelihood and consequences are expressed in five descriptors ('not likely,' 'low,' 'moderate,' 'high,' and 'expected' for failure likelihood and 'negligible,' 'low,' 'moderate,' 'high,' and 'extreme' for consequences). The consequences can include financial, reputational, regulatory and legal, and others that are appropriate for the site conditions. The failure likelihood and consequences are combined using a matrix such as the one provided in Table 9-3. Agreement on the descriptions and boundaries used for each of the likelihoods, consequences, and confidence levels should be established early during the workshop. Failure modes of high concern can then be identified according to the "warm" colors (upper right quadrant) in Table 9-3. For instance, if a failure mode has a high likelihood of occurrence and the consequence of failure with respect to a specific item such as regulatory and legal is considered extreme, then the risk will be in the "dark orange" area and will be of high concern.

**Table 9-3: FMEA Outcomes Combining Likelihood of Failure and Consequences**

Consequence	Likelihood				
	Not Likely	Low	Moderate	High	Expected
Extreme					
High					
Moderate					
Low					
Negligible					

A risk management strategy is selected from various options for each high and at least moderate risk failure modes. The selected options that comprise the risk management plan can be preventive (to reduce the likelihood of the "failure") or mitigative (to address potential consequences), or both.

**Environmental Risk Assessment**

The ERA considers probabilities and potential consequences of ARD/ML to an environmental component. An ERA may consider one specific issue, for example, the risk of surface water impact to a single aquatic species, or the issue may be much broader. The basic approach remains the same: identify a hazard (or failure mode) and pathway and the consequences of such a failure. The combination of these hazards and consequences represents the risk. Chapters 3 and 4 provide additional information on the environmental risk assessment process.

**Risk Modeling**

Risk models incorporate risk into scientific and engineering models. Risk models define risk according to the objectives of the system under consideration and the nature and risk tolerance of the various stakeholders involved. Modelling codes used for evaluation of risk generally include specific features that support decision analysis, such as in the STELLA and GoldSim codes. These codes allow for calculation of probability density functions (PDF) that take into account model input uncertainty and are suited to the evaluation of sensitivity analyses and "what-if" scenarios.

In many instances, the data available to adequately address stakeholders' perceptions and needs are insufficient, in particular, in the case of very complex systems that are expected to function or persist for long periods of time. For instance, the consequences of a processing tailings dam failure at a closed site can be catastrophic when the tailings are acid generating and a permanent water cover has been constructed as part of the closure strategy. On the other hand, failure of a dry stack of chemically inert tailings is much less likely to have as significant an impact because of the lack of a transport medium and chemical reactivity. Risk models, therefore, are important tools to help identify and implement mine waste management measures needed to prevent or minimize, or both prevent and minimize, potential impacts.

**Contingency Plans**

Contingency plans are developed for those failure modes where a significant residual risk remains after the application of ARD prevention and control approaches. A contingency plan should include targeted monitoring, trigger levels for actions, and specific responses in case a certain event should occur. For example, if a failure mode is the potential for ARD seepage from a waste rock pile, then monitoring can be established for sulphate concentrations in waste rock seepage as an early indicator of potential ARD formation. If significant increases in sulphate concentrations are measured, then contingency measures such as covers, drainage collection, or more restrictive segregation criteria might be implemented.

Contingency plans, or adaptive management, must have clear monitoring targets and actions associated with specific events and outcomes.

### 9.2.8 Monitoring Performance and Assessment of Success

To achieve the objectives of a management plan, both the implementation and the results of implementation of an ARD management plan must be monitored. Implementation indicators reflect how well the management plan is being executed. Performance indicators reflect how well elements of the management plan are performing against expected performance values. Monitoring involves the measurement of implementation and performance in accordance with indicators. Assessment involves the comparison of observed indicator values compared to expected values.

If assessment indicates that achieved implementation indicators vary significantly from the values established in the management plan, then implementation must be adjusted to meet the required indicator values, or the management plan has to be modified. Examples of implementation indicators are as-built records compared with design values of the tailings dam and waste rock piles, and placement of ARD mine wastes in the correct locations specified in the management plan.

If assessment indicates that achieved performance indicators vary significantly from the expected values in the management plan, then the management plan must be modified to achieve the desired performance (objectives). Examples of performance indicators are seepage water quality from waste rock piles or in groundwater quality as compared to anticipated quality, and treated water discharge qualities compared with treatment quality objectives. Individual indicators must be established to determine what will be monitored and how monitoring will be conducted. Groundwater quality monitoring can be established by selecting groundwater sampling locations and the analytical parameters. Measured concentrations are indicator values, and these values can be compared with groundwater concentration objectives for that location as well as the concentration changes anticipated over time in the management plan. To enable the rapid assessment of implementation and performance, trigger values should be established for 'alerts' and 'response' actions. When an 'alert' value is reached during monitoring, an increased level of monitoring and assessment is triggered. When a 'response' value is reached, the required assessment and response actions (e.g., contingency measures) should be initiated.

Table 9-4 provides a broad grouping and listing of typical implementation and performance indicators that could be applied to monitor and assess implementation and performance of an ARD management plan. This listing does not cover all possibilities and other approaches may be feasible or desirable.

The general descriptions of performance indicators, shown in Table 9-4, must be translated into specific observations, measurements, or tests that are sufficient to understand the nature and behaviour of each major element of the ARD management plan.

A number of indicators may provide a greater understanding of a current condition or the rate of change, although there is no single program of monitoring that is applicable to all mine sites. An example is the suite of parameters that can be measured and monitored to define the state of oxidation and contaminant release from a mine waste rock facility, including monitoring of temperature, gases (O<sub>2</sub> and CO<sub>2</sub>), stored ARD products accumulating in the pile, surface and groundwater quality in the seeps or downstream environment, or the productivity and abundance of biota in the receiving environment. The various attributes of these different indicators for assessing different control technologies are summarized in Table 9-4. The selection of the most appropriate key indicators will depend on the performance issues that are of most relevance to both assessing and demonstrating the success of the management plan.

Seep flow rate measurements are often early and sensitive indicators of performance of stockpile or waste rock pile infiltration and contaminant transport control measures. Combined with water quality testing, flow measurements support calculation of the loads of contaminant releases to surface water, and flow measurements therefore are key performance indicators. Monitoring approaches for on-site and off-site facilities and receptors are described in Chapter 8.

Performance indicators should be carefully selected to optimize both the number and frequency of observations or sampling and the complexity of monitoring. Indicators that most directly represent the properties or effects of interest are usually the most accurate indicators. The frequency of measurements or observations should take into account rates of change; periods of monitoring should be limited to periods when the indicator is relevant and there should be regular reviews of indicators and their relevance to determine if monitoring of some parameters should be terminated, or if others should be introduced.

**Table 9-4: Monitoring and Performance Assessment of Success**

<b>Monitoring Purpose</b>	<b>Assessment Questions</b>	<b>Nature of Monitoring</b>	<b>Key Implementation &amp; Performance Indicators</b>
Sources Classification Monitoring mainly of performance indicators	Are the waste rock characteristics as anticipated?	Waste rock classifications, quantities & ARD properties.	Variance of characteristics from those designed for in MP.1
	Are tailings characteristics as anticipated?	Tailings classifications, quantities & ARD properties.	Variance of characteristics from those designed for in MP.
	Are mine face exposure surface characteristics as anticipated?	Mine face geometry, fracturing and ARD properties.	Variance of characteristics from those designed for in MP.
	Are other properties (e.g., groundwater and surface water) as anticipated?	Climate, groundwater and surface water quality	Variance of characteristics from those designed for in MP.
MP execution Monitoring mainly of implementation	Is mining plan, schedule, and face exposures in accordance	Mapping of mine face development and ARD rock	Variance of as-mined geometry and rock classification from that

indicators	with MP?	types exposed.	designed for in the MP.
	Is mine wastes and tailings management in accordance with MP?	Record mine waste and tailings production, handling and placement.	Variance of mine waste and tailings quantities and management from MP.
	Are materials used for control element construction in accordance with MP specs?	Sample and test construction materials in situ properties and placement locations.	Construction material properties and placement locations variance from MP.
	Are control structures being constructed in accordance with MP?	Observe construction and check dimension and products. Produce as-built drawings.	Variance of as-built construction from the design requirements in the MP.
	Is ARD collection, treatment and water balance in accordance with MP?	Measure flows and water quality, record treatment operations, and production results.	Variance of ARD water flows, water balance, and treatment plant operation from MP.
	Is the management and reporting structure in accordance with MP?	Audit management and reporting structure implemented.	Variance of management and reporting structure from MP.
Component Performance Monitoring mainly of performance indicators	Under water deposits	Monitoring depends on components and indicators of performance relative to each control technology.	Key indicators can vary. Variance of observed from design values monitored for each control technology and component. Oxidation products (solids & liquids)
	Under covers deposits	Indicators of ARD generation	Oxidation products and ARD seepage
	Collection systems	Indicators of ARD generation	% diversion; reliability/stability
	Diversion systems	Indicators of efficient diversion	% collection; reliability/stability
	Collection systems	Indicators of efficient collection	Reliability; unplanned discharges
	ARD water storage systems	Indicators of reliable storage	Discharge quality and reliability
	Water treatment systems	Indicators of adequate treatment	Density and stability
	Sludge disposal systems	Indicators of effective disposal	Stability of material in disposal site
Performance trajectory Comparing change in performance with predicted change in performance – to enable model calibration and revise prediction	Is the evolution of ARD from sources/deposits under the applied control measures developing in accordance with model predictions? That is, are the control systems working?	Monitoring involves the comparison of the predicted time history of change in indicator values with the time history observed values from field monitoring for the various sources/deposits.	Variance of observed from predicted time history indicates need for recalibration of predictive models and reassessment of control measures effectiveness and requirements to meet MP long-term objectives.
	Sources/deposits include:	WQ during operation & flooding	Potential to meet MP objectives
	Underground mine	WQ during operations & closure (flooding)	Potential to meet MP objectives
	Open pit mine	Drainage WQ, temp, O2, stability	Potential to meet MP objectives
	Waste rock facilities	Pond & seepage WQ, stability	Potential to meet MP objectives
	Tailings dams	Efficiency, erosion, stability	Potential to meet MP objectives
	Collection systems	Efficiency, reliability, cost	Potential to meet MP objectives
	Treatment plants	Density, stability	Potential to meet MP objectives
	Sludge disposal facilities	Density, leachability	Potential to meet MP objectives
Environmental impacts Monitoring mainly of performance indicators relating to environmental impacts	Are the environmental impacts on the surface of the sources/deposits and in the receiving environment achieving MP objectives for the following:	Monitoring of the potentially impacted environment; including the surfaces over sources and the downstream surface and groundwater environment	Indicators used for monitoring environmental impacts are typically a measure of quantity and quality of the natural resources and biota over and downstream of sources/deposits.
	Surface land use, aesthetics, and	Vegetation; soil and terrestrial	Vegetation & biota species

	productivity?	biota; appearance; land use.	abundance; productivity; appearance & land use.
	Surface water quality in the receiving environment?	Surface water flows and quality over and downstream.	Flow rates; contaminant concentrations; aquatic productivity.
	Groundwater quality in the receiving environment? Air quality and downwind deposition effects?	Groundwater elevations and quality in around & downstream	Groundwater elevations; contaminant concentrations.
	Social impacts in the affected community?	Air quality over and downwind deposits rates and amounts. Ongoing impacts to the quality of life in affected communities.	Particulates in air; downwind deposits characteristics, and rates. Community health, culture and recreational pursuits.
	Economic impact in the affected community?	Economic impacts to affected communities.	Job opportunities, economic burden, sustained economic benefits.
Management and maintenance Sustainability Monitoring of both implementation and performance indicators relating primarily to long-term sustainability	Are the ongoing management and maintenance (M&M) activities required in the MP sustainable during operations and very long-term? Aspects to be monitored and assessed include:	Long-term implementation of fiscal, management, operating, & maintenance systems and performance and sustainability of these activities in accordance with MP and the MP objectives; including:	Key implementation and performance indicators for sustainability of the management and maintenance activities include current indicators and assessments of change trajectory compared with predicted by the MP.
	<ul style="list-style-type: none"> <li>▪ Financial sustainability of required M&amp;M.</li> </ul>	<ul style="list-style-type: none"> <li>▪ Size and performance of financial security relative to MP forecasts.</li> </ul>	Value (size), security, and change in value of financial assurance. Presence, completeness, authority, and effectiveness of management.
	<ul style="list-style-type: none"> <li>▪ Sustainability of management structure.</li> </ul>	<ul style="list-style-type: none"> <li>▪ Succession process for M&amp;M and durability of custodianship.</li> </ul>	Ongoing completion of monitoring requirements of MP.
	<ul style="list-style-type: none"> <li>▪ Sustainability of monitoring activities.</li> </ul>	<ul style="list-style-type: none"> <li>▪ Sustained success of completing monitoring activities of MP.</li> </ul>	Ongoing completion of maintenance requirements of MP.
	<ul style="list-style-type: none"> <li>▪ Sustainability of operating and maintenance activities.</li> </ul>	<ul style="list-style-type: none"> <li>▪ Sustained success of completing maintenance activities of MP.</li> </ul>	On-going completion of operating requirements of MP.

<sup>1</sup>MP – management plan

### 9.3 Implementing the Acid Rock Drainage Management Plan

Ideally, the ARD management plan has been developed as part of the original mine plan and environmental assessment. General requirements for implementation of the management plan are often contained in permits issued by regulatory agencies. Appropriate senior-level management responsibility and accountability must be put in place, together with access to adequate human and financial resources, to implement the plan and audit its effectiveness. The ARD management plan, including its assessment of performance, should be shared with communities and other stakeholders as discussed in Chapter 10.

A key aspect in implementing the ARD management plan with regard to mine scheduling is to establish a practical basis whereby the management measures can be part of the short-range and long-range mine planning (see the Mt. Milligan Project mini case study for an example: **Mt. Milligan Project**). Operating environmental staff knowledgeable in the basis of the ARD management plan should participate in the ongoing operations planning meetings and the geologic assessments. The environmental staff should also explain the environmental and geochemical considerations in a way that is understandable and useable for mine production staff.

The transition from project development to mine operations is a critical period because details and commitments for ARD management can be lost. Ideally, operating



staff participate in the final stages of mine feasibility and environmental assessment and permitting because they have first-hand knowledge of ARD management strategies, plans, and commitments.

### 9.3.1 Integrating Acid Rock Drainage Management into Mine and Process Operations

In general, the mining industry has embraced EMS. EMS is widely applied at mine sites. Application of these systems is based on corporate environmental policy and follows a typical cycle of planning, implementation and operation, checking and corrective action, management review, and continual improvement. The schematic in Figure 9-5 shows a typical EMS cycle and its components.

**Figure 9-5: Typical Environmental Management Model**

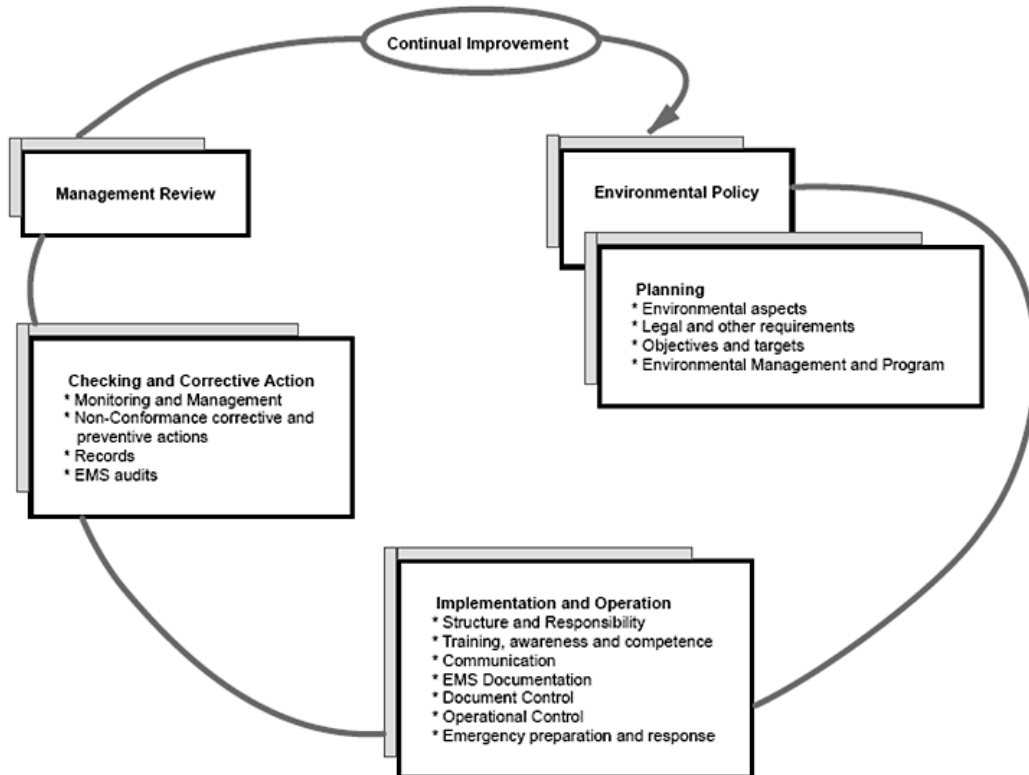

Various other environmental-related management plans exist at mines, such as a biodiversity management plans, closure plans, waste management plans, integrated waste and water management plans, monitoring plans, and various other mine development plans. ARD management plans are often connected to these plans as part of the overall EMS. Where ARD is a significant issue, ARD should have its own management plan with linkages to related plans in the EMS. Where ARD is a smaller issue, its management could be integrated into other plans of the EMS (e.g., as part of the environmental monitoring plan where prediction programs indicate a low ARD potential).

Typically, the EMS and the ARD management plan are reviewed annually with major revisions every 3 to 5 years or the EMS and ARD management plans might change when triggered by a major change in operations (e.g., new ore body or metallurgical process).

ARD management plans are also an integral part of closure plans where ARD is a significant issue. Closure plans may be somewhat conceptual early in the mine life but closure plans become more specific as mining progresses. Closure plans should be quite detailed about 3 to 5 years before the completion of mining operations. Closure plans should be integrated into mine production plans and, in the last years of mine operations, become a large part of the production plan in order to make effective use of mine site resources.

Additional features of a successful corporate or site-level ARD management structure include the following:

- Incorporating environmental awareness training (including ARD issues) into the induction training program for all mine staff
- Ensuring that environmental reporting becomes a standard agenda item at relevant operations and corporate meetings
- Developing clear action triggers for all key ARD monitoring points to ensure proactive action
- Including personnel from the corporate environment department who will have the responsibility to ensure that proper consideration is given to the life-cycle environmental risks into project development teams
- Conducting post-incident investigation of incidents where environmental and ARD monitoring criteria are exceeded or when a noncompliance incident is reported to determine the cause of the incident and define and implement corrective measures to prevent a repeated occurrence.

The evaluation, design, and operating cycle depicted in Figure 9-6 is typically repeated during each of the mine life stages as a continuous process, as illustrated in Figure 9-7. Such a total life cycle approach is clearly applicable for green field projects and will proceed through all the mine life cycle stages. However, the evaluation, design, and operating cycle can also be applied to projects that are not further developed after the exploration stage, existing operations, and closed mines.

**Figure 9-6: The Cycle for Developing and Implementing ARD Management Plans in each Life Cycle Stage**

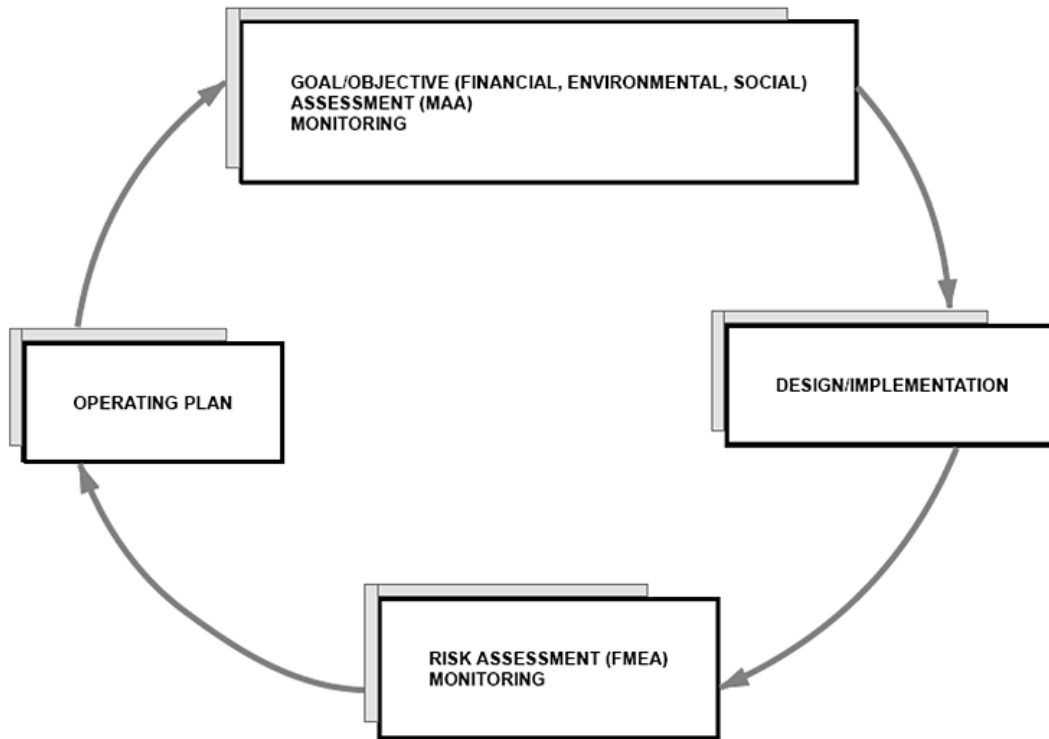

**Figure 9-7: Mine Life Cycle Development and Implementation of ARD Management Plans**

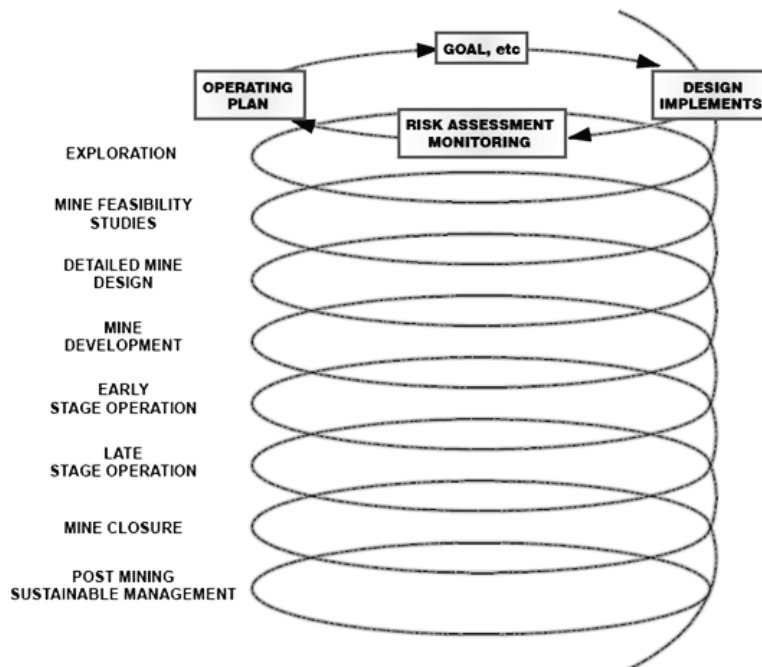

In the case of advanced exploration projects that are not further developed, at least one cycle of the design process presented in Figure 9-7 would be applied. For such projects, an ARD management plan can be developed and implemented for exploration. When the decision is made to end the exploration activities without further mine development, a closure plan should be developed and implemented. In that case, the project proceeds directly from exploration to closure.

### 9.3.2 Management System Roles and Responsibilities

The corporate staff should play an important role in ensuring the development and integration of the ARD management plan into the mine site's EMS. That role includes auditing the implementation and success of the EMS. Corporate staff can assist with strategic planning in the EMS and with consistent environmental performance when key mine operating staff change.

While precise company structures differ between companies, key features and components of an effective management structure for ARD plans might include the following:

- A senior level person who takes responsibility for the corporate environmental (and ARD) management system including policies and guidelines, and may be a key resource for technical information on ARD. The corporate environment department oversees the company's overall environmental programs, including ARD management standards and guidance, and prepares status reports for the company executive and may assist in compiling the business units report to the board of directors.
- The mine site's general manager has ultimate responsibility for the implementation of the ARD management plan and integrating the responsibilities into the relevant operations departments.
- The chief geologist, who is responsible for the geological block model (and ARD block model where needed).
- The mine and mill managers and superintendents are typically responsible for implementing the ARD management plan because the plan must be integrated into mine operational activities.
- The site's environment department should primarily review, audit, and monitor the ARD management plan, ensuring that the plan is being followed by mine operations' functional groups. This could include evaluating field data and performance against the objectives of the plan, interpreting the data, and linking data from the mine or the mill (e.g., comparing mine dispatch data on segregation of waste rock against seep survey data from the dump or reviewing sulphate and metal concentrations in tailing pond or waste dump seepage). Where required, the environment department should have an appropriately qualified scientist or engineer with practical experience across a wide range of relevant disciplines to ensure that the ARD management issues relevant to the mining and process operation are understood.

The bullet items above are examples of possible roles and responsibilities and illustrate the range of activities and multidisciplinary aspects of ARD management plan implementation. Mines will employ different organizational structures based on specific needs and personnel.

## 9.4 Long-Term Considerations

An ARD management plan should provide for the sustained existence and performance of the structures that are required to achieve long-term prevention and mitigation of ARD. In this Section 9.4, some of these long-term issues and effects are presented that should be considered in the development of ARD management plans to manage present and future impacts.

### 9.4.1 Design Horizon

The robustness of the technology selected to address ARD issues determines, to a great extent, the long-term success of ARD prevention and mitigation. The cost of more robust technologies should be compared to the costs of planning and maintenance for very long periods of time.

Regardless, there is a need to make a rational and practical decision on the service life for which management measures are designed and during the time period they need to be assessed. While there are no consistent or universal regulatory guidelines, many designs and cost analyses are conducted for a time horizon of 100 years. From a cost perspective, the financial provision that caters for events during the next 100 years is very similar to a financial provision that caters for longer periods of time, when measured in net present value (NPV) terms, depending on the discount rate used in the calculations. The various investment uncertainties will often have a bigger impact on the NPV than a timeline that extends beyond 100 years. However, many companies and regulatory agencies are examining other methods of assessing the long-term cost of ARD management beyond NPV calculations.

### 9.4.2 Long-Term Resources

There are various mechanisms that are used throughout the world to manage post-closure monitoring and maintenance requirements across the spectrum of closure activities and ARD management is only one component of the overall closure plan. The key post-closure activities related specifically to ARD can range from a relatively active site presence (and cost) for long-term operation of water management and water treatment to a relatively minimal requirement of periodic monitoring and maintenance of structures to control water levels and maintain flooded conditions. In many cases, given thorough site characterization and application of the "design for closure" principle, only a performance monitoring period of two to ten years may be required.

The operating model for this post-closure maintenance can vary as follows:

- Continued operation post closure by the mining company (This model is typically seen in larger mining companies that continue to have operating sites elsewhere combined with the financial wherewithal to ensure funding. Within this model, the site might be managed primarily by third-party contractors or by company employees.)
- Third-party management of the site, funded either by the former owner/operator or by a commercial arrangement with the third party
- Completion of decommissioning activities, post-closure management and monitoring of the site by the owner/operator for some time period during the evaluation of the performance of the closure measures, followed by turnover to a government or regulatory authority under a regulatory release for continuing monitoring or maintenance, as required
- Sale of the property to a new owner/operator for subsequent reopening (This type of transaction will require some agreement on the transfer or retention of liabilities for the former owner. The contractual and regulatory acceptance of the transfer of liabilities will typically depend on the confidence that is placed in the evaluation of post-closure liabilities.)

With respect to the staffing or human resources for closure, there are again a variety of options that are typically considered within a closure plan, ranging from staffing from remaining operating staff, use of contractors and consultants, to developing local business opportunities to operate the post-closure site.

A critical element in the definition of the post-closure management model is the quantification of the time period for active site management and the associated costs.

There are a number of different international guidelines on closure funding and many countries are still in the process of developing legislation and guidance on these closure funding mechanisms. It is beyond the scope of this document to discuss the mechanisms in detail; however, the following guiding principles are becoming standard for closure planning and financial assurance:

- Define the time period for post-closure management based on predictive modeling, monitoring, assessment and prediction model calibration and validation, and then negotiation with the relevant regulatory authorities
- Define the specific activities and associated costs, using a risk-based approach (The risk based evaluation considers uncertainty in predictions and performance of ARD management measures and expected value [or range] of costs.)
- Define the performance criteria and triggers for action (These in turn typically trigger a re-evaluation of the closure cost modelling.)
- Develop a financial model to quantify the provision required over time, considering the uncertainties of both the site requirements and the potential investment risks and uncertainties
- Define the financial assurance mechanism either internally to the company or externally to ensure that the funds are available as required and when needed (Typically, this will include some form of audit of the financial reserve. Again, guidance varies by jurisdiction or country regarding financial tests to select the appropriate mechanism.)
- Link the cycle of planning, monitoring, auditing, and corrective action within the ARD management and closure plans to update the financial modelling

### 9.4.3 Information/Institutional Knowledge Retention

A significant issue in implementing mine decommissioning and post-closure activities is that key information, previously obtained and recorded by mine operating staff, might be discarded or lost at the time of the cessation of mine production. Electronic storage can greatly facilitate future retrieval, but to be effective, all relevant information must be in, or be converted to, electronic format.

The EMS implemented by the mine should make specific provision for the identification, recording and cataloguing, electronic storage (where possible), and preservation of all data relevant to ARD management and assessment (e.g., see ISO 14001 standard [ISO, 2004]).

The type of data that should be retained, include the following:

- Exploration logs and data
- Detailed mining plans and survey data for actual mining operations
- Production records for mine and beneficiation plant
- Records on waste and residues (e.g., treatment sludges) production for mine and beneficiation plant
- Depositional history and construction details for all wastes
- Records on backfill materials placed back into underground and open pit mine workings
- All environmental monitoring data (e.g., air, water levels, water flows, water quality, soils, dust, ecological, geochemical, and waste characterization)
- Records on environmental noncompliances and stakeholder complaints
- All specialist environmental and ARD reports produced by or for the mine

### 9.4.4 Changing Standards/Stakeholder Needs and Expectations

Stakeholders (regulators and communities) expectations change with the stage of mine development. What may be considered appropriate for an ARD management plan differs for new, operating, and closed mines. The expectations of the stakeholders, who will be the decision makers at the time of mine closure, must be provided for in the development of an ARD management plan including, if required, the post-closure custodianship of the site.

Regulatory conditions continue to become more stringent with time and the bar for minimum compliance is therefore often raised (or “the goal posts are shifted”). A

mine that develops and implements an ARD management plan based on an objective and scientific assessment of all its risks from a sustainable development perspective, even when it is not required by current regulatory requirements, will have the inherent capacity to meet changes in the regulatory and community environment. This resilience is especially valuable for mining projects that have a long life, measured in decades, where the issues of tightening and more stringent regulatory controls over the mine life cycle are a reality. This resilience also allows the mine to plan for the future.

## 9.5 References

- Department of Industry, Tourism and Resources (DITR), 2006-2008. Leading Practice Sustainable Development Program for the Mining Industry. <http://www.ret.gov.au/resources/Pages/Publications.aspx>.
- Dushnisky, K., and S.G. Vick, 1994. Evaluating risk to the environment from mining using failure modes and effects analysis. In: C.D. Shackelford, P.P. Nelson and M.J.S. Roth (Eds.), *Uncertainty in the Geologic Environment: From Theory to Practice*, ASCE, 2:848-865.
- Gibson, R.B., 2005. *Sustainability Assessment*. Earthscan Publications.
- Haines, Y.Y., 2004. *Risk Modeling, Assessment, and Management*, 2nd Edition. John Wiley and Sons, Hoboken, NJ.
- ISO 14001, 2004. *Environmental management systems - requirements with guidance for use*. International Organization of Standards.
- Robertson, A. MacG., and S. Shaw, 2004. Use of the Multiple Accounts Analysis Process for Sustainability Optimization. In: *Proceedings of the SME Annual Meeting*, February 23-25, Denver, CO.
- Shaw, S.C., Robertson, A. MacG., Maehl, W.C., Kuipers, J., and S. Haight, 2001. Review of the Multiple Accounts Analysis Alternatives Evaluation Process Completed for the Reclamation of the Zortman and Landusky Mine Sites. National Association of Abandoned Mine Lands Annual Conference, August 19-22, Athens, OH.

## List of Tables

- Table 9-1: Mine Life Cycle Considerations for the Development of ARD Management Plans
- Table 9-2: Technical Disciplines Involved in the Development of an ARD Management Plan
- Table 9-3: FMEA Outcomes Combining Likelihood of Failure and Consequences
- Table 9-4: Monitoring and Performance Assessment of Success

## List of Figures

- Figure 9-1: Flowchart for Performance Assessment and Management Review
- Figure 9-2: Hierarchy of Management Tools
- Figure 9-3: Open Pit Bench Plan Developed During the Feasibility Phase of a Mine Project
- Figure 9-4: Overall Segregation of Various Waste Rock Units Based on their ARD Potential and Physical Characteristics
- Figure 9-5: Typical Environmental Management Model
- Figure 9-6: The Cycle for Developing and Implementing ARD Management Plans in each Life Cycle Stage
- Figure 9-7: Mine Life Cycle Development and Implementation of ARD Management Plans

# Chapter 10

## From GARDGuide

### 10.0 Acid Rock Drainage Communication and Consulting

- 10.1 Introduction
- 10.2 Why Communicate and Consult about Acid Rock Drainage?
  - 10.2.1 Stakeholder Perceptions about Acid Rock Drainage
  - 10.2.2 Benefits of Communication and Consultation about Acid Rock Drainage
- 10.3 Mining Disciplines Involved in Acid Rock Drainage Management and Communication
  - 10.3.1 Integration of Functions
- 10.4 Planning Communication and Consultation on Acid Rock Drainage
  - 10.4.1 The Focus of Consulting and Communication
  - 10.4.2 Regulatory and Other Requirements for Communication and Consultation
  - 10.4.3 Tailor Objectives of Stakeholder Engagement to the Situation at Hand
- 10.5 Communication and Consultation about Acid Rock Drainage for each Mining Phase
- 10.6 Good-Practice Principles and Approaches
  - 10.6.1 Inclusive Engagement
  - 10.6.2 Get in Early
  - 10.6.3 Be Respectful to People and Cultural Norms
  - 10.6.4 Accessible and Transparent Information
  - 10.6.5 Ongoing Feedback and Acknowledgment
  - 10.6.6 Dispute Management and Resolution
  - 10.6.7 The Principles of Risk Communication
- 10.7 Responsibilities of Regulators
- 10.8 Guidelines for Acid Rock Drainage Reporting
- 10.9 References
- List of Tables
- List of Figures

## 10.0 Acid Rock Drainage Communication and Consulting

### 10.1 Introduction

The purpose of this Chapter 10 is to provide guidance to mining companies in their internal communication, external communication, and consultation with neighbouring communities, regulators, and other stakeholders about ARD during the life of a mine. Key components of this chapter are outlined in Figure 10-1.

**Figure 10-1: Chapter 10 Layout/Road Map**

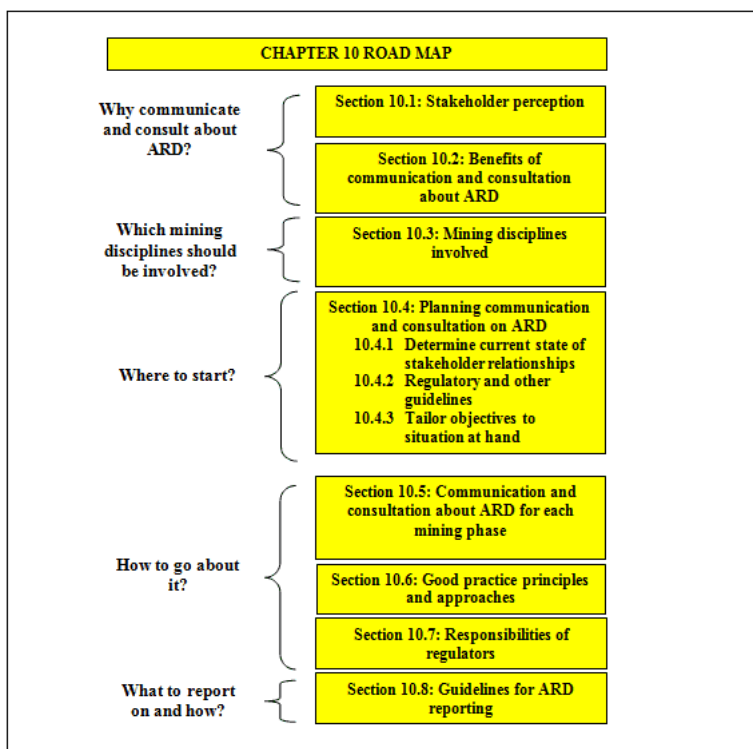

This chapter should also be useful to governments, NGOs, and other stakeholders about good practice principles and approaches that may be applicable to communication and consultation initiatives.

Effective communication on ARD cannot be managed in isolation and is only one aspect of the overall mine communication and consultation process. An integrated communication and consultation strategy related to ARD is essential and should reflect key issues to be addressed. While this chapter highlights some specific ARD considerations in communication, the information presented about ARD management is conducted within the broader spectrum of the project or mine consultation processes. The good practice principles and approaches to communication and consultation, and the need for capacity building of stakeholders, apply equally to developed and developing countries. However, the issues, questions, messages, and communication methods are different for each mining phase.

## 10.2 Why Communicate and Consult about Acid Rock Drainage?

The level of knowledge about ARD generation and mitigation has increased dramatically during the last 20 years within the mining industry, academia, and regulatory agencies. To be fully useful, however, the relevant knowledge applicable to a particular mine or project needs to be translated into a format that can be readily understood by a broad range of stakeholders that could be affected by the project. This consultation should examine the predictions of future drainage quality and the effectiveness of mitigation plans, their degree of uncertainty, and contingency measures to address that uncertainty. Such an open dialogue on what is known, and what can be predicted with varying levels of confidence, helps to build understanding and trust, and ultimately results in a better ARD management plan.

This Section 10.2 presents and discusses stakeholder perceptions and fears about ARD, and the benefits of stakeholder communication and consultation about ARD.

### 10.2.1 Stakeholder Perceptions about Acid Rock Drainage

Stakeholders generally do not distinguish between ARD, NMD, or SD, nor do they distinguish between mine commodities. Until the stakeholders have a better understanding of the issues, they may express their fears about such things “mine water pollution,” “poor quality water,” “long-term liability,” and “toxic spills.” ARD is different from most other environmental mining issues. If not properly managed, ARD can persist over very long periods of time and may require ongoing study and treatment.

From a stakeholder perspective, regardless of whether the mine is in the developing world or developed world, stakeholders might have some of the following perceptions and views about ARD:

- ARD is perceived as toxic and therefore scary. It turns streams red, kills aquatic life, and renders water unsuitable for domestic purposes. In some countries, such as Papua New Guinea, the red color is culturally associated with a bleeding Mother Earth.

- ARD is perceived as forming somewhat uncontrollably when mining occurs. Also, ARD can migrate into the environment with little warning and therefore risks are harder to explain. This is complicated by the varying levels of understanding and acceptance levels of risk: a lay person's understanding and perception of risk differs fundamentally from how scientists view risk.
- Some scientific predictions and environmental assessments about ARD have been wrong in the past. The Internet contains examples of ARD from mines having caused significant environmental, social, and economic problems.
- ARD may already have contaminated groundwater and soils, and people question whether the mining company will compensate people for lost resources.
- People doubt the company's ability to stop ARD, especially where there is a substantial cost and a lack of assurance that it is well managed and controlled.
- Impacts can last from decades to thousands of years unless stopped (claims that are also easily made on the Internet).

Communicating and consulting with stakeholders about issues such as those above is essential to the company's social license to operate, even if the mine does not have a high risk of ARD. ARD issues should, therefore, be part of the company's stakeholder communications strategy. Moreover, where ARD is a significant concern, these issues and perceptions pose special challenges, need special measures and skilled people to communicate effectively, and may require the involvement of representatives from all relevant technical disciplines in a company.

It is useful to remember that "trustworthiness goes up when you communicate things that it would be in your self-interest to conceal".

### 10.2.2 Benefits of Communication and Consultation about Acid Rock Drainage

Communicating and consulting proactively and transparently about ARD is a necessary and effective way to build good relations with all stakeholders. If communication is done effectively, it contributes to social acceptance of a company's general business strategy and mining projects and results in better projects and operations, as shown below:

- People fear what they do not understand. Demystifying the concept of ARD by explaining how it forms, how it can be prevented, and how it can be mitigated helps stakeholders overcome concerns and fosters engagement. A good example of general information on ARD/ML developed by the BC Ministry of Energy, Mines & Petroleum Resources for a lay audience can be found here: [General Information on Metal Leaching and Acid Rock Drainage](#)
- By providing accurate and timely information, the risk of rumours and the spreading of misinformation and speculation can be reduced. Without accurate information, the media and other stakeholders substitute their own information, which is often based on bad examples of past practice.
- By ensuring that all stakeholders share the same timely accurate information, the community as a whole can develop an informed view on ARD issues.
- Consultation provides balancing of perspectives (IAP2, 2002). By consulting a wide array of stakeholders, a more moderate and pragmatic set of views is generally gained (IFC, 2006a).
- Transparency builds trust and credibility, even if the news is not good.
- Demonstrating to stakeholders, regulators, NGOs, lenders, and others that a company honours its commitments to openness and transparency enables progress.
- Communication represents an opportunity for supporting and building stakeholder capacity to better understand good-practice mining environmental management, and to understand how standards and guidelines are set and used by regulators to evaluate a project.
- Receiving assistance from stakeholders in identifying risks, potential effects, and opportunities to consider can lead to better understanding.
- By listening and engaging, companies are better placed to identify issues at an early stage and deal with issues proactively rather than reactively (Australian Government Department of Industry, Tourism, and Resources, 2007).
- Creating understanding and a supportive environment for decision-making is good business practice.

## 10.3 Mining Disciplines Involved in Acid Rock Drainage Management and Communication

Ultimately, where ARD is a significant concern, representatives from all mining disciplines, and many mine employees (especially if they live within nearby communities), are involved in communication about ARD. The challenge is, over the life of a mine often with rotating personnel, to instill a lasting culture of constructive internal and external communication.

A mine's communications department (or public affairs, public relations or community relations department) cannot communicate and consult in isolation. Personnel in these departments may be highly skilled communicators, but they are not normally geochemists, engineers, or mine planners, so the communications department often needs help to explain the complex concept of ARD to stakeholders. The ARD experts and the communications departments need to work closely to understand and effectively convey messages.

### 10.3.1 Integration of Functions

Many large organizations struggle with internal communication. People in mining companies work in their special disciplines, each representing an important aspect of the business and each with their own responsibility.

Internal communication in a company needs to be designed to be effective between different functional groups at a mine. The functional groups must work together to implement the mine's ARD management plan (see Chapter 9), including stakeholder engagement, communication and consultation, and



performance monitoring. Integration should lead to ARD management and communication being fully incorporated into geological programs, mining, milling, environmental and social management, and communications. At mines where there is a significant risk of ARD, it may be necessary to specifically denote functions and responsibilities pertaining to ARD in the job descriptions of relevant personnel.

Stakeholder engagement needs to be managed as an integral part of company business functions, even if the mining company is small with few staff. The company should provide communications training for personnel and should integrate communications into projects and operations. This increases the chances that ARD communication will serve the purposes of the project, rather than becoming a costly peripheral exercise that is out of touch with operational realities that raises expectations that cannot be met (IFC, 2007). Communication should be driven by a well-defined strategy, and have a clear set of objectives, timetable, budget, and allocation of responsibilities to professional communicators. Many small mining companies subcontract the bulk of communications to consultants, assigning just one staff member as the company spokesperson or liaison.

If there is a significant risk or perception of a risk of ARD, it is advisable to devote a section of the mine’s public consultation and disclosure plan (PCDP) or overall communications plan to ongoing communication about ARD, and build in a mechanism for evaluation of the effectiveness of the ARD communication. It is important to ensure that grievance and compensation procedures are able to specifically deal with ARD. All staff should be made aware of the program and understand why it is being undertaken and what implications it might have for the outcome of the project (IFC, 2007). Personnel in business functions should fully understand the mining process and ARD issues in order to communicate effectively in lay language.

## 10.4 Planning Communication and Consultation on Acid Rock Drainage

The following basic planning steps, before engaging with stakeholders and communicating and consulting about ARD, are described in this Section 10.4:

- Determine the current state of the mine’s relations with its stakeholders
- Understand the legal and other requirements pertaining to stakeholder engagement regarding ARD
- Ensure that the technical aspects are well understood and accurately and properly prepared for presentation
- Understand the level of knowledge and experience of the stakeholders with ARD
- Tailor the objectives of communication and consultation to the known issues and the situation at hand

### 10.4.1 The Focus of Consulting and Communication

The focus should always be on conflict prevention, rather than conflict management (Zandvliet, 2007).

The crux of successful communication and consultation is not what you do but how you do it (Zandvliet, 2007). Company-community issues are never due only to external factors. Daily operational activities, more than community projects, determine community perception. Community support is determined by how companies operate, in addition to what they do.

People’s perceptions have to be taken seriously. To them, their perceptions are real, even if factually incorrect. The following examples illustrate this message:

- A company convenes a public meeting (i.e., what the company does is selecting a good communication and consultation methodology), but convenes the meeting badly (i.e., chooses a venue not accessible to stakeholders; creates an “us and them” situation in seating arrangements; discusses technical issues at too high a level; does not allow sufficient time for questions and debate; or becomes defensive and dismissive in answering questions from stakeholders). Thus, how the company conducted the meeting has catastrophic results: open conflict between company and stakeholders, entrenched negative perceptions, and excellent material for negative publicity.
- A company convenes a public meeting that is supposed to be public consultation but presents a single plan with all the conclusions in place to manage ARD; a company has made decisions on what is acceptable risk with respect to ARD and water quality; or a company has decided on a design that requires perpetual treatment without prior discussions with the community.

Thus, consultation and communication about ARD will be influenced by how the company goes about its business, and consequently by whether its stakeholder relationships are good or poor. If relations are poor, communication about ARD will be challenging, and vice versa. Environmental incidents typically serve as a trigger to unleash broader issues that have not been addressed. Even a rumour about ARD can spark a disproportional community reaction when other aspects of the stakeholder relationship have not been dealt with constructively. If the existing risk is already high, and an ARD problem is possible, the risk of losing social license to operate will increase.

Table 10-1 contains a simple assessment tool mines can use to assess current standing in terms of stakeholder engagement (World Bank, 2004). This table is not comprehensive but is illustrative of some of the issues that a mine may face when engagement is not proceeding as planned. These issues vary between geographic regions, ethnic groups, and socioeconomic levels.

**Table 10-1: Assessment Tool: Indicators of Negative Engagement with Stakeholders**

	Corporation-Community	Corporation-Government	Corporation-Critics
<b>Early indicators</b>	*Community leaders, elders stating they do not feel respected *Visits at the company gate/ people staying at the gate with complaints	*Government presence in the area of operations is primarily through the military *Government expects company to build community infrastructure	*Questions are raised regarding company actions from home government *Questions from local or international journalists on company activities

	<ul style="list-style-type: none"> <li>*Reliance on 1-2 community spokespersons (few representatives indicate a narrow representation of interests)</li> <li>*The same problem arising over and over</li> <li>*Evidence that individuals, rather than the community, benefit from company-community interaction</li> <li>*Staff feel unsafe visiting communities</li> <li>*Cold reception in community during visits</li> <li>*Accusations of company association with a repressive government</li> <li>*Community accusations that the company is 'arrogant,' 'not caring'</li> </ul>	<ul style="list-style-type: none"> <li>*Government disengages its services from the area of corporate operations</li> <li>*Reliance on bribery to get the government to fulfill its duties</li> <li>*Limited access of company staff to government officials</li> <li>*Government interference with internal company policies (e.g., staff hiring/firing)</li> <li>*Both government and company state that the other party is responsible for community relations</li> </ul>	<ul style="list-style-type: none"> <li>*International advocacy NGOs critical of company actions start establishing local branches</li> <li>*Being mentioned on activist websites (getting on their radar screen)</li> <li>*Being accused of arrogant, defensive or legalistic tone ("we are right and they are wrong")</li> <li>*Refusal of NGOs to meet with the company</li> </ul>
<b>Late indicators</b>	<ul style="list-style-type: none"> <li>*Rising trends in theft (no reporting and company seen as target)</li> <li>*Work stoppages</li> <li>*Demands and hostile tone of community demands increases</li> <li>*Bad press</li> <li>*Increasing crime in the area of operations</li> <li>*Increased conflict between communities or within communities</li> <li>*Kidnappings, targeted assaults toward the company</li> <li>*Sabotage</li> <li>*Increasing reliance on police/army</li> </ul>	<ul style="list-style-type: none"> <li>*Government encourages communities to demand (and expect) provision of social services from company</li> <li>*State security forces are involved in sabotage activities against the company</li> <li>*State security forces are a risk to corporate staff and assets</li> <li>*Security forces associated with the corporate presence commit HR abuses (risk of litigation)</li> <li>*Government revenues are explicitly used for warfare or violence against the citizenry</li> </ul>	<ul style="list-style-type: none"> <li>*NGOs encourage community demonstrations against company</li> <li>*NGO advocacy campaigns against company</li> <li>*Divestment campaigns</li> <li>*Consumer boycotts</li> <li>*Shareholder activism critical of company actions</li> <li>*Websites against the company</li> <li>*NGOs and lawyers actively seeking witnesses for court cases</li> <li>*Litigation</li> </ul>

#### 10.4.2 Regulatory and Other Requirements for Communication and Consultation

Before designing a communication and consultation plan, the applicable laws and regulations need to be consulted. The minimum requirements for communication and consultation are often indicated in the applicable mining or environmental laws of the jurisdiction in which the mine operates (see Chapter 3). In some countries, laws other than those for mining and environment could govern communication and consultation. These include access to information (more than 50 countries worldwide now have legislation regarding access to information), administration of public justice, health, and other applicable laws. Bills (i.e., laws) that are not yet promulgated often carry moral force. Complying with in-country regulatory requirements will not bring about social acceptance of a project or stakeholder understanding of an ARD situation. Legislation and regulations usually state the minimum requirements, which will not be adequate if ARD is a significant issue, especially in countries where regulations are not well developed or stakeholders do not trust the government. One way of building trust and credibility at the local level is to assist local stakeholders to understand international guidelines and standards, explain which of their provisions relate to ARD, and show how the mine will apply these to ARD at the local level. The Equator Principles and the IFC Environmental and Social Standards are often useful. For example, the IFC indicators (IFC, 2006b) for free, prior, and informed consultation state that communities should be consulted about impacts that are discovered after operations have started. These impacts would typically include significant changes in the quality of mining discharges, such as impacts related to ARD.

Establish whether there are applicable international conventions. In Europe, for example, the Aarhus Convention on Public Participation (Anon., 1998) indicates that ARD issues that may arise should be disclosed.

Although the International Labour Organization (ILO) Convention 169 on Indigenous and Tribal Peoples (ILO, 1989) is directed at governments, companies should study the provisions of this convention for guidance. The provisions of the convention are binding in 17 countries (13 of which are in Latin America). Articles 6 and 15 deal with consultation by government, and companies can assist government with this consultation process.

Local or regional guides on consultation (including "public participation", "stakeholder engagement", "community relations", and "community engagement") that stakeholders could use to determine whether the company is adequately communicating should also be consulted. Many developed countries have such guidance, bearing in mind those guides are neither recipes nor manuals. In all cases, it is recommended that a company start the process by seeking local and wider stakeholder input into the processes they choose to use.

Company values and commitments often contain requirements for communication and consultation. At a minimum, project and mine site personnel should be keenly familiar with their company's values and commitments, and should be able to relate these to ARD. Publicly stated values and commitments that are not respected can lead to considerable mistrust between a company and its stakeholders.

#### 10.4.3 Tailor Objectives of Stakeholder Engagement to the Situation at Hand

There is no "one-size-fits-all" approach when it comes to engagement. The type of relationship will differ according to the location, local culture, scale of the

project, phase of project development, and the interests of the stakeholders. Figure 10-2 (IFC, 2007) illustrates types of stakeholder engagement and the intensity that people are engaged. A more systematic approach is illustrated in the Spectrum of Public Participation, as shown in Figure 10-3, developed by the International Association for Public Participation (IAP2, 2006a,b,c).

**Figure 10-2: Types of stakeholder engagement and the intensity with which people are engaged (IFC, 2007).**  
Engagement with stakeholders about an ARD situation under different scenarios is indicated on the figure

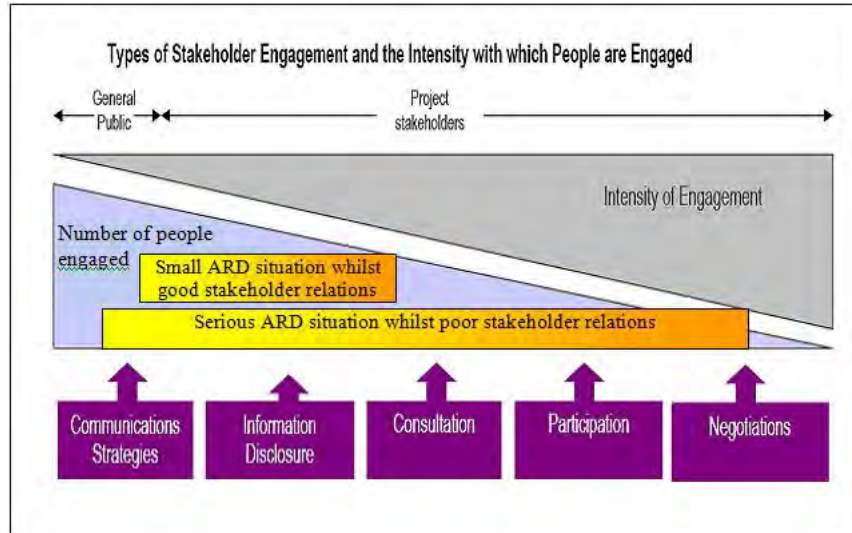

**Figure 10-3: IAP2's Public Participation Spectrum**

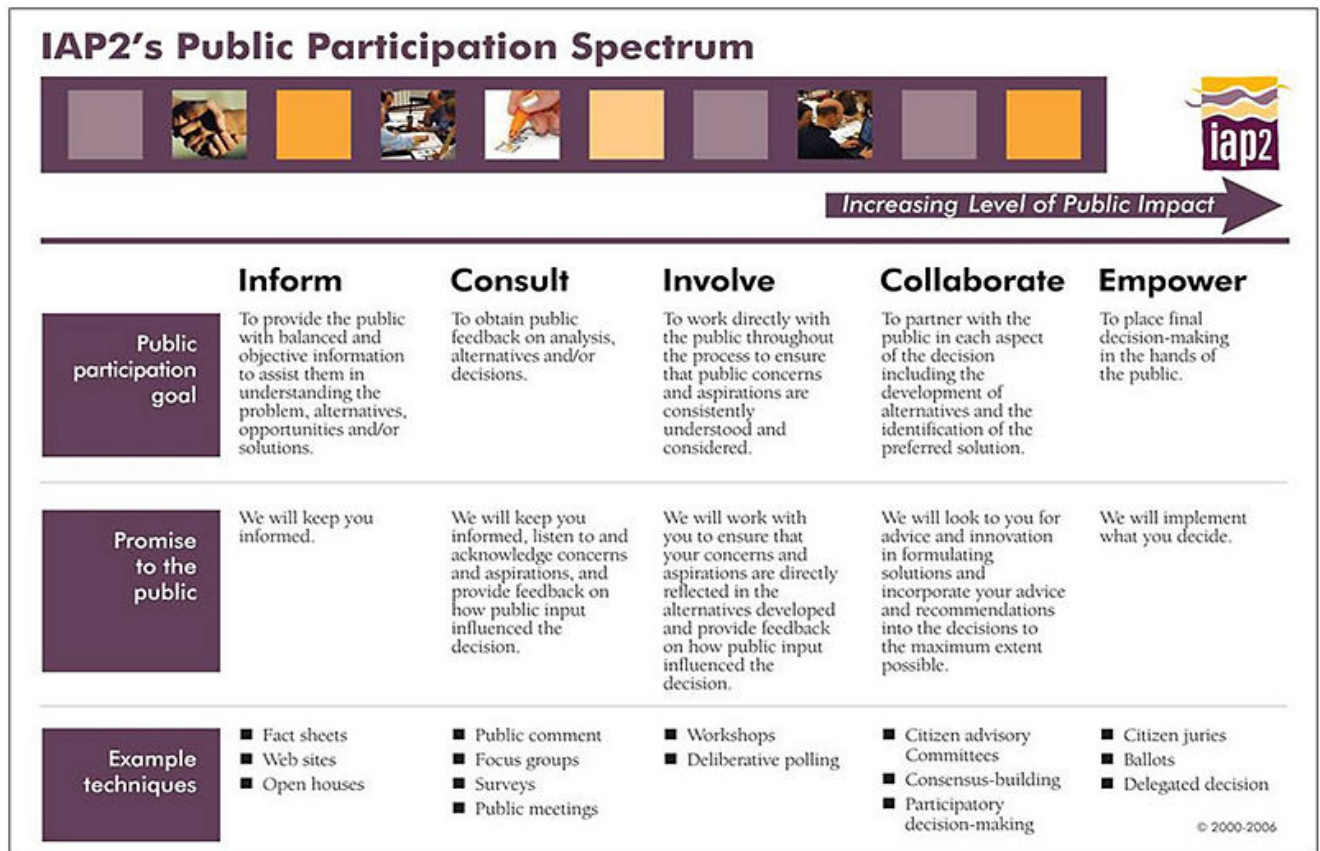

The spectrum is a useful tool for mines to select the objectives and nature of stakeholder engagement tailored to their particular situation at various stages

during the mining process. Each level of the spectrum has a different objective and a different promise to the public. The terms denoting the different levels are based on dictionary definitions.

The more sensitive the stakeholders the less they trust the company and government, the more impact the stakeholders want on decision-making, and the further to the right on the spectrum they want to be. For example, when a mine operates in a situation of trust between the company, its neighbours, and other stakeholders and an ARD problem arises, communication and consultation would typically occur at the inform and consult levels of the spectrum, taking less time, less involvement of mine personnel, and less cost. On the other hand, a large and potentially far-reaching ARD problem, with potentially significant impacts to people, their water resources and the environment, and especially where there is little trust between the mine and its stakeholders, will be more difficult to manage, will require involvement of all levels of mine personnel, and will cost more time and money.

## 10.5 Communication and Consultation about Acid Rock Drainage for each Mining Phase

The objectives and nature of communication and consultation about ARD may evolve over the life of the mine. However, consistency in mine personnel and stakeholders involved in consultation helps to build rapport and trust. Companies should be particularly sensitive of the potential effect on relationships during changes in senior mine personnel. Where possible, outgoing senior personnel should introduce the incoming personnel. For example, a mine project leader should involve and introduce the incoming operating mine manager to stakeholders as soon as practical. This inspires confidence in the community that commitments made to manage ARD during the EIS process and permitting will be addressed during mine operations, even as these responsibilities are transferred to different personnel. During the life of the mine, new stakeholders will emerge and, therefore, basic information supplied in the beginning would have to be repeated to assist new stakeholders to understand ARD.

Regardless of the type of mine drainage involved, and the particular commodity, the approaches to and guidelines for communication and consultation are the same and globally applicable, whether in the developing or developed world. Education levels vary among stakeholders in all countries and cultural considerations are important in all societies. Only the stakeholders and issues are different. Processes depend on local circumstance, stakeholders, level of education/literacy, cultural imperatives, current level of trust in and relationship with the mining company, and the nature and severity of problems and impacts. Thus, there is no easy formula, except to try to manage the process proactively and adapt the established good practice approaches and principles for stakeholder engagement (IFC, 2007) and tailor the processes to each situation. A few important good practice approaches and principles are presented in the Section 10.6 (modified from IFC, 1998; IFC, 2007; Chamber of Mines of South Africa, 2002; and IAP2, 2006a,b,c).

Table 10-2 contains a list of sources with more in-depth information.

## 10.6 Good-Practice Principles and Approaches

### 10.6.1 Inclusive Engagement

A solid foundation of the stakeholder consultation program is based on recognizing the broad range of potentially interested parties, and the influence of the parties on the project outcomes. Stakeholders within a sector or a community do not form a homogenous group, and include people with different aspirations, values, and challenges. There may be cultural and tribal influences that influence how stakeholders and their influence are defined. So, for example, special efforts have to be made in patriarchal mining communities to engage with women. Women's ability to participate in the engagement process may be limited for many reasons and it is the responsibility of the company to identify such groups and seek their input, otherwise the consultation will be incomplete.

**Table 10-2: Sources with More Information on Principles, Approaches, and Techniques for Communication and Consultation with Stakeholders**

Title	Description
ICMM's Community Development Tool-kit	Provides various tools from assessment to monitoring. Includes such items as stakeholder identification, community mapping, partnership assessment, and indicator development.
Stakeholder Engagement. A good-practice handbook for companies doing business in emerging markets (IFC, 2007)	This is a most useful tool for mining companies. Part One contains the key concepts and principles of stakeholder engagement, the practices that are known to work, and the tools to support effective delivery. Part Two shows how these principles, practices, and tools fit with the different phases of the project cycle, from initial concept through construction and operations, to divestment and/or decommissioning. Each of these phases presents different risks and opportunities and thus different practices need to be employed and integrated into management systems at each stage.
Working with indigenous communities (Australian Government Department of Industry, Tourism and Resource, 2007)	Companies that are signatories to the Minerals Council of Australia's Enduring Value framework (MCA, 2005), based on the International Council on Mining and Metals' Sustainable Development Principles (ICMM, 2003), undertake to 'engage with and respond to stakeholders through open consultation processes' integral to each stage of a mining operation, from design and construction, through to operation and closure. The handbook provides guidance on how to translate these higher level policy commitments into improved practices on the ground. It focuses on the challenges that companies may encounter as they engage with indigenous communities. Companies need to develop trusting and mutually respectful relationships with local

	communities. The handbook contains practical examples on how to implement good practice at the site level.
Best Practices in Community Involvement (NOAMI, 2003)	In 2002, case studies related to community involvement were completed for three Canadian mine sites, along with experiences in community involvement at abandoned mines in the United States. The “lessons learned” from these studies were developed into principles for use by governments, industry, local communities and other parties as a template for the development of policy and citizen engagement plans prior to, during and after the rehabilitation of problematic sites. The final report and the pamphlet are available on the NOAMI website.
The Practitioner’s Handbook on Stakeholder Engagement. (Account Ability, United Nations Environment Programme, Stakeholder Research Associates Canada Inc. 2005).	This handbook is the result of UNEP’s interest to in producing a best practice guide to stakeholder engagement. It provides practical guidance, advice, methodologies, and signposts for further information to those interested in how to make stakeholder engagement more effective and beneficial for the organizations and stakeholders.
Ask First: A guide to respecting Indigenous heritage places and values (Australian Heritage Commission, 2002)	The main part of this guide is the consultation and negotiation process with indigenous peoples. It contains good-practice principles and useful guidelines for identification of traditional owners, other indigenous people and nonindigenous stakeholders.
The IAP2 Public Participation Toolbox (International Association for Public Participation) (IAP2a,b,c)	This useful toolbox contains a comprehensive listing of public participation techniques and the strong and weak points of each.

Typical questions to ask when developing a stakeholder contact list are as follows (modified from IFC, 1998; IFC, 2007):

- Do local laws or international initiatives the mine has committed to, specify which stakeholders to consult?
- Who would be directly or indirectly affected? (ARD has the potential to cause effects well downstream of the mine.)
- Who may perceive themselves to be adversely impacted (even if they are not) or who considers themselves the representatives of impacted people?
- What are the various interests of project stakeholders, even if not affected, and what effects might this have on the project?
- Which stakeholders work in or with the affected communities? These could include local government officials, community leaders, NGOs and other civil society organizations. While these groups may not be affected by the project, they may be able to influence the relationship of the mine with affected communities. They could also play a role in identifying risks, potential impacts, and opportunities. NGOs, particularly those who represent communities directly affected by a project, can be important sources of local knowledge, sounding boards for project design and mitigation, and conduits for consulting with sensitive groups. NGOs can also act as partners in planning, and assist implementing and monitoring various project-related programs.
- Which stakeholders might help to enhance the project design or reduce project costs?
- Who strongly supports or opposes the changes that the project will bring and why? The most vocal opposition to a project may come from stakeholders outside the affected area - in other parts of the country, or from other countries. If there is NGO opposition, engaging them early to try and understand their critiques offers an opportunity to manage these issues before they escalate or find another outlet for expression.
- Whose opposition could be detrimental to the success of the project? For example, if negatively influenced by other stakeholders without the benefit of balancing perspectives, the opposition of government, politicians and lenders, would be detrimental.
- Which stakeholder organizations might the mine wish to partner with in the implementation of community development projects? These may include NGOs, government bodies, multilateral organizations, donors, and religious groups.
- Which groups may be interested but may find it difficult to participate? Such groups could include women, the youth, and old and vulnerable people.

Remain sensitive to changes in society, especially when the mine may be operating for two or more decades. Therefore, be flexible in communications planning. Leadership may change; new politicians may become prominent; new organizations may become established; key people may move away and values may change.

### 10.6.2 Get in Early

Don’t wait until there is a problem to engage. Engaging with stakeholders from the start – as part of the mine’s core business strategy – enables a proactive cultivation of relationships that can serve as “capital” during challenging times. Reaching out to third parties, such as local government officials or NGOs, for assistance as allies or intermediaries only after a problem occurs may be more difficult because of perceived reputational risks of being associated with the company (IFC, 2007). In regard to ARD, especially if there is a high risk of ARD developing, early communication should include what ARD is, how it forms, and how the mine intends to manage the risk.

### 10.6.3 Be Respectful to People and Cultural Norms

Every society is different. Stakeholder values might differ from the values of company personnel, particularly when the company personnel come from different parts of a country or of the world. This can lead to mine personnel being seen as ‘outsiders’ or ‘intruders,’ or at best as a surrogate government that can deliver benefits. Become a good neighbour by showing respect to people and their values. Ensure that contractors do the same.

Include local cultural norms and basic customary greetings in the local language in induction training. Publicly and with respect, recognize local leadership, and involve local leadership in communicating with the community. Use communication personnel that speak local languages and understand local culture and customs.

The special values, and how they are expressed, for local water bodies, sacred sites, and resources by the community may appear strange to company personnel, but such values are often important elements of a local culture. While these sentiments might not be fully understood, they need to be appreciated and addressed in the ARD management plan. Mutual capacity building of the local community members in technical mining and environmental issues, including ARD and of the mining company personnel and consultants in local cultural aspects, is required and a key step in building communication and ultimately trust.

#### 10.6.4 Accessible and Transparent Information

Consultation at all levels will be more constructive if regulators, affected communities, and other stakeholders have accurate and timely information about aspects that may have impact on them (IFC, 2007).

It is important that governments and companies in the extractive industries recognize transparency and the need to enhance public financial management and accountability. It is also important to achieve this transparency in the context of respect for contracts and laws (Extractive Industries Transparency Initiative, 2005, Principles 5 and 6).

The benefits of using visual materials during communication and consultation (e.g., before and after photographs from other mines, photographs of monitoring and testing by scientists, line drawings and simple graphics) throughout the mine life cannot be overemphasized. (Figure 10-4).

**Figure 10-4: A notice board in a mining community in Ghana where materials are on permanent display. ARD monitoring results can be displayed in this way, and constantly updated to show progress**

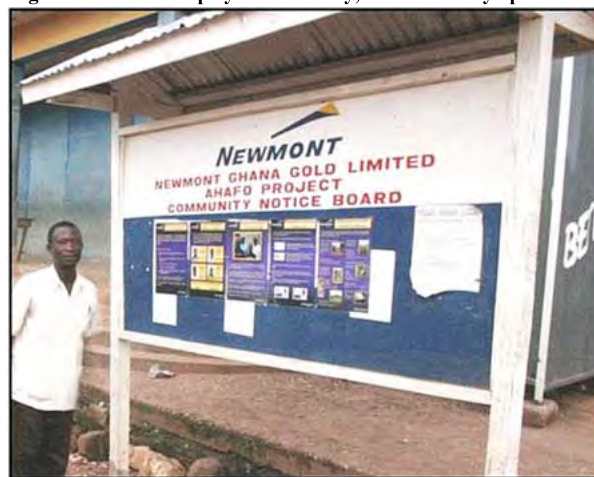

The crux of making information accessible to a wide range of people is to have a good mix of written, visual, and verbal information. Materials should be available in local languages and complex concepts. For example, ARD should be explained in simple lay person's language. When explaining complicated concepts to lay people, use the words that will be understood and not the words you would use when talking to a colleague.

Complex technical documents, such as environmental and social impact reports, should be summarized, simplified, and translated, and also visually displayed. Before and after photographs from elsewhere in the world illustrating how rehabilitation, including cleanup of ARD, was done, are very useful in assisting stakeholders to comprehend that impacts can be mitigated. Many mine communities do not have access to the Internet and some communities do not have telephone or postal services. Therefore, materials should also be available as hard copies. Local methods of disseminating information within stakeholder groups should be used. Site visits are also a good method of increasing understanding and information dissemination.

#### 10.6.5 Ongoing Feedback and Acknowledgment

Keep thorough records of meetings held, who attended, what was discussed, undertakings given, materials distributed, and grievances received and dealt with. It is important to record the results of consultation, consolidate the issues, questions, and views of all stakeholders into a comments/issues and response report. It is a good idea to categorize this report into groups of issues and, where ARD is an issue, dedicate a category specifically to ARD. Also, conduct an evaluation from time to time of how stakeholders experienced the consultation process pertaining to

##### Evaluating a consultation process – typical questions to ask

The number of people that attended meetings is not an indication of a successful consultation process. Success depends on how stakeholders experienced the process. Typical questions to ask include:

- Was the information we provided easy for you to understand?

ARD. This evaluation can be done in a number of formal or informal ways. What is important is that the evaluation should be outcome-based. Include these data into any reporting done. If the results of the evaluation were not good, do not hide it, but list points for improvement and commit to deal with the poor results.

People want to feel like they are being heard; if people feel like they are not being acknowledged, they lose interest or start mistrusting the process. Consulting people entails an implicit “promise” that, at a minimum, their views will be considered during the decision-making process. It also means taking feedback received during the consultation process seriously and making best efforts to address issues raised through changes (e.g., to project design or proposed mitigation measures). In the case of an ARD issue arising and a process being launched to evaluate different options of resolving the problem, stakeholders want to know what happened to their suggestions, they require feedback on the option selected and ongoing feedback of monitoring results. Feedback can be provided in various written, visual, and verbal ways.

- Did you find the information useful?
- Did you learn something new?
- Did you get the impression that we valued your inputs?
- Did you receive sufficient feedback?
- Do you feel that we have honoured the commitments that we made?

For each question, add a “why.” Responses will provide the mine with direction on how to improve its process.

In addition, the Social and Environmental Assessment and Management Systems Standard of the IFC Performance Standards on Social and Environmental Sustainability (IFC, 2006b) contains a component on ‘community engagement’, together with a number of indicators for ascertaining free, prior and informed consultation which could be used in the evaluation.

### 10.6.6 Dispute Management and Resolution

Ideally, methods of addressing disagreements and disputes should be in place from the early stages of the project (usually the beginning of the social and environmental assessment process for the proposed mine). Addressing disagreements and dispute should be done throughout construction and operations to the end of project life. Processes might be established by government laws, regulations, permits, or established by the company and in cases of some informal processes might be established by the local community. Mechanisms of resolving disagreements and disputes should be known by all stakeholders. Such mechanisms should be applicable to addressing issues that may arise related to ARD.

As with the broader process of stakeholder engagement, mine and project management should stay informed and involved in issues as they develop so that decisive action can be taken when needed to avoid escalation of disputes. IFC (2007) lists points worth considering when setting up a mechanism for addressing disputes and disagreements.

### 10.6.7 The Principles of Risk Communication

When mine personnel communicate about ARD, the communicating is about risk. More than three decades of research and hundreds of articles published in scientific journals underpin the science of risk communication (Covello, 1998). Sandman (1986) states that “The most common sources of risk information are people who are professionally inclined to ignore feelings. And how do people respond when their feelings are ignored? They escalate — yell louder, cry harder, listen less — which in turn stiffens the experts, which further provokes the audience. The inevitable result is the classic drama of stereotypes in conflict: the cold scientist or bureaucrat versus the hysterical citizen.”

Mine personnel that have contact with stakeholders and neighbours can reduce the mine’s social risk by becoming familiar with and applying the basic principles of risk communication. Some ways of reducing social risk are listed below:

- Understand that the risks that could kill people and the risks that upset people are often completely different (Covello, 1998).
- Do not use the Decide, Announce, Defend (DAD) Model: Leave room for dialogue and resolving disputes before decisions are implemented (Covello, 1998).
- Express caring, empathy and commitment, respond humanely, and show respect. Do not trivialize people’s feelings. These attributes account for over 50 percent of trust in high-concern situations. When people are worried and upset, they don’t care what you know until they know that you care. People often decide if a person is caring within 9 seconds (Covello, 1998).
- Adapt to the fact that some people might use health, safety, and environmental risks as a proxy or surrogate for other social, political, or economic concerns (Covello, 1998). Assist them to express their unspoken but real concerns. For example, nearby neighbours may claim compensation for ARD-polluted water, but their real concern may be that a nearby community received more “benefits” from the mine than they did. To enter into an endless argument about whether or not the water is polluted will be futile. Personally and patiently explaining the criteria for distribution of benefits may resolve the issue.
- Do not use complex technical language to communicate information about risks. (Covello, 1998). Keep the language appropriate to the audience and the topic of discussion.
- Coordinate and collaborate with other credible sources (USEPA, 1988). If ARD is perceived to be a risk or hazard by stakeholders, enable and support the stakeholders to compare water quality variables to international standards and guidelines. Indicate which international bodies have research or other programs in place and also indicate that the company will work with those to ensure the latest technology and best practice is brought to bear on the problem.
- Avoid negative public relations techniques such as stonewalling, smoke-screening, whitewashing, and blaming someone else (Susskind and Field, 1996).
- Let go of some control. Allow stakeholders to select the dates and times of meetings, to indicate the language of their choice, to indicate by what methods they would like to receive their information, to assist in listing criteria for making choices, and to assist in exploring alternatives (Greyling, 1999). Lay people “undeterred by conventional expert wisdom, often have good ideas that experts can adapt to the situation at hand; at a minimum,

lay people are the experts on what frightens them and what would reassure them” (Sandman, 1986).

## 10.7 Responsibilities of Regulators

In some countries, regulators have the responsibility for conducting consultation before making decisions such as granting exploration permits, environmental permits, or approving an ARD rehabilitation plan or an ARD management plan.

In many countries’ laws, this responsibility includes regulators placing an advertisement in a local newspaper and convening a public hearing (or public meeting). If no or little communication and consultation preceded this, and no relationship exists between the mining company and its stakeholders, such a public gathering could be catastrophic. This would place the regulator in a difficult position to authorize a permit for an activity, even if the activity had technical and economic merit and was environmentally acceptable.

Mine companies are, therefore, advised to share responsibilities with government for disclosure and consultation (IFC, 2007). Below are examples of recommended approaches:

- Assign a dedicated member of personnel (usually the environmental manager) to identify the appropriate contact person (or persons) and an alternate for each relevant regulator at all spheres of government with whom to establish a relationship. Meet with the contact person regularly, both formally and informally.
- In regard to ARD, bear in mind that while government officials may have tertiary qualifications, these qualifications may be in disciplines totally different from geochemistry, water quality, or mine design. Make special efforts to explain ARD in simpler terms and support their capacity building. More general information on metal leaching and ARD, such as that produced by the BC Ministry of Energy Mines and Petroleum Resources (2006), might be helpful.
- Take regulators to on-site visits to the mine and processing plant, and assist them to fully understand the mining process and activities that could cause ARD.
- At times, bring different regulators together to assist in coordination.
- Keep regulators fully informed of communication and consultation initiatives by the mining company and ensure that regulators receive all materials intended for external audiences, including materials related to ARD. If important meetings are to be held with stakeholders, invite regulators in advance and, if necessary, schedule the meetings for a time and date that suits regulators.
- If regulators have responsibility for convening public hearings, offer to assist to convene and record the meeting, offer to develop relevant materials and visual displays, and offer to distribute materials in advance. Ensure, however, that the regulator is still the convenor. Communicate also to the regulator that the mine would be conducting its own consultation process in advance.
- Assist regulators by consolidating the issues, questions, and views of stakeholders into a single report, with responses to each issue (commonly referred to as a comments/issues and response report) issues log, or issues tracking register. Such a consolidated record will portray a wide range of views and will demonstrate that the views of extreme critics are not representative of the larger majority (IFC, 2006a).

In some countries, government may discourage public involvement in decisions. This discouragement places the mining company and NGOs in a difficult position. An innovative solution may be needed for such scenarios that respects government needs but still provides some information and opportunity for consultation with stakeholders. Building capacity of government officials regarding the trust and respect they will gain from consulting with stakeholders is beneficial and leads to better decisions without undermining a government official’s mandate.

## 10.8 Guidelines for Acid Rock Drainage Reporting

It is important to have transparent and accurate internal and external reporting by mining companies (and this should include reporting on ARD) because transparent reporting contributes to improved practice, may be a requirement by lenders or regulatory authorities, and, more broadly, builds credibility with stakeholders.

Aspects that might be addressed in the ARD report are as follows:

- The risk (likelihood and consequence) of ARD from mine components such as waste facilities, mine workings and stockpiles, typically based on the inherent ARD characteristics of the materials mined and managed
- Results of monitoring before construction and operation, compared to results of monitoring during construction and operation and to regional or country requirements or international guidelines relevant to the project (Reporting on the results of monitoring by external, independent monitors is particularly useful for establishing credibility.)
- Any significant commitments made to regulators and stakeholders and progress with these commitments (In particular, publicize any material changes to commitments or implementation actions that vary from publicly disclosed documents. [IFC, 2007])
- Any significant ARD issues that arise during operations, steps to address the issue, steps to rehabilitate any contamination, disclosure of the situation and consultation with stakeholders, and any modifications required to the mine’s closure plan as a result
- After closure, reporting on implementation of the mine’s closure plan, including success in mitigating ARD and monitoring results over time

ARD issues, management plans, and performance could be integrated into overall corporate or specific mine site health safety environment and community (HSEC) plan or sustainability reports (see, for example, Placer Dome, 2005). ARD management is usually only one of several environmental issues a company or site is addressing, and stakeholders appreciate a full analysis and accounting of environmental performance.



All the mine's stakeholders, including regulators, local communities, project-affected people, the media, and the mine's shareholders should be included in the reporting process. Reporting by text in fairly simple language, with ample use of photographs, is more effective than merely presenting performance tables.

More frequent reporting may be required where a significant ARD issue has arisen. This could be done in a number of ways: at meetings with stakeholders, at an annual environmental report-back meeting and site visit, at meetings of the mine's monitoring forum (if this has been established), in written materials, and in the media. Earley and Staub (2006) report that at a Santa Cruz mine site an extensive database of monitoring results was compiled. Various publications, including memos and brochures, were produced for internal and external communication among the workers at the sites; by state, local, and federal government representatives; by regulators and by the public. Such materials could also be placed on community notice boards.

## 10.9 References

Account\_Ability, United Nations Environment Programme, Stakeholder Research Associates Canada Inc., 2005. The Practitioner's Handbook on Stakeholder Engagement.

<http://www.accountability.org.uk>

<http://www.StakeholderResearch.com>

<http://www.uneptie.org>

Anon., 1998. Aarhus Convention on Public Participation. <http://www.unece.org/env/pp/welcome.html>

Australian Heritage Commission, 2002. Ask First: A guide to respecting Indigenous heritage places and values.

<http://www.environment.gov.au/heritage/ahc/publications/commission/books/ask-first.html>

British Columbia (BC) Ministry of Mines and Petroleum Resources, 2006. General Information and Metal Leaching and Acid Rock Drainage.

<http://www.em.gov.bc.ca>

Chamber of Mines of South Africa, 2002. Public participation guidelines for stakeholders in the mining industry, First Edition. Consultative Forum on Mining and the Environment, Chamber of Mines of South Africa, Marshalltown, South Africa. <http://www.bullion.org.za>

Covello, V. T., 1998. Risk and Trust in Communications. International Council on Metals and the Environment (ICME) Newsletter, Centre for Risk Communications, New York, NY.

Earley III, D., and M.W. Staub, 2006. Sustainable Mining Best Practices and Certification. In: R.I. Barnhisel (Ed.), Poster paper 7th International Conference on Acid Rock Drainage (ICARD), March 26-30, St. Louis, MO, American Society of Mining and Reclamation (ASMR), Lexington, KY.

Equator Principles, <http://www.equator-principles.com>

Extractive Industries Transparency Initiative, 2005. <http://eitransparency.org>

Greyling, T., 1999. Towards environmental dispute resolution: appropriate public participation. In: Proceedings of a Conference on Environmental Dispute Resolution, June, Fourways, South Africa.

International Association for Public Participation (IAP2), 2002. Public Participation – critical for sustainable development. IAP2 submission to the World Summit on Sustainable Development. <http://www.iap2.org>

International Association for Public Participation (IAP2a), 2006a. Spectrum of Public Participation. <http://www.iap2.org>

International Association for Public Participation (IAP2), 2006b. Planning for Effective Public Participation. IAP2 Certificate Training Course Module 1.

International Association for Public Participation (IAP2), 2006c. IAP2 Public Participation Toolbox. <http://www.iap2.org>

International Council on Mining & Metals (ICMM), 2003. Sustainable Development Principals. <http://www.icmm.com/our-work/sustainable-development-framework/10-principles>

International Finance Corporation (IFC), 1998. Good Practice Manual, Doing Better Business through Effective Public Consultation and Disclosure.

International Finance Corporation (IFC), 2006a. The BTC Pipeline Project: Lessons of Experience.

International Finance Corporation (IFC), 2006b. Performance Standards on Social and Environmental Sustainability. <http://www.ifc.org/enviro>

International Finance Corporation (IFC), 2007. Stakeholder Engagement. A good practice handbook for companies doing business in emerging markets. <http://www.ifc.org>

International Labour Organization (ILO), 1989. ILO Convention 169 on Indigenous and Tribal Peoples. <http://www.ilo.org>

Australian Government Department of Industry, Tourism and Resources, 2007. Working with Indigenous Communities. Leading Practice Sustainable Development Program, DITR, Canberra. <http://www.ret.gov.au/sdmining>

Minerals Council of Australia (MCA), 2005. Enduring Value: The Australian Minerals Industry Framework for Sustainable Development. <http://www.minerals.org.au>

National Orphaned/Abandoned Mines Initiative (NOAMI), 2003. Best Practices in Community Involvement: Planning For and Rehabilitating Abandoned and Orphaned Mines in Canada. <http://www.abandoned-mines.org>

Placer Dome, 2005. Sustainability report. Canadian Operations, Placer Dome, Toronto, ON.

Sandman, P.M., 1986. Explaining Environmental Risk: Dealing with the public. TSCA Assistance Office, Office of Toxic Substances, U.S. EPA, November, 14-25.

Susskind, L. and P. Field, 1996. Dealing with an Angry Public - The Mutual Gains Approach to Resolving Disputes. MIT Harvard.

World Bank, 2004. Social Development Notes. Conflict prevention and reconstruction. Redefining corporate social risk mitigation strategies. No. 16.

U.S. Environmental Protection Agency (USEPA), 1988. Seven Cardinal Rules of Risk Communication. Pamphlet drafted by Vincent T. Covello and Frederick H. Allen, OPA-87-020, April, Washington, DC.

Zandvliet, L., 2007. CDA Collaborative Learning Projects.

## List of Tables

Table 10-1: Assessment Tool: Indicators of Negative Engagement with Stakeholders

Table 10-2: Sources with More Information on Principles, Approaches, and Techniques for Communication and Consultation with Stakeholders

[Top of this page](#)

## List of Figures

Figure 10-1: Chapter 10 Layout/Road Map

Figure 10-2: Types of stakeholder engagement and the intensity with which people are engaged (IFC, 2007). Engagement with stakeholders about an ARD situation under different scenarios is indicated on the figure

Figure 10-3: IAP2's Public Participation Spectrum

Figure 10-4: A notice board in a mining community in Ghana where materials are on permanent display. ARD monitoring results can be displayed in this way, and constantly updated to show progress



# General Information on Metal Leaching and Acid Rock Drainage

From GARDGuide

## Contents

- 1 FROM: BC Ministry of Energy, Mines & Petroleum Resources
- 2 What is Metal Leaching and Acid Rock Drainage?
- 3 Why is ML/ARD Significant?
- 4 How Can the Effects of ML/ARD be Mitigated?
- 5 Avoidance
- 6 Flooding of Mine Waste Materials
- 7 Covers
- 8 Blending of Materials
- 9 Drainage Treatment
- 10 How is ML/ARD regulated in British Columbia?
- 11 Additional References

*FROM: BC Ministry of Energy, Mines & Petroleum Resources*

## What is Metal Leaching and Acid Rock Drainage?

- Metal leaching and acid rock drainage are naturally occurring processes that are caused when minerals containing metals and sulphur (called sulphides) come in contact with both air and water.
- When sulphides are exposed to water and the oxygen from air, they react (or oxidize). This oxidizing of sulphides can also produce acid. If this acid is carried by streams or other natural watercourses it is called acid rock drainage (ARD).
- The acid in ARD can leach metals from surrounding rocks causing drainage that has high amounts of dissolved metals (such as iron, aluminum, copper, lead, silver, zinc). This is called metal leaching (ML). Other metals can also be leached from react in non-acidic drainage (such as selenium, zinc, molybdenum, nickel, arsenic and antimony).
- Not all rocks that contain sulphide minerals will become acid generating. It depends on the

amount of neutralizing minerals and materials (such as limestone) that are present in the rocks. If there is balance, or if there is an excess of neutralizing minerals, the rocks may not generate metal leaching and add rock drainage (ML/ARD). If there is excess sulphide minerals, then ML/ARD will typically develop after all of the neutralizing minerals have dissolved. This can result in a significant time delay to the development of ML/ARD in rocks.

- The rocks at most metal and some coal mines contain high amounts of sulphide minerals. The excavating and crushing of ores during mining greatly increases the amount of rock surfaces that can be exposed to oxygen and water. Therefore mining activities can have a high potential for leaching acid and metals.
- ML/ARD can occur from sulphide bearing mining wastes or from open pit or underground mine surfaces. Mining wastes often include mineralized rock that is not of ore grade (called waste rock) and tailings which is sand sized material left over from processing ore.
- Most mining operations leach metals to some degree. The potential for environmental impacts depends on many factors including the amount of metals in the mine drainage, the amount of acid-neutralizing ability in nearby rocks and water, the amount of dilution available in streams and how sensitive the receiving environment is.
- Mining is not the only industry that can cause ML/ARD. Forestry, road construction and other industrial activities that dig up sulphide bearing rocks have caused significant ML/ARD. For example, the Halifax airport had a major problem with ARD when it constructed a new runway in sulphide bearing rocks.

## **Why is ML/ARD Significant?**

- ML/ARD can have significant negative impacts on the environment if not adequately managed. High levels of metals and/or acid can be harmful or toxic to living organisms. Metals that are absorbed by plant and animal tissue can also be passed through the food chain.
- Once ML/ARD has been initiated it can persist for hundreds of years until the sulphides are completely oxidized and the acid and metals are leached from the rocks.
- Historical mining practices did not recognize or manage ML/ARD. A number of older mines in BC (e.g., Britannia and Mt. Washington) have caused significant environmental impacts due to ML/ARD.
- ML/ARD can be very expensive to manage once it has developed. For example, in British Columbia water treatment plants to treat ML/ARD have cost more than \$10 million to put in place and have had operating costs of up to \$1.5 million per year. Other management strategies can also be very expensive.
- ML/ARD associated with mining activities is a globally significant issue. There are several organizations world-wide that are dedicated to improving mining practices and developing new technologies to reduce the environmental effects and liabilities associated with ML/ARD.

## How Can the Effects of ML/ARD be Mitigated?

- Proper planning of new mining developments can reduce the risks, liabilities and the costs associated with ML/ARD.
- Testing of the chemistry of the rocks before they are mined can predict whether ML/ARD will be an issue that needs to be prevented or managed. If the potential for leaching of acid and metals is identified through testwork, there are number of strategies that can be used to prevent and manage ML/ARD.
- Each mitigation strategy has strengths and weaknesses and not all strategies are applicable for all mine sites and their environments. Each strategy also has unique monitoring and maintenance needs.
- Many management strategies rely on preventing oxygen contact with sulphide minerals or reducing the amount of water that comes in contact with ARD generating wastes to minimize the amount of leaching that occurs. The sulphide minerals can stay in the rocks for hundreds of years, so mitigation strategies must often be designed to last forever.
- Often mines use a combination of different strategies to ensure environmental protection. Sometimes additional measures are provided for back-up or contingency safeguards.
- Mine sites and their environments are dynamic and continue to change after mining is finished. For example, changes can occur to water movement to a mine through climate variations and non-mining water users. Changes can also happen to the ecology of a mine site as nature reestablishes itself, and to the chemistry of the site from a variety of factors. These changes can significantly influence the effectiveness of mitigation strategies over time.
- Many ML/ARD mitigation technologies are relatively new and have performance uncertainties and limited performance histories.
- Due to changes that can happen after mining and uncertainties with the performance of many mitigation technologies, regular monitoring, maintenance and responsive management are key to long-term success in preventing impacts from ML/ARD.
- The main mitigation strategies that are used to prevent and manage ML/ARD are avoidance, flooding, covers, blending, and drainage treatment.

## Avoidance

- Sometimes it is possible to avoid mining some, or all, of the sulphide bearing rocks that could generate ML/ARD problems. If this is not practical, then other mitigation strategies may be needed to ensure protection of the environment.

## **Flooding of Mine Waste Materials**

- Flooding sulphide bearing mining wastes with water limits their contact with oxygen and effectively prevents the formation of ARD.
- Flooding can be done behind a constructed dam, in old mine pits or underground workings or in natural water bodies such as ponds or lakes.
- The timing that flooding occurs is important. Mine wastes should be flooded before they become acid generating or metal leaching, otherwise some metals and acid will dissolve into the water and this will have to be managed.
- Although flooding can effectively prevent sulphide oxidation and the acid generation process, there can sometimes be residual metal leaching issues. One way that this can be prevented is by isolating the mining wastes from the overlying water by placing a barrier of clean rock or other material.
- Flooding has to be maintained in the mine wastes at all times, even during extreme climatic conditions (dry and wet). The flooding of sulphide bearing mine waste behind dam structures also leaves a legacy which requires long-term inspection, monitoring and maintenance to ensure that they last forever.
- Flooding of mine wastes is the most common mitigation strategy used at newer mines. Flooding has been used successfully at many mines in BC including Equity Silver, Eskay Creek, Goldstream, Huckleberry, Island Copper, Johnny Mountain, Kemess South, Mount Polley, Myra Falls, Premier, QR Gold, Samatosum, and Snip.

## **Covers**

- Covering mining wastes can limit the amount of oxygen and/or water that reaches the wastes. This can decrease the amount of drainage from the wastes and the quantity of acid and metals in the drainage that has to be managed.
- Covers can be simple (such as one made of soil or glacial till) or complex engineered systems.
- Although covers can reduce the quantity and severity of ML/ARD, they are susceptible to break down over time from wind and water erosion, cracking, burrowing by animals, and plant roots.
- Soil covers are also used at most mines to re-establish plant growth at the end of mining.
- Covers to mitigate ML/ARD have been used with varying degrees of success at several BC mines including Cirque, Equity Silver, Gibraltar, Myra Falls and Sullivan.

## **Blending of Materials**

- Mining wastes that have the potential to generate ARD can be mixed with materials that have acid-neutralizing qualities, such as limestone or other mine waste materials.
- Although blending is a potentially effective mitigation strategy, it can be very difficult to get enough mixing to prevent all acid generation and there can sometimes be residual metal

leaching that occurs.

- Blending is generally more successful for small volumes of mining wastes and/or wastes that have low amounts of sulphide minerals.
- Blending has been used at several BC mines with varying degrees of success including Elk, Samatosum, Quinsam and Quintette.

## **Drainage Treatment**

- Mine water that contains leached acid and metals can be treated in water treatment plants. Lime is used to neutralize the acid and precipitate out the metals. Other chemicals are used to treat drainage with non-acidic metal leaching.
- Drainage treatment does not prevent ML/ARD. Mine lands that have ML/ARD and treatment plants generally have on-site environmental impacts and the land cannot be used for other purposes. Treatment must go on for as long as the drainage is impacted by leached acid and metals, often for centuries.
- The treatment process usually produces large amounts of other wastes (called sludge) which have to be stored and managed to make sure they do not release metals in the future.
- Water treatment is very expensive and requires a lot of resources to maintain. The mine operator must exercise great care and watchfulness, often for hundreds of years.
- Drainage treatment plants can reliably produce acceptable drainage and can be a very effective means of protecting the environment. However, due to its high costs and significant environmental impact it is usually viewed as the mitigation strategy of last resort.
- Drainage collection and treatment is the most common strategy used for managing ML/ARD at older mines. Water treatment is currently used at the Brenda, Equity Silver, Island Copper, Myra Falls, Nickel Plate, Premier, Samatosum and Sullivan mines.

## **How is ML/ARD regulated in British Columbia?**

- The challenge faced by the Ministry of Energy, Mines and Petroleum Resources is how to regulate mining and exploration activities in a way that supports the Provincial goal of sustainable resource development while ensuring the environment is protected, mining lands are reclaimed and the risk and environmental liabilities are minimized.
- The Provincial government's regulatory approach is guided by several over-riding principles:
  - A mining company has to demonstrate the ability and intent to operate a mine in a way that protects the environment.
  - Every mine and its environment are unique so mines are evaluated on a site-specific basis.
  - If significant disturbance of bedrock is proposed, then a ML/ARD assessment



program is required before mine approval. This program involves predicting the potential for ML/ARD from all mine materials, developing prevention/mitigation strategies, and outlining monitoring programs that will be used to assess the performance of proposed ML/ARD management strategies.

- Where there is a high degree of uncertainty or environmental risk involved, back-up plans are required.
- The prevention of ML/ARD is preferred. When ML/ARD cannot be prevented, mines are required to reduce the quantity and improve the quality of drainage to levels that protect the environment. An important secondary objective is to minimize the impacts to mining lands and mine site water courses that restrict their future productive use.
- The Ministry will exercise a cautious approach when the level of information or understanding is deficient.
- The Provincial government requires reasonable assurance that environmental risks will be minimized and that taxpayers are not going to have to pay for the costs of reclaiming mines and managing ML/ARD.
- The Ministry requires a financial security that covers the cost of reclaiming a mine and any ongoing costs for managing ML/ARD. This security is raised and lowered throughout the life of a mine to correspond to the level of land disturbance and the cost of reclamation and any mitigation.
- The Ministry uses the Mines Act and the Health Safety and Reclamation code to regulate mining. As well, the Ministry of Energy, Mines & Petroleum Resources and the Ministry of Environment have a joint policy on metal leaching and acid rock drainage at minesites in BC. The Ministry also has a guideline document for assessing and mitigating ML/ARD plus a manual of some ML/ARD prediction techniques.
- The available scientific tools, combined with a well-informed, cautious approach, should allow mines with the potential for ML/ARD to extract the province's mineral and coal resources, while protecting the environment and minimizing risks.

## **Additional References**

- Policy for Metal Leaching and Acid Rock Drainage at Minesites in British Columbia, Ministry of Energy and Mines and Ministry of Environment, Lands and Parks.  
<http://www.empr.gov.bc.ca/Mining/ProjectApprovals/MLandARD/Pages/Policy.aspx>
- Guidelines for Metal Leaching and Acid Rock Drainage at Minesites in British Columbia, Ministry of Energy and Mines.  
<http://www.empr.gov.bc.ca/Mining/ProjectApprovals/MLandARD/Pages/Guidelines.aspx>

Prepared by: Kim Bellefontaine  
Senior Mine Review Geologist  
Mining & Minerals Division

# Chapter 11

## From GARDGuide

### 11.0 ARD Management in the Future

#### 11.1 Introduction

##### 11.1.1 ARD through the Sustainable Development "Lens"

#### 11.2 ARD Research and Management – Today and Tomorrow

##### 11.2.1 History and Status of ARD Research and Management

##### 11.2.2 The Future of ARD Research and Management

#### 11.3 Stakeholder Roles

#### References

## 11.0 ARD Management in the Future

### 11.1 Introduction

This chapter briefly examines the current state and the future of ARD research and management. It begins with a discussion of the relevance and application of sustainable development to ARD management since, today and in the future, ARD management is viewed and managed through a sustainable development “lens”. The second section briefly examines the state of research and possible future developments in ARD science and engineering. The final section reviews the roles of the various stakeholders in advancing ARD science and management.

#### 11.1.1 ARD through the Sustainable Development "Lens"

With its potentially wide-ranging and multigenerational consequences, ARD is an important ‘sustainable development’ issue. It is helpful, therefore, to view ARD and its management through a sustainable development “lens”.

The goal of sustainable development was outlined in Chapter 1 of the Guide and is repeated here for ease of reference:

“to maximize the contribution to the well-being of the current generation in a way that ensures an equitable distribution of its costs and benefits, without reducing the potential for future generations to meet their own needs” (MMSD, 2002).

- In practice, sustainable development calls for an integrated, balanced, and responsible approach that accounts for short- and long-term environmental, social, economic, and governance considerations. Sustainable development is a shared responsibility, with governments, civil societies, community leaders, and mining operators all playing important roles.

Clean and available water is a fundamental global need for current and future generations. These resources are under increasing demand from growing populations and industrial use around the world. As ARD can affect water use for decades, the proactive and responsible care of this resource is a fundamental sustainability issue.

Few regulations specifically require ‘sustainable development’ (see Chapter 3). Yet, industry is increasingly utilizing the framework of sustainable development to inform business and operational decisions, largely driven by the need to protect its social license to operate. Most major mining companies have established their own, internal sustainable development (sometimes also termed sustainability or corporate responsibility) principles with their associated goals and targets. There are also industry-wide, external principles, such as those developed by the International Council on Mining & Metals (ICMM). In addition, International Finance Corporation (IFC) guidelines and safeguard policies also drive much of the sustainable development considerations.

The text box below provides some sustainable development guidelines relevant to environmental and ARD management and the mining industry in general.

#### Sustainable development guidelines:

- IFC Guidelines for the Mining Sector. <http://www1.ifc.org/wps/wcm/connect/1f4dc28048855af4879cd76a6515bb18/Final%2B-%2BMining.pdf?MOD=AJPERES&id=1323153264157>
- MMSD publications, including strategies and tools for sustainable development at the global and regional levels. <http://pubs.iied.org/>
- Australia’s Leading Practice for Sustainable Development, including guides of ARD, mine closure, and mine rehabilitation. <http://www.ret.gov.au/Resources/Pages/Resources.aspx>

- Global Reporting Initiative (GRI) Minerals and Mining Sector supplement, which outlines sustainable development indicators most relevant to the mining industry. <http://www.globalreporting.org/>
- Equator Principles, applied by most financial institutions in reviewing applications for financing. <http://www.equator-principles.com/>

It is prudent to consult these internal and external principles and goals and interpret them in developing an ARD management plan.

Global standards, such as the ICMM Principles, are useful to help understand issues that need to be considered within the framework of sustainable development. However, applications of these principles, especially within the context of a mine site, are invariably local in nature. Local factors, such as the environmental and ecological characteristics, economic development, and cultural values, determine the degree of priority among issues that need to be considered and addressed.

In ARD management, sustainable development typically involves the mining company engaging stakeholders and finding optimal solutions that minimize risk, maximize benefits to multiple stakeholders, and manage trade-offs. Fundamentally, it is a matter of exercising socially responsible practices. Sustainable development requires looking for the solution from a whole society and a whole mine-life-cycle perspective and for the long-term. A sustainable development view favours prevention of ARD over mitigation and treatment. It also involves considering the long-term cost of ARD management in assessing the feasibility of a mine project or major expansion or modification, including the closure costs and post-closure site activities.

The relative importance of the different considerations for ARD is highly dependent on the local environmental as well as socioeconomic characteristics. Stakeholders' aspirations, priorities, and preference help shape the targets and parameters for ARD management planning. The planning timeframe, the level of acceptable risk, and range of possible financing mechanisms all depend to a large extent on stakeholders' views. On the other hand, engaging stakeholders also helps in identifying opportunities to address other needs and concerns within an integrated ARD management solution.

The costs and the benefits of ARD management occur to different stakeholders and at different timeframes. Left unmitigated, the impacts impose costs to the community-at-large, often for generations. A well-designed ARD management plan, on the other hand, while increasing near-term costs for the company, creates long-term benefits to the community, local government, and other stakeholders, and reduces risks to the environment. Recognizing realistically the nature of these costs over time, relative to the desired and anticipated benefits, is critical to the development of an acceptable solution.

Sustainable development practices, including broadening the ARD planning perspectives, incorporating stakeholder concerns, and communicating ARD management performance to stakeholders, might increase short-term costs to the mining company. However, they can provide considerable long-term benefits, including:

- Reducing the risk of business, closure costs, and operational interruptions
- Providing financial incentives in terms of reduced financing and insurance rates
- Staying ahead of regulatory requirements
- Protecting reputation and the social license to operate

Many aspects of sustainable development may not seem directly relevant to ARD management at first glance. However, some case histories in the industry have demonstrated the value of applying the broader perspective early in ARD planning. For example, at the Britannia Mine in British Columbia, Canada, including a geothermal energy system to extract ARD heat for a local utility, a recreational area, and a sustainable community around the site constitute part of an integrated ARD management solution that partially funds the ARD mitigation cost (Meech et al., 2006). Similarly, metal recovery activities (e.g., re-mining, processing wastes or metal recovery from ARD) might be implemented that benefit the company as well as the local community (e.g., Gusek and Clarke-Whistler, 2005). The examples illustrate how integrating environmental, social, and economic aspects can produce sustainable solutions that benefit all parties involved.

In summary, sustainable development provides a valuable "lens" to view ARD at a particular mine and to develop appropriate management plans that address both potential short and long-term issues.

## 11.2 ARD Research and Management - Today and Tomorrow

### 11.2.1 History and Status of ARD Research and Management

As described in the Guide, research and knowledge of ARD management has grown rapidly over the last 50 years and particularly over the last 20 years. In broad terms, some major advances may be summarized:

- 1950s - improved understanding of the causes of ARD, including the role of micro-organisms
- 1960s - development of early prediction techniques starting in the coal fields of the southeastern USA and in Canada
- 1970s - development of ARD prevention approaches, including segregation and selective handling of wastes and of water treatment systems
- 1980s - start of comprehensive research programs, development of water cover prevention technology, and improved national and global technology transfer and exchange
- 1990s - enhanced recognition of sustainability concepts, development of a comprehensive approach to ARD management and development of soil cover models and multiple layer and store and release covers
- 2000s - standard incorporation of sustainability principles, improved integration of ARD management into mine plans, and improved assessment of costs and implications for mine development.

Perhaps the greatest achievement over the last 50 years, however, is the increased awareness and comprehensive understanding of the ARD issue among

all stakeholders. With this foundation, the future of ARD research and management is promising.

### 11.2.2 The Future of ARD Research and Management

Future ARD research and management experience will bring further advances. Ultimately, the goal should be to implement characterization, prediction and prevention programs at all mines so that material levels of ARD and ML are not produced. Sulphide oxidation might not be stopped, but its effects could be reduced to insignificant levels. Many mines might achieve zero discharge of effluents through the application of water minimization, recycle, and technological innovation.

To achieve the ARD goal, advances must be made to address:

- Appropriate characterization and prediction programs that support effective ARD prevention and management in all geo-climatic environments
- Prevention and management plans that are fully integrated into mine plans as a normal course of doing business
- Costs of ARD management are fully assessed and incorporated into mine feasibility assessments including the full cost closure and post-closure scenarios for short and long term risks
- Permits and approvals reflect understanding and confidence in ARD management approaches and regulatory bodies have the capacity to apply regulations that are relevant to effective ARD management
- Liabilities associated with historic mines are reduced through cost-effective ARD mitigation, and where necessary by passive treatment
- Stakeholders fully understand the risks and management approaches to address ARD issues and have confidence in their success through verification of prediction and prevention approaches

Substantial progress is likely to be achieved towards this goal over the next 10 years through a combined effort of the mining industry, government agencies, financial institutions, universities, and other stakeholders. This GARD Guide is aimed at supporting such an effort by compiling global information and presenting it in a format that is accessible to all.

The following are some possible milestones:

- In 3 years – improved integration of ARD management into mine operations, effective evaluation and costing of ARD management in feasibility studies and effective exchange of case studies by the mining industry and government agencies
- In 5 years – a field verified, standardized approach to prediction and risk assessment and management, improved understanding of scale up of ARD prediction from lab to field and improved resource recovery (water and metals) technologies for ARD
- In 10 years – a field proven suite of prevention and mitigation tools to address multiple ARD problem sets in various geoclimatic locations

Specific research is needed to fill knowledge gaps, some of which are listed below. In many cases, the approaches and technologies are available and may be proven for particular mines or geo-climatic environments, but it may not be known if they are broadly applicable.

#### *Characterization and Prediction*

- Methods to scale-up laboratory prediction methods to full-scale mine facilities
- Prediction approaches for underground mines
- More long-term field verification of prediction programs
- Methods to predict drainage from waste rock dumps and tailing impoundments in arid environments
- Tests of the southeastern US coal field “rules of thumb” for prediction to coal mines in other geoclimatic regions
- Improved coupled models for predicting acid generation and metal dissolution and mobility in waste rock dumps
- Improved and more timely kinetic prediction methods for ARD and ML
- Improved guidelines on the interpretation of kinetic test results, including coal wastes

#### *Prevention and Mitigation*

- Improved prevention and mitigation techniques for pit walls and underground mines
- Development and demonstration of ARD passivation technologies
- Development of implementation guidelines for blending and layering of waste rock
- Understanding of the application and implementation of tailing paste and tailing-waste rock co-disposal
- Verification of performance and criteria for design and application of covers on waste rock dumps and tailing impoundments in various geo-climatic conditions
- Further field and long-term demonstration and case studies for all prevention and mitigation approaches

#### *Treatment*

- Cost-effective methods for sulphate removal
- Development of in-pit water treatment methods
- Methods to predict and evaluate the operating life of constructed wetlands and other passive treatment systems
- Passive systems for manganese removal
- Economic recovery of metals at relatively low concentrations from ARD
- Design approaches for wetland treatment of ARD from metal mines (i.e., wide range of metal parameters)

## ARD Management

- Demonstrated case studies of integrating ARD prevention into mine plans
- Improved and standardized approaches of risk assessment and management for ARD prevention and mitigation

### 11.3 Stakeholder Roles

Achieving the goal for ARD management outlined above will require participation of all stakeholders. Some of their roles are listed below:

- Mining industry – develop management systems and integrate ARD into mining plans, develop case studies, share on-site experience, and support research
- Regulatory agencies – develop improved methods of risk management, share case histories (especially for closed and abandoned mines), encourage communication between stakeholders and continue to search for means to address ARD from abandoned mines
- Financial institutions – incorporate guidance (such as the GARD Guide) and define expectations into their evaluation of financing requests by mining companies
- Multi-lateral organizations - incorporate guidance (such as the GARD Guide) into their documents and foster its implementation in developing countries
- Consulting community – apply best practice approaches in ARD prevention plans and share experience and knowledge
- Universities – focus applied research projects to fill ARD knowledge gaps, work closely with the mining industry and other stakeholders, and train new scientists and engineers in best practice
- NGOs – assist in assessing and communicating risk among stakeholders
- Communities – contribute to building case studies and long-term ARD management approaches as part of attaining and maintaining the social license to operate

INAP and the Global Alliance are dedicated to reducing liabilities associated with sulphide-bearing materials and will play their part in advancing best practice in ARD management. INAP will fulfill its role by promoting and facilitating ARD prevention and treatment through global networking, technology transfer and collaborative research. These activities will be achieved through peer reviews, workshops and conferences, leveraged research and policy development.

INAP believes that this GARD Guide will be a key element in expanding ARD prevention and treatment capacity in the mining industry and its numerous stakeholders. INAP is committed to making the Guide the premier global authority on ARD in prevention and treatment and a “resource of choice” on ARD best practice.

To achieve this, the Guide needs to continue to evolve and improve. The current version represents only an initial step. Participation of all stakeholders is key. INAP and its member companies will continue to be actively engaged in regular reviews of the Guide and will ensure that all of its technical innovations on ARD that are not confidential are included in the Guide.

INAP encourages all readers of this Guide to provide input through the Wiki or to contact INAP or the Global Alliance.

## References

Global Environmental Management Initiative (GEMI), 2007. Metrics Navigator.  
<http://www.gemi.org/metricsnavigator>

International Council of Mining & Metals (ICMM), 2003. 10 Principles for sustainable development performance.  
<http://www.icmm.com/our-work/sustainable-development-framework/10-principles>

Gusek, J., and K. Clarke-Whistler, 2005. Where does the recovery of metal resources from passive treatment systems fit in sustainable development initiatives associated with large mining projects. Annual Meeting of the American Society for Mining and Reclamation, June 19-24, Breckenridge, CO.

Leading Practice Sustainable Development Program (LPSDP), 2007. Managing acid and metalliferous drainage. Canberra: Australian Government Department of Industry Tourism and Resources.

Meech, J.A., McPhie, M., Clausen, K., Simpson, Y., Lang, B., Campbell, E., Johnstone, S., and P. Condon, 2006. Transformation of a derelict mine site into a sustainable community: the Britannia project. *Journal of Cleaner Production*, 14:349.

# Acronyms

## From GARDGuide

### ACRONYMS

<b>Acronym/ Abbreviation</b>	<b>Definition</b>
ABA	acid base accounting
ACG	Australian Centre for Geomechanics
ACMER	Australian Centre for Mining Environmental Research
ADTI	Acid Drainage Technology Initiative
Ag	silver
Al	aluminum
ALD	anoxic limestone drain
AMD	acid mine drainage, acid and metalliferous drainage (Australia)
ANC	acid neutralizing capacity
ANFO	ammonium nitrate fuel oil

ANZECC	Australian and New Zealand Environmental and Conservation Council
AP	acid (generation) potential
APHA	American Public Health Association
AWWA	American Water Works Association
ARD	acid rock drainage
ARMCANZ	Agriculture and Resource Management Council of Australia and New Zealand
As	arsenic
AS	Australian Standards
ASTM	American Standards for Testing and Materials
Au	gold
AVIRIS	airborne visible/infrared imaging spectrometer
AVS	acid volatile sulphide
BA	before-after
BACI	before-after-control-impact

BAT	best available technology
BCAMDTF	British Columbia Acid Mine Drainage Task Force
BC MEND	British Columbia Mine Environmental Neutral Drainage
BC MEMPR	British Columbia Ministry of Energy, Mines and Petroleum Resources
BCR	biochemical reactor
BIF	banded iron formation
BLM	Biotic Ligand Model
BMF	biomagnification factor
BREF	best available reference
Ca	calcium
CaCO <sub>3</sub>	calcium carbonate
CA	cluster analysis
CANMET	Canada Centre for Mineral and Energy Technology
CBR	contaminant body residue



CCBE	cover with capillary barrier effect
Cd	cadmium
CEN	Comité Européen de Normalisation
CESR	cost effective sulphate removal
CI	control-impact
Co	cobalt
COI	constituent of interest
COPC	contaminant of potential concern
CPE	chlorinated polyethylene
Cr	chromium
CSIR	Council for Scientific and Industrial Research
CSM	conceptual site model
Cu	copper
DAD	decide, announce, defend
DEM	digital elevation model

DIAND	Department of Indian Affairs and Northern Development
DQO	data quality objective
DSM	dynamic system model
DWAF	Department of Water Affairs and Forestry
EA	environmental assessment
EC	European Commission
EC	electrical conductivity/electrical conductance
EDR	electrodialysis reversal
EIA	environmental impact assessment
EIS	environmental impact study
EMP	environmental management plan
EMS	environmental management system
ERA	environmental risk assessment
ESIA	environmental and social impact assessment

EU	European Union
F	fluoride
FA	factor analysis
Fe	iron
FIDIC	International Federation of Consulting Engineers
FLT	field leaching test
FMEA	failure mode and effects analysis
FS	feasibility study
GARD Guide	Global Acid Rock Drainage Guide
GB	Guobiao Standard (China National Standard)
GCL	geosynthetic clay liner
GIS	geographic information system
GPS	global positioning system
GRI	Global Reporting Initiative
ha	hectare

HCT	humidity cell test
HDPE	high density polyethylene
HDS	high density sludge
HHRA	human health risk assessment
HSEC	health, safety, environment, and community
IAP2	International Association for Public Participation
ICARD	International Conference on Acid Rock Drainage
ICMI	International Cyanide Management Institute
ICMM	International Council of Mining and Metals
ICP-MS	inductively coupled plasma-mass spectrometry
ILO	International Labour Organization
IMPI	integrated and managed passive treatment
IMWA	International Mine Water Association
INAP	International Network for Acid Prevention
IOR	intrinsic oxidation rate

IPPC	Integrated Pollution Prevention and Control
IFC	International Finance Corporation
ISO	International Standards Organization
kg	kilogram
KPCS	Kimberley Process Certification Scheme
KPI	key performance indicator
LLDPE	linear low density polyethylene
LOE	line of evidence
MAA	multiple accounts analysis
MAC	Mining Association of Canada
MCA	Minerals Council of Australia
MEND	Mine Environmental Neutral Drainage (Initiative)
Mg	magnesium
mg/kg	milligrams per kilogram

mg/L	milligrams per liter
MIW	mining influenced water
ML	metal leaching
µm	micrometer
mm	millimeter
M&M	management and maintenance
MMER	Metal Mining Effluent Regulations
MMSD	Minerals, Mining, and Sustainable Development (project)
Mn	manganese
MP	management plan
MRG	metal-rich granules
MSF	metal sensitive fractions
MVT	Mississippi Valley Type
MWMP	Meteoric Water Mobility Procedure
NAG	net acid generation (test method) or non-acid generating

NAPP	net acid producing potential
NASA	National Aeronautics and Space Administration
NBR	Norma Brasileira Registrada
NCV	net carbonate value
NEPC	National Environmental Protection Council
NF	nano-filtration
NGO	non-governmental organization
Ni	nickel
NMD	neutral mine drainage
NNP	net neutralization potential
NOAMI	National Orphaned/Abandoned Mines Initiative
NP	neutralization potential
NPR	net potential ratio
NPV	net present value

NRCan	Natural Resources Canada
NZS	New Zealand Standards
O&M	operation and maintenance
OLD	open limestone drain
OSM	Office of Surface Mining
PaDEP	Pennsylvania Department of Environmental Protection
PADRE	Partnership for Acid Drainage Remediation in Europe
PAG	potentially acid generating
Pb	lead
PCA	principal component analysis
PD	probability distribution
PDCP	public consultation and disclosure plan
PDF	probability density function
PE	polyethylene
PPA	potential problem assessment



PVC	polyvinyl chloride
QA	quality assurance
QAPP	quality assurance project plan
QC	quality control
RAPS	reducing and alkalinity producing system
redox	reduction oxidation
RMA	Resource Management Act
RMP	risk management plan
RO	reverse osmosis
ROPC	receptor of potential concern
RQD	rock quality designation
S	sulphur
SAP	sampling and analysis plan
SAPS	successive alkalinity producing system

Sb	antimony
SD	saline drainage
Se	selenium
SEM	scanning electron microscope
SOP	standard operating procedure
SPARRO	slurry precipitation and recycle reverse osmosis
SPLP	Synthetic Precipitation Leaching Procedure
SRB	sulphate-reducing bacteria
SSD	species sensitivity distribution
SWCC	soil water characteristic curve
SQG	Sediment Quality Guideline
SUNY	State University of New York
TAM	trophically available metal
TCLP	Toxicity Characteristic Leaching Procedure
TDR	time-domain reflectometry

TDS	total dissolved solids
TIC	total inorganic carbon
TIE	toxicity identification evaluation
TOC	total organic carbon
TRC	tissue residue criterion/criteria
TSF	tailings storage facility
U	uranium
UNEP	United Nations Environment Programme
US	United States
USA	United States of America
USEPA	United States Environmental Protection Agency
USGS	United States Geological Survey
VEC	valued ecosystem component
VFA	volatile fatty acids

VMS	volcanogenic massive sulphide
WAD	weak acid dissociable
WEF	Water Environment Federation
WET	Waste Extraction Test
WHO	World Health Organization
WQ	water quality
WQG	water quality guideline
WOE	weight of evidence
WRC	Water Research Commission
XRD	X-ray diffraction
Zn	zinc



# Glossary

## From GARDGuide

### GLOSSARY

This glossary includes terms that can be found in this GARD Guide. All definitions are common scientific usage.

Use your **browser Edit/Find function** to search for terms on this page.

**abandoned mine** - Excavations, structures, or equipment remaining from a former mining operation that, for all practical purposes, have been deserted while no intent of further mining is evident. An assumption of "abandoned" may be incorrect if an owner still exists, even if the owner has not performed any activity at the location for a long period, in which case the mine may be "inactive."

**acid-base accounting (ABA)** - An analytical technique applied to mine wastes and geologic materials that determines the potential acidity from sulfur analysis versus the neutralization potential. It is used to predict the potential of that material to be acid producing or acid neutralizing.

**acid generating** - Refers to ore and mine wastes that contain sulfur or sulfides, which produce acid when oxidized. Acid can also be present as acid sulfates or generated by their weathering, produced originally from oxidation of sulfides.

**acid potential (AP)** - The ability of a rock or geologic material to produce acid leachates; may also be referred to as acid generation potential or AGP.

**acid rain** - Term referring to the deposition of a mixture of wet (rain, snow, sleet, fog, dew) and dry (acidifying particles and gases) acidic components.

**acid rock drainage (ARD)** - A low pH, metal-laden, sulfate-rich drainage that occurs during land disturbance where sulfur or metal sulfides are exposed to atmospheric conditions. It forms under natural conditions from the oxidation of sulfide minerals and where the acidity exceeds the alkalinity. Non-mining exposures, such as along highway road cuts, may produce similar drainage. Also known as **acid mine drainage (AMD)** when it originates from mining areas.

**acidity** - The titratable acid as measured in accordance with standard methods. It is normally reported as milligrams per liter as calcium carbonate (CaCO<sub>3</sub>),.

**acidophile** - Inorganic substance or living organism (or part thereof) that favors acidic conditions or acids.

**active treatment systems** - Systems that treat drainage with active addition of chemical reagents or the application of external energy.

**advection** - Refers to processes of transport and mixing of properties (energy, heat, moisture, etc.) of a fluid by mass motion of that fluid in the horizontal plane. In the atmosphere, the horizontal transfer of anything by the movement of air, i.e. wind. Common examples of advection include heat and moisture.

**agronomic** - Pertains to the growing of crops under cultivation.

**alkalinity** - The titratable alkalinity, using a standard acid titrant, as performed in accordance with standard methods. It is normally reported as milligrams per liter as calcium carbonate ( $\text{CaCO}_3$ ), but it may also be reported as milliequivalents per liter as bicarbonate ( $\text{HCO}_3^-$ ).

**alteration** - A change produced in a rock by chemical or physical action.

**aluminosilicate mineral** - A mineral in rock or soil based on aluminum and silicon, such as a feldspar, mica, or clay mineral.

**ameliorate** - To improve or make better. Commonly referring to soil, when improving soil with respect to its plant growth properties.

**amendment** - A material that is incorporated into another substance to improve its properties. For instance, into soil to improve soil quality and/or plant growth, or into a mine waste facility to improve its geotechnical and/or environmental properties.

**anion** - An ion with a negative charge.

**anoxic limestone drain (ALD)** - A buried trench or cell of limestone into which anoxic water is introduced to raise pH and add alkalinity, without coating the limestone with precipitates resulting from metal (Fe, Mn) oxidation.

**anthropogenic** - Formed through or related to the activities of humans.

**aquifer** - A geologic formation, group of formations, or part of a formation that contains sufficient saturated permeable material to yield significant quantities of water to springs and wells.

**aquitard** - A geologic formation, group of formations, or part of a formation with low values of hydraulic conductivity, which allows some movement of water through it, but at rates of flow lower than those of adjacent aquifers.

**authigenic mineral** – Mineral that developed in place. Mainly refers to sedimentary material formed during or after deposition.

**autotrophic bacterium** - An organism that produces complex organic compounds from simple inorganic molecules using energy from light or inorganic chemical reactions.

**backfill** - Geologic materials returned to an open pit or placed back into an underground mine, after desirable minerals have been removed, to bring a surface mine back to original contour, partially refill an open pit, or to improve stability of underground workings.

**background** - Natural concentrations of an element in natural materials that exclude human influence. A background measurement represents an idealized situation and is typically more difficult to measure than a **baseline**.

**barometric pumping** - Variation in the ambient atmospheric pressure that causes motion of air in porous and fractured earth materials, such as waste rock piles.

**baseline** - A baseline measurement represents concentrations measured at some point in time and may or may not represent the true background. Baseline concentrations are typically expressed as a range, not as a single value.

**beneficial reuse** - Using a substance normally considered a waste product in a new application or product.

**beneficiation** - The processing of ores for the purpose of regulating the size of a desired product; removing unwanted constituents; and improving the quality, purity, or assay grade of a desired product. Concentration or other preparation of ores can be for smelting by screening, drying, flotation, or gravity or magnetic separation. Improvement of the grade of ores can be by milling, screening, flotation, sintering, gravity concentration, or other chemical and mechanical processes.

**benthos** - The organisms living on or in the bottom of water bodies.

**bioaccessibility** - The fraction of a substance that is available for absorption by an organism.

**bioavailability** - The fraction of a substance that can be absorbed by the body through the gastrointestinal system, the pulmonary system and the skin. By its definition, bioavailability also includes the process of bioaccessibility.

**biodiversity** - The variety of living organisms at all levels of organization.

**biogeochemistry** - The scientific study of the chemical, physical, geological, and biological



processes and reactions that govern the composition of the natural environment (including the biosphere, the hydrosphere, the pedosphere, the atmosphere, and the lithosphere), and the cycles of matter and energy that transport the Earth's chemical components in time and space.

**bioirrigation** - The exchange of dissolved substances between pore water and overlying water.

**biomagnification** - Uptake of a contaminant through a food chain resulting in increasing concentrations through multiple trophic levels.

**biomass** - Standing crop of living material usually expressed as the amount of live or dry weight per unit area; usually associated with soil microbes, animals, and plant residues.

**bioreactivity**- Governs whether a contaminant will be assimilated into a cell if it is **bioavailable**.

**biota** – In ecology, the plant and animal life of a region

**bioturbation** - The movement and relocation of bottom sediments by the activities of bottom-dwelling organisms.

**block model** – A model of an ore deposit generated by interpolating assay values from irregularly distributed drill hole data to a regular two- or three-dimensional grid.

**borehole** - The generalised term for any narrow shaft drilled in the ground, either vertically, horizontally, or inclined.

**borrow area** - Place from which earthy or rock materials are removed to serve as fill or for other construction purposes.

**brackish water** - Slightly salty water.

**brines** - Water saturated or nearly saturated with a salt.

**bulk density** - A measure of the mass of soil or rock (or other solid phase material) per unit volume, for instance g/cm<sup>3</sup>.

**capillary barrier** - A space between two surfaces which is purposely made wide enough to prevent the movement of moisture through the space by capillary action, for instance, by using a layer of coarser rock between finer materials Also frequently referred to as “capillary break”.

**capital investment** - The money paid to purchase a capital asset or a fixed asset.

**carbonates** - A class of rocks containing calcium (Ca) and/or magnesium (Mg) carbonate, such as limestone and dolomite.

**catchment** - See **watershed**.

**cation** – An ion with a positive charge.

**chain pillar** - A series of pillars left between panels that support the mine roof and allow access to the mine panels as well as air exchange in an underground mine.

**chemocline** - The border region or interface between water volumes with two contrasting and predominating chemistries within a body of water.

**cleanup** - Actions taken to address a release or threat of release of a hazardous substance that could affect humans and/or the environment. The term is sometimes used interchangeably with remedial action, removal action, response action, or corrective action.

**colonization** - The movement of new individuals or species into an area.

**commodity** - An article of commerce or a product that can be used for commerce. In a narrow sense, products traded on authorized commodity exchanges. Types of commodities include agricultural products, metals, petroleum, foreign currencies, and financial instruments.

**community** - Assemblage of plants and animals occurring in natural systems.

**compaction** - Increase in soil bulk density, caused by loading at the surface, generally by wheel traffic; the action of moving soil particles closer together by compressing the pore space.

**compost** - The end result of controlled aerobic decomposition ([http://en.wikipedia.org/wiki/Aerobic\\_decomposition](http://en.wikipedia.org/wiki/Aerobic_decomposition)) of organic matter ([http://en.wikipedia.org/wiki/Organic\\_matter](http://en.wikipedia.org/wiki/Organic_matter)) known as composting (<http://en.wikipedia.org/wiki/Composting>) . It is used in landscaping (<http://en.wikipedia.org/wiki/Landscaping>) , horticulture (<http://en.wikipedia.org/wiki/Horticulture>) and agriculture (<http://en.wikipedia.org/wiki/Agriculture>) as a soil conditioner ([http://en.wikipedia.org/wiki/Soil\\_conditioner](http://en.wikipedia.org/wiki/Soil_conditioner)) and fertilizer (<http://en.wikipedia.org/wiki/Fertilizer>) to add vital humus (<http://en.wikipedia.org/wiki/Humus>) or humic acids ([http://en.wikipedia.org/wiki/Humic\\_acids](http://en.wikipedia.org/wiki/Humic_acids)) . It is also useful for erosion control, land and stream reclamation, wetland construction, and as landfill cover.

**composite sample** - A sample made by the combination of several distinct subsamples. Composite samples are often prepared to represent a minable or treatable unit of material when it is not economically feasible or desirable to analyze a large quantity of individual samples; to represent a particular type or classification of material; or when subsample volumes are insufficient to allow analyses by desired analytical techniques.

**conceptual site model** - A representation of a site and its environment that represents what is known or suspected about contaminant sources as well as the physical, chemical and biological processes that affect contaminant transport to potential environmental receptors.

**contaminant** - Any physical, chemical, biological, or radiological substance or matter that has an adverse effect on human and ecological receptors as well as environmental media (e.g., air, water, soil, sediment).

**convection** - In physics, convection is the transport and mixing of properties (energy, heat, moisture, etc.) of a fluid by mass motion of that fluid. In meteorology, convection generally refers to such transport and mixing in the vertical direction, and **advection** refers to processes in the horizontal plane.

**corrosive** - A corrosive substance is one that will destroy or irreversibly damage another substance with which it comes in contact. The main hazards to people include damage to eyes, skin and tissue under the skin, but inhalation or ingestion of a corrosive substance can damage the respiratory and gastrointestinal tracts.

**cryoconcentration** – The concentration of chemical constituents in a liquid due to freezing.

**crystallinity** –The degree of structural order in a solid.

**data** - Any information about a feature or condition; usually implies a numerical format but also can be textual information.

**data quality objective (DQO)** - Qualitative and quantitative statement of the overall level of uncertainty that a decision-maker will accept in results or decisions based on environmental data. A DQO provides the statistical framework for planning and managing environmental data operations consistent with the user's needs.

**density** - The number of individuals per unit area.

**diagenetic mineral** - Mineral that underwent a physical, chemical, or biological change after its initial formation, for instance due to changes in pressure, temperature, or fluid interaction.

**discharge point** - Location at which mineral-processing waste is pumped into a basin or impoundment.

**dissolved oxygen** - A measure of water quality indicating the amount of oxygen dissolved in water. This is one of the most important indicators of a water body's condition, because most aquatic organisms require dissolved oxygen.

**dissolved solids** - The weight of matter, including both organic and inorganic matter, in solution in a stated volume of water. The amount of dissolved solids is usually determined by filtering water through a glass or 0.45- $\mu\text{m}$  pore-diameter micrometer filter, weighing the filtrate residue remaining after the evaporation of the water, and drying the salts to constant weight at 180°C.

**dolomitic limestone** - Limestone (calcium carbonate) containing a significant percentage of dolomite (calcium-magnesium carbonate).

**drainage** - Any water draining from a natural or human-made feature, including natural surface water runoff, mine drainage, and groundwater that has come to the surface.

**ecology** - The study of the interrelationship of organisms with their environment.

**ecosystem** - A community of organisms considered together with the nonliving factors of its environment.

**effluent** - A material, usually a liquid waste, that is emitted by a source, which is often industrial, such as a metallurgical or water treatment process. Gaseous effluents are usually called **emissions**.

**electrical conductivity** - Indicates the concentration of ionized constituents in a water sample or soil matrix.

**emissions** - Gaseous materials emitted by a source.

**environmental impact assessment** - A process required under national or regional environmental legislation in which potential environmental, physical, and social impacts and mitigation measures are identified, evaluated, and discussed. A provision for notifying citizens and considering their comments is commonly integral to the process.

**epithermal deposits** - A mineral deposit consisting of veins and replacement bodies that usually occurs in volcanic or sedimentary rocks, containing precious metals, and sometimes, although rarely, base metals. Typically formed at shallow depths (i.e., within about 1 km of the Earth's surface) in a temperature range between 50 to 200 degrees C, usually resulting in characteristic vein-like structures.

**erosion** - The entrainment and transportation of soil through the action of wind, water, or ice.

**evapoconcentration** - The concentration of chemical constituents in a liquid due to evaporative processes.

**evapotranspiration** - The sum of evaporation and plant transpiration from the earth's land surface to atmosphere.

**exothermic reaction** - A chemical reaction that releases energy in the form of heat. It is the opposite of an endothermic reaction.

**extraction** - The process of mining and removal of ore from a mine. This term is often used in relation to all processes of obtaining metals from ores, which involve breaking down ore both mechanically (crushing) and chemically (decomposition), and separating the metal from the

associated gangue.

**extraction ratio** - The ratio of the amount of ore removed to the amount of ore remaining in a mine or disposed of as waste.

**fauna** – The animal component of natural systems.

**fermentation** – A process which derives energy from the oxidation of organic compounds, such as carbohydrates, using an electron acceptor, which is usually an organic compound

**fermenting bacteria** - Anaerobic bacteria that use organic molecules as their final electron acceptor to produce fermentation end-products.

**flora** - The plant component of natural systems.

**flotation** - The method of mineral separation in which a froth, created in water by a variety of reagents, floats some finely ground minerals while other minerals sink.

**footprint** - The planimetric area covered by a mine operation and associated roads, ponds, and other structures.

**framboidal pyrite** - Spherically shaped agglomerations of minute (approximately 0.25 micrometer) crystals of pyrite (FeS<sub>2</sub>). It is the most reactive of all pyrite morphologies.

**gangue** - The minerals without value in an ore; that part of an ore that is not economically desirable but cannot be avoided when mining the deposit. It is separated from the ore during beneficiation.

**geographic information system (GIS)** - A computer program or system that allows storage, retrieval, and analysis of spatially related information in both graphical and database formats.

**geomembrane** – Impermeable material (usually a **geosynthetic**) used as a cut-off or liner to prevent movement of water.

**geophysical survey** - The systematic collection of geophysical data for spatial studies. Geophysical surveys may use a great variety of sensing instruments, and data may be collected from above or below the Earth's surface or from aerial or marine platforms.

**geostatistics** - The mathematical assessment of variability in a biological, chemical, or physical parameter across a distance or area.

**geosynthetics** - The term used to describe a range of generally polymeric products used to solve civil engineering problems.

**glory hole** - An informal term for a large mine excavation open to the surface, such as a mine

shaft or an open pit mine. In the block caving method of underground mining, ore collapses from above into a mine tunnel. If enough ore is removed, the ground surface collapses into a surface depression called a glory hole.

**gradient** - The inclination of profile grade line from the horizontal, expressed as a percentage (synonym = rate of grade).

**groundwater** - Water in the zone below the surface of the earth where voids are filled with water. This is in contrast to surface water.

**habitat** - The place where a population (e.g., human, animal, plant, microorganism) lives, its surroundings, and its contents, both living and nonliving.

**heap leach/heap leaching** - An industrial mining process to extract precious metals and copper compounds from ore. The mined ore is crushed into small chunks and heaped on an impermeable plastic and/or clay lined leach pad where it can be irrigated with a leach solution to dissolve the valuable metals. Either sprinklers, or often drip irrigation, are used to minimize evaporation. The solution then percolates through the heap, leaches out the precious metal, and is collected.

**hot spot** - An area or volume of ore, mine soil, spoil, tailings, or waste with an enhanced reactivity relative to the remainder.

**hydraulic backfill** - Any kind of backfill carried by water through pipelines into an underground mine. Solid particles are sluiced through the water quickly without having the chance to settle until they reach the dumping point.

**hydraulic conductivity** - A property of soil or rock that describes the ease with which water can move through pore spaces or fractures. It depends on the intrinsic permeability of the material and on the degree of saturation.

**hydraulic head** - A specific measurement of water pressure above a geodetic datum. It is usually measured as a water surface elevation, expressed in units of length, at the entrance (or bottom) of a well.

**hydrolysis** - The process of splitting the water molecule into separate components of hydrogen ions ( $H^+$ ) and hydroxide ions ( $OH^-$ ) that often react with other constituents present.

**hydrometallurgical process** - Part of the field of extractive metallurgy involving the use of aqueous chemistry for the recovery of metals from ores, concentrates, and recycled or residual materials. Hydrometallurgy is typically divided into three general areas: leaching, solution concentration and purification, and metal recovery.

**hyporheic zone** - The region beneath and lateral to a stream bed, where mixing of shallow

groundwater and surface water occur. The flow dynamics and behavior in this zone (termed hyporheic flow) is recognized to be important for surface water/groundwater interactions, as well as fish spawning, among other processes.

**impoundment** - A closed basin that is dammed or excavated and is used for the storage, holding, settling, treatment, or discharge of water, sediment, and/or liquid wastes.

**in situ treatment** – Treatment performed in place, without disturbance, removal, or excavation of the material being treated.

**infiltration** - The downward entry of water into a soil or other geologic material.

**infrastructure** - Elements that support development of a mine, including transportation, utility, and communication systems.

**inoculum** - A source or medium for introduction of microorganisms.

**karst topography** - A landscape shaped by the dissolution of a layer or layers of soluble bedrock, usually carbonate rock such as limestone or dolomite. Due to subterranean drainage, there may be very limited surface water, even to the absence of all rivers and lakes.

**kriging** - A geostatistical analysis procedure used to estimate an ore grade or biological, chemical, or physical value at locations where no samples were collected.

**land use** - The primary use of a specific land area.

**laterite** - A surface formation in hot and wet tropical areas which is enriched in iron and aluminum and develops by intensive and long lasting weathering of the underlying parent rock.

**leaching** - Removal by dissolution, desorption, or other chemical reaction from a solid matrix by passing liquids through the material.

**limestone** - A sedimentary rock consisting largely of calcite ( $\text{CaCO}_3$ ).

**Limnology** - The study of inland waters, such as lakes and ponds, rivers, springs, streams and wetlands. This comprises the biological, chemical, physical, geological, and other attributes of all inland waters (running and standing waters, both fresh and saline, natural or man-made).

**lithology** - The character of a rock described in terms of its structure, color, mineral composition, grain size, and arrangement of its visible features that in the aggregate impart individuality to the rock. The term is often used to classify rock materials for characterization purposes along with the degree of alteration and acid-base characteristics.

**littoral** - Shallow water zone in lakes and ponds.

**lysimeter** - An enclosed column containing a solid (such as soil) that is used to measure **leaching** and/or **evapotranspiration**.

**manure** - Solid wastes from livestock, often mixed with bedding materials such as straw or hay.

**metalloids** - is a term used in chemistry when classifying the chemical elements. On the basis of their general physical and chemical properties, nearly every element in the periodic table can be termed either a metal or a nonmetal. However, a few elements with intermediate properties, such as antimony, arsenic, boron, and silicon, are referred to as **metalloids**

**metallurgy** - The science and technology of extracting and refining metals and the creation of materials or products from metals.

**metallurgical processing** - The methods employed to clean, process, and prepare metallic ores for the final marketable product.

**metastable** - A general scientific concept that describes states of delicate equilibrium. A system is in a **metastable state** when it is in equilibrium (not changing with time) but is susceptible to fall into lower-energy states with only slight interaction. An example of a metastable system is a supersaturated solution.

**methanogens** - A group of single-celled microorganisms, that produce methane as a metabolic byproduct in anoxic conditions. They are common in wetlands, where they are responsible for marsh gas, and in the guts of animals such as ruminants and humans.

**microclimate** - Localized temperature, moisture, wind, and other climate conditions, caused by differences in hydrologic climate and vegetation differences due to topography or surface configuration. For example, windbreaks create microclimates.

**milling** - The crushing and grinding of ore. The term may include the removal of harmful constituents or constituents without economic value from the ore and preparation for additional processing or sale to market.

**mine** - An opening or excavation in the ground for the purpose of extracting minerals.

**mine rehabilitation** - Modern mine rehabilitation aims to minimize and mitigate the environmental effects of mining.

**mineral deposit** - An occurrence of any valuable commodity or mineral that is of a sufficient size and grade (concentration) to have potential for economic development under favorable conditions.

**mineralogy** - The study of minerals and their formation, occurrence, use, properties, composition, and classification; also refers to the specific mineral or assemblage of minerals at a



location or in a rock unit.

**mining** - The process of extracting useful minerals from the earth's crust.

**mitigation** - Correction of damage caused by mining activity (e.g., mine subsidence, wetland impacts, acid drainage).

**monitoring** - The periodic or continuous surveillance or testing to determine the level of compliance with process or statutory requirements in various media or in humans, plants, and animals.

**mucking** – To remove rocks or clay excavated in mining.

**mulch** - A layer of nonliving material applied or occurring on the surface that is placed on top of a growth medium to control erosion and weed growth and to conserve moisture.

**net present value** - **Net present value (NPV)** or **net present worth (NPW)** is defined as the total present value (PV) of a time series of cash flows. It is a standard method for using the time value of money to appraise long-term projects. Used for capital budgeting, and widely throughout economics, it measures the excess or shortfall of cash flows, in present value terms, once financing charges are met.

**neutral mine drainage** - A neutral pH, metal-laden, sulfate-rich drainage that occurs during land disturbance where sulfur or metal sulfides are exposed to atmospheric conditions. It forms under natural conditions from the oxidation of sulfide minerals and where the alkalinity equals or exceeds the acidity.

**neutralization potential (NP)** - The amount of alkaline or basic material in rock or soil materials that is estimated by acid reaction followed by titration to determine the capability of neutralizing acid from exchangeable acidity or pyrite oxidation. May also be referred to as acid neutralization potential or ANP.

**neutralization reaction** – A chemical reaction in which an acid and a base or alkali (soluble base) react to produce salt and water, which do not exhibit any of the acid or base properties.

**ore** - The naturally occurring material from which a mineral or minerals of economic value can be extracted profitably or to satisfy social or political objectives. The term is generally, but not always, used to refer to metalliferous material and is often modified by the names of the valuable metal constituents.

**ore deposit** - A mineral deposit that has been tested and found to be of sufficient size, grade, and accessibility to be extracted for a profit at a specific time, based on economic assumptions.

**organic matter** - The accumulation of disintegrated and decomposed biological residues and

other organic compounds synthesized by microorganisms or used in mining and metallurgical processing; found in soils, ores, concentrates, waste rocks, tailings, and metallurgical processing wastes.

**overburden** - Material of any nature, consolidated or unconsolidated, that overlies a deposit of useful and minable materials or ores, especially those deposits that are mined from the surface by open cuts or pits.

**oxidation** - A chemical process involving a reaction(s) that produces an increase in the oxidation state of elements such as iron and sulfur.

**passive treatment systems** - Systems that treat acid mine drainage without continual and active additions of chemicals, including aerobic and anaerobic wetlands, anoxic limestone drains, successive alkalinity-producing systems, and open limestone channels.

**pathway** - The physical course a chemical or pollutant takes from its source to an exposed organism.

**peat** - An accumulation of partially decayed vegetation matter. Peat forms in wetlands or peatlands.

**periphyton** - A complex mixture of algae, bacteria, microbes, and detritus that is attached to submerged surfaces in most aquatic ecosystems. It serves as an important food source for many aquatic organisms. It can also absorb contaminants; removing them from the water column and limiting their movement through the environment.

**permafrost** - Soil at or below the freezing point of water for two or more years. Most permafrost is located in high latitudes (i.e. land in close proximity to the North and South poles), but alpine permafrost may exist at high altitudes in much lower latitudes.

**pH** - A measure of the acidity (pH less than 7) or alkalinity (pH greater than 7) of a solution; a pH of 7 is considered neutral. It is a measure of the hydrogen ion concentration (more specifically, the negative log of the hydrogen ion activity for glass electrodes) of a soil suspension or solution.

**photochemistry** – A sub-discipline of chemistry, is the study of the interactions between atoms, small molecules, and light (or electromagnetic radiation).

**photosynthesis** – A metabolic pathway that converts carbon dioxide into organic compounds, especially sugars, using the energy from sunlight. Photosynthesis occurs in plants, algae, and many species of bacteria.

**physiography** – The physical structure and shape of an environment.

**phyto-remediation** – The treatment of environmental problems through the use of plants.

**pit lake** - Any perennial or ephemeral water body that occupies an excavation in the land surface created for the collection of ore material.

**pollutant** - Any organic substance, inorganic substance, a combination of organic and inorganic substances, a pathogenic organism, or heat that, when introduced into the environment, adversely impacts the usefulness of a resource.

**pore water** - Water occupying the voids in soil or sediment.

**porphyry copper deposits** – Large to very large low-grade copper ore bodies which are associated with porphyritic intrusive rocks. The ore generally occurs as disseminations along hairline fractures as well as within larger veins, which often form a stockwork.

**porosity** - A measure of the void spaces in a material. Expressed as a fraction between 0 and 1, or as a percentage between 0 and 100%.

**potentiometric map** - A contour map of the potentiometric or water level surface. As on the surface of the earth, water flows from high elevation, or potential, to low elevation. Thus a potentiometric map indicates which direction water is moving in the subsurface.

**production** - The total amount of mass produced by a plant, mine, aquifer, and so forth.

**prospecting** – The physical search for minerals, fossils, precious metals, or mineral specimens.

**pyrometallurgical process** - The thermal treatment of minerals and metallurgical ores and concentrates to bring about physical and chemical transformations in the materials to enable recovery of valuable metals.

**quality assurance/ quality control (QA/ QC)** - A system of procedures, checks, audits, and corrective actions to ensure that all research design and performance, environmental monitoring and sampling, and other technical and reporting activities are of the quality that meets the testing objectives.

**random sample** - A subset of a statistical population in which each item has an equal and independent chance of being chosen.

**receptor** - An ecological entity exposed to a stressor.

**reclamation** - Rehabilitation or return of disturbed land to productive uses; includes all activities of spoil movement, grading, and seeding; and the return of productivity equal to or exceeding that prior to its being disturbed.

**redox** - Shorthand for reduction-oxidation. Describes all chemical reactions in which atoms have their oxidation number (oxidation state) changed, most commonly through the transfer of electrons.

**refining** - The purification of a crude metal product; normally the stage following smelting.

**remediation** - Cleanup or other methods used to remove or contain a toxic spill or hazardous materials from a site. It is the process of correcting, counteracting, or removing an environmental problem and often refers to the removal of potentially toxic materials from soil or water.

**remining** - The return to underground or surface mines or previously mined areas for further ore removal by surface mining and reclaiming to current reclamation standards. It also refers to the process of mining for processing of mine and mill wastes (processed or unprocessed) to extract additional metals or other commodities due to a change in extraction technology or economics that make such remining profitable.

**representative sample** - A portion of material or water that is as nearly identical in content and consistency as possible to that in the larger body of material or water being sampled.

**respiration** - The metabolic oxidation of organic compounds by living organisms to produce energy (i.e., breathing).

**riparian** - The land bordering a stream channel.

**risk** - A measure of the probability that damage to life, health, property, and/ or the environment will occur as a result of a given hazard.

**risk assessment** - A qualitative and/or quantitative evaluation of the risk posed to human health and/or the environment by the actual or potential presence and/or use of specific pollutants. Risk assessments are conducted for a number of reasons, including to establish whether an ecological risk exists, to identify the need for additional data collection, to focus on the dangers of a specific pollutant or the risks posed to a specific site, and to help develop contingency plans and other responses to pollutant releases.

**risk management** - The process of evaluating and selecting alternative regulatory and non-regulatory responses to risk. The selection process necessarily requires the consideration of legal, economic, and behavioral factors.

**sample** - A representative portion of a population.

**sedimentation** - The process of depositing entrained soil particles or geologic materials from water. In a mining context, it usually results from erosion of disturbed land and is considered a negative impact to streams and other water bodies.

**sediment** - any particulate matter that can be transported by fluid flow, and which eventually is deposited.

**sewage sludge** - The mainly organic, solid residual materials resulting from the treatment of sewage, often used as a soil amendment.

**shale** - A thinly bedded or fissile sedimentary rock formed from clay or silt.

**shovel** - Machine used to excavate ore or other minerals and to load these minerals for transport. Its bucket is loaded from the top, and the bottom is opened for emptying the contents.

**skarn** - Skarn is a metamorphic rock formed during metamorphism and in the contact zone of magmatic intrusions like granites with carbonate-rich rocks such as limestone or dolomite

**slimes** – Material of silt or clay in size, resulting from the washing, concentration, or treatment of ground ore.

**slope** - The degree to which the ground angle deviates from horizontal, expressed as a percent rise over run or as a degree angle.

**slurry** - Any mixture of solids and fluids that behaves as a fluid and can be transported hydraulically (e.g., by pipeline). See also **tailings**.

**smelting** - The chemical reduction of a metal from its ore or concentrate by a process usually involving fusion, so that earthy and other impurities separate as lighter and more fusible slags, and can readily be removed from the reduced metal. The process commonly involves addition of reagents (fluxes) that facilitate chemical reactions and the separation of metals from impurities.

**sorption** - refers to the action of both absorption and adsorption taking place simultaneously. As such, it is the effect of gases or liquids being incorporated into a material of a different state and adhering to the surface of another molecule. Absorption is the incorporation of a substance in one state into another of a different state (e.g., liquids being absorbed by a solid or gases being absorbed by a liquid). Adsorption is the physical adherence or bonding of ions and molecules onto the surface of another molecule.

**stakeholders** - a person, group, organization, or system that affects or can be affected by an organization's actions.

**stratigraphy** – The layering or bedding of varying rock types reflecting changing environments of formation and deposition. Also, a branch of geology that concerns itself with the study of rock layers and layering (stratification).

**stressor** - An event that provokes stress.

**sulfosalts** –Complex sulfide minerals with the general formula:  $A_mB_nS_p$ ; where A represents a metal such as copper, lead, or silver; B represents a semi-metal such as arsenic, antimony or bismuth; and S is sulfur or rarely selenium.

**surface mining (strip mining)** - A procedure of mining that entails the complete removal of overburden material; may generally refer to either an area and/or a contour mine.

**surface water** - Water at or near the land surface, such as lakes and streams, as opposed to groundwater.

**sustainable development** – A pattern of resource use that aims to meet human needs while preserving the environment so that these needs can be met not only in the present, but in the indefinite future. The term was used by the Brundtland Commission which coined what has become the most often-quoted definition of sustainable development as development that "meets the needs of the present without compromising the ability of future generations to meet their own needs."

**tailings** - The solid waste product (gangue and other material) resulting from the milling and mineral concentration process (washing, concentration, and/or treatment) applied to ground ore. This term is usually used for sand to clay-sized refuse that is considered too low in mineral values to be treated further, as opposed to the concentrates that contain the valuable metals.

**tailings dam** - See **tailings impoundment**.

**tailings impoundment** - Any structure designed and constructed for the purpose of capturing and retaining liquid-solid slurries of mill tailings in which the solids settle. The liquid may or may not be discharged or captured for recycling after the solids have settled out of suspension. *Tailings pond* and *tailings dam* are often used interchangeably with *tailings impoundment* and *tailings storage facilities*.

**taxa** - Taxonomic groups.

**thermal stratification** - Refers to a temperature layering effect that occurs in water. Stratification is due to differences in water density: warm water is less dense than cool water and therefore tends to float on top of the cooler heavier water.

**thermoclines** - The border region or interface between water volumes with two contrasting temperatures (and frequently densities and composition) within a body of water.

**topography** –The physical structure, shape, and features (natural and man-made) of an environment.

**toxicity** - A property of a substance that indicates its ability to cause physical and/or physiological harm to an organism (plant, animal, or human), usually under particular conditions

and above a certain concentration limit, below which no toxicity effects have been observed.

**turbidity** - The cloudiness or haziness of a fluid caused by individual particles (suspended solids) that are generally invisible to the naked eye. The measurement of turbidity is a key test of water quality.

**vadose zone** - The portion of Earth between the land surface and the water table or zone of saturation. Also named the *unsaturated zone*.

**volcanogenic massive sulphide (VMS) deposits** - A type of metal sulfide ore deposit, mainly copper-lead-zinc, which is associated with and created by volcanic-associated hydrothermal events in submarine environments.

**waste rock** - Barren or mineralized rock that has been mined but is of insufficient value to warrant treatment and, therefore, is removed ahead of the metallurgical processes and disposed of on site. The term is usually used for wastes that are larger than sand-sized material and can be up to large boulders in size; also referred to as *waste rock dump* or *rock pile*.

**water balance** - An accounting of the inflow to, outflow from, and storage changes of water in a hydrologic unit over a fixed period.

**water quality standards** - Ambient standards for water bodies. The standards prescribe the use of the water body and establish the water quality criteria that must be met to protect designated uses.

**watershed** - The land area that drains into a stream. The watershed for a major river may encompass a number of smaller watersheds that ultimately combine at a common point.

**weathering** - Process whereby earthy or rocky materials are changed in color, texture, composition, or form (with little or no transportation) by exposure to atmospheric agents.

**weir** - A small overflow-type dam commonly used to raise the level of a river or stream. Water flows over the top of a weir, although some weirs have sluice gates which release water at a level below the top of the weir. The crest of an overflow spillway on a large dam is often called a weir. Weirs are frequently used for flow measurements.

**wetlands** - Land areas containing ponded water or saturated surface soil for some portion of the growing season. Those with standing water for long periods may be mined only under special conditions, and the owner usually must reconstruct more acres of wetlands than originally disturbed.

**workings** - The entire system of openings (underground as well as at the surface) in a mine.

## OTHER USEFUL GLOSSARIES

- General geological dictionary - <http://www.webref.org/geology/geology.htm>
- Glossary of general mining and processing terms -  
<http://www.northernminer.com/resources/tools/glossary.aspx>
- Mineral Information Finder, a very comprehensive web site -  
<http://www.rocksandminerals.com/glossary.htm>
- Minerals Information Institute, photos and descriptions of minerals -  
<http://www.mii.org/mineral-photos-type>
- 19th and 20th century mining terms, based in Australia -  
<http://www.heritagearchaeology.com.au/Glossary.htm>
- Many useful technical glossaries: US. Geological Survey: <http://www.usgs.gov/>
- SME (2008). Basics of Metal Mining Influenced Water (edited by V.T. McLemore). Society for Mining, Metallurgy, and Exploration.





**INAP member companies:**

