

Integrating the Healthcare Enterprise



5 **IHE Quality, Research and Public Health  
Technical Framework Supplement**

10 **Birth and Fetal Death Reporting-Enhanced  
(BFDR-E)**

HL7<sup>®</sup> FHIR<sup>®</sup> R4

Using Resources at FMM Level 2-5

15 **Revision 4.1 – Trial Implementation**

20 Date: December 29, 2021  
Author: QRPH Technical Committee  
Email: qrph@ihe.net

25 **Please verify you have the most recent version of this document. See [here](#) for Trial Implementation and Final Text versions and [here](#) for Public Comment versions.**

## Foreword

30 This is a supplement to the IHE Quality, Research and Public Health (QRPH) Technical Framework. Each supplement undergoes a process of public comment and trial implementation before being incorporated into the volumes of the Technical Frameworks.

This supplement is published on December 29, 2021 for trial implementation and may be available for testing at subsequent IHE Connectathons. The supplement may be amended based on the results of testing. Following successful testing it will be incorporated into the Quality, 35 Research and Public Health Technical Framework. Comments are invited and can be submitted at [http://www.ihe.net/QRPH\\_Public\\_Comments](http://www.ihe.net/QRPH_Public_Comments).

“Boxed” instructions like the sample below indicate to the Volume Editor how to integrate the relevant section(s) into the relevant Technical Framework volume.

<i>Amend Section X.X by the following:</i>
--

40 Where the amendment adds text, make the added text **bold underline**. Where the amendment removes text, make the removed text **~~bold strikethrough~~**. When entire new sections are added, introduce with editor’s instructions to “add new text” or similar, which for readability are not bolded or underlined.

45 General information about IHE can be found at [IHE](#).

Information about the IHE Quality, Research and Public Health domain can be found at [IHE Domains](#).

Information about the organization of IHE Technical Frameworks and Supplements and the process used to create them can be found at [Profiles](#) and [IHE Process](#).

50 The current version of the IHE Quality, Research and Public Health Technical Framework can be found at [Quality, Research and Public Health Technical Framework](#).

## CONTENTS

55	Introduction to this Supplement.....	12
	Open Issues and Questions .....	13
	Closed Issues .....	14
	IHE Technical Frameworks General Introduction.....	17
9	Copyright Licenses.....	17
60	10 Trademark .....	17
	IHE Technical Frameworks General Introduction Appendices.....	18
	Appendix A – Actors .....	18
	Appendix B – Transactions.....	19
	Appendix D – Glossary.....	19
65	<b>Volume 1 - Profiles.....</b>	<b>23</b>
	Domain-specific additions .....	23
	X Birth and Fetal Death Reporting-Enhanced (BFDR-E) Profile .....	23
	X.1 BFDR-E Actors, Transactions, and Content Modules .....	24
	X.1.1 Actor Descriptions and Actor Profile Requirements.....	27
70	X.1.1.1 Content Creator.....	27
	X.1.1.2 Content Consumer .....	27
	X.1.1.3 Form Filler.....	28
	X.1.1.4 Form Manager .....	28
	X.1.1.5 Form Receiver .....	29
75	X.1.1.6 Form Processor .....	29
	X.1.1.7 Form Receiver Document Exporter.....	29
	X.1.1.8 Form Processor Document Exporter .....	29
	X.1.1.9 Form Receiver Message Exporter .....	30
	X.1.1.10 Form Processor Message Exporter .....	30
80	X.1.1.11 Form Archiver .....	30
	X.1.1.12 Data Consumer .....	30
	X.1.1.13 Data Responder.....	30
	X.2 BFDR-E Actor Options.....	30
	X.2.1 LDS Pre-Pop Option .....	31
85	X.2.2 LDS-VR Pre-Pop Option.....	32
	X.2.3 Archive Form Option .....	32
	X.2.4 Antepartum Import Option.....	32
	X.2.5 Provider Supplied Live Birth Reporting Option .....	32
	X.2.6 Provider Supplied Mother's Live Birth Information Option .....	33
90	X.2.7 Provider Supplied Facility's Live Birth Information Option .....	33
	X.2.8 Provider Supplied Fetal Death Reporting Option .....	33
	X.2.9 Fetal Death Facility's Information Option.....	33
	X.2.10 Fetal Death Mother's Information Option .....	33
	X.2.11 Jurisdiction Live Birth Reporting Option.....	34
95	X.2.12 Jurisdiction Fetal Death Reporting Option.....	34

	X.2.13 Void Certificate Reporting Option .....	34
	X.2.14 Coded Cause of Death Reporting Option.....	34
	X.2.15 Coded Race/Ethnicity Reporting Option.....	34
	X.3 BFDR-E Required Actor Groupings .....	35
100	X.4 BFDR-E Overview .....	35
	X.4.1 Concepts .....	36
	X.4.2 Use Cases .....	37
	X.4.2.1 Use Case #1: Forms Data Capture with Messaging .....	37
	X.4.2.1.1 Use Case Description.....	37
105	X.4.2.1.2 Processing Steps .....	37
	X.4.2.1.2.1 Pre-conditions .....	37
	X.4.2.1.2.2 Main Flow .....	37
	X.4.2.1.2.3 Post-conditions.....	37
	X.4.2.1.3 Process Flow .....	38
110	X.4.2.2 Use Case #2: Forms Data Capture with Document Submission .....	39
	X.4.2.2.1 Use Case Description.....	40
	X.4.2.2.2 Processing Steps .....	40
	X.4.2.2.2.1 Pre-conditions .....	40
	X.4.2.2.2.2 Main Flow .....	40
115	X.4.2.2.2.3 Post-conditions.....	40
	X.4.2.2.3 Process Flow .....	40
	X.4.2.3 Use Case #3: Native Forms Data Capture .....	41
	X.4.2.3.1 Use Case Description.....	41
	X.4.2.3.2 Processing Steps .....	42
120	X.4.2.3.2.1 Pre-conditions .....	42
	X.4.2.3.2.2 Main Flow .....	42
	X.4.2.3.2.3 Post-conditions.....	42
	X.4.2.3.3 Process Flow .....	42
	X.4.2.4 Use Case #4: EMR BFDR Document Submission.....	43
125	X.4.2.4.1 Use Case Description.....	43
	X.4.2.4.2 Processing Steps .....	44
	X.4.2.4.2.1 Pre-conditions .....	44
	X.4.2.4.2.2 Main Flow .....	44
	X.4.2.4.2.3 Post-conditions.....	44
130	X.4.2.4.3 Process Flow .....	44
	X.4.2.5 Use Case #5: Mother’s Information Data Collection .....	44
	X.4.2.5.1 Mother’s Information Data Collection Use Case Description.....	44
	X.4.2.5.2 Mother’s Information Data Collection Process Flow .....	45
	X.5 Security Considerations .....	46
135	X.6 Cross Profile Considerations.....	46
	X.6.1 mRFD – Mobile Retrieve Form for Data Capture.....	46
	X.6.2 XD*– Cross Enterprise Document Sharing,b, Cross Enterprise Document Media Interchange, or Cross Enterprise Document Reliable Interchange.....	46

	X.6.3 Sharing Value Sets (SVS) .....	47
140	X.7 BFDR Data Elements .....	47
	Appendices to Volume 1 .....	48
	Appendix A – BFDR-E Profile - Sample Forms .....	49
	A.1 Sample Birth Reporting Facilities Worksheet .....	49
	A.2 Sample US Fetal Death Facilities Worksheet .....	50
145	A.3 Sample US mother’s live birth information for Child’s Birth Certificate.....	52
	A.4 Sample Patient’s Worksheet for the Report of Fetal Death .....	52
	Appendix B – BFDR-E Profile - Data Element Definitions.....	53
	<b>Volume 2 – Transactions .....</b>	<b>77</b>
	3.46 BFDRQuery [QRPH-46].....	77
150	3.46.1 Scope .....	77
	3.46.2 Actor Roles.....	77
	3.46.3 Referenced Standards .....	78
	3.46.4 Messages .....	78
	3.46.4.1 BFDRQuery Message.....	78
155	3.46.4.1.1 Trigger Events .....	78
	3.46.4.1.2 Message Semantics .....	78
	3.46.4.1.3 Expected Actions .....	79
	3.46.5 Security Considerations.....	79
	3.46.5.1 Security Audit Considerations – BFDRQuery [QRPH-46] (ADT).....	79
160	3.46.5.1.1 Data Responder Actor audit message: .....	80
	3.46.5.1.2 Data Consumer Actor audit message:.....	81
	3.37.5.1.3 Form Receiver Message Exporter Actor audit message.....	83
	3.37.5.1.4 Form Processor Message Exporter Actor audit message .....	85
	Appendices to Volume 2.....	87
165	Namespace Additions for Volume 2.....	87
	<b>Volume 3 – Content Modules.....</b>	<b>88</b>
	5 IHE Namespaces, Concept Domains and Vocabularies .....	88
	5.1 IHE Quality, Research and Public Health Namespaces.....	88
	5.2 IHE Quality, Research and Public Health Concept Domains .....	89
170	5.3 IHE Quality, Research and Public Health Format Codes and Vocabularies .....	90
	5.3.1 IHE Format Codes.....	90
	5.3.2 IHEActCode Vocabulary .....	90
	5.3.3 IHERoleCode Vocabulary.....	90
	6 CDA Content Modules .....	91
175	6.3.1 CDA Document Templates .....	91
	6.3.2 CDA Header Templates .....	91
	6.3.3 CDA Section Templates.....	91
	6.3.4 CDA Entry Content Module Templates.....	91
	6.4 Section not applicable .....	91
180	6.5 Value Sets .....	91
	6.5.1 Value Sets Used by this Profile.....	92

	6.5.2 Value Sets Defined by this profile .....	107
	6.6 Data Mappings .....	107
	6.6.1 Form Data Element Mappings .....	107
185	6.6.1.1 Form Derivation Rules .....	108
	6.6.1.1.1 ANTI: Antibiotics [received by the newborn for suspected neonatal sepsis] .....	108
	6.6.1.1.2 AVEN1: Assisted Ventilation [required immediately following delivery] .....	110
190	6.6.1.1.3 AVEN6 Abnormal Conditions of the Newborn [Assisted ventilation for 6 or more hours].....	111
	6.6.1.1.4 BINJ Abnormal Conditions of the Newborn [Significant birth injury(skeletal fracture(s), peripheral nerve injury, and/or soft tissue/solid organ hemorrhage which requires intervention)].....	112
195	6.6.1.1.5 NICU Abnormal Conditions of the Newborn [Admission to NICU].....	113
	6.6.1.1.6 SEIZ Abnormal Conditions of the Newborn [Seizure or serious neurologic dysfunction] .....	113
	6.6.1.1.7 SURF Abnormal Conditions of the Newborn [[Newborn given] Surfactant replacement therapy].....	114
200	6.6.1.1.8 NOA54 Abnormal Conditions of the Newborn [None of the above].....	115
	6.6.1.1.9 DNA54 Abnormal Conditions of the Newborn [Pending] .....	116
	6.6.1.1.10 APGAR5 Apgar Score [5 Minute] .....	116
	6.6.1.1.11 APGAR10 Apgar Score [10 Minute] .....	117
	6.6.1.1.12 ATTENDN Attendant's Name.....	118
205	6.6.1.1.13 ATTEND Attendant's Title.....	119
	6.6.1.1.14 ATTENDS Attendant [Other specified] .....	120
	6.6.1.1.15 NPI Attendant's NPI .....	121
	6.6.1.1.16 BWG Birth weight (Infant's) [grams] .....	122
	6.6.1.1.17 BWO Birth weight (Infant's) [ounces] .....	123
210	6.6.1.1.18 BWP Birth weight (Infant's) [pounds] .....	124
	6.6.1.1.19 ANTB Characteristics of Labor and Delivery [Antibiotics[received by the mother during labor]].....	125
	6.6.1.1.20 AUGL Characteristics of Labor and Delivery [Augmentation of labor] .....	126
215	6.6.1.1.21 CHOR Characteristics of Labor and Delivery [[Clinical] Chorioamnionitis [diagnosed during labor or maternal temperature >=38 degrees (100.4F)]] .....	127
	6.6.1.1.22 ESAN Characteristics of Labor and Delivery [[Epidural or spinal]Anesthesia[during labor]] .....	128
	6.6.1.1.23 INDL Characteristics of Labor and Delivery [Induction of labor].....	129
220	6.6.1.1.24 STER Characteristics of Labor and Delivery [Steroids [(glucocorticoids) for fetal lung maturation received by the mother prior to delivery]] .....	130
	6.6.1.1.25 NOA04 Characteristics of Labor and Delivery [None of the above] .....	131
	6.6.1.1.26 DNA04.....	132
	6.6.1.1.27 IDOB_YR Child Date of Birth [Year].....	132

225	6.6.1.1.28 IDOB_MO Child Date of Birth [Month].....	133
	6.6.1.1.29 IDOB_DY Child Date of Birth [Day] .....	134
	6.6.1.1.30 KIDFNAME Child's First Name/ Name of Fetus [optional at the discretion of the parents].....	135
230	6.6.1.1.31 KIDMNAME Child's Middle Name / Name of Fetus [optional at the discretion of the parents].....	135
	6.6.1.1.32 KIDLNAME Child's Last Name / Name of Fetus [optional at the discretion of the parents].....	136
	6.6.1.1.33 KIDSUFFIX Child's Last Name Suffix.....	137
	6.6.1.1.34 BFED Child [Infant being breastfed] .....	138
235	6.6.1.1.35 ILIV Child [Infant living at time of report].....	138
	6.6.1.1.36 IRECNUM Child [Newborn Medical Record Number].....	139
	6.6.1.1.37 ISEX Child [(infant) Sex].....	140
	6.6.1.1.38 ITRAN Child [Infant transferred within 24 hours of delivery/name the facility FTRAN].....	141
240	6.6.1.1.39 FTRAN Child [Infant transferred within 24 hours of delivery/name the facility].....	142
	6.6.1.1.40 TB Child [Time of Birth].....	143
	6.6.1.1.41 ANEN Congenital Anomalies of the Newborn [Anencephaly] .....	143
	6.6.1.1.42 CCHD Congenital Anomalies of the Newborn [Cyanotic congenital heart disease].....	144
245	6.6.1.1.43 CDH Congenital Anomalies of the Newborn [Congenital diaphragmatic hernia].....	145
	6.6.1.1.44 CDIC Congenital Anomalies of the Newborn [Suspected chromosomal disorder karyotype confirmed].....	146
250	6.6.1.1.45 CDIS Congenital Anomalies of the Newborn [Suspected chromosomal Disorder] .....	148
	6.6.1.1.46 CDIP Congenital Anomalies of the Newborn [Suspected chromosomal disorder karyotype pending] .....	149
	6.6.1.1.47 CL Congenital Anomalies of the Newborn [Cleft Lip with or without Cleft Palate] .....	150
255	6.6.1.1.48 CP Congenital Anomalies of the Newborn [Cleft Palate alone] .....	151
	6.6.1.1.49 DOWC Congenital Anomalies of the Newborn [Down Karyotype Confirmed].....	152
	6.6.1.1.50 DOWN Congenital Anomalies of the Newborn [Down Syndrome].....	153
260	6.6.1.1.51 DOWP Congenital Anomalies of the Newborn [Down Karyotype Pending] .....	154
	6.6.1.1.52 GAST Congenital Anomalies of the Newborn [Gastroschisis].....	155
	6.6.1.1.53 HYPO Congenital Anomalies of the Newborn [Hypospadias] .....	156
	6.6.1.1.54 LIMB Congenital Anomalies of the Newborn [Limb reduction defect] .....	157
265	6.6.1.1.55 MNSB Congenital Anomalies of the Newborn [Meningomyelocele/Spina Bifida] .....	158
	6.6.1.1.56 OMPH Congenital Anomalies of the Newborn [Omphalocele].....	159

	6.6.1.1.57 NOA55 Congenital Anomalies of the Newborn [None of the anomalies listed above].....	160
270	6.6.1.1.58 DNA55 Date of Last Live Birth .....	161
	6.6.1.1.59 YLLB Date of Last Live Birth.....	161
	6.6.1.1.60 MLLB Date Last Normal Menses Began .....	162
	6.6.1.1.61 DLMP_DY Date Last Normal Menses Began [Day] .....	163
	6.6.1.1.62 DLMP_MO Date Last Normal Menses Began [Month] .....	164
275	6.6.1.1.63 DLMP_YR Date Last Normal Menses Began [Year] .....	165
	6.6.1.1.64 YOPO Date of Last Other Pregnancy Outcome [Year].....	166
	6.6.1.1.65 MOPO Date of Last Other Pregnancy Outcome [Month] .....	167
	6.6.1.1.66 ADDRESS_D Facility Address .....	168
	6.6.1.1.67 FNAME Facility Name [if Not institution, give street and number].....	169
280	6.6.1.1.68 FNPI Facility National Provider Identifier .....	169
	6.6.1.1.69 CHAM Infections Present and Treated During This Pregnancy [Chlamydia] .....	170
	6.6.1.1.70 GON Infections Present and Treated During This Pregnancy [Gonorrhea] .....	171
285	6.6.1.1.71 HEPB Infections Present and Treated During This Pregnancy [Hepatitis B].....	172
	6.6.1.1.72 HEPC Infections Present and Treated During This Pregnancy [Hepatitis C].....	173
	6.6.1.1.73 SYPH Infections Present and Treated During This Pregnancy [Syphilis] .....	174
290	6.6.1.1.74 NOA02 Infections Present and Treated During This Pregnancy [None of the above].....	175
	6.6.1.1.75 AINT Maternal Morbidity [Admission to Intensive care [unit]].....	175
	6.6.1.1.76 MTR Maternal Morbidity [Maternal Transfusion].....	176
295	6.6.1.1.77 PLAC Maternal Morbidity [[Third or fourth degree] perineal laceration] .....	177
	6.6.1.1.78 RUT Maternal Morbidity [Ruptured Uterus] .....	178
	6.6.1.1.79 UHYS Maternal Morbidity [Unplanned hysterectomy] .....	179
	6.6.1.1.80 UOPR Maternal Morbidity [Unplanned operat[ing]ion [room procedure following delivery]] .....	180
300	6.6.1.1.81 NOA05 Maternal Morbidity [None of the above] NOTE: NOA05 is also used for onset of labor.....	180
	6.6.1.1.82 PRES Method of Delivery [Fetal presentation [at birth] – Cephalic] ....	181
	6.6.1.1.83 ROUT Method of Delivery [[Final]Route and method of delivery] .....	183
305	6.6.1.1.84 TLAB Method of Delivery [Trial of labor attempted] .....	185
	6.6.1.1.85 MFNAME Mother's Current Legal Name [First Name] .....	186
	6.6.1.1.86 MMNAME Mother's Current Legal Name [Middle Name].....	187
	6.6.1.1.87 MLNAME Mother's Current Legal Name [Last Name].....	187
	6.6.1.1.88 MSUFF Mother's Current Legal Name [suffix] .....	188
310	6.6.1.1.89 HFT Mother's Height [Feet] .....	189



	6.6.1.1.90 HIN Mother's Height [Inches] .....	190
	6.6.1.1.91 MRECNM Mother's Medical Record Number .....	191
	6.6.1.1.92 PWGT Mother's Pre-pregnancy Weight .....	191
315	6.6.1.1.93 NFACL Mother [If Mother transferred for maternal medical or fetal indications for delivery, enter name of facility mother transferred from.] .....	193
	6.6.1.1.94 TRAN Mother Transferred for Maternal Medical or Fetal Indications for Delivery .....	193
	6.6.1.1.95 DWGT Mother's Weight at Delivery .....	194
320	6.6.1.1.96 POPO Number of Other Pregnancy Outcomes .....	195
	6.6.1.1.97 PLBD Number of Previous Live Births now dead [do not include this child] .....	196
	6.6.1.1.98 PLBL Number of Previous Live Births now living [do not include this child] .....	197
325	6.6.1.1.99 OWGEST Obstetric Estimate of Gestation .....	198
	6.6.1.1.100 CERV Obstetric Procedures [Cervical cerclage] .....	199
	6.6.1.1.101 ECVF Obstetric Procedures [Failed External cephalic Version] .....	200
	6.6.1.1.102 ECVS Obstetric Procedures [Successful External cephalic version] ...	200
	6.6.1.1.103 TOC Obstetric Procedures [Tocolysis] .....	201
330	6.6.1.1.104 NOA03 Obstetric Procedures [None of the above] .....	202
	6.6.1.1.105 PROM Onset of Labor [Premature Rupture] .....	203
	6.6.1.1.106 PRIC Onset of Labor [Precipitous Labor] .....	203
	6.6.1.1.107 PROL Onset of Labor [Prolonged Labor] .....	204
335	6.6.1.1.108 NOA05 Onset of Labor [None of the above NOTE: NOA05 is also used for Maternal Morbidity] .....	205
	6.6.1.1.109 SFN Place Where Birth Occurred [State Facility Number] .....	206
	6.6.1.1.110 FLOC Where Birth Occurred [Facility City/Town] .....	207
	6.6.1.1.111 CNAME Where Birth Occurred [County Name] .....	207
	6.6.1.1.112 CNTYO Where Birth Occurred [County Code] .....	208
340	6.6.1.1.113 BPLACE Where Birth Occurred [Birth Place] .....	209
	6.6.1.1.114 PLUR Plurality .....	212
	6.6.1.1.115 DOFP_MO Prenatal Care Visits [Month] .....	213
	6.6.1.1.116 DOFP_DY Prenatal Care Visits [Day] .....	214
	6.6.1.1.117 DOFP_YR Prenatal Care Visits [Year] .....	215
345	6.6.1.1.118 NPREV Prenatal Care Visits [Total number of prenatal visits for this pregnancy] .....	216
	6.6.1.1.119 PAY Principal Source of Payment for this Delivery .....	217
	6.6.1.1.120 PDIAB Risk Factors in this Pregnancy [Pre-pregnancy Diabetes] .....	217
	6.6.1.1.121 GDIAB Risk Factors in this Pregnancy [Gestational Diabetes] .....	218
350	6.6.1.1.122 PHYPE Risk Factors in this Pregnancy [Prepregnancy Hypertension] .....	219
	6.6.1.1.123 GHYPE Risk Factors in this Pregnancy [Gestational Hypertension] ...	220
	6.6.1.1.124 EHYPE Risk Factors in this Pregnancy [Eclampsia] .....	221
	6.6.1.1.125 PPB Risk Factors in this Pregnancy [Previous preterm births] .....	222

	6.6.1.1.126 INFT Risk Factors in this Pregnancy [Infertility treatment] .....	223
355	6.6.1.1.127 INFT_DRG Risk Factors in this Pregnancy [Fertility Enhancing Drugs, AI] .....	223
	6.6.1.1.128 INFT_ART Risk Factors in this Pregnancy [Asst. Rep. Technology] ..	224
	6.6.1.1.129 PCES Risk Factors in this Pregnancy [Previous cesarean] .....	225
360	6.6.1.1.130 NPCES Risk Factors in this Pregnancy [Number of previous cesareans] .....	226
	6.6.1.1.131 NOA01 Risk Factors in this Pregnancy [None of the above].....	227
	6.6.1.1.132 SORD Set Order .....	228
	6.6.1.1.133 FSEX Child [fetus) Sex] .....	229
	6.6.1.1.134 FDOD_YR Date of Delivery [(Fetus) Year] .....	230
365	6.6.1.1.135 FDOD_MO Derivation Rule Date of Delivery [Fetus) Month] .....	231
	6.6.1.1.136 FDOD_DY Date of Delivery [Fetus) Day] .....	231
	6.6.1.1.137 ETIME Estimated Time of Fetal Death.....	232
	6.6.1.1.138 LIVEB Not Single Birth [specify number of infants in this delivery born alive.] .....	233
370	6.6.1.1.139 FDTH Number of Fetal Deaths .....	234
	6.6.1.1.140 HYST Method of Delivery [Hysterotomy/Hysterectomy] .....	235
	6.6.1.1.141 TD Time of Delivery .....	236
	6.6.1.1.142 AUTOP Was an Autopsy Performed? .....	236
	6.6.1.1.143 FWO Weight of Fetus [in ounces].....	237
375	6.6.1.1.144 FWG Weight of Fetus [grams preferred, specify unit].....	238
	6.6.1.1.145 FWP Weight of Fetus [in pounds] .....	239
	6.6.1.1.146 LM Infections Present and Treated During this Pregnancy [Listeria]..	240
	6.6.1.1.147 GBS Infections Present and Treated During this Pregnancy [Group B Streptococcus].....	241
380	6.6.1.1.148 CMV Infections Present and Treated During this Pregnancy [Cytomeglovirus] .....	242
	6.6.1.1.149 B19 Infections Present and Treated During this Pregnancy [Parvovirus] .....	242
	6.6.1.1.150 HISTOP Was a Histological Placental Examination Performed? .....	243
385	6.6.1.1.151 TOXO Infections Present and Treated During this Pregnancy [Toxoplasmosis].....	244
	6.6.1.1.152 PNC.....	245
	6.6.4 Discrete Data Import Element Mappings From APS to LDS-VR Content Document .....	246
390	6.6.5 QRPH Data Mapping to Provider FHIR Resources .....	253
	6.6.5.1 Provider FHIR Resource Bundle Content .....	253
	6.6.5.2 FHIR Resource Data Specifications .....	256
	6.6.2 QRPH BFDR Provider Reporting FHIR Document Composition Bundle Content Specification .....	278
395	6.6.2.1 Referenced Standards .....	278
	6.6.2.2 Live Birth Report FHIR Provider Document Composition Bundle Content ...	278



## Introduction to this Supplement

Whenever possible, IHE profiles are based on established and stable underlying standards. However, if an IHE domain determines that an emerging standard has high likelihood of industry adoption, and the standard offers significant benefits for the use cases it is attempting to address, the domain may develop IHE profiles based on such a standard. During Trial Implementation, the IHE domain will update and republish the IHE profile as the underlying standard evolves.

Product implementations and site deployments may need to be updated in order for them to remain interoperable and conformant with an updated IHE profile.

This BFDR-E Profile incorporates content from Release 4 of the HL7<sup>®</sup> FHIR<sup>®</sup> specification. HL7 describes FHIR Change Management and Versioning at <https://www.hl7.org/fhir/versions.html>.

HL7 provides a rating of the maturity of FHIR content based on the FHIR Maturity Model (FMM): level 0 (draft) through N (Normative). See <http://hl7.org/fhir/versions.html#maturity>.

The FMM levels for FHIR content used in this profile are:

FHIR Resource Name	FMM Level
Composition	2
MedicationAdministration	2
Procedure	3
Observation	5
Condition	3
Encounter	2
Patient	5
Coverage	2

415 This supplement references the following documents<sup>1</sup>. The reader should review these documents as needed:

1. PCC Technical Framework, Volume 1

---

<sup>1</sup> The first six documents can be located on the IHE Website at [http://www.ihe.net/Technical\\_Frameworks](http://www.ihe.net/Technical_Frameworks). The remaining documents can be obtained from their respective publishers.

2. PCC Technical Framework, Volume 2
3. PCC Technical Framework Supplement: CDA Content Modules
4. [IT Infrastructure Technical Framework Volume 1](#)
- 420 5. [IT Infrastructure Technical Framework Volume 2](#)
6. [IT Infrastructure Technical Framework Volume 3](#)
7. HL7 and other standards documents referenced in Volume 1 and Volume 2
8. Birth Edit Specifications for the 2003 Revision of the U.S. Standard Certificate of Live Birth (4/2004; 3/2005; Updated 7/2012)
- 425 9. Natality 2003 Revision – File In-Processing Documentation (14 Dec 2010)
10. Fetal Death Edit Specifications for the 2003 Revision of the U.S. Standard Report of Fetal Death.
11. International Classification of Diseases, Tenth Revision (ICD-10)
- 430 12. Reference: Making Every Baby Count Audit and review of stillbirths and neonatal deaths  
<http://apps.who.int/iris/bitstream/10665/249523/1/9789241511223-eng.pdf?ua=1>
  - 12.1 This document contains WHO statistics for prenatal data, labor and delivery data, and some newborn data, the latter being focused on stillborn and newborn deaths.

## Open Issues and Questions

435

Item Count	Issue Description	Status
1	Failed External cephalic Version – mapping to CDA output is listed as ‘Pending’ due to underlying HL7 Specification – missing. Profiling deferred pending HL7 resolution of the modelling.	Further discussion with HL7 pending.
2	Addition of FHIR resources is deferred at this time	Will revisit pending additional work in this area.
3	Consider a Data Consumer Option or binding for Content Creator when adding FHIR to this profile.	
4	The HL7 CDA IG for Birth and Fetal Death Reporting will be updated to align with in-progress updates to the v2.6 messaging implementation guide. Mapping of new attributes included in the messaging guide have not yet been mapped to the CDA mapping in volume 3.	This mapping will be updated once the underlying HL7 CDA IG is updated with this content.
5	NCHS will be updating the references and links for newly released Edit Specifications and forms for Birth and Fetal Death Reporting.	Awaiting link update content from NCHS
6	NCHS will be reviewing the recently deleted items.	Updates to content may be applied for deleted items.

IHE Quality, Research and Public Health Technical Framework Supplement – Birth and Fetal Death Reporting-Enhanced (BFDR-E)

Item Count	Issue Description	Status
7	Referencing the Child's record in FHIR mapping should be reviewed in public comment.	Pending public comment review and feedback
8	Observations for the Fetus in FHIR may need to be expressed as observations for the mother as there may be no record for the fetus created.	Pending public comment review and feedback. If observations are needed for the mother's record, then we will need to request LOINC Codes
9	Father's Education Level is not available through link.RelatedPerson which is the mechanism for FHIR to reference the father of the child.	May be considered for extensions to RelatedPerson.
10	All FHIR Mappings need to be reviewed for replicating structure definitions to remove US-CORE for Volume3	Pending public comment review and feedback
11	<i>Method of Delivery Trial Labor Finding (NCHS)</i> Has not value set to link to at this time. Use "90306000 Trial labor (finding)" from SNOMED-CT	Pending public comment review and feedback
12	Need to find a way to represent Logic for <b>\$VitalSignsResultUnits</b> in Mother's Pre-pregnancy Weight	Pending public comment review and feedback
13	<b>\$BabyFacilityLocation</b> in Source in EMR Using CDA Labor and Delivery Summary-VR XPATH (1b) "This derivation rule is subject to Realm specificity. For example, in the US, a value set lookup using the code from CNTYO." Needs to be reviewed.	Pending public comment review and feedback
14	In the 6.6.1.1.127 INFT_DRG Risk Factors in this Pregnancy table <b>Example</b> – "OBX 19 CWE 73775-9^Risk factors in this pregnancy^LN  445151000124101^ Fertility enhancing drug therapy^SNM     F" Value no longer exists, in SNOMED	Pending public comment review and feedback
15	6.6.1.1.150 HISTOP Was a Histological Placental Examination Performed " <b>\$EventOutcomesObservationValue</b> " Previous logic may have included this value set: ( <a href="#">Histological Placental Examination Performed (NCHS)</a> )Logic update may be needed.	Pending public comment review and feedback
16	Naming of the Observation - Mother Received WIC Foodis US centric, will have to be renamed for this IHE profile to fully adhere to international terminology	Pending public comment review and feedback
17	Add Manual Assisted Ventilation with OID	CDC Verifying

## Closed Issues

Item	Issue Description	Status
1	Do we continue to offer grouping guidance?	No required grouping

IHE Quality, Research and Public Health Technical Framework Supplement – Birth and Fetal Death Reporting-Enhanced (BFDR-E)

Item	Issue Description	Status
2	We will need to review whether both XPHR and MS are both appropriate for this profile or whether we need to limit to MS to capture the required attributes for the U.S. death report. Also, the HL7 Continuity of Care Document (CCD).	Considerations deferred. Continue with LDS. Pre-population using currently CCDA will remain out of scope pending IHE harmonization efforts. CCDA Refactoring impact on XPHR, MS, CCD references.
3	We will need to review whether both XPHR and MS are both appropriate for this profile or whether we need to limit to MS to capture the required attributes for the U.S. death report. Also, the HL7 Continuity of Care Document (CCD).	Considerations deferred. Continue with LDS. Pre-population using currently CCDA will remain out of scope pending IHE harmonization efforts. CCDA Refactoring impact on XPHR, MS, CCD references.
4	The 'Save Form For Continued Editing' Option on the Form Manager has no specific strategies identified.	George Cole confirmed this is intended and supported functionality for RFD.
5	Review representation of RFD pre-pop options with 2 CDA pre-pop documents (LDS and LDHP) and content constrained by this profile	Can be done, but committee selected to update LDS-VR rather than use 2 pre-pop documents based on implementer feedback
6	TEMPLATE OPEN ISSUE: The template does not really support the need to specify the mappings for the form receiver message exporter, form receiver CDA exporter, and the Pre-population requirements for the Form Manager. These have been reflected together as sub-sections to 6.3.1.D.4 Data Element Requirement Mappings.	Resolved: Referred to documentation.
7	Template Issue: Where should the list of data elements be specified in this new template? In the past, they were included in X.6 Content Module in some profiles. We have tentatively included a new Section X.7 Data Requirements until this issue has been resolved.	Added a reference to the Appendix in X.7 as follows: This profile defines specific data element content. These data elements are used to create the HL7 CDA Birth and Fetal Death Reporting Document, generate the HL7 BFDR-E Message, or populate a form defined to gather the required structured data, such as the US BFDR-E Form. That set of data elements in the form are identified and defined in Appendix B.
8	Should there be only one option, the LDS-VR Option' – this had been considered but we want to be able to offer a lower participation threshold where possible – the pre-pop Option may need to be renamed, but it supports the LDS or the LDS-VR document.	Resolved.
9	The use of Null flavors for unknown is under review by HL7. This is slated for discussion in May HL7. This also impacts the output mapping to CDA documents as we are 'silent' on how to handle the 'N' status of each observation.	This has been resolved in the HL7 IG and does not need to be further constrained. Clarified the mapping in handling UNKNOWN.

IHE Quality, Research and Public Health Technical Framework Supplement – Birth and Fetal Death Reporting-Enhanced (BFDR-E)

Item	Issue Description	Status
10	<p>Review of Birth vs FDeath Forms to assess any impact on logic in using numbers as a reference. Some information is needed in one form vs the other, and there may be differences in the information captured on the form for similar concepts.</p> <p>There are differences in the form numbers between the 2 documents, so any reference to the form numbers needs to be handled separately between birth and fetal death.</p>	Added 2 tables to volume 4 to clarify the mapping to the two US forms.
11	HL7 CDA document is missing specification of UCUM units for some metrics. No profiling added pending HL7 resolution of this issue.	HL7 spec already references the data type PQ, so no change needed.
12	PPO: DEPRECATED. Sample forms do not reflect that this is removed at this time	Removed forms from Vol 1 Appendix A.1 and A.2 for the BC and FD to replace with NCHS web links to these forms. Also, need guidance from DVS to include language that indicates removed items from form
13	International considerations for form options currently identified as US Form Option on form manager	No change needed. BFDR-E Form Manager has already been generalized to Form Pre-pop Option
14	Need to post sample CDA documents for BFDR-Birth and BFDR-FD	No change to profile. Update FTP site with samples from CDA IG.
15	Fever Greater Than 100.4 (NCHS) value set - This is not likely to be present on a problem list and instead will be represented in discrete data if the temperature was taken	Decided to limit prepopulation for this item when fever greater than 100.4 is on the problem list and chorioamnionitis.
16	Timing and capture of chromosomal/congenital conditions is not necessarily conducive to clinical workflow (e.g., suspected is not usually documented in the record). Review of systems is probably correct, but missing symptoms or other observations that would specifically put this into a status of ‘suspected’	We are looking for a finding in the general appearance section.
17	The finalized and published HL7 CDA STU documents are expected to be available to HL7 members early June 2014, and to non-members by early September 2014.	All of the HL7 VR related standards have been published as STUs and are posted on the HL7 STU comments website.
18	The number of fetal deaths in the delivery (FDTH) is not currently mapped to the HL7 CDA Fetal Death Document. There is currently no attribute in the CDA given that there is no request for this information on the forms used as a basis for this work.	Included the mapping for FDTH for consistency with the HL7 CDA IG



## **IHE Technical Frameworks General Introduction**

440 The [IHE Technical Framework General Introduction](#) is shared by all of the IHE domain technical frameworks. Each technical framework volume contains links to this document where appropriate.

### **9 Copyright Licenses**

445 IHE technical documents refer to, and make use of, a number of standards developed and published by several standards development organizations. Please refer to the IHE Technical Frameworks General Introduction, [Chapter 9 - Copyright Licenses](#) for copyright license information for frequently referenced base standards. Information pertaining to the use of IHE International copyrighted materials is also available there.

### **10 Trademark**

450 IHE<sup>®</sup> and the IHE logo are trademarks of the Healthcare Information Management Systems Society in the United States and trademarks of IHE Europe in the European Community. Please refer to the IHE Technical Frameworks General Introduction, [Chapter 10 - Trademark](#) for information on their use.

## IHE Technical Frameworks General Introduction Appendices

455 The [IHE Technical Framework General Introduction Appendices](#) are components shared by all of the IHE domain technical frameworks. Each technical framework volume contains links to these documents where appropriate.

460 *Update the following appendices to the General Introduction as indicated below. Note that these are **not** appendices to this domain's Technical Framework (TF-1, TF-2, TF-3 or TF-4) but rather, they are appendices to the IHE Technical Frameworks General Introduction located [here](#).*

### [Appendix A – Actors](#)

465

*Add the following **new or modified** actors to the [IHE Technical Frameworks General Introduction Appendix A](#):*

Actor	Definition
Data Consumer	The Data Consumer is responsible for initiating a query to a Data Responder for resource information, and receiving the result of the query.
Data Responder	The Data Responder is responsible for receiving a query and supplying the corresponding resource information.
Form Receiver Document Exporter	This Form Receiver Document Exporter receives data submitted through the Submit Form [ITI-35] transaction, transforms that data to create a document, and shares that newly created document with a Content Consumer.
Form Processor Document Exporter	This Form Processor Document Exporter receives data submitted through the Submit Form [ITI-35] transaction, transforms that data to create a document, and shares that newly created document with a Content Consumer.
Form Receiver Message Exporter	This Form Receiver Message Exporter receives data submitted through the Submit Form [ITI-35] transaction, transforms that data to an HL7 message, and sends that message to an Information Recipient.
Form Processor Message Exporter	This Form Processor Message Exporter receives data submitted through the Submit Form [ITI-35] transaction, transforms that data to an HL7 message, and sends that message to an Information Recipient.

470

## Appendix B – Transactions

475 Add the following *new or modified* transactions to the [IHE Technical Frameworks General Introduction Appendix B](#):

Transaction	Definition
BFDRQuery [QRPH-46]	This transaction connects a Data Consumer to a Data Responder to allow query/retrieve of birth or fetal death reporting related health information.

## Appendix D – Glossary

480 Add the following *new or modified* glossary terms to the [IHE Technical Frameworks General Introduction Appendix D](#):

Glossary Term	Definition
Apgar score	Apgar score is a systematic measure for evaluating the physical condition of the infant at specific intervals following birth. It is a score that assesses the general physical condition of a newborn or infant by assigning a value of 0, 1, or 2 to each of five criteria: heart rate, respiratory effort, muscle tone, skin color, and response to stimuli. The five scores are added together, with a perfect score being 10. Apgar scores are usually evaluated at one minute and five minutes after birth. If the 5 minute Apgar score is < 6 then additional Apgar scores at 10 minutes are required.
Antibiotic	Antibiotic is a chemotherapeutic agent that inhibits or abolishes the growth of micro-organisms, such as bacteria, fungi, or protozoans.
Anorexia	Anorexia nervosa is a psychiatric illness that describes an eating disorder characterized by extremely low body weight and body image distortion with an obsessive fear of gaining weight.
Asthma	Asthma is a chronic (long-lasting) inflammatory disease of the airways. In those susceptible to asthma, this inflammation causes the airways to narrow periodically; this, in turn, produces wheezing and breathlessness, sometimes to the point where the patient gasps for air.
Breech presentation	Breech presentation is a presentation of the fetal buttocks or feet in labor; the feet may be alongside the buttocks (complete breech presentation); the legs may be extended against the trunk and the feet lying against the face (frank breech presentation); or one or both feet or knees may be prolapsed into the maternal vagina (incomplete breech presentation).
Cesarean section	Cesarean section, or C-section, is an extraction of the fetus, placenta, and membranes through an incision in the maternal abdominal and uterine walls.
Cephalic presentation	Cephalic presentation is the presentation of part of the fetus, listed as vertex, occiput anterior (OA), occiput posterior (OP).

IHE Quality, Research and Public Health Technical Framework Supplement – Birth and Fetal Death Reporting-Enhanced (BFDR-E)

Glossary Term	Definition
Cerebral palsy	Cerebral palsy describes a group of permanent disorders of the development of movement and posture, causing activity limitation, that are attributed to nonprogressive disturbances that occurred in the developing fetal or infant brain. The motor disorders of cerebral palsy are often accompanied by disturbances of sensation, perception, cognition, communication, and behavior, by epilepsy, and by secondary musculoskeletal problems.
Chromosome abnormalities	Chromosome abnormalities consist of any change occurring in the structure or number of any of the chromosomes of a given species. In humans, a number of physical disabilities and disorders are directly associated with aberrations of both the autosomes and the sex chromosomes, including Down, Turner's, and Klinefelter's syndromes.
Cleft lip	Cleft lip with or without cleft palate is the incomplete closure of the lip. It may be unilateral, bilateral, or median.
Cleft palate	Cleft palate is an incomplete fusion of the palatal shelves. It may be limited to the soft palate or may extend into the hard palate.
Congenital heart defect	Congenital heart defect (CHD) is a defect in the structure of the heart and great vessels of a newborn. Obstruction defects. CHD can be classified as: Obstruction defects occur when heart valves, arteries, or veins are abnormally narrow or blocked. Septal defects, for defects concerning the separation between left heart and right heart. Cyanotic defects, including persistent truncus arteriosus, total anomalous pulmonary venous connection, tetralogy of Fallot, transposition of the great vessels, and tricuspid atresia.
Congenital hip dysplasia	Congenital hip dysplasia is a hip joint malformation present at birth, thought to have a genetic component Clinical Hip dislocation, asymmetry of legs and fat folds; congenital hip dislocation may be asymptomatic and must be diagnosed by physical examination.
Cystic fibrosis	Cystic fibrosis (CF) is an inherited disease that affects the lungs, digestive system, sweat glands, and male fertility. Its name derives from the fibrous scar tissue that develops in the pancreas, one of the principal organs affected by the disease.
Down syndrome	Down syndrome or trisomy 21 is a genetic disorder caused by the presence of all or part of an extra 21st chromosome.
Eczema	Eczema is an acute or chronic noncontagious inflammation of the skin, characterized chiefly by redness, itching, and the outbreak of lesions that may discharge serous matter and become encrusted and scaly.
Endocrine disorder	Endocrine system is an integrated system of small organs which involve the release of extracellular signaling molecules known as hormones. Hypofunction of endocrine glands can occur as result of loss of reserve, hyposecretion, agenesis, atrophy or active destruction. Hyperfunction can occur as result of hypersecretion, loss of suppression, hyperplastic or neoplastic change, or hyperstimulation.
Epidural anesthesia	Epidural anesthesia is a regional anesthetic that is administered to the mother to control the pain of labor. It includes delivery of the agent into a limited space with the distribution of the analgesic effect limited to the lower body.
Esophageal atresia	Congenital esophageal atresia (EA) represents a failure of the esophagus to develop as a continuous passage. Instead, it ends as a blind pouch.
Food allergies	Food allergies are the body's abnormal responses to harmless foods; the reactions are caused by the immune system's reaction to some food proteins.

IHE Quality, Research and Public Health Technical Framework Supplement – Birth and Fetal Death Reporting-Enhanced (BFDR-E)

Glossary Term	Definition
Gastroesophageal reflux	Gastroesophageal reflux is the reflux of the stomach and duodenal contents into the esophagus.
Gastroschisis	Gastroschisis is an abnormality of the anterior abdominal wall, lateral to the umbilicus, resulting in herniation of the abdominal contents directly into the amniotic cavity. It is differentiated from omphalocele by the location of the defect and the absence of a protective membrane.
General anesthesia	General anesthesia is the induction of a state of unconsciousness with the absence of pain sensation over the entire body, through the administration of anesthetic drugs. It is used during certain medical and surgical procedures.
Genitourinary tract	Genitourinary tract is the organ system of all the reproductive organs and the urinary system. These are often considered together due to their common embryological origin.
Gestational age (weeks of amenorrhea)	One measure of gestational age is the number of completed weeks elapsed between the first day of the last normal menstrual period and the date of delivery. Gestational age can also be measured based on ultrasound early in pregnancy.
Gestational diabetes	Gestational diabetes – glucose intolerance requiring treatment - is a condition that occurs during pregnancy. Like other forms of diabetes, gestational diabetes involves a defect in the way the body processes and uses sugars (glucose) in the diet.
Heart malformation	Heart malformation or congenital heart defect (CHD) is a defect in the structure of the heart and great vessels of a newborn. Most heart defects either obstruct blood flow in the heart or vessels near it or cause blood to flow through the heart in an abnormal pattern, although other defects affecting heart rhythm can also occur.
Hemoglobin disease	<p>Hemoglobin is produced by genes that control the expression of the hemoglobin protein. Defects in these genes can produce abnormal hemoglobins and anemia, which are conditions termed "hemoglobinopathies". Abnormal hemoglobins appear in one of three basic circumstances:</p> <p>Structural defects in the hemoglobin molecule.</p> <p>Diminished production of one of the two subunits of the hemoglobin molecule.</p> <p>Abnormal associations of otherwise normal subunits.</p>
Hydrocephalus	Hydrocephalus is the abnormal accumulation of cerebrospinal fluid (CSF) in the ventricles, or cavities, of the brain. This may cause increased intracranial pressure inside the skull and progressive enlargement of the head, convulsion, and mental disability.
Immunoglobulin	Immunoglobulin is a concentrated preparation of gamma globulins, predominantly IgG, from a large pool of human donors; used for passive immunization against measles, hepatitis A, and varicella and for replacement therapy in patients with immunoglobulin deficiencies.
Induction of labor	Induction of labor is the initiation of uterine contractions by medical and/or surgical means for the purpose of delivery before the spontaneous onset of labor (i.e., before labor has begun).
In-utero transfer	An in-utero transfer consists in transferring, while the fetus is still in-utero, of the high-risks pregnant mother to another specialized birthing facility. Conversely, post-natal transfers are transfers that occur after the delivery.
Intra-uterine growth retardation (IUGR)	Intrauterine growth retardation (IUGR) occurs when the unborn baby is at or below the 10th weight percentile for his or her age (in weeks).
Intubation	Tracheal intubation is the placement of a flexible plastic tube into the trachea to protect the patient's airway and provide a means of mechanical ventilation.
Meningomyelocele	Meningomyelocele is a herniation of the meninges and spinal cord tissue.

IHE Quality, Research and Public Health Technical Framework Supplement – Birth and Fetal Death Reporting-Enhanced (BFDR-E)

<b>Glossary Term</b>	<b>Definition</b>
Neural tube defects	Neural tube defect will occur in human embryos if there is an interference with the closure of the neural tube.
Nuchal translucency scan	Nuchal translucency scan is an ultrasonographic prenatal screening scan to help identify higher risks of Down syndrome in a fetus. The scan is carried out at 11-13 weeks pregnancy and assesses the amount of fluid behind the neck of the fetus. Fetuses at risk of Down tend to have a higher amount of fluid around the neck.
Omphalocele	Omphalocele is a defect in the anterior abdominal wall, accompanied by herniation of some abdominal organs through a widened umbilical ring into the umbilical stalk
Pre-eclampsia	Pre-eclampsia is a disorder occurring during late pregnancy or immediately following parturition, characterized by hypertension, edema, and proteinuria. Also called toxemia of pregnancy.
Preterm birth	Preterm birth is a live birth of less than 37 completed weeks of gestation.
Premature labor	Premature labor describes the contractions of the uterus less than 37 weeks in a pregnancy.
Presentation	Presentation is the part of the fetus lying over the pelvic inlet; the presenting body part of the fetus.
Polymalformative syndrome	Polymalformative syndrome is set of non-random birth defects deriving from the same cause. It involves multiple systems of the organism (eyes, ears, central nervous system, heart, musculoskeletal...). Its screening, mostly by clinical examination means, is systematically made at birth.
Spina bifida	Spina bifida is a herniation of the meninges and/or spinal cord tissue through a bony defect of spine closure.
Spinal anesthesia	Spinal anesthesia or sub-arachnoidal block is a form of regional anesthesia involving the injection of local anesthetic into the cerebrospinal fluid.
Fetal death	Fetal death is a death prior to the complete expulsion or extraction from its mother of a product of human conception, irrespective of the duration of pregnancy and which is not an induced termination of pregnancy. The death is indicated by the fact that after such expulsion or extraction, the fetus does not breathe or show any other evidence of life, such as beating of the heart, pulsation of the umbilical cord, or definite movement of the voluntary muscles. Heartbeats are to be distinguished from fleeting respiratory efforts or gasps.
Metabolism disorder	Metabolism disorders are disorders that affect chemical processes that take place in living organisms, resulting in growth, generation of energy, elimination of wastes, and other body functions as they relate to the distribution of nutrients in the blood after digestion.
Ultrasound	Ultrasound study is a radiologic study using sound waves used in the assessment of gestational age, size, growth, anatomy, and blood flow of a fetus or in the assessment of maternal anatomy and blood flow.
Vaginal birth/spontaneous	Vaginal birth/spontaneous birth is the delivery of the entire fetus through the vagina by the natural force of labor with or without manual assistance from the delivery attendant.
Vaginal birth with forceps	Vaginal birth with forceps is the delivery of the fetal head through the vagina by the application of obstetrical forceps to the fetal head.
Vaginal birth with vacuum	Vaginal birth with vacuum is the delivery of the fetal head through the vagina by the application of a vacuum cup or ventouse to the fetal head.
Vertex Presentation	Vertex presentation is the presentation of the upper or back part of the infant's head

## Volume 1 - Profiles

### 485 **Domain-specific additions**

None

<i>Add new Section X</i>
--------------------------

### 490 **X Birth and Fetal Death Reporting-Enhanced (BFDR-E) Profile**

The Birth and Fetal Death Reporting-Enhanced (BFDR-E) Profile provides a means to capture and communicate information needed to report births and fetal deaths for vital registration purposes. BFDR-E builds upon the earlier Birth and Fetal Death Reporting (BFDR) Profile that utilizes actors and transactions defined in the ITI Retrieve Form for Data Capture (RFD) Profile or the Mobile Retrieve Form for Data Capture (mRFD) Profile to capture structured data using digital forms.

BFDR-E defines a specialized Labor and Delivery Summary (LDS-VR) CDA document. The LDS-VR document is used to prepopulate an electronic form (worksheet) that collects the information needed for submission to vital records according to specified pre-population rules. BFDR-E supports pre-population of the worksheet form using either the specialized LDS-VR document or a more general Labor and Delivery Summary (LDS) document that does not conform to all the further constraints of an LDS-VR document. Use of the LDS-VR Pre-population Option optimizes the initial Birth and Fetal Death Report form data population.

BFDR-E also defines a FHIR query and associated pre-population rules to be used with mRFD to pre-populate the provider report form.

BFDR-E further defines a mechanism to transform form submission data and record it in a FHIR document designed to exchange the information in a standard format. BFDR-E defines Form Receiver Document Exporter and Form Processor Document Exporter Actors to perform the transform on the form submission data and share that document with a Content Consumer. BFDR-E defines the IHE BFDR Document Template which adapts the HL7 BFDR FHIR document to support standard interchange of the information gathered from the form.

BFDR-E also defines a mechanism to transform form submission data and transmit it as a standard HL7 v2 message. The BFDRFeed [QRPH-37] transaction adapts the HL7 V2.6 BFDR Message for this purpose. BFDR-E defines the BFDRFeed transaction to transmit this message.

515 **X.1 BFDR-E Actors, Transactions, and Content Modules**

This section defines the actors, transactions, and/or content modules in this profile. General definitions of actors are given in the Technical Frameworks General Introduction Appendix A at [http://www.ihe.net/Technical\\_Frameworks](http://www.ihe.net/Technical_Frameworks).

520 The BFDR-E Profile defines three ways to exchange data required for birth and fetal death reporting in an electronic form. First, creation of a BFDR Provider Live Birth FHIR Report Document and a BFDR Provider Fetal Death Report Document is supported. Second, communication of the BFDR content in an HL7 message is supported. Third, a form-based data collection method is supported using RFD transactions and pre-population from a Labor and Delivery Summary Document (LDS) to supplement human data entry. A specialized LDS-VR document is specified to maximize the number of data elements that can be prepopulated in the form so as to minimize the amount of human data entry required. The form data may be used directly by a birth reporting system, or there may be further processing of the form data to produce standard birth and fetal death content in the BFDR Birth FHIR Document, the BFDR Fetal Death FHIR Document, or the BFDR message format.

525  
530 Figure X.1-1 shows the actors directly involved in the BFDR-E Profile and the relevant transactions between them.

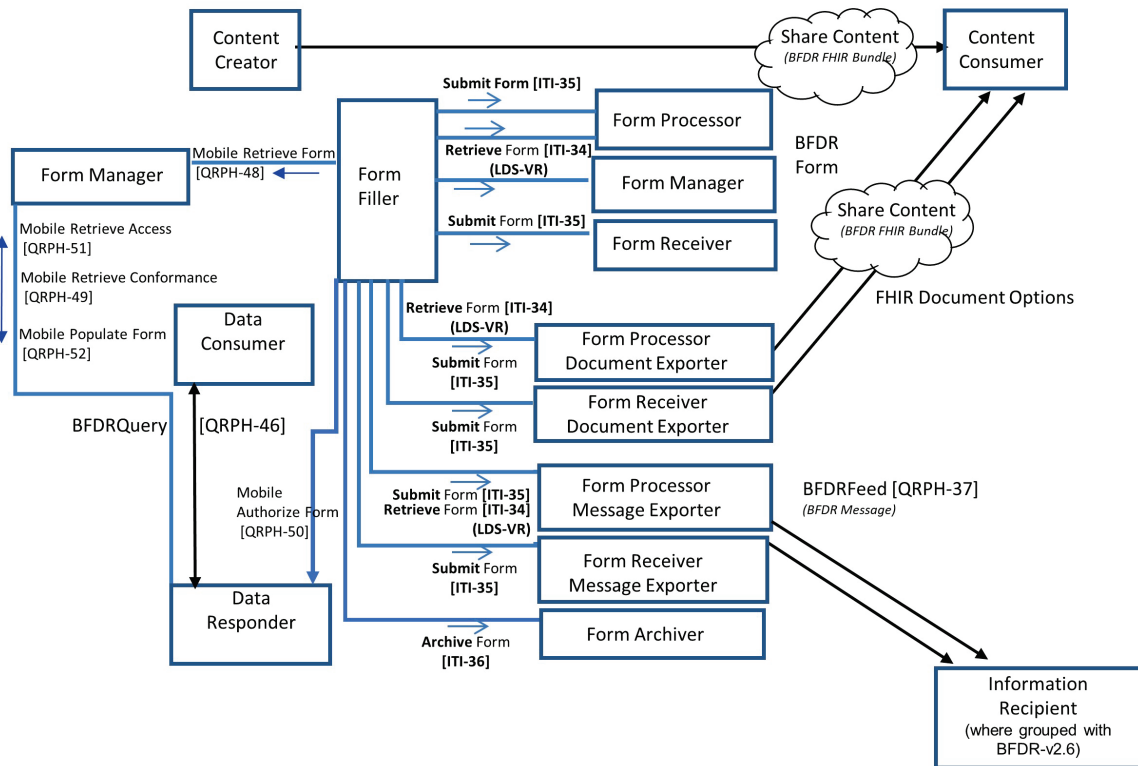

**Figure X.1-1: BFDR-E Actor Diagram**



**Table X.1-1: BFDR-E Profile - Actors and Transactions**

<b>Actors</b> (see Note 1 and Note 2)	<b>Transactions</b>	<b>Optionality</b>	<b>TF Reference</b>
Form Filler	Retrieve Form [ITI-34]	R	ITI TF-2: 3.34
	Submit Form [ITI-35]	R	ITI TF-2: 3.35
	Archive Form [ITI-36]	O	ITI TF-2: 3.36
	Mobile Retrieve form (Request) [QRPH-48]	C <sup>Note1</sup>	QRPH TF-2: 3.48.4.1
	Mobile Authorize Form [QRPH-50]	C <sup>Note1</sup>	QRPH TF-2: 3.50.4.1
Form Manager	Retrieve Form [ITI-34]	R	ITI TF-2: 3.34
	Mobile Populate Form (Request) [QRPH-52]	C <sup>Note2</sup>	QRPH TF-2: 3.52.4.1
	Mobile Retrieve Access Token (Request) [QRPH51]	C <sup>Note2</sup>	QRPH TF-2: 3.51.4.1
	Mobile Retrieve Form (Response) [QRPH-48]	C <sup>Note2</sup>	QRPH TF-2: 3.48.4.1
	Mobile Retrieve Capability (Request) [QRPH-49]	C <sup>Note2</sup>	QRPH TF-2: 3.49.4.1
Form Processor	Retrieve Form [ITI-34]	R	ITI TF-2: 3.34
	Submit Form [ITI-35]	R	ITI TF-2: 3.35
Form Receiver	Submit Form [ITI-35]	R	ITI TF-2: 3.35
Form Receiver Document Exporter	Submit Form [ITI-35]	R	ITI TF-2: 3.35
Form Processor Document Exporter	Submit Form [ITI-35]	R	ITI TF-2: 3.35
	Retrieve Form [ITI-34]	R	ITI TF-2: 3.34
Form Receiver Message Exporter	Submit Form [ITI-35]	R	ITI TF-2: 3.35
	BFDRFeed [QRPH-37]	R	QRPH TF 2: 3.37
Form Processor Message Exporter	Submit Form [ITI-35]	R	ITI TF-2: 3.35
	Retrieve Form [ITI-34]	R	ITI TF-2: 3.34
	BFDRFeed [QRPH-37]	R	QRPH TF 2: 3.37
Form Archiver	Archive Form [ITI-36]	R	ITI TF-2: 3.36
Data Consumer	BFDRQuery [QRPH-46]	R	QRPH TF 2: 3.46
Data Responder	BFDRQuery [QRPH-46]	R	QRPH TF 2: 3.46
	Mobile Populate Form (Response) [QRPH-52]	R	QRPH TF-2: 3.52.4.2
	Mobile Authorize Form (Response) [QRPH-50]	O	QRPH TF-2: 3.50.4.1

Actors (see Note 1 and Note 2)	Transactions	Optionality	TF Reference
	Mobile Retrieve Access Token (Response) [QRPH-51]	O	QRPH TF-2: 3.51.4.1
	Mobile Retrieve Capability (Response)[QRPH-49]	O	QRPH TF-2: 3.49.4.1
Content Creator	NA	NA	NA
Content Consumer	NA	NA	NA

535 Note 1: The Form Filler must support at least one of RFD or mRFD. If the Form Filler supports RFD, it SHALL support Retrieve Form [ITI-34] and Submit Form [ITI-35]. If the Form Filler supports mRFD, it SHALL support Mobile Retrieve form (Request) [QRPH-48] and Mobile Authorize Form [QRPH-50]

540 Note 2: The Form Manager must support at least one of RFD or mRFD. If the Form Filler supports RFD, it SHALL support Retrieve Form [ITI-34]. If the Form Filler supports mRFD, it SHALL support Mobile Populate Form (Request) [QRPH-52], Mobile Retrieve Access Token (Request) [QRPH51], Mobile Retrieve Form (Response) [QRPH-48], and Mobile Retrieve Capability (Request)[QRPH-49]

**Table X.1-2: BFDR-E Profile - Actors and Content Modules**

Actors	Content Modules	Optionality	Reference
Content Creator	BFDR FHIR Document Provider Live Birth Report Composition Bundle	C <sup>Note 1</sup>	QRPH TF-3: 6.6.2
	BFDR FHIR Document Provider Fetal Death Report Composition Bundle	C <sup>Note 1</sup>	QRPH TF-3: 6.6.2
Form Receiver Document Exporter	BFDR FHIR Document Provider Live Birth Report Composition Bundle	C <sup>Note 1</sup>	QRPH TF-3: 6.6.2
	BFDR FHIR Document Provider Fetal Death Report Composition Bundle	C <sup>Note 1</sup>	QRPH TF-3: 6.6.2
Form Processor Document Exporter	BFDR FHIR Document Provider Live Birth Report Composition Bundle	C <sup>Note 1</sup>	QRPH TF-3: 6.6.2
	BFDR FHIR Document Provider Fetal Death Report Composition Bundle	C <sup>Note 1</sup>	QRPH TF-3: 6.6.2
Content Consumer	BFDR Fetal Birth Document (for live births) (1.3.6.1.4.1.19376.1.7.3.1.1.19.2)	R	QRPH TF-3: 6.3.1.D1.5
	BFDR Fetal Death Document (for fetal death) (1.3.6.1.4.1.19376.1.7.3.1.1.19.3)	R	QRPH TF-3: 6.3.1.D2.5

Actors	Content Modules	Optionality	Reference
Form Filler with Pre-Pop Option	LDS Document (1.3.6.1.4.1.19376.1.5.3.1.1.21.1.2)	R	PCC Labor and Delivery Profiles Trial Implementation Supplement, Vol 3, Sec 6.3.1.B
Form Filler with LDS-VR Pre-Pop Option	LDS-VR Document (1.3.6.1.4.1.19376.1.7.3.1.1.19.1.1)	R	QRPH TF-3: 6.3.1.D3.5
Form Manager	LDS Document (1.3.6.1.4.1.19376.1.5.3.1.1.21.1.2)	R	PCC Labor and Delivery Profiles Trial Implementation Supplement, Vol 3, Sec 6.3.1.B
	LDS-VR Document (1.3.6.1.4.1.19376.1.7.3.1.1.19.1.1)	R	QRPH TF-3: 6.3.1.D3.5
Form Processor	LDS Document (1.3.6.1.4.1.19376.1.5.3.1.1.21.1.2)	R	PCC Labor and Delivery Profiles Trial Implementation Supplement, Vol 3, Sec 6.3.1.B
	LDS-VR Document (1.3.6.1.4.1.19376.1.7.3.1.1.19.1.1)	R	QRPH TF-3: 6.3.1.D3.5

## X.1.1 Actor Descriptions and Actor Profile Requirements

### 545 X.1.1.1 Content Creator

The Content Creator SHALL be able to create both a valid BFDR Provider Live Birth Composition Bundle and a valid BFDR Provider Fetal Death Composition Bundle.

550 Detailed rules for the BFDR Provider Live Birth Composition Bundle are fully defined in QRPH TF-3: 6.6.2, and detailed rules for the BFDR Provider Fetal Death Composition Bundle are fully defined QRPH TF-3: 6.6.2.

### X.1.1.2 Content Consumer

555 The Content Consumer SHALL consume both a valid BFDR Provider Live Birth Composition Bundle and a valid BFDR Provider Fetal Death Composition Bundle Detailed rules for the BFDR Provider Live Birth Composition Bundle are fully defined in QRPH TF-3: 6.6.2, and detailed rules for the BFDR Provider Fetal Death Composition Bundle are fully defined QRPH TF-3: 6.6.2.

The Content Consumer SHALL implement the Discrete Data Import Option when consuming a QRPH IHE BFDR Provider Live Birth Document or IHE BFDR Provider Fetal Death Document.

560

### **X.1.1.3 Form Filler**

The Form Filler is defined in the ITI Retrieve Form for Data Capture (RFD) Profile and in the QRPH Retrieve Form for Data Capture (mRFD).

The Form Filler SHALL support XHTML of the Retrieve Form [ITI-34] transaction.

565 The form is presented when a certifier is ready to enter birth or fetal death information for the purpose of completing the vital records information.

The Form Filler SHALL support at least one of two possible pre-population options: The LDS Pre-pop Option or the LDS-VR Pre-pop Option.

- 570 • A Form Filler implementing the Pre-Pop Option SHALL supply a valid LDS Document (1.3.6.1.4.1.19376.1.5.3.1.1.21.1.2) as the pre-pop document for the Retrieve Form [ITI-34] transaction.
- A Form Filler implementing the LDS-VR Pre-pop Option SHALL supply a valid LDS-VR Document (1.3.6.1.4.1.19376.1.7.3.1.1.19.1.1) as the pre-pop document for the Retrieve Form [ITI-34] transaction.

575 The Form Filler SHALL encode the prepopData parameter of the Retrieve Form [ITI-34] transaction using the XML content of the pre-pop document.

The Form Filler MAY support the Archive Form Option to support recording of the form submission data at an alternate actor identified by the Form Filler.

580 In order to support the need to save a form for editing at a later time, the Form Filler SHALL be able to request a form for the same patient multiple times. (Further guidance on the workflow requirements to support this capability is outside the scope of this profile.)

### **X.1.1.4 Form Manager**

The Form Manager SHALL support all the requirements defined for the Form Manager in ITI RFD [ITI TF-1:17] and in the QRPH Retrieve Form for Data Capture (mRFD).

585 The Form Manager SHALL support XHTML of the Retrieve Form [ITI-34] transaction.

A Form Manager in the BFDR-E Profile SHALL accept pre-pop data in the form of content defined by the IHE PCC LDS document template (Template id 1.3.6.1.4.1.19376.1.5.3.1.1.21.1.2) or the IHE QRPH LDS-VR document template (Template id 1.3.6.1.4.1.19376.1.7.3.1.1.19.1.1) and return a form that has been appropriately pre-populated based on the pre-population rules specified in QRPH TF-3: 6.3.1.D3.4 Data Element Requirement Mappings for Form Pre-Population.

590

The system fulfilling this role in the BFDR Profile implementing mRFD SHALL gather the Querypopulation data using the Query for Birth Reporting Data (BFDRQuery) [QRPH-47] message to the Data Responder to retrieve the Birth or Fetal Death Reporting data to populate the form. If a form is requested for the same birth or fetal death then the Form Manager shall supply the previously populated and saved form.

595

### **X.1.1.5 Form Receiver**

The Form Receiver is defined in ITI RFD [ITI TF-1:17].

600 The Form Receiver SHALL receive the populated form from the Form Filler when the form is submitted. No further requirements are placed on the Form Receiver within the scope of this profile.

### **X.1.1.6 Form Processor**

The Form Processor is defined in ITI RFD [ITI TF-1:17].

The Form Processor SHALL support XHTML of the Retrieve Form [ITI-34] transaction.

605 A Form Processor in the BFDR-E Profile SHALL accept pre-pop data in the form of content defined by the IHE PCC LDS Profile (1.3.6.1.4.1.19376.1.5.3.1.1.21.1.2 or the IHE QRPH (LDS-VR) (1.3.6.1.4.1.19376.1.7.3.1.1.19.1.1) and return a form that has been appropriately pre-populated based on the mapping rules specified in QRPH TF-3: 6.3.1.D2.4 Data Element Requirement Mappings for Form Pre-Population.

610 If the same request is submitted for the same birth or fetal death then the Form Processor shall supply the previously populated and saved form.

The Form Processor SHALL receive the populated form from the Form Filler when the form is submitted. No further requirements are placed on the Form Processor within the scope of this profile.

615 Note: This actor is not used for mRFD (see Form Manager).

### **X.1.1.7 Form Receiver Document Exporter**

620 The Form Receiver Document Exporter receives data submitted through the Submit Form [ITI-35] transaction, transforms that data to create a FHIR document, and shares that newly created FHIR document with a Content Consumer. For BFDR, this transforms that data to create the BFDR Provider Live Birth Report FHIR Document Content defined in QRPH TF-3: 6.6.2 or the BFDR Provider Fetal Death Report FHIR defined in QRPH TF-3: 6.6.2, and shares that newly created BFDR document with a Content Consumer. Specification of the transformation rules from the US BFDR Form to the FHIR document content is defined in QRPH TF-3: 6.6.1 Form Data Element.

### **X.1.1.8 Form Processor Document Exporter**

630 The Form Processor Document Exporter receives data submitted through the Submit Form [ITI-35] transaction, transforms that data to create a FHIR document, and shares that newly created FHIR document with a Content Consumer. For BFDR, this transforms that data to create the BFDR Provider Live Birth Report FHIR Document Content defined in QRPH TF-3: 6.6.2 or the BFDR Provider Fetal Death Report FHIR Document Content defined in QRPH TF-3: 6.6.2, and shares that newly created BFDR document with a Content Consumer. Specification of the

transformation rules from the US BFDR Form to the FHIR content is defined in QRPH TF-3: 6.6.1 Form Data Element Mappings.

#### **X.1.1.9 Form Receiver Message Exporter**

- 635 The Form Receiver Message Exporter receives data submitted through the Submit Form [ITI-35] transaction, transforms that data to an HL7 message, and sends that message to an Information Recipient. For BFDR, this transforms that data to be in compliance with the requirements of the BFDRFeed [QRPH-37] transaction and sends that data to an Information Recipient. Detailed rules for the BFDRFeed [QRPH-37] transaction are fully defined in QRPH TF-2: 3.37.
- 640 Transformation rules from the form to the message content are fully specified in QRPH TF-3: 6.6.1 Form Data Element Mappings.

#### **X.1.1.10 Form Processor Message Exporter**

- 645 The Form Processor Message Exporter receives data submitted through the Submit Form [ITI-35] transaction, transforms that data to an HL7 message, and sends that message to an Information Recipient. For BFDR, this transforms that data to be in compliance with the requirements of the BFDRFeed [QRPH-37] transaction and sends that data to an Information Recipient. Detailed rules for the BFDRFeed [QRPH-37] transaction are fully defined in QRPH TF-2: 3.37. Transformation rules from the form to the message content are fully specified in QRPH TF-3: 6.6.1 Form Data Element Mappings.

#### **650 X.1.1.11 Form Archiver**

The actions of the Form Archiver are defined in ITI RFD [ITI TF-1:17].

The Form Archiver MAY be leveraged to support traceability of the form data used to create submitted documents. No further refinements of that document are stated by this profile.

#### **X.1.1.12 Data Consumer**

- 655 The Data Consumer is responsible for initiating a query using the BFDRQuery [QRPH-46] message to the Data Responder to retrieve the Birth and Fetal Death Reporting data.

#### **X.1.1.13 Data Responder**

The Data Responder is responsible for responding to a BFDRQuery [QRPH-46] message to the Data Consumer to provide the Birth and Fetal Death Reporting data.

### **660 X.2 BFDR-E Actor Options**

Options that may be selected for each actor in this profile, if any, are listed in Table X.2-1. Dependencies between options when applicable are specified in notes.

**Table X.2-1: BFDR-E - Actors and Options**

Actor	Option Name	TF Reference
Content Creator	Antepartum Import	QRPH TF-1: X.2.4
Content Consumer	View	PCC TF-2: 3.1.1
	Document Import	PCC TF-2: 3.1.2
	Discrete Data Import	PCC TF-2: 3.1.4
Form Filler	LDS Pre-Pop <sup>Note 1</sup>	QRPH TF-1: X.2.1
	LDS-VR Pre-Pop <sup>Note 1</sup>	QRPH TF-1: X.2.2
	Archive Form	QRPH TF-1: X.2.3
Form Manager	None	--
Form Processor	None	--
Form Receiver	None	--
Form Receiver Document Exporter	None	--
Form Processor Document Exporter	None	--
Form Receiver Message Exporter Form Processor Message Exporter	Provider Supplied Live Birth Reporting Option <sup>Note 2V</sup>	QRPH TF-1: X.2.5
	Provider Supplied Mother's Live Birth Information Option <sup>Note 2</sup>	QRPH TF-1: X.2.6
	Provider Supplied Facility's Live Birth Information Option <sup>Note 2</sup>	QRPH TF-1: X.2.7
	Provider Supplied Fetal Death Reporting Option	QRPH TF-1: X.2.8
	Fetal Death Facility's Information Option	QRPH TF-1: X.2.9
	Fetal Death Mother's Information Option	QRPH TF-1: X.2.10
	Jurisdiction Live Birth Reporting Option	QRPH TF-1: X.2.11
	Jurisdiction Fetal Death Reporting Option	QRPH TF-1: X.2.12
Form Archiver	None	--
Data Consumer	None	
Data Responder	None	

Note 1: At least one of these options SHALL be supported.

Note 2: At least one of these birth reporting options SHALL be supported

665

### X.2.1 LDS Pre-Pop Option

This option defines the document submission requirements placed on Form Fillers for providing pre-pop data to the Form Manager. The Form Filler's support for the LDS Pre-Pop Option

670 determines how pre-population data is handled when the Form Filler retrieves the form using the Retrieve Form [ITI-34] transaction:

If the Form Filler supports the LDS Pre-Pop Option, the value of the pre-pop Data parameter in the Retrieve Form Request (see ITI TF-2: 3.34.4.1.2) shall be a well-formed xml document as defined in the PCC Labor and Delivery Summary (LDS) Content Profile (see Labor and Delivery Profiles Trial Implementation Supplement, 6.3.1.B Labor and Delivery Summary 1.3.6.1.4.1.19376.1.5.3.1.1.21.1.2).

### **X.2.2 LDS-VR Pre-Pop Option**

This option defines the document submission requirements placed on Form Fillers for providing pre-pop data to the Form Manager, describing specific content and vocabulary constraints to the PCC LDS that will optimize the ability to process the clinical content to fill in the BFDR Form. The Form Filler's support for the LDS-VR Pre-Pop Option determines how pre-population data is handled when the Form Filler retrieves the form using the Retrieve Form [ITI-34] transaction.

If the Form Filler supports the LDS-VR Pre-Pop Option, the value of the pre-pop Data parameter in the Retrieve Form Request (see ITI TF-2: 3.34.4.1.2) shall be a well-formed xml document as defined in the PCC Labor and Delivery Summary (LDS) Content Profile (see PCC Labor and Delivery Profiles Trial Implementation Supplement, Section Y.7) as constrained by QRPH TF-3: 6.3.1.A for the specification of the LDS content required as and LDS-VR Document (1.3.6.1.4.1.19376.1.7.3.1.1.19.1.1).

### **X.2.3 Archive Form Option**

690 If the Form Filler supports the Archive Form Option, it shall implement the Archive Form [ITI-36] transaction.

### **X.2.4 Antepartum Import Option**

This option defines the discrete data import requirements placed on Content Creators for incorporating information from the antepartum setting in the LDS or LDS-VR.

695 A Content Creator that supports the Antepartum Import Option SHALL support the Content Consumer of the IHE PCC Antepartum Summary (APS) Profile with the Discrete Data Import Option for those attributes specified by this option. Detailed discrete data import rules for the information that will support the pre-pop attributes are fully defined in QRPH TF-3: 6.6.4 Discrete Data Import Element Mappings to LDS-VR Content Document.

### **X.2.5 Provider Supplied Live Birth Reporting Option**

700 This option is intended to support communications from the system collecting the worksheet information from the facility (e.g., Electronic Health Record) to a jurisdictional vital records office for a live birth. The Form Receiver Message Exporter, the Information Source, and the Information Recipients implementing this option shall support the content defined for the



705 Provider Supplied Live Birth Reporting Option (PSLBI) in the BFDRFeed [QRPH-37] transaction, see QRPH TF-2: 3.38.4.1

### **X.2.6 Provider Supplied Mother's Live Birth Information Option**

710 This option is intended to support communications from the system collecting the worksheet information from the mother (e.g., Personal Health Record, Patient Portal) to a jurisdictional vital records office for a live birth. The Form Receiver Message Exporter, the Information Source, and the Information Recipients implementing this option shall support the content defined for the Provider Supplied Mother's Live Birth Information Option (PSMLBI) in the BFDRFeed [QRPH-37] transaction, see QRPH TF-2: 3.37.4.1

### **X.2.7 Provider Supplied Facility's Live Birth Information Option**

715 This option is intended to support communications from the provider to the jurisdictional vital records office for both the facility's work sheet and the mother's live birth information. The Form Receiver Message Exporter, the Information Source, and the Information Recipients implementing this option shall support the content defined for the Provider Supplied Facility's Live Birth Information Option (PSFLBI) in the BFDRFeed [QRPH-37] transaction, see QRPH TF-2: 3.37.4.1

### **X.2.8 Provider Supplied Fetal Death Reporting Option**

725 This option is intended to support communications from the provider to the jurisdictional vital records office for both the facility's work sheet and the mother's information for a fetal death. The Form Receiver Message Exporter, the Information Source, and the Information Recipients implementing this option shall support the content defined for the Provider Supplied Fetal Death Reporting Option (PSFDI) in the BFDRFeed [QRPH-37] transaction, see QRPH TF-2: 3.37.4.1

### **X.2.9 Fetal Death Facility's Information Option**

730 This option is intended to support communications from the system collecting the worksheet information from the facility (e.g., Electronic Health Record) to a jurisdictional vital records office for a fetal death. The Form Receiver Message Exporter, the Information Source, and the Information Recipients implementing this option shall support the content defined for the Fetal Death Facility's Information Option (PSFFDI) in the BFDRFeed [QRPH-37] transaction, see QRPH TF-2: 3.37.4.1

### **X.2.10 Fetal Death Mother's Information Option**

735 This option is intended to support communications from the system collecting the worksheet information from the mother (e.g., Personal Health Record, Patient Portal) to a jurisdictional vital records office for a fetal death. The Form Receiver Message Exporter, the Information Source, and the Information Recipients implementing this option shall support the content defined for the Fetal Death Mother's Information Option (PSMFDI) in the BFDRFeed [QRPH-37] transaction, see QRPH TF-2: 3.37.4.1

### **X.2.11 Jurisdiction Live Birth Reporting Option**

745 This option is intended to support communications from the jurisdictional vital records office to a national statistics agency for a live birth. The Form Receiver Message Exporter, the Information Source, and the Information Recipients implementing this option shall support the content defined for the Jurisdiction Live Birth Reporting Option (JLBI) in the BFDRFeed [QRPH-37] transaction, see QRPH TF-2: 3.37.4.1.

### **X.2.12 Jurisdiction Fetal Death Reporting Option**

750 This option is intended to support communications from the jurisdictional vital records office to a national statistics agency for a fetal death. The Form Receiver Message Exporter, the Information Source, and the Information Recipients implementing this option shall support the content defined for the Jurisdiction Fetal Death Reporting Option (JFDI) in the BFDRFeed [QRPH-37] transaction, see QRPH TF-2: 3.37.4.1.

### **X.2.13 Void Certificate Reporting Option**

755 This option is intended to support instructions from the jurisdictional vital records office to a national statistics agency to void a previously recorded live birth certificate or fetal death report. The Information Source, and the Information Recipients implementing this option shall support the content defined for the Void Certificate Reporting Option (JVFDI) in the BFDRFeed [QRPH-37] transaction, see QRPH TF-2: 3.37.4.1.

### **X.2.14 Coded Cause of Death Reporting Option**

760 This option is intended to support communications from a national statistics agency to the jurisdictional vital records office. The Information Source and the Information Recipients shall support the content defined for the Coded Cause of Death Reporting Option (CCOFD) in the BFDRFeed [QRPH-37] transaction, see QRPH TF-2: 3.37.4.1.

Actors that support this option are able to send or receive coded cause of death information.

### **X.2.15 Coded Race/Ethnicity Reporting Option**

765 This option is intended to support communications from the national statistics agency to a jurisdictional vital records office. The Information Source and the Information Recipients shall support the content defined for the Coded Race/Ethnicity Reporting Option (CREI) in the BFDRFeed [QRPH-37] transaction, see QRPH TF-2: 3.38.4.1.

770 Actors that support this option are able to send or receive race and ethnicity information.

In some jurisdictions, it is prohibited to send race and/or ethnicity. Use of this option may be constrained by national extension.

### X.3 BFDR-E Required Actor Groupings

775 An actor from this profile (Column 1) shall implement all of the required transactions and/or content modules in this profile *in addition to* all of the transactions required for the grouped actor (Column 2).

Section X.5 describes some optional groupings that may be of interest for security considerations and Section X.6 describes some optional groupings in other related profiles.

**Table X.3-1: BFDR-E - Required Actor Groupings**

BFDR-e Actor	Actor to be grouped with	Reference	Content Bindings Reference
Content Creator with Antepartum Import Option	PCC APS Content Consumer with Discrete Data Import Option	QRPH TF-1: X.2.4	PCC TF Antepartum Profiles Trial Implementation Supplement, Vol 1, Sec X PCC TF-2: 3.1.4 <sup>Note 1</sup>
Content Consumer	None	--	--
Form Filler	None	--	--
Form Manager	None	--	--
Form Processor	None	--	--
Form Receiver	None	--	--
Form Receiver Document Exporter	None	--	--
Form Processor Document Exporter	None		
Form Receiver Message Exporter	None	--	--
Form Processor Message Exporter	None		
Form Archiver	None	--	--
Data Consumer	None	--	--
Data Responder	None	--	--

780 Note 1: A Content Creator supporting the Antepartum Import Option SHALL be grouped with the APS Content Consumer with the Discrete Data Import Option for those attributes specified by the Antepartum Import Option; see QRPH TF-1: X.2.4.

### X.4 BFDR-E Overview

785 Vital Records birth certificates and fetal death reports include important demographic, medical and key information about the antepartum period, the labor and delivery process and the newborn/fetal death. Much of the medical and health information collected for the birth certificate and fetal death report can be pre-populated with information already available in the Electronic Health Record (EMR). A responsible Health Care Provider (HCP) or designated  
790 representative must review and complete the information to ensure data quality for vital

registration purposes. These data may then be used by public health agencies to track maternal and infant health to target interventions for at risk populations.

795 The national statistics agencies have a long and enduring history that serves to provide essential data on births and deaths. Within the United States, for instance, this is the oldest and most successful example of inter-governmental data sharing in Public Health. Currently, these data typically are gathered by hospital personnel from the hospital’s medical records using paper worksheets. The process of capturing Vital Records information manually is duplicative, labor-intensive, costly, and can be error prone. As a result, the timeliness and quality of these data are adversely affected.

#### 800 **X.4.1 Concepts**

Some jurisdictions have established detailed specifications for collecting and reporting the items on the Certificate of Live Birth and the Report of Fetal Death. It is critical that all vital registration areas follow these standards to promote uniformity in data collection across registration areas.

805 Additionally, standard worksheets are used to enhance the collection of quality, reliable data. Forms for the “mother’s live birth information for Child’s Birth Certificate” have been established by some jurisdictions to identify information to be collected directly from the mother. The “Facility Worksheet for the Live Birth Certificate” identifies information for which the best  
810 standardized collection. The "Patient's Worksheet for the Report of Fetal Death" and the "Facility Worksheet for the Report of Fetal Death" have also been established for the purpose of reporting fetal death information.

The hospital is responsible for completing the Record of Live Birth in the jurisdiction's Electronic Birth Registration System (EBRS). Information collected from the mother on the  
815 mother’s live birth information must be data entered into the EBRS. Facility Worksheet data transmitted electronically into the EBRS from the EMR must be reviewed for completeness and accuracy. The birth records specialist plays an essential role in gathering the information and ensuring that all information is complete before transmission to the vital registration system at the states/jurisdictional vital record offices. Select birth data may be transmitted later to public  
820 health authorities as allowed by individual state statute and other vital records stakeholders.

Example Forms:

- [Facility Worksheet](https://www.cdc.gov/nchs/data/dvs/facility-worksheet-2016.pdf) (<https://www.cdc.gov/nchs/data/dvs/facility-worksheet-2016.pdf>)
- [U.S. Standard Certificate of Live Birth](http://www.cdc.gov/nchs/data/dvs/birth11-03final-ACC.pdf) (<http://www.cdc.gov/nchs/data/dvs/birth11-03final-ACC.pdf>)
- 825 • <https://www.cdc.gov/nchs/data/dvs/FDEATH11-03finalACC.pdf>
- [Mother’s Worksheet for Child’s Birth Certificate](#)
- [Patient’s worksheet for the report of fetal death](#)

830 In the following use cases, the birth information specialist (BIS) will review and complete the Facilities Worksheet using information that has already been prepopulated by the EMR system. The mother also completes the Mother' Worksheet for Child's Birth Certificate and/or the Patient's Worksheet for the Report of Fetal Death. The BIS verifies the accuracy of the information and submits the form. This may be constrained in the US Extension to support only the forms for data submission for specific jurisdictional implementations. The form is received by a system that is configured to transform the facilities worksheet information into a standard  
835 FHIR document or HL7 message, depending upon the input format preferred by the vital registration system of the jurisdiction. The information is communicated to the vital registration system where further vital registration functions are addressed to formalize the birth certificate or fetal death report. The use case will also support the option for the FHIR document or HL7 message to be generated directly by a system, without using form-based collection.

## 840 **X.4.2 Use Cases**

### **X.4.2.1 Use Case #1: Forms Data Capture with Messaging**

845 The Forms Data Capture with Messaging use case uses Retrieve Form for Data Capture (RFD) to present Facilities Worksheet for pre-population, and the Form Receiver system transforms the information into a BFDRFeed [QRPH-37] message to transmit the information to Public Health EBRS.

#### **X.4.2.1.1 Use Case Description**

850 When the delivery has been documented in the system, a Labor and Delivery Summary document (LDS, LDS-VR) is created with Vital Record Birth and Fetal Death Reporting Content requirements. This summary document is provided as pre-population data to a public health IHE ITI Retrieve Form for Data Capture (RFD) Form Manager. The RFD Form Receiver provides the content to the EBRS by way of a transform to the corresponding BFDRFeed [QRPH-37] message.

#### **X.4.2.1.2 Processing Steps**

##### **X.4.2.1.2.1 Pre-conditions**

855 A delivery has been documented in the EMR system.

##### **X.4.2.1.2.2 Main Flow**

This flow captures the EBRS information using forms provided by public health and transmits the data that is captured to public health using HL7 Messaging (BFDRFeed [QRPH-37]).

##### **X.4.2.1.2.3 Post-conditions**

860 The EBRS has received the data.

#### **X.4.2.1.3 Process Flow**

865 The process flow of this use case is defined by ITI RFD. Please refer to ITI TF-1: 17 for a description of the process flow for RFD. The Form Filler may be implemented by the birthing facility or by the child’s clinician in instances of home birth etc. The process flow for the BFDR-E is described below.

870 The provider EMR presents the Facilities Worksheet providing an LDS or LDS-VR document for Pre-population by the Form Manager. The birth information specialist completes the form, verifies the accuracy of all information, and submits the form. The birth information specialist may also interview the mother for completion of the mother’s information to complete the reporting for the birth or fetal death. The Form Receiver Message Exporter transforms the information from the form into an HL7 BFDRFeed [QRPH-37] message and transmits that message to the EBRS system using the BFDRFeed [QRPH-37] transaction using the provider to jurisdiction reporting options for Report Jurisdiction Fetal Death. The National Statistics Agency returns coded cause of fetal death and Coded Race / Ethnicity Option for the fetal death to the jurisdiction EBRS. Due to paper jam damage of the printed official certificate that bears the death report number, the jurisdictional vital records office sends a Void Certificate Reporting message to the national statistics agency to void the submission. The fetal death registration will subsequently be transmitted with a new fetal death report number using the same transaction series between the originating jurisdictional vital records office and the National Statistics Agency.

875

880

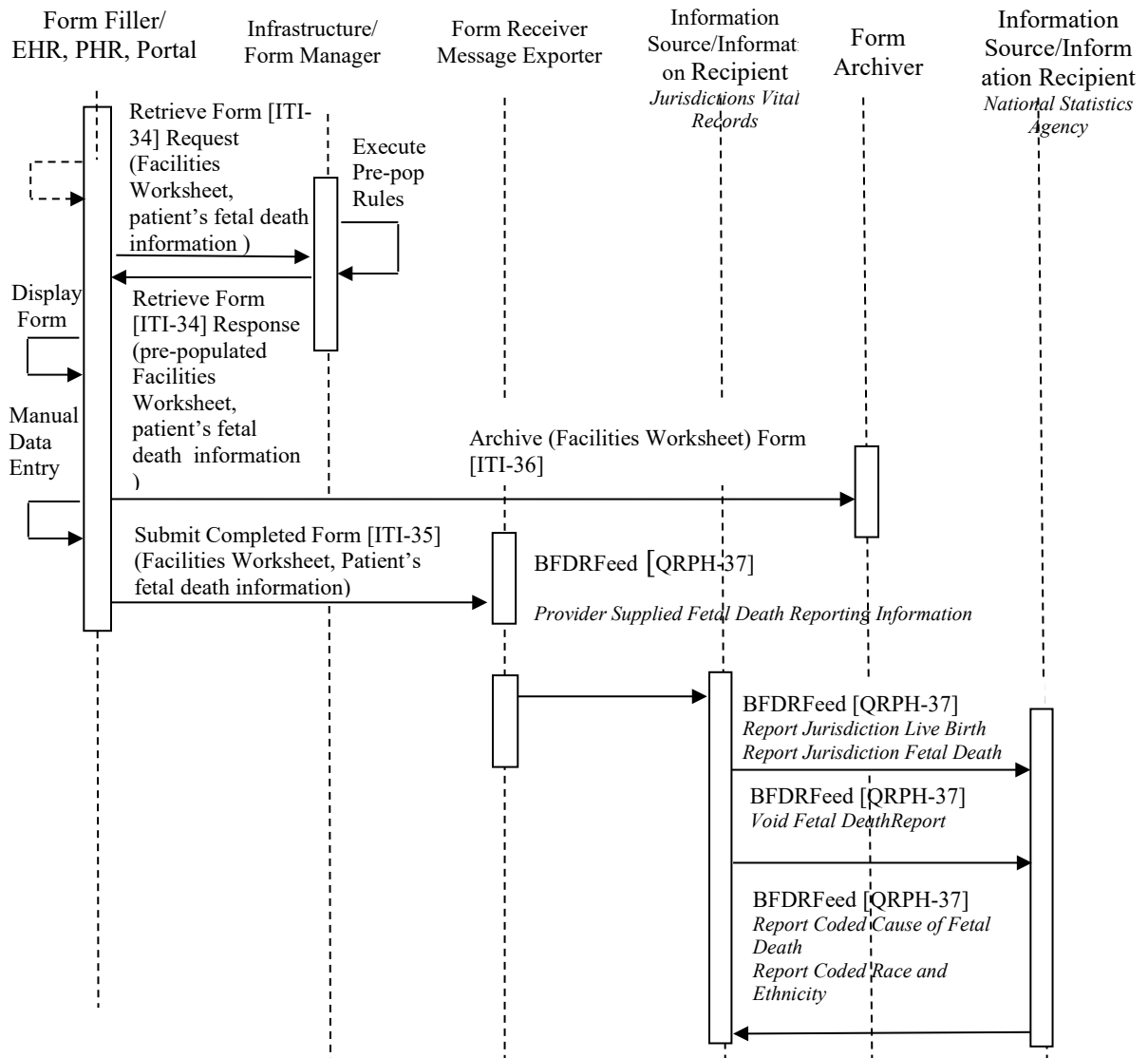

Figure X.4.2.1.3-1: Use Case 1 - Forms Data Capture with Messaging

#### X.4.2.2 Use Case #2: Forms Data Capture with Document Submission

885 The Forms Data Capture with Document Submission use case uses Retrieve Form for Data Capture (RFD) to present the Facilities Worksheet for pre-population, and the Form Receiver system transforms the information into a BFDR Birth FHIR Document or a BFDR Fetal Death FHIR Document to transmit the information to Public Health.

#### **X.4.2.2.1 Use Case Description**

890 When the delivery has been documented in the system, a Labor and Delivery Summary document (LDS, LDS-VR) is created with Vital Record Birth and Fetal Death Reporting Content requirements. This summary document is provided as pre-population data to a public health IHE ITI Retrieve Form for Data Capture (RFD) Forms Manager. The RFD Form Receiver provides the content to the EBRS by way of a transform to the corresponding BFDR Birth FHIR Document or the BFDR Fetal Death FHIR Document.

#### **X.4.2.2.2 Processing Steps**

##### **X.4.2.2.2.1 Pre-conditions**

A delivery has been documented in the EMR system.

##### **X.4.2.2.2.2 Main Flow**

900 This flow captures the EBRS information using forms provided by public health and transmits the data that is captured to public health using the BFDR Birth FHIR Document or the BFDR Fetal Death FHIR Document.

##### **X.4.2.2.2.3 Post-conditions**

The EBRS has received the data.

#### **X.4.2.2.3 Process Flow**

905 The process flow of this use case is defined by ITI mRFD. Please refer to ITI TF-1:17 for a description of the process flow for mRFD. The Form Filler may be implemented by the birthing facility or by the child’s clinician in instances of home birth etc. The process flow for the BFDR-E is described below.

910 The provider EMR presents the Facilities Worksheet providing an LDS or LDS-VR document for Pre-population by the Form Manager. The birth information specialist completes the form, verifies the accuracy of all information, and submits the form. The RFD Form Receiver provides the content to the EBRS by way of a transform to the corresponding BFDR Provider Live Birth Report FHIR Document or the BFDR Provider Fetal Death Report FHIR Document.

915



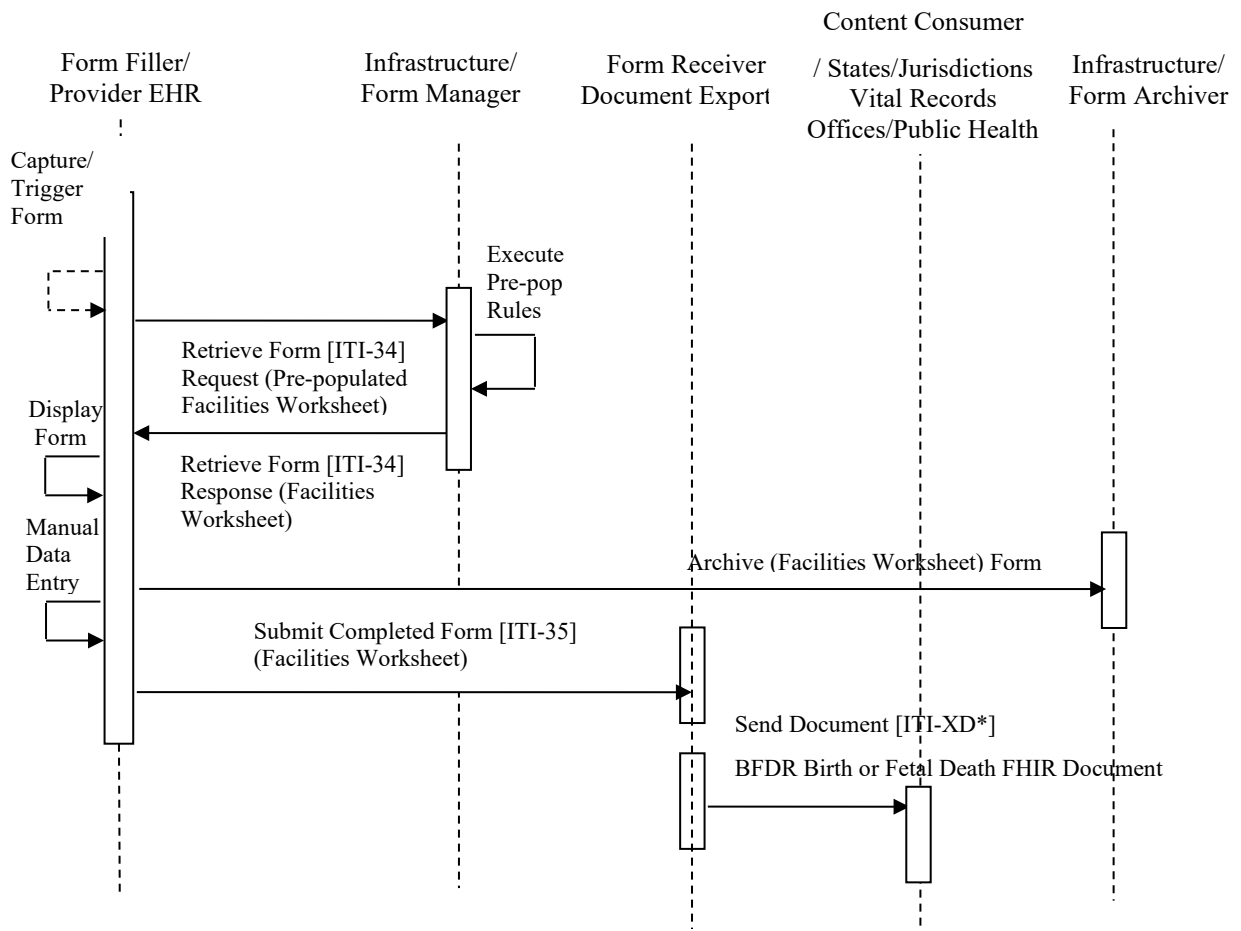

**Figure X.4.2.2.3-1: Use Case 2- Forms Data Capture with Document Submission**

### X.4.2.3 Use Case #3: Native Forms Data Capture

920 The birth information specialist logs into the EMR and accesses the record of a newborn patient  
to begin the process of completing information required for birth and fetal death reporting. The  
EMR presents a form to the BIS that contains some data that has been pre-populated. She  
925 reviews the form, completes the remaining items, and verifies that the record is complete and  
accurate before submitting to transmit the data electronically into the EBRS. The EBRS record is  
saved, additional EBRS processing completed, and the record is filed electronically by the EBRS  
with the state vital statistics office.

#### X.4.2.3.1 Use Case Description

When the delivery has been documented in the system, a Labor and Delivery Summary document (LDS, LDS-VR) is created with Vital Record Birth and Fetal Death Reporting Content

930 requirements. This document is provided as pre-population data to a public health IHE ITI Retrieve Form for Data Capture Forms Processor. The RFD Form Processor information is consumed directly by the EBRS.

#### **X.4.2.3.2 Processing Steps**

##### **X.4.2.3.2.1 Pre-conditions**

A delivery has been documented in the EMR system.

##### **935 X.4.2.3.2.2 Main Flow**

This flow captures the EBRS information using forms provided by public health and incorporates the data that is captured using product-defined methods.

##### **X.4.2.3.2.3 Post-conditions**

The EBRS has received the data.

##### **940 X.4.2.3.3 Process Flow**

The provider EMR presents the Facilities Worksheet providing an LDS or LDS-VR document for Pre-population by the Form Manager. The birth information specialist completes the form, verifies the accuracy of all information, and submits the form. The RFD Processor information is consumed directly by the EBRS.

945

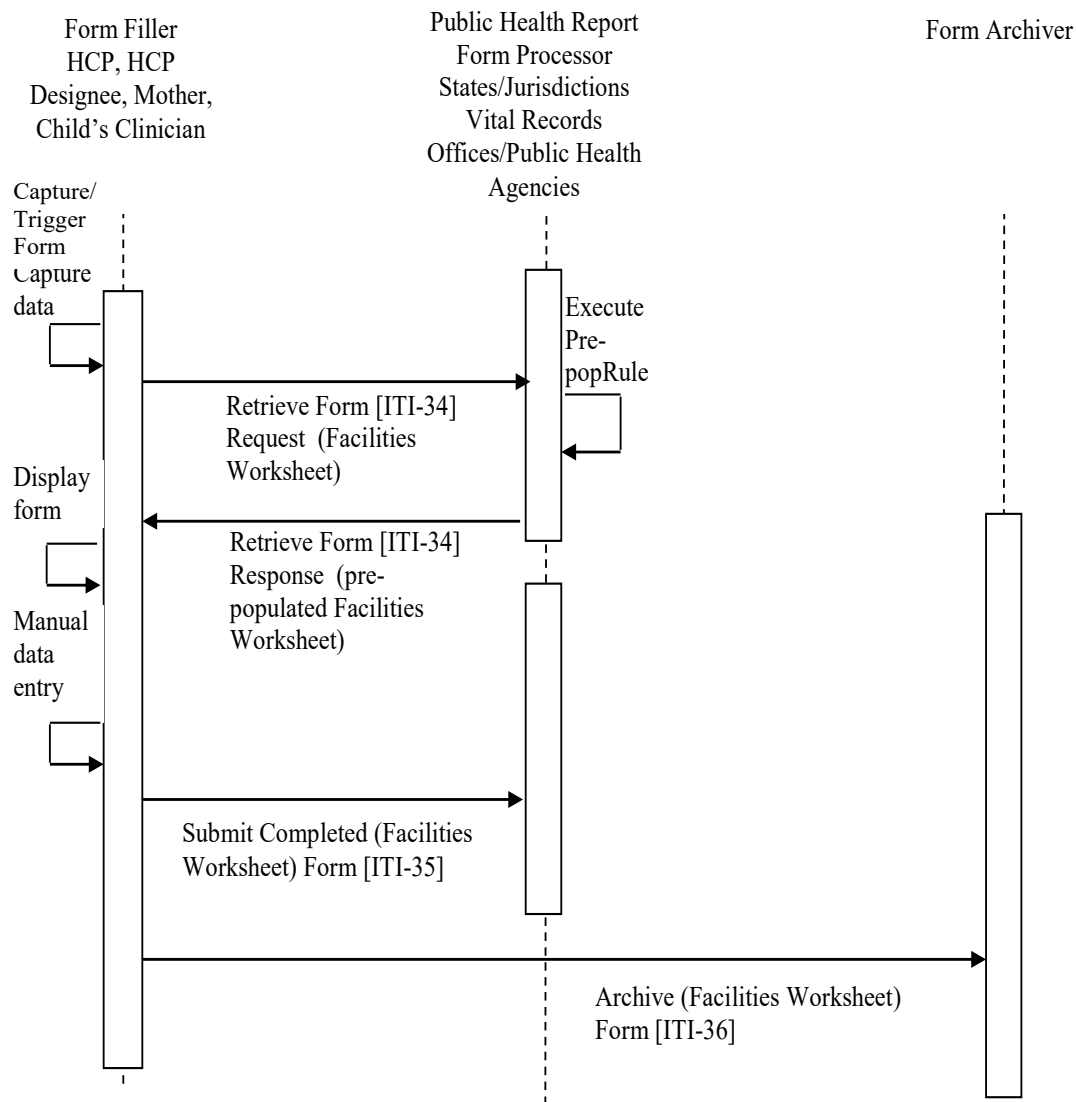

**Figure X.4.2.3.3-1: Use Case 3 - Native Forms Data Capture**

950 **X.4.2.4 Use Case #4: EMR BFDR Document Submission**

The EMR BFDR Document Submission use case creates the QRPH BFDR FHIR document directly and transmits the document to the EBRS.

**X.4.2.4.1 Use Case Description**

955 When the delivery has been documented in the system, the EMR system creates the QRPH BFDR document and sends it to the EBRS.

#### X.4.2.4.2 Processing Steps

##### X.4.2.4.2.1 Pre-conditions

A delivery has been documented in the EMR system.

##### X.4.2.4.2.2 Main Flow

960 This flow sends the birth registration information to the EBRS using the BFDR Document (FHIR).

##### X.4.2.4.2.3 Post-conditions

The EBRS has received the data.

##### X.4.2.4.3 Process Flow

965 The provider EMR sends the QRPH BFDR document to the EBRS.

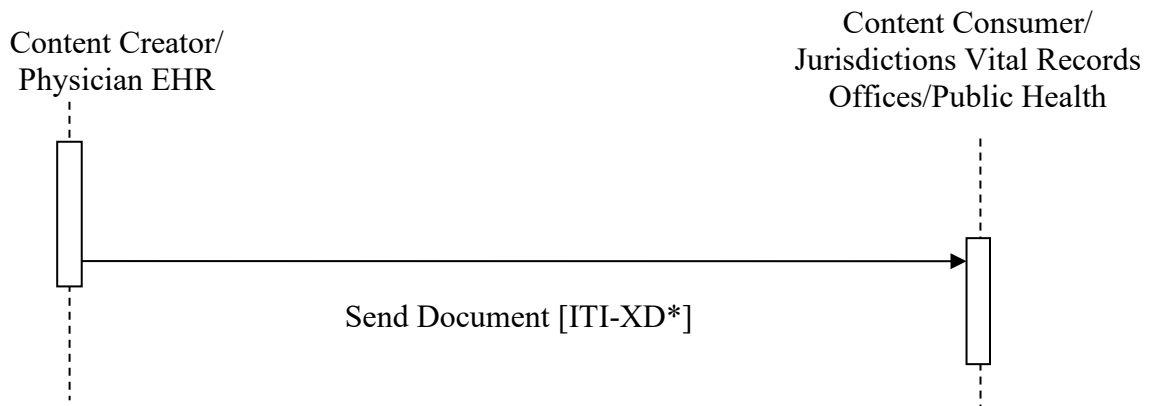

Figure X.4.2.4.3-1: Use Case 5- EMR BFDR Document Submission

#### X.4.2.5 Use Case #5: Mother’s Information Data Collection

970 In the Mother’s Information Data Collection use case, the mother uses a PHR with a SMART-on-FHIR app to complete the relevant portions of the mother’s information for the newborn’s vital record. The completed reporting information is sent to the EBRS where the jurisdiction completes the processing of the information with the national statistics agency.

##### X.4.2.5.1 Mother’s Information Data Collection Use Case Description

975 When the mother is ready to provide information that will be used to generate the vital records report associated with the delivery, the mother’s delivery vital record SMART-on-FHIR app

queries the EHR using BFDRQuery (QRPH-46) to retrieve information about the parents. The mother is able to complete the form with information not already available through the PHR.

980 Once the reporting information is documented using the app, the system creates an HL7 BFDR message or a BFDR FHIR document and sends the message to the EBRS directly. The EBRS communicates jurisdiction information to the national statistic agency where the standard coded cause of death is determined and returned to the jurisdiction.

#### X.4.2.5.2 Mother’s Information Data Collection Process Flow

985 The SMART-on-FHIR app Data Consumer sends the BFDRQuery [QRPH-46] message to the PHR Data Responder to assist the mother in completing delivery reporting details. The mother’s delivery reporting information is sent to the jurisdiction vital records office EBRS.

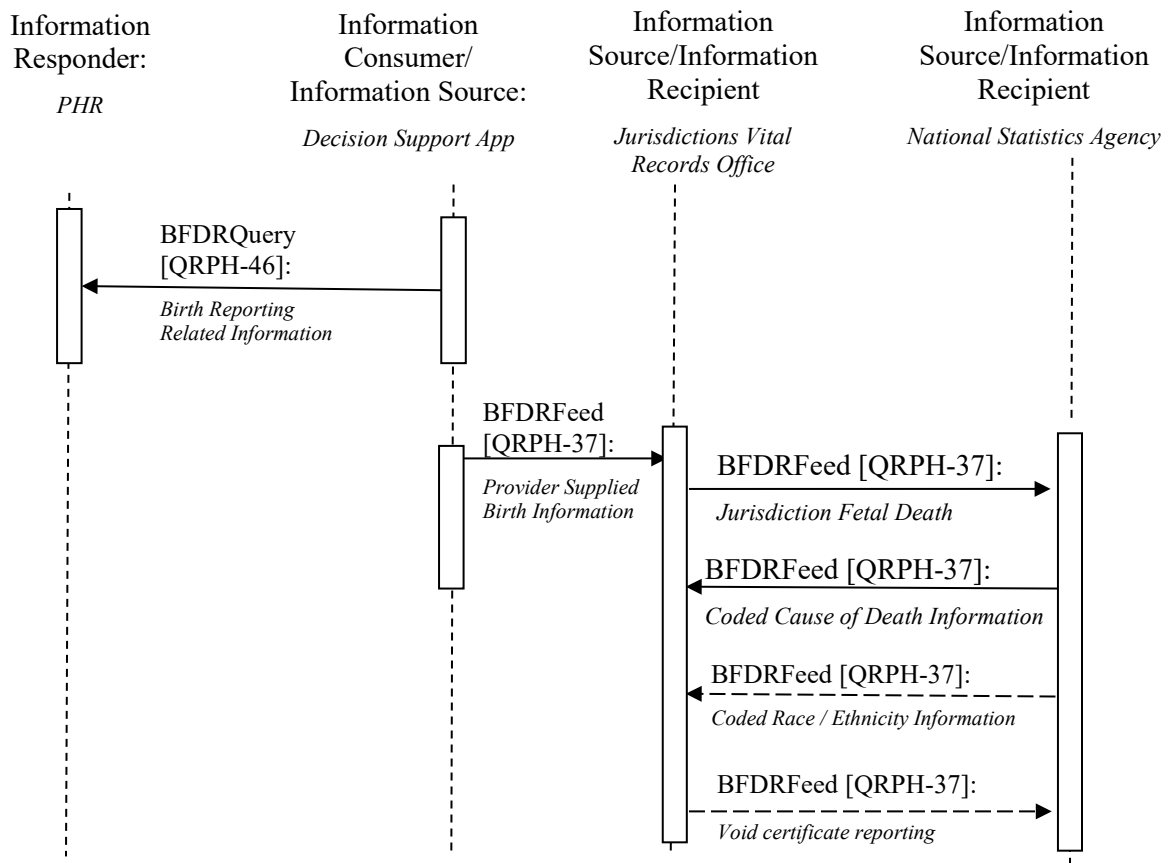

Figure X.4.2.5.2-1: Use Case 6- Mother’s Information Data Collection

## 990 **X.5 Security Considerations**

BFDR includes clinical content related to the information subject. As such, it is anticipated that the transfers of Personal Health Information (PHI) will be protected. The IHE ITI Audit Trail and Node Authentication (ATNA) Profile SHOULD be implemented by all of the actors involved in the IHE transactions specified in this profile to protect node-to-node communication and to produce an audit trail of the PHI related actions when they exchange messages, though other private security mechanisms MAY be used to secure content within enterprise managed systems. Details regarding ATNA logging will be further described in Volume 2.

1000 The content of the form also results in a legal document, and the Form Manager MAY include a digital signature using ITI Document Digital Signature (DSG) Profile to assure that the form content submitted cannot be changed.

For security purposes, when sending information specifically to vital records Electronic Registration Systems, systems will also need to know the identity of the user and the location to identify the data source. In this case, the Cross-Enterprise User Assertion (XUA) Profile MAY be utilized to support this implementation.

## 1005 **X.6 Cross Profile Considerations**

The following informative narrative is offered as implementation guidance.

### **X.6.1 mRFD – Mobile Retrieve Form for Data Capture**

1010 The BFDRQuery[46] transaction may be used with Mobile Retrieve form for Data Capture as an alternative for form pre-population. To accomplish this, the Data Consumer should be grouped with the Form Manager of mRFD, and the Data Responder should be grouped with the Form Filler of mRFD.

### **X.6.2 XD\*– Cross Enterprise Document Sharing.b, Cross Enterprise Document Media Interchange, or Cross Enterprise Document Reliable Interchange**

1015 The use of the IHE XD\* family of transactions is encouraged to support standards-based interoperability between systems acting as Content Creator and Content Consumer. The grouping of Content Creator and Content Consumer Actors with ITI XD\* Actors is defined in the PCC Technical Framework (PCC TF-1:3.7.1). Below is a summary of recommended IHE transport transactions that MAY be utilized by systems playing the roles of Content Creator or Content Consumer to support the use cases defined in this profile:

- 1020 • A Document Source in XDS.b, a Portable Media Creator in XDM, or a Document Source in XDR might be grouped with the BFDR-E Content Creator. A Document Consumer in XDS.b, a Portable Media Importer in XDM, or a Document Recipient in XDR might be grouped with the BFDR-E Content Consumer. A registry/repository-based infrastructure is defined by the IHE Cross Enterprise Document Sharing (XDS.b) that includes profile support that can be leveraged to facilitate retrieval of public health related information
- 1025

from a document sharing infrastructure: Multi-Patient Query (MPQ), Document Metadata Subscription (DSUB).

- 1030 • A media-based infrastructure is defined by the IHE Cross Enterprise Document Media Interchange (XDM) Profile. A Portable Media Creator in XDM might be grouped with the BFDR-E Content Creator. A Portable Media Importer in XDM might be grouped with the BFDR-E Content Consumer.
- 1035 • A reliable messaging-based infrastructure is defined by the IHE Cross Enterprise Document Reliable Interchange (XDR) Profile. A Document Source in XDR might be grouped with the BFDR-E Content Creator. A Document Recipient in XDR might be grouped with the BFDR-E Content Consumer.

### **X.6.3 Sharing Value Sets (SVS)**

Actors in the BFDR-E Profile may support the Sharing Value Sets (SVS) Profile in order to use a common uniform managed vocabulary for dynamic management of form mapping rules.

## **X.7 BFDR Data Elements**

- 1040 This profile defines specific data element content. These data elements are used to create the BFDR Provider Live Birth Report FHIR Document or the BFDR Provider Fetal Death Report FHIR Document, generate the HL7 BFDRFeed [QRPH-37] message, or populate a form defined to gather the required structured data, such as the US BFDR Form. That set of data elements in the form are identified and defined in Appendix B.

1045

# Appendices to Volume 1



## Appendix A – BFDR-E Profile - Sample Forms

### A.1 Sample Birth Reporting Facilities Worksheet

1050 The sample Birth Reporting Facilities Worksheet form included in this content profile reflects the U.S. Standard Certificate of Live Birth reporting requirements from the birthing facility. However, the BFDR Content Profile may be modified by national extension to include and accommodate international birth reporting requirements. The sample form is posted at <https://www.cdc.gov/nchs/data/dvs/facility-worksheet-2016.pdf>.

1055 Note: The following form elements are no longer included as part of the U.S. national birth file and will be removed from the facilities worksheet form in the next formal release of that document:

- Date of last prenatal care visit
- Premature rupture of the membranes  $\geq 12$  hours (Onset of labor)
- Precipitous labor  $< 3$  hours (Onset of labor)
- Prolonged labor  $\Rightarrow 20$  hours (Onset of labor)
- 1060 • Tocolysis (Obstetric procedure)
- Cervical cerclage (Obstetric procedure)
- Unplanned operating room procedures (Maternal morbidity)
- Significant birth injury (Abnormal condition of the Newborn)
- Other previous poor pregnancy outcomes (Risk Factors in this Pregnancy)
- 1065 • Moderate/heavy meconium staining of the amniotic fluid (Characteristics of Labor and Delivery)
- Fetal intolerance of labor (Characteristics of Labor and Delivery)

## A.2 Sample US Fetal Death Facilities Worksheet

1070 The sample Fetal Death Reporting Facilities Worksheet form included in this content profile reflects the U.S. Standard Report of Fetal Death reporting requirements from the birthing facility. However, the BFDR Content Profile may be modified to include and accommodate international fetal death reporting requirements. The sample form is posted at <http://www.cdc.gov/nchs/data/dvs/FacilityFetal04.pdf>.

1075 Note: The following form elements are no longer included as part of the U.S. national fetal death file and will be removed from the facilities worksheet form in the next formal release of that document:

- Total number of prenatal visits for this pregnancy
  - Edit flag - Total number of prenatal visits for this pregnancy
- Date of last prenatal care visit\*
- Mother’s weight at delivery
  - Edit flag – Mother’s weight at delivery
- Number of other pregnancy outcomes
- Date of last other pregnancy outcome
- Mother/patient transferred for maternal medical or fetal indications for delivery?
- Previous preterm birth (Risk factors for this pregnancy)
- 1085 • Other previous poor pregnancy outcomes (Risk factors for this pregnancy)\*
- Gonorrhea (Infections present and/or treated during this pregnancy\*\*)
- Syphilis (Infections present and/or treated during this pregnancy\*\*)
- Chlamydia (Infections present and/or treated during this pregnancy\*\*)
- Listeria (Infections present and/or treated during this pregnancy\*\*)
- 1090 • Group B strep (Infections present and/or treated during this pregnancy\*\*)

- Cytomegalovirus (Infections present and/or treated during this pregnancy\*\*)
- Parvovirus (Infections present and/or treated during this pregnancy\*\*)
- Toxoplasmosis (Infections present and/or treated during this pregnancy\*\*)
- Other (Specify) (Infections present and/or treated during this pregnancy\*\*)
- 1095 • Hysterotomy/hysterectomy (Method of delivery)
- Maternal transfusion (Maternal morbidity)
- Third or fourth degree perineal laceration (Maternal morbidity)
- Unplanned hysterectomy (Maternal morbidity)
- Unplanned operating room procedure (Maternal morbidity)
- 1100 • Anencephaly (Congenital anomalies of the fetus\*\*)
- Meningomyelocele/Spina bifida (Congenital anomalies of the fetus\*\*)
- Cyanotic congenital heart disease (Congenital anomalies of the fetus\*\*)
- Congenital diaphragmatic hernia (Congenital anomalies of the fetus\*\*)
- Omphalocele (Congenital anomalies of the fetus\*\*)
- 1105 • Gastroschisis (Congenital anomalies of the fetus\*\*)
- Limb reduction defect (Congenital anomalies of the fetus\*\*)
- Cleft Lip with or without Cleft Palate (Congenital anomalies of the fetus\*\*)
- Cleft palate alone (Congenital anomalies of the fetus\*\*)
- Down syndrome- karyotype confirmed/pending (Congenital anomalies of the fetus\*\*)
- 1110 • Suspected Chromosomal disorder - karyotype confirmed/pending (Congenital anomalies of the fetus\*\*)
- Hypospadias (Congenital anomalies of the fetus\*\*)

\* Item previously announced as dropped from the national birth file.

\*\*All checkboxes on the national standard worksheet under this category have been dropped.

### **A.3 Sample US mother’s live birth information for Child’s Birth Certificate**

1115 The sample mother’s live birth information for Child’s Birth Certificate form included in this content profile reflects the reporting requirements from the mother. However, the BFDR Content Profile may be modified to include and accommodate international reporting requirements that may be captured from the mother. The sample form is posted at <https://www.cdc.gov/nchs/data/dvs/moms-worksheet-2016.pdf>.

1120 Note: The following form elements are no longer included as part of the U.S. Mother’s Worksheet for Child’s Birth Certificate file and will be removed from the worksheet form in the next formal release of that document:

- Has the mother ever been married?
- Mother Married (At birth, conception, or any time between)

### **A.4 Sample Patient’s Worksheet for the Report of Fetal Death**

1125 The sample Patient’s Worksheet for the Report of Fetal Death form included in this content profile reflects the reporting requirements from the mother. However, the BFDR Content Profile may be modified to include and accommodate international reporting requirements that may be captured from the mother. The sample form is posted at <https://www.cdc.gov/nchs/data/dvs/patientwkstfetaldeath.pdf>.

Note: The following form elements are no longer included as part of the U.S. Patient’s Worksheet for the Report of Fetal Death file and will be removed from the worksheet form in the next formal release of that document:

- 1130
- Has the mother ever been married?
  - Mother Married (At birth, conception, or any time between)

## Appendix B – BFDR-E Profile - Data Element Definitions

The following data elements are used in Vital Records Birth and Fetal Death Reporting:

Attribute Name	Used in Birth	Used in Fetal Death	Birth and Fetal Death Report Data Element	Description
ANTI	Y	N	Abnormal conditions of the newborn: Antibiotics [received by the newborn for suspected neonatal sepsis]	Any antibacterial drug given systemically (intravenous or intramuscular.) For example, penicillin, ampicillin, gentamicin, cefotaxime, etc.)
AVEN1	Y	N	Abnormal conditions of the newborn: Assisted ventilation [required immediately following delivery]	Infant given manual breaths for any duration with bag and mask or bag and endotracheal tube within the first several minutes from birth. Excludes free flow (blow-by) oxygen only, laryngoscopy for aspiration of meconium, nasal cannula, and bulb suction.
AVEN6	Y	N	Abnormal conditions of the newborn: Assisted ventilation for 6 or more hours	Infant given mechanical ventilation (breathing assistance) by any method for more than 6 hours. Includes conventional, high frequency and/or continuous positive pressure (CPAP). Excludes free flow oxygen only, laryngoscopy for aspiration of meconium and nasal cannula.
BINJ	Y	N	Abnormal conditions of the newborn: Significant birth injury [(skeletal fracture(s), peripheral nerve injury, and/or soft tissue/solid organ hemorrhage which requires intervention)]	Significant birth injury: (skeletal fracture(s), peripheral nerve injury and/or soft tissue/solid organ hemorrhage which requires intervention). Defined as present immediately following delivery or manifesting following delivery. Includes any bony fracture or weakness or loss of sensation but excludes fractured clavicles and transient facial nerve palsy. Soft tissue hemorrhage requiring evaluation and/or treatment includes sub-galeal (progressive extravasation within the scalp) hemorrhage, giant cephalohematoma, extensive truncal, facial and /or extremity ecchymosis accompanied by evidence of anemia and/or hypovolemia and or hypotension. Solid organ hemorrhage includes subcapsular hematoma of the liver, fractures of the spleen, or adrenal hematoma. All require confirmation by diagnostic imaging or exploratory laparotomy.
NICU	Y	N	Abnormal conditions of the newborn: Admission to NICU	Admission into a facility or unit staffed and equipped to provide continuous mechanical ventilatory support for the newborn. Include NICU admission at any time during the infant’s hospital stay following delivery. Do not include units that do not provide continuous mechanical ventilation. Do not include well-baby nurseries or special care nurseries (i.e., Level II nursery). Do not include if the newborn was taken to the NICU for observation but is not admitted to the NICU.

IHE Quality, Research and Public Health Technical Framework Supplement – Birth and Fetal Death Reporting-Enhanced (BFDR-E)

Attribute Name	Used in Birth	Used in Fetal Death	Birth and Fetal Death Report Data Element	Description
SEIZ	Y	N	Abnormal conditions of the newborn: Seizure or serious neurologic dysfunction	Seizure defined as any involuntary repetitive, convulsive movement or behavior. Serious neurologic dysfunction defined as severe alteration of alertness such as obtundation, stupor, or coma, i.e., hypoxicischemic encephalopathy. Excludes lethargy or hypotonia in the absence of other neurologic findings. Exclude symptoms associated with CNS congenital anomalies.
SURF	Y	N	Abnormal conditions of the newborn:[Newborn given] Surfactant replacement therapy	Newborn given surfactant replacement therapy: Endotracheal instillation of a surface active suspension for the treatment of surfactant deficiency either due to preterm birth or pulmonary injury resulting in decreased lung compliance (respiratory distress). Includes both artificial and extracted natural surfactant.
NOA54	Y	N	Abnormal conditions of the newborn: None of the above	None of the listed abnormal conditions of the newborn.
DNA54	Y	N	Abnormal conditions of the newborn: Pending	If the data are not available when the abnormal conditions of the newborn are provided, the pending flag is set. The item will appear on the final review screen for entry before information is sent to vital records.
APGAR5	Y	N	Apgar Score: 5 Minute	A systematic measure for evaluating the physical condition of the infant at specific intervals following birth. Enter the infant's Apgar score at 5 minutes.
APGAR10	Y	N	Apgar Score: 10 Minute	A systematic measure for evaluating the physical condition of the infant at specific intervals following birth. If the score at 5 minutes is less than 6, enter the infant's Apgar score at 10 minutes.
ATTENDN	Y	Y	Attendant's name	The name of the attendant (the person responsible for delivering the child), their title, and their National Provider Identification (NPI) Number.
ATTEND	Y	Y	Attendant's title:	The title of the person (attendant) responsible for delivering the child. The attendant at birth is defined as the individual physically present at the delivery who is responsible for the delivery. Titles include: M.D. (doctor of medicine); D.O. (doctor of osteopathy); CNM/CM (certified nurse midwife/certified midwife); Other midwife (midwife other than a CNM/CM); and Other (specify)
ATTENDS	Y	Y	Attendant: Other specified	The specific title of the person (attendant) responsible for delivering the child if not included in the list of provided titles. Examples include nurse, father, police officer, and EMS technician. The attendant at birth is defined as the individual physically present at the delivery who is responsible for the delivery.

IHE Quality, Research and Public Health Technical Framework Supplement – Birth and Fetal Death Reporting-Enhanced (BFDR-E)

Attribute Name	Used in Birth	Used in Fetal Death	Birth and Fetal Death Report Data Element	Description
NPI	Y	Y	Attendant's NPI	The National Provider Identification Number (NPI) of the person (attendant) responsible for delivering the child.
BWG	Y	N	Birth weight (Infant's)	Infant's birthweight in grams.
BWO	Y	N	Birth weight (Infant's)	Infant's birthweight in ounces.
BWP	Y	N	Birth weight (Infant's)	Infant's birthweight in pounds.
ANTB	Y	N	Characteristics of labor and delivery: Antibiotics[received by the mother during labor]	Antibiotics received by the mother during labor. Includes antibacterial medications given systemically (intravenous or intramuscular) to the mother in the interval between the onset of labor and the actual delivery. Includes: Ampicillin, Penicillin, Clindamycin, Erythromycin, Gentamicin, Cefataxine, and Ceftriaxone. Information about the course of labor and delivery. Mother should have undergone labor, regardless of method of delivery. Check the timing of the administration of the antibacterial medications. Check this item only if medications were received systemically by the mother during labor. If information on onset of labor cannot be determined from the records, check with the birth attendant.
AUGL	Y	N	Characteristics of labor and delivery: Augmentation of labor	Augmentation of labor: Stimulation of uterine contractions by drug or manipulative technique with the intent to reduce the time of delivery (i.e., after labor has begun). Check this item if medication was given or procedures to augment labor were performed AFTER labor began. If it is not clear whether medication or procedures were performed before or after labor had begun, review records to determine when labor began and when medication were given or procedures performed. If this information is unclear or not available check with the birth attendant. Do not include if induction of labor was performed.
CHOR	Y	N	Characteristics of labor and delivery: [Clinical] Chorioamnionitis [diagnosed during labor or maternal temperature >=38 degrees (100.4F)]	Any recorded maternal temperature at or above 38oC (100.4oF) or clinical diagnosis of chorioamnionitis during labor made by the delivery attendant (usually includes more than one of the following: fever, uterine tenderness and/or irritability, leukocytosis, or fetal tachycardia). Information about the course of labor and delivery.
ESAN	Y	N	Characteristics of labor and delivery: [Epidural or spinal]Anesthesia[during labor]	Administration to the mother of a regional anesthetic to control the pain of labor. Delivery of the agent into a limited space with the distribution of the analgesic effect limited to the lower body. Mother should have undergone labor, regardless of method of delivery.

IHE Quality, Research and Public Health Technical Framework Supplement – Birth and Fetal Death Reporting-Enhanced (BFDR-E)

Attribute Name	Used in Birth	Used in Fetal Death	Birth and Fetal Death Report Data Element	Description
INDL	Y	N	Characteristics of labor and delivery: Induction of labor	Induction of labor: Initiation of uterine contractions by medical and/or surgical means for the purpose of delivery before the spontaneous onset of labor (i.e., before labor has begun). Examples of methods include, but are not limited to: artificial rupture of membranes, balloons, oxytocin, prostaglandin, luminaria, or other cervical ripening agents. Check this item if medication was given or procedures to induce labor were performed BEFORE labor began. If it is not clear whether medication or procedures were performed before or after labor had begun, review records to determine when labor began and when medications were given or procedures performed. If this information is unclear or not available check with the birth attendant. Induction of labor should be checked even if the attempt to initiate labor is not successful or the induction follows a spontaneous rupture of the membrane without contractions. Does not include augmentation of labor, which applies only after labor/contractions have begun.
STER	Y	N	Characteristics of labor and delivery: Steroids [(glucocorticoids) for fetal lung maturation received by the mother prior to delivery]	Steroids received by the mother prior to delivery to accelerate fetal lung maturation. Typically administered in anticipation of preterm (less than 37 completed weeks of gestation) delivery Steroids. Includes: Betamethasone dexamethasone, or hydrocortisone specifically given to accelerate fetal lung maturation in anticipation of preterm delivery. Does not include: Steroid medication given to the mother as an anti- inflammatory treatment before or after delivery. Three conditions must be met for this item. Check this item when 1) steroid medication was given to the mother 2) prior to delivery 3) for fetal lung maturation. Steroids may be administered to the mother prior to admittance to the hospital for delivery. Review the mother’s prenatal care and other hospital records for mention of steroid administration for this purpose.
NOA04	Y	N	Characteristics of labor and delivery: None of the above	None of the listed characteristics of labor and delivery that provide information about the course of labor and delivery.
IDOB_YR	Y	N	Child: Date of Birth: Year	The infant’s date (year) of birth.
IDOB_MO	Y	N	Child: Date of Birth: Month	The infant’s date (month) of birth.
IDOB_DY	Y	N	Child: Date of Birth: Day	The infant’s date (day) of birth.
KIDFNAME	Y	Y	Child’s First Name/ Name of Fetus(optional at the discretion of the parents)	The legal name (first) of the child as provided by the parents.
KIDMNAME	Y	Y	Child’s Middle Name / Name of Fetus(optional at the discretion of the parents)	The legal name (middle) of the child as provided by the parents.



IHE Quality, Research and Public Health Technical Framework Supplement – Birth and Fetal Death Reporting-Enhanced (BFDR-E)

Attribute Name	Used in Birth	Used in Fetal Death	Birth and Fetal Death Report Data Element	Description
KIDLNAME	Y	Y	Child’s Last Name / Name of Fetus(optional at the discretion of the parents)	The legal name (last) of the child as provided by the parents.
KIDSUFFIX	Y	Y	Child’s Last Name Suffix:	The legal name (suffix) of the child as provided by the parents.
BFED	Y	N	Child: Infant being breastfed?	Information on whether the infant was receiving breastmilk/colostrum during the period between birth and discharge from the hospital. Breastfeeding refers to the establishment of breastmilk through the action of breastfeeding or pumping (expressing). Include any attempt to establish breastmilk production during the period between birth and discharge from the hospital. Include if the infant received formula in addition to being breastfed. Does not include the intent to breastfeed.
ILIV	Y	N	Child: Infant living at time of report?	Information on the infant’s survival. Check “Yes” if the infant is living. Check “Yes” if the infant has already been discharged to home care. Check “No” if it is known that the infant has died. If the infant was transferred but the status is known, indicate the known status.
IRECNUM	Y	N	Child: Newborn Medical Record Number	The medical record number assigned to the newborn.
ISEX	Y	N	Child: (infant) Sex -	The sex of the infant.
ITRAN	Y	N	Child: Infant transferred within 24 hours of delivery/name the facility FTRAN	Transfer status of the infant within 24 hours after delivery.
FTRAN	Y	N	Child: Infant transferred within 24 hours of delivery/name the facility	
TB	Y	N	Child: Time of Birth	The infant’s time of birth.
ANEN	Y	Y	Congenital anomalies of the Newborn: Anencephaly	Partial or complete absence of the brain and skull. Also called anencephalus, acrania, or absent brain. Also includes infants with craniorachischisis (anencephaly with a contiguous spine defect).
CCHD	Y	Y	Congenital anomalies of the Newborn: Cyanotic congenital heart disease	Congenital heart defects that cause cyanosis.
CDH	Y	Y	Congenital anomalies of the Newborn:- Congenital diaphragmatic hernia	Defect in the formation of the diaphragm allowing herniation of abdominal organs into the thoracic cavity.

IHE Quality, Research and Public Health Technical Framework Supplement – Birth and Fetal Death Reporting-Enhanced (BFDR-E)

Attribute Name	Used in Birth	Used in Fetal Death	Birth and Fetal Death Report Data Element	Description
CDIC	Y	Y	Congenital anomalies of the Newborn: Suspected chromosomal disorder karyotype confirmed	Suspected chromosomal disorder karyotype confirmed
CDIS	Y	Y	Congenital anomalies of the Newborn: Suspected chromosomal Disorder	Suspected chromosomal disorder: Includes any constellation of congenital malformations resulting from or compatible with known syndromes caused by detectable defects in chromosome structure.
CDIP	Y	Y	Congenital anomalies of the Newborn: Suspected chromosomal disorder karyotype pending	Suspected chromosomal disorder karyotype pending.
CL	Y	Y	Congenital anomalies of the Newborn: Cleft Lip with or without Cleft Palate	Cleft lip with or without cleft palate refers to incomplete closure of the lip. Cleft lip may be unilateral, bilateral or median; all should be included in this category.
CP	Y	Y	Congenital anomalies of the Newborn: Cleft Palate alone	Cleft palate refers to incomplete fusion of the palatal shelves. This may be limited to the soft palate or may also extend into the hard palate. Cleft palate in the presence of cleft lip should be included in the “Cleft Lip with or without cleft Palate” category, rather than here.
DOWC	Y	Y	Congenital anomalies of the Newborn: Down Karyotype Confirmed	Down Karyotype confirmed
DOWN	Y	Y	Congenital anomalies of the Newborn: Down Syndrome	Down Syndrome: Trisomy 21 - A chromosomal abnormality caused by the presence of all or part of a third copy of chromosome 21. Check if a diagnosis of Down syndrome, Trisomy 21 is confirmed or pending.
DOWP	Y	Y	Congenital anomalies of the Newborn: Down Karyotype Pending	Down Karyotype pending
GAST	Y	Y	Congenital anomalies of the Newborn: Gastroschisis	An abnormality of the anterior abdominal wall, lateral to the umbilicus, resulting in herniation of the abdominal contents directly into the amniotic cavity. Differentiated from omphalocele by the location of the defect and absence of a protective membrane.
HYPO	Y	Y	Congenital anomalies of the Newborn: Hypospadias	Hypospadias: Incomplete closure of the male urethra resulting in the urethral meatus opening on the ventral surface of the penis. Includes first degree – on the glans ventral to the tip, second degree – in the coronal sulcus, and third degree – on the penile shaft.
LIMB	Y	Y	Congenital anomalies of the Newborn: Limb reduction defect	Limb reduction defect: (excluding congenital amputation and dwarfing syndromes) Complete or partial absence of a portion of an extremity secondary to failure to develop.

IHE Quality, Research and Public Health Technical Framework Supplement – Birth and Fetal Death Reporting-Enhanced (BFDR-E)

Attribute Name	Used in Birth	Used in Fetal Death	Birth and Fetal Death Report Data Element	Description
MNSB	Y	Y	Congenital anomalies of the Newborn: Meningomyelocele/Spina Bifida	Spina bifida is herniation of the meninges and/or spinal cord tissue through a bony defect of spine closure. Meningomyelocele is herniation of meninges and spinal cord tissue. Meningocele (herniation of meninges without spinal cord tissue) should also be included in this category. Both open and closed (covered with skin) lesions should be included. Do not include Spina bifida occulta (a midline bony spinal defect without protrusion of the spinal cord or meninges).
OMPH	Y	Y	Congenital anomalies of the Newborn: Omphalocele	A defect in the anterior abdominal wall, accompanied by herniation of some abdominal organs through a widened umbilical ring into the umbilical stalk. The defect is covered by a membrane, (different from gastroschisis, see below), although this sac may rupture. Also called exomphalos. Umbilical hernia (completely covered by skin) should not be included in this category.
NOA55	Y	Y	Congenital anomalies of the Newborn: None of the anomalies listed above	None of the listed congenital anomalies of the newborn or fetus.
YLLB	Y	Y	Date of last live birth:	The year of birth of the last live-born infant.
MLLB	Y	Y	Date of last live birth:	The month of birth of the last live-born infant.
DLMP_DY	Y	Y	Date last Normal Menses began:	The date the mother’s last normal menstrual period began.
DLMP_MO	Y	Y	Date last Normal Menses began:	The date the mother’s last normal menstrual period began.
DLMP_YR	Y	Y	Date last Normal Menses began:	The date the mother’s last normal menstrual period began.
YOPO	Y	Y	Date of Last Other Pregnancy Outcome: Year	The date (year) that the last pregnancy that did not result in a live birth ended. Includes pregnancy losses at any gestation age. Examples: spontaneous or induced losses or ectopic pregnancy. If applicable, enter the month and year. If date information is incomplete, Enter all parts of the date that are known. Enter “unknown” for any parts of the date that are missing. Do not estimate or guess a date.
MOPO	Y	Y	Date of Last Other Pregnancy Outcome: Month	The date (month) that the last pregnancy that did not result in a live birth ended. Includes pregnancy losses at any gestation age. Examples: spontaneous or induced losses or ectopic pregnancy. If applicable, enter the month and year. If date information is incomplete, Enter all parts of the date that are known. Enter “unknown” for any parts of the date that are missing. Do not estimate or guess a date.

IHE Quality, Research and Public Health Technical Framework Supplement – Birth and Fetal Death Reporting-Enhanced (BFDR-E)

Attribute Name	Used in Birth	Used in Fetal Death	Birth and Fetal Death Report Data Element	Description
ADDRESS_D	Y	Y	Facility Address	
FNAME	Y	Y	Facility Name (if Not institution, give street and number)	The name of the facility where the delivery took place.
FNPI	Y	Y	Facility National Provider Identifier	National Provider Identifier.
CHAM	Y	Y	Infections present and treated during this pregnancy: Chlamydia	Chlamydia: A positive test for Chlamydia trachomatis. Infections present at the time of the pregnancy diagnosis or a confirmed diagnosis during the pregnancy with or without documentation of treatment. Documentation of treatment during this pregnancy is adequate if a definitive diagnosis is not present in the available record.
GON	Y	Y	Infections present and treated during this pregnancy: Gonorrhea	Gonorrhea: A positive test/culture for Neisseria gonorrhoea. Infections present at the time of the pregnancy diagnosis or a confirmed diagnosis during the pregnancy with or without documentation of treatment. Documentation of treatment during this pregnancy is adequate if a definitive diagnosis is not present in the available record.
HEPB	Y	N	Infections present and treated during this pregnancy: Hepatitis B	Hepatitis B (HBV, serum hepatitis): A positive test for the hepatitis B virus. Infections present at the time of the pregnancy diagnosis or a confirmed diagnosis during the pregnancy with or without documentation of treatment. Documentation of treatment during this pregnancy is adequate if a definitive diagnosis is not present in the available record.
HEPC	Y	N	Infections present and treated during this pregnancy: Hepatitis C	Hepatitis C (non-A, non-B hepatitis (HCV)): A positive test for the hepatitis C virus. Infections present at the time of the pregnancy diagnosis or a confirmed diagnosis during the pregnancy with or without documentation of treatment. Documentation of treatment during this pregnancy is adequate if a definitive diagnosis is not present in the available record.
SYPH	Y	Y	Infections present and treated during this pregnancy: Syphilis	Syphilis (also called lues) A positive test for Treponema pallidum. Infections present at the time of the pregnancy diagnosis or a confirmed diagnosis during the pregnancy with or without documentation of treatment. Documentation of treatment during this pregnancy is adequate if a definitive diagnosis is not present in the available record.
NOA02	Y	Y	Infections present and treated during this pregnancy: None of the above	None of the listed infections were present and treated during this pregnancy.
AINT	Y	Y	Maternal Morbidity: - Admission to Intensive care [unit]	Admission to intensive care unit: Any admission, planned or unplanned, of the mother to a facility/unit designated as providing intensive care. Serious complications experienced by the mother associated with labor and delivery.

IHE Quality, Research and Public Health Technical Framework Supplement – Birth and Fetal Death Reporting-Enhanced (BFDR-E)

Attribute Name	Used in Birth	Used in Fetal Death	Birth and Fetal Death Report Data Element	Description
MTR	Y	Y	Maternal Morbidity: Maternal Transfusion	Maternal transfusion: Includes infusion of whole blood or packed red blood cells within the period specified. Serious complications experienced by the mother associated with labor and delivery.
PLAC	Y	Y	Maternal Morbidity: [Third or fourth degree] perineal laceration	Third or fourth degree perineal laceration: 3rd degree laceration extends completely through the perineal skin, vaginal mucosa, perineal body and anal sphincter. 4th degree laceration is all of the above with extension through the rectal mucosa. Serious complications experienced by the mother associated with labor and delivery.
RUT	Y	Y	Maternal Morbidity: Ruptured Uterus	Ruptured Uterus: Tearing of the uterine wall. Uterine rupture is a full-thickness disruption of the uterine wall that also involves the overlying visceral peritoneum (uterine serosa). Does not include uterine dehiscence in which the fetus, placenta, and umbilical cord remain contained with the uterine cavity. Does not include a silent or incomplete rupture or an asymptomatic separation.
UHYS	Y	Y	Maternal Morbidity: Unplanned hysterectomy	Unplanned hysterectomy: Surgical removal of the uterus that was not planned prior to admission for delivery. Includes an anticipated or possible but not definitively planned procedure. Serious complications experienced by the mother associated with labor and delivery.
UOPR	Y	Y	Maternal Morbidity: Unplanned operat[ing]ion [room procedure following delivery]	Unplanned operating room procedure following delivery: Any transfer of the mother back to a surgical area for an operative procedure that was not planned prior to the admission for delivery. Excludes postpartum tubal ligations. Serious complications experienced by the mother associated with labor and delivery.
NOA05	Y	Y	Maternal Morbidity:None of the above  NOTE: NOA05 is also used for onset of labor	None of the listed serious complications experienced by the mother associated with labor and delivery.
PRES	Y	Y	Method of Delivery: Fetal presentation [at birth]: Cephalic	The physical process by which the complete delivery of the fetus was affected. Fetal presentation at birth - Cephalic: Presenting part of the fetus listed as vertex, occiput anterior (OA), occiput posterior (OP); Breech: Presenting part of the fetus listed as breech, complete breech, frank breech, footling breech; Other: Any other presentation not listed above.

IHE Quality, Research and Public Health Technical Framework Supplement – Birth and Fetal Death Reporting-Enhanced (BFDR-E)

Attribute Name	Used in Birth	Used in Fetal Death	Birth and Fetal Death Report Data Element	Description
ROUT	Y	Y	Method of Delivery: [Final]Route and method of delivery	The physical process by which the complete delivery of the fetus was affected. Includes: Vaginal/spontaneous: delivery of the entire fetus through the vagina by the nature force of labor with or without manual assistance from the delivery attendant; Vaginal/forceps: Delivery of the fetal head through the vagina by the application of obstetrical forceps to the fetal head; Vaginal/vacuum: Delivery of the fetal head through the vagina by the application of a vacuum cup or ventouse to the fetal head; or Cesarean: Extraction of the fetus, placenta, and membranes through an incision in the maternal abdominal and uterine walls.
TLAB	Y	Y	Method of Delivery: Trial of labor attempted	If cesarean, indicate if a trial of labor was attempted (labor was allowed, augmented, or induced with plans for a vaginal delivery).
MFNAME	Y	Y	Mother's Current Legal Name: First Name	The current legal first name of the mother.
MMNAME	Y	Y	Mother's Current Legal Name: Middle Name	The current legal middle name of the mother.
MLNAME	Y	Y	Mother's Current Legal Name: Last Name	The current legal last name of the mother.
MSUFF	Y	Y	Mother's Current Legal Name: suffix	The current legal name suffix of the mother.
HFT	Y	Y	Mother's Height: Feet	Mother's height feet
HIN	Y	Y	Mother's Height: Inches	Mother's height inches
MRECNUM	Y	Y	Mother's medical record number	The mother's medical record number for this facility admission
PWGT	Y	Y	Mother's pre-pregnancy weight	The mother's prepregnancy weight
NFACL	Y	Y	Mother: If Mother transferred for maternal medical or fetal indications for delivery, enter name of facility mother transferred from.	Indicates the name of the facility the mother was transferred from if the mother was transferred from another facility. Transfers include hospital to hospital, birth facility to hospital, etc. Does not include home to hospital.
TRAN	Y	Y	Mother transferred for maternal medical or fetal indications for delivery?	Indicates if the mother was transferred from another facility. Transfers include hospital to hospital, birth facility to hospital, etc. Does not include home to hospital.
DWGT	Y	Y	Mother's weight at delivery	The mother's weight at the time of delivery.
POPO	Y	Y	Number of other pregnancy outcomes	Total number of other pregnancy outcomes that did not result in a live birth. Includes pregnancy losses of any gestation age. Examples: spontaneous or induced losses or ectopic pregnancy.

IHE Quality, Research and Public Health Technical Framework Supplement – Birth and Fetal Death Reporting-Enhanced (BFDR-E)

Attribute Name	Used in Birth	Used in Fetal Death	Birth and Fetal Death Report Data Element	Description
PLBD	Y	Y	Number of previous live births now dead (do not include this child)	The total number of previous live-born infants now dead.
PLBL	Y	Y	Number of previous live births now living (do not include this child)	The total number of previous live-born infants now living.
PNC	Y	Y	Prenatal Care	The mother did not receive prenatal care at any time during the pregnancy.
OWGEST	Y	Y	Obstetric Estimate of Gestation	The best obstetric estimate of the infant’s gestational age (OE) in completed weeks is based on the clinician’s final estimate of gestation. The final number of weeks should be available in the OB admission H&P as the first source. The final number of weeks may also be obtained from the PNC records as a secondary source if the information is not available in the OB admissions H&P.
CERV	Y	N	Obstetric procedures: Cervical cerclage	Cervical cerclage: Circumferential banding or suture of the cervix to prevent or treat dilation. Includes: MacDonald’s suture; Shirodkar procedure; and Abdominal cerclage via laparotomy. Obstetric procedures: Medical treatment or invasive/manipulative procedure performed during this pregnancy to treat the pregnancy or to manage labor and/or delivery.
ECVF	Y	N	Obstetric procedures: Failed External cephalic Version	Failed External cephalic version: Failed attempt to convert a fetus from a nonvertex to a vertex presentation by external manipulation. Obstetric procedures: Medical treatment or invasive/manipulative procedure performed during this pregnancy to treat the pregnancy or to manage labor and/or delivery.
ECVS	Y	N	Obstetric procedures: Successful External cephalic version	Successful External cephalic version: Successful conversion of a fetus from a nonvertex to a vertex presentation by external manipulation. Obstetric procedures: Medical treatment or invasive/manipulative procedure performed during this pregnancy to treat the pregnancy or to manage labor and/or delivery.
TOC	Y	N	Obstetric procedures: Tocolysis	Tocolysis: Administration of any agent with the intent to inhibit preterm uterine contractions to extend the length of the pregnancy. Medications: Magnesium sulfate (for preterm labor); Terbutaline; Indocin (for preterm labor). Obstetric procedures: Medical treatment or invasive/manipulative procedure performed during this pregnancy to treat the pregnancy or to manage labor and/or delivery.

IHE Quality, Research and Public Health Technical Framework Supplement – Birth and Fetal Death Reporting-Enhanced (BFDR-E)

Attribute Name	Used in Birth	Used in Fetal Death	Birth and Fetal Death Report Data Element	Description
NOA03	Y	N	Obstetric procedures: None of the above	None of the listed obstetric procedures were performed for medical treatment or invasive/manipulative procedures during this pregnancy to treat the pregnancy or to manage labor and/or delivery.
PROM	Y	N	Onset of labor: Premature Rupture	Premature Rupture of the Membranes (prolonged $\geq$ 12 hours): Spontaneous tearing of the amniotic sac, (natural breaking of the “bag of waters”), 12 hours or more before labor begins. Serious complications experienced by the mother associated with labor and delivery.
PRIC	Y	N	Onset of labor: Precipitous Labor	Precipitous labor (<3hours): Labor that progresses rapidly and lasts for less than 3 hours. Serious complications experienced by the mother associated with labor and delivery.
PROL	Y	N	Onset of labor: Prolonged Labor	Prolonged labor ( $\geq$ 20 hours): Labor that progresses slowly and lasts for 20 hours or more. Serious complications experienced by the mother associated with labor and delivery.
NOA05	Y	N	Onset of labor: None of the above NOTE: NOA05 is also used for Maternal Morbidity	None of the listed serious complications experienced by the mother associated with labor and delivery.
SFN	Y	Y	Place where birth occurred: State Facility Number	Place where birth occurred: State Facility Number
FLOC	Y	Y	Place where birth occurred: Facility City/Town	Place where birth occurred: Facility City/Town
CNAME	Y	Y	Place where birth occurred: County Name	Place where birth occurred: County Name
CNTYO	Y	Y	Place where birth occurred: County Code	Place where birth occurred: County Code
BPLACE	Y	N	Place where birth occurred: Birth Place	Place where birth occurred: Birth Place
PLUR	Y	Y	Plurality	The number of fetuses delivered live or dead at any time in the pregnancy regardless of gestational age or if the fetuses were delivered at different dates in the pregnancy. (“Reabsorbed” fetuses, those which are not “delivered” (expulsed or extracted from the mother) should not be counted.)
DOFP_MO	Y	Y	Prenatal care visits: Date of first prenatal care visit: Month	The month a physician or other health care professional first examined and/or counseled the pregnant woman for the pregnancy.
DOFP_DY	Y	Y	Date of first prenatal care visit: Day	The day a physician or other health care professional first examined and/or counseled the pregnant woman for the pregnancy.



IHE Quality, Research and Public Health Technical Framework Supplement – Birth and Fetal Death Reporting-Enhanced (BFDR-E)

Attribute Name	Used in Birth	Used in Fetal Death	Birth and Fetal Death Report Data Element	Description
DOFP_YR	Y	Y	Date of first prenatal care visit: Year	The year a physician or other health care professional first examined and/or counseled the pregnant woman for the pregnancy.
NPREV	Y	Y	Prenatal care visits: Total number of prenatal visits for this pregnancy	The total number of visits recorded in the record. A prenatal visit is one in which the physician or other health care professional examines or counsels the pregnant woman for her pregnancy Do not include visits for laboratory and other testing in which a physician or health care professional did not examine or counsel the pregnant woman Access the most recent prenatal records available. If up-to-date records are not available, contact the prenatal care provider for the most current information. Count the prenatal visits recorded in the record. Exclude visits for laboratory and other tests or classes in which the mother was not seen by a physician or other health care professional for pregnancy-related care. If it is not clear whether the mother was seen by a physician or other health care professional, include the visit(s) in the total number.
PAY	Y	N	Principal source of payment for this delivery	The principal source of payment at the time of delivery: Includes: Private insurance (Blue Cross/Blue Shield, Aetna, etc.); Medicaid (or a comparable State program); Self-pay (no third party identified); Other (Indian Health Service, CHAMPUS/ TRICARE, other government [Federal, State, local]); Unknown
PDIAB	Y	Y	Risk factors in this pregnancy: Prepregnancy Diabetes	Prepregnancy Diabetes (diagnosis of glucose intolerance requiring treatment before this pregnancy).
GDIAB	Y	Y	Risk factors in this pregnancy: Gestational Diabetes	Gestational Diabetes (diagnosis of glucose intolerance requiring treatment during this pregnancy).
PHYPE	Y	Y	Risk factors in this pregnancy: Prepregnancy Hypertension	Prepregnancy (Chronic) Hypertension (Elevation of blood pressure above normal for age, gender, and physiological condition with diagnosis prior to the onset of this pregnancy. Does not include gestational (pregnancy induced) hypertension (PIH)).
GHYPE	Y	Y	Risk factors in this pregnancy: Gestational Hypertension	Gestational Hypertension (Elevation of blood pressure above normal for age, gender, and physiological condition with diagnosis in this pregnancy (pregnancy-induced hypertension or preeclampsia.))
EHYPE	Y	Y	Risk factors in this pregnancy: Eclampsia	Eclampsia Hypertension (Elevation of blood pressure above normal for age, gender, and physiological condition with proteinuria with generalized seizures or coma.) May include pathologic edema.

IHE Quality, Research and Public Health Technical Framework Supplement – Birth and Fetal Death Reporting-Enhanced (BFDR-E)

Attribute Name	Used in Birth	Used in Fetal Death	Birth and Fetal Death Report Data Element	Description
PPB	Y	Y	Risk factors in this pregnancy: Previous preterm births	History of pregnancy(ies) terminating in a live birth of less than 37 completed weeks of gestation.
INFT	Y	Y	Risk factors in this pregnancy: Infertility treatment	Any assisted reproductive treatment used to initiate the pregnancy. Includes: Any assisted reproductive treatment used to initiate the pregnancy. Includes: <ul style="list-style-type: none"> <li>- Drugs (such as Clomid, Pergonal)</li> <li>- Artificial insemination</li> <li>- Technical procedures (such as in-vitro fertilization)</li> </ul> Drugs (such as Clomid, Pergonal); Artificial insemination; Technical procedures (such as in-vitro fertilization).
INFT_DRG	Y	Y	Risk factors in this pregnancy: Infertility: Fertility Enhancing Drugs, AI	Fertility-enhancing drugs, artificial insemination or intrauterine insemination Any fertility enhancing drugs (e.g., Clomid, Pergonal), artificial insemination or intrauterine insemination used to initiate the pregnancy.
INFT_ART	Y	Y	Risk factors in this pregnancy: Infertility: Asst. Rep. Technology	Assisted reproductive technology (e.g., in vitro fertilization (IVF), gamete intrafallopian transfer GIFT)) Any assisted reproductive technology (ART/technical procedures (e.g., IVF, GIFT, ZIFT)) used to initiate the pregnancy.
PCES	Y	Y	Risk factors in this pregnancy: Previous cesarean	Previous delivery by extracting the fetus, placenta, and membranes through an incision in the mother’s abdominal and uterine walls.
NPCES	Y	Y	Risk factors in this pregnancy: Number of previous cesareans	Number of previous deliveries extracting the fetus, placenta, and membranes through an incision in the mother’s abdominal and uterine walls.
NOA01	Y	Y	Risk factors in this pregnancy: None of the above	The patient had none of the listed risk factors in this pregnancy.
SORD	Y	Y	Set Order	Order this infant was delivered in the set.
FSEX	N	Y	Child: (fetus) Sex -	The sex of the fetus.
FDOD_YR	N	Y	Date of Delivery (Fetus) Year	Date of Delivery (Fetus) Year
FDOD_MO	N	Y	Date of Delivery (Fetus) Month	Date of Delivery (Fetus) Month
FDOD_DY	N	Y		Date of Delivery (Fetus) Day
ETIME	N	Y	Estimated Time of Fetal Death	Item to indicate when the fetus died with respect to labor and assessment.

IHE Quality, Research and Public Health Technical Framework Supplement – Birth and Fetal Death Reporting-Enhanced (BFDR-E)

Attribute Name	Used in Birth	Used in Fetal Death	Birth and Fetal Death Report Data Element	Description
LIVEB	Y	N	Not single birth - specify number of infants in this delivery born alive.	Specify the number of infants in this delivery born alive
FDTH	N	Y	Number of fetal deaths	Specify the number of fetal deaths in this delivery
HYST	N	Y	Method of Delivery: Hysterotomy/Hysterectomy?	Hysterotomy/Hysterectomy was the physical process by which the complete delivery of the fetus was affected.  Hysterotomy: Incision into the uterus extending into the uterine cavity. May be performed vaginally or transabdominally. Hysterectomy: Surgical removal of the uterus. May be performed abdominally or vaginally.
TD	N	Y	Time of delivery	Hour and minute fetus was delivered.
AUTOP	N	Y	Was an autopsy performed?	Information on whether or not an autopsy was performed
FWO	N	Y	Weight of Fetus (in ounces)	Fetus' weight in ounces.
FWG	N	Y	Weight of Fetus (grams preferred, specify unit)	Fetus' weight in grams.
FWP	N	Y	Weight of Fetus (in pounds)	Fetus' weight in pounds.
LM	N	Y	Infections present and treated during this pregnancy: Listeria	Listeria: A diagnosis of or positive test for Listeria monocytogenes. Infections present at the time of the pregnancy diagnosis or a confirmed diagnosis during the pregnancy with or without documentation of treatment. Documentation of treatment during this pregnancy is adequate if a definitive diagnosis is not present in the available record.
GBS	N	Y	Infections present and treated during this pregnancy: Group B Streptococcus	Group B Streptococcus: A diagnosis of or positive test for Streptococcus agalactiae or group B streptococcus. Infections present at the time of the pregnancy diagnosis or a confirmed diagnosis during the pregnancy with or without documentation of treatment. Documentation of treatment during this pregnancy is adequate if a definitive diagnosis is not present in the available record.
CMV	N	Y	Infections present and treated during this pregnancy: Cytomeglovirus	Cytomegalovirus (CMV): A diagnosis of or positive test for Cytomegalovirus. Infections present at the time of the pregnancy diagnosis or a confirmed diagnosis during the pregnancy with or without documentation of treatment. Documentation of treatment during this pregnancy is adequate if a definitive diagnosis is not present in the available record.

IHE Quality, Research and Public Health Technical Framework Supplement – Birth and Fetal Death Reporting-Enhanced (BFDR-E)

Attribute Name	Used in Birth	Used in Fetal Death	Birth and Fetal Death Report Data Element	Description
B19	N	Y	Infections present and treated during this pregnancy: Parvovirus	Parvovirus: A diagnosis of or positive test for Parvovirus B19. Infections present at the time of the pregnancy diagnosis or a confirmed diagnosis during the pregnancy with or without documentation of treatment. Documentation of treatment during this pregnancy is adequate if a definitive diagnosis is not present in the available record
HISTOP	N	Y	Was a Histological Placental Examination performed?	Information on whether or not a histological placental examination was performed
TOXO	N	Y	Infections present and treated during this pregnancy: Toxoplasmosis	Toxoplasmosis: A diagnosis of or positive test for Toxoplasma gondii.
COD18a1	N	Y	Initiating Cause/Condition - Rupture of membranes prior to onset of labor	NA
COD18a2	N	Y	Initiating Cause/Condition - Abruptio placenta	NA
COD18a3	N	Y	Initiating Cause/Condition - Placental insufficiency	NA
COD18a4	N	Y	Initiating Cause/Condition - Prolapsed cord	NA
COD18a5	N	Y	Initiating Cause/Condition - Chorioamnionitis	NA
COD18a6	N	Y	Initiating Cause/Condition - Other complications of placenta, cord, or membranes	NA
COD18a7	N	Y	Initiating Cause/Condition - Unknown	NA
COD18a8	N	Y	Initiating Cause/Condition - Maternal conditions/diseases literal	NA
COD18a9	N	Y	Initiating Cause/Condition - Other complications of placenta, cord, or membranes literal	NA
COD18a10	N	Y	Initiating Cause/Condition - Other obstetrical or pregnancy complications literal	NA

IHE Quality, Research and Public Health Technical Framework Supplement – Birth and Fetal Death Reporting-Enhanced (BFDR-E)

Attribute Name	Used in Birth	Used in Fetal Death	Birth and Fetal Death Report Data Element	Description
COD18a11	N	Y	Initiating Cause/Condition - Fetal anomaly literal	NA
COD18a12	N	Y	Initiating Cause/Condition - Fetal injury literal	NA
COD18a13	N	Y	Initiating Cause/Condition - Fetal infection literal	NA
COD18a14	N	Y	Initiating Cause/Condition - Other fetal conditions/disorders literal	NA
COD18b1	N	Y	Other Significant Cause/Condition - Rupture of membranes prior to onset of labor	NA
COD18b2	N	Y	Other Significant Cause/Condition - Abruptio placenta	NA
COD18b3	N	Y	Other Significant Cause/Condition - Placental insufficiency	NA
COD18b4	N	Y	Other Significant Cause/Condition - Prolapsed cord	NA
COD18b5	N	Y	Other Significant Cause/Condition - Chorioamnionitis	NA
COD18b6	N	Y	Other Significant Cause/Condition - Other complications of placenta, cord, or membranes	NA
COD18b7	N	Y	Other Significant Cause/Condition - Unknown	NA
COD18b8	N	Y	Other Significant Cause/Condition - Maternal conditions/diseases literal	NA
COD18b9	N	Y	Other Significant Cause/Condition - Other complications of placenta, cord, or membranes literal	NA

IHE Quality, Research and Public Health Technical Framework Supplement – Birth and Fetal Death Reporting-Enhanced (BFDR-E)

Attribute Name	Used in Birth	Used in Fetal Death	Birth and Fetal Death Report Data Element	Description
COD18b10	N	Y	Other Significant Cause/Condition - Other obstetrical or pregnancy complications literal	NA
COD18b11	N	Y	Other Significant Cause/Condition - Fetal anomaly literal	NA
COD18b12	N	Y	Other Significant Cause/Condition - Fetal injury literal	NA
COD18b13	N	Y	Other Significant Cause/Condition - Fetal infection literal	NA
COD18b14	N	Y	Other Significant Cause/Condition - Other fetal conditions/disorders literal	NA
UNUM	Y	Y	Mother's Residence: Apartment or Unit Number	Mother's Residence: Apartment or Unit Number
CITY	Y	Y	Mother's Residence: City, Town or Location	Mother's Residence: City or Town name
CITYC	Y	Y	Mother's Residence: Code for City, Town or Location	Mother's Residence: City or Town code
COUNTY	Y	Y	Mother's Residence: County*	Mother's Residence: County
LIMITS	Y	Y	Mother's Residence: Inside City Limits	Indicates if the mother's residence is within city limits
STATE	Y	Y	Mother's Residence: State	Mother's Residence: State/Province
STNAME	Y	Y	Mother's Residence: Street Name	Mother's Residence: Street Name
STNUM	Y	Y	Mother's Residence: Street Number	Mother's Residence: Street Number
ZIP	Y	Y	Mother's Residence: Zip Code	Mother's Residence: Zip Code
LIMITS	Y	Y	Mother's Residence: Inside City Limits*	Indicates if the mother's residence is within city limits
MSTNAME	Y	Y	Mother's Mailing Address*: Name	The mother's mailing address (complete number and street name)
MAPT	Y	Y	Mother's Mailing Address: Apartment	The mother's mailing address (Apartment number)
MCITY	Y	Y	Mother's Mailing Address: City	The mother's mailing address (city or town name)
MSTATE	Y	Y	Mother's Mailing Address: State	The mother's mailing address (state, territory or province)
MZIP	Y	Y	Mother's Mailing Address: Zip	The mother's mailing address (zip code)

IHE Quality, Research and Public Health Technical Framework Supplement – Birth and Fetal Death Reporting-Enhanced (BFDR-E)

Attribute Name	Used in Birth	Used in Fetal Death	Birth and Fetal Death Report Data Element	Description
MCOUNTRY	Y	Y	Mother's Mailing Address: Country	The mother's mailing address (country)
MDOB_YR	Y	Y	Mother's Date of Birth* Year	The mother's date (year) of birth
MDOB_MO	Y	Y	Mother's Date of Birth* Month	The mother's date (month) of birth
MDOB_DY	Y	Y	Mother's Date of Birth* Day	The mother's date (day) of birth
BPLACEC_CNT*	Y	Y	Birthplace – Code for Mother's country of birth	Code for Mother's country of birth
BPLACE_ST*	Y	Y	Birthplace – Mother's state of birth	Mother's state of birth (literal)
BPLACE_TERR*	Y	Y	Birthplace – Mother's territory of birth	Mother's territory of birth (literal)
BPLACEC_STATE_TERR*	Y	Y	Birthplace – Code for Mother's state or territory of birth	Code for Mother's state or territory of birth
METHNIC1	Y	Y	Mother of Hispanic Origin? Mexican/Mexican American/ Chicana	Mother's Hispanic Origin is Mexican/Mexican American/Chicana
METHNIC2	Y	Y	Mother of Hispanic Origin? Puerto Rican	Mother's Hispanic Origin is Puerto Rican
METHNIC3	Y	Y	Mother of Hispanic Origin? Cuban	Mother's Hispanic Origin is Cuban
METHNIC4	Y	Y	Mother of Hispanic Origin? Other Spanish/Hispanic/Latina	Mother's Hispanic Origin is Other Spanish/Hispanic/Latina
METHNIC5	Y	Y	Mother of Hispanic Origin? Other Literal Entry	Mother's Hispanic Origin is Other (specify)
MRACE1	Y	Y	Mother's Race: White	Mother's Race is White
MRACE2	Y	Y	Mother's Race: Black or African American	Mother's Race: Black or African American
MRACE3	Y	Y	Mother's Race: American Indian or Alaska Native	Mother's Race: American Indian or Alaska Native
MRACE4	Y	Y	Mother's Race: Asian Indian	Mother's Race: Asian Indian
MRACE5	Y	Y	Mother's Race: Chinese	Mother's Race: Chinese
MRACE6	Y	Y	Mother's Race: Filipino	Mother's Race: Filipino
MRACE7	Y	Y	Mother's Race: Japanese	Mother's Race: Japanese

IHE Quality, Research and Public Health Technical Framework Supplement – Birth and Fetal Death Reporting-Enhanced (BFDR-E)

Attribute Name	Used in Birth	Used in Fetal Death	Birth and Fetal Death Report Data Element	Description
MRACE8	Y	Y	Mother's Race: Korean	Mother's Race: Korean
MRACE9	Y	Y	Mother's Race: Vietnamese	Mother's Race: Vietnamese
MRACE10	Y	Y	Mother's Race: Other Asian	Mother's Race: Other Asian (specify)
MRACE11	Y	Y	Mother's Race: Native Hawaiian	Mother's Race: Native Hawaiian
MRACE12	Y	Y	Mother's Race: Guamanian or Chamorro	Mother's Race: Guamanian or Chamorro
MRACE13	Y	Y	Mother's Race: Samoan	Mother's Race: Samoan
MRACE14	Y	Y	Mother's Race: Other Pacific Islander	Mother's Race: Other Pacific Islander (specify)
MRACE15	Y	Y	Mother's Race: Other Race	Mother's Race: Other Race (specify)
MRACE16	Y	Y	Mother's Race: First American Indian or Alaska Native	Mother's Race: First American Indian or Alaska Native (literal)
MRACE17	Y	Y	Mother's Race: Second American Indian or Alaska Native	Mother's Race: Second American Indian or Alaska Native (literal)
MRACE18	Y	Y	Mother's Race: First Other Asian	Mother's Race: First Other Asian (literal)
MRACE19	Y	Y	Mother's Race: Second Other Asian	Mother's Race: Second Other Asian (literal)
MRACE20	Y	Y	Mother's Race: First Other Pacific Islander	Mother's Race: First Other Pacific Islander (literal)
MRACE21	Y	Y	Mother's Race: Second Other Pacific Islander	Mother's Race: Second Other Pacific Islander (literal)
MRACE22	Y	Y	Mother's Race: First Other Race	Mother's Race: First Other Race (literal)
MRACE22	Y	Y	Mother's Race: Second Other Race	Mother's Race: Second Other Race (literal)
CMHR	Y	Y	Mother: Did the mother get WIC food for herself during this pregnancy	Indicates if there was use of the Women, Infant’s and Children (WIC) nutritional program by the mother during the pregnancy
CIGPN	Y	Y	Cigarette Smoking before and during pregnancy: Number of cigarettes smoked prior to pregnancy	Number cigarettes smoked prior to pregnancy
CIGPP	Y	Y	Cigarette Smoking before and during pregnancy :Number of packs of cigarettes smoked prior to pregnancy	Number of packs smoked prior to pregnancy



IHE Quality, Research and Public Health Technical Framework Supplement – Birth and Fetal Death Reporting-Enhanced (BFDR-E)

Attribute Name	Used in Birth	Used in Fetal Death	Birth and Fetal Death Report Data Element	Description
CIGFN	Y	Y	Cigarette Smoking before and during pregnancy: Number of cigarettes smoked in 1st three months of pregnancy	Number of cigarettes smoked in 1st three months
CIGFP	Y	Y	Cigarette Smoking before and during pregnancy: Number of packs of cigarettes smoked in the first three months of pregnancy	Number of packs smoked in 1st three months
CIGSN	Y	Y	Cigarette Smoking before and during pregnancy: Number of cigarettes smoked in the 2nd three months of pregnancy	Number of cigarettes smoked in 2nd three months
CIGSP	Y	Y	Cigarette Smoking before and during pregnancy: Number of packs of cigarettes smoked in the 2nd three months of pregnancy	Number of packs smoked in 2nd three months
CIGLN			Cigarette Smoking before and during pregnancy: Number cigarettes smoked in 3rd three months of pregnancy	Number of cigarettes smoked in third trimester
CIGLP	Y	Y	Cigarette Smoking before and during pregnancy: Number of packs of cigarettes smoked in the 3rd three months of pregnancy	Number of packs smoked in third trimester
FBPLACE_S T_TER_L	Y	Y	Father's Birthplace (State or Territory)	The geographic location (state or territory) of the father's place of birth (literal).
FBPLACE_S T_L	Y	Y	Father's Birthplace (Code for Father's State of Birth)	The geographic location (state) of the father's place of birth (code).
FBPLACE_S T_TER_C	Y	Y	Father's Birthplace (Code for Father's State or Territory of Birth)	The geographic location (state or territory) of the father's place of birth (code).
FBPLACE_C NT_C	Y	Y	Father's Birthplace (Code for Father's Country of Birth)	The geographic location (country) of the father's place of birth (code).
FFNAME	Y	Y	Father's Current Legal Name*: First Name	The current legal first name of the father.

IHE Quality, Research and Public Health Technical Framework Supplement – Birth and Fetal Death Reporting-Enhanced (BFDR-E)

Attribute Name	Used in Birth	Used in Fetal Death	Birth and Fetal Death Report Data Element	Description
FMNAME	Y	Y	Father's Current Legal Name*: Middle Name	The current legal middle name of the father.
FLNAME	Y	Y	Father's Current Legal Name*: Last Name	The current legal last name of the father.
FSUFF	Y	Y	Father's Current Legal Name*: Suffix	The current legal name suffix of the father.
FNREF	Y	Y	Father's Current Legal Name*: Refused	Indicates if the father's name can be entered and the mother refuses to name the father. This should only occur when the mother was married at birth, conception, or any time in between and refuses the name of her husband.
FDOB_YR	Y	Y	Father's Date of Birth*: Year	The father's date (year) of birth
FDOB_MO	Y	Y	Father's Date of Birth*: Month	The father's date (month) of birth
FDOB_DY	Y	Y	Father's Date of Birth*: Day	The father's date (day) of birth
FEDUC	Y	N	Father's Education*	The highest degree or level of schooling completed by the father at the time of this delivery
FETHNIC1	Y	N	Father of Hispanic Origin? Mexican, Mexican American or Chicano	Father is Mexican, Mexican American or Chicano
FETHNIC2	Y	N	Father of Hispanic Origin? Puerto Rican	Father is Puerto Rican
FETHNIC3	Y	N	Father of Hispanic Origin? Cuban	Father is Cuban
FETHNIC4	Y	N	Father of Hispanic Origin? Other	Father is other: Spanish/Hispanic/Latino
FETHNIC5	Y	N	Father of Hispanic Origin? Other literal entry	Other literal entry
FRACE1	Y	N	Father's Race: White	Father's Race is White
FRACE2	Y	N	Father's Race: Black or African American	Father's Race is Black or African American
FRACE3	Y	N	Father's Race: American Indian or Alaska Native	Father's Race is American Indian or Alaska Native (Name of the enrolled or principal tribe)
FRACE4	Y	N	Father's Race: Asian Indian	Father's Race is Asian Indian
FRACE5	Y	N	Father's Race: Chinese	Father's Race is Chinese
FRACE6	Y	N	Father's Race: Filipino	Father's Race is Filipino
FRACE7	Y	N	Father's Race: Japanese	Father's Race is Japanese

IHE Quality, Research and Public Health Technical Framework Supplement – Birth and Fetal Death Reporting-Enhanced (BFDR-E)

Attribute Name	Used in Birth	Used in Fetal Death	Birth and Fetal Death Report Data Element	Description
FRACE8	Y	N	Father's Race: Korean	Father's Race is Korean
FRACE9	Y	N	Father's Race: Vietnamese	Father's Race is Vietnamese
FRACE10	Y	N	Father's Race: Other Asian	Father's Race is Other Asian (specify)
FRACE11	Y	N	Father's Race: Native Hawaiian	Father's Race is Native Hawaiian
FRACE12	Y	N	Father's Race: Guamanian or Chamorro	Father's Race is Guamanian or Chamorro
FRACE13	Y	N	Father's Race: Samoan	Father's Race is Samoan
FRACE14	Y	N	Father's Race: Other Pacific Islander	Father's Race is Other Pacific Islander (specify)
FRACE15	Y	N	Father's Race: Other Race	Father's Race is Other Race (specify)
FRACE16	Y	N	Father's Race: First American Indian or Alaska Native	Father's Race is First American Indian or Alaska Native (literal)
FRACE17	Y	N	Father's Race: Second American Indian or Alaska Native	Father's Race is Second American Indian or Alaska Native (literal)
FRACE18	Y	N	Father's Race: First Other Asian	Father's Race is: First Other Asian (literal)
FRACE19	Y	N	Father's Race: Second Other Asian	Father's Race is: Second Other Asian (literal)
FRACE20	Y	N	Father's Race: First Other Pacific Islander	Father's Race is First Other Pacific Islander (literal)
FRACE21	Y	N	Father's Race: Second Other Pacific Islander	Father's Race is Second Other Pacific Islander (literal)
FRACE22	Y	N	Father's Race: First Other Race	Father's Race is: First Other Race (literal)
FRACE23	Y	N	Father's Race: Second Other Race	Father's Race is: Second Other Race (literal)
MSSN	Y	N	Mother's Jurisdiction Identifier (e.g., Security Number)	The jurisdiction identifier (e.g., social security number (SSN)) of the mother
FSSN	Y	N	Father's Jurisdiction Identifier (e.g., Security Number)	The jurisdiction identifier (e.g., social security number (SSN)) of the father named on the certificate.
ACKN	Y	N	Acknowledgment of paternity signed	The mother and father signed a form (Insert name of the State acknowledgement of paternity form) in which the father accepted legal responsibility for the child?
MHT	Y	Y	Mother's body height	Open Issue: Mother's Body Height is listed as a separate new LOINC code
BREGDATE	Y	N	Date of birth registration	The date on which the birth was registered.
FAGE	Y	Y	Father's reported age in years	A record of the father's age at the time of birth or delivery.

IHE Quality, Research and Public Health Technical Framework Supplement – Birth and Fetal Death Reporting-Enhanced (BFDR-E)

Attribute Name	Used in Birth	Used in Fetal Death	Birth and Fetal Death Report Data Element	Description
HDELPLAN	Y	N	Planned to deliver at home	Open Issue: Planned to deliver at home is part of the Birthplace value set, but a separate LOINC code has been assigned for the draft HL7 spec. Boolean indicator (Yes/No/Unknown) that indicates whether the mother intended to have a home birth. Only value this observation if the birth took place at home.
MAGE	Y	Y	Mother’s reported age in years	Mother’s age is calculated using mother’s date of birth (completed dates only) and the child’s date of birth. Calculated age must be >8 and < 65
NOINAME	Y	Y	Baby name not yet chosen	Open Issue: Baby name not yet chosen is not in edit specifications. An indicator that the name for a newborn baby has not yet been chosen. Enter "Yes" if no name has been chosen
BATTEND	Y	N	Birth attendant details	Name and identifier information for the person attending the birth.
BCERTIFIER	Y	N	Birth certifier details	Name and identifier information for the person certifying the birth.
CERTDATE	Y	N	Date birth certified	The date the birth was certified by the certifying professional.
FDREGDATE	N	Y	Date of fetal death registration	The date the fetal death was registered at the jurisdictional vital statistics office.
FDELDATE	N	Y	Date of fetal delivery	The date of delivery for the fetus.
FETNAME	N	Y	Name of fetus	Name given to the fetus.
INFOSRC	Y	N	Person providing information for mother’s live birth information	The name of the person providing information for the mother's worksheet.
RELINFOSRC	Y	N	Relationship of person providing information for mother’s live birth information	The relationship between the mother and the person providing information for the mother's worksheet
DISPMET	N	Y	Fetal remains disposition method	To reflect the method by which the fetal remains were disposed
OTHCOD	N	Y	Death cause other significant conditions	Coded value that provides information on one or more significant condition that contributed to death but did not result in the underlying cause that is elsewhere described. This data is returned to the jurisdiction as an ICD 10 code.
INITCOD	N	Y	Initiating cause of death or condition	Coded value that indicates the disease, injury, or complication that was implicated as the initiating cause of fetal death. This data is returned to the jurisdiction as an ICD 10 code.
MARITAL	Y	Y	The mother’s marital status	The mother’s marital status

1135

## Volume 2 – Transactions

Add Section 3.46

### 1140 3.46 BFDRQuery [QRPH-46]

The Data Consumer retrieves death reporting related health information from the Data Responder.

#### 3.46.1 Scope

1145 This transaction connects a Data Consumer to a Data Responder to allow query/retrieve of birth or fetal death reporting related health information.

#### 3.46.2 Actor Roles

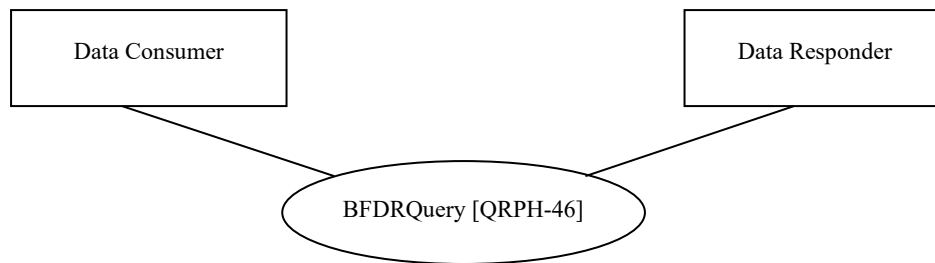

Figure 3.46.2-1: Use Case Diagram between Data Consumer and Data Responder

Table 3.46.2-1: Actor Roles

<b>Actor:</b>	Data Consumer
<b>Role:</b>	The Data Consumer is responsible for creating a FHIR-based request for birth or fetal death reporting related health information and retrieving this information from the Data responder.
<b>Actor:</b>	Data Responder
<b>Role:</b>	The Data Responder responds to the request for birth or fetal death reporting related health information or provides the appropriate response if the information does not exist.

1150

### 3.46.3 Referenced Standards

- HL7 FHIR standard STU3  
[http://www.hl7.org/implement/standards/product\\_brief.cfm?product\\_id=449](http://www.hl7.org/implement/standards/product_brief.cfm?product_id=449)

### 3.46.4 Messages

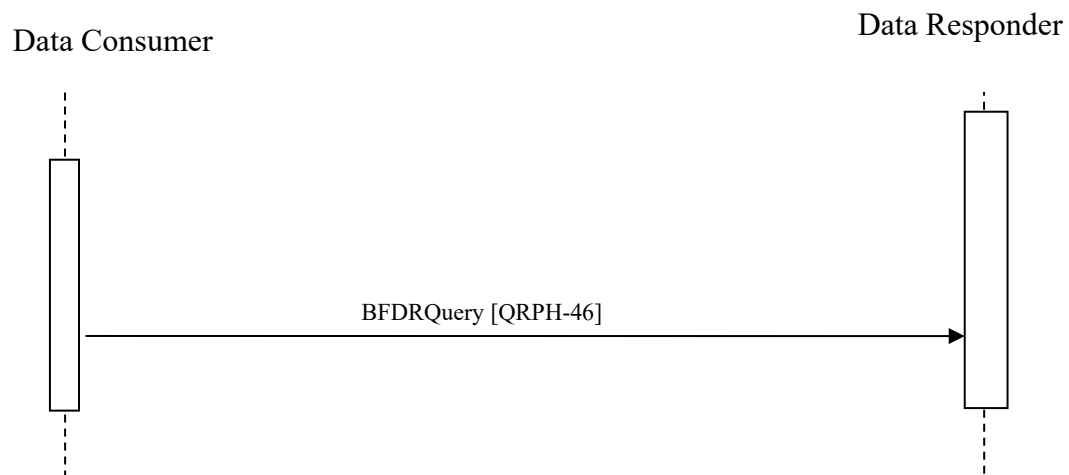

1155

**Figure 3.46.4-1: Interaction Diagram**

#### 3.46.4.1 BFDRQuery Message

Data Consumer retrieves the birth or fetal death reporting related health information from the Data Responder.

##### 1160 3.46.4.1.1 Trigger Events

Data Consumer shall trigger a FHIR-based query [QRPH-46] to the Data Responder when:

- The birth clerk is preparing to complete the birth or fetal death reporting details for jurisdictional vital records reporting

##### 3.46.4.1.2 Message Semantics

1165 The message is a FHIR HTTP or HTTPS GET of Birth or Fetal Death Reporting Data where the parameter provided is the PatientID of the mother. While both HTTP and HTTPS are permitted, the implementation SHOULD consider HTTPS.

As the information is retrieved from multiple resources, the URL resources for this operation are

- Resources relating to the mother (using the id of the mother):
  - [base]/Composition/[id]

1170

- [base]/Patient/[id]
- [base]/Condition/[id]
- [base]/Observation/[id]
- [base]/Procedure/[id]
- 1175 ○ [base]/MedicationAdministration/[id]
- [base]/Encounter/[id]
- [base]/Coverage/[id]
- Resources relating to the newborn or fetus (using the id of the newborn or fetus):

- [base]/Patient/[id]
- 1180 ○ [base]/MedicationAdministration/[id]
- [base]/Procedure/[id]
- [base]/Observation/[id]
- [base]/Condition/[id]
- [base]/Encounter/[id]

#### 1185 **3.46.4.1.3 Expected Actions**

The Data Consumer initiates the retrieve request for the resources specified in QRPH TF-3: 6.6.5.2 FHIR Resource Data Specifications using HTTP or HTTPS GET, and the Data Responder responds using the resources specified in QRPH TF-3: 6.6.5.2 FHIR Resource Data Specifications according to the FHIR GET specification with the requested birth or fetal death reporting related health information Birth or Fetal Death Reporting information or an error message. See: <http://hl7.org/fhir/http.html#read>.

1190

#### **3.46.5 Security Considerations**

This transaction includes identifiable health information, and depending upon the implementation and application, may constitute a disclosure of health information that require audit, encryption, and authentication of the Data Consumer and Data responder. For further guidance, see ITI TF-2: Appendix Z.

1195

#### **3.46.5.1 Security Audit Considerations – BFDRQuery [QRPH-46] (ADT)**

The BFDRQuery [QRPH-46] (FHIR GET) messages are audited as “PHI Export” events, as defined in ITI TF-2: Table 3.20.4.1.1.1-1. The following tables show items that are required to be part of the audit record for these specific BFDRQuery transactions.

1200

### 3.46.5.1.1 Data Responder Actor audit message:

	Field Name	Opt	Value Constraints
<b>Event</b> AuditMessage/ EventIdentification	EventID	M	EV(110106, DCM, "Export")
	EventActionCode	M	"C" (create) for QRPH-46 (BFDRQuery)
	EventDateTime	M	not specialized
	EventOutcomeIndicator	M	not specialized
	EventTypeCode	M	EV("QRPH-46", "IHE Transactions", "BFDRQuery")
Source (Death Reporting Data Responder) (1)			
Human Requestor (0..n)			
Destination (Death Reporting Data Consumer) (1)			
Audit Source (Death Reporting Data Responder) (1)			
Patient (1)			

Where:

<b>Source</b> AuditMessage/ ActiveParticipant	UserID	M	The identity of the Birth and Fetal Death Reporting Data Responder facility and responder application; concatenated together, separated by the   character.
	AlternativeUserID	M	The process ID as used within the local operating system in the local system logs.
	UserName	U	not specialized
	UserIsRequestor	M	not specialized
	RoleIDCode	M	EV(110153, DCM, "Source")
	NetworkAccessPointTypeCode	M	"1" for machine (DNS) name, "2" for IP address
	NetworkAccessPointID	M	The machine name or IP address

<b>Human Requestor (if known)</b> AuditMessage/ ActiveParticipant	UserID	M	Identity of the human that initiated the transaction.
	AlternativeUserID	U	not specialized
	UserName	U	not specialized
	UserIsRequestor	M	not specialized
	RoleIDCode	U	Access Control role(s) the user holds that allows this transaction.
	NetworkAccessPointTypeCode	NA	
	NetworkAccessPointID	NA	

<b>Destination</b> AuditMessage/ ActiveParticipant	UserID	M	The identity of the Birth and Fetal Death Reporting Data Consumer facility and responder application; concatenated together, separated by the   character.
	AlternativeUserID	M	not specialized
	UserName	U	not specialized
	UserIsRequestor	M	not specialized



IHE Quality, Research and Public Health Technical Framework Supplement – Birth and Fetal Death Reporting-Enhanced (BFDR-E)

	RoleIDCode	M	EV(110152, DCM, “Destination”)
	NetworkAccessPointTypeCode	M	“1” for machine (DNS) name, “2” for IP address
	NetworkAccessPointID	M	The machine name or IP address, as specified in RFC3881.

1205

<b>Audit Source</b> AuditMessage/ AuditSourceIdentification	AuditSourceID	U	not specialized
	AuditEnterpriseSiteID	U	not specialized
	AuditSourceTypeCode	U	not specialized

<b>Patient</b> (AuditMessage/ ParticipantObjectIdentification)	ParticipantObjectTypeCode	M	“1” (person)
	ParticipantObjectTypeCodeRole	M	“1” (patient)
	ParticipantObjectDataLifeCycle	U	not specialized
	ParticipantObjectIDTypeCode	M	EV(2, RFC-3881, “Patient Number”)
	ParticipantObjectSensitivity	U	not specialized
	ParticipantObjectID	M	The patient ID in HL7 CX format.
	ParticipantObjectName	U	not specialized
	ParticipantObjectQuery	U	not specialized
	ParticipantObjectDetail	M	Type=MSH-10 (the literal string), Value=the value of MSH-10 (from the message content, base64 encoded)

**3.46.5.1.2 Data Consumer Actor audit message:**

	Field Name	Opt	Value Constraints
<b>Event</b> AuditMessage/ EventIdentification	EventID	M	EV(110107, DCM, “Import”)
	EventActionCode	M	“C” (create) for QRPH-46 (BFDRQuery)
	EventDateTime	M	not specialized
	EventOutcomeIndicator	M	not specialized
	EventTypeCode	M	EV(“QRPH-46”, “IHE Transactions”, “BFDRQuery”)
Source (Death Reporting Data Consumer) (1)			
Destination (Death Reporting Data Responder) (1)			
Audit Source (Death Reporting Data Consumer) (1)			
Patient(1)			

1210 Where:

IHE Quality, Research and Public Health Technical Framework Supplement – Birth and Fetal Death Reporting-Enhanced (BFDR-E)

---

<b>Source</b> <b>AuditMessage/</b> <b>ActiveParticipant</b>	UserID	M	The identity of the Birth and Fetal Death Reporting Data Responder facility and responder application; concatenated together, separated by the   character
	AlternativeUserID	U	<i>not specialized</i>
	UserName	U	<i>not specialized</i>
	UserIsRequestor	M	<i>not specialized</i>
	RoleIDCode	M	EV(110153, DCM, “Source”)
	NetworkAccessPointTypeCode	M	“1” for machine (DNS) name, “2” for IP address
	NetworkAccessPointID	M	The machine name or IP address

<b>Destination</b> <b>AuditMessage/</b> <b>ActiveParticipant</b>	UserID	M	The identity of the Birth and Fetal Death Reporting Data Consumer facility and responder application; concatenated together, separated by the   character
	AlternativeUserID	M	The process ID as used within the local operating system in the local system logs.
	UserName	U	<i>not specialized</i>
	UserIsRequestor	M	<i>not specialized</i>
	RoleIDCode	M	EV(110152, DCM, “Destination”)
	NetworkAccessPointTypeCode	M	“1” for machine (DNS) name, “2” for IP address
	NetworkAccessPointID	M	The machine name or IP address

<b>Audit Source</b> <b>AuditMessage/</b> <b>AuditSourceIdentification</b>	AuditSourceID	U	<i>not specialized</i>
	AuditEnterpriseSiteID	U	<i>not specialized</i>
	AuditSourceTypeCode	U	<i>not specialized</i>

<b>Patient</b> (AuditMessage/ ParticipantObjectIdentification)	ParticipantObjectTypeCode	M	“1” (person)
	ParticipantObjectTypeCodeRole	M	“1” (patient)
	<i>ParticipantObjectDataLifeCycle</i>	<i>U</i>	<i>not specialized</i>
	ParticipantObjectIDTypeCode	M	EV(2, RFC-3881, “Patient Number”)
	<i>ParticipantObjectSensitivity</i>	<i>U</i>	<i>not specialized</i>
	ParticipantObjectID	M	The patient ID in HL7 CX format.
	<i>ParticipantObjectName</i>	<i>U</i>	<i>not specialized</i>
	<i>ParticipantObjectQuery</i>	<i>U</i>	<i>not specialized</i>
ParticipantObjectDetail	M	Type=MSH-10 (the literal string), Value=the value of MSH-10 (from the message content, base64 encoded)	

1215 **3.37.5.1.3 Form Receiver Message Exporter Actor audit message**

	Field Name	Opt	Value Constraints
<b>Event</b> AuditMessage / EventIdentification	EventID	M	EV(110106, DCM, “Export”)
	EventActionCode	M	“C” (create) “U” (update)
	<i>EventDateTime</i>	<i>M</i>	<i>not specialized</i>
	<i>EventOutcomeIndicator</i>	<i>M</i>	<i>not specialized</i>
	EventTypeCode	M	EV(“QRPH-37”, “IHE Transactions”, “BFDRFeed”)
Source (Form Receiver Message Exporter Actor) (1)			
Human Requestor (0..n)			
Destination (Information Recipient Actor) (1)			
Audit Source (Form Receiver Message Exporter Actor) (1)			
Patient (1)			

Where:

<b>Source</b> AuditMessage/ ActiveParticipant	UserID	M	The identity of the Form Receiver Message Exporter facility and sending application from the HL7 message; concatenated together, separated by the   character.
	AlternativeUserID	M	The process ID as used within the local operating system in the local system logs.
	<i>UserName</i>	<i>U</i>	<i>not specialized</i>
	<i>UserIsRequestor</i>	<i>M</i>	<i>not specialized</i>
	RoleIDCode	M	EV(110153, DCM, “Source”)
	NetworkAccessPointTypeCode	M	“1” for machine (DNS) name, “2” for IP address
	NetworkAccessPointID	M	The machine name or IP address

IHE Quality, Research and Public Health Technical Framework Supplement – Birth and Fetal Death Reporting-Enhanced (BFDR-E)

<b>Human Requestor (if known)</b> <b>AuditMessage/ActiveParticipant</b>	UserID	M	Identity of the human that initiated the transaction.
	<i>AlternativeUserID</i>	U	<i>not specialized</i>
	<i>UserName</i>	U	<i>not specialized</i>
	<i>UserIsRequestor</i>	M	<i>not specialized</i>
	RoleIDCode	U	Access Control role(s) the user holds that allows this transaction.
	NetworkAccessPointTypeCode	NA	
	NetworkAccessPointID	NA	

<b>Destination</b> <b>AuditMessage/ActiveParticipant</b>	UserID	M	The identity of the Information Recipient Public Health Organization and receiving application from the HL7 message; concatenated together, separated by the   character.
	<i>AlternativeUserID</i>	M	<i>not specialized</i>
	<i>UserName</i>	U	<i>not specialized</i>
	<i>UserIsRequestor</i>	M	<i>not specialized</i>
	RoleIDCode	M	EV(110152, DCM, “Destination”)
	NetworkAccessPointTypeCode	M	“1” for machine (DNS) name, “2” for IP address
	NetworkAccessPointID	M	The machine name or IP address

1220

<b>Audit Source</b> <b>AuditMessage/AuditSourceIdentification</b>	<i>AuditSourceID</i>	U	<i>not specialized</i>
	<i>AuditEnterpriseSiteID</i>	U	<i>not specialized</i>
	<i>AuditSourceTypeCode</i>	U	<i>not specialized</i>

<b>Patient (AuditMessage/ParticipantObjectIdentification)</b>	ParticipantObjectTypeCode	M	“1” (person)
	ParticipantObjectTypeCodeRole	M	“1” (patient)
	<i>ParticipantObjectDataLifeCycle</i>	U	<i>not specialized</i>
	ParticipantObjectIDTypeCode	M	EV(2, RFC-3881, “Patient Number”)
	<i>ParticipantObjectSensitivity</i>	U	<i>not specialized</i>
	ParticipantObjectID	M	The patient ID in HL7 CX format.
	<i>ParticipantObjectName</i>	U	<i>not specialized</i>
	<i>ParticipantObjectQuery</i>	U	<i>not specialized</i>
	ParticipantObjectDetail	M	Type=MSH-10 (the literal string), Value=the value of MSH-10 (from the message content, base64 encoded)

### 3.37.5.1.4 Form Processor Message Exporter Actor audit message

	Field Name	Opt	Value Constraints
<b>Event AuditMessage / EventIdentification</b>	EventID	M	EV(110106, DCM, "Export")
	EventActionCode	M	"C" (create) "U" (update)
	EventDateTime	M	not specialized
	EventOutcomeIndicator	M	not specialized
	EventTypeCode	M	EV("QRPH-37", "IHE Transactions", "BFDRFeed")
Source (Form Processor Message Exporter Actor) (1)			
Human Requestor (0..n)			
Destination (Information Recipient Actor) (1)			
Audit Source (Form Processor Message Exporter Actor) (1)			
Patient (1)			

1225 Where:

<b>Source AuditMessage/ ActiveParticipant</b>	UserID	M	The identity of the Form Processor Message Exporter facility and sending application from the HL7 message; concatenated together, separated by the   character.
	AlternativeUserID	M	The process ID as used within the local operating system in the local system logs.
	UserName	U	not specialized
	UserIsRequestor	M	not specialized
	RoleIDCode	M	EV(110153, DCM, "Source")
	NetworkAccessPointTypeCode	M	"1" for machine (DNS) name, "2" for IP address
	NetworkAccessPointID	M	The machine name or IP address

<b>Human Requestor (if known) AuditMessage/ ActiveParticipant</b>	UserID	M	Identity of the human that initiated the transaction.
	AlternativeUserID	U	not specialized
	UserName	U	not specialized
	UserIsRequestor	M	not specialized
	RoleIDCode	U	Access Control role(s) the user holds that allows this transaction.
	NetworkAccessPointTypeCode	NA	
	NetworkAccessPointID	NA	

<b>Destination AuditMessage/ ActiveParticipant</b>	UserID	M	The identity of the Information Recipient Public Health Organization and receiving application from the HL7 message; concatenated together, separated by the   character.
	AlternativeUserID	M	not specialized

IHE Quality, Research and Public Health Technical Framework Supplement – Birth and Fetal Death Reporting-Enhanced (BFDR-E)

	<i>UserName</i>	<i>U</i>	<i>not specialized</i>
	<i>UserIsRequestor</i>	<i>M</i>	<i>not specialized</i>
	<i>RoleIDCode</i>	<i>M</i>	EV(110152, DCM, “Destination”)
	<i>NetworkAccessPointTypeCode</i>	<i>M</i>	“1” for machine (DNS) name, “2” for IP address
	<i>NetworkAccessPointID</i>	<i>M</i>	The machine name or IP address

<b>Audit Source AuditMessage/ AuditSourceIdentification</b>	<i>AuditSourceID</i>	<i>U</i>	<i>not specialized</i>
	<i>AuditEnterpriseSiteID</i>	<i>U</i>	<i>not specialized</i>
	<i>AuditSourceTypeCode</i>	<i>U</i>	<i>not specialized</i>

<b>Patient (AuditMessage/ ParticipantObjectIdentification)</b>	<i>ParticipantObjectTypeCode</i>	<i>M</i>	“1” (person)
	<i>ParticipantObjectTypeCodeRole</i>	<i>M</i>	“1” (patient)
	<i>ParticipantObjectDataLifeCycle</i>	<i>U</i>	<i>not specialized</i>
	<i>ParticipantObjectIDTypeCode</i>	<i>M</i>	EV(2, RFC-3881, “Patient Number”)
	<i>ParticipantObjectSensitivity</i>	<i>U</i>	<i>not specialized</i>
	<i>ParticipantObjectID</i>	<i>M</i>	The patient ID in HL7 CX format.
	<i>ParticipantObjectName</i>	<i>U</i>	<i>not specialized</i>
	<i>ParticipantObjectQuery</i>	<i>U</i>	<i>not specialized</i>
	<i>ParticipantObjectDetail</i>	<i>M</i>	Type=MSH-10 (the literal string), Value=the value of MSH-10 (from the message content, base64 encoded)

1230

## Appendices to Volume 2

None

### Namespace Additions for Volume 2

1235

The Quality, Research and Public Health domain registry of OIDs is located at [https://wiki.ihe.net/index.php/QRPH\\_Registry](https://wiki.ihe.net/index.php/QRPH_Registry)

Volume 2 additions to the Quality, Research and Public Health OID Registry are:

1240

None

1245

## Volume 3 – Content Modules

### 5 IHE Namespaces, Concept Domains and Vocabularies

*Add to Section 5 Namespaces, Concept Domains and Vocabularies*

1250

#### 5.1 IHE Quality, Research and Public Health Namespaces

The Quality, Research and Public Health registry of OIDs is located at [https://wiki.ihe.net/index.php/QRPH\\_Registry](https://wiki.ihe.net/index.php/QRPH_Registry)

1255 Additions to the Quality, Research and Public Health OID Registry are:

codeSystem	codeSystemName	Description
2.16.840.1.113883.6.1	LOINC	Logical Observation Identifier Names and Codes
2.16.840.1.113883.6.96	SNOMED-CT	Systematized Nomenclature Of Medicine Clinical Terms
2.16.840.1.113883.6.88	RxNorm	RxNorm
2.16.840.1.113883.12.1	AdministrativeGender	See the HL7 AdministrativeGender Vocabulary
2.16.840.1.113883	ServiceDeliveryLocation	See the HL7 ServiceDeliveryLocation Vocabulary

*Add to Section 5 Namespaces and Vocabularies*

codeSystem	codeSystemName	Description
1.3.6.1.4.1.19376.1.5.3.1	IHE PCC Template Identifiers	This is the root OID for all IHE PCC Templates. A list of PCC templates can be found below in CDA Release 2.0 Content Modules.
1.3.6.1.4.1.19376.1.7.3.1.1	IHE BFDR Template Identifiers	This is the root OID for all the IHE BFDR Templates.
1.3.6.1.4.1.19376.1.5.3.2	IHEActCode	See IHEActCode Vocabulary below
1.3.6.1.4.1.19376.1.5.3.3	IHE PCC RoleCode	See IHERoleCode Vocabulary below
1.3.6.1.4.1.19376.1.5.3.4		Namespace OID used for IHE Extensions to CDA Release 2.0
2.16.840.1.113883.10.20.1	CCD Root OID	Root OID used for by ASTM/HL7 Continuity of Care Document
2.16.840.1.113883.5.112	RouteOfAdministration	See the HL7 RouteOfAdministration Vocabulary
2.16.840.1.113883.5.1063	SeverityObservation	See the HL7 SeverityObservation Vocabulary



IHE Quality, Research and Public Health Technical Framework Supplement – Birth and Fetal Death Reporting-Enhanced (BFDR-E)

<b>codeSystem</b>	<b>codeSystemName</b>	<b>Description</b>
2.16.840.1.113883.1.11.12212	MaritalStatus	See the HL7 MaritalStatus Vocabulary
2.16.840.1.113883	ServiceDeliveryLocation	See the HL7 ServiceDeliveryLocation Vocabulary
2.16.840.1.113883.12.1	AdministrativeGender	See the HL7 AdministrativeGender Vocabulary
2.16.840.1.113883.5.111	Role	See the HL7 Role Vocabulary
2.16.840.1.113883.5.1077	EducationLevel	See the HL7 EducationLevel Vocabulary
2.16.840.1.113883.6.1	LOINC	Logical Observation Identifier Names and Codes
2.16.840.1.113883.6.96	SNOMED-CT	SNOMED Clinical Terms
2.16.840.1.113883.6.103	ICD-9CM (diagnosis codes)	International Classification of Diseases, Clinical Modifiers, Version 9
2.16.840.1.113883.6.104	ICD-9CM (procedure codes)	International Classification of Diseases, Clinical Modifiers, Version 9
2.16.840.1.113883.6.3	ICD10	International Classification of Diseases Revision 10 (ICD 10) Note this does NOT have the CM changes and is specifically for international use.
2.16.840.1.113883.6.4	ICD-10-PCS	International Classification of Diseases, 10th Revision, Procedure Coding System
2.16.840.1.113883.6.90	ICD-10-CM	International Classification of Diseases, 10th Revision, Clinical Modification
2.16.840.1.113883.6.26	MEDCIN	A classification system from MEDICOMP Systems.
2.16.840.1.113883.6.88	RxNorm	RxNorm
2.16.840.1.113883.6.63	FDCC	First DataBank Drug Codes
2.16.840.1.113883.6.12	C4	Current Procedure Terminology 4 (CPT-4) codes.
2.16.840.1.113883.6.257	Minimum Data Set for Long Term Care	The root OID for Minimum Data Set Answer Lists
2.16.840.1.113883.2.8.1.1	CCAM	Classification Commune des Actes Medicaux
2.16.840.1.113883.6.21	NUBC	National Uniform Billing Codes (US)

1260

## 5.2 IHE Quality, Research and Public Health Concept Domains

For a listing of the Quality, Research and Public Health Concept Domains see:

NA

1265

<b>conceptDomain</b>	<b>conceptDomainName</b>	<b>Description</b>
None		

## 5.3 IHE Quality, Research and Public Health Format Codes and Vocabularies

### 5.3.1 IHE Format Codes

1270

List in the table below any **new** format codes to be added to the IHE Format Codes page at <https://profiles.ihe.net/fhir/ihe.formatcode.fhir/index.html>. For public comment, the additions must be listed in the table below. The domain technical committee must ensure any new codes are also added to the html page prior to publication for trial implementation.

1275

Profile	Format Code	Media Type	Template ID
None			

### 5.3.2 IHEActCode Vocabulary

1280

List in the table below, any **new** additions to the IHEActCode Vocabulary wiki page at [http://wiki.ihe.net/index.php/IHEActCode\\_Vocabulary](http://wiki.ihe.net/index.php/IHEActCode_Vocabulary). For public comment, the additions must be listed in the table below. The domain technical committee must ensure any new codes are also added to the wiki page prior to publication for trial implementation.

Code	Description
None	

### 5.3.3 IHERoleCode Vocabulary

1285

List in the table below any **new** additions to the IHERoleCode Vocabulary wiki page at [http://wiki.ihe.net/index.php/IHERoleCode\\_Vocabulary](http://wiki.ihe.net/index.php/IHERoleCode_Vocabulary). For public comment, the additions must be listed in the table below. The domain technical committee must ensure any new codes are also added to the wiki page prior to publication for trial implementation.

1290

Code	Description
None	

## 6 CDA Content Modules

### 6.3.1 CDA Document Templates

*Add to Section 6.3.1.D Document Content Modules*

### 1295 6.3.2 CDA Header Templates

*Add to Section 6.3.2 Header Content Module Templates*

None

### 6.3.3 CDA Section Templates

*Add to Section 6.3.3.10 Section Content Module Templates*

1300 None

### 6.3.4 CDA Entry Content Module Templates

*Add to Section 6.3.4.E Entry Content Modules*

None

## 6.4 Section not applicable

1305 This heading is not currently used in a CDA document.

## 6.5 Value Sets

1310 The following table describes each of the value sets used to support the BFDR-E Profile. These are all published by and available from the PHIN Vocabulary Access and Distribution System (PHIN VADS). Each of the value sets below are established as extensional with the discrete values available at the PHIN-VADS URL provided. Version status may change from time-to-time as these value sets are maintained by NCHS, so version number should not be referenced when using these value sets in support of the BFDR-E Profile. Similarly, associated date related metadata attributes will change as a result of value set maintenance activities and can be obtained at the PHIN-VADS URL provided. BFDR-E Vocabulary has dynamic binding of value sets. In 1315 dynamic binding the most current version of the value set in the terminology server is used.

## 6.5.1 Value Sets Used by this Profile

**Table 6.5.1-1: Value Sets used in the BFDR-e Profile**

Name	Identifier	Purpose	Source	PHIN VADS URL	Groups
10 Min Apgar Score (NCHS)	1.3.6.1.4.1.19 376.1.7.3.1.1.13.8.13	To reflect the 10 Min Apgar Score	LOINC	<a href="https://phinvads.cdc.gov/vads/ViewValueSet.action?oid=1.3.6.1.4.1.19376.1.7.3.1.1.13.8.13">https://phinvads.cdc.gov/vads/ViewValueSet.action?oid=1.3.6.1.4.1.19376.1.7.3.1.1.13.8.13</a>	IHE BFDR
5 Min Apgar Score (NCHS)	1.3.6.1.4.1.19 376.1.7.3.1.1.13.8.12	To reflect the 5 Min Apgar Score	LOINC	<a href="https://phinvads.cdc.gov/vads/ViewValueSet.action?oid=1.3.6.1.4.1.19376.1.7.3.1.1.13.8.12">https://phinvads.cdc.gov/vads/ViewValueSet.action?oid=1.3.6.1.4.1.19376.1.7.3.1.1.13.8.12</a>	IHE BFDR
Anencephaly of the Newborn (NCHS)	1.3.6.1.4.1.19 376.1.7.3.1.1.13.8.53	To reflect Anencephaly of the Newborn as an anomaly of the newborn	SNOME D-CT	<a href="https://phinvads.cdc.gov/vads/ViewValueSet.action?oid=1.3.6.1.4.1.19376.1.7.3.1.1.13.8.53">https://phinvads.cdc.gov/vads/ViewValueSet.action?oid=1.3.6.1.4.1.19376.1.7.3.1.1.13.8.53</a>	IHE BFDR
Antibiotic Administration Procedure (NCHS)	1.3.6.1.4.1.19 376.1.7.3.1.1.13.8.178	To reflect Antibiotic Administration Procedure during labor and delivery	SNOME D-CT	<a href="https://phinvads.cdc.gov/vads/ViewValueSet.action?oid=1.3.6.1.4.1.19376.1.7.3.1.1.13.8.178">https://phinvads.cdc.gov/vads/ViewValueSet.action?oid=1.3.6.1.4.1.19376.1.7.3.1.1.13.8.178</a>	IHE BFDR
Antibiotics (NCHS)	1.3.6.1.4.1.19 376.1.7.3.1.1.13.8.3	To reflect that antibiotics were received by the mother during delivery and by the newborn for suspected neonatal sepsis	RxNorm	<a href="https://phinvads.cdc.gov/vads/ViewValueSet.action?oid=1.3.6.1.4.1.19376.1.7.3.1.1.13.8.3">https://phinvads.cdc.gov/vads/ViewValueSet.action?oid=1.3.6.1.4.1.19376.1.7.3.1.1.13.8.3</a>	IHE BFDR
Antibiotics Received During Labor Finding (NCHS)	2.16.840.1.11 4222.4.11.7535	To identify findings that the mother has received antibiotics during labor.	SNOME D-CT	<a href="https://phinvads.cdc.gov/vads/ViewValueSet.action?oid=2.16.840.1.114222.4.11.7535">https://phinvads.cdc.gov/vads/ViewValueSet.action?oid=2.16.840.1.114222.4.11.7535</a>	IHE BFDR
Artificial or Intrauterine Insemination (NCHS)	1.3.6.1.4.1.19 376.1.7.3.1.1.13.8.145	To reflect the Artificial or Intrauterine Insemination as a Risk Factor in Pregnancy	SNOME D-CT	<a href="https://phinvads.cdc.gov/vads/ViewValueSet.action?oid=1.3.6.1.4.1.19376.1.7.3.1.1.13.8.145">https://phinvads.cdc.gov/vads/ViewValueSet.action?oid=1.3.6.1.4.1.19376.1.7.3.1.1.13.8.145</a>	IHE BFDR
Assisted Ventilation (NCHS)	2.16.840.1.11 4222.4.11.7156	To reflect that the newborn was provided assisted ventilation reflecting an abnormal condition of the newborn	SNOME D-CT	<a href="https://phinvads.cdc.gov/vads/ViewValueSet.action?oid=2.16.840.1.114222.4.11.7156">https://phinvads.cdc.gov/vads/ViewValueSet.action?oid=2.16.840.1.114222.4.11.7156</a>	IHE BFDR

IHE Quality, Research and Public Health Technical Framework Supplement – Birth and Fetal Death Reporting-Enhanced (BFDR-E)

Name	Identifier	Purpose	Source	PHIN VADS URL	Groups
Assisted Ventilation Finding (NCHS)	2.16.840.1.114222.4.11.7533	To identify findings that the newborn received assisted ventilation immediately following delivery.	PHIN VS (CDC Local Coding System)	<a href="https://phinvads.cdc.gov/vads/ViewValueSet.action?oid=2.16.840.1.114222.4.11.7533">https://phinvads.cdc.gov/vads/ViewValueSet.action?oid=2.16.840.1.114222.4.11.7533</a>	IHE BFDR
Assisted Ventilation for >6 hours Finding (NCHS)	2.16.840.1.114222.4.11.7534	To identify findings that the newborn received assisted ventilation for >6 hours following delivery.	PHIN VS (CDC Local Coding System)	<a href="https://phinvads.cdc.gov/vads/ViewValueSet.action?oid=2.16.840.1.114222.4.11.7533">https://phinvads.cdc.gov/vads/ViewValueSet.action?oid=2.16.840.1.114222.4.11.7533</a>	IHE BFDR
Assistive Reproductive Technology (NCHS)	1.3.6.1.4.1.19376.1.7.3.1.1.13.8.146	To reflect the Assistive Reproductive Technology as a Risk Factor in Pregnancy	SNOME D-CT	<a href="https://phinvads.cdc.gov/vads/ViewValueSet.action?oid=1.3.6.1.4.1.19376.1.7.3.1.1.13.8.146">https://phinvads.cdc.gov/vads/ViewValueSet.action?oid=1.3.6.1.4.1.19376.1.7.3.1.1.13.8.146</a>	IHE BFDR
Augmentation of Labor Finding (NCHS)	2.16.840.1.114222.4.11.7532	To identify findings that labor was augmented	SNOME D-CT	<a href="https://phinvads.cdc.gov/vads/ViewValueSet.action?oid=2.16.840.1.114222.4.11.7532">https://phinvads.cdc.gov/vads/ViewValueSet.action?oid=2.16.840.1.114222.4.11.7532</a>	IHE BFDR
Augmentation of Labor - Medication (NCHS)	1.3.6.1.4.1.19376.1.7.3.1.1.13.8.23	To reflect a medication used for the of Augmentation of Labor	RxNorm	<a href="https://phinvads.cdc.gov/vads/ViewValueSet.action?oid=1.3.6.1.4.1.19376.1.7.3.1.1.13.8.23">https://phinvads.cdc.gov/vads/ViewValueSet.action?oid=1.3.6.1.4.1.19376.1.7.3.1.1.13.8.23</a>	IHE BFDR
Augmentation of Labor - Procedure (NCHS)	1.3.6.1.4.1.19376.1.7.3.1.1.13.8.22	To reflect a procedure of Augmentation of Labor	SNOME D-CT	<a href="https://phinvads.cdc.gov/vads/ViewValueSet.action?oid=1.3.6.1.4.1.19376.1.7.3.1.1.13.8.22">https://phinvads.cdc.gov/vads/ViewValueSet.action?oid=1.3.6.1.4.1.19376.1.7.3.1.1.13.8.22</a>	IHE BFDR
Autopsy Planned (NCHS)	2.16.840.1.114222.4.11.7140	To reflect that an autopsy was planned	SNOME D-CT	<a href="https://phinvads.cdc.gov/vads/ViewValueSet.action?oid=2.16.840.1.114222.4.11.7140">https://phinvads.cdc.gov/vads/ViewValueSet.action?oid=2.16.840.1.114222.4.11.7140</a>	IHE BFDR

IHE Quality, Research and Public Health Technical Framework Supplement – Birth and Fetal Death Reporting-Enhanced (BFDR-E)

Name	Identifier	Purpose	Source	PHIN VADS URL	Groups
Birth Plurality of Delivery (NCHS)	1.3.6.1.4.1.19 376.1.7.3.1.1.13.8.132	To reflect the Plurality, which is the number of fetuses delivered live or dead at any time in the pregnancy regardless of gestational age or if the fetuses were delivered at different dates in the pregnancy. (“Reabsorbed” fetuses, those which are not “delivered” (expulsed or extracted from the mother) should not be counted.)	LOINC	<a href="https://phinvads.cdc.gov/vads/ViewValueSet.action?oid=1.3.6.1.4.1.19376.1.7.3.1.1.13.8.132">https://phinvads.cdc.gov/vads/ViewValueSet.action?oid=1.3.6.1.4.1.19376.1.7.3.1.1.13.8.132</a>	IHE BFDR
Birth Weight (NCHS)	1.3.6.1.4.1.19 376.1.7.3.1.1.13.8.20	To reflect the Birth Weight	LOINC	<a href="https://phinvads.cdc.gov/vads/ViewValueSet.action?oid=1.3.6.1.4.1.19376.1.7.3.1.1.13.8.20">https://phinvads.cdc.gov/vads/ViewValueSet.action?oid=1.3.6.1.4.1.19376.1.7.3.1.1.13.8.20</a>	IHE BFDR
Birthplace Clinic Office (NCHS)	1.3.6.1.4.1.19 376.1.7.3.1.1.13.8.197	To reflect the birth occurred in the at clinic or office	SNOME D-CT	<a href="https://phinvads.cdc.gov/vads/ViewValueSet.action?oid=1.3.6.1.4.1.19376.1.7.3.1.1.13.8.197">https://phinvads.cdc.gov/vads/ViewValueSet.action?oid=1.3.6.1.4.1.19376.1.7.3.1.1.13.8.197</a>	IHE BFDR
Birth Place Freestanding Birthing Center (NCHS)	1.3.6.1.4.1.19 376.1.7.3.1.1.13.8.196	To reflect the birth occurred at a freestanding birthing center	SNOME D-CT	<a href="https://phinvads.cdc.gov/vads/ViewValueSet.action?oid=1.3.6.1.4.1.19376.1.7.3.1.1.13.8.196">https://phinvads.cdc.gov/vads/ViewValueSet.action?oid=1.3.6.1.4.1.19376.1.7.3.1.1.13.8.196</a>	IHE BFDR
Birth Place Home Intended (NCHS)	1.3.6.1.4.1.19 376.1.7.3.1.1.13.8.193	To reflect the birth occurred in the at home as intended	SNOME D-CT	<a href="https://phinvads.cdc.gov/vads/ViewValueSet.action?oid=1.3.6.1.4.1.19376.1.7.3.1.1.13.8.193">https://phinvads.cdc.gov/vads/ViewValueSet.action?oid=1.3.6.1.4.1.19376.1.7.3.1.1.13.8.193</a>	IHE BFDR
Birth Place Home Unintended (NCHS)	1.3.6.1.4.1.19 376.1.7.3.1.1.13.8.194	To reflect the birth occurred in the at home as unintended	SNOME D-CT	<a href="https://phinvads.cdc.gov/vads/ViewValueSet.action?oid=1.3.6.1.4.1.19376.1.7.3.1.1.13.8.194">https://phinvads.cdc.gov/vads/ViewValueSet.action?oid=1.3.6.1.4.1.19376.1.7.3.1.1.13.8.194</a>	IHE BFDR
Birth Place Home Unknown Intention (NCHS)	1.3.6.1.4.1.19 376.1.7.3.1.1.13.8.195	To reflect the birth occurred in the at home with intention unknown	SNOME D-CT	<a href="https://phinvads.cdc.gov/vads/ViewValueSet.action?oid=1.3.6.1.4.1.19376.1.7.3.1.1.13.8.195">https://phinvads.cdc.gov/vads/ViewValueSet.action?oid=1.3.6.1.4.1.19376.1.7.3.1.1.13.8.195</a>	IHE BFDR
Birthplace Hospital (NCHS)	1.3.6.1.4.1.19 376.1.7.3.1.1.13.8.192	To reflect the birth occurred in the hospital	SNOME D-CT	<a href="https://phinvads.cdc.gov/vads/ViewValueSet.action?oid=1.3.6.1.4.1.19376.1.7.3.1.1.13.8.192">https://phinvads.cdc.gov/vads/ViewValueSet.action?oid=1.3.6.1.4.1.19376.1.7.3.1.1.13.8.192</a>	IHE BFDR

IHE Quality, Research and Public Health Technical Framework Supplement – Birth and Fetal Death Reporting-Enhanced (BFDR-E)

Name	Identifier	Purpose	Source	PHIN VADS URL	Groups
Birthplace Setting (NCHS)	1.3.6.1.4.1.19 376.1.7.3.1.1. 13.8.184	To reflect the birthplace of the newborn (setting)	LOINC	<a href="https://phinvads.cdc.gov/vads/ViewValueSet.action?oid=1.3.6.1.4.1.19376.1.7.3.1.1.13.8.184">https://phinvads.cdc.gov/vads/ViewValueSet.action?oid=1.3.6.1.4.1.19376.1.7.3.1.1.13.8.184</a>	IHE BFDR
Body Weight (NCHS)	2.16.840.1.11 4222.4.11.74 21	To Reflect the question as to the body weight of the patient	LOINC	<a href="https://phinvads.cdc.gov/vads/ViewValueSet.action?oid=2.16.840.1.114222.4.11.7421">https://phinvads.cdc.gov/vads/ViewValueSet.action?oid=2.16.840.1.114222.4.11.7421</a>	IHE BFDR
Breastfed Infant (NCHS)	1.3.6.1.4.1.19 376.1.7.3.1.1. 13.8.41	To reflect Breastfed Infant at discharge	SNOME D-CT	<a href="https://phinvads.cdc.gov/vads/ViewValueSet.action?oid=1.3.6.1.4.1.19376.1.7.3.1.1.13.8.41">https://phinvads.cdc.gov/vads/ViewValueSet.action?oid=1.3.6.1.4.1.19376.1.7.3.1.1.13.8.41</a>	IHE BFDR
Certified Midwife (NCHS)	1.3.6.1.4.1.19 376.1.7.3.1.1. 13.8.17	To reflect the Title of the Attendant responsible for the delivery Procedure as a Certified Midwife	SNOME D-CT	<a href="https://phinvads.cdc.gov/vads/ViewValueSet.action?oid=1.3.6.1.4.1.19376.1.7.3.1.1.13.8.17">https://phinvads.cdc.gov/vads/ViewValueSet.action?oid=1.3.6.1.4.1.19376.1.7.3.1.1.13.8.17</a>	IHE BFDR
Cervical Cerclage (NCHS)	1.3.6.1.4.1.19 376.1.7.3.1.1. 13.8.125	To reflect Obstetric Procedures as Cervical Cerclage	SNOME D-CT	<a href="https://phinvads.cdc.gov/vads/ViewValueSet.action?oid=1.3.6.1.4.1.19376.1.7.3.1.1.13.8.125">https://phinvads.cdc.gov/vads/ViewValueSet.action?oid=1.3.6.1.4.1.19376.1.7.3.1.1.13.8.125</a>	IHE BFDR
Chlamydia (NCHS)	1.3.6.1.4.1.19 376.1.7.3.1.1. 13.8.93	To reflect Chlamydia as Infections present and treated during this pregnancy	SNOME D-CT	<a href="https://phinvads.cdc.gov/vads/ViewValueSet.action?oid=1.3.6.1.4.1.19376.1.7.3.1.1.13.8.93">https://phinvads.cdc.gov/vads/ViewValueSet.action?oid=1.3.6.1.4.1.19376.1.7.3.1.1.13.8.93</a>	IHE BFDR
Chorioamnionitis During Labor (NCHS)	1.3.6.1.4.1.19 376.1.7.3.1.1. 13.8.24	To reflect a Chorioamnionitis During Labor	SNOME D-CT	<a href="https://phinvads.cdc.gov/vads/ViewValueSet.action?oid=1.3.6.1.4.1.19376.1.7.3.1.1.13.8.24">https://phinvads.cdc.gov/vads/ViewValueSet.action?oid=1.3.6.1.4.1.19376.1.7.3.1.1.13.8.24</a>	IHE BFDR
Cleft Lip with or without Cleft Palate (NCHS)	1.3.6.1.4.1.19 376.1.7.3.1.1. 13.8.58	To reflect Cleft Lip with/without Cleft Palate as an anomaly of the newborn	SNOME D-CT	<a href="https://phinvads.cdc.gov/vads/ViewValueSet.action?oid=1.3.6.1.4.1.19376.1.7.3.1.1.13.8.58">https://phinvads.cdc.gov/vads/ViewValueSet.action?oid=1.3.6.1.4.1.19376.1.7.3.1.1.13.8.58</a>	IHE BFDR
Cleft Palate Alone (NCHS)	1.3.6.1.4.1.19 376.1.7.3.1.1. 13.8.189	To reflect Cleft Palate alone as an anomaly of the newborn	SNOME D-CT	<a href="https://phinvads.cdc.gov/vads/ViewValueSet.action?oid=1.3.6.1.4.1.19376.1.7.3.1.1.13.8.189">https://phinvads.cdc.gov/vads/ViewValueSet.action?oid=1.3.6.1.4.1.19376.1.7.3.1.1.13.8.189</a>	IHE BFDR
Conception Date (NCHS)	1.3.6.1.4.1.19 376.1.7.3.1.1. 13.8.180	To reflect Conception Date	LOINC	<a href="https://phinvads.cdc.gov/vads/ViewValueSet.action?oid=1.3.6.1.4.1.19376.1.7.3.1.1.13.8.180">https://phinvads.cdc.gov/vads/ViewValueSet.action?oid=1.3.6.1.4.1.19376.1.7.3.1.1.13.8.180</a>	IHE BFDR

IHE Quality, Research and Public Health Technical Framework Supplement – Birth and Fetal Death Reporting-Enhanced (BFDR-E)

Name	Identifier	Purpose	Source	PHIN VADS URL	Groups
Congenital Diaphragmatic Hernia (NCHS)	1.3.6.1.4.1.19 376.1.7.3.1.1. 13.8.55	To reflect Congenital Diaphragmatic Hernia as an anomaly of the newborn	SNOME D-CT	<a href="https://phinvads.cdc.gov/vads/ViewValueSet.action?oid=1.3.6.1.4.1.19376.1.7.3.1.1.13.8.55">https://phinvads.cdc.gov/vads/ViewValueSet.action?oid=1.3.6.1.4.1.19376.1.7.3.1.1.13.8.55</a>	IHE BFDR
Cyanotic Congenital Heart Disease (NCHS)	1.3.6.1.4.1.19 376.1.7.3.1.1. 13.8.54	To reflect Cyanotic Congenital Heart Disease as an anomaly of the newborn	SNOME D-CT	<a href="https://phinvads.cdc.gov/vads/ViewValueSet.action?oid=1.3.6.1.4.1.19376.1.7.3.1.1.13.8.54">https://phinvads.cdc.gov/vads/ViewValueSet.action?oid=1.3.6.1.4.1.19376.1.7.3.1.1.13.8.54</a>	IHE BFDR
Cytomegalovirus (NCHS)	1.3.6.1.4.1.19 376.1.7.3.1.1. 13.8.167	To reflect infection with Cytomegalovirus	SNOME D-CT	<a href="https://phinvads.cdc.gov/vads/ViewValueSet.action?oid=1.3.6.1.4.1.19376.1.7.3.1.1.13.8.167">https://phinvads.cdc.gov/vads/ViewValueSet.action?oid=1.3.6.1.4.1.19376.1.7.3.1.1.13.8.167</a>	IHE BFDR
Date of Last Live Birth (NCHS)	1.3.6.1.4.1.19 376.1.7.3.1.1. 13.8.67	To reflect the Date of Last Live Birth	LOINC	<a href="https://phinvads.cdc.gov/vads/ViewValueSet.action?oid=1.3.6.1.4.1.19376.1.7.3.1.1.13.8.67">https://phinvads.cdc.gov/vads/ViewValueSet.action?oid=1.3.6.1.4.1.19376.1.7.3.1.1.13.8.67</a>	IHE BFDR
Date of Last Menses (NCHS)	1.3.6.1.4.1.19 376.1.7.3.1.1. 13.8.69	To reflect the Date of Last Menses	LOINC	<a href="https://phinvads.cdc.gov/vads/ViewValueSet.action?oid=1.3.6.1.4.1.19376.1.7.3.1.1.13.8.69">https://phinvads.cdc.gov/vads/ViewValueSet.action?oid=1.3.6.1.4.1.19376.1.7.3.1.1.13.8.69</a>	IHE BFDR
Date of Last Other Pregnancy Outcome (NCHS)	1.3.6.1.4.1.19 376.1.7.3.1.1. 13.8.70	To reflect the Date of Last Other Pregnancy Outcome such as spontaneous or induced losses or ectopic pregnancy	LOINC	<a href="https://phinvads.cdc.gov/vads/ViewValueSet.action?oid=1.3.6.1.4.1.19376.1.7.3.1.1.13.8.70">https://phinvads.cdc.gov/vads/ViewValueSet.action?oid=1.3.6.1.4.1.19376.1.7.3.1.1.13.8.70</a>	IHE BFDR
Delivery (NCHS)	1.3.6.1.4.1.19 376.1.7.3.1.1. 13.8.14	To reflect the Delivery Procedure	SNOME D-CT	<a href="https://phinvads.cdc.gov/vads/ViewValueSet.action?oid=1.3.6.1.4.1.19376.1.7.3.1.1.13.8.14">https://phinvads.cdc.gov/vads/ViewValueSet.action?oid=1.3.6.1.4.1.19376.1.7.3.1.1.13.8.14</a>	IHE BFDR
Doctor of Osteopathic Medicine (NCHS)	1.3.6.1.4.1.19 376.1.7.3.1.1. 13.8.16	To reflect the Title of the Attendant responsible for the delivery Procedure as a Doctor of Osteopathic Medicine	SNOME D-CT	<a href="https://phinvads.cdc.gov/vads/ViewValueSet.action?oid=1.3.6.1.4.1.19376.1.7.3.1.1.13.8.16">https://phinvads.cdc.gov/vads/ViewValueSet.action?oid=1.3.6.1.4.1.19376.1.7.3.1.1.13.8.16</a>	IHE BFDR
Downs Syndrome (NCHS)	1.3.6.1.4.1.19 376.1.7.3.1.1. 13.8.61	To reflect Downs Syndrome as an anomaly of the newborn	SNOME D-CT	<a href="https://phinvads.cdc.gov/vads/ViewValueSet.action?oid=1.3.6.1.4.1.19376.1.7.3.1.1.13.8.61">https://phinvads.cdc.gov/vads/ViewValueSet.action?oid=1.3.6.1.4.1.19376.1.7.3.1.1.13.8.61</a>	IHE BFDR
Eclampsia (NCHS)	1.3.6.1.4.1.19 376.1.7.3.1.1. 13.8.140	To reflect Risk Factors of Eclampsia	SNOME D-CT	<a href="https://phinvads.cdc.gov/vads/ViewValueSet.action?oid=1.3.6.1.4.1.19376.1.7.3.1.1.13.8.140">https://phinvads.cdc.gov/vads/ViewValueSet.action?oid=1.3.6.1.4.1.19376.1.7.3.1.1.13.8.140</a>	IHE BFDR



IHE Quality, Research and Public Health Technical Framework Supplement – Birth and Fetal Death Reporting-Enhanced (BFDR-E)

Name	Identifier	Purpose	Source	PHIN VADS URL	Groups
Epidural/Spinal Anesthesia - Medication (NCHS)	2.16.840.1.114222.4.11.7475	To Reflect an Epidural and Spinal Anesthesia Medication	RxNorm	<a href="http://phinvads.cdc.gov/vads/ViewValueSet.action?oid=2.16.840.1.114222.4.11.7475">http://phinvads.cdc.gov/vads/ViewValueSet.action?oid=2.16.840.1.114222.4.11.7475</a>	IHE BFDR
Epidural Anesthesia - Procedure (NCHS)	1.3.6.1.4.1.19376.1.7.3.1.1.13.8.27	To reflect an Epidural Anesthesia Procedure	SNOME D-CT	<a href="https://phinvads.cdc.gov/vads/ViewValueSet.action?oid=1.3.6.1.4.1.19376.1.7.3.1.1.13.8.27">https://phinvads.cdc.gov/vads/ViewValueSet.action?oid=1.3.6.1.4.1.19376.1.7.3.1.1.13.8.27</a>	IHE BFDR
Estimated Time Of Fetal Death (NCHS)	2.16.840.1.114222.4.11.7426	To reflect the question as to the estimated time of fetal death	LOINC	<a href="http://phinvads.cdc.gov/vads/ViewValueSet.action?oid=2.16.840.1.114222.4.11.7426">http://phinvads.cdc.gov/vads/ViewValueSet.action?oid=2.16.840.1.114222.4.11.7426</a>	IHE BFDR
External Cephalic Version (NCHS)	1.3.6.1.4.1.19376.1.7.3.1.1.13.8.127	To reflect Obstetric Procedures as External Cephalic Version	SNOME D-CT	<a href="https://phinvads.cdc.gov/vads/ViewValueSet.action?oid=1.3.6.1.4.1.19376.1.7.3.1.1.13.8.127">https://phinvads.cdc.gov/vads/ViewValueSet.action?oid=1.3.6.1.4.1.19376.1.7.3.1.1.13.8.127</a>	IHE BFDR
Facility Location ICU (NCHS)	1.3.6.1.4.1.19376.1.7.3.1.1.13.8.2	To reflect that the patient (mother) was treated in the ICU for complications associated with labor and delivery reflecting a maternal morbidity.	HL7 Service Delivery Location	<a href="https://phinvads.cdc.gov/vads/ViewValueSet.action?oid=1.3.6.1.4.1.19376.1.7.3.1.1.13.8.2">https://phinvads.cdc.gov/vads/ViewValueSet.action?oid=1.3.6.1.4.1.19376.1.7.3.1.1.13.8.2</a>	IHE BFDR
Facility Location NICU (NCHS)	1.3.6.1.4.1.19376.1.7.3.1.1.13.8.1	To reflect that the newborn was admitted to the NICU reflecting an abnormal condition of the newborn	HL7 Service Delivery Location	<a href="https://phinvads.cdc.gov/vads/ViewValueSet.action?oid=1.3.6.1.4.1.19376.1.7.3.1.1.13.8.1">https://phinvads.cdc.gov/vads/ViewValueSet.action?oid=1.3.6.1.4.1.19376.1.7.3.1.1.13.8.1</a>	IHE BFDR
Facility Location OR (NCHS)	1.3.6.1.4.1.19376.1.7.3.1.1.13.8.104	To reflect that the patient (mother) was treated in the OR for an unplanned operation for complications associated with labor and delivery reflecting unplanned operation	HL7 Service Delivery Location	<a href="https://phinvads.cdc.gov/vads/ViewValueSet.action?oid=1.3.6.1.4.1.19376.1.7.3.1.1.13.8.104">https://phinvads.cdc.gov/vads/ViewValueSet.action?oid=1.3.6.1.4.1.19376.1.7.3.1.1.13.8.104</a>	IHE BFDR
Female Gender (NCHS)	1.3.6.1.4.1.19376.1.7.3.1.1.13.8.43	To reflect the Female Gender	HL7 Administrative Gender	<a href="https://phinvads.cdc.gov/vads/ViewValueSet.action?oid=1.3.6.1.4.1.19376.1.7.3.1.1.13.8.43">https://phinvads.cdc.gov/vads/ViewValueSet.action?oid=1.3.6.1.4.1.19376.1.7.3.1.1.13.8.43</a>	IHE BFDR
Fertility Enhancing Drugs Medications (NCHS)	1.3.6.1.4.1.19376.1.7.3.1.1.13.8.144	To reflect that Fertility Enhancing Drugs were administered as a risk factor for pregnancy	RxNorm	<a href="https://phinvads.cdc.gov/vads/ViewValueSet.action?oid=1.3.6.1.4.1.19376.1.7.3.1.1.13.8.144">https://phinvads.cdc.gov/vads/ViewValueSet.action?oid=1.3.6.1.4.1.19376.1.7.3.1.1.13.8.144</a>	IHE BFDR

IHE Quality, Research and Public Health Technical Framework Supplement – Birth and Fetal Death Reporting-Enhanced (BFDR-E)

Name	Identifier	Purpose	Source	PHIN VADS URL	Groups
Autopsy Performed (NCHS)	1.3.6.1.4.1.19 376.1.7.3.1.1. 13.8.1	To reflect Autopsy was performed	SNOME D-CT	<a href="https://phinvads.cdc.gov/vads/ViewValueSet.action?oid=1.3.6.1.4.1.19376.1.7.3.1.1.23.8.1">https://phinvads.cdc.gov/vads/ViewValueSet.action?oid=1.3.6.1.4.1.19376.1.7.3.1.1.23.8.1</a>	IHE BFDR
Fetal Death Time Point (NCHS)	2.16.840.1.11 4222.4.11.71 12	A list of time points during the delivery process at which the fetal death is thought to have occurred. Note, SNOMED is being used as the primary source for codes within the value set.	SNOME D-CT	<a href="https://phinvads.cdc.gov/vads/ViewValueSet.action?oid=2.16.840.1.114222.4.11.7112">https://phinvads.cdc.gov/vads/ViewValueSet.action?oid=2.16.840.1.114222.4.11.7112</a>	IHE BFDR
Fetal Presentation at Birth-Breech (NCHS)	1.3.6.1.4.1.19 376.1.7.3.1.1. 13.8.108	To reflect the Fetal Presentation at Birth-Breech method of delivery	SNOME D-CT	<a href="https://phinvads.cdc.gov/vads/ViewValueSet.action?oid=1.3.6.1.4.1.19376.1.7.3.1.1.13.8.108">https://phinvads.cdc.gov/vads/ViewValueSet.action?oid=1.3.6.1.4.1.19376.1.7.3.1.1.13.8.108</a>	IHE BFDR
Fetal Presentation at Birth-Cephalic (NCHS)	1.3.6.1.4.1.19 376.1.7.3.1.1. 13.8.109	To reflect the Fetal Presentation at Birth-Cephalic method of delivery	SNOME D-CT	<a href="https://phinvads.cdc.gov/vads/ViewValueSet.action?oid=1.3.6.1.4.1.19376.1.7.3.1.1.13.8.109">https://phinvads.cdc.gov/vads/ViewValueSet.action?oid=1.3.6.1.4.1.19376.1.7.3.1.1.13.8.109</a>	IHE BFDR
Fetal Presentation at Birth-Other (NCHS)	1.3.6.1.4.1.19 376.1.7.3.1.1. 13.8.110	To reflect the Fetal Presentation at Birth-Other	SNOME D-CT	<a href="https://phinvads.cdc.gov/vads/ViewValueSet.action?oid=1.3.6.1.4.1.19376.1.7.3.1.1.13.8.110">https://phinvads.cdc.gov/vads/ViewValueSet.action?oid=1.3.6.1.4.1.19376.1.7.3.1.1.13.8.110</a>	IHE BFDR
Fever Greater Than 100.4 (NCHS)	1.3.6.1.4.1.19 376.1.7.3.1.1. 13.8.25	To reflect a Fever Greater Than 100.4 During Labor	SNOME D-CT	<a href="https://phinvads.cdc.gov/vads/ViewValueSet.action?oid=1.3.6.1.4.1.19376.1.7.3.1.1.13.8.25">https://phinvads.cdc.gov/vads/ViewValueSet.action?oid=1.3.6.1.4.1.19376.1.7.3.1.1.13.8.25</a>	IHE BFDR
First Prenatal Care Visit (NCHS)	1.3.6.1.4.1.19 376.1.7.3.1.1. 13.8.133	To reflect the Date of the First Prenatal Care Visit	LOINC	<a href="https://phinvads.cdc.gov/vads/ViewValueSet.action?oid=1.3.6.1.4.1.19376.1.7.3.1.1.13.8.133">https://phinvads.cdc.gov/vads/ViewValueSet.action?oid=1.3.6.1.4.1.19376.1.7.3.1.1.13.8.133</a>	IHE BFDR
Fourth Degree Perineal Laceration (NCHS)	1.3.6.1.4.1.19 376.1.7.3.1.1. 13.8.101	To reflect Fourth Degree Perineal Laceration as a maternal morbidity	SNOME D-CT	<a href="https://phinvads.cdc.gov/vads/ViewValueSet.action?oid=1.3.6.1.4.1.19376.1.7.3.1.1.13.8.101">https://phinvads.cdc.gov/vads/ViewValueSet.action?oid=1.3.6.1.4.1.19376.1.7.3.1.1.13.8.101</a>	IHE BFDR
Gastroschisis of the Newborn (NCHS)	1.3.6.1.4.1.19 376.1.7.3.1.1. 13.8.62	To reflect Gastroschisis of the Newborn as an anomaly of the newborn	SNOME D-CT	<a href="https://phinvads.cdc.gov/vads/ViewValueSet.action?oid=1.3.6.1.4.1.19376.1.7.3.1.1.13.8.62">https://phinvads.cdc.gov/vads/ViewValueSet.action?oid=1.3.6.1.4.1.19376.1.7.3.1.1.13.8.62</a>	IHE BFDR

IHE Quality, Research and Public Health Technical Framework Supplement – Birth and Fetal Death Reporting-Enhanced (BFDR-E)

Name	Identifier	Purpose	Source	PHIN VADS URL	Groups
Gestational Diabetes (NCHS)	1.3.6.1.4.1.19 376.1.7.3.1.1.13.8.137	To reflect Risk Factors of Gestational Diabetes	SNOME D-CT	<a href="https://phinvads.cdc.gov/vads/ViewValueSet.action?oid=1.3.6.1.4.1.19376.1.7.3.1.1.13.8.137">https://phinvads.cdc.gov/vads/ViewValueSet.action?oid=1.3.6.1.4.1.19376.1.7.3.1.1.13.8.137</a>	IHE BFDR
Gestational Hypertension (NCHS)	1.3.6.1.4.1.19 376.1.7.3.1.1.13.8.139	To reflect Risk Factors of Gestational Hypertension	SNOME D-CT	<a href="https://phinvads.cdc.gov/vads/ViewValueSet.action?oid=1.3.6.1.4.1.19376.1.7.3.1.1.13.8.139">https://phinvads.cdc.gov/vads/ViewValueSet.action?oid=1.3.6.1.4.1.19376.1.7.3.1.1.13.8.139</a>	IHE BFDR
Gonorrhea (NCHS)	2.16.840.1.11 4222.4.11.6071	To reflect Gonorrhea as Infections present and treated during this pregnancy	SNOME D-CT	<a href="https://phinvads.cdc.gov/vads/ViewValueSet.action?oid=2.16.840.1.114222.4.11.6071">https://phinvads.cdc.gov/vads/ViewValueSet.action?oid=2.16.840.1.114222.4.11.6071</a>	IHE BFDR
Group B Streptococcus (NCHS)	1.3.6.1.4.1.19 376.1.7.3.1.1.13.8.166	To reflect Infection with Group B Streptococcus	SNOME D-CT	<a href="https://phinvads.cdc.gov/vads/ViewValueSet.action?oid=1.3.6.1.4.1.19376.1.7.3.1.1.13.8.166">https://phinvads.cdc.gov/vads/ViewValueSet.action?oid=1.3.6.1.4.1.19376.1.7.3.1.1.13.8.166</a>	IHE BFDR
Height (NCHS)	2.16.840.1.11 4222.4.11.7155	To reflect the mother's height	LOINC	<a href="https://phinvads.cdc.gov/vads/ViewValueSet.action?oid=2.16.840.1.114222.4.11.7155">https://phinvads.cdc.gov/vads/ViewValueSet.action?oid=2.16.840.1.114222.4.11.7155</a>	IHE BFDR
Hepatitis B (NCHS)	1.3.6.1.4.1.19 376.1.7.3.1.1.13.8.96	To reflect Hepatitis B as Infections present and treated during this pregnancy	SNOME D-CT	<a href="https://phinvads.cdc.gov/vads/ViewValueSet.action?oid=1.3.6.1.4.1.19376.1.7.3.1.1.13.8.96">https://phinvads.cdc.gov/vads/ViewValueSet.action?oid=1.3.6.1.4.1.19376.1.7.3.1.1.13.8.96</a>	IHE BFDR
Hepatitis C (NCHS)	1.3.6.1.4.1.19 376.1.7.3.1.1.13.8.97	To reflect Hepatitis C as Infections present and treated during this pregnancy	SNOME D-CT	<a href="https://phinvads.cdc.gov/vads/ViewValueSet.action?oid=1.3.6.1.4.1.19376.1.7.3.1.1.13.8.97">https://phinvads.cdc.gov/vads/ViewValueSet.action?oid=1.3.6.1.4.1.19376.1.7.3.1.1.13.8.97</a>	IHE BFDR
Histological Placental Examination (NCHS)	2.16.840.1.11 4222.4.11.7138	To reflect the Histological Placental Examination for fetal death		<a href="https://phinvads.cdc.gov/vads/ViewValueSet.action?oid=2.16.840.1.114222.4.11.7138">https://phinvads.cdc.gov/vads/ViewValueSet.action?oid=2.16.840.1.114222.4.11.7138</a>	IHE BFDR
Hypospadias (NCHS)	1.3.6.1.4.1.19 376.1.7.3.1.1.13.8.63	To reflect Hypospadias as an anomaly of the newborn	SNOME D-CT	<a href="https://phinvads.cdc.gov/vads/ViewValueSet.action?oid=1.3.6.1.4.1.19376.1.7.3.1.1.13.8.63">https://phinvads.cdc.gov/vads/ViewValueSet.action?oid=1.3.6.1.4.1.19376.1.7.3.1.1.13.8.63</a>	IHE BFDR
Hysterotomy Hysterectomy (NCHS)	1.3.6.1.4.1.19 376.1.7.3.1.1.13.8.150	To reflect hysterotomy/hysterectomy as the method of delivery in fetal death	SNOME D-CT	<a href="https://phinvads.cdc.gov/vads/ViewValueSet.action?oid=1.3.6.1.4.1.19376.1.7.3.1.1.13.8.150">https://phinvads.cdc.gov/vads/ViewValueSet.action?oid=1.3.6.1.4.1.19376.1.7.3.1.1.13.8.150</a>	IHE BFDR
ICU Care (NCHS)	1.3.6.1.4.1.19 376.1.7.3.1.1.13.8.188	To reflect that the mother was transferred to ICU following the birth	SNOME D-CT	<a href="https://phinvads.cdc.gov/vads/ViewValueSet.action?oid=1.3.6.1.4.1.19376.1.7.3.1.1.13.8.188">https://phinvads.cdc.gov/vads/ViewValueSet.action?oid=1.3.6.1.4.1.19376.1.7.3.1.1.13.8.188</a>	IHE BFDR

IHE Quality, Research and Public Health Technical Framework Supplement – Birth and Fetal Death Reporting-Enhanced (BFDR-E)

Name	Identifier	Purpose	Source	PHIN VADS URL	Groups
IM Medication Administration Route (NCHS)	1.3.6.1.4.1.19 376.1.7.3.1.1.13.8.5	To reflect that Intramuscular Medication Administration Route was used to administer a medication	HL7 Route of Administration	<a href="https://phinvads.cdc.gov/vads/ViewValueSet.action?oid=1.3.6.1.4.1.19376.1.7.3.1.1.13.8.5">https://phinvads.cdc.gov/vads/ViewValueSet.action?oid=1.3.6.1.4.1.19376.1.7.3.1.1.13.8.5</a>	IHE BFDR
Induction of Labor (NCHS)	1.3.6.1.4.1.19 376.1.7.3.1.1.13.8.34	To reflect that there was an Induction of Labor	SNOME D-CT	<a href="https://phinvads.cdc.gov/vads/ViewValueSet.action?oid=1.3.6.1.4.1.19376.1.7.3.1.1.13.8.34">https://phinvads.cdc.gov/vads/ViewValueSet.action?oid=1.3.6.1.4.1.19376.1.7.3.1.1.13.8.34</a>	IHE BFDR
Induction of Labor Finding (NCHS)	2.16.840.1.114222.4.11.7531	To identify findings that labor was induced	SNOME D-CT	<a href="https://phinvads.cdc.gov/vads/ViewValueSet.action?oid=2.16.840.1.114222.4.11.7531">https://phinvads.cdc.gov/vads/ViewValueSet.action?oid=2.16.840.1.114222.4.11.7531</a>	IHE BFDR
Infertility Treatment (NCHS)	1.3.6.1.4.1.19 376.1.7.3.1.1.13.8.143	To reflect Risk Factors of Pregnancy Infertility Treatment	SNOME D-CT	<a href="https://phinvads.cdc.gov/vads/ViewValueSet.action?oid=1.3.6.1.4.1.19376.1.7.3.1.1.13.8.143">https://phinvads.cdc.gov/vads/ViewValueSet.action?oid=1.3.6.1.4.1.19376.1.7.3.1.1.13.8.143</a>	IHE BFDR
Institution Referred to (NCHS)	1.3.6.1.4.1.19 376.1.7.3.1.1.13.8.191	To reflect the institution to which the patient was referred	LOINC	<a href="https://phinvads.cdc.gov/vads/ViewValueSet.action?oid=1.3.6.1.4.1.19376.1.7.3.1.1.13.8.191">https://phinvads.cdc.gov/vads/ViewValueSet.action?oid=1.3.6.1.4.1.19376.1.7.3.1.1.13.8.191</a>	IHE BFDR
IV Medication Administration Route (NCHS)	1.3.6.1.4.1.19 376.1.7.3.1.1.13.8.4	To reflect that IV Medication Administration Route was used to administer a medication	HL7 Route of Administration	<a href="https://phinvads.cdc.gov/vads/ViewValueSet.action?oid=1.3.6.1.4.1.19376.1.7.3.1.1.13.8.4">https://phinvads.cdc.gov/vads/ViewValueSet.action?oid=1.3.6.1.4.1.19376.1.7.3.1.1.13.8.4</a>	IHE BFDR
Karyotype Confirmed (NCHS)	1.3.6.1.4.1.19 376.1.7.3.1.1.13.8.56	To reflect Karyotype Confirmed as an anomaly of the newborn	SNOME D-CT	<a href="https://phinvads.cdc.gov/vads/ViewValueSet.action?oid=1.3.6.1.4.1.19376.1.7.3.1.1.13.8.56">https://phinvads.cdc.gov/vads/ViewValueSet.action?oid=1.3.6.1.4.1.19376.1.7.3.1.1.13.8.56</a>	IHE BFDR
Karyotype Determination (NCHS)	1.3.6.1.4.1.19 376.1.7.3.1.1.13.8.154	To reflect Karyotype determination as an anomaly of the newborn	SNOME D-CT	<a href="https://phinvads.cdc.gov/vads/ViewValueSet.action?oid=1.3.6.1.4.1.19376.1.7.3.1.1.13.8.154">https://phinvads.cdc.gov/vads/ViewValueSet.action?oid=1.3.6.1.4.1.19376.1.7.3.1.1.13.8.154</a>	IHE BFDR
Karyotype Result (NCHS)	1.3.6.1.4.1.19 376.1.7.3.1.1.13.8.59	To reflect Karyotyping to determine that the result is pending	LOINC	<a href="https://phinvads.cdc.gov/vads/ViewValueSet.action?oid=1.3.6.1.4.1.19376.1.7.3.1.1.13.8.59">https://phinvads.cdc.gov/vads/ViewValueSet.action?oid=1.3.6.1.4.1.19376.1.7.3.1.1.13.8.59</a>	IHE BFDR
Limb Reduction Defect (NCHS)	6.1.4.1.19376.1.7.3.1.1.13.8.64	To reflect Limb Reduction Defect as an anomaly of the newborn	SNOME D-CT	<a href="https://phinvads.cdc.gov/vads/ViewValueSet.action?oid=6.1.4.1.19376.1.7.3.1.1.13.8.64">https://phinvads.cdc.gov/vads/ViewValueSet.action?oid=6.1.4.1.19376.1.7.3.1.1.13.8.64</a>	IHE BFDR
Listeria (NCHS)	1.3.6.1.4.1.19 376.1.7.3.1.1.13.8.147	To reflect Listeria as Infections present and treated during this pregnancy		<a href="https://phinvads.cdc.gov/vads/ViewValueSet.action?oid=1.3.6.1.4.1.19376.1.7.3.1.1.13.8.147">https://phinvads.cdc.gov/vads/ViewValueSet.action?oid=1.3.6.1.4.1.19376.1.7.3.1.1.13.8.147</a>	IHE BFDR

IHE Quality, Research and Public Health Technical Framework Supplement – Birth and Fetal Death Reporting-Enhanced (BFDR-E)

Name	Identifier	Purpose	Source	PHIN VADS URL	Groups
Male Gender (NCHS)	1.3.6.1.4.1.19 376.1.7.3.1.1. 13.8.42	To reflect the Male Gender	HL7 Administrative Gender	<a href="https://phinvads.cdc.gov/vads/ValueSet.action?oid=1.3.6.1.4.1.19376.1.7.3.1.1.13.8.42">https://phinvads.cdc.gov/vads/ValueSet.action?oid=1.3.6.1.4.1.19376.1.7.3.1.1.13.8.42</a>	IHE BFDR
Meningomyelocele/Spina Bifida - Newborn (NCHS)	1.3.6.1.4.1.19 376.1.7.3.1.1. 13.8.65	To reflect Meningomyelocele/Spina Bifida of the Newborn as an anomaly of the newborn	SNOMED-CT	<a href="https://phinvads.cdc.gov/vads/ValueSet.action?oid=1.3.6.1.4.1.19376.1.7.3.1.1.13.8.65">https://phinvads.cdc.gov/vads/ValueSet.action?oid=1.3.6.1.4.1.19376.1.7.3.1.1.13.8.65</a>	IHE BFDR
Method of Delivery Cesarean Finding (NCHS)	2.16.840.1.11 4222.4.11.75 27	To identify findings of delivery of the entire fetus through the vaginal wall (cesarean)	SNOMED-CT	<a href="https://phinvads.cdc.gov/vads/ValueSet.action?oid=2.16.840.1.114222.4.11.7527">https://phinvads.cdc.gov/vads/ValueSet.action?oid=2.16.840.1.114222.4.11.7527</a>	IHE BFDR
Method of Delivery Vaginal Forceps Finding (NCHS)	2.16.840.1.11 4222.4.11.75 28	To identify findings of delivery of the fetus using vaginal forceps	SNOMED-CT	<a href="https://phinvads.cdc.gov/vads/ValueSet.action?oid=2.16.840.1.114222.4.11.7528">https://phinvads.cdc.gov/vads/ValueSet.action?oid=2.16.840.1.114222.4.11.7528</a>	IHE BFDR
Method of Delivery Vaginal-Spon Finding (NCHS)	2.16.840.1.11 4222.4.11.75 26	To identify findings of delivery of the entire fetus through the vagina by the natural force of labor with or without manual assistance from the delivery attendant.	SNOMED-CT	<a href="https://phinvads.cdc.gov/vads/ValueSet.action?oid=2.16.840.1.114222.4.11.7526">https://phinvads.cdc.gov/vads/ValueSet.action?oid=2.16.840.1.114222.4.11.7526</a>	IHE BFDR
Method of Delivery Vaginal Vacuum Finding (NCHS)	2.16.840.1.11 4222.4.11.75 29	To identify findings of delivery of the fetus using vaginal vacuum	SNOMED-CT	<a href="https://phinvads.cdc.gov/vads/ValueSet.action?oid=2.16.840.1.114222.4.11.7529">https://phinvads.cdc.gov/vads/ValueSet.action?oid=2.16.840.1.114222.4.11.7529</a>	IHE BFDR
Midwife (NCHS)	1.3.6.1.4.1.19 376.1.7.3.1.1. 13.8.18	To reflect the Title of the Attendant responsible for the delivery Procedure as a Midwife excluding registered midwife which is reflected in the 'certified midwife' value set	SNOMED-CT	<a href="https://phinvads.cdc.gov/vads/ValueSet.action?oid=1.3.6.1.4.1.19376.1.7.3.1.1.13.8.18">https://phinvads.cdc.gov/vads/ValueSet.action?oid=1.3.6.1.4.1.19376.1.7.3.1.1.13.8.18</a>	IHE BFDR
Mothers Delivery Weight (NCHS)	1.3.6.1.4.1.19 376.1.7.3.1.1. 13.8.120	To reflect the Mother's Delivery Weight	LOINC	<a href="https://phinvads.cdc.gov/vads/ValueSet.action?oid=1.3.6.1.4.1.19376.1.7.3.1.1.13.8.120">https://phinvads.cdc.gov/vads/ValueSet.action?oid=1.3.6.1.4.1.19376.1.7.3.1.1.13.8.120</a>	IHE BFDR

IHE Quality, Research and Public Health Technical Framework Supplement – Birth and Fetal Death Reporting-Enhanced (BFDR-E)

Name	Identifier	Purpose	Source	PHIN VADS URL	Groups
Neonatal Death (NCHS)	1.3.6.1.4.1.19 376.1.7.3.1.1. 13.8.149	To reflect that the newborn died	SNOME D-CT	<a href="https://phinvads.cdc.gov/vads/ViewValueSet.action?oid=1.3.6.1.4.1.19376.1.7.3.1.1.13.8.149">https://phinvads.cdc.gov/vads/ViewValueSet.action?oid=1.3.6.1.4.1.19376.1.7.3.1.1.13.8.149</a>	IHE BFDR
Neonatal Sepsis (NCHS)	1.3.6.1.4.1.19 376.1.7.3.1.1. 13.8.6	To reflect that the newborn had suspected neonatal sepsis reflecting an abnormal condition of the newborn	SNOME D-CT	<a href="https://phinvads.cdc.gov/vads/ViewValueSet.action?oid=1.3.6.1.4.1.19376.1.7.3.1.1.13.8.6">https://phinvads.cdc.gov/vads/ViewValueSet.action?oid=1.3.6.1.4.1.19376.1.7.3.1.1.13.8.6</a>	IHE BFDR
Newborn Receiving Surfactant Replacement Therapy (NCHS)	1.3.6.1.4.1.19 376.1.7.3.1.1. 13.8.11	To reflect that the Newborn received Surfactant Replacement Therapy reflecting an abnormal condition of the newborn	RxNorm	<a href="https://phinvads.cdc.gov/vads/ViewValueSet.action?oid=1.3.6.1.4.1.19376.1.7.3.1.1.13.8.11">https://phinvads.cdc.gov/vads/ViewValueSet.action?oid=1.3.6.1.4.1.19376.1.7.3.1.1.13.8.11</a>	IHE BFDR
Pregnancy Resulting From Fertility Enhancing Drugs (NCHS)	2.16.840.1.11 4222.4.11.74 23	The value set contains a list of items to indicate whether a pregnancy resulted from fertility enhancing drugs	SNOME D-CT	<a href="http://phinvads.cdc.gov/vads/ViewValueSet.action?oid=2.16.840.1.114222.4.11.7423">http://phinvads.cdc.gov/vads/ViewValueSet.action?oid=2.16.840.1.114222.4.11.7423</a>	IHE BFDR
Surfactant Replacement Therapy (NCHS)	2.16.840.1.11 4222.4.11.74 31	Surfactant Replacement Therapy (NCHS)	SNOME D-CT	<a href="https://phinvads.cdc.gov/vads/ViewValueSet.action?oid=2.16.840.1.114222.4.11.7431">https://phinvads.cdc.gov/vads/ViewValueSet.action?oid=2.16.840.1.114222.4.11.7431</a>	IHE BFDR
NICU Care (NCHS)	1.3.6.1.4.1.19 376.1.7.3.1.1. 13.8.198	To reflect the that the baby was transferred to NICU following the birth	SNOME D-CT	<a href="https://phinvads.cdc.gov/vads/ViewValueSet.action?oid=1.3.6.1.4.1.19376.1.7.3.1.1.13.8.198">https://phinvads.cdc.gov/vads/ViewValueSet.action?oid=1.3.6.1.4.1.19376.1.7.3.1.1.13.8.198</a>	IHE BFDR
Number of Fetal Deaths This Delivery (NCHS)	1.3.6.1.4.1.19 376.1.7.3.1.1. 13.8.164	To reflect the Number of Fetal Deaths This Delivery	LOINC	<a href="https://phinvads.cdc.gov/vads/ViewValueSet.action?oid=1.3.6.1.4.1.19376.1.7.3.1.1.13.8.164">https://phinvads.cdc.gov/vads/ViewValueSet.action?oid=1.3.6.1.4.1.19376.1.7.3.1.1.13.8.164</a>	IHE BFDR
Number of Live Births (NCHS)	1.3.6.1.4.1.19 376.1.7.3.1.1. 13.8.68	To reflect the Number of Live Births for the current pregnancy	LOINC	<a href="https://phinvads.cdc.gov/vads/ViewValueSet.action?oid=1.3.6.1.4.1.19376.1.7.3.1.1.13.8.68">https://phinvads.cdc.gov/vads/ViewValueSet.action?oid=1.3.6.1.4.1.19376.1.7.3.1.1.13.8.68</a>	IHE BFDR
Number of Preterm Births (NCHS)	1.3.6.1.4.1.19 376.1.7.3.1.1. 13.8.187	To reflect the number of preterm births in prior pregnancies	LOINC	<a href="https://phinvads.cdc.gov/vads/ViewValueSet.action?oid=1.3.6.1.4.1.19376.1.7.3.1.1.13.8.187">https://phinvads.cdc.gov/vads/ViewValueSet.action?oid=1.3.6.1.4.1.19376.1.7.3.1.1.13.8.187</a>	IHE BFDR
Number of Previous Cesareans (NCHS)	1.3.6.1.4.1.19 376.1.7.3.1.1. 13.8.148	To reflect the Number of Previous Cesareans as a Risk Factor in Pregnancy	LOINC	<a href="https://phinvads.cdc.gov/vads/ViewValueSet.action?oid=1.3.6.1.4.1.19376.1.7.3.1.1.13.8.148">https://phinvads.cdc.gov/vads/ViewValueSet.action?oid=1.3.6.1.4.1.19376.1.7.3.1.1.13.8.148</a>	IHE BFDR

IHE Quality, Research and Public Health Technical Framework Supplement – Birth and Fetal Death Reporting-Enhanced (BFDR-E)

Name	Identifier	Purpose	Source	PHIN VADS URL	Groups
Number of Previous Live Births Now Dead (NCHS)	1.3.6.1.4.1.19 376.1.7.3.1.1. 13.8.122	To reflect the Number of Previous Live Births Now Dead	LOINC	<a href="https://phinvads.cdc.gov/vads/ViewValueSet.action?oid=1.3.6.1.4.1.19376.1.7.3.1.1.13.8.122">https://phinvads.cdc.gov/vads/ViewValueSet.action?oid=1.3.6.1.4.1.19376.1.7.3.1.1.13.8.122</a>	IHE BFDR
Number of Previous Live Births Now Living (NCHS)	1.3.6.1.4.1.19 376.1.7.3.1.1. 13.8.123	To reflect the Number of Live Births Now Living	LOINC	<a href="https://phinvads.cdc.gov/vads/ViewValueSet.action?oid=1.3.6.1.4.1.19376.1.7.3.1.1.13.8.123">https://phinvads.cdc.gov/vads/ViewValueSet.action?oid=1.3.6.1.4.1.19376.1.7.3.1.1.13.8.123</a>	IHE BFDR
Number of Prior Pregnancies (NCHS)	1.3.6.1.4.1.19 376.1.7.3.1.1. 13.8.71	To reflect the Number of Prior Pregnancies	LOINC	<a href="https://phinvads.cdc.gov/vads/ViewValueSet.action?oid=1.3.6.1.4.1.19376.1.7.3.1.1.13.8.71">https://phinvads.cdc.gov/vads/ViewValueSet.action?oid=1.3.6.1.4.1.19376.1.7.3.1.1.13.8.71</a>	IHE BFDR
Number Prenatal Care Visits (NCHS)	1.3.6.1.4.1.19 376.1.7.3.1.1. 13.8.135	To reflect the Number Prenatal Care Visits	LOINC	<a href="https://phinvads.cdc.gov/vads/ViewValueSet.action?oid=1.3.6.1.4.1.19376.1.7.3.1.1.13.8.135">https://phinvads.cdc.gov/vads/ViewValueSet.action?oid=1.3.6.1.4.1.19376.1.7.3.1.1.13.8.135</a>	IHE BFDR
Obstetric Estimate of Gestation (NCHS)	1.3.6.1.4.1.19 376.1.7.3.1.1. 13.8.124	To reflect the Obstetric Estimate of Gestation of the newborn	LOINC	<a href="https://phinvads.cdc.gov/vads/ViewValueSet.action?oid=1.3.6.1.4.1.19376.1.7.3.1.1.13.8.124">https://phinvads.cdc.gov/vads/ViewValueSet.action?oid=1.3.6.1.4.1.19376.1.7.3.1.1.13.8.124</a>	IHE BFDR
Omphalocele of the Newborn (NCHS)	1.3.6.1.4.1.19 376.1.7.3.1.1. 13.8.66	To reflect Omphalocele of the Newborn as an anomaly of the newborn	SNOME D-CT	<a href="https://phinvads.cdc.gov/vads/ViewValueSet.action?oid=1.3.6.1.4.1.19376.1.7.3.1.1.13.8.66">https://phinvads.cdc.gov/vads/ViewValueSet.action?oid=1.3.6.1.4.1.19376.1.7.3.1.1.13.8.66</a>	IHE BFDR
Parvovirus (NCHS)	1.3.6.1.4.1.19 376.1.7.3.1.1. 13.8.168	To reflect infection with Parvovirus	SNOME D-CT	<a href="https://phinvads.cdc.gov/vads/ViewValueSet.action?oid=1.3.6.1.4.1.19376.1.7.3.1.1.13.8.168">https://phinvads.cdc.gov/vads/ViewValueSet.action?oid=1.3.6.1.4.1.19376.1.7.3.1.1.13.8.168</a>	IHE BFDR
Physician (NCHS)	1.3.6.1.4.1.19 376.1.7.3.1.1. 13.8.15	To reflect the Title of the Attendant responsible for the delivery Procedure as a Physician	SNOME D-CT	<a href="https://phinvads.cdc.gov/vads/ViewValueSet.action?oid=1.3.6.1.4.1.19376.1.7.3.1.1.13.8.15">https://phinvads.cdc.gov/vads/ViewValueSet.action?oid=1.3.6.1.4.1.19376.1.7.3.1.1.13.8.15</a>	IHE BFDR
Precipitous Labor (NCHS)	1.3.6.1.4.1.19 376.1.7.3.1.1. 13.8.130	To reflect Onset of labor with Precipitous Labor	SNOME D-CT	<a href="https://phinvads.cdc.gov/vads/ViewValueSet.action?oid=1.3.6.1.4.1.19376.1.7.3.1.1.13.8.130">https://phinvads.cdc.gov/vads/ViewValueSet.action?oid=1.3.6.1.4.1.19376.1.7.3.1.1.13.8.130</a>	IHE BFDR
Premature Rupture (NCHS)	1.3.6.1.4.1.19 376.1.7.3.1.1. 13.8.129	To reflect Onset of labor with Premature Rupture	SNOME D-CT	<a href="https://phinvads.cdc.gov/vads/ViewValueSet.action?oid=1.3.6.1.4.1.19376.1.7.3.1.1.13.8.129">https://phinvads.cdc.gov/vads/ViewValueSet.action?oid=1.3.6.1.4.1.19376.1.7.3.1.1.13.8.129</a>	IHE BFDR
Prepregnancy Diabetes (NCHS)	1.3.6.1.4.1.19 376.1.7.3.1.1. 13.8.136	To reflect Risk Factors of Prepregnancy Diabetes	SNOME D-CT	<a href="https://phinvads.cdc.gov/vads/ViewValueSet.action?oid=1.3.6.1.4.1.19376.1.7.3.1.1.13.8.136">https://phinvads.cdc.gov/vads/ViewValueSet.action?oid=1.3.6.1.4.1.19376.1.7.3.1.1.13.8.136</a>	IHE BFDR



IHE Quality, Research and Public Health Technical Framework Supplement – Birth and Fetal Death Reporting-Enhanced (BFDR-E)

Name	Identifier	Purpose	Source	PHIN VADS URL	Groups
Prepregnancy Hypertension (NCHS)	1.3.6.1.4.1.19 376.1.7.3.1.1. 13.8.138	To reflect Risk Factors of Prepregnancy Hypertension	SNOME D-CT	<a href="https://phinvads.cdc.gov/vads/ViewValueSet.action?oid=1.3.6.1.4.1.19376.1.7.3.1.1.13.8.138">https://phinvads.cdc.gov/vads/ViewValueSet.action?oid=1.3.6.1.4.1.19376.1.7.3.1.1.13.8.138</a>	IHE BFDR
Pre-Pregnancy Weight (NCHS)	1.3.6.1.4.1.19 376.1.7.3.1.1. 13.8.118	To reflect the mother's Pre-Pregnancy Weight	LOINC	<a href="https://phinvads.cdc.gov/vads/ViewValueSet.action?oid=1.3.6.1.4.1.19376.1.7.3.1.1.13.8.118">https://phinvads.cdc.gov/vads/ViewValueSet.action?oid=1.3.6.1.4.1.19376.1.7.3.1.1.13.8.118</a>	IHE BFDR
Preterm Birth (NCHS)	1.3.6.1.4.1.19 376.1.7.3.1.1. 13.8.141	To reflect Risk Factors of Preterm Birth (history)	SNOME D-CT	<a href="https://phinvads.cdc.gov/vads/ViewValueSet.action?oid=1.3.6.1.4.1.19376.1.7.3.1.1.13.8.141">https://phinvads.cdc.gov/vads/ViewValueSet.action?oid=1.3.6.1.4.1.19376.1.7.3.1.1.13.8.141</a>	IHE BFDR
Previous Cesarean (NCHS)	1.3.6.1.4.1.19 376.1.7.3.1.1. 13.8.147	To reflect Risk Factors of Pregnancy Previous Cesarean	SNOME D-CT	<a href="https://phinvads.cdc.gov/vads/ViewValueSet.action?oid=2.16.840.1.114222.4.11.7165">https://phinvads.cdc.gov/vads/ViewValueSet.action?oid=2.16.840.1.114222.4.11.7165</a>	IHE BFDR
Previous Other Pregnancy Outcomes (NCHS)	1.3.6.1.4.1.19 376.1.7.3.1.1. 13.8.121	To reflect the Previous Other Pregnancy Outcomes	LOINC	<a href="https://phinvads.cdc.gov/vads/ViewValueSet.action?oid=1.3.6.1.4.1.19376.1.7.3.1.1.13.8.121">https://phinvads.cdc.gov/vads/ViewValueSet.action?oid=1.3.6.1.4.1.19376.1.7.3.1.1.13.8.121</a>	IHE BFDR
Problem Status Active (NCHS)	1.3.6.1.4.1.19 376.1.7.3.1.1. 13.8.119	To reflect the Problem Status Active	SNOME D-CT	<a href="https://phinvads.cdc.gov/vads/ViewValueSet.action?oid=1.3.6.1.4.1.19376.1.7.3.1.1.13.8.119">https://phinvads.cdc.gov/vads/ViewValueSet.action?oid=1.3.6.1.4.1.19376.1.7.3.1.1.13.8.119</a>	IHE BFDR
Prolonged Labor (NCHS)	1.3.6.1.4.1.19 376.1.7.3.1.1. 13.8.131	To reflect Onset of labor with Prolonged Labor	SNOME D-CT	<a href="https://phinvads.cdc.gov/vads/ViewValueSet.action?oid=1.3.6.1.4.1.19376.1.7.3.1.1.13.8.131">https://phinvads.cdc.gov/vads/ViewValueSet.action?oid=1.3.6.1.4.1.19376.1.7.3.1.1.13.8.131</a>	IHE BFDR
Route and Method of Delivery - Cesarean (NCHS)	1.3.6.1.4.1.19 376.1.7.3.1.1. 13.8.114	To reflect the Route and Method of Delivery as Cesarean Delivery	SNOME D-CT	<a href="https://phinvads.cdc.gov/vads/ViewValueSet.action?oid=1.3.6.1.4.1.19376.1.7.3.1.1.13.8.114">https://phinvads.cdc.gov/vads/ViewValueSet.action?oid=1.3.6.1.4.1.19376.1.7.3.1.1.13.8.114</a>	IHE BFDR
Route and Method of Delivery - Forceps (NCHS)	1.3.6.1.4.1.19 376.1.7.3.1.1. 13.8.112	To reflect the Route and Method of Delivery as Forceps Delivery	SNOME D-CT	<a href="https://phinvads.cdc.gov/vads/ViewValueSet.action?oid=1.3.6.1.4.1.19376.1.7.3.1.1.13.8.112">https://phinvads.cdc.gov/vads/ViewValueSet.action?oid=1.3.6.1.4.1.19376.1.7.3.1.1.13.8.112</a>	IHE BFDR
Route and Method of Delivery - Scheduled C (NCHS)	1.3.6.1.4.1.19 376.1.7.3.1.1. 13.8.116	To reflect the Route and Method of Delivery as Scheduled Cesarean	SNOME D-CT	<a href="https://phinvads.cdc.gov/vads/ViewValueSet.action?oid=1.3.6.1.4.1.19376.1.7.3.1.1.13.8.116">https://phinvads.cdc.gov/vads/ViewValueSet.action?oid=1.3.6.1.4.1.19376.1.7.3.1.1.13.8.116</a>	IHE BFDR
Route and Method of Delivery - Spontaneous (NCHS)	1.3.6.1.4.1.19 376.1.7.3.1.1. 13.8.111	To reflect the Route and Method of Delivery as Spontaneous Delivery	SNOME D-CT	<a href="https://phinvads.cdc.gov/vads/ViewValueSet.action?oid=1.3.6.1.4.1.19376.1.7.3.1.1.13.8.111">https://phinvads.cdc.gov/vads/ViewValueSet.action?oid=1.3.6.1.4.1.19376.1.7.3.1.1.13.8.111</a>	IHE BFDR



IHE Quality, Research and Public Health Technical Framework Supplement – Birth and Fetal Death Reporting-Enhanced (BFDR-E)

Name	Identifier	Purpose	Source	PHIN VADS URL	Groups
Route Method of Delivery - Trial of Labor (NCHS)	1.3.6.1.4.1.19 376.1.7.3.1.1. 13.8.115	To reflect the Route and Method of Delivery if Cesarean was as Trial of Labor Attempted	SNOME D-CT	<a href="https://phinvads.cdc.gov/vads/ViewValueSet.action?oid=1.3.6.1.4.1.19376.1.7.3.1.1.13.8.115">https://phinvads.cdc.gov/vads/ViewValueSet.action?oid=1.3.6.1.4.1.19376.1.7.3.1.1.13.8.115</a>	IHE BFDR
Route and Method of Delivery - Vacuum (NCHS)	1.3.6.1.4.1.19 376.1.7.3.1.1. 13.8.113	To reflect the Route and Method of Delivery as Vacuum Delivery	SNOME D-CT	<a href="https://phinvads.cdc.gov/vads/ViewValueSet.action?oid=1.3.6.1.4.1.19376.1.7.3.1.1.13.8.113">https://phinvads.cdc.gov/vads/ViewValueSet.action?oid=1.3.6.1.4.1.19376.1.7.3.1.1.13.8.113</a>	IHE BFDR
Ruptured Uterus (NCHS)	1.3.6.1.4.1.19 376.1.7.3.1.1. 13.8.102	To reflect Ruptured Uterus as a maternal morbidity	SNOME D-CT	<a href="https://phinvads.cdc.gov/vads/ViewValueSet.action?oid=1.3.6.1.4.1.19376.1.7.3.1.1.13.8.102">https://phinvads.cdc.gov/vads/ViewValueSet.action?oid=1.3.6.1.4.1.19376.1.7.3.1.1.13.8.102</a>	IHE BFDR
Scheduled Cesarean Finding (NCHS)	2.16.840.1.11 4222.4.11.75 30	To identify findings that a Cesarean Section was scheduled	SNOME D-CT	<a href="https://phinvads.cdc.gov/vads/ViewValueSet.action?oid=2.16.840.1.114222.4.11.7530">https://phinvads.cdc.gov/vads/ViewValueSet.action?oid=2.16.840.1.114222.4.11.7530</a>	IHE BFDR
Seizure or Serious Neurologic Dysfunction (NCHS)	1.3.6.1.4.1.19 376.1.7.3.1.1. 13.8.10	To reflect that the newborn suffered a Seizure or Serious Neurologic Dysfunction reflecting an abnormal condition of the newborn	SNOME D-CT	<a href="https://phinvads.cdc.gov/vads/ViewValueSet.action?oid=1.3.6.1.4.1.19376.1.7.3.1.1.13.8.10">https://phinvads.cdc.gov/vads/ViewValueSet.action?oid=1.3.6.1.4.1.19376.1.7.3.1.1.13.8.10</a>	IHE BFDR
Significant Birth Injury (NCHS)	1.3.6.1.4.1.19 376.1.7.3.1.1. 13.8.9	To reflect that the newborn suffered a Significant Birth Injury (skeletal fracture(s), peripheral nerve injury, and/ or soft tissue/solid organ hemorrhage which requires intervention) reflecting an abnormal condition of the newborn	SNOME D-CT	<a href="https://phinvads.cdc.gov/vads/ViewValueSet.action?oid=1.3.6.1.4.1.19376.1.7.3.1.1.13.8.9">https://phinvads.cdc.gov/vads/ViewValueSet.action?oid=1.3.6.1.4.1.19376.1.7.3.1.1.13.8.9</a>	IHE BFDR
Spinal Anesthesia - Procedure (NCHS)	1.3.6.1.4.1.19 376.1.7.3.1.1. 13.8.29	To reflect a Spinal Anesthesia Procedure	SNOME D-CT	<a href="https://phinvads.cdc.gov/vads/ViewValueSet.action?oid=1.3.6.1.4.1.19376.1.7.3.1.1.13.8.29">https://phinvads.cdc.gov/vads/ViewValueSet.action?oid=1.3.6.1.4.1.19376.1.7.3.1.1.13.8.29</a>	IHE BFDR
Spontaneous Onset of Labor (NCHS)	1.3.6.1.4.1.19 376.1.7.3.1.1. 13.8.35	To reflect that there was a Spontaneous Onset of Labor	SNOME D-CT	<a href="https://phinvads.cdc.gov/vads/ViewValueSet.action?oid=1.3.6.1.4.1.19376.1.7.3.1.1.13.8.35">https://phinvads.cdc.gov/vads/ViewValueSet.action?oid=1.3.6.1.4.1.19376.1.7.3.1.1.13.8.35</a>	IHE BFDR

IHE Quality, Research and Public Health Technical Framework Supplement – Birth and Fetal Death Reporting-Enhanced (BFDR-E)

Name	Identifier	Purpose	Source	PHIN VADS URL	Groups
Steroids For Fetal Lung Maturation (NCHS)	2.16.840.1.114222.4.11.7425	The value set contains a list of items to indicate whether steroids (glucocorticoids) for fetal lung maturation was received by the mother before delivery	SNOME D-CT	<a href="https://phinvads.cdc.gov/vads/ViewValueSet.action?oid=2.16.840.1.114222.4.11.7423">https://phinvads.cdc.gov/vads/ViewValueSet.action?oid=2.16.840.1.114222.4.11.7423</a>	IHE BFDR
Suspected Chromosomal Disorder (NCHS)	1.3.6.1.4.1.19376.1.7.3.1.1.13.8.57	To reflect Suspected Chromosomal Disorder as an anomaly of the newborn	SNOME D-CT	<a href="https://phinvads.cdc.gov/vads/ViewValueSet.action?oid=1.3.6.1.4.1.19376.1.7.3.1.1.13.8.57">https://phinvads.cdc.gov/vads/ViewValueSet.action?oid=1.3.6.1.4.1.19376.1.7.3.1.1.13.8.57</a>	IHE BFDR
Syphilis (NCHS)	1.3.6.1.4.1.19376.1.7.3.1.1.13.8.98	To reflect Syphilis as Infections present and treated during this pregnancy	SNOME D-CT	<a href="https://phinvads.cdc.gov/vads/ViewValueSet.action?oid=1.3.6.1.4.1.19376.1.7.3.1.1.13.8.98">https://phinvads.cdc.gov/vads/ViewValueSet.action?oid=1.3.6.1.4.1.19376.1.7.3.1.1.13.8.98</a>	IHE BFDR
Third Degree Perineal Laceration (NCHS)	1.3.6.1.4.1.19376.1.7.3.1.1.13.8.100	To reflect Third Degree Perineal Laceration as a maternal morbidity	SNOME D-CT	<a href="https://phinvads.cdc.gov/vads/ViewValueSet.action?oid=1.3.6.1.4.1.19376.1.7.3.1.1.13.8.100">https://phinvads.cdc.gov/vads/ViewValueSet.action?oid=1.3.6.1.4.1.19376.1.7.3.1.1.13.8.100</a>	IHE BFDR
Tocolysis (NCHS)	1.3.6.1.4.1.19376.1.7.3.1.1.13.8.128	To reflect Obstetric Procedures as Tocolysis	SNOME D-CT	<a href="https://phinvads.cdc.gov/vads/ViewValueSet.action?oid=1.3.6.1.4.1.19376.1.7.3.1.1.13.8.128">https://phinvads.cdc.gov/vads/ViewValueSet.action?oid=1.3.6.1.4.1.19376.1.7.3.1.1.13.8.128</a>	IHE BFDR
Toxoplasmosis (NCHS)	1.3.6.1.4.1.19376.1.7.3.1.1.13.8.169	To reflect infection with Toxoplasmosis	SNOME D-CT	<a href="https://phinvads.cdc.gov/vads/ViewValueSet.action?oid=1.3.6.1.4.1.19376.1.7.3.1.1.13.8.169">https://phinvads.cdc.gov/vads/ViewValueSet.action?oid=1.3.6.1.4.1.19376.1.7.3.1.1.13.8.169</a>	IHE BFDR
Transfer In (NCHS)	1.3.6.1.4.1.19376.1.7.3.1.1.13.8.177	To reflect if the mother was transferred to this facility	Admit source (HL7)	<a href="https://phinvads.cdc.gov/vads/ViewValueSet.action?oid=1.3.6.1.4.1.19376.1.7.3.1.1.13.8.177">https://phinvads.cdc.gov/vads/ViewValueSet.action?oid=1.3.6.1.4.1.19376.1.7.3.1.1.13.8.177</a>	IHE BFDR
Transfer to (NCHS)	1.3.6.1.4.1.19376.1.7.3.1.1.13.8.190	To reflect if the infant was transferred within 24 hours of delivery to another facility	SNOME D-CT	<a href="https://phinvads.cdc.gov/vads/ViewValueSet.action?oid=1.3.6.1.4.1.19376.1.7.3.1.1.13.8.190">https://phinvads.cdc.gov/vads/ViewValueSet.action?oid=1.3.6.1.4.1.19376.1.7.3.1.1.13.8.190</a>	IHE BFDR
Transferred for Maternal Medical or Fetal Indications for Delivery (NCHS)	1.3.6.1.4.1.19376.1.7.3.1.1.13.8.176	To reflect Transferred for Maternal Medical or Fetal Indications for Delivery	SNOME D-CT	<a href="https://phinvads.cdc.gov/vads/ViewValueSet.action?oid=1.3.6.1.4.1.19376.1.7.3.1.1.13.8.176">https://phinvads.cdc.gov/vads/ViewValueSet.action?oid=1.3.6.1.4.1.19376.1.7.3.1.1.13.8.176</a>	IHE BFDR

Name	Identifier	Purpose	Source	PHIN VADS URL	Groups
Transfusion Whole Blood or Packed Red Bld (NCHS)	1.3.6.1.4.1.19 376.1.7.3.1.1.13.8.99	To reflect Transfusion Whole Blood or Packed Red Blood as a maternal morbidity	SNOME D-CT	<a href="https://phinvads.cdc.gov/vads/ViewValueSet.action?oid=1.3.6.1.4.1.19376.1.7.3.1.1.13.8.99">https://phinvads.cdc.gov/vads/ViewValueSet.action?oid=1.3.6.1.4.1.19376.1.7.3.1.1.13.8.99</a>	IHE BFDR
Unplanned Hysterectomy (NCHS)	1.3.6.1.4.1.19 376.1.7.3.1.1.13.8.103	To reflect Ruptured Uterus as a maternal morbidity	SNOME D-CT	<a href="https://phinvads.cdc.gov/vads/ViewValueSet.action?oid=1.3.6.1.4.1.19376.1.7.3.1.1.13.8.103">https://phinvads.cdc.gov/vads/ViewValueSet.action?oid=1.3.6.1.4.1.19376.1.7.3.1.1.13.8.103</a>	IHE BFDR
Unplanned Operation (NCHS)	1.3.6.1.4.1.19 376.1.7.3.1.1.13.8.105	To reflect Ruptured Uterus as a maternal morbidity	SNOME D-CT	<a href="https://phinvads.cdc.gov/vads/ViewValueSet.action?oid=1.3.6.1.4.1.19376.1.7.3.1.1.13.8.105">https://phinvads.cdc.gov/vads/ViewValueSet.action?oid=1.3.6.1.4.1.19376.1.7.3.1.1.13.8.105</a>	IHE BFDR
U.S. Territories (NCHS)	1.3.6.1.4.1.19 376.1.7.3.1.1.13.8.19	To reflect the U.S. Territories	FIPS 5-2	<a href="https://phinvads.cdc.gov/vads/ViewValueSet.action?oid=1.3.6.1.4.1.19376.1.7.3.1.1.13.8.19">https://phinvads.cdc.gov/vads/ViewValueSet.action?oid=1.3.6.1.4.1.19376.1.7.3.1.1.13.8.19</a>	IHE BFDR

## 6.5.2 Value Sets Defined by this profile

1320 None

## 6.6 Data Mappings

This section defines mappings to and from the standard data elements defined in this profile.

### 6.6.1 Form Data Element Mappings

1325 The data elements defined in this profile can be computed from data elements in the Labor and Delivery Summary (LDS) of the electronic health record that is used as the pre-pop document. The LDS mapping rules described below overlays these data elements typically presented to the birth registrar in a form. The Derivation Rule includes a specification defining the source section and entry along with the rules for examining the LDS content to determine whether or not the data element is satisfied. These rules may specify examination of one or more LDS locations to

1330 make a determination of the data element result. While any LDS document may be used to populate the form, the IHE PCC Labor and Delivery Summary Document as constrained by the LDS-VR will result in the maximum number of pre-populated data elements.

1335 The following sub-sections include a table for each data element that describes the pre-population rules to derive the data elements in this profile from the pre-population via mRFD/QRPH-46, via RFD/(LDS-VR/LDS). The Derivation Rule identifies whether or not the form value is checked (Y/N). The variables used to define the rule describe the mapping to the EMR FHIR Resources or the EMR Labor and Delivery CDA (LDS-VR) XPATH. The Value

Sets reference the Value Subsets which are published and available from the Public Health Information Network Vocabulary Access and Distribution System (PHIN-VADS).

1340 Also included in these tables is the mapping to the HL7 BFDR FHIR Document location and content to populate in that location for reporting to the Jurisdiction EBRS.

Also included in these tables is the mapping to the HL7 BFDR V2.6 Message location and content to populate in that location for reporting to the Jurisdiction EBRS.

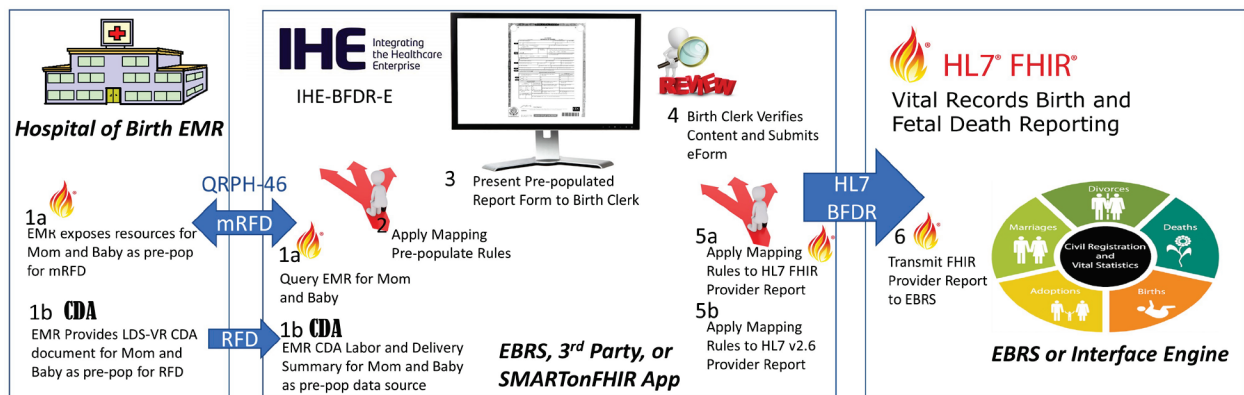

1. EBRS or 3<sup>rd</sup> Party Uses EMR uses EMR clinical data as a source for birth and fetal death reporting information
  - a. Queries EMR for mom/baby clinical data supporting Birth and Fetal Death Reporting using resource mapping from IHE BFDR, OR
  - b. EMR supplies LDS-VR CDA document as pre-pop data when retrieving the Birth Reporting form
2. EBRS or 3<sup>rd</sup> Party Using mapping pre-population rules and CDC-Defined value sets specified in IHE BFDR-E, determine attribute values (aligned with NCHS Edit Specifications)
3. Automatically Pre-populate eForm with BFDR attributes derived from the pre-population Rules applied to the EMR data and present to the Birth Clerk from within their EMR environment (e.g. via SMARTonFHIR App)
4. Birth Clerk reviews report content, makes any required updates, and submits form
 

NOTE: The mapping could be automated without the human review to autogenerate the report to vital records
5. Apply the mapping rules from the BFDR attributes to generate the
  - a. HL7 FHIR Vital Records BFDR
  - b. HL7 v2.6 Vital Records BFDR
6. Transmit the HL7 FHIR HL7 FHIR Vital Records BFDR to vital Records (EBRS or Interface Engine)

1345

### 6.6.1.1 Form Derivation Rules

Variable definitions within this section are only scoped within each rule. For this document, the convention is that Variable names begin with ‘\$’.

#### 6.6.1.1.1 ANTI: Antibiotics [received by the newborn for suspected neonatal sepsis]

ANTI Derivation Rule (2)
IF (\$Indication CONTAINS ValueSet ( <i>Neonatal Sepsis (NCHS)</i> ) AND (\$CodedProductName CONTAINS ValueSet ( <i>Antibiotics (NCHS)</i> )) AND (\$Route CONTAINS ValueSet ( <i>IM Medication Administration Route (NCHS)</i> ) OR ValueSet ( <i>IV Medication Administration Route (NCHS)</i> ), OR IF \$ProcedureCode CONTAINS ValueSet ( <i>Antibiotic Administration Procedure (NCHS)</i> ) THEN ANTI SHALL = “Y” ELSE “N”.

IHE Quality, Research and Public Health Technical Framework Supplement – Birth and Fetal Death Reporting-Enhanced (BFDR-E)

Variable Name	Source in EMR Using FHIR (1a)	Source in EMR Using CDA Labor and Delivery Summary-VR XPATH (1b)	
<b>\$CodedProductName</b>	MedicationAdministration.medication[x].medicationCodableConcept	ClinicalDocument/component/structuredBody/component/section[templateId[@root='1.3.6.1.4.1.19376.1.5.3.1.1.21.2.4']]/subject/relatedSubject/code[@code='NCHILD' AND id=idOfTheChild]/component/section[templateId[@root='1.3.6.1.4.1.19376.1.5.3.1.3.21']]/entry/substanceAdministration/consumable/manufacturedProduct/labeledDrug/code	
<b>\$Route</b>	MedicationAdministration.dosage.route	ClinicalDocument/component/structuredBody/component/section[[templateId[@root=1.3.6.1.4.1.19376.1.5.3.1.1.21.2.4]]/subject/relatedSubject/code[@code='NCHILD' AND id=idOfTheChild]/component/section[templateId[@root=1.3.6.1.4.1.19376.1.5.3.1.3.21]]/substanceAdministration/routeCode	
<b>\$Indication</b>	MedicationAdministration.reasonReference	ClinicalDocument/component/structuredBody/component/section[[templateId[@root='1.3.6.1.4.1.19376.1.5.3.1.1.21.2.4']]/subject/relatedSubject/code[@code='NCHILD' AND id=idOfTheChild]/component/section[templateId[@root='1.3.6.1.4.1.19376.1.5.3.1.3.21']]/substanceAdministration/entryRelationship[@typeCode='RS ON']/act[cda:templateId[@root='1.3.6.1.4.1.19376.1.5.3.1.4.4.1]]/code	
<b>\$ProcedureCode</b>	Procedure.code of newborn	ClinicalDocument/component/structuredBody/component/section[templateId[@root='1.3.6.1.4.1.19376.1.5.3.1.1.21.2.4']]/subject/relatedSubject/code[@code='NCHILD' AND id=idOfTheChild]/component/section[templateId[@root='1.3.6.1.4.1.19376.1.5.3.1.1.13.2.11']]/entry/procedure/code	
Mapping to HL7 FHIR BFDR (5a)			
FHIR Profile/Resource	Content		
<a href="#">Composition - Provider Live Birth Report</a> <ul style="list-style-type: none"> <li><a href="#">ConditionAbnormalConditionOfNewborn</a></li> </ul>	IF ANTI = 'Y' then condition.code = '434621000124103', CodeSystemName='SNOMED CT', DisplayName=' Antibiotics Received for Suspected Neonatal Sepsis'		
Mapping to HL7 v2.6 BFDR (5b)			
Mapping Location and Content	Example	Usage	
OBX-2 SHALL contain CWE OBX-3 SHALL contain 73812-0^Abnormal conditions of the newborn OBX-5 SHALL contain 434621000124103^ Antibiotics given for suspected neonatal sepsis	OBX 1 CWE 73812-0^Abnormal conditions of the Newborn ^LN  434621000124103^ Antibiotics given for suspected neonatal sepsis^SNM      F	PSMLBDI	
		PSMFDI	
		PSLBI	Y
		PSFLBI	Y
		PSFFDI	
		PSFDI	
		JLBI	Y
		JFDI	
CCOFDI			

1350

### 6.6.1.1.2 AVEN1: Assisted Ventilation [required immediately following delivery]

AVEN1 Derivation Rule (2)			
IF ((\$ProcedureCode CONTAINS ValueSet ( <a href="#">Assisted Ventilation (NCHS)</a> ) AND (\$ProcedureStartTime -\$BirthTime < 5 minutes)) OR (\$EventOutcomesObservationCode CONTAINS ValueSet ( <a href="#">PHVS AssistedVentilationMinutesAfterBirth NCHS</a> )) OR (\$ProblemCode CONTAINS ValueSet ( <a href="#">PHVS AssistedVentilationMinutesAfterBirth NCHS</a> ))) THEN AVEN1 SHALL = "Y" ELSE "N"			
Variable Name	Source in EMR Using FHIR (1a)	Source in EMR Using CDA Labor and Delivery Summary-VR XPATH (1b)	
\$ProblemCode	Condition.code of newborn	ClinicalDocument/component/structuredBody/component/section[templateId[@root='1.3.6.1.4.1.19376.1.5.3.1.1.21.2.4']]/subject/relatedSubject/code[@code='NCHILD' AND id=idOfTheChild]/component/section[templateId[@root='1.3.6.1.4.1.19376.1.5.3.1.3.6']]/entry/act/entryRelationship/observation/value	
\$ProcedureCode	Procedure.code of newborn	ClinicalDocument/component/structuredBody/component/section[templateId[@root='1.3.6.1.4.1.19376.1.5.3.1.1.21.2.4']]/subject/relatedSubject/code[@code='NCHILD' AND id=idOfTheChild]/component/section[templateId[@root='1.3.6.1.4.1.19376.1.5.3.1.1.13.2.11']]/entry/procedure/code	
\$ProcedureStartTime	Performed[x].period of newborn	ClinicalDocument/component/structuredBody/component/section[templateId[@root='1.3.6.1.4.1.19376.1.5.3.1.1.21.2.4']]/subject/relatedSubject/code[@code='NCHILD' AND id=idOfTheChild]/component/section[templateId[@root='1.3.6.1.4.1.19376.1.5.3.1.1.13.2.11']]/entry/procedure/effectiveTime/low	
\$BirthTime	Patient. Birthdate of newborn	ClinicalDocument/component/structuredBody/component/section/templateId[@root='1.3.6.1.4.1.19376.1.5.3.1.1.21.2.4']/subject/relatedSubject[code[@code='NCHILD' AND id=idOfTheChild]]/subject/birthTime	
\$EventOutcomesObservationCode	NA (only review condition.code)	ClinicalDocument/component/structuredBody/component/section[templateId[@root='1.3.6.1.4.1.19376.1.5.3.1.1.21.2.4']]/subject/relatedSubject/code[@code='NCHILD' AND id=idOfTheChild]/component/section[templateId[@root='1.3.6.1.4.1.19376.1.7.3.1.1.13.7']]/entry/observation/value	
Mapping to HL7 FHIR BFDR (5a)			
FHIR Profile/Resource	Content		
<a href="#">Composition - Provider Live Birth Report</a> <ul style="list-style-type: none"> <li><a href="#">ConditionAbnormalConditionOfNewborn</a></li> </ul>	IF AVEN1 = 'Y' then condition.code = 'PHC1250', CodeSystemName= 'PHIN VS (CDC Local Coding System)', DisplayName=' Assisted ventilation required immediately following Delivery'		
Mapping to HL7 v2.6 BFDR (5b)			
Mapping Location and Content	Example	Usage	
OBX-2 SHALL contain CWE OBX-3 SHALL contain 73812-0^Abnormal conditions of the newborn OBX-5 SHALL contain PHC1250^Assisted ventilation required immediately following delivery	OBX 1 CWE 73812-0^Abnormal conditions of the Newborn ^LN  PHC1250^ Assisted ventilation required immediately following delivery^CDCPHINVS      F	PSMLBDI	
		PSMFDI	
		PSLBI	Y
		PSFLBI	Y
		PSFFDI	
		PSFDI	
	JLBI	Y	



		JFDI	
		CCOFDI	

**6.6.1.1.3 AVEN6 Abnormal Conditions of the Newborn [Assisted ventilation for 6 or more hours]**

<b>AVEN6 Derivation Rule (2)</b>			
IF ((\$ProcedureCode CONTAINS ValueSet ( <a href="#">Assisted Ventilation (NCHS)</a> ) AND (\$ProcedureEndTime – \$ProcedureStartTime >=6 hours)) OR (\$EventOutcomesObservationCode CONTAINS ValueSet ( <a href="#">PHVS AssistedVentilationMoreThanSixHours NCHS</a> ) OR (\$ProblemCode CONTAINS ValueSet ( <a href="#">PHVS AssistedVentilationMoreThanSixHours NCHS</a> )) THEN AVEN6 SHALL = “Y” ELSE “N”			
<b>Variable Name</b>	<b>Source in EMR Using FHIR (1a)</b>	<b>Source in EMR Using CDA Labor and Delivery Summary-VR XPATH (1b)</b>	
<b>\$ProcedureCode</b>	Procedure.code of newborn	ClinicalDocument/component/structuredBody/component/section[templateId[@root='1.3.6.1.4.1.19376.1.5.3.1.1.21.2.4']]/subject/relatedSubject/code[@code='NCHILD' AND id=idOfTheChild]/component/section[templateId[@root='1.3.6.1.4.1.19376.1.5.3.1.1.13.2.11']]/entry/procedure/code	
<b>\$ProcedureEndTime</b>	Performed[x].period of newborn	ClinicalDocument/component/structuredBody/component/section[templateId[@root='1.3.6.1.4.1.19376.1.5.3.1.1.21.2.4']]/subject/relatedSubject/code[@code='NCHILD' AND id=idOfTheChild]/component/section[templateId[@root='1.3.6.1.4.1.19376.1.5.3.1.1.13.2.11']]/entry/procedure/effectiveTime/high	
<b>\$ProcedureStartTime</b>	Performed[x].period of newborn	ClinicalDocument/component/structuredBody/component/section[templateId[@root='1.3.6.1.4.1.19376.1.5.3.1.1.21.2.4']]/subject/relatedSubject/code[@code='NCHILD' AND id=idOfTheChild]/component/section[templateId[@root='1.3.6.1.4.1.19376.1.5.3.1.1.13.2.11']]/entry/procedure/effectiveTime/low	
<b>\$EventOutcomesObservationCode</b>	NA (only review condition.code)	ClinicalDocument/component/structuredBody/component/section[templateId[@root='1.3.6.1.4.1.19376.1.5.3.1.1.21.2.4']]/subject/relatedSubject/code[@code='NCHILD' AND id=idOfTheChild]/component/section[templateId[@root='1.3.6.1.4.1.19376.1.7.3.1.1.13.7']]/entry/observation/value	
<b>\$ProblemCode</b>	Condition.code of newborn	ClinicalDocument/component/structuredBody/component/section[templateId[@root='1.3.6.1.4.1.19376.1.5.3.1.1.21.2.4']]/subject/relatedSubject/code[@code='NCHILD' AND id=idOfTheChild]/component/section[templateId[@root='1.3.6.1.4.1.19376.1.5.3.1.3.6']]/entry/act/entryRelationship/observation/value	
<b>Mapping to HL7 FHIR BFDR (5a)</b>			
<b>FHIR Profile/Resource</b>		<b>Content</b>	
<a href="#">Composition - Provider Live Birth Report</a> <ul style="list-style-type: none"> <li><a href="#">ConditionAbnormalConditionOfNewborn</a></li> </ul>		IF AVEN6 = 'Y' then condition.code = 'PHC1251', CodeSystemName= 'PHIN VS (CDC Local Coding System)', DisplayName='Assisted ventilation required for more than six hours'	
<b>Mapping to HL7 v2.6 BFDR (5b)</b>			
<b>Mapping Location and Content</b>		<b>Example</b>	<b>Usage</b>
OBX-2 SHALL contain CWE			PSMLBDI

OBX-3 SHALL contain 73812-0^Abnormal conditions of the newborn OBX-5 SHALL contain 434621000124103^Antibiotics given for suspected neonatal sepsis	OBX 1 CWE 73812-0^Abnormal conditions of the Newborn ^LN  434621000124103^ Antibiotics given for suspected neonatal sepsis^SNM      F	PSMFDI	
		PSLBI	Y
		PSFLBI	Y
		PSFFDI	
		PSFDI	
		JLBI	Y
		JFDI	
		CCOFDI	

1355

**6.6.1.1.4 BINJ Abnormal Conditions of the Newborn [Significant birth injury(skeletal fracture(s), peripheral nerve injury, and/or soft tissue/solid organ hemorrhage which requires intervention)]**

BINJ Derivation Rule (2)			
IF \$ProblemObservation CONTAINS ValueSet ( <a href="#">Significant Birth Injury (NCHS)</a> ), THEN BINJ SHALL = “Y” ELSE “N”			
Variable Name	Source in EMR Using FHIR (1a)	Source in EMR Using CDA Labor and Delivery Summary-VR XPATH (1b)	
\$ProblemObservation	Condition.code of newborn	ClinicalDocument/component/structuredBody/component/section[templateId[@root='1.3.6.1.4.1.19376.1.5.3.1.1.21.2.4'] AND subject/relatedSubject[code[@code='NCHILD' AND id=idOfTheChild]]/component/section[templateId[@root='1.3.6.1.4.1.19376.1.7.3.1.1.13.7']]/entry[templateId[@root='1.3.6.1.4.1.19376.1.5.3.1.4.5']]/observation/value	
Mapping to HL7 FHIR BFDR (5a)			
FHIR Profile/Resource	Content		
<a href="#">Composition - Provider Live Birth Report</a> <ul style="list-style-type: none"> <li><a href="#">ConditionAbnormalConditionOfNewborn</a></li> </ul>	IF BINJ = 'Y' then condition.code = '56110009', CodeSystemName= 'SNOMED CT', DisplayName='Birth trauma of fetus'		
Mapping to HL7 v2.6 BFDR (5b)			
Mapping Location and Content	Example	Usage	
OBX-2 SHALL contain CWE OBX-3 SHALL contain 73812-0^Abnormal conditions of the newborn OBX-5 SHALL contain 56110009^Birth trauma of fetus	OBX 1 CWE 73812-0^Abnormal conditions of the Newborn ^LN  56110009^Birth trauma of fetus^SNM      F	PSMLBDI	
		PSMFDI	
		PSLBI	Y
		PSFLBI	Y
		PSFFDI	
		PSFDI	
		JLBI	Y
		JFDI	
CCOFDI			



**6.6.1.1.5 NICU Abnormal Conditions of the Newborn [Admission to NICU]**

NICU Derivation Rule (2)			
IF (\$PatientTransferType CONTAINS ( <a href="#">NICU Care (NCHS)</a> ), THEN NICU SHALL = “Y” ELSE “N”			
Variable Name	Source in EMR Using FHIR (1a)	Source in EMR Using CDA Labor and Delivery Summary-VR XPATH (1b)	
\$PatientTransferType	PENDING	ClinicalDocument/component/structuredBody/component/section[templateId[@root='1.3.6.1.4.1.19376.1.5.3.1.1.21.2.4'] subject/relatedSubject/code[@code='NCHILD' AND id=idOfTheChild]/component/section[templateId[@root='1.3.6.1.4.1.19376.1.7.3.1.113.7']]/entry[templateId[@root='1.3.6.1.4.1.19376.1.5.3.1.1.25.1.4.1']]/act/code	
Mapping to HL7 FHIR BFDR (5a)			
FHIR Profile/Resource	Content		
<a href="#">Composition - Provider Live Birth Report</a> <ul style="list-style-type: none"> <li><a href="#">ConditionAbnormalConditionOfNewborn</a></li> </ul>	IF NICU = 'Y' then condition.code = '405269005', CodeSystemName= 'SNOMED CT', DisplayName= ' Neonatal intensive care unit'		
Mapping to HL7 v2.6 BFDR (5b)			
Mapping Location and Content	Example	Usage	
OBX-2 SHALL contain CWE OBX-3 SHALL contain 73812-0^Abnormal conditions of the newborn OBX-5 SHALL contain 405269005^Neonatal intensive care unit	OBX 1 CWE 73812-0^Abnormal conditions of the Newborn ^LN  405269005^ Neonatal intensive care unit^SNM      F	PSMLBDI	
		PSMFDI	
		PSLBI	Y
		PSFLBI	Y
		PSFFDI	
		PSFDI	
		JLBI	Y
		JFDI	
CCOFDI			

1360

**6.6.1.1.6 SEIZ Abnormal Conditions of the Newborn [Seizure or serious neurologic dysfunction]**

SEIZ Derivation Rule (2)		
IF (\$ProblemCode CONTAINS ValueSet ( <a href="#">Seizure or Serious Neurologic Dysfunction (NCHS)</a> ) THEN SEIZ SHALL = “Y” ELSE “N”		
Variable Name	Source in EMR Using FHIR (1a)	Source in EMR Using CDA Labor and Delivery Summary-VR XPATH (1b)
\$ProblemCode	Condition.code of newborn	ClinicalDocument/component/structuredBody/component/section[templateId[@root='1.3.6.1.4.1.19376.1.5.3.1.1.21.2.4']]/subject/relatedSubject/code[@code='NCHILD' AND

		id=idOfTheChild]/component/section[templateId[@root='1.3.6.1.4.1.19376.1.5.3.1.3.6']]/entry/act/entryRelationship/observation/value																		
Mapping to HL7 FHIR BFDR (5a)																				
FHIR Profile/Resource	Content																			
<a href="#">Composition - Provider Live Birth Report</a>	IF SEIZ = 'Y' then																			
<ul style="list-style-type: none"> <li><a href="#">ConditionAbnormalConditionOfNewborn</a></li> </ul>	condition.code = '91175000', CodeSystemName= 'SNOMED CT', DisplayName='Seizure'																			
Mapping to HL7 v2.6 BFDR (5b)																				
Mapping Location and Content	Example	Usage																		
OBX-2 SHALL contain CWE OBX-3 SHALL contain 73812-0^Abnormal conditions of the newborn OBX-5 SHALL contain 91175000^Seizure	OBX 1 CWE 73812-0^Abnormal conditions of the Newborn ^LN  91175000^ Seizure^SNM      F	<table border="1"> <tr><td>PSMLBDI</td><td></td></tr> <tr><td>PSMFDI</td><td></td></tr> <tr><td>PSLBI</td><td>Y</td></tr> <tr><td>PSFLBI</td><td>Y</td></tr> <tr><td>PSFFDI</td><td></td></tr> <tr><td>PSFDI</td><td></td></tr> <tr><td>JLBI</td><td>Y</td></tr> <tr><td>JFDI</td><td></td></tr> <tr><td>CCOFDI</td><td></td></tr> </table>	PSMLBDI		PSMFDI		PSLBI	Y	PSFLBI	Y	PSFFDI		PSFDI		JLBI	Y	JFDI		CCOFDI	
PSMLBDI																				
PSMFDI																				
PSLBI	Y																			
PSFLBI	Y																			
PSFFDI																				
PSFDI																				
JLBI	Y																			
JFDI																				
CCOFDI																				

1365

**6.6.1.1.7 SURF Abnormal Conditions of the Newborn** [[Newborn given] Surfactant replacement therapy]

SURF Derivation Rule (2)		
IF (\$CodedProductName CONTAINS ValueSet ( <a href="#">Newborn Receiving Surfactant Replacement Therapy (NCHS)</a> ) OR \$ProcedureCode CONTAINS ValueSet ( <a href="#">Surfactant Replacement Therapy (NCHS)</a> ), THEN SURF SHALL = "Y" ELSE "N"		
Variable Name	Source in EMR Using FHIR (1a)	Source in EMR Using CDA Labor and Delivery Summary-VR XPATH (1b)
\$CodedProductName	MedicationAdministration.medication[x].medicationCodeableConcept of newborn	ClinicalDocument/component/structuredBody/component/section[templateId[@root='1.3.6.1.4.1.19376.1.5.3.1.1.21.2.4']]/subject/relatedSubject/code[@code='NCHILD' AND id=idOfTheChild]/component/section[templateId[@root='1.3.6.1.4.1.19376.1.5.3.1.3.21']]/entry/substanceAdministration/consumable/manufacturedProduct/labeledDrug/code
\$ProcedureCode	Procedure.code of newborn	ClinicalDocument/component/structuredBody/component/section[templateId[@root='1.3.6.1.4.1.19376.1.5.3.1.1.21.2.4']]/subject/relatedSubject/code[@code='NCHILD' AND id=idOfTheChild]/component/section[templateId[@root='1.3.6.1.4.1.19376.1.5.3.1.1.13.2.11']]/entry/procedure/code
Mapping to HL7 FHIR BFDR (5a)		
FHIR Profile/Resource	Content	
<a href="#">Composition - Provider Live Birth Report</a>	IF SURF = 'Y' then	

<ul style="list-style-type: none"> <li><a href="#">ConditionAbnormalConditionOfNewborn</a></li> </ul>		condition.code ='43470100012410', CodeSystemName='SNOMED CT', DisplayName=' Surfactant replacement therapy'		
Mapping to HL7 v2.6 BFDR (5b)				
Mapping Location and Content		Example	Usage	
OBX-2 SHALL contain CWE OBX-3 SHALL contain 73812-0^Abnormal conditions of the newborn OBX-5 SHALL contain 434701000124101^Surfactant replacement therapy		OBX 1 CWE 73812-0^Abnormal conditions of the Newborn ^LN  434701000124101^ Surfactant replacement therapy ^SNM      F	PSMLBDI	
			PSMFDI	
			PSLBI	Y
			PSFLBI	Y
			PSFFDI	
			PSFDI	
			JLBI	Y
			JFDI	
			CCOFDI	

**6.6.1.1.8 NOA54 Abnormal Conditions of the Newborn [None of the above]**

NOA54 Derivation Rule (2)			
This SHALL require data entry and SHALL NOT be a result of a default from the other attributes in the list.			
Variable Name	Source in EMR Using FHIR (1a)	Source in EMR Using CDA Labor and Delivery Summary-VR XPATH (1b)	
NA	NA	NA	
Mapping to HL7 FHIR BFDR (5a)			
FHIR Profile/Resource	Content		
<a href="#">Composition - Provider Live Birth Report</a> <ul style="list-style-type: none"> <li><a href="#">ConditionAbnormalConditionOfNewborn</a></li> </ul>	IF NOA54 = 'Y' then condition.code ='260413007', CodeSystemName='SNOMED CT', DisplayName='None'		
Mapping to HL7 v2.6 BFDR (5b)			
Mapping Location and Content	Example	Usage	
OBX-2 SHALL contain CWE OBX-3 SHALL contain 73812-0^Abnormal conditions of the newborn OBX-5 SHALL contain 260413007 None (qualifier value)	OBX 1 CWE 73812-0^Abnormal conditions of the Newborn ^LN  260413007^None (qualifier value)^SNM      F	PSMLBDI	
		PSMFDI	
		PSLBI	Y
		PSFLBI	Y
		PSFFDI	
		PSFDI	
		JLBI	Y
		JFDI	

		CCOFDI	
--	--	--------	--

### 6.6.1.1.9 DNA54 Abnormal Conditions of the Newborn [Pending]

DNA54 Derivation Rule (2)				
This section intentionally left blank.				
Variable Name	Source in EMR Using FHIR (1a)	Source in EMR Using CDA Labor and Delivery Summary-VR XPATH (1b)		
This section intentionally left blank.	This section intentionally left blank.	This section intentionally left blank.		
Mapping to HL7 FHIR BFDR (5a)				
FHIR Profile/Resource		Content		
N/A		N/A		
Mapping to HL7 v2.6 BFDR (5b)				
Mapping Location and Content		Example	Usage	
N/A		N/A	PSMLBDI	
			PSMFDI	
			PSLBI	
			PSFLBI	
			PSFFDI	
			PSFDI	
			JLBI	
			JFDI	
		CCOFDI		

1370

### 6.6.1.1.10 APGAR5 Apgar Score [5 Minute]

APGAR5 Derivation Rule (2)			
IF (\$GeneralAppearanceObservationCode CONTAINS ValueSet ( <a href="#">5 Min Apgar Score (NCHS)</a> ), THEN “APGAR5” = (\$GeneralAppearanceObservationValue)			
Variable Name	Source in EMR Using FHIR (1a)	Source in EMR Using CDA Labor and Delivery Summary-VR XPATH (1b)	
\$GeneralAppearanceObservationCode	Observation.code of newborn	ClinicalDocument/component/structuredBody/component/section[templateId[@root='1.3.6.1.4.1.19376.1.5.3.1.1.21.2.4']/subject/relatedSubject/code[@code='NCHILD' AND id=idOfTheChild]/component/section[templateId[@root='1.3.6.1.4.1.19376.1.5.3.1.1.9.15.1']/co	

		component/section[templateId[@root='1.3.6.1.4.1.19376.1.5.3.1.1.9.16']]/entry/observation/code		
<b>\$GeneralAppearanceObservationValue</b>	Observation.code of newborn	ClinicalDocument/component/structuredBody/component/section[templateId[@root='1.3.6.1.4.1.19376.1.5.3.1.1.21.2.4']]/subject/relatedSubject/code[@code='NCHILD' AND id=idOfTheChild]/component/section[templateId[@root='1.3.6.1.4.1.19376.1.5.3.1.1.9.15.1']]/component/section[templateId[@root='1.3.6.1.4.1.19376.1.5.3.1.1.9.16']]/entry/observation/value		
<b>Mapping to HL7 FHIR BFDR (5a)</b>				
<b>FHIR Profile/Resource</b>		<b>Content</b>		
<a href="#">Composition - Provider Live Birth Report</a> <ul style="list-style-type: none"> <li>PENDING</li> </ul>		observation.code=' 9274-2', CodeSystemName= 'LOINC', DisplayName=' Score^5M post birth'  AND  observation.value= APGAR5		
<b>Mapping to HL7 v2.6 BFDR (5b)</b>				
<b>Mapping Location and Content</b>		<b>Example</b>	<b>Usage</b>	
OBX-2 SHALL contain NM OBX-3 SHALL contain 9274-2^Score^5M post birth OBX-5 SHALL contain the 5-minute Apgar Score		OBX 1 NM 9274-2^ Score^5M post birth ^LN  4	PSMLBDI	
			PSMFDI	
			PSLBI	Y
			PSFLBI	Y
			PSFFDI	
			PSFDI	
			JLBI	Y
			JFDI	
		CCOFDI		

### 6.6.1.1.11 APGAR10 Apgar Score [10 Minute]

<b>APGAR10 Derivation Rule (2)</b>		
IF ("APGAR5" <6), AND (\$GeneralAppearanceObservationCode CONTAINS ValueSet ( <a href="#">10 Min Apgar Score (NCHS)</a> ), THEN "APGAR10" = (\$GeneralAppearanceObservationValue)		
<b>Variable Name</b>	<b>Source in EMR Using FHIR (1a)</b>	<b>Source in EMR Using CDA Labor and Delivery Summary-VR XPATH (1b)</b>
<b>\$GeneralAppearanceObservationCode</b>	Observation.code of newborn	ClinicalDocument/component/structuredBody/component/section[templateId[@root='1.3.6.1.4.1.19376.1.5.3.1.1.21.2.4']]/subject/relatedSubject/code[@code='NCHILD' AND id=idOfTheChild]/component/section[templateId[@root='1.3.6.1.4.1.19376.1.5.3.1.1.9.15.1']]/component/section[templateId[@root='1.3.6.1.4.1.19376.1.5.3.1.1.9.16']]/entry/observation/code
<b>\$GeneralAppearanceObservationValue</b>	Observation.code of newborn	ClinicalDocument/component/structuredBody/component/section[templateId[@root='1.3.6.1.4.1.19376.1.5.3.1.1.21.2.4']]/

IHE Quality, Research and Public Health Technical Framework Supplement – Birth and Fetal Death Reporting-Enhanced (BFDR-E)

		subject/relatedSubject/code[@code='NCHILD' AND id=idOfTheChild]/component/section[templateId[@root='1.3.6.1.4.1.19376.1.5.3.1.1.9.15.1']/component/section[templateId[@root='1.3.6.1.4.1.19376.1.5.3.1.1.9.16']/entry/observation/value	
Mapping to HL7 FHIR BFDR (5a)			
FHIR Profile/Resource	Content		
<a href="#">Composition - Provider Live Birth Report</a> <ul style="list-style-type: none"> <li>PENDING</li> </ul>	observation.code='9271-8', CodeSystemName= 'LOINC', DisplayName=' Score^10M post birth' AND observation.value= APGAR10		
Mapping to HL7 v2.6 BFDR (5b)			
Mapping Location and Content	Example	Usage	
OBX-2 SHALL contain NM OBX-3 SHALL contain 9271-8 ^Score^10M post birth OBX-5 SHALL contain the 10-minute Apgar Score	OBX 1 NM 9271-8 ^ Score^10M post birth ^LN  8	PSMLBDI	
		PSMFDI	
		PSLBI	Y
		PSFLBI	Y
		PSFFDI	
		PSFDI	
		JLBI	Y
		JFDI	
CCOFDI			

1375 6.6.1.1.12 ATTENDN Attendant's Name

ATTENDN Derivation Rule (2)		
"ATTENDN" SHALL be populated using \$ProviderName WHERE \$ProcedureCode CONTAINS ValueSet ( <a href="#">Delivery (NCHS)</a> ) WHERE the provider is the person responsible for delivering the child.		
Variable Name	Source in EMR Using FHIR (1a)	Source in EMR Using CDA Labor and Delivery Summary-VR XPATH (1b)
\$ProviderName	procedure.performer.actor Reference (Practitioner.name)	ClinicalDocument/component/structuredBody/component/section[templateId[@root='1.3.6.1.4.1.19376.1.5.3.1.1.21.2.3']/component/section[templateId[@root='1.3.6.1.4.1.19376.1.5.3.1.1.13.2.11']/entry/procedure/performer/assignedEntity/assignedPerson/name
\$ProcedureCode	procedure.code	ClinicalDocument/component/structuredBody/component/section[templateId[@root='1.3.6.1.4.1.19376.1.5.3.1.1.21.2.3']/component/section[templateId[@root='1.3.6.1.4.1.19376.1.5.3.1.1.13.2.11']/entry/procedure/code
Mapping to HL7 FHIR BFDR (5a)		
FHIR Profile/Resource	Content	
<a href="#">Composition - Provider Live Birth Report</a> OR	/performer/assignedEntity/assignedPerson/name = ATTENDN	

<a href="#">Composition - Provider Fetal Death Report</a>			
<ul style="list-style-type: none"> <li>PENDING</li> </ul>			
Mapping to HL7 v2.6 BFDR (5b)			
Mapping Location and Content	Example	Usage	
OBX-2 SHALL contain XCN OBX-3 SHALL contain 87286-1 ^ Birth attendant OBX-5 SHALL contain Name and identifier information for the person attending the birth.	OBX 1 XCN  87286-1  ^ Birth attendant ^LN ^Walshingham^Albert^DR^^Good Health Hospital^^NPI	PSMLBDI	
		PSMFDI	
		PSLBI	Y
		PSFLBI	Y
		PSFFDI	Y
		PSFDI	Y
		JLBI	Y
		JFDI	Y
CCOFDI			

#### 6.6.1.1.13 ATTEND Attendant's Title

ATTEND Derivation Rule (2)		
IF \$ProcedureCode CONTAINS ValueSet ( <a href="#">Delivery (NCHS)</a> ), THEN IF \$ProviderType CONTAINS ValueSet ( <a href="#">Physician (NCHS)</a> ), THEN “ATTEND” SHALL = “1”, ELSE IF \$ProviderType CONTAINS ValueSet ( <a href="#">Doctor of Osteopathic Medicine (NCHS)</a> ), THEN “ATTEND” SHALL = “2”, ELSE IF \$ProviderType CONTAINS ValueSet ( <a href="#">Certified Midwife (NCHS)</a> ), THEN “ATTEND” SHALL = “3”, ELSE IF \$ProviderType CONTAINS ValueSet ( <a href="#">Midwife (NCHS)</a> ), THEN “ATTEND” SHALL = “4”, ELSE IF \$ProviderType NOT NULL THEN “ATTEND” SHALL = “5”, ELSE “ATTEND” SHALL = “9”		
Variable Name	Source in EMR Using FHIR (1a)	Source in EMR Using CDA Labor and Delivery Summary-VR XPATH (1b)
\$ProcedureCode	procedure.code	ClinicalDocument/component/structuredBody/component/section[templateId[@root='1.3.6.1.4.1.19376.1.5.3.1.1.21.2.3']]/component/section[templateId[@root='1.3.6.1.4.1.19376.1.5.3.1.1.13.2.11']]/entry/procedure/code
\$ProviderType	procedure.performer.role	ClinicalDocument/component/structuredBody/component/section[templateId[@root='1.3.6.1.4.1.19376.1.5.3.1.1.21.2.3']]/component/section[templateId[@root='1.3.6.1.4.1.19376.1.5.3.1.1.13.2.11']]/entry/procedure/performer/assignedEntity/code
Mapping to HL7 FHIR BFDR (5a)		
FHIR Profile/Resource	Content	
<a href="#">Composition - Provider Live Birth Report</a> OR <a href="#">Composition - Provider Fetal Death Report</a> <ul style="list-style-type: none"> <li>PENDING</li> </ul>	/performer/assignedEntity/assignedPerson/code = ATTEND	

Mapping to HL7 v2.6 BFDR (5b)			
Mapping Location and Content	Example	Usage	
OBX-2 SHALL contain CWE OBX-3 SHALL contain 73764-3^Birth Attendant Title OBX-5 SHALL contain a value selected from value the set Birth Attendant Title (Birth Attendant Titles) <a href="https://phinvads.cdc.gov/vads/ViewValueSet.action?oid=2.16.840.1.114222.4.11.7111">https://phinvads.cdc.gov/vads/ViewValueSet.action?oid=2.16.840.1.114222.4.11.7111</a>	OBX 1 CWE 73764-3^Birth Attendant^LN  76231001^Osteopath^SNM     F	PSMLBDI	
		PSMFDI	
		PSLBI	Y
		PSFLBI	Y
		PSFFDI	Y
		PSFDI	Y
		JLBI	Y
		JFDI	Y
CCOFDI			

#### 6.6.1.1.14 ATTENDS Attendant [Other specified]

ATTENDS Derivation Rule (2)			
IF \$ProcedureCode CONTAINS ValueSet ( <a href="#">Delivery (NCHS)</a> ) AND “ATTEND” = “5”, THEN ATTENDS SHALL = \$ProviderType			
Variable Name	Source in EMR Using FHIR (1a)	Source in EMR Using CDA Labor and Delivery Summary-VR XPATH (1b)	
\$ProcedureCode	procedure.code	ClinicalDocument/component/structuredBody/component/section[templateId[@root='1.3.6.1.4.1.19376.1.5.3.1.1.21.2.3']/component/section[templateId[@root='1.3.6.1.4.1.19376.1.5.3.1.1.13.2.11']/entry/procedure/code	
\$ProviderType	procedure.performer.role	ClinicalDocument/component/structuredBody/component/section[templateId[@root='1.3.6.1.4.1.19376.1.5.3.1.1.21.2.3']/component/section[templateId[@root='1.3.6.1.4.1.19376.1.5.3.1.1.13.2.11']/entry/procedure/performer/assignedEntity/code	
Mapping to HL7 FHIR BFDR (5a)			
FHIR Profile/Resource	Content		
<a href="#">Composition - Provider Live Birth Report</a> OR <a href="#">Composition - Provider Fetal Death Report</a> <ul style="list-style-type: none"> <li>PENDING</li> </ul>	/performer/assignedEntity/assignedPerson/name = ATTENDS		
Mapping to HL7 v2.6 BFDR (5b)			
Mapping Location and Content	Example	Usage	
OBX-2 SHALL contain CWE OBX-3 SHALL contain 73764-3^Attendants's Title OBX-5 SHALL contain OTH^ Other(specify) ^NullFlavor OBX-5 SHALL contain the Text Description of the Attendant’s Title in Alternate Text	OBX 3 CWE 73764-3^Attendants's Title^LN  OTH^ Other(specify)^NullFlavor^^Chief Birthing Specialist     F	PSMLBDI	
		PSMFDI	
		PSLBI	Y
		PSFLBI	Y
		PSFFDI	Y



73764-3^ Birth attendant title	PSFDI	Y
	JLBI	Y
	JFDI	Y
	CCOFDI	

1380

### 6.6.1.1.15 NPI Attendant's NPI

NPI Derivation Rule (2)			
“NPI” SHALL be populated using the \$ProviderID WHERE \$ProcedureCode CONTAINS ValueSet ( <a href="#">Delivery (NCHS)</a> ) where the \$ProviderID is expressed as the National Provider Identifier (NPI)			
Variable Name	Source in EMR Using FHIR (1a)	Source in EMR Using CDA Labor and Delivery Summary-VR XPATH (1b)	
\$ProviderID	procedure.code	ClinicalDocument/component/structuredBody/component/section[templateId[@root='1.3.6.1.4.1.19376.1.5.3.1.1.21.2.3']]/component/section[templateId[@root='1.3.6.1.4.1.19376.1.5.3.1.1.13.2.11']]/entry/procedure/code	
\$ProcedureCode	procedure.performer.actor Reference (Practitioner.identifier)	ClinicalDocument/component/structuredBody/component/section[templateId[@root='1.3.6.1.4.1.19376.1.5.3.1.1.21.2.3']]/component/section[templateId[@root='1.3.6.1.4.1.19376.1.5.3.1.1.13.2.11']]/entry/procedure/performer/assignedEntity/id/@extension	
Mapping to HL7 FHIR BFDR (5a)			
FHIR Profile/Resource	Content		
<a href="#">Composition - Provider Live Birth Report</a> OR <a href="#">Composition - Provider Fetal Death Report</a> <ul style="list-style-type: none"> <li>PENDING</li> </ul>	/performer/assignedEntity/id = NPI		
Mapping to HL7 v2.6 BFDR (5b)			
Mapping Location and Content	Example	Usage	
OBX-2 SHALL contain XCN OBX-3 SHALL contain 87286-1 ^ Birth attendant OBX-5 SHALL contain Name and identifier information for the person attending the birth.	OBX 1 XCN  87286-1  ^ Birth attendant details ^LN  ^Walshingham^Albert^DR^^Good Health Hospital^^s^NPI	PSMLBDI	
		PSMFDI	
		PSLBI	Y
		PSFLBI	Y
		PSFFDI	Y
		PSFDI	Y
		JLBI	Y
		JFDI	Y
CCOFDI			

### 6.6.1.1.16 BWG Birth weight (Infant’s) [grams]

BWG Derivation Rule (2)																
IF \$VitalSignsTypeCode CONTAINS ValueSet ( <i>Body Weight (NCHS)</i> ) = WHERE \$VitalSignsMethodCode CONTAINS ValueSet ( <i>Birth Weight (NCHS)</i> ), THEN “BWG” SHALL = \$VitalSignsResultValue WHERE Result Value Units are expressed in grams																
Variable Name	Source in EMR Using FHIR (1a)	Source in EMR Using CDA Labor and Delivery Summary-VR XPATH (1b)														
\$VitalSignsTypeCode	Observation.code of newborn	ClinicalDocument/component/structuredBody/component/section[templateId[@root='1.3.6.1.4.1.19376.1.5.3.1.1.21.2.4']]/subject/relatedSubject/code[@code='NCHILD' AND id=idOfTheChild]/component/section[templateId[@root='1.3.6.1.4.1.19376.1.5.3.1.1.9.15.1']]/component/section[templateId[@root='1.3.6.1.4.1.19376.1.5.3.1.1.5.3.2']]/entry/organizer/component/observation/code														
\$VitalSignsMethodCode	Observation.method	ClinicalDocument/component/structuredBody/component/section[templateId[@root='1.3.6.1.4.1.19376.1.5.3.1.1.21.2.4']]/subject/relatedSubject/code[@code='NCHILD' AND id=idOfTheChild]/component/section[templateId[@root='1.3.6.1.4.1.19376.1.5.3.1.1.9.15.1']]/component/section[templateId[@root='1.3.6.1.4.1.19376.1.5.3.1.1.5.3.2']]/entry/organizer/component/observation/methodCode														
\$VitalSignsResultValue	Observation.valueQuantity	ClinicalDocument/component/structuredBody/component/section[templateId[@root='1.3.6.1.4.1.19376.1.5.3.1.1.21.2.4']]/subject/relatedSubject/code[@code='NCHILD' AND id=idOfTheChild]/component/section[templateId[@root='1.3.6.1.4.1.19376.1.5.3.1.1.9.15.1']]/component/section[templateId[@root='1.3.6.1.4.1.19376.1.5.3.1.1.5.3.2']]/entry/organizer/component/observation/value														
Mapping to HL7 FHIR BFDR (5a)																
FHIR Profile/Resource	Content															
<a href="#">Composition - Provider Live Birth Report</a> <ul style="list-style-type: none"> <li>PENDING</li> </ul>	observation.code=' 8339-4', CodeSystemName= 'LOINC', DisplayName='Body Weight^at birth' AND observation.value[x]= BWG(PQ) observation.value[x].unit= 'gm'															
Mapping to HL7 v2.6 BFDR (5b)																
Mapping Location and Content	Example	Usage														
OBX-2 SHALL contain NM OBX-3 SHALL contain 8339-4 ^Body weight^at birth OBX-5 SHALL contain the birthweight in Grams OBX-6 SHALL indicate grams using UCUM units: SHALL contain gm	OBX 24 NM 8339-4 ^ Body weight^at birth^LN  1200 gm	<table border="1"> <tr> <td>PSMLBDI</td> <td></td> </tr> <tr> <td>PSMFDI</td> <td></td> </tr> <tr> <td>PSLBI</td> <td>Y</td> </tr> <tr> <td>PSFLBI</td> <td>Y</td> </tr> <tr> <td>PSFFDI</td> <td></td> </tr> <tr> <td>PSFDI</td> <td></td> </tr> <tr> <td>JLBI</td> <td>Y</td> </tr> </table>	PSMLBDI		PSMFDI		PSLBI	Y	PSFLBI	Y	PSFFDI		PSFDI		JLBI	Y
PSMLBDI																
PSMFDI																
PSLBI	Y															
PSFLBI	Y															
PSFFDI																
PSFDI																
JLBI	Y															

		JFDI	
		CCOFDI	

1385

**6.6.1.1.17 BWO Birth weight (Infant’s) [ounces]**

<b>BWO Derivation Rule (2)</b>						
<p>IF \$VitalSignsTypeCode CONTAINS ValueSet (<i>Body Weight (NCHS)</i>) WHERE \$VitalSignsMethodCode CONTAINS ValueSet (<i>Birth Weight (NCHS)</i>), THEN “BWO” SHALL = \$VitalSignsResultValue WHERE Result Value Units are expressed in ounces.</p> <p>The preferred measure is in grams rather than ounces. Refer to BWG.</p>						
<b>Variable Name</b>	<b>Source in EMR Using FHIR (1a)</b>	<b>Source in EMR Using CDA Labor and Delivery Summary-VR XPATH (1b)</b>				
\$VitalSignsTypeCode	Observation.code of newborn	ClinicalDocument/component/structuredBody/component/section[templateId[@root='1.3.6.1.4.1.19376.1.5.3.1.1.21.2.4']]/subject/relatedSubject/code[@code='NCHILD' AND id=idOfTheChild]/component/section[templateId[@root='1.3.6.1.4.1.19376.1.5.3.1.1.9.15.1']]/component/section[templateId[@root='1.3.6.1.4.1.19376.1.5.3.1.1.5.3.2']]/entry/organizer/component/observation/code				
\$VitalSignsMethodCode	Observation.method of newborn	ClinicalDocument/component/structuredBody/component/section[templateId[@root='1.3.6.1.4.1.19376.1.5.3.1.1.21.2.4']]/subject/relatedSubject/code[@code='NCHILD' AND id=idOfTheChild]/component/section[templateId[@root='1.3.6.1.4.1.19376.1.5.3.1.1.9.15.1']]/component/section[templateId[@root='1.3.6.1.4.1.19376.1.5.3.1.1.5.3.2']]/entry/organizer/component/observation/methodCode				
\$VitalSignsResultValue	Observation.valueQuantity	ClinicalDocument/component/structuredBody/component/section[templateId[@root='1.3.6.1.4.1.19376.1.5.3.1.1.21.2.4']]/subject/relatedSubject/code[@code='NCHILD' AND id=idOfTheChild]/component/section[templateId[@root='1.3.6.1.4.1.19376.1.5.3.1.1.9.15.1']]/component/section[templateId[@root='1.3.6.1.4.1.19376.1.5.3.1.1.5.3.2']]/entry/organizer/component/observation/value				
<b>Mapping to HL7 FHIR BFDR (5a)</b>						
<b>FHIR Profile/Resource</b>	<b>Content</b>					
<p><a href="#">Composition - Provider Live Birth Report</a></p> <ul style="list-style-type: none"> <li>PENDING</li> </ul>	<p>observation.code=' 8339-4', CodeSystemName= 'LOINC', DisplayName='Body Weight^at birth'</p> <p>AND</p> <p>observation.value[x]= BWO(PQ)</p> <p>Observation.value[x].unit= 'oz'</p> <p>NOTE: Preferred measure of weight is in Grams.</p>					
<b>Mapping to HL7 v2.6 BFDR (5b)</b>						
<b>Mapping Location and Content</b>	<b>Example</b>	<b>Usage</b>				
<p>OBX-2 SHALL contain NM</p> <p>OBX-3 SHALL contain 8339-4 ^Body weight^at birth</p>	<p>OBX 24 NM 8339-4 ^Body weight^at birth^LN  1200 oz</p>	<table border="1"> <tr> <td>PSMLBDI</td> <td></td> </tr> <tr> <td>PSMFDI</td> <td></td> </tr> </table>	PSMLBDI		PSMFDI	
PSMLBDI						
PSMFDI						

IHE Quality, Research and Public Health Technical Framework Supplement – Birth and Fetal Death Reporting-Enhanced (BFDR-E)

OBX-5 SHALL contain the birthweight in Ounces OBX-6 SHALL indicate ounces using UCUM units: SHALL contain oz NOTE: it is preferred to send in grams (see BWG)	PSLBI	Y
	PSFLBI	Y
	PSFFDI	
	PSFDI	
	JLBI	Y
	JFDI	
	CCOFDI	

**6.6.1.1.18 BWP Birth weight (Infant's) [pounds]**

BWP Derivation Rule (2)		
IF \$VitalSignsTypeCode CONTAINS ValueSet ( <i>Body Weight (NCHS)</i> ) WHERE \$VitalSignsMethodCode CONTAINS ValueSet ( <i>Birth Weight (NCHS)</i> ), THEN “BWP” SHALL = \$VitalSignsResultValue WHERE Result Value Units are expressed in pounds.  The preferred measure is in grams rather than pounds. Refer to BWG.		
Variable Name	Source in EMR Using FHIR (1a)	Source in EMR Using CDA Labor and Delivery Summary-VR XPATH (1b)
\$VitalSignsTypeCode	Observation.code	ClinicalDocument/component/structuredBody/component/section[templateId[@root='1.3.6.1.4.1.19376.1.5.3.1.1.21.2.4']]/subject/relatedSubject/code[@code='NCHILD' AND id=idOfTheChild]/component/section[templateId[@root='1.3.6.1.4.1.19376.1.5.3.1.1.9.15.1']]/component/section[templateId[@root='1.3.6.1.4.1.19376.1.5.3.1.1.5.3.2']]/entry/organizer/component/observation/code
\$VitalSignsMethodCode	Observation.method of newborn	ClinicalDocument/component/structuredBody/component/section[templateId[@root='1.3.6.1.4.1.19376.1.5.3.1.1.21.2.4']]/subject/relatedSubject/code[@code='NCHILD' AND id=idOfTheChild]/component/section[templateId[@root='1.3.6.1.4.1.19376.1.5.3.1.1.9.15.1']]/component/section[templateId[@root='1.3.6.1.4.1.19376.1.5.3.1.1.5.3.2']]/entry/organizer/component/observation/methodCode
\$VitalSignsResultValue	Observation.valueQuantity	ClinicalDocument/component/structuredBody/component/section[templateId[@root='1.3.6.1.4.1.19376.1.5.3.1.1.21.2.4']]/subject/relatedSubject/code[@code='NCHILD' AND id=idOfTheChild]/component/section[templateId[@root='1.3.6.1.4.1.19376.1.5.3.1.1.9.15.1']]/component/section[templateId[@root='1.3.6.1.4.1.19376.1.5.3.1.1.5.3.2']]/entry/organizer/component/observation/value
Mapping to HL7 FHIR BFDR (5a)		
FHIR Profile/Resource	Content	
<a href="#">Composition - Provider Live Birth Report</a> <ul style="list-style-type: none"> <li>PENDING</li> </ul>	observation.code= Code=' 8339-4', CodeSystemName= 'LOINC', DisplayName='Body Weight^at birth'  AND  observation.value[x]= BWP(PQ)  Observation.value[x].unit= 'lb'	

IHE Quality, Research and Public Health Technical Framework Supplement – Birth and Fetal Death Reporting-Enhanced (BFDR-E)

Mapping to HL7 v2.6 BFDR (5b)			
Mapping Location and Content	Example	Usage	
OBX-2 SHALL contain NM OBX-3 SHALL contain 8339-4 ^ Body weight^at birth OBX-5 SHALL contain the birthweight in Pounds OBX-6 SHALL indicate pounds using UCUM units: SHALL contain lb NOTE: it is preferred to send in grams (see BWG)	OBX 24 NM 8339-4 ^Body weight^at birth ^LN  1200 lb	PSMLBDI	
		PSMFDI	
		PSLBI	Y
		PSFLBI	Y
		PSFFDI	
		PSFDI	
		JLBI	Y
		JFDI	
		CCOFDI	

1390

**6.6.1.1.19 ANT B Characteristics of Labor and Delivery [Antibiotics[received by the mother during labor]]**

ANT B Derivation Rule (2)		
Variable Name	Source in EMR Using FHIR (1a)	Source in EMR Using CDA Labor and Delivery Summary-VR XPATH (1b)
IF ((\$CodedProductName CONTAINS ValueSet ( <a href="#">Antibiotics (NCHS)</a> ) AND (\$Route CONTAINS ValueSet ( <a href="#">IM Medication Administration Route (NCHS)</a> ) OR ValueSet ( <a href="#">IV Medication Administration Route (NCHS)</a> )) AND (\$AdministrationTime >= \$ProcedureStartTime AND \$AdministrationTime <=\$ProcedureEndTime) WHERE \$ProcedureCode CONTAINS ValueSet ( <a href="#">Delivery (NCHS)</a> ) OR \$EventOutcomesObservationCode CONTAINS ValueSet ( <a href="#">Antibiotics Received During Labor Finding (NCHS)</a> )) THEN “ANTB” SHALL = “Y” ELSE “N”		
\$CodedProductName	MedicationAdministration.medication[x].medicationCodeableConcept	ClinicalDocument/component/structuredBody/component/section[templateId[@root=1.3.6.1.4.1.19376.1.5.3.1.3.21]]/entry/substanceAdministration/consuable/manufacturedProduct/labeledDrug/code
\$Route	MedicationAdministration.dosage.route	ClinicalDocument/component/structuredBody/component/section[templateId[@root='1.3.6.1.4.1.19376.1.5.3.1.3.21']]/substanceAdministration /routeCode
\$AdministrationTime	MedicationAdministration.effective[x]	ClinicalDocument/component/structuredBody/component/section[templateId[@root='1.3.6.1.4.1.19376.1.5.3.1.3.21']]/substanceAdministration/effectiveTime/low
\$ProcedureStartTime	Procedure.Performed[x].period	ClinicalDocument/component/structuredBody/component/section[templateId[@root='1.3.6.1.4.1.19376.1.5.3.1.1.21.2.3']]/component/section[templateId[@root='1.3.6.1.4.1.19376.1.5.3.1.1.13.2.11']]/entry/effectiveTime/low
\$ProcedureEndTime	Procedure.Performed[x].period	ClinicalDocument/component/structuredBody/component/section[templateId[@root=1.3.6.1.4.1.19376.1.5.3.1.1.21.2.3]]/component/section[templateId[@root=1.3.6.1.4.1.19376.1.5.3.1.1.13.2.11]]/entry/effectiveTime/high

IHE Quality, Research and Public Health Technical Framework Supplement – Birth and Fetal Death Reporting-Enhanced (BFDR-E)

<b>\$ProcedureCode</b>	Procedure.code	ClinicalDocument/component/structuredBody/component/section[templateId[@root='1.3.6.1.4.1.19376.1.5.3.1.1.21.2.3']]/component/section[templateId[@root='1.3.6.1.4.1.19376.1.5.3.1.1.13.2.11']]/entry/procedure/code																			
<b>\$EventOutcomesObservationCode</b>	observation.code	ClinicalDocument/component/structuredBody/component/section[templateId[@root='1.3.6.1.4.1.19376.1.5.3.1.1.21.2.3']]/component/section[templateId[@root='1.3.6.1.4.1.19376.1.7.3.1.1.13.7']]/entry[templateId[@root='1.3.6.1.4.1.19376.1.5.3.1.1.25.1.4.1']]/act/code																			
Mapping to HL7 FHIR BFDR (5a)																					
FHIR Profile/Resource		Content																			
<a href="#">Composition - Provider Live Birth Report</a> <ul style="list-style-type: none"> <li>PENDING</li> </ul>		IF ANTB = 'Y' then condition.code =73813-8', CodeSystemName= 'LOINC', DisplayName='Characteristics of labor and delivery' AND condition.value[x]=' 634771000124114', CodeSystemName= 'SNOMED CT', DisplayName='Antibiotics received during labor'																			
Mapping to HL7 v2.6 BFDR (5b)																					
Mapping Location and Content		Example	Usage																		
OBX-2 SHALL contain CWE OBX-3 SHALL contain 73813-8^ Characteristics of labor and delivery OBX-5 SHALL contain 434691000124101^Antibiotics received during labor		OBX 23 CWE 73813-8^Characteristics of labor and delivery^LN  434691000124101^Antibiotics received during labor^SNM     F	<table border="1"> <tr><td>PSMLBDI</td><td></td></tr> <tr><td>PSMFDI</td><td></td></tr> <tr><td>PSLBI</td><td>Y</td></tr> <tr><td>PSFLBI</td><td>Y</td></tr> <tr><td>PSFFDI</td><td></td></tr> <tr><td>PSFDI</td><td></td></tr> <tr><td>JLBI</td><td>Y</td></tr> <tr><td>JFDI</td><td></td></tr> <tr><td>CCOFDI</td><td></td></tr> </table>	PSMLBDI		PSMFDI		PSLBI	Y	PSFLBI	Y	PSFFDI		PSFDI		JLBI	Y	JFDI		CCOFDI	
PSMLBDI																					
PSMFDI																					
PSLBI	Y																				
PSFLBI	Y																				
PSFFDI																					
PSFDI																					
JLBI	Y																				
JFDI																					
CCOFDI																					

**6.6.1.1.20 AUGL Characteristics of Labor and Delivery [Augmentation of labor]**

AUGL Derivation Rule (2)		
IF (\$ProcedureCode CONTAINS ValueSet ( <a href="#">Augmentation of Labor - Procedure (NCHS)</a> ) OR \$CodedProductName CONTAINS ( <a href="#">Augmentation of Labor - Medication (NCHS)</a> ) OR \$EventOutcomesObservationCode CONTAINS ValueSet ( <a href="#">Augmentation of Labor Finding (NCHS)</a> )OR \$ProblemCode CONTAINS ValueSet ( <a href="#">Augmentation of Labor Finding (NCHS)</a> ), THEN "AUGL" SHALL ="Y" ELSE "N"		
Variable Name	Source in EMR Using FHIR (1a)	Source in EMR Using CDA Labor and Delivery Summary-VR XPATH (1b)
<b>\$ProcedureCode</b>	Procedure.code	ClinicalDocument/component/structuredBody/component/section[templateId[@root='1.3.6.1.4.1.19376.1.5.3.1.1.21.2.3']]/component/section[templateId[@root='1.3.6.1.4.1.19376.1.5.3.1.1.13.2.11']]/entry/procedure/code

<b>\$CodedProductName</b>	MedicationAdministration.medication[x].medicationCodableConcept	ClinicalDocument/component/structuredBody/component/section[templateId[@root='1.3.6.1.4.1.19376.1.5.3.1.3.21']]>entry/substanceAdministration/consumentable/manufacturedProduct/labelDrug/code																		
<b>\$EventOutcomesObservationCode</b>	observation.code	ClinicalDocument/component/structuredBody/component/section[templateId[@root='1.3.6.1.4.1.19376.1.5.3.1.1.21.2.3']]>component/section[templateId[@root='1.3.6.1.4.1.19376.1.7.3.1.1.13.7']]>entry[templateId[@root='1.3.6.1.4.1.19376.1.5.3.1.1.25.1.4.1']]>act/code																		
<b>\$ProblemCode</b>	condition.code	ClinicalDocument/component/structuredBody/component/section[templateId[@root='1.3.6.1.4.1.19376.1.5.3.1.3.6']]>entry/act/entryRelationship/observation/value																		
Mapping to HL7 FHIR BFDR (5a)																				
FHIR Profile/Resource	Content																			
<a href="#">Composition - Provider Live Birth Report</a> <ul style="list-style-type: none"> <li>PENDING</li> </ul>	IF AUGL = 'Y' then condition.code='73813-8', CodeSystemName= 'LOINC', DisplayName='Characteristics of labor and delivery' AND condition.value[x]='237001001', CodeSystemName= 'SNOMED CT', DisplayName= 'Augmentation of labor'																			
Mapping to HL7 v2.6 BFDR (5b)																				
Mapping Location and Content	Example	Usage																		
OBX-2 SHALL contain CWE OBX-3 SHALL contain 73813-8^ Characteristics of labor and delivery OBX-5 SHALL contain 237001001^Augmentation of Labor	OBX 23 CWE 73813-8^Characteristics of labor and delivery^LN  237001001^Augmentation of Labor^SNM     F	<table border="1"> <tr><td>PSMLBDI</td><td></td></tr> <tr><td>PSMFDI</td><td></td></tr> <tr><td>PSLBI</td><td>Y</td></tr> <tr><td>PSFLBI</td><td>Y</td></tr> <tr><td>PSFFDI</td><td></td></tr> <tr><td>PSFDI</td><td></td></tr> <tr><td>JLBI</td><td>Y</td></tr> <tr><td>JFDI</td><td></td></tr> <tr><td>CCOFDI</td><td></td></tr> </table>	PSMLBDI		PSMFDI		PSLBI	Y	PSFLBI	Y	PSFFDI		PSFDI		JLBI	Y	JFDI		CCOFDI	
PSMLBDI																				
PSMFDI																				
PSLBI	Y																			
PSFLBI	Y																			
PSFFDI																				
PSFDI																				
JLBI	Y																			
JFDI																				
CCOFDI																				

1395

**6.6.1.1.21 CHOR Characteristics of Labor and Delivery** [[Clinical] Chorioamnionitis [diagnosed during labor or maternal temperature >=38 degrees (100.4F)]]

CHOR Derivation Rule (2)
IF (\$ProblemCode CONTAINS ValueSet ( <a href="#">Chorioamnionitis During Labor (NCHS)</a> ) OR ( <a href="#">Fever Greater Than 100.4 (NCHS)</a> ) THEN "CHOR" SHALL = "Y" ELSE "N"

Variable Name	Source in EMR Using FHIR (1a)	Source in EMR Using CDA Labor and Delivery Summary-VR XPATH (1b)																		
<b>\$ProblemCode</b>	condition.code	ClinicalDocument/component/structuredBody/component/section[templateId[@root='1.3.6.1.4.1.19376.1.5.3.1.3.6']]/entry/act/entryRelationship/observation/value																		
Mapping to HL7 FHIR BFDR (5a)																				
FHIR Profile/Resource	Content																			
<a href="#">Composition - Provider Live Birth Report</a> <ul style="list-style-type: none"> <li>PENDING</li> </ul>	IF CHOR = 'Y' then condition.code = '73813-8', CodeSystemName= 'LOINC', DisplayName='Characteristics of labor and delivery' AND condition.value[x]='11612004', CodeSystemName= 'SNOMED CT', DisplayName= 'Chorioamnionitis'																			
Mapping to HL7 v2.6 BFDR (5b)																				
Mapping Location and Content	Example	Usage																		
OBX-2 SHALL contain CWE OBX-3 SHALL contain 73813-8^ Characteristics of labor and delivery OBX-5 SHALL contain 11612004^ Chorioamnionitis	OBX 23 CWE 73813-8^Characteristics of labor and delivery^LN  11612004^Chorioamnionitis^SNM     F	<table border="1"> <tr><td>PSMLBDI</td><td></td></tr> <tr><td>PSMFDI</td><td></td></tr> <tr><td>PSLBI</td><td>Y</td></tr> <tr><td>PSFLBI</td><td>Y</td></tr> <tr><td>PSFFDI</td><td></td></tr> <tr><td>PSFDI</td><td></td></tr> <tr><td>JLBI</td><td>Y</td></tr> <tr><td>JFDI</td><td></td></tr> <tr><td>CCOFDI</td><td></td></tr> </table>	PSMLBDI		PSMFDI		PSLBI	Y	PSFLBI	Y	PSFFDI		PSFDI		JLBI	Y	JFDI		CCOFDI	
PSMLBDI																				
PSMFDI																				
PSLBI	Y																			
PSFLBI	Y																			
PSFFDI																				
PSFDI																				
JLBI	Y																			
JFDI																				
CCOFDI																				

### 6.6.1.1.22 ESAN Characteristics of Labor and Delivery [[Epidural or spinal]Anesthesia[during labor]]

ESAN Derivation Rule (2)		
IF (\$CodedProductName CONTAINS ValueSet ( <a href="#">Epidural/Spinal Anesthesia - Medication (NCHS)</a> ) OR (\$ProcedureCode CONTAINS ( <a href="#">Epidural Anesthesia - Procedure (NCHS)</a> ) OR ( <a href="#">Spinal Anesthesia - Procedure (NCHS)</a> ) THEN "ESAN" SHALL be "Y" ELSE "N"		
Variable Name	Source in EMR Using FHIR (1a)	Source in EMR Using CDA Labor and Delivery Summary-VR XPATH (1b)
<b>\$CodedProductName</b>	MedicationAdministration.medication[x].medicationCodeableConcept	ClinicalDocument/component/structuredBody/component/section[templateId[@root='1.3.6.1.4.1.19376.1.5.3.1.3.21']]/entry/substanceAdministration/consumable/manufacturedProduct/labeledDrug/code



IHE Quality, Research and Public Health Technical Framework Supplement – Birth and Fetal Death Reporting-Enhanced (BFDR-E)

<b>\$ProcedureCode</b>	procedure.code	ClinicalDocument/component/structuredBody/component/section[templateId[@root='1.3.6.1.4.1.19376.1.5.3.1.1.21.2.3']]/component/section[templateId[@root='1.3.6.1.4.1.19376.1.5.3.1.1.13.2.11']]/entry/procedure/code	
Mapping to HL7 FHIR BFDR (5a)			
FHIR Profile/Resource	Content		
<a href="#">Composition - Provider Live Birth Report</a> <ul style="list-style-type: none"> <li>PENDING</li> </ul>	IF ESAN = 'Y' then condition.code = '73813-8', CodeSystemName= 'LOINC', DisplayName='Characteristics of labor and delivery' AND condition.value[x]='231064003', CodeSystemName= 'SNOMED CT', DisplayName= 'Intrathecal injection of local anesthetic agent'		
Mapping to HL7 v2.6 BFDR (5b)			
Mapping Location and Content	Example	Usage	
OBX-2 SHALL contain CWE OBX-3 SHALL contain 73813-8^ Characteristics of labor and delivery OBX-5 SHALL contain 231064003^ Intrathecal injection of local anesthetic agent	OBX 23 CWE 73813-8^Characteristics of labor and delivery^LN  231064003^ Intrathecal injection of local anesthetic agent^SNM     F	PSMLBDI	
		PSMFDI	
		PSLBI	Y
		PSFLBI	Y
		PSFFDI	
		PSFDI	
		JLBI	Y
		JFDI	
CCOFDI			

1400

**6.6.1.1.23 INDL Characteristics of Labor and Delivery [Induction of labor]**

INDL Derivation Rule (2)		
IF (\$ProcedureCode CONTAINS ValueSet ( <a href="#">Induction of Labor (NCHS)</a> ) OR \$EventOutcomesObservationCode CONTAINS ValueSet ( <a href="#">Induction of Labor Finding (NCHS)</a> ) OR \$ProblemCode CONTAINS ValueSet ( <a href="#">Induction of Labor Finding (NCHS)</a> ) THEN "INDL" SHALL = "Y" ELSE "N"		
Variable Name	Source in EMR Using FHIR (1a)	Source in EMR Using CDA Labor and Delivery Summary-VR XPATH (1b)
<b>\$ProcedureCode</b>	procedure.code	ClinicalDocument/component/structuredBody/component/section[templateId[@root='1.3.6.1.4.1.19376.1.5.3.1.1.21.2.3']]/component/section[templateId[@root='1.3.6.1.4.1.19376.1.5.3.1.1.13.2.11']]/entry/procedure/code
<b>\$EventOutcomesObservationCode</b>	condition.code	ClinicalDocument/component/structuredBody/component/section[templateId[@root='1.3.6.1.4.1.19376.1.5.3.1.1.21.2.3']]/component/section[templateId[@root='1.3.6.1.4.1.19376.1.7.3.1.1.13.7']]/entry[templateId[@root='1.3.6.1.4.1.19376.1.5.3.1.1.25.1.4.1']]/act/code

IHE Quality, Research and Public Health Technical Framework Supplement – Birth and Fetal Death Reporting-Enhanced (BFDR-E)

<b>\$ProblemCode</b>	condition.code	ClinicalDocument/component/structuredBody/component/section[templateId[@root='1.3.6.1.4.1.19376.1.5.3.1.3.6']]/entry/act/entryRelationship/observation/value																		
Mapping to HL7 FHIR BFDR (5a)																				
FHIR Profile/Resource	Content																			
<a href="#">Composition - Provider Live Birth Report</a> <ul style="list-style-type: none"> <li>PENDING</li> </ul>	IF INDL = 'Y' then condition.code = '73813-8', CodeSystemName= 'LOINC', DisplayName='Characteristics of labor and delivery' AND condition.value[x]=' 236958009', CodeSystemName= 'SNOMED CT', DisplayName= 'Induction of labor'																			
Mapping to HL7 v2.6 BFDR (5b)																				
Mapping Location and Content	Example	Usage																		
OBX-2 SHALL contain CWE OBX-3 SHALL contain 73813-8^ Characteristics of labor and delivery OBX-5 SHALL contain 236958009^Induction of labor	OBX 23 CWE 73813-8^Characteristics of labor and delivery^LN  236958009^Induction of labor^SNM     F	<table border="1"> <tr><td>PSMLBDI</td><td></td></tr> <tr><td>PSMFDI</td><td></td></tr> <tr><td>PSLBI</td><td>Y</td></tr> <tr><td>PSFLBI</td><td>Y</td></tr> <tr><td>PSFFDI</td><td></td></tr> <tr><td>PSFDI</td><td></td></tr> <tr><td>JLBI</td><td>Y</td></tr> <tr><td>JFDI</td><td></td></tr> <tr><td>CCOFDI</td><td></td></tr> </table>	PSMLBDI		PSMFDI		PSLBI	Y	PSFLBI	Y	PSFFDI		PSFDI		JLBI	Y	JFDI		CCOFDI	
PSMLBDI																				
PSMFDI																				
PSLBI	Y																			
PSFLBI	Y																			
PSFFDI																				
PSFDI																				
JLBI	Y																			
JFDI																				
CCOFDI																				

**6.6.1.1.24 STER Characteristics of Labor and Delivery** [Steroids [(glucocorticoids) for fetal lung maturation received by the mother prior to delivery]]

STER Derivation Rule (2)		
IF (\$ProcedureCode CONTAINS ValueSet ( <a href="#">Steroids For Fetal Lung Maturation (NCHS)</a> ) THEN "STER" SHALL = "Y" ELSE "N"		
Variable Name	Source in EMR Using FHIR (1a)	Source in EMR Using CDA Labor and Delivery Summary-VR XPATH (1b)
<b>\$ProcedureCode</b>	procedure.code	ClinicalDocument/component/structuredBody/component/section[templateId[@root='1.3.6.1.4.1.19376.1.5.3.1.1.21.2.3']]/component/section[templateId[@root='1.3.6.1.4.1.19376.1.5.3.1.1.13.2.11']]/entry/procedure/code
Mapping to HL7 FHIR BFDR (5a)		
FHIR Profile/Resource	Content	
<a href="#">Composition - Provider Live Birth Report</a> <ul style="list-style-type: none"> <li>PENDING</li> </ul>	IF STER = 'Y' then condition.code = '73813-8', CodeSystemName= 'LOINC', DisplayName='Characteristics of labor and delivery'	

	AND condition.value[x]='634621000124113', CodeSystemName='SNOMED CT', DisplayName='Steroids (glucocorticoids) for fetal lung maturation (procedure)'		
Mapping to HL7 v2.6 BFDR (5b)			
Mapping Location and Content	Example	Usage	
OBX-2 SHALL contain CWE OBX-3 SHALL contain 73813-8^ Characteristics of labor and delivery OBX-5 SHALL contain 434611000124106 ^Maternal antenatal administration of corticosteroids for fetal lung maturation	OBX 23 CWE 73813-8^Characteristics of labor and delivery^LN  434611000124106 ^Maternal antenatal administration of corticosteroids for fetal lung maturation ^SNM     F	PSMLBDI	
		PSMFDI	
		PSLBI	Y
		PSFLBI	Y
		PSFFDI	
		PSFDI	
		JLBI	Y
		JFDI	
CCOFDI			

1405

**6.6.1.1.25 NOA04 Characteristics of Labor and Delivery [None of the above]**

NOA04 Derivation Rule (2)		
This SHALL require data entry and SHALL NOT be a result of a default from the other attributes in the list.		
Variable Name	Source in EMR Using FHIR (1a)	Source in EMR Using CDA Labor and Delivery Summary-VR XPATH (1b)
N/A	N/A	N/A
Mapping to HL7 FHIR BFDR (5a)		
FHIR Profile/Resource	Content	
<a href="#">Composition - Provider Live Birth Report</a> <ul style="list-style-type: none"> <li>PENDING</li> </ul>	IF NOA04 = 'Y' then condition.code = '73813-8', CodeSystemName= 'LOINC', DisplayName='Characteristics of labor and delivery' AND condition.value[x]='260413007', CodeSystemName= 'SNOMED CT', DisplayName= 'None'	
Mapping to HL7 v2.6 BFDR (5b)		
Mapping Location and Content	Example	Usage
OBX-2 SHALL contain CWE OBX-3 SHALL contain 73813-8^ Characteristics of labor and delivery	OBX 23 CWE 73813-8^Characteristics of labor and delivery^LN  260413007^ None (qualifier value)^SNM     F	PSMLBDI
		PSMFDI
		PSLBI

IHE Quality, Research and Public Health Technical Framework Supplement – Birth and Fetal Death Reporting-Enhanced (BFDR-E)

OBX-5 SHALL contain 260413007^ None (qualifier value)	PSFLBI	Y
	PSFFDI	
	PSFDI	
	JLBI	Y
	JFDI	
	CCOFDI	

**6.6.1.1.26 DNA04**

DNA04 Derivation Rule (2)		
This section intentionally left blank.		
Variable Name	Source in EMR Using FHIR (1a)	Source in EMR Using CDA Labor and Delivery Summary-VR XPATH (1b)
N/A	N/A	N/A
Mapping to HL7 FHIR BFDR (5a)		
FHIR Profile/Resource	Content	
<a href="#">Composition - Provider Live Birth Report</a> OR <a href="#">Composition - Provider Fetal Death Report</a> <ul style="list-style-type: none"> <li>PENDING</li> </ul>	PENDING	
Mapping to HL7 v2.6 BFDR (5b)		
Mapping Location and Content	Example	Usage
PENDING	PENDING	PSMLBDI PSMFDI PSLBI PSFLBI PSFFDI PSFDI JLBI JFDI CCOFDI

**6.6.1.1.27 IDOB\_YR Child Date of Birth [Year]**

IDOB_YR Derivation Rule (2)
“IDOB_YR” SHALL be populated using the Year part of \$BirthTime WHERE the Year is represented using 4-digits.

Variable Name	Source in EMR Using FHIR (1a)	Source in EMR Using CDA Labor and Delivery Summary-VR XPATH (1b)	
\$BirthTime	Patient. Birthdate of newborn	ClinicalDocument/component/structuredBody/component/section/templateId[@root='1.3.6.1.4.1.19376.1.5.3.1.1.21.2.4']/subject/relatedSubject/code[@code='NCHILD' AND id=idOfTheChild]/subject/birthTime	
<b>Mapping to HL7 FHIR BFDR (5a)</b>			
<b>FHIR Profile/Resource</b>		<b>Content</b>	
<a href="#">Composition - Provider Live Birth Report</a> <ul style="list-style-type: none"> <li>PENDING</li> </ul>		patient.birthDate contains IDOB_YR/IDOB_MO/IDOB_DY	
<b>Mapping to HL7 v2.6 BFDR (5b)</b>			
<b>Mapping Location and Content</b>	<b>Example</b>	<b>Usage</b>	
PID-29 SHALL contain the Newborn's date and time of birth	PID 1  123456688^^^MRN  Johnson^Baby  20110313 F         N	PSMLBDI	
		PSMFDI	
		PSLBI	Y
		PSFLBI	Y
		PSFFDI	
		PSFDI	
		JLBI	Y
		JFDI	
CCOFDI			

1410

#### 6.6.1.1.28 IDOB\_MO Child Date of Birth [Month]

<b>IDOB_MO Derivation Rule (2)</b>		
"IDOB_MO" SHALL be populated using the Year part of \$BirthTime WHERE the Month is represented using 2-digits.		
Variable Name	Source in EMR Using FHIR (1a)	Source in EMR Using CDA Labor and Delivery Summary-VR XPATH (1b)
\$BirthTime	Patient. Birthdate of newborn	ClinicalDocument/component/structuredBody/component/section/templateId[@root='1.3.6.1.4.1.19376.1.5.3.1.1.21.2.4']/subject/relatedSubject[code[@code='NCHILD' AND id=idOfTheChild]]/subject/birthTime
<b>Mapping to HL7 FHIR BFDR (5a)</b>		
<b>FHIR Profile/Resource</b>		<b>Content</b>
<a href="#">Composition - Provider Live Birth Report</a> <ul style="list-style-type: none"> <li>PENDING</li> </ul>		patient.birthDate contains IDOB_YR/IDOB_MO/IDOB_DY
<b>Mapping to HL7 v2.6 BFDR (5b)</b>		
<b>Mapping Location and Content</b>	<b>Example</b>	<b>Usage</b>

IHE Quality, Research and Public Health Technical Framework Supplement – Birth and Fetal Death Reporting-Enhanced (BFDR-E)

PID-7 SHALL contain the Newborn’s date and time of birth	PID 1  123456688^^^MRN  Johnson^Baby  20110313 F         N	PSMLBDI	
		PSMFDI	
		PSLBI	Y
		PSFLBI	Y
		PSFFDI	
		PSFDI	
		JLBI	Y
		JFDI	
CCOFDI			

6.6.1.1.29 IDOB\_DY Child Date of Birth [Day]

IDOB_DY Derivation Rule (2)			
“IDOB_DY” SHALL be populated using the Year part of <b>\$BirthTime</b> WHERE the Day is represented using 2-digits.			
Variable Name	Source in EMR Using FHIR (1a)	Source in EMR Using CDA Labor and Delivery Summary-VR XPATH (1b)	
<b>\$BirthTime</b>	Patient. Birthdate of newborn	ClinicalDocument/component/structuredBody/component/section/templateId[@root='1.3.6.1.4.1.19376.1.5.3.1.1.21.2.4']/subject/relatedSubject/code[@code='NCHILD' AND id=idOfTheChild]/subject/birthTime	
Mapping to HL7 FHIR BFDR (5a)			
FHIR Profile/Resource	Content		
<a href="#">Composition - Provider Live Birth Report</a> • PENDING	patient.birthDate contain IDOB_YR/IDOB_MO/IDOB_DY		
Mapping to HL7 v2.6 BFDR (5b)			
Mapping Location and Content	Example	Usage	
PID-7 SHALL contain the Newborn’s date and time of birth	PID 1  123456688^^^MRN  Johnson^Baby  20110313 F         N	PSMLBDI	
		PSMFDI	
		PSLBI	Y
		PSFLBI	Y
		PSFFDI	
		PSFDI	
		JLBI	Y
		JFDI	
CCOFDI			

1415

**6.6.1.1.30 KIDFNAME Child's First Name/ Name of Fetus [optional at the discretion of the parents]**

KIDFNAME Derivation Rule (2)			
"KIDFNAME" SHALL be populated using the First Name part of \$ChildName.			
Variable Name	Source in EMR Using FHIR (1a)	Source in EMR Using CDA Labor and Delivery Summary-VR XPATH (1b)	
\$ChildName	patient.name of newborn	ClinicalDocument/component/structuredBody/component/section/templateId[@root='1.3.6.1.4.1.19376.1.5.3.1.1.21.2.4']/subject/relatedSubject/code[@code='NCHILD' AND id=idOfTheChild]/subject/name/given[1]	
Mapping to HL7 FHIR BFDR (5a)			
FHIR Profile/Resource		Content	
<a href="#">Composition - Provider Live Birth Report</a> OR <a href="#">Composition - Provider Fetal Death Report</a> <ul style="list-style-type: none"> <li>PENDING</li> </ul>		patient.name.given.value[1] contains KIDFNAME	
Mapping to HL7 v2.6 BFDR (5b)			
Mapping Location and Content	Example	Usage	
PID-5 SHALL contain the New born name.  In the case of fetal death reporting, a name may be provided at the discretion of the parents Using PID-5. When the name is not provided, a value must still be placed in this field since the field is required. In that case, HL7 recommends the following:  ~^U . The "U" for the name type code in the second name indicates that it is unspecified. Since there may be no name components populated, this means there is no legal name, nor is there an alias. This guide will interpret this sequence to mean there is no newborn or fetus name.	PID 1  123456688^^^MRN  Johnson^Baby 20110313 F       N	PSMLBDI	Y
		PSMFDI	Y
		PSLBI	Y
		PSFLBI	Y
		PSFFDI	Y
		PSFDI	Y
		JLBI	Y
		JFDI	Y
CCOFDI	Y		

**6.6.1.1.31 KIDMNAME Child's Middle Name / Name of Fetus [optional at the discretion of the parents]**

KIDMNAME Derivation Rule (2)		
"KIDMNAME" SHALL be populated using the Middle Name part of \$ChildName.		
Variable Name	Source in EMR Using FHIR (1a)	Source in EMR Using CDA Labor and Delivery Summary-VR XPATH (1b)
\$ChildName	patient.name of newborn	ClinicalDocument/component/structuredBody/component/section/templateId[@root='1.3.6.1.4.1.19376.1.5.3.1.1.21.2.4']/subject/relatedSubject/code[@code='NCHILD' AND id=idOfTheChild]/subject/name/given[2]

IHE Quality, Research and Public Health Technical Framework Supplement – Birth and Fetal Death Reporting-Enhanced (BFDR-E)

Mapping to HL7 FHIR BFDR (5a)			
FHIR Profile/Resource	Content		
<a href="#">Composition - Provider Live Birth Report</a> OR <a href="#">Composition - Provider Fetal Death Report</a> <ul style="list-style-type: none"> <li>PENDING</li> </ul>	patient.name.given.value [2] contains KIDMNAME		
Mapping to HL7 v2.6 BFDR (5b)			
Mapping Location and Content	Example	Usage	
PID-5 SHALL contain the New born name. In the case of fetal death reporting, a name may be provided at the discretion of the parents using PID-5. When the name is not provided, a value must still be placed in this field since the field is required. In that case, HL7 recommends the following:  ~^U . The "U" for the name type code in the second name indicates that it is unspecified. Since there may be no name components populated, this means there is no legal name, nor is there an alias. This guide will interpret this sequence to mean there is no newborn or fetus name.	PID 1  123456688^^^MRN  Johnson^Baby 20110313 F         N	PSMLBDI	Y
		PSMFDI	Y
		PSLBI	Y
		PSFLBI	Y
		PSFFDI	Y
		PSFDI	Y
		JLBI	Y
		JFDI	Y
CCOFDI	Y		

1420

**6.6.1.1.32 KIDLNAME Child’s Last Name / Name of Fetus [optional at the discretion of the parents]**

KIDLNAME Derivation Rule (2)			
“KIDLNAME” SHALL be populated using the Last Name part of \$ChildName.			
Variable Name	Source in EMR Using FHIR (1a)	Source in EMR Using CDA Labor and Delivery Summary-VR XPATH (1b)	
\$ChildName	patient.name of newborn	ClinicalDocument/component/structuredBody/component/section/templateId[@root='1.3.6.1.4.1.19376.1.5.3.1.1.21.2.4']/subject/relatedSubject/code[@code='NCHILD' AND id=idOfTheChild]/subject/name/family	
Mapping to HL7 FHIR BFDR (5a)			
FHIR Profile/Resource	Content		
<a href="#">Composition - Provider Live Birth Report</a> OR <a href="#">Composition - Provider Fetal Death Report</a> <ul style="list-style-type: none"> <li>PENDING</li> </ul>	patient.name.family.value contains KIDLNAME		
Mapping to HL7 v2.6 BFDR (5b)			
Mapping Location and Content	Example	Usage	
PID-5 SHALL contain the New born name.		PSMLBDI	Y



IHE Quality, Research and Public Health Technical Framework Supplement – Birth and Fetal Death Reporting-Enhanced (BFDR-E)

<p>In the case of fetal death reporting, a name may be provided at the discretion of the parents using PID-5. When the name is not provided, a value must still be placed in this field since the field is required. In that case, HL7 recommends the following:  ~^U . The "U" for the name type code in the second name indicates that it is unspecified. Since there may be no name components populated, this means there is no legal name, nor is there an alias. This guide will interpret this sequence to mean there is no newborn or fetus name.</p>	<p>PID 1  123456688^^^MRN  Johnson^Baby 20110313 F       N</p>	PSMFDI	Y
		PSLBI	Y
		PSFLBI	Y
		PSFFDI	Y
		PSFDI	Y
		JLBI	Y
		JFDI	Y
		CCOFDI	Y

6.6.1.1.33 KIDSUFFIX Child’s Last Name Suffix

KIDSUFFIX Derivation Rule (2)			
<p>“KIDSUFFIX” SHALL be populated using the Suffix part of \$ChildName.</p>			
Variable Name	Source in EMR Using FHIR (1a)	Source in EMR Using CDA Labor and Delivery Summary-VR XPATH (1b)	
\$ChildName	patient.name of newborn	ClinicalDocument/component/structuredBody/component/section/templateId[@root='1.3.6.1.4.1.19376.1.5.3.1.1.21.2.4']/subject/relatedSubject/code[@code='NCHILD' AND id=idOfTheChild]/subject/name/suffix	
Mapping to HL7 FHIR BFDR (5a)			
FHIR Profile/Resource		Content	
<p><a href="#">Composition - Provider Live Birth Report</a> OR <a href="#">Composition - Provider Fetal Death Report</a></p> <ul style="list-style-type: none"> <li>PENDING</li> </ul>		<p>Composition.subject[PatientChild] patient.name.suffix.value contains KIDSUFFIX</p>	
Mapping to HL7 v2.6 BFDR (5b)			
Mapping Location and Content	Example	Usage	
<p>PID-5 SHALL contain the New born name. In the case of fetal death reporting, a name may be provided at the discretion of the parents using PID-5. When the name is not provided, a value must still be placed in this field since the field is required. In that case, HL7 recommends the following:  ~^U . The "U" for the name type code in the second name indicates that it is unspecified. Since there may be no name components populated, this means there is no legal name, nor is there an alias. This guide will interpret this sequence to mean there is no newborn or fetus name.</p>	<p>PID 1  123456688^^^MRN  Johnson^Baby 20110313 F       N</p>	PSMLBDI	Y
		PSMFDI	Y
		PSLBI	Y
		PSFLBI	Y
		PSFFDI	Y
		PSFDI	Y
		JLBI	Y
		JFDI	Y
CCOFDI	Y		

### 6.6.1.1.34 BFED Child [Infant being breastfed]

BFED Derivation Rule (2)			
IF \$ProblemCode CONTAINS ValueSet ( <a href="#">Breastfed Infant (NCHS)</a> ) THEN BFED SHALL be “Y”.			
Variable Name	Source in EMR Using FHIR (1a)	Source in EMR Using CDA Labor and Delivery Summary-VR XPATH (1b)	
\$ProblemCode	condition.code of newborn	ClinicalDocument/component/structuredBody/component/section[templateId[@root='1.3.6.1.4.1.19376.1.5.3.1.1.21.2.4']]/subject/relatedSubject/code[@code='NCHILD' AND id=idOfTheChild]/component/section[templateId[@root='1.3.6.1.4.1.19376.1.5.3.1.3.6']]/entry/act/entryRelationship/observation/value	
Mapping to HL7 FHIR BFDR (5a)			
FHIR Profile/Resource	Content		
<a href="#">Composition - Provider Live Birth Report</a> <ul style="list-style-type: none"> <li>PENDING</li> </ul>	/code@code= Code='3756-9', CodeSystemName= 'LOINC', DisplayName=' Infant is being breastfed at discharge' AND /value@value= Boolean form of BFED		
Mapping to HL7 v2.6 BFDR (5b)			
Mapping Location and Content	Example	Usage	
OBX-2 SHALL contain CWE OBX-3 SHALL contain 73756-9^Infant is being breastfed at discharge OBX-5 SHALL contain a value selected from PHVS_YesNoUnknown_CDC Yes No Unknown (YNU)	OBX 34 CWE 73756-9^Infant is being breastfed at discharge^LN  Y^Yes^PHVS_YesNoUnknown_CDC      F	PSMLBDI	
		PSMFDI	
		PSLBI	Y
		PSFLBI	Y
		PSFFDI	
		PSFDI	
		JLBI	Y
		JFDI	
CCOFDI			

### 6.6.1.1.35 ILIV Child [Infant living at time of report]

ILIV Derivation Rule (2)		
IF (NOT (\$ProblemObservationCode CONTAINS ValueSet ( <a href="#">Neonatal Death (NCHS)</a> ) OR (\$DeceasedIndicator = 'True')) THEN “ILIV” SHALL = ‘Y’ ELSE ‘N’		
Variable Name	Source in EMR Using FHIR (1a)	Source in EMR Using CDA Labor and Delivery Summary-VR XPATH (1b)

IHE Quality, Research and Public Health Technical Framework Supplement – Birth and Fetal Death Reporting-Enhanced (BFDR-E)

<b>\$ProblemObservation Code</b>	condition.code	ClinicalDocument/component/structuredBody/component/section[templateId[@root='1.3.6.1.4.1.19376.1.5.3.1.1.21.2.4']]/subject/relatedSubject/code[@code='NCHILD' AND id=idOfTheChild]/component/section[templateId[@root='1.3.6.1.4.1.19376.1.7.3.1.1.13.7']]/entry/observation/value																		
<b>\$DeceasedIndicator</b>	patient.deceased[x].deceasedBoolean of newborn	ClinicalDocument/component/structuredBody/component/section/templateId[@root='1.3.6.1.4.1.19376.1.5.3.1.1.21.2.4']/subject/relatedSubject[code[@code='NCHILD' AND id=idOfTheChild]]/subject/sdtc:deceasedInd																		
Mapping to HL7 FHIR BFDR (5a)																				
FHIR Profile/Resource	Content																			
<a href="#">Composition - Provider Live Birth Report</a> <ul style="list-style-type: none"> <li>PENDING</li> </ul>	/code@code= Code='73757-7', CodeSystemName= 'LOINC', DisplayName='Infant living at time of report' AND /value@value= Boolean form of ILIV																			
Mapping to HL7 v2.6 BFDR (5b)																				
Mapping Location and Content	Example	Usage																		
OBX-2 SHALL contain CWE OBX-3 SHALL contain 73757-7^Infant living at time of report OBX-5 SHALL contain a value selected from PHVS_YesNoUnknown_CDC –Yes No Unknown (YNU)	OBX 59 CWE 73757-7^Infant living at time of report^LN  Y^Yes^PHVS_YesNoUnknown_CDC      F	<table border="1"> <tr><td>PSMLBDI</td><td></td></tr> <tr><td>PSMFDI</td><td></td></tr> <tr><td>PSLBI</td><td>Y</td></tr> <tr><td>PSFLBI</td><td>Y</td></tr> <tr><td>PSFFDI</td><td></td></tr> <tr><td>PSFDI</td><td></td></tr> <tr><td>JLBI</td><td>Y</td></tr> <tr><td>JFDI</td><td></td></tr> <tr><td>CCOFDI</td><td></td></tr> </table>	PSMLBDI		PSMFDI		PSLBI	Y	PSFLBI	Y	PSFFDI		PSFDI		JLBI	Y	JFDI		CCOFDI	
PSMLBDI																				
PSMFDI																				
PSLBI	Y																			
PSFLBI	Y																			
PSFFDI																				
PSFDI																				
JLBI	Y																			
JFDI																				
CCOFDI																				

1430

**6.6.1.1.36 IRECNUM Child [Newborn Medical Record Number]**

IRECNUM Derivation Rule (2)		
“IRECNUM” SHALL = \$BabyMedRecNum		
Variable Name	Source in EMR Using FHIR (1a)	Source in EMR Using CDA Labor and Delivery Summary-VR XPATH (1b)
<b>\$BabyMedRecNum</b>	patient.identifier	ClinicalDocument/component/structuredBody/component/section/templateId[@root='1.3.6.1.4.1.19376.1.5.3.1.1.21.2.4']/subject/relatedSubject[code[@code='NCHILD' AND id=idOfTheChild]]/sdtc:id
Mapping to HL7 FHIR BFDR (5a)		
FHIR Profile/Resource	Content	
<a href="#">Composition - Provider Live Birth Report</a> <ul style="list-style-type: none"> <li>PENDING</li> </ul>	/subject/relatedSubject/subject/sdtc:Id = IRECNUM	

Mapping to HL7 v2.6 BFDR (5b)			
Mapping Location and Content	Example	Usage	
PID-3 In the case of fetal death reporting, a medical record number may be provided at the discretion of the parents using PID-3.	PID 1  123456688^^^MRN  Johnson^Baby 20110313 F         N	PSMLBDI	Y
		PSMFDI	
		PSLBI	Y
		PSFLBI	Y
		PSFFDI	
		PSFDI	
		JLBI	Y
		JFDI	
CCOFDI	Y		

### 6.6.1.1.37 ISEX Child [(infant) Sex]

ISEX Derivation Rule (2)			
IF \$Gender CONTAINS ValueSet ( <a href="#">Male Gender (NCHS)</a> ) THEN "ISEX" SHALL ='M' ELSE IF \$Gender CONTAINS ValueSet ( <a href="#">Female Gender (NCHS)</a> ) THEN "ISEX" SHALL ='F' ELSE THEN "ISEX" SHALL ='N'			
Variable Name	Source in EMR Using FHIR (1a)	Source in EMR Using CDA Labor and Delivery Summary-VR XPATH (1b)	
\$Gender	PENDING	ClinicalDocument/component/structuredBody/component/section[templateId[@root='2.16.840.1.113883.10.20.1.21']/subject/relatedSubject/code[@code='NCHILD' AND id=idOfTheChild]/subject/relatedSubject/subject/administrativeGenderCode	
Mapping to HL7 FHIR BFDR (5a)			
FHIR Profile/Resource	Content		
<a href="#">Composition - Provider Live Birth Report</a> <ul style="list-style-type: none"> <li>PENDING</li> </ul>	/subject/relatedSubject/subject/administrativeGenderCode = ISEX		
Mapping to HL7 v2.6 BFDR (5b)			
Mapping Location and Content	Example	Usage	
PID-8	PID 1  123456688^^^MRN  Johnson^Baby 20110313 F         N	PSMLBDI	
		PSMFDI	
		PSLBI	Y
		PSFLBI	Y
		PSFFDI	
		PSFDI	
		JLBI	Y
		JFDI	

		CCOFDI	Y
--	--	--------	---

1435

**6.6.1.1.38 ITRAN Child** [Infant transferred within 24 hours of delivery/name the facility FTRAN]

ITRAN Derivation Rule (2)			
<p><b>\$PatientTransferType</b> CONTAINS ValueSet (<i>Transfer to (NCHS)</i>) and (Coded <b>\$PatientTransferTime</b> – <b>\$BirthTime</b>) &lt;= 24 hours THEN ITRAN SHALL = “Y” ELSE ITRAN SHALL = “N”</p>			
Variable Name	Source in EMR Using FHIR (1a)	Source in EMR Using CDA Labor and Delivery Summary-VR XPATH (1b)	
<b>\$PatientTransferType</b>	procedure.code of newborn	ClinicalDocument/component/structuredBody/component/section[templateId[@root='1.3.6.1.4.1.19376.1.5.3.1.1.21.2.4']]/subject/relatedSubject/code[@code='NCHILD' AND id=idOfTheChild]/component/section[templateId[@root='1.3.6.1.4.1.19376.1.7.3.1.1.13.7']/entry[templateId[@root='1.3.6.1.4.1.19376.1.5.3.1.1.25.1.4.1']/act/code	
<b>\$PatientTransferTime</b>	procedure.Performed[x].period of newborn	ClinicalDocument/component/structuredBody/component/section[templateId[@root='1.3.6.1.4.1.19376.1.5.3.1.1.21.2.4']]/subject/relatedSubject/code[@code='NCHILD' AND id=idOfTheChild]/component/section[templateId[@root='1.3.6.1.4.1.19376.1.7.3.1.1.13.7']/entry[templateId[@root='1.3.6.1.4.1.19376.1.5.3.1.1.25.1.4.1']/act/effectiveTime[high	
<b>\$BirthTime</b>	patient.birthDate of newborn	/ClinicalDocument/component/structuredBody/component/section/templateId[@root='1.3.6.1.4.1.19376.1.5.3.1.1.21.2.4']/subject/relatedSubject/code[@code='NCHILD' AND id=idOfTheChild]/subject/birthTime	
Mapping to HL7 FHIR BFDR (5a)			
FHIR Profile/Resource	Content		
<p><a href="#">Composition - Provider Live Birth Report</a></p> <ul style="list-style-type: none"> <li>PENDING</li> </ul>	<p>/code@code= Code='73758-5', CodeSystemName= 'LOINC', DisplayName= 'Infant was transferred within 24 hours of delivery'</p> <p>AND</p> <p>/value@value= Boolean form of ITRAN</p>		
Mapping to HL7 v2.6 BFDR (5b)			
Mapping Location and Content	Example	Usage	
<p>OBX-2 SHALL contain CWE</p> <p>OBX-3 SHALL contain 73758-5^Infant was transferred within 24 hours of delivery</p> <p>OBX-5 SHALL contain a value selected from value the set from PHVS_YesNoUnknown_CDC Yes No Unknown (YNU)</p>	<p>OBX 32 CWE 73758-5^ Infant was transferred within 24 hours of delivery ^LN  N^No^ PHVS_YesNoUnknown_CDC      F</p>	PSMLBDI	
		PSMFDI	
		PSLBI	Y
		PSFLBI	Y
		PSFFDI	
		PSFDI	
		JLBI	Y

		JFDI	
		CCOFDI	

**6.6.1.1.39 FTRAN Child [Infant transferred within 24 hours of delivery/name the facility]**

FTRAN Derivation Rule (2)			
IF \$PatientTransferType CONTAINS ValueSet ( <i>Institution Referred to (NCHS)</i> ) and (\$PatientTransferTime – \$BirthTime) <= 24 hours THEN FTRAN SHALL = \$PatientInstitutionTransferName			
Variable Name	Source in EMR Using FHIR (1a)	Source in EMR Using CDA Labor and Delivery Summary-VR XPATH (1b)	
\$PatientTransferType	procedure.code of newborn	ClinicalDocument/component/structuredBody/component/section[templateId[@root='1.3.6.1.4.1.19376.1.5.3.1.1.21.2.3']] /component/section[templateId[@root='1.3.6.1.4.1.19376.1.7.3.1.1.13.7']] /component/section[templateId[@root='1.3.6.1.4.1.19376.1.5.3.1.1.25.1.4.1']] /entry/act/entryRelationship/observation/code	
\$PatientTransferTime	procedure.Performed[x].period of newborn	ClinicalDocument/component/structuredBody/component/section[templateId[@root='1.3.6.1.4.1.19376.1.5.3.1.1.21.2.4']] /component/section[templateId[@root='1.3.6.1.4.1.19376.1.7.3.1.1.13.7']] /component/section[templateId[@root='1.3.6.1.4.1.19376.1.5.3.1.1.25.1.4.1']] /entry/act/entryRelationship/observation/effectiveTime[high]	
\$BirthTime	patient.birthDate of newborn	/ClinicalDocument/component/structuredBody/component/section/templateId[@root='1.3.6.1.4.1.19376.1.5.3.1.1.21.2.4'] /subject/relatedSubject/code[@code='NCHILD' AND id=idOfTheChild] /sub/ect/birthTime	
\$PatientInstitutionTransferName	procedure.value of newborn	ClinicalDocument/component/structuredBody/component/section[templateId[@root='1.3.6.1.4.1.19376.1.5.3.1.1.21.2.3']] /component/section[templateId[@root='1.3.6.1.4.1.19376.1.7.3.1.1.13.7']] /component/section[templateId[@root='1.3.6.1.4.1.19376.1.5.3.1.1.25.1.4.1']] /entry/act/entryRelationship/observation/value	
Mapping to HL7 FHIR BFDR (5a)			
FHIR Profile/Resource		Content	
<a href="#">Composition - Provider Live Birth Report</a> • PENDING		/participant/participantRole/name = FTRAN	
Mapping to HL7 v2.6 BFDR (5b)			
Mapping Location and Content		Example	Usage
OBX-2 SHALL contain XON OBX-3 SHALL contain 73770-0^ Name of facility infant transferred to OBX-5 SHALL contain the name of the facility the infant was transferred to. (Only value if the infant was transferred within 24 hours of delivery.)		OBX 32 XON 73770-0^ Name of facility infant transferred to^LN   Good Health Hospital^L^^^^&2.16.840.1.113883.19.4.6^ISO^XX^^^^1234      F	PSMLBDI PSMFDI PSLBI PSFLBI PSFFDI PSFDI
			Y Y

		JLBI	Y
		JFDI	
		CCOFDI	

#### 6.6.1.1.40 TB Child [Time of Birth]

TB Derivation Rule (2)			
“TB” SHALL = Time part of \$BirthTime			
Variable Name	Source in EMR Using FHIR (1a)	Source in EMR Using CDA Labor and Delivery Summary-VR XPATH (1b)	
\$BirthTime	patient.birthDate of newborn	/ClinicalDocument/component/structuredBody/component/section/templateId[@root='1.3.6.1.4.1.19376.1.5.3.1.1.21.2.4']/subject/relatedSubject/code[@code='NCHILD' AND id=idOfTheChild]/subject/birthTime	
Mapping to HL7 FHIR BFDR (5a)			
FHIR Profile/Resource		Content	
<a href="#">Composition - Provider Live Birth Report</a> <ul style="list-style-type: none"> <li>PENDING</li> </ul>		/subject/relatedSubject/subject/birthTime = TB	
Mapping to HL7 v2.6 BFDR (5b)			
Mapping Location and Content	Example	Usage	
PID-7 SHALL contain the Newborn’s date and time of birth,	PID 1  123456688^^^MRN  Johnson^Baby 20110313 F         N	PSMLBDI	
		PSMFDI	
		PSLBI	Y
		PSFLBI	Y
		PSFFDI	
		PSFDI	
		JLBI	Y
		JFDI	
CCOFDI			

1440

#### 6.6.1.1.41 ANEN Congenital Anomalies of the Newborn [Anencephaly]

ANEN Derivation Rule (2)		
IF (\$NervousSystemObservationCode CONTAINS ValueSet ( <a href="#">Anencephaly of the Newborn (NCHS)</a> ) OR (\$ProblemCode CONTAINS ValueSet ( <a href="#">Anencephaly of the Newborn (NCHS)</a> ) THEN “ANEN” SHALL = “Y” ELSE		
Variable Name	Source in EMR Using FHIR (1a)	Source in EMR Using CDA Labor and Delivery Summary-VR XPATH (1b)

IHE Quality, Research and Public Health Technical Framework Supplement – Birth and Fetal Death Reporting-Enhanced (BFDR-E)

<b>\$NervousSystemObservationCode</b>	N/A- only verified by condition.code	ClinicalDocument/component/structuredBody/component/section[templateId[@root='1.3.6.1.4.1.19376.1.5.3.1.1.21.2.4']]/subject/relatedSubject/code[@code='NCHILD' AND id=idOfTheChild]/component/section[templateId[@root='1.3.6.1.4.1.19376.1.5.3.1.1.9.15.1']]/component/section[templateId[@root='1.3.6.1.4.1.19376.1.5.3.1.1.9.35']]/entry/observation/value
<b>\$ProblemCode</b>	condition.code of newborn	ClinicalDocument/component/structuredBody/component/section[templateId[@root='1.3.6.1.4.1.19376.1.5.3.1.1.21.2.4']]/subject/relatedSubject/code[@code='NCHILD' AND id=idOfTheChild]/component/section[templateId[@root='1.3.6.1.4.1.19376.1.5.3.1.3.6']]/entry/act/entryRelationship/observation/value
<b>Mapping to HL7 FHIR BFDR (5a)</b>		
<b>FHIR Profile/Resource</b>		<b>Content</b>
<a href="#">Composition - Provider Live Birth Report</a> OR <a href="#">Composition - Provider Fetal Death Report</a> <ul style="list-style-type: none"> <li>PENDING</li> </ul>		IF ANEN = 'Y' then /code@code= Code= '73780-9', CodeSystemName= 'LOINC', DisplayName='Congenital anomalies of the newborn' AND /value@code= Code=' 89369001', CodeSystemName= 'SNOMED CT', DisplayName= 'Anencephalus'
<b>Mapping to HL7 v2.6 BFDR (5b)</b>		
<b>Mapping Location and Content</b>		<b>Example</b>
OBX-2 SHALL contain CWE OBX-3 SHALL contain 73780-9^Congenital anomalies of the newborn OBX-5 SHALL contain 89369001^Anencephalus		OBX 27 CWE 73780-9^Congenital anomalies of the Newborn ^LN  89369001^Anencephalus^SNM      F
		<b>Usage</b>
		PSMLBDI
		PSMFDI
		PSLBI
		PSFLBI
		PSFFDI
		PSFDI
		JLBI
		JFDI
		CCOFDI

**6.6.1.1.42 CCHD Congenital Anomalies of the Newborn [Cyanotic congenital heart disease]**

<b>CCHD Derivation Rule (2)</b>		
IF (\$HeartSystemObservationCode CONTAINS ValueSet ( <a href="#">Cyanotic Congenital Heart Disease (NCHS)</a> ) OR (\$ProblemCode CONTAINS ValueSet ( <a href="#">Cyanotic Congenital Heart Disease (NCHS)</a> ) THEN "CCHD" SHALL = "Y" ELSE "N".		
<b>Variable Name</b>	<b>Source in EMR Using FHIR (1a)</b>	<b>Source in EMR Using CDA Labor and Delivery Summary-VR XPATH (1b)</b>



IHE Quality, Research and Public Health Technical Framework Supplement – Birth and Fetal Death Reporting-Enhanced (BFDR-E)

<b>\$HeartSystemObservationCode</b>	N/A- only verified by condition.code	ClinicalDocument/component/structuredBody/component/section[templateId[@root='1.3.6.1.4.1.19376.1.5.3.1.1.21.2.4']]/subject/relatedSubject/code[@code='NCHILD' AND id=idOfTheChild]/component/section[templateId[@root='1.3.6.1.4.1.19376.1.5.3.1.1.9.15.1']]/component/section[templateId[@root='1.3.6.1.4.1.19376.1.5.3.1.1.9.29']]/entry/act/entryRelationship/observation/code																			
<b>\$ProblemCode</b>	condition.code of newborn	ClinicalDocument/component/structuredBody/component/section[templateId[@root='1.3.6.1.4.1.19376.1.5.3.1.1.21.2.4']]/subject/relatedSubject/code[@code='NCHILD' AND id=idOfTheChild]/component/section[templateId[@root='1.3.6.1.4.1.19376.1.5.3.1.3.6']]/entry/act/entryRelationship/observation/value																			
<b>Mapping to HL7 FHIR BFDR (5a)</b>																					
<b>FHIR Profile/Resource</b>		<b>Content</b>																			
<a href="#">Composition - Provider Live Birth Report</a> OR <a href="#">Composition - Provider Fetal Death Report</a> <ul style="list-style-type: none"> <li>PENDING</li> </ul>		IF CCHD = 'Y' then  /code@code= Code= '73780-9', CodeSystemName= 'LOINC', DisplayName='Congenital anomalies of the newborn'  AND  /value@code= Code='12770006', CodeSystemName= 'SNOMED CT', DisplayName='Cyanotic congenital heart disease'																			
<b>Mapping to HL7 v2.6 BFDR (5b)</b>																					
<b>Mapping Location and Content</b>		<b>Example</b>	<b>Usage</b>																		
OBX-2 SHALL contain CWE OBX-3 SHALL contain 73780-9^Congenital anomalies of the newborn OBX-5 SHALL contain 12770006^Cyanotic congenital heart disease		OBX 27 CWE 73780-9^Congenital anomalies of the Newborn ^LN  12770006^Cyanotic congenital heart disease^SNM     F	<table border="1"> <tr><td>PSMLBDI</td><td></td></tr> <tr><td>PSMFDI</td><td></td></tr> <tr><td>PSLBI</td><td>Y</td></tr> <tr><td>PSFLBI</td><td>Y</td></tr> <tr><td>PSFFDI</td><td>Y</td></tr> <tr><td>PSFDI</td><td>Y</td></tr> <tr><td>JLBI</td><td>Y</td></tr> <tr><td>JFDI</td><td>Y</td></tr> <tr><td>CCOFDI</td><td></td></tr> </table>	PSMLBDI		PSMFDI		PSLBI	Y	PSFLBI	Y	PSFFDI	Y	PSFDI	Y	JLBI	Y	JFDI	Y	CCOFDI	
PSMLBDI																					
PSMFDI																					
PSLBI	Y																				
PSFLBI	Y																				
PSFFDI	Y																				
PSFDI	Y																				
JLBI	Y																				
JFDI	Y																				
CCOFDI																					

1445

**6.6.1.1.43 CDH Congenital Anomalies of the Newborn [Congenital diaphragmatic hernia]**

<b>CDH Derivation Rule (2)</b>		
IF (\$GeneralAppearanceObservationCode CONTAINS ValueSet ( <a href="#">Congenital Diaphragmatic Hernia (NCHS)</a> ) OR (\$ProblemCode CONTAINS ValueSet ( <a href="#">Congenital Diaphragmatic Hernia (NCHS)</a> ) THEN "CDH" SHALL = "Y" ELSE "N".		
<b>Variable Name</b>	<b>Source in EMR Using FHIR (1a)</b>	<b>Source in EMR Using CDA Labor and Delivery Summary-VR XPATH (1b)</b>

IHE Quality, Research and Public Health Technical Framework Supplement – Birth and Fetal Death Reporting-Enhanced (BFDR-E)

<b>\$GeneralAppearance ObservationCode</b>	N/A- only verified by condition.code	ClinicalDocument/component/structuredBody/component/section[templateId[@root='1.3.6.1.4.1.19376.1.5.3.1.1.21.2.4']]/subject/relatedSubject/code[@code='NCHILD' AND id=idOfTheChild]/component/section[templateId[@root='1.3.6.1.4.1.19376.1.5.3.1.1.9.15.1']]/component/section[templateId[@root='1.3.6.1.4.1.19376.1.5.3.1.1.9.16']]/entry/observation/value		
<b>\$ProblemCode</b>	condition.code of newborn	ClinicalDocument/component/structuredBody/component/section[templateId[@root='1.3.6.1.4.1.19376.1.5.3.1.1.21.2.4']]/subject/relatedSubject/code[@code='NCHILD' AND id=idOfTheChild]/component/section[templateId[@root='1.3.6.1.4.1.19376.1.5.3.1.3.6']]/entry/act/entryRelationship/observation/value		
<b>Mapping to HL7 FHIR BFDR (5a)</b>				
<b>FHIR Profile/Resource</b>		<b>Content</b>		
<a href="#">Composition - Provider Live Birth Report</a> OR <a href="#">Composition - Provider Fetal Death Report</a> <ul style="list-style-type: none"> <li>PENDING</li> </ul>		IF CDH = 'Y' then /code@code= Code= '73780-9', CodeSystemName= 'LOINC', DisplayName='Congenital anomalies of the newborn' AND /value@code= Code='17190001', CodeSystemName= 'SNOMED CT', DisplayName= 'Congenital diaphragmatic hernia'		
<b>Mapping to HL7 v2.6 BFDR (5b)</b>				
<b>Mapping Location and Content</b>		<b>Example</b>	<b>Usage</b>	
OBX-2 SHALL contain CWE OBX-3 SHALL contain 73780-9^Congenital anomalies of the newborn OBX-5 SHALL contain 17190001^Congenital diaphragmatic hernia		OBX 27 CWE 73780-9^Congenital anomalies of the Newborn ^LN  17190001^Congenital diaphragmatic hernia^SNM    F	PSMLBDI	
			PSMFDI	
			PSLBI	Y
			PSFLBI	Y
			PSFFDI	Y
			PSFDI	Y
			JLBI	Y
			JFDI	Y
		CCOFDI		

1450

**6.6.1.1.44 CDIC Congenital Anomalies of the Newborn [Suspected chromosomal disorder karyotype confirmed]**

<b>CDIC Derivation Rule (2)</b>
---------------------------------

IHE Quality, Research and Public Health Technical Framework Supplement – Birth and Fetal Death Reporting-Enhanced (BFDR-E)

<p>IF ((\$GeneralAppearanceObservationCode CONTAINS ValueSet (<i>Karyotype Confirmed (NCHS)</i>) AND \$GeneralAppearanceObservationCode Code CONTAINS ValueSet (<i>Suspected Chromosomal Disorder (NCHS)</i>) OR (\$ProblemCode CONTAINS ValueSet (<i>Karyotype Confirmed (NCHS)</i>) AND (\$ProblemCode Code CONTAINS ValueSet (<i>Suspected Chromosomal Disorder (NCHS)</i>)) THEN “CDIC” SHALL = “Y” ELSE “N”.</p>			
Variable Name	Source in EMR Using FHIR (1a)	Source in EMR Using CDA Labor and Delivery Summary-VR XPATH (1b)	
\$GeneralAppearanceObservationCode	N/A- only verified by condition.code	ClinicalDocument/component/structuredBody/component/section[templateId[@root='1.3.6.1.4.1.19376.1.5.3.1.1.21.2.4']/subject/relatedSubject/code[@code='NCHILD' AND id=idOfTheChild]/component/section[templateId[@root='1.3.6.1.4.1.19376.1.5.3.1.1.9.15.1']/component/section[templateId[@root='1.3.6.1.4.1.19376.1.5.3.1.1.9.16']/entry//observation/value	
\$ProblemCode	condition.code of newborn	ClinicalDocument/component/structuredBody/component/section[templateId[@root='1.3.6.1.4.1.19376.1.5.3.1.1.21.2.4']/subject/relatedSubject/code[@code='NCHILD' AND id=idOfTheChild]/component/section[templateId[@root='1.3.6.1.4.1.19376.1.5.3.1.3.6']/entry/act/entryRelationship/observation/value	
Mapping to HL7 FHIR BFDR (5a)			
FHIR Profile/Resource	Content		
<a href="#">Composition - Provider Live Birth Report</a> OR <a href="#">Composition - Provider Fetal Death Report</a> <ul style="list-style-type: none"> <li>PENDING</li> </ul>	IF CDIC = 'Y' then /code@code= Code= '73780-9', CodeSystemName= 'LOINC', DisplayName='Congenital anomalies of the newborn' AND /value@code= Code='409709004', CodeSystemName='SNOMED CT', DisplayName= 'Chromosomal Disorder' AND /entryRelationship/code@code Code=' 73778-3', CodeSystemName= 'LOINC', DisplayName=' Suspected chromosomal disorder karyotype status' /entryRelationship/value@code Code=' 442124003', CodeSystemName= 'SNOMED CT', DisplayName= 'Karyotype evaluation abnormal'		
Mapping to HL7 v2.6 BFDR (5b)			
Mapping Location and Content	Example	Usage	
OBX-2 SHALL contain CWE OBX-3 SHALL contain 73780-9^Congenital anomalies of the newborn OBX-5 SHALL contain 409709004^Chromosomal disorder (disorder) AND a second OBX segment WHERE: OBX-2 SHALL contain CWE OBX-3 SHALL contain 73778-3^Suspected chromosomal disorder karyotype status OBX-5 SHALL contain 442124003^Karyotype evaluation abnormal	OBX 27 CWE 73780-9^Congenital anomalies of the Newborn ^LN  409709004^Chromosomal disorder^SNM      F  OBX 27 CWE 73778-3 ^Suspected chromosomal disorder karyotype status^LN  442124003^Karyotype evaluation abnormal^SNM      F	PSMLBDI	
		PSMFDI	
		PSLBI	Y
		PSFLBI	Y
		PSFFDI	Y
		PSFDI	Y
		JLBI	Y
JFDI	Y		

		CCOFDI	
--	--	--------	--

### 6.6.1.1.45 CDIS Congenital Anomalies of the Newborn [Suspected chromosomal Disorder]

CDIS Derivation Rule (2)																			
IF (NOT (\$GeneralAppearanceObservationCode CONTAINS ValueSet ( <i>Karyotype Confirmed (NCHS)</i> ) AND (\$GeneralAppearanceObservationCode Code CONTAINS ValueSet ( <i>Suspected Chromosomal Disorder (NCHS)</i> ) OR (NOT (\$ProblemCode CONTAINS ValueSet ( <i>Karyotype Confirmed (NCHS)</i> ) AND (\$ProblemCode Code CONTAINS ValueSet ( <i>Suspected Chromosomal Disorder (NCHS)</i> )) THEN “CDIS” SHALL = “Y” ELSE “N”																			
Variable Name	Source in EMR Using FHIR (1a)	Source in EMR Using CDA Labor and Delivery Summary-VR XPATH (1b)																	
\$GeneralAppearanceObservationCode	N/A- only verified by condition.code	ClinicalDocument/component/structuredBody/component/section[templateId[@root='1.3.6.1.4.1.19376.1.5.3.1.1.21.2.4']]/subject/relatedSubject/code[@code='NCHILD' AND id=idOfTheChild]/component/section[templateId[@root='1.3.6.1.4.1.19376.1.5.3.1.1.9.15.1']]/component/section[templateId[@root='1.3.6.1.4.1.19376.1.5.3.1.1.9.16']]/entry/observation/value																	
\$ProblemCode	condition.code of newborn	ClinicalDocument/component/structuredBody/component/section[templateId[@root='1.3.6.1.4.1.19376.1.5.3.1.1.21.2.4']]/subject/relatedSubject/code[@code='NCHILD' AND id=idOfTheChild]/component/section[templateId[@root='1.3.6.1.4.1.19376.1.5.3.1.3.6']]/entry/act/entryRelationship/observation/value																	
Mapping to HL7 FHIR BFDR (5a)																			
FHIR Profile/Resource		Content																	
<a href="#">Composition - Provider Live Birth Report</a> OR <a href="#">Composition - Provider Fetal Death Report</a> <ul style="list-style-type: none"> <li>PENDING</li> </ul>		IF CDIS = 'Y' then /code@code= Code= '73780-9', CodeSystemName= 'LOINC', DisplayName='Congenital anomalies of the newborn' AND /value@code= Code='409709004', CodeSystemName='SNOMED CT', DisplayName= 'Chromosomal Disorder'																	
Mapping to HL7 v2.6 BFDR (5b)																			
Mapping Location and Content		Example	Usage																
OBX-2 SHALL contain CWE OBX-3 SHALL contain 73780-9^Congenital anomalies of the newborn OBX-5 SHALL contain 409709004^Chromosomal disorder		OBX 2 CWE 73780-9^Congenital anomalies of the Newborn ^LN  409709004^Chromosomal disorder^SNM     F	<table border="1"> <tr> <td>PSMLBDI</td> <td></td> </tr> <tr> <td>PSMFDI</td> <td></td> </tr> <tr> <td>PSLBI</td> <td>Y</td> </tr> <tr> <td>PSFLBI</td> <td>Y</td> </tr> <tr> <td>PSFFDI</td> <td>Y</td> </tr> <tr> <td>PSFDI</td> <td>Y</td> </tr> <tr> <td>JLBI</td> <td>Y</td> </tr> <tr> <td>JFDI</td> <td>Y</td> </tr> </table>	PSMLBDI		PSMFDI		PSLBI	Y	PSFLBI	Y	PSFFDI	Y	PSFDI	Y	JLBI	Y	JFDI	Y
PSMLBDI																			
PSMFDI																			
PSLBI	Y																		
PSFLBI	Y																		
PSFFDI	Y																		
PSFDI	Y																		
JLBI	Y																		
JFDI	Y																		

		CCOFDI	
--	--	--------	--

1455

**6.6.1.1.46 CDIP Congenital Anomalies of the Newborn [Suspected chromosomal disorder karyotype pending]**

CDIP Derivation Rule (2)		
IF (\$GeneralAppearanceObservationCode CONTAINS ValueSet ( <i>Suspected Chromosomal Disorder (NCHS)</i> ) OR \$ProblemCode CONTAINS ValueSet ( <i>Suspected Chromosomal Disorder (NCHS)</i> ) AND (\$ProcedureCode Contains ( <i>Karyotype Determination (NCHS)</i> ) AND act classCode='ACT' moodCode='INT') AND (NOT \$CodedResultCode ( <i>Karyotype Result (NCHS)</i> )) THEN “CDIP” SHALL = “Y” ELSE “N”.		
Variable Name	Source in EMR Using FHIR (1a)	Source in EMR Using CDA Labor and Delivery Summary-VR XPATH (1b)
\$GeneralAppearanceObservationCode	N/A- only verified by condition.code	ClinicalDocument/component/structuredBody/component/section[templateId[@root='1.3.6.1.4.1.19376.1.5.3.1.1.21.2.4']]/subject/relatedSubject/code[@code='NCHILD' AND id=idOfTheChild]/component/section[templateId[@root='1.3.6.1.4.1.19376.1.5.3.1.1.9.15.1']]/component/section[templateId[@root='1.3.6.1.4.1.19376.1.5.3.1.1.9.16']]/entry/act/entryRelationship/observation/code
\$ProblemCode	condition.code of newborn	ClinicalDocument/component/structuredBody/component/section[templateId[@root='1.3.6.1.4.1.19376.1.5.3.1.1.21.2.4']]/subject/relatedSubject/code[@code='NCHILD' AND id=idOfTheChild]/component/section[templateId[@root='1.3.6.1.4.1.19376.1.5.3.1.3.6']]/entry/act/entryRelationship/observation/value
\$ProcedureCode	procedure.code of newborn	ClinicalDocument/component/structuredBody/component/section[templateId[@root='1.3.6.1.4.1.19376.1.5.3.1.1.21.2.4']]/subject/relatedSubject/code[@code='NCHILD' AND id=idOfTheChild]/component/section[templateId[@root='1.3.6.1.4.1.19376.1.5.3.1.1.13.2.11']]/entry/procedure/code
\$CodedResultCode	observation.code of newborn constrained by: ( <a href="http://ihe.net/fhir/StructureDefinition/IHE.BFDRE.NewbornObservationsKaryotype">http://ihe.net/fhir/StructureDefinition/IHE.BFDRE.NewbornObservationsKaryotype</a> )	ClinicalDocument/component/structuredBody/component/section[templateId[@root='1.3.6.1.4.1.19376.1.5.3.1.1.21.2.4'] AND subject/relatedSubject[code[@code='NCHILD' AND id=idOfTheChild]]]/component/section[templateId[@root='1.3.6.1.4.1.19376.1.7.3.1.1.13.7']]/entry[templateId[@root='1.3.6.1.4.1.19376.1.5.3.1.4.13']]/observation/code
Mapping to HL7 FHIR BFDR (5a)		
FHIR Profile/Resource	Content	
<a href="#">Composition - Provider Live Birth Report</a> OR <a href="#">Composition - Provider Fetal Death Report</a> <ul style="list-style-type: none"> <li>PENDING</li> </ul>	IF CDIP = 'Y' then  /code@code= Code= '73780-9', CodeSystemName= 'LOINC', DisplayName='Congenital anomalies of the newborn'  AND  /value@code= Code='409709004', CodeSystemName= 'SNOMED CT', DisplayName= 'Chromosomal Disorder'  AND	

IHE Quality, Research and Public Health Technical Framework Supplement – Birth and Fetal Death Reporting-Enhanced (BFDR-E)

	<p>/entryRelationship/code@code Code=' 73778-3', CodeSystemName= 'LOINC', DisplayName=' Suspected chromosomal disorder karyotype status'</p> <p>/entryRelationship/value@code Code='312948004', CodeSystemName= 'SNOMED CT', DisplayName= 'Karyotype determination'</p>		
Mapping to HL7 v2.6 BFDR (5b)			
Mapping Location and Content	Example	Usage	
<p>OBX-2 SHALL contain CWE</p> <p>OBX-3 SHALL contain 73780-9^Congenital anomalies of the newborn</p> <p>OBX-5 SHALL contain 409709004^Chromosomal disorder (disorder)</p> <p>AND a second OBX segment WHERE:</p> <p>OBX-2 SHALL contain CWE</p> <p>OBX-3 SHALL contain 73778-3^Suspected chromosomal disorder karyotype status</p> <p>OBX-5 SHALL contain 312948004^ Karyotype determination</p>	<p>OBX 27 CWE 73780-9^Congenital anomalies of the Newborn ^LN  409709004^Chromosomal disorder^SNM      F</p> <p>OBX 27 CWE 73778-3^Suspected chromosomal disorder karyotype ^LN  312948004^ Karyotype determination^SNM      F</p>	PSMLBDI	
		PSMFDI	
		PSLBI	Y
		PSFLBI	Y
		PSFFDI	Y
		PSFDI	Y
		JLBI	Y
		JFDI	Y
CCOFDI			

6.6.1.1.47 CL Congenital Anomalies of the Newborn [Cleft Lip with or without Cleft Palate]

CL Derivation Rule (2)		
<p>IF (\$GeneralAppearanceObservationCode CONTAINS ValueSet (<a href="#">Cleft Lip with or without Cleft Palate (NCHS)</a>) OR (\$ProblemCode CONTAINS ValueSet (<a href="#">Cleft Lip with or without Cleft Palate (NCHS)</a>)) THEN "CL" SHALL = "Y" ELSE "N".</p>		
Variable Name	Source in EMR Using FHIR (1a)	Source in EMR Using CDA Labor and Delivery Summary-VR XPATH (1b)
\$GeneralAppearanceObservationCode	N/A- only verified by condition.code	ClinicalDocument/component/structuredBody/component/section[templateId[@root='1.3.6.1.4.1.19376.1.5.3.1.1.21.2.4']]/subject/relatedSubject/code[@code='NCHILD' AND id=idOfTheChild]/component/section[templateId[@root='1.3.6.1.4.1.19376.1.5.3.1.1.9.15.1']]/component/section[templateId[@root='1.3.6.1.4.1.19376.1.5.3.1.1.9.16']]/entry/observation/value
\$ProblemCode	condition.code	ClinicalDocument/component/structuredBody/component/section[templateId[@root='1.3.6.1.4.1.19376.1.5.3.1.1.21.2.4']]/subject/relatedSubject/code[@code='NCHILD' AND id=idOfTheChild]/component/section[templateId[@root='1.3.6.1.4.1.19376.1.5.3.1.3.6']]/entry/act/entryRelationship/observation/value
Mapping to HL7 FHIR BFDR (5a)		
FHIR Profile/Resource	Content	
<a href="#">Composition - Provider Live Birth Report</a> OR	IF CL = 'Y' then	

IHE Quality, Research and Public Health Technical Framework Supplement – Birth and Fetal Death Reporting-Enhanced (BFDR-E)

<a href="#">Composition - Provider Fetal Death Report</a> <ul style="list-style-type: none"> <li>PENDING</li> </ul>		/code@code= Code= '73780-9', CodeSystemName= 'LOINC', DisplayName='Congenital anomalies of the newborn' AND /value@code= Code= '80281008', CodeSystemName= 'SNOMED CT', DisplayName= 'Cleft lip'			
Mapping to HL7 v2.6 BFDR (5b)					
Mapping Location and Content		Example		Usage	
OBX-2 SHALL contain CWE OBX-3 SHALL contain 73780-9^Congenital anomalies of the newborn OBX-5 SHALL contain 80281008^Cleft lip		OBX 27 CWE 73780-9^Congenital anomalies of the Newborn ^LN  80281008^Cleft lip^SNM      F		PSMLBDI	
				PSMFDI	
				PSLBI	Y
				PSFLBI	Y
				PSFFDI	Y
				PSFDI	Y
				JLBI	Y
				JFDI	Y
				CCOFDI	

1460

**6.6.1.1.48 CP Congenital Anomalies of the Newborn [Cleft Palate alone]**

CP Derivation Rule (2)		
IF (\$GeneralAppearanceObservationCode CONTAINS ValueSet ( <a href="#">Cleft Palate Alone (NCHS)</a> ) OR (\$ProblemCode CONTAINS ValueSet ( <a href="#">Cleft Palate Alone (NCHS)</a> )) THEN "CP" SHALL = "Y" ELSE "N".		
Variable Name	Source in EMR Using FHIR (1a)	Source in EMR Using CDA Labor and Delivery Summary-VR XPATH (1b)
\$GeneralAppearanceObservationCode	N/A- only verified by condition.code	ClinicalDocument/component/structuredBody/component/section[templateId[@root='1.3.6.1.4.1.19376.1.5.3.1.1.21.2.4']]/subject/relatedSubject/code[@code='NCHILD' AND id=idOfTheChild]/component/section[templateId[@root='1.3.6.1.4.1.19376.1.5.3.1.1.9.15.1']]/component/section[templateId[@root='1.3.6.1.4.1.19376.1.5.3.1.1.9.16']]/entry/observation/value
\$ProblemCode	condition.code of newborn	ClinicalDocument/component/structuredBody/component/section[templateId[@root='1.3.6.1.4.1.19376.1.5.3.1.1.21.2.4']]/subject/relatedSubject/code[@code='NCHILD' AND id=idOfTheChild]/component/section[templateId[@root='1.3.6.1.4.1.19376.1.5.3.1.3.6']]/entry/act/entryRelationship/observation/value
Mapping to HL7 FHIR BFDR (5a)		
FHIR Profile/Resource		Content
<a href="#">Composition - Provider Live Birth Report</a> OR <a href="#">Composition - Provider Fetal Death Report</a> <ul style="list-style-type: none"> <li>PENDING</li> </ul>		IF CP = 'Y' then /code@code= Code= '73780-9', CodeSystemName= 'LOINC', DisplayName='Congenital anomalies of the newborn'

		AND /value@code= Code= '87979003', CodeSystemName='SNOMED CT', DisplayName= 'Cleft palate'	
Mapping to HL7 v2.6 BFDR (5b)			
Mapping Location and Content	Example	Usage	
OBX-2 SHALL contain CWE OBX-3 SHALL contain 73780-9^Congenital anomalies of the newborn OBX-5 SHALL contain 87979003^ Cleft palate	OBX 27 CWE 73780-9^Congenital anomalies of the Newborn ^LN  87979003^ Cleft palate^SNM      F	PSMLBDI	
		PSMFDI	
		PSLBI	Y
		PSFLBI	Y
		PSFFDI	Y
		PSFDI	Y
		JLBI	Y
		JFDI	Y
		CCOFDI	

#### 6.6.1.1.49 DOWC Congenital Anomalies of the Newborn [Down Karyotype Confirmed]

DOWC Derivation Rule (2)		
IF ((\$GeneralAppearanceObservationCode CONTAINS ValueSet ( <a href="#">Karyotype Confirmed (NCHS)</a> ) AND (\$GeneralAppearanceObservationCode CONTAINS ValueSet ( <a href="#">Downs Syndrome (NCHS)</a> ) THEN "DOWC" SHALL = "Y" ELSE "N"		
Variable Name	Source in EMR Using FHIR (1a)	Source in EMR Using CDA Labor and Delivery Summary-VR XPATH (1b)
\$GeneralAppearanceObservationCode	N/A- only verified by condition.code	ClinicalDocument/component/structuredBody/component/section[templateId[@root='1.3.6.1.4.1.19376.1.5.3.1.1.21.2.4']/subject/relatedSubject/code[@code='NCHILD' AND id=idOfTheChild]/component/section[templateId[@root='1.3.6.1.4.1.19376.1.5.3.1.1.9.15.1']/component/section[templateId[@root='1.3.6.1.4.1.19376.1.5.3.1.1.9.16']]/entry//observation/value
\$ProblemCode	condition.code	
Mapping to HL7 FHIR BFDR (5a)		
FHIR Profile/Resource	Content	
<a href="#">Composition - Provider Live Birth Report</a> OR <a href="#">Composition - Provider Fetal Death Report</a> <ul style="list-style-type: none"> <li>PENDING</li> </ul>	IF DOWC = 'Y' then /code@code= Code= '73780-9', CodeSystemName= 'LOINC', DisplayName='Congenital anomalies of the newborn' AND /value@code= Code= '70156005', CodeSystemName='SNOMED CT', DisplayName= 'Anomaly of chromosome pair 21' AND	



IHE Quality, Research and Public Health Technical Framework Supplement – Birth and Fetal Death Reporting-Enhanced (BFDR-E)

	/entryRelationship/code@code Code=' 73778-3', CodeSystemName=' LOINC', DisplayName=' Suspected chromosomal disorder karyotype status'		
	/entryRelationship/value@code Code=' 442124003', CodeSystemName=' SNOMED CT', DisplayName=' Karyotype evaluation abnormal'		
Mapping to HL7 v2.6 BFDR (5b)			
Mapping Location and Content	Example	Usage	
OBX-2 SHALL contain CWE OBX-3 SHALL contain 73780-9^Congenital anomalies of the newborn OBX-5 SHALL contain 70156005^Anomaly of chromosome pair 21 (disorder) AND a second OBX segment WHERE: OBX-2 SHALL contain CWE OBX-3 SHALL contain 73779-1^Down syndrome karyotype status OBX-5 SHALL contain 442124003^Karyotype evaluation abnormal (finding)	OBX 27 CWE 73780-9^Congenital anomalies of the Newborn ^LN  70156005^Anomaly of chromosome pair 21^SNM      F  OBX 27 CWE 73779-1^Down syndrome karyotype status ^LN  442124003^Karyotype evaluation abnormal (finding)^SNM      F	PSMLBDI	
		PSMFDI	
		PSLBI	Y
		PSFLBI	Y
		PSFFDI	Y
		PSFDI	Y
		JLBI	Y
		JFDI	Y
CCOFDI			

6.6.1.1.50 DOWN Congenital Anomalies of the Newborn [Down Syndrome]

DOWN Derivation Rule (2)		
IF (\$GeneralAppearanceObservationCode CONTAINS ValueSet ( <a href="#">Downs Syndrome (NCHS)</a> ) THEN “DOWN” SHALL = “Y” ELSE “N”		
Variable Name	Source in EMR Using FHIR (1a)	Source in EMR Using CDA Labor and Delivery Summary-VR XPATH (1b)
\$GeneralAppearanceObservationCode	N/A- only verified by condition.code	ClinicalDocument/component/structuredBody/component/section[templateId[@root='1.3.6.1.4.1.19376.1.5.3.1.1.21.2.4']/subject/relatedSubject/code[@code='NCHILD' AND id=idOfTheChild]/component/section[templateId[@root='1.3.6.1.4.1.19376.1.5.3.1.1.9.15.1']/component/section[templateId[@root='1.3.6.1.4.1.19376.1.5.3.1.1.9.16']]/entry//observation/value
\$ProblemCode	condition.code of newborn	
Mapping to HL7 FHIR BFDR (5a)		
FHIR Profile/Resource	Content	
<a href="#">Composition - Provider Live Birth Report</a> OR <a href="#">Composition - Provider Fetal Death Report</a> <ul style="list-style-type: none"> <li>PENDING</li> </ul>	IF DOWN = 'Y' then  /code@code= Code= '73780-9', CodeSystemName=' LOINC', DisplayName='Congenital anomalies of the newborn'  AND	

		/value@code= Code= '70156005', CodeSystemName='SNOMED CT', DisplayName= 'Anomaly of chromosome pair 21'		
Mapping to HL7 v2.6 BFDR (5b)				
Mapping Location and Content		Example	Usage	
OBX-2 SHALL contain CWE OBX-3 SHALL contain 73780-9^Congenital anomalies of the newborn OBX-5 SHALL contain 70156005^Anomaly of chromosome pair 21		OBX 27 CWE 73780-9^Congenital anomalies of the Newborn ^LN  70156005^Anomaly of chromosome pair 21^SNM      F	PSMLBDI	
			PSMFDI	
			PSLBI	Y
			PSFLBI	Y
			PSFFDI	Y
			PSFDI	Y
			JLBI	Y
			JFDI	Y
		CCOFDI		

1465

#### 6.6.1.1.51 DOWP Congenital Anomalies of the Newborn [Down Karyotype Pending]

DOWP Derivation Rule (2)		
IF (\$GeneralAppearanceObservationCode CONTAINS ValueSet ( <a href="#">Downs Syndrome (NCHS)</a> ) AND (\$ProcedureCode CONTAINS ( <a href="#">Karyotype Determination (NCHS)</a> ) AND act classCode='ACT' moodCode='INT') AND (NOT \$CodedResultCode ( <a href="#">Karyotype Result (NCHS)</a> ) THEN DOWP" SHALL = "Y" ELSE "N"		
Variable Name	Source in EMR Using FHIR (1a)	Source in EMR Using CDA Labor and Delivery Summary-VR XPATH (1b)
\$GeneralAppearanceObservationCode	N/A- only verified by condition.code	ClinicalDocument/component/structuredBody/component/section[templateId[@root='1.3.6.1.4.1.19376.1.5.3.1.1.21.2.4']]/subject/relatedSubject/code[@code='NCHILD' AND id=idOfTheChild]/component/section[templateId[@root='1.3.6.1.4.1.19376.1.5.3.1.1.9.15.1']]/component/section[templateId[@root='1.3.6.1.4.1.19376.1.5.3.1.1.9.16']]/entry/observation/value
\$ProcedureCode	procedure.code of newborn	ClinicalDocument/component/structuredBody/component/section[templateId[@root='1.3.6.1.4.1.19376.1.5.3.1.1.21.2.4']]/subject/relatedSubject/code[@code='NCHILD' AND id=idOfTheChild]/component/section[templateId[@root='1.3.6.1.4.1.19376.1.5.3.1.1.13.2.11']]/entry/procedure/code
\$CodedResultCode	observation.code of newborn constrained by: <a href="http://ihe.net/fhir/StructureDefinition/IHE.BFDRE.NewbornObservationsKaryotype">http://ihe.net/fhir/StructureDefinition/IHE.BFDRE.NewbornObservationsKaryotype</a> )	ClinicalDocument/component/structuredBody/component/section[templateId[@root='1.3.6.1.4.1.19376.1.5.3.1.3.28']]/subject/relatedSubject/code[@code='NCHILD' AND id=idOfTheChild]/entry/observation/code
Mapping to HL7 FHIR BFDR (5a)		

IHE Quality, Research and Public Health Technical Framework Supplement – Birth and Fetal Death Reporting-Enhanced (BFDR-E)

FHIR Profile/Resource	Content																			
<p><a href="#">Composition - Provider Live Birth Report</a> OR <a href="#">Composition - Provider Fetal Death Report</a></p> <ul style="list-style-type: none"> <li>PENDING</li> </ul>	<p>IF DOWP = 'Y' then</p> <p>/code@code= Code= '73780-9', CodeSystemName= 'LOINC', DisplayName='Congenital anomalies of the newborn'</p> <p>AND</p> <p>/value@code= Code= '70156005', CodeSystemName= 'SNOMED CT', DisplayName= 'Anomaly of chromosome pair 21'</p> <p>AND</p> <p>/entryRelationship/code@code Code= '73778-3', CodeSystemName= 'LOINC', DisplayName=' Suspected chromosomal disorder karyotype status'</p> <p>/entryRelationship/value@code Code='312948004', CodeSystemName= 'SNOMED CT', DisplayName= 'Karyotype determination'</p>																			
Mapping to HL7 v2.6 BFDR (5b)																				
Mapping Location and Content	Example	Usage																		
<p>OBX-2 SHALL contain CWE</p> <p>OBX-3 SHALL contain 73780-9^Congenital anomalies of the newborn</p> <p>OBX-5 SHALL contain 70156005^Anomaly of chromosome pair 21</p> <p>AND a second OBX segment WHERE:</p> <p>OBX-2 SHALL contain CWE</p> <p>OBX-3 SHALL contain 73779-1^Down syndrome karyotype status</p> <p>OBX-5 SHALL contain 312948004^ Karyotype determination</p>	<p>OBX 27 CWE 73780-9^Congenital anomalies of the Newborn ^LN  70156005^Anomaly of chromosome pair 21 (disorder)^SNM      F</p> <p>OBX 27 CWE 73779-1^ Down syndrome karyotype status ^LN  ^312948004^ Karyotype determination^SNM      F</p>	<table border="1"> <tr> <td>PSMLBDI</td> <td></td> </tr> <tr> <td>PSMFDI</td> <td></td> </tr> <tr> <td>PSLBI</td> <td>Y</td> </tr> <tr> <td>PSFLBI</td> <td>Y</td> </tr> <tr> <td>PSFFDI</td> <td>Y</td> </tr> <tr> <td>PSFDI</td> <td>Y</td> </tr> <tr> <td>JLBI</td> <td>Y</td> </tr> <tr> <td>JFDI</td> <td>Y</td> </tr> <tr> <td>CCOFDI</td> <td></td> </tr> </table>	PSMLBDI		PSMFDI		PSLBI	Y	PSFLBI	Y	PSFFDI	Y	PSFDI	Y	JLBI	Y	JFDI	Y	CCOFDI	
PSMLBDI																				
PSMFDI																				
PSLBI	Y																			
PSFLBI	Y																			
PSFFDI	Y																			
PSFDI	Y																			
JLBI	Y																			
JFDI	Y																			
CCOFDI																				

6.6.1.1.52 GAST Congenital Anomalies of the Newborn [Gastroschisis]

GAST Derivation Rule (2)		
<p>IF (\$AbdomenObservationCode CONTAINS ValueSet (<a href="#">Gastroschisis of the Newborn (NCHS)</a>) OR (\$ProblemCode CONTAINS ValueSet (<a href="#">Gastroschisis of the Newborn (NCHS)</a>) THEN “GAST” SHALL = “Y” ELSE “N”.</p>		
Variable Name	Source in EMR Using FHIR (1a)	Source in EMR Using CDA Labor and Delivery Summary-VR XPATH (1b)
<p>\$AbdomenObservationCode</p>	<p>N/A- only verified by condition.code</p>	<p>ClinicalDocument/component/structuredBody/component/section[templateId[@root='1.3.6.1.4.1.19376.1.5.3.1.1.21.2.4']/subject/relatedSubject/code[@code='NCHILD' AND id=idOfTheChild]/component/section[templateId[@root='1.3.6.1.4.1.19376.1.5.3.1.1.9.15.1']/component/section[templateId[@root='1.3.6.1.4.1.19376.1.5.3.1.1.9.31']]/entry//observation/valueNewborn Delivery Information Section</p>

IHE Quality, Research and Public Health Technical Framework Supplement – Birth and Fetal Death Reporting-Enhanced (BFDR-E)

<b>\$ProblemCode</b>	condition.code of newborn	ClinicalDocument/component/structuredBody/component/section[templateId[@root='1.3.6.1.4.1.19376.1.5.3.1.1.21.2.4']]/subject/relatedSubject/code[@code='NCHILD' AND id=idOfTheChild]/component/section[templateId[@root='1.3.6.1.4.1.19376.1.5.3.1.3.6']]/entry/act/entryRelationship/observation/value																		
Mapping to HL7 FHIR BFDR (5a)																				
FHIR Profile/Resource	Content																			
<a href="#">Composition - Provider Live Birth Report</a> OR <a href="#">Composition - Provider Fetal Death Report</a> <ul style="list-style-type: none"> <li>PENDING</li> </ul>	IF GAST = 'Y' then  /code@code= Code= '73780-9', CodeSystemName= 'LOINC', DisplayName='Congenital anomalies of the newborn'  AND  /value@code= Code= '72951007', CodeSystemName= 'SNOMED CT', DisplayName= 'Gastroschisis'																			
Mapping to HL7 v2.6 BFDR (5b)																				
Mapping Location and Content	Example	Usage																		
OBX-2 SHALL contain CWE OBX-3 SHALL contain 73780-9^Congenital anomalies of the newborn OBX-5 SHALL contain 72951007^Gastroschisis	OBX 27 CWE 73780-9^Congenital anomalies of the Newborn ^LN  72951007^Gastroschisis^SNM      F	<table border="1"> <tr><td>PSMLBDI</td><td></td></tr> <tr><td>PSMFDI</td><td></td></tr> <tr><td>PSLBI</td><td>Y</td></tr> <tr><td>PSFLBI</td><td>Y</td></tr> <tr><td>PSFFDI</td><td>Y</td></tr> <tr><td>PSFDI</td><td>Y</td></tr> <tr><td>JLBI</td><td>Y</td></tr> <tr><td>JFDI</td><td>Y</td></tr> <tr><td>CCOFDI</td><td></td></tr> </table>	PSMLBDI		PSMFDI		PSLBI	Y	PSFLBI	Y	PSFFDI	Y	PSFDI	Y	JLBI	Y	JFDI	Y	CCOFDI	
PSMLBDI																				
PSMFDI																				
PSLBI	Y																			
PSFLBI	Y																			
PSFFDI	Y																			
PSFDI	Y																			
JLBI	Y																			
JFDI	Y																			
CCOFDI																				

1470

**6.6.1.1.53 HYPO Congenital Anomalies of the Newborn [Hypospadias]**

HYPO Derivation Rule (2)		
If (\$RenoGenitaliaObservationCode = CONTAINS ValueSet ( <i>Hypospadias (NCHS)</i> ) OR (\$ProblemCode = CONTAINS ValueSet ( <i>Hypospadias (NCHS)</i> )) THEN “HYPO” SHALL = “Y” ELSE “N”.		
Variable Name	Source in EMR Using FHIR (1a)	Source in EMR Using CDA Labor and Delivery Summary-VR XPATH (1b)
<b>\$RenoGenitaliaObservationCode</b>	PENDING	ClinicalDocument/component/structuredBody/component/section[templateId[@root='1.3.6.1.4.1.19376.1.5.3.1.1.21.2.4']]/subject/relatedSubject/code[@code='NCHILD' AND id=idOfTheChild]/component/section[templateId[@root='1.3.6.1.4.1.19376.1.5.3.1.1.9.15.1']]/component/section[templateId[@root='1.3.6.1.4.1.19376.1.5.3.1.1.9.16']]/entry/observation/value
<b>\$ProblemCode</b>	PENDING	ClinicalDocument/component/structuredBody/component/section[templateId[@root='1.3.6.1.4.1.19376.1.5.3.1.1.21.2.4']]/

IHE Quality, Research and Public Health Technical Framework Supplement – Birth and Fetal Death Reporting-Enhanced (BFDR-E)

		subject/relatedSubject/code[@code='NCHILD' AND id=idOfTheChild]/component/section[templateId[@root='1.3.6.1.4.1.19376.1.5.3.1.3.6']]/entry/act/entryRelationship/observation/value																		
Mapping to HL7 FHIR BFDR (5a)																				
FHIR Profile/Resource	Content																			
<a href="#">Composition - Provider Live Birth Report</a> OR <a href="#">Composition - Provider Fetal Death Report</a> <ul style="list-style-type: none"> <li>PENDING</li> </ul>	IF HYPO = 'Y' then  /code@code= Code= '73780-9', CodeSystemName= 'LOINC', DisplayName='Congenital anomalies of the newborn'  AND  /value@code= Code= '416010008', CodeSystemName= 'SNOMED CT', DisplayName= 'Hypospadias'																			
Mapping to HL7 v2.6 BFDR (5b)																				
Mapping Location and Content	Example	Usage																		
OBX-2 SHALL contain CWE OBX-3 SHALL contain 73780-9^Congenital anomalies of the newborn OBX-5 SHALL contain 416010008^Hypospadias	OBX 27 CWE 73780-9^Congenital anomalies of the Newborn ^LN  416010008^Hypospadias^SNM      F	<table border="1"> <tr><td>PSMLBDI</td><td></td></tr> <tr><td>PSMFDI</td><td></td></tr> <tr><td>PSLBI</td><td>Y</td></tr> <tr><td>PSFLBI</td><td>Y</td></tr> <tr><td>PSFFDI</td><td>Y</td></tr> <tr><td>PSFDI</td><td>Y</td></tr> <tr><td>JLBI</td><td>Y</td></tr> <tr><td>JFDI</td><td>Y</td></tr> <tr><td>CCOFDI</td><td></td></tr> </table>	PSMLBDI		PSMFDI		PSLBI	Y	PSFLBI	Y	PSFFDI	Y	PSFDI	Y	JLBI	Y	JFDI	Y	CCOFDI	
PSMLBDI																				
PSMFDI																				
PSLBI	Y																			
PSFLBI	Y																			
PSFFDI	Y																			
PSFDI	Y																			
JLBI	Y																			
JFDI	Y																			
CCOFDI																				

6.6.1.1.54 LIMB Congenital Anomalies of the Newborn [Limb reduction defect]

LIMB Derivation Rule (2)		
IF (\$MusculoskeletalObservationCode CONTAINS ValueSet ( <a href="#">Limb Reduction Defect (NCHS)</a> ) OR (\$ProblemCode CONTAINS ValueSet ( <a href="#">Limb Reduction Defect (NCHS)</a> )) THEN "LIMB" SHALL = "Y" ELSE "N".		
Variable Name	Source in EMR Using FHIR (1a)	Source in EMR Using CDA Labor and Delivery Summary-VR XPATH (1b)
\$MusculoskeletalObservationCode	N/A- only verified by condition.code	ClinicalDocument/component/structuredBody/component/section[templateId[@root='1.3.6.1.4.1.19376.1.5.3.1.1.21.2.4']]/subject/relatedSubject/code[@code='NCHILD' AND id=idOfTheChild]/component/section[templateId[@root='1.3.6.1.4.1.19376.1.5.3.1.1.9.15.1']]/component/section[templateId[@root='1.3.6.1.4.1.19376.1.5.3.1.1.9.34']]/entry/observation/valueNewborn Delivery Information Section
\$ProblemCode	condition.code of newborn	ClinicalDocument/component/structuredBody/component/section[templateId[@root='1.3.6.1.4.1.19376.1.5.3.1.1.21.2.4']]/subject/relatedSubject/code[@code='NCHILD' AND id=idOfTheChild]/component/section[templateId[@root='1.3.6.1.4.1.19376.1.5.3.1.3.6']]/entry/act/entryRelationship/observation/value

IHE Quality, Research and Public Health Technical Framework Supplement – Birth and Fetal Death Reporting-Enhanced (BFDR-E)

Mapping to HL7 FHIR BFDR (5a)			
FHIR Profile/Resource	Content		
<a href="#">Composition - Provider Live Birth Report</a> OR <a href="#">Composition - Provider Fetal Death Report</a> <ul style="list-style-type: none"> <li>PENDING</li> </ul>	IF LIMB = 'Y' then /code@code= Code= '73780-9', CodeSystemName= 'LOINC', DisplayName='Congenital anomalies of the newborn' AND /value@code= Code= '67341007', CodeSystemName= 'SNOMED CT', DisplayName= 'Longitudinal deficiency of limb'		
Mapping to HL7 v2.6 BFDR (5b)			
Mapping Location and Content	Example	Usage	
OBX-2 SHALL contain CWE OBX-3 SHALL contain 73780-9^Congenital anomalies of the newborn OBX-5 SHALL contain 67341007^Longitudinal deficiency of limb	OBX 27 CWE 73780-9^Congenital anomalies of the Newborn ^LN  67341007^Longitudinal deficiency of limb^SNM     F	PSMLBDI	
		PSMFDI	
		PSLBI	Y
		PSFLBI	Y
		PSFFDI	Y
		PSFDI	Y
		JLBI	Y
		JFDI	Y
CCOFDI			

6.6.1.1.55 MNSB Congenital Anomalies of the Newborn [Meningomyelocele/Spina Bifida]

MNSB Derivation Rule (2)		
IF (\$NeurologicSystemObservationCode CONTAINS ValueSet ( <a href="#">Meningomyelocele/Spina Bifida - Newborn (NCHS)</a> ) OR (\$ProblemCode CONTAINS ValueSet ( <a href="#">Meningomyelocele/Spina Bifida - Newborn (NCHS)</a> ) THEN "MNSB" SHALL = "Y" ELSE "N".		
Variable Name	Source in EMR Using FHIR (1a)	Source in EMR Using CDA Labor and Delivery Summary-VR XPATH (1b)
\$NeurologicSystemObservationCode	N/A- only verified by condition.code	ClinicalDocument/component/structuredBody/component/section[templateId[@root='1.3.6.1.4.1.19376.1.5.3.1.1.21.2.4']]/subject/relatedSubject/code[@code='NCHILD' AND id=idOfTheChild]/component/section[templateId[@root='1.3.6.1.4.1.19376.1.5.3.1.1.9.15.1']]/component/section[templateId[@root='1.3.6.1.4.1.19376.1.5.3.1.1.9.35']]/entry//observation/value
\$ProblemCode	condition.code of newborn	ClinicalDocument/component/structuredBody/component/section[templateId[@root='1.3.6.1.4.1.19376.1.5.3.1.1.21.2.4']]/subject/relatedSubject/code[@code='NCHILD' AND id=idOfTheChild]/component/section[templateId[@root='1.3.6.1.4.1.19376.1.5.3.1.3.6']]/entry/act/entryRelationship/observation/value
Mapping to HL7 FHIR BFDR (5a)		

FHIR Profile/Resource		Content																			
<a href="#">Composition - Provider Live Birth Report</a> OR <a href="#">Composition - Provider Fetal Death Report</a> <ul style="list-style-type: none"> <li>PENDING</li> </ul>		IF MNSB = 'Y' then /code@code= Code= '73780-9', CodeSystemName= 'LOINC', DisplayName='Congenital anomalies of the newborn' AND /value@code= Code= '67341007', CodeSystemName= 'SNOMED CT', DisplayName= 'Longitudinal deficiency of limb'																			
Mapping to HL7 v2.6 BFDR (5b)																					
Mapping Location and Content		Example	Usage																		
OBX-2 SHALL contain CWE OBX-3 SHALL contain 73780-9^Congenital anomalies of the newborn OBX-5 SHALL contain 67531005^Spina bifida		OBX 27 CWE 73780-9^Congenital anomalies of the Newborn ^LN  67531005^Spina bifida^SNM      F	<table border="1"> <tr><td>PSMLBDI</td><td></td></tr> <tr><td>PSMFDI</td><td></td></tr> <tr><td>PSLBI</td><td>Y</td></tr> <tr><td>PSFLBI</td><td>Y</td></tr> <tr><td>PSFFDI</td><td>Y</td></tr> <tr><td>PSFDI</td><td>Y</td></tr> <tr><td>JLBI</td><td>Y</td></tr> <tr><td>JFDI</td><td>Y</td></tr> <tr><td>CCOFDI</td><td></td></tr> </table>	PSMLBDI		PSMFDI		PSLBI	Y	PSFLBI	Y	PSFFDI	Y	PSFDI	Y	JLBI	Y	JFDI	Y	CCOFDI	
PSMLBDI																					
PSMFDI																					
PSLBI	Y																				
PSFLBI	Y																				
PSFFDI	Y																				
PSFDI	Y																				
JLBI	Y																				
JFDI	Y																				
CCOFDI																					

1475

### 6.6.1.1.56 OMPH Congenital Anomalies of the Newborn [Omphalocele]

OMPH Derivation Rule (2)		
IF (\$AbdomenObservationCode CONTAINS ValueSet ( <i>Omphalocele of the Newborn (NCHS)</i> ) OR (\$ProblemCode CONTAINS ValueSet ( <i>Omphalocele of the Newborn (NCHS)</i> )) THEN "OMPH" SHALL = "Y" ELSE "N".		
Variable Name	Source in EMR Using FHIR (1a)	Source in EMR Using CDA Labor and Delivery Summary-VR XPATH (1b)
\$AbdomenObservationCode	N/A- only verified by condition.code	ClinicalDocument/component/structuredBody/component/section[templateId[@root='1.3.6.1.4.1.19376.1.5.3.1.1.21.2.4']/subject/relatedSubject/code[@code='NCHILD' AND id=idOfTheChild]/component/section[templateId[@root='1.3.6.1.4.1.19376.1.5.3.1.1.9.15.1']/component/section[templateId[@root='1.3.6.1.4.1.19376.1.5.3.1.1.9.31']/entry//observation/value
\$ProblemCode	condition.code of newborn	ClinicalDocument/component/structuredBody/component/section[templateId[@root='1.3.6.1.4.1.19376.1.5.3.1.1.21.2.4']/subject/relatedSubject/code[@code='NCHILD' AND id=idOfTheChild]/component/section[templateId[@root='1.3.6.1.4.1.19376.1.5.3.1.3.6']/entry/act/entryRelationship/observation/value
Mapping to HL7 FHIR BFDR (5a)		
FHIR Profile/Resource		Content
<a href="#">Composition - Provider Live Birth Report</a>		IF OMPH = 'Y' then

IHE Quality, Research and Public Health Technical Framework Supplement – Birth and Fetal Death Reporting-Enhanced (BFDR-E)

OR <a href="#">Composition - Provider Fetal Death Report</a> • PENDING	/code@code= Code= '73780-9', CodeSystemName= 'LOINC', DisplayName='Congenital anomalies of the newborn'  AND  /value@code= Code= '18735004', CodeSystemName= 'SNOMED CT', DisplayName= 'Congenital omphalocele'		
Mapping to HL7 v2.6 BFDR (5b)			
Mapping Location and Content	Example	Usage	
OBX-2 SHALL contain CWE OBX-3 SHALL contain 73780-9^Congenital anomalies of the newborn OBX-5 SHALL contain 18735004^Congenital omphalocele	OBX 27 CWE 73780-9^Congenital anomalies of the Newborn ^LN  17190001^18735004^Congenital omphalocele^SNM      F	PSMLBDI	
		PSMFDI	
		PSLBI	Y
		PSFLBI	Y
		PSFFDI	Y
		PSFDI	Y
		JLBI	Y
		JFDI	Y
CCOFDI			

**6.6.1.1.57 NOA55 Congenital Anomalies of the Newborn** [None of the anomalies listed above]

NOA55 Derivation Rule (2)			
This SHALL require data entry and SHALL NOT be a result of a default from the other attributes in the list.			
Variable Name	Source in EMR Using FHIR (1a)	Source in EMR Using CDA Labor and Delivery Summary-VR XPATH (1b)	
N/A	N/A	N/A	
Mapping to HL7 FHIR BFDR (5a)			
FHIR Profile/Resource	Content		
<a href="#">Composition - Provider Live Birth Report</a> OR <a href="#">Composition - Provider Fetal Death Report</a> • PENDING	IF NOA55= 'Y' then  /code@code= Code= '73780-9', CodeSystemName= 'LOINC', DisplayName='Congenital anomalies of the newborn'  AND  /value@code= Code= '260413007', CodeSystemName= 'SNOMED CT', DisplayName= 'None'		
Mapping to HL7 v2.6 BFDR (5b)			
Mapping Location and Content	Example	Usage	
OBX-2 SHALL contain CWE	OBX 27 CWE 73780-9^Congenital anomalies of the Newborn	PSMLBDI	
		PSMFDI	



OBX-3 SHALL contain 73780-9^Congenital anomalies of the newborn OBX-5 SHALL contain 260413007^None (qualifier value)	^LN  260413007^None (qualifier value)^SNM      F	PSLBI	Y
		PSFLBI	Y
		PSFFDI	Y
		PSFDI	Y
		JLBI	Y
		JFDI	Y
		CCOFDI	

1480

### 6.6.1.1.58 DNA55 Date of Last Live Birth

DNA55 Derivation Rule (2)																				
This section intentionally left blank.																				
Variable Name	Source in EMR Using FHIR (1a)	Source in EMR Using CDA Labor and Delivery Summary-VR XPATH (1b)																		
N/A	N/A	N/A																		
Mapping to HL7 FHIR BFDR (5a)																				
FHIR Profile/Resource	Content																			
<a href="#">Composition - Provider Live Birth Report</a> OR <a href="#">Composition - Provider Fetal Death Report</a> <ul style="list-style-type: none"> <li>PENDING</li> </ul>	PENDING																			
Mapping to HL7 v2.6 BFDR (5b)																				
Mapping Location and Content	Example	Usage																		
PENDING	PENDING	<table border="1"> <tr><td>PSMLBDI</td><td></td></tr> <tr><td>PSMFDI</td><td></td></tr> <tr><td>PSLBI</td><td></td></tr> <tr><td>PSFLBI</td><td></td></tr> <tr><td>PSFFDI</td><td></td></tr> <tr><td>PSFDI</td><td></td></tr> <tr><td>JLBI</td><td></td></tr> <tr><td>JFDI</td><td></td></tr> <tr><td>CCOFDI</td><td></td></tr> </table>	PSMLBDI		PSMFDI		PSLBI		PSFLBI		PSFFDI		PSFDI		JLBI		JFDI		CCOFDI	
PSMLBDI																				
PSMFDI																				
PSLBI																				
PSFLBI																				
PSFFDI																				
PSFDI																				
JLBI																				
JFDI																				
CCOFDI																				

### 6.6.1.1.59 YLLB Date of Last Live Birth

YLLB Derivation Rule (2)
--------------------------

IHE Quality, Research and Public Health Technical Framework Supplement – Birth and Fetal Death Reporting-Enhanced (BFDR-E)

<p>IF \$PregnancyHistoryObservationCode CONTAINS ValueSet (<i>Date of Last Live Birth (NCHS)</i>), THEN (IF \$PregnancyHistoryObservationValue NOT NULL THEN “YLLB” SHALL = the Year part of \$PregnancyHistoryObservationValue WHERE \$PregnancyHistoryObservationValue is expressed as Date AND WHERE the Year is represented using 4-digits ELSE “YLLB” SHALL = ‘8888’) ELSE “YLLB” SHALL = ‘9999’</p>			
Variable Name	Source in EMR Using FHIR (1a)	Source in EMR Using CDA Labor and Delivery Summary-VR XPATH (1b)	
\$PregnancyHistoryObservationCode	observation.code constrained by: ( http://ihe.net/fhir/StructureDefinition/IHE.BFDRE.MaternalObservationsLLB )	ClinicalDocument/component/structuredBody/component/section[templateId[@root='1.3.6.1.4.1.19376.1.5.3.1.1.5.3.4']] /entry /observation/code Pregnancy History Section	
\$PregnancyHistoryObservationValue	observation.valueDateTime	ClinicalDocument/component/structuredBody/component/section[templateId[@root='1.3.6.1.4.1.19376.1.5.3.1.1.5.3.4']] /entry /observation/value	
Mapping to HL7 FHIR BFDR (5a)			
FHIR Profile/Resource		Content	
<a href="#">Composition - Provider Live Birth Report</a> OR <a href="#">Composition - Provider Fetal Death Report</a> <ul style="list-style-type: none"> <li>PENDING</li> </ul>		/code@code= Code='68499-3', CodeSystemName= 'LOINC', DisplayName='Date last live birth' AND /value@value= YLLB	
Mapping to HL7 v2.6 BFDR (5b)			
Mapping Location and Content	Example	Usage	
OBX-2 SHALL contain DTM OBX-3 SHALL contain 68499-3^Date last live birth OBX-5 SHALL contain the date of birth of the last live-born infant (month and year) excluding this delivery. Includes live-born infants now living and now dead. If this was a multiple delivery, include all live born infants who preceded the live born infant in this delivery. If first born, do not include this infant. If second born, include the first born. (Month and year should be provided.)	OBX 14 DTM 68499-3^Date last live birth^LN  20090926	PSMLBDI	
		PSMFDI	
		PSLBI	Y
		PSFLBI	Y
		PSFFDI	Y
		PSFDI	Y
		JLBI	Y
		JFDI	Y
CCOFDI			

1485

6.6.1.1.60 MLLB Date Last Normal Menses Began

MLLB Derivation Rule (2)
<p>IF \$PregnancyHistoryObservationCode CONTAINS ValueSet (<i>Date of Last Live Birth (NCHS)</i>), THEN (IF \$PregnancyHistoryObservationValue NOT NULL THEN “MLLB” SHALL = the Month part of \$PregnancyHistoryObservationValue WHERE \$PregnancyHistoryObservationValue is expressed as Date AND WHERE the Month is represented using 2-digits ELSE “MLLB” SHALL = ‘88’) ELSE “YLLB” SHALL = ‘99’</p>

IHE Quality, Research and Public Health Technical Framework Supplement – Birth and Fetal Death Reporting-Enhanced (BFDR-E)

Variable Name	Source in EMR Using FHIR (1a)	Source in EMR Using CDA Labor and Delivery Summary-VR XPATH (1b)	
\$PregnancyHistoryObservationCode	observation.code constrained by: ( http://ihe.net/fhir/StructureDefinition/IHE.BFDRE.MaternalObservationsLLB )	ClinicalDocument/component/structuredBody/component/section[templateId[@root='1.3.6.1.4.1.19376.1.5.3.1.1.5.3.4']]entry/observation/code	
\$PregnancyHistoryObservationValue	observation.valueDateTime	ClinicalDocument/component/structuredBody/component/section[templateId[@root='1.3.6.1.4.1.19376.1.5.3.1.1.5.3.4']]entry/observation/value	
Mapping to HL7 FHIR BFDR (5a)			
FHIR Profile/Resource	Content		
<a href="#">Composition - Provider Live Birth Report</a> OR <a href="#">Composition - Provider Fetal Death Report</a> <ul style="list-style-type: none"> <li>PENDING</li> </ul>	/code@code= Code='68499-3', CodeSystemName= 'LOINC', DisplayName='Date last live birth' AND /value@value= MLLB		
Mapping to HL7 v2.6 BFDR (5b)			
Mapping Location and Content	Example	Usage	
OBX-2 SHALL contain DTM OBX-3 SHALL contain 68499-3^Date last live birth OBX-5 SHALL contain the date of birth of the last live-born infant (month and year) excluding this delivery. Includes live-born infants now living and now dead. If this was a multiple delivery, include all live born infants who preceded the live born infant in this delivery. If first born, do not include this infant. If second born, include the first born. (Month and year should be provided.)	OBX 14 DTM 68499-3^Date last live birth^LN  20090926	PSMLBDI	
		PSMFDI	
		PSLBI	Y
		PSFLBI	Y
		PSFFDI	Y
		PSFDI	Y
		JLBI	Y
		JFDI	Y
CCOFDI			

6.6.1.1.61 DLMP\_DY Date Last Normal Menses Began [Day]

DLMP_DY Derivation Rule (2)		
IF \$PregnancyHistoryObservationCode CONTAINS ValueSet ( <a href="#">Date of Last Menses (NCHS)</a> ), THEN "DLMP_DY" SHALL = Day part of \$PregnancyHistoryObservationValue WHERE \$PregnancyHistoryObservationValue is expressed as Date		
Variable Name	Source in EMR Using FHIR (1a)	Source in EMR Using CDA Labor and Delivery Summary-VR XPATH (1b)
\$PregnancyHistoryObservationCode	observation.code constrained by: ( http://ihe.net/fhir/StructureDefinition/IHE.BFDRE.MaternalObservationsLLB )	ClinicalDocument/component/structuredBody/component/section[templateId[@root='1.3.6.1.4.1.19376.1.5.3.1.1.5.3.4']]entry/observation/code

IHE Quality, Research and Public Health Technical Framework Supplement – Birth and Fetal Death Reporting-Enhanced (BFDR-E)

	structureDefinition/IHE.BFDRE.MaternalObservationsLMP)																			
<b>\$PregnancyHistoryObservationValue</b>	observation.valueDateTime	ClinicalDocument/component/structuredBody/component/section[templateId[@root='1.3.6.1.4.1.19376.1.5.3.1.1.5.3.4']]//entry/observation/value																		
<b>Mapping to HL7 FHIR BFDR (5a)</b>																				
<b>FHIR Profile/Resource</b>		<b>Content</b>																		
<a href="#">Composition - Provider Live Birth Report</a> OR <a href="#">Composition - Provider Fetal Death Report</a> <ul style="list-style-type: none"> <li>PENDING</li> </ul>		/code@code= Code=' 8665-2', CodeSystemName= 'LOINC', DisplayName=' Date last menstrual period'  AND  /value@value contains DLMP_DY																		
<b>Mapping to HL7 v2.6 BFDR (5b)</b>																				
<b>Mapping Location and Content</b>	<b>Example</b>	<b>Usage</b>																		
OBX-2 SHALL contain DTM OBX-3 SHALL contain 8665-2^Date last menstrual period OBX-5 SHALL contain the date the mother's last normal menstrual period began. (month, day and year.)	OBX 16 DTM 8665-2^ Date last menstrual period   20100418	<table border="1"> <tr><td>PSMLBDI</td><td></td></tr> <tr><td>PSMFDI</td><td></td></tr> <tr><td>PSLBI</td><td>Y</td></tr> <tr><td>PSFLBI</td><td>Y</td></tr> <tr><td>PSFFDI</td><td>Y</td></tr> <tr><td>PSFDI</td><td>Y</td></tr> <tr><td>JLBI</td><td>Y</td></tr> <tr><td>JFDI</td><td>Y</td></tr> <tr><td>CCOFDI</td><td></td></tr> </table>	PSMLBDI		PSMFDI		PSLBI	Y	PSFLBI	Y	PSFFDI	Y	PSFDI	Y	JLBI	Y	JFDI	Y	CCOFDI	
PSMLBDI																				
PSMFDI																				
PSLBI	Y																			
PSFLBI	Y																			
PSFFDI	Y																			
PSFDI	Y																			
JLBI	Y																			
JFDI	Y																			
CCOFDI																				

**6.6.1.1.62 DLMP\_MO Date Last Normal Menses Began [Month]**

<b>DLMP_MO Derivation Rule (2)</b>		
IF \$PregnancyHistoryObservationCode CONTAINS ValueSet ( <a href="#">Date of Last Menses (NCHS)</a> ), THEN "DLMP_MO" SHALL = Month part of \$PregnancyHistoryObservationValue WHERE \$PregnancyHistoryObservationValue is expressed as Date		
<b>Variable Name</b>	<b>Source in EMR Using FHIR (1a)</b>	<b>Source in EMR Using CDA Labor and Delivery Summary-VR XPATH (1b)</b>
<b>\$PregnancyHistoryObservationCode</b>	observation.code constrained by: ( <a href="http://ihe.net/fhir/StructureDefinition/IHE.BFDRE.MaternalObservationsLMP">http://ihe.net/fhir/StructureDefinition/IHE.BFDRE.MaternalObservationsLMP</a> )	ClinicalDocument/component/structuredBody/component/section[templateId[@root='1.3.6.1.4.1.19376.1.5.3.1.1.5.3.4']]//entry/observation/code
<b>\$PregnancyHistoryObservationValue</b>	observation.valueDateTime	ClinicalDocument/component/structuredBody/component/section[templateId[@root='1.3.6.1.4.1.19376.1.5.3.1.1.5.3.4']]//entry/observation/value

Mapping to HL7 FHIR BFDR (5a)			
FHIR Profile/Resource	Content		
<a href="#">Composition - Provider Live Birth Report</a> OR <a href="#">Composition - Provider Fetal Death Report</a> <ul style="list-style-type: none"> <li>PENDING</li> </ul>	/code@code= Code=' 8665-2', CodeSystemName= 'LOINC', DisplayName=' Date last menstrual period' AND /value@value contains DLMP_MO		
Mapping to HL7 v2.6 BFDR (5b)			
Mapping Location and Content	Example	Usage	
OBX-2 SHALL contain DTM OBX-3 SHALL contain 8665-2^Date last menstrual period OBX-5 SHALL contain the date the mother's last normal menstrual period began. (month, day and year.)	OBX 16 DTM 8665-2^ Date last menstrual period   20100418	PSMLBDI	
		PSMFDI	
		PSLBI	Y
		PSFLBI	Y
		PSFFDI	Y
		PSFDI	Y
		JLBI	Y
		JFDI	Y
CCOFDI			

1490

### 6.6.1.1.63 DLMP\_YR Date Last Normal Menses Began [Year]

----- Derivation Rule (2)		
IF \$PregnancyHistoryObservationCode CONTAINS ValueSet ( <a href="#">Date of Last Menses (NCHS)</a> ), THEN "DLMP_YR" SHALL = Year part of \$PregnancyHistoryObservationValue WHERE \$PregnancyHistoryObservationValue is expressed as Date		
Variable Name	Source in EMR Using FHIR (1a)	Source in EMR Using CDA Labor and Delivery Summary-VR XPATH (1b)
\$PregnancyHistoryObservationCode	observation.code constrained by: ( <a href="http://ihe.net/fhir/StructureDefinition/IHE.BFDRE.MaternalObservationsLMP">http://ihe.net/fhir/StructureDefinition/IHE.BFDRE.MaternalObservationsLMP</a> )	ClinicalDocument/component/structuredBody/component/section[templateId[@root='1.3.6.1.4.1.19376.1.5.3.1.1.5.3.4']] /entry/observation/code
\$PregnancyHistoryObservationValue	observation.valueDateTime	ClinicalDocument/component/structuredBody/component/section[templateId[@root='1.3.6.1.4.1.19376.1.5.3.1.1.5.3.4']] /entry/observation/value
Mapping to HL7 FHIR BFDR (5a)		

IHE Quality, Research and Public Health Technical Framework Supplement – Birth and Fetal Death Reporting-Enhanced (BFDR-E)

FHIR Profile/Resource		Content		
<a href="#">Composition - Provider Live Birth Report</a> OR <a href="#">Composition - Provider Fetal Death Report</a> <ul style="list-style-type: none"> <li>PENDING</li> </ul>		/code@code= Code=' 8665-2', CodeSystemName= 'LOINC', DisplayName=' Date last menstrual period' AND /value@value contains DLMP_YR		
Mapping to HL7 v2.6 BFDR (5b)				
Mapping Location and Content		Example	Usage	
OBX-2 SHALL contain DTM OBX-3 SHALL contain 8665-2^Date last menstrual period OBX-5 SHALL contain the date the mother's last normal menstrual period began. (month, day and year.)		OBX 16 DM 8665-2^ Date last menstrual period   20100418	PSMLBDI	
			PSMFDI	
			PSLBI	Y
			PSFLBI	Y
			PSFFDI	Y
			PSFDI	Y
			JLBI	Y
			JFDI	Y
			CCOFDI	

1495

6.6.1.1.64 YOPO Date of Last Other Pregnancy Outcome [Year]

YOPO Derivation Rule (2)		
IF \$PregnancyHistoryObservationCode CONTAINS ValueSet ( <a href="#">Date of Last Other Pregnancy Outcome (NCHS)</a> ), THEN (IF \$PregnancyHistoryObservationValue NOT NULL THEN "YOPO" SHALL = the Year part of \$PregnancyHistoryObservationValue WHERE \$PregnancyHistoryObservationValue is expressed as Date AND WHERE the Year is represented using 4-digits ELSE YOPO" SHALL = '8888') ELSE "YOPO" SHALL = '9999'		
Variable Name	Source in EMR Using FHIR (1a)	Source in EMR Using CDA Labor and Delivery Summary-VR XPATH (1b)
\$PregnancyHistoryObservationCode	observation.code constrained by: (http://ihe.net/fhir/StructureDefinition/IHE.BFDRE.MaternalObservationsOPO)	ClinicalDocument/component/structuredBody/component/section[templateId[@root='1.3.6.1.4.1.19376.1.5.3.1.1.5.3.4']]//entry/observation/code
\$PregnancyHistoryObservationValue	observation.valueDateTime	ClinicalDocument/component/structuredBody/component/section[templateId[@root='1.3.6.1.4.1.19376.1.5.3.1.1.5.3.4']]//entry/observation/value
Mapping to HL7 FHIR BFDR (5a)		
FHIR Profile/Resource		Content

IHE Quality, Research and Public Health Technical Framework Supplement – Birth and Fetal Death Reporting-Enhanced (BFDR-E)

<a href="#">Composition - Provider Live Birth Report</a> OR <a href="#">Composition - Provider Fetal Death Report</a> <ul style="list-style-type: none"> <li>PENDING</li> </ul>	/code@code= Code='69043-8', CodeSystemName= 'LOINC', DisplayName='Other pregnancy outcomes'  AND  /effectiveTime contains YOPO		
Mapping to HL7 v2.6 BFDR (5b)			
Mapping Location and Content	Example	Usage	
OBX-2 SHALL contain DTM OBX-3 SHALL contain 68500-8^Date last other pregnancy outcome OBX-5 SHALL contain the date that the last pregnancy that did not result in a live birth ended. Includes pregnancy losses at any gestation age. (month and year)	OBX 16 DTM 68500-8^Date last other pregnancy outcome  20100418	PSMLBDI	
		PSMFDI	
		PSLBI	Y
		PSFLBI	Y
		PSFFDI	Y
		PSFDI	Y
		JLBI	Y
		JFDI	Y
CCOFDI			

1500

**6.6.1.1.65 MOPO Date of Last Other Pregnancy Outcome [Month]**

MOPO Derivation Rule (2)		
IF \$PregnancyHistoryObservationCode CONTAINS ValueSet ( <a href="#">Date of Last Other Pregnancy Outcome (NCHS)</a> ), THEN (IF \$PregnancyHistoryObservationValue NOT NULL THEN “MOPO” SHALL = the Month part of \$PregnancyHistoryObservationValue WHERE \$PregnancyHistoryObservationValue is expressed as Date AND WHERE the Month is represented using 2-digits ELSE “MOPO” SHALL = ‘88’) ELSE “MOPO” SHALL = ‘99’		
Variable Name	Source in EMR Using FHIR (1a)	Source in EMR Using CDA Labor and Delivery Summary-VR XPATH (1b)
\$PregnancyHistoryObservationCode	observation.code constrained by: ( <a href="http://ihe.net/fhir/StructureDefinition/IHE.BFDRE.MaternalObservationsOPO">http://ihe.net/fhir/StructureDefinition/IHE.BFDRE.MaternalObservationsOPO</a> )	ClinicalDocument/component/structuredBody/component/section[templateId[@root='1.3.6.1.4.1.19376.1.5.3.1.1.5.3.4']]//entry/observation/code
\$PregnancyHistoryObservationValue	observation.valueDateTime	ClinicalDocument/component/structuredBody/component/section[templateId[@root='1.3.6.1.4.1.19376.1.5.3.1.1.5.3.4']]//entry/observation/value
Mapping to HL7 FHIR BFDR (5a)		
FHIR Profile/Resource	Content	
<a href="#">Composition - Provider Live Birth Report</a> OR <a href="#">Composition - Provider Fetal Death Report</a>	/code@code= Code='69043-8', CodeSystemName= 'LOINC', DisplayName='Other pregnancy outcomes'	

IHE Quality, Research and Public Health Technical Framework Supplement – Birth and Fetal Death Reporting-Enhanced (BFDR-E)

<ul style="list-style-type: none"> <li>PENDING</li> </ul>	AND /effectiveTime contains MOPO																		
Mapping to HL7 v2.6 BFDR (5b)																			
Mapping Location and Content	Example																		
OBX-2 SHALL contain DTM OBX-3 SHALL contain 68500-8^Date last other pregnancy outcome OBX-5 SHALL contain the date that the last pregnancy that did not result in a live birth ended. Includes pregnancy losses at any gestation age. (month and year)	OBX 16 DTM 68500-8^Date last other pregnancy outcome  20100418																		
	<table border="1"> <tr><td>PSMLBDI</td><td></td></tr> <tr><td>PSMFDI</td><td></td></tr> <tr><td>PSLBI</td><td>Y</td></tr> <tr><td>PSFLBI</td><td>Y</td></tr> <tr><td>PSFFDI</td><td>Y</td></tr> <tr><td>PSFDI</td><td>Y</td></tr> <tr><td>JLBI</td><td>Y</td></tr> <tr><td>JFDI</td><td>Y</td></tr> <tr><td>CCOFDI</td><td></td></tr> </table>	PSMLBDI		PSMFDI		PSLBI	Y	PSFLBI	Y	PSFFDI	Y	PSFDI	Y	JLBI	Y	JFDI	Y	CCOFDI	
PSMLBDI																			
PSMFDI																			
PSLBI	Y																		
PSFLBI	Y																		
PSFFDI	Y																		
PSFDI	Y																		
JLBI	Y																		
JFDI	Y																		
CCOFDI																			

6.6.1.1.66 ADDRESS\_D Facility Address

ADDRESS_D Derivation Rule (2)										
“Facility Address” SHALL be populated using the \$ChildFacilityAddress.										
Variable Name	Source in EMR Using FHIR (1a)	Source in EMR Using CDA Labor and Delivery Summary-VR XPATH (1b)								
\$ChildFacilityAddress	encounter.serviceProvider(organization.name)	ClinicalDocument/componentOf/encompassingEncounter/location/healthCareFacility/location/addr								
Mapping to HL7 FHIR BFDR (5a)										
FHIR Profile/Resource	Content									
<a href="#">Composition - Provider Live Birth Report</a> OR <a href="#">Composition - Provider Fetal Death Report</a> <ul style="list-style-type: none"> <li>PENDING</li> </ul>	/participant/participantRole/addr = ADDRESS_D									
Mapping to HL7 v2.6 BFDR (5b)										
Mapping Location and Content	Example	Usage								
PID-11 where XAD_BR-7 Address Type is BDL (.Birth delivery location (address where birth occurred)) from PHVS_BirthReportingAddressType_NCHS	PID 1  123456688^^^MRN  Johnson^Baby  20110313 F  300 Main St^^Metropolis^Rhode Island^03443^BDL       N	<table border="1"> <tr><td>PSMLBDI</td><td></td></tr> <tr><td>PSMFDI</td><td></td></tr> <tr><td>PSLBI</td><td>Y</td></tr> <tr><td>PSFLBI</td><td>Y</td></tr> </table>	PSMLBDI		PSMFDI		PSLBI	Y	PSFLBI	Y
PSMLBDI										
PSMFDI										
PSLBI	Y									
PSFLBI	Y									



		PSFFDI	Y
		PSFDI	Y
		JLBI	Y
		JFDI	Y
		CCOFDI	

1505

**6.6.1.1.67 FNAME Facility Name [if Not institution, give street and number]**

FNAME Derivation Rule (2)																				
FNAME” SHALL be populated using the \$ChildFacilityName.																				
Variable Name	Source in EMR Using FHIR (1a)	Source in EMR Using CDA Labor and Delivery Summary-VR XPATH (1b)																		
\$ChildFacilityName	encounter.serviceProvider(organization.name)	ClinicalDocument/componentOf/encompassingEncounter/location/healthCareFacility/location/name																		
Mapping to HL7 FHIR BFDR (5a)																				
FHIR Profile/Resource	Content																			
<a href="#">Composition - Provider Live Birth Report</a> OR <a href="#">Composition - Provider Fetal Death Report</a> <ul style="list-style-type: none"> <li>PENDING</li> </ul>	/participant/participantRole/playingEntity/name = FNAME																			
Mapping to HL7 v2.6 BFDR (5b)																				
Mapping Location and Content	Example	Usage																		
OBX-2 SHALL contain AD OBX-3 SHALL contain 62330-6 ^Birth Hospital Facility Name OBX-5 SHALL contain the name of the facility where the delivery occurred	OBX 16 AD  62330-6^Birth Hospital Facility Name    Good Health Hospital	<table border="1"> <tr><td>PSMLBDI</td><td></td></tr> <tr><td>PSMFDI</td><td></td></tr> <tr><td>PSLBI</td><td>Y</td></tr> <tr><td>PSFLBI</td><td>Y</td></tr> <tr><td>PSFFDI</td><td>Y</td></tr> <tr><td>PSFDI</td><td>Y</td></tr> <tr><td>JLBI</td><td>Y</td></tr> <tr><td>JFDI</td><td>Y</td></tr> <tr><td>CCOFDI</td><td></td></tr> </table>	PSMLBDI		PSMFDI		PSLBI	Y	PSFLBI	Y	PSFFDI	Y	PSFDI	Y	JLBI	Y	JFDI	Y	CCOFDI	
PSMLBDI																				
PSMFDI																				
PSLBI	Y																			
PSFLBI	Y																			
PSFFDI	Y																			
PSFDI	Y																			
JLBI	Y																			
JFDI	Y																			
CCOFDI																				

**6.6.1.1.68 FNPI Facility National Provider Identifier**

FNPI Derivation Rule (2)
“FNPI” SHALL be populated using the \$ChildFacilityNPI.

IHE Quality, Research and Public Health Technical Framework Supplement – Birth and Fetal Death Reporting-Enhanced (BFDR-E)

Variable Name	Source in EMR Using FHIR (1a)	Source in EMR Using CDA Labor and Delivery Summary-VR XPATH (1b)																		
\$ChildFacilityNPI	encounter.serviceProvider(organization.identifier)	ClinicalDocument/componentOf/encompassingEncounter/location/healthCareFacility/location/id																		
<b>Mapping to HL7 FHIR BFDR (5a)</b>																				
FHIR Profile/Resource		Content																		
<a href="#">Composition - Provider Live Birth Report</a> OR <a href="#">Composition - Provider Fetal Death Report</a> <ul style="list-style-type: none"> <li>PENDING</li> </ul>		/participant/participantRole/id = FNPI																		
<b>Mapping to HL7 v2.6 BFDR (5b)</b>																				
Mapping Location and Content	Example	Usage																		
OBX-2 SHALL contain AD OBX-3 SHALL contain 62329-8 ^Facility ID OBX-5 SHALL contain the national identifier of the facility where the delivery occurred	OBX 16 AD 62329-8 I^Facility ID    12345	<table border="1"> <tr><td>PSMLBDI</td><td></td></tr> <tr><td>PSMFDI</td><td></td></tr> <tr><td>PSLBI</td><td>Y</td></tr> <tr><td>PSFLBI</td><td>Y</td></tr> <tr><td>PSFFDI</td><td>Y</td></tr> <tr><td>PSFDI</td><td>Y</td></tr> <tr><td>JLBI</td><td>Y</td></tr> <tr><td>JFDI</td><td>Y</td></tr> <tr><td>CCOFDI</td><td></td></tr> </table>	PSMLBDI		PSMFDI		PSLBI	Y	PSFLBI	Y	PSFFDI	Y	PSFDI	Y	JLBI	Y	JFDI	Y	CCOFDI	
PSMLBDI																				
PSMFDI																				
PSLBI	Y																			
PSFLBI	Y																			
PSFFDI	Y																			
PSFDI	Y																			
JLBI	Y																			
JFDI	Y																			
CCOFDI																				

**6.6.1.1.69 CHAM Infections Present and Treated During This Pregnancy [Chlamydia]**

<b>CHAM Derivation Rule (2)</b>		
IF (\$ProblemCode CONTAINS ValueSet ( <a href="#">Chlamydia (NCHS)</a> ) OR (\$InfectionHistoryProblemCode CONTAINS ValueSet ( <a href="#">Chlamydia (NCHS)</a> ) THEN “CHAM” SHALL = “Y” ELSE “N”.		
Variable Name	Source in EMR Using FHIR (1a)	Source in EMR Using CDA Labor and Delivery Summary-VR XPATH (1b)
\$ProblemCode	condition.code	ClinicalDocument/component/structuredBody/component/section[templateId[@root='1.3.6.1.4.1.19376.1.5.3.1.3.6']]/entry/act/entryRelationship/observation/value
\$InfectionHistoryProblemCode	N/A- only verified by condition.code	ClinicalDocument/component/structuredBody/component/section[templateId[@root='1.3.6.1.4.1.19376.1.5.3.1.1.16.2.1.1.1']]/entry/act/entryRelationship/observation/value
<b>Mapping to HL7 FHIR BFDR (5a)</b>		
FHIR Profile/Resource		Content
<a href="#">Composition - Provider Live Birth Report</a>		IF CHAM = 'Y' then

OR <a href="#">Composition - Provider Fetal Death Report</a> • PENDING	/code@code= Code= '72519-2', CodeSystemName= 'LOINC', DisplayName= 'Infections present and or treated during this pregnancy for live birth' AND /value@code= Code= '105629000', CodeSystemName= 'SNOMED CT', DisplayName= 'Chlamydia infection'																				
Mapping to HL7 v2.6 BFDR (5b)																					
Mapping Location and Content	Example																				
For Live Birth: OBX-2 SHALL contain CWE OBX-3 SHALL contain 72519-2^ Infections present &or treated during this pregnancy for live birth OBX-5 SHALL contain 105629000^Chlamydial infection  For Fetal Death: OBX-2 SHALL contain CWE OBX-3 SHALL contain 73769-2^ Infections present and treated during the pregnancy for fetal death OBX-5 SHALL contain 105629000^Chlamydial infection	For Live Birth: OBX 20 CWE 72519-2^Infections present and treated during this pregnancy for live birth^LN  105629000^Chlamydial infection ^SNM     F  For Fetal Death: OBX 19 CWE 73769-2^Infections present treated during the pregnancy for fetal death^LN  105629000^Chlamydial infection ^SNM     F																				
	<table border="1"> <thead> <tr> <th colspan="2">Usage</th> </tr> </thead> <tbody> <tr> <td>PSMLBDI</td> <td></td> </tr> <tr> <td>PSMFDI</td> <td></td> </tr> <tr> <td>PSLBI</td> <td>Y</td> </tr> <tr> <td>PSFLBI</td> <td>Y</td> </tr> <tr> <td>PSFFDI</td> <td>Y</td> </tr> <tr> <td>PSFDI</td> <td>Y</td> </tr> <tr> <td>JLBI</td> <td>Y</td> </tr> <tr> <td>JFDI</td> <td>Y</td> </tr> <tr> <td>CCOFDI</td> <td></td> </tr> </tbody> </table>	Usage		PSMLBDI		PSMFDI		PSLBI	Y	PSFLBI	Y	PSFFDI	Y	PSFDI	Y	JLBI	Y	JFDI	Y	CCOFDI	
Usage																					
PSMLBDI																					
PSMFDI																					
PSLBI	Y																				
PSFLBI	Y																				
PSFFDI	Y																				
PSFDI	Y																				
JLBI	Y																				
JFDI	Y																				
CCOFDI																					

1510

### 6.6.1.1.70 GON Infections Present and Treated During This Pregnancy [Gonorrhea]

GON Derivation Rule (2)		
IF (\$ProblemCode CONTAINS ValueSet ( <a href="#">Gonorrhea (NCHS)</a> ) OR (\$InfectionHistoryProblemCode CONTAINS ValueSet ( <a href="#">Gonorrhea (NCHS)</a> )) THEN "GON" SHALL = "Y" ELSE "N".		
Variable Name	Source in EMR Using FHIR (1a)	Source in EMR Using CDA Labor and Delivery Summary-VR XPATH (1b)
\$ProblemCode	condition.code	ClinicalDocument/component/structuredBody/component/section[templateId[@root='1.3.6.1.4.1.19376.1.5.3.1.3.6']]/entry/act/entryRelationship/observation/value
\$InfectionHistoryProblemCode	N/A- only verified by condition.code	ClinicalDocument/component/structuredBody/component/section[templateId[@root='1.3.6.1.4.1.19376.1.5.3.1.1.16.2.1.1.1']]/entry/act/entryRelationship/observation/value
Mapping to HL7 FHIR BFDR (5a)		
FHIR Profile/Resource	Content	
<a href="#">Composition - Provider Live Birth Report</a> OR <a href="#">Composition - Provider Fetal Death Report</a> • PENDING	IF GON = 'Y' then  /code@code= Code= '72519-2', CodeSystemName= 'LOINC', DisplayName= 'Infections present and or treated during this pregnancy for live birth' AND	

		/value@code= Code= '1562800', CodeSystemName= 'SNOMED CT', DisplayName= 'Gonorrhea'	
Mapping to HL7 v2.6 BFDR (5b)			
Mapping Location and Content		Example	
<p>For Live Birth:                      OBX-2 SHALL contain CWE                      OBX-3 SHALL contain 72519-2^ Infections present &amp;or treated during this pregnancy for live birth                      OBX-5 SHALL contain 15628003^Gonorrhea</p> <p>For Fetal Death:                      OBX-2 SHALL contain CWE                      OBX-3 SHALL contain 73769-2^ Infections present and treated during the pregnancy for fetal death                      OBX-5 SHALL contain 15628003^Gonorrhea</p>		<p>For Live Birth:                      OBX 20 CWE 72519-2^Infections present and treated during this pregnancy for live birth^LN  15628003^Gonorrhea^SNM     F</p> <p>For Fetal Death:                      OBX 19 CWE 73769-2^Infections present treated during the pregnancy for fetal death^LN 15628003^Gonorrhea^SNM     F</p>	
		PSMLBDI	
		PSMFDI	
		PSLBI	Y
		PSFLBI	Y
		PSFFDI	Y
		PSFDI	Y
		JLBI	Y
		JFDI	Y
		CCOFDI	

### 6.6.1.1.71 HEPB Infections Present and Treated During This Pregnancy [Hepatitis B]

HEPB Derivation Rule (2)		
IF (\$ProblemCode CONTAINS ValueSet ( <a href="#">Hepatitis B (NCHS)</a> ) OR (\$InfectionHistoryProblemCode CONTAINS ValueSet ( <a href="#">Hepatitis B (NCHS)</a> )) THEN "HEPB" SHALL = "Y" ELSE "N".		
Variable Name	Source in EMR Using FHIR (1a)	Source in EMR Using CDA Labor and Delivery Summary-VR XPATH (1b)
\$ProblemCode	condition.code	ClinicalDocument/component/structuredBody/component/section[templateId[@root='1.3.6.1.4.1.19376.1.5.3.1.3.6']]/entry/act/entryRelationship/observation/value
\$InfectionHistoryProblemCode	N/A- only verified by condition.code	ClinicalDocument/component/structuredBody/component/section[templateId[@root='1.3.6.1.4.1.19376.1.5.3.1.1.16.2.1.1.1']]/entry/act/entryRelationship/observation/value
Mapping to HL7 FHIR BFDR (5a)		
FHIR Profile/Resource	Content	
<a href="#">Composition - Provider Live Birth Report</a> <ul style="list-style-type: none"> <li>PENDING</li> </ul>	IF HEPB = 'Y' then /code@code= Code= '72519-2', CodeSystemName= 'LOINC', DisplayName= 'Infections present and or treated during this pregnancy for live birth' AND /value@code= Code= '66071002', CodeSystemName= 'SNOMED CT', DisplayName= 'Type B viral hepatitis'	
Mapping to HL7 v2.6 BFDR (5b)		
Mapping Location and Content	Example	Usage

IHE Quality, Research and Public Health Technical Framework Supplement – Birth and Fetal Death Reporting-Enhanced (BFDR-E)

<p>For Live Birth: OBX-2 SHALL contain CWE OBX-3 SHALL contain 72519-2^ Infections present &amp;or treated during this pregnancy for live birth OBX-5 SHALL contain 66071002^ Type B viral hepatitis</p> <p>For Fetal Death: OBX-2 SHALL contain CWE OBX-3 SHALL contain 73769-2^ Infections present and treated during the pregnancy for fetal death OBX-5 SHALL contain 66071002^ Type B viral hepatitis</p>	<p>For Live Birth: OBX 20 CWE 72519-2^Infections present and treated during this pregnancy for live birth^LN  66071002^ Type B viral hepatitis ^SNM     F</p> <p>For Fetal Death: OBX 19 CWE 73769-2^Infections present treated during the pregnancy for fetal death^LN 66071002^ Type B viral hepatitis ^SNM     F</p>	PSMLBDI	
		PSMFDI	
		PSLBI	Y
		PSFLBI	Y
		PSFFDI	
		PSFDI	
		JLBI	Y
		JFDI	
CCOFDI			

1515

**6.6.1.1.72 HEPC Infections Present and Treated During This Pregnancy [Hepatitis C]**

HEPC Derivation Rule (2)			
IF (\$ProblemCode CONTAINS ValueSet ( <a href="#">Hepatitis C (NCHS)</a> ) OR (\$InfectionHistoryProblemCode CONTAINS ValueSet ( <a href="#">Hepatitis C (NCHS)</a> )) THEN “HEPC” SHALL = “Y” ELSE “N”.			
Variable Name	Source in EMR Using FHIR (1a)	Source in EMR Using CDA Labor and Delivery Summary-VR XPATH (1b)	
\$ProblemCode	condition.code	ClinicalDocument/component/structuredBody/component/section[templateId[@root='1.3.6.1.4.1.19376.1.5.3.1.3.6']]/entry/act/entryRelationship/observation/value	
\$InfectionHistoryProblemCode	N/A- only verified by condition.code	ClinicalDocument/component/structuredBody/component/section[templateId[@root='1.3.6.1.4.1.19376.1.5.3.1.1.16.2.1.1.1']]/entry/act/entryRelationship/observation/value	
Mapping to HL7 FHIR BFDR (5a)			
FHIR Profile/Resource	Content		
<a href="#">Composition - Provider Live Birth Report</a>	<p>IF HEPC = 'Y' then</p> <p>/code@code= Code= '72519-2', CodeSystemName= 'LOINC', DisplayName= 'Infections present and or treated during this pregnancy for live birth'</p> <p>AND</p> <p>/value@code= Code= '50711007', CodeSystemName= 'SNOMED CT', DisplayName= 'Viral hepatitis C'</p>		
Mapping to HL7 v2.6 BFDR (5b)			
Mapping Location and Content	Example	Usage	
<p>For Live Birth: OBX-2 SHALL contain CWE OBX-3 SHALL contain 72519-2^Infections present &amp;or treated during this pregnancy for live birth OBX-5 SHALL contain 50711007^Viral hepatitis C</p>	<p>For Live Birth: OBX 20 CWE 72519-2^Infections present and treated during this pregnancy for live birth^LN  50711007^Viral hepatitis C^SNM     F</p>	PSMLBDI	
		PSMFDI	
		PSLBI	Y
		PSFLBI	Y

IHE Quality, Research and Public Health Technical Framework Supplement – Birth and Fetal Death Reporting-Enhanced (BFDR-E)

For Fetal Death: OBX-2 SHALL contain CWE OBX-3 SHALL contain 73769-2^Infections present and treated during the pregnancy for fetal death OBX-5 SHALL contain 50711007^Viral hepatitis C	For Fetal Death: OBX 19 CWE 73769-2^Infections present treated during the pregnancy for fetal death^LN 50711007^Viral hepatitis C^SNM      F	PSFFDI	
		PSFDI	
		JLBI	Y
		JFDI	
		CCOFDI	

**6.6.1.1.73 SYPH Infections Present and Treated During This Pregnancy [Syphilis]**

SYPH Derivation Rule (2)			
IF (\$ProblemCode CONTAINS ValueSet ( <a href="#">Syphilis (NCHS)</a> ) OR (\$InfectionHistoryProblemCode CONTAINS ValueSet ( <a href="#">Syphilis (NCHS)</a> )) THEN “SYPH” SHALL =“Y” ELSE “N”.			
Variable Name	Source in EMR Using FHIR (1a)	Source in EMR Using CDA Labor and Delivery Summary-VR XPATH (1b)	
\$ProblemCode	condition.code	ClinicalDocument/component/structuredBody/component/section[templateId[@root='1.3.6.1.4.1.19376.1.5.3.1.3.6']]/entry/act/entryRelationship/observation/value	
\$InfectionHistoryProblemCode	N/A- only verified by condition.code	ClinicalDocument/component/structuredBody/component/section[templateId[@root='1.3.6.1.4.1.19376.1.5.3.1.1.16.2.1.1.1']]/entry/act/entryRelationship/observation/value	
Mapping to HL7 FHIR BFDR (5a)			
FHIR Profile/Resource	Content		
<a href="#">Composition - Provider Live Birth Report</a> OR <a href="#">Composition - Provider Fetal Death Report</a> <ul style="list-style-type: none"> <li>PENDING</li> </ul>	IF SYPH = 'Y' then  /code@code= Code= '72519-2', CodeSystemName= 'LOINC', DisplayName= 'Infections present and or treated during this pregnancy for live birth'  AND  /value@code= Code= '76272004', CodeSystemName= 'SNOMED CT', DisplayName= 'Syphilis'		
Mapping to HL7 v2.6 BFDR (5b)			
Mapping Location and Content	Example	Usage	
For Live Birth: OBX-2 SHALL contain CWE OBX-3 SHALL contain 72519-2^Infections present &or treated during this pregnancy for live birth OBX-5 SHALL contain 76272004^Syphilis  For Fetal Death: OBX-2 SHALL contain CWE OBX-3 SHALL contain 73769-2^Infections present and treated during the pregnancy for fetal death OBX-5 SHALL contain 76272004^Syphilis	For Live Birth: OBX 20 CWE 72519-2^Infections present and treated during this pregnancy for live birth^LN  76272004^Syphilis ^SNM   F  For Fetal Death: OBX 19 CWE 73769-2^Infections present treated during the pregnancy for fetal death^LN 76272004^Syphilis^SNM      F	PSMLBDI	
		PSMFDI	
		PSLBI	Y
		PSFLBI	Y
		PSFFDI	Y
		PSFDI	Y
		JLBI	Y
JFDI	Y		

		CCOFDI	
--	--	--------	--

1520

**6.6.1.1.74 NOA02 Infections Present and Treated During This Pregnancy [None of the above]**

NOA02 Derivation Rule (2)																					
This SHALL require data entry and SHALL NOT be a result of a default from the other attributes in the list.																					
Variable Name	Source in EMR Using FHIR (1a)	Source in EMR Using CDA Labor and Delivery Summary-VR XPATH (1b)																			
N/A	N/A	N/A																			
Mapping to HL7 FHIR BFDR (5a)																					
FHIR Profile/Resource		Content																			
<a href="#">Composition - Provider Live Birth Report</a> OR <a href="#">Composition - Provider Fetal Death Report</a> <ul style="list-style-type: none"> <li>PENDING</li> </ul>		IF NOA02 = 'Y' ssthen /code@code= Code= '72519-2', CodeSystemName= 'LOINC', DisplayName= 'Infections present and or treated during this pregnancy for live birth' AND /value@code= Code= '260413007', CodeSystemName= 'SNOMED CT', DisplayName= 'None'																			
Mapping to HL7 v2.6 BFDR (5b)																					
Mapping Location and Content		Example	Usage																		
For Live Birth: OBX-2 SHALL contain CWE OBX-3 SHALL contain 72519-2^Infections present &or treated during this pregnancy for live birth OBX-5 SHALL contain 76272004^Syphilis (disorder)		For Live Birth: OBX 20 CWE 72519-2^Infections present and treated during this pregnancy for live birth^LN  260413007^None (qualifier value)^SNM     F	<table border="1"> <tr><td>PSMLBDI</td><td></td></tr> <tr><td>PSMFDI</td><td></td></tr> <tr><td>PSLBI</td><td>Y</td></tr> <tr><td>PSFLBI</td><td>Y</td></tr> <tr><td>PSFFDI</td><td>Y</td></tr> <tr><td>PSFDI</td><td>Y</td></tr> <tr><td>JLBI</td><td>Y</td></tr> <tr><td>JFDI</td><td>Y</td></tr> <tr><td>CCOFDI</td><td></td></tr> </table>	PSMLBDI		PSMFDI		PSLBI	Y	PSFLBI	Y	PSFFDI	Y	PSFDI	Y	JLBI	Y	JFDI	Y	CCOFDI	
PSMLBDI																					
PSMFDI																					
PSLBI	Y																				
PSFLBI	Y																				
PSFFDI	Y																				
PSFDI	Y																				
JLBI	Y																				
JFDI	Y																				
CCOFDI																					
For Fetal Death: OBX-2 SHALL contain CWE OBX-3 SHALL contain 73769-2^Infections present and treated during the pregnancy for fetal death OBX-5 SHALL contain 260413007^None (qualifier value)		For Fetal Death: OBX 19 CWE 73769-2^Infections present treated during the pregnancy for fetal death^LN 260413007^None (qualifier value)^SNM     F																			

**6.6.1.1.75 AINT Maternal Morbidity [Admission to Intensive care [unit]]**

AIN T Derivation Rule (2)
IF (\$EventOutcomesObservationCode CONTAINS ValueSet ( <a href="#">ICU Care (NCHS)</a> ) THEN "AINT" SHALL be "Y" ELSE "N".

IHE Quality, Research and Public Health Technical Framework Supplement – Birth and Fetal Death Reporting-Enhanced (BFDR-E)

Variable Name	Source in EMR Using FHIR (1a)	Source in EMR Using CDA Labor and Delivery Summary-VR XPATH (1b)	
\$EventOutcomesObservationCode	procedure.code	ClinicalDocument/component/structuredBody/component/section[templateId[@root='1.3.6.1.4.1.19376.1.5.3.1.1.21.2.3']]/component/section[templateId[@root='1.3.6.1.4.1.19376.1.7.3.1.1.13.7']]/entry[templateId[@root='1.3.6.1.4.1.19376.1.5.3.1.1.25.1.4.1']]/act/code	
<b>Mapping to HL7 FHIR BFDR (5a)</b>			
FHIR Profile/Resource		Content	
<a href="#">Composition - Provider Live Birth Report</a> OR <a href="#">Composition - Provider Fetal Death Report</a> <ul style="list-style-type: none"> <li>PENDING</li> </ul>		IF AINT = 'Y' then /code@code= Code= '73781-7', CodeSystemName= 'LOINC', DisplayName= 'Maternal morbidity' AND /value@code= Code= '309904001', CodeSystemName= 'SNOMED CT', DisplayName= 'Intensive care unit'	
<b>Mapping to HL7 v2.6 BFDR (5b)</b>			
Mapping Location and Content	Example	Usage	
OBX-2 SHALL contain CWE OBX-3 SHALL contain 73781-7^ Maternal morbidity OBX-5 SHALL contain 309904001^Intensive care unit	OBX 23 CWE 73781-7^Maternal Morbidity ^LN  309904001^Intensive care unit^SNM     Fs	PSMLBDI	
		PSMFDI	
		PSLBI	Y
		PSFLBI	Y
		PSFFDI	Y
		PSFDI	Y
		JLBI	Y
		JFDI	Y
CCOFDI			

**6.6.1.1.76 MTR Maternal Morbidity [Maternal Transfusion]**

<b>MTR Derivation Rule (2)</b>		
IF (\$ProcedureCode CONTAINS ValueSet ( <a href="#">Transfusion Whole Blood or Packed Red Bld (NCHS)</a> ) THEN "MTR" SHALL be "Y" ELSE "N"		
Variable Name	Source in EMR Using FHIR (1a)	Source in EMR Using CDA Labor and Delivery Summary-VR XPATH (1b)
\$ProcedureCode	procedure.code	ClinicalDocument/component/structuredBody/component/section[templateId[@root='1.3.6.1.4.1.19376.1.5.3.1.1.21.2.3']]/component/section[templateId[@root='1.3.6.1.4.1.19376.1.5.3.1.1.13.2.11']]/entry/procedure/code
<b>Mapping to HL7 FHIR BFDR (5a)</b>		
FHIR Profile/Resource		Content



<a href="#">Composition - Provider Live Birth Report</a> OR <a href="#">Composition - Provider Fetal Death Report</a> <ul style="list-style-type: none"> <li>PENDING</li> </ul>	IF MTR = 'Y' then /code@code= Code= '73781-7', CodeSystemName= 'LOINC', DisplayName= 'Maternal morbidity' AND /value@code= Code= '116859006', CodeSystemName= 'SNOMED CT', DisplayName= 'Maternal Transfusion'		
Mapping to HL7 v2.6 BFDR (5b)			
Mapping Location and Content	Example	Usage	
OBX-2 SHALL contain CWE OBX-3 SHALL contain 73781-7^ Maternal morbidity OBX-5 SHALL contain 116859006^Transfusion of blood product (procedure)	OBX 22 CWE 73781-7^Maternal Morbidity ^LN  116859006^Transfusion of blood product^SNM     F	PSMLBDI	
		PSMFDI	
		PSLBI	Y
		PSFLBI	Y
		PSFFDI	Y
		PSFDI	Y
		JLBI	Y
		JFDI	Y
CCOFDI			

1525

### 6.6.1.1.77 PLAC Maternal Morbidity [[Third or fourth degree] perineal laceration]

PLAC Derivation Rule (2)		
IF (\$EventOutcomesObservationCode CONTAINS ValueSet ( <a href="#">Third Degree Perineal Laceration (NCHS)</a> ) OR ( <a href="#">Fourth Degree Perineal Laceration (NCHS)</a> ) OR \$ProblemCode CONTAINS ValueSet ( <a href="#">Third Degree Perineal Laceration (NCHS)</a> ) OR ( <a href="#">Fourth Degree Perineal Laceration (NCHS)</a> )) THEN "PLAC" SHALL be "Y" ELSE "N"		
Variable Name	Source in EMR Using FHIR (1a)	Source in EMR Using CDA Labor and Delivery Summary-VR XPATH (1b)
\$EventOutcomesObservationCode	procedure.code	CodeClinicalDocument/component/structuredBody/component/section[templateId[@root='1.3.6.1.4.1.19376.1.5.3.1.1.21.2.3']]/component/section[templateId[@root='1.3.6.1.4.1.19376.1.7.3.1.1.13.7']]/entry/observation/value
\$ProblemCode	condition.code	ClinicalDocument/component/structuredBody/component/section[templateId[@root='1.3.6.1.4.1.19376.1.5.3.1.3.6']]/entry/act/entryRelationship/observation/value
Mapping to HL7 FHIR BFDR (5a)		
FHIR Profile/Resource	Content	
<a href="#">Composition - Provider Live Birth Report</a> OR <a href="#">Composition - Provider Fetal Death Report</a> <ul style="list-style-type: none"> <li>PENDING</li> </ul>	IF PLAC = 'Y' then /code@code= Code= '73781-7', CodeSystemName= 'LOINC', DisplayName= 'Maternal morbidity' AND	

IHE Quality, Research and Public Health Technical Framework Supplement – Birth and Fetal Death Reporting-Enhanced (BFDR-E)

		/value@code= Code= '398019008', CodeSystemName= 'SNOMED CT', DisplayName= 'Perineal laceration during delivery'		
Mapping to HL7 v2.6 BFDR (5b)				
Mapping Location and Content		Example	Usage	
OBX-2 SHALL contain CWE OBX-3 SHALL contain 73781-7^ Maternal morbidity OBX-5 SHALL contain 398019008^Perineal laceration during delivery (disorder)		OBX 22 CWE 73781-7^Maternal Morbidity ^LN  398019008^Perineal laceration during delivery (disorder)^SNM     F	PSMLBDI	
			PSMFDI	
			PSLBI	Y
			PSFLBI	Y
			PSFFDI	Y
			PSFDI	Y
			JLBI	Y
			JFDI	Y
		CCOFDI		

6.6.1.1.78 RUT Maternal Morbidity [Ruptured Uterus]

RUT Derivation Rule (2)		
IF (\$EventOutcomesObservationCode CONTAINS ValueSet ( <a href="#">Ruptured Uterus (NCHS)</a> ) OR (\$ProblemCode CONTAINS ValueSet ( <a href="#">Ruptured Uterus (NCHS)</a> )) THEN "RUT" SHALL be "Y" ELSE "N"		
Variable Name	Source in EMR Using FHIR (1a)	Source in EMR Using CDA Labor and Delivery Summary-VR XPATH (1b)
\$EventOutcomesObservationCode	procedure.code	CodeClinicalDocument/component/structuredBody/component/section[templateId[@root='1.3.6.1.4.1.19376.1.5.3.1.1.21.2.3']]/component/section[templateId[@root='1.3.6.1.4.1.19376.1.7.3.1.1.13.7']]/entry/observation/value
\$ProblemCode	condition.code	ClinicalDocument/component/structuredBody/component/section[templateId[@root='1.3.6.1.4.1.19376.1.5.3.1.3.6']]/entry/act/entryRelationship/observation/value
Mapping to HL7 FHIR BFDR (5a)		
FHIR Profile/Resource	Content	
<a href="#">Composition - Provider Live Birth Report</a> OR <a href="#">Composition - Provider Fetal Death Report</a> <ul style="list-style-type: none"> <li>PENDING</li> </ul>	IF RUT = 'Y' then /code@code= Code= '73781-7', CodeSystemName= 'LOINC', DisplayName= 'Maternal morbidity' AND /value@code= Code= '34430009', CodeSystemName= 'SNOMED CT', DisplayName= 'Rupture of uterus'	
Mapping to HL7 v2.6 BFDR (5b)		
Mapping Location and Content	Example	Usage

OBX-2 SHALL contain CWE OBX-3 SHALL contain 73781-7^ Maternal morbidity OBX-5 SHALL contain 34430009^Rupture of uterus (disorder)	OBX 22 CWE 73781-7^Maternal Morbidity ^LN  34430009^Rupture of uterus (disorder)^SNM     F	PSMLBDI	
		PSMFDI	
		PSLBI	Y
		PSFLBI	Y
		PSFFDI	Y
		PSFDI	Y
		JLBI	Y
		JFDI	Y
CCOFDI			

1530

**6.6.1.1.79 UHYS Maternal Morbidity [Unplanned hysterectomy]**

UHYS Derivation Rule (2)			
IF (\$ProcedureCode CONTAINS ValueSet ( <a href="#">Unplanned Hysterectomy (NCHS)</a> ) THEN “UHYS” SHALL be “Y” ELSE “N”			
Variable Name	Source in EMR Using FHIR (1a)	Source in EMR Using CDA Labor and Delivery Summary-VR XPATH (1b)	
\$ProcedureCode	procedure.code	ClinicalDocument/component/structuredBody/component/section[templateId[@root='1.3.6.1.4.1.19376.1.5.3.1.1.21.2.3']]/component/section[templateId[@root='1.3.6.1.4.1.19376.1.5.3.1.1.13.2.11']]/entry/procedure/code	
Mapping to HL7 FHIR BFDR (5a)			
FHIR Profile/Resource	Content		
<a href="#">Composition - Provider Live Birth Report</a> OR <a href="#">Composition - Provider Fetal Death Report</a> <ul style="list-style-type: none"> <li>PENDING</li> </ul>	IF UHYS = 'Y' then /code@code= Code= '73781-7', CodeSystemName= 'LOINC', DisplayName= 'Maternal morbidity' AND /value@code= Code= '625654015', CodeSystemName= 'SNOMED CT', DisplayName= 'Emergency cesarean hysterectomy'		
Mapping to HL7 v2.6 BFDR (5b)			
Mapping Location and Content	Example	Usage	
OBX-2 SHALL contain CWE OBX-3 SHALL contain 73781-7^ Maternal morbidity OBX-5 SHALL contain 236987005^Emergency cesarean hysterectomy (procedure)	OBX 22 CWE 73781-7^Maternal Morbidity ^LN  236987005^Emergency cesarean hysterectomy (procedure)^SNM     F	PSMLBDI	
		PSMFDI	
		PSLBI	Y
		PSFLBI	Y
		PSFFDI	Y
		PSFDI	Y
JLBI	Y		

		JFDI	Y
		CCOFDI	

**6.6.1.1.80 UOPR Maternal Morbidity [Unplanned operation [room procedure following delivery]]**

UOPR Derivation Rule (2)																					
IF (\$ProcedureCode CONTAINS ValueSet ( <i>Unplanned Operation (NCHS)</i> ) “UOPR” SHALL be “Y” ELSE “N”																					
Variable Name	Source in EMR Using FHIR (1a)	Source in EMR Using CDA Labor and Delivery Summary-VR XPATH (1b)																			
\$ProcedureCode	procedure.code	ClinicalDocument/component/structuredBody/component/section[templateId[@root='1.3.6.1.4.1.19376.1.5.3.1.1.21.2.3']/component/section[templateId[@root='1.3.6.1.4.1.19376.1.5.3.1.1.13.2.11']/entry/procedure/code																			
Mapping to HL7 FHIR BFDR (5a)																					
FHIR Profile/Resource		Content																			
<a href="#">Composition - Provider Live Birth Report</a> OR <a href="#">Composition - Provider Fetal Death Report</a> <ul style="list-style-type: none"> <li>PENDING</li> </ul>		IF UOPR = 'Y' then /code@code= Code= '73781-7', CodeSystemName= 'LOINC', DisplayName= 'Maternal morbidity' AND /value@code= Code= '177217006', CodeSystemName= 'SNOMED CT', DisplayName= 'Immediate repair of obstetric laceration'																			
Mapping to HL7 v2.6 BFDR (5b)																					
Mapping Location and Content		Example	Usage																		
OBX-2 SHALL contain CWE OBX-3 SHALL contain 73781-7^ Maternal morbidity OBX-5 SHALL contain 442261000124103^Emergency operation following delivery		OBX 22 CWE 73781-7^Maternal Morbidity ^LN  442261000124103^ Emergency operation following delivery^SNM     F	<table border="1"> <tr><td>PSMLBDI</td><td></td></tr> <tr><td>PSMFDI</td><td></td></tr> <tr><td>PSLBI</td><td>Y</td></tr> <tr><td>PSFLBI</td><td>Y</td></tr> <tr><td>PSFFDI</td><td>Y</td></tr> <tr><td>PSFDI</td><td>Y</td></tr> <tr><td>JLBI</td><td>Y</td></tr> <tr><td>JFDI</td><td>Y</td></tr> <tr><td>CCOFDI</td><td></td></tr> </table>	PSMLBDI		PSMFDI		PSLBI	Y	PSFLBI	Y	PSFFDI	Y	PSFDI	Y	JLBI	Y	JFDI	Y	CCOFDI	
PSMLBDI																					
PSMFDI																					
PSLBI	Y																				
PSFLBI	Y																				
PSFFDI	Y																				
PSFDI	Y																				
JLBI	Y																				
JFDI	Y																				
CCOFDI																					

1535

**6.6.1.1.81 NOA05 Maternal Morbidity [None of the above] NOTE: NOA05 is also used for onset of labor**

NOA05 Derivation Rule (2)
---------------------------

IHE Quality, Research and Public Health Technical Framework Supplement – Birth and Fetal Death Reporting-Enhanced (BFDR-E)

This SHALL require data entry and SHALL NOT be a result of a default from the other attributes in the list.																				
Variable Name	Source in EMR Using FHIR (1a)	Source in EMR Using CDA Labor and Delivery Summary-VR XPATH (1b)																		
N/A	N/A	N/A																		
Mapping to HL7 FHIR BFDR (5a)																				
FHIR Profile/Resource	Content																			
<a href="#">Composition - Provider Live Birth Report</a> OR <a href="#">Composition - Provider Fetal Death Report</a> <ul style="list-style-type: none"> <li>PENDING</li> </ul>	IF NOA05 = 'Y' then /code@code= Code= '73781-7', CodeSystemName= 'LOINC', DisplayName= 'Maternal morbidity' AND /value@code= Code= '260413007', CodeSystemName= 'SNOMED CT', DisplayName= 'None'																			
Mapping to HL7 v2.6 BFDR (5b)																				
Mapping Location and Content	Example	Usage																		
OBX-2 SHALL contain CWE OBX-3 SHALL contain 73781-7^ Maternal morbidity OBX-5 SHALL contain 260413007^None (qualifier value)	OBX 22 CWE 73781-7^Maternal Morbidity ^LN  260413007^None (qualifier value)^SNM     F	<table border="1"> <tr><td>PSMLBDI</td><td></td></tr> <tr><td>PSMFDI</td><td></td></tr> <tr><td>PSLBI</td><td>Y</td></tr> <tr><td>PSFLBI</td><td>Y</td></tr> <tr><td>PSFFDI</td><td>Y</td></tr> <tr><td>PSFDI</td><td>Y</td></tr> <tr><td>JLBI</td><td>Y</td></tr> <tr><td>JFDI</td><td>Y</td></tr> <tr><td>CCOFDI</td><td></td></tr> </table>	PSMLBDI		PSMFDI		PSLBI	Y	PSFLBI	Y	PSFFDI	Y	PSFDI	Y	JLBI	Y	JFDI	Y	CCOFDI	
PSMLBDI																				
PSMFDI																				
PSLBI	Y																			
PSFLBI	Y																			
PSFFDI	Y																			
PSFDI	Y																			
JLBI	Y																			
JFDI	Y																			
CCOFDI																				

**6.6.1.1.82 PRES Method of Delivery [Fetal presentation [at birth] – Cephalic]**

PRES Derivation Rule (2)		
IF (\$EventOutcomesObservationCode CONTAINS ValueSet ( <a href="#">Fetal Presentation at Birth- Cephalic (NCHS)</a> ) OR \$ProblemCode CONTAINS ValueSet ( <a href="#">Fetal Presentation at Birth- Cephalic (NCHS)</a> s) THEN “PRES” SHALL = “1” ELSE IF (\$EventOutcomesObservationCode CONTAINS ValueSet ( <a href="#">Fetal Presentation at Birth- Breech (NCHS)</a> ) OR \$ProblemCode CONTAINS ValueSet ( <a href="#">Fetal Presentation at Birth- Breech (NCHS)</a> ) THEN “PRES” SHALL = “2” ELSE IF (\$EventOutcomesObservationCode CONTAINS ValueSet ( <a href="#">Fetal Presentation at Birth- Other (NCHS)</a> ) OR \$ProblemCode CONTAINS ValueSet ( <a href="#">Fetal Presentation at Birth- Other (NCHS)</a> ) THEN “PRES” SHALL = “3” ELSE “PRES” SHALL = “9”		
Variable Name	Source in EMR Using FHIR (1a)	Source in EMR Using CDA Labor and Delivery Summary-VR XPATH (1b)
\$EventOutcomesObservationCode	condition.code	ClinicalDocument/component/structuredBody/component/section[templateId[@root='1.3.6.1.4.1.19376.1.5.3.1.1.21.2.3']/component/section[templateId[@root='1.3.6.1.4.1.19376.1.7.3.1.1.13.7']]/entry/observation/value

IHE Quality, Research and Public Health Technical Framework Supplement – Birth and Fetal Death Reporting-Enhanced (BFDR-E)

<b>\$ProblemCode</b>	condition.code	ClinicalDocument/component/structuredBody/component/section[templateId[@root='1.3.6.1.4.1.19376.1.5.3.1.3.6']]/entry/act/entryRelationship/observation/value	
Mapping to HL7 FHIR BFDR (5a)			
FHIR Profile/Resource	Content		
<a href="#">Composition - Provider Live Birth Report</a> OR <a href="#">Composition - Provider Fetal Death Report</a> <ul style="list-style-type: none"> <li>PENDING</li> </ul>	IF PRES = '1' then entryRelationship/code@code= Code= '73761-9', CodeSystemName= 'LOINC', DisplayName= 'Fetal presentation at birth' AND entryRelationship/value@code= Code= '6096002', CodeSystemName= 'SNOMED CT', DisplayName= 'Breech presentation' ELSE IF PRES = '2' then entryRelationship/code@code= Code= '73761-9', CodeSystemName= 'LOINC', DisplayName= 'Fetal presentation at birth' AND entryRelationship/value@code= Code= '70028003', CodeSystemName= 'SNOMED CT', DisplayName= 'Vertex Presentation' ELSE IF PRES = '3' then entryRelationship/code@code= Code= '73761-9', CodeSystemName= 'LOINC', DisplayName= 'Fetal presentation at birth' AND entryRelationship/value@code= Code= '394841004', CodeSystemName= 'SNOMED CT', DisplayName= 'Other category' ELSE IF PRES = '9' then entryRelationship/code@code= Code= '73761-9', CodeSystemName= 'LOINC', DisplayName= 'Fetal presentation at birth' AND entryRelationship/value@code= Code= '261665006', CodeSystemName= 'SNOMED CT', DisplayName= 'Unknowncategory'		
Mapping to HL7 v2.6 BFDR (5b)			
Mapping Location and Content	Example	Usage	
OBX-2 SHALL contain CWE OBX-3 SHALL contain 73761-9^Fetal Presentation at Birth OBX-5 SHALL contain 70028003^Vertex presentation (finding) OBX-2 SHALL contain CWE OBX-3 SHALL contain 73761-9^Fetal Presentation at Birth	OBX 24 CWE 73761-9^Fetal presentation at Birth^LN  70028003^Cephalic^SNM     F	PSMLBDI	
		PSMFDI	
	PSLBI	Y	
	PSFLBI	Y	
	PSFFDI	Y	
	PSFDI	Y	
		JLBI	Y

OBX-5 SHALL contain 6096002^Breech Presentation	OBX 20 CWE 73761-9^Fetal presentation at Birth^LN  394841004^ Other category^SNM     F	JFDI	Y
OBX-2 SHALL contain CWE OBX-3 SHALL contain 73761-9^Fetal Presentation at Birth OBX-5 SHALL contain 394841004^Other category (qualifier value)		CCOFDI	

1540

**6.6.1.1.83 ROUT Method of Delivery [[Final]Route and method of delivery]**

ROUT Derivation Rule (2)		
IF ((\$ProcedureCode CONTAINS ValueSet ( <a href="#">Route and Method of Delivery - Spontaneous (NCHS)</a> ) OR (\$EventOutcomesObservationCode CONTAINS ValueSet ( <a href="#">Method of Delivery Vaginal-Spon Finding (NCHS)</a> ) OR (\$ProblemCode CONTAINS ValueSet ( <a href="#">Method of Delivery Vaginal-Spon Finding (NCHS)</a> ) THEN "ROUT" SHALL = "1" ELSE IF (\$ProcedureCode CONTAINS ValueSet ( <a href="#">Route and Method of Delivery - Forceps (NCHS)</a> ) OR (\$EventOutcomesObservationCode CONTAINS ValueSet ( <a href="#">Method of Delivery Vaginal Forceps Finding (NCHS)</a> ) OR (\$ProblemCode CONTAINS ValueSet ( <a href="#">Method of Delivery Vaginal Forceps Finding (NCHS)</a> ) THEN "ROUT" SHALL = "2" ELSE IF (\$ProcedureCode CONTAINS ValueSet ( <a href="#">Route and Method of Delivery - Vacuum (NCHS)</a> ) OR (\$EventOutcomesObservationCode CONTAINS ValueSet ( <a href="#">Method of Delivery Vaginal Vacuum Finding (NCHS)</a> ) OR (\$ProblemCode CONTAINS ValueSet ( <a href="#">Method of Delivery Vaginal Vacuum Finding (NCHS)</a> ) THEN "ROUT" SHALL = "3" ELSE IF (\$ProcedureCode CONTAINS ValueSet ( <a href="#">Route and Method of Delivery - Cesarean (NCHS)</a> ) OR (\$EventOutcomesObservationCode CONTAINS ValueSet ( <a href="#">Method of Delivery Cesarean Finding (NCHS)</a> ) OR (\$ProblemCode CONTAINS ValueSet ( <a href="#">Method of Delivery Cesarean Finding (NCHS)</a> ) THEN "ROUT" SHALL = "4" ELSE "ROUT" SHALL = "9".		
Variable Name	Source in EMR Using FHIR (1a)	Source in EMR Using CDA Labor and Delivery Summary-VR XPATH (1b)
\$ProcedureCode	procedure.code	ClinicalDocument/component/structuredBody/component/section[templateId[@root='1.3.6.1.4.1.19376.1.5.3.1.1.21.2.3']]/component/section[templateId[@root='1.3.6.1.4.1.19376.1.5.3.1.1.13.2.11']]/entry/procedure/code
\$EventOutcomesObservationCode	condition.code	ClinicalDocument/component/structuredBody/component/section[templateId[@root='1.3.6.1.4.1.19376.1.5.3.1.1.21.2.3']]/component/section[templateId[@root='1.3.6.1.4.1.19376.1.7.3.1.1.13.7']]/entry[templateId[@root='1.3.6.1.4.1.19376.1.5.3.1.1.25.1.4.1']]/act/codes
\$ProblemCode	condition.code	ClinicalDocument/component/structuredBody/component/section[templateId[@root='1.3.6.1.4.1.19376.1.5.3.1.3.6']]/entry/act/entryRelationship/observation/value
Mapping to HL7 FHIR BFDR (5a)		
FHIR Profile/Resource	Content	
<a href="#">Composition - Provider Live Birth Report</a> OR <a href="#">Composition - Provider Fetal Death Report</a> <ul style="list-style-type: none"> <li>PENDING</li> </ul>	IF ROUT = '1' then  entryRelationship/code@code= Code= '73762-7', CodeSystemName= 'LOINC', DisplayName= 'Final route and method of delivery'  AND entryRelationship/value@code= Code= '48782003', CodeSystemName= 'SNOMED CT', DisplayName= 'Delivery normal'  ELSE IF ROUT = '2' then	

IHE Quality, Research and Public Health Technical Framework Supplement – Birth and Fetal Death Reporting-Enhanced (BFDR-E)

	<p>entryRelationship/code@code= Code= '73762-7', CodeSystemName= 'LOINC', DisplayName= 'Final route and method of delivery'</p> <p>AND entryRelationship/value@code= Code= '302383004', CodeSystemName= 'SNOMED CT', DisplayName= 'Forceps delivery'</p> <p>ELSE IF ROUT = '3' then</p> <p>entryRelationship/code@code= Code= '73762-7', CodeSystemName= 'LOINC', DisplayName= 'Final route and method of delivery'</p> <p>AND entryRelationship/value@code= Code= '61586001', CodeSystemName= 'SNOMED CT', DisplayName= 'Delivery by vacuum extraction'</p> <p>ELSE IF ROUT = '4' then</p> <p>entryRelationship/code@code= Code= '73762-7', CodeSystemName= 'LOINC', DisplayName= 'Final route and method of delivery'</p> <p>AND entryRelationship/value@code= Code= '11466000', CodeSystemName= 'SNOMED CT', DisplayName= 'Cesarean section'</p> <p>ELSE IF ROUT = '9' then</p> <p>entryRelationship/code@code= Code= '73762-7', CodeSystemName= 'LOINC', DisplayName= 'Final route and method of delivery'</p> <p>AND entryRelationship/value@code= Code= '261665006', CodeSystemName= 'SNOMED CT', DisplayName= 'Unknown category'</p>									
<b>Mapping to HL7 v2.6 BFDR (5b)</b>										
Mapping Location and Content	Example	Usage								
<p>OBX-2 SHALL contain CWE</p> <p>OBX-3 SHALL contain 73762-7^Final Route and Method of Delivery</p> <p>OBX-5 SHALL contain 48782003^Delivery normal</p>	<p>OBX 20 CWE 73762-7^Final Route and Method of Delivery^LN  48782003 ^ Delivery normal ^SNM     F</p>	<table border="1"> <tr><td>PSMLBDI</td><td></td></tr> <tr><td>PSMFDI</td><td></td></tr> <tr><td>PSLBI</td><td>Y</td></tr> </table>	PSMLBDI		PSMFDI		PSLBI	Y		
PSMLBDI										
PSMFDI										
PSLBI	Y									
<p>OBX-2 SHALL contain CWE</p> <p>OBX-3 SHALL contain 73762-7^ Final Route and Method of Delivery</p> <p>OBX-5 SHALL contain 302383004^Forceps delivery</p>	<p>OBX 20 CWE 73762-7^Final Route and Method of Delivery^LN   302383004^ Forceps delivery^SNM     F</p>	<table border="1"> <tr><td>PSFLBI</td><td>Y</td></tr> <tr><td>PSFFDI</td><td>Y</td></tr> <tr><td>PSFDI</td><td>Y</td></tr> <tr><td>JLBI</td><td>Y</td></tr> </table>	PSFLBI	Y	PSFFDI	Y	PSFDI	Y	JLBI	Y
PSFLBI	Y									
PSFFDI	Y									
PSFDI	Y									
JLBI	Y									
<p>OBX-2 SHALL contain CWE</p> <p>OBX-3 SHALL contain 73762-7^ Final Route and Method of Delivery</p> <p>OBX-5 SHALL contain 61586001^ Delivery by vacuum extraction</p>	<p>OBX 20 CWE 73762-7^Final Route and Method of Delivery^LN   61586001^ Delivery by vacuum extraction^SNM     F</p>	<table border="1"> <tr><td>JFDI</td><td>Y</td></tr> <tr><td>CCOFDI</td><td></td></tr> </table>	JFDI	Y	CCOFDI					
JFDI	Y									
CCOFDI										
<p>OBX-2 SHALL contain CWE</p>	<p>OBX 20 CWE 73762-7^Final Route and Method of</p>									



OBX-3 SHALL contain 73762-7^Final Route and Method of Delivery	Delivery^LN  11466000^Cesarean section^SNM     F		
OBX-5 SHALL contain 11466000^ Cesarean section			

### 6.6.1.1.84 TLAB Method of Delivery [Trial of labor attempted]

TLAB Derivation Rule (2)		
<p>IF ((\$ProcedureCode CONTAINS ValueSet (<a href="#">Route and Method of Delivery - Cesarean (NCHS)</a>) OR (\$EventOutcomesObservationCode CONTAINS ValueSet (<a href="#">Scheduled Cesarean Finding (NCHS)</a>) OR (\$ProblemCode CONTAINS ValueSet (<a href="#">Scheduled Cesarean Finding (NCHS)</a>) THEN (IF (\$EventOutcomesObservationCode CONTAINS ValueSet (<a href="#">Method of Delivery Trial Labor Finding (NCHS)</a>)OR (\$ProblemCode CONTAINS ValueSet (<a href="#">Route Method of Delivery - Trial of Labor (NCHS)</a>) THEN “TLAB” SHALL be “Y” ELSE IF NOT \$ProcedureCode CONTAINS ValueSet (<a href="#">Route and Method of Delivery - Scheduled C (NCHS)</a>) THEN “TLAB” SHALL NOT be available for data entry and SHALL be “X” ELSE IF =NULL THEN “U”) ELSE “N”.</p>		
Variable Name	Source in EMR Using FHIR (1a)	Source in EMR Using CDA Labor and Delivery Summary-VR XPATH (1b)
\$ProcedureCode	procedure.code	ClinicalDocument/component/structuredBody/component/section[templateId[@root='1.3.6.1.4.1.19376.1.5.3.1.1.21.2.3']]/component/section[templateId[@root='1.3.6.1.4.1.19376.1.5.3.1.1.13.2.11']]/entry/procedure/code
\$ProblemCode	condition.code	ClinicalDocument/component/structuredBody/component/section[templateId[@root='1.3.6.1.4.1.19376.1.5.3.1.3.6']]/entry/act/entryRelationship/observation/value
\$EventOutcomesObservationCode	condition.code	ClinicalDocument/component/structuredBody/component/section[templateId[@root='1.3.6.1.4.1.19376.1.5.3.1.1.21.2.3']]/component/section[templateId[@root='1.3.6.1.4.1.19376.1.7.3.1.1.13.7']]/entry[templateId[@root='1.3.6.1.4.1.19376.1.5.3.1.1.25.1.4.1']]/act/code
Mapping to HL7 FHIR BFDR (5a)		
FHIR Profile/Resource	Content	
<a href="#">Composition - Provider Live Birth Report</a> OR <a href="#">Composition - Provider Fetal Death Report</a> <ul style="list-style-type: none"> <li>PENDING</li> </ul>	IF TLAB = 'Y' then /code@code= Code= '72149-8', CodeSystemName= 'LOINC', DisplayName= 'Delivery method' AND entryRelationship /code@code= Code= '73762-7', CodeSystemName= 'LOINC', DisplayName= 'Final route and method of delivery' AND /entryRelationship/value@code= Code= '11466000', CodeSystemName= 'SNOMED CT', DisplayName= 'Cesarean section' AND /entryRelationship/entryRelationship/code@code= Code= '73760-1', CodeSystemName= 'LOINC', DisplayName= 'If cesarean, a trial of labor was attempted' AND	

IHE Quality, Research and Public Health Technical Framework Supplement – Birth and Fetal Death Reporting-Enhanced (BFDR-E)

		/entryRelationship /entryRelationship/value@code= Boolean form of TLAB		
Mapping to HL7 v2.6 BFDR (5b)				
Mapping Location and Content		Example	Usage	
OBX-2 SHALL contain CWE OBX-3 SHALL contain 73760-1^If cesarean, a trial of labor was attempted OBX-5 SHALL contain boolean indication using PHVS_YesNoUnknown_CDC Yes No Unknown (YNU)		OBX 24 CWE 73761-9^Fetal presentation at Birth^LN   N^No^ PHVS_YesNoUnknown_CDC      F	PSMLBDI	
			PSMFDI	
			PSLBI	Y
			PSFLBI	Y
			PSFFDI	Y
			PSFDI	Y
			JLBI	Y
			JFDI	Y
		CCOFDI		

6.6.1.1.85 MFNAME Mother's Current Legal Name [First Name]

MFNAME Derivation Rule (2)		
"MFNAME" SHALL be populated using the First Name part of \$MotherName.		
Variable Name	Source in EMR Using FHIR (1a)	Source in EMR Using CDA Labor and Delivery Summary-VR XPATH (1b)
\$MotherName	patient.name	/ClinicalDocument/ recordTarget/patientRole/patient/name
Mapping to HL7 FHIR BFDR (5a)		
FHIR Profile/Resource	Content	
<a href="#">Composition - Provider Live Birth Report</a> OR <a href="#">Composition - Provider Fetal Death Report</a> <ul style="list-style-type: none"> <li>PENDING</li> </ul>	PENDING	
Mapping to HL7 v2.6 BFDR (5b)		
Mapping Location and Content	Example	Usage
PENDING	PENDING	PSMLBDI
		PSMFDI
		PSLBI
		PSFLBI
		PSFFDI
		PSFDI
		JLBI

		JFDI	
		CCOFDI	

1545

**6.6.1.1.86 MMNAME Mother's Current Legal Name [Middle Name]**

MMNAME Derivation Rule (2)																					
“MMNAME” SHALL be populated using the Middle Name part of part \$MotherName.																					
Variable Name	Source in EMR Using FHIR (1a)	Source in EMR Using CDA Labor and Delivery Summary-VR XPATH (1b)																			
\$MotherName	patient.name	/ClinicalDocument/ recordTarget/patientRole/patient/name																			
Mapping to HL7 FHIR BFDR (5a)																					
FHIR Profile/Resource		Content																			
<a href="#">Composition - Provider Live Birth Report</a> OR <a href="#">Composition - Provider Fetal Death Report</a> <ul style="list-style-type: none"> <li>PENDING</li> </ul>		PENDING																			
Mapping to HL7 v2.6 BFDR (5b)																					
Mapping Location and Content		Example	Usage																		
PENDING		PENDING	<table border="1"> <tr><td>PSMLBDI</td><td></td></tr> <tr><td>PSMFDI</td><td></td></tr> <tr><td>PSLBI</td><td></td></tr> <tr><td>PSFLBI</td><td></td></tr> <tr><td>PSFFDI</td><td></td></tr> <tr><td>PSFDI</td><td></td></tr> <tr><td>JLBI</td><td></td></tr> <tr><td>JFDI</td><td></td></tr> <tr><td>CCOFDI</td><td></td></tr> </table>	PSMLBDI		PSMFDI		PSLBI		PSFLBI		PSFFDI		PSFDI		JLBI		JFDI		CCOFDI	
PSMLBDI																					
PSMFDI																					
PSLBI																					
PSFLBI																					
PSFFDI																					
PSFDI																					
JLBI																					
JFDI																					
CCOFDI																					

**6.6.1.1.87 MLNAME Mother's Current Legal Name [Last Name]**

MLNAME Derivation Rule (2)		
“MLNAME” SHALL be populated using the Last Name part of part of \$MotherName.		
Variable Name	Source in EMR Using FHIR (1a)	Source in EMR Using CDA Labor and Delivery Summary-VR XPATH (1b)
\$MotherName	patient.name	/ClinicalDocument/ recordTarget/patientRole/patient/name
Mapping to HL7 FHIR BFDR (5a)		

FHIR Profile/Resource		Content																			
<a href="#">Composition - Provider Live Birth Report</a> OR <a href="#">Composition - Provider Fetal Death Report</a> <ul style="list-style-type: none"> <li>PENDING</li> </ul>		PENDING																			
Mapping to HL7 v2.6 BFDR (5b)																					
Mapping Location and Content		Example	Usage																		
PENDING		PENDING	<table border="1"> <tr><td>PSMLBDI</td><td></td></tr> <tr><td>PSMFDI</td><td></td></tr> <tr><td>PSLBI</td><td></td></tr> <tr><td>PSFLBI</td><td></td></tr> <tr><td>PSFFDI</td><td></td></tr> <tr><td>PSFDI</td><td></td></tr> <tr><td>JLBI</td><td></td></tr> <tr><td>JFDI</td><td></td></tr> <tr><td>CCOFDI</td><td></td></tr> </table>	PSMLBDI		PSMFDI		PSLBI		PSFLBI		PSFFDI		PSFDI		JLBI		JFDI		CCOFDI	
PSMLBDI																					
PSMFDI																					
PSLBI																					
PSFLBI																					
PSFFDI																					
PSFDI																					
JLBI																					
JFDI																					
CCOFDI																					

1550

**6.6.1.1.88 MSUFF Mother's Current Legal Name [suffix]**

MSUFF Derivation Rule (2)													
"MSUFF" SHALL be populated using the Last Name Suffix part of part of \$MotherName.													
Variable Name	Source in EMR Using FHIR (1a)	Source in EMR Using CDA Labor and Delivery Summary-VR XPATH (1b)											
\$MotherName	patient.name	/ClinicalDocument/ recordTarget/patientRole/patient/name											
Mapping to HL7 FHIR BFDR (5a)													
FHIR Profile/Resource		Content											
<a href="#">Composition - Provider Live Birth Report</a> OR <a href="#">Composition - Provider Fetal Death Report</a> <ul style="list-style-type: none"> <li>PENDING</li> </ul>		PENDING											
Mapping to HL7 v2.6 BFDR (5b)													
Mapping Location and Content		Example	Usage										
PENDING		PENDING	<table border="1"> <tr><td>PSMLBDI</td><td></td></tr> <tr><td>PSMFDI</td><td></td></tr> <tr><td>PSLBI</td><td></td></tr> <tr><td>PSFLBI</td><td></td></tr> <tr><td>PSFFDI</td><td></td></tr> </table>	PSMLBDI		PSMFDI		PSLBI		PSFLBI		PSFFDI	
PSMLBDI													
PSMFDI													
PSLBI													
PSFLBI													
PSFFDI													

		PSFDI	
		JLBI	
		JFDI	
		CCOFDI	

### 6.6.1.1.89 HFT Mother's Height [Feet]

HFT Derivation Rule (2)												
IF (\$VitalSignsTypeCode CONTAINS ValueSet ( <i>Height (NCHS)</i> ), THEN “HFT” SHALL = feet part of \$VitalSignsResultValue WHERE \$VitalSignsResultUnits are expressed in Feet and Inches.												
Variable Name	Source in EMR Using FHIR (1a)	Source in EMR Using CDA Labor and Delivery Summary-VR XPATH (1b)										
\$VitalSignsTypeCode	observation.code constrained by: (http://ihe.net/fhir/StructureDefinition/IHE.BFDRE.MaternalObservationsHT)	ClinicalDocument/component/structuredBody/component/section[templateId[@root='1.3.6.1.4.1.19376.1.5.3.1.1.9.15.1']]/component/section[templateId[@root='1.3.6.1.4.1.19376.1.5.3.1.1.5.3.2']]/entry/organizer/component/observation/code										
\$VitalSignsResultValue	observation.valueQuantity	ClinicalDocument/component/structuredBody/component/section[templateId[@root='1.3.6.1.4.1.19376.1.5.3.1.1.9.15.1']]/component/section[templateId[@root='1.3.6.1.4.1.19376.1.5.3.1.1.5.3.2']]/entry/organizer/component/observation/value										
\$VitalSignsResultUnits	Observation.valueQuantity	ClinicalDocument/component/structuredBody/component/section[templateId[@root='1.3.6.1.4.1.19376.1.5.3.1.1.9.15.1']]/component/section[templateId[@root='1.3.6.1.4.1.19376.1.5.3.1.1.5.3.2']]/entry/organizer/component/observation/value[@units]										
Mapping to HL7 FHIR BFDR (5a)												
FHIR Profile/Resource	Content											
<a href="#">Composition - Provider Live Birth Report</a> OR <a href="#">Composition - Provider Fetal Death Report</a> <ul style="list-style-type: none"> <li>PENDING</li> </ul>	/code@code= Code='3137-7', CodeSystemName= 'LOINC', DisplayName='Body height' AND /value@value= HFT(PQ) /value/@unit= 'ft'											
Mapping to HL7 v2.6 BFDR (5b)												
Mapping Location and Content	Example	Usage										
OBX-2 SHALL contain NM OBX-3 SHALL contain 83846-6^ Mother's body height OBX-5 SHALL contain the Mother's Height in Inches OBX-6 SHALL indicate feet using UCUM units: SHALL contain ft	OBX 9 NM 83846-6^ Mother's body height ^LN 6 ft	<table border="1"> <tr> <td>PSMLBDI</td> <td>Y</td> </tr> <tr> <td>PSMFDI</td> <td>Y</td> </tr> <tr> <td>PSLBI</td> <td>Y</td> </tr> <tr> <td>PSFLBI</td> <td>Y</td> </tr> <tr> <td>PSFFDI</td> <td>Y</td> </tr> </table>	PSMLBDI	Y	PSMFDI	Y	PSLBI	Y	PSFLBI	Y	PSFFDI	Y
PSMLBDI	Y											
PSMFDI	Y											
PSLBI	Y											
PSFLBI	Y											
PSFFDI	Y											

IHE Quality, Research and Public Health Technical Framework Supplement – Birth and Fetal Death Reporting-Enhanced (BFDR-E)

		PSFDI	Y
		JLBI	Y
		JFDI	Y
		CCOFDI	

**6.6.1.1.90 HIN Mother's Height [Inches]**

<b>HIN Derivation Rule (2)</b>													
IF \$VitalSignsTypeCode CONTAINS ValueSet ( <i>Height (NCHS)</i> ), THEN "HIN" SHALL = Inches part of \$VitalSignsResultValue WHERE \$VitalSignsResultUnits are expressed in Feet and Inches.													
Variable Name	Source in EMR Using FHIR (1a)	Source in EMR Using CDA Labor and Delivery Summary-VR XPATH (1b)											
\$VitalSignsTypeCode	observation.code constrained by: (http://ihe.net/fhir/StructureDefinition/IHE.BFDRE.MaternalObservationsHT)	ClinicalDocument/component/structuredBody/component/section[templateId[@root='1.3.6.1.4.1.19376.1.5.3.1.1.9.15.1']]/component/section[templateId[@root='1.3.6.1.4.1.19376.1.5.3.1.1.5.3.2']]/entry/organizer/component/observation/code											
\$VitalSignsResultValue	observation.valueQuantity	ClinicalDocument/component/structuredBody/component/section[templateId[@root='1.3.6.1.4.1.19376.1.5.3.1.1.9.15.1']]/component/section[templateId[@root='1.3.6.1.4.1.19376.1.5.3.1.1.5.3.2']]/entry/organizer/component/observation/value											
\$VitalSignsResultUnits	Observation.valueQuantity	ClinicalDocument/component/structuredBody/component/section[templateId[@root='1.3.6.1.4.1.19376.1.5.3.1.1.9.15.1']]/component/section[templateId[@root='1.3.6.1.4.1.19376.1.5.3.1.1.5.3.2']]/entry/organizer/component/observation/value[@units]											
<b>Mapping to HL7 FHIR BFDR (5a)</b>													
FHIR Profile/Resource		Content											
<a href="#">Composition - Provider Live Birth Report</a> OR <a href="#">Composition - Provider Fetal Death Report</a> <ul style="list-style-type: none"> <li>PENDING</li> </ul>		/code@code= Code='3137-7', CodeSystemName= 'LOINC', DisplayName='Body height' AND /value@value= HIN(PQ) /value/@unit= 'in'											
<b>Mapping to HL7 v2.6 BFDR (5b)</b>													
Mapping Location and Content		Example	Usage										
OBX-2 SHALL contain NM OBX-3 SHALL contain 83846-6^ Mother's body height OBX-5 SHALL contain the Mother's Height in Inches OBX-6 SHALL indicate inches using UCUM units: SHALL contain in		OBX 9 NM 83846-6^ Mother's body height ^LN  58 in	<table border="1"> <tr> <td>PSMLBDI</td> <td>Y</td> </tr> <tr> <td>PSMFDI</td> <td>Y</td> </tr> <tr> <td>PSLBI</td> <td>Y</td> </tr> <tr> <td>PSFLBI</td> <td>Y</td> </tr> <tr> <td>PSFFDI</td> <td>Y</td> </tr> </table>	PSMLBDI	Y	PSMFDI	Y	PSLBI	Y	PSFLBI	Y	PSFFDI	Y
PSMLBDI	Y												
PSMFDI	Y												
PSLBI	Y												
PSFLBI	Y												
PSFFDI	Y												

		PSFDI	Y
		JLBI	Y
		JFDI	Y
		CCOFDI	

1555

### 6.6.1.1.91 MRECNUM Mother's Medical Record Number

MRECNUM Derivation Rule (2)																					
"MRECNUM" SHALL be populated using \$MotherMedRecNum.																					
Variable Name	Source in EMR Using FHIR (1a)	Source in EMR Using CDA Labor and Delivery Summary-VR XPATH (1b)																			
\$MotherMedRecNum	patient.identifier	/ClinicalDocument/patientRole/id																			
Mapping to HL7 FHIR BFDR (5a)																					
FHIR Profile/Resource		Content																			
<a href="#">Composition - Provider Live Birth Report</a> OR <a href="#">Composition - Provider Fetal Death Report</a> • PENDING		recordTarget/patientRole/id = MRECNUM																			
Mapping to HL7 v2.6 BFDR (5b)																					
Mapping Location and Content		Example	Usage																		
NK1-33 where NK1-3 (Relationship) is MTH (Mother)		NK1 I Johnson^Susanna^J^III^~~~~~ MD 1830 Sunshine Drive^^Beautiful City^HerState^86534- 1111^^H                  9876546688^^^M RN	<table border="1"> <tr><td>PSMLBDI</td><td>Y</td></tr> <tr><td>PSMFDI</td><td>Y</td></tr> <tr><td>PSLBI</td><td>Y</td></tr> <tr><td>PSFLBI</td><td>Y</td></tr> <tr><td>PSFFDI</td><td>Y</td></tr> <tr><td>PSFDI</td><td>Y</td></tr> <tr><td>JLBI</td><td></td></tr> <tr><td>JFDI</td><td></td></tr> <tr><td>CCOFDI</td><td></td></tr> </table>	PSMLBDI	Y	PSMFDI	Y	PSLBI	Y	PSFLBI	Y	PSFFDI	Y	PSFDI	Y	JLBI		JFDI		CCOFDI	
PSMLBDI	Y																				
PSMFDI	Y																				
PSLBI	Y																				
PSFLBI	Y																				
PSFFDI	Y																				
PSFDI	Y																				
JLBI																					
JFDI																					
CCOFDI																					

### 6.6.1.1.92 PWGT Mother's Pre-pregnancy Weight

PWGT Derivation Rule (2)
IF \$VitalSignsTypeCode CONTAINS ValueSet ( <i>Body Weight (NCHS)</i> ) where \$VitalSignsMethodCode CONTAINS ValueSet ( <i>Pre-Pregnancy Weight (NCHS)</i> ), THEN "PWGT" SHALL = \$VitalSignsResultValue.

IHE Quality, Research and Public Health Technical Framework Supplement – Birth and Fetal Death Reporting-Enhanced (BFDR-E)

Variable Name	Source in EMR Using FHIR (1a)	Source in EMR Using CDA Labor and Delivery Summary-VR XPATH (1b)																		
\$VitalSignsTypeCode	observation.code constrained by: (http://ihe.net/fhir/StructureDefinition/IHE.BFDRE.MaternalObservationsHT)	ClinicalDocument/component/structuredBody/component/section[templateId[@root='1.3.6.1.4.1.19376.1.5.3.1.1.9.15.1']]/component/section[templateId[@root='1.3.6.1.4.1.19376.1.5.3.1.1.5.3.2']]/entry/organizer/component/observation/code																		
\$VitalSignsMethodCode	Observation.method	ClinicalDocument/component/structuredBody/component/section[templateId[@root='1.3.6.1.4.1.19376.1.5.3.1.1.9.15.1']]/component/section[templateId[@root='1.3.6.1.4.1.19376.1.5.3.1.1.5.3.2']]/entry/organizer/component/observation/methodCode																		
\$VitalSignsResultValue	Observation.valueQuantity	ClinicalDocument/component/structuredBody/component/section[templateId[@root='1.3.6.1.4.1.19376.1.5.3.1.1.9.15.1']]/component/section[templateId[@root='1.3.6.1.4.1.19376.1.5.3.1.1.5.3.2']]/entry/organizer/component/observation/value																		
\$VitalSignsResultUnits	observation.valueQuantity	PENDING																		
Mapping to HL7 FHIR BFDR (5a)																				
FHIR Profile/Resource	Content																			
<a href="#">Composition - Provider Live Birth Report</a> OR <a href="#">Composition - Provider Fetal Death Report</a> <ul style="list-style-type: none"> <li>PENDING</li> </ul>	/code@code= Code='56077-1', CodeSystemName= 'LOINC', DisplayName= 'Body weight -- pre current pregnancy' AND /value@value= PWGT(PQ) /value/@unit= 'lb'																			
Mapping to HL7 v2.6 BFDR (5b)																				
Mapping Location and Content	Example	Usage																		
OBX-2 SHALL contain NM OBX-3 SHALL contain 56077-1^Body weight ^ pre current pregnancy OBX-5 SHALL contain the mother's weight before becoming pregnant OBX-6 SHALL indicate pounds using UCUM units: SHALL contain lb	OBX 10 NM 56077_1^Body weight-pre current pregnancy^LN  94 lb	<table border="1"> <tr><td>PSMLBDI</td><td>Y</td></tr> <tr><td>PSMFDI</td><td>Y</td></tr> <tr><td>PSLBI</td><td>Y</td></tr> <tr><td>PSFLBI</td><td>Y</td></tr> <tr><td>PSFFDI</td><td>Y</td></tr> <tr><td>PSFDI</td><td>Y</td></tr> <tr><td>JLBI</td><td>Y</td></tr> <tr><td>JFDI</td><td>Y</td></tr> <tr><td>CCOFDI</td><td></td></tr> </table>	PSMLBDI	Y	PSMFDI	Y	PSLBI	Y	PSFLBI	Y	PSFFDI	Y	PSFDI	Y	JLBI	Y	JFDI	Y	CCOFDI	
PSMLBDI	Y																			
PSMFDI	Y																			
PSLBI	Y																			
PSFLBI	Y																			
PSFFDI	Y																			
PSFDI	Y																			
JLBI	Y																			
JFDI	Y																			
CCOFDI																				



1560

**6.6.1.1.93 NFACL Mother [if Mother transferred for maternal medical or fetal indications for delivery, enter name of facility mother transferred from.]**

NFACL Derivation Rule (2)																				
IF \$AdmitSrc CONTAINS value set ( <i>Transfer In (NCHS)</i> ) OR \$ProblemCode Contains Value Set ( <i>Transferred for Maternal Medical or Fetal Indications for Delivery (NCHS)</i> ), THEN NFACL SHALL = \$ReferringFacilityName ELSE NFACL SHALL = NULL'.																				
Variable Name	Source in EMR Using FHIR (1a)	Source in EMR Using CDA Labor and Delivery Summary-VR XPATH (1b)																		
\$AdmitSrc	encounter.hospitalization.admitSource	encompassingEncounter/sdct:admissionSourceReferralCode																		
\$ProblemCode	condition.code	ClinicalDocument/component/structuredBody/component/section[templateId[@root='1.3.6.1.4.1.19376.1.5.3.1.3.6']]/entry/act/entryRelationship/observation/value																		
\$ReferringFacilityName	encounter.hospitalization.origin(location.name)	/encompassingEncounter/encounterParticipant[@typeCode='REF']/assignedEntity/representedOrganization																		
Mapping to HL7 FHIR BFDR (5a)																				
FHIR Profile/Resource	Content																			
<a href="#">Composition - Provider Live Birth Report</a> OR <a href="#">Composition - Provider Fetal Death Report</a> • PENDING	/participant/participantRole/scopingEntity/name = NFACL																			
Mapping to HL7 v2.6 BFDR (5b)																				
Mapping Location and Content	Example	Usage																		
PV1-6	PV1  I  ^Simple Birth Clinic       PI	<table border="1"> <tr><td>PSMLBDI</td><td></td></tr> <tr><td>PSMFDI</td><td></td></tr> <tr><td>PSLBI</td><td>Y</td></tr> <tr><td>PSFLBI</td><td>Y</td></tr> <tr><td>PSFFDI</td><td>Y</td></tr> <tr><td>PSFDI</td><td>Y</td></tr> <tr><td>JLBI</td><td>Y</td></tr> <tr><td>JFDI</td><td>Y</td></tr> <tr><td>CCOFDI</td><td></td></tr> </table>	PSMLBDI		PSMFDI		PSLBI	Y	PSFLBI	Y	PSFFDI	Y	PSFDI	Y	JLBI	Y	JFDI	Y	CCOFDI	
PSMLBDI																				
PSMFDI																				
PSLBI	Y																			
PSFLBI	Y																			
PSFFDI	Y																			
PSFDI	Y																			
JLBI	Y																			
JFDI	Y																			
CCOFDI																				

**6.6.1.1.94 TRAN Mother Transferred for Maternal Medical or Fetal Indications for Delivery**

TRAN Derivation Rule (2)
--------------------------

IHE Quality, Research and Public Health Technical Framework Supplement – Birth and Fetal Death Reporting-Enhanced (BFDR-E)

IF \$AdmitSrc CONTAINS Value Set ( <a href="#">Transfer In (NCHS)</a> ) OR \$ProblemCode CONTAINS Value Set ( <a href="#">Transferred for Maternal Medical or Fetal Indications for Delivery (NCHS)</a> ), THEN “TRAN” SHALL = “Y” ELSE IF \$AdmitSrc NOT NULL, THEN TRAN SHALL = “N” ELSE TRAN SHALL = “U”.			
Variable Name	Source in EMR Using FHIR (1a)	Source in EMR Using CDA Labor and Delivery Summary-VR XPATH (1b)	
\$AdmitSrc	encounter.hospitalization.admitSource	encompassingEncounter/sdtc:admissionSourceReferralCode	
\$ProblemCode	condition.code	ClinicalDocument/component/structuredBody/component/section[templateId[@root='1.3.6.1.4.1.19376.1.5.3.1.3.6']]/entry/act/entryRelationship/observation/value	
Mapping to HL7 FHIR BFDR (5a)			
FHIR Profile/Resource	Content		
<a href="#">Composition - Provider Live Birth Report</a> OR <a href="#">Composition - Provider Fetal Death Report</a> <ul style="list-style-type: none"> <li>PENDING</li> </ul>	/code@code= Code='73763-5', CodeSystemName= 'LOINC', DisplayName=' Mother was transferred for maternal medical or fetal indications for delivery' AND /value@value= Boolean form of TRAN		
Mapping to HL7 v2.6 BFDR (5b)			
Mapping Location and Content	Example	Usage	
OBX-2 SHALL contain CWE OBX-3 SHALL contain 73763-5^ Mother was transferred for maternal medical or fetal indications for delivery OBX-5 SHALL contain boolean indication of whether a trial of labor was attempted using PHVS_YesNoUnknown_CDC Yes No Unknown (YNU)	OBX 4 CWE 73763-5^Mother transferred for maternal medical or fetal indications for delivery?^LN  N^No^PHVS_YesNoUnknown_CDC      F	PSMLBDI	
		PSMFDI	
		PSLBI	Y
		PSFLBI	Y
		PSFFDI	Y
		PSFDI	Y
		JLBI	Y
		JFDI	Y
CCOFDI			

1565

6.6.1.1.95 DWGT Mother's Weight at Delivery

DWGT Derivation Rule (2)		
IF \$VitalSignsTypeCode CONTAINS ValueSet ( <a href="#">Body Weight (NCHS)</a> ) where \$VitalSignsMethodCode CONTAINS ValueSet ( <a href="#">Mothers Delivery Weight (NCHS)</a> ), THEN “DWGT” SHALL = \$VitalSignsResultValue.		
Variable Name	Source in EMR Using FHIR (1a)	Source in EMR Using CDA Labor and Delivery Summary-VR XPATH (1b)
\$VitalSignsTypeCode	observation.code constrained by: (http://ihe.net/fhir/S	ClinicalDocument/component/structuredBody/component/section[templateId[@root='1.3.6.1.4.1.19376.1.5.3.1.1.9.15.1']]/component/section[templateId[@

IHE Quality, Research and Public Health Technical Framework Supplement – Birth and Fetal Death Reporting-Enhanced (BFDR-E)

	tructureDefinition/IHE.BFDRE.MaternalObservationsHT)	root='1.3.6.1.4.1.19376.1.5.3.1.1.5.3.2']/entry/organizer/component/observation/code	
<b>\$VitalSignsMethodCode</b>	Observation.method	ClinicalDocument/component/structuredBody/component/section[templateId[@root='1.3.6.1.4.1.19376.1.5.3.1.1.9.15.1']/component/section[templateId[@root='1.3.6.1.4.1.19376.1.5.3.1.1.5.3.2']/entry/organizer/component/observation/methodCode	
<b>\$VitalSignsResultValue</b>	Observation.valueQuantity	ClinicalDocument/component/structuredBody/component/section[templateId[@root='1.3.6.1.4.1.19376.1.5.3.1.1.9.15.1']/component/section[templateId[@root='1.3.6.1.4.1.19376.1.5.3.1.1.5.3.2']/entry/organizer/component/observation/value	
<b>\$VitalSignsResultUnits</b>	observation.valueQuantity	PENDING	
Mapping to HL7 FHIR BFDR (5a)			
FHIR Profile/Resource	Content		
<a href="#">Composition - Provider Live Birth Report</a> OR <a href="#">Composition - Provider Fetal Death Report</a> <ul style="list-style-type: none"> <li>PENDING</li> </ul>	/code@code= Code='69461-2', CodeSystemName= 'LOINC', DisplayName= 'Body weight mother -- at delivery' AND /value@value= DWGT(PQ) /value/@unit= 'lb'		
Mapping to HL7 v2.6 BFDR (5b)			
Mapping Location and Content	Example	Usage	
OBX-2 SHALL contain NM OBX-3 SHALL contain 69461-2^ Body weight at delivery OBX-5 SHALL contain the mother's weight at the time of delivery OBX-6 SHALL indicate pounds using UCUM units: SHALL contain lb	OBX 10 NM 69461-2^ Body weight at delivery^LN  124lb	PSMLBDI	
		PSMFDI	
		PSLBI	Y
		PSFLBI	Y
		PSFFDI	Y
		PSFDI	Y
		JLBI	Y
		JFDI	Y
CCOFDI			

**6.6.1.1.96 POPO Number of Other Pregnancy Outcomes**

POPO Derivation Rule (2)		
IF \$PregnancyHistoryObservationCode CONTAINS ValueSet ( <a href="#">Previous Other Pregnancy Outcomes (NCHS)v</a> ), THEN "POPO" SHALL = \$PregnancyHistoryObservationValue.		
Variable Name	Source in EMR Using FHIR (1a)	Source in EMR Using CDA Labor and Delivery Summary-VR XPATH (1b)

IHE Quality, Research and Public Health Technical Framework Supplement – Birth and Fetal Death Reporting-Enhanced (BFDR-E)

<b>\$PregnancyHistoryObservationCode</b>	observation.code in value set (Previous Other Pregnancy Outcomes (NCHS) 1.3.6.1.4.1.19376.1.7.3.1.1.13.8.121)	ClinicalDocument/component/structuredBody/component/section[templateId[@root='1.3.6.1.4.1.19376.1.5.3.1.1.5.3.4']]entry/observation/code																		
<b>\$PregnancyHistoryObservationValue</b>	observation.valueC odableConcept	ClinicalDocument/component/structuredBody/component/section[templateId[@root='1.3.6.1.4.1.19376.1.5.3.1.1.5.3.4']]entry/observation/value																		
Mapping to HL7 FHIR BFDR (5a)																				
FHIR Profile/Resource	Content																			
<a href="#">Composition - Provider Live Birth Report</a> OR <a href="#">Composition - Provider Fetal Death Report</a> <ul style="list-style-type: none"> <li>PENDING</li> </ul>	/code@code= Code='69043-8', CodeSystemName= 'LOINC', DisplayName= 'Other pregnancy outcomes' AND /value@value= POPO(int)																			
Mapping to HL7 v2.6 BFDR (5b)																				
Mapping Location and Content	Example	Usage																		
OBX-2 SHALL contain NM OBX-3 SHALL contain 69043-8^Other pregnancy outcomes OBX-5 SHALL contain the total number of other pregnancy outcomes that did not result in a live birth. Includes pregnancy losses of any gestation age. For multiple deliveries include all previous pregnancy losses before this infant in this pregnancy and in previous pregnancies.	OBX 15 NM 69043-8^Other pregnancy outcomes  1	<table border="1"> <tr><td>PSMLBDI</td><td></td></tr> <tr><td>PSMFDI</td><td></td></tr> <tr><td>PSLBI</td><td>Y</td></tr> <tr><td>PSFLBI</td><td>Y</td></tr> <tr><td>PSFFDI</td><td>Y</td></tr> <tr><td>PSFDI</td><td>Y</td></tr> <tr><td>JLBI</td><td>Y</td></tr> <tr><td>JFDI</td><td>Y</td></tr> <tr><td>CCOFDI</td><td></td></tr> </table>	PSMLBDI		PSMFDI		PSLBI	Y	PSFLBI	Y	PSFFDI	Y	PSFDI	Y	JLBI	Y	JFDI	Y	CCOFDI	
PSMLBDI																				
PSMFDI																				
PSLBI	Y																			
PSFLBI	Y																			
PSFFDI	Y																			
PSFDI	Y																			
JLBI	Y																			
JFDI	Y																			
CCOFDI																				

1570

**6.6.1.1.97 PLBD Number of Previous Live Births now dead [do not include this child]**

PLBD Derivation Rule (2)		
IF \$PregnancyHistoryObservationCode CONTAINS ValueSet ( <i>Number of Previous Live Births Now Dead (NCHS)</i> ), THEN "PLBD" SHALL = \$PregnancyHistoryObservationValue.		
Variable Name	Source in EMR Using FHIR (1a)	Source in EMR Using CDA Labor and Delivery Summary-VR XPATH (1b)
<b>\$PregnancyHistoryObservationCode</b>	observation.code in value set (Number of Previous Live Births Now Dead (NCHS) 1.3.6.1.4.1.19376.1.7.3.1.1.13.8.122)	ClinicalDocument/component/structuredBody/component/section[templateId[@root='1.3.6.1.4.1.19376.1.5.3.1.1.5.3.4']]entry/observation/code

IHE Quality, Research and Public Health Technical Framework Supplement – Birth and Fetal Death Reporting-Enhanced (BFDR-E)

<b>\$PregnancyHistoryObservationValue</b>	observation.valueC odableConcept	ClinicalDocument/component/structuredBody/component/section[templateId[ @root='1.3.6.1.4.1.19376.1.5.3.1.1.5.3.4']]entry/observation/value	
Mapping to HL7 FHIR BFDR (5a)			
FHIR Profile/Resource	Content		
<a href="#">Composition - Provider Live Birth Report</a> OR <a href="#">Composition - Provider Fetal Death Report</a> <ul style="list-style-type: none"> <li>PENDING</li> </ul>	/code@code= Code='68496-9', CodeSystemName= 'LOINC', DisplayName= 'Live births now dead'  AND  /value@value= PLBD(int)		
Mapping to HL7 v2.6 BFDR (5b)			
Mapping Location and Content	Example	Usage	
OBX-2 SHALL contain NM OBX-3 SHALL contain 68496-9^Live births.now dead OBX-5 SHALL contain the total number of previous live-born infants now dead. For multiple deliveries include all live-born infants before this infant in the pregnancy who are now dead. If the first born, do not include this infant	OBX 15 NM 68496-9^Live births.now dead  1	PSMLBDI	
		PSMFDI	
		PSLBI	Y
		PSFLBI	Y
		PSFFDI	Y
		PSFDI	Y
		JLBI	Y
		JFDI	Y
CCOFDI			

**6.6.1.1.98 PLBL Number of Previous Live Births now living [do not include this child]**

PLBL Derivation Rule (2)		
IF \$PregnancyHistoryObservationCode CONTAINS ValueSet ( <a href="#">Number of Previous Live Births Now Living (NCHS)</a> ), THEN "PLBL" SHALL = \$PregnancyHistoryObservationValue.		
Variable Name	Source in EMR Using FHIR (1a)	Source in EMR Using CDA Labor and Delivery Summary-VR XPATH (1b)
<b>\$PregnancyHistoryObservationCode</b>	observation.code in value set (Number of Previous Live Births Now Living (NCHS) 1.3.6.1.4.1.19376.1.7.3.1.1.13.8.123)	ClinicalDocument/component/structuredBody/component/section[templateId[ @root='1.3.6.1.4.1.19376.1.5.3.1.1.5.3.4']]entry/observation/code
<b>\$PregnancyHistoryObservationValue</b>	observation.valueC odableConcept	ClinicalDocument/component/structuredBody/component/section[templateId[ @root='1.3.6.1.4.1.19376.1.5.3.1.1.5.3.4']]entry/observation/value
Mapping to HL7 FHIR BFDR (5a)		
FHIR Profile/Resource	Content	

IHE Quality, Research and Public Health Technical Framework Supplement – Birth and Fetal Death Reporting-Enhanced (BFDR-E)

<a href="#">Composition - Provider Live Birth Report</a> OR <a href="#">Composition - Provider Fetal Death Report</a> <ul style="list-style-type: none"> <li>PENDING</li> </ul>	/code@code= Code='11638-4', CodeSystemName= 'LOINC', DisplayName= 'Births still living' AND /value@value= PLBL(int)		
Mapping to HL7 v2.6 BFDR (5b)			
Mapping Location and Content	Example	Usage	
OBX-2 SHALL contain NM OBX-3 SHALL contain 11638-4^Births.still living OBX-5 SHALL contain the total number of previous live-born infants now living. For multiple deliveries include all live-born infants before this infant in the pregnancy. If the first born, do not include this infant.	OBX 12 NM 11638-4^Births.still living^LN  2	PSMLBDI	
		PSMFDI	
		PSLBI	Y
		PSFLBI	Y
		PSFFDI	Y
		PSFDI	Y
		JLBI	Y
		JFDI	Y
CCOFDI			

6.6.1.1.99 OWGEST Obstetric Estimate of Gestation

OWGEST Derivation Rule (2)		
IF \$PregnancyHistoryObservationCode CONTAINS ValueSet ( <i>Obstetric Estimate of Gestation (NCHS)</i> ), THEN "OWGEST" SHALL = \$PregnancyHistoryObservationValue.		
Variable Name	Source in EMR Using FHIR (1a)	Source in EMR Using CDA Labor and Delivery Summary-VR XPATH (1b)
\$PregnancyHistoryObservationCode	observation.code in value set (Obstetric Estimate of Gestation (NCHS) 1.3.6.1.4.1.19376.1.7.3.1.1.13.8.124)	ClinicalDocument/component/structuredBody/component/section[templateId[@root='1.3.6.1.4.1.19376.1.5.3.1.1.5.3.4']]>entry/observation/code
\$PregnancyHistoryObservationValue	observation.valueC odableConcept	ClinicalDocument/component/structuredBody/component/section[templateId[@root='1.3.6.1.4.1.19376.1.5.3.1.1.5.3.4']]>entry/observation/value
Mapping to HL7 FHIR BFDR (5a)		
FHIR Profile/Resource	Content	
<a href="#">Composition - Provider Live Birth Report</a> OR <a href="#">Composition - Provider Fetal Death Report</a> <ul style="list-style-type: none"> <li>PENDING</li> </ul>	/code@code= Code='11884-4', CodeSystemName= 'LOINC', DisplayName= 'Gestational age Estimated' AND /value@value= OWGEST(int)	
Mapping to HL7 v2.6 BFDR (5b)		

Mapping Location and Content	Example	Usage	
OBX-2 SHALL contain NM OBX-3 SHALL contain 11884-4^Obstetric estimate of gestation OBX-5 SHALL contain the best obstetric estimate of the infant’s gestation in completed weeks based on the birth attendant’s final estimate of gestation. This estimate of gestation should be determined by all perinatal factors and assessments such as ultrasound, but not the neonatal exam. Ultrasound taken early in pregnancy is preferred. Do not complete solely based on the infant’s date of birth and the mothers date of last menstrual period.	OBX 25 NM 11884-4^Obstetric estimate of gestation^LN  39 wk	PSMLBDI	
		PSMFDI	
		PSLBI	Y
		PSFLBI	Y
		PSFFDI	Y
		PSFDI	Y
		JLBI	Y
		JFDI	Y
CCOFDI			

1575

### 6.6.1.1.100 CERV Obstetric Procedures [Cervical cerclage]

CERV Derivation Rule (2)			
IF \$ProcedureCode CONTAINS ValueSet ( <a href="#">Cervical Cerclage (NCHS)</a> ), THEN “CERV” SHALL = ‘Y’ ELSE “CERV” SHALL = ‘N’.			
Variable Name	Source in EMR Using FHIR (1a)	Source in EMR Using CDA Labor and Delivery Summary-VR XPATH (1b)	
\$ProcedureCode	procedure.code	ClinicalDocument/component/structuredBody/component/section[templateId[@root='1.3.6.1.4.1.19376.1.5.3.1.1.21.2.3']]/component/section[templateId[@root='1.3.6.1.4.1.19376.1.5.3.1.1.13.2.11']]/entry/procedure/code	
Mapping to HL7 FHIR BFDR (5a)			
FHIR Profile/Resource	Content		
<a href="#">Composition - Provider Live Birth Report</a> <ul style="list-style-type: none"> <li>PENDING</li> </ul>	IF CERV = 'Y' then /code@code= Code= '265636007', CodeSystemName= 'SNOMED CT', DisplayName= 'Cerclage of cervix' /@negationInd = false		
Mapping to HL7 v2.6 BFDR (5b)			
Mapping Location and Content	Example	Usage	
OBX-2 SHALL contain CWE OBX-3 SHALL contain 73814-6^Obstetric procedures performed OBX-5 SHALL contain 265636007^Cerclage of cervix (procedure)	OBX 21 CWE 73814-6^Obstetric procedures^LN  265636007^Cerclage of cervix (procedure)^SNM     F	PSMLBDI	
		PSMFDI	
		PSLBI	Y
		PSFLBI	Y
		PSFFDI	
		PSFDI	
JLBI	Y		

		JFDI	
		CCOFDI	

### 6.6.1.1.101 ECVF Obstetric Procedures [Failed External cephalic Version]

ECVF Derivation Rule (2)				
IF \$ProcedureCode CONTAINS ValueSet ( <a href="#">External Cephalic Version (NCHS)</a> ) as 'INT' and Negation=TRUE, THEN "ECVF" SHALL = 'Y' ELSE "ECVF" SHALL = 'N'.				
Variable Name	Source in EMR Using FHIR (1a)	Source in EMR Using CDA Labor and Delivery Summary-VR XPATH (1b)		
\$ProcedureCode	procedure.code	ClinicalDocument/component/structuredBody/component/section[templateId[@root='1.3.6.1.4.1.19376.1.5.3.1.1.21.2.3']]/component/section[templateId[@root='1.3.6.1.4.1.19376.1.5.3.1.1.13.2.11']]/entry/procedure/code		
Mapping to HL7 FHIR BFDR (5a)				
FHIR Profile/Resource		Content		
<a href="#">Composition - Provider Live Birth Report</a>		PENDING		
<ul style="list-style-type: none"> <li>PENDING</li> </ul>				
Mapping to HL7 v2.6 BFDR (5b)				
Mapping Location and Content		Example	Usage	
OBX-2 SHALL contain CWE		OBX 21 CWE 73814-6^Obstetric procedures^LN  240278000^ External cephalic version (procedure)^SNM     F OBX 21 CWE 73820-3^Successful external cephalic version ^LN  N^No^HL70532     F	PSMLBDI	
OBX-3 SHALL contain 73814-6^Obstetric procedures performed			PSMFDI	
OBX-5 SHALL contain 240278000^External cephalic version (procedure)			PSLBI	Y
AND			PSFLBI	Y
OBX-2 SHALL contain CWE			PSFFDI	
OBX-3 SHALL contain 73820-3^Successful external cephalic version			PSFDI	
OBX-5 SHALL contain boolean indication (No)			JLBI	Y
			JFDI	
		CCOFDI		

1580

### 6.6.1.1.102 ECVS Obstetric Procedures [Successful External cephalic version]

ECVS Derivation Rule (2)			
IF \$ProcedureCode CONTAINS ValueSet ( <a href="#">External Cephalic Version (NCHS)</a> ), AND NOT ('INT' and Negation)=TRUE, THEN "ECVS" SHALL = 'Y' ELSE "ECVS" SHALL = 'N'.			
Variable Name	Source in EMR Using FHIR (1a)	Source in EMR Using CDA Labor and Delivery Summary-VR XPATH (1b)	



IHE Quality, Research and Public Health Technical Framework Supplement – Birth and Fetal Death Reporting-Enhanced (BFDR-E)

<b>\$ProcedureCode</b>	procedure.code	ClinicalDocument/component/structuredBody/component/section[templateId[@root='1.3.6.1.4.1.19376.1.5.3.1.1.21.2.3']]/component/section[templateId[@root='1.3.6.1.4.1.19376.1.5.3.1.1.13.2.11']]/entry/procedure/code	
Mapping to HL7 FHIR BFDR (5a)			
FHIR Profile/Resource	Content		
<a href="#">Composition - Provider Live Birth Report</a> <ul style="list-style-type: none"> <li>PENDING</li> </ul>	IF ECVS = 'Y' then /code@code= Code= '240278000', CodeSystemName= 'SNOMED CT', DisplayName= 'External Cephalic Version' /@negationInd = false		
Mapping to HL7 v2.6 BFDR (5b)			
Mapping Location and Content	Example	Usage	
OBX-2 SHALL contain CWE OBX-3 SHALL contain 73814-6^Obstetric procedures performed OBX-5 SHALL contain 240278000^External cephalic version (procedure) AND OBX-2 SHALL contain CWE OBX-3 SHALL contain 73820-3^Successful external cephalic version OBX-5 SHALL contain boolean indication (Yes)	OBX 21 CWE 73814-6^Obstetric procedures^LN  240278000^ External cephalic version (procedure)^SNM     F OBX 21 CWE 73820-3^Successful external cephalic version ^LN  Y^Yes^HL70532     F	PSMLBDI	
		PSMFDI	
		PSLBI	Y
		PSFLBI	Y
		PSFFDI	
		PSFDI	
		JLBI	Y
		JFDI	
CCOFDI			

6.6.1.1.103 TOC Obstetric Procedures [Tocolysis]

TOC Derivation Rule (2)		
IF \$ProcedureCode CONTAINS ValueSet ( <a href="#">Tocolysis (NCHS)</a> ), THEN "TOC" SHALL = 'Y' ELSE "TOC" SHALL = 'N'.		
Variable Name	Source in EMR Using FHIR (1a)	Source in EMR Using CDA Labor and Delivery Summary-VR XPATH (1b)
<b>\$ProcedureCode</b>	procedure.code	ClinicalDocument/component/structuredBody/component/section[templateId[@root='1.3.6.1.4.1.19376.1.5.3.1.1.21.2.3']]/component/section[templateId[@root='1.3.6.1.4.1.19376.1.5.3.1.1.13.2.11']]/entry/procedure/code
Mapping to HL7 FHIR BFDR (5a)		
FHIR Profile/Resource	Content	
<a href="#">Composition - Provider Live Birth Report</a> <ul style="list-style-type: none"> <li>PENDING</li> </ul>	IF TOC = 'Y' then /code@code= Code= '103747003', CodeSystemName= 'SNOMED CT', DisplayName= 'Tocolysis' /@negationInd = false	
Mapping to HL7 v2.6 BFDR (5b)		

IHE Quality, Research and Public Health Technical Framework Supplement – Birth and Fetal Death Reporting-Enhanced (BFDR-E)

Mapping Location and Content	Example	Usage	
OBX-2 SHALL contain CWE OBX-3 SHALL contain 73814-6^Obstetric procedures performed OBX-5 SHALL contain 103747003^Tocolysis (procedure)	OBX 21 CWE 73814-6^Obstetric procedures^LN  103747003^Tocolysis (procedure)^SNM     Fs	PSMLBDI	
		PSMFDI	
		PSLBI	Y
		PSFLBI	Y
		PSFFDI	
		PSFDI	
		JLBI	Y
		JFDI	
CCOFDI			

6.6.1.1.104 NOA03 Obstetric Procedures [None of the above]

NOA03 Derivation Rule (2)			
This SHALL require data entry and SHALL NOT be a result of a default from the other attributes in the list.			
Variable Name	Source in EMR Using FHIR (1a)	Source in EMR Using CDA Labor and Delivery Summary-VR XPATH (1b)	
N/A	N/A	N/A	
Mapping to HL7 FHIR BFDR (5a)			
FHIR Profile/Resource	Content		
<a href="#">Composition - Provider Live Birth Report</a> <ul style="list-style-type: none"> <li>PENDING</li> </ul>	IF NOA03 = 'Y' then /code@code= Code= '260413007', CodeSystemName= 'SNOMED CT', DisplayName= 'None' /@negationInd = false		
Mapping to HL7 v2.6 BFDR (5b)			
Mapping Location and Content	Example	Usage	
OBX-2 SHALL contain CWE OBX-3 SHALL contain 73814-6^Obstetric procedures performed OBX-5 SHALL contain 260413007^None (qualifier value)	OBX 21 CWE 73814-6^Obstetric procedures^LN  260413007^None (qualifier value)^SNM     F	PSMLBDI	
		PSMFDI	
		PSLBI	Y
		PSFLBI	Y
		PSFFDI	
		PSFDI	
		JLBI	Y
		JFDI	
CCOFDI			

1585

**6.6.1.1.105 PROM Onset of Labor [Premature Rupture]**

PROM Derivation Rule (2)			
IF \$EventOutcomesObservationCode CONTAINS ValueSet ( <i>Premature Rupture (NCHS)</i> ) OR \$ProblemCode CONTAINS ValueSet ( <i>Premature Rupture (NCHS)</i> ), THEN “PROM” SHALL = ‘Y’ ELSE “PROM” SHALL = ‘N’.			
Variable Name	Source in EMR Using FHIR (1a)	Source in EMR Using CDA Labor and Delivery Summary-VR XPATH (1b)	
\$EventOutcomesObservationCode	condition.code	ClinicalDocument/component/structuredBody/component/section[templateId[@root='1.3.6.1.4.1.19376.1.5.3.1.1.21.2.3']]/component/section[templateId[@root='1.3.6.1.4.1.19376.1.7.3.1.1.13.7']]/entry/observation/value	
\$ProblemCode	condition.code	ClinicalDocument/component/structuredBody/component/section[templateId[@root='1.3.6.1.4.1.19376.1.5.3.1.3.6']]/entry/act/entryRelationship/observation/value	
Mapping to HL7 FHIR BFDR (5a)			
FHIR Profile/Resource	Content		
<a href="#">Composition - Provider Live Birth Report</a> <ul style="list-style-type: none"> <li>PENDING</li> </ul>	IF PROM = 'Y' then /code@code= Code= '73774-2', CodeSystemName= 'LOINC', DisplayName= 'Onset of labor' AND /value@code= Code= '44223004', CodeSystemName= 'SNOMED CT', DisplayName= 'Premature rupture of membranes'		
Mapping to HL7 v2.6 BFDR (5b)			
Mapping Location and Content	Example	Usage	
OBX-2 SHALL contain CWE OBX-3 SHALL contain 73774-2^ Onset of labor OBX-5 SHALL contain 44223004^Premature Rupture of membranes (disorder)	OBX 22 CWE 73774-2^Onset of labor 44223004^Premature Rupture of membranes (disorder)^SNM     F	PSMLBDI	
		PSMFDI	
		PSLBI	Y
		PSFLBI	Y
		PSFFDI	
		PSFDI	
		JLBI	Y
		JFDI	
CCOFDI			

**6.6.1.1.106 PRIC Onset of Labor [Precipitous Labor]**

PRIC Derivation Rule (2)
--------------------------

IF \$EventOutcomesObservationCode CONTAINS ValueSet ( <a href="#">Precipitous Labor (NCHS)</a> ) OR \$ProblemCode CONTAINS ValueSet ( <a href="#">Precipitous Labor (NCHS)</a> ), THEN “PRIC” SHALL = ‘Y’ ELSE “PRIC” SHALL = ‘N’.																				
Variable Name	Source in EMR Using FHIR (1a)	Source in EMR Using CDA Labor and Delivery Summary-VR XPATH (1b)																		
\$EventOutcomesObservationCode	condition.code	ClinicalDocument/component/structuredBody/component/section[templateId[@root='1.3.6.1.4.1.19376.1.5.3.1.1.21.2.3']]/component/section[templateId[@root='1.3.6.1.4.1.19376.1.7.3.1.1.13.7']]/entry/observation/value																		
\$ProblemCode	condition.code	ClinicalDocument/component/structuredBody/component/section[templateId[@root='1.3.6.1.4.1.19376.1.5.3.1.3.6']]/entry/act/entryRelationship/observation/value																		
Mapping to HL7 FHIR BFDR (5a)																				
FHIR Profile/Resource	Content																			
<a href="#">Composition - Provider Live Birth Report</a> <ul style="list-style-type: none"> <li>PENDING</li> </ul>	IF PRIC = 'Y' then /code@code= Code= '73774-2', CodeSystemName= 'LOINC', DisplayName= 'Onset of labor' AND /value@code= Code= '51920004', CodeSystemName= 'SNOMED CT', DisplayName= 'Precipitate labor'																			
Mapping to HL7 v2.6 BFDR (5b)																				
Mapping Location and Content	Example	Usage																		
OBX-2 SHALL contain CWE OBX-3 SHALL contain 73774-2^ Onset of labor OBX-5 SHALL contain 51920004^Precipitate labor (disorder)	OBX 22 CWE 73774-2^Onset of labor  51920004^Precipitate labor (disorder)^SNM     F	<table border="1"> <tr><td>PSMLBDI</td><td></td></tr> <tr><td>PSMFDI</td><td></td></tr> <tr><td>PSLBI</td><td>Y</td></tr> <tr><td>PSFLBI</td><td>Y</td></tr> <tr><td>PSFFDI</td><td></td></tr> <tr><td>PSFDI</td><td></td></tr> <tr><td>JLBI</td><td>Y</td></tr> <tr><td>JFDI</td><td></td></tr> <tr><td>CCOFDI</td><td></td></tr> </table>	PSMLBDI		PSMFDI		PSLBI	Y	PSFLBI	Y	PSFFDI		PSFDI		JLBI	Y	JFDI		CCOFDI	
PSMLBDI																				
PSMFDI																				
PSLBI	Y																			
PSFLBI	Y																			
PSFFDI																				
PSFDI																				
JLBI	Y																			
JFDI																				
CCOFDI																				

1590 **6.6.1.1.107 PROL Onset of Labor [Prolonged Labor]**

PROL Derivation Rule (2)		
IF \$EventOutcomesObservationCode CONTAINS ValueSet ( <a href="#">Prolonged Labor (NCHS)</a> ) OR \$ProblemCode CONTAINS ValueSet ( <a href="#">Prolonged Labor (NCHS)</a> ), THEN “PROL” SHALL = ‘Y’ ELSE “PROL” SHALL = ‘N’.		
Variable Name	Source in EMR Using FHIR (1a)	Source in EMR Using CDA Labor and Delivery Summary-VR XPATH (1b)

IHE Quality, Research and Public Health Technical Framework Supplement – Birth and Fetal Death Reporting-Enhanced (BFDR-E)

<b>\$EventOutcomesObservationCode</b>	condition.code	ClinicalDocument/component/structuredBody/component/section[templateId[@root='1.3.6.1.4.1.19376.1.5.3.1.1.21.2.3']]/component/section[templateId[@root='1.3.6.1.4.1.19376.1.7.3.1.1.13.7']]/entry /observation/value																		
<b>\$ProblemCode</b>	condition.code	ClinicalDocument/component/structuredBody/component/section[templateId[@root='1.3.6.1.4.1.19376.1.5.3.1.3.6']]/entry/act/entryRelationship/observation/value																		
Mapping to HL7 FHIR BFDR (5a)																				
FHIR Profile/Resource	Content																			
<a href="#">Composition - Provider Live Birth Report</a> <ul style="list-style-type: none"> <li>PENDING</li> </ul>	IF PROL = 'Y' then  /code@code= Code= '73774-2', CodeSystemName= 'LOINC', DisplayName= 'Onset of labor'  AND  /value@code= Code= '53443007', CodeSystemName= 'SNOMED CT', DisplayName= Prolonged labor'																			
Mapping to HL7 v2.6 BFDR (5b)																				
Mapping Location and Content	Example	Usage																		
OBX-2 SHALL contain CWE OBX-3 SHALL contain 73774-2^ Onset of labor OBX-5 SHALL contain 53443007^Prolonged labor (disorder)	OBX 22 CWE 73774-2^Onset of labor  53443007^Prolonged labor (disorder)^SNM     F	<table border="1"> <tr><td>PSMLBDI</td><td></td></tr> <tr><td>PSMFDI</td><td></td></tr> <tr><td>PSLBI</td><td>Y</td></tr> <tr><td>PSFLBI</td><td>Y</td></tr> <tr><td>PSFFDI</td><td></td></tr> <tr><td>PSFDI</td><td></td></tr> <tr><td>JLBI</td><td>Y</td></tr> <tr><td>JFDI</td><td></td></tr> <tr><td>CCOFDI</td><td></td></tr> </table>	PSMLBDI		PSMFDI		PSLBI	Y	PSFLBI	Y	PSFFDI		PSFDI		JLBI	Y	JFDI		CCOFDI	
PSMLBDI																				
PSMFDI																				
PSLBI	Y																			
PSFLBI	Y																			
PSFFDI																				
PSFDI																				
JLBI	Y																			
JFDI																				
CCOFDI																				

**6.6.1.1.108 NOA05 Onset of Labor** [None of the above NOTE: NOA05 is also used for Maternal Morbidity]

NOA05 Derivation Rule (2)		
This SHALL require data entry and SHALL NOT be a result of a default from the other attributes in the list.		
Variable Name	Source in EMR Using FHIR (1a)	Source in EMR Using CDA Labor and Delivery Summary-VR XPATH (1b)
N/A	N/A	N/A
Mapping to HL7 FHIR BFDR (5a)		
FHIR Profile/Resource	Content	
<a href="#">Composition - Provider Live Birth Report</a> <ul style="list-style-type: none"> <li>PENDING</li> </ul>	IF NOA05 = 'Y' then	

IHE Quality, Research and Public Health Technical Framework Supplement – Birth and Fetal Death Reporting-Enhanced (BFDR-E)

		/code@code= Code= '73774-2', CodeSystemName= 'LOINC', DisplayName= 'Onset of labor'																			
		AND																			
		/value@code= Code= '260413007', CodeSystemName= 'SNOMED CT', DisplayName= 'None'																			
Mapping to HL7 v2.6 BFDR (5b)																					
Mapping Location and Content		Example	Usage																		
OBX-2 SHALL contain CWE OBX-3 SHALL contain 73774-2^ Onset of labor OBX-5 SHALL contain 260413007^None (qualifier value)		OBX 22 CWE 73774-2^Onset of labor  53443007^260413007^None (qualifier value)^SNM     F	<table border="1"> <tr><td>PSMLBDI</td><td></td></tr> <tr><td>PSMFDI</td><td></td></tr> <tr><td>PSLBI</td><td>Y</td></tr> <tr><td>PSFLBI</td><td>Y</td></tr> <tr><td>PSFFDI</td><td></td></tr> <tr><td>PSFDI</td><td></td></tr> <tr><td>JLBI</td><td>Y</td></tr> <tr><td>JFDI</td><td></td></tr> <tr><td>CCOFDI</td><td></td></tr> </table>	PSMLBDI		PSMFDI		PSLBI	Y	PSFLBI	Y	PSFFDI		PSFDI		JLBI	Y	JFDI		CCOFDI	
PSMLBDI																					
PSMFDI																					
PSLBI	Y																				
PSFLBI	Y																				
PSFFDI																					
PSFDI																					
JLBI	Y																				
JFDI																					
CCOFDI																					

1595

**6.6.1.1.109 SFN Place Where Birth Occurred [State Facility Number]**

SFN Derivation Rule (2)								
"SFN" SHALL be populated using \$BabyFacilityStateID.								
Variable Name	Source in EMR Using FHIR (1a)	Source in EMR Using CDA Labor and Delivery Summary-VR XPATH (1b)						
\$BabyFacilityStateID	encounter.serviceProvider(organization.identifier)	/ClinicalDocument/componentOf/encompassingEncounter/location/healthCareFacility/location/id						
Mapping to HL7 FHIR BFDR (5a)								
FHIR Profile/Resource	Content							
<a href="#">Composition - Provider Live Birth Report</a> OR <a href="#">Composition - Provider Fetal Death Report</a> <ul style="list-style-type: none"> <li>PENDING</li> </ul>	/participant/participantRole/id = SFN							
Mapping to HL7 v2.6 BFDR (5b)								
Mapping Location and Content	Example	Usage						
OBX-2 SHALL contain AD OBX-3 SHALL contain 62329-8^ Birth Hospital Facility Id	OBX 16 AD  62329-8^ Birth Hospital Facility Id   300 Main St^^Metropolis^Rhode Island^03443^	<table border="1"> <tr><td>PSMLBDI</td><td></td></tr> <tr><td>PSMFDI</td><td></td></tr> <tr><td>PSLBI</td><td>Y</td></tr> </table>	PSMLBDI		PSMFDI		PSLBI	Y
PSMLBDI								
PSMFDI								
PSLBI	Y							

IHE Quality, Research and Public Health Technical Framework Supplement – Birth and Fetal Death Reporting-Enhanced (BFDR-E)

OBX-5 SHALL contain the address of the facility where the delivery occurred	PSFLBI	Y
	PSFFDI	Y
	PSFDI	Y
	JLBI	Y
	JFDI	Y
	CCOFDI	

**6.6.1.1.110 FLOC Where Birth Occurred [Facility City/Town]**

FLOC Derivation Rule (2)			
“FLOC” SHALL = City/Town part of \$BabyFacilityLocation.			
Variable Name	Source in EMR Using FHIR (1a)	Source in EMR Using CDA Labor and Delivery Summary-VR XPATH (1b)	
\$BabyFacilityLocation	encounter.serviceProvider(organization.address)	ClinicalDocument/component/structuredBody/component/section/templateId[@root='1.3.6.1.4.1.19376.1.5.3.1.1.21.2.4']/relatedSubject/code[@code='NCHILD' AND id=idOfTheChild]/addr/city	
Mapping to HL7 FHIR BFDR (5a)			
FHIR Profile/Resource	Content		
<a href="#">Composition - Provider Live Birth Report</a> OR <a href="#">Composition - Provider Fetal Death Report</a> • PENDING	/participant/participantRole/addr contains FLOC		
Mapping to HL7 v2.6 BFDR (5b)			
Mapping Location and Content	Example	Usage	
OBX-2 SHALL contain AD OBX-3 SHALL contain 62331-4 ^Birth Hospital Facility Address OBX-5 SHALL contain the address of the facility where the delivery occurred	OBX 16 AD  62331-4 ^Birth Hospital Facility Address   300 Main St^^Metropolis^Rhode Island^03443^	PSMLBDI	
		PSMFDI	
		PSLBI	Y
		PSFLBI	Y
		PSFFDI	Y
		PSFDI	Y
		JLBI	Y
		JFDI	Y
CCOFDI			

**6.6.1.1.111 CNAME Where Birth Occurred [County Name]**

CNAME Derivation Rule (2)
---------------------------

IHE Quality, Research and Public Health Technical Framework Supplement – Birth and Fetal Death Reporting-Enhanced (BFDR-E)

“CNAME” SHALL = County name part of \$BabyFacilityLocation.			
Variable Name	Source in EMR Using FHIR (1a)	Source in EMR Using CDA Labor and Delivery Summary-VR XPATH (1b)	
\$BabyFacilityLocation	encounter.serviceProvider(organization.address)	ClinicalDocument/component/structuredBody/component/section/templateId[@root='1.3.6.1.4.1.19376.1.5.3.1.1.21.2.4']/relatedSubject/code[@code='NCHLD' AND id=idOfTheChild]/addr/county	
Mapping to HL7 FHIR BFDR (5a)			
FHIR Profile/Resource	Content		
<a href="#">Composition - Provider Live Birth Report</a> OR <a href="#">Composition - Provider Fetal Death Report</a> <ul style="list-style-type: none"> <li>PENDING</li> </ul>	/participant/participantRole/addr contains CNAME		
Mapping to HL7 v2.6 BFDR (5b)			
Mapping Location and Content	Example	Usage	
OBX-2 SHALL contain AD OBX-3 SHALL contain 62331-4 ^Birth Hospital Facility Address OBX-5 SHALL contain the address of the facility where the delivery occurred	OBX 16 AD  62331-4 ^Birth Hospital Facility Address   300 Main St^^Metropolis^Rhode Island^03443^	PSMLBDI	
		PSMFDI	
		PSLBI	Y
		PSFLBI	Y
		PSFFDI	Y
		PSFDI	Y
		JLBI	Y
		JFDI	Y
CCOFDI			

1600

6.6.1.1.112 CNTYO Where Birth Occurred [County Code]

CNTYO Derivation Rule (2)		
“CNTYO” SHALL = County Code part of \$BabyFacilityLocation.		
Variable Name	Source in EMR Using FHIR (1a)	Source in EMR Using CDA Labor and Delivery Summary-VR XPATH (1b)
\$BabyFacilityLocation	encounter.serviceProvider(organization.address)	/participant/participantRole/addr This derivation rule is subject to Realm specificity. For example, in the US, a value set lookup using the code from CNTYO.
Mapping to HL7 FHIR BFDR (5a)		
FHIR Profile/Resource	Content	
<a href="#">Composition - Provider Live Birth Report</a> OR <a href="#">Composition - Provider Fetal Death Report</a>	/participant/participantRole/addr contains CNTYO	



IHE Quality, Research and Public Health Technical Framework Supplement – Birth and Fetal Death Reporting-Enhanced (BFDR-E)

• PENDING			
Mapping to HL7 v2.6 BFDR (5b)			
Mapping Location and Content	Example	Usage	
OBX-2 SHALL contain AD OBX-3 SHALL contain 62331-4 ^Birth Hospital Facility Address OBX-5 SHALL contain the address of the facility where the delivery occurred	OBX 16 AD  62331-4 ^Birth Hospital Facility Address   300 Main St^^Metropolis^Rhode Island^03443^	PSMLBDI	
		PSMFDI	
		PSLBI	Y
		PSFLBI	Y
		PSFFDI	Y
		PSFDI	Y
		JLBI	Y
		JFDI	Y
		CCOFDI	

6.6.1.1.113 BPLACE Where Birth Occurred [Birth Place]

BPLACE Derivation Rule (2)		
IF \$EventOutcomesObservationCode CONTAINS ValueSet ( <a href="#">Birthplace Setting (NCHS)</a> ) THEN IF \$EventOutcomesObservationValue CONTAINS ValueSet ( <a href="#">Birthplace Hospital (NCHS)</a> ) THEN BPLACE SHALL = '1' ELSE IF \$EventOutcomesObservationValue CONTAINS ValueSet ( <a href="#">Birth Place Freestanding Birthing Center (NCHS)</a> ) THEN BPLACE SHALL = '2' ELSE IF \$EventOutcomesObservationValue CONTAINS ValueSet ( <a href="#">Birth Place Home Intended (NCHS)</a> ) THEN BPLACE SHALL = '3' ELSE IF \$EventOutcomesObservationValue CONTAINS ValueSet ( <a href="#">Birth Place Home Unintended (NCHS)</a> ) THEN BPLACE SHALL = '4' ELSE IF \$EventOutcomesObservationValue CONTAINS ValueSet ( <a href="#">Birth Place Home Unknown Intention (NCHS)</a> ) THEN BPLACE SHALL = '5' ELSE IF \$EventOutcomesObservationValue CONTAINS ValueSet ( <a href="#">Birthplace Clinic Office (NCHS)</a> ) THEN BPLACE SHALL = '6' ELSE BPLACE SHALL = '7'.		
Variable Name	Source in EMR Using FHIR (1a)	Source in EMR Using CDA Labor and Delivery Summary-VR XPATH (1b)
\$EventOutcomesObservationCode	observation.code constrained by: ( <a href="http://ihe.net/fhir/StructureDefinition/IHE.BFDRE.NewbornObservationsBPLACE">http://ihe.net/fhir/StructureDefinition/IHE.BFDRE.NewbornObservationsBPLACE</a> )	ClinicalDocument/component/structuredBody/component/section[templateId[@root='1.3.6.1.4.1.19376.1.5.3.1.1.21.2.4']]/subject/relatedSubject/code[@code='NCHILD' AND id=idOfTheChild]/component/section[templateId[@root='1.3.6.1.4.1.19376.1.7.3.1.1.13.7']]/entry/observation/code
\$EventOutcomesObservationValue	observation.valueCodableConcept	ClinicalDocument/component/structuredBody/component/section[templateId[@root='1.3.6.1.4.1.19376.1.5.3.1.1.21.2.4']]/subject/relatedSubject/code[@code='NCHILD' AND id=idOfTheChild]/component/section[templateId[@root='1.3.6.1.4.1.19376.1.7.3.1.1.13.7']]/entry/observation/value
Mapping to HL7 FHIR BFDR (5a)		
FHIR Profile/Resource	Content	

IHE Quality, Research and Public Health Technical Framework Supplement – Birth and Fetal Death Reporting-Enhanced (BFDR-E)

<p><u>Composition - Provider Live Birth Report</u></p> <ul style="list-style-type: none"> <li>PENDING</li> </ul>	<pre> IF BPLACE = '1' then /participant/participantRole/code@code = Code= '22232009', CodeSystemName= 'SNOMED CT', DisplayName= 'Hospital'  ELSE IF BPLACE = '2' then /participant/participantRole/code@code = Code= '91154008', CodeSystemName= 'SNOMED CT', DisplayName= 'Free- standing birthing center'  ELSE IF BPLACE = '3' then (/participant/participantRole/code@code = Code= '169813005', CodeSystemName= 'SNOMED CT', DisplayName= 'Home birth' AND /entryRelationship/component/[home Birth Plan [Observation: templateId 2.16.840.1.113883.10.20.26.26]] /code@code = Code= '73765-0', CodeSystemName= 'LOINC', DisplayName= 'Home birth' /value@code = '1') ELSE IF BPLACE = '4' then (/participant/participantRole/code@code = Code= '169813005', CodeSystemName= 'SNOMED CT', DisplayName= 'Home birth' AND /entryRelationship/component/[home Birth Plan [Observation: templateId 2.16.840.1.113883.10.20.26.26]] /code@code = Code= '73765-0', CodeSystemName= 'LOINC', DisplayName= 'Home birth' /value@code = '0') ELSE IF BPLACE = '5' then (/participant/participantRole/code@code = Code= '169813005', CodeSystemName= 'SNOMED CT', DisplayName= 'Home birth' AND /entryRelationship/component/[home Birth Plan [Observation: templateId 2.16.840.1.113883.10.20.26.26]] /code@code = Code= '73765-0', CodeSystemName= 'LOINC', DisplayName= 'Home birth' /value@code = NULL Flavor) ELSE IF BPLACE = '6' then /participant/participantRole/code@code = Code= '67190003', CodeSystemName= 'SNOMED CT', DisplayName= 'Free- standing clinic'  ELSE IF BPLACE = '7' then /participant/participantRole/code@code = Code= '394841004', CodeSystemName= 'SNOMED CT', DisplayName= 'Other'                 </pre>		
<b>Mapping to HL7 v2.6 BFDR (5b)</b>			
<b>Mapping Location and Content</b>	<b>Example</b>	<b>Usage</b>	
PID-11 (for address if not in facility);		PSMLBDI	

IHE Quality, Research and Public Health Technical Framework Supplement – Birth and Fetal Death Reporting-Enhanced (BFDR-E)

<p>If in Facility:                  OBX-2 SHALL contain CWE                  OBX-3 SHALL contain 73766-8^Place where birth occurred                  OBX-5 SHALL contain 22232009^Hospital</p> <p>PID-11 (for address if not in facility);                  If in Facility:                  OBX-2 SHALL contain CWE                  OBX-3 SHALL contain 73766-8^Place where birth occurred                  OBX-5 SHALL contain 67190003^Free-standing clinic</p> <p>PID-11 (for address if not in facility);                  If in Facility:                  OBX-2 SHALL contain CWE                  OBX-3 SHALL contain 73766-8^Place where birth occurred                  OBX-5 SHALL contain 91154008^Free-standing birthing center</p> <p>PID-11 (for address if not in facility);                  If in Facility:                  OBX-2 SHALL contain CWE                  OBX-3 SHALL contain 73766-8^Place where birth occurred                  OBX-5 SHALL contain one of:                  408839006^Planned Home Birth, SNM                  408838003^Unplanned Home Birth, SNM                  PHC1297^Unknown if Planned Home Birth, PHINVS</p> <p>PID-11 (for address if not in facility);                  If in Facility:                  OBX-2 SHALL contain CWE                  OBX-3 SHALL contain 73766-8^Place where birth occurred                  OBX-5 SHALL contain OTH^Other, NullFlavor</p> <p>PID-11 (for address if not in facility);                  If in Facility:                  OBX-2 SHALL contain CWE                  OBX-3 SHALL contain 73766-8^Place where birth occurred                  OBX-5 SHALL contain UNK^Unknown, NullFlavor</p>	<p>OBX 1 CWE 73766-8^Birth/delivery location type^LN  22232009^Hospital^SNM     F</p>	<p>PSMFDI</p>		
			PSLBI	Y
			PSFLBI	Y
			PSFFDI	Y
		<p>OBX 1 CWE 73766-8^Birth/delivery location type^LN  67190003^Free-standing clinic ^SNM     F</p>	PSFDI	Y
			JLBI	Y
			JFDI	Y
		<p>OBX 1 CWE 73766-8^Birth/delivery location type^LN  91154008^Free-standing birthing center ^SNM     F</p>	CCOFDI	
	<p>OBX 1 CWE 73766-8^Birth/delivery location type^LN  408838003^Unplanned Home Birth^SNM     F</p>			
	<p>OBX 1 CWE 73766-8^Birth/delivery location type^LN  OTH^Other^NullFlavor     F</p>			
	<p>OBX 1 CWE 73766-8^Birth/delivery location type^LN  UNK^Unknown^NullFlavor     F</p>			

### 6.6.1.1.114 PLUR Plurality

PLUR Derivation Rule (2)			
IF \$EventOutcomesObservationCode CONTAINS ValueSet ( <a href="#">Birth Plurality of Delivery (NCHS)</a> ), THEN “PLUR” SHALL = \$EventOutcomesObservationValue.			
Variable Name	Source in EMR Using FHIR (1a)	Source in EMR Using CDA Labor and Delivery Summary-VR XPATH (1b)	
\$EventOutcomesObservationCode	observation.code constrained by: ( <a href="http://ihe.net/fhir/StructureDefinition/IHE.BFDRE.NewbornObservationsPLUR">http://ihe.net/fhir/StructureDefinition/IHE.BFDRE.NewbornObservationsPLUR</a> )	ClinicalDocument/component/structuredBody/component/section[templateId[@root='1.3.6.1.4.1.19376.1.5.3.1.1.21.2.4']/subject/relatedSubject/code[@code='NCHILD' AND id=idOfTheChild]/component/section[templateId[@root='1.3.6.1.4.1.19376.1.7.3.1.1.13.7']/entry/observation/code	
\$EventOutcomesObservationValue	observation.valueQuantity	ClinicalDocument/component/structuredBody/component/section[templateId[@root='1.3.6.1.4.1.19376.1.5.3.1.1.21.2.4']/subject/relatedSubject/code[@code='NCHILD' AND id=idOfTheChild]/component/section[templateId[@root='1.3.6.1.4.1.19376.1.7.3.1.1.13.7']/entry/observation/value	
Mapping to HL7 FHIR BFDR (5a)			
FHIR Profile/Resource	Content		
<a href="#">Composition - Provider Live Birth Report</a> OR <a href="#">Composition - Provider Fetal Death Report</a> <ul style="list-style-type: none"> <li>PENDING</li> </ul>	/code@code= Code='57722-1', CodeSystemName= 'LOINC', DisplayName= 'Birth plurality' AND /value@value= PLUR(int)		
Mapping to HL7 v2.6 BFDR (5b)			
Mapping Location and Content	Example	Usage	
OBX-2 SHALL contain NM OBX-3 SHALL contain 57722-1^Birth plurality OBX-5 SHALL contain the number of fetuses delivered live or dead at any time in the pregnancy regardless of gestational age or if the fetuses were delivered at different dates in the pregnancy	OBX 30 NM 57722-1^Birth plurality^LN  1	PSMLBDI	
		PSMFDI	
		PSLBI	Y
		PSFLBI	Y
		PSFFDI	Y
		PSFDI	Y
		JLBI	Y
		JFDI	Y
CCOFDI			

**6.6.1.1.115 DOFP\_MO Prenatal Care Visits [Month]**

<b>DOFP_MO Derivation Rule (2)</b>			
IF \$PregnancyHistoryObservationCode CONTAINS ValueSet ( <i>First Prenatal Care Visit (NCHS)</i> ) THEN (IF \$PregnancyHistoryObservationValue NOT NULL THEN “DOFP_MO” SHALL = the Month part of \$PregnancyHistoryObservationValue WHERE the Month is represented using 2-digits ELSE DOFP_MO” SHALL = ‘88’) ELSE “DOFP_MO” SHALL = ‘99’.			
<b>Variable Name</b>	<b>Source in EMR Using FHIR (1a)</b>	<b>Source in EMR Using CDA Labor and Delivery Summary-VR XPATH (1b)</b>	
\$PregnancyHistoryObservationCode	observation.code constrained by: (http://ihe.net/fhir/StructureDefinition/IHE.BFDRE.NewbornObservationsDOP)	ClinicalDocument/component/structuredBody/component/section[templateId[@root='1.3.6.1.4.1.19376.1.5.3.1.1.5.3.4']]//entry/observation/code	
\$PregnancyHistoryObservationValue	observation.valueDateTime	ClinicalDocument/component/structuredBody/component/section[templateId[@root='1.3.6.1.4.1.19376.1.5.3.1.1.5.3.4']]//entry/observation/value	
<b>Mapping to HL7 FHIR BFDR (5a)</b>			
<b>FHIR Profile/Resource</b>		<b>Content</b>	
<a href="#">Composition - Provider Live Birth Report</a> OR <a href="#">Composition - Provider Fetal Death Report</a> <ul style="list-style-type: none"> <li>PENDING</li> </ul>		/effectiveTime/low	
<b>Mapping to HL7 v2.6 BFDR (5b)</b>			
<b>Mapping Location and Content</b>	<b>Example</b>	<b>Usage</b>	
OBX-2 SHALL contain DTM OBX-3 SHALL contain 69044-6^Date first prenatal visit OBX-5 SHALL contain the date a physician or other health care professional first examined and/or counseled the pregnant woman for the pregnancy.	OBX 5 DTM 69044-6^Date first prenatal visit^LN  20100528     F	PSMLBDI	
		PSMFDI	
		PSLBI	Y
		PSFLBI	Y
		PSFFDI	Y
		PSFDI	Y
		JLBI	Y
		JFDI	Y
CCOFDI			

1610

**6.6.1.1.116 DOFP\_DY Prenatal Care Visits [Day]**

<b>DOFP_DY Derivation Rule (2)</b>			
IF \$PregnancyHistoryObservationCode CONTAINS ValueSet ( <i>First Prenatal Care Visit (NCHS)</i> ) THEN (IF \$PregnancyHistoryObservationValue NOT NULL THEN “DOFP_DY” SHALL CONTAINS the Day part of \$PregnancyHistoryObservationValue WHERE the Day is represented using 2-digits ELSE DOFP_DY” SHALL = ‘88’) ELSE “DOFP_DY” SHALL = ‘99’.			
<b>Variable Name</b>	<b>Source in EMR Using FHIR (1a)</b>	<b>Source in EMR Using CDA Labor and Delivery Summary-VR XPATH (1b)</b>	
\$PregnancyHistoryObservationCode	observation.code constrained by: (http://ihe.net/fhir/StructureDefinition/IHE.BFDRE.NewbornObservationsDOFP)	ClinicalDocument/component/structuredBody/component/section[templateId[@root='1.3.6.1.4.1.19376.1.5.3.1.1.5.3.4']]//entry/observation/code	
\$PregnancyHistoryObservationValue	observation.valueDateTime	ClinicalDocument/component/structuredBody/component/section[templateId[@root='1.3.6.1.4.1.19376.1.5.3.1.1.5.3.4']]//entry/observation/value	
<b>Mapping to HL7 FHIR BFDR (5a)</b>			
<b>FHIR Profile/Resource</b>		<b>Content</b>	
<a href="#">Composition - Provider Live Birth Report</a> OR <a href="#">Composition - Provider Fetal Death Report</a> <ul style="list-style-type: none"> <li>PENDING</li> </ul>		/effectiveTime/low	
<b>Mapping to HL7 v2.6 BFDR (5b)</b>			
<b>Mapping Location and Content</b>	<b>Example</b>	<b>Usage</b>	
OBX-2 SHALL contain DTM OBX-3 SHALL contain 69044-6^Date first prenatal visit OBX-5 SHALL contain the date a physician or other health care professional first examined and/or counseled the pregnant woman for the pregnancy.	OBX 5 DTM 69044-6^Date first prenatal visit^LN  20100528     F	PSMLBDI	
		PSMFDI	
		PSLBI	Y
		PSFLBI	Y
		PSFFDI	Y
		PSFDI	Y
		JLBI	Y
		JFDI	Y
CCOFDI			

**6.6.1.1.117 DOFP\_YR Prenatal Care Visits [Year]**

<b>DOFP_YR Derivation Rule (2)</b>			
IF \$PregnancyHistoryObservationCode CONTAINS ValueSet ( <i>First Prenatal Care Visit (NCHS)</i> ), THEN (IF \$PregnancyHistoryObservationValue NOT NULL THEN “DOFP_YR” SHALL = the Year part of \$PregnancyHistoryObservationValue WHERE the Year is represented using 4-digits ELSE DOFP_YR” SHALL = ‘8888’) ELSE “DOFP_YR” SHALL = ‘9999’.			
<b>Variable Name</b>	<b>Source in EMR Using FHIR (1a)</b>	<b>Source in EMR Using CDA Labor and Delivery Summary-VR XPATH (1b)</b>	
\$PregnancyHistoryObservationCode	observation.code constrained by: (http://ihe.net/fhir/StructureDefinition/IHE.BFDRE.NewbornObservationsDOP)	ClinicalDocument/component/structuredBody/component/section[templateId[@root='1.3.6.1.4.1.19376.1.5.3.1.1.5.3.4']]/entry/observation/code	
\$PregnancyHistoryObservationValue	observation.valueDateTime	ClinicalDocument/component/structuredBody/component/section[templateId[@root='1.3.6.1.4.1.19376.1.5.3.1.1.5.3.4']]/entry/observation/value	
<b>Mapping to HL7 FHIR BFDR (5a)</b>			
<b>FHIR Profile/Resource</b>		<b>Content</b>	
<a href="#">Composition - Provider Live Birth Report</a> OR <a href="#">Composition - Provider Fetal Death Report</a> <ul style="list-style-type: none"> <li>PENDING</li> </ul>		/effectiveTime/low	
<b>Mapping to HL7 v2.6 BFDR (5b)</b>			
<b>Mapping Location and Content</b>	<b>Example</b>	<b>Usage</b>	
OBX-2 SHALL contain DTM OBX-3 SHALL contain 69044-6^Date first prenatal visit OBX-5 SHALL contain the date a physician or other health care professional first examined and/or counseled the pregnant woman for the pregnancy.	OBX 5 DTM 69044-6^Date first prenatal visit^LN  20100528     F	PSMLBDI	
		PSMFDI	
		PSLBI	Y
		PSFLBI	Y
		PSFFDI	Y
		PSFDI	Y
		JLBI	Y
		JFDI	Y
CCOFDI			

**6.6.1.1.118 NPREV Prenatal Care Visits [Total number of prenatal visits for this pregnancy]**

NPREV Derivation Rule (2)			
IF \$PregnancyHistoryObservationCode CONTAINS ValueSet ( <i>Number Prenatal Care Visits (NCHS)</i> ), THEN “NPREV” SHALL = \$PregnancyHistoryObservationValue.			
Variable Name	Source in EMR Using FHIR (1a)	Source in EMR Using CDA Labor and Delivery Summary-VR XPATH (1b)	
\$PregnancyHistoryObservationCode	observation.code constrained by: (http://ihe.net/fhir/StructureDefinition/IHE.BFDRE.NewbornObservationsNPREV)	ClinicalDocument/component/structuredBody/component/section[templateId[@root='1.3.6.1.4.1.19376.1.5.3.1.1.5.3.4']]>entry/observation/code	
\$PregnancyHistoryObservationValue	observation.valueDateTime	ClinicalDocument/component/structuredBody/component/section[templateId[@root='1.3.6.1.4.1.19376.1.5.3.1.1.5.3.4']]>entry/observation/value	
Mapping to HL7 FHIR BFDR (5a)			
FHIR Profile/Resource		Content	
<a href="#">Composition - Provider Live Birth Report</a> OR <a href="#">Composition - Provider Fetal Death Report</a> <ul style="list-style-type: none"> <li>PENDING</li> </ul>		/entryRelationship/observation/code@code= Code='68493-6', CodeSystemName= 'LOINC', DisplayName= 'Prenatal visits for this pregnancy'  AND  /value@value= NPREV(int)	
Mapping to HL7 v2.6 BFDR (5b)			
Mapping Location and Content	Example	Usage	
OBX-2 SHALL contain NM OBX-3 SHALL contain 68493-6^ Prenatal visits for this pregnancy OBX-5 SHALL contain the total number of visits recorded in the record.	OBX 8 NM 68493-6^Prenatal visits for this pregnancy^LN  10	PSMLBDI	
		PSMFDI	
		PSLBI	Y
		PSFLBI	Y
		PSFFDI	Y
		PSFDI	Y
		JLBI	Y
		JFDI	Y
CCOFDI			



1625

**6.6.1.1.119 PAY Principal Source of Payment for this Delivery**

PAY Derivation Rule (2)			
NOTE: The US-Specific codes associated with this value set are not yet mapped to the form data from HITSP selected ANSI X12 Values. Until such time as these codes are mapped, this attribute will require implementation-specific mapping.			
Variable Name	Source in EMR Using FHIR (1a)	Source in EMR Using CDA Labor and Delivery Summary-VR XPATH (1b)	
PENDING	Coverage.type	PENDING	
Mapping to HL7 FHIR BFDR (5a)			
FHIR Profile/Resource	Content		
<a href="#">Composition - Provider Live Birth Report</a> <ul style="list-style-type: none"> <li>PENDING</li> </ul>	entryRelationship/observation/ code@code= Code= '68461-3', CodeSystemName= 'LOINC', DisplayName= 'Payment source' AND /value@code = PAY using Value Set 'Birth and Fetal Death Financial Class (NCHS) (2.16.840.1.114222.4.11.7163)		
Mapping to HL7 v2.6 BFDR (5b)			
Mapping Location and Content	Example	Usage	
PV1-20 SHALL contain PAY using the PHVS_BirthAndFetalDeathFinancialClass_NCHS	PV1  N    ^^^^^^Simple Birth Clinic         2^MEDICAID^PHVS_BirthAndFetalDeathFinancialClass_NCHS	PSMLBDI	
		PSMFDI	
		PSLBI	Y
		PSFLBI	Y
		PSFFDI	
		PSFDI	
		JLBI	Y
		JFDI	
CCOFDI			

**6.6.1.1.120 PDIAB Risk Factors in this Pregnancy [Pre-pregnancy Diabetes]**

PDIAB Derivation Rule (2)		
IF \$PregnancyHistoryObservationValue CONTAINS ValueSet ( <a href="#">Prepregnancy Diabetes (NCHS)</a> ) OR \$ProblemCode CONTAINS ValueSet ( <a href="#">Prepregnancy Diabetes (NCHS)</a> ), THEN "PDIAB" SHALL = 'Y' ELSE "PDIAB" SHALL = 'N'.		
Variable Name	Source in EMR Using FHIR (1a)	Source in EMR Using CDA Labor and Delivery Summary-VR XPATH (1b)
\$PregnancyHistoryObservationValue	condition.code	ClinicalDocument/component/structuredBody/component/section[templateId[@root='1.3.6.1.4.1.19376.1.5.3.1.1.5.3.4']] /entry /observation/value
\$ProblemCode	condition.code	ClinicalDocument/component/structuredBody/component/section[templateId[@root='1.3.6.1.4.1.19376.1.5.3.1.3.6']] /entry/act/entryRelationship/observation/value

IHE Quality, Research and Public Health Technical Framework Supplement – Birth and Fetal Death Reporting-Enhanced (BFDR-E)

Mapping to HL7 FHIR BFDR (5a)			
FHIR Profile/Resource	Content		
<a href="#">Composition - Provider Live Birth Report</a> OR <a href="#">Composition - Provider Fetal Death Report</a> <ul style="list-style-type: none"> <li>PENDING</li> </ul>	IF PDIAB = 'Y' then  /code@code= Code= '73775-9', CodeSystemName= 'LOINC', DisplayName= 'Risk factors in this pregnancy'  AND  /value@code= Code= '73211009', CodeSystemName= 'SNOMED CT', DisplayName= 'Diabetes mellitus'		
Mapping to HL7 v2.6 BFDR (5b)			
Mapping Location and Content	Example	Usage	
OBX-2 SHALL contain CWE OBX-3 SHALL contain 73775-9^Risk Factors in this Pregnancy OBX-5 SHALL contain 73211009^Diabetes mellitus (disorder)	OBX 17 CWE 73775-9^Risk factors in this pregnancy^LN  73211009^Diabetes mellitus (disorder)^SNM     F	PSMLBDI	
		PSMFDI	
		PSLBI	Y
		PSFLBI	Y
		PSFFDI	Y
		PSFDI	Y
		JLBI	Y
		JFDI	Y
CCOFDI			

6.6.1.1.121 GDIAB Risk Factors in this Pregnancy [Gestational Diabetes]

GDIAB Derivation Rule (2)		
IF \$PregnancyHistoryObservationValue CONTAINS ValueSet ( <a href="#">Gestational Diabetes (NCHS)</a> ) OR \$ProblemCode CONTAINS ValueSet ( <a href="#">Gestational Diabetes (NCHS)</a> ), THEN "GDIAB" SHALL = 'Y' ELSE "GDIAB" SHALL = 'N'.		
Variable Name	Source in EMR Using FHIR (1a)	Source in EMR Using CDA Labor and Delivery Summary-VR XPATH (1b)
\$PregnancyHistoryObservationValue	condition.code	ClinicalDocument/component/structuredBody/component/section[templateId[@root='1.3.6.1.4.1.19376.1.5.3.1.1.5.3.4']] /entry /observation/value
\$ProblemCode	condition.code	ClinicalDocument/component/structuredBody/component/section[templateId[@root='1.3.6.1.4.1.19376.1.5.3.1.3.6']] /entry/act/entryRelationship/observation/value
Mapping to HL7 FHIR BFDR (5a)		
FHIR Profile/Resource	Content	
<a href="#">Composition - Provider Live Birth Report</a> OR <a href="#">Composition - Provider Fetal Death Report</a> <ul style="list-style-type: none"> <li>PENDING</li> </ul>	IF GDIAB = 'Y' then  /code@code= Code= '73775-9', CodeSystemName= 'LOINC', DisplayName= 'Risk factors in this pregnancy'  AND	

		/value@code= Code= '11687002', CodeSystemName= 'SNOMED CT', DisplayName= 'Gestational diabetes mellitus'		
Mapping to HL7 v2.6 BFDR (5b)				
Mapping Location and Content		Example	Usage	
OBX-2 SHALL contain CWE OBX-3 SHALL contain 73775-9^Risk Factors in this Pregnancy OBX-5 SHALL contain 11687002^Gestational diabetes mellitus (disorder)		OBX 17 CWE 11687002^Gestational diabetes mellitus (disorder)^LN  73211009^Diabetes mellitus (disorder)^SNM     F	PSMLBDI	
			PSMFDI	
			PSLBI	Y
			PSFLBI	Y
			PSFFDI	Y
			PSFDI	Y
			JLBI	Y
			JFDI	Y
		CCOFDI		

1630

#### 6.6.1.1.122 PHYPE Risk Factors in this Pregnancy [Prepregnancy Hypertension]

PHYPE Derivation Rule (2)		
IF (\$PregnancyHistoryObservationValue CONTAINS ValueSet ( <a href="#">Prepregnancy Hypertension (NCHS)</a> )OR \$ProblemCode CONTAINS ValueSet ( <a href="#">Prepregnancy Hypertension (NCHS)</a> ) AND NOT (\$PregnancyHistoryObservationValue CONTAINS ( <a href="#">Gestational Hypertension (NCHS)</a> ) OR \$ProblemCode CONTAINS ( <a href="#">Gestational Hypertension (NCHS)</a> ) THEN "PHYPE" SHALL = 'Y' ELSE "PHYPE" SHALL = 'N'.		
Variable Name	Source in EMR Using FHIR (1a)	Source in EMR Using CDA Labor and Delivery Summary-VR XPATH (1b)
\$PregnancyHistoryObservationValue	condition.code	ClinicalDocument/component/structuredBody/component/section[templateId[@root='1.3.6.1.4.1.19376.1.5.3.1.1.5.3.4']] / entry / observation / value
\$ProblemCode	condition.code	ClinicalDocument/component/structuredBody/component/section[templateId[@root='1.3.6.1.4.1.19376.1.5.3.1.3.6']] / entry / act / entryRelationship / observation / value
Mapping to HL7 FHIR BFDR (5a)		
FHIR Profile/Resource	Content	
<a href="#">Composition - Provider Live Birth Report</a> OR <a href="#">Composition - Provider Fetal Death Report</a> <ul style="list-style-type: none"> <li>PENDING</li> </ul>	IF PHYP = 'Y' then /code@code= Code= '73775-9', CodeSystemName= 'LOINC', DisplayName= 'Risk factors in this pregnancy' AND /value@code= Code= '38341003', CodeSystemName= 'SNOMED CT', DisplayName= 'Hypertensive disorder, systemic arterial'	
Mapping to HL7 v2.6 BFDR (5b)		
Mapping Location and Content	Example	Usage

IHE Quality, Research and Public Health Technical Framework Supplement – Birth and Fetal Death Reporting-Enhanced (BFDR-E)

OBX-2 SHALL contain CWE OBX-3 SHALL contain 73775-9^Risk Factors in this Pregnancy OBX-5 SHALL contain 38341003^Hypertensive disorder, systemic arterial (disorder)	OBX 17 CWE 11687002^Gestational diabetes mellitus (disorder)^LN  38341003^Hypertensive disorder, systemic arterial (disorder)^SNM     F	PSMLBDI	
		PSMFDI	
		PSLBI	Y
		PSFLBI	Y
		PSFFDI	Y
		PSFDI	Y
		JLBI	Y
		JFDI	Y
CCOFDI			

6.6.1.1.123 GHYPE Risk Factors in this Pregnancy [Gestational Hypertension]

GHYPE Derivation Rule (2)			
IF (\$PregnancyHistoryObservationValue CONTAINS ValueSet ( <a href="#">Gestational Hypertension (NCHS)</a> ) OR \$ProblemCode CONTAINS ValueSet ( <a href="#">Gestational Hypertension (NCHS)</a> ) AND NOT (\$PregnancyHistoryObservationValue CONTAINS ( <a href="#">Prepregnancy Hypertension (NCHS)</a> ) OR \$ProblemCode CONTAINS ( <a href="#">Prepregnancy Hypertension (NCHS)</a> ) THEN “GHYPE” SHALL = ‘Y’ ELSE “GHYPE” SHALL = ‘N’.			
Variable Name	Source in EMR Using FHIR (1a)	Source in EMR Using CDA Labor and Delivery Summary-VR XPATH (1b)	
\$PregnancyHistoryObservationValue	condition.code	ClinicalDocument/component/structuredBody/component/section[templateId[@root='1.3.6.1.4.1.19376.1.5.3.1.1.5.3.4']] / entry / observation / value	
\$ProblemCode	condition.code	ClinicalDocument/component/structuredBody/component/section[templateId[@root='1.3.6.1.4.1.19376.1.5.3.1.3.6']] / entry / act / entryRelationship / observation / value	
Mapping to HL7 FHIR BFDR (5a)			
FHIR Profile/Resource	Content		
<a href="#">Composition - Provider Live Birth Report</a> OR <a href="#">Composition - Provider Fetal Death Report</a> <ul style="list-style-type: none"> <li>PENDING</li> </ul>	IF GHYP = 'Y' then  /code@code= Code= '73775-9', CodeSystemName= 'LOINC', DisplayName= 'Risk factors in this pregnancy'  AND  /value@code= Code= '48194001', CodeSystemName= 'SNOMED CT', DisplayName= 'Pregnancy-induced hypertension'		
Mapping to HL7 v2.6 BFDR (5b)			
Mapping Location and Content	Example	Usage	
OBX-2 SHALL contain CWE OBX-3 SHALL contain 73775-9^Risk Factors in this Pregnancy OBX-5 SHALL contain 48194001^Pregnancy-induced hypertension (disorder)	OBX 17 CWE 73775-9^Risk factors in this pregnancy^LN  48194001^ Pregnancy-induced hypertension (disorder)^SNM     F	PSMLBDI	
		PSMFDI	
		PSLBI	Y
		PSFLBI	Y

		PSFFDI	Y
		PSFDI	Y
		JLBI	Y
		JFDI	Y
		CCOFDI	

1635

**6.6.1.1.124 EHYPE Risk Factors in this Pregnancy [Eclampsia]**

EHYPE Derivation Rule (2)			
IF (\$PregnancyHistoryObservationValue CONTAINS ValueSet ( <a href="#">Eclampsia (NCHS)</a> ) OR \$ProblemCode CONTAINS ValueSet ( <a href="#">Eclampsia (NCHS)</a> ), THEN “EHYPE” SHALL = ‘Y’ ELSE “EHYPE” SHALL = ‘N’.			
Variable Name	Source in EMR Using FHIR (1a)	Source in EMR Using CDA Labor and Delivery Summary-VR XPATH (1b)	
\$PregnancyHistoryObservationValue	condition.code	ClinicalDocument/component/structuredBody/component/section[templateId[@root='1.3.6.1.4.1.19376.1.5.3.1.1.5.3.4']] / entry / observation / value	
\$ProblemCode	condition.code	ClinicalDocument/component/structuredBody/component/section[templateId[@root='1.3.6.1.4.1.19376.1.5.3.1.3.6']] / entry / act / entryRelationship / observation / value	
Mapping to HL7 FHIR BFDR (5a)			
FHIR Profile/Resource	Content		
<a href="#">Composition - Provider Live Birth Report</a> OR <a href="#">Composition - Provider Fetal Death Report</a> <ul style="list-style-type: none"> <li>PENDING</li> </ul>	IF EHYP = 'Y' then /code@code= Code= '73775-9', CodeSystemName= 'LOINC', DisplayName= 'Risk factors in this pregnancy' AND /value@code= Code= '15938005', CodeSystemName= 'SNOMED CT', DisplayName= 'Eclampsia'		
Mapping to HL7 v2.6 BFDR (5b)			
Mapping Location and Content	Example	Usage	
OBX-2 SHALL contain CWE OBX-3 SHALL contain 73775-9^Risk Factors in this Pregnancy OBX-5 SHALL contain 15938005^Eclampsia (disorder)	OBX 1 CWE 73775-9^Risk factors in this pregnancy^LN  15938005^Eclampsia (disorder)^SNM     F	PSMLBDI	
		PSMFDI	
		PSLBI	Y
		PSFLBI	Y
		PSFFDI	Y
		PSFDI	Y
		JLBI	Y
		JFDI	Y
CCOFDI			

### 6.6.1.1.125 PPB Risk Factors in this Pregnancy [Previous preterm births]

PPB Derivation Rule (2)																				
IF \$PregnancyHistoryObservationValue CONTAINS ValueSet ( <i>Preterm Birth (NCHS)</i> ) OR \$ProblemCode CONTAINS ValueSet ( <i>Preterm Birth (NCHS)</i> ) OR (\$PregnancyHistoryObservationCode CONTAINS ValueSet ( <i>Number of Preterm Births (NCHS)</i> ) AND \$PregnancyHistoryObservationValue >0) THEN “PPB” SHALL = ‘Y’ ELSE “PPB” SHALL = ‘N’.																				
Variable Name	Source in EMR Using FHIR (1a)	Source in EMR Using CDA Labor and Delivery Summary-VR XPATH (1b)																		
\$PregnancyHistoryObservationValue	condition.code	ClinicalDocument/component/structuredBody/component/section[templateId[@root='1.3.6.1.4.1.19376.1.5.3.1.1.5.3.4']]/entry/observation/value																		
\$ProblemCode	condition.code	ClinicalDocument/component/structuredBody/component/section[templateId[@root='1.3.6.1.4.1.19376.1.5.3.1.3.6']]/entry/act/entryRelationship/observation/value																		
\$PregnancyHistoryObservationCode	condition.code	ClinicalDocument/component/structuredBody/component/section[templateId[@root='1.3.6.1.4.1.19376.1.5.3.1.1.5.3.4']]/entry/observation/code																		
Mapping to HL7 FHIR BFDR (5a)																				
FHIR Profile/Resource	Content																			
<a href="#">Composition - Provider Live Birth Report</a> OR <a href="#">Composition - Provider Fetal Death Report</a> <ul style="list-style-type: none"> <li>PENDING</li> </ul>	IF PPB = 'Y' then  /code@code= Code= '73775-9', CodeSystemName= 'LOINC', DisplayName= 'Risk factors in this pregnancy'  AND  /value@code= Code= '161765003', CodeSystemName= 'SNOMED CT', DisplayName= 'History of - premature delivery'																			
Mapping to HL7 v2.6 BFDR (5b)																				
Mapping Location and Content	Example	Usage																		
OBX-2 SHALL contain CWE OBX-3 SHALL contain 73775-9^Risk Factors in this Pregnancy OBX-5 SHALL contain 161765003^History of - premature delivery (situation)	OBX 17 CWE 73775-9^Risk factors in this pregnancy^LN  161765003^History of - premature delivery (situation)^SNM     F	<table border="1"> <tr><td>PSMLBDI</td><td></td></tr> <tr><td>PSMFDI</td><td></td></tr> <tr><td>PSLBI</td><td>Y</td></tr> <tr><td>PSFLBI</td><td>Y</td></tr> <tr><td>PSFFDI</td><td>Y</td></tr> <tr><td>PSFDI</td><td>Y</td></tr> <tr><td>JLBI</td><td>Y</td></tr> <tr><td>JFDI</td><td>Y</td></tr> <tr><td>CCOFDI</td><td></td></tr> </table>	PSMLBDI		PSMFDI		PSLBI	Y	PSFLBI	Y	PSFFDI	Y	PSFDI	Y	JLBI	Y	JFDI	Y	CCOFDI	
PSMLBDI																				
PSMFDI																				
PSLBI	Y																			
PSFLBI	Y																			
PSFFDI	Y																			
PSFDI	Y																			
JLBI	Y																			
JFDI	Y																			
CCOFDI																				

**6.6.1.1.126 INFT Risk Factors in this Pregnancy [Infertility treatment]**

INFT Derivation Rule (2)																				
IF \$PregnancyHistoryObservationValue CONTAINS ValueSet ( <a href="#">Infertility Treatment (NCHS)</a> ) OR \$ProblemCode CONTAINS ValueSet ( <a href="#">Infertility Treatment (NCHS)</a> ) THEN “INFT” SHALL = ‘Y’ ELSE “INFT” SHALL = ‘N’.																				
Variable Name	Source in EMR Using FHIR (1a)	Source in EMR Using CDA Labor and Delivery Summary-VR XPATH (1b)																		
\$PregnancyHistoryObservationValue	condition.code	ClinicalDocument/component/structuredBody/component/section[templateId[@root='1.3.6.1.4.1.19376.1.5.3.1.1.5.3.4']]/entry/observation/value																		
\$ProblemCode	condition.code	ClinicalDocument/component/structuredBody/component/section[templateId[@root='1.3.6.1.4.1.19376.1.5.3.1.3.6']]/entry/act/entryRelationship/observation/value																		
Mapping to HL7 FHIR BFDR (5a)																				
FHIR Profile/Resource	Content																			
<a href="#">Composition - Provider Live Birth Report</a> OR <a href="#">Composition - Provider Fetal Death Report</a> <ul style="list-style-type: none"> <li>PENDING</li> </ul>	IF INFT = 'Y' then /code@code= Code= '73775-9', CodeSystemName= 'LOINC', DisplayName= 'Risk factors in this pregnancy' AND /value@code= Code= '65046005', CodeSystemName= 'SNOMED CT', DisplayName= 'Infertility Therapy'																			
Mapping to HL7 v2.6 BFDR (5b)																				
Mapping Location and Content	Example	Usage																		
OBX-2 SHALL contain CWE OBX-3 SHALL contain 73775-9^Risk Factors in this Pregnancy OBX-5 SHALL contain 58533008^ Artificial insemination (procedure)	OBX 18 CWE 73775-9^Risk factors in this pregnancy^LN  5853300865046005^ Artificial insemination (procedure)^SDM    F	<table border="1"> <tr><td>PSMLBDI</td><td></td></tr> <tr><td>PSMFDI</td><td></td></tr> <tr><td>PSLBI</td><td>Y</td></tr> <tr><td>PSFLBI</td><td>Y</td></tr> <tr><td>PSFFDI</td><td>Y</td></tr> <tr><td>PSFDI</td><td>Y</td></tr> <tr><td>JLBI</td><td>Y</td></tr> <tr><td>JFDI</td><td>Y</td></tr> <tr><td>CCOFDI</td><td></td></tr> </table>	PSMLBDI		PSMFDI		PSLBI	Y	PSFLBI	Y	PSFFDI	Y	PSFDI	Y	JLBI	Y	JFDI	Y	CCOFDI	
PSMLBDI																				
PSMFDI																				
PSLBI	Y																			
PSFLBI	Y																			
PSFFDI	Y																			
PSFDI	Y																			
JLBI	Y																			
JFDI	Y																			
CCOFDI																				

1640

**6.6.1.1.127 INFT\_DRG Risk Factors in this Pregnancy [Fertility Enhancing Drugs, AI]**

INFT_DRG Derivation Rule (2)
IF \$CodedProductName CONTAINS ValueSet ( <a href="#">Fertility Enhancing Drugs Medications (NCHS)</a> ) THEN “INFT_DRG” SHALL = ‘Y’ ELSE IF \$PregnancyHistoryObservationValue CONTAINS ( <a href="#">Artificial or Intrauterine Insemination (NCHS)</a> ) THEN “INFT_DRG” SHALL = ‘Y’ ELSE IF (\$PregnancyHistoryObservationCode CONTAINS ValueSet ( <a href="#">Pregnancy</a> ))

IHE Quality, Research and Public Health Technical Framework Supplement – Birth and Fetal Death Reporting-Enhanced (BFDR-E)

<i>Resulting From Fertility Enhancing Drugs (NCHS)v</i> OR \$ProblemCode CONTAINS ( <i>Artificial or Intrauterine Insemination (NCHS)</i> ) THEN INFT_DRG SHALL = 'Y' ELSE "INFT_DRG" SHALL = 'N'.			
Variable Name	Source in EMR Using FHIR (1a)	Source in EMR Using CDA Labor and Delivery Summary-VR XPATH (1b)	
\$CodedProductName	MedicationStatement.medication[x].medicationCodableConcept	ClinicalDocument/component/structuredBody/component/section[templateId[@root='1.3.6.1.4.1.19376.1.5.3.1.3.21']]/entry/substanceAdministration/consumentable/manufacturedProduct/labeledDrug/code	
\$PregnancyHistoryObservationValue	condition.code	ClinicalDocument/component/structuredBody/component/section[templateId[@root='1.3.6.1.4.1.19376.1.5.3.1.1.5.3.4']]/entry/observation/value	
\$PregnancyHistoryObservationCode	PENDING	PENDING	
\$ProblemCode	condition.code	ClinicalDocument/component/structuredBody/component/section[templateId[@root='1.3.6.1.4.1.19376.1.5.3.1.3.6']]/entry/act/entryRelationship/observation/value	
Mapping to HL7 FHIR BFDR (5a)			
FHIR Profile/Resource	Content		
<a href="#">Composition - Provider Live Birth Report</a> OR <a href="#">Composition - Provider Fetal Death Report</a> <ul style="list-style-type: none"> <li>PENDING</li> </ul>	IF INFT_DRG = 'Y' then  /code@code= Code= '73775-9', CodeSystemName= 'LOINC', DisplayName= 'Risk factors in this pregnancy'  AND  /value@code= Code= '58533008', CodeSystemName= 'SNOMED CT', DisplayName= 'Artificial insemination'		
Mapping to HL7 v2.6 BFDR (5b)			
Mapping Location and Content	Example	Usage	
OBX-2 SHALL contain CWE OBX-3 SHALL contain 73775-9^Risk Factors in this Pregnancy OBX-5 SHALL contain 445151000124101^ Fertility enhancing drug therapy	OBX 19 CWE 73775-9^Risk factors in this pregnancy^LN   445151000124101^ Fertility enhancing drug therapy^SNM     F	PSMLBDI	
		PSMFDI	
		PSLBI	Y
		PSFLBI	Y
		PSFFDI	Y
		PSFDI	Y
		JLBI	Y
		JFDI	Y
CCOFDI			

6.6.1.1.128 INFT\_ART Risk Factors in this Pregnancy [Asst. Rep. Technology]

INFT_ART Derivation Rule (2)
------------------------------



IHE Quality, Research and Public Health Technical Framework Supplement – Birth and Fetal Death Reporting-Enhanced (BFDR-E)

IF \$PregnancyHistoryObservationValue CONTAINS ValueSet ( <a href="#">Assistive Reproductive Technology (NCHS)</a> ) OR \$ProblemCode CONTAINS ValueSet ( <a href="#">Assistive Reproductive Technology (NCHS)</a> ) THEN “INFT_ART” SHALL = ‘Y’ ELSE “INFT_ART” SHALL = ‘N’.			
Variable Name	Source in EMR Using FHIR (1a)	Source in EMR Using CDA Labor and Delivery Summary-VR XPATH (1b)	
\$PregnancyHistoryObservationValue	condition.code	ClinicalDocument/component/structuredBody/component/section[templateId[@root='1.3.6.1.4.1.19376.1.5.3.1.1.5.3.4']]/entry/observation/value	
\$ProblemCode	condition.code	ClinicalDocument/component/structuredBody/component/section[templateId[@root='1.3.6.1.4.1.19376.1.5.3.1.3.6']]/entry/act/entryRelationship/observation/value	
Mapping to HL7 FHIR BFDR (5a)			
FHIR Profile/Resource	Content		
<a href="#">Composition - Provider Live Birth Report</a> OR <a href="#">Composition - Provider Fetal Death Report</a> <ul style="list-style-type: none"> <li>PENDING</li> </ul>	IF PCES = 'Y' then /code@code= Code= '73775-9', CodeSystemName= 'LOINC', DisplayName= 'Risk factors in this pregnancy' AND /value@code= Code= '200144004', CodeSystemName= 'SNOMED CT', DisplayName= 'Deliveries by cesarean'		
Mapping to HL7 v2.6 BFDR (5b)			
Mapping Location and Content	Example	Usage	
OBX-2 SHALL contain CWE OBX-3 SHALL contain 73775-9^Risk Factors in this Pregnancy OBX-5 SHALL contain 63487001^Assisted fertilization (procedure)	OBX 19 CWE 73775-9^Risk factors in this pregnancy^LN  63487001^Assisted fertilization (procedure)^SNM     F	PSMLBDI	
		PSMFDI	
		PSLBI	Y
		PSFLBI	Y
		PSFFDI	Y
		PSFDI	Y
		JLBI	Y
		JFDI	Y
CCOFDI			

1645

**6.6.1.1.129 PCES Risk Factors in this Pregnancy [Previous cesarean]**

PCES Derivation Rule (2)
IF \$PregnancyHistoryObservationValue CONTAINS ValueSet ( <a href="#">Previous Cesarean (NCHS)</a> ) OR \$ProblemCode CONTAINS ValueSet ( <a href="#">Previous Cesarean (NCHS)</a> ) THEN “PCES” SHALL = ‘Y’ ELSE “PCES” SHALL = ‘N’.

IHE Quality, Research and Public Health Technical Framework Supplement – Birth and Fetal Death Reporting-Enhanced (BFDR-E)

Variable Name	Source in EMR Using FHIR (1a)	Source in EMR Using CDA Labor and Delivery Summary-VR XPATH (1b)	
<b>\$PregnancyHistoryObservationValue</b>	condition.code	ClinicalDocument/component/structuredBody/component/section[templateId[@root='1.3.6.1.4.1.19376.1.5.3.1.1.5.3.4']]//entry/observation/value	
<b>\$ProblemCode</b>	condition.code	ClinicalDocument/component/structuredBody/component/section[templateId[@root='1.3.6.1.4.1.19376.1.5.3.1.3.6']]//entry/act/entryRelationship/observation/value	
Mapping to HL7 FHIR BFDR (5a)			
FHIR Profile/Resource	Content		
<a href="#">Composition - Provider Live Birth Report</a> OR <a href="#">Composition - Provider Fetal Death Report</a> <ul style="list-style-type: none"> <li>PENDING</li> </ul>	IF NPCES = 'Y' then  /code@code= Code= '73775-9', CodeSystemName= 'LOINC', DisplayName= 'Risk factors in this pregnancy'  AND  /value@code= Code= '200144004', CodeSystemName= 'SNOMED CT', DisplayName= 'Deliveries by cesarean'		
Mapping to HL7 v2.6 BFDR (5b)			
Mapping Location and Content	Example	Usage	
OBX-2 SHALL contain CWE OBX-3 SHALL contain 73775-9^Risk Factors in this Pregnancy OBX-5 SHALL contain 200144004^Deliveries by cesarean (finding)	OBX 19 CWE 73775-9^Risk factors in this pregnancy^LN  200144004^Deliveries by cesarean (finding)^SNM     F	PSMLBDI	
		PSMFDI	
		PSLBI	Y
		PSFLBI	Y
		PSFFDI	Y
		PSFDI	Y
		JLBI	Y
		JFDI	Y
CCOFDI			

**6.6.1.1.130 NPCES Risk Factors in this Pregnancy [Number of previous cesareans]**

NPCES Derivation Rule (2)		
IF \$PregnancyHistoryObservationCode CONTAINS ValueSet ( <a href="#">Number of Previous Cesareans (NCHS)</a> ), THEN “NPCES” SHALL = \$PregnancyHistoryObservationValue.		
Variable Name	Source in EMR Using FHIR (1a)	Source in EMR Using CDA Labor and Delivery Summary-VR XPATH (1b)
<b>\$PregnancyHistoryObservationCode</b>	observation.code in value set (Number of Previous Cesareans (NCHS) 1.3.6.1.4.1.19376.1.7.3.1.1.13.8.148)	ClinicalDocument/component/structuredBody/component/section[templateId[@root='1.3.6.1.4.1.19376.1.5.3.1.1.5.3.4']]//entry/observation/code

IHE Quality, Research and Public Health Technical Framework Supplement – Birth and Fetal Death Reporting-Enhanced (BFDR-E)

	constrained by: (http://ihe.net/fhir/StructureDefinition/IHE.BFDRE.MaternalObservationsNPCES)																			
<b>\$PregnancyHistoryObservationValue</b>	observation.valueQuantity	ClinicalDocument/component/structuredBody/component/section[templateId[@root='1.3.6.1.4.1.19376.1.5.3.1.1.5.3.4']] entry/ observation/value																		
Mapping to HL7 FHIR BFDR (5a)																				
FHIR Profile/Resource	Content																			
<a href="#">Composition - Provider Live Birth Report</a> OR <a href="#">Composition - Provider Fetal Death Report</a> <ul style="list-style-type: none"> <li>PENDING</li> </ul>	IF PCES = 'Y' then /code@code= Code= '73775-9', CodeSystemName= 'LOINC', DisplayName= 'Risk factors in this pregnancy' AND /value@code= Code= '200144004', CodeSystemName= 'SNOMED CT', DisplayName= 'Deliveries by cesarean' /entryRelationship/observation/code@code= Code= '68497-7', CodeSystemName= 'LOINC', DisplayName= 'Previous cesarean deliveries' AND /value@value= NPCES(int)																			
Mapping to HL7 v2.6 BFDR (5b)																				
Mapping Location and Content	Example	Usage																		
OBX-2 SHALL contain NM OBX-3 SHALL contain 68497-7^Previous cesarean deliveries OBX-5 SHALL contain The number of previous cesarean deliveries	OBX 8 NM 68497-7^Previous cesarean deliveries^LN  1	<table border="1"> <tr><td>PSMLBDI</td><td></td></tr> <tr><td>PSMFDI</td><td></td></tr> <tr><td>PSLBI</td><td>Y</td></tr> <tr><td>PSFLBI</td><td>Y</td></tr> <tr><td>PSFFDI</td><td>Y</td></tr> <tr><td>PSFDI</td><td>Y</td></tr> <tr><td>JLBI</td><td>Y</td></tr> <tr><td>JFDI</td><td>Y</td></tr> <tr><td>CCOFDI</td><td></td></tr> </table>	PSMLBDI		PSMFDI		PSLBI	Y	PSFLBI	Y	PSFFDI	Y	PSFDI	Y	JLBI	Y	JFDI	Y	CCOFDI	
PSMLBDI																				
PSMFDI																				
PSLBI	Y																			
PSFLBI	Y																			
PSFFDI	Y																			
PSFDI	Y																			
JLBI	Y																			
JFDI	Y																			
CCOFDI																				

1650

**6.6.1.1.131 NOA01 Risk Factors in this Pregnancy [None of the above]**

NOA01 Derivation Rule (2)		
This attribute SHALL NOT be determined by default. If there are no other risk factors identified through other attributes, the form manager SHALL require data entry to assure the accuracy of the data.		
Variable Name	Source in EMR Using FHIR (1a)	Source in EMR Using CDA Labor and Delivery Summary-VR XPATH (1b)

IHE Quality, Research and Public Health Technical Framework Supplement – Birth and Fetal Death Reporting-Enhanced (BFDR-E)

N/A	N/A	N/A	
Mapping to HL7 FHIR BFDR (5a)			
FHIR Profile/Resource	Content		
<a href="#">Composition - Provider Live Birth Report</a> OR <a href="#">Composition - Provider Fetal Death Report</a> <ul style="list-style-type: none"> <li>PENDING</li> </ul>	IF NOA01 = 'Y' then /code@code= Code= '73775-9', CodeSystemName= 'LOINC', DisplayName= 'Risk factors in this pregnancy' AND /value@code= Code= '260413007', CodeSystemName= 'SNOMED CT', DisplayName= 'None'		
Mapping to HL7 v2.6 BFDR (5b)			
Mapping Location and Content	Example	Usage	
OBX-2 SHALL contain CWE OBX-3 SHALL contain 73775-9^Risk Factors in this Pregnancy OBX-5 SHALL contain 260413007^None (qualifier value)	OBX 19 CWE 73775-9^Risk factors in this pregnancy^LN  260413007^None (qualifier value)^SNM     F	PSMLBDI	
		PSMFDI	
		PSLBI	Y
		PSFLBI	Y
		PSFFDI	Y
		PSFDI	Y
		JLBI	Y
		JFDI	Y
CCOFDI			

6.6.1.1.132 SORD Set Order

SORD Derivation Rule (2)		
IF \$MultipleBirthInd = 'true' THEN "SORD" SHALL be populated using \$MultipleBirthOrder AND using '99' where not known ELSE IF Multiple Birth = 'false' "SORD" SHALL = '88'.		
Variable Name	Source in EMR Using FHIR (1a)	Source in EMR Using CDA Labor and Delivery Summary-VR XPATH (1b)
\$MultipleBirthInd	patient.multipleBirth[x].multipleBirthBoolean	ClinicalDocument/component/structuredBody/component/section/templateId[@root='1.3.6.1.4.1.19376.1.5.3.1.1.21.2.4']/subject/relatedSubject/code[@code='NCHILD' AND id=idOfTheChild]/subject/relatedSubject/subject/sdtc:multipleBirthInd
\$MultipleBirthOrder	patient.multipleBirth[x].multipleBirthInteger	ClinicalDocument/component/structuredBody/component/section/templateId[@root='1.3.6.1.4.1.19376.1.5.3.1.1.21.2.4']/subject/relatedSubject/code[@code='NCHILD' AND id=idOfTheChild]/subject/relatedSubject/subject/sdtc:multipleBirthOrderNumber
Mapping to HL7 FHIR BFDR (5a)		
FHIR Profile/Resource	Content	

<a href="#">Composition - Provider Live Birth Report</a> OR <a href="#">Composition - Provider Fetal Death Report</a> <ul style="list-style-type: none"> <li>PENDING</li> </ul>	/code@code= Code='73771-8', CodeSystemName= 'LOINC', DisplayName= 'Birth order'  AND  /value@value= SORD(int)		
Mapping to HL7 v2.6 BFDR (5b)			
Mapping Location and Content	Example	Usage	
PID-25	PID 1  987645432^^^MRN  ~^^^U  201105302349 M         N  2	PSMLBDI	
		PSMFDI	
		PSLBI	Y
		PSFLBI	Y
		PSFFDI	Y
		PSFDI	Y
		JLBI	Y
		JFDI	Y
CCOFDI			

1655

### 6.6.1.1.133 FSEX Child [fetus] Sex]

FSEX Derivation Rule (2)		
IF \$Gender CONTAINS ValueSet ( <a href="#">Male Gender (NCHS)</a> ) THEN "FSEX" SHALL ='M' ELSE IF \$Gender CONTAINS ValueSet ( <a href="#">Female Gender (NCHS)</a> ) THEN "FSEX" SHALL ='F' ELSE THEN "FSEX" SHALL ='N'.		
Variable Name	Source in EMR Using FHIR (1a)	Source in EMR Using CDA Labor and Delivery Summary-VR XPATH (1b)
\$Gender	patient.gender	ClinicalDocument/component/structuredBody/component/section[templateId[@root='2.16.840.1.113883.10.20.1.21.2.4']/subject/relatedSubject/code[@code='NCHILD' AND id=idOfTheChild]/subject/relatedSubject/subject/administrativeGenderCode
Mapping to HL7 FHIR BFDR (5a)		
FHIR Profile/Resource	Content	
<a href="#">Composition - Provider Fetal Death Report</a> <ul style="list-style-type: none"> <li>PENDING</li> </ul>	/subject/relatedSubject/subject/administrativeGender = FSEX	
Mapping to HL7 v2.6 BFDR (5b)		
Mapping Location and Content	Example	Usage
PID-8	PID 1  123456688^^^MRN  Johnson^Baby  20110313 F         N	PSMLBDI
		PSMFDI
		PSLBI
		PSFLBI

		PSFFDI	Y
		PSFDI	Y
		JLBI	
		JFDI	Y
		CCOFDI	

**6.6.1.1.134 FDOD\_YR Date of Delivery [(Fetus) Year]**

FDOD_YR Derivation Rule (2)			
IF \$ProcedureCode CONTAINS ValueSet ( <a href="#">Delivery (NCHS)</a> ) THEN “FDOD_YR” SHALL = Year part of \$ProcedureEndTime.			
Variable Name	Source in EMR Using FHIR (1a)	Source in EMR Using CDA Labor and Delivery Summary-VR XPATH (1b)	
\$ProcedureCode	procedure.code	ClinicalDocument/component/structuredBody/component/section[templateId[@root='1.3.6.1.4.1.19376.1.5.3.1.1.21.2.3']]/component/section[templateId[@root='1.3.6.1.4.1.19376.1.5.3.1.1.13.2.11']]/entry/procedure/code	
\$ProcedureEndTime	procedure.code	ClinicalDocument/component/structuredBody/component/section[templateId[@root='1.3.6.1.4.1.19376.1.5.3.1.1.21.2.3']]/component/section[templateId[@root='1.3.6.1.4.1.19376.1.5.3.1.1.13.2.11']]/entry/procedure/effectiveTime/high	
Mapping to HL7 FHIR BFDR (5a)			
FHIR Profile/Resource		Content	
<a href="#">Composition - Provider Fetal Death Report</a>		PENDING	
<ul style="list-style-type: none"> <li>PENDING</li> </ul>			
Mapping to HL7 v2.6 BFDR (5b)			
Mapping Location and Content	Example	Usage	
PID-29	PID 1  123456688^^^MRN  Johnson^Baby  20170408120700 F              20170408120700	PSMLBDI	
		PSMFDI	
		PSLBI	
		PSFLBI	
		PSFFDI	Y
		PSFDI	Y
		JLBI	
		JFDI	Y
CCOFDI			

**6.6.1.1.135 FDOD\_MO Derivation Rule Date of Delivery [Fetus] Month]**

FDOD_MO Derivation Rule (2)			
IF \$ProcedureCode CONTAINS ValueSet ( <a href="#">Delivery (NCHS)</a> ) THEN “FDOD_MO” SHALL = Month part of \$ProcedureEndTime.			
Variable Name	Source in EMR Using FHIR (1a)	Source in EMR Using CDA Labor and Delivery Summary-VR XPATH (1b)	
\$ProcedureCode	procedure.code	ClinicalDocument/component/structuredBody/component/section[templateId[@root='1.3.6.1.4.1.19376.1.5.3.1.1.21.2.3']]/component/section[templateId[@root='1.3.6.1.4.1.19376.1.5.3.1.1.13.2.11']]/entry/procedure/code	
\$ProcedureEndTime	procedure.code	ClinicalDocument/component/structuredBody/component/section[templateId[@root='1.3.6.1.4.1.19376.1.5.3.1.1.21.2.3']]/component/section[templateId[@root='1.3.6.1.4.1.19376.1.5.3.1.1.13.2.11']]/entry/procedure/effectiveTime/high	
Mapping to HL7 FHIR BFDR (5a)			
FHIR Profile/Resource		Content	
<a href="#">Composition - Provider Fetal Death Report</a> <ul style="list-style-type: none"> <li>PENDING</li> </ul>		PENDING	
Mapping to HL7 v2.6 BFDR (5b)			
Mapping Location and Content	Example	Usage	
PID-29	PID 1  123456688^^^MRN  Johnson^Baby  20170408120700 F                20170408120700	PSMLBDI	
		PSMFDI	
		PSLBI	
		PSFLBI	
		PSFFDI	Y
		PSFDI	Y
		JLBI	
		JFDI	Y
CCOFDI			

1660

**6.6.1.1.136 FDOD\_DY Date of Delivery [Fetus] Day]**

FDOD_DY Derivation Rule (2)		
IF \$ProcedureCode CONTAINS ValueSet ( <a href="#">Delivery (NCHS)</a> ) THEN “FDOD_DYR” SHALL = Day part of \$ProcedureEndTime.		
Variable Name	Source in EMR Using FHIR (1a)	Source in EMR Using CDA Labor and Delivery Summary-VR XPATH (1b)

IHE Quality, Research and Public Health Technical Framework Supplement – Birth and Fetal Death Reporting-Enhanced (BFDR-E)

<b>\$ProcedureCode</b>	procedure.code	ClinicalDocument/component/structuredBody/component/section[templateId[@root='1.3.6.1.4.1.19376.1.5.3.1.1.21.2.3']]/component/section[templateId[@root='1.3.6.1.4.1.19376.1.5.3.1.1.13.2.11']]/entry/procedure/code	
<b>\$ProcedureEndTime</b>	procedure.code	ClinicalDocument/component/structuredBody/component/section[templateId[@root='1.3.6.1.4.1.19376.1.5.3.1.1.21.2.3']]/component/section[templateId[@root='1.3.6.1.4.1.19376.1.5.3.1.1.13.2.11']]/entry/procedure/effectiveTime/high	
Mapping to HL7 FHIR BFDR (5a)			
FHIR Profile/Resource		Content	
<a href="#">Composition - Provider Fetal Death Report</a> <ul style="list-style-type: none"> <li>PENDING</li> </ul>		PENDING	
Mapping to HL7 v2.6 BFDR (5b)			
Mapping Location and Content	Example	Usage	
PID-29	PID 1  123456688^^^MRN  Johnson^Baby  20170408120700 F                20170408120700	PSMLBDI	
		PSMFDI	
		PSLBI	
		PSFLBI	
		PSFFDI	Y
		PSFDI	Y
		JLBI	
		JFDI	Y
CCOFDI			

6.6.1.1.137 ETIME Estimated Time of Fetal Death

ETIME Derivation Rule (2)		
IF \$EventOutcomesObservationCode CONTAINS ValueSet ( <a href="#">Estimated Time Of Fetal Death (NCHS)</a> ), THEN “ETIME” SHALL = \$EventOutcomesObservationValue WHERE \$EventOutcomesObservationValue contains ValueSet ( <a href="#">Fetal Death Time Point (NCHS)</a> ).		
Variable Name	Source in EMR Using FHIR (1a)	Source in EMR Using CDA Labor and Delivery Summary-VR XPATH (1b)
<b>\$EventOutcomesObservationCode</b>	observation.code constrained by: ( <a href="http://ihe.net/fhir/StructureDefinition/IHE.BFDRE.NewbornObservationsETIME">http://ihe.net/fhir/StructureDefinition/IHE.BFDRE.NewbornObservationsETIME</a> )	ClinicalDocument/component/structuredBody/component/section[templateId[@root='1.3.6.1.4.1.19376.1.5.3.1.1.21.2.4']]/subject/relatedSubject/code[@code='NCHILD' AND id=idOfTheChild]/component/section[templateId[@root='1.3.6.1.4.1.19376.1.7.3.1.1.13.7']]/entry/observation/code
<b>\$EventOutcomesObservationValue</b>	observation.valueDateTime	ClinicalDocument/component/structuredBody/component/section[templateId[@root='1.3.6.1.4.1.19376.1.5.3.1.1.21.2.4']]/



		subject/relatedSubject/code[@code='NCHILD' AND id=idOfTheChild]/component/section[templateId[@root='1.3.6.1.4.1.19376.1.7.3.1.1.13.7']]/entry/observation/value																		
Mapping to HL7 FHIR BFDR (5a)																				
FHIR Profile/Resource	Content																			
<a href="#">Composition - Provider Fetal Death Report</a>	PENDING																			
<ul style="list-style-type: none"> <li>PENDING</li> </ul>																				
Mapping to HL7 v2.6 BFDR (5b)																				
Mapping Location and Content	Example	Usage																		
OBX-2 SHALL contain CWE OBX-3 SHALL contain 73811-2^Estimated time of fetal death OBX-5 SHALL contain a value selected from value the set Fetal Death Time Points (NCHS) <a href="https://phinvads.cdc.gov/vads/ViewValueSet.action?oid=2.16.840.1.114222.4.11.7112">https://phinvads.cdc.gov/vads/ViewValueSet.action?oid=2.16.840.1.114222.4.11.7112</a>	OBX 19 CWE 73811-2^Estimated time of fetal death ^LN  634751000124116 ^ Dead at time of first assessment, no labor ongoing (observable entity)^SNM     F	<table border="1"> <tr><td>PSMLBDI</td><td></td></tr> <tr><td>PSMFDI</td><td></td></tr> <tr><td>PSLBI</td><td></td></tr> <tr><td>PSFLBI</td><td></td></tr> <tr><td>PSFFDI</td><td>Y</td></tr> <tr><td>PSFDI</td><td>Y</td></tr> <tr><td>JLBI</td><td></td></tr> <tr><td>JFDI</td><td>Y</td></tr> <tr><td>CCOFDI</td><td></td></tr> </table>	PSMLBDI		PSMFDI		PSLBI		PSFLBI		PSFFDI	Y	PSFDI	Y	JLBI		JFDI	Y	CCOFDI	
PSMLBDI																				
PSMFDI																				
PSLBI																				
PSFLBI																				
PSFFDI	Y																			
PSFDI	Y																			
JLBI																				
JFDI	Y																			
CCOFDI																				

1665

**6.6.1.1.138 LIVEB Not Single Birth [specify number of infants in this delivery born alive.]**

LIVEB Derivation Rule (2)		
\$EventOutcomesObservationCode CONTAINS ValueSet ( <a href="#">Number of Live Births (NCHS)</a> ), THEN SHALL = \$EventOutcomesObservationValue.		
Variable Name	Source in EMR Using FHIR (1a)	Source in EMR Using CDA Labor and Delivery Summary-VR XPATH (1b)
\$EventOutcomesObservationCode	observation.code constrained by: ( <a href="http://ihe.net/fhir/StructureDefinition/IHE.BFDRE.MaternalObservationsLIVEB">http://ihe.net/fhir/StructureDefinition/IHE.BFDRE.MaternalObservationsLIVEB</a> )	ClinicalDocument/component/structuredBody/component/section[templateId[@root='1.3.6.1.4.1.19376.1.5.3.1.1.21.2.3']] / component/section[templateId[@root='1.3.6.1.4.1.19376.1.7.3.1.1.13.7']] / entry / observation / code
\$EventOutcomesObservationValue	observation.valueDateTime	ClinicalDocument/component/structuredBody/component/section[templateId[@root='1.3.6.1.4.1.19376.1.5.3.1.1.21.2.4']] / subject/relatedSubject/code[@code='NCHILD' AND id=idOfTheChild] / component/section[templateId[@root='1.3.6.1.4.1.19376.1.7.3.1.1.13.7']] / entry / observation / value
Mapping to HL7 FHIR BFDR (5a)		
FHIR Profile/Resource	Content	

IHE Quality, Research and Public Health Technical Framework Supplement – Birth and Fetal Death Reporting-Enhanced (BFDR-E)

<a href="#">Composition - Provider Live Birth Report</a> OR <a href="#">Composition - Provider Fetal Death Report</a> <ul style="list-style-type: none"> <li>PENDING</li> </ul>	/code@code= Code='73773-4', CodeSystemName= 'LOINC', DisplayName= 'Number of infants in this delivery born alive' AND /value@value= LIVEB(int)		
Mapping to HL7 v2.6 BFDR (5b)			
Mapping Location and Content	Example	Usage	
OBX-2 SHALL contain NM OBX-3 SHALL contain 73773-4^Number of infants in this delivery born alive OBX-5 SHALL specify the number of live born in this delivery	OBX 8 NM 73773-4^Number of infants in this delivery born alive ^LN  1	PSMLBDI	
		PSMFDI	
		PSLBI	Y
		PSFLBI	Y
		PSFFDI	Y
		PSFDI	Y
		JLBI	Y
		JFDI	Y
CCOFDI			

### 6.6.1.1.139 FDTH Number of Fetal Deaths

FDTH Derivation Rule (2)		
IF \$EventOutcomesObservationCode CONTAINS ValueSet ( <a href="#">Number of Fetal Deaths This Delivery (NCHS)</a> ), THEN SHALL = \$EventOutcomesObservationValue.		
Variable Name	Source in EMR Using FHIR (1a)	Source in EMR Using CDA Labor and Delivery Summary-VR XPATH (1b)
\$EventOutcomesObservationCode	observation.code constrained by: ( <a href="http://ihe.net/fhir/StructureDefinition/IHE.BFDRE.MaternalObservationsFDTH">http://ihe.net/fhir/StructureDefinition/IHE.BFDRE.MaternalObservationsFDTH</a> )	ClinicalDocument/component/structuredBody/component/section[templateId[@root='1.3.6.1.4.1.19376.1.5.3.1.1.21.2.3']/component/section[templateId[@root='1.3.6.1.4.1.19376.1.7.3.1.1.13.7']]/entry/ observation/code
\$EventOutcomesObservationValue	observation.valueDate	ClinicalDocument/component/structuredBody/component/section[templateId[@root='1.3.6.1.4.1.19376.1.5.3.1.1.21.2.4']]/subject/relatedSubject/code[@code='NCHILD' AND id=idOfTheChild]/component/section[templateId[@root='1.3.6.1.4.1.19376.1.7.3.1.1.13.7']]/entry/ observation/value
Mapping to HL7 FHIR BFDR (5a)		
FHIR Profile/Resource	Content	
<a href="#">Composition - Provider Fetal Death Report</a> <ul style="list-style-type: none"> <li>PENDING</li> </ul>	PENDING	
Mapping to HL7 v2.6 BFDR (5b)		

Mapping Location and Content	Example	Usage	
OBX-2 SHALL contain NM OBX-3 SHALL contain 73772-6^ Number of fetal deaths delivered OBX-5 SHALL specify the number of fetal deaths in this delivery	OBX 8 NM 73772-6^ Number of fetal deaths delivered^LN  1	PSMLBDI	
		PSMFDI	
		PSLBI	
		PSFLBI	
		PSFFDI	Y
		PSFDI	Y
		JLBI	
		JFDI	Y
		CCOFDI	

1670

### 6.6.1.1.140 HYST Method of Delivery [Hysterotomy/Hysterectomy]

HYST Derivation Rule (2)			
IF \$ProcedureCode CONTAINS ValueSet ( <i>Hysterotomy Hysterectomy (NCHS)</i> ), THEN “HYST” SHALL = ‘Y’, ELSE “HYST” SHALL = ‘N’.			
Variable Name	Source in EMR Using FHIR (1a)	Source in EMR Using CDA Labor and Delivery Summary-VR XPATH (1b)	
\$ProcedureCode	procedure.code	ClinicalDocument/component/structuredBody/component/section[templateId[@root='1.3.6.1.4.1.19376.1.5.3.1.1.21.2.3']]/component/section[templateId[@root='1.3.6.1.4.1.19376.1.5.3.1.1.13.2.11']]/entry/procedure/code	
Mapping to HL7 FHIR BFDR (5a)			
FHIR Profile/Resource		Content	
<a href="#">Composition - Provider Fetal Death Report</a> <ul style="list-style-type: none"> <li>PENDING</li> </ul>		PENDING	
Mapping to HL7 v2.6 BFDR (5b)			
Mapping Location and Content	Example	Usage	
OBX-2 SHALL contain CWE OBX-3 SHALL contain 73759-3^ Hysterotomy or hysterectomy was performed at delivery OBX-5 SHALL contain boolean indication (Yes/No/Unknown/Not Applicable) of whether a hysterotomy or hysterectomy was performed using HL7 0532 Expanded yes/no indicator (NCHS)	OBX 21 CWE 73759-3^ Hysterotomy or hysterectomy was performed at delivery^LN   N^No^HL70532     F	PSMLBDI	
		PSMFDI	
		PSLBI	
		PSFLBI	
		PSFFDI	
		PSFDI	
		JLBI	
		JFDI	
		CCOFDI	

### 6.6.1.1.141 TD Time of Delivery

TD Derivation Rule (2)		
IF \$ProcedureCode CONTAINS ValueSet ( <i>Delivery (NCHS)</i> ), THEN “TD” SHALL = \$ProcedureEndTime.		
Variable Name	Source in EMR Using FHIR (1a)	Source in EMR Using CDA Labor and Delivery Summary-VR XPATH (1b)
\$ProcedureCode	procedure.code	ClinicalDocument/component/structuredBody/component/section[templateId[@root='1.3.6.1.4.1.19376.1.5.3.1.1.21.2.3']/component/section[templateId[@root='1.3.6.1.4.1.19376.1.5.3.1.1.13.2.11']/entry/procedure/code
\$ProcedureEndTime	procedure.code	ClinicalDocument/component/structuredBody/component/section[templateId[@root='1.3.6.1.4.1.19376.1.5.3.1.1.21.2.3']/component/section[templateId[@root='1.3.6.1.4.1.19376.1.5.3.1.1.13.2.11']/entry/procedure/effectiveTime/low
Mapping to HL7 FHIR BFDR (5a)		
FHIR Profile/Resource		Content
<a href="#">Composition - Provider Fetal Death Report</a> <ul style="list-style-type: none"> <li>PENDING</li> </ul>		PENDING
Mapping to HL7 v2.6 BFDR (5b)		
Mapping Location and Content	Example	Usage
PID-7	PID 1  123456688^^^MRN  Johnson^Baby  20170408120700 F               20170408120700	PSMLBDI
		PSMFDI
		PSLBI
		PSFLBI
		PSFFDI
		PSFDI
		JLBI
		JFDI
CCOFDI		

### 6.6.1.1.142 AUTOP Was an Autopsy Performed?

AUTOP Derivation Rule (2)		
IF (\$ProcedureCode CONTAINS ValueSet CONTAINS ValueSet ( <i>Autopsy Performed (NCHS)</i> ) THEN “AUTOP” SHALL = “Y” ELSE IF \$ProcedureCode CONTAINS ValueSet CONTAINS ValueSet ( <i>Autopsy Planned (NCHS)</i> ) THEN “AUTOP” SHALL = “P” ELSE “N”.		
Variable Name	Source in EMR Using FHIR (1a)	Source in EMR Using CDA Labor and Delivery Summary-VR XPATH (1b)

IHE Quality, Research and Public Health Technical Framework Supplement – Birth and Fetal Death Reporting-Enhanced (BFDR-E)

<b>\$ProcedureCode</b>	procedure.code	ClinicalDocument/component/structuredBody/component/section[templateId[@root='1.3.6.1.4.1.19376.1.5.3.1.1.21.2.4']]/subject/relatedSubject/code[@code='NCHILD' AND id=idOfTheChild]/component/section[templateId[@root='1.3.6.1.4.1.19376.1.5.3.1.1.13.2.11']]/entry/procedure/code
<b>Mapping to HL7 FHIR BFDR (5a)</b>		
<b>FHIR Profile/Resource</b>		<b>Content</b>
<a href="#">Composition - Provider Fetal Death Report</a> <ul style="list-style-type: none"> <li>PENDING</li> </ul>		PENDING
<b>Mapping to HL7 v2.6 BFDR (5b)</b>		
<b>Mapping Location and Content</b>		<b>Example</b>
OBX-2 SHALL contain CWE OBX-3 SHALL contain 73768-4^Autopsy was performed OBX-5 SHALL contain a value selected from value the set Autopsy Examination (NCHS) <a href="https://phinvads.cdc.gov/vads/ViewValueSet.action?oid=2.16.840.1.114222.4.11.7137">https://phinvads.cdc.gov/vads/ViewValueSet.action?oid=2.16.840.1.114222.4.11.7137</a>		OBX 19 CWE 73768-4^Autopsy was performed ^LN  4455100009109^ Autopsy not performed ^SNM     F
		<b>Usage</b>
		PSMLBDI
		PSMFDI
		PSLBI
		PSFLBI
		PSFFDI
		PSFDI
		JLBI
		JFDI
		CCOFDI

1675

**6.6.1.1.143 FWO Weight of Fetus [in ounces]**

<b>FWO Derivation Rule (2)</b>		
IF \$VitalSignsTypeCode CONTAINS ValueSet ( <i>Body Weight (NCHS)</i> ) where \$VitalSignsMethodCode CONTAINS ValueSet ( <i>Birth Weight (NCHS)</i> ) THEN “FWO” SHALL = \$VitalSignsResultValue WHERE units are specified in Ounces The preferred measure is in grams rather than ounces. Refer to FWG.		
<b>Variable Name</b>	<b>Source in EMR Using FHIR (1a)</b>	<b>Source in EMR Using CDA Labor and Delivery Summary-VR XPATH (1b)</b>
<b>\$VitalSignsTypeCode</b>	observation.code constrained by: ( <a href="http://ihe.net/fhir/StructureDefinition/IHE.BFDRE.FetusObservationsFW">http://ihe.net/fhir/StructureDefinition/IHE.BFDRE.FetusObservationsFW</a> )	ClinicalDocument/component/structuredBody/component/section[templateId[@root='1.3.6.1.4.1.19376.1.5.3.1.1.21.2.4']]/subject/relatedSubject/code[@code='NCHILD' AND id=idOfTheChild]/component/section[templateId[@root='1.3.6.1.4.1.19376.1.5.3.1.1.9.15.1']]/component/section[templateId[@root='1.3.6.1.4.1.19376.1.5.3.1.1.5.3.2']]/entry/organizer/component/observation/code
<b>\$VitalSignsResultValue</b>	observation.valueQuantity	ClinicalDocument/component/structuredBody/component/section[templateId[@root='1.3.6.1.4.1.19376.1.5.3.1.1.21.2.4']]/subject/relatedSubject/code[@code='NCHILD' AND id=idOfTheChild]/component/section[templateId[@root='1.3.6.1.4.1.19376.1.5.3.1.1.9.15.1']]/component/section[templateId[@root='1.3.6.1.4.1.19376.1.5.3.1.1.5.3.2']]/entry/organizer/component/observation/valueClinicalDocument

IHE Quality, Research and Public Health Technical Framework Supplement – Birth and Fetal Death Reporting-Enhanced (BFDR-E)

<b>\$VitalSignsMethodCode</b>	observation.valueQuantity	ClinicalDocument/component/structuredBody/component/section[templateId[@root='1.3.6.1.4.1.19376.1.5.3.1.1.21.2.4']]/subject/relatedSubject/code[@code='NCHILD' AND id=idOfTheChild]/component/section[templateId[@root='1.3.6.1.4.1.19376.1.5.3.1.1.9.15.1']]/component/section[templateId[@root='1.3.6.1.4.1.19376.1.5.3.1.1.5.3.2']]/entry/organizer/component/observation/methodCode
<b>Mapping to HL7 FHIR BFDR (5a)</b>		
<b>FHIR Profile/Resource</b>		<b>Content</b>
<a href="#">Composition - Provider Fetal Death Report</a> <ul style="list-style-type: none"> <li>PENDING</li> </ul>		PENDING
<b>Mapping to HL7 v2.6 BFDR (5b)</b>		
<b>Mapping Location and Content</b>		<b>Example</b>
OBX-2 SHALL contain NM OBX-3 SHALL contain 8339-4 ^Weight at delivery OBX-5 SHALL contain the birthweight in Grams converted from Ounces OBX-6 SHALL indicate ounces using UCUM units: SHALL contain oz NOTE: it is preferred to send in grams (see FWG)		OBX 24 NM 8339-4 ^ Body weight at birth ^LN  1200 oz
		<b>Usage</b>
		PSMLBDI
		PSMFDI
		PSLBI
		PSFLBI
		PSFFDI
		PSFDI
		JLBI
		JFDI
		CCOFDI

**6.6.1.1.144 FWG Weight of Fetus [grams preferred, specify unit]**

<b>FWG Derivation Rule (2)</b>		
IF \$VitalSignsTypeCode CONTAINS ValueSet ( <i>Body Weight (NCHS)</i> ) where \$VitalSignsMethodCode CONTAINS ValueSet ( <i>Birth Weight (NCHS)</i> ) THEN “FWG” SHALL = \$VitalSignsResultValue WHERE units are specified in Grams.		
<b>Variable Name</b>	<b>Source in EMR Using FHIR (1a)</b>	<b>Source in EMR Using CDA Labor and Delivery Summary-VR XPATH (1b)</b>
<b>\$VitalSignsTypeCode</b>	observation.code constrained by: (http://ihe.net/fhir/StructureDefinition/IHE.BFDRE.FetusObservationsFW)	ClinicalDocument/component/structuredBody/component/section[templateId[@root='1.3.6.1.4.1.19376.1.5.3.1.1.21.2.4']]/subject/relatedSubject/code[@code='NCHILD' AND id=idOfTheChild]/component/section[templateId[@root='1.3.6.1.4.1.19376.1.5.3.1.1.9.15.1']]/component/section[templateId[@root='1.3.6.1.4.1.19376.1.5.3.1.1.5.3.2']]/entry/organizer/component/observation/code
<b>\$VitalSignsResultValue</b>	observation.valueQuantity	ClinicalDocument/component/structuredBody/component/section[templateId[@root='1.3.6.1.4.1.19376.1.5.3.1.1.21.2.4']]/subject/relatedSubject/code[@code='NCHILD' AND id=idOfTheChild]/component/section[templateId[@root='1.3.6.1.4.1.19376.1.5.3.1.1.9.15.1']]/component/section[templateId[@root='1.3.6.1.4.1.19376.1.5.3.1.1.5.3.2']]/entry/organizer/component/observation/valueClinicalDocument

IHE Quality, Research and Public Health Technical Framework Supplement – Birth and Fetal Death Reporting-Enhanced (BFDR-E)

<b>\$VitalSignsMethodCode</b>	observation.valueQuantity	ClinicalDocument/component/structuredBody/component/section[templateId[@root='1.3.6.1.4.1.19376.1.5.3.1.1.21.2.4']]/subject/relatedSubject/code[@code='NCHILD' AND id=idOfTheChild]/component/section[templateId[@root='1.3.6.1.4.1.19376.1.5.3.1.1.9.15.1']]/component/section[templateId[@root='1.3.6.1.4.1.19376.1.5.3.1.1.5.3.2']]/entry/organizer/component/observation/methodCode
<b>Mapping to HL7 FHIR BFDR (5a)</b>		
<b>FHIR Profile/Resource</b>		<b>Content</b>
<a href="#">Composition - Provider Fetal Death Report</a> <ul style="list-style-type: none"> <li>PENDING</li> </ul>		PENDING
<b>Mapping to HL7 v2.6 BFDR (5b)</b>		
<b>Mapping Location and Content</b>		<b>Example</b>
OBX-2 SHALL contain NM OBX-3 SHALL contain 8339-4 ^Weight at delivery OBX-5 SHALL contain the birthweight in Grams OBX-6 SHALL indicate grams using UCUM units: SHALL contain gm		OBX 24 NM 8339-4 ^ Body weight at birth ^LN  1200 gm
		<b>Usage</b>
		PSMLBDI
		PSMFDI
		PSLBI
		PSFLBI
		PSFFDI
		PSFDI
		JLBI
		JFDI
		CCOFDI

1680 **6.6.1.1.145 FWP Weight of Fetus [in pounds]**

<b>FWP Derivation Rule (2)</b>		
IF \$VitalSignsTypeCode CONTAINS ValueSet ( <i>Body Weight (NCHS)</i> ) where \$VitalSignsMethodCode CONTAINS ValueSet ( <i>Birth Weight (NCHS)</i> ) THEN “FWP” SHALL = \$VitalSignsResultValue WHERE units are specified in Pounds The preferred measure is in grams rather than ounces. Refer to FWG.		
<b>Variable Name</b>	<b>Source in EMR Using FHIR (1a)</b>	<b>Source in EMR Using CDA Labor and Delivery Summary-VR XPATH (1b)</b>
<b>\$VitalSignsTypeCode</b>	observation.code constrained by: (http://ihe.net/fhir/StructureDefinition/IHE.BFDRE.FetusObservationsFW)	ClinicalDocument/component/structuredBody/component/section[templateId[@root='1.3.6.1.4.1.19376.1.5.3.1.1.21.2.4']]/subject/relatedSubject/code[@code='NCHILD' AND id=idOfTheChild]/component/section[templateId[@root='1.3.6.1.4.1.19376.1.5.3.1.1.9.15.1']]/component/section[templateId[@root='1.3.6.1.4.1.19376.1.5.3.1.1.5.3.2']]/entry/organizer/component/observation/code
<b>\$VitalSignsResultValue</b>	observation.valueQuantity	ClinicalDocument/component/structuredBody/component/section[templateId[@root='1.3.6.1.4.1.19376.1.5.3.1.1.21.2.4']]/subject/relatedSubject/code[@code='NCHILD' AND id=idOfTheChild]/component/section[templateId[@root='1.3.6.1.4.1.19376.1.5.3.1.1.9.15.1']]/component/section[templateId[@root='1.3.6.1.4.1.19376.1.5.3.1.1.5.3.2']]/entry/organizer/component/observation/valueClinicalDocument

IHE Quality, Research and Public Health Technical Framework Supplement – Birth and Fetal Death Reporting-Enhanced (BFDR-E)

<b>\$VitalSignsMethodCode</b>	observation.valueQuantity	ClinicalDocument/component/structuredBody/component/section[templateId[@root='1.3.6.1.4.1.19376.1.5.3.1.1.21.2.4']/subject/relatedSubject/code[@code='NCHILD' AND id=idOfTheChild]/component/section[templateId[@root='1.3.6.1.4.1.19376.1.5.3.1.1.9.15.1']/component/section[templateId[@root='1.3.6.1.4.1.19376.1.5.3.1.1.5.3.2']/entry/organizer/component/observation/methodCode																			
Mapping to HL7 FHIR BFDR (5a)																					
FHIR Profile/Resource		Content																			
<a href="#">Composition - Provider Fetal Death Report</a> <ul style="list-style-type: none"> <li>PENDING</li> </ul>		PENDING																			
Mapping to HL7 v2.6 BFDR (5b)																					
Mapping Location and Content		Example	Usage																		
OBX-2 SHALL contain NM OBX-3 SHALL contain 8339-4 ^Weight at delivery OBX-5 SHALL contain the birthweight in Grams converted from Pounds OBX-6 SHALL indicate pounds using UCUM units: SHALL contain lb NOTE: it is preferred to send in grams (see FWG)		OBX 24 NM 8339-4 ^ Body weight at birth ^LN  1200 lb	<table border="1"> <tr><td>PSMLBDI</td><td></td></tr> <tr><td>PSMFDI</td><td></td></tr> <tr><td>PSLBI</td><td></td></tr> <tr><td>PSFLBI</td><td></td></tr> <tr><td>PSFFDI</td><td>Y</td></tr> <tr><td>PSFDI</td><td>Y</td></tr> <tr><td>JLBI</td><td></td></tr> <tr><td>JFDI</td><td>Y</td></tr> <tr><td>CCOFDI</td><td></td></tr> </table>	PSMLBDI		PSMFDI		PSLBI		PSFLBI		PSFFDI	Y	PSFDI	Y	JLBI		JFDI	Y	CCOFDI	
PSMLBDI																					
PSMFDI																					
PSLBI																					
PSFLBI																					
PSFFDI	Y																				
PSFDI	Y																				
JLBI																					
JFDI	Y																				
CCOFDI																					

6.6.1.1.146 LM Infections Present and Treated During this Pregnancy [Listeria]

LM Derivation Rule (2)		
IF (\$ProblemCode CONTAINS ValueSet ( <a href="#">Listeria (NCHS)</a> ) OR (\$InfectionHistoryProblemCode CONTAINS ValueSet ( <a href="#">Listeria (NCHS)</a> )) THEN “LM” SHALL = “Y” ELSE “N”.		
Variable Name	Source in EMR Using FHIR (1a)	Source in EMR Using CDA Labor and Delivery Summary-VR XPATH (1b)
<b>\$ProblemCode</b>	problem.code	ClinicalDocument/component/structuredBody/component/section[templateId[@root='1.3.6.1.4.1.19376.1.5.3.1.3.6']/entry/act/entryRelationship/observation/value
<b>\$InfectionHistoryProblemCode</b>	problem.code	ClinicalDocument//component/structuredBody/component/section[templateId[@root='1.3.6.1.4.1.19376.1.5.3.1.1.16.2.1.1.1']/entry/act/entryRelationship/observation/value
Mapping to HL7 FHIR BFDR (5a)		
FHIR Profile/Resource		Content
<a href="#">Composition - Provider Fetal Death Report</a> <ul style="list-style-type: none"> <li>PENDING</li> </ul>		PENDING



Mapping to HL7 v2.6 BFDR (5b)			
Mapping Location and Content	Example	Usage	
OBX-2 SHALL contain CWE OBX-3 SHALL contain 73769-2^ Infections present and treated during the pregnancy for fetal death OBX-5 SHALL contain 4241002^ Listeriosis (disorder)	OBX 19 CWE 73769-2^Infections present treated during the pregnancy for fetal death^LN  4241002^ Listeriosis (disorder)^SNM      F	PSMLBDI	
		PSMFDI	
		PSLBI	
		PSFLBI	
		PSFFDI	Y
		PSFDI	Y
		JLBI	
		JFDI	Y
CCOFDI			

1685

**6.6.1.1.147 GBS Infections Present and Treated During this Pregnancy [Group B Streptococcus]**

GBS Derivation Rule (2)		
IF (\$ProblemCode CONTAINS ValueSet ( <a href="#">Group B Streptococcus (NCHS)</a> ) OR (\$InfectionHistoryProblemCode CONTAINS ValueSet ( <a href="#">Group B Streptococcus (NCHS)</a> ) THEN “GBS” SHALL = “Y” ELSE “N”.		
Variable Name	Source in EMR Using FHIR (1a)	Source in EMR Using CDA Labor and Delivery Summary-VR XPATH (1b)
\$ProblemCode	problem.code	ClinicalDocument/component/structuredBody/component/section[templateId[@root='1.3.6.1.4.1.19376.1.5.3.1.3.6']]/entry/act/entryRelationship/observation/value
\$InfectionHistoryProblemCode	problem.code	ClinicalDocument//component/structuredBody/component/section[templateId[@root='1.3.6.1.4.1.19376.1.5.3.1.1.16.2.1.1.1']]/entry/act/entryRelationship/observation/value
Mapping to HL7 FHIR BFDR (5a)		
FHIR Profile/Resource	Content	
<a href="#">Composition - Provider Fetal Death Report</a> <ul style="list-style-type: none"> <li>PENDING</li> </ul>	PENDING	
Mapping to HL7 v2.6 BFDR (5b)		
Mapping Location and Content	Example	Usage
OBX-2 SHALL contain CWE OBX-3 SHALL contain 73769-2^ Infections present and treated during the pregnancy for fetal death OBX-5 SHALL contain 426933007^Streptococcus agalactiae infection (disorder)	OBX 19 CWE 73769-2^Infections present treated during the pregnancy for fetal death^LN  426933007^Streptococcus agalactiae infection (disorder)^SNM      F	PSMLBDI
		PSMFDI
		PSLBI
		PSFLBI
		PSFFDI

		PSFDI	Y
		JLBI	
		JFDI	Y
		CCOFDI	

**6.6.1.1.148 CMV Infections Present and Treated During this Pregnancy**  
[Cytomegalovirus]

CMV Derivation Rule (2)			
IF (\$ProblemCode CONTAINS ValueSet ( <a href="#">Cytomegalovirus (NCHS)</a> ) OR (\$InfectionHistoryProblemCode CONTAINS ValueSet ( <a href="#">Cytomegalovirus (NCHS)</a> ) THEN “CMV” SHALL = “Y” ELSE “N”.			
Variable Name	Source in EMR Using FHIR (1a)	Source in EMR Using CDA Labor and Delivery Summary-VR XPATH (1b)	
\$ProblemCode	problem.code	ClinicalDocument/component/structuredBody/component/section[templateId[@root='1.3.6.1.4.1.19376.1.5.3.1.3.6']]/entry/act/entryRelationship/observation/value	
\$InfectionHistoryProblemCode	problem.code	ClinicalDocument//component/structuredBody/component/section[templateId[@root='1.3.6.1.4.1.19376.1.5.3.1.1.16.2.1.1.1']]/entry/act/entryRelationship/observation/value	
Mapping to HL7 FHIR BFDR (5a)			
FHIR Profile/Resource		Content	
<a href="#">Composition - Provider Fetal Death Report</a> • PENDING		PENDING	
Mapping to HL7 v2.6 BFDR (5b)			
Mapping Location and Content	Example	Usage	
OBX-2 SHALL contain CWE OBX-3 SHALL contain 73769-2^ Infections present and treated during the pregnancy for fetal death OBX-5 SHALL contain 28944009^Cytomegalovirus infection (disorder)	OBX 19 CWE 73769-2^Infections present treated during the pregnancy for fetal death^LN  28944009^Cytomegalovirus infection (disorder)^SNM      F	PSMLBDI	
		PSMFDI	
		PSLBI	
		PSFLBI	
		PSFFDI	Y
		PSFDI	Y
		JLBI	
		JFDI	Y
CCOFDI			

1690

**6.6.1.1.149 B19 Infections Present and Treated During this Pregnancy** [Parvovirus]

B19 Derivation Rule (2)
-------------------------

IHE Quality, Research and Public Health Technical Framework Supplement – Birth and Fetal Death Reporting-Enhanced (BFDR-E)

IF (\$ProblemCode CONTAINS ValueSet ( <i>Parvovirus (NCHS)</i> ) OR (\$InfectionHistoryProblemCode CONTAINS ValueSet ( <i>Parvovirus (NCHS)</i> ) THEN “B19” SHALL = “Y” ELSE “N”.																				
Variable Name	Source in EMR Using FHIR (1a)	Source in EMR Using CDA Labor and Delivery Summary-VR XPATH (1b)																		
\$ProblemCode	problem.code	ClinicalDocument/component/structuredBody/component/section[templateId[@root='1.3.6.1.4.1.19376.1.5.3.1.3.6']] /entry/act/entryRelationship/observation/value																		
\$InfectionHistoryProblemCode	problem.code	ClinicalDocument//component/structuredBody/component/section[templateId[@root='1.3.6.1.4.1.19376.1.5.3.1.1.16.2.1.1.1']] /entry/act/entryRelationship/observation/value																		
Mapping to HL7 FHIR BFDR (5a)																				
FHIR Profile/Resource		Content																		
<a href="#">Composition - Provider Fetal Death Report</a> • PENDING		PENDING																		
Mapping to HL7 v2.6 BFDR (5b)																				
Mapping Location and Content	Example	Usage																		
OBX-2 SHALL contain CWE OBX-3 SHALL contain 73769-2^ Infections present and treated during the pregnancy for fetal death OBX-5 SHALL contain 186748004^Parvovirus	OBX 19 CWE 73769-2^Infections present treated during the pregnancy for fetal death^LN  186748004^Parvovirus^SNM     F	<table border="1"> <tr><td>PSMLBDI</td><td></td></tr> <tr><td>PSMFDI</td><td></td></tr> <tr><td>PSLBI</td><td></td></tr> <tr><td>PSFLBI</td><td></td></tr> <tr><td>PSFFDI</td><td>Y</td></tr> <tr><td>PSFDI</td><td>Y</td></tr> <tr><td>JLBI</td><td></td></tr> <tr><td>JFDI</td><td>Y</td></tr> <tr><td>CCOFDI</td><td></td></tr> </table>	PSMLBDI		PSMFDI		PSLBI		PSFLBI		PSFFDI	Y	PSFDI	Y	JLBI		JFDI	Y	CCOFDI	
PSMLBDI																				
PSMFDI																				
PSLBI																				
PSFLBI																				
PSFFDI	Y																			
PSFDI	Y																			
JLBI																				
JFDI	Y																			
CCOFDI																				

6.6.1.1.150 HISTOP Was a Histological Placental Examination Performed?

HISTOP Derivation Rule (2)		
IF (\$EventOutcomesObservationCode CONTAINS ValueSet ( <i>Histological Placental Examination (NCHS)</i> ) THEN “HISTOP” SHALL = \$EventOutcomesObservationValue.		
Variable Name	Source in EMR Using FHIR (1a)	Source in EMR Using CDA Labor and Delivery Summary-VR XPATH (1b)
\$EventOutcomesObservationCode	observation.code constrained by: ( <a href="http://ihe.net/fhir/StructureDefinition/IHE.BFDRE.FetusObservations/HISTOP">http://ihe.net/fhir/StructureDefinition/IHE.BFDRE.FetusObservations/HISTOP</a> ) of the mother or fetus	ClinicalDocument/component/structuredBody/component/section[templateId[@root='1.3.6.1.4.1.19376.1.5.3.1.1.21.2.4'] AND subject/relatedSubject[code[@code='NCHILD' AND id=idOfTheChild]]]/component/section[templateId[@root='1.3.6.1.4.1.19376.1.7.3.1.1.13.7']] /entry[templateId[@root='1.3.6.1.4.1.19376.1.5.3.1.4.13']] /observation/code

<b>\$EventOutcomesObservationValue</b>	observation.value Boolean	ClinicalDocument/component/structuredBody/component/section[templateId[@root='1.3.6.1.4.1.19376.1.5.3.1.1.21.2.4'] AND subject/relatedSubject[code[@code='NCHILD' AND id=idOfTheChild]]/component/section[templateId[@root='1.3.6.1.4.1.19376.1.7.3.1.1.13.7']]/entry[templateId[@root='1.3.6.1.4.1.19376.1.5.3.1.4.13']]/observation/value																			
Mapping to HL7 FHIR BFDR (5a)																					
FHIR Profile/Resource		Content																			
<a href="#">Composition - Provider Fetal Death Report</a> • PENDING		PENDING																			
Mapping to HL7 v2.6 BFDR (5b)																					
Mapping Location and Content		Example	Usage																		
OBX-2 SHALL contain CWE OBX-3 SHALL contain 73767-6^Histological placental examination was performed OBX-5 SHALL contain a value selected from value set Histological Placental Examination (NCHS) <a href="https://phinvads.cdc.gov/vads/ViewValueSet.action?oid=2.16.840.1.114222.4.11.7138">https://phinvads.cdc.gov/vads/ViewValueSet.action?oid=2.16.840.1.114222.4.11.7138</a>		OBX 19 CWE 73767-6^Histological placental examination was performed^LN  262008008^ Not Performed^SNM     F	<table border="1"> <tr><td>PSMLBDI</td><td></td></tr> <tr><td>PSMFDI</td><td></td></tr> <tr><td>PSLBI</td><td></td></tr> <tr><td>PSFLBI</td><td></td></tr> <tr><td>PSFFDI</td><td>Y</td></tr> <tr><td>PSFDI</td><td>Y</td></tr> <tr><td>JLBI</td><td></td></tr> <tr><td>JFDI</td><td>Y</td></tr> <tr><td>CCOFDI</td><td></td></tr> </table>	PSMLBDI		PSMFDI		PSLBI		PSFLBI		PSFFDI	Y	PSFDI	Y	JLBI		JFDI	Y	CCOFDI	
PSMLBDI																					
PSMFDI																					
PSLBI																					
PSFLBI																					
PSFFDI	Y																				
PSFDI	Y																				
JLBI																					
JFDI	Y																				
CCOFDI																					

1695

### 6.6.1.1.151 TOXO Infections Present and Treated During this Pregnancy [Toxoplasmosis]

TOXO Derivation Rule (2)		
IF (\$ProblemCode CONTAINS ValueSet ( <a href="#">Toxoplasmosis (NCHS)</a> ) OR (\$InfectionHistoryProblemCode CONTAINS ValueSet ( <a href="#">Toxoplasmosis (NCHS)</a> )) THEN “TOXO” SHALL = “Y” ELSE “N”.		
Variable Name	Source in EMR Using FHIR (1a)	Source in EMR Using CDA Labor and Delivery Summary-VR XPATH (1b)
<b>\$ProblemCode</b>	problem.code	ClinicalDocument/component/structuredBody/component/section[templateId[@root='1.3.6.1.4.1.19376.1.5.3.1.3.6']]/entry/act/entryRelationship/observation/value
<b>\$InfectionHistoryProblemCode</b>	problem.code	ClinicalDocument/component/structuredBody/component/section[templateId[@root='1.3.6.1.4.1.19376.1.5.3.1.1.16.2.1.1.1']]/entry/act/entryRelationship/observation/value
Mapping to HL7 FHIR BFDR (5a)		
FHIR Profile/Resource		Content
<a href="#">Composition - Provider Fetal Death Report</a> • PENDING		PENDING

Mapping to HL7 v2.6 BFDR (5b)			
Mapping Location and Content	Example	Usage	
OBX-2 SHALL contain CWE OBX-3 SHALL contain 73769-2^ Infections present and treated during the pregnancy for fetal death OBX-5 SHALL contain 187192000^ Toxoplasmosis (disorder)	OBX 19 CWE 73769-2^Infections present treated during the pregnancy for fetal death^LN  187192000^ Toxoplasmosis (disorder)^SNM      F	PSMLBDI	
		PSMFDI	
		PSLBI	
		PSFLBI	
		PSFFDI	Y
		PSFDI	Y
		JLBI	
		JFDI	Y
CCOFDI			

### 6.6.1.1.152 PNC

PNC Derivation Rule (2)		
IF \$PregnancyHistoryObservationCode CONTAINS ValueSet ( <i>No Prenatal Care Visit (NCHS)</i> ) THEN (IF \$PregnancyHistoryObservationValue = 'True' THEN PNC SHALL = 'Y' ELSE IF \$PregnancyHistoryObservationValue = 'False' "PNC" SHALL = 'N') ELSE Data Entry SHALL be required to capture PNC.		
Variable Name	Source in EMR Using FHIR (1a)	Source in EMR Using CDA Labor and Delivery Summary-VR XPATH (1b)
\$PregnancyHistoryObservationCode	observation.code in value set (Number of Previous Cesareans (NCHS) 1.3.6.1.4.1.19376.1.7.3.1.1.13.8.148) constrained by: (http://ihe.net/fhir/StructureDefinition/IHE.BFDRE.MaternalObservationsPNC)	ClinicalDocument/component/structuredBody/component/section[templateId[@root='1.3.6.1.4.1.19376.1.5.3.1.1.5.3.4']]/entry/observation/code
\$PregnancyHistoryObservationValue	observation.valueBoolean	ClinicalDocument/component/structuredBody/component/section[templateId[@root='1.3.6.1.4.1.19376.1.5.3.1.1.5.3.4']]/entry/observation/value
Mapping to HL7 FHIR BFDR (5a)		
FHIR Profile/Resource	Content	
<a href="#">Composition - Provider Live Birth Report</a> OR <a href="#">Composition - Provider Fetal Death Report</a> <ul style="list-style-type: none"> <li>PENDING</li> </ul>	/code@code= Code='73776-7', CodeSystemName= 'LOINC', DisplayName=' No-prenatal care indicator' AND /value@value= Boolean form of PNCss	
Mapping to HL7 v2.6 BFDR (5b)		

Mapping Location and Content	Example	Usage	
OBX-2 SHALL contain CWE OBX-3 SHALL contain 73776-7^No Prenatal Care Indicator OBX-5 SHALL contain a value selected from value the set from PHVS_YesNo_HL7_2x	OBX 32 CWE 73776-7^ No prenatal care indicator ^LN  N^No^ PHVS_YesNo_HL7_2x      F	PSMLBDI	
		PSMFDI	
		PSLBI	Y
		PSFLBI	Y
		PSFFDI	Y
		PSFDI	Y
		JLBI	Y
		JFDI	Y
		CCOFDI	

### 6.6.4 Discrete Data Import Element Mappings From APS to LDS-VR Content Document

1700

This section identifies the form data elements that may be available from the Antepartum Summary Record (APS), and the associated mapping for discrete data import of these data elements from the APS. Form Fillers that support the Antepartum Import Option SHALL support import of these attributes where available for incorporation into the LDS or LDS-VR pre-population document.

1705

**Table 6.6.4-1: Discrete Data Import Elements Data Mapped to LDS-VR Content Document Modules for Birth**

Attribute Name <QRPH TF-1: Appx B>	Birth and Fetal Death Report Data Element	APS Section Level Map (if specific)	APS Entry Level Map	LDS Mapping
DOFP_MO DOFP_DY DOFP_Y	Date of first prenatal care visit	Antepartum Summary Specification 1.3.6.1.4.1.19376.1.5.3.1.1.11.2 Pregnancy History 1.3.6.1.4.1.19376.1.5.3.1.1.5.3.4	Pregnancy Observation 1.3.6.1.4.1.19376.1.5.3.1.4.1.3.5	/component/section[templateId[@root='1.3.6.1.4.1.19376.1.5.3.1.1.5.3.4']] /entry/observation/code Using valueset First Prenatal Care Visit (NCHS) 1.3.6.1.4.1.19376.1.7.3.1.1.13.8.133 Documenting ../effectiveTime using date timestamp associated with the event

IHE Quality, Research and Public Health Technical Framework Supplement – Birth and Fetal Death Reporting-Enhanced (BFDR-E)

Attribute Name <QRPH TF-1: Appx B>	Birth and Fetal Death Report Data Element	APS Section Level Map (if specific)	APS Entry Level Map	LDS Mapping
NPREV	Total number of prenatal care visits for this pregnancy	Antepartum Summary Specification 1.3.6.1.4.1.19376.1.5.3.1.1.11.2 Pregnancy History 1.3.6.1.4.1.19376.1.5.3.1.1.5.3.4	Pregnancy Observation 1.3.6.1.4.1.19376.1.5.3.1.4.1 3.5	/component/section[templateId[@root='1.3.6.1.4.1.19376.1.5.3.1.1.5.3.4']] /entry/observation/code Using valueset Number Prenatal Care Visits (NCHS) 1.3.6.1.4.1.19376.1.7.3.1.1.13.8.135 Documenting ../value using INT
OWGEST	Obstetric Estimate of Gestation	Antepartum Summary Specification 1.3.6.1.4.1.19376.1.5.3.1.1.11.2 Pregnancy History 1.3.6.1.4.1.19376.1.5.3.1.1.5.3.4	Pregnancy Observation 1.3.6.1.4.1.19376.1.5.3.1.4.1 3.5	/component/section[templateId[@root='1.3.6.1.4.1.19376.1.5.3.1.1.5.3.4']] /entry/observation/code Using valueset Estimate of Gestation (templateId: 2.16.840.1.113883.10.20.26.21) Documenting ../value using INT NOTE: The preferred source for the Obstetric Estimate of Gestation is the OB History and Physical. The primary source would be the OB admission H&P. This information may also be available in the prenatal care record (e.g., APS), but this should be used as a secondary source if the OB admission H&P does not contain this information.
DLMP_D Y DLMP_M O DLMP_Y R	Date last normal menses began	Antepartum Summary Specification 1.3.6.1.4.1.19376.1.5.3.1.1.11.2 Pregnancy History 1.3.6.1.4.1.19376.1.5.3.1.1.5.3.4	Pregnancy Observation 1.3.6.1.4.1.19376.1.5.3.1.4.1 3.5	/component/section[templateId[@root='1.3.6.1.4.1.19376.1.5.3.1.1.5.3.4']] /entry/observation/code Using valueset Last Menstrual Period Date (templateId: 2.16.840.1.113883.10.20.26.33) Documenting ../effectiveTime using date timestamp associated with the event
PLBL	Number of previous live births now living	Antepartum Summary Specification 1.3.6.1.4.1.19376.1.5.3.1.1.11.2 Pregnancy History 1.3.6.1.4.1.19376.1.5.3.1.1.5.3.4	Pregnancy Observation 1.3.6.1.4.1.19376.1.5.3.1.4.1 3.5	/component/section[templateId[@root='1.3.6.1.4.1.19376.1.5.3.1.1.5.3.4']] /entry/observation/code Using valueset Number of Previous Live Births Now Living (NCHS) 1.3.6.1.4.1.19376.1.7.3.1.1.13.8.123 Documenting ../value using INT

IHE Quality, Research and Public Health Technical Framework Supplement – Birth and Fetal Death Reporting-Enhanced (BFDR-E)

Attribute Name <QRPH TF-1: Appx B>	Birth and Fetal Death Report Data Element	APS Section Level Map (if specific)	APS Entry Level Map	LDS Mapping
PLBD	Number of previous live births now dead	Antepartum Summary Specification 1.3.6.1.4.1.19376.1.5.3.1.1.11.2 Pregnancy History 1.3.6.1.4.1.19376.1.5.3.1.1.5.3.4	Pregnancy Observation 1.3.6.1.4.1.19376.1.5.3.1.4.1 3.5	/component/section[templateId[@root='1.3.6.1.4.1.19376.1.5.3.1.1.5.3.4']] /entry/observation/code Using valueset Number of Previous Live Births Now Dead (NCHS) 1.3.6.1.4.1.19376.1.7.3.1.1.13.8.122 Documenting ../value using INT
YLLB MLLB	Date of last live birth	Antepartum Summary Specification 1.3.6.1.4.1.19376.1.5.3.1.1.11.2 Pregnancy History 1.3.6.1.4.1.19376.1.5.3.1.1.5.3.4	Pregnancy Observation 1.3.6.1.4.1.19376.1.5.3.1.4.1 3.5	/component/section[templateId[@root='1.3.6.1.4.1.19376.1.5.3.1.1.5.3.4']] /entry/observation/code Using valueset Date of Last Live Birth (NCHS) 1.3.6.1.4.1.19376.1.7.3.1.1.13.8.67 Documenting ../effectiveTime using date timestamp associated with the event
POPO	Number of other pregnancy outcomes	Antepartum Summary Specification 1.3.6.1.4.1.19376.1.5.3.1.1.11.2 Pregnancy History 1.3.6.1.4.1.19376.1.5.3.1.1.5.3.4	Pregnancy Observation 1.3.6.1.4.1.19376.1.5.3.1.4.1 3.5	/component/section[templateId[@root='1.3.6.1.4.1.19376.1.5.3.1.1.5.3.4']] /entry/observation/code Using valueset Previous Other Pregnancy Outcomes (NCHS) 1.3.6.1.4.1.19376.1.7.3.1.1.13.8.121 Documenting ../value using INT
YOPO MOPO	Date of last other pregnancy outcome	Antepartum Summary Specification 1.3.6.1.4.1.19376.1.5.3.1.1.11.2 Pregnancy History 1.3.6.1.4.1.19376.1.5.3.1.1.5.3.4	Pregnancy Observation 1.3.6.1.4.1.19376.1.5.3.1.4.1 3.5	/component/section[templateId[@root='1.3.6.1.4.1.19376.1.5.3.1.1.5.3.4']] /entry/observation/code Using valueset Date of Last Other Pregnancy Outcome (NCHS) 1.3.6.1.4.1.19376.1.7.3.1.1.13.8.70 Documenting ../effectiveTime using date timestamp associated with the event
PDIAB	Risk factors in this pregnancy: Pre-Pregnancy Diabetes	Antepartum Summary Specification 1.3.6.1.4.1.19376.1.5.3.1.1.11.2 Pregnancy History 1.3.6.1.4.1.19376.1.5.3.1.1.5.3.4	Pregnancy Observation 1.3.6.1.4.1.19376.1.5.3.1.4.1 3.5	/component/section[templateId[@root='1.3.6.1.4.1.19376.1.5.3.1.1.5.3.4']] /entry/observation/value Using valueset Prepregnancy Diabetes (NCHS) 1.3.6.1.4.1.19376.1.7.3.1.1.13.8.136 Documenting PregnancyObservation/code/@code=7 3775-9 Risk Factors in this Pregnancy



IHE Quality, Research and Public Health Technical Framework Supplement – Birth and Fetal Death Reporting-Enhanced (BFDR-E)

Attribute Name <QRPH TF-1: Appx B>	Birth and Fetal Death Report Data Element	APS Section Level Map (if specific)	APS Entry Level Map	LDS Mapping
GDIAB	Risk factors in this pregnancy: Gestational Diabetes	Antepartum Summary Specification 1.3.6.1.4.1.19376.1.5.3.1.1.11.2 Pregnancy History 1.3.6.1.4.1.19376.1.5.3.1.1.5.3.4	Pregnancy Observation 1.3.6.1.4.1.19376.1.5.3.1.4.1 3.5	/component/section[templateId[@root='1.3.6.1.4.1.19376.1.5.3.1.1.5.3.4']] /entry/observation/value Using valueset Gestational Diabetes (NCHS)1.3.6.1.4.1.19376.1.7.3.1.1.13.8.137 Documenting PregnancyObservation/code/@code=7 3775-9 Risk Factors in this Pregnancy
PHYPE	Risk factors in this pregnancy: pre-pregnancy hypertension	Antepartum Summary Specification 1.3.6.1.4.1.19376.1.5.3.1.1.11.2 Pregnancy History 1.3.6.1.4.1.19376.1.5.3.1.1.5.3.4	Pregnancy Observation 1.3.6.1.4.1.19376.1.5.3.1.4.1 3.5	/component/section[templateId[@root='1.3.6.1.4.1.19376.1.5.3.1.1.5.3.4']] /entry/observation/value Using valueset Prepregnancy Hypertension (NCHS) 1.3.6.1.4.1.19376.1.7.3.1.1.1 3.8.138 Documenting PregnancyObservation/code/@code=7 3775-9 Risk Factors in this Pregnancy
GHYPE	Risk factors in this pregnancy: gestational hypertension	Antepartum Summary Specification 1.3.6.1.4.1.19376.1.5.3.1.1.11.2 Pregnancy History 1.3.6.1.4.1.19376.1.5.3.1.1.5.3.4	Pregnancy Observation 1.3.6.1.4.1.19376.1.5.3.1.4.1 3.5	/component/section[templateId[@root='1.3.6.1.4.1.19376.1.5.3.1.1.5.3.4']] /entry/observation/value Using valueset Gestational Hypertension (NCHS) 1.3.6.1.4.1.19376.1.7.3.1.1.13.8.139 Documenting PregnancyObservation/code/@code=7 3775-9 Risk Factors in this Pregnancy
EHYPE	Risk factors in this pregnancy: gestational eclampsia	Antepartum Summary Specification 1.3.6.1.4.1.19376.1.5.3.1.1.11.2 Pregnancy History 1.3.6.1.4.1.19376.1.5.3.1.1.5.3.4	Pregnancy Observation 1.3.6.1.4.1.19376.1.5.3.1.4.1 3.5	/component/section[templateId[@root='1.3.6.1.4.1.19376.1.5.3.1.1.5.3.4']] /entry/observation/value Using valueset Eclampsia (NCHS) 1.3.6.1.4.1.19376.1.7.3.1.1.13.8.140 Documenting PregnancyObservation/code/@code=7 3775-9 Risk Factors in this Pregnancy
PPB	Previous Preterm Births	Antepartum Summary Specification 1.3.6.1.4.1.19376.1.5.3.1.1.11.2 Pregnancy History 1.3.6.1.4.1.19376.1.5.3.1.1.5.3.4	Pregnancy Observation 1.3.6.1.4.1.19376.1.5.3.1.4.1 3.5	/component/section[templateId[@root='1.3.6.1.4.1.19376.1.5.3.1.1.5.3.4']] /entry/observation/code Using valueset Preterm Birth (NCHS) 1.3.6.1.4.1.19376.1.7.3.1.1.13.8.141 Documenting ../value using INT

IHE Quality, Research and Public Health Technical Framework Supplement – Birth and Fetal Death Reporting-Enhanced (BFDR-E)

Attribute Name <QRPH TF-1: Appx B>	Birth and Fetal Death Report Data Element	APS Section Level Map (if specific)	APS Entry Level Map	LDS Mapping
INFT	Pregnancy resulted from infertility treatment	Antepartum Summary Specification 1.3.6.1.4.1.19376.1.5.3.1.1.11.2 Pregnancy History 1.3.6.1.4.1.19376.1.5.3.1.1.5.3.4	Pregnancy Observation 1.3.6.1.4.1.19376.1.5.3.1.4.1 3.5	/component/section[templateId[@root='1.3.6.1.4.1.19376.1.5.3.1.1.5.3.4']] /entry/observation/value Using valueset Infertility Treatment (NCHS)1.3.6.1.4.1.19376.1.7.3.1.1.13.8.143 Documenting PregnancyObservation/code/@code=7 3775-9 Risk Factors in this Pregnancy
INFT_DRG	Fertility-enhancing drugs, artificial insemination, or intrauterine insemination	Antepartum Summary Specification 1.3.6.1.4.1.19376.1.5.3.1.1.11.2 Pregnancy History 1.3.6.1.4.1.19376.1.5.3.1.1.5.3.4	Pregnancy Observation 1.3.6.1.4.1.19376.1.5.3.1.4.1 3.5	/component/section[templateId[@root='1.3.6.1.4.1.19376.1.5.3.1.1.5.3.4']] /entry/observation/value Using valueset Artificial or Intrauterine Insemination (NCHS) 1.3.6.1.4.1.19376.1.7.3.1.1.13.8.145 Documenting PregnancyObservation/code/@code=7 3775-9 Risk Factors in this Pregnancy
INFT_ART	Assisted reproductive technology (e.g., in-vitro fertilization [IVF] gamete intrafallopian transfer [GIFT])	Antepartum Summary Specification 1.3.6.1.4.1.19376.1.5.3.1.1.11.2 Pregnancy History 1.3.6.1.4.1.19376.1.5.3.1.1.5.3.4	Pregnancy Observation 1.3.6.1.4.1.19376.1.5.3.1.4.1 3.5	/component/section[templateId[@root='1.3.6.1.4.1.19376.1.5.3.1.1.5.3.4']] /entry/observation/value Using valueset Assistive Reproductive Technology (NCHS)1.3.6.1.4.1.19376.1.7.3.1.1.13.8.146 Documenting PregnancyObservation/code/@code=7 3775-9 Risk Factors in this Pregnancy
PCES	Previous Cesarean	Antepartum Summary Specification 1.3.6.1.4.1.19376.1.5.3.1.1.11.2 Pregnancy History 1.3.6.1.4.1.19376.1.5.3.1.1.5.3.4	Pregnancy Observation 1.3.6.1.4.1.19376.1.5.3.1.4.1 3.5	/component/section[templateId[@root='1.3.6.1.4.1.19376.1.5.3.1.1.5.3.4']] /entry/observation/value Using valueset Previous Cesarean (NCHS) 2.16.840.1.114222.4.11.7165 Documenting PregnancyObservation/code/@code=7 3775-9 Risk Factors in this Pregnancy
NPCES	Number of previous cesareans	Antepartum Summary Specification 1.3.6.1.4.1.19376.1.5.3.1.1.11.2 Pregnancy History 1.3.6.1.4.1.19376.1.5.3.1.1.5.3.4	Pregnancy Observation 1.3.6.1.4.1.19376.1.5.3.1.4.1 3.5	/component/section[templateId[@root='1.3.6.1.4.1.19376.1.5.3.1.1.5.3.4']] /entry/observation/code Using valueset Number of Previous Cesareans (NCHS) 1.3.6.1.4.1.19376.1.7.3.1.1.13.8.148 Documenting ../value using INT

IHE Quality, Research and Public Health Technical Framework Supplement – Birth and Fetal Death Reporting-Enhanced (BFDR-E)

Attribute Name <QRPH TF-1: Appx B>	Birth and Fetal Death Report Data Element	APS Section Level Map (if specific)	APS Entry Level Map	LDS Mapping
GON	Infections present and/or treated during this pregnancy: Gonorrhea	Antepartum Summary Specification 1.3.6.1.4.1.19376.1.5.3.1.1.11.2 Code History of Infection 1.3.6.1.4.1.19376.1.5.3.1.1.16.2.1.1.1	Problem Concern Entry 1.3.6.1.4.1.19376.1.5.3.1.4.5.2	ClinicalDocument/structuredBody/component/section[templateId[@root='1.3.6.1.4.1.19376.1.5.3.1.1.16.2.1.1.1']] /entry/act/entryRelationship/observation/value Using valueset Gonorrhea (NCHS)2.16.840.1.114222.4.11.6071 Documenting ../code = 'finding', '404684003'
SYPH	Infections present and/or treated during this pregnancy: Syphilis	Antepartum Summary Specification 1.3.6.1.4.1.19376.1.5.3.1.1.11.2 Code History of Infection 1.3.6.1.4.1.19376.1.5.3.1.1.16.2.1.1.1	Problem Concern Entry 1.3.6.1.4.1.19376.1.5.3.1.4.5.2	ClinicalDocument/structuredBody/component/section[templateId[@root='1.3.6.1.4.1.19376.1.5.3.1.1.16.2.1.1.1']] /entry/act/entryRelationship/observation/value Using valueset Syphilis (NCHS)1.3.6.1.4.1.19376.1.7.3.1.1.13.8.98 Documenting ../code = 'finding', '404684003'
CHAM	Infections present and/or treated during this pregnancy: Chlamydia	Antepartum Summary Specification 1.3.6.1.4.1.19376.1.5.3.1.1.11.2 Code History of Infection 1.3.6.1.4.1.19376.1.5.3.1.1.16.2.1.1.1	Problem Concern Entry 1.3.6.1.4.1.19376.1.5.3.1.4.5.2	ClinicalDocument/structuredBody/component/section[templateId[@root='1.3.6.1.4.1.19376.1.5.3.1.1.16.2.1.1.1']] /entry/act/entryRelationship/observation/value Using valueset Chlamydia (NCHS)1.3.6.1.4.1.19376.1.7.3.1.1.13.8.93 Documenting ../code = 'finding', '404684003'
HEPB	Infections present and/or treated during this pregnancy: Hepatitis B (HBV, serum hepatitis)	Antepartum Summary Specification 1.3.6.1.4.1.19376.1.5.3.1.1.11.2 Code History of Infection 1.3.6.1.4.1.19376.1.5.3.1.1.16.2.1.1.1	Problem Concern Entry 1.3.6.1.4.1.19376.1.5.3.1.4.5.2	ClinicalDocument/structuredBody/component/section[templateId[@root='1.3.6.1.4.1.19376.1.5.3.1.1.16.2.1.1.1']] /entry/act/entryRelationship/observation/value Using valueset Hepatitis B (NCHS)1.3.6.1.4.1.19376.1.7.3.1.1.13.8.96 Documenting ../code = 'finding', '404684003'

IHE Quality, Research and Public Health Technical Framework Supplement – Birth and Fetal Death Reporting-Enhanced (BFDR-E)

Attribute Name <QRPH TF-1: Appx B>	Birth and Fetal Death Report Data Element	APS Section Level Map (if specific)	APS Entry Level Map	LDS Mapping
HEPC	Infections present and/or treated during this pregnancy: Hepatitis C (non A or non B hepatitis [HCV])	Antepartum Summary Specification 1.3.6.1.4.1.19376.1.5.3.1.1.11.2 Code History of Infection 1.3.6.1.4.1.19376.1.5.3.1.1.16.2.1.1.1	Problem Concern Entry 1.3.6.1.4.1.19376.1.5.3.1.4.5.2	ClinicalDocument/structuredBody/component/section[templateId[[@root='1.3.6.1.4.1.19376.1.5.3.1.1.16.2.1.1.1']]]/entry/act/entryRelationship/observation/value Using valueset Hepatitis C (NCHS)1.3.6.1.4.1.19376.1.7.3.1.1.13.8.97 Documenting ../code = 'finding', '404684003'
LM	Infections present and/or treated during this pregnancy: Listeria	Antepartum Summary Specification 1.3.6.1.4.1.19376.1.5.3.1.1.11.2 Code History of Infection 1.3.6.1.4.1.19376.1.5.3.1.1.16.2.1.1.1	Problem Concern Entry 1.3.6.1.4.1.19376.1.5.3.1.4.5.2	ClinicalDocument/structuredBody/component/section[templateId[[@root='1.3.6.1.4.1.19376.1.5.3.1.1.16.2.1.1.1']]]/entry/act/entryRelationship/observation/value Using valueset Listeria (NCHS)1.3.6.1.4.1.19376.1.7.3.1.1.13.8.147 Documenting ../code = 'finding', '404684003'
GBS	Infections present and/or treated during this pregnancy: Group B Streptococcus	Antepartum Summary Specification 1.3.6.1.4.1.19376.1.5.3.1.1.11.2 Code History of Infection 1.3.6.1.4.1.19376.1.5.3.1.1.16.2.1.1.1	Problem Concern Entry 1.3.6.1.4.1.19376.1.5.3.1.4.5.2	ClinicalDocument/structuredBody/component/section[templateId[[@root='1.3.6.1.4.1.19376.1.5.3.1.1.16.2.1.1.1']]]/entry/act/entryRelationship/observation/value Using valueset Group B Streptococcus (NCHS)1.3.6.1.4.1.19376.1.7.3.1.1.13.8.166 Documenting ../code = 'finding', '404684003'
CMV	Infections present and/or treated during this pregnancy: Cytomegalovirus	Antepartum Summary Specification 1.3.6.1.4.1.19376.1.5.3.1.1.11.2 Code History of Infection 1.3.6.1.4.1.19376.1.5.3.1.1.16.2.1.1.1	Problem Concern Entry 1.3.6.1.4.1.19376.1.5.3.1.4.5.2	ClinicalDocument/structuredBody/component/section[templateId[[@root='1.3.6.1.4.1.19376.1.5.3.1.1.16.2.1.1.1']]]/entry/act/entryRelationship/observation/value Using valueset Cytomegalovirus (NCHS)1.3.6.1.4.1.19376.1.7.3.1.1.13.8.167 Documenting ../code = 'finding', '404684003'

IHE Quality, Research and Public Health Technical Framework Supplement – Birth and Fetal Death Reporting-Enhanced (BFDR-E)

Attribute Name <QRPH TF-1: Appx B>	Birth and Fetal Death Report Data Element	APS Section Level Map (if specific)	APS Entry Level Map	LDS Mapping
B19	Infections present and/or treated during this pregnancy: Parvovirus	Antepartum Summary Specification 1.3.6.1.4.1.19376.1.5.3.1.1.11.2 Code History of Infection 1.3.6.1.4.1.19376.1.5.3.1.1.16.2.1.1.1	Problem Concern Entry 1.3.6.1.4.1.19376.1.5.3.1.4.5.2	ClinicalDocument/structuredBody/component/section[templateId[[@root='1.3.6.1.4.1.19376.1.5.3.1.1.16.2.1.1.1']]]/entry/act/entryRelationship/observation/value  Using valueset Parvovirus (NCHS)1.3.6.1.4.1.19376.1.7.3.1.1.13.8.168  Documenting ../code = 'finding', '404684003'
TOXO	Infections present and/or treated during this pregnancy: Toxoplasmosis	Antepartum Summary Specification 1.3.6.1.4.1.19376.1.5.3.1.1.11.2 Code History of Infection 1.3.6.1.4.1.19376.1.5.3.1.1.16.2.1.1.1	Problem Concern Entry 1.3.6.1.4.1.19376.1.5.3.1.4.5.2	ClinicalDocument/structuredBody/component/section[templateId[[@root='1.3.6.1.4.1.19376.1.5.3.1.1.16.2.1.1.1']]]/entry/act/entryRelationship/observation/value  Using valueset Toxoplasmosis (NCHS)1.3.6.1.4.1.19376.1.7.3.1.1.13.8.169  Documenting ../code = 'finding', '404684003'

## 6.6.5 QRPH Data Mapping to Provider FHIR Resources

1710

### 6.6.5.1 Provider FHIR Resource Bundle Content

FHIR Resource	Optionality	Cardinality	Structured Definition
Composition	R	1..1	<a href="http://ihe.net/fhir/StructureDefinition/IHE.BFDRE.Composition">http://ihe.net/fhir/StructureDefinition/IHE.BFDRE.Composition</a>
MedicationAdministration	RE	0..*	<a href="http://ihe.net/fhir/StructureDefinition/IHE.BFDRE.MotherMedicationAdministration">http://ihe.net/fhir/StructureDefinition/IHE.BFDRE.MotherMedicationAdministration</a>
MedicationAdministration	RE	0..*	<a href="http://ihe.net/fhir/StructureDefinition/IHE.BFDRE.NewbornMedicationAdministration">http://ihe.net/fhir/StructureDefinition/IHE.BFDRE.NewbornMedicationAdministration</a> NOTE: Attributes related to newborn or fetus
Procedure	RE	0..*	<a href="http://ihe.net/fhir/StructureDefinition/IHE.BFDRE.MotherProcedure">http://ihe.net/fhir/StructureDefinition/IHE.BFDRE.MotherProcedure</a>
Procedure	RE	0..*	<a href="http://ihe.net/fhir/StructureDefinition/IHE.BFDRE.NewbornProcedure">http://ihe.net/fhir/StructureDefinition/IHE.BFDRE.NewbornProcedure</a> NOTE: Attributes related to newborn or fetus

IHE Quality, Research and Public Health Technical Framework Supplement – Birth and Fetal Death Reporting-Enhanced (BFDR-E)

FHIR Resource	Optional ity	Cardinal ity	Structured Definition
Observation	RE	0..1	<p><a href="http://ihe.net/fhir/StructureDefinition/IHE.BFDRE.MaternalObservations">http://ihe.net/fhir/StructureDefinition/IHE.BFDRE.MaternalObservations</a> which is a composite of:</p> <ul style="list-style-type: none"> <li>• <a href="http://ihe.net/fhir/StructureDefinition/IHE.BFDRE.MaternalObservationsPLUR">http://ihe.net/fhir/StructureDefinition/IHE.BFDRE.MaternalObservationsPLUR</a></li> <li>• <a href="http://ihe.net/fhir/StructureDefinition/IHE.BFDRE.MaternalObservationsLIVEB">http://ihe.net/fhir/StructureDefinition/IHE.BFDRE.MaternalObservationsLIVEB</a></li> <li>• <a href="http://ihe.net/fhir/StructureDefinition/IHE.BFDRE.MaternalObservationsFDTH">http://ihe.net/fhir/StructureDefinition/IHE.BFDRE.MaternalObservationsFDTH</a></li> <li>• <a href="http://ihe.net/fhir/StructureDefinition/IHE.BFDRE.MaternalObservationsLLB">http://ihe.net/fhir/StructureDefinition/IHE.BFDRE.MaternalObservationsLLB</a></li> <li>• <a href="http://ihe.net/fhir/StructureDefinition/IHE.BFDRE.MaternalObservationsLMP">http://ihe.net/fhir/StructureDefinition/IHE.BFDRE.MaternalObservationsLMP</a></li> <li>• <a href="http://ihe.net/fhir/StructureDefinition/IHE.BFDRE.MaternalObservationsOPO">http://ihe.net/fhir/StructureDefinition/IHE.BFDRE.MaternalObservationsOPO</a></li> <li>• <a href="http://ihe.net/fhir/StructureDefinition/IHE.BFDRE.MaternalObservationsDOFP">http://ihe.net/fhir/StructureDefinition/IHE.BFDRE.MaternalObservationsDOFP</a></li> <li>• <a href="http://ihe.net/fhir/StructureDefinition/IHE.BFDRE.MaternalObservationsPLBD">http://ihe.net/fhir/StructureDefinition/IHE.BFDRE.MaternalObservationsPLBD</a></li> <li>• <a href="http://ihe.net/fhir/StructureDefinition/IHE.BFDRE.MaternalObservationsPLBL">http://ihe.net/fhir/StructureDefinition/IHE.BFDRE.MaternalObservationsPLBL</a></li> <li>• <a href="http://ihe.net/fhir/StructureDefinition/IHE.BFDRE.MaternalObservationsPPB">http://ihe.net/fhir/StructureDefinition/IHE.BFDRE.MaternalObservationsPPB</a></li> <li>• <a href="http://ihe.net/fhir/StructureDefinition/IHE.BFDRE.MaternalObservationsOWGEST">http://ihe.net/fhir/StructureDefinition/IHE.BFDRE.MaternalObservationsOWGEST</a></li> <li>• <a href="http://ihe.net/fhir/StructureDefinition/IHE.BFDRE.MaternalObservationsNPCES">http://ihe.net/fhir/StructureDefinition/IHE.BFDRE.MaternalObservationsNPCES</a></li> <li>• <a href="http://ihe.net/fhir/StructureDefinition/IHE.BFDRE.MaternalObservationsNPREV">http://ihe.net/fhir/StructureDefinition/IHE.BFDRE.MaternalObservationsNPREV</a></li> <li>• <a href="http://ihe.net/fhir/StructureDefinition/IHE.BFDRE.MaternalObservationsPOPO">http://ihe.net/fhir/StructureDefinition/IHE.BFDRE.MaternalObservationsPOPO</a></li> <li>• <a href="http://ihe.net/fhir/StructureDefinition/IHE.BFDRE.MaternalObservationsPNC">http://ihe.net/fhir/StructureDefinition/IHE.BFDRE.MaternalObservationsPNC</a></li> <li>• <a href="http://ihe.net/fhir/StructureDefinition/IHE.BFDRE.MaternalObservationsHT">http://ihe.net/fhir/StructureDefinition/IHE.BFDRE.MaternalObservationsHT</a></li> <li>• <a href="http://ihe.net/fhir/StructureDefinition/IHE.BFDRE.MaternalObservationsWT">http://ihe.net/fhir/StructureDefinition/IHE.BFDRE.MaternalObservationsWT</a></li> </ul>

IHE Quality, Research and Public Health Technical Framework Supplement – Birth and Fetal Death Reporting-Enhanced (BFDR-E)

FHIR Resource	Optional ity	Cardinal ity	Structured Definition
Observation	RE	0..1	<a href="http://ihe.net/fhir/StructureDefinition/IHE.BFDRE.NewbornObservations">http://ihe.net/fhir/StructureDefinition/IHE.BFDRE.NewbornObservations</a> which is a composite of: <ul style="list-style-type: none"> <li>• <a href="http://ihe.net/fhir/StructureDefinition/IHE.BFDRE.NewbornObservationsAPGAR5">http://ihe.net/fhir/StructureDefinition/IHE.BFDRE.NewbornObservationsAPGAR5</a></li> <li>• <a href="http://ihe.net/fhir/StructureDefinition/IHE.BFDRE.NewbornObservationsAPGAR10">http://ihe.net/fhir/StructureDefinition/IHE.BFDRE.NewbornObservationsAPGAR10</a></li> <li>• <a href="http://ihe.net/fhir/StructureDefinition/IHE.BFDRE.NewbornObservationsBW">http://ihe.net/fhir/StructureDefinition/IHE.BFDRE.NewbornObservationsBW</a></li> <li>• <a href="http://ihe.net/fhir/StructureDefinition/IHE.BFDRE.NewbornObservationsFW">http://ihe.net/fhir/StructureDefinition/IHE.BFDRE.NewbornObservationsFW</a></li> <li>• <a href="http://ihe.net/fhir/StructureDefinition/IHE.BFDRE.NewbornObservationsBPLACE">http://ihe.net/fhir/StructureDefinition/IHE.BFDRE.NewbornObservationsBPLACE</a></li> <li>• <a href="http://ihe.net/fhir/StructureDefinition/IHE.BFDRE.NewbornObservationsKaryotype">http://ihe.net/fhir/StructureDefinition/IHE.BFDRE.NewbornObservationsKaryotype</a></li> </ul> NOTE: Attributes related to newborn or fetus
Observation	RE	0..1	<a href="http://ihe.net/fhir/StructureDefinition/IHE.BFDRE.FetusObservations">http://ihe.net/fhir/StructureDefinition/IHE.BFDRE.FetusObservations</a> which is a composite of: <ul style="list-style-type: none"> <li>• <a href="http://ihe.net/fhir/StructureDefinition/IHE.BFDRE.FetusObservationsFW">http://ihe.net/fhir/StructureDefinition/IHE.BFDRE.FetusObservationsFW</a></li> <li>• <a href="http://ihe.net/fhir/StructureDefinition/IHE.BFDRE.FetusObservationsETIME">http://ihe.net/fhir/StructureDefinition/IHE.BFDRE.FetusObservationsETIME</a></li> <li>• <a href="http://ihe.net/fhir/StructureDefinition/IHE.BFDRE.FetusObservationsHISTOP">http://ihe.net/fhir/StructureDefinition/IHE.BFDRE.FetusObservationsHISTOP</a></li> </ul> NOTE: Attributes related to newborn or fetus
Condition	RE	0..*	<a href="http://ihe.net/fhir/StructureDefinition/IHE.BFDRE.MotherCondition">http://ihe.net/fhir/StructureDefinition/IHE.BFDRE.MotherCondition</a>
Condition	RE	0..*	<a href="http://ihe.net/fhir/StructureDefinition/IHE.BFDRE.NewbornCondition">http://ihe.net/fhir/StructureDefinition/IHE.BFDRE.NewbornCondition</a> NOTE: Attributes related to newborn or fetus
Condition	RE	0..*	<a href="http://ihe.net/fhir/StructureDefinition/IHE.BFDRE.FetusCondition">http://ihe.net/fhir/StructureDefinition/IHE.BFDRE.FetusCondition</a> NOTE: Attributes related to newborn or fetus
Encounter	R	1..1	<a href="http://ihe.net/fhir/StructureDefinition/IHE.BFDRE.MotherBirthEncounter">http://ihe.net/fhir/StructureDefinition/IHE.BFDRE.MotherBirthEncounter</a>
Encounter	RE	0..*	<a href="http://ihe.net/fhir/StructureDefinition/IHE.BFDRE.NewbornBirthEncounter">http://ihe.net/fhir/StructureDefinition/IHE.BFDRE.NewbornBirthEncounter</a> NOTE: Attributes related to newborn or fetus
Encounter	RE	0..*	<a href="http://ihe.net/fhir/StructureDefinition/IHE.BFDRE.FetusDeliveryEncounter">http://ihe.net/fhir/StructureDefinition/IHE.BFDRE.FetusDeliveryEncounter</a> NOTE: Attributes related to newborn or fetus
Patient	RE	1..1	<a href="http://ihe.net/fhir/StructureDefinition/IHE.BFDRE.MotherPatient">http://ihe.net/fhir/StructureDefinition/IHE.BFDRE.MotherPatient</a>
Patient	RE	0..*	<a href="http://ihe.net/fhir/StructureDefinition/IHE.BFDRE.NewbornPatient">http://ihe.net/fhir/StructureDefinition/IHE.BFDRE.NewbornPatient</a> NOTE: Attributes related to newborn or fetus
Patient	RE	0..*	<a href="http://ihe.net/fhir/StructureDefinition/IHE.BFDRE.FetusPatient">http://ihe.net/fhir/StructureDefinition/IHE.BFDRE.FetusPatient</a> NOTE: Attributes related to newborn or fetus
Coverage	RE	0..*	<a href="http://ihe.net/fhir/StructureDefinition/IHE.BFDRE.Coverage">http://ihe.net/fhir/StructureDefinition/IHE.BFDRE.Coverage</a>

### 6.6.5.2 FHIR Resource Data Specifications

The following table shows the mapping of the FHIR Resources supporting the content for each of the BFDR Data Elements/Attributes. Data Responders SHALL support the Resources identified by this table. Data Consumers SHALL be able to retrieve birth and fetal death reporting related health information from the specified resource for one or more attributes.

1715

**Table 6.6.5.2-1: Required Mappings – Birth and Fetal Death Reporting Attribute to FHIR Resource**

FHIR Resource Location	FHIR Source Element Name	Notes	Attribute Name <QRPH TF-1: Appx B>	Birth and Fetal Death Report Data Element
Attributes related to mother as the primary patient. The newborn or fetus will be referenced by their ID.				
MedicationAdministration.Resource	medication[x].medicationCodableConcept	SHALL include the coded product name using the following value sets unless further extended by national extension where these products were given to the patient: Antibiotics (NCHS) 1.3.6.1.4.1.19376.1.7.3.1.1.13.8.3 Augmentation of Labor - Medication (NCHS) 1.3.6.1.4.1.19376.1.7.3.1.1.13.8.23 Epidural/Spinal Anesthesia - Medication (NCHS) 2.16.840.1.114222.4.11.7475	ANTI AUGL ESAN	Abnormal conditions of the newborn: <ul style="list-style-type: none"> <li>• Antibiotics [received by the newborn for suspected neonatal sepsis]</li> </ul> Characteristics of labor and delivery: <ul style="list-style-type: none"> <li>• Augmentation of labor</li> <li>• [Epidural or spinal] Anesthesia [during labor]</li> </ul>



FHIR Resource Location	FHIR Source Element Name	Notes	Attribute Name <QRPH TF-1: Appx B>	Birth and Fetal Death Report Data Element
MedicationAdministration.Resource	dosage.route	SHALL specifically indicate the route where IV or IM administration route is used to administer the medications using the following value sets unless further extended by national extension: IV Medication Administration Route (NCHS) 1.3.6.1.4.1.19376.1.7.3.1.1.13.8.4 IM Medication Administration Route (NCHS) 1.3.6.1.4.1.19376.1.7.3.1.1.13.8.5	ANTI ANTB	Abnormal conditions of the newborn: Antibiotics [received by the newborn for suspected neonatal sepsis]  Antibiotics received by the mother during labor. Includes antibacterial medications given systemically (intravenous or intramuscular) to the mother in the interval between the onset of labor and the actual delivery. Includes: Ampicillin, Penicillin, Clindamycin, Erythromycin, Gentamicin, Cefataxine, and Ceftriaxone. Information about the course of labor and delivery.
MedicationAdministration.Resource	reasonReference	Neonatal Sepsis (NCHS) 1.3.6.1.4.1.19376.1.7.3.1.1.13.8.6	ANTI	Abnormal conditions of the newborn: Antibiotics [received by the newborn for suspected neonatal sepsis]
MedicationAdministration.Resource	medication[x].medicationCodableConcept	Fertility Enhancing Drugs Medications (NCHS) 1.3.6.1.4.1.19376.1.7.3.1.1.13.8.144	INFT_DRG	Fertility-enhancing drugs, artificial insemination, or intrauterine insemination

IHE Quality, Research and Public Health Technical Framework Supplement – Birth and Fetal Death Reporting-Enhanced (BFDR-E)

Procedure.Resource	Code	<p>SHALL include the coded procedure using the following value sets unless further extended by national extension where these procedures were performed on the patient:</p> <p>Augmentation of Labor - Procedure (NCHS) 1.3.6.1.4.1.19376.1.7.3.1.1.13.8.22</p> <p>Epidural Anesthesia - Procedure (NCHS) 1.3.6.1.4.1.19376.1.7.3.1.1.13.8.27</p> <p>Spinal Anesthesia - Procedure (NCHS) 1.3.6.1.4.1.19376.1.7.3.1.1.13.8.29</p> <p>Induction of Labor (NCHS) 1.3.6.1.4.1.19376.1.7.3.1.1.13.8.34</p> <p>Steroids For Fetal Lung Maturation (NCHS) 2.16.840.1.114222.4.11.7423</p> <p>Delivery (NCHS) 1.3.6.1.4.1.19376.1.7.3.1.1.13.8.14</p> <p>Unplanned Operation (NCHS) 1.3.6.1.4.1.19376.1.7.3.1.1.13.8.105</p> <p>Unplanned Hysterectomy (NCHS) 1.3.6.1.4.1.19376.1.7.3.1.1.13.8.103</p> <p>Transfusion Whole Blood or Packed Red Bld (NCHS) 1.3.6.1.4.1.19376.1.7.3.1.1.13.8.99</p> <p>Cervical Cerclage (NCHS) 1.3.6.1.4.1.19376.1.7.3.1.1.13.8.125</p> <p>External Cephalic Version (NCHS) 1.3.6.1.4.1.19376.1.7.3.1.1.13.8.127</p> <p>Tocolysis (NCHS) 1.3.6.1.4.1.19376.1.7.3.1.1.13.8.128</p> <p>Hysterotomy Hysterectomy (NCHS) 1.3.6.1.4.1.19376.1.7.3.1.1.13.8.150</p> <p>Histological Placental Examination (NCHS) 2.16.840.1.114222.4.11.7138</p> <p>Delivery (NCHS) 1.3.6.1.4.1.19376.1.7.3.1.1.13.8.14</p>	<p>AUGL ESAN INDL STER UOPR UHYS MTR CERV ECVF ECVS TOC HYST HISTOP ANTB AINT</p>	<p>Characteristics of labor and delivery:</p> <ul style="list-style-type: none"> <li>• Augmentation of labor</li> <li>• [Epidural or spinal]Anesthesia[during labor]</li> <li>• Induction of labor</li> <li>• Steroids [(glucocorticoids) for fetal lung maturation received by the mother prior to delivery]</li> </ul> <p>Maternal Morbidity:</p> <ul style="list-style-type: none"> <li>• Unplanned operat[ing]ion [room procedure following delivery]</li> <li>• Unplanned hysterectomy</li> <li>• Maternal Transfusion</li> </ul> <p>Obstetric procedures:</p> <ul style="list-style-type: none"> <li>• Cervical cerclage</li> <li>• Failed External cephalic Version</li> <li>• Successful External cephalic version</li> <li>• Tocolysis</li> </ul> <p>Method of Delivery:</p> <ul style="list-style-type: none"> <li>• Hysterotomy/Hysterecto my</li> </ul>
--------------------	------	--	---	---

FHIR Resource Location	FHIR Source Element Name	Notes	Attribute Name <QRPH TF-1: Appx B>	Birth and Fetal Death Report Data Element
		For External Cephalic Version, the procedure should be documented whether it is performed during prenatal care record or during labor and delivery.		Was a Histological Placental Examination performed? Abnormal conditions of the newborn: <ul style="list-style-type: none"> <li>• Antibiotics [received by the newborn for suspected neonatal sepsis]</li> </ul> Maternal Morbidity: - Admission to Intensive care [unit]
	Performed[x].period	SHALL be included for all procedures performed if known		
	Outcome	For Failed External Cephalic Version outcome= 385671000 unsuccessful, SNOMED-CT	ECVF	Obstetric procedures: <ul style="list-style-type: none"> <li>• Failed External cephalic</li> </ul>
	performer.actor Reference (Practitioner.identifier)	SHALL also indicate the NPI for the delivery event identified by the following procedure value set: Delivery (NCHS) 1.3.6.1.4.1.19376.1.7.3.1.1.13.8.14	NPI	The National Provider Identification Number (NPI) of the person (attendant) responsible for delivering the child.
	Performer.role	SHALL also indicate the provider role for the delivery event identified by the following procedure value set: Delivery (NCHS) 1.3.6.1.4.1.19376.1.7.3.1.1.13.8.14 Using the following value sets unless otherwise constrained by jurisdiction: Physician (NCHS) 1.3.6.1.4.1.19376.1.7.3.1.1.13.8.15 Doctor of Osteopathic Medicine (NCHS) 1.3.6.1.4.1.19376.1.7.3.1.1.13.8.16 Certified Midwife (NCHS) 1.3.6.1.4.1.19376.1.7.3.1.1.13.8.17 /Midwife (NCHS) 1.3.6.1.4.1.19376.1.7.3.1.1.13.8.18	ATTEND	The title of the person (attendant) responsible for delivering the child. The attendant at birth is defined as the individual physically present at the delivery who is responsible for the delivery. Titles include: M.D. (doctor of medicine); D.O. (doctor of osteopathy); CNM/CM (certified nurse midwife/certified midwife); Other midwife (midwife other than a CNM/CM); and Other (specify)

FHIR Resource Location	FHIR Source Element Name	Notes	Attribute Name <QRPH TF-1: Appx B>	Birth and Fetal Death Report Data Element
	performer.actor Reference (Practitioner.name)	SHALL also indicate the provider name for the delivery event identified by the following procedure value set: Delivery (NCHS) 1.3.6.1.4.1.19376.1.7.3.1.1.13.8.14	ATTENDN	The name of the attendant (the person responsible for delivering the child), their title, and their National Provider Identification (NPI) Number.
	Method (HL7 extension: procedure-method)	Route and Method of Delivery SHALL be documented using the following value sets unless further extended by national extension: Route and Method of Delivery - Spontaneous (NCHS) 1.3.6.1.4.1.19376.1.7.3.1.1.13.8.111 Route and Method of Delivery - Forceps (NCHS) 1.3.6.1.4.1.19376.1.7.3.1.1.13.8.112 Route and Method of Delivery - Vacuum (NCHS) 1.3.6.1.4.1.19376.1.7.3.1.1.13.8.113 Route and Method of Delivery - Scheduled C (NCHS) 1.3.6.1.4.1.19376.1.7.3.1.1.13.8.116 Route and Method of Delivery - Cesarean (NCHS) 1.3.6.1.4.1.19376.1.7.3.1.1.13.8.114	ROUT	Delivery of the fetal head through the vagina by the application of obstetrical forceps to the fetal head; Vaginal/vacuum Delivery of the fetal head through the vagina by the application of a vacuum cup or ventouse to the fetal head; or Cesarean: Extraction of the fetus, placenta, and membranes through an incision in the maternal abdominal and uterine walls.

IHE Quality, Research and Public Health Technical Framework Supplement – Birth and Fetal Death Reporting-Enhanced (BFDR-E)

Condition.Resource	code	<p>SHALL include the following problems where these conditions existed during the pregnancy if known:</p> <p>Induction of Labor Finding (NCHS) 2.16.840.1.114222.4.11.7531</p> <p>Method of Delivery Vaginal-Spon Finding (NCHS) 2.16.840.1.114222.4.11.7526</p> <p>Method of Delivery Vaginal Forceps Finding (NCHS) 2.16.840.1.114222.4.11.7528</p> <p>Method of Delivery Vaginal Vacuum Finding (NCHS) 2.16.840.1.114222.4.11.7529</p> <p>Method of Delivery Cesarean Finding (NCHS) 2.16.840.1.114222.4.11.7527</p> <p>Trial of Labor 1.3.6.1.4.1.19376.1.7.3.1.1.13.8.115</p> <p>Transferred for Maternal Medical or Fetal Indications for Delivery (NCHS) 1.3.6.1.4.1.19376.1.7.3.1.1.13.8.176</p> <p>Chlamydia (NCHS) 1.3.6.1.4.1.19376.1.7.3.1.1.13.8.93</p> <p>Gonorrhea (NCHS) 2.16.840.1.114222.4.11.6071</p> <p>Hepatitis B (NCHS) 1.3.6.1.4.1.19376.1.7.3.1.1.13.8.96</p> <p>Hepatitis C (NCHS) 1.3.6.1.4.1.19376.1.7.3.1.1.13.8.97</p> <p>Syphilis (NCHS) 1.3.6.1.4.1.19376.1.7.3.1.1.13.8.98</p> <p>Listeria (NCHS) 1.3.6.1.4.1.19376.1.7.3.1.1.13.8.147</p> <p>Group B Streptococcus (NCHS) 1.3.6.1.4.1.19376.1.7.3.1.1.13.8.166</p> <p>Cytomegalovirus (NCHS) 1.3.6.1.4.1.19376.1.7.3.1.1.13.8.167</p> <p>Parvovirus (NCHS) 1.3.6.1.4.1.19376.1.7.3.1.1.13.8.168</p> <p>Toxoplasmosis (NCHS) 1.3.6.1.4.1.19376.1.7.3.1.1.13.8.169</p> <p>Prepregnancy Diabetes (NCHS) 1.3.6.1.4.1.19376.1.7.3.1.1.13.8.136</p>	<p>INDL ROUT TLAB TRAN GON SYPH CHAM HEPB HEPC LM GBS CMV B19 TOXO PDIAB GDIAB PHYPE GHYPE EHYPE PPB INFT INFT_DRG INFT_ART INFT_DRG PCES PLAC RUT PRES PRIC PROL PROM</p>	<p>Characteristics of labor and delivery: Induction of labor Method of Delivery: [Final]Route and method of delivery: Vaginal/spontaneous Vaginal/forceps Vaginal/vacuum Cesarean Method of Delivery: Trial of labor attempted Mother transferred for maternal medical or fetal indications for delivery? Infections present and/or treated during this pregnancy:</p> <ul style="list-style-type: none"> <li>• Gonorrhea</li> <li>• Syphilis</li> <li>• Chlamydia</li> <li>• Hepatitis B (HBV, serum hepatitis)</li> <li>• Hepatitis C (non A or non B hepatitis [HCV])</li> <li>• Listeria</li> <li>• Group B Streptococcus</li> <li>• Cytomegalovirus</li> <li>• Parvovirus</li> <li>• Toxoplasmosis</li> </ul> <p>Risk factors in this pregnancy:</p> <ul style="list-style-type: none"> <li>• Prepregnancy Diabetes</li> <li>• Gestational Diabetes</li> </ul>
--------------------	------	---	--	---

		<p>Gestational Diabetes (NCHS) 1.3.6.1.4.1.19376.1.7.3.1.1.13.8.137</p> <p>Prepregnancy Hypertension (NCHS) 1.3.6.1.4.1.19376.1.7.3.1.1.13.8.138</p> <p>Gestational Hypertension (NCHS) 1.3.6.1.4.1.19376.1.7.3.1.1.13.8.139</p> <p>Eclampsia (NCHS) 1.3.6.1.4.1.19376.1.7.3.1.1.13.8.140</p> <p>Preterm Birth (NCHS) 1.3.6.1.4.1.19376.1.7.3.1.1.13.8.141</p> <p>Infertility Treatment (NCHS) 1.3.6.1.4.1.19376.1.7.3.1.1.13.8.143</p> <p>Artificial or Intrauterine Insemination (NCHS) 1.3.6.1.4.1.19376.1.7.3.1.1.13.8.145</p> <p>Assistive Reproductive Technology (NCHS) 1.3.6.1.4.1.19376.1.7.3.1.1.13.8.146</p> <p>Pregnancy Resulting From Fertility Enhancing Drugs (NCHS) 2.16.840.1.114222.4.11.7423</p> <p>Previous Cesarean (NCHS) 2.16.840.1.114222.4.11.7165</p> <p>Third Degree Perineal Laceration (NCHS) 1.3.6.1.4.1.19376.1.7.3.1.1.13.8.100</p> <p>Fourth Degree Perineal Laceration (NCHS) 1.3.6.1.4.1.19376.1.7.3.1.1.13.8.101</p> <p>Ruptured Uterus (NCHS) 1.3.6.1.4.1.19376.1.7.3.1.1.13.8.102</p> <p>Fetal Presentation at Birth- Breech (NCHS) 1.3.6.1.4.1.19376.1.7.3.1.1.13.8.108</p> <p>Fetal Presentation at Birth- Cephalic (NCHS) 1.3.6.1.4.1.19376.1.7.3.1.1.13.8.109</p> <p>Fetal Presentation at Birth- Other (NCHS) 1.3.6.1.4.1.19376.1.7.3.1.1.13.8.110</p> <p>Precipitous Labor (NCHS) 1.3.6.1.4.1.19376.1.7.3.1.1.13.8.130</p> <p>Prolonged Labor (NCHS) 1.3.6.1.4.1.19376.1.7.3.1.1.13.8.131</p>	<ul style="list-style-type: none"> <li>• Prepregnancy Hypertension</li> <li>• Gestational Hypertension</li> <li>• Eclampsia</li> <li>• Previous preterm births</li> <li>• Infertility treatment</li> <li>• Infertility: Fertility Enhancing Drugs, AI</li> <li>• Infertility: Asst. Rep. Technology</li> <li>• Previous cesarean</li> </ul> <p>Maternal Morbidity: [Third or fourth degree] perineal laceration Ruptured Uterus Method of Delivery: Fetal presentation [at birth]: Cephalic Onset of labor: Precipitous Labor Prolonged Labor Premature Rupture</p>
--	--	--	---

IHE Quality, Research and Public Health Technical Framework Supplement – Birth and Fetal Death Reporting-Enhanced (BFDR-E)

FHIR Resource Location	FHIR Source Element Name	Notes	Attribute Name <QRPH TF-1: Appx B>	Birth and Fetal Death Report Data Element
		Premature Rupture (NCHS) 1.3.6.1.4.1.19376.1.7.3.1.1.13.8.129		
	code	SHALL include the following problems where these conditions existed during the delivery if known: Chorioamnionitis During Labor (NCHS) 1.3.6.1.4.1.19376.1.7.3.1.1.13.8.24	CHOR	Characteristics of labor and delivery: [Clinical] Chorioamnionitis [diagnosed during labor or maternal temperature >=38 degrees (100.4F)]
Observation.Resource	Code	Birth Plurality of Delivery (NCHS) 1.3.6.1.4.1.19376.1.7.3.1.1.13.8.132	PLUR	The number of fetuses delivered live or dead at any time in the pregnancy regardless of gestational age or if the fetuses were delivered at different dates in the pregnancy. ("Reabsorbed" fetuses, those which are not "delivered" (expulsed or extracted from the mother) should not be counted.)
	valueQuantity	Integer		
Observation.Resource	Code	Number of Live Births (NCHS) 1.3.6.1.4.1.19376.1.7.3.1.1.13.8.68	LIVEB	Not single birth - specify number of infants in this delivery born alive.
	valueQuantity	integer		
Observation.Resource	Code	Number of Fetal Deaths This Delivery (NCHS) 1.3.6.1.4.1.19376.1.7.3.1.1.13.8.164	FDTH	Number of fetal deaths
	valueQuantity	Integer		
Observation.Resource	Code	Date of Last Live Birth (NCHS) 1.3.6.1.4.1.19376.1.7.3.1.1.13.8.67	YLLB	Date of last live birth

IHE Quality, Research and Public Health Technical Framework Supplement – Birth and Fetal Death Reporting-Enhanced (BFDR-E)

FHIR Resource Location	FHIR Source Element Name	Notes	Attribute Name <QRPH TF-1: Appx B>	Birth and Fetal Death Report Data Element
	ValueDateTime	timestamp	MLLB	
Observation.Resource	Code	Date of Last Menses (NCHS) 1.3.6.1.4.1.19376.1.7.3.1.1.13.8.69	DLMP_DY DLMP_MO DLMP_YR	Date last normal menses began
	ValueDateTime	timestamp		
Observation.Resource	Code	Date of Last Other Pregnancy Outcome (NCHS) 1.3.6.1.4.1.19376.1.7.3.1.1.13.8.70 (e.g., spontaneous or induced losses or ectopic pregnancy)	YOPO MOPO	Date of last other pregnancy outcome
	ValueDateTime	timestamp		
Observation.Resource	code	First Prenatal Care Visit (NCHS) 1.3.6.1.4.1.19376.1.7.3.1.1.13.8.133	DOFP_MO DOFP_DY DOFP_Y	Date of first prenatal care visit
	valueDateTime	timestamp For the First Prenatal Care Visit, the following guidance should be noted: 1. First Prenatal Care Visit effectiveTime SHALL be NULL if any of the following are true: a. the patient received prenatal care but the information is not in the record b. it is unknown whether or not the patient received prenatal care c. there was no prenatal care		
Observation.Resource	code	Number of Previous Live Births Now Dead (NCHS) 1.3.6.1.4.1.19376.1.7.3.1.1.13.8.122	PLBD	Number of previous live births now dead (do not include this child)
	valueQuantity	integer		
Observation.Resource	code	Number of Previous Live Births Now Living (NCHS) 1.3.6.1.4.1.19376.1.7.3.1.1.13.8.123	PLBL	Number of previous live births now living (do not include this child)
	valueQuantity	integer		



IHE Quality, Research and Public Health Technical Framework Supplement – Birth and Fetal Death Reporting-Enhanced (BFDR-E)

FHIR Resource Location	FHIR Source Element Name	Notes	Attribute Name <QRPH TF-1: Appx B>	Birth and Fetal Death Report Data Element
Observation.Resource	code	Number of Preterm Births (NCHS) 1.3.6.1.4.1.19376.1.7.3.1.1.13.8.187	PPB	Risk factors in this pregnancy: Previous preterm births
	valueQuantity	Integer		
Observation.Resource	code	Obstetric Estimate of Gestation (NCHS) 1.3.6.1.4.1.19376.1.7.3.1.1.13.8.124	OWGEST	Obstetric Estimate of Gestation
	valueQuantity	Integer		
Observation.Resource	code	Number of Previous Cesareans (NCHS) 1.3.6.1.4.1.19376.1.7.3.1.1.13.8.148	NPCES	Risk factors in this pregnancy: Number of previous cesareans
	valueQuantity	Integer		
Observation.Resource	code	Number Prenatal Care Visits (NCHS) 1.3.6.1.4.1.19376.1.7.3.1.1.13.8.135	NPREV	Prenatal care visits: Total number of prenatal visits for this pregnancy
	valueQuantity	integer For the Number of Prenatal Care Visits, the following guidance should be noted: 1. The value SHALL be NULL if this is unknown or not available in the record. 2. The value SHALL be the count of the total number of prenatal visits a. Count only visits recorded in the most current record available. Do not estimate additional prenatal visits when the prenatal record is not up to date b. The value SHALL be '0' only if it is known that there were no prenatal care visits.		
Observation.Resource	code	Previous Other Pregnancy Outcomes (NCHS) 1.3.6.1.4.1.19376.1.7.3.1.1.13.8.121	POPO	Number of other pregnancy outcomes
	valueQuantity	Integer		

IHE Quality, Research and Public Health Technical Framework Supplement – Birth and Fetal Death Reporting-Enhanced (BFDR-E)

FHIR Resource Location	FHIR Source Element Name	Notes	Attribute Name <QRPH TF-1: Appx B>	Birth and Fetal Death Report Data Element
Observation.Resource	code	code=73776-7 No-prenatal care indicator, LOINC	PNC	An indication that a physician or other healthcare professional has not examined and/or counselled the pregnant woman for the pregnancy
	valueBoolean	boolean		
Observation.Resource	Code	Mother’s Height SHALL be included, using the value set: Height (NCHS) 1.3.6.1.4.1.19376.1.7.3.1.1.13.8.190	HFT HIN	Mother's Height: Feet Mother's Height: Inches
	valueQuantity	The height SHALL be expressed using UCUM for units with the preference to express in feet and inches.		
Observation.Resource	Code	Mother’s Weight SHALL be included, using the value set: Body Weight (NCHS) 2.16.840.1.114222.4.11.7421	PWGT DWGT	Mother's pre-pregnancy weight Mother's weight at delivery
	method	using the following value set unless further extended by national extension: Mothers Delivery Weight (NCHS) 1.3.6.1.4.1.19376.1.7.3.1.1.13.8.120 Pre-Pregnancy Weight (NCHS) 1.3.6.1.4.1.19376.1.7.3.1.1.13.8.118		
	valueQuantity	the weight SHALL be expressed using UCUM for units with the preference to express in pounds unless further extended by national extension		
Encounter.Resource	part of	Type Reference(Encounter) Where reference encounter is the child		
	hospitalization.admitSource		NFACL	Mother: If Mother transferred for maternal medical or fetal indications for delivery, enter name of facility mother transferred from.
	hospitalization.origin(location.name)			

IHE Quality, Research and Public Health Technical Framework Supplement – Birth and Fetal Death Reporting-Enhanced (BFDR-E)

FHIR Resource Location	FHIR Source Element Name	Notes	Attribute Name <QRPH TF-1: Appx B>	Birth and Fetal Death Report Data Element
<i>Attributes related to mother supplied information</i>				
Patient.resource	Name	SHALL be populated with Mother's Current Legal Name	MFNAME MMNAME MLNAME MSUFF	Mother's Current Legal Name
		SHALL be populated with Mother's Maiden Name	MAIDEN	Mother's Maiden Name
	Id	SHALL be populated with the Mother's Medical Record Number	MRECNUM	The mother's medical record number for this facility admission
		SHALL be populated with the jurisdiction identifier of the mother (NOTE: may be restricted by jurisdiction)	MSSN	The jurisdiction identifier (e.g., social security number (SSN)) of the mother

FHIR Resource Location	FHIR Source Element Name	Notes	Attribute Name <QRPH TF-1: Appx B>	Birth and Fetal Death Report Data Element
	address	SHALL be populated with residential addresses	UNUM CITY CITYC COUNTY LIMITS STATE STNAME STNUM ZIP LIMITS	Mother’s Residence: Apartment or Unit Number Mother’s Residence: City or Town name Mother’s Residence: City or Town code Mother’s Residence: County Indicates if the mother’s residence is within city limits Mother’s Residence: State/Province Mother’s Residence: Street Name Mother’s Residence: Street Number Mother’s Residence: Zip Code Indicates if the mother’s residence is within city limits
		SHALL be populated with mailing addresses	MSTNAME MAPT MCITY MSTATE MZIP MCOUNTRY	The mother’s mailing address (complete number and street name) The mother’s mailing address (Apartment number) The mother’s mailing address (city or town name) The mother’s mailing address (state, territory or province) The mother’s mailing address (zip code) The mother’s mailing address (country)

FHIR Resource Location	FHIR Source Element Name	Notes	Attribute Name <QRPH TF-1: Appx B>	Birth and Fetal Death Report Data Element
		SHALL be populated with birth address (state/province and country)	BPLACEC_CNT* BPLACE_ST * BPLACE_TER* BPLACEC_ST_TER *	Code for Mother’s country of birth Mother’s state of birth (literal) Mother’s territory of birth (literal) Code for Mother’s state or territory of birth
	birthdate	SHALL be populated with the mother’s date of birth	MDOB_YR MDOB_MO MDOB_DY	The mother’s date (year) of birth The mother’s date (month) of birth The mother’s date (day) of birth
	maritalStatus	SHALL be populated with the mother’s marital status if known and as restricted by jurisdiction	MARITAL	The mother’s marital status
<i>Attributes related to father from the mother supplied information, such that link.RelatedPerson reflects the father of the newborn or fetus</i>				
RelatedPerson	Id	SHOULD contain the jurisdiction identifier of the father named on the certificate (if known and as permitted or required by Jurisdiction)	FSSN	The jurisdiction identifier (e.g., social security number (SSN)) of the father named on the certificate.

FHIR Resource Location	FHIR Source Element Name	Notes	Attribute Name <QRPH TF-1: Appx B>	Birth and Fetal Death Report Data Element
	Address	SHALL be populated with the father’s place of birth (state/province and country)	FBPLACE_ST_TER_L FBPLACE_ST_L FBPLACE_ST_TER_C FBPLACE_CNT_C	<p>The geographic location (state or territory) of the father’s place of birth (literal).</p> <p>The geographic location (state) of the father’s place of birth (code).</p> <p>The geographic location (state or territory) of the father’s place of birth (code).</p> <p>The geographic location (country) of the father’s place of birth (code).</p>
	Name	SHALL be populated with the father’s legal name	FFNAME FMNAME FLNAME FSUFF FNREF	<p>The current legal first name of the father.</p> <p>The current legal middle name of the father.</p> <p>The current legal last name of the father.</p> <p>The current legal name suffix of the father.</p> <p>Indicates if the father’s name can be entered and the mother refuses to name the father. This should only occur when the mother was married at birth, conception, or any time in between and refuses the name of her husband.</p>

IHE Quality, Research and Public Health Technical Framework Supplement – Birth and Fetal Death Reporting-Enhanced (BFDR-E)

FHIR Resource Location	FHIR Source Element Name	Notes	Attribute Name <QRPH TF-1: Appx B>	Birth and Fetal Death Report Data Element
	Birthdate	SHALL be populated with the father’s date of birth	FDOB_YR FDOB_MO FDOB_DY	The father’s date (year) of birth The father’s date (month) of birth The father’s date (day) of birth
<i>Attributes related to newborn or fetus, such that ID reflects the newborn or fetus</i>				
Patient.resource	multipleBirth[x].multipleBirthInteger	SHALL be present if known	SORD	The order born in the delivery, live-born or fetal death.
	id	SHALL be populated with the newborn’s Medical Record Number	IRECNUM	Child: Newborn Medical Record Number
	birthdate	SHALL be present	AVEN1 IDOB_YR IDOB_MO IDOB_DY ITRAN FTRAN TB	Abnormal conditions of the newborn: Assisted ventilation [required immediately following delivery] Child: Date of Birth: <ul style="list-style-type: none"> <li>• Year</li> <li>• Month</li> <li>• Day</li> </ul> Child: Infant transferred within 24 hours of delivery/name the facility, FTRAN Child: Time of Birth

IHE Quality, Research and Public Health Technical Framework Supplement – Birth and Fetal Death Reporting-Enhanced (BFDR-E)

FHIR Resource Location	FHIR Source Element Name	Notes	Attribute Name <QRPH TF-1: Appx B>	Birth and Fetal Death Report Data Element
	Name	SHALL be present if available.	KIDFNAME KIDMNAME KIDLNAME KIDSUFFIX	The name of the newborn or fetus
	gender	SHALL be present	ISEX	The sex of the infant.
	deceased[x].deceasedBoolean	SHALL be present if infant has died	ILIV	Child: Infant living at time of report?
	deceased[x].deceasedDateTime			
	identifier	Infant’s Medical Record Number SHALL be present to indicate the number assigned by the organization	IRECNUM	Child: Newborn Medical Record Number
Observation.Resource	code	Body Weight (NCHS) 2.16.840.1.114222.4.11.7421	BWG BWO BWP FWO FWG FWP	Birth weight (Infant’s) in <ul style="list-style-type: none"> <li>• Grams</li> <li>• Ounces</li> <li>• Pounds</li> </ul> Weight of Fetus in <ul style="list-style-type: none"> <li>• Ounces</li> <li>• Grams</li> <li>• Pounds</li> </ul>
	method	Birth Weight (NCHS) 1.3.6.1.4.1.19376.1.7.3.1.1.13.8.20		
	valueQuantity	The weight SHALL be expressed using UCUM for units with the preference to express in grams		
Observation.Resource	Code	Apgar Score SHALL be provided for the 5-Minute Apgar Score, using the value set: 5 Min Apgar Score (NCHS) 1.3.6.1.4.1.19376.1.7.3.1.1.13.8.12 IF the 5-Minute Apgar Score is <= 5, then the 10-Minute Apgar Score SHALL be provided, Identified using the value set: 10 Min Apgar Score (NCHS) 1.3.6.1.4.1.19376.1.7.3.1.1.13.8.13	APGAR5 APGAR10	Apgar Score: <ul style="list-style-type: none"> <li>• 5 Minute</li> <li>• 10 Minute</li> </ul>
	Value	where the value is INT<=10		



IHE Quality, Research and Public Health Technical Framework Supplement – Birth and Fetal Death Reporting-Enhanced (BFDR-E)

Condition.Resource	Code	<p>Breastfed Infant (NCHS) 1.3.6.1.4.1.19376.1.7.3.1.1.13.8.41</p> <p>Neonatal Death (NCHS) 1.3.6.1.4.1.19376.1.7.3.1.1.13.8.149</p> <p>Seizure or Serious Neurologic Dysfunction (NCHS) 1.3.6.1.4.1.19376.1.7.3.1.1.13.8.10</p> <p>Meningomyelocele/Spina Bifida - Newborn (NCHS) 1.3.6.1.4.1.19376.1.7.3.1.1.13.8.65</p> <p>Anencephaly of the Newborn (NCHS) 1.3.6.1.4.1.19376.1.7.3.1.1.13.8.53</p> <p>Cleft Lip with or without Cleft Palate (NCHS) 1.3.6.1.4.1.19376.1.7.3.1.1.13.8.58</p> <p>Cleft Palate Alone (NCHS) 1.3.6.1.4.1.19376.1.7.3.1.1.13.8.189</p> <p>Cyanotic Congenital Heart Disease (NCHS) 1.3.6.1.4.1.19376.1.7.3.1.1.13.8.54</p> <p>Gastroschisis of the Newborn (NCHS) 1.3.6.1.4.1.19376.1.7.3.1.1.13.8.62</p> <p>Limb Reduction Defect (NCHS) 6.1.4.1.19376.1.7.3.1.1.13.8.64</p> <p>Omphalocele of the Newborn (NCHS) 1.3.6.1.4.1.19376.1.7.3.1.1.13.8.66</p> <p>Hypospadias (NCHS) 1.3.6.1.4.1.19376.1.7.3.1.1.13.8.63</p> <p>Significant Birth Injury (NCHS) 1.3.6.1.4.1.19376.1.7.3.1.1.13.8.9</p> <p>Suspected Chromosomal Disorder (NCHS) 1.3.6.1.4.1.19376.1.7.3.1.1.13.8.57</p> <p>Downs Syndrome (NCHS) 1.3.6.1.4.1.19376.1.7.3.1.1.13.8.61</p> <p>Karyotype Confirmed (NCHS) 1.3.6.1.4.1.19376.1.7.3.1.1.13.8.56</p> <p>Congenital Diaphragmatic Hernia (NCHS) 1.3.6.1.4.1.19376.1.7.3.1.1.13.8.55</p> <p>Assisted Ventilation for &gt;6 hours Finding (NCHS) 2.16.840.1.114222.4.11.7534</p>	<p>BFED</p> <p>ILIV</p> <p>SIEZ</p> <p>MNSB</p> <p>ANEN</p> <p>CL</p> <p>CP</p> <p>CCHD</p> <p>GAST</p> <p>LIMB</p> <p>OMPH</p> <p>HYPO</p> <p>BINJ</p> <p>CDIS</p> <p>CDIC</p> <p>CDIP</p> <p>DOWN</p> <p>DOWC</p> <p>DOWP</p> <p>CDH</p> <p>AVEN6</p> <p>AVEN1</p> <p>TRANS</p>	<p>Infant being breastfed?</p> <p>Infant living at time of report?</p> <p>Congenital anomalies of the Newborn:</p> <ul style="list-style-type: none"> <li>• Seizure or serious neurologic dysfunction</li> <li>• Meningomyelocele/Spina Bifida</li> <li>• Anencephaly</li> <li>• Cleft Lip with or without Cleft Palate</li> <li>• Cleft Palate alone</li> <li>• Cyanotic congenital heart disease</li> <li>• Gastroschisis</li> <li>• Limb reduction defect</li> <li>• Omphalocele</li> <li>• Hypospadias</li> <li>• Significant birth injury</li> <li>• Suspected chromosomal Disorder</li> <li>• Suspected chromosomal disorder karyotype confirmed</li> <li>• Suspected chromosomal disorder karyotype pending</li> <li>• Down Syndrome</li> <li>• Down Karyotype Confirmed</li> <li>• Down Karyotype Pending</li> </ul>
--------------------	------	---	---	--

IHE Quality, Research and Public Health Technical Framework Supplement – Birth and Fetal Death Reporting-Enhanced (BFDR-E)

FHIR Resource Location	FHIR Source Element Name	Notes	Attribute Name <QRPH TF-1: Appx B>	Birth and Fetal Death Report Data Element
		Assisted Ventilation Finding (NCHS) 2.16.840.1.114222.4.11.7533 Transfer to (NCHS) 1.3.6.1.4.1.19376.1.7.3.1.1.13.8.190		<ul style="list-style-type: none"> <li>Congenital diaphragmatic hernia</li> </ul> Assisted ventilation for 6 or more hours Assisted ventilation [required immediately following delivery]
	onset[x].onsetDateTime	Problem Date and Time SHALL be included for all problems if known		
Procedure.Resource	Code	Antibiotic Administration Procedure (NCHS) 1.3.6.1.4.1.19376.1.7.3.1.1.13.8.178 Assisted Ventilation (NCHS) 2.16.840.1.114222.4.11.7156 Karyotype Determination (NCHS) 1.3.6.1.4.1.19376.1.7.3.1.1.13.8.154 Autopsy Performed (NCHS) 1.3.6.1.4.1.19376.1.7.3.1.1.13.8.1 Autopsy Planned (NCHS) 2.16.840.1.114222.4.11.7140 Surfactant Replacement Therapy (NCHS) 2.16.840.1.114222.4.11.7431 Transfer to facility (NCHS) 1.3.6.1.4.1.19376.1.7.3.1.1.13.8.190	ANTI AVEN1 AVEN6 AUTOP DOWC DOWP CDC CDP ITRAN FTRAN	Assisted ventilation [required immediately following delivery] Assisted ventilation for 6 or more hours Congenital anomalies of the Newborn: <ul style="list-style-type: none"> <li>Suspected chromosomal disorder karyotype confirmed</li> <li>Suspected chromosomal disorder karyotype pending</li> <li>Down Karyotype Confirmed</li> <li>Down Karyotype Pending</li> </ul> Was an autopsy performed? Child: Infant transferred within 24 hours of delivery/name the facility
	Performed[x].period	Procedure Date and Time SHALL be included for all procedures performed if known		
	Value	Procedure value SHALL contain the name of the receiving facility where procedure.code contains: Transfer to facility (NCHS) 1.3.6.1.4.1.19376.1.7.3.1.1.13.8.190	FTRAN	Child: Infant transferred within 24 hours of delivery/name the facility

FHIR Resource Location	FHIR Source Element Name	Notes	Attribute Name <QRPH TF-1: Appx B>	Birth and Fetal Death Report Data Element
MedicationAdministration.Resource	medication[x].medicationCodableConcept	Newborn Receiving Surfactant Replacement Therapy (NCHS) 1.3.6.1.4.1.19376.1.7.3.1.1.13.8.11 Antibiotics (NCHS) 1.3.6.1.4.1.19376.1.7.3.1.1.13.8.3	SURF ANTI	Abnormal conditions of the newborn: <ul style="list-style-type: none"> <li>• Surfactant replacement therapy</li> <li>• Antibiotics [received by the newborn for suspected neonatal sepsis]</li> </ul>
	dosage.route	SHALL specifically indicate the route where IV or IM administration route is used where Antibiotics are administered for Neonatal Sepsis using the following value sets unless further extended by national extension: IM Medication Administration Route (NCHS) 1.3.6.1.4.1.19376.1.7.3.1.1.13.8.5 IV Medication Administration Route (NCHS) 1.3.6.1.4.1.19376.1.7.3.1.1.13.8.4	ANTI	Abnormal conditions of the newborn: <ul style="list-style-type: none"> <li>• Antibiotics [received by the newborn for suspected neonatal sepsis]</li> </ul>
	reasonReference	Medication indication SHALL be coded using SNOMED-CT where Antibiotics are administered for Neonatal Sepsis using the value set: Neonatal Sepsis (NCHS) 1.3.6.1.4.1.19376.1.7.3.1.1.13.8.6		
Observation.Resource	Code	Birthplace Setting (NCHS) 1.3.6.1.4.1.19376.1.7.3.1.1.13.8.184	BPLACE	Place where birth occurred: Birth Place

IHE Quality, Research and Public Health Technical Framework Supplement – Birth and Fetal Death Reporting-Enhanced (BFDR-E)

FHIR Resource Location	FHIR Source Element Name	Notes	Attribute Name <QRPH TF-1: Appx B>	Birth and Fetal Death Report Data Element
	value	Birthplace Hospital (NCHS) 1.3.6.1.4.1.19376.1.7.3.1.1.13.8.192 Birth Place Home Intended (NCHS) 1.3.6.1.4.1.19376.1.7.3.1.1.13.8.193 Birth Place Home Unintended (NCHS) 1.3.6.1.4.1.19376.1.7.3.1.1.13.8.194 Birth Place Home Unknown Intention (NCHS)1.3.6.1.4.1.19376.1.7.3.1.1.13.8.195 Birthplace Clinic Office (NCHS) 1.3.6.1.4.1.19376.1.7.3.1.1.13.8.197 Birth Place Freestanding Birthing Center (NCHS) 1.3.6.1.4.1.19376.1.7.3.1.1.13.8.196		
Observation.Resource	Code	Histological Placental Examination Performed (NCHS) 2.16.840.1.114222.4.11.7430	HISTOP	Was a Histological Placental Examination performed?
	Value	Histological Placental Examination (NCHS) 2.16.840.1.114222.4.11.7138		
Observation.Resource	Code	Estimated Time Of Fetal Death (NCHS) 2.16.840.1.114222.4.11.7426	ETIME	Estimated Time of Fetal Death
	Value	Fetal Death Time Point (NCHS) 2.16.840.1.114222.4.11.7112		
Encounter.Resource	location.location.type	NICU Care (NCHS) 1.3.6.1.4.1.19376.1.7.3.1.1.13.8.198	NICU	Abnormal conditions of the newborn: Admission to NICU
	location.period	In support of some jurisdictional needs, the date and time that the patient was transferred out MAY be documented		
	Location.status	Where EncounterLocationStatus = planned	TRANS	Infant transferred within 24 hours of delivery
	Location.name	Where EncounterLocationStatus = planned	FTRAN	Infant transferred within 24 hours of delivery/name the facility

FHIR Resource Location	FHIR Source Element Name	Notes	Attribute Name <QRPH TF-1: Appx B>	Birth and Fetal Death Report Data Element
	serviceProvider(organization.name)		ADDRESS_D FLOC	The name of the city, town, township, village, or other location where the birth occurred.
	serviceProvider(organization.identifier)		SFN	Place where birth occurred: State Facility Number
Observation.resource	Code	Karyotype Result (NCHS) 1.3.6.1.4.1.19376.1.7.3.1.1.13.8.59	CDIC CDIP	Abnormal conditions of the newborn:
	Value	The 'value' element not constrained	DOWC DOWP	<ul style="list-style-type: none"> <li>• Suspected chromosomal disorder karyotype confirmed</li> <li>• Suspected chromosomal disorder karyotype pending</li> <li>• Down Karyotype Confirmed</li> <li>• Down Karyotype Pending</li> </ul>
Coverage.resource	Type	Potential vocabularies to use include HL7 ActCoverageType X12 Data Element 1336	PAY	Principal source of payment for this delivery

## 6.6.2 QRPB BFDR Provider Reporting FHIR Document Composition Bundle Content Specification

- 1720 This section specifies the content that is conveyed to communicate the Provider Live Birth Report information as compiled from source reporting. As described in Volume 1 use cases, this may be used to convey compiled live birth reporting information to a jurisdiction, from the jurisdiction to the national agency, or from the jurisdiction to an analytics organization. This specification is designed for international use based upon the underlying HL7 BFDR FHIR specification. National extensions in Volume 4 may further constrain local concepts
- 1725

### 6.6.2.1 Referenced Standards

This section specifies the content that is conveyed to communicate the BFDR information as:

Title	URL
HL7 FHIR standard STU	<a href="http://hl7.org/fhir/index.html">http://hl7.org/fhir/index.html</a>
Vital Records Birth and Fetal Death Reporting FHIR Implementation Guide based on FHIR R4	<a href="https://trifolia-fhir.lantanagroup.com/igs/lantana_hapi_r4/hl7-fhir-us-bfdr/index.html">https://trifolia-fhir.lantanagroup.com/igs/lantana_hapi_r4/hl7-fhir-us-bfdr/index.html</a>

### 6.6.2.2 Live Birth Report FHIR Provider Document Composition Bundle Content

- 1730 The following table specifies the FHIR Resources and Structured Definitions supporting the BFDR Provider Live Birth Report FHIR Document Composition Bundle. Inclusion in the FHIR Document Composition Bundle may be further constrained by jurisdiction disclosure policies. Optionality for each of the FHIR Document Composition Bundle Options is detailed in the Optionality column.
- 1735

**Table 6.6.2.2-1: FHIR Document Composition Bundle Structure Definitions**

FHIR Resource location	Optionality	Cardinality	Structured Definition
<a href="#">Birth Record Identifier</a>		[1..1]	<a href="http://build.fhir.org/ig/HL7/vrdr/StructureDefinition-VRDR-BirthRecordIdentifier.html">http://build.fhir.org/ig/HL7/vrdr/StructureDefinition-VRDR-BirthRecordIdentifier.html</a> (PUBLICATION PENDING: <a href="http://hl7.org/fhir/us/vrdr/StructureDefinition/BirthRecordIdentifier">http://hl7.org/fhir/us/vrdr/StructureDefinition/BirthRecordIdentifier</a> )

## Volume 4 – National Extensions

*Add appropriate Country section*

### 4 National Extensions

#### 1740 4.1 National Extensions for IHE USA

##### 4.1.1 Comment Submission

This national extension document was authored under the sponsorship and supervision of IHE QRPH with collaboration from the CDC/National Center for Health Statistics, who welcome comments on this document and the IHE USA initiative. Comments should be directed to:

1745 [http://www.ihe.net/QRPH\\_Public\\_Comments](http://www.ihe.net/QRPH_Public_Comments)

##### 4.1.2 Birth and Fetal Death Reporting – Extended (BFDR-E)

###### 4.1.2.1 BFDR US Volume 1 Constraints

###### 4.1.2.1.1 BFDR Actors and Options US Constraints

1750 The US National Extension constrains the actors and options defined in QRPH TF-1: Table X.2-1: BFDR - Actors and Options. Birth and Fetal Death reporting in the US requires that State Jurisdictions support the following Profile Options for message transactions that will be conducted with NCHS and Provider information sources. Information is also provided for prospective Infrastructure/HIE communications that may serve to facilitate some of these communications.

1755 Additionally, standard worksheets are used to enhance the collection of quality, reliable data. A common, standard form, entitled “Mother’s Worksheet for Child’s Birth Certificate”, has been established to identify information to be collected directly from the mother. The “Facility Worksheet for the Live Birth Certificate” was developed to identify information for which the best sources are the mother’s and infant’s medical records. The use of separate worksheets promotes a standardized collection across states. The "Patient's Worksheet for the Report of Fetal Death" and the "Facility Worksheet for the Report of Fetal Death" have also been established for the purpose of reporting fetal death information.

1760 The hospital is responsible for completing the Record of Live Birth in the jurisdiction's Electronic Birth Registration System (EBRS). Information collected from the mother on the mother’s live birth information must be data entered into the EBRS. Facility Worksheet data transmitted electronically into the EBRS from the EMR must be reviewed for completeness and accuracy. The birth records specialist plays an essential role in gathering the information and ensuring that all information is complete before transmission to the vital registration system at

1770 the states/jurisdictional vital record offices. Select birth data may be transmitted later to public health authorities as allowed by individual state statute and other vital records stakeholders

### **4.1.2.3 BFDR US Volume 3 Constraints**

#### **4.1.2.3.1 BFDR US Forms Pre-population**

1775 The U.S. Standard Certificate of Live Birth and the U.S. Standard Report of Fetal Death SHALL use derived elements to populate the processing variables as indicated in Table 6.6.1-1: Form Data Elements Data Mapped to Input Content Document Modules and as specified in the Birth Edit Specifications and the Fetal Death Edit Specifications for the 2003 Revisions of the U.S. Standard Certificate of Live Birth and the U.S. Standard Report of Fetal Death.

1780 Standard worksheets are used in the U.S. to enhance the collection of quality, reliable data for birth and fetal death events. A common, standard form, entitled “Mother’s Worksheet for Child’s Birth Certificate”, has been established to identify information to be collected directly from the mother. The “Facility Worksheet for the Live Birth Certificate” was developed to identify information for which the best sources are the mother’s and infant’s medical records.

1785 The U.S. currently limits the data that may be pre-populated from an EMR for birth and fetal death events to a subset of vital records’ medical/health data requirements, that is, primarily those items included in the U.S. Standard Facility Worksheet for the Live Birth Certificate and the U.S. Standard Facility Worksheet for the Report of Fetal Death. The initial goal will be to monitor and assess the quality of the data that will be exchanged between electronic health record and vital records systems and the quality of the process of information exchange.

#### **4.1.2.3.2 BFDR-E Data Element Index**

1790 A relevant data set for birth and fetal death record content reporting includes those elements identified within the US efforts under the CDC/National Center for Health Statistics (NCHS) that can be computed from data elements in the electronic health record. The BFDR-E Summary CDA mapping rules described below overlays these data elements typically presented to the birth registrar. This Derived Data Element Index specifies which sections are intended to cover which domains, the value sets to be used to interpret the Summary CDA Document content, and rules for examining Summary CDA content to determine whether or not the data element is satisfied. These rules may specify examination of one or more Summary CDA Document locations to make a determination of the data element result. The list includes derived data elements that compose knowledge concepts not currently represented in standards, most of which are optional. 1795 Where such standards do not exist, the Form Manager will enhance with non-standard fields. 1800 Any Summary CDA document may be used to populate the form.

#### **4.1.2.3.3 BFDR-E Form Manager Pre-population Data Element Mapping Specification**

1805 Table 4.1.2.1.2-1 describes the US domain mapping to the BFDR-e data elements and the form for the U.S. Standard Facility Worksheet for the Live Birth Certificate. It also indicates attributes



1810 that are permissible in the US for pre-population and those that require data entry. Further edit specifications are in the Birth Edit Specifications for the 2003 Revision of the U.S. Standard Certificate of Live Birth (4/2004; 3/2005; Updated 7/2012). Mapping to these attributes is also provided below. For the US, all of the data elements are required. Form Managers SHALL support direct data entry to offer the opportunity to modify all pre-populated information before it is submitted to VR systems

Note: The following attributes are no longer part of the National requirements, but may continue to be used by the jurisdictions:

- CERV
- 1815 • BINJ
- TOC
- PROM
- PRIC
- PROL
- 1820 • HIST
- LM
- GBS
- CMV
- B19
- 1825 • TOXO

Note: Demographic information is sourced from the mother's worksheet throughout, and any EMR mapping provided is intended to facilitate record matching.

**Table 4.I.2.3.3-1: Form Element Mapping Specification for Birth**

US Birth Registration Form Question	Description	Mapping to US Birth Registration Form Number	US Requirements for Direct Data Entry or Pre-populate	BFDR-E Data Element
Facility name: Include the name of Facility where birth occurred	The name of the facility where the delivery took place. If not an institution, give street and number.	1	Pre-populate	FNAME

IHE Quality, Research and Public Health Technical Framework Supplement – Birth and Fetal Death Reporting Enhanced (BFDR-e)

US Birth Registration Form Question	Description	Mapping to US Birth Registration Form Number	US Requirements for Direct Data Entry or Pre-populate	BFDR-E Data Element
Facility I.D. (National Provider Identifier)	Facility National Provider Identifier	2	Pre-populate	FNPI
Facility: City, Town or Location of birth	The name of the city, town, township, village, or other location where the birth occurred.	3	Pre-populate	ADDRESS_D FLOC
Facility: County of birth	The name of the county where the birth occurred.	4	Pre-populate	CNAME CNTYO
Type of Place of birth	The type of place where the birth occurred.	5	Pre-populate	BPLACE
Date of first prenatal care visit	The date a physician or other health care professional first examined and/or counseled the pregnant woman for the pregnancy.	6	Pre-populate	DOFP_YR, DOFP_MO, DOFP_DY
No Prenatal Care	There was no prenatal care.	6	Pre-populate	PNC
Total number of prenatal care visits for this pregnancy	The total number of prenatal visits recorded in the record.	7	Pre-populate	NPREV
Date last normal menses began	The date the mother's last normal menstrual period began. This item is used to compute the gestational age of the infant.	8	Pre-populate	DLMP_YR, DLMP_MO, DLMP_DY
<!-- #9. Number of previous live births now living -->	The total number of previous live-born infants now living.	9	Pre-populate	PLBL
Number of previous live births now dead	The total number of previous live-born infants now dead..	10	Pre-populate	PLBD
Date of last live birth	The date of birth of the last live-born infant.	11	Pre-populate	YLLB, MLLB
Total number of other pregnancy outcomes	The total number of other pregnancy outcomes that did not result in a live birth. Includes pregnancy losses of any gestational age. Examples: spontaneous or induced losses or ectopic pregnancy	12	Pre-populate	POPO

IHE Quality, Research and Public Health Technical Framework Supplement – Birth and Fetal Death Reporting Enhanced (BFDR-e)

US Birth Registration Form Question	Description	Mapping to US Birth Registration Form Number	US Requirements for Direct Data Entry or Pre-populate	BFDR-E Data Element
Date of last other pregnancy outcome	The date of the last pregnancy that did not result in a live birth ended. Includes pregnancy losses of any gestational age. Examples: spontaneous or induced losses or ectopic pregnancy	13	Pre-populate	YOPO, MOPO
Risk factors in this pregnancy	Risk factors of the mother during this pregnancy.	14	Pre-populate	GDIAB, PHYPE, GHYPE, PPB, VB, INFT, PCES, NPCES
Infections present and/or treated during this pregnancy	Infections present at the time of the pregnancy diagnosis or a confirmed diagnosis during the pregnancy with or without documentation of treatment. Documentation of treatment during this pregnancy is adequate if a definitive diagnosis is not present in the available record.	15	Pre-populate	GON, SYPH, CHAM, HEPB, HEPC
Obstetric procedures	Medical treatment or invasive/manipulative procedure performed during this pregnancy to treat the pregnancy or to manage labor and/or delivery.	16	Pre-populate	CERV, TOC, ECVS, ECVF
Onset of Labor	Serious complications experienced by the mother associated with labor and delivery.	17	Pre-populate	PROM, PRIC, PROL
Date of birth	The infant's date of birth	18	Pre-populate	IDOB_YR, IDOB_MO, IDOB_DY
Time of birth	The infant's time of birth	19	Pre-populate	TB
Certifier's name and title: OMIT	The individual who certified to the fact that the birth occurred.	20	Direct Data Entry	No Attribute conveyed
Date certified:	The date that the birth was certified.	21	Direct Data Entry	No Attribute conveyed
Principal source of payment for this delivery	The principal source of payment at the time of delivery.	22	Pre-populate	PAY
Infant's medical record number	The medical record number assigned to the newborn.	23	Pre-populate	IRECNUM

IHE Quality, Research and Public Health Technical Framework Supplement – Birth and Fetal Death Reporting Enhanced (BFDR-e)

US Birth Registration Form Question	Description	Mapping to US Birth Registration Form Number	US Requirements for Direct Data Entry or Pre-populate	BFDR-E Data Element
Was the mother transferred to this facility for maternal medical or fetal indications for delivery?	Information about the transfer status of the mother prior to delivery. Transfers include hospital to hospital, birth facility to hospital, etc. Does not include home to hospital.	24	Pre-populate	TRAN
Attendant's name	The name of the person responsible for delivering the child.	25A	Pre-populate	ATTENDN
Attendants title	The title of the person responsible for delivering the child. The attendant at birth is defined as the individual physically present at the delivery who is responsible for the delivery.	25B	Pre-populate	ATTEND
Attendant's N.P.I.	The National Provider Identification Number of the person responsible for delivering the child. The attendant at birth is defined as the individual physically present at the delivery who is responsible for the delivery.	25C	Pre-populate	NPI
Mother's weight at delivery	The mother's weight at the time of delivery. The preferred unit of measure is in pounds.	26	Pre-populate	DWGT
Characteristics of labor and delivery	Information about the course of labor and delivery.	27	Pre-populate	INDL, AUGL, STER, ANTB, CHOR, ESAN
Method of Delivery	The physical process by which the complete delivery of the fetus was affected.	28	Pre-populate	ROUT, PRES, TLAB
Maternal morbidity	Serious complications experienced by the mother associated with labor and delivery.	29	Pre-populate	MTR, PLAC, RUT, UHYS, AINT, UOPR
Birthweight	The weight of the infant at birth. The preferred unit of measure is in grams.	30	Pre-populate	BWG
Obstetric estimate of gestation at delivery	The best obstetric estimate to the infant's gestation in completed weeks based on birth attendant's final estimate of gestation. This estimate of gestation should be determined by all perinatal factors and assessments such as ultrasound, but not the neonatal exam.	31	Pre-populate	OWGEST

IHE Quality, Research and Public Health Technical Framework Supplement – Birth and Fetal Death Reporting Enhanced (BFDR-e)

US Birth Registration Form Question	Description	Mapping to US Birth Registration Form Number	US Requirements for Direct Data Entry or Pre-populate	BFDR-E Data Element
Sex (Male, Female, or Not yet determined)	Sex of the infant.	32	Pre-populate	ISEX
APGAR Score at 5 minutes	A systematic measure for evaluating the physical condition of the infant at 5 minutes following birth.	33A	Pre-populate	APGAR5
APGAR Score at 10 minutes-	A systematic measure for evaluating the physical condition of the infant at 10 minutes following birth. The APGAR score at 10 minutes is documented if the score at 5 minutes is less than 6.	33B	Pre-populate	APGAR10
Plurality	The number of fetuses delivered live or dead at any time in the pregnancy regardless of gestational age or if the fetuses were delivered at different dates in the pregnancy.	34	Pre-populate	PLUR
If not single birth (Order delivered in the pregnancy, specify 1st, 2nd, 3rd, 4th, 5th, 6th, 7th, etc.) (Include all live births and fetal losses resulting from this pregnancy): Not Applicable	The order born in the delivery, live-born or fetal death.	35	Pre-populate	SORD
If not single birth, specify number of infants in this delivery born alive	The number of infants in this delivery born alive at any point in the pregnancy.	36	Pre-populate	LIVEB
Abnormal conditions of the newborn	Disorders or significant morbidity experienced by the newborn.	37	Pre-populate	AVEN1, AVEN6, NICU, SURF, ANTI, SEIZ, BINJ

IHE Quality, Research and Public Health Technical Framework Supplement – Birth and Fetal Death Reporting Enhanced (BFDR-e)

US Birth Registration Form Question	Description	Mapping to US Birth Registration Form Number	US Requirements for Direct Data Entry or Pre-populate	BFDR-E Data Element
Congenital anomalies of the newborn	Malformations of the newborn diagnosed prenatally or after delivery.	38	Pre-populate	ANEN, MNSB, CCHD, CDH, OMPH, GAST, LIMB, CL, CP, DOWN, DOWC, DOWP, CDIS, CDIC, CDIP, HYPO
Was infant transferred within 24 hours of delivery	Transfer status of the infant within 24 hours after delivery.	39	Pre-populate	ITRAN
Is infant living at time of report	Information on the infant's survival.	40	Pre-populate	ILIV
Is infant being breastfed at discharge	Information on whether the infant is being breast-fed before discharge from the hospital.	41	Pre-populate	BFED
Maternal height	The mother's height The preferred unit of measure is in feet and inches.	42	Pre-populate	HFT, HIN
Maternal weight immediately before this pregnancy	The mother's pre-pregnancy weight The preferred unit of measure is in pounds.	43	Pre-populate	PWGT

**Table 4.1.2.3.3-2: Form Element Mapping Specification for Fetal Death**

US Fetal Death Report Form Question	Description	Mapping to US Fetal Death Report Form Number	US Requirements for Direct Data Entry or Pre-populate	BFDR-E Data Element
Facility name: Include the name of Facility where birth occurred-	The name of the facility where the delivery took place. If not an institution, give street and number.	1	Pre-populate	FNAME
Facility I.D. (National Provider Identifier)	Facility National Provider Identifier	2	Pre-populate	FNPI

IHE Quality, Research and Public Health Technical Framework Supplement – Birth and Fetal Death Reporting Enhanced (BFDR-e)

<b>US Fetal Death Report Form Question</b>	<b>Description</b>	<b>Mapping to US Fetal Death Report Form Number</b>	<b>US Requirements for Direct Data Entry or Pre-populate</b>	<b>BFDR-E Data Element</b>
Facility: City, Town or Location of delivery	The name of the city, town, township, village, or other location where the birth occurred.	3	Pre-populate	FLOC
Facility: County of delivery	The name of the county where the delivery occurred.	4	Pre-populate	CNAME CNTYO
Type of Place of delivery	The type of place where the delivery occurred.	5	Pre-populate	BPLACE
Date of first prenatal care visit	The date a physician or other health care professional first examined and/or counseled the pregnant woman for the pregnancy.	6	Pre-populate	DOFP_YR, DOFP_MO, DOFP_DY
No Prenatal Care	There was no prenatal care.	6	Pre-populate	PNC
Total number of prenatal care visits for this pregnancy	The total number of prenatal visits recorded in the record.	7	Pre-populate	NPREV
Date last normal menses began	The date the mother/patient's last normal menstrual period began. This item is used to compute the gestational age of the fetus.	8	Pre-populate	DLMP_YR, DLMP_MO, DLMP_DY
Number of previous live births now living	The total number of previous live-born infants now living.	9	Pre-populate	PLBL
Number of previous live births now dead	The total number of previous live-born infants now dead.	10	Pre-populate	PLBD
Date of last live birth	The date of birth of the last live-born infant.	11	Pre-populate	YLLB, MLLB
Total number of other pregnancy outcomes	The total number of other pregnancy outcomes that did not result in a live birth. Includes pregnancy losses of any gestational age. Examples: spontaneous or induced losses or ectopic pregnancy	12	Pre-populate	POPO
Date of last other pregnancy outcome	The date of the last pregnancy that did not result in a live birth ended. Includes pregnancy losses of any gestational age. Examples: spontaneous or induced losses or ectopic pregnancy	13	Pre-populate	YOPO, MOPO

IHE Quality, Research and Public Health Technical Framework Supplement – Birth and Fetal Death Reporting Enhanced (BFDR-e)

<b>US Fetal Death Report Form Question</b>	<b>Description</b>	<b>Mapping to US Fetal Death Report Form Number</b>	<b>US Requirements for Direct Data Entry or Pre-populate</b>	<b>BFDR-E Data Element</b>
Risk factors in this pregnancy	Risk factors of the mother during this pregnancy.	14	Pre-populate	GDIAB, PHYPE, GHYPE, PPB, PPO, VB, INFT, PCES, NPCES
Infections present and/or treated during this pregnancy	Infections present at the time of the pregnancy diagnosis or a confirmed diagnosis during the pregnancy with or without documentation of treatment. Documentation of treatment during this pregnancy is adequate if a definitive diagnosis is not present in the available record.	15	Pre-populate	GON, SYPH, CHAM, LM, GBS, CMV, B19, TOXO
Date of Delivery	The fetus' date of delivery	16	Pre-populate	FDOD_YR , FDOD_MO , FDOD_DY ,
Time of Delivery	The fetus' date of delivery	17	Pre-populate	TD
Name and title of person completing report:	The individual who certified to the fact that the delivery occurred.	18	Direct Data Entry	No Attribute conveyed
Date Report Completed	The date that the delivery was certified.	19	Direct Data Entry	No Attribute conveyed
Was the mother transferred to this facility for maternal medical or fetal indications for delivery?	Information about the transfer status of the mother prior to delivery. Transfers include hospital to hospital, birth facility to hospital, etc. Does not include home to hospital.	20	Pre-populate	TRAN
Attendant's name	The name of the person responsible for delivering the fetus.	21A	Pre-populate	ATTENDN
Attendants title	The title of the person responsible for delivering the fetus. The attendant is defined as the individual physically present at the delivery who is responsible for the delivery.	21B	Pre-populate	ATTEND
Attendant's N.P.I.	The National Provider Identification Number of the person responsible for delivering the fetus. The attendant is defined as the individual physically present at the delivery who is responsible for the delivery.	21C	Pre-populate	NPI



IHE Quality, Research and Public Health Technical Framework Supplement – Birth and Fetal Death Reporting Enhanced (BFDR-e)

<b>US Fetal Death Report Form Question</b>	<b>Description</b>	<b>Mapping to US Fetal Death Report Form Number</b>	<b>US Requirements for Direct Data Entry or Pre-populate</b>	<b>BFDR-E Data Element</b>
Mother/patient's weight at delivery	The mother/patient's weight at the time of delivery. The preferred unit of measure is in pounds.	22	Pre-populate	DWGT
Method of Delivery:	Information about the course of labor and delivery.	23	Pre-populate	ROUT, PRES, TLAB, HYST
Maternal morbidity	Serious complications experienced by the mother/patient associated with labor and delivery.	24	Pre-populate	MTR, PLAC, RUT, UHYS, AINT, UOPR
Weight of Fetus:	The weight of the fetus at delivery. The preferred unit of measure is in grams.	25	Pre-populate	FWG
Obstetric estimate of gestation at delivery	The best obstetric estimate to the fetus gestation in completed weeks based on birth attendant's final estimate of gestation. This estimate of gestation should be determined by all perinatal factors and assessments such as ultrasound, but not the neonatal exam.	26	Pre-populate	OWGEST
Sex (Male, Female, or Unknown):	Sex of the fetus.	27	Pre-populate	FSEX
Plurality	The number of fetuses delivered live or dead at any time in the pregnancy regardless of gestational age or if the fetuses were delivered at different dates in the pregnancy.	28	Pre-populate	PLUR
If not single delivery (Order delivered in the pregnancy, specify 1st, 2nd, 3rd, 4th, 5th, 6th, 7th, etc.) (Include all live births and fetal losses resulting from this pregnancy): Not Applicable-	The order this fetus was delivered in the set. Include all live-births and fetal death.	29	Pre-populate	SORD
If not single birth, specify number of infants in this delivery born alive	The number of infants in this delivery born alive at any point in the pregnancy.	30	Pre-populate	LIVEB

IHE Quality, Research and Public Health Technical Framework Supplement – Birth and Fetal Death Reporting Enhanced (BFDR-e)

US Fetal Death Report Form Question	Description	Mapping to US Fetal Death Report Form Number	US Requirements for Direct Data Entry or Pre-populate	BFDR-E Data Element
Malformations of the fetus diagnosed prenatally or after delivery	Malformations of the fetus diagnosed prenatally or after delivery.	31	Pre-populate	ANEN, MNSB, CCHD, CDH, OMPH, GAST, LIMB, CL, CP, DOWC, DOWN, DOWP, CDIC, CDIS, CDIP, HYPO
Method of Disposition	Method of final disposition of the dead fetus.	32	Direct Data Entry	DISP
Initiating Cause/Condition	The initiating cause/condition is for reporting a single condition that most likely began the sequence of events resulting in the death of the fetus. NOTE: While up to 7 initiating causes may be collected from the provider, there is only 1 Initiating Cause/Condition returned from NCHS.	33	Direct Data Entry	IICOD
Other Significant Causes or Conditions	Other significant causes or conditions include all other conditions contributing to death. These conditions may be conditions that are triggered by the initiating cause or causes that are not among the sequence of events triggered by the initiating cause.	34	Direct Data Entry	IOSC1, IOSC2, IOSC3, IOSC4, IOSC5, IOSC6, IOSC7
Was an autopsy performed?	Information on whether or not an autopsy was performed.	35	Pre-populate	AUTOP
Was a histological placental examination performed?	Information on whether or not a histological placental examination was performed.	36	Pre-populate	HISTOP
Were autopsy or histological placental examination results used in determining the cause of fetal death?	Information on whether the findings of the autopsy or histological placental examination, if performed, were used in completing the medical portion of the fetal death report.	37	Direct Data Entry	AUTOPF
Estimated time of fetal death	Item to indicate when the fetus died with respect to labor and assessment.	38	Pre-populate	ETIME

1830 **4.I.6.6.5.2 BFDR-E FHIR Resource Data Specifications**

The following table shows US constraints on the mapping of the FHIR Resources supporting the content for each of the BFDR Data Elements/Attributes. Data Responders SHALL support the Resources identified by this table. Data Consumers SHALL be able to retrieve birth and fetal death reporting related health information from the specified resource for one or more attributes.

1835 **Table 4.I.6.6.5.2-1: Required Mappings – Birth and Fetal Death Reporting Attribute to FHIR Resource**

FHIR Resource Location	FHIR Source Element Name	Notes	Attribute Name <QRPH TF-1: Appx B>	Birth and Fetal Death Report Data Element
<i>Attributes related to mother supplied information</i>				
Patient.resource	Name	SHALL be populated with Mother's Current Legal Name	MFNAME MMNAME MLNAME MSUFF	Mother's Current Legal Name

IHE Quality, Research and Public Health Technical Framework Supplement – Birth and Fetal Death Reporting Enhanced (BFDR-e)

FHIR Resource Location	FHIR Source Element Name	Notes	Attribute Name <QRPH TF-1: Appx B>	Birth and Fetal Death Report Data Element
	us-core-race (NOTE: may be restricted by jurisdiction)	SHOULD be populated if known with the mother's race	MRACE1 MRACE2 MRACE3 MRACE4 MRACE5 MRACE6 MRACE7 MRACE8 MRACE9 MRACE10 MRACE11 MRACE12 MRACE13 MRACE14 MRACE15 MRACE16 MRACE17 MRACE18 MRACE19 MRACE20 MRACE21 MRACE22 MRACE22	Mother's Race is White Mother's Race: Black or African American Mother's Race: American Indian or Alaska Native Mother's Race: Asian Indian Mother's Race: Chinese Mother's Race: Filipino Mother's Race: Japanese Mother's Race: Korean Mother's Race: Vietnamese Mother's Race: Other Asian (specify) Mother's Race: Native Hawaiian Mother's Race: Guamanian or Chamorro Mother's Race: Samoan Mother's Race: Other Pacific Islander (specify) Mother's Race: Other Race (specify) Mother's Race: First American Indian or Alaska Native (literal) Mother's Race: Second American Indian or Alaska Native (literal) Mother's Race: First Other Asian (literal) Mother's Race: Second Other Asian (literal) Mother's Race: First Other Pacific Islander (literal) Mother's Race: Second Other Pacific Islander (literal) Mother's Race: First Other Race (literal) Mother's Race: Second Other Race (literal)
	us-core-ethnicity (NOTE: may be restricted by jurisdiction)	SHOULD be populated if known with the mother's ethnicity	METHNIC1 METHNIC2 METHNIC3 METHNIC4 METHNIC5	Mother's Hispanic Origin is Mexican/Mexican American/Chicana Mother's Hispanic Origin is Puerto Rican Mother's Hispanic Origin is Cuban Mother's Hispanic Origin is Other Spanish/Hispanic/Latina Mother's Hispanic Origin is Other (specify)
<i>Attributes related to father from the mother supplied information, such that link.RelatedPerson reflects the father of the newborn or fetus</i>				

IHE Quality, Research and Public Health Technical Framework Supplement – Birth and Fetal Death Reporting Enhanced (BFDR-e)

FHIR Resource Location	FHIR Source Element Name	Notes	Attribute Name <QRPH TF-1: Appx B>	Birth and Fetal Death Report Data Element
RelatedPerson	us-core-ethnicity (NOTE: may be restricted by jurisdiction)	SHOULD be populated if known with the father's ethnicity	FETHNIC1 FETHNIC2 FETHNIC3 FETHNIC4 FETHNIC5	Father is Mexican, Mexican American or Chicano Father is Puerto Rican Father is Cuban Father is other: Spanish/Hispanic/Latino Other literal entry
	us-core-race (NOTE: may be restricted by jurisdiction)	SHOULD be populated if known with the father's race	FRACE1 FRACE2 FRACE3 FRACE4 FRACE5 FRACE6 FRACE7 FRACE8 FRACE9 FRACE10 FRACE11 FRACE12 FRACE13 FRACE14 FRACE15 FRACE16 FRACE17 FRACE18 FRACE19 FRACE20 FRACE21 FRACE22 FRACE23	Father's Race is White Father's Race is Black or African American Father's Race is American Indian or Alaska Native (Name of the enrolled or principal tribe) Father's Race is Asian Indian Father's Race is Chinese Father's Race is Filipino Father's Race is Japanese Father's Race is Korean Father's Race is Vietnamese Father's Race is Other Asian (specify) Father's Race is Native Hawaiian Father's Race is Guamanian or Chamorro Father's Race is Samoan Father's Race is Other Pacific Islander (specify) Father's Race is Other Race (specify) Father's Race is First American Indian or Alaska Native (literal) Father's Race is Second American Indian or Alaska Native (literal) Father's Race is: First Other Asian (literal) Father's Race is: Second Other Asian (literal) Father's Race is First Other Pacific Islander (literal) Father's Race is Second Other Pacific Islander (literal) Father's Race is: First Other Race (literal) Father's Race is: Second Other Race (literal)