

COPPER-NICKEL MINING VISUAL ANALYSIS AND DESIGN CRITERIA

COPPER-NICKEL MINING VISUAL ANALYSIS AND DESIGN CRITERIA

**A STUDY PREPARED BY:
BRW**

BATHER-RINGROSE-WOLSFELD-
JARVIS-GARDNER, INC. ✓
7101 YORK AVENUE SOUTH
MINNEAPOLIS, MINNESOTA 55435

FOR THE COPPER-NICKEL PROJECT
MINNESOTA ENVIRONMENTAL QUALITY
BOARD

MARCH, 1978

CONTENTS

ONE

STUDY PURPOSE AND METHODOLOGY.	1
--------------------------------	---

TWO

COPPER-NICKEL MINING	3
Component Designs	3
Relationships	12
Design Alternatives	15

THREE

STUDY AREA LANDSCAPE	19
Physiography and Water Bodies	21
Vegetation and Soils	27
Development	37
Landscape Composites	41
Visual Conditions	49

FOUR

VISUAL DESIGN CRITERIA	53
Angle of View	56
Observer Distance	58
Line of Sight	60
Frequency of Views	62
Development Level.	64
Size and Shape.	66
Color and Texture	68

FIVE

CRITERIA APPLICATION.	71
Regional Design	71
Component Design	72

Figure	Page	Figure	Page
1. Methodology	2	26. Frequency of Views	63
2. Open Pit Mine	4	27. Development Level	65
3. Waste Rock and Tailings Basin	5	28. Size and Shape	67
4. Underground Mine Headframe and Hoist/Storage Facility and Coarse Crusher	6	29. Color and Texture.	69
5. Ore Storage, 2nd and 3rd Stage Crushing and Screening.	7	30. Relative Siting Desirability Ratings	75
6. Mill Building	8	31. Maximum Component Design Limits.	77
7. Waste Tailing Thickeners.	9		
8. Smelting Building and Refinery and Storage.	10		
9. Stacks and Acid Plant and Cooling Tower	11		
10. Mining Component Relation- ships	13		
11. Waste Rock Design Alterna- tives	17		
12. Tailings Basin Design Alternatives	18		
13. Visual Analysis Study Area Location.	20		
14. Physiography and Physiographic Areas	25		
15. Vegetation I	31		
16. Soils	33		
17. Vegetation II	35		
18. Development	39		
19. Landscape Composites.	43		
20. Landscape Composites.	45		
21. Landscape Composites.	47		
22. Study Area Landscape Visual Conditions	51		
23. Angle of View	57		
24. Observer Distance	59		
25. Line of Sight	61		

ONE

STUDY PURPOSE AND METHODOLOGY

Several mining companies have indicated a desire to extract low-grade copper-nickel ore from the Duluth Complex in northeastern Minnesota. A Regional Environmental Impact Study of the effects of the proposed open-pit and underground mining is being prepared by the Copper-Nickel Project Staff of the Minnesota Environmental Quality Board in accordance with State laws.

The Minnesota Environmental Quality Board commissioned BRW to conduct a visual analysis which would enable the State to predict and control the visual impacts of copper-nickel mining on the regional visual environment. This report is one part of that visual analysis.

The purpose of this report is to describe the methodology developed for analyzing the visual character of the study area landscape, and for determining mining component design criteria. Primary consideration is given to visual design criteria for waste rock dumps and tailings basins with lesser attention to the mine, mill, smelter facilities and other related appurtenances.

No attempt is made to judge: the visual quality of the individual mining compon-

ents; the overall visual desirability of mining in the study area; nor the relative visual quality of the various landscape conditions. Rather, we assess the relative visual change which would be caused to different landscape conditions and suggest those landscape conditions which are more capable of visually absorbing mining components.

The purpose of this methodology and the resultant design criteria is to minimize the change which copper-nickel mining would bring to the visual environment of the study area through appropriate component location and design based upon basic design principles. We consider the possible visual designs for each component and suggest appropriate landscape conditions for siting the component which minimize visual change.

The rationale for this methodology is based upon the following premises:

- o It is futile to attempt to cosmetically solve mining component and landscape condition incompatibility.
- o While it is not possible (nor perhaps desirable) to hide components of the size required, there are places in which the impact or visual change is less disruptive.

The methodology is an open-ended process applicable to all visual conditions possible in the study area. It allows prediction of how the landscape condition under consideration for component siting would affect the way in which the component would be visually perceived. The methodology as described in Figure 1 requires analysis of the visual design

character of the mining components and analysis of the visual character of the study area landscape, as prerequisites to establishment of design criteria which can then be used to evaluate the suitability of specific site development based upon the visual conditions of that site.

MINING COMPONENT VISUAL ANALYSIS

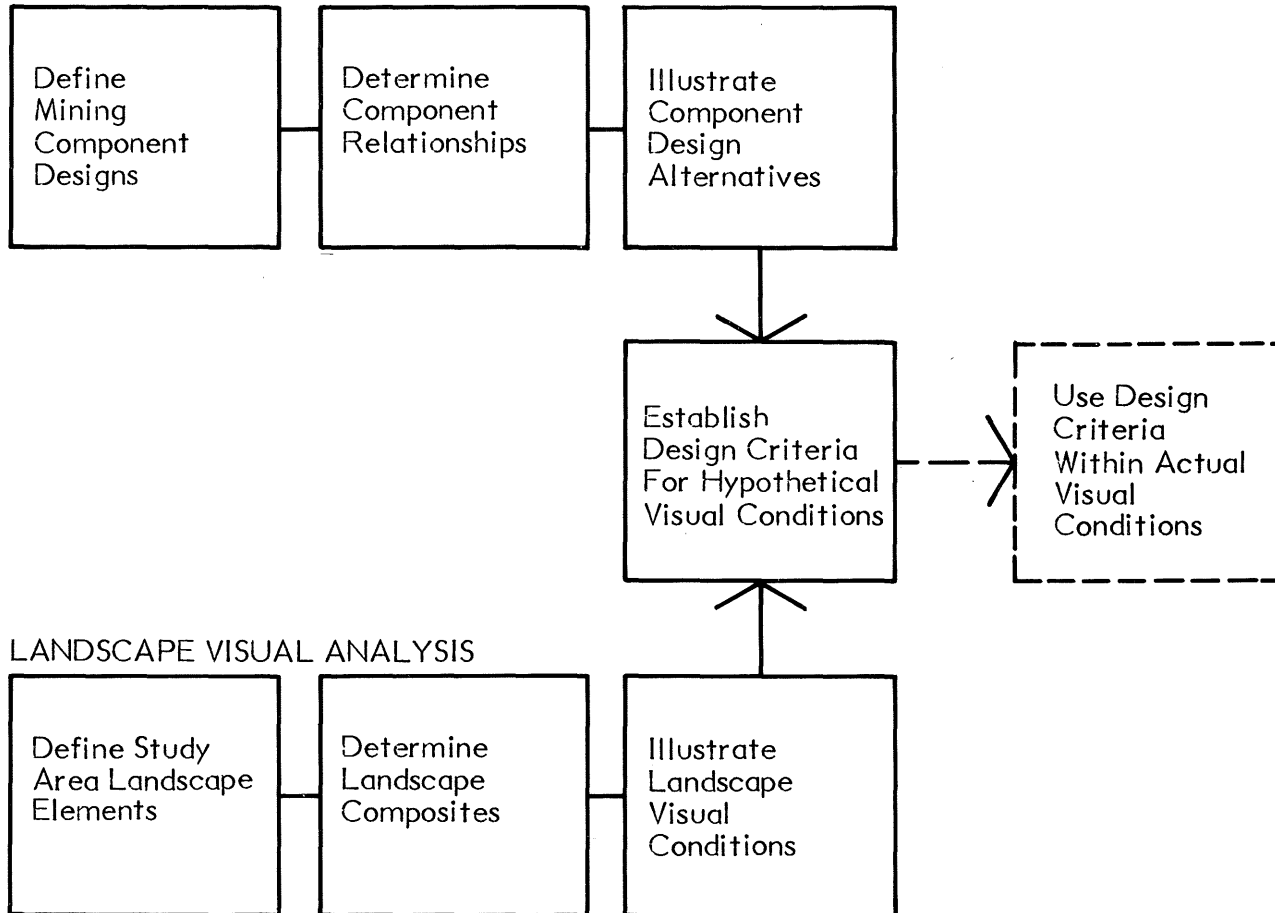

METHODOLOGY

VISUAL ANALYSIS AND DESIGN CRITERIA FOR COPPER-NICKEL MINING

Figure 1

TWO

COPPER-NICKEL MINING

The process of copper-nickel mining is limited by several engineering constraints, which in turn determine the visual design of the components. For purposes of analyzing the visual design of the various mining components it is necessary to make several assumptions concerning the nature of the mining operations.

Component Designs

The Copper-Nickel Staff is considering several hypothetical operation models. There are models being used for various periods of operation; for varying grades of ore; some dealing with only open pit ore production; some with only underground mining. The model we will use for this analysis includes open-pit and underground mining. Our model assumes 30 years of mining with one ore processing complex serving two mines:

- o One open-pit at 11.33×10^6 tons per year
- o One underground at 5.35×10^6 tons per year

for a total of 16.68×10^6 tons of copper-nickel ore to be processed each year.

The processing complex we will analyze is of a size capable of handling this annual volume of coarse ore with a corresponding annual copper-nickel metal output of 100×10^3 tons. The visual designs of the appropriately sized components are presented in Figures 2 through 9. Only components and related appurtenances of major visual significance are presented. It should be noted, however, that an integrated mining and processing operation typically includes several miles of roadways, pipelines, conveyors, power transmission lines, and sometimes railroad tracks; in addition to several minor storage areas, dikes, and other related support facilities.

We have approximated the typical size and form of the components based upon present engineering constraints, some of which are flexible as discussed later in this chapter.

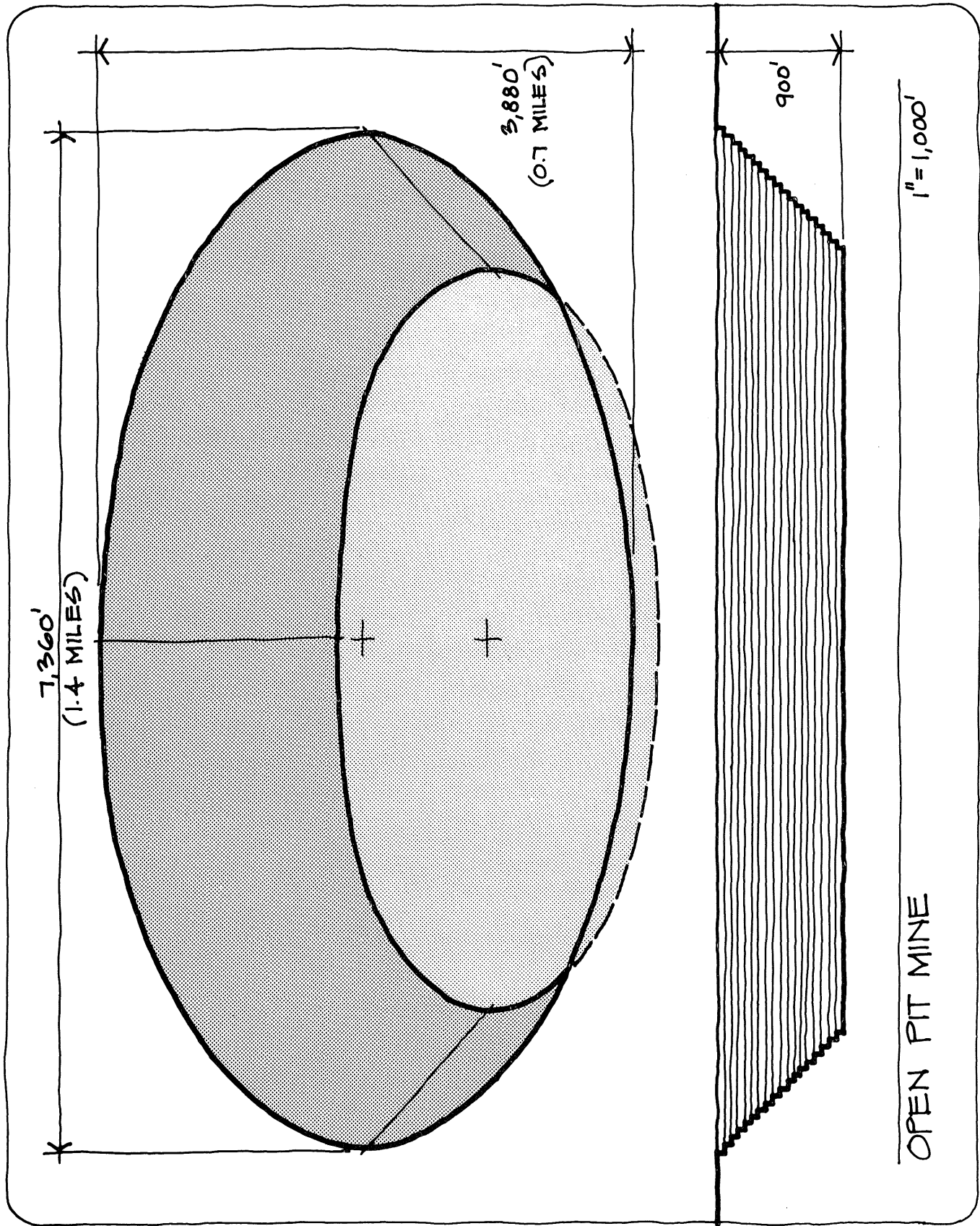

VISUAL ANALYSIS



MINNESOTA ENVIRONMENTAL QUALITY BOARD
COPPER-NICKEL PROJECT

MARCH, 1978

Figure 2

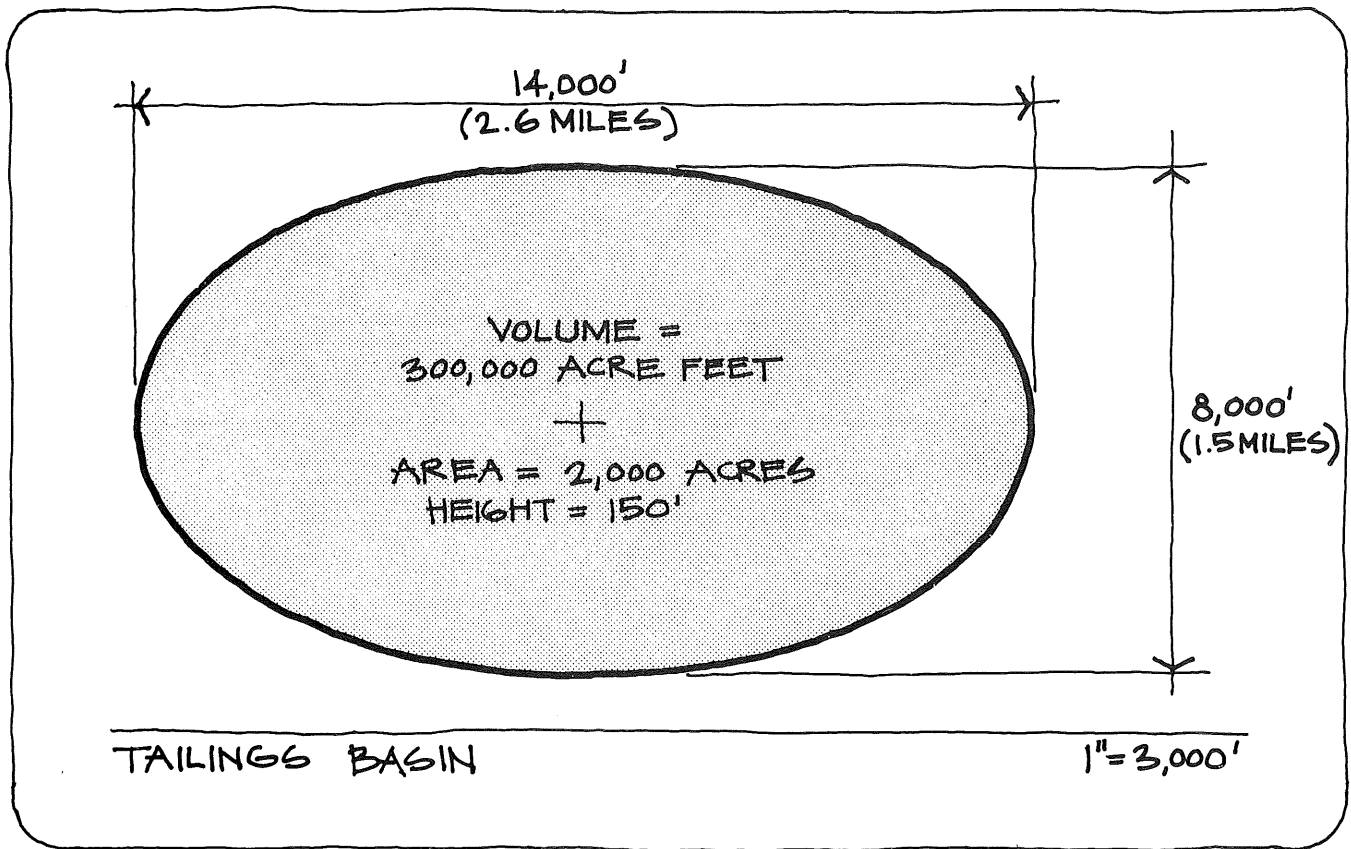
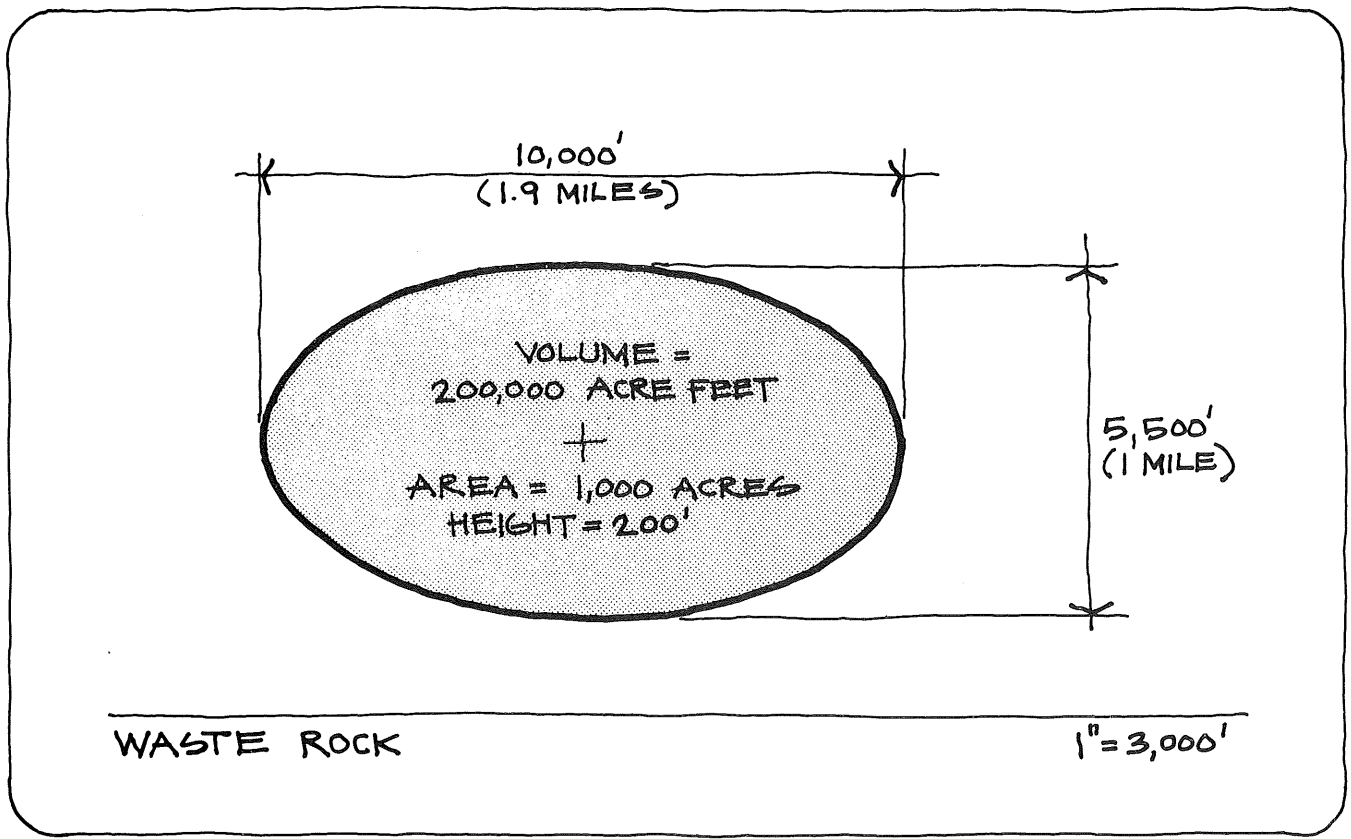

VISUAL ANALYSIS



MINNESOTA ENVIRONMENTAL QUALITY BOARD
COPPER-NICKEL PROJECT

MARCH 1978

Figure 3

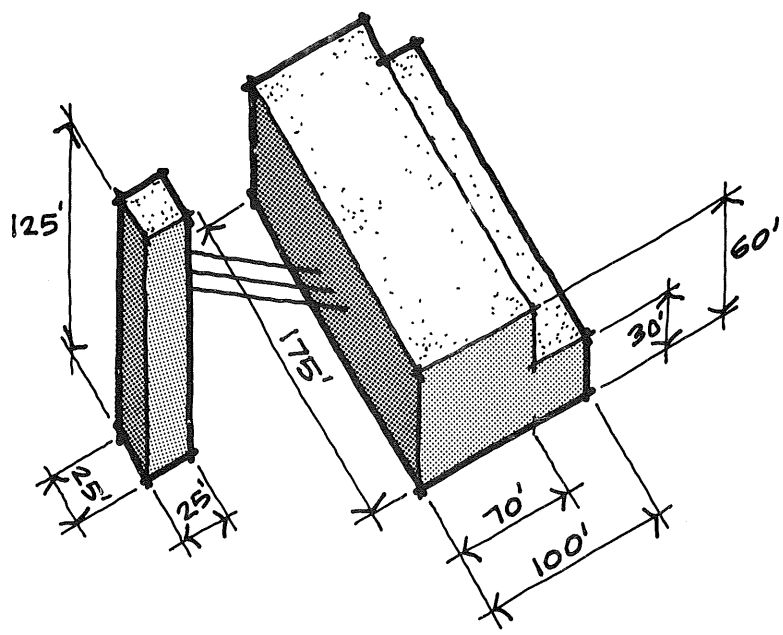

MINE HEADFRAME & HOIST/STORAGE FACILITY

1" = 100'

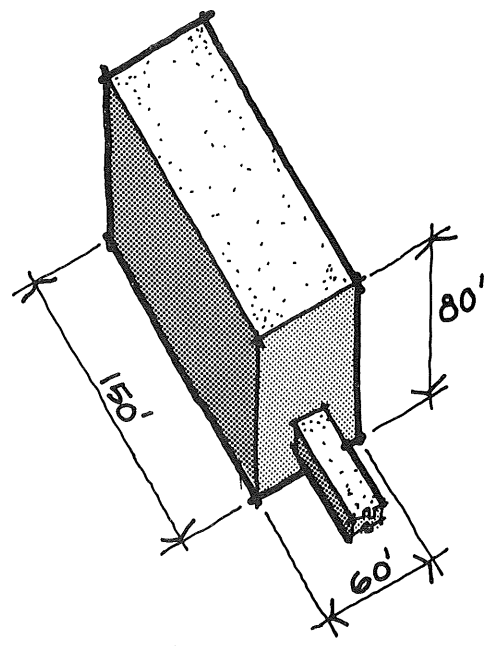

COARSE CRUSHER

1" = 100'

VISUAL ANALYSIS



MINNESOTA ENVIRONMENTAL QUALITY BOARD
COPPER-NICKEL PROJECT

MARCH 1978

Figure 4

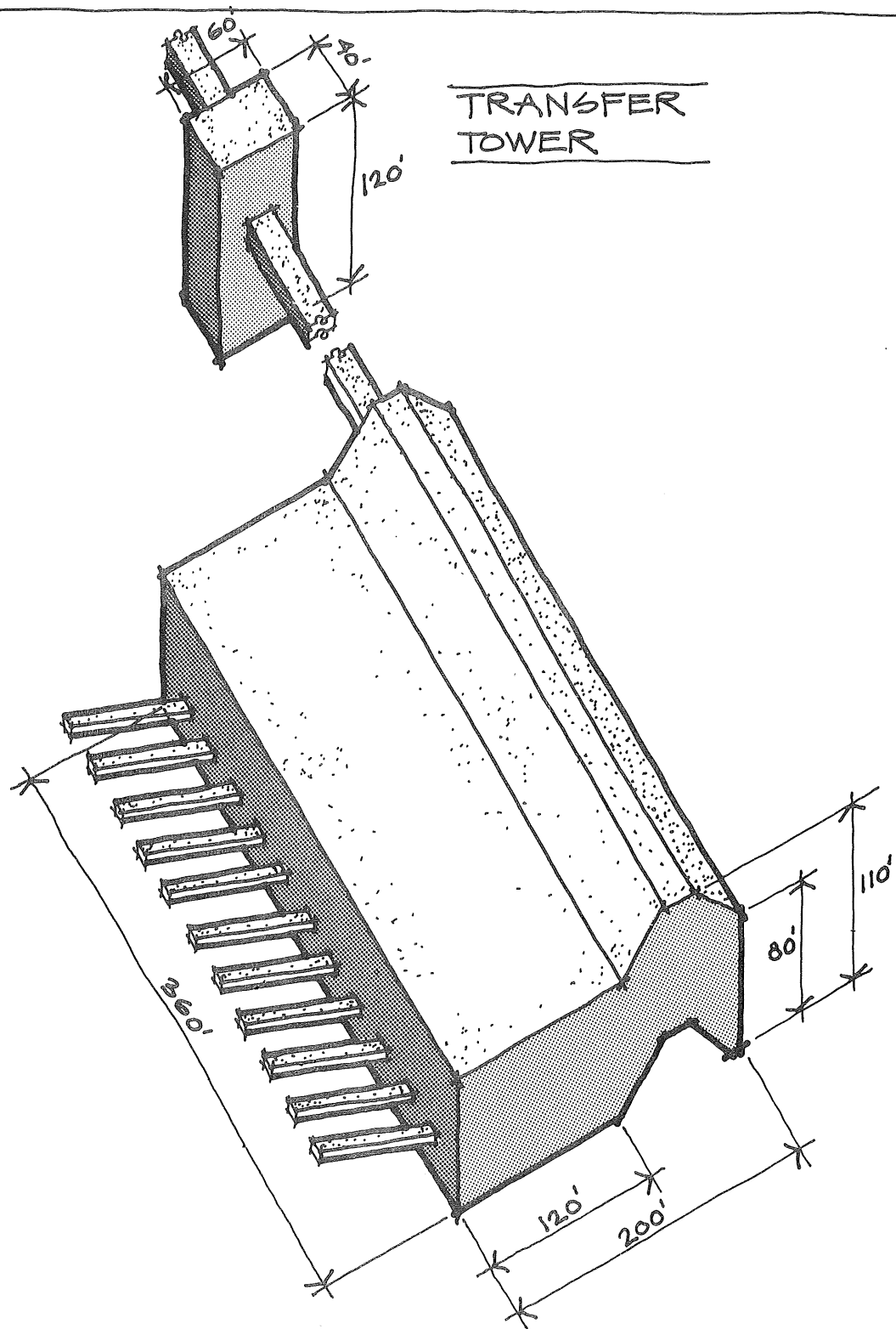

ORE STORAGE, 2ND AND 3RD STAGE
CRUSHING, & SCREENING

1" = 100'

VISUAL ANALYSIS



MINNESOTA ENVIRONMENTAL QUALITY BOARD
COPPER-NICKEL PROJECT

MARCH 1975

Figure 5

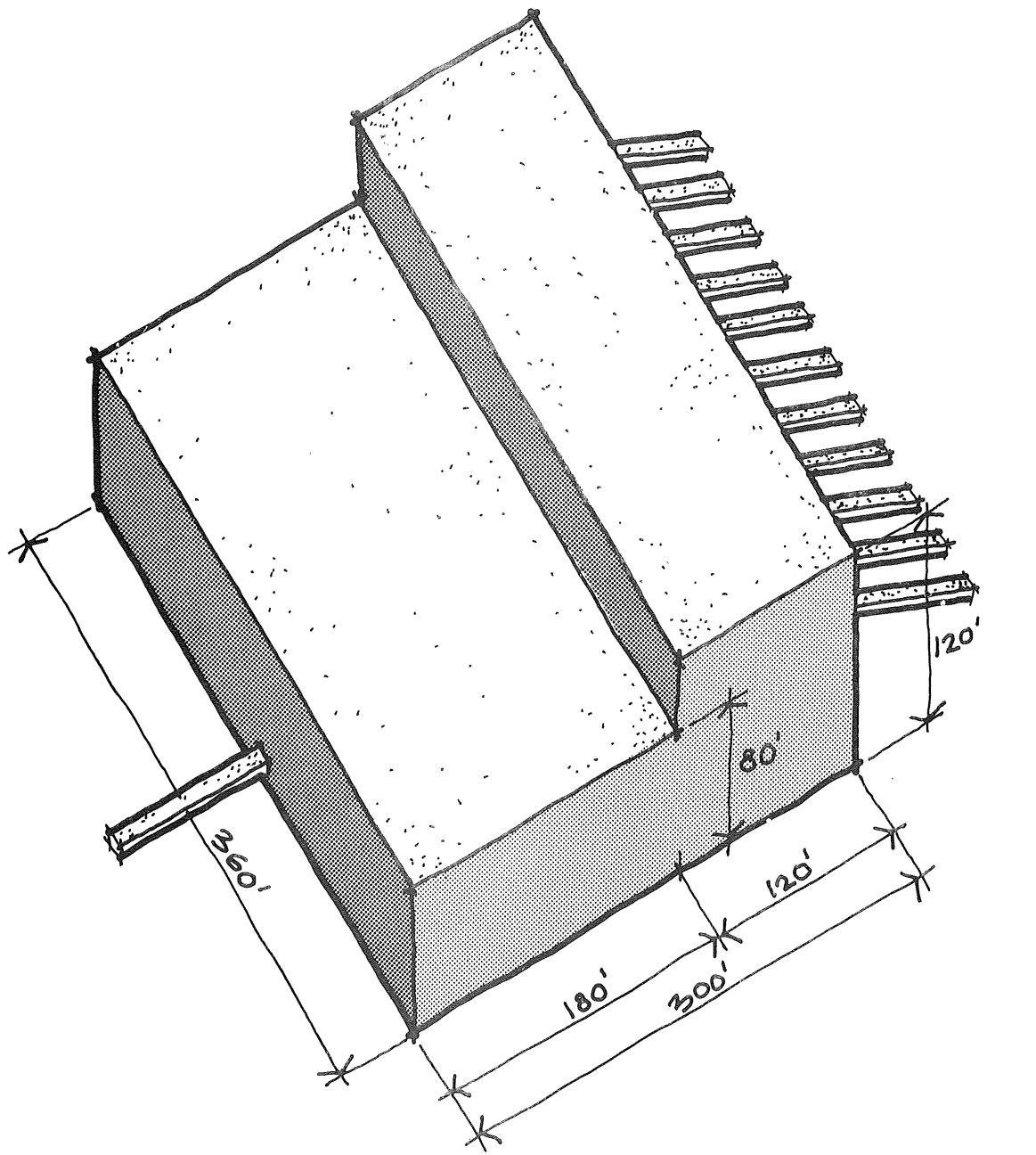

MILL BUILDING

1" = 100'

VISUAL ANALYSIS



MINNESOTA ENVIRONMENTAL QUALITY BOARD
COPPER-NICKEL PROJECT

MARCH 1978

Figure 6

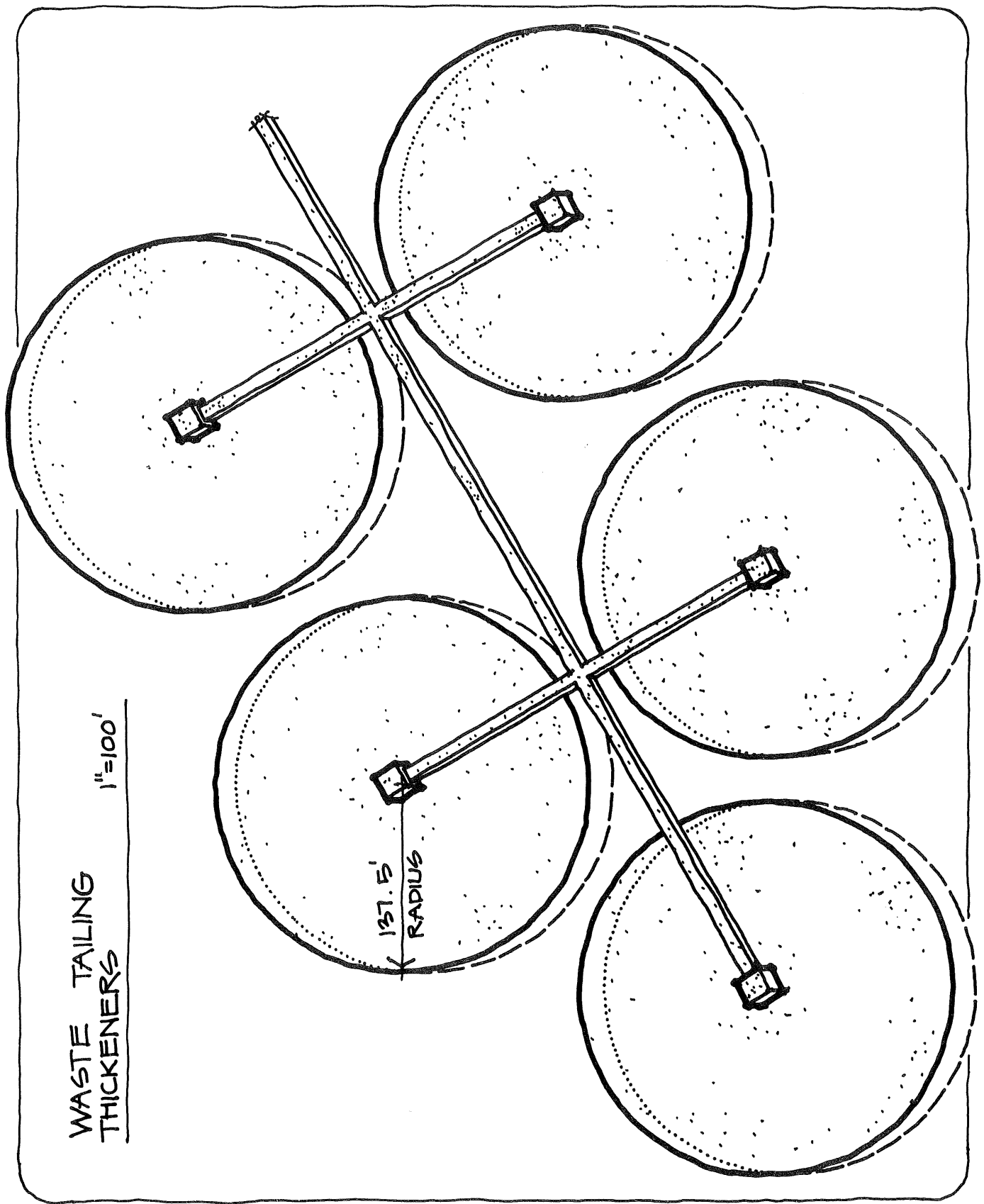

VISUAL ANALYSIS



MINNESOTA ENVIRONMENTAL QUALITY BOARD
 COPPER-NICKEL PROJECT

MARCH 1978

Figure 7

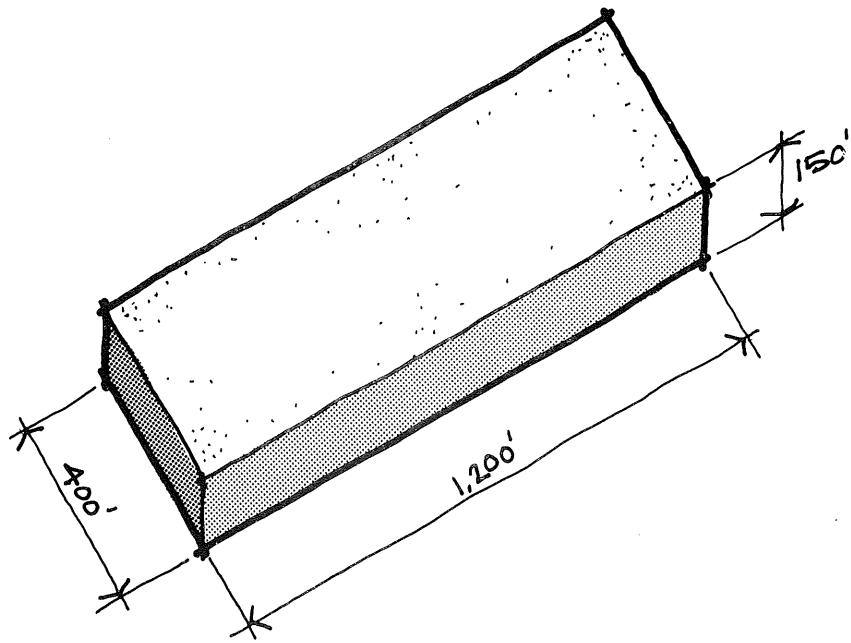

SMELTING BUILDING

1" = 400'

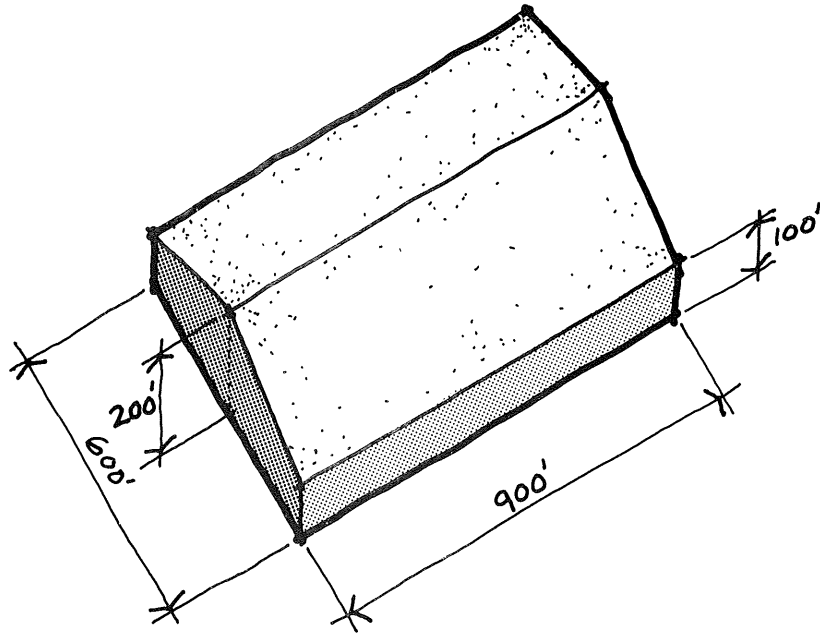

REFINERY & STORAGE

1" = 400'

VISUAL ANALYSIS



MINNESOTA ENVIRONMENTAL QUALITY BOARD
COPPER-NICKEL PROJECT

MARCH 1978

Figure 8

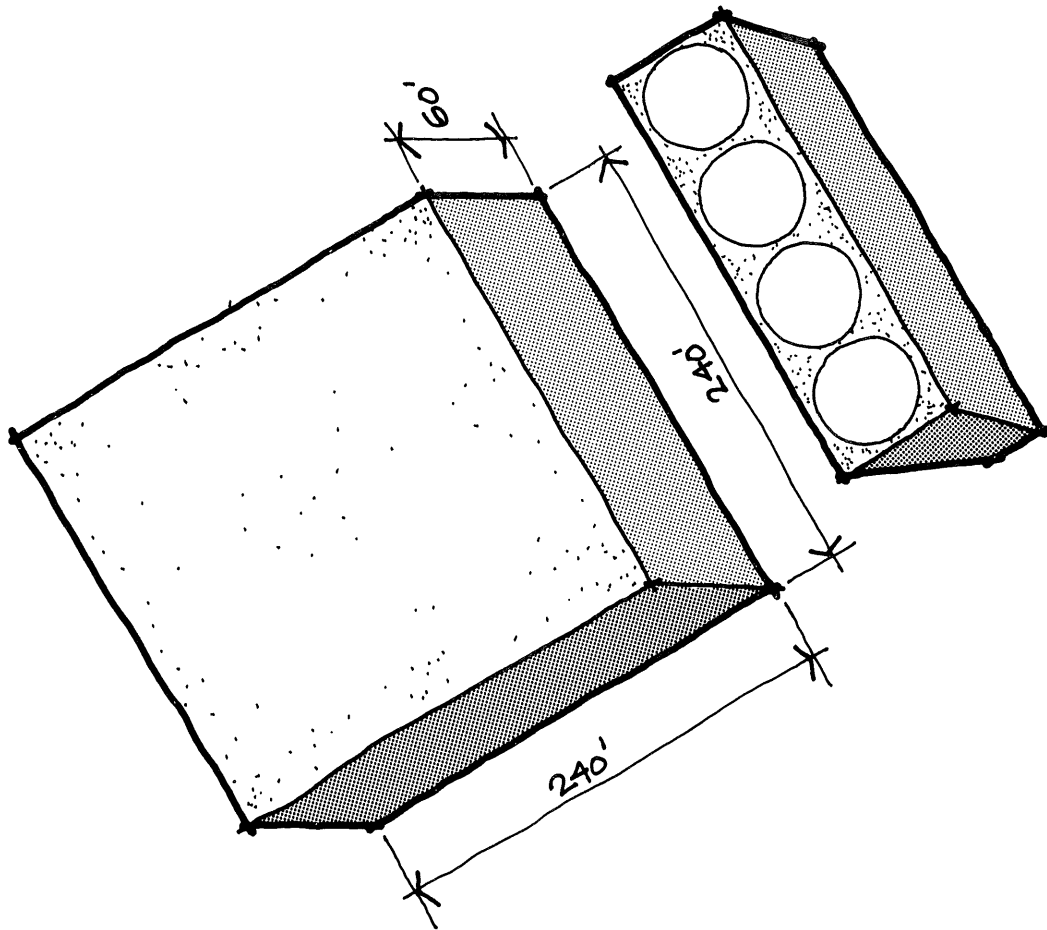

ACID PLANT & COOLING TOWER 1" = 100'

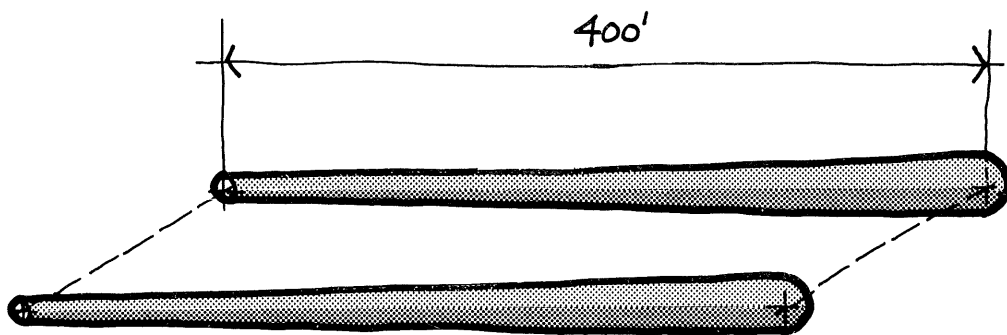

STACKS 1" = 100'

VISUAL ANALYSIS



MINNESOTA ENVIRONMENTAL QUALITY BOARD
COPPER-NICKEL PROJECT

MARCH 1978

Figure 9

Relationships

The relative scale of the mining components is illustrated in Figure 10, together with the functional relationships of the various components. We are assuming an integrated mining and processing complex and have indicated maximum distance relationships based upon economic feasibility.

We are assuming the open pit and underground mine to be in close proximity. The open pit mine terraced profile is illustrated and the approximate amount of surface area disturbed is given. The mine shape is shown only conceptually, it's true shape would be irregular and would be in a constant state of change. The waste rock from the open pit mining would be transported by truck to one or more waste rock dumps. The maximum distance for this haul is approximately three miles. The overburden would be stored nearby for possible coverage of the waste rock. Expected volumes for these two components are indicated on Figure 10.

The underground mine would be virtually concealed with the only surface indication of mining being the head frame and hoist/storage structures. No development would take place over that area being mined.

The maximum distance for coarse ore truck haulage from the open pit or underground mines to the crushers and mill building would be three miles. This distance could be increased considerably if rail were used for coarse ore transportation.

The distance from the mill to the tailings pond or ponds is set at a maximum of 10 miles. The tailings would be transported by pipeline slurry.

The distance from the mill to the smelter, refinery and other related facilities is virtually unlimited. The smelter and refinery may be a part of the integrated operation, or may be located elsewhere in the region. If the smelter is near the mill, the concentrate would be transported by slurry pipeline and dried at the smelter. If the smelter is located elsewhere in the region, the concentrate is first dried and then transported by rail or truck.

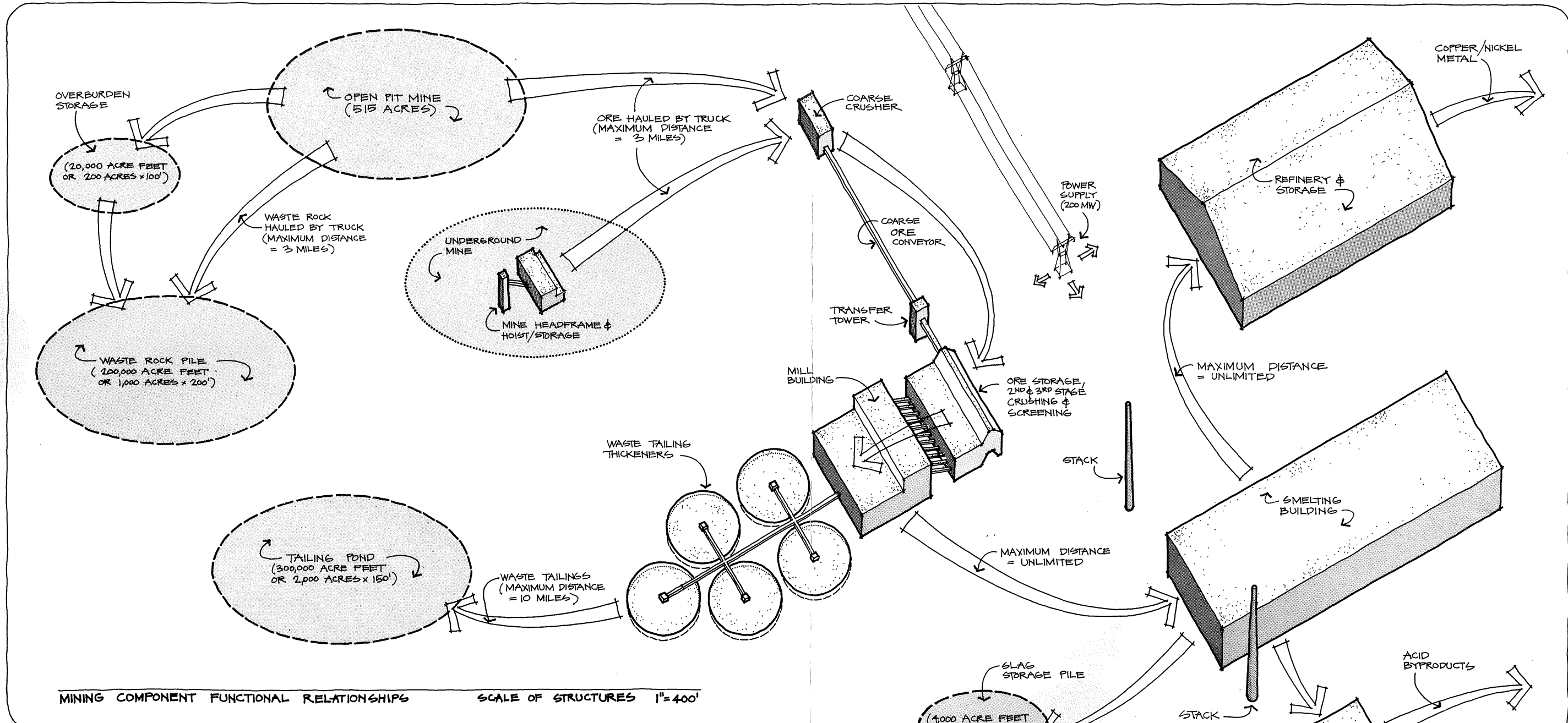
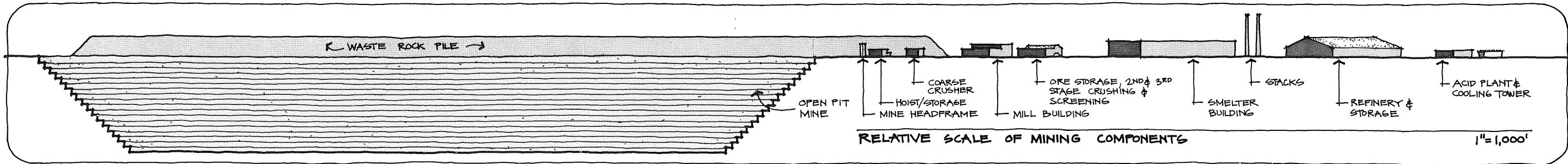

MINING COMPONENT RELATIONSHIPS

VISUAL ANALYSIS



MINNESOTA ENVIRONMENTAL QUALITY BOARD
COPPER-NICKEL PROJECT

MARCH, 1978

Figure 10

Design Alternatives

The engineering constraints which limit the visual design of mining components are fairly static for the mine and most of the structural components which have been described. For the significant non-structural components such as waste rock and tailings basins the limits are somewhat more flexible.

The 30-year volume of 200×10^3 acre feet of waste rock can be disposed of in various ways. The disposal methods are not limited however. The waste rock hauled from the mine to dump by truck can be deposited in various terrains and more than one pile provided the dump is within the three mile distance limit. The range of alternative terrains is illustrated in Figure 11.

On a flat site, although the piles may range as high as 500 feet, it is not economically feasible to consider piles of less than 50 feet in height. Assuming one pile, and a 200 foot height, the final 30 year volume from the open pit mine would cover some 1,000 acres. The shape of this 1,000 acre coverage is extremely variable. If more than one dumping site were used, the acreage at each site would diminish accordingly.

If the waste rock were dumped on a

sloped site or in a valley or bog the height would vary considerably. In the case of a sloped site, although the height is difficult to measure, it might range quite high. In the case of dumping in a valley or bog the depression might be filled to level with the surrounding topography, or dumping may continue with the net effect being a lower pile.

If tailings are stored in close proximity to the open pit mine, some waste rock would be used for dike or dam construction.

Tailings from the ore mill, transported by pipeline in the form of a slurry, can be stored in a broad range of terrains as shown on Figure 12. The rather long 10-mile distance economically feasible for transport provides a great deal of flexibility in tailings basin location and increases the likelihood that all of the alternative terrain situations be possible in any given storage problem.

The 30-year volume of 300×10^3 acre feet of tailings, if stored in one basin on a flat site, would cover approximately 2,000 acres if the maximum dike height of 150 feet is used. This maximum height is based upon engineering/economic feasibility and may be further limited by State and Federal regulations. The lower height limit for dikes or dams

is 50 feet. The dike construction would be staged over time, with additional steps added outboard as the tailings reached basin capacity.

If the tailings are stored on a sloped site the ultimate capacity would be reduced, with the same dike height restrictions, and depending upon the angle of slope, would cover more acreage than a flat site basin.

If tailings are stored in a valley, the valley could be contained by a dam or dams with evolutionary dam construction similar to flat site dikes.

Another possibility for storage in the study area is location in a bog. With slurry of tailings over the bog material, the compressed bog material would form a basically impervious liner. It is also believed that the tailings heavy metals would be adsorbed by the bog material. There could be problems with seepage control, and leaching potential exists, making the bog use feasibility questionable.

Valleys and bogs in the study area are relatively shallow and it would be likely that when the tailings reached the level of surrounding topography dike construction would be used to enclose the area, with the net effect being lower dikes

relative to the surrounding topography than if constructed on flat sites.

It is possible and usually preferred that more than one basin be used for storage of the 30 year 300×10^3 acre feet of tailings. This applies to all of the alternative basin designs discussed.

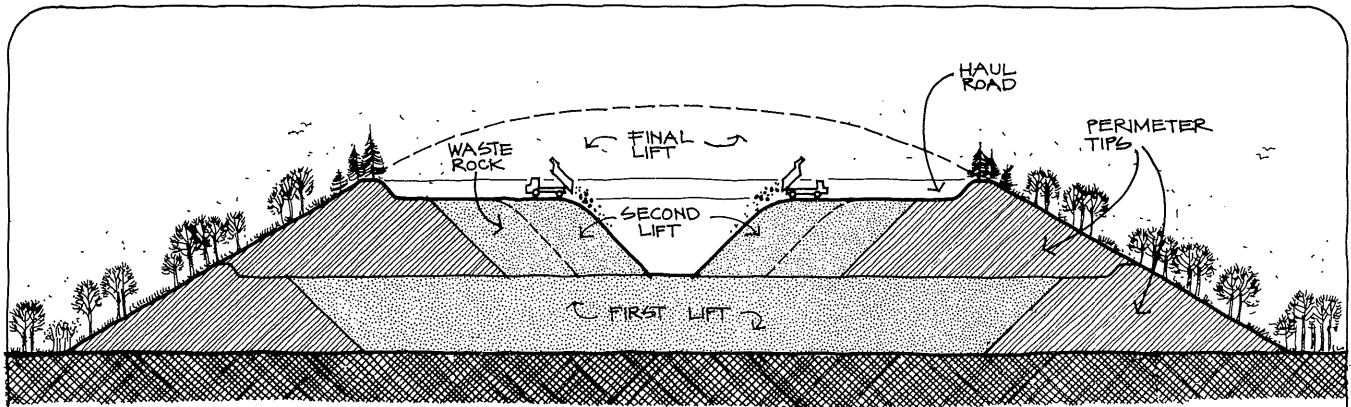

ON FLAT SITE

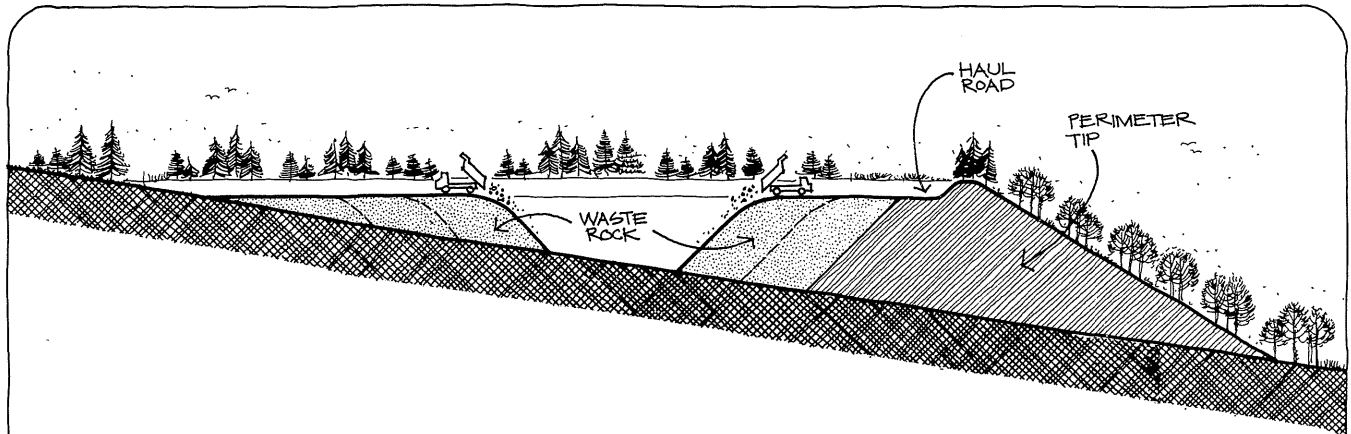

ON SLOPED SITE

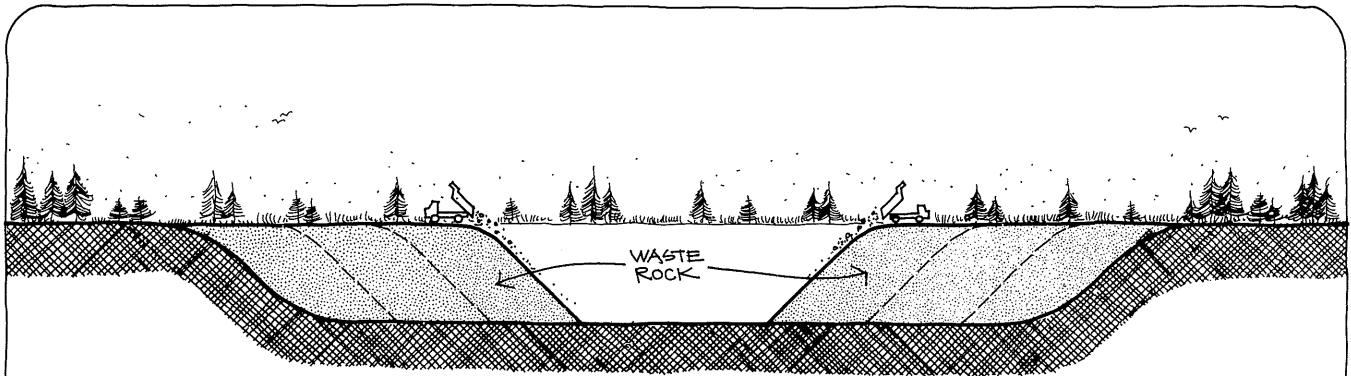

IN VALLEY OR BOG

WASTE ROCK DESIGN ALTERNATIVES

VISUAL ANALYSIS



MINNESOTA ENVIRONMENTAL QUALITY BOARD
COPPER-NICKEL PROJECT

MARCH 1978

Figure 11

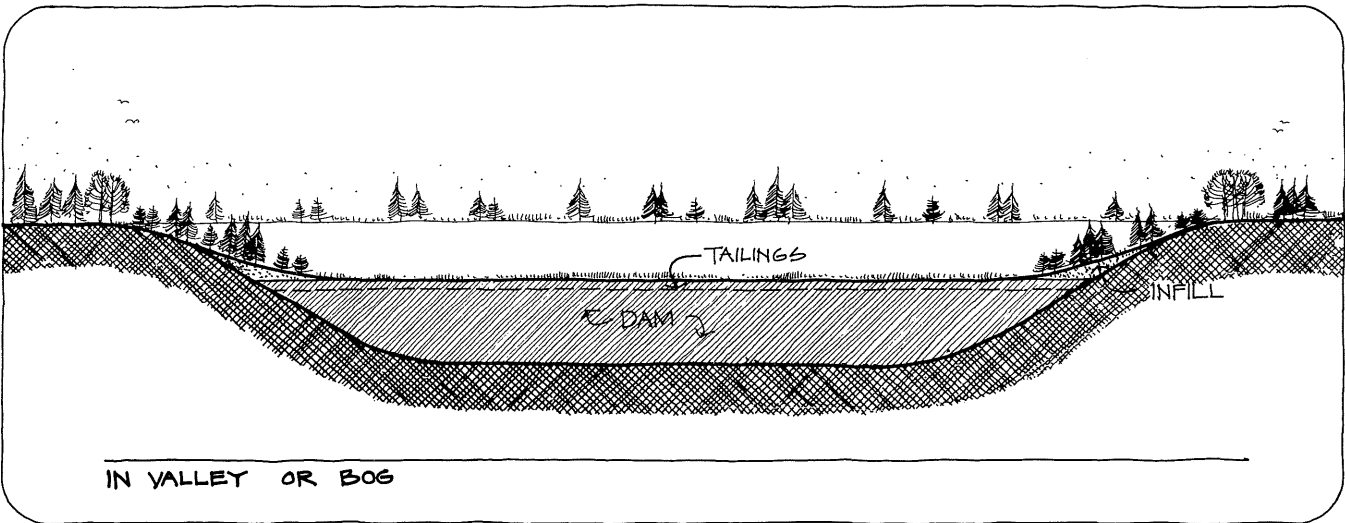
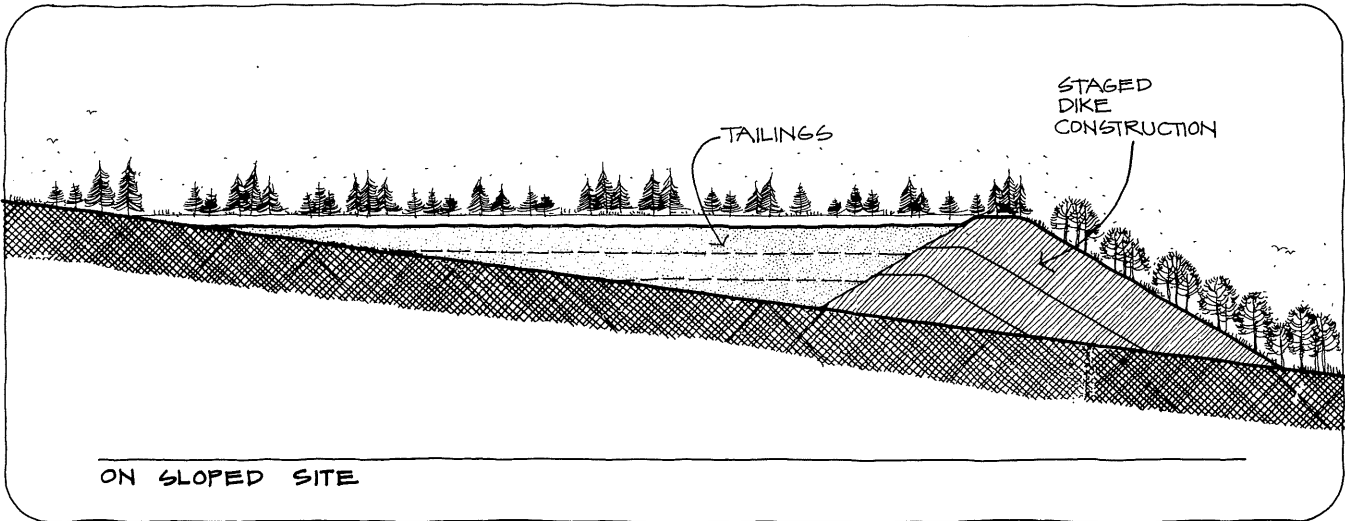
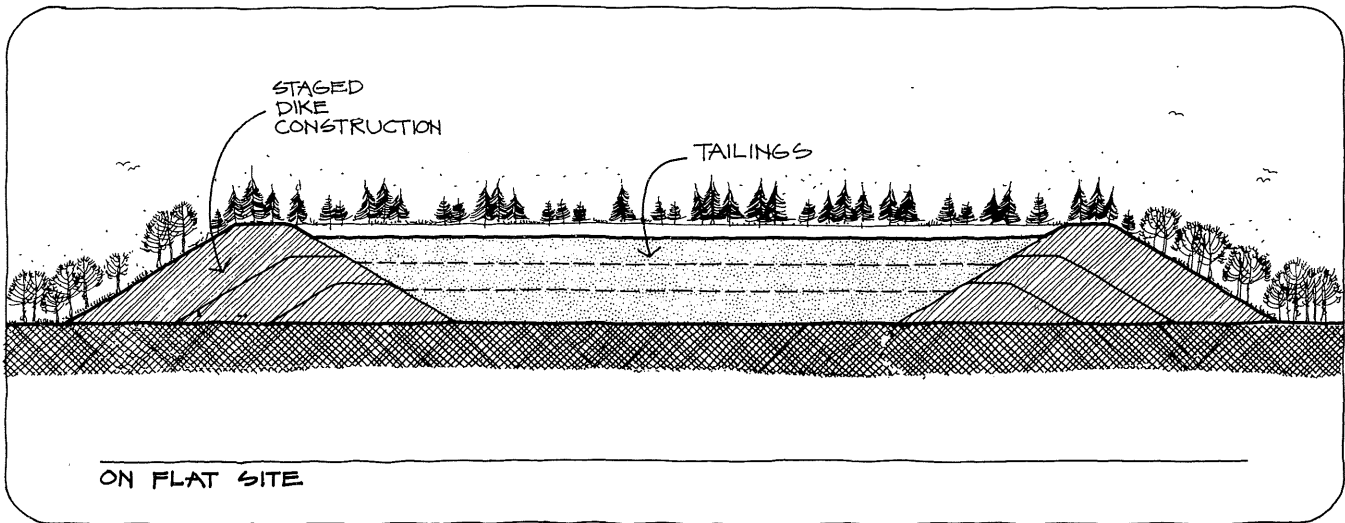

TAILINGS BASIN DESIGN ALTERNATIVES

VISUAL ANALYSIS



MINNESOTA ENVIRONMENTAL QUALITY BOARD
COPPER-NICKEL PROJECT

MARCH 1978

Figure 12

THREE

STUDY AREA LANDSCAPE

Evaluation of the landscape as the visual setting for potential copper-nickel mining component location requires analysis of each of the individual landscape elements which form the visual condition of the study area. For purposes of this study elements shall be defined as parts of the landscape such as land forms, types of water bodies, vegetative communities, or types and levels of human development.

First, the elements will be discussed individually. Then, since the elements are actually perceived as parts of a composite setting, the composite types which are typical of the area will be illustrated. Finally, the composites will be shown as perspectives, similar to the way in which the landscape visual conditions actually are perceived. These perspectives translate the detailed analysis into examples of the visual conditions.

Figure 13 shows the location of the visual analysis study area in relation to the State, and in relation to the Regional Copper-Nickel Study Area used by the Copper-Nickel Staff for other planning activities.

Physiography and Water Bodies

In the study area, the majority of the landforms are results of the movement of glaciers. The large spine known as Embarrass Mountain, the most prominent landform of the area, is the result of geological processes. Complex processes of erosion and climate, as well as man's use of the land, have modified the landforms. Since we are dealing with a relatively small and homogeneous area in terms of climate, we will not discuss its variable influences but will assume them to be uniform throughout the area.

The landforms have been grouped into distinct areas. This grouping has been done and is discussed from a geological point of view in a separate report for the Copper-Nickel Study, prepared by the Geological Society. They have divided the area into the following seven areas: Area A, the Shallow Bedrock-Moraine Area; Area B, the Drumlin-Bog Area; Area C, the Embarrass and Dunka Rivers Sand Plain Area; Area D, the Outwash-Moraine Complex; Area E, Embarrass Mountain-Taconite Mining Area; Area F, the Seven Beaver-Sand Lake Wetland Area; and Area G, the Aurora-Markham Till Plain Area. These areas are illustrated on the clear overlay for Figure 14.

Due to the predominance of the glacial

processes in the formation of the lands, the types and presence of water bodies is woven together with the total physiography as one element. We will therefore discuss the elements of landforms and water bodies together.

The landform that is described as Area A is the most frequent landform in the study area. On Figure 14, it is colored dark brown to represent the moraines, and green to represent the bogs. Moraines are defined as large hilly areas of rock and soil mixtures that were deposited as debris when the glacier melted or that were pushed along in front of the glacier as it advanced. In Area A the bogs are scattered among the moraines in a distinctive pattern. The moraines and hilly areas give a relatively rigid character to the land. Some rise as much as 50 to 75 feet above the surrounding flatter areas.

Deposits of greenstone lava are found in the area of Ely. They indicate the earliest period of volcanic action in the study area, predating the formation of Embarrass Mountain. The Laurentian Divide, on Figure 14, marks the limit of the fault of the earth during this first upheaval in the Early Precambrian Period. There are also outcroppings of gabbro throughout the southern portions of Area A indicative of the upheaval of

the earth in the Late Precambrian Period, marked by the fault line on Figure 14 as the Duluth Contact.

The Kawishiwi River is located in the northeastern and northern portions of the study area; while in the southern most portions, the St. Louis River is of major importance as a landscape element. The rest of the study area could be characterized as having numerous small creeks that cut through the bogs.

In Area D there is also a predominance of moraines, but they form more distinct rolling hills than in Area A because of a greater change in elevation between the hills and flat lands. The title of the area comes from the most distinct of all of these moraines, the Vermillion moraine. It is a terminal moraine or that landform which marks the furthest advance of the ice during a glacial period. It rises as much as 100 feet when compared to the surrounding land and is the second highest area of elevation, second only to Embarrass Mountain. Area D has several deep roundish kettle lakes with bedrock bottoms scattered throughout the area. The overall character of the northern portion of the area is much like the Boundary Waters Canoe Area, to the northeast of the study area.

Embarrass Mountain rises to 450 feet

above the surrounding area elevation and serves as the dominant landform that cuts through the study area in a south-westerly direction. This direction was determined by the upheavel and south-easterly tilt of the earth during the Middle Precambrian Period when the Algoman Intrusive Rocks such as slate and granite were formed. The upheavel also had significant influence on the formation of the ores. The area is now most distinctively marked by the iron ore mining processes associated with northern Minnesota. The northwestern face illustrates the mountain before the mining process. The southeastern face shows the landform after mining.

Area C is an outwash plain area that marks the floodplains of the melt waters of the glacier as it spilled over depositing layers of sands and gravel. On Figure 14 the areas can be distinguished by the light sand and reddish brown areas which represent the plains and rolling areas respectively. To the eye the land seems flat, but gradually is more rolling as it blends into the areas where there are moraines. The Dunka and Embarrass Rivers, with their tributaries, are found in the area.

Areas F and G are also quite flat but are characteristically boggy wetlands. Area F has two large lakes in its southern

portion while Area G has many small lakes, as well as a portion of the St. Louis River. Area G has some areas of outwash plains much like Area C, so would not appear to be such an extensive bog as is Area F.

Finally, Area B represents the Drumlin-Bog Area. The drumlins are colored golden yellow on Figure 14. It is an area of rolling hills, (drumlins have often been described as cigar shaped hills). The rounded hills rise 50 to 75 feet in an eighth to a quarter of a mile, then extend in a flat area for a half to a quarter of a mile before descending to the next valley. They were formed by glacial advance that predates the formation of the moraines, but the cause of their formation is not clear. In the valleys there are typically bogs, lakes or river beds. The Drumlins are the second most frequent landform of the study area.

The landforms have been described in terms of general shape and size, much as the mining components have been described. In addition, the colors and textures of the soils and rock masses influence the overall visual images. The dark browns of the peatlands and the slate grays and greens and browns contrast with the reds, yellows and blues of the ores.

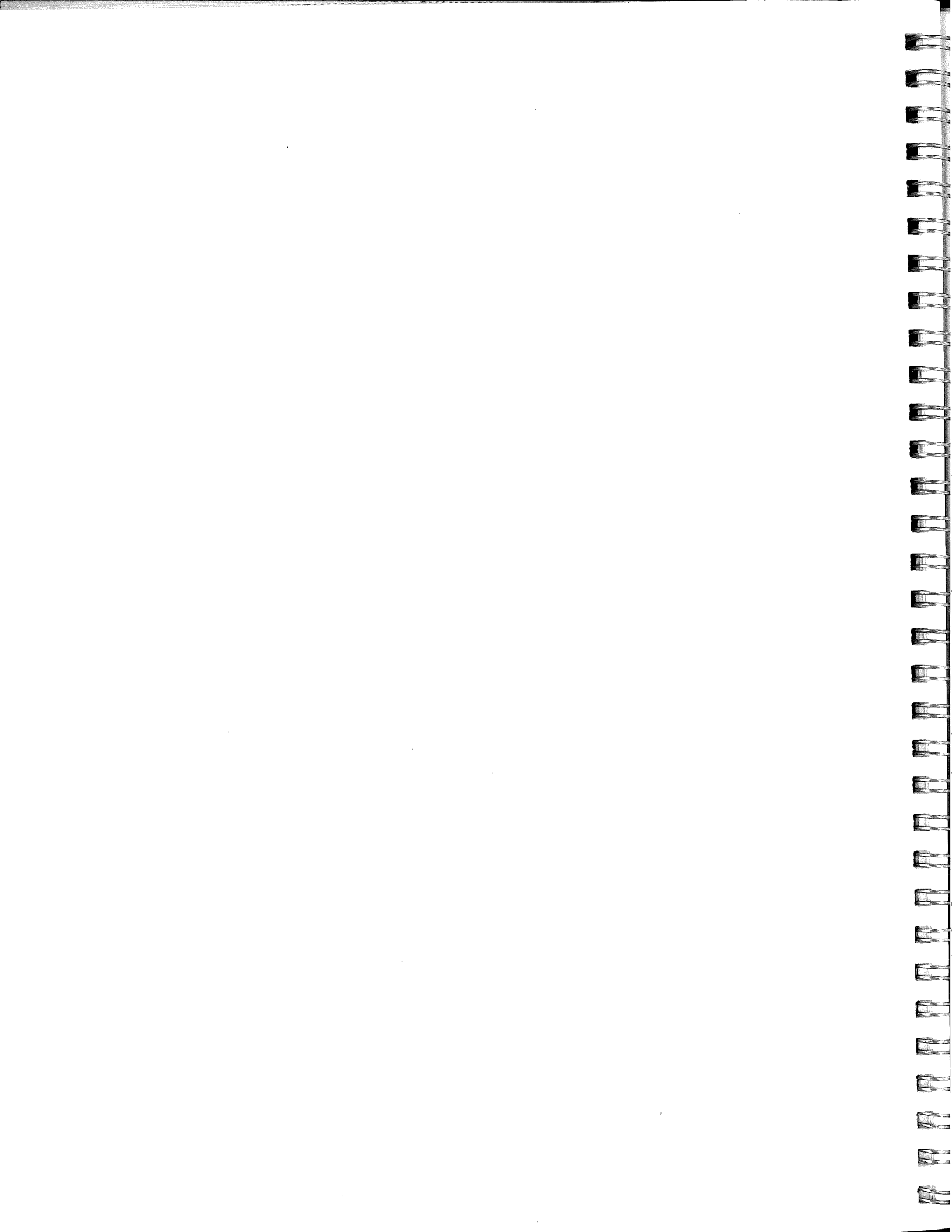

PHYSIOGRAPHY

- GROUND MORAINE
- TERMINAL OR RECESSIONAL MORAINE
- DRUMLIN
- OUTWASH
- ICE CONTACT DEPOSIT
- BOG
- LAKE
- MINING
- BEDROCK OUTCROP
- DATA UNAVAILABLE

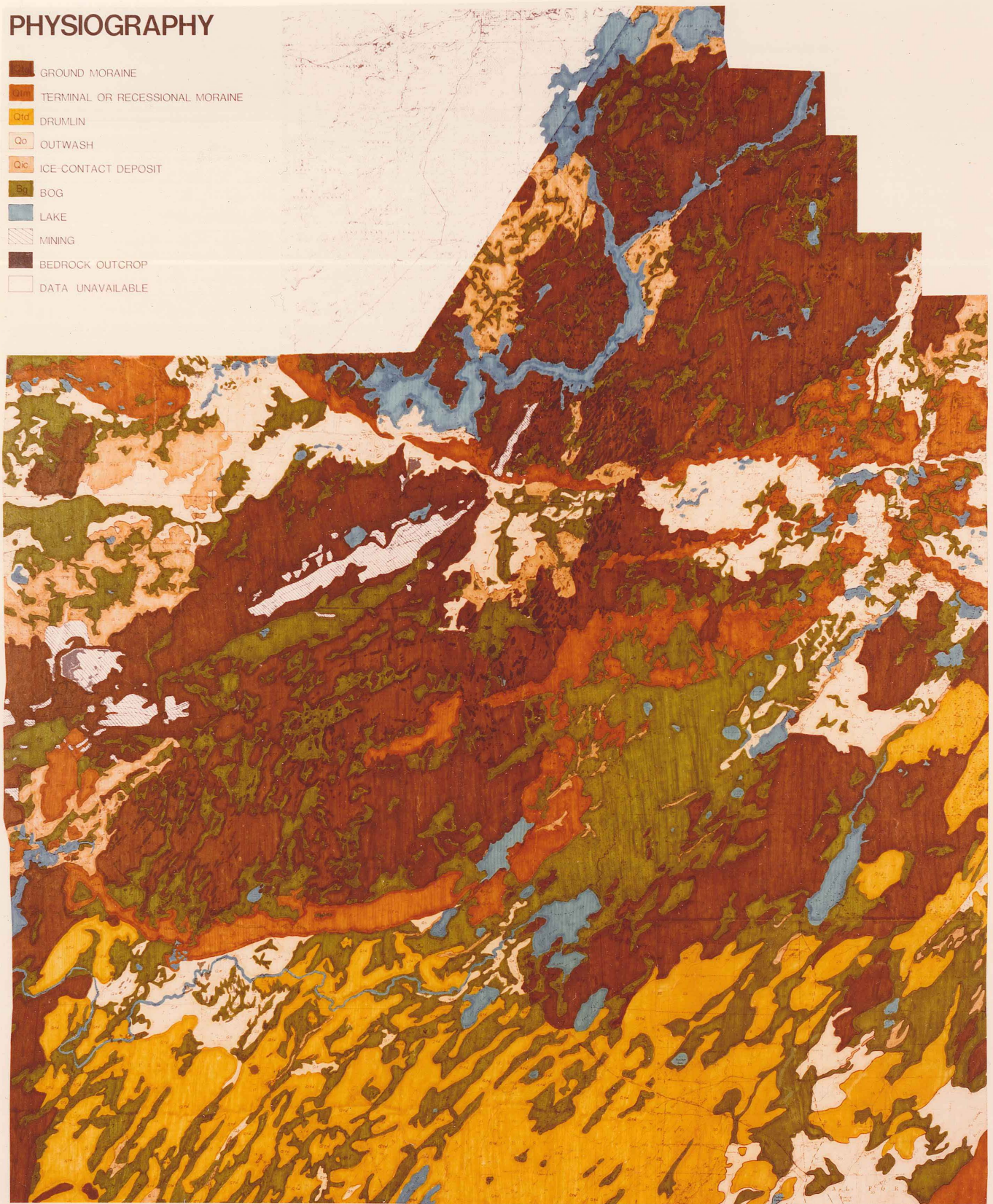

VISUAL ANALYSIS

MINNESOTA ENVIRONMENTAL QUALITY BOARD
COPPER-NICKEL PROJECT



MARCH 1978

Figure 14

PHYSIOGRAPHIC AREAS

- A SHALLOW BEDROCK-MORaine AREA
- B DRUMLIN-BOG AREA
- C EMBARRASS-DUNKA RIVERS SAND PLAIN AREA
- D OUTWASH-MORaine COMPLEX AREA
- E EMBARRASS MOUNTAINS-TACONITE MINING AREA
- F SEVEN BEAVER-SAND LAKE WETLAND AREA
- G AURORA-MARKHAM TILL PLAIN AREA
- a-a₁ LOCATION OF SECTIONS FOR COMPOSITES

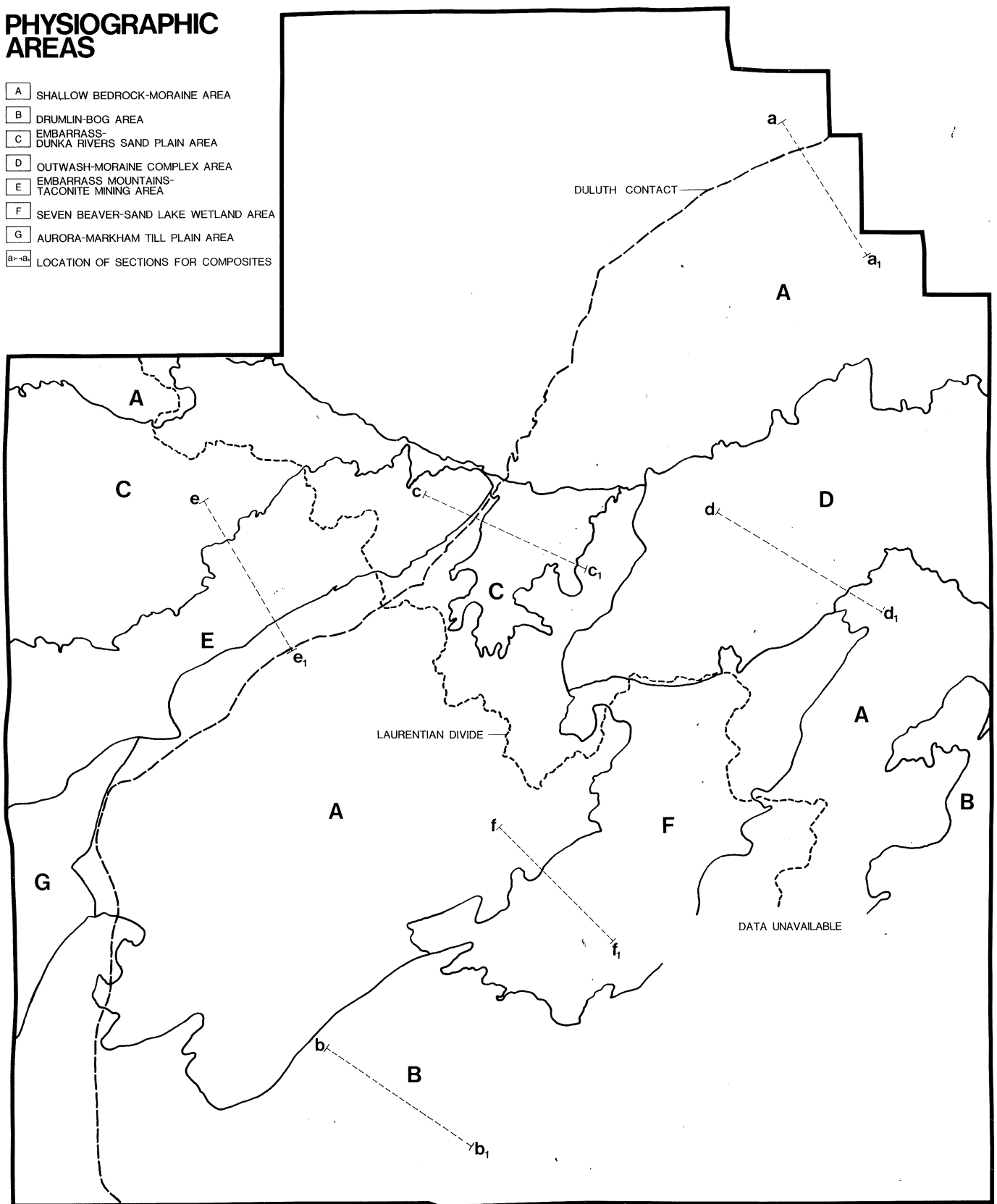

VISUAL ANALYSIS

MINNESOTA ENVIRONMENTAL QUALITY BOARD
COPPER-NICKEL PROJECT

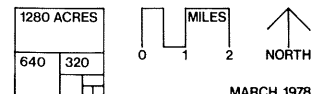

MARCH, 1978





Figure 14 (overlay)

Vegetation and Soils

The perceived shape of the landforms is often changed by the presence of vegetation. The type of vegetation may have major affects on accentuating or negating the landforms. This is especially evident in Areas A, F and G where the vegetation may hide the visual character of the land when seen at eye level.

Figures 15, 16, and 17 serve to describe the vegetative communities. The dominant vegetative types of the area have been taken from the Minnesota Land Management Information System (MLMIS) computer data information variables Map 23 for the Arrowhead Region. The MLMIS computer data is also being used in other analyses for the Copper-Nickel Study. Figure 15 is a computer print out enlarged to the appropriate scale for the study area. The data were interpreted from aerial photographs to show areas of predominant forest cover types. The data represent a broad regional overview and could be said to represent the general predominance of a community-type over a very large area. It is not site specific. Areas may have been forested or cleared since the recording of the data and may not be reflected on this map.



The types of vegetative communities in



the area are most frequently aspen-birch represented by the tree symbol  and spruce-fir represented by . There are large areas of pine communities represented by , and lands that are labeled unproductive  or nonforested , where nonforested means there is some active use of the land for development. There are no hardwood communities recorded in the area.

The aspen-birch communities alter the perception of the landform seasonally while the dense form of the evergreen communities have year round effect, serving as a permanent natural screen.

Figure 16 illustrates a regional overview of the types of soils within the study area. It was interpreted to the computer data stored in the MLMIS data system as variable 15, and was taken from the Soil Conservation Service - soil associations maps. As was true for the vegetation information, the data represent generalizations of those types of soils found in the study area. Soils associations maps show the landscape areas where the same soil type, mixed in the same pattern are found. The same types of soils may occur in another area. If they are in a different pattern they are part of a different association. A sample taken at any spot may not show all of the soils of the association, but many samples taken over

a large area would result in a high proportion of that association.

The soils associations that are most frequent in the study area are soil types 7, 8 and 9 symbolized respectively by the following symbols:    . They are generally described as undulating to hilly soils. They are relatively neutral soils, with moderate drainage characteristics, suited to plants that require some drainage such as the pines, firs, softwoods and hardwoods.

There are also large areas of peat soils such as Greenwood soil type or Moose-lake soil type symbolized respectively by  and the symbol of the house  . These soils are highly saturated with high organic content. They are highly acidic soils and are poor for any kind of use. Acid loving plants would thrive on the soils.

In addition to these soils, south of the Laurentian Divide, there is a predominance of soil type 5 described as wet-undulating and symbolized by  . These soils, while being neutral base, are saturated. Plant materials like alder and willow would thrive on these soils.

North of Embarrass Mountain and west of the Duluth Contact line there are

large areas of soil type 26 described as undulating and symbolized with a diamond  . These soils are neutral and fairly well drained.

There are several other types of soils which occur infrequently in the study area. We have shown them as "other soils" in the legend, and because of their infrequent occurrence we will not identify nor discuss them by type.

By combining data from these two data sources, more information on the vegetative communities can be obtained. It is portrayed in Figure 17. This map represents an interpretation of the vegetation from Figure 15. Within areas of one vegetation type there may be large areas of different soils types as found by overlaying the soils types with the vegetation types. The potential influence of the soils on the composition of the communities is reflected in this figure to show a more detailed refinement of the vegetative communities. Where there are wetter more acidic soils, like soils 57 and 58 located in areas of aspen birch dominance from the cover map, there are likely to be cedar, fir and spruce mixed into the complex of species. Marsh areas will probably be sedges and lowland brush types (type D on Figure 17). These areas that are

marked spruce-fir on the vegetative cover map, Figure 15, are likely to be true black spruce or peat marshes (Type E on Figure 17). Areas where soils are neutral and that have better drainage but are cover-typed with spruce-fir are likely to have a predominance of fir alder and birch mixed fir (Type C on Figure 17). Areas of pines from the vegetation cover map that occur over the wetter and more acidic soils are likely to have aspen and birch mixed together in the stands, (Type B). Type A is the pure pine stand.

More detailed data is available within part of the visual analysis study area to check the accuracy of the interpretations made in developing Figure 17. When compared to the data from the more detailed study done by the Department of Natural Resources (MDNR) for the "detailed study area" marked on Figure 17, there is a high correlation of data which serves to support the interpretations. Comparison of the MDNR Detailed Study Legend below to the Figure 17 Legend shows the greater level of refinement provided within each vegetative community by the MDNR study.

Figure 17 Legend

- A - Pine/fir
- B - Aspen/birch/
jack pine
- C - Mixed forest
- D - Spruce/cedar/
fir
- E - Black spruce/
spruce-peat
lands
- F - Lake
- G - Nonproductive
- Not recorded

MDNR Detailed
Study Legend

- R - Red pine
- W - White pine
- E - Ash, elm,
maple
- A - Aspen, birch
- H - Hazel
- J - Jack pine
- N - Mixed aspen,
pine, fir
- E - Ash, elm,
maple
- C - Cedar
- G - Grass or open
- O - Marsh
- Q - Mixed spruce,
balsam
- B - Spruce, fir
- D - Lowland
shrubs
- K - Nonproduc-
tive swamp
(peat)
- S - Black spruce
- T - Tamarac
- B - Spruce, fir
- L - Open water
(lake, etc.)
- i - Industrial &
residential
- P - Planted
- F - Farm

Subdividing the information in Figure 17 into the areas discussed in the Physiography section, we can make some comparisons of the visual character of the vegetation of these areas.

The vegetation in Area A is highly diverse with mixed conifers, pure pine stands, and mixed deciduous. The complexity of the visual environment is increased by this added complexity in the vegetation.

Looking at Area B, the portions of vegetation emphasize the landforms in the southwesterly directions. The tops of the hills have aspen-birch communities with pines, while the valleys are marshes and bogs with spruce and fir.







Area C is characterized as having large aspen areas and areas of pines with mixed conifer and aspen-birch areas scattered throughout, but not in such a complex mixture as is evident in A.

There is an obvious divide in the vegetation types in Area D, marking where there are soils changes. The northern portion with drier soils has pines and aspen-birch communities, while the southern portion shows largely mixed conifers and true black spruce swamps on the more acidic soils.

Area E has a predominance of one community group--the aspen birch-type.

Both Areas F and G have largely black spruce and mixed conifer types of cover.

VEGETATION I

-  WHITE, RED, JACK PINE
-  SPRUCE-FIR
-  ASPEN-BIRCH
-  UNPRODUCTIVE
-  NON-FORESTED
-  MAPLE-BIRCH-BASSWOOD

SOURCE: V23-NEW FOREST COVER TYPE
MINNESOTA LAND MANAGEMENT
INFORMATION SYSTEM

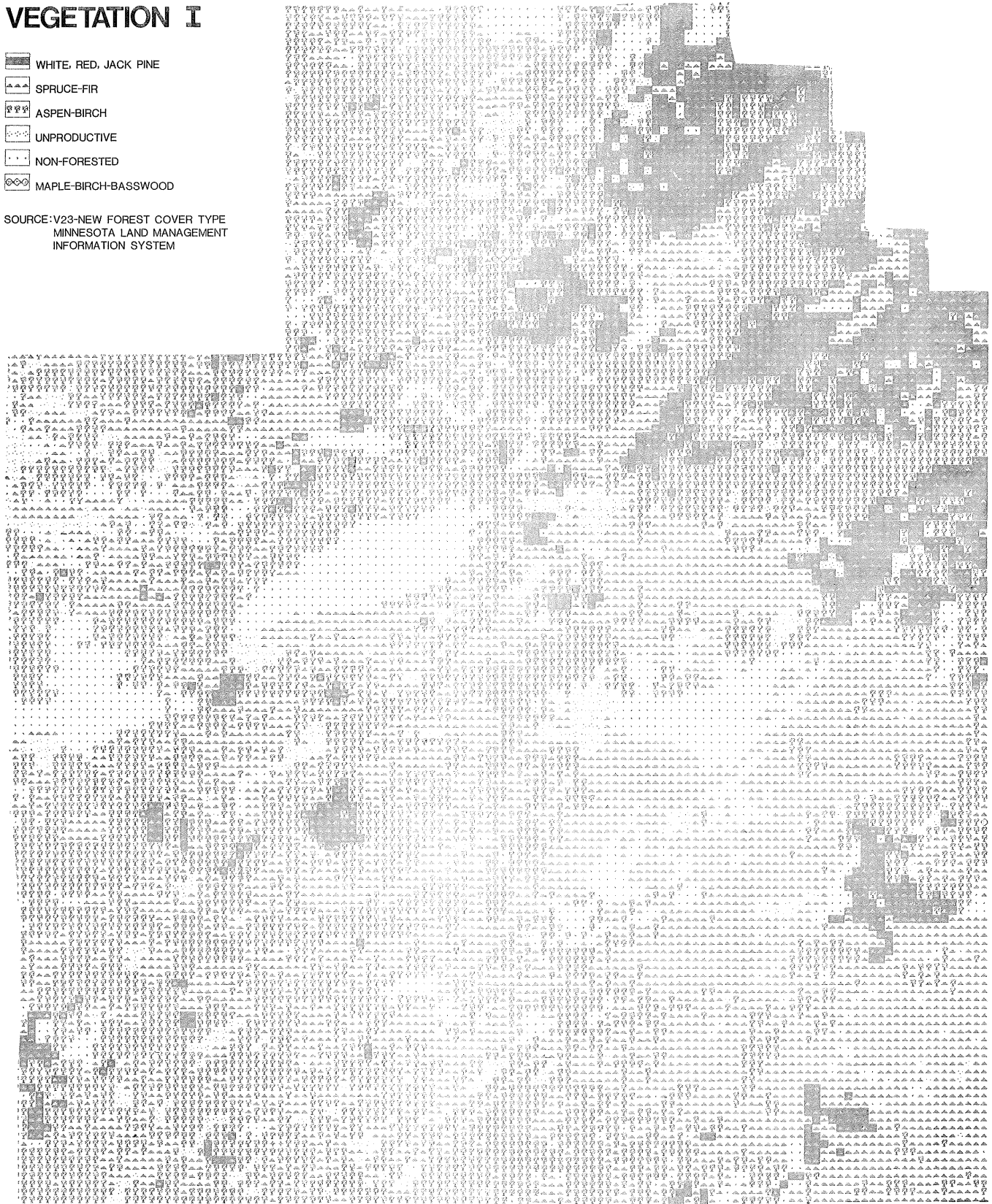

VISUAL ANALYSIS

MINNESOTA ENVIRONMENTAL QUALITY BOARD
COPPER-NICKEL PROJECT







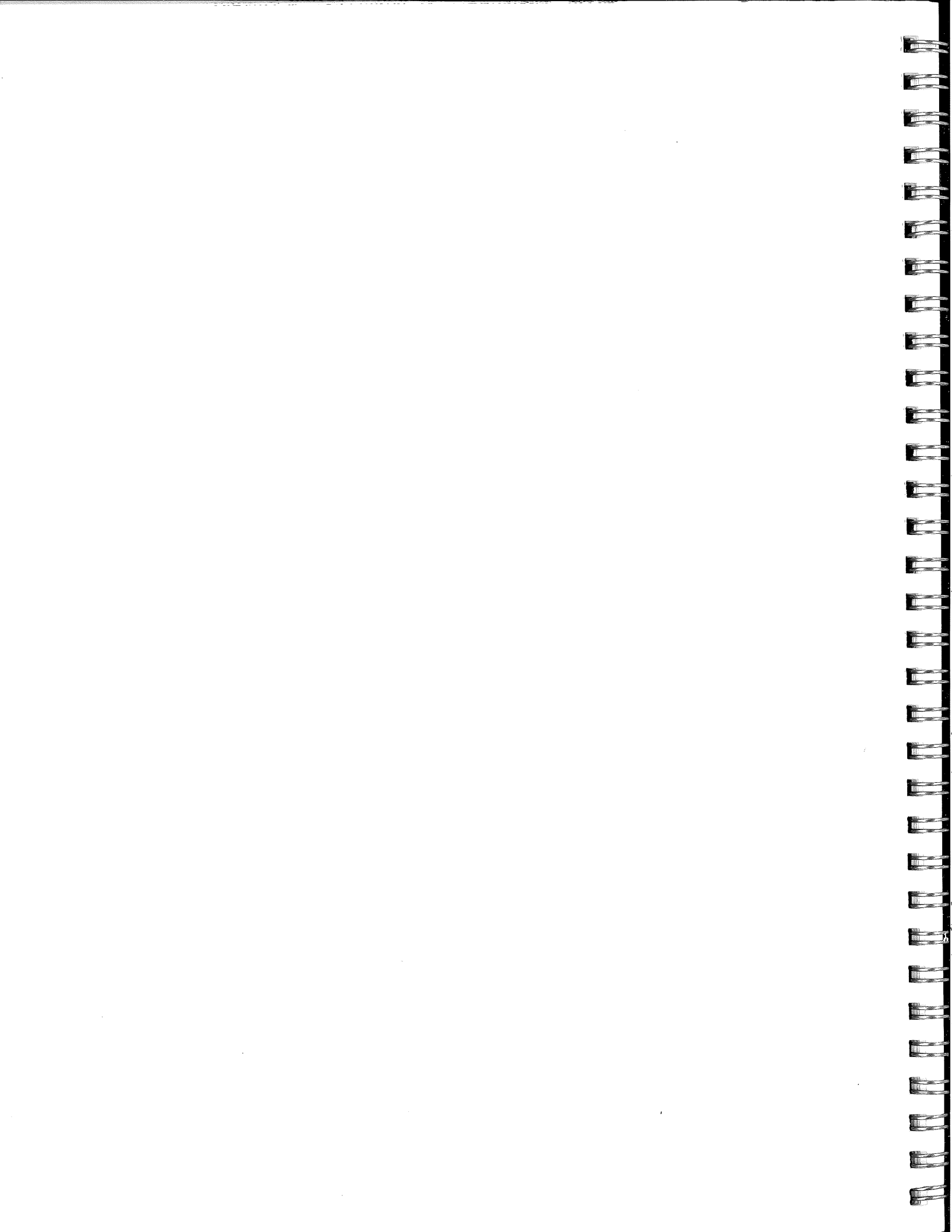















MARCH, 1978

Figure 15



SOILS

-  WET UNDULATING
 -  UNDULATING TO STEEP UNDIFFERENTIATED
 -  UNDULATING TO HILLY
 -  UNDULATING TO HILLY
 -  UNDULATING
 -  NEARLY LEVEL
 -  NEARLY LEVEL
 -  MINE
 -  WATER
 -  WATERSHED BOUNDARY
 -  a-a
-  OTHER SOILS
 -  NEARLY LEVEL
 -  UNDULATING
 -  UNDULATING
 -  NEARLY LEVEL
 -  UNDULATING
 -  UNDULATING
 -  UNDULATING
 -  UNDULATING
- SOURCE: V15 SCS SOILS
MINNESOTA LAND MANAGEMENT
INFORMATION SYSTEM

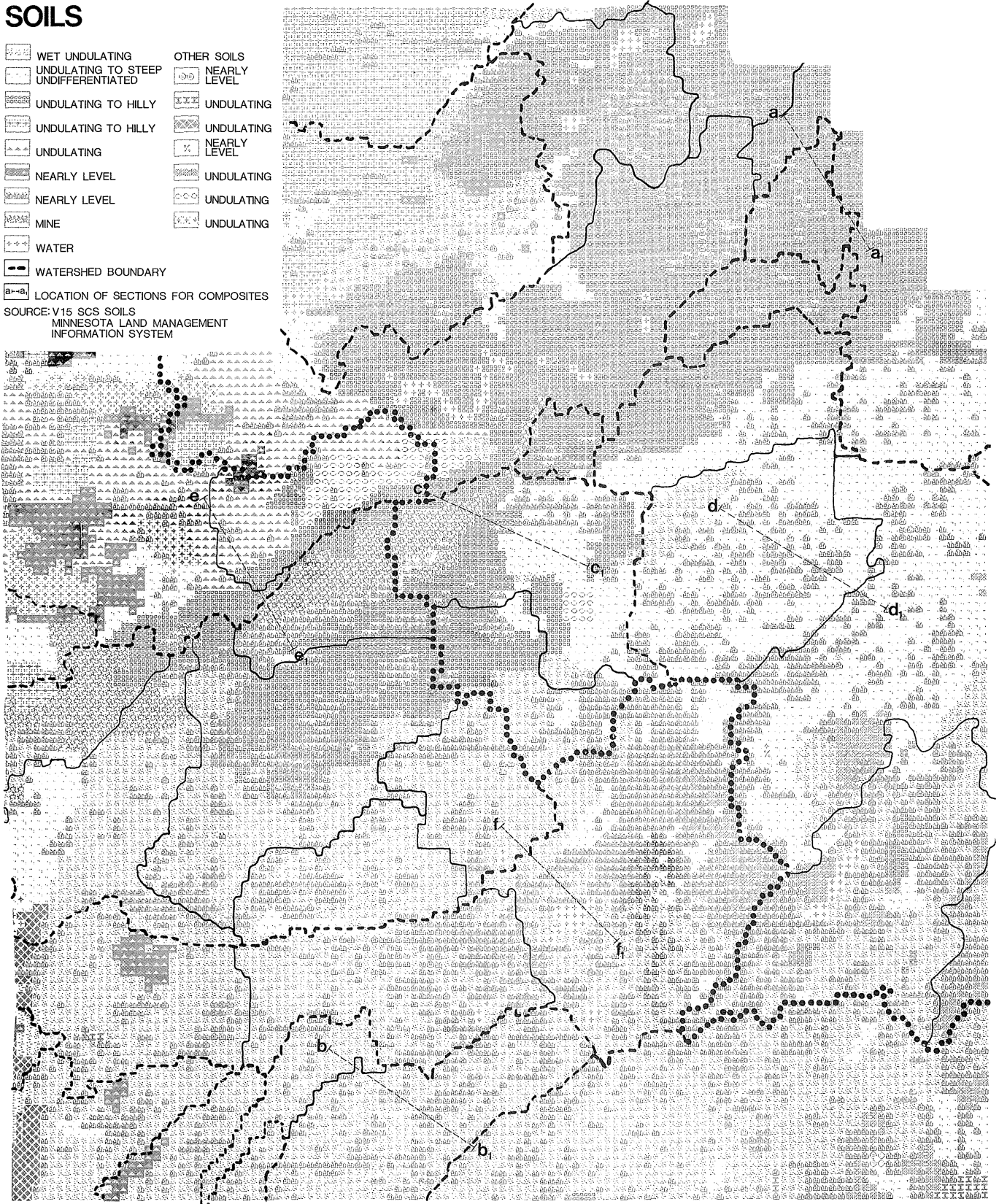

VISUAL ANALYSIS

MINNESOTA ENVIRONMENTAL QUALITY BOARD
COPPER-NICKEL PROJECT



1200 ACRES

640 320

0 1 2 MILES







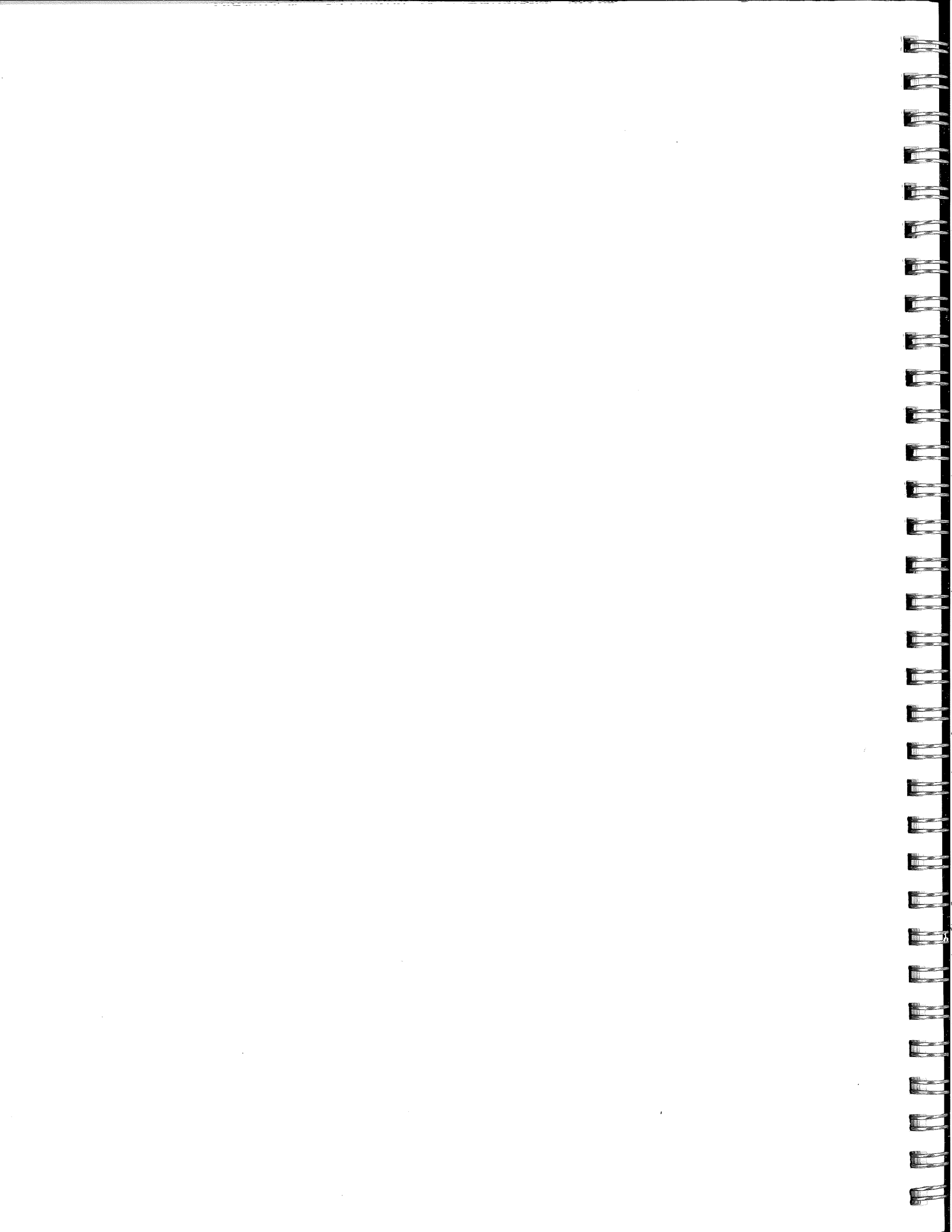

↑ NORTH

MARCH, 1978

Figure I6



VEGETATION II

-  A-PINE/FIR
-  B-ASPEN/BIRCH/JACK PINE
-  C-MIXED FOREST
-  D-SPRUCE/CEDAR/FIR
-  E-BLACK SPRUCE/SPRUCE-PEAT LANDS
-  F-LAKE
-  G-NONPRODUCTIVE
-  LOCATION OF SECTIONS FOR COMPOSITES

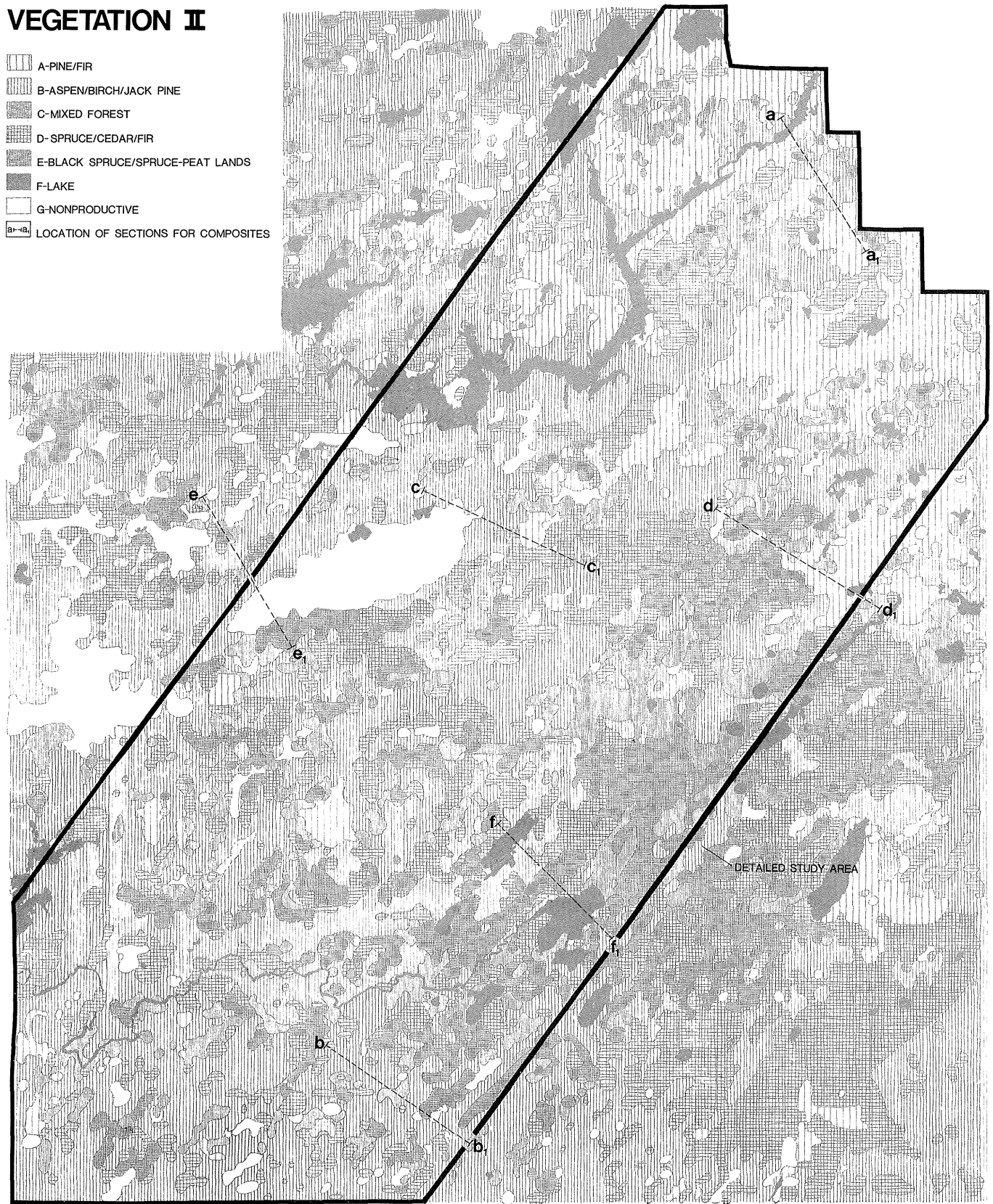

VISUAL ANALYSIS

MINNESOTA ENVIRONMENTAL QUALITY BOARD
COPPER-NICKEL PROJECT

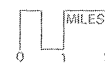

MARCH, 1978

Figure 17

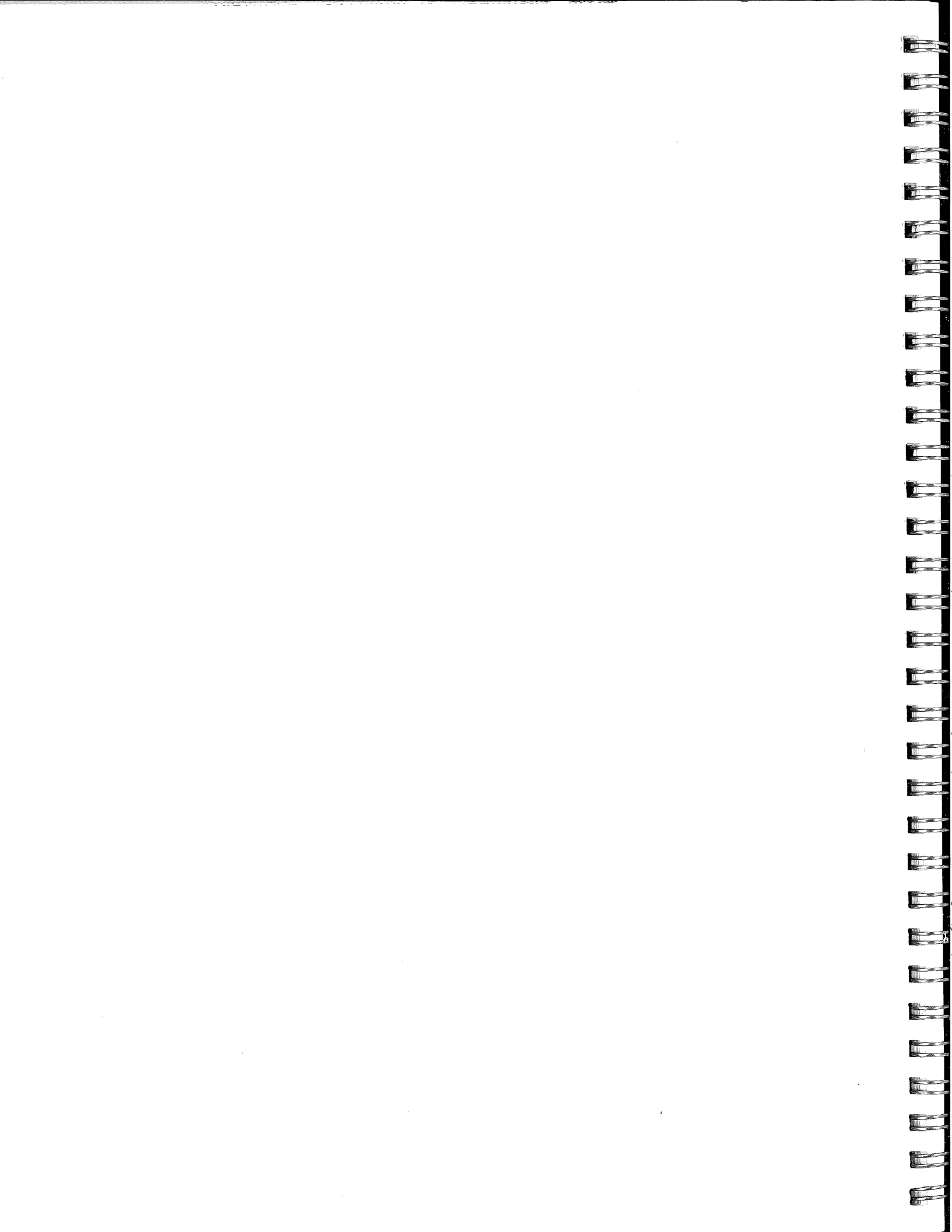





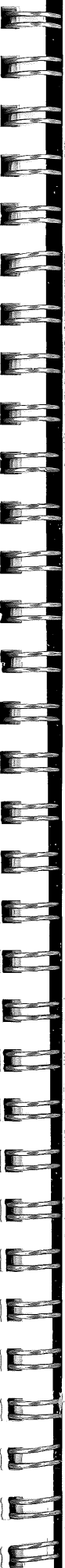

Development

Man has visually altered the natural landscape through various forms of development. The mining in Area E represents the extreme effects of these development activities. In the rest of the study area, as Figure 18 illustrates, there is relatively little existing development except roads, railroads and some small mining towns.



DEVELOPMENT

-  CITY
-  ROAD
-  RAILROAD
-  PLANT AREA
-  MINING
-  LOCATION OF SECTIONS FOR COMPOSITES

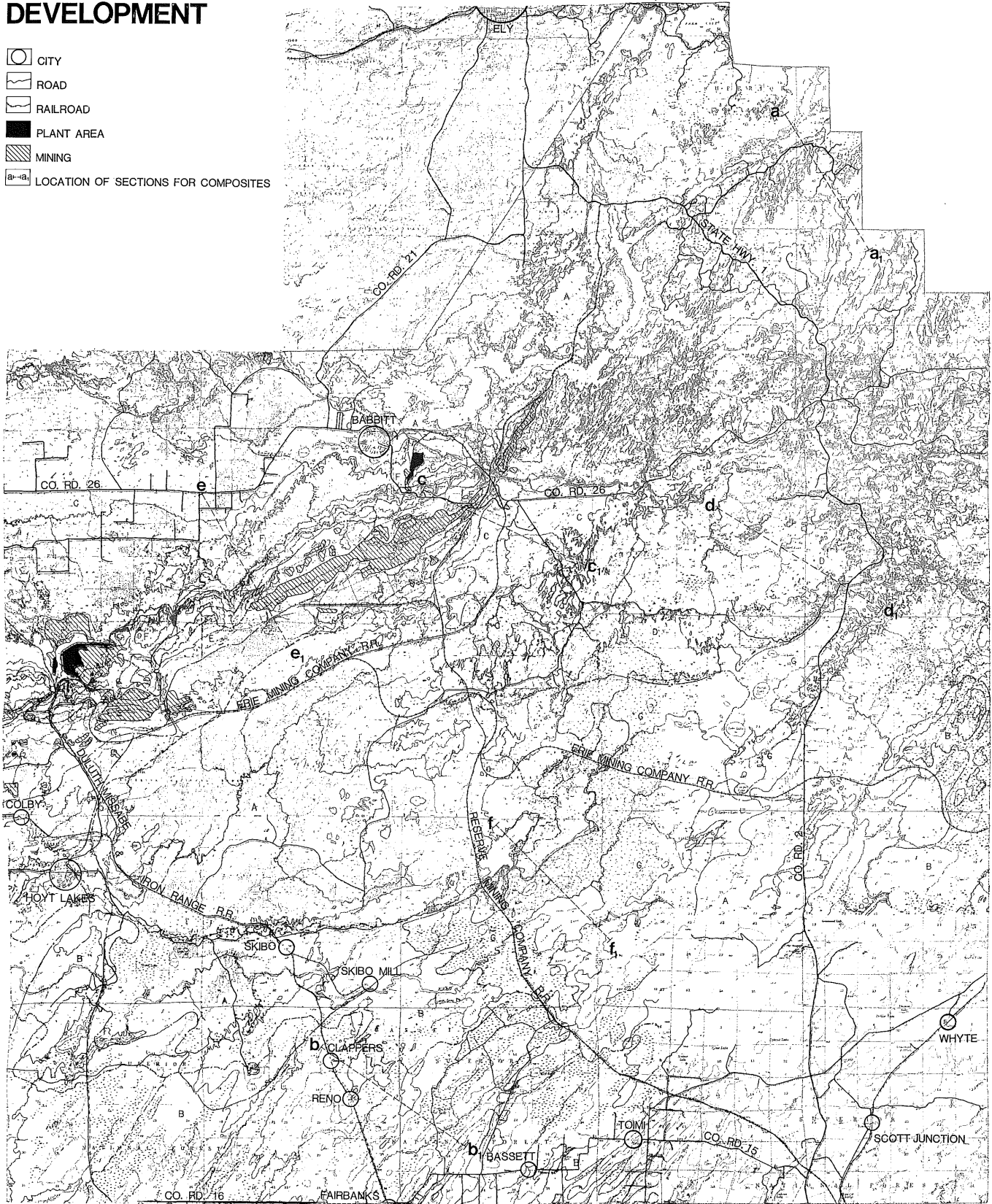

MINNESOTA ENVIRONMENTAL QUALITY BOARD
COPPER-NICKEL PROJECT

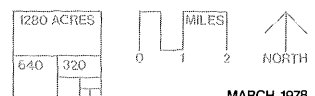

MARCH, 1978

Figure 18

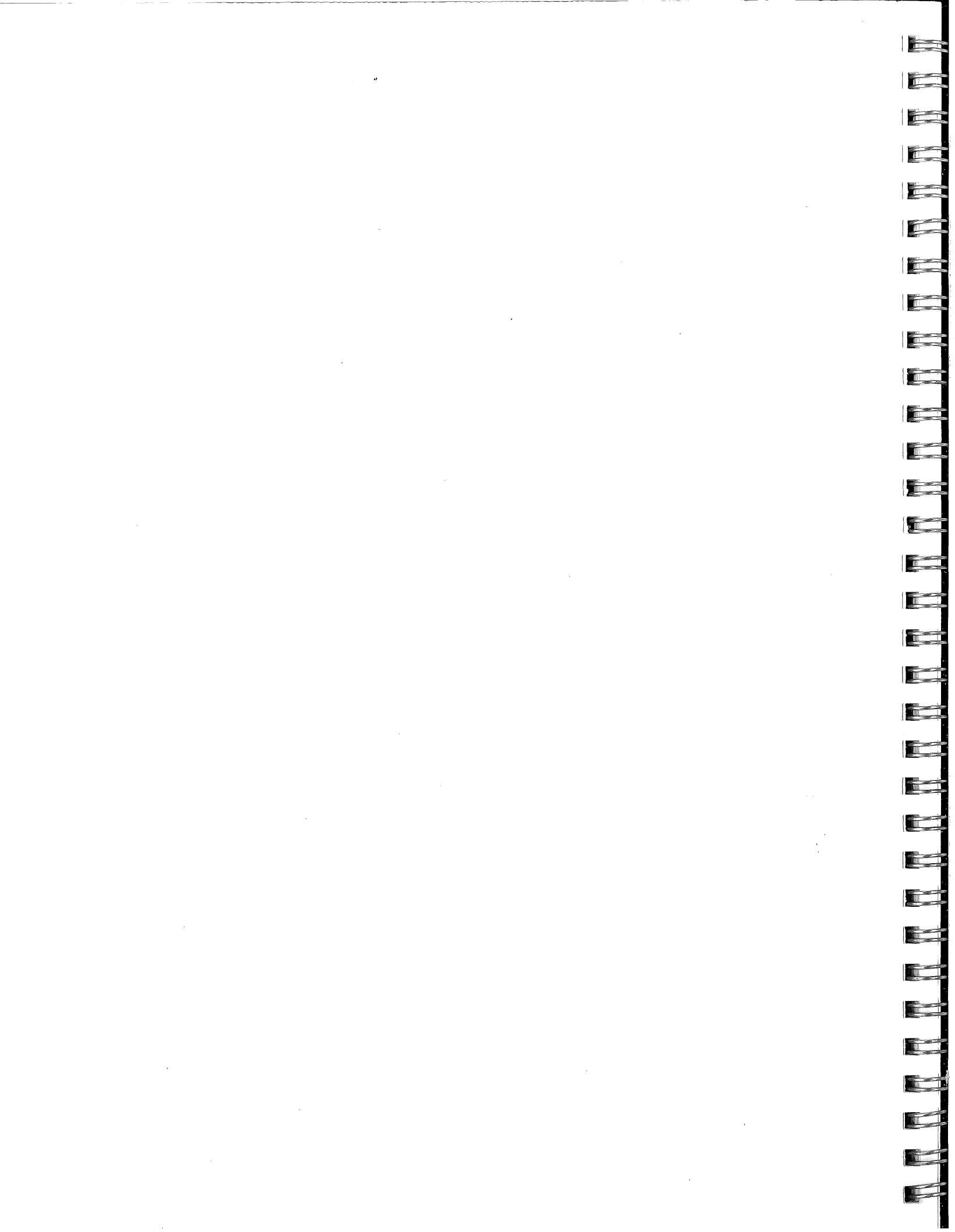

Landscape Composites

To illustrate the composite of the landforms and vegetative relationships, Figures 19, 20, and 21 are presented. These cross-sections illustrate the composites of landforms and vegetation. Their locations are illustrated on Figures 14, 16, 17 and 18.

Each section shows the characteristic landscape composite of the area and the character of its interface with adjacent areas. The top section which is delineated with vegetation shows a 10 to 1 exaggeration of the landforms to illustrate the potential influence of that form on perception of other forms. The smaller darker section below shows a 1 to 1 relationship, or true section of the same area, to show the real character of the land form as seen by the eye. The scales below the sections show the information that was taken from Figures 14 and 16 to describe the composite character of the section while referring it back to individual elements of the area in plan. Since the cross-sections occur almost totally within the MDNR "detailed study area," we have shown the more refined vegetation data on the scales and have illustrated the vegetative images accordingly.

Figure 19 shows Areas A and B. The rugged and complex character of Area A contrasts with the rolling hills and repeated vegetation types of Area B.

Figure 20 shows sections of the flat outwash plain area of C located up against the Embarrass Mountain area on one end and the gradually rolling transition into the moraines of A on the other end. The pines and lowland brush as well as the stunted black spruce give the area an open character. Area D, by contrast to Area A, is an area where the moraines are drawn out over the land negating their effect. The Vermillion Moraine seems inconsequential by comparison. Much of the area is shown as open marsh.

Finally in Figure 21 sections through both Embarrass Mountain and Area F are shown. (The portion of Area G that occurs in the study area would look like F.) In studying the section for Area E as it changes into Areas C and A, there is a marked contrast in the elevation from C to E, but not as marked from E to A. The section illustrating Area F shows it as flat and swampy with the greatest density of vegetation cover of all the areas.

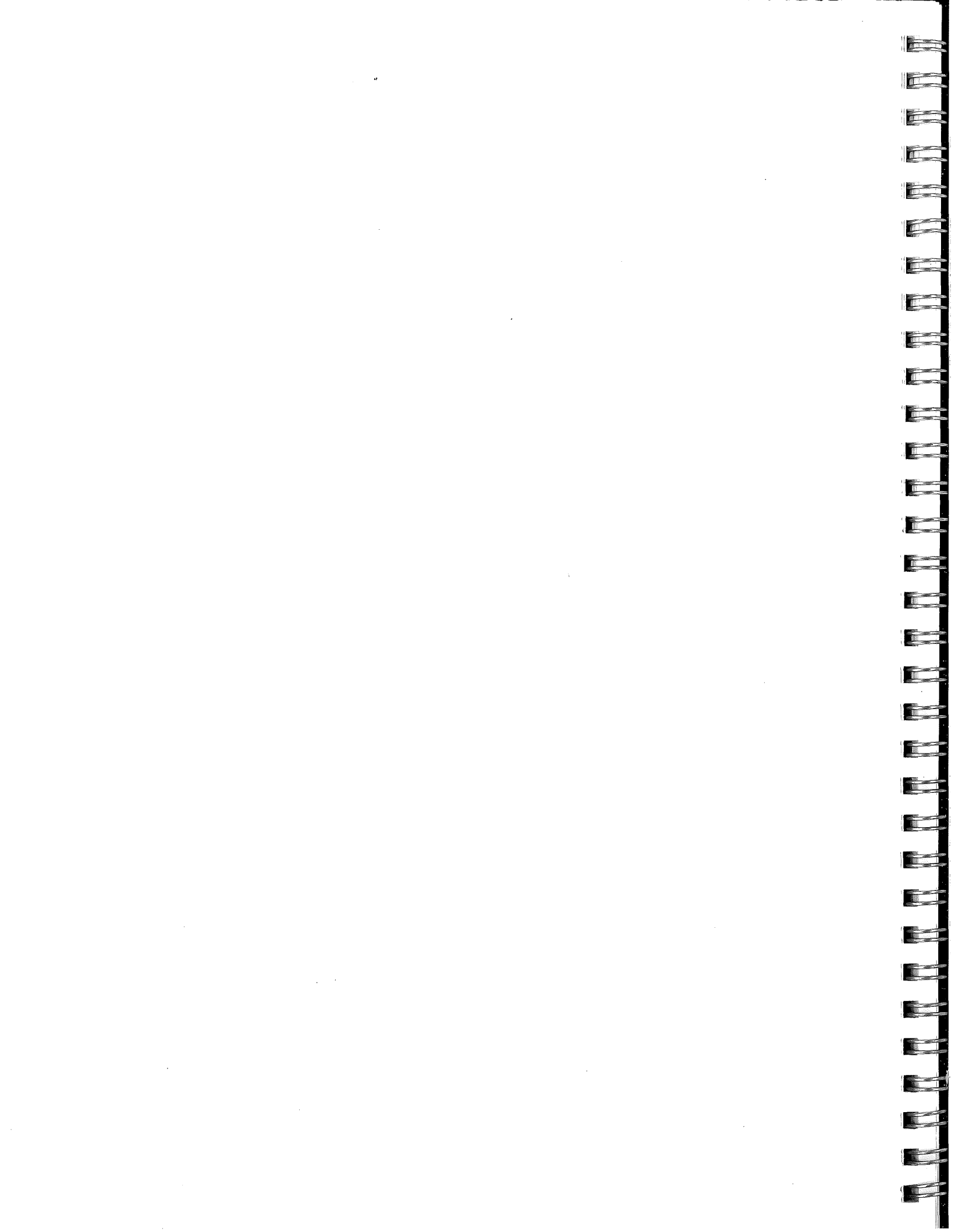

SECTION a-a₁

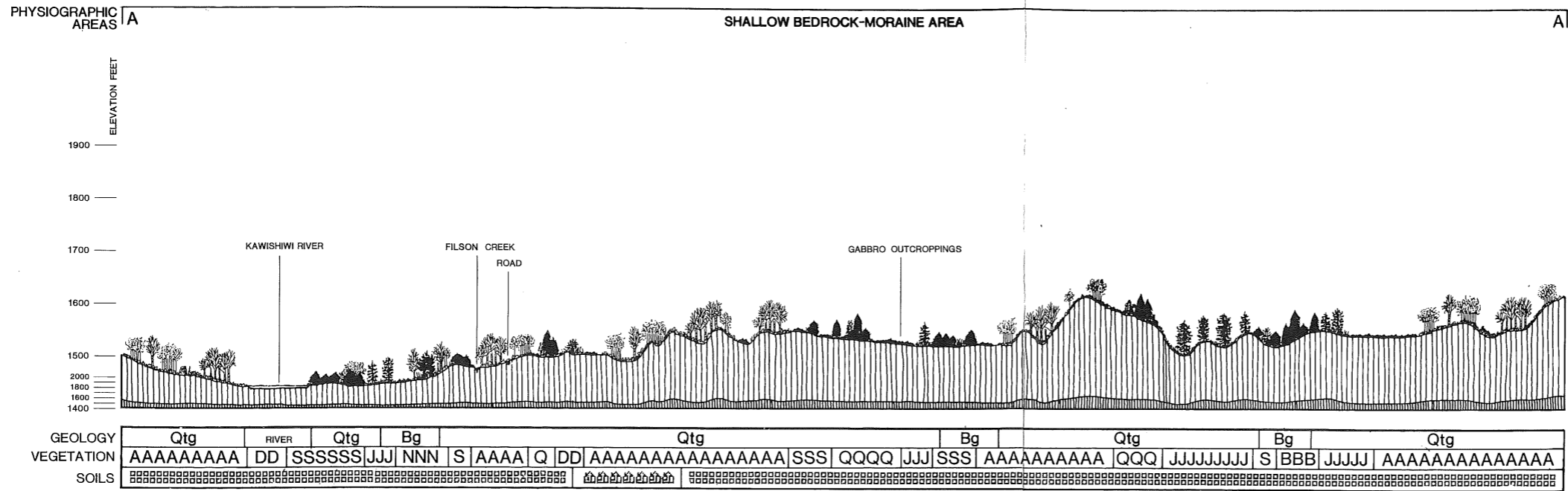

SECTION b-b₁

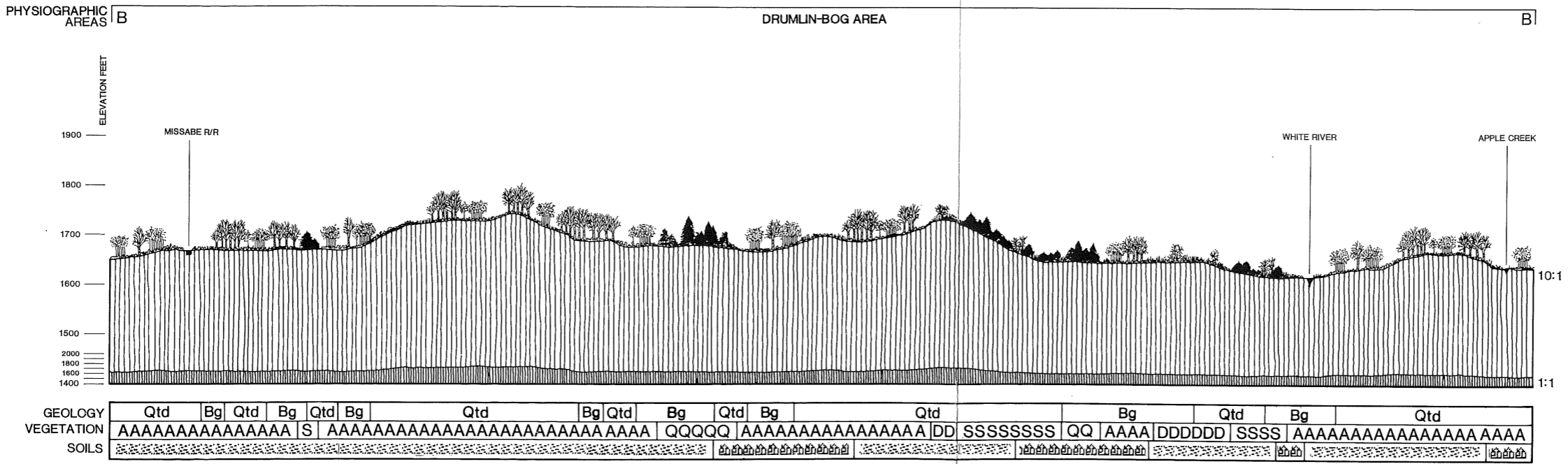

LANDSCAPE COMPOSITES

VISUAL ANALYSIS

MINNESOTA ENVIRONMENTAL QUALITY BOARD
COPPER-NICKEL PROJECT

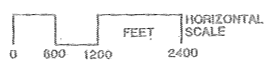

MARCH, 1978

Figure 19

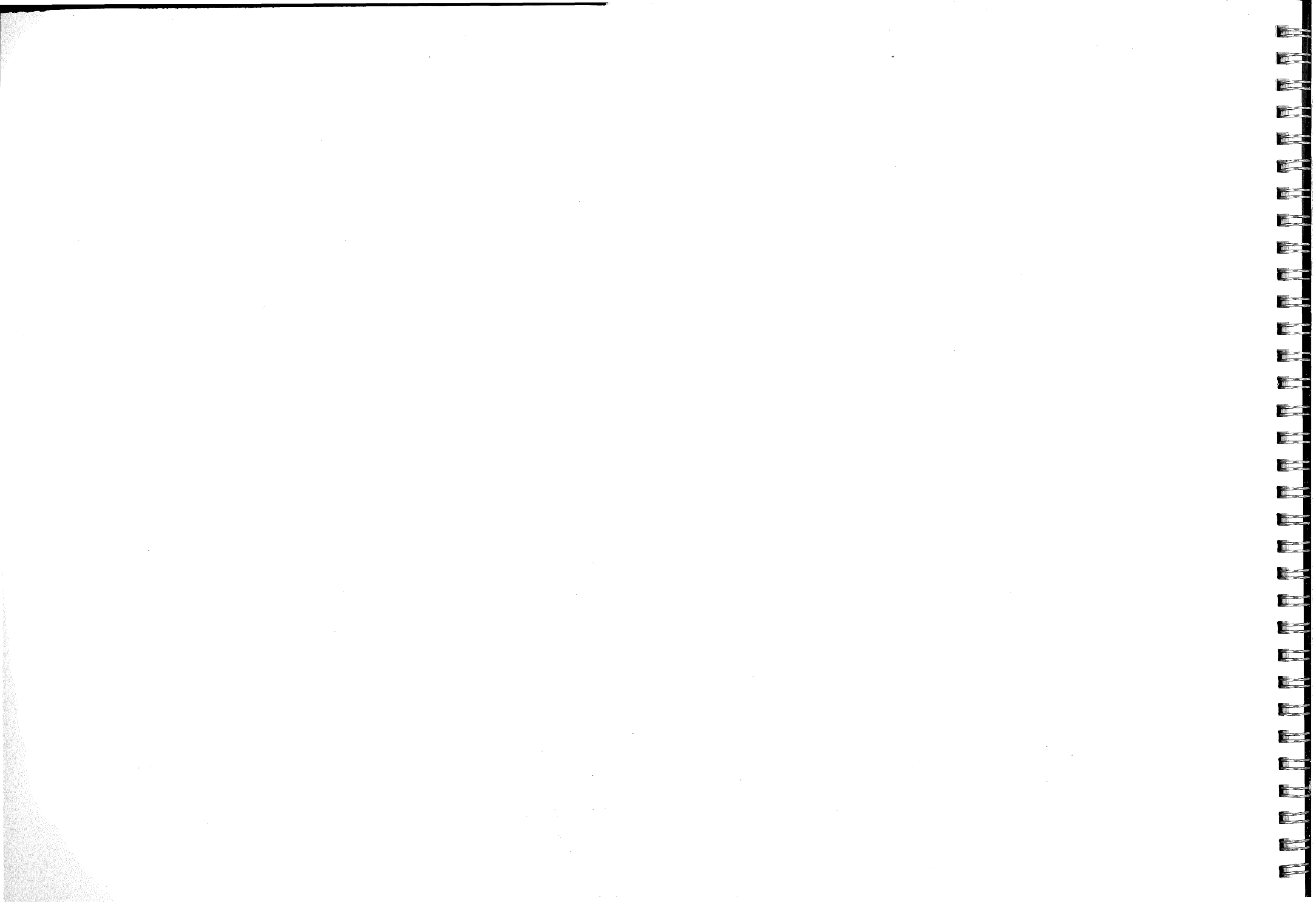

SECTION C-C₁

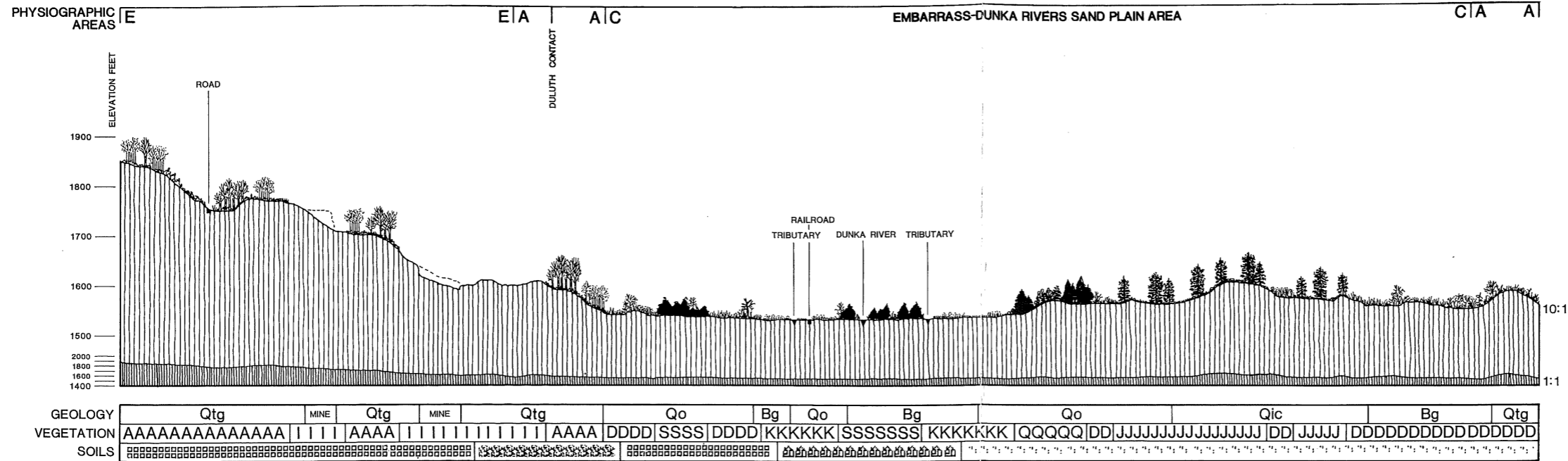

SECTION d-d₁

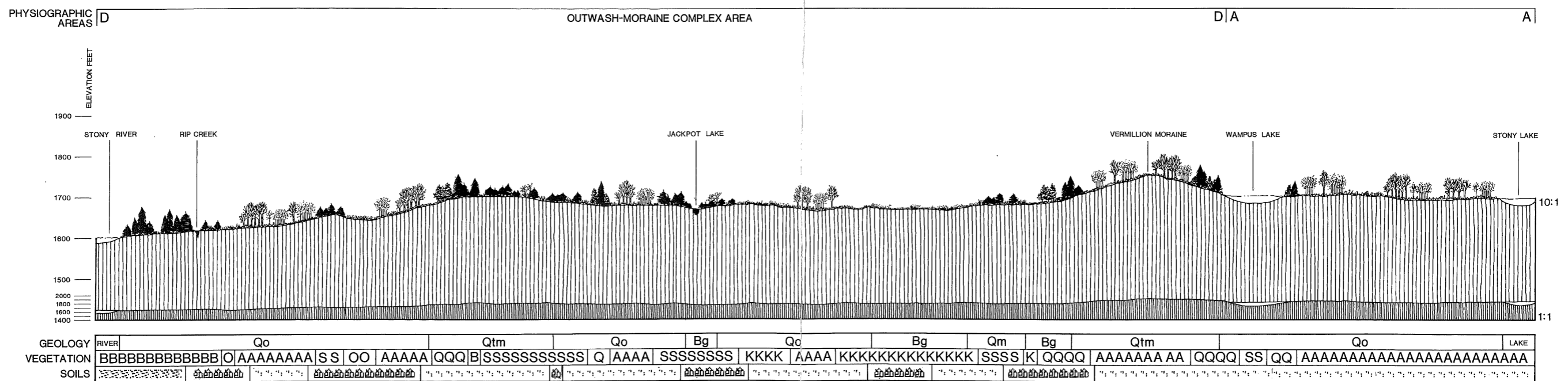

LANDSCAPE COMPOSITES

VISUAL ANALYSIS

MINNESOTA ENVIRONMENTAL QUALITY BOARD
COPPER-NICKEL PROJECT

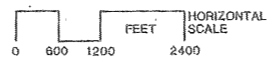

MARCH 1978

Figure 20

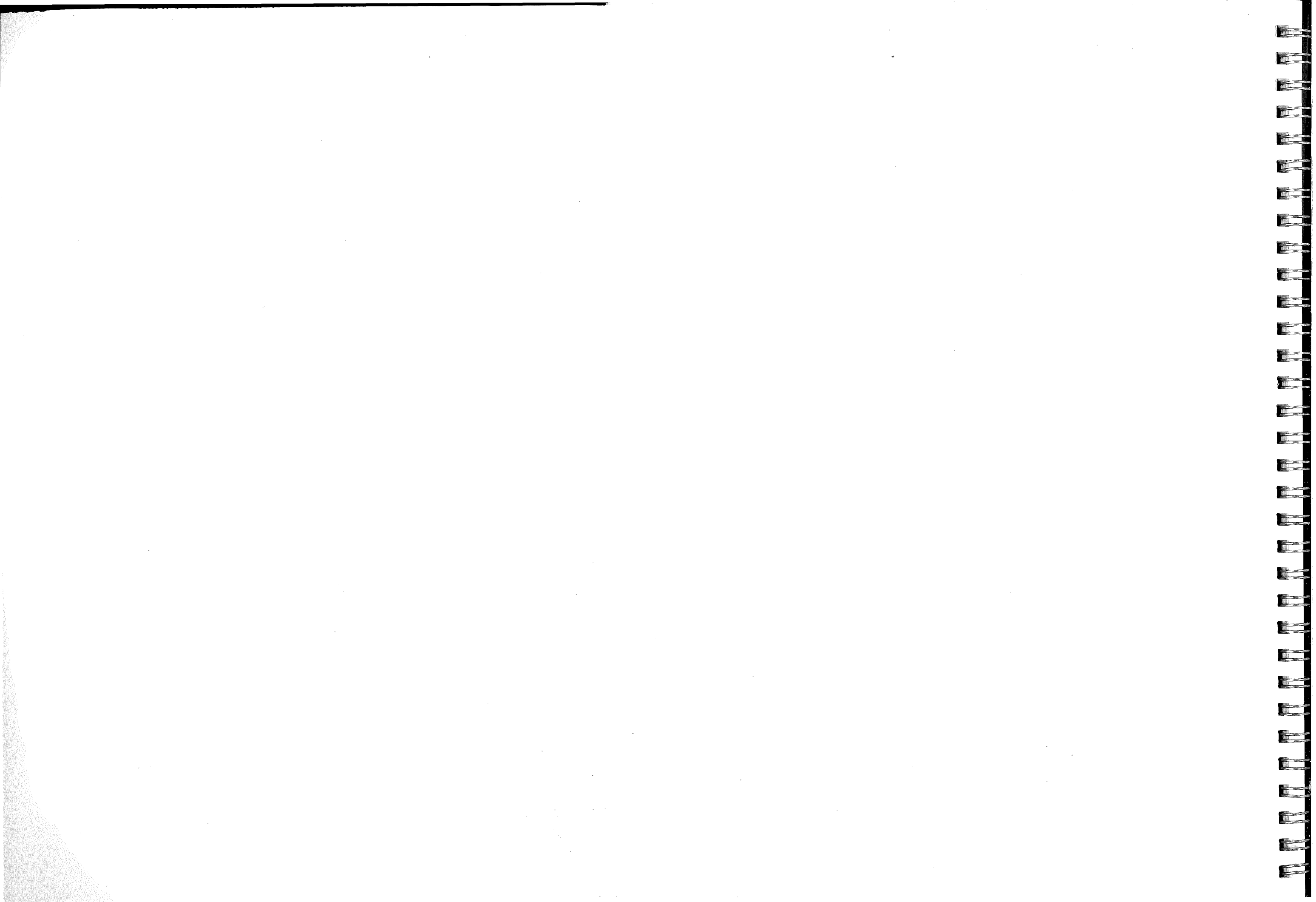

SECTION e-e₁

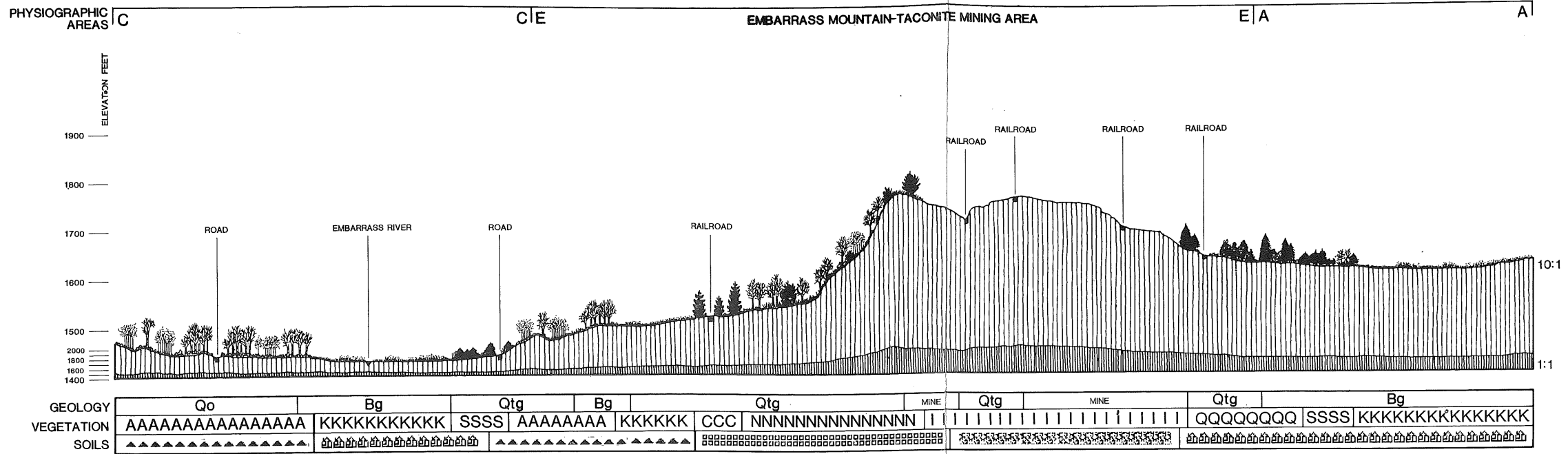

SECTION f-f₁

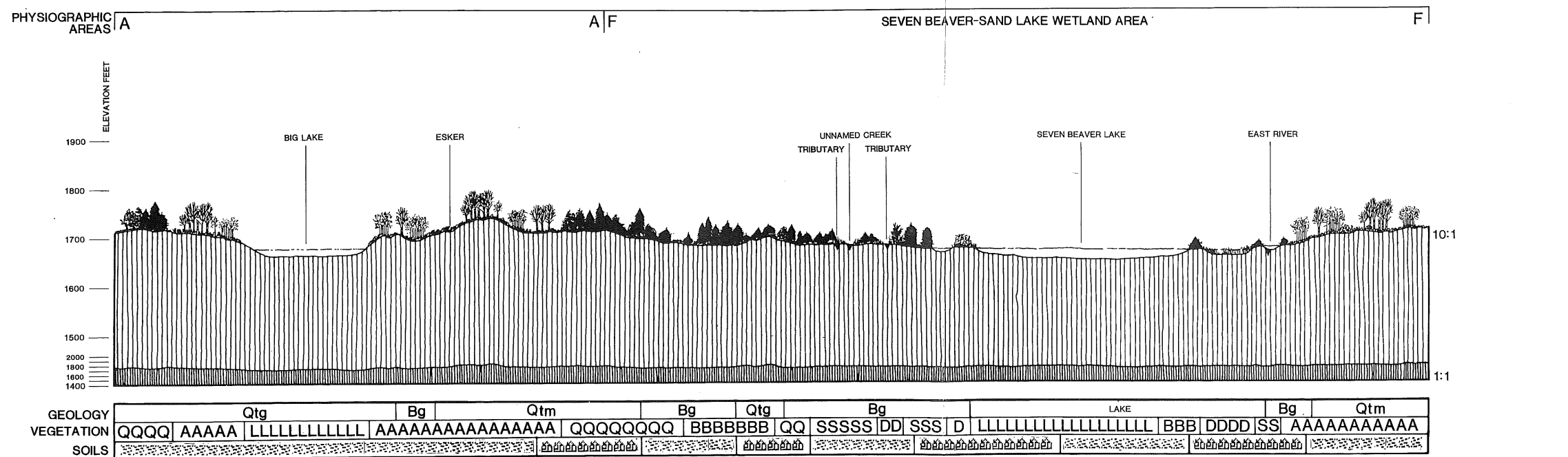

LANDSCAPE COMPOSITES

VISUAL ANALYSIS

MINNESOTA ENVIRONMENTAL QUALITY BOARD
COPPER-NICKEL PROJECT

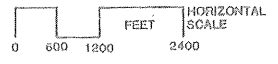

MARCH, 1978

Figure 21

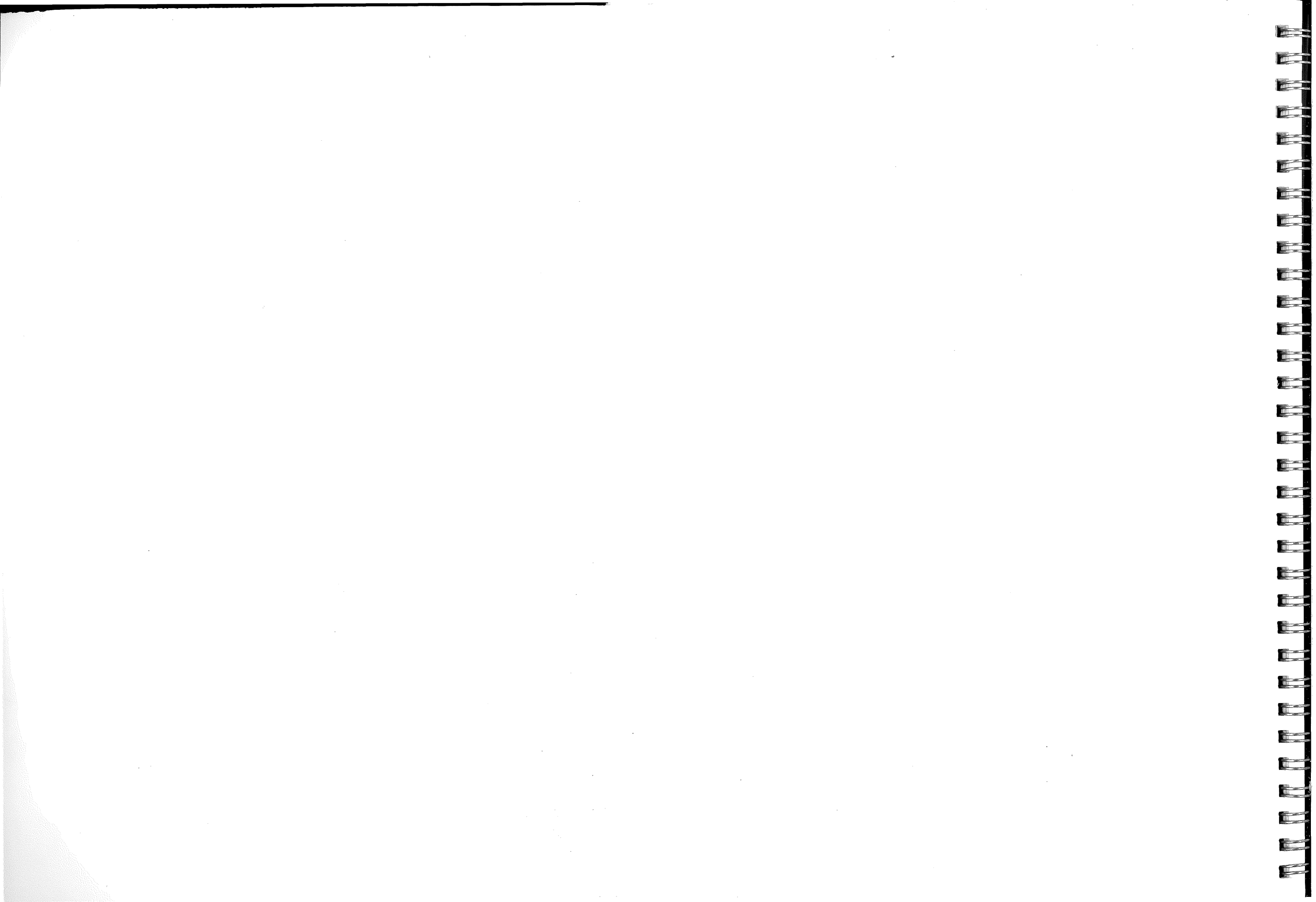

Visual Conditions

Figure 22 shows perspectives of the visual forms of the land. These perspectives translate the landscape element composites into examples of visual conditions which are present in the study area. The perspectives have been vertically exaggerated, similar to the exaggeration used for the landscape composite sections. The vertical exaggeration makes it possible to illustrate the landforms, which in reality are somewhat flatter.

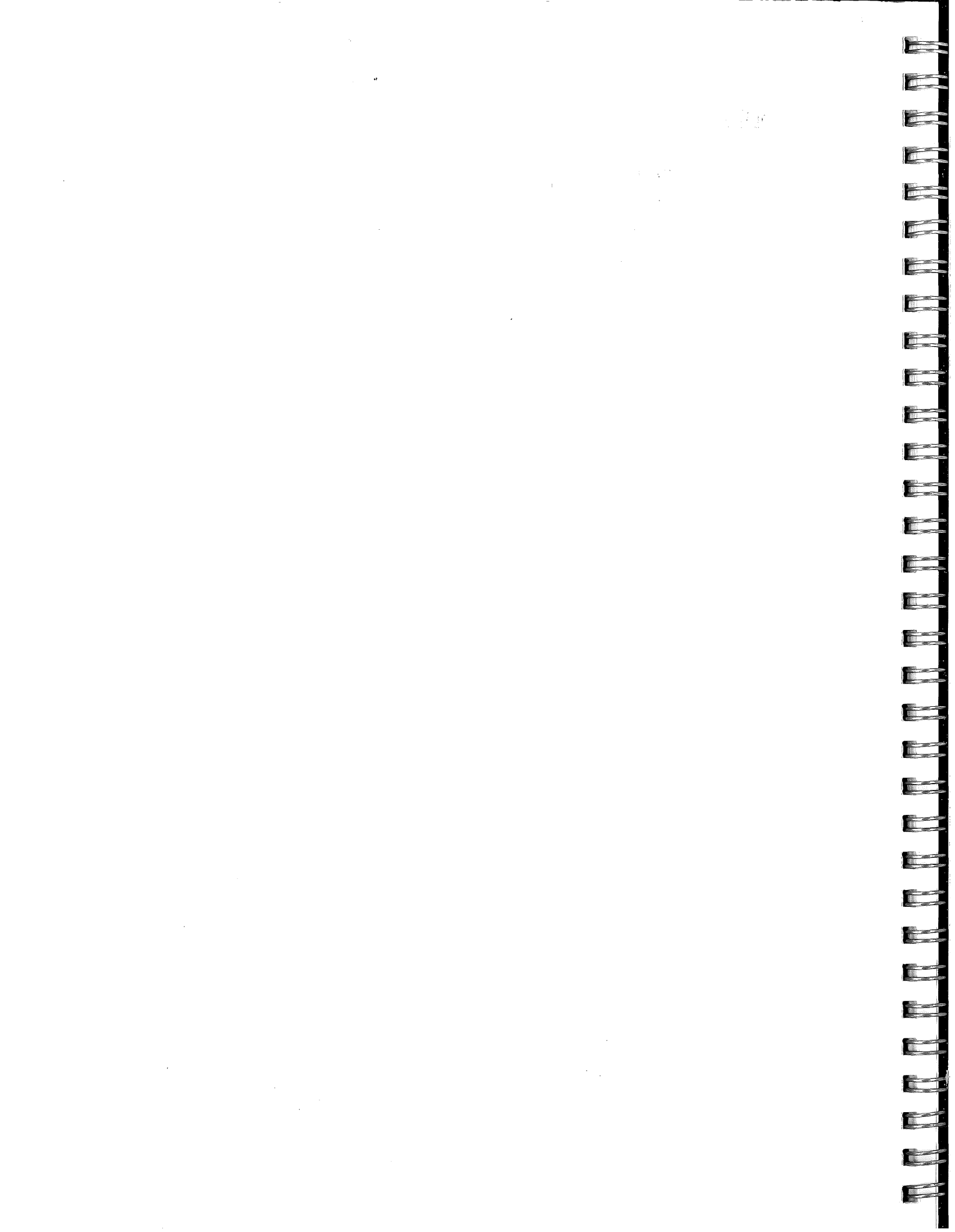

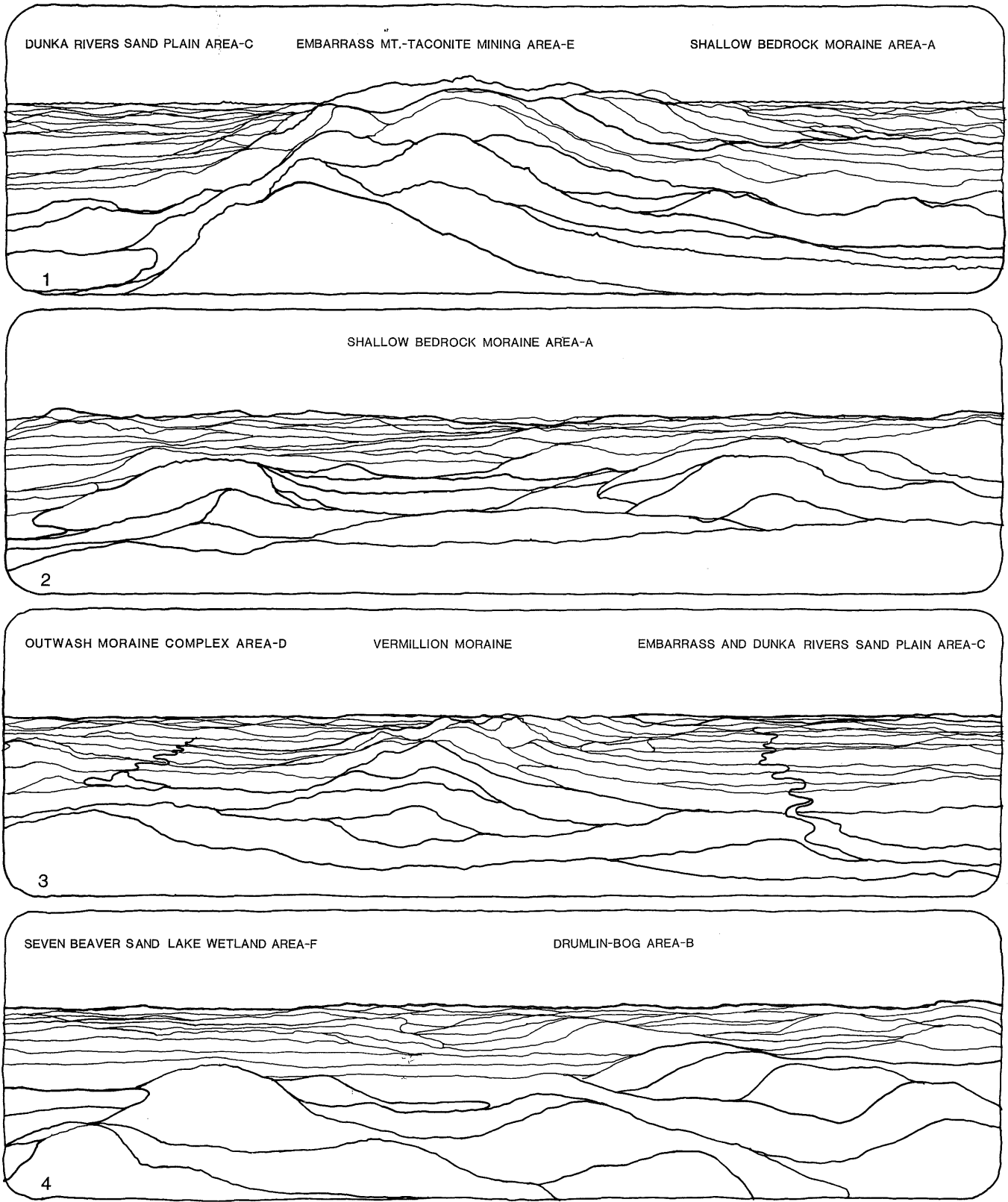

STUDY AREA LANDSCAPE VISUAL CONDITIONS

VISUAL ANALYSIS



MINNESOTA ENVIRONMENTAL QUALITY BOARD
 COPPER-NICKEL PROJECT

MARCH, 1978

Figure 22

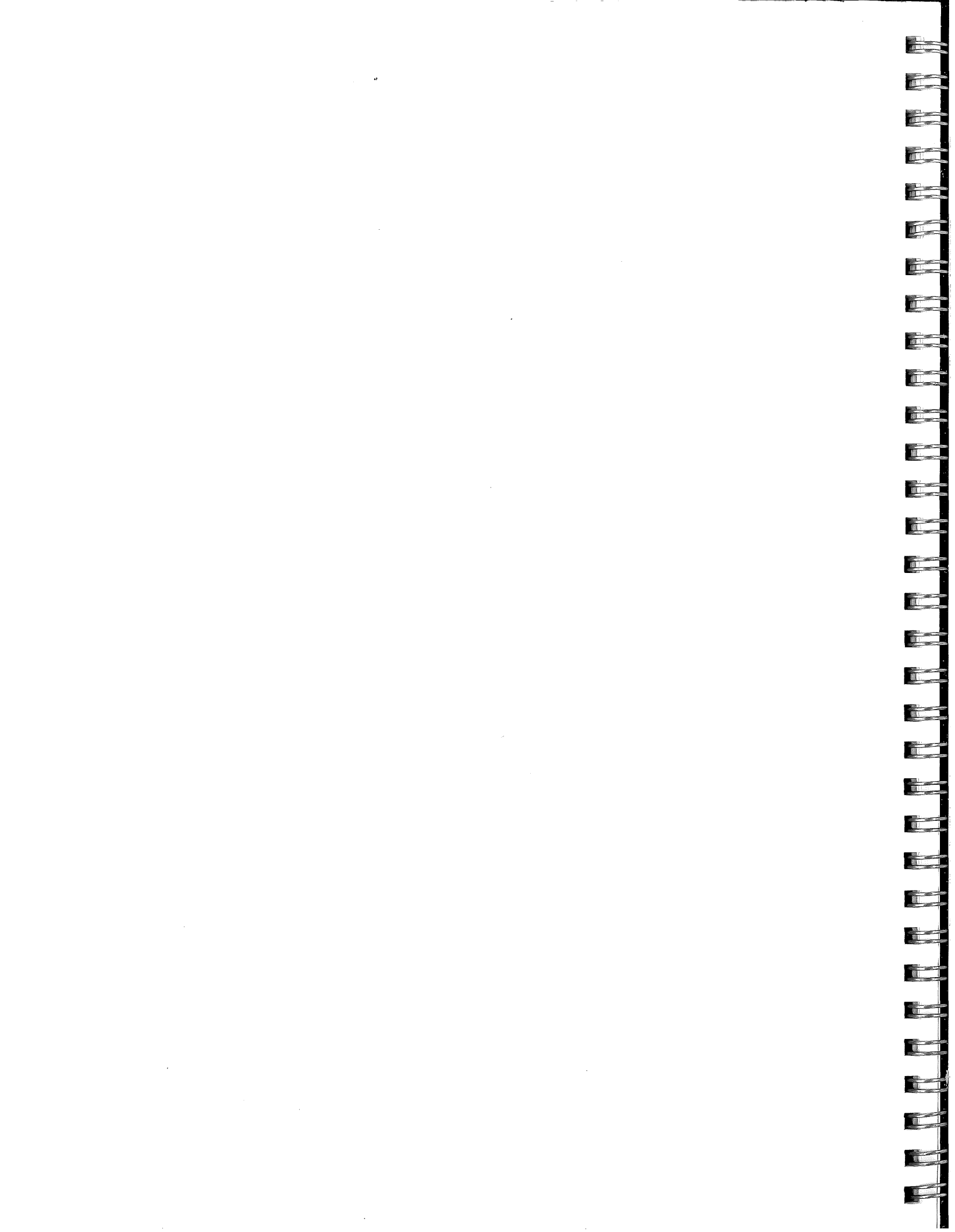

FOUR

VISUAL DESIGN CRITERIA

With the understanding of the design limits of copper-nickel mining components and with the illustration of the range of probable study area visual conditions, it is now possible to establish visual design criteria; which if followed will allow the State to control the amount of visual change which copper-nickel mining will cause to the study area.

The criteria deal with design on two levels: regional design of the study area, which we shall call siting or location; and design of the components themselves.

These criteria are meant to be used as a preview of what the visual change to a site under consideration for component location would be. With the use of these criteria the relative visual desirability of siting the component can be assessed and balanced against other siting forces.

These criteria are the basic design principles, which if applied, will minimize the visual change which component siting would cause to the existing visual environment. The automatic application of these criteria will not assure a visually acceptable environment. Visual aesthetic acceptability depends upon the public

belief that copper-nickel mining is necessary and beneficial. With that understanding, the design criteria have been developed upon the following premises:

- o It is futile to attempt to cosmetically solve mining component and landscape condition incompatibility. Improper location cannot be solved by component design.
- o While it is not possible (nor perhaps desirable) to hide components of the size required, there are places in which the impact or visual change is less disruptive. Thus regional design, or location, is more important than component design in minimizing visual change.

We have used the smelter buildings to illustrate regional design criteria because the structures are relatively static in component design and limited by engineering constraints. Thus, siting is the only means by which visual impact of these components can be controlled. The smelter is also the most flexible of all the structures in location as discussed in Chapter Two, and therefore stands a better chance of being located in any of the visual conditions described in Chapter Three. Waste rock piles or tailings

basins, while somewhat flexible in location, are also flexible in component design as shown in Chapter Two, Figures 11 and 12. Waste rock piles can be split up into small or large piles, put in bogs, etc. all of which drastically changes the visual character of the component. The same is true for tailings basins. In effect then there are innumerable variations on the waste rock and tailings basin component design concepts and these components, after being properly located in the region, should be designed to fit the visual character of the surrounding landscape elements.

We have presented the design criteria with regional design considerations first. Criteria 1 through 5 deal only with siting. Criteria 6 and 7, in addition to being siting considerations, also take into account design of the components as a means of fitting in with the surrounding environment to minimize visual change.

While it is recognized that component locations will be based primarily upon other environmental and engineering considerations, it is preferable that visual design considerations be taken into account early in the trade-off planning process, rather than as an after thought. Since it is not believed that visual design compatibility will be paramount in the

trade-offs which need to be made in siting decisions, this methodology realizes that visual design conditions will not always be optimal, and allows the application of design criteria in a cumulative manner. That is, the more criteria which can be followed, the less disruptive the visual effect of component siting will be.

Successful application of these criteria depends upon the user. Essential to the proper use of these criteria is an understanding of basic design fundamentals, experience with previous application of design criteria, and a thorough understanding of the mining industry. A designer must be capable of recognizing the conditions to which these criteria apply, and be aware of those situations which require study beyond which these criteria can address.

Through repeated application of these criteria and adaptation to solve unique visual situations, it is hoped that these criteria will be refined and expanded. Repeated application will uncover additional possibilities as well as limits.



Angle of View

1. Components should be sited at the lowest practicable elevation relative to the surrounding topography.

This criterion addresses the topographic relationship between potential observer viewpoints and component elevation. Components viewed below the horizon line cause less visual change to the visual setting than components viewed above the horizon line. When the silhouette of the component breaks the horizon, the component attracts visual attention. This is especially true when more of the component is above the horizon than below, as a result of a low angle of view.

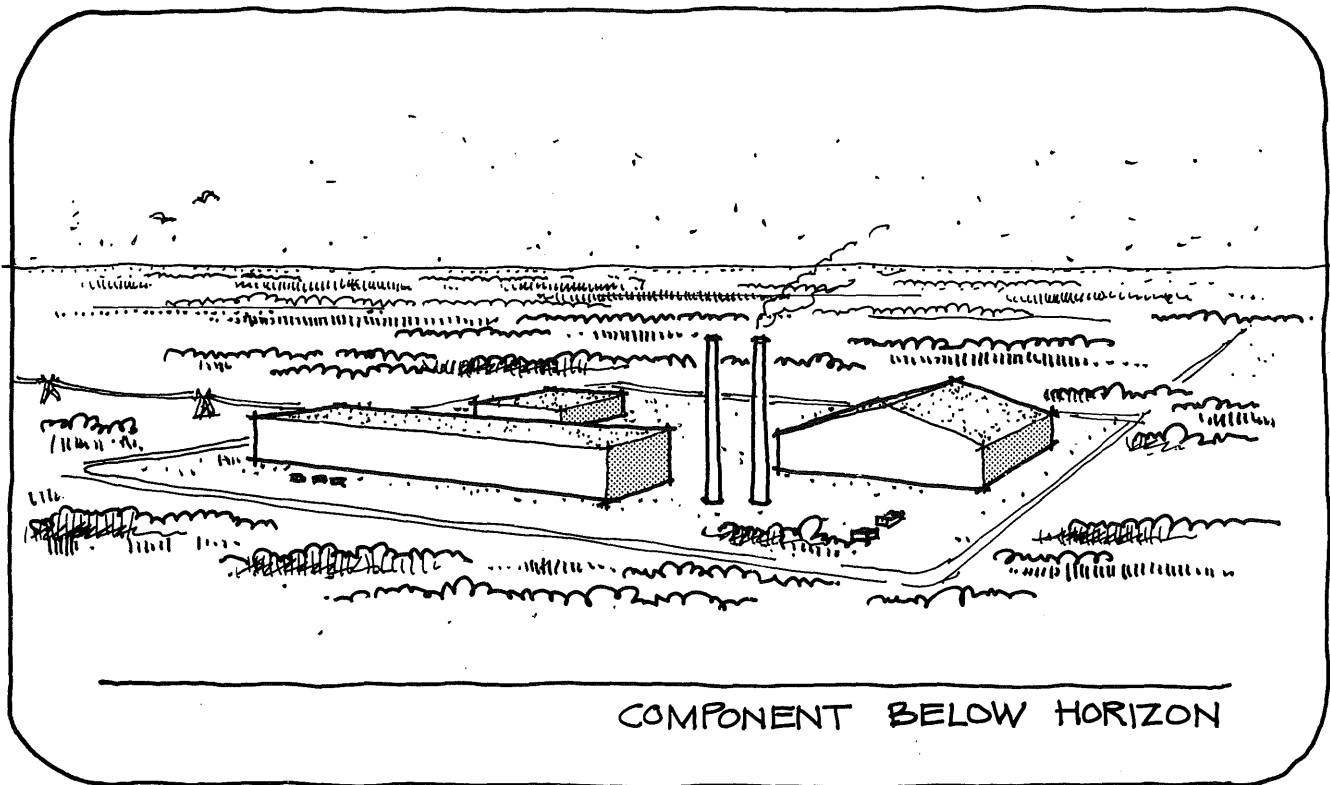
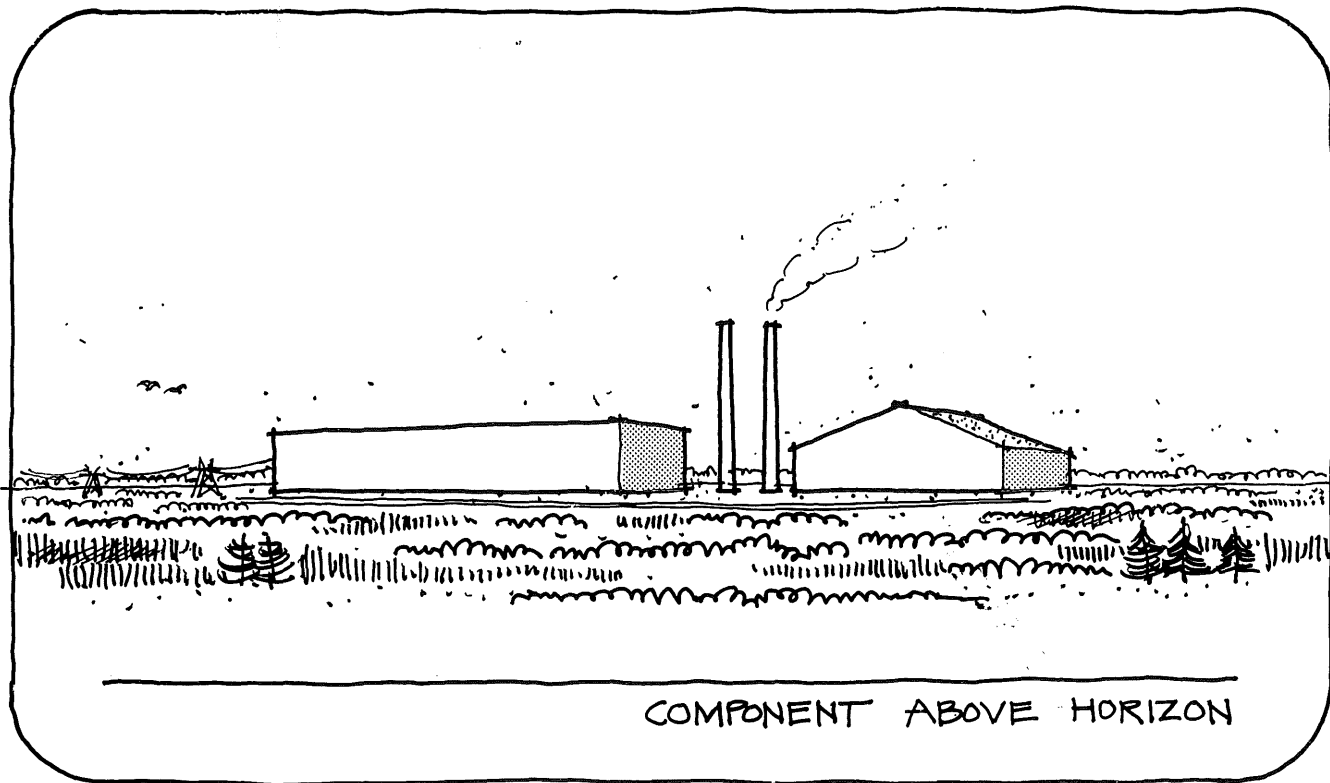

ANGLE OF VIEW

VISUAL ANALYSIS

MINNESOTA ENVIRONMENTAL QUALITY BOARD
COPPER-NICKEL PROJECT



MARCH 1978

Figure 23

Observer Distance

2. Components should be sited as far as possible from important observer viewpoints.

As the distance between an observer viewpoint and a component increases the component becomes less significant in relation to the other elements in the observers field of view. The distance beyond which the component ceases to be perceived as a significant element in the field of view is affected by most of the other design principles in this chapter, but could be approximated with additional research and empirical testing.

Application of this criterion requires not only mapping existing human use areas, but should also consider potential human use areas as well as intensity of use. Further evaluation of the relative sensitivity of the human activities to the visual change caused by mining components would provide the relative importance of maximizing observer to component distance from one use area, as compared to the importance of maximizing observer to component distance from another use area, when that choice is required.

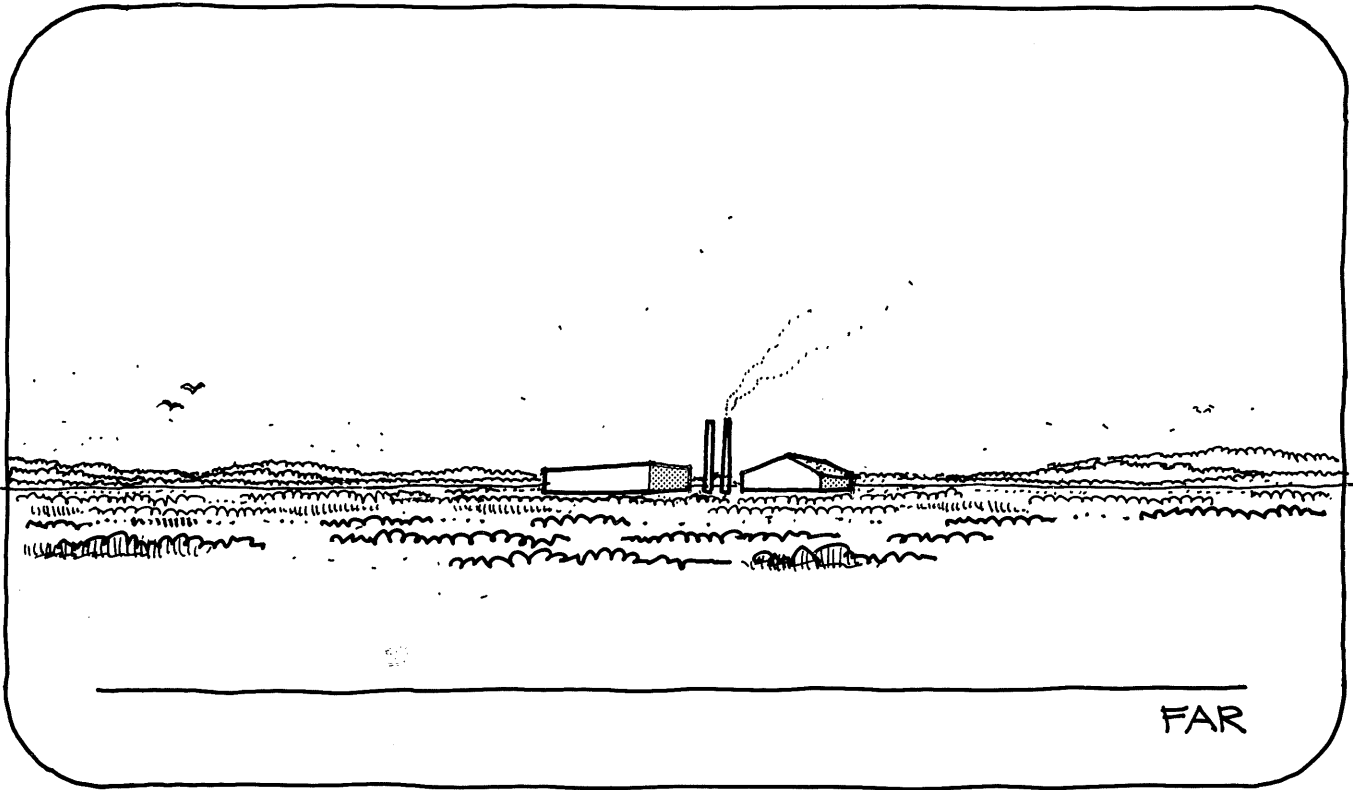
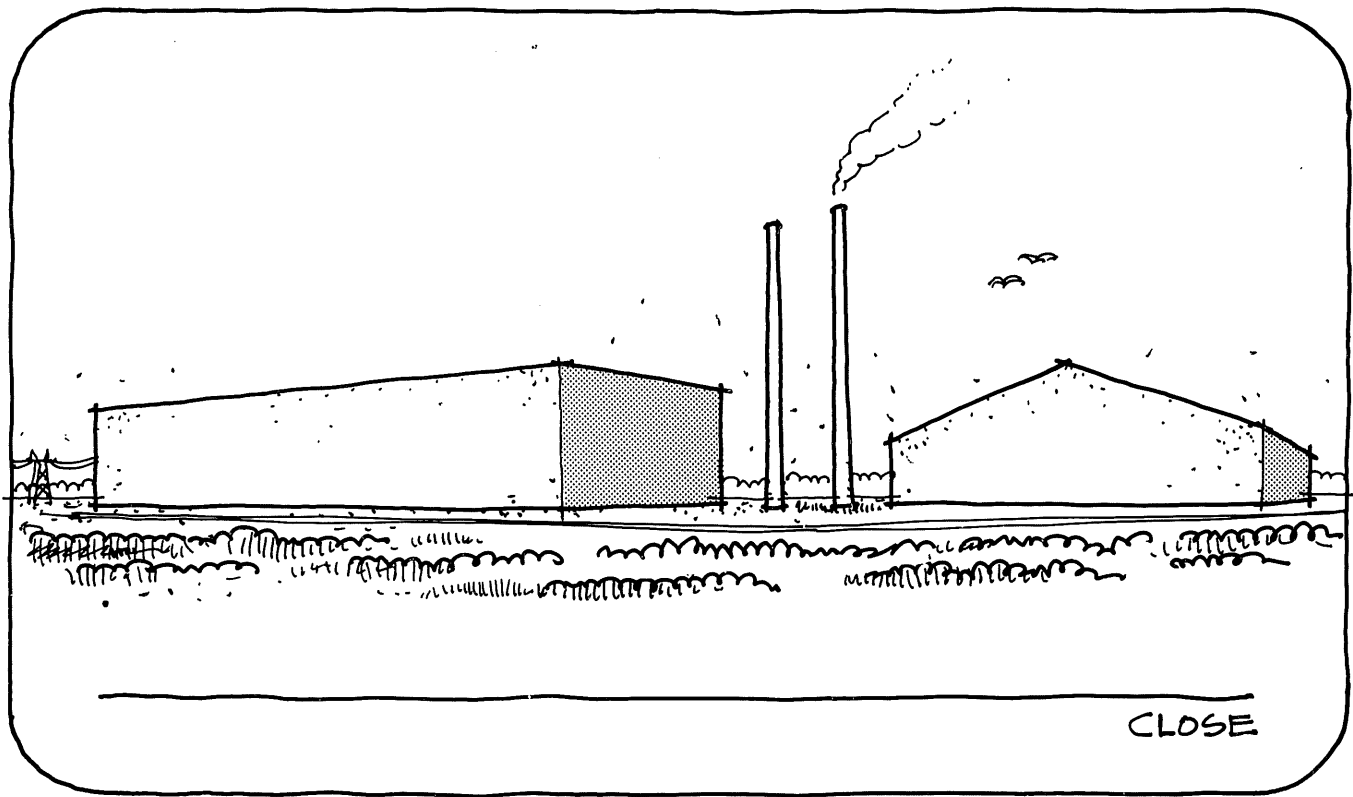

OBSERVER DISTANCE

VISUAL ANALYSIS



MINNESOTA ENVIRONMENTAL QUALITY BOARD
COPPER-NICKEL PROJECT

MARCH 1978

Figure 24

Line of Sight

3. Components should be sited relative to important observer viewpoints such that the line of site to the components is interrupted by natural elements.

An interrupted or screened view of a component results in less change to the visual environment than does an uninterrupted or unscreened view of the same component. There are a large number of opportunities for taking advantage of natural topographic features and vegetation, as described in Chapter Three, for screening views. Application of this criterion requires knowledge of location and relative importance of existing and potential human use areas as described in criterion 2 above.

It is possible to create screens for significant viewpoints, but in most cases such screening would be costly, and the costs would need to be balanced against the costs of siting the component in a location which is screened from significant viewpoints by natural topography and/or vegetation. If vegetation is planted as a screen it should be located as close as possible to the viewpoint to accomplish maximum screening relative to the observers angle of view. It should also be

planted as soon as possible to allow time for growth. The advantages of the fast growing seasonal screen of the deciduous species should be weighed against the year-round screen of the slower growing conifers.

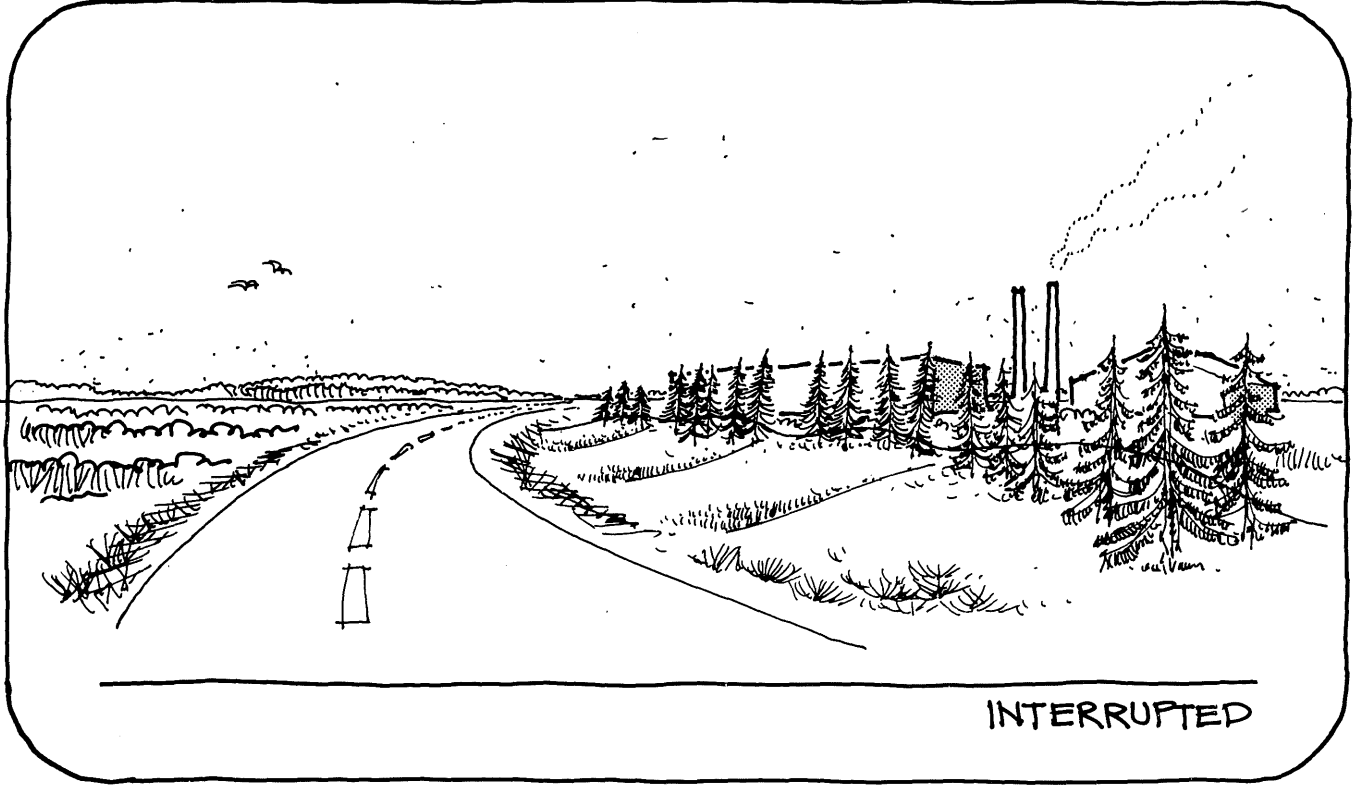
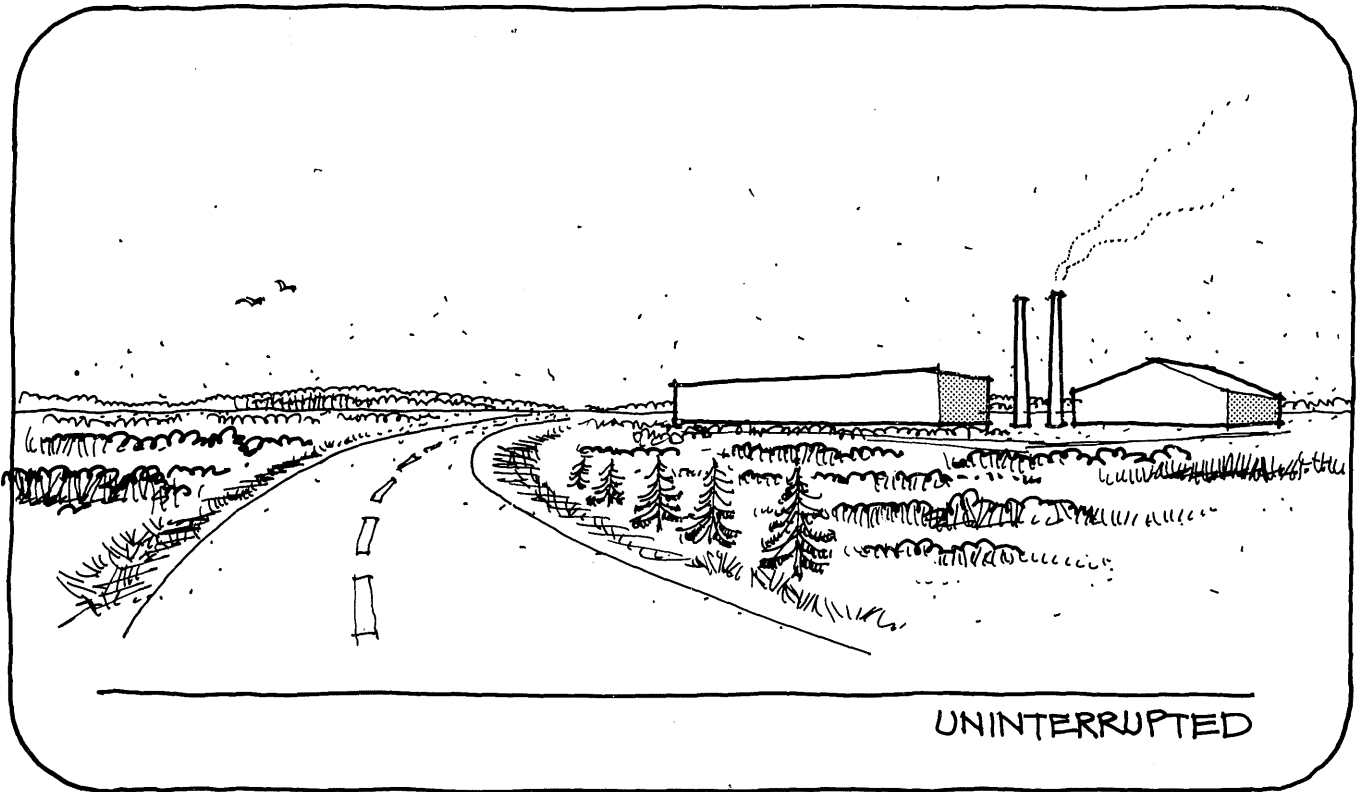

LINE OF SIGHT

VISUAL ANALYSIS



MINNESOTA ENVIRONMENTAL QUALITY BOARD
COPPER-NICKEL PROJECT

MARCH 1975

Figure 25

Frequency of Views

4. Components should be sited in locations with infrequent viewpoints.

Components which are visible from many viewpoints result in a greater perceived change to the visual environment than components sited such that they are viewed from only one viewpoint. Application of this criterion requires knowledge of location and relative importance of existing and potential human use areas as described in criterion 2 above.

Dispersed components have a greater probability of being frequently viewed than does a single site for several components. Several dispersed components may in some cases be visible from one viewpoint. This situation is certain to severely change the visual environment, and should be avoided if possible.

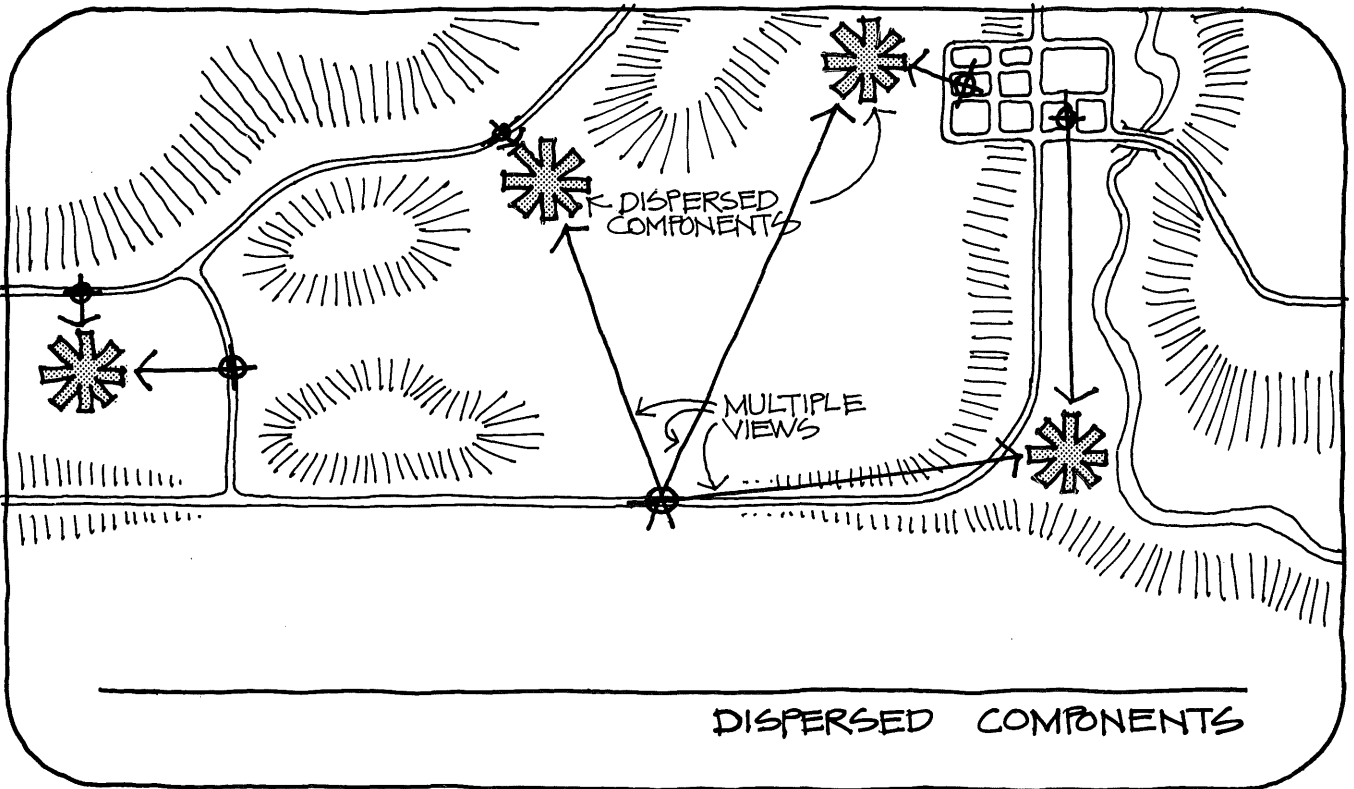
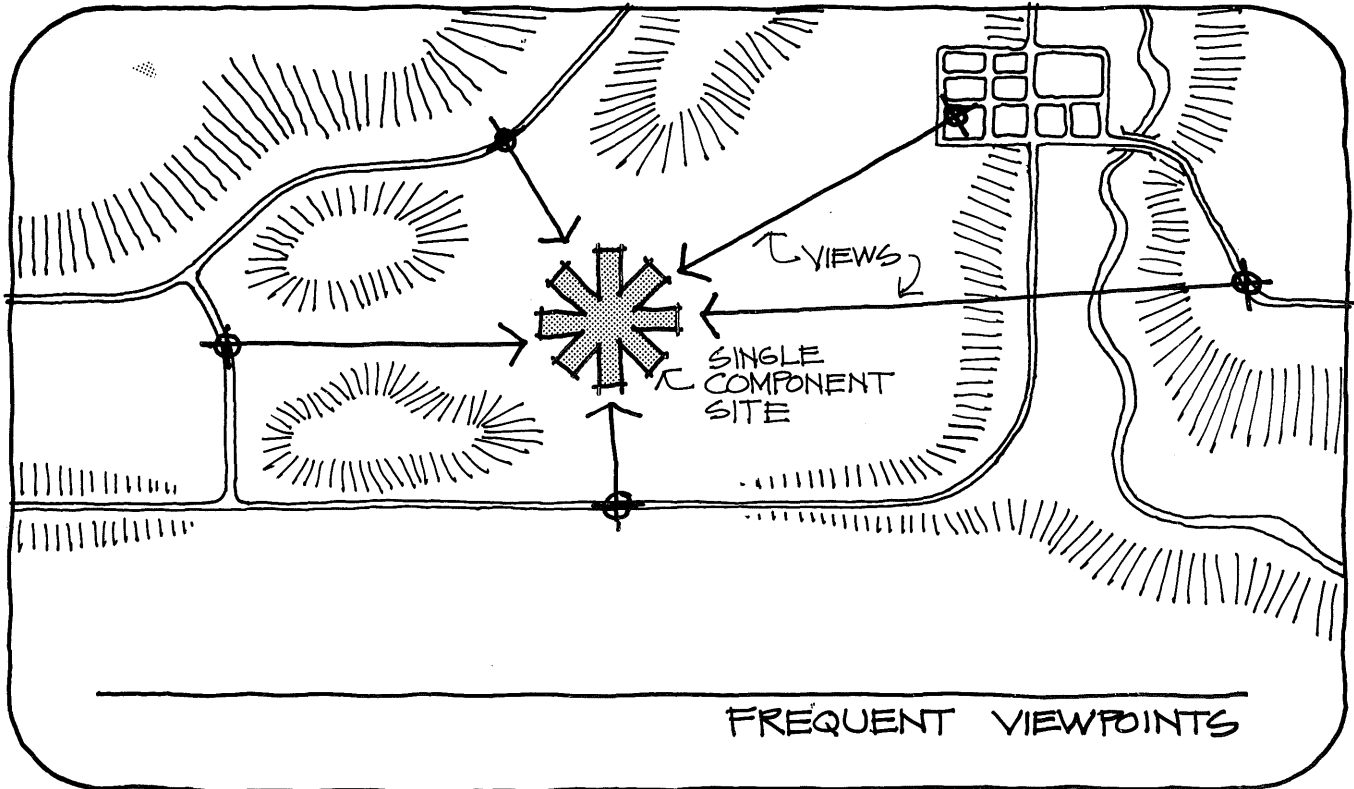

FREQUENCY OF VIEWS

VISUAL ANALYSIS



MINNESOTA ENVIRONMENTAL QUALITY BOARD
COPPER-NICKEL PROJECT

MARCH 1978

Figure 26

Development Level

5. Components should be sited in areas which have already been disturbed by development.

The study area is not heavily developed; most of the study area is in a natural or undisturbed state. The most disturbed visual settings are the iron ore mining areas, and the cities with their related commercial, residential, institutional and other structures. It is likely that developments such as these will tend to expand if copper-nickel mining becomes a reality in the study area.

It is preferred that copper-nickel mining components be located in those landscape settings which have already been disturbed by iron ore mining activities, thus preserving the natural areas for existing and future recreational enjoyment.

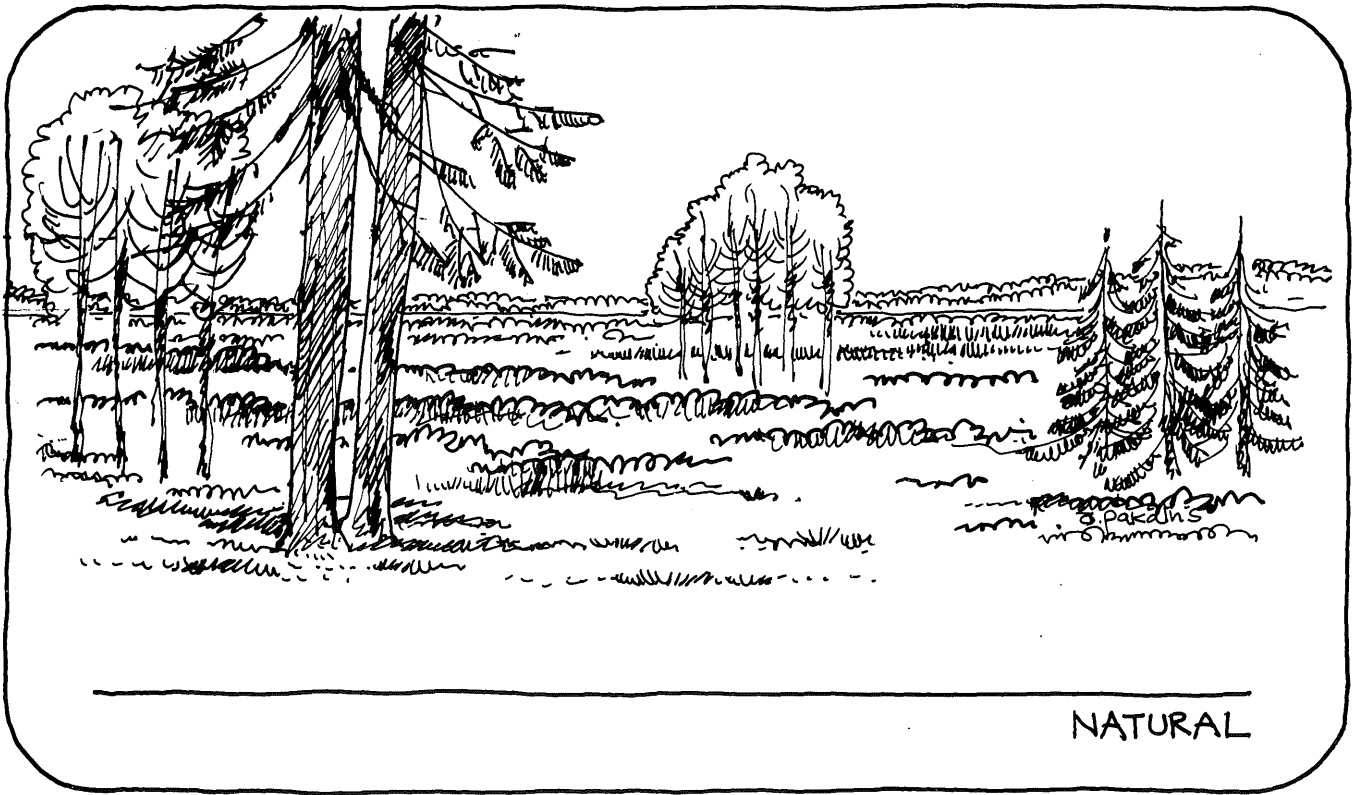

NATURAL

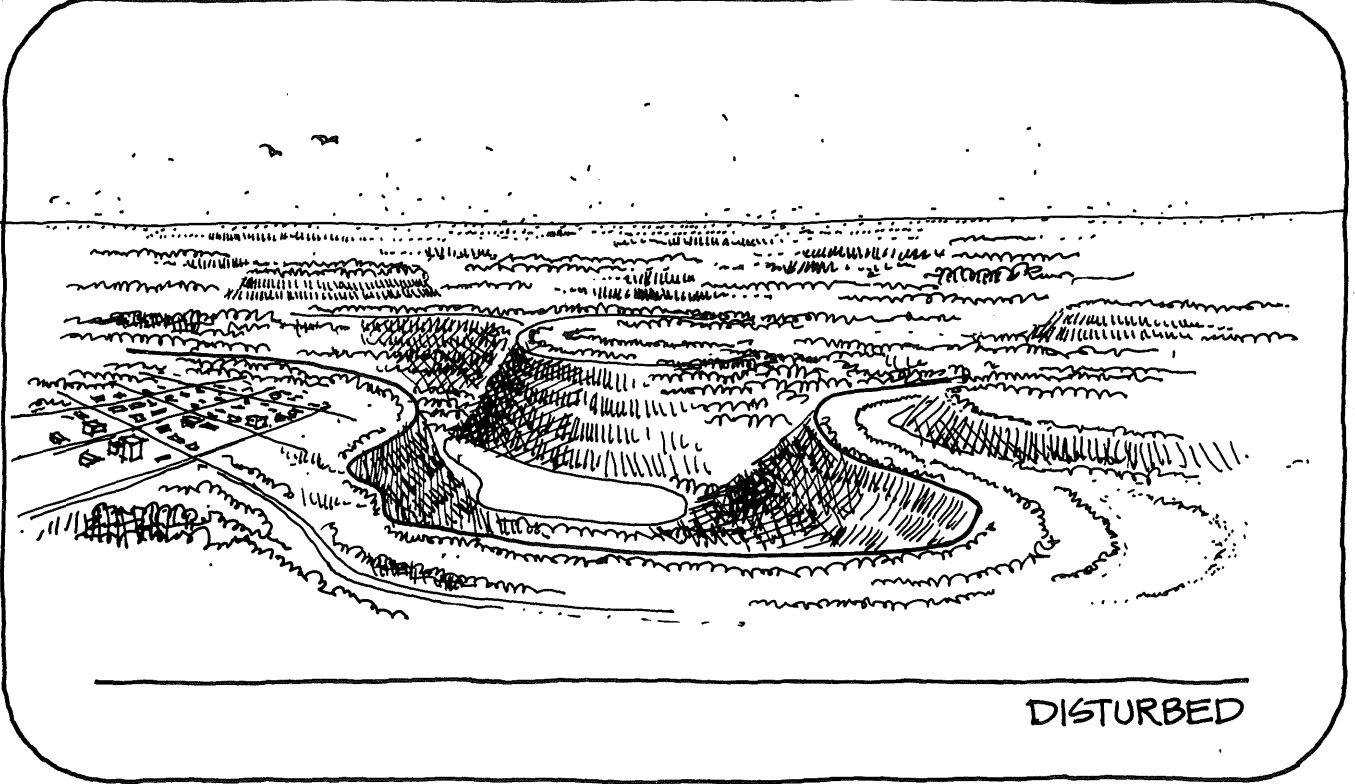

DISTURBED

DEVELOPMENT LEVEL

VISUAL ANALYSIS



MINNESOTA ENVIRONMENTAL QUALITY BOARD
COPPER-NICKEL PROJECT

MARCH 1978

Figure 27

Size and Shape

6. Components should be sited in landscapes with forms similar in size and shape to the form of the components. Components with flexible visual design alternatives should be designed similar in size and shape to the surrounding landforms.

Similarity in size and shape is one of the most important design criteria for minimizing change to the visual environment. Structures should be sited in areas where the landscape elements are as similar in height to the structures as possible. Other components should be designed to be very similar in size and shape to the surrounding landforms. The basic configurations are illustrated in Chapter One, Figures 11 and 12, but there are many variations on these basic designs. Height, area, and side slope should be as similar to the surrounding landforms as practicable.

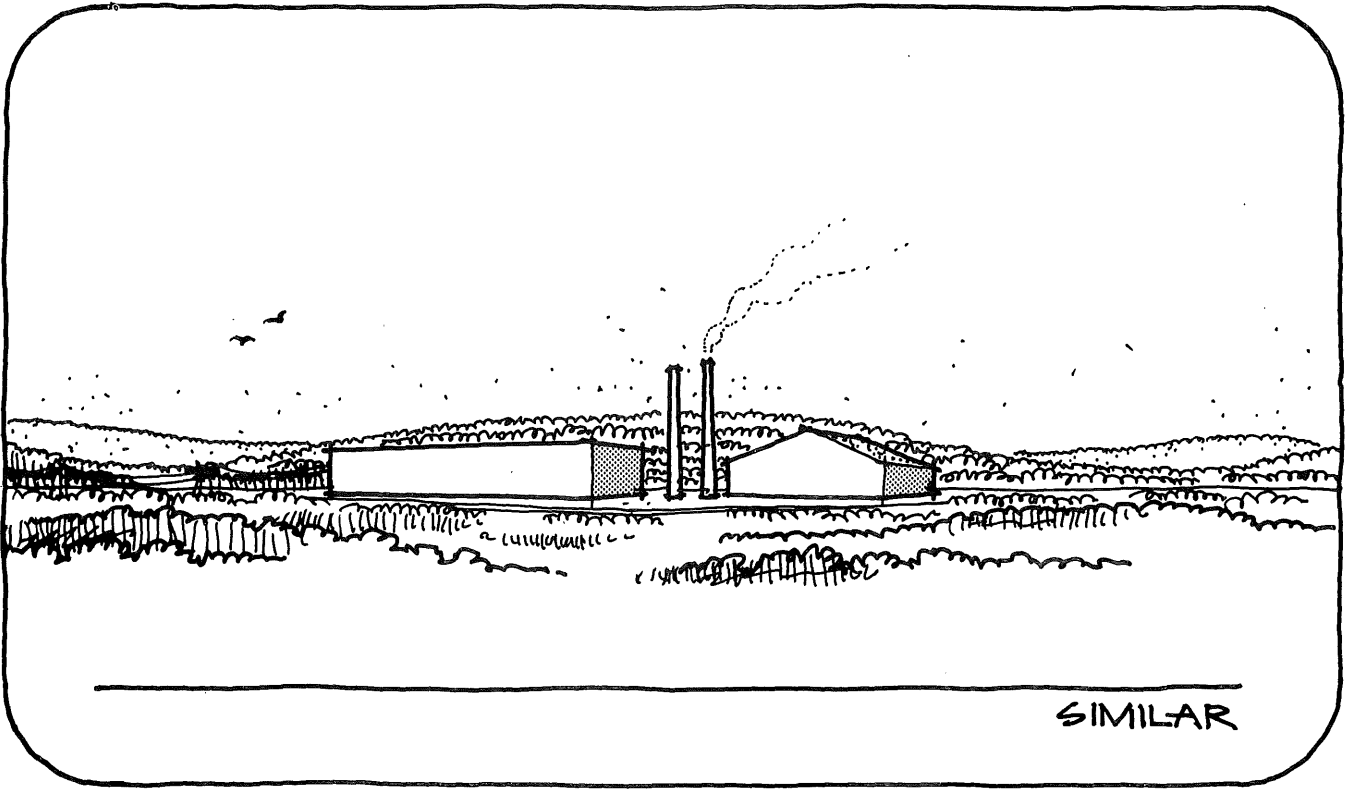
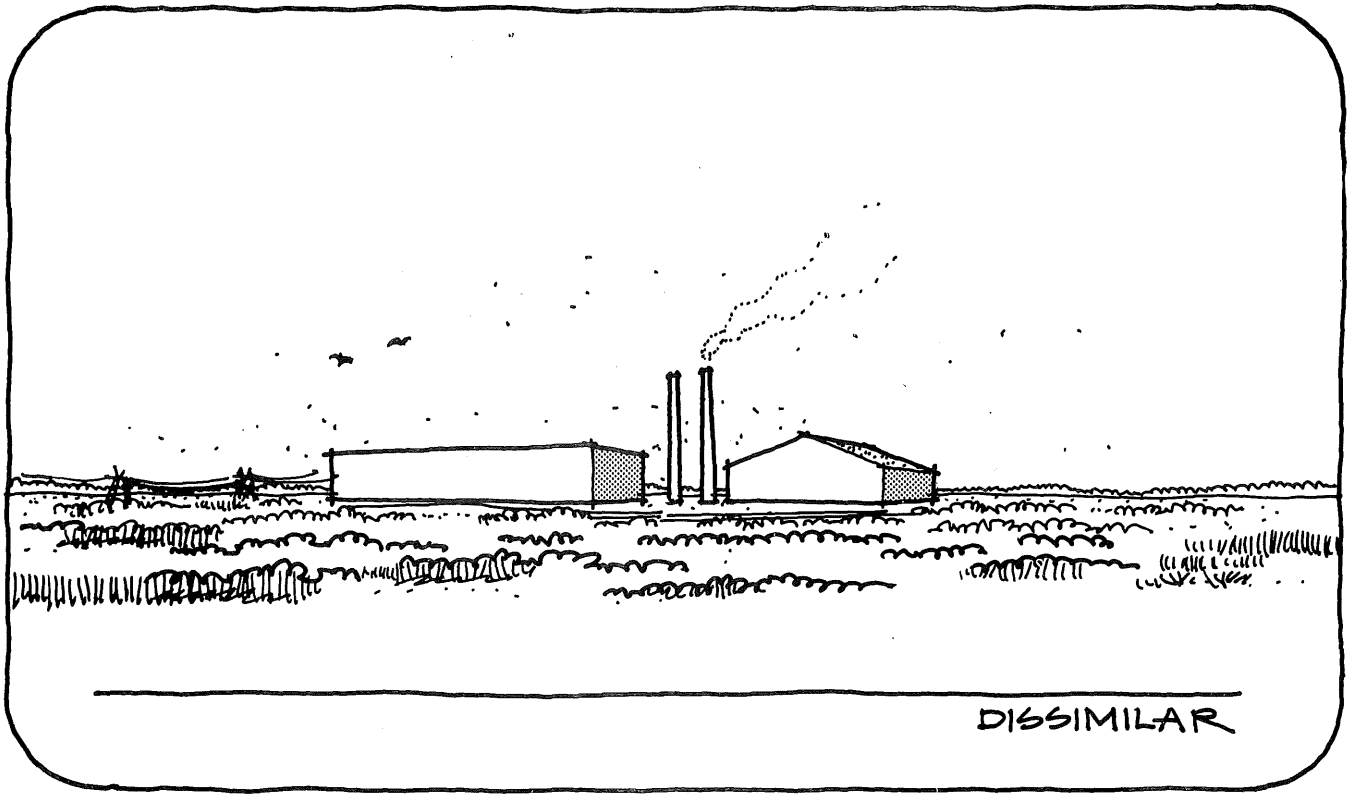

SIZE & SHAPE

VISUAL ANALYSIS



MINNESOTA ENVIRONMENTAL QUALITY BOARD
COPPER-NICKEL PROJECT

MARCH 1978

Figure 28

Color and Texture

7. Components should be sited in landscapes with colors and textures similar to the color and texture of the component. Components should be designed similar in color and texture to the surrounding landscape elements.

While it is futile to attempt to solve siting and other component design incompatibilities with cosmetic texture and color applications, the use of similar color and texture can do a great deal towards minimizing change to the visual environment when many of the other design criteria are also complied with.

The use of color and texture on structures is illustrated in Figure 29. Surface texture can be made compatible with surrounding elements with a variety of materials. Surface color can be coordinated with the background planes which relate to structure surfaces when viewed from significant viewpoints.

The use of color and texture is very important to waste rock pile and tailings basin design. When waste rock or tailings are stored in visual environments which are highly vegetated, it is desirable that the waste rock piles and tailings basins also be vegetated.

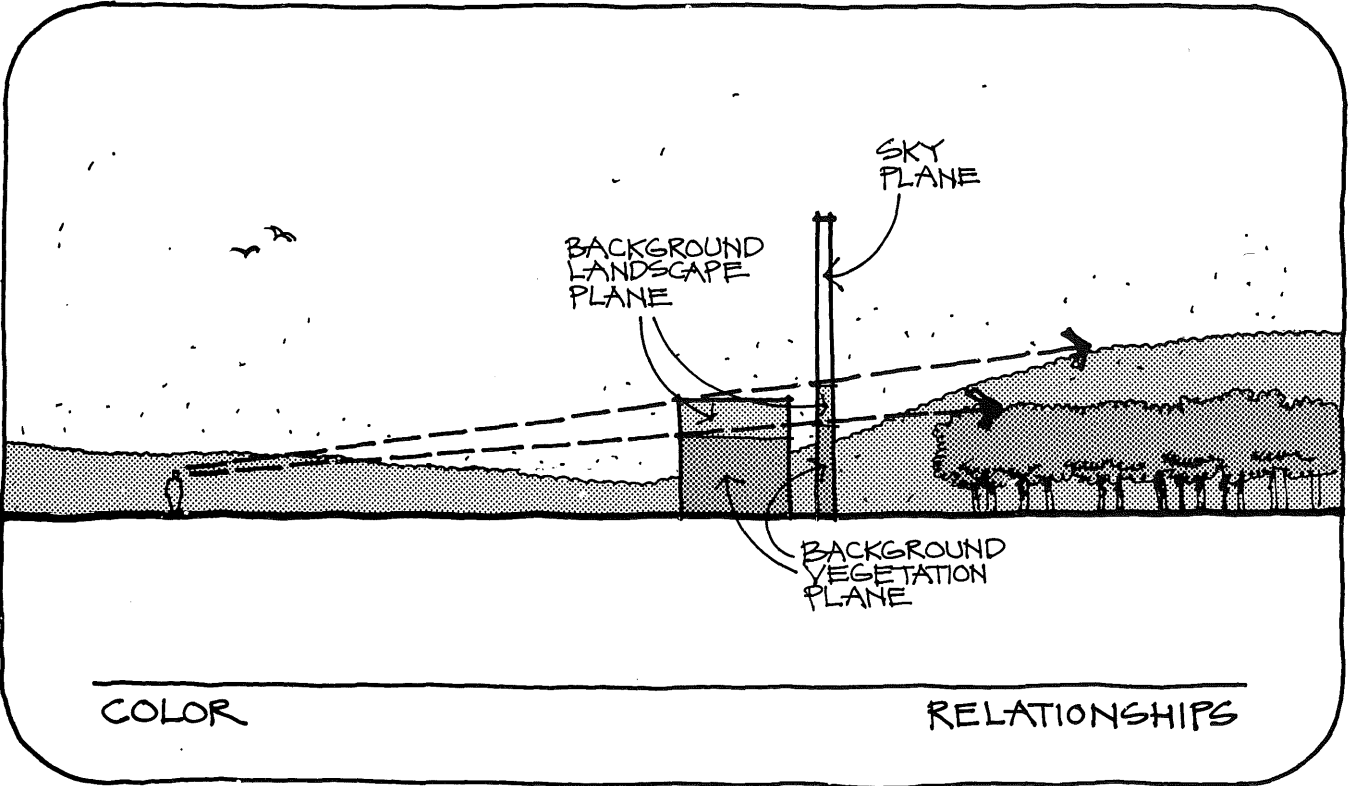
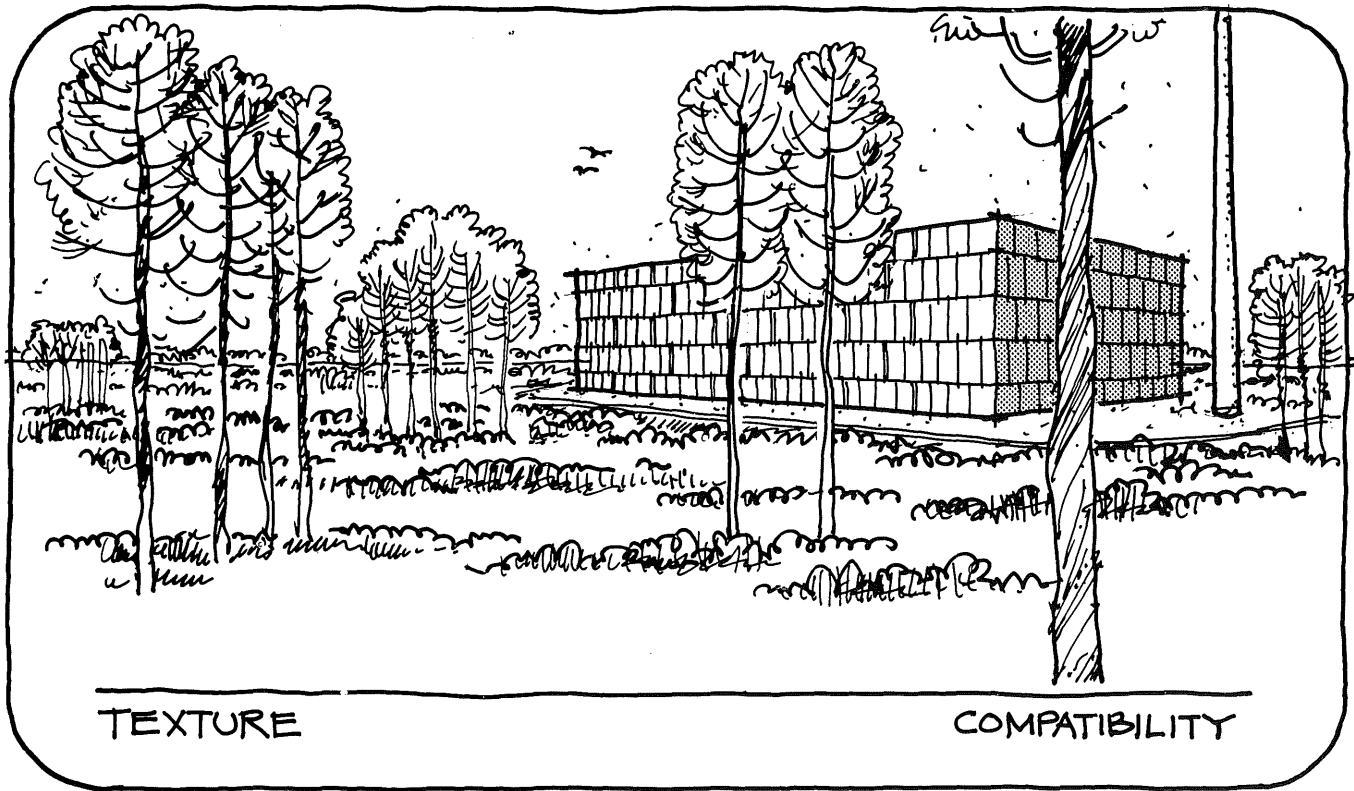

COLOR & TEXTURE

VISUAL ANALYSIS



MINNESOTA ENVIRONMENTAL QUALITY BOARD
COPPER-NICKEL PROJECT

MARCH 1978

Figure 29



FIVE

CRITERIA APPLICATION

We have shown that visual aesthetic design criteria cannot separate the consideration of regional design from component design. We have shown that component design and perception are in fact dependent upon the setting and the visual conditions of the landscape in which the component is sited. We therefore presented siting considerations as a guide for designing the study area visual environment, followed by component design considerations as a guide for fitting the components to the selected sites.

The next step then would be to assess the suitability of siting each type of mining component within each of the visual conditions in the study area. With proper identification of human use areas within the study area and with the use of computer programs, components could be hypothesized at virtually every point in the study area, and the visual suitability could be assessed and mapped. Identification of the human use areas and evaluation of the sensitivity of the human activities to visual change are beyond the scope of this study.

We can, however, rate the desirability, in terms of Criteria 5, 6 and 7, of siting mining components within the landscape

conditions described in Figures 20 through 22. The other criteria cannot be considered because they require identification of human use areas. We can also suggest component designs within each visual condition which would further minimize visual change. These desirability ratings can be used in siting considerations, to be balanced against other siting forces. The suggested component designs will serve as a basis for designing within the actual site conditions after sites have been selected.

Regional Design

For purposes of illustrating application of the regional design criteria, we will rate the desirability of siting waste rock piles and tailings basins in each of the six landscape conditions described in Chapter Three. In addition to the six basic landscape conditions, we will also rate the desirability of siting components in the transition zones between the physiographic areas. These transition zones are defined as the interface between adjacent areas. There are eleven different types of transition zones.

The desirability of siting these components within each landscape condition is further complicated by the consideration of the three basic component design alternatives. The ratings for each land-

scape condition sometimes differ by component design alternative. The ratings in Figure 30 show the relative desirability of siting waste rock piles and tailings basins within each of the basic landscape conditions and transition zones based upon the development level, landform size and shape, and color and texture.

Component Design

After the components have been properly sited, considerations of size and shape, and color and texture, in component design can do a great deal to further minimize visual change. Figure 31 presents suggested maximum limits for waste rock and tailings basin acreage, height and side slope in each of the basic landscape conditions and transition zones. The components should be shaped to look as much like the landforms presented in Figures 19 through 22 as possible in each appropriate landscape condition. For example, when dumping waste rock in Physiographic Area B, the piles should be shaped to look like the drumlins shown in Figure 19, Section b-b₁, and in Figure 14.

When waste rock or tailings are stored in visual environments which are highly vegetated, it is desirable that the waste

rock piles and tailings basins also be vegetated with similar species.

The vegetation possibilities for waste rock dumps and tailings basins are illustrated in Figures 11 and 12, Chapter Two. During operation the waste rock piles on flat or sloped sites can be vegetated by use of the mine surface overburden as perimeter tips. The perimeter tips are usually built in stages, with each stage preceding waste rock dumping at that level. The sloped sides of the perimeter tip can be stabilized immediately after construction by seeding with a grass and legume mixture, followed shortly thereafter with tree seedlings. Trees should not be planted until the slope has stabilized, but should be done before the grass and legume root-matt becomes too dense for tree establishment. The surface of the final waste rock lift can be left to naturally vegetate with pioneer species or can be covered also with 6 to 24 inches of overburden and seeded with an herbaceous mixture similar to that used on the tips. Trees can then be similarly planted. Vegetation of waste rock dumped in a valley or bog can be accomplished in a similar fashion.

Vegetation possibilities for tailings basins are similar to those for waste rock.

In the case of basins on flat or sloped sites the dike stages could be seeded with grasses and legumes on a temporary basis, and vegetated permanently with trees after the last lift has been constructed. If waste rock is used for dike construction the last lift should be covered with mine overburden prior to vegetation.

The surface of the tailings can be vegetated when the basin has reached capacity. The tailings do not require covering with overburden, but because of the acids from sulfides, it will very likely be necessary to spread lime to neutralize the ph to a level ammenable to vegetation growth. The same procedure obviously holds for tailings stored in a valley or bog.



		BASIC LANDSCAPE CONDITIONS						LANDSCAPE TRANSITION ZONES												
		A	B	C	D	E	F*	A/B	A/C	A/D	A/E	A/F	A/G	B/F	B/G	C/E	D/F	E/G		
COMPONENT DESIGN ALTERNATIVES	FLAT SITE																			
	SLOPED SITE																			
	VALLEY OR BOG																			

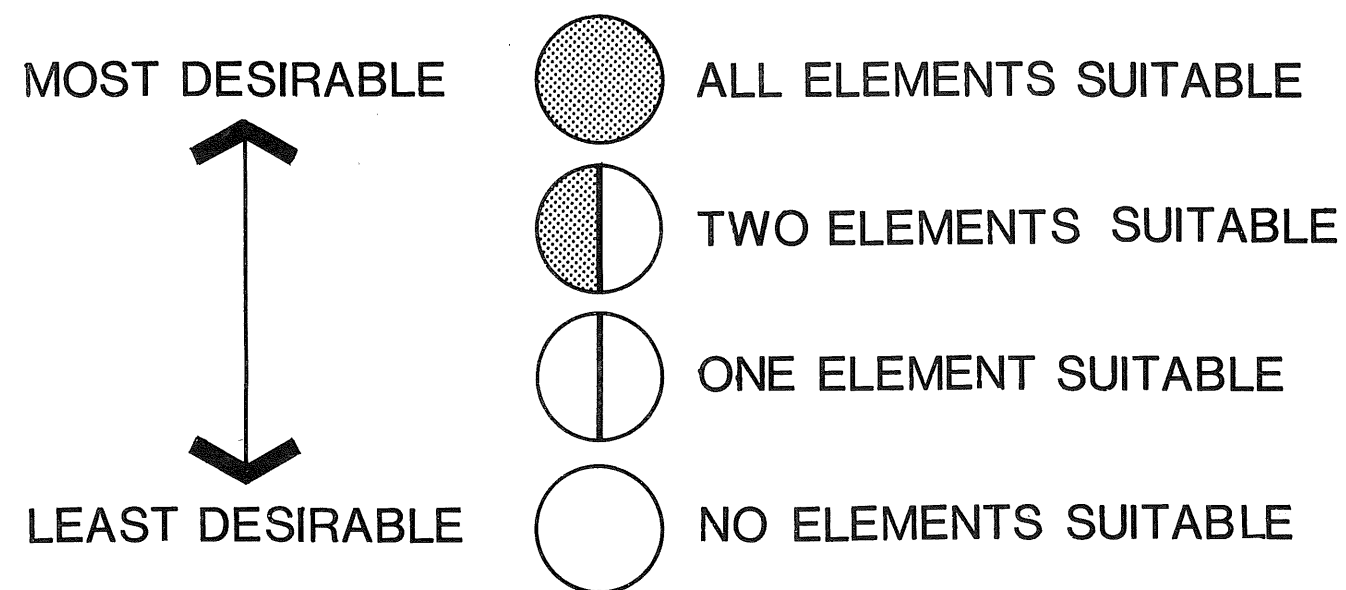

LANDSCAPE CONDITION ELEMENTS
 LANDFORM SIZE & SHAPE
 COLOR & TEXTURE
 DEVELOPMENT LEVEL

* FOR PURPOSES OF THIS STUDY LANDSCAPE CONDITION G WAS CONSIDERED SIMILAR TO CONDITION F .

RELATIVE SITING DESIRABILITY RATINGS

VISUAL ANALYSIS



MINNESOTA ENVIRONMENTAL QUALITY BOARD
 COPPER-NICKEL PROJECT

MARCH 1978

Figure 30

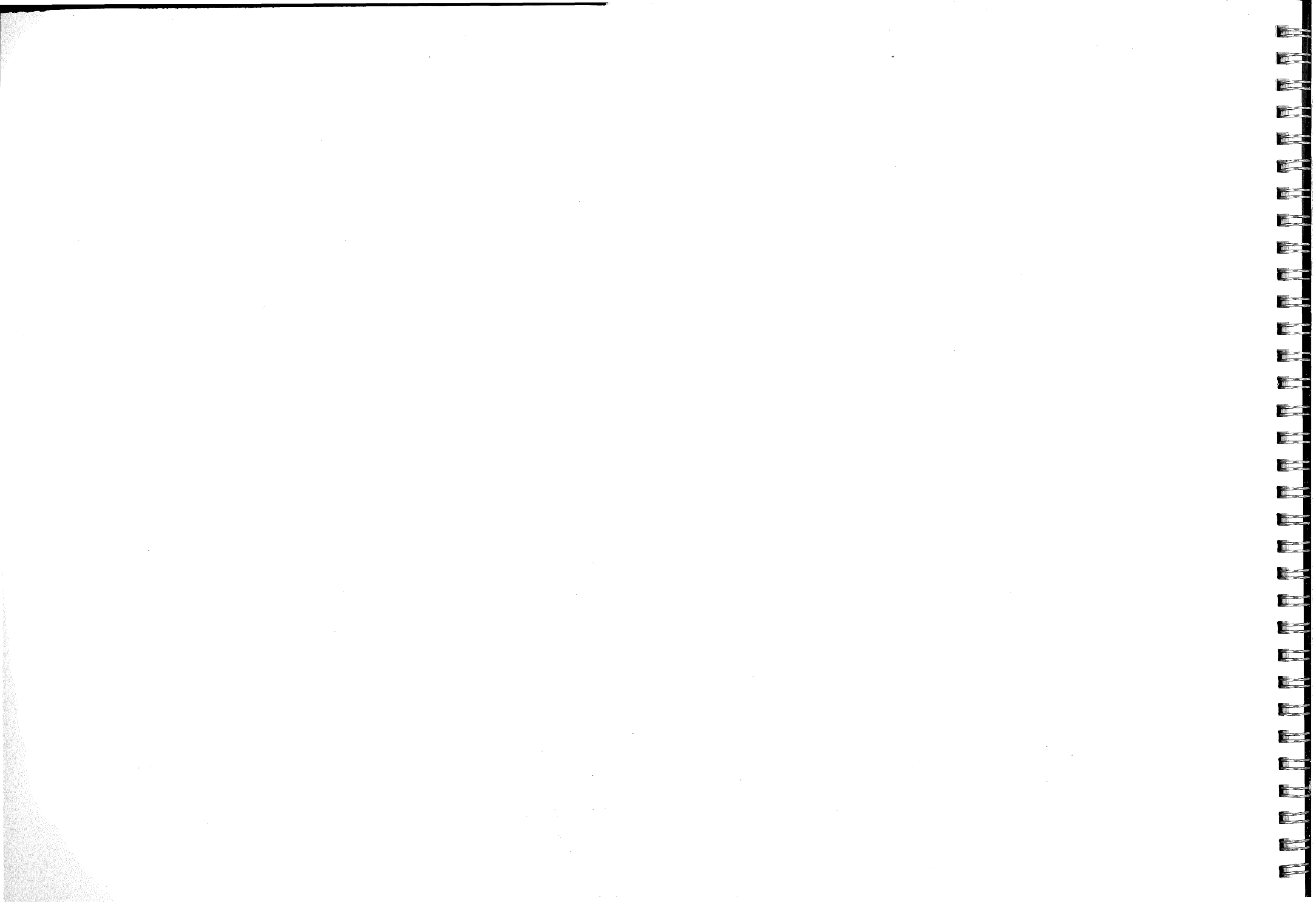

		BASIC LANDSCAPE CONDITIONS						LANDSCAPE TRANSITION ZONES										
		A	B	C	D	E	F*	A/B	A/C	A/D	A/E	A/F	A/G	B/F	B/G	C/E	D/F	E/G
WASTE ROCK PILE OR TAILINGS BASIN MAXIMUM LIMITS	ACREAGE	500	1000	/	750		/	1000	500	750		500	500	1000	1000		750	
	HEIGHT (FT.)	75	50	/	100	** 300	/	50	75	100	** 300	75	75	50	50	** 300	100	** 300
	SIDE SLOPE ***	40%	20%	/	20%	20%	/	20%	40%	20%	20%	40%	40%	20%	20%	20%	20%	20%

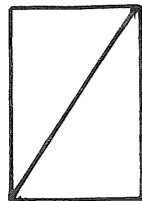

UNDESIRABLE SITING (SEE FIGURE 30)

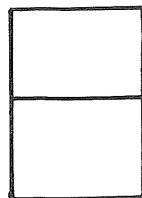

NO MAXIMUM LIMIT

* FOR PURPOSES OF THIS STUDY
LANDSCAPE CONDITION G WAS CONSIDERED
SIMILAR TO CONDITION F

** TAILINGS BASIN HEIGHT LIMITED TO
150 FEET.

*** SLOPES SHOULD VARY FOR ANY ONE
COMPONENT SIMILAR TO VARIATIONS IN
THE LANDFORM WHICH IS BEING COPIED.

MAXIMUM COMPONENT DESIGN LIMITS

VISUAL ANALYSIS



MINNESOTA ENVIRONMENTAL QUALITY BOARD
COPPER-NICKEL PROJECT

MARCH 1978

Figure 31

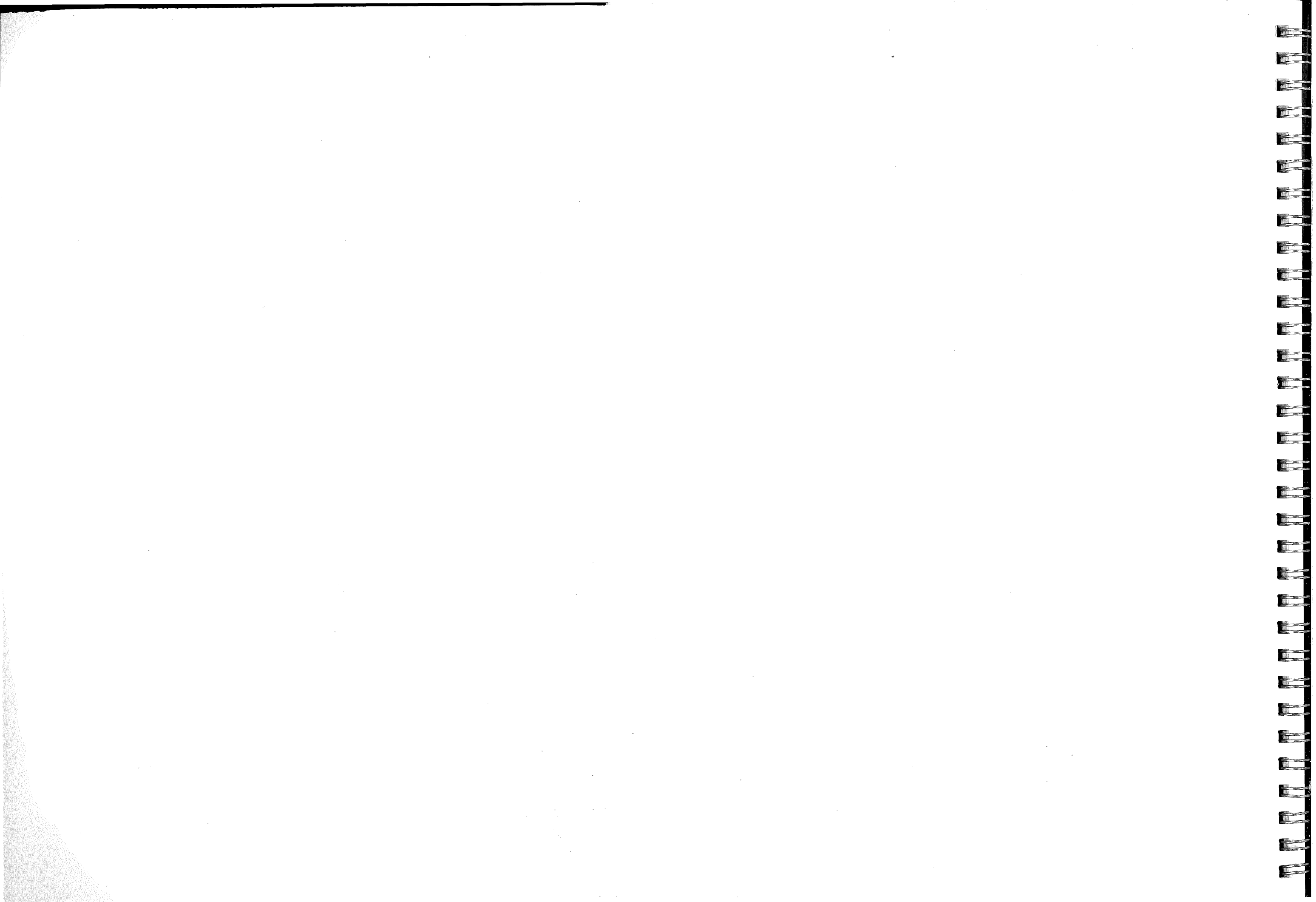

**THIS STUDY WAS PREPARED BY:
BATHER-RINGROSE-WOLSFELD-
JARVIS-GARDNER, INC.**

**CRAIG AMUNDSEN, AIA-PROJECT MANAGER
GAIL ELNICKY, ASLA
ARIJS PAKALNS, AIA**