

CN 126

This document is made available electronically by the Minnesota Legislative Reference Library  
as part of an ongoing digital archiving project. <http://www.leg.state.mn.us/lrl/lrl.asp>

SULFUR DIOXIDE CONVERSION LITERATURE SURVEY

JULY 1978

*Library Project* SULFUR DIOXIDE CONVERSION LITERATURE SURVEY *7. 8. 1977*

TABLE OF CONTENTS

	<u>Page</u>
Summary	1
Sulfur dioxide conversion laboratory studies	10
Direct Photo-oxidation	10
Indirect Photo-oxidation	19
SO <sub>2</sub> -singlet oxygen system	19
SO <sub>2</sub> -O <sub>3</sub> "	21
SO <sub>2</sub> -NO <sub>x</sub> "	21
SO <sub>2</sub> -H <sub>2</sub> O <sub>2</sub> "	25
SO <sub>2</sub> -CH <sub>3</sub> O <sub>2</sub> "	26
SO <sub>2</sub> -H <sub>2</sub> O                "	26
SO <sub>2</sub> -CH <sub>3</sub> O               "	29
SO <sub>2</sub> -olefin-ozone       "	29
Fate of SO <sub>3</sub>	31
SO <sub>2</sub> -smog                "	31
Liquid Phase Oxidation	36
Uncatalyzed oxidation of SO <sub>2</sub> by O <sub>2</sub> (with and without ammonia)	36
Catalyzed oxidation of SO <sub>2</sub> by O <sub>2</sub>	44
Oxidation of SO <sub>2</sub> by ozone	53
Catalyzed oxidation on dry surfaces	61
Sulfur dioxide Conversion Field Studies	68
Power Plants	68
Colbert Power Plant	68
Frankfurt/Main, Germany Power Plant	70
Crystal River Power Plant	70
Morgantown Power Plant	71
Keystone and Northport Power Plants	75
Four Corners Power Plant	81
Labadie Power Plant	84
TVA's Cumberland Power Plant	93
Centralia Power Plant	95
Great Canadian Oil Sands Power Plant	96
Sour Gas Plant	99
Sour Gas Plant, Calgary, Alberta	99

	<u>Page</u>
Urban and Area Sources	100
Los Angeles Basin	100
Tennessee Valley Area	100
St. Louis Urban Area	101
Western Europe	104
Atlantic Ocean	104
North Sea	105
Smelter Studies	105
Nickel Smelter, Sudbury, Ontario	105
Non-ferrous smelter, Puget Sound, Washington	111
Plume Chemistry Models	112

## LIST OF TABLES

- Table 1. Mechanisms that convert sulfur dioxide to sulfates
- Table 2. Reported SO<sub>2</sub> oxidation rates.
- Table 3. Theoretical rates of reaction (ppm hr<sup>-1</sup>) of SO<sub>2</sub> (<sup>3</sup>B<sub>1</sub>) reactions with various impurity species and O<sub>2</sub> in a hypothetical sunlight - irradiated lower troposphere.
- Table 4. Summary of photo-oxidation studies of SO<sub>2</sub>, SO<sub>2</sub>-Air mixture
- Table 5. Enthalpy changes, rate constants and reaction rates for potentially important reactions of ground state SO<sub>2</sub> and SO<sub>3</sub> molecules in the lower atmosphere.
- Table 6. Summary of liquid Phase SO<sub>2</sub> oxidation studies
- Table 7. Nomenclature and values used for plume SO<sub>2</sub> oxidation calculations
- Table 8. Summary of experiments involving SO<sub>2</sub> reactions in the presence of different particulates
- Table 9. Summary of SO<sub>2</sub> oxidation field studies
- Table 10. Coal-fired power plant normalized and averaged SO<sub>2</sub> conversion data
- Table 11. Comparison of predicted and observed conversion of SO<sub>2</sub> to sulfate

LIST OF FIGURES

Figure 1. Crossplume  $O_3$  and  $SO_2$  variations in the Morgantown power plant plumes at several downwind distances.

Figure 2. Basic geometry of the box model

Figure 3. The elliptical ring plume model

## SUMMARY

### Laboratory Studies

Four mechanisms have been identified in the oxidation of sulfur dioxide to sulfate. These mechanisms, summarized in Table 1, are direct photo-oxidation, indirect photo-oxidation, uncatalyzed and catalyzed liquid phase oxidation and catalyzed oxidation on dry surfaces. Reported oxidation rates are summarized in Table 2.

### Direct Photo-Oxidation

Direct photo-oxidation is the oxidation of  $\text{SO}_2$  by atmospheric oxygen in the presence of sunlight; this mechanism is not significant in the oxidation of  $\text{SO}_2$  to sulfate. The maximum theoretical rates from direct photo-oxidation reactions correspond to less than  $0.02\%/hr^{-1}$  (Calvert, 1977).

Laboratory studies have reported rates up to  $24\%/hr^{-1}$  (Renzetti and Doyle, 1960) for direct photo-oxidation. These rates are not applicable to direct photo-oxidation as observed in the atmosphere due to variations in intensity and spectra distribution of radiation, presence of gaseous impurities, reactive container surfaces and experimental difficulties with temperature, pressure, humidity and reactant concentrations (Calvert, 1977).

### Indirect Photo-Oxidation

Indirect photo-oxidation of  $\text{SO}_2$  involves the chemical reaction of  $\text{SO}_2$  in a mixture of air containing oxides of nitrogen ( $\text{NO}_x$ ), hydrocarbons (HC), hydroxyl radical (HO), hydroperoxyl radical ( $\text{HO}_2$ ) and other species.

Indirect photo-oxidation of rates in the laboratory are affected by a variety of experimental factors including concentration of  $\text{SO}_2$  and reacting

Table 1. Mechanisms that convert sulfur dioxide to sulfates.

Mechanism	Overall Reaction	Factors on Which Sulfate Formation Primarily Depends
1. Direct Photo-oxidation	$\text{SO}_2 \xrightarrow[\text{Water}]{\text{Light, Oxygen}} \text{H}_2\text{SO}_4$	Sulfur dioxide concentration, sunlight intensity
2. Indirect Photo-oxidation	$\text{SO}_2 \xrightarrow[\text{Organic oxidants, OH}]{\text{Smog, Water, NO}_x} \text{H}_2\text{SO}_4$	Sulfur dioxide concentration, sunlight intensity, concentration of $\text{NO}_x$ , OH and organics
3. Liquid phase oxidation	$\text{SO}_2 \xrightarrow{\text{water}} \text{H}_2\text{SO}_3$	Ammonia concentration temperature, pH
a. uncatalyzed oxidation by $\text{O}_2$ with and without $\text{NH}_3$	$\text{NH}_3 + \text{H}_2\text{SO}_3 \xrightarrow{\text{oxygen}} \text{NH}_4^+ + \text{SO}_4^+$	
b. catalyzed oxidation by $\text{O}_2$	$\text{SO}_2 \xrightarrow[\text{Heavy metal ions}]{\text{Oxygen, water}} \text{SO}_4^-$	Concentration of heavy metal (Fe, Mn) ions, pH, temperature
c. oxidation by ozone and strong oxidizing agents	$\text{SO}_2 \xrightarrow[\text{Ozone and strong oxidizing agents}]{\text{water}} \text{H}_2\text{SO}_4$	Concentration of ozone or oxidizing agent, pH
4. Catalyzed oxidation on dry surfaces	$\text{SO}_2 \xrightarrow[\text{Carbon, water}]{\text{Oxygen, particulate}} \text{H}_2\text{SO}_4$	Carbon particle concentration (Surface area)

Table 2. Reported SO<sub>2</sub> oxidation rates.

Laboratory Studies

direct photo-oxidation	<0.02% hr <sup>-1</sup>
indirect photo-oxidation	ave. 0 - 2.7% hr <sup>-1</sup> range 0-100% hr <sup>-1</sup>
liquid phase-oxidation	6-150% hr <sup>-1</sup>
catalyzed oxidation on dry surfaces	no rates reported

Field Studies

0-200% hr<sup>-1</sup>

Most values in the range 0-10% hr<sup>-1</sup>



species, irradiation sources, reaction vessels, water vapor, and gaseous impurities. Sulfur dioxide oxidation rates have been calculated using theoretical models and experimental data.

Indirect oxidation of  $\text{SO}_2$  by singlet oxygen, ozone,  $\text{NO}_x$  and  $\text{CH}_3\text{O}$  is not significant in the ambient environment (Calvert, et al., 1977; Davis and Klauber, 1975; Daubendiek and Calvert, 1973; Gerhard and Johnstone, 1955; Jaffee and Klein, 1966; Levy et al., 1976; Daubendiek and Calvert, 1975; Calvert and McQuigg, 1975). The gas phase oxidation of  $\text{SO}_2$  by  $\text{HO}$  may be the most important homogeneous sulfate formation mechanism. Reaction rates of  $0.4\%/hr^{-1}$  in clean atmospheres to  $2.7\%/hr^{-1}$  (Calvert et al., 1977) in polluted atmospheres have been calculated. More information is needed, however, to quantify  $\text{HO}$  concentrations in the ambient atmosphere and in industrial plumes (Wang, 1975).  $\text{HO}_2$  and  $\text{CH}_3\text{O}_2$  are thought to be important in the gas phase oxidation of  $\text{SO}_2$ ; however, experimental estimates of these reactants and the reactions themselves are not extensive. Reaction rates of up to  $2\%/hr^{-1}$  in polluted atmospheres have been postulated (Calvert et al., 1977). Oxidation rates of up to  $3\%/hr^{-1}$  in polluted atmospheres have been calculated for the ozone-olefin system (Cox and Penkett, 1971).

Experimental results of  $\text{SO}_2$  oxidation in smog are conflicting and encompass a variety of reactants and concentrations, irradiation sources and reaction vessels. Reaction rates of  $0-100\%/hr^{-1}$  have been reported for  $\text{SO}_2$ -smog systems (Prager et al., 1960; Endow et al., 1963; Harkins and Nicksie, 1965; Smith and Urone, 1974; Wilson and Levy, 1970a, 1970b; Cox and Penkett, 1971, 1972; Roberts and Friedlander, 1976; Miller, 1977).

#### Uncatalyzed and Catalyzed liquid phase oxidation

In general the liquid-phase oxidation of  $\text{SO}_2$  involves the diffusion of

molecular  $\text{SO}_2$  and other gases into a water droplet where the gases may encounter nucleating aerosol particles. Oxidation then proceeds through the process of hydration and subsequent dissociation of the dissolved gases and oxidation of sulfite or bisulfite ion.

The results reported in the literature for the oxidation of  $\text{SO}_2$  in the liquid phase vary. Many studies were conducted using higher concentrations of catalyst than normally found in the ambient atmosphere (Van den Heuvel and Mason, 1962; Cheng, Corn and Frohlinger, 1971; Penkett, 1972). The calculation of ambient air oxidation rates from these studies required extrapolation of the higher reactant concentration data to low levels found in the ambient environment.

Oxidation in the aqueous phase has been found to be sensitive to pH, temperature, relative humidity, catalyst type, catalyst concentration,  $\text{NH}_3$  concentration and  $\text{SO}_2$  concentration (Fuller and Crist, 1941; Junge and Ryan, 1958; Van den Heuvel and Mason, 1963; Scott and Hobbs, 1967; Matteson et al., 1969; Brimblecombe and Spedding, 1975; Barrie and Georgii, 1976; Penkett, 1972; Penkett and Garland, 1974).

Oxidation rates ranging from 0 to  $15\%/hr^{-1}$  have been reported for the uncatalyzed oxidation of  $\text{SO}_2$  by  $\text{O}_2$  (with and without ammonia) (Van den Heuvel and Mason, 1963; Scott and Hobbs, 1967; McKay, 1971; Miller and de Pena, 1975; Beilke, et al., 1975). Ammonia, although not a true catalyst, is important in the oxidation reaction because it maintains a high pH and forms sulfate salts which in turn lower solution vapor pressure (Freiberg, 1974).

Metal catalyzed oxidation rates for  $\text{SO}_2$  ranging from 0- $90\%/hr^{-1}$  have been reported (Cheng, et al., 1971; Brimblecombe and Spedding, 1975; Barrie

and Georgii, 1976). Dissolved manganese and iron are the most efficient catalysts; vanadium has been shown to be inefficient (Junge and Ryan, 1958; Foster, 1969; Matteson et al., 1969; Cheng et al., 1971). A synergistic effect has been observed between iron and manganese, suggesting that plume oxidation rates may be accelerated in the presence of several catalysts (Barrie and Georgii, 1976).

Oxidation has been observed to stop at a pH of 2.2 (Junge and Ryan, 1958; Barrie and Georgii, 1976). Freiberg (1974) proposed a model for oxidation that depends strongly on pH, temperature, and relative humidity. Unlike Freiberg's model (1974), Barrie and Georgii (1976) found that oxidation increased with higher temperature.

Oxidation of  $\text{SO}_2$  by ozone at a rate of  $12.6\%/hr^{-1}$  has been reported (Penkett, 1972). Plume oxidation by this mechanism is potentially important, particularly at distances farther from the source, where ozone concentrations have not been depleted by reaction with NO (Penkett and Garland, 1974; Beilke and Gravenhorst, 1977).

Overall aqueous phase oxidation rates ranging from 0-150%/hr<sup>-1</sup> have been reported (Foster, 1969).

#### Catalyzed Oxidation on Dry Surfaces

The heterogeneous solid catalyzed gas phase oxidation studies reported in the literature lack reaction rate and/or mechanism studies relating dry heterogeneously catalyzed  $\text{SO}_2$  oxidation systems to atmospheric processes (Novokov et al., 1974; Smith, et al., 1974; Low et al., 1971; Goodsel et al., 1972). These reactions do not appear significant when compared to aqueous phase oxidation systems (Davis and Lunsford, 1976).

Manganese, iron, lead, and other suspended particulates in urban air have been reported as efficient catalysts; vanadium; however, appears to be a poor catalyst (Corn and Cheng, 1972; Urone et al.; 1968).

### Field Studies

The conversion of sulfur dioxide in power plants, plumes, urban areas, and smelter plumes has been investigated. These studies encompass a variety of sampling, analytical, and modelling techniques. Many rate controlling factors believed to be important for both laboratory and field studies are: temperature, humidity, solar radiation, catalytic particles, hydrocarbons, and free radicals (e.g., HO). No single factor is dominant under all conditions.

Most investigators believe that either indirect photo-oxidation or liquid phase oxidation of SO<sub>2</sub> in plumes and the atmosphere are the most significant mechanisms (Davis and Klauber, 1975; Newman et al., 1975a, 1975b; Whitby et al., 1977; Poeschel and Van Valin, 1977; Lusic et al., 1977; Dana et al., 1975). Other controlling factors include the nature of the plume and existing meteorological conditions (Dittenhoefer and de Pena, 1977). For example, gas phase oxidation by HO radical may be important during the summer months when UV fluxes, temperature and relative humidity are greater because these conditions favor HO production. Conversely, liquid phase oxidation likely predominates in the winter when conditions do not favor indirect gas phase oxidation.

The relative importance of catalyzed and uncatalyzed liquid phase processes depends on the presence of active transition metal species. Catalytic processes may predominate in power plant plumes where particulate metals

are abundant. A pollution control-equipped smelter plume contains fewer catalytic surfaces and consequently catalytic reactions may be insignificant.

The type of mechanism which predominates in a single plume over the course of a year may experience both seasonal and diurnal variations. On a diurnal basis, higher UV fluxes occur during daylight hours, which favor indirect gas phase oxidation; conversely these mechanisms become slower or less important at night. The relative importance of the individual mechanism in a plume may also vary with distance from the source. Oxidation by HO or ozone may predominate farther downwind while catalyzed-uncatalyzed liquid phase oxidation may be more important close to the source (Davis et al. 1974, Davis and Klauber, 1975).

In summary, investigators have not elucidated the complex chemical reactions of SO<sub>2</sub> oxidation. Field investigations have shown that humidity, sunlight, temperature, catalyst concentration, and catalyst type are important factors in the oxidation process (Gartrell et al, 1963; Weber, 1970; Davis et al., 1974; Newman, et al., 1975a, 1975b). Neither the importance of the individual mechanisms nor the variation of the oxidation rate with distance have been determined. Some studies show that the oxidation rate remains constant throughout plume travel, while others show increasing or decreasing trends in oxidation rates (Whitby et al., 1977; Lusic and Wiebe, 1976). Problems in methodology with the plume field studies have not been resolved (James and Foster, 1976; Newman et al., 1975a, 1975b; Whitby et al., 1977; Wilson et al., 1976; Lusic and Wiebe, 1976). Some of these include type of instrumentation, the method of calculating rates, the method of collecting data in the plume, the

laboratory analysis of particulate sulfate and so forth.

SO<sub>2</sub> oxidation rates in the range 0-300%/hr<sup>-1</sup> have been measured for power plant, urban and smelter plumes; most values are in the range 0-10%/hr<sup>-1</sup> and average values in this group are about 2%/hr<sup>-1</sup>

(Gartrell et al., 1963; Davis et al., 1974; Dittenhoefer and de Pena, 1977; Pueschel, 1977; Lysis et al., 1977; Newman et al., 1975a, 1975b; Forrest and Newman, 1977; Weber, 1970; Dana et al., 1975).

#### Plume Chemistry Modeling

Because of the lack of a well-defined experimental data base which describes the complex SO<sub>2</sub> chemical system, a single inclusive chemical reaction dispersion model has not been developed and verified. However, until more sophisticated mechanisms are elucidated, the incorporation of first or second order oxidation expressions into diffusion models appears to be a reasonable approximation for most purposes.

### SULFUR DIOXIDE CONVERSION LABORATORY STUDIES

Four important mechanisms have been identified in the oxidation of  $\text{SO}_2$  to sulfate; these mechanisms (listed in Table 1) are affected by a variety of factors including the concentration of reacting species present, temperature, and humidity.

Sulfur dioxide may be dissociated into  $\text{SO}$  and  $\text{O}$  atoms but this reaction requires 135 kcal/mol and is not possible energetically for wavelengths of absorbed light greater than  $2180 \text{ \AA}$ . Since  $\text{SO}_2$  in the troposphere absorbs only light of wavelengths greater than  $2180 \text{ \AA}$ , photo-dissociation does not occur in the troposphere and will not be considered further in this review.

The results of laboratory studies pertaining to direct photo-oxidation, indirect photo-oxidation, air oxidation in liquid droplets, catalyzed oxidation in liquid droplets and catalyzed oxidation on dry surfaces are presented in the following section.

#### Direct Photo-oxidation

Direct photo-oxidation is the homogeneous oxidation of  $\text{SO}_2$  and  $\text{SO}_2\text{-O}_2$  mixture in the presence of ultraviolet light. The photochemistry of  $\text{SO}_2$  excited within the lower atmosphere provides, in principal, several pathways which may lead to the oxidation or other transformation of  $\text{SO}_2$ .  $\text{SO}_2$  absorbs light within the UV region of solar radiation incident within the troposphere at two bands (from  $2400\text{-}3300 \text{ \AA}$  and from  $3400\text{-}4000 \text{ \AA}$ ). Excitation of  $\text{SO}_2$  leads to the formation of a single non-emitting triplet state,  $\text{SO}_2 (^3\text{B}_1)$ . It appears that the  $\text{SO}_2 (^3\text{B}_1)$  molecule is the major photochemically active species formed in the photo-excitation of  $\text{SO}_2$ .

(Okuda et al. 1969). Calvert et al. (1977) developed theoretical rates of reaction of  $\text{SO}_2$  ( $^3\text{B}_1$ ) reactions with various impurity species and  $\text{O}_2$  in a hypothetical sun-irradiated lower troposphere. These rates are given in Table 3.

The rates in Table 3 are considered very slow, and even under the most favorable conditions they are below those estimated for the indirect oxidation of ground state  $\text{SO}_2$ .

Calvert et al. (1977) concluded that the major chemical effect of  $\text{SO}_2$  photo-oxidation by sunlight within a polluted atmosphere is the generation of excited singlet -  $\text{O}_2$  species through reactions 1 and 2.

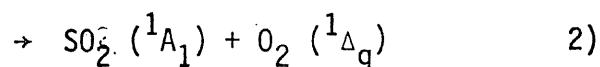
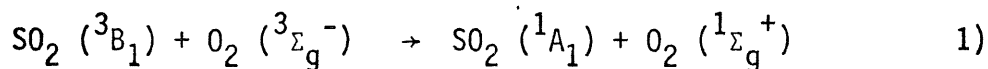

The authors also concluded that the data support the occurrence of a slow rate of  $\text{SO}_2$  photo-oxidation probably through reactions 3 and 4 or 5 and 6.

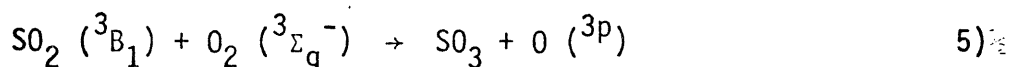
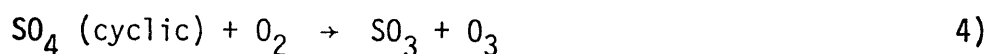
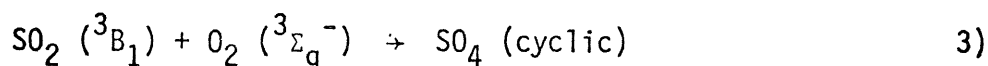

The maximum rates for these reactions correspond to less than 0.02 percent/hour. The observed ratios of  $\text{SO}_2$  oxidation in air are higher; therefore, oxidation of  $\text{SO}_2$  occurs by reactions other than those involving photo-excited  $\text{SO}_2$  molecules.



Table 3. The theoretical rate of reaction ( $\text{ppm hr}^{-1}$ ) of  $\text{SO}_2$  ( $^3\text{B}_1$ ) reactions with various impurity species and  $\text{O}_2$  in a hypothetical sunlight-irradiated lower troposphere. <sup>a,b</sup>

Reactant molecule	Reaction No.		Initial $\{\text{SO}_2\}$ , ppm		
			500	0.5	0.05
NO	13	A <sup>c</sup>	$3.1 \times 10^{-2}$	$3.1 \times 10^{-5}$	$3.1 \times 10^{-6}$
		B <sup>c</sup>	$8.9 \times 10^{-2}$	$8.9 \times 10^{-5}$	$8.9 \times 10^{-6}$
CO	14	A	$9.9 \times 10^{-7}$	$9.9 \times 10^{-10}$	$9.9 \times 10^{-11}$
		B	$2.9 \times 10^{-6}$	$2.9 \times 10^{-9}$	$2.9 \times 10^{-10}$
$\text{C}_2\text{H}_2$	15	A	$6.1 \times 10^{-4}$	$6.1 \times 10^{-7}$	$6.1 \times 10^{-8}$
		B	$1.8 \times 10^{-3}$	$1.8 \times 10^{-6}$	$1.8 \times 10^{-7}$
cis-2- $\text{C}_4\text{H}_8$	16	A	$5.0 \times 10^{-2}$	$5.0 \times 10^{-5}$	$5.0 \times 10^{-6}$
		B	$1.5 \times 10^{-1}$	$1.5 \times 10^{-4}$	$1.5 \times 10^{-5}$
iso- $\text{C}_4\text{H}_8$	17	A	$3.4 \times 10^{-4}$	$3.4 \times 10^{-7}$	$3.4 \times 10^{-8}$
		B	$9.7 \times 10^{-4}$	$9.7 \times 10^{-7}$	$9.7 \times 10^{-8}$
$\text{SO}_2$	4	A	$8.1 \times 10^{-3}$	$8.1 \times 10^{-9}$	$8.1 \times 10^{-11}$
		B	$2.4 \times 10^{-2}$	$2.4 \times 10^{-8}$	$2.4 \times 10^{-10}$
$\text{O}_2$ <sup>d</sup>	10	A	<9.0	$<9.0 \times 10^{-3}$	$<9.0 \times 10^{-4}$
		B	<17.0	$<1.7 \times 10^{-2}$	$<1.7 \times 10^{-3}$
	5,6,7	A	$<1.0 \times 10^{-1}$	$<1.0 \times 10^{-4}$	$<1.0 \times 10^{-5}$
		B	$<1.9 \times 10^{-1}$	$<1.9 \times 10^{-4}$	$<1.9 \times 10^{-5}$

a. Adapted from Calvert et al. (1977)

b. Calculated for a solar zenith angle of  $40^\circ$ , near sea level,  $25^\circ\text{C}$ , 1 atm, 50 percent relative humidity, and 1 ppm of the specific impurity molecule present; in the case of  $\text{SO}_2$  impurity, the column heads represent the amount present.

c. Rows labeled A - 50 percent RH, no pressure saturation or wavelength effects on intersystem crossing ratio. Row labeled B - pressure saturation effects and wavelength effects assumed.

d. Oxygen is assumed to be present in each case at 156.7 Torr (air at 50% relative humidity,  $25^\circ\text{C}$ ).

Laboratory studies also have shown that there is a low rate of  $\text{SO}_3(\text{H}_2\text{SO}_4)$  formation in dilute  $\text{SO}_2$ -air mixtures. Studies of the reaction kinetics are subject to errors due to varying intensity and spectral distribution of radiation, gaseous impurities, reactant concentrations, humidity, temperature and reactive container surfaces. Reported quantum yields and theoretical calculations indicate that direct photo-oxidation is too slow to account for transformations of  $\text{SO}_2$  which are observed for short time periods such as found in power plant and smelter plumes.

Table 4 provides a summary of photo-oxidation studies of  $\text{SO}_2$ ,  $\text{SO}_2$ -air mixture.

Table 4. Summary of photo-oxidation studies of SO<sub>2</sub>, SO<sub>2</sub>-air mixtures.

Investigator	Experimental Conditions	Reported Quantum Yield ( $\phi$ )	Conversion Rate Based on 1st Order Rate Constant (in sunlight)
Gerhard and Johnstone (1955)	sunlamp, SO <sub>2</sub> (5 to 30 ppm), RH (32 to 91%), T (75 to 89° C); natural sunlight		0.20%/hour 0.1-0.2%/hour
Renzetti and Doyle (1960)	sunlamp, SO <sub>2</sub> (0.2-0.6 ppm), 50% RH, irradiation <sub>2</sub> time (17 to 27 min) sunlamp SO <sub>2</sub> (P <sub>SO<sub>2</sub></sub> =12.7 mm), O <sub>2</sub> (P <sub>O<sub>2</sub></sub> =10.6 mm); 23°C., no water vapor	3x10 <sup>-1</sup> 3.6x10 <sup>-2</sup>	24%/hour
Urone, et al. (1968)	sunlamp, SO <sub>2</sub> (12 ppm), 50%RH, irradiation <sub>2</sub> time (20-30 hours)	-	0.1%/hour
Cox and Penkett (1970)	natural sunlight, SO <sub>2</sub> (0.07 to 0.76 ppm), bright, hazy, and cloudy sunlight (rates up to 100%/hour attributed to wall effects and contamination by HC and NO <sub>x</sub> )	1.0x10 <sup>-2</sup>	0.04-0.65%/hour
Cox (1972)	sunlamp, low SO <sub>2</sub> /O <sub>2</sub> , 23 ± 2°C	1.3x10 <sup>-3</sup>	0.02-0.04%/hour
Sethi (1971)	sunlamp, SO <sub>2</sub> (20-100 torr), O <sub>2</sub> (50-390 torr), room temperature	1.7x10 <sup>-2</sup> to 2x10 <sup>-3</sup>	1.25%/hour
Friend et al. (1973)	sunlamp, SO <sub>2</sub> (0.1-1.0 ppm), O <sub>2</sub> (19-23%)	1.0x10 <sup>-9</sup>	<<0.01%/hour
Takahasi and Kasahara (1976)	Sunlamp, SO <sub>2</sub> (0.05-10 ppm), RH (80, 60, <10%), maximum irradiation time (12.5 minutes)	8x10 <sup>-3</sup>	0.07%/hour

Gerhard and Johnstone (1955) investigated the rate of photo-oxidation ( $3650-2950 \text{ \AA}$ ) of  $\text{SO}_2$  (5 to 30 ppm) at 32 to 91% relative humidity and 75 to 89°F in a Lucite chamber using both a mercury sunlamp and natural sunlight for irradiation. The rate of  $\text{H}_2\text{SO}_4$  formation was determined to be first order with respect to  $\text{SO}_2$  and was 0.68%/hour in artificial light with a mass median particle diameter of 0.19 to 0.45  $\mu\text{m}$ . Quantum yields were not determined. The oxidation rate was unaffected by humidity, presence or absence of salt nuclei, or concentration of  $\text{NO}_2$  over the range of concentrations studied. The rate of reaction in the dark was negligible under the experimental conditions. Since the intensity of light in the  $\text{SO}_2$  absorbing region from the mercury sunlamp was about three times the intensity of noon sunlight, the authors extrapolated the mercury sunlamp rate to noon sunlight and obtained a rate of about 0.2%/hour. Although the authors felt the experiments in natural sunlight were somewhat uncertain due to experimental conditions, a reaction rate of 0.1-0.2%/hour was postulated.

Renzetti and Doyle (1960) studied the oxidation of  $\text{SO}_2$  in air as part of a program to investigate the photochemical formation of aerosol in sulfur-dioxide-hydrocarbon systems; experiments were conducted in a continuous stirred-flow reactor using a medium pressure mercury sunlamp. A quantum yield of 0.3 molecules per quantum absorbed was obtained for  $\text{SO}_2$  concentrations of 0.2 to 0.6 ppm, 50% humidity, and with reactor residence times of 17 to 27 minutes. The quantum yield decreased to 0.036 molecules using a light source of  $3130 \text{ \AA}$  wavelength at 25°C with no water vapor and with an increased  $\text{SO}_2$  and  $\text{O}_2$  concentration ( $P_{\text{SO}_2} = 12.7 \text{ mm}$  and  $P_{\text{O}_2} = 10.6 \text{ mm}$ ). The authors conclude that the differences in the results are probably due to the higher total pressure, lower concentrations of

reactants, and presence of water vapor as was the case for the first experiment. Also, estimating absorption rates and estimating rate of photo-oxidation in the reactor likely introduced error in the final results. When a quantum yield of 0.3 was assumed for sunlight, an average photo-oxidation rate of 24%/hour was obtained which was considerably higher than rates reported by Gerhard and Johnstone (1955), Urone et al. (1968), Cox and Penkett (1970), and other investigators.

Urone et al. (1968) using a procedure similar to Renzetti and Doyle (1960) determined the conversion rates of  $\text{SO}_2$  using a UV lamp which had an irradiation intensity approximately seven times the intensity of the noonday sunlight in the same wavelength region. A thirty-hour irradiation experiment ( $\text{SO}_2$ -12 ppm, 50% RH) yielded a conversion rate of 0.6%/hour or about 0.1%/hour when extrapolated to noonday sunlight. A twenty-hour experiment also yielded nearly identical results.

Cox and Penkett (1970) studied the oxidation of  $\text{SO}_2$  at low concentrations in air using natural sunlight; the concentration of gaseous  $\text{SO}_2$  and aerosol was measured using radioactive  $^{35}\text{SO}_2$  and the rate of reaction was determined from the decay of  $\text{SO}_2$  and the yield of aerosol. Reactions were conducted in an aluminum reaction chamber with a Perspex lid which transmitted about 50% of the natural UV radiation (3000-3200  $\text{\AA}$ ).  $\text{SO}_2$  concentrations of 0.07 to 0.76 ppm resulted in conversion rates of 0.04 to 0.65%/hour determined from aerosol formation under conditions of bright sunlight, hazy sunlight and sunlight with clouds. Conversion rates calculated from  $\text{SO}_2$  decay were found to be as high as 100%/hour. These high rates were attributed to surface (container wall) effects and traces of HC (0.1-0.5 ppm) and  $\text{NO}_x$  (<.005 ppm) in the air streams. A comparison

of the average value of the rate constant determined from aerosol measurements with published data for the specific absorption rate of  $\text{SO}_2$  in natural sunlight resulted in a quantum yield of  $10^{-2}$  for the photo-oxidation. Cox (1972) determined the quantum yield for sulfur trioxide production ( $\phi \text{SO}_3$ ) for the photolysis of  $\text{SO}_2$ ,  $\text{SO}_2\text{-O}_2$  and  $\text{SO}_2\text{-air}$  mixtures in the first allowed wavelength absorption region 2400-4000 Å at  $23 \pm 2^\circ \text{C}$  in a static system to investigate the variation in reported quantum yields determined under different conditions. Reactions were conducted in a cylindrical quartz cell using a UVS 500 medium pressure mercury arc (light flux in photons per second:  $1.0 \times 10^{17}$  for 2400-4000 Å,  $4.3 \times 10^{16}$  for 2900-4000 Å, and  $2.5 \times 10^{15}$  for 3130 Å). At low concentrations of  $\text{SO}_2$  relative to  $\text{O}_2$  or air, the quantum yield of  $\text{SO}_3$  ( $\phi \text{SO}_3$ ) was  $1 \times 10^{-3}$  but increased to a maximum of  $5 \times 10^{-3}$  at the initial concentration ratio of  $\text{SO}_2\text{-O}_2$ . For pure  $\text{SO}_2$ ,  $\phi \text{SO}_3$  was lower ( $3.4 \times 10^{-3}$ ) than when small amounts of  $\text{O}_2$  were present. The author reported some evidence that high  $\phi \text{SO}_3$  may result from a surface reaction. An extrapolation of the low  $\text{SO}_2$  data to atmospheric oxidation in natural sunlight resulted in an estimate of  $\phi \text{SO}_3$  of  $0.3 \times 10^{-3}$ ; this value would result in an oxidation rate of about 0.02-0.04 %/hour, comparable to sunlight rates.

Sethi (1971) photolyzed mixtures of  $\text{SO}_2$  (20-100 torr) and  $\text{O}_2$  (50-390 torr) at 3130 Å and at room temperature in quartz cells using mercury lamps. The only product of the photolysis was  $\text{SO}_3$  and this study marked a direct identification of the product. Quantum yields for the disappearance of  $\text{SO}_2$  were determined using a photometric method to monitor  $\text{SO}_2$  concentration. Quantum yields of  $\text{SO}_3$  were not determined because of poor reproducibility in the determinations of  $\text{SO}_3$  concentrations. The quantum yield of  $\text{SO}_2$  was independent of  $\text{SO}_2$  concentration in the range 11.6 to 50.4 torr and

independent of  $O_2$  concentration in the range 50.0 to 390.6 torr. Over an eight hour photolysis with an intense UV source, conversions of about 10% were observed at  $3130 \text{ \AA}$ , and  $\phi SO_2$  was  $1.7 \times 10^{-2}$  molecule per quantum absorbed; over the integrated wavelength range of 2800 to 4200  $\text{\AA}$ ,  $\phi SO_2$  was  $2 \times 10^{-3}$  molecule per quantum absorbed. The differences in  $\phi SO_2$  values were explained in terms of wavelength dependence of the rate constants for two primary reactions yielding a ground state and triplet  $SO_2$ . The authors indicated that  $SO_3$  was the only product formed,  $\phi SO_3 = \phi SO_2$ , based on the stoichiometry of the reaction  $2 SO_2 + O_2 \rightarrow 2 SO_3$ .

Friend et al. (1973) investigated  $SO_2$  photo-oxidation in the first allowed absorption region (2500-3200  $\text{\AA}$ ) as part of a study of the mechanism of formation of stratospheric aerosols. Experiments were conducted using a pyrex reaction chamber with quartz optical windows and a medium-pressure, high intensity mercury lamp. The quantum yield for the photo-oxidation of  $SO_2$  by  $O_2$  was less than  $1.0 \times 10^{-9}$  which is the lowest yield of studies reported in this review; the corresponding oxidation rate for sunlight is much less than 0.01%/hour.

Takahasi and Kasahara (1976) investigated the effects of environmental factors on the photo-oxidation of  $SO_2$ . Experiments were conducted with  $SO_2$  concentrations in the range from 0.05 to 10 ppm; humidity of 80%, 60%, and less than 10%; a maximum irradiation time of 12.5 minutes; and a UV intensity of  $0.15 \text{ m W/cm}^2$  - sterad. Particle number, particle concentration, and volumetric rate of particle formation were strongly dependent on both  $SO_2$  vapor concentration and humidity. The overall quantum yield was  $8 \times 10^{-3}$  with a corresponding reaction rate of 0.04%/hour. This rate, when extrapolated to noonday summer sunlight in Japan, is 0.7%/hour.

Indirect Photo-Oxidation

Early investigations of  $\text{SO}_2$  oxidation concentrated on catalyzed liquid-phase oxidation as the most probable oxidation mechanism. More recently, field studies have supported indirect gas phase oxidation as an important mechanism for  $\text{SO}_2$  oxidation. It is possible that early studies had experimental problems; e.g.,  $\text{SO}_2$  conversion on filters, analytical technique, and so forth.

Homogeneous gas phase oxidations proceed via 2nd or 3rd order processes between  $\text{SO}_2$  and other molecular oxidizing agents or free radical oxidizing agents. Calvert et al. (1977) in an extensive review of the literature presented a compilation of homogeneous reaction paths and recommended rate constants based on experimental and theoretical considerations. Table 5 is a compiled listing of the rate data and mechanisms taken from Calvert et al. (1977) and other investigators.

 $\text{SO}_2$  - Singlet Oxygen System

Reactions 7-8 in Table 5 summarize the  $\text{SO}_2$ -singlet-oxygen system. Calvert et al. (1977), after reviewing the literature, estimated a rate of about  $1.4 \times 10^{-7}\%$ /hour for the oxidation of  $\text{SO}_2$  by  $\text{O}_2(^1\Sigma_g^+)$  for typical values of  $\{\text{O}_2(^1\Sigma_g^+)\} = 6 \times 10^2$  molec/cm<sup>3</sup> and concluded that the rate of singlet oxygen reactions with  $\text{SO}_2$  in the lower atmosphere is insignificant.

Davis and Klauber (1975), in their review of the literature, estimated a rate constant of about  $10^{-19}$  cm<sup>3</sup>/molec sec for the reaction of  $\text{O}_2(^1\Delta)$  with  $\text{SO}_2$  and also opined that singlet  $\text{O}_2$  reaction with  $\text{SO}_2$  is not important in the lower atmosphere.

Davis and Klauber (1975) derived a rate constant of  $2 \times 10^{-14}$  cm<sup>3</sup> molec<sup>-1</sup> sec<sup>-1</sup> for the oxidation of  $\text{SO}_2$  by  $\text{O}(^3P)$  where the  $[\text{O}(^3P)] \cong 1 \times 10^4$  molec/cm<sup>3</sup>.

Calvert et al. (1977) derived a rate constant of  $(5.7 \pm 0.5) \times 10^{-14}$  cm<sup>3</sup> molec<sup>-1</sup> sec<sup>-1</sup> for the oxidation of  $\text{SO}_2$  by  $\text{O}(^3P)$ . In a highly polluted



Table 5. Enthalpy changes, rate constants and reaction rates for potentially important reactions of ground state SO<sub>2</sub> and SO<sub>3</sub> molecules in the lower troposphere. <sup>a</sup>

Reaction			Reaction Rate (%/hr)	
			Polluted Atm	Clean Atm
(7) O <sub>2</sub> ( <sup>1</sup> Δ <sub>g</sub> ) + SO <sub>2</sub> → SO <sub>4</sub> (biradical), SO <sub>4</sub> (cyclic)	~25, ~28			
(8) O <sub>2</sub> ( <sup>1</sup> Δ <sub>g</sub> ) + SO <sub>2</sub> → SO <sub>3</sub> + O( <sup>3</sup> P)	-13.4	(3.9 ± 0.9) × 10 <sup>-20</sup>	1.4 × 10 <sup>-6</sup>	
(9) O <sub>2</sub> ( <sup>1</sup> Δ <sub>g</sub> ) + SO <sub>2</sub> → O <sub>2</sub> ( <sup>3</sup> Γ <sub>g</sub> <sup>-</sup> ) + SO <sub>2</sub>	22.5			
(10) O <sub>2</sub> ( <sup>1</sup> Γ <sub>g</sub> <sup>+</sup> ) + SO <sub>2</sub> → SO <sub>4</sub> (biradical), SO <sub>4</sub> (cyclic)	~40, ~43			
(11) O <sub>2</sub> ( <sup>1</sup> Γ <sub>g</sub> <sup>+</sup> ) + SO <sub>2</sub> → SO <sub>3</sub> + O( <sup>3</sup> P)	1.7	6.6 × 10 <sup>-16</sup>	1.4 × 10 <sup>-7</sup>	
(12) O <sub>2</sub> ( <sup>1</sup> Γ <sub>g</sub> <sup>+</sup> ) + SO <sub>2</sub> → SO <sub>2</sub> + O <sub>2</sub> ( <sup>1</sup> Δ <sub>g</sub> )	15.1			
(13) O( <sup>3</sup> P) + SO <sub>2</sub> (+M) → SO <sub>3</sub> (+M)	83.3	(5.7 ± 0.5) × 10 <sup>-14</sup>	1.2 × 10 <sup>-2</sup>	
(14) O <sub>3</sub> + SO <sub>2</sub> → O <sub>2</sub> + SO <sub>3</sub>	57.8	< 8 × 10 <sup>-24</sup>	1.4 × 10 <sup>-4</sup>	8.6 × 10 <sup>-6</sup>
(20) NO <sub>2</sub> + SO <sub>2</sub> → NO + SO <sub>2</sub>	10.0	8.8 × 10 <sup>-30</sup>	1.0 × 10 <sup>-11</sup>	
(18) NO <sub>3</sub> + SO <sub>2</sub> → NO <sub>2</sub> + SO <sub>3</sub>	32.8	< 7 × 10 <sup>-21</sup>	6.3 × 10 <sup>-8</sup>	
(21) ONOO + SO <sub>2</sub> → NO <sub>2</sub> + SO <sub>3</sub>	~30	< 7 × 10 <sup>-21</sup>	< 3.8 × 10 <sup>-4</sup>	
(19) N <sub>2</sub> O <sub>5</sub> + SO <sub>2</sub> → N <sub>2</sub> O <sub>4</sub> + SO <sub>3</sub>	24.6	< 4 × 10 <sup>-23</sup>	3.6 × 10 <sup>-6</sup>	
(22) HO <sub>2</sub> + SO <sub>2</sub> → HO + SO <sub>3</sub>	19.3	> (8.7 ± 1.3) × 10 <sup>-16</sup>	1.9	0.15
(24) HO <sub>2</sub> + SO <sub>2</sub> (+M) → HO <sub>2</sub> SO <sub>2</sub> (+M)	~7	not obs. exp.		
(25) CH <sub>3</sub> O <sub>2</sub> + SO <sub>2</sub> → CH <sub>3</sub> O + SO <sub>3</sub>	~27	(5.3 ± 2.5) × 10 <sup>-15</sup>	2.0	0.02
(26) CH <sub>3</sub> O <sub>2</sub> + SO <sub>2</sub> → CH <sub>3</sub> O <sub>2</sub> SO <sub>2</sub>	~31			
(27) HO + SO <sub>2</sub> (+M) → HOSO <sub>2</sub> (+M)	~37	(1.1 ± 0.3) × 10 <sup>-12</sup>	2.7	0.4
(29) CH <sub>3</sub> O + SO <sub>2</sub> (+M) → CH <sub>3</sub> OSO <sub>2</sub> (+M)	~24	~6 × 10 <sup>-15</sup>	0.01	
(32) RCHO + SO <sub>2</sub> → RCHO + SO <sub>3</sub>	~98		3.0	0.1
(33) RCH <sup>0-0-0</sup> —CHR + SO <sub>2</sub> → 2RCHO + SO <sub>3</sub>	~89			
(34) SO <sub>3</sub> + H <sub>2</sub> O → H <sub>2</sub> SO <sub>4</sub>	24.6	(9.1 ± 2.0) × 10 <sup>-13</sup>		

atmosphere with  $\{O(^3P)\} = 2 \times 10^5 \text{ molec/cm}^3$  an oxidation rate of  $1.2 \times 10^{-2}\%/hour$  is calculated.

#### SO<sub>2</sub> - O<sub>3</sub> System

Direct oxidation of SO<sub>2</sub> by ozone in the gas phase is a slow but exothermic reaction (equation 14, Table 5)

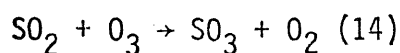

Davis et al. (1974) using the technique of stop-flow TOF mass spectrometry calculated an upper limit for the rate constant of equation 14 of equal to or less than  $10^{-20} \text{ cm}^3 \text{ molec}^{-1} \text{ sec}^{-1}$  (360° K, 200 m torr of O<sub>3</sub> and 20 m torr of SO<sub>2</sub>).

Daubendiek and Calvert (1973) calculated a rate constant of less than  $8 \times 10^{-24} \text{ cm}^3 \text{ molec}^{-1} \text{ sec}^{-1}$ . Using Daubendiek and Calvert's rate constant and an ozone concentration of  $5 \times 10^{13} \text{ molec cm}^{-3}$  (about 2 ppm), which is a high ozone concentration that has been reported in some areas of the U.S., a sulfur dioxide oxidation rate of  $1.4 \times 10^{-4}\%/hour$  is calculated. If an O<sub>3</sub> concentration of  $3.0 \times 10^{12} \text{ molecules/cm}^3$ , which was measured in the Cu-Ni Study Region in NE Minnesota, is used along with Daubendiek and Calvert's rate constant, an oxidation rate of  $8.6 \times 10^{-6}\%/hour$  is calculated.

#### SO<sub>2</sub> - NO<sub>x</sub> System

A number of investigators have studied the oxidation and subsequent particle formation of SO<sub>2</sub> by NO<sub>x</sub>. Present data indicate that the oxides of nitrogen (NO<sub>2</sub>, NO<sub>3</sub>, ONOO, N<sub>2</sub>O<sub>5</sub>) do not contribute significantly to the oxidation of SO<sub>2</sub>.

Gerhard and Johnstone (1955) studied the effect of 1 to 2 ppm NO<sub>2</sub> on the oxidation of 10 to 20 ppm SO<sub>2</sub> (temp, 78-86° F; RH, 60-77%) when irradiated with light in the wavelength range 2950-3650 Å. No measurable effect on SO<sub>2</sub> oxidation was observed. No reaction was observed in the dark with 20 ppm SO<sub>2</sub> and 1.0 ppm NO<sub>2</sub>. Irradiation of 1.0 ppm NO<sub>2</sub> in air without SO<sub>2</sub> did not produce aerosol. The addition of NO<sub>2</sub> concentration which was 5 to 20% of the SO<sub>2</sub> concentration had no measurable effect on reaction rate.

Renzetti and Doyle (1960) found that the addition of 1 ppm NO<sub>2</sub> to 0.14 ppm SO<sub>2</sub> enhanced the photo-oxidation of SO<sub>2</sub> but that the addition of 1 ppm NO to 0.5 ppm SO<sub>2</sub> at 50% humidity hindered the formation of aerosol. The enhancement effect of NO<sub>2</sub> is accounted for by the reaction

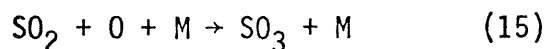

and the suppressing effect of NO by the reaction

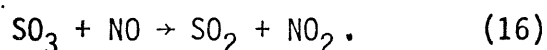

Altshuller and Bufalini (1965) suggest that the removal of SO<sub>3</sub> or the deactivation of excited SO<sub>2</sub> with NO is a more likely mechanism.

Jaffee and Klein (1966) irradiated nitrogen dioxide in the presence of SO<sub>2</sub> at 3660 Å; SO<sub>2</sub> does not absorb light at this wavelength but NO<sub>2</sub> is photolyzed to NO and O. In the SO<sub>2</sub> - NO<sub>2</sub> - air system, SO<sub>2</sub> concentrations ranged from 2.13 x 10<sup>4</sup> to 143 x 10<sup>4</sup> moles/liter and NO<sub>2</sub> concentrations ranged from 1.47 x 10<sup>4</sup> to 5.15 x 10<sup>4</sup> moles/liter. The rate constant k<sub>17</sub> for the overall reaction  $\text{SO}_2 + \text{O} + \text{M} \xrightarrow{k_{17}} \text{SO}_3 + \text{M}$  (17) at {M} = 2 torr was found to be 1.4 x 10<sup>10</sup> l<sup>2</sup> mole<sup>-2</sup> sec<sup>-1</sup>.

A dark reaction rate constant of 3.7 x 10<sup>-3</sup> l mole<sup>-1</sup>, which is negligible, was also observed. Levy et al. (1976) reported a value for k<sub>17</sub> of 9.3 x 10<sup>9</sup> l<sup>2</sup> mole<sup>-2</sup> sec<sup>-1</sup> at atmospheric pressure. The authors reported that

if  $10^4$  oxygen atoms/cm<sup>3</sup> are assumed for an SO<sub>2</sub>-laden plume, a half life of 3.5 years is calculated for the oxidation reaction, which is a very slow reaction rate.

Katz and Gale (1970) found that the presence of NO<sub>2</sub> increased the rate of SO<sub>2</sub> oxidation. The addition of 0-0.87 ppm NO<sub>2</sub> to 3.3 ppm SO<sub>2</sub> in air (temp 36°, 8.8 mg H<sub>2</sub>O/l dry air, UV light intensity equivalent to 70% noon sunlight) resulted in a doubling of the rate constant for both dry and wet air. Oxidation was not observed under dark conditions.

Urone et al. (1970) reported on the photochemical and thermal reactions of SO<sub>2</sub> with NO<sub>2</sub> in air at higher gas concentrations than those in the ambient air. The reaction of 1000 ppm SO<sub>2</sub> and 1.50% NO<sub>2</sub> in dry air yielded a rate constant of about 1.9%/hour after 1 hour irradiation time. A white crystalline solid which was identified as NSO<sub>5</sub> formed on the walls of the reaction vessel. A mixture of 1000 ppm SO<sub>2</sub> and 1.50% NO<sub>2</sub> in dry air was stored in the dark at room temperature for 2.5 hours, irradiated for 15 minutes, and then kept in the dark at room temperature. Results showed that reaction in the dark did not occur prior to irradiation and that reaction did occur in the dark after irradiation.

Smith and Urone (1974) investigated the SO<sub>2</sub> - NO<sub>2</sub> - air system. At 0.85 ppm NO<sub>2</sub> and 1.7 ppm NO<sub>2</sub> the rate of oxidation of 2 ppm SO<sub>2</sub> in air was about  $3.0 \times 10^{-4}$  ppm/min compared to  $1.7 \times 10^{-4}$  ppm/min for SO<sub>2</sub> in air alone. At higher concentrations of NO<sub>2</sub>, however, the reaction rate did not vary from that of SO<sub>2</sub> in air alone. The dark reaction between SO<sub>2</sub> and NO<sub>2</sub> was also studied; no measurable reaction rate was observed at NO<sub>2</sub> concentration up to 10.2 ppm and reaction time up to 5000 minutes. Gas phase oxidation products were not detected; however, if they were present, they probably

would not have been detected with the methods used. At 50% humidity the  $\text{SO}_2 - \text{NO}_2$  reaction rate increased twofold to  $15 \times 10^4$  ppm/minute.

Daubendiek and Calvert (1975) estimated rate constants for the  $\text{NO}_3\text{-SO}_2$  and  $\text{N}_2\text{O}_5\text{-SO}_2$  systems in experiments at room temperature and the following initial reactant pressures (torr): 1)  $\text{SO}_2 - 1.96$ ,  $\text{N}_2\text{O}_5 - 11.9$ ; 2)  $\text{SO}_2 - 8.5$ ,  $\text{N}_2\text{O}_5 - 2.5$ ,  $\text{O}_3 - 10.6$ ,  $\text{O}_2 - 450$ ; 3)  $\text{SO}_2 - 16.7$ ,  $\text{N}_2\text{O}_5 - 7.62$ ,  $\text{O}_3 - 36.6$ . Upper limits for the reaction rate constants were calculated for the reactions:

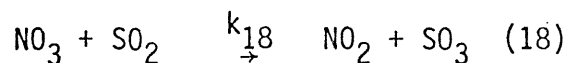

and

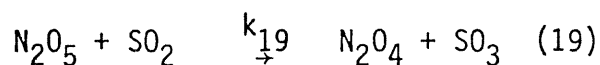

The reaction rate constant for  $k_{18}$  was found to be less than or equal to  $4.2 \text{ l mole}^{-1} \text{ sec}^{-1}$  ( $7.0 \times 10^{-21} \text{ cm}^3/\text{molec sec}$ ) and the constant for  $k_{19}$  was found to be less than or equal to  $2.5 \times 10^{-2} \text{ l mole}^{-1} \text{ sec}^{-1}$  ( $4 \times 10^{-23} \text{ cm}^3/\text{molec sec}$ ) at  $30^\circ \text{ C}$ . The data also suggest that these reactions are not important removal paths for  $\text{SO}_2$  in sunlight irradiated  $\text{NO}_x\text{-HC}$  polluted atmospheres. It was also found that very dry gaseous mixtures of  $\text{SO}_3$  and  $\text{NO}_2$  gases react rapidly to form a relatively nonvolatile white solid with a 1:1 ratio of  $\text{SO}_3$  and  $\text{NO}_2$  which may have been the same solid observed by Urone et al. (1970).

Davis and Klauber (1975) reported estimated rate constants of  $k_{18} \approx 10^{-21}$  and  $k_{19} \approx 10^{-23} \text{ cm}^3/\text{molec sec}$ .

Calvert et al. (1977) reported that for  $\text{NO}_2$  concentrations of  $5 \times 10^{12} \text{ molec cm}^{-3}$  (0.20 ppm) the concentrations of  $\text{NO}_3$  and  $\text{N}_2\text{O}_5$  which are expected in heavy photochemical smog are  $2.5 \times 10^7$  and  $2.5 \times 10^9 \text{ molec cm}^{-3}$ , respectively. These concentrations would result in oxidation rates of  $\text{SO}_2$  by  $\text{NO}_2$ ,  $\text{NO}_3$ , and

$\text{N}_2\text{O}_5$  of the order:  $1.6 \times 10^{-11}$ ,  $6.2 \times 10^{-8}$  and  $3.6 \times 10^{-6}$  percent/hour.

### $\text{SO}_2 - \text{HO}_2$ System

The  $\text{HO}_2\text{-SO}_2$  reaction is thought to be an important reaction in homogeneous gas phase oxidation; however, experimental estimates of reaction (22) are not extensive.

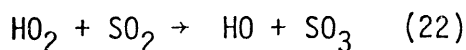

Payne et al. (1973) determined rate constants for the reaction of the hydroperoxyl radical with atmospheric  $\text{SO}_2$  using a photochemical  $^{18}\text{O}_2$  competitive isotope labeling technique. Rate measurements of reaction 22 versus reaction 23 were made.

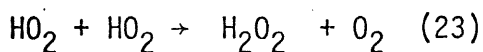

At  $300^\circ\text{K}$  the rate constant for reaction (22) was found to be  $(8.7 \pm 1.8) \times 10^{-16} \text{ cm}^3 \text{ molec}^{-1} \text{ sec}^{-1}$ .

Calvert et al. (1977) reviewed the literature relating to reaction 23 and concluded that  $k_{23}$  may be higher due to possible temperature and humidity effects.

Davis and Klauber (1975) reported a rate constant of about  $10^{-15} \text{ cm}^3 \text{ molec}^{-1} \text{ sec}^{-1}$  for reaction (22).

A typical  $\text{HO}_2$  concentration expected in an unpolluted atmosphere is about  $5 \times 10^8 \text{ molec/cm}^3$  (Levy, 1971) and the level expected in a highly polluted atmosphere is about  $6 \times 10^9 \text{ molec/cm}^3$  (Demerjian et al., 1974). These levels lead to a rate of  $\text{SO}_2$  oxidation by  $\text{HO}_2$  ( $k_{25} 8.7 \times 10^{-16} \text{ cm}^3 \text{ molec}^{-1} \text{ sec}^{-1}$ ) of about 1.9%/hour for a polluted environment and about 0.15%/hour for a clean environment.

Reaction (24) which results in HO<sub>2</sub> addition to SO<sub>2</sub> rather than abstraction has not been observed experimentally and is not thought to be competitive with the abstraction reaction.

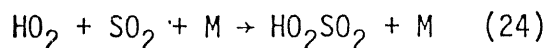

By analogy Calvert and McQuigg (1975) estimated that the reaction rate constant for the HO<sub>2</sub> addition would be about  $10^{-16} \text{ cm}^3 \text{ molec}^{-1} \text{ sec}^{-1}$  with a resulting oxidation rate less than 0.1 percent/hour in a highly polluted atmosphere.

#### SO<sub>2</sub> - CH<sub>3</sub>O<sub>2</sub> System

The CH<sub>3</sub>O<sub>2</sub> radical is probably the most abundant of the organic peroxy radicals in the atmosphere; it is expected to be present in highly polluted atmospheres at  $10^9 \text{ molec/cm}^3$  (Demerjian et al., 1974) and an oxidation rate of up to 2 percent/hour is calculated; in a clean atmosphere a rate of 0.02 percent/hour is expected.

#### SO<sub>2</sub> - HO System

The HO addition to SO<sub>2</sub> is probably the most important of the homogeneous reaction paths of SO<sub>2</sub> oxidation in the troposphere.

Wood et al. (1974) presented evidence for the importance of the hydroxyl (HO) reaction mechanism as part of the study of the mechanism of aerosol formation from SO<sub>2</sub> oxidation. Studies were performed using steady-state photolysis of mixtures of SO<sub>2</sub>, CO, H<sub>2</sub>O and N<sub>2</sub> over a wide range of concentrations and pressures. In these experiments, CO competes with SO<sub>2</sub> for HO and the effect of varying concentration ratios on CO<sub>2</sub> production is measured. Hydroxyl radical is formed through the photochemical dissociation of water

molecules by UV radiation. The competing reactions are:

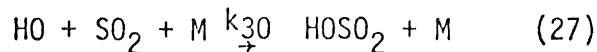

and

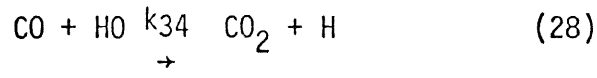

The studies showed that the oxidation of  $\text{SO}_2$  by HO was pressure dependent below 500 torr and pseudo-bimolecular at higher pressures. A high pressure limit of  $k_{27} = 3.8 \times 10^{-13} \text{ cm}^3 \text{ molec}^{-1} \text{ sec}^{-1}$  was obtained for the reaction rate constant.

Castleman et al. (1975) continued the competitive  $\text{SO}_2$  - CO reaction studies of Wood et al. (1974) and reported a pseudo-second order rate constant of  $k_{27} = 6.0 \times 10^{-13} \text{ cm}^3 \text{ molec}^{-1} \text{ sec}^{-1}$  ( $887 \text{ ppm}^{-1} \text{ min}^{-1}$ ) at a total pressure of 760 torr  $\text{N}_2$  and letting  $k_{28} = 1.4 \times 10^{-13} \text{ cm}^3 \text{ molec}^{-1} \text{ sec}^{-1}$ . At pressures less than 20 torr, the third-order rate constant was found to be  $1.6 \times 10^{-31} \text{ cm}^6 \text{ molec}^{-2} \text{ sec}^{-1}$ . In a polluted atmosphere with an HO concentration of  $5 \times 10^6 \text{ molec cm}^{-3}$  or higher, the  $\text{SO}_2$  conversion rate at 760 torr would be about 2 percent/hour.

Castleman et al. (1975) also determined the rate of reaction of  $\text{SO}_3$  molecules with  $\text{H}_2\text{O}$  using a fast-flow technique. Two alternative reaction schemes were examined: 1) a direct gas phase reaction with water ( $\text{SO}_3 + \text{H}_2\text{O} + \text{M} \rightarrow \text{H}_2\text{SO}_4 + \text{M}$ ) and 2) a surface reaction whereby  $\text{SO}_3$  is scavenged by a pre-existing aerosol particle. At room temperature ( $300^\circ \text{K}$ ) and total pressures ranging from 1.0 to 1.3 torr, a pseudo-molecular rate value of  $9.1 \times 10^{-13} \text{ cm}^3 \text{ molec}^{-1} \text{ sec}^{-1}$  was obtained. It was concluded that in the atmosphere the direct gas phase reaction with water occurred to produce  $\text{H}_2\text{SO}_4$  molecules and substantial scavenging of  $\text{SO}_3$  by existing particles would not be expected to occur.



Cox (1975) also investigated the oxidation of  $\text{SO}_2$  by HO using competitive  $\text{SO}_2$ -CO reaction studies. Photolysis at 1 atm yielded an upper limit of  $k_{27} = (6.0 \times 0.8) \times 10^{-13} \text{ cm}^3 \text{ molec}^{-1} \text{ sec}^{-1}$  and  $k_{28} = 1.5 \times 10^{-13} \text{ cm}^3 \text{ molec}^{-1} \text{ sec}^{-1}$ .

Sie et al. (1976) presented evidence that the rate constant for the reaction  $\text{HO} + \text{CO} \rightarrow \text{H} + \text{CO}_2$  used as reference in the competitive CO- $\text{SO}_2$  studies was pressure sensitive. Sie et al. found that the rate constant increased with pressure over the range 20 to 774 torr in the case of added  $\text{H}_2$  or  $\text{SF}_6$  gas.

Calvert et al. (1977) reevaluated the rate constants in the literature for the  $\text{SO}_2$ -HO system for high pressure data based on the pressure sensitivity of the rate constant  $k_{28}$ . The rate constant  $k_{28}$  was revised to  $3.0 \times 10^{-13} \text{ cm}^3 \text{ molec}^{-1} \text{ sec}^{-1}$  and a value of  $k_{27} = (1.1 \pm 0.3) \times 10^{-12} \text{ cm}^3 \text{ molec}^{-1} \text{ sec}^{-1}$  was suggested as the appropriate rate constant for the oxidation of  $\text{SO}_2$  by HO. Based on this rate constant, Calvert et al. (1977) estimated that  $\text{SO}_2$  oxidation by HO may be as high as 2.7 percent/hour in a dirty atmosphere and about 0.4 percent/hour in the clean troposphere based on HO concentrations of  $7 \times 10^{-6} \text{ molec cm}^{-3}$  (Calvert and McQuigg, 1975) and  $1 \times 10^6 \text{ molec cm}^{-3}$  (Crutzen and Fishman, 1977), respectively.

Wang, et al. (1975) measured diurnal variations in the hydroxyl radical concentration of ambient air using a laser-induced fluorescence technique. Values ranged from below the detection limit of  $5 \times 10^6 \text{ molec cm}^{-3}$  at night or on rainy or cloudy days to greater than  $10^7 \text{ molec cm}^{-3}$  during sunny days in the summer. Two peaks in HO concentration were observed, one in the early afternoon and a second in the late afternoon.

SO<sub>2</sub> - CH<sub>3</sub>O System

There are no kinetic data based on experimental studies related to reaction 29. Calvert and McQuigg (1975) estimated the rate constant at about  $k_{29} = 6 \times 10^{-15} \text{ cm}^3/\text{molec sec}$ .

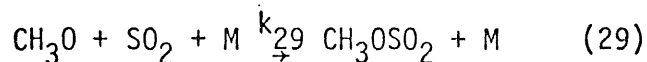

Using a CH<sub>3</sub>O concentration of  $5 \times 10^6 \text{ molec/cm}^3$  an estimated rate of 0.01 percent/hour, which seems unimportant, is calculated.

SO<sub>2</sub> - Olefin - Ozone System

Sulfur dioxide and ozone react very slowly at low temperatures and at ambient concentrations; however, when an alkene is added to the system, rapid oxidation occurs even in the dark.

Cox and Penkett (1971) studied sulfuric acid aerosol formation for four different olefins; in each case the initial reactant concentrations were about 2 ppm olefin, 0.4 ppm O<sub>3</sub> and 0.11 ppm SO<sub>2</sub>. Aerosol production did not vary with SO<sub>2</sub> concentration and the amounts of aerosol formed were similar for all the olefins used and less than the amount of O<sub>3</sub> consumed. Initial rates of aerosol production varied with different olefins; the rates of aerosol formation were greater for internally unsaturated olefins (cis-1-pentene and 2-methyl-2-butene) than for the terminally unsaturated olefins (propene and 4-methyl-1-pentene). At ozone and olefin concentrations of 0.05 ppm, the oxidation rate of 0.1 ppm SO<sub>2</sub> is calculated to be about 3 percent/hour for cis-2-pentene and 0.4 percent for propene.

Cox and Penkett (1972) expanded their previous work and postulated that SO<sub>2</sub> interacts with an intermediate product resulting from the reaction between ozone and olefin. Two possible reactions were proposed based on the

Criegee mechanism of ozone-alkane reactions in solution. (They also postulated that  $\text{SO}_2$  can compete with other removal processes of the intermediates such as decomposition and reaction with the chamber walls.)

a) Reaction of a zwitterion with  $\text{SO}_2$

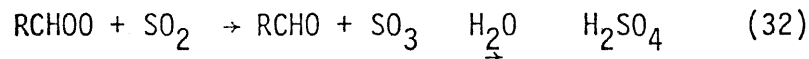
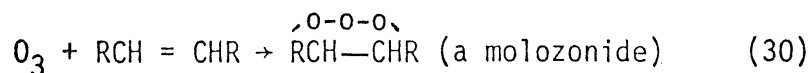

b) Reaction of the molozonide with  $\text{SO}_2$

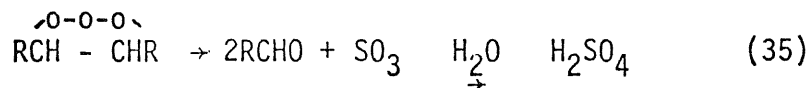

The addition of  $\text{SO}_2$  (0.07-15 ppm) to  $\text{O}_3$  (0.35-0.90 ppm) and olefin (1.0-2.0 ppm) was examined by Cox and Penkett (1972) for several olefins. The aerosol formation rate was determined primarily by the ozone-olefin reaction; the rate was unaffected by a reduction of  $\text{O}_2$  in the air and did not appear to be affected by surface reactions. A strong unexplained inhibitory effect on the oxidation was observed with increased water vapor in the mixture. The rate of  $\text{SO}_3$  formation was expressed by  $\text{RSO}_3 = k [\text{SO}_2] [\text{Intermediate}]$ . In polluted air ( $[\text{O}_3] = 0.10$  ppm,  $[\text{olefin}] = 0.05$  ppm,  $[\text{SO}_2] = 0.1$  ppm) at 40 percent RH the oxidation rate was 3.0 percent/hour. In clean air ( $[\text{O}_3] = 0.03$  ppm,  $[\text{olefin}] = 0.005$  ppm,  $[\text{SO}_2] < 0.1$  ppm), an oxidation rate of 0.1 percent/hour was calculated.

These reactions could be more important downwind of the plume rather than close to the source due to the rapid reaction that occurs between  $\text{O}_3$  and  $\text{NO}$ .

The Criegee intermediate is also reduced through reaction with NO.

Calvert et al. (1977) calculated reaction rates for the Criegee intermediate and estimated reaction rates in a highly polluted atmosphere

( $[\text{alkene}] = 0.10 \text{ ppm}$ ,  $[\text{O}_3] = 0.15 \text{ ppm}$ ,  $[\text{SO}_2] = 0.05 \text{ ppm}$ ) of 0.013 percent/hour and 0.007 percent/hour at 50 percent and 100 percent RH (25° C) for a terminal bond alkene and rates of 0.3 percent and 0.2 percent/hour at 50% and 100 percent RH (25° C) for an internal bond alkene.

### Fate of SO<sub>3</sub>

The SO<sub>3</sub> formed through the reaction of ground state SO<sub>2</sub> with other species reacts immediately with water to form sulfuric acid.

Castleman et al. (1975) estimate a reaction rate constant,  $k_{34}$ , of  $(9.1 \pm 2.0) \times 10^{-13} \text{ cm}^3/\text{molec}^{-1} \text{ sec}^{-1}$  from flow experiments at low pressures.

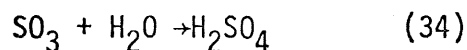

### SO<sub>2</sub> - Smog System

The experimental results reported in the literature for SO<sub>2</sub> - smog systems are conflicting and include a variety of reactants, reactant concentrations, irradiation sources, and reaction vessels.

Prager et al. (1960) studied the formation of aerosols from different types of hydrocarbons mixed with NO<sub>2</sub> in the presence and absence of SO<sub>2</sub>. Reactant concentrations were 10 ppm olefin, 5 ppm NO<sub>2</sub> and 2 ppm SO<sub>2</sub>. Results of these experiments showed that saturated hydrocarbons produced little or no aerosol in the presence of NO<sub>2</sub> and SO<sub>2</sub>, while monoolefins produced some aerosol in the presence of only NO<sub>2</sub>, but large amounts when SO<sub>2</sub> was added to the HC-NO<sub>2</sub> mixture. Aerosol production increased with number of carbon

atoms in the monoolefin. Irradiation of cyclic saturated hydrocarbons in the presence of  $\text{NO}_2$  produced little or no aerosol, while irradiation of cyclic unsaturated hydrocarbons in the presence of  $\text{NO}_2$  gave a large amount of aerosol whether or not  $\text{SO}_2$  was present.  $\text{SO}_2$  did not significantly affect the rate of aerosol production or the amount of aerosol produced. Prager et al. found that aerosol formation was not affected in any way by relative humidity.

Renzetti and Doyle (1960) found that unsaturated hydrocarbons resulted in enhanced aerosol production in a large number of experiments with 3 ppm of various HC, 1 ppm  $\text{NO}_x$  and 0.1 to 5.0 ppm  $\text{SO}_2$ . Saturated and aromatic HC did not increase the oxidation rate. In the absence of  $\text{SO}_2$ , however, the aerosol production was not increased for the unsaturated HC -  $\text{NO}_x$  mixture except for cyclohexene. Renzetti and Doyle also found a humidity effect on light scattering for the HC- $\text{NO}_x$ - $\text{SO}_2$  system. Light scattering increased at 50 percent RH compared to a decrease at 0 percent RH under identical conditions; the rate of  $\text{SO}_2$  consumption was not measured in these experiments..

Endow et al. (1963) irradiated a system of 3.0 ppm olefin, 1.0 ppm  $\text{NO}_2$  and 0.5 ppm  $\text{SO}_2$  at 50 percent RH and at 10 to 20 percent RH. The aerosols formed at higher humidity differed in physical and chemical properties from those formed at lower humidity. They also calculated an oxidation rate of 1.8 percent/minute for  $\text{SO}_2$  (0.1 ppm) during photolysis of 1.0 ppm NO and 1 ppm 2 methyl-2-butene.

Harkins and Nicksic (1965) studying a system of 5 ppm propylene, 2 ppm NO and 5 ppm  $\text{SO}_2$  and a system of 10 ppm ethylene, 5 ppm NO and 10 ppm  $\text{SO}_2$  found that when  $\text{SO}_2$  was present in any of the runs aerosol formed and when  $\text{SO}_2$  was absent aerosol did not form. The authors found that the aerosol formed was  $\text{H}_2\text{SO}_4$

and that  $\text{SO}_2$  did not provide condensation nuclei for organic aerosol. The effect of humidity was assessed on irradiation of sulfur free fuel and on the same fuel containing 0.1 percent sulfur. When relative humidity was varied from 30 to 70 percent and the chamber temperature was maintained at  $100^\circ \text{F}$ , the maximum aerosol formation occurred at about 1.5 hours. An inverse correlation between relative humidity and  $\text{SO}_2$ -induced aerosol was observed. When the temperature was varied from  $50^\circ \text{F}$  to  $100^\circ \text{F}$  at constant humidity, a three-fold increase in aerosol formation was observed. A combination of the temperature and relative humidity data showed that the percent increase in aerosol formation was an inverse function of the absolute concentration of water in the chamber.

Smith and Urone (1974) studied the oxidation of  $\text{SO}_2$  (2 ppm) alone and in the presence of  $\text{NO}_2$ , propylene, and water vapor. The reaction of  $\text{SO}_2$  alone was  $1.7 \times 10^{-4}$  ppm/min (about 0.55 percent/hour). When  $\text{NO}_2$  was added to  $\text{SO}_2$  the rate increased (3.3 ppm/min) for an  $\text{SO}_2:\text{NO}$  ratio of 1 or 2 but the rate decreased (1.8 ppm/min) when the ratio was less than 0.6. When  $\text{NO}_2$  and propylene were added to  $\text{SO}_2$  the reaction rate increased 100-fold over the reaction of  $\text{SO}_2$  alone depending on the amount of propylene and the  $\text{SO}_2:\text{NO}_2$  ratio. At 50 percent RH the  $\text{SO}_2\text{-NO}_2$  system reaction rate was found to increase.

Wilson and Levy (1970a, 1970b) examined the smog process in  $\text{SO}_2\text{-NO}_2$ -hydrocarbon systems in an attempt to assess the effects of  $\text{SO}_2$  in smog. It was generally observed that the decay of  $\text{SO}_2$  increased in proportion to the reactivity of the hydrocarbons. No quantitative values developed from this work. A dramatic effect on the overall reaction rate was observed in some high humidity runs.

Cox and Penkett (1971) studied low concentration systems of  $\text{SO}_2$  (0.05 to 1.0 ppm), NO (0.03 to 0.73 ppm) and 2-pentene (0.16 to 1.03 ppm). Irradiation of  $\text{SO}_2$  alone formed about  $5.2 \mu\text{g}/\text{m}^3$  aerosol at about 100 minutes followed by a decline in production. When nitric oxide and olefins were added, aerosol formation increased to a maximum of about  $40 \mu\text{g}/\text{m}^3$  after 11 minutes. Rate constants were calculated based on a first order reaction with respect to  $\text{SO}_2$ . The first order constant for  $\text{SO}_2$  alone was 0.2 percent/hour. When 0.03 ppm NO and 0.1 ppm cis-2-pentene were added to 0.05 ppm  $\text{SO}_2$  the rate increased by a factor of 10 (2.5 percent/hour) over  $\text{SO}_2$  alone.

Cox and Penkett (1972) studied the oxidation of  $\text{SO}_2$  in a system of olefin and ozone. They postulated that  $\text{SO}_2$  reacts with an intermediate product resulting from the reaction of ozone and olefin and the authors suggested that this reaction was of importance in the atmosphere. Reaction rates of about 3.0 percent per hour were calculated for a polluted atmosphere.

Roberts and Friedlander (1976) studied the formation of sulfur containing aerosols under ambient smog conditions in a large Teflon chamber irradiated with natural sunlight. Seven olefins were used in the studies although most of the experiments dealt with the 1-heptene- $\text{SO}_2$ -NO system. Qualitatively, the results of all experiments were similar in that  $\text{SO}_2$  decay was low until the  $\text{O}_3$  concentration increased above 0.05 ppm at which point  $\text{SO}_2$  concentration decreased rapidly. It was observed that as NO is converted to  $\text{NO}_2$ , the concentrations of  $\text{SO}_2$ ,  $\text{O}_3$ , 1-heptene and  $b_{\text{scat}}$  were constant and that aerosol formation resulted from the reaction of  $\text{SO}_2$  with a reactive intermediate which was produced by the reaction of  $\text{O}_3$  with 1-heptene, similar to that proposed by Cox and Penkett (1972). Particle size

distributions were measured and it was found that the distribution of sulfur with respect to decreasing particle size changed with time, eventually becoming bimodal at 0.2  $\mu\text{m}$ . Based on pseudo first-order depletion of  $\text{SO}_2$ , the reaction rates varied from 0-90 percent/hour depending on the initial  $\text{SO}_2$  concentration. The rates were surprisingly high considering the low relative humidity of < 40 percent.

Miller (1977) conducted smog chamber experiments to determine the relationships between the gaseous precursors in polluted air ( $\text{NO}_x$ , NMHC,  $\text{SO}_2$ ) and  $\text{SO}_2$  oxidation.  $\text{SO}_2$  oxidation rates were derived from analysis of aerosol formation under both laboratory and ambient conditions. Laboratory experiments were conducted using a system of  $\text{NO}_x$ ,  $\text{SO}_2$ , and NMHC. The maximum rate of  $\text{SO}_2$  oxidation occurred during the first 3 hours of irradiation and was found to be strongly related to the initial NMHC/ $\text{NO}_x$  ratio. Over the six-hour irradiation period, the conversion of  $\text{SO}_2$  to sulfate aerosol was only weakly related to initial NMHC/ $\text{NO}_x$  ratios. For constant NMHC and  $\text{NO}_x$  concentrations the rate of sulfate formation was directly proportional to  $\text{SO}_2$  concentration over an  $\text{SO}_2$  concentration range of 33 to 900 ppb. Ambient air studies showed that maximum  $\text{SO}_2$  oxidation rates occurred during the first 2 hours of irradiation and subsequent aerosol formation decreased after 3 hours. Ambient rates were in the range 1.6 - 5.5 percent/hour for HC/ $\text{NO}_x$  ratios of 3.7 to 10.0.

In both laboratory and field studies by Miller (1977) the size distribution of sulfate aerosol occurred between 0.1 and 0.2  $\mu\text{m}$  diameters. The authors indicated that kinetic models which have been applied to the data showed that HO accounts for at least one half of the total  $\text{SO}_2$  oxidation and that  $\text{RO}_2$  and  $\text{HO}_2$  radicals account for the remaining; also, it can be shown that diradicals or "zwitterions" resulting from olefin-ozone reactions



contribute minimally to the overall process.

### LIQUID PHASE SO<sub>2</sub> OXIDATION

Oxidation of SO<sub>2</sub> in the liquid phase may be categorized into three processes:

- 1) uncatalyzed oxidation by O<sub>2</sub>,
- 2) metal-catalyzed oxidation by O<sub>2</sub> and
- 3) oxidation by O<sub>3</sub>.

In general, the oxidation process involves the diffusion of molecules of SO<sub>2</sub> and other gases into a water droplet where the gases may encounter nucleating aerosol particles. Oxidation then proceeds through the process of hydration and oxidation of the associated sulfite or bisulfite species.

The oxidation of SO<sub>2</sub> in the liquid phase is considered a quasi-homogeneous reaction since all of the reactants are in solution; some investigators also refer to these reactions as heterogeneous. Homogeneous reactions according to the chemical definition involve reactants which are in the same phase while heterogeneous reactions involve reactants which are in different phases; atmospheric scientists, however, generally consider the homogeneous reactions to involve a single chemical component which may be present in more than one phase while heterogeneous reactions involve more than one chemical component. Table 6 at the end of this section summarizes the studies of SO<sub>2</sub> oxidation in the liquid phase.

#### Uncatalyzed Oxidation of SO<sub>2</sub> by O<sub>2</sub> (with and without NH<sub>3</sub>)

Fuller and Crist (1941) presented the earliest work on the oxidation of sulfur dioxide by O<sub>2</sub>; they studied the reaction of SO<sub>2</sub> and pure O<sub>2</sub> with and without the inhibitor mannitol, and with and without a copper catalyst. They also found the oxidation of sulfite ions by O<sub>2</sub> to be a very long chain

reaction. In the absence of an added catalyst the reaction  $\text{SO}_3 + \frac{1}{2}\text{O}_2 \rightarrow \text{SO}_4^-$  was found to be first order with a rate constant of  $0.013 \pm 0.0015 \text{ sec}^{-1}$ .

The reaction occurred at  $25^\circ\text{C}$  in pure  $\text{O}_2$  atmospheres and a first order relationship existed for sulfite concentrations up to 0.015 M. When the inhibitor mannitol was added, the inhibitory effect was uniform over a  $10^5$ -fold change in mannitol concentration; when the mannitol concentration was below  $10^7 \text{ M}$ , the inhibitory effect was no longer observed. The catalytic effect of  $\text{Cu}^{++}$  was investigated and the data were found to fit the expression

$$\frac{-d(\text{SO}_3^-)}{dt} = [k_1 + k_3 (\text{Cu}^{++})] [\text{SO}_3^-] \quad 35)$$

The oxidation rate was found to be directly dependent on  $\text{Cu}^{++}$  at ion concentrations greater than  $10^{-9} \text{ M}$ ;  $k_3$ , the catalytic constant, was  $2.5 \times 10^{-6} \text{ M}^{-1} \text{ sec}^{-1}$ . The effect of pH was also investigated and the rate was found to increase with increasing pH. A rate expression consistent with the assumption of sulfite being oxidized was derived.

$$\frac{-d(\text{SO}_3^-)}{dt} = [k_1 + k_4 (\text{H}^+)^{\frac{1}{2}}] [\text{SO}_3^-] \quad 36)$$

The value of  $k_4$  was found to be  $(6.6 \pm 0.47) \text{ M}^{-\frac{1}{2}} \text{ sec}^{-1}$  based on a value of  $5 \times 10^{-6}$  for the second ionization constant of sulfurous acid. Levy et al. (1976) revised the rate constant,  $k_4 = 59 \text{ M}^{-\frac{1}{2}} \text{ sec}^{-1}$ , based on a second dissociation rate constant of  $6.3 \times 10^{-8}$ .

Bassett and Parker (1951) studied the oxidation of sulfurous acid by oxides of manganese, by ferric and cupric salts and by molecular oxygen in the presence of dissolved salts. They concluded that the uncatalyzed oxidation by  $\text{O}_2$  proceeded through ionic complexes of  $\text{O}_2$  such as  $(\text{O}_2 \cdot \text{SO}_3)^-$

and  $(O_2 \cdot S_2O_5)^-$ . The manganese ion-catalyzed reaction was postulated to involve a complex such as  $[O_2 \cdot Mn(SO_3)_2]^-$  which undergoes self-oxidation and reduction. Cobalt, nickel and ferrous ions were assumed to give rise to similar but less reactive complexes.

Several investigators have studied the aqueous phase oxidation of  $SO_2$  in the presence of  $NH_3$ . Although this reaction is referred to as ammonia catalysis in the literature, the effect of ammonia is probably due to the buffering of high pH rather than catalysis. Junge and Ryan (1958) made one of the first efforts to study the role of  $SO_2$  oxidation in air chemistry; they studied the  $SO_2$  oxidation process in uncatalyzed and in dilute catalytic solutions. They found that the uncatalyzed reaction produced negligible sulfate and was not photosensitive with normal daylight. They explained the main features of  $SO_2$  oxidation in terms of the  $SO_2 - NH_3 -$  catalytic solution system whereby  $NH_3$  served to neutralize the sulfate formed in the reaction. The authors did not mention the role of  $NH_3$  in maintaining high pH and, therefore, a high sulfite concentration. Theoretical calculations of the  $SO_2-NH_3$ -fog system estimated  $2.9 \mu g/m^3$  of sulfate would be formed in a clean atmosphere containing  $20 \mu g/m^3$   $SO_2$  and  $3 \mu g/m^3$  of  $NH_3$  with a liquid water content of  $0.1 g/m^3$ . It was estimated that the same fog in polluted air with  $500 \mu g/m^3$  of  $SO_2$  and  $10 \mu g/m^3$   $NH_3$  would form  $26.2 \mu g/m^3$  of sulfate, or about one order of magnitude more.

Van den Heuvel and Mason (1963) measured the rate of formation of salt (assumed to be ammonium sulfate) in water droplets exposed to air containing  $SO_2$ ,  $NH_3$  and water vapor; the exposure times ranged from 7.5 to 30 minutes. The investigators found that the production of ammonium sulfate by the absorption of  $NH_3$  and  $SO_2$  by water drops was proportional to the product of the surface area of the drops and the time of exposure and that the

production of salt was controlled by diffusion of the reacting gases in the liquid rather than by gas-phase diffusion. The rate limiting process is given by

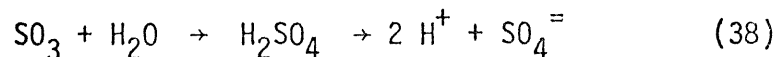

and the ammonia reaction is given by

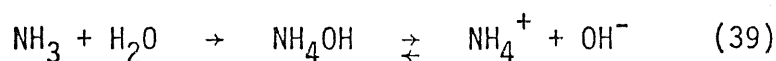

For  $\text{SO}_2$  alone in air, the amount of sulfate formed was at least two orders of magnitude smaller than when  $\text{NH}_3$  is present. An oxidation rate of  $2.5\%/\text{min}^{-1}$  was obtained by extrapolation of laboratory data to an industrial atmosphere containing  $100 \mu\text{g SO}_2/\text{m}^3$  and  $10 \mu\text{g NH}_3/\text{m}^3$ . Due to methodology problems the authors indicated their results were only semi-quantitative.

Scott and Hobbs (1967) considered a set of nine chemical equilibrium equations which assumed that equilibrium is maintained between gaseous and dissolved  $\text{SO}_2$ ,  $\text{NH}_3$ , and  $\text{CO}_2$  and between the ions produced in the dissociation between the dissolved species:

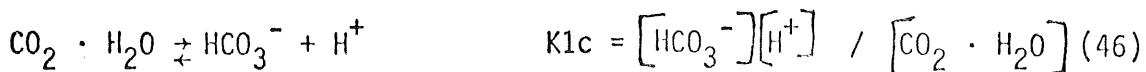
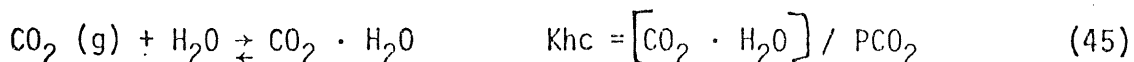
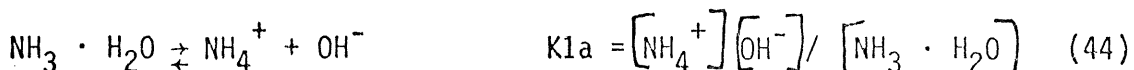
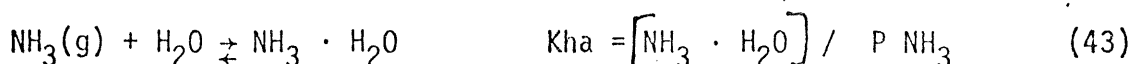
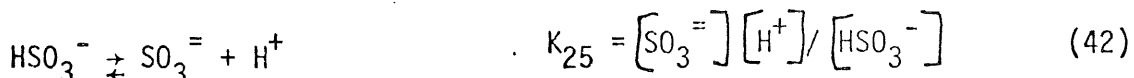
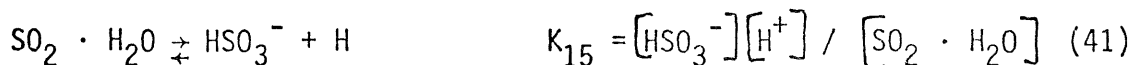
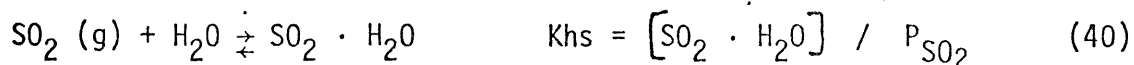

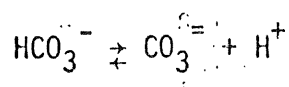

$$K_{2c} = \frac{[\text{CO}_3^{2-}][\text{H}^+]}{[\text{HCO}_3^-]} \quad (47)$$

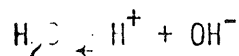

$$K_w = [\text{H}^+][\text{OH}^-] \quad (48)$$

The formation of  $\text{SO}_4^{2-}$  was assumed to be limited by the oxidation of the sulfite ion described by the first order rate equation:

$$\frac{d[\text{SO}_4^{2-}]}{dt} = k[\text{SO}_3^{2-}] \quad (49)$$

Based on the analysis of the data of Van den Heuvel and Mason (1963), the rate constant  $k$  was determined to be  $0.1 \text{ min}^{-1}$ . Calculations made under these assumptions did not result in a rate limiting value for sulfate formation or in a linear dependence on the initial  $\text{SO}_2$  partial pressure. The theoretical curves show that for the concentration of sulfate in water droplets as a function of time, the presence of  $\text{NH}_3$  will increase the amount of sulfate produced by the reaction after it has run for some time. An oxidation rate of 2.5%/hour was derived.

McKay (1971) revised and extended the calculations of Scott and Hobbs (1967). The oxidation was examined assuming the rate law of Fuller and Crist (1941)  $[k = 0.013 + 59 [\text{H}^+]^{1/2} \text{ sec}^{-1}]$  and the ionization constants of Scott and Hobbs (1967). McKay predicted an order of magnitude faster oxidation than Scott and Hobbs (1967) had assumed. The calculation also showed the increase of the reaction rate with decreasing temperature which was explained by the increased solubility of ammonia and sulfur dioxide at lower temperatures. The negative temperature effect was not noted by other authors at the time of the study, although it has been demonstrated in more recent work. Based on the data an oxidation rate of about 13%/hour is suggested.

Miller and de Pena (1972) measured the formation of sulfate in raindrop-size distilled water droplets for partial pressures of  $\text{SO}_2$  ranging from  $10^{-6}$  to  $4 \times 10^{-3}$  atm following the experimental method of Van den Heuvel and Mason (1963) and the basic model of Scott and Hobbs (1972). A  $k$  value of about  $0.003 \text{ sec}^{-1}$  was calculated for the first order reaction 
$$d \frac{[\text{SO}_4^{=}]}{dt} = K [\text{SO}_3^{=}]$$
 which is close to the value used by Scott and Hobbs (1967), but some of the data suggest oxidation rates of only 0.1%/hour.

Beilke et al. (1975) presented experimental results on the oxidation of  $\text{SO}_2$  by oxygen in aqueous solution in the atmospheric pH range of 3-6; discrepancies in the oxidation rate predicted by other investigators were partially resolved. The data of Beilke et al. considered the rate of sulfate formation as a function of pH at two temperatures, 3 and  $25^\circ \text{C}$  and show 1) no measurable temperature dependence on the rate of conversion of  $\text{SO}_2$  to sulfate and 2) a trend close to, but not exactly proportional to,  $[\text{H}^+]^{-2}$  in the pH range of 3-6. Beilke and Gravenhorst (1977) suggest that the lack of temperature effect may have arisen from the compensating effects of  $\text{SO}_2$  solubility which decreases with temperature while the rate constant for 
$$\text{SO}_3^{=} + \frac{1}{2} \text{O}_2 \xrightarrow{k} \text{SO}_4^{=}$$
 increases with temperature.

Beilke et al. (1975) calculated an oxidation rate in the range  $10^{-5}$  to  $15\%/\text{hr}^{-1}$  as the pH varies from 3 to 6 for typical atmospheric cloud droplets (liquid water content about  $1 \text{ gm m}^{-3}$ ).

Beilke and Gravenhorst (1977), in order to determine the rate controlling step for  $\text{SO}_2$  oxidation in a droplet system, calculated the  $\text{SO}_2$  transfer both within and toward the droplets. Their calculations show that equilibrium between  $\text{SO}_2$  in the gas phase and sulfur (IV) in cloud and fog droplets occurs within less than one second. The authors compared three mechanisms

Foster (1969) derived theoretical growth rates of  $H_2SO_4$  droplet nucleated by  $MnSO_4$  crystals in a humid,  $SO_2$  polluted atmosphere and applied the data to the problem of  $SO_2$  oxidation in power plant plumes. Foster considered the reaction,  $2SO_2 + 2H_2O + O_2 \xrightarrow{\text{catalyst}} 2H_2SO_4$ . The following rate expressions were derived for iron and manganese catalysis:

$$\text{Rate of } SO_2 \text{ oxidation by Mn catalyst} = \frac{22.4 K_i C_1^2 V}{10^{-6} GD} \times 100\% \text{ per min} \quad (51)$$

$$\text{Rate of } SO_2 \text{ oxidation by Fe catalyst} = 22.4 \frac{DWK_k (1-f_o)}{H+} \frac{K_i n_i f_i}{M_i} \times 100\% \text{ per min} \quad (52)$$

where the symbols and typical values for plume calculations are given in Table 7.

Table 7. Nomenclature and values used for plume  $SO_2$  oxidation calculations\*

		Nomenclature	Value
General	W	Effluent dust burden, g/liter	$2 \times 10^{-3}$
	G	Effluent $SO_2$ content, ppm	$2.5 \times 10^3$
	D	Effluent dilution factor	$10^{-3}$
	$f_o$	Fraction of total sulfur oxidized	$10^{-1}$
	S	Droplet sulfate concentrations, mol/liter $H_2O$	1
Manganese ( $Mn_3O_4$ )	$M_i$	Oxide molecular weight, g/mol	$2.29 \times 10^2$
	$n_i$	Number of catalytic ions per molecule	3
	$f_i$	Fraction by weight of dust soluble	$2 \times 10^{-4}$
	$K_i$	Rate constant	**
	$C_i$	Catalytic concentration within the droplets	**
Iron ( $Fe_2O_3$ )	$M_i$	Oxide molecular weight, g/mol	$1.60 \times 10^2$
	$n_i$	Number of catalytic ions per molecule	2
	$f_i$	Fraction by weight of dust soluble	$10^{-2}$
	$K_H$	Solubility constant	*

\* From Foster 1969

\*\* Values not provided

When the values from Table 7 were substituted into the rate equations along with assumed values for  $[H^+]$ ,  $C_i$  and  $K_i$   $SO_2$  plume oxidation rates of 0.09%/min for Mn and rates of 0.15-1.5%/min for Fe were calculated, suggesting that iron oxides are the major catalysts for the aqueous phase oxidation of  $SO_2$  in plumes.

Matteson et al. (1969) studied the  $SO_2$  oxidation mechanism using a manganese sulfate aerosol under conditions which approach those in the atmosphere. Trace amounts of  $SO_2$  gas in a flowing humid air stream were exposed to submicron size aqueous aerosols of  $MnSO_4$  for periods up to 15 minutes. Rates of  $SO_2$  absorption in the aerosol droplets and rates of  $H_2SO_4$  formation were measured. The proposed kinetic theory was based on a four-step chemical reaction involving the formation of intermediate complexes:

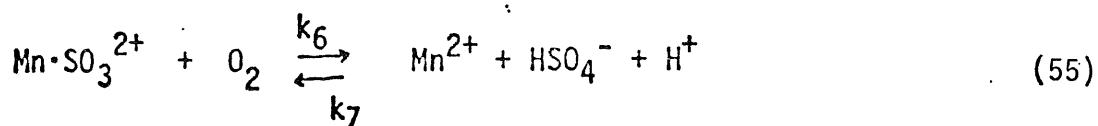
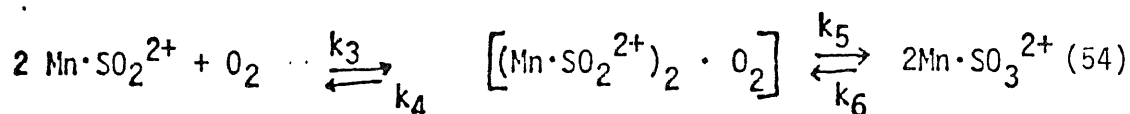
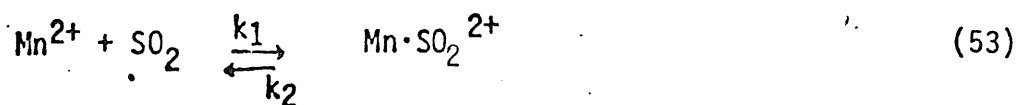

Based on theoretical analysis, the reaction rate is proportional to  $[Mn^{++}]^2$  and the rate equation is given by 
$$-\frac{d(SO_2)}{dt} = K [Mn^{2+}]^2$$

The rate constant  $k_1$  was experimentally found to be  $2.4 \times 10^5 \text{ Mole}^{-1} \text{ sec}^{-1}$ . The authors found no definite correlation between humidity and reaction rate; however, it was observed that almost no sulfate was found when the relative



of SO<sub>2</sub> oxidation in droplets: 1) oxidation by O<sub>2</sub> without catalyst, 2) oxidation by O<sub>2</sub> with catalyst, and 3) oxidation by ozone. Based on the assumption that sulfite ion rather than bisulfite ion is the oxygen carrier, the oxidation of SO<sub>2</sub> by O<sub>2</sub> was found to be unimportant unless the pH of the droplet is higher than about pH 6, which agrees with the reported literature.

The authors also concluded that in the SO<sub>2</sub>/NH<sub>3</sub>/H<sub>2</sub>O system the major function of NH<sub>3</sub> in the pH range 4-5 is not to enhance the SO<sub>2</sub>-oxidation but rather to convert a pre-existing sulfate containing droplet into an ammonium sulfate droplet, which contrasts to the reported literature. The absorption of ammonia could, however, shift the pH value from the lower range to a range where SO<sub>2</sub> oxidation by O<sub>2</sub> in the presence of catalysts is more important.

#### Catalyzed Oxidation of SO<sub>2</sub> by O<sub>2</sub>

Catalytic oxidation of SO<sub>2</sub> in a droplet occurs according to the process:

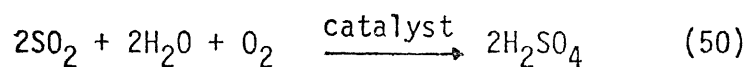

Catalysts such as manganese, iron, copper, and vanadium have been studied in the oxidation of SO<sub>2</sub>. Some of the factors affecting catalytic oxidation are particle or droplet size, absorption rate of sulfur dioxide, chemical composition, rate of diffusion of reactants within the aerosol, temperature, and relative humidity.

Junge and Ryan (1958) studied iron-catalyzed reaction of SO<sub>2</sub> oxidation in acid solutions by bubbling air containing SO<sub>2</sub> through dilute catalyst solutions. The effect of various catalysts (MnCl<sub>2</sub>, CuCl<sub>2</sub>, FeCl<sub>2</sub>, CoCl<sub>2</sub>, NH<sub>4</sub>OH, NaCl, and distilled water) was tested by adding 1 μg/cm<sup>3</sup> of each to

$51 \times 10^4 \mu\text{g}/\text{m}^3 \text{SO}_2$  and the solution was examined for sulfate concentration after 3 hours. Manganese was found to be the most effective catalyst with the formation of  $329 \mu\text{g}/\text{cm}^3$  sulfate. In the presence of  $\text{FeCl}_2$  the sulfate formation reached a limiting value after 1-3 hours and sulfate formation was a linear function of the initial  $\text{SO}_2$  concentration. It was also found that pH dropped during the course of the reaction and that oxidation stopped at a pH of 2.2.

Cheng et al. (1971) was critical of Junge and Ryan's technique of using gas bubbles to simulate an aerosol-gas system because the influences of mixing effects and mass transfer mechanisms on the reaction kinetics were not considered.

Johnstone and Coughanower (1958) investigated the rate of  $\text{SO}_2$  oxidation by metal (manganese, iron, copper and nickel) in a single drop of the salt solution suspended in air. High concentrations of reactants were used; the equilibrium concentration of  $\text{SO}_2$  in the chamber corresponded to 20 to 200 ppm at atmospheric pressure and the catalyst concentration was varied from 250 to 1000 ppm (drops measured 700 to 900  $\mu\text{m}$  diameter).

A mathematical model was developed for the gaseous diffusion into a liquid drop accompanied by zero order reaction in the liquid phase. The zero order rate constant was obtained from experiments on homogeneous liquid-phase oxidation of sulfurous acid. The rate of sulfuric acid formation depended on the concentration of  $\text{SO}_2$  and the nature and concentration of the catalyst. A reaction rate of 1%/min was obtained assuming a  $1\mu\text{m}$  size  $\text{MnSO}_4$  crystal and 1 ppm  $\text{SO}_2$  concentration in fog droplets.  $\text{MnSO}_4$  was the most effective catalyst. Cheng et al. (1971) doubted the validity of the assumption that the reaction was controlled by liquid phase gas diffusion.

humidity was below 95% probably as a result of inadequate hydration of the metal salt. The authors felt that a similar mechanism could be involved for other catalysts. Cheng et al. (1971) commented that experimental data obtained from the work of Matteson et al. (1969) are basically incorrect due to improper recording of reaction times in the experiments.

Cheng et al. (1971) investigated the effectiveness of selected metal salts which had previously been reported to act as catalysts ( $\text{MnSO}_4$ ,  $\text{MnCl}_2$ , and  $\text{CuSO}_4$ ) in the catalytic oxidation of  $\text{SO}_2$  to  $\text{H}_2\text{SO}_4$  given by the basic reaction,  $2\text{SO}_2 + 2\text{H}_2\text{O} + \text{O}_2 \xrightarrow{\text{catalyst}} 2\text{H}_2\text{SO}_4$ . An aerosol stabilizing technique was developed which does not alter the physical or chemical properties of the aerosol. Aerosol particles were deposited on supporting inert Teflon beads; the Teflon beads were then packed into a flow reactor and exposed to influent  $\text{SO}_2$  concentrations of 3 to 18 ppm in humid air. Relative humidity of the air appeared to exert the major influence on the oxidation rate. At  $23^\circ\text{C}$  and 740 mm Hg higher humidity always resulted in higher oxidation rates.  $\text{MnSO}_4$ ,  $\text{MnCl}_2$  and  $\text{CuSO}_4$  aerosols were found to be 12.2, 3.5, and 2.4 times respectively, more effective than  $\text{NaCl}$  aerosol in catalyzing  $\text{SO}_2$  oxidation on a milligram-to-milligram basis. When  $\text{MnSO}_4$  aerosol was used as a catalyst, a derived reaction rate showed that the overall rate was first order with respect to  $\text{SO}_2$  concentration in the gas phase. The rate equation adjusted for atmospheric conditions is given by:

$$-R \left( \frac{\mu\text{g of SO}_2}{(\text{min}) (\text{mg of MnSO}_4)} \right) = 0.67 \times 10^{-2} \left( \frac{\text{m}^3 \text{ of air}}{(\text{min}) (\text{mg of MnSO}_4)} \right) C \left( \frac{\mu\text{g of SO}_2}{\text{m}^3 \text{ of air}} \right) \quad (57)$$

The following assumptions were made in determining a natural fog reaction rate condition in an industrial atmosphere:

1. Air SO<sub>2</sub> concentration, 0.1 ppm.
2. Average fog droplet diameter 15 μm.
3. Half of the fog droplets contain catalyst capable of oxidizing SO<sub>2</sub> to sulfuric acid and the catalyst concentration within these droplets is equivalent to 500 ppm of MnSO<sub>4</sub>.
4. Fog concentration 0.2 g of water per cubic meter of air.

Using these assumptions the catalyst concentration was calculated to be equivalent to 50 μg MnSO<sub>4</sub> per cubic meter of ambient air (average urban air concentration: about 10 μg/m<sup>3</sup>). Under conditions approximating an atmosphere heavily polluted by aerosol particles, an oxidation rate of about 2%/hr was obtained.

Chen and Barron (1972) studied the homogeneous oxidation of SO<sub>2</sub> by cobalt ions. A rate constant was not determined but the reaction rate was independent of oxygen concentration (zero order), three-halves order with respect to sulfite concentration and one half order with respect to cobalt concentration:

$$r = - \frac{d [O_2]}{dt} = k [Co(H_2O)_6^{3+}]^{1/2} [SO_3^{2-}]^{3/2}$$

and  $k = k_3 \left( \frac{k_1}{k_5} \right)^{1/2}$

A free radical chain mechanism was proposed with the cobaltic hexaquo complex ion as the initiator.

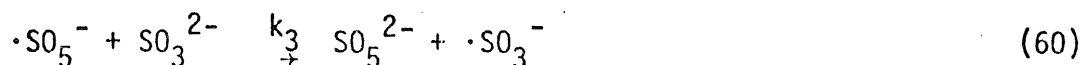
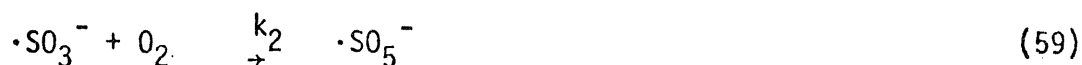
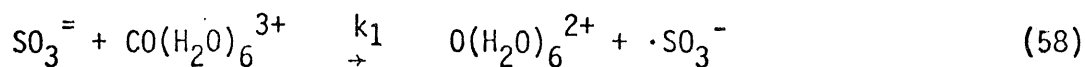

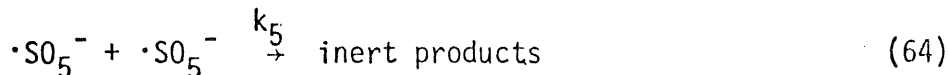
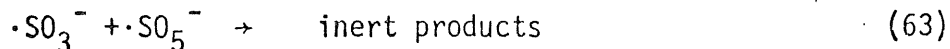
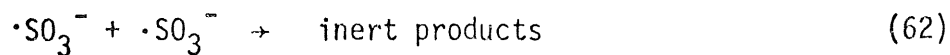

Many of the studies on  $\text{SO}_2$  oxidation were conducted using high  $\text{SO}_2$  concentrations which require a large extrapolation to the ambient atmosphere. Bimblecombe and Spedding (1974) attempted to correct this deficiency by measuring the rate of  $\text{SO}_2$  oxidation at low concentrations of  $\text{SO}_2$  (about  $10^{-5}$  M) in aqueous solutions containing Fe III at concentrations of about  $10^{-6}$  M using a radioactive tracer method of analysis. The efficiency of iron as a catalyst is indicated by the fact that even in "pure" water the oxidation rate was measurable, presumably due to traces of iron at concentrations of about  $10^{-8}$  M; the rate constant in "pure" water ranges from  $2.3 \times 10^{-6} \text{ sec}^{-1}$  at pH 4 to  $40 \times 10^{-6} \text{ sec}^{-1}$  at pH 6.

The authors proposed a free radical mechanism with hydroxylated  $\text{Fe}^{3+}$  as the initiator.

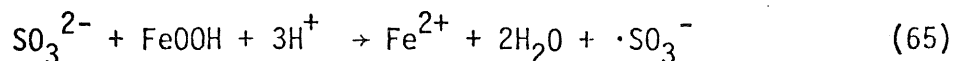

At pH values in the range 4-5 most of the  $\text{Fe}^{3+}$  would be present as a hydroxylated species and since this species has a higher redox potential than  $\text{Fe}^{3+}$ , it would appear that FeOOH is a better oxidizing agent than  $\text{Fe}^{3+}$  for the production of  $\cdot\text{SO}_3^-$  radicals.

To explain the radical chain termination, the authors propose that  $\text{Fe}^{2+}$  is oxidized back to the  $\text{Fe}^{3+}$  state by reacting with other radical species in the radical chain:

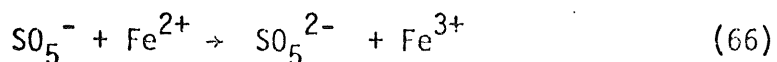

Regeneration of  $\text{Fe}^{3+}$  in this way would allow small amounts of  $\text{Fe}^{3+}$  in the atmosphere to oxidize large amounts of  $\text{SO}_2$ .

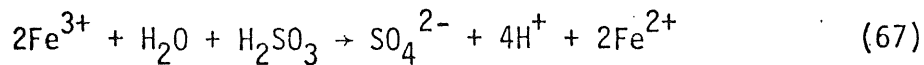

Assuming an  $\text{SO}_2$  concentration of  $28 \mu\text{g}/\text{m}^3$ , an  $\text{Fe}^{3+}$  concentration of  $10^{-6}$  and a pH of 5 then an oxidation rate for fog ( $10^{-4} \text{H}_2\text{O}/\text{m}^3$ ) condition is calculated at 3.2%/day.

Brimblecombe and Spedding (1975) measured the rate of  $\text{Fe}_2\text{O}_3$  dissolution and fly ash to determine whether  $\text{Fe}^{3+}$  would be significant in atmosphere  $\text{SO}_2$  oxidation.  $\text{Fe}_2\text{O}_3$  at pH 3 dissolved slowly (rate of dissolution =  $2.4 \times 10^{-9}$  mole  $\text{g}^{-1} \text{sec}^{-1}$ );  $\text{Fe}^{3+}$  concentrations of  $4 \times 10^{-6} \text{M}$  could have been present assuming  $0.1 \mu\text{g}/\text{m}^3$   $\text{Fe}_2\text{O}_3$  is present in the atmosphere. Pulverized fly ash (33%  $\text{CaO}$ , 2.4%  $\text{MgO}$ , 9.6%  $\text{Fe}_2\text{O}_3$  and 0.06%  $\text{MnO}_2$ ) was very soluble; at pH 3 over 10% of the iron present dissolved in less than 20 minutes lending support to the importance of  $\text{Fe}^{3+}$  in  $\text{SO}_2$  oxidation from coal-burning energy sources.

Freiberg (1974) developed a theoretical model to quantitatively assess the effects of humidity and temperature on the mechanism of heterogeneous oxidation of  $\text{SO}_2$  to sulfate by using the rate expression he developed for the iron catalyzed oxidation of  $\text{SO}_2$  in dilute acid solutions at low  $[\text{Fe}^{3+}]$  (Freiberg, 1975). Freiberg developed a parametric expression for the gas phase:

$$\frac{d(\text{SO}_2)}{dt} = -K_0 \psi_s^2 K_s^2 \left[ \frac{B_n K_n \lambda z}{2(1-\text{RH}) K_w} \right]^3 [\text{SO}_2]^2 [\text{Fe}^{3+}] [\text{NH}_3]^3 \quad (68)$$

where  $[\text{SO}_2]$ ,  $[\text{Fe}^{3+}]$ ,  $[\text{NH}_3]$  are concentrations in the gas phase;

$k_s$ ,  $K_n$ ,  $K_w$  are dissociated constants for sulfurous acid, ammonia, and water respectively;  $B_s$  and  $B_n$  are Ostwald constants for  $\text{SO}_2$  and  $\text{NH}_3$ ,

respectively;  $\lambda z$  is the pressure-lowering coefficient for  $(\text{NH}_4)_2\text{SO}_4$ , and RH is relative humidity.

In his development, Freiberg assumed that the effect of droplet curvature on lowering vapor pressure could be ignored; this assumption is valid for droplets of a radius larger than  $0.1\mu\text{m}$ . Freiberg, on the assumption that the rate of diffusion of  $\text{SO}_2$  to and in the droplet is fast with respect to the rate of oxidation did not take into account the number and size of the water droplets. Freiberg also showed that the oxidation of  $\text{SO}_2$  in droplets depends strongly on pH.

In the droplets,  $\text{SO}_2$  and  $\text{O}_2$  diffuse throughout the solution and catalytically react with  $[\text{Fe}^{+++}]$  to form  $\text{H}_2\text{SO}_4$ . As  $\text{H}_2\text{SO}_4$  is formed and neutralized by  $\text{NH}_3$  the vapor pressure is lowered and more water condenses to continue the process. As more water condenses, the  $\text{SO}_2$  oxidation rate could be affected in one of three ways: 1) The amount of soluble  $\text{SO}_2$  available for oxidation increases; 2) The pH increases; and 3) the  $[\text{Fe}^{3+}]$  is diluted. Since the 1st and 3rd effects compensate one another, the RH affects the oxidation rate only by changing the pH. Freiberg showed that the rate of iron-catalyzed oxidation of  $\text{SO}_2$  was dependent on RH, viz.:

$$\frac{d[\text{SO}_2]}{dt} \propto 1/[1-\text{RH}]^3 \quad (69)$$

When RH increases from 80 to 90%, the oxidation rate increased eight times.

The mechanism proposed by Freiberg (1975) allows for the simultaneous heterogeneous oxidation of  $\text{SO}_2$  by  $\text{O}_2$  in the presence of  $\text{Fe}^{+++}$  as a catalyst and by  $\text{Fe}^{+++}$  in the presence of  $\text{O}_2$ . The second order rate constant,  $K_T$ , depends on  $[\text{Fe}^{3+}]$ ; the mechanism predicts that the dependence of  $K_T$  on  $[\text{Fe}^{3+}]$  changes from 1st order to zero order as  $[\text{Fe}^{3+}]$  increases. For  $[\text{Fe}^{3+}] \leq 1.06 \times 10^{-2}$

moles/liter the dependence of  $K_T$  on  $[Fe^{3+}]$  may be considered first order.

The simultaneous oxidation of  $SO_2$  and  $Fe^{++}$  are predicted when both  $Fe^{+++}$  and  $Fe^{++}$  are present initially. The overall reaction rate changes from a 2nd order dependence on  $[SO_2]^2 / [H^+]^3$  to first order dependence on  $[SO_2] / [H^+]$  as pH and/or  $[SO_2]$  increase.

low  $SO_2$  and/or low pH:

$$\frac{d [SO_4^{2-}]}{dt} = K_T K_S^2 \frac{[Fe^{3+}] [H_2SO_3]^2}{[H^+]^3} \quad (70)$$

where  $K_T$  = overall rate constant

$K_S^2$  = dissociation constant for sulfurous acid

high  $SO_2$  and/or high pH (4-8);

$$\frac{-d [H_2SO_3]}{dt} = \frac{K_1 [Fe^{3+}] [H_2SO_3]}{[H^+]} \quad (71)$$

where  $K_1$  = reaction rate constant

Freiberg shows that although one would expect the reaction rate to increase with temperature because the rate constant for the catalytic oxidation increases with temperature, the total effect is a decrease in yield of the reaction as temperature increases. Specifically, the rate constant  $K_0$ , and the dissociation constant of  $NH_3$  in  $H_2O$ ,  $K_n$ , result in an increase in rate but the Ostwald constants of  $NH_3$  and  $SO_2$  ( $B_n$  and  $B_s$ ) and the dissociation constants of  $H_2SO_3$  and  $H_2O$  ( $K_s$  and  $K_w$ ) cause a decrease in rate with temperature. These factors dominate and the net result is a decrease in reaction rate of iron-catalyzed oxidation of  $SO_2$  by about an order of magnitude for an increment of  $5^\circ C$  over the range  $5^\circ - 30^\circ C$ .



Freiberg commented that temperature/relative humidity relationships are consistent with observed rates in the atmosphere by citing that major air pollution incidents at Donora, Pa; Meuse Valley, Belgium; and London, England occurred under stagnant weather conditions of low temperature and high relative humidity.

Barrie and Georgii (1976) studied the catalyzed oxidation of  $\text{SO}_2$  at  $25^\circ \text{C}$  and  $8^\circ \text{C}$  using single droplets of dilute, heavy metal solutions (concentration,  $10^{-6}$  -  $10^{-4}$  M) which were exposed to trace concentrations of  $\text{SO}_2$  in air (10 - 1000 ppb). A psuedo first order reaction was determined from the experimental data:

$$\frac{d[\text{SO}_4^{=}]}{dt} = k[\text{SO}_3^{=}]. \quad (72)$$

In the pH range 2.0-4.5,  $\text{Mn}^{++}$  was the most effective catalyst followed by  $\text{Fe}^{++}$  and to a lesser extent  $\text{Fe}^{3+}$ .  $\text{Cu}^{2+}$  ions were found to be neither effective catalysts of  $\text{SO}_2$  oxidation nor inhibitors of manganese catalyzed  $\text{SO}_2$  oxidation. Manganese catalyzed  $\text{SO}_2$  oxidation rates in dilute aqueous solution depended on catalyst concentrations, pH, and temperature. Oxidation was highest at high pH and high temperature, and conversely decreased with decreasing pH and was negligible at pH 2. Results suggested that manganese is complexed as  $[\text{Mn}^{2+} \text{SO}_3^{=} \text{SO}_3^{=} \text{SO}_3^{=} \text{SO}_3^{=} ]^{4-}$  before participating in the oxidation reaction. A similar dependence was observed by Junge and Ryan (1958) for oxidation rates in  $10^{-5}$  M  $\text{FeCl}_2$  solution but they could not explain the results. Barrie and Georgii (1976) commented that observed pH dependence of  $\text{SO}_2$  absorption rate shows that the rate is proportional to the amount of  $\text{SO}_2$  reactant in the droplet; and below pH 2 very little  $\text{SO}_2$  is dissolved in the droplet so the oxidation is negligible. As temperatures increase from  $8^\circ \text{C}$  to  $25^\circ \text{C}$ ,  $\text{Mn}^{2+}$  solution, pH 2.0-4.5, resulted in an increase in the oxidation rate by

a factor of 5 to 10. A synergistic effect between  $\text{Fe}^{2+}$  and  $\text{Mn}^{2+}$  was observed; the addition of  $\text{Fe}^{2+}$  to  $\text{Mn}^{2+}$  solutions increased the rate of  $\text{SO}_2$  oxidation and reduced the dependence of absorption rate on temperature. The rate constant of  $10^{-4}$  M  $\text{MnCl}_2$  solution was  $9.4 \times 10^2 \text{ sec}^{-1}$  and the rate constant of  $10^{-4}$  M  $\text{FeCl}_2$  solution was  $5.8 \times 10^2 \text{ sec}^{-1}$ , but the rate constant in a solution of  $10^{-4}$  M  $\text{MnCl}_2$  and  $10^{-4}$  M  $\text{FeCl}_2$  increased to  $140 \times 10^2 \text{ sec}^{-1}$ . Estimated urban oxidation rates are between 0.08 and 2.0%/hr, depending on the temperature and the heavy metal content of the cloud. Catalyst concentrations of  $10^{-5}$  M or higher could result in significant  $\text{SO}_2$  oxidation in urban clouds.

Beilke and Gravenhorst (1977) agreed that oxidation in the presence of catalyst could be significant in  $\text{SO}_2$  oxidation in urban fogs where catalyst concentrations are high, but would be of little importance in areas with low catalyst concentrations. This mechanism would not be important in background areas unless the pH were greater than 5. Oxidation rates in the presence of catalyst proceed faster (by about two orders of magnitude) than in the absence of catalysts.

#### Oxidation of $\text{SO}_2$ by Ozone

The homogeneous gas phase reaction between  $\text{SO}_2$  and  $\text{O}_3$  is slow; however, the reaction is accelerated in water droplets.

Penkett (1972) determined the reaction rates of ozone dissolved in water in the range of  $3$  to  $5 \times 10^{-6}$  M with  $\text{SO}_2$ ,  $\text{NO}_2$  and  $\text{H}_2\text{S}$ ; the concentration of total sulfite was in excess of ozone concentration. The oxidation of bisulfite ( $\text{HSO}_3^-$ ) was determined to be first order with respect to ozone. The reaction with  $\text{NaNO}_2$  was also determined to be first order with

respect to ozone but the data were not considered accurate enough to establish the order of the sulfide reaction. The overall reaction was determined to be second order; the rate expression is given by

$\frac{-d [O_3]}{dt} = k_2 [O_3] [HSO_3^-]$ ; the rate constant  $k_2$  was found to be  $(3.32 \pm 0.11) \times 10^5 \text{ M}^{-1} \text{ sec}^{-1}$ . A reaction rate of 12.6%/hr is calculated under typical cloud conditions assuming a liquid water content of 0.1 to 1 g of liquid water/m<sup>3</sup>, 10<sup>0</sup> C, pH = 5,  $[SO_2] = 0.007 \text{ ppm}$  and  $[O_3] = 0.05 \text{ ppm}$ . This rate is about 70 times larger than that predicted by the method of Scott and Hobbs (1967) under the same conditions but is in the same range, depending on pH, as McKay's (1971) calculations.

Penkett and Garland (1974) expanded the work of Penkett (1972) using a fog chamber designed to simulate atmospheric conditions over a pH range of 4 to 7 at 10<sup>0</sup> C; the results agreed with those calculated earlier, assuming 0.1 ppm SO<sub>2</sub> and 0.05 ppm O<sub>3</sub> in a fog containing 0.1 ml liquid water/m<sup>3</sup>. The oxidation at pH 6 led to an observed rate of  $(2.4 \pm 1.0) \times 10^{-4} \text{ ppm/min}$  which compared well to a calculated rate of  $2.1 \times 10^{-4} \text{ ppm/min}$ . The oxidation rate expression is given by:

$$R(O_3) = (3.76 \times 10^{-4}) [HSO_3^-] \text{ units of moles/liter/sec} \quad (73)$$

For comparison the rate of oxidation of SO<sub>2</sub> in fog by O<sub>2</sub> in the absence of a catalyst  $[R(O_2)]$  was calculated using McKay's (1971) equation:

$$R(O_2) = [4.18 \times 10^{-4} + 1.77 (H^+)^{\frac{1}{2}}] [SO_3^-] \text{ units of moles/liter/sec} \quad (74)$$

At pH 6,  $R(O_2)$  was less than half the value of  $R(O_3)$  and as the pH decreased,  $R(O_2)$  became insignificant compared to  $R(O_3)$ .

Beilke and Gravenhorst (1977) estimated sulfate formation rates on the basis of the data of Penkett (1972) and others, assuming that transport processes for both  $\text{SO}_2$  gas and  $\text{O}_3$  gas are fast compared to  $\text{SO}_2$  oxidation in the droplet. At 1.0 ppb  $\text{SO}_2$ , 40 ppb  $\text{O}_3$  and  $10^\circ \text{C}$ , the oxidation rate of  $\text{SO}_2$  by ozone was higher than either the oxidation of  $\text{SO}_2$  by  $\text{O}_2$  with or without catalyst. The authors concluded that oxidation by strong oxidizing agents appeared to be the dominant mechanism of  $\text{SO}_2$  oxidation in liquid drops, although some experimental factors such as the effect of pH and  $\text{O}_3$  concentrations remained to be resolved.

Table 6 Summary of liquid phase SO<sub>2</sub> oxidation studies.

Investigator	Conversion rate/ rate coefficient	Mechanism	Comments
Fuller and Crist (1941)	$k = 0.013 + 0.0015 \text{ sec}$ $k = 0.013 + 2.5 (\text{Cu}^{++})$ $k = 0.013 + 6.6 [\text{H}^+]^{\frac{1}{2}}$	long chain reaction; first order sulfite oxidation by O <sub>2</sub> with copper catalyst; with acid catalyst.	rate constant for added acid was based on second dissociation constant of H <sub>2</sub> SO <sub>3</sub> equal to $5 \times 10^{-6}$ ; Levy et al. (1976) revised the constant to $59 \text{ l.}^{-\frac{1}{2}} \text{ sec}^{-1}$ based on a second dissociation constant of $6.3 \times 10^{-8}$ .
Bassett and Parker (1951)		oxidation of sulfurous acid by oxides of Mn <sup>++</sup> , Fe <sup>++</sup> and Cu <sup>++</sup> salts and O <sub>2</sub> .	authors postulated the uncatalyzed oxidation proceeded through complexes such as (O <sub>2</sub> ·SO <sub>3</sub> ) <sup>=</sup> and (O <sub>2</sub> ·S <sub>2</sub> O <sub>5</sub> ) <sup>=</sup> ; the catalyzed oxidation proceeded through complexes such as [O <sub>2</sub> ·Mn(SO <sub>3</sub> ) <sub>2</sub> ] <sup>=</sup> .
Junge and Ryan (1958)		oxidation of SO <sub>2</sub> by O <sub>2</sub> with and without NH <sub>3</sub> and metal catalysts (Mn <sup>++</sup> , Cu <sup>++</sup> , Fe <sup>++</sup> , Co <sup>++</sup> , Na <sup>+</sup> ).	one of the first efforts to study the role of SO <sub>2</sub> oxidation in air chemistry; found that the uncatalyzed reaction produced negligible sulfate; explained SO <sub>2</sub> oxidation in terms of SO <sub>2</sub> -NH <sub>3</sub> -catalytic system whereby NH <sub>3</sub> neutralized the sulfate in the reaction; found Mn <sup>++</sup> to be the most effective catalyst followed by Fe <sup>++</sup> ; sulfate formation linearly dependent on initial SO <sub>2</sub> concentration; reaction practically stopped at pH of 2.2; experimental method criticized by Cheng et al. (1971).
Johnstone and Coughanower (1958)	reaction rate of 1%/min <sup>-1</sup> calculated for fog droplets	SO <sub>2</sub> oxidation by metal catalyst (manganese, iron, copper and nickel)	developed mathematical model for SO <sub>2</sub> gaseous diffusion with a liquid drop accompanied by zero order reaction in the liquid phase; rate measured in single drops depended on concentration of SO <sub>2</sub> and catalyst; Mn <sup>++</sup> most effective catalyst; high concentrations of SO <sub>2</sub> and catalyst were used.

Table 6 (contd.) Summary of liquid phase SO<sub>2</sub> oxidation studies.

Investigator	Conversion rate/ rate coefficient	Mechanism	Comments
Van den Heuvel and Mason (1963)	oxidation rate 2.5%/min <sup>-1</sup>	SO <sub>2</sub> oxidation catalyzed by NH <sub>3</sub> 2SO <sub>2</sub> + O <sub>2</sub> → 2SO <sub>3</sub> SO <sub>3</sub> + H <sub>2</sub> O → H <sub>2</sub> SO <sub>4</sub> NH <sub>3</sub> + H <sub>2</sub> O → NH <sub>4</sub> OH → NH <sub>4</sub> <sup>+</sup> + OH <sup>-</sup>	laboratory data were extrapolated to ambient conditions to obtain the rate constant.
Scott and Hobbs (1967)	1st order rate equation $d [SO_4^{2-}] = k [SO_3^-] dt$ k = 0.1 min <sup>-1</sup> oxidation rate of 2.5 %/hr <sup>-1</sup> was derived	SO <sub>2</sub> oxidation catalyzed by NH <sub>3</sub> ; authors developed a set of nine chemical equilibrium equations which assumed gaseous and ionic equilib- rium among SO <sub>2</sub> , NH <sub>3</sub> and CO <sub>2</sub> .	k estimated from the data of Van den Heuvel and Mason (1963).
Foster (1969)	SO <sub>2</sub> conversion rates: 0.09%/min <sup>-1</sup> for Mn 0.15-1.5%/min <sup>-1</sup> for Fe	SO <sub>2</sub> oxidation by metal catalyst 2SO <sub>2</sub> + 2H <sub>2</sub> O + O <sub>2</sub> $\xrightarrow{\text{catalyst}}$ 2H <sub>2</sub> SO <sub>4</sub>	derived theoretical rates for SO <sub>2</sub> oxidation by iron and manganese and applied the data to power plant plumes; suggested iron oxides are major cata- lyst; oxidation by iron was pH dependent.
Matteson et al. (1969)	$\frac{-d(SO_2)}{dt} = k_1 [Mn^{2+}]^2$ k <sub>1</sub> = 2.4 x 10 <sup>5</sup> m <sup>-1</sup> sec <sup>-1</sup>	SO <sub>2</sub> oxidation by metal catalyst; 4 step chemical reaction involving the formation of intermediate complexes: Mn <sup>++</sup> + SO <sub>2</sub> $\xrightleftharpoons[k_1]{k_2}$ Mn·SO <sub>2</sub> <sup>++</sup> 2MnSO <sub>2</sub> <sup>++</sup> + O <sub>2</sub> $\xrightleftharpoons[k_2]{k_3}$ [(MnSO <sub>4</sub> <sup>++</sup> ) <sub>2</sub> ·O <sub>2</sub> ] $\xrightleftharpoons[k_3]{k_4}$ 2Mn·SO <sub>3</sub> <sup>++</sup> MnSO <sub>3</sub> <sup>2+</sup> + O <sub>2</sub> $\xrightleftharpoons[k_4]{k_5}$ Mn <sup>++</sup> + HSO <sub>4</sub> <sup>-</sup> + H <sup>+</sup> HSO <sub>4</sub> <sup>-</sup> + H <sup>+</sup> $\rightleftharpoons$ H <sub>2</sub> SO <sub>4</sub>	authors found no definite correlation between humidity and reaction rate; at < 95% RH no sulfate formed due to inadequate hydration of the metal salt; similar mechanism proposed for other metal catalysts; Cheng et al. (1971) criticize results due to improper experimental methods.

Table 6 (contd.). Summary of liquid phase SO<sub>2</sub> oxidation studies.

Investigator	Conversion rate/ rate coefficients	Mechanism	Comments
Cheng et al. (1971)	2%/hr <sup>-1</sup> using Mn <sup>++</sup> as catalyst and heavily polluted urban atmosphere	SO <sub>2</sub> oxidation by metal catalyst $2\text{SO}_2 + 2\text{H}_2\text{O} + \text{O}_2 \xrightarrow{\text{catalyst}} 2\text{H}_2\text{SO}_4$	investigated effectiveness of MnSO <sub>4</sub> , MnCl <sub>2</sub> and CuSO <sub>4</sub> as catalysts; humidity influences reaction rate; ambient oxidation rates estimated based on laboratory data; 1st order with respect to SO <sub>2</sub> using MnSO <sub>4</sub> as catalyst.
McKay (1971)	$\frac{d[\text{SO}_4^{=}]}{dt} = k [\text{SO}_3^{=}]$ $k = [0.013 = 59 \frac{(\text{H}^+)^2}{\text{sec}^{-1}}]$ oxidation rate of 13%/hr <sup>-1</sup> was suggested by the data	SO <sub>2</sub> oxidation catalyzed by NH <sub>3</sub> (Scott and Hobbs 1967)	revised and extended calculation of Scott and Hobbs (1967) using the rate expression of Fuller and Crist (1941) and the ionization constants of Scott and Hobbs (1967); found a negative temperature correlation.
Chen and Barron (1972)		SO <sub>2</sub> oxidation by cobalt free radical chain mechanism with the cobaltic hexaquo complex as the initiator	rate constant not developed; reaction rate independent of O <sub>2</sub> , three-halves order with respect to sulfite concentration and one-half order with respect to cobalt concentration.
Penkett (1972)	$\frac{-d[\text{O}_3]}{dt} = k_2 [\text{O}_3][\text{HSO}_3^-]$ $k_2 = (3.32 \pm 0.13) \times 10^5 \text{ m}^{-1} \text{ sec}^{-1}$ conversion rate of 12.6%/hr <sup>-1</sup> calculated for a typical cloud	SO <sub>2</sub> oxidation by ozone	calculated rate about 70 times larger than that predicted by Scott and Hobbs (1967) under the same conditions but is in the same range as McKay's (1971) calculations depending on pH
Miller and de Pena (1972)	$\frac{d[\text{SO}_4^{=}]}{dt} = k [\text{SO}_3^{=}]$ $k \sim 0.003 \text{ sec}^{-1}$ an oxidation rate of only 0.1%/hr <sup>-1</sup> suggested by some of the data	SO <sub>2</sub> oxidation catalyzed by NH <sub>3</sub> (Scott and Hobbs 1967)	followed experimental method of Van den Heuvel and Mason (1963) and the basic model of Scott and Hobbs (1967).

Table 6 (contd.). Summary of liquid phase SO<sub>2</sub> oxidation studies.

Investigator	Conversion rate/ rate coefficient	Mechanism	Comments
Penkett and Garland (1974)	oxidation rate at pH 6 (2.4 ± 1.0) × 10 <sup>-4</sup> ppm min <sup>-1</sup>	SO <sub>2</sub> oxidation by ozone	expanded work of Penkett (1972) to simulate atmospheric conditions at a pH of 4 to 7 at 10 <sup>0</sup> C; results agreed with earlier work
Brimblecombe and Spedding (1974)	oxidation rate of 3.2%/ day <sup>-1</sup> calculated for fog conditions using 10 <sup>-6</sup> M Fe <sup>3+</sup> and 28 μg/m <sup>3</sup> SO <sub>2</sub>	SO <sub>2</sub> oxidation by O <sub>2</sub> with trace Fe <sup>+++</sup> as catalyst; proposed free radical mechanism with hydroxylated Fe <sup>+++</sup> as the initiator	measured an oxidation rate in "pure water" presumably caused by traces of Fe <sup>+++</sup> (10 <sup>-8</sup> M); attempted to use concentrations of reactants in the range of the ambient atmosphere eliminating the need for large extra- polations.
Freiberg (1974) (1975)	low SO <sub>2</sub> concentration and/or low pH: $\frac{d[\text{SO}_4^{2-}]}{dt} = \frac{k_T k_S^2 [\text{Fe}^{3+}] [\text{H}_2\text{SO}_3]^2}{[\text{H}^+]^3}$  high SO <sub>2</sub> concentration and/or high pH: $\frac{-d[\text{H}_2\text{SO}_3]}{dt} = \frac{k_L [\text{Fe}^{3+}] [\text{H}_2\text{SO}_3]}{[\text{H}^+]}$	SO <sub>2</sub> oxidation by iron catalyst; complex mecha- nism reaction	developed a theoretical model to assess effect of humidity and tempera- ture; SO <sub>2</sub> oxidation at low SO <sub>2</sub> concentration and/or low pH was directly dependent on humidity, k proportional to [H <sup>+</sup> ] <sup>3</sup> and a 5 <sup>0</sup> C increment in temperature decreased reaction rate by an order of magnitude.



Table (contd.). Summary of liquid phase SO<sub>2</sub> oxidation studies.

Investigator	Conversion rate/ rate coefficient	Mechanism	Comments
Bielke et al. (1975)	conversion rate between 10 <sup>-5</sup> to 15%/hr <sup>-1</sup> as pH varies from 3 to 6 for typical atmospheric cloud droplets	SO <sub>2</sub> oxidation by O <sub>2</sub>	partially resolved discrepancies in the oxidation rate predicted by other investigators; at 3 and 25 <sup>o</sup> C and a pH range of 3-6, temperature dependence was independent of the conversion rate; a trend approximately proportional to [H <sup>+</sup> ] <sup>-2</sup> was observed for the pH range of 3-6.
Barrie and Georgii (1976)	$\frac{d(SO_4^{2-})}{dt} = k [SO_3^{2-}]$ <p>                     k = 9.4 x 10<sup>2</sup> sec<sup>-1</sup>                      for [MnCl<sub>2</sub>] = 10<sup>-4</sup> M                      k = 5.8 x 10<sup>2</sup> sec<sup>-1</sup>                      for [FeCl<sub>2</sub>] = 10<sup>-4</sup> M                      k = 140 x 10<sup>2</sup> sec<sup>-1</sup>                      for 10<sup>-4</sup> M FeCl<sub>2</sub> and                      10<sup>-4</sup> M MnCl<sub>2</sub> solution                 </p> oxidation rates between 0.08 and 2.0%/hr <sup>-1</sup> estimated for typical urban cloud	SO <sub>2</sub> oxidation by metal catalyst; Mn possibly complexed as [Mn <sup>2+</sup> (SO <sub>3</sub> <sup>=</sup> ) <sub>3</sub> ] <sup>4-</sup> prior to reaction	pseudo 1st order reaction; Mn <sup>++</sup> most effective catalyst; Cu <sup>++</sup> not effective catalyst; oxidation highest at high pH and high temperature; oxidation rate decreased with decreasing pH and is negligible at pH 2; synergistic effect observed for Mn and Fe combination.
Bielke and Gravenhorst (1977)	rate constant between 10 <sup>-6</sup> and 1.5%/hr <sup>-1</sup> for droplet pH between 3 and 6 and a cloud with water content of 0.1 g/m <sup>3</sup>  rate constant between 2 x 10 <sup>-6</sup> and 3.0%/hr <sup>-1</sup> rate faster than O <sub>2</sub> oxidation; with or without catalyst	oxidation by O <sub>2</sub> without catalyst  oxidation by O <sub>2</sub> with catalyst oxidation by O <sub>3</sub>	compared three mechanisms of SO <sub>2</sub> oxidation in droplets: 1) oxidation by O <sub>2</sub> without catalyst - unimportant unless droplet pH is greater than pH 6, major function of NH <sub>3</sub> in the pH range 4-5 in the SO <sub>2</sub> /NH <sub>3</sub> /H <sub>2</sub> O system is to convert a pre-existing sulfate containing droplet into an ammonium sulfate droplet; 2) oxidation by O <sub>2</sub> with catalyst not important for background atmospheric sulfate formation unless pH > 5 may be important in urban areas of higher heavy metal concentrations; 3) oxidation by ozone - appears to be dominant mechanism of SO <sub>2</sub> oxidation in cloud droplets.

### CATALYZED OXIDATION ON DRY SURFACES

Processes discussed so far involve gas transfer to phases which are well mixed and in which chemical rates are thought to occur uniformly.

Heterogeneous processes can also occur directly on surfaces, either by gases adsorbed on dry solid or at the interface between aqueous and solid phases in moist aerosols. Although it would seem that metal oxides could be effective catalysts, they tend to be concentrated in the larger aerosol particles ( $<3 \mu\text{m}$ ) while sulfates occur in the smaller particles ( $<2 \mu\text{m}$ ). Carbon, however, does occur in the same particle size class as sulfates.

Novokov et al. (1974) obtained experimental evidence for the possible role of carbon and soot particles as a catalyst for the oxidation of  $\text{SO}_2$  in the atmosphere. The study involved the analysis of sulfates produced in the laboratory by the oxidation of  $\text{SO}_2$  on graphite particles and combustion-produced soot particles using the technique of electron spectroscopy chemical analysis (ESCA).

The ESCA spectrum of graphite particles exposed to  $\text{SO}_2$  in filtered ambient air showed two peaks corresponding to sulfate and sulfide; blank filter spectra showed no measurable peaks. Soot particles from a premixed propane-oxygen flame produced results similar to the graphite experiments. The soot experiments were conducted using 300 ppm  $\text{SO}_2$ , 5 minutes exposure time and dry air, or pre-humidified particle-free air, or  $\text{N}_2$ . The ESCA spectra of the pre-humidified air system were higher than the dry air system. Both dry and pre-humidified  $\text{N}_2$ , when used instead of air, produced very low background sulfate peaks showing that  $\text{O}_2$  is important in the oxidation process. Although water molecules enhanced the sulfate production in the

in the air-SO<sub>2</sub>-soot system, the possibility of SO<sub>2</sub> oxidation by dissolved molecular O<sub>2</sub> in water droplets was not significant because blank unsooted filters exposed to SO<sub>2</sub> and pre-humidified air showed only low, background sulfate (temperature of the chamber was elevated to prevent water droplet formation). No rate data were presented in the study.

Corn and Cheng (1972) studied the catalysis of SO<sub>2</sub> in air using insoluble particles of CaCO<sub>3</sub>, V<sub>2</sub>O<sub>5</sub>, Fe<sub>2</sub>O<sub>3</sub>, fly-ash from a coal-burning power plant, MnO<sub>2</sub>, activated carbon, and suspended particulate matter from urban air. A technique of aerosol stabilization was used (Cheng et al. 1971) which consisted of depositing the aerosol on Teflon beads in a fluidized bed. The Teflon beads with deposited aerosol were then packed into a flow reactor and progress of the reaction was monitored by measuring the SO<sub>2</sub> effluent concentrations using a microcoulometer. The reactor was calibrated using Teflon beads without catalyst (dummy reactor). The amount of SO<sub>2</sub> catalyzed by aerosol was determined by comparing the SO<sub>2</sub> breakthrough curves of the reactor with catalyst beads to the dummy reactor under identical conditions (23° C, 740 mm Hg).

The results of the study showed that CaCO<sub>3</sub>, V<sub>2</sub>O<sub>5</sub> and fly ash from a coal-fired power plant did not catalyze oxidation of SO<sub>2</sub>. Activated carbon, MnO<sub>2</sub>, suspended particulates from urban air and Fe<sub>2</sub>O<sub>3</sub> all adsorbed SO<sub>2</sub>.

The activated carbon system consisted of 10 mg activated carbon and 8-14.4 ppm SO<sub>2</sub> at 20% relative humidity and reaction time up to 60 minutes. Steady state rates of adsorption, or conversion, of 0.13 and 0.021 µg SO<sub>2</sub>/min/mg charcoal were reached at SO<sub>2</sub> concentrations of 8.0 and 14.4 ppm, respectively. The experiments did not distinguish whether SO<sub>2</sub> underwent steady-state conversion in the reactor or whether there was catalyzed

oxidation on the carbon surface.

The  $\text{MnO}_2$  system consisted of 20-30 mg  $\text{MnO}_2$ , 8.0-14.4 ppm  $\text{SO}_2$  in air at 0-85% RH. Sorption did not occur in dry air; at 30-85% RH there was evidence for significant adsorption of  $\text{SO}_2$  and adsorption increased with increasing humidity.

The urban suspended particulate system consisted of 25 mg suspended particulates, 8.0-14.4 ppm  $\text{SO}_2$  in air at 20%-95% RH. Sorption was increased by relative humidity; 1 mg sample at 95% RH adsorbed more  $\text{SO}_2$  than 25 mg of the same sample at 20% RH.

The  $\text{Fe}_2\text{O}_3$  system consisted of 30 mg  $\text{Fe}_2\text{O}_3$ , 8.0-14.4 ppm  $\text{SO}_2$  in air at 0-95% RH. Sorption of  $\text{Fe}_2\text{O}_3$  began at 0% RH and was greatly accelerated at 95% RH. At the same  $\text{SO}_2$  feed rate, more  $\text{SO}_2$  was removed in the reactor at 14.4 ppm  $\text{SO}_2$  than at 8 ppm suggesting that sorption was not entirely due to chemical reaction. Physical sorption increases as the partial pressure of the adsorbing gas increases and the authors suggest that part of the  $\text{SO}_2$  removed from the air streams was physically adsorbed on the oxide. Some desorption was observed as the reactor was purged with air.

Chun and Quon (1973) also investigated the heterogeneous oxidation of sulfur dioxide in air by ferric oxide particles. The procedure involved generating ferric oxide by the combustion of iron pentacarbonyl which was deposited in a film on a filter-reactor;  $\text{SO}_2$  in air was then metered over the reactor.  $\text{SO}_2$  was analyzed colorimetrically and sulfate by nephelometry. The study system consisted of 5-19 ppm  $\text{SO}_2$ , 5 mg  $\text{Fe}_2\text{O}_3$  per filter, 5-90 minutes reaction time and 50-94% RH. At ambient temperatures the heterogeneous oxidation of  $\text{SO}_2$  on surfaces of non-hygroscopic metal oxide particles is not a true catalytic reaction since the active sites on the

surfaces of the particles become occupied by the reaction products and are no longer available for further reaction. The authors use the term "capacity limited heterogeneous reaction" to designate this class of gas-solid reactions.

The capacity of the  $\text{Fe}_2\text{O}_3$  particles to oxidize  $\text{SO}_2$  in air was found to be 62.6  $\mu\text{g}/\text{mg}$   $\text{Fe}_2\text{O}_3$  averaged over 25 measurements. A first order heterogeneous rate constant of  $9.4 \times 10^{-3} \text{ ppm}^{-1} \text{ min}^{-1}$  was calculated as the average of six determinations (range:  $4.6 \times 10^{-3}$  to  $12.3 \times 10^{-3} \text{ ppm}^{-1} \text{ min}^{-1}$ ). The rate constant did not appear to be correlated with either relative humidity or  $\text{SO}_2$  concentration in the ranges studied.

Urone et al. (1968) studied the reactions of  $\text{SO}_2$  in the presence of hydrocarbons, nitrogen dioxide, moisture, particulates and ultraviolet radiation using colorimetric and radio-tracer analysis techniques. Gaseous mixtures of  $\text{SO}_2$  kept in the dark did not react;  $\text{SO}_2$  oxidation under UV irradiation equivalent to noonday sunlight was about 0.1%/hr. Very high reactivity (within minutes) was observed for  $\text{SO}_2$  in the presence of powdered oxides of iron, lead and calcium. Low reactivity was observed for sodium chloride, calcium carbonate, aluminum oxide and vanadium pentoxide.

Table 8 summarizes  $\text{SO}_2$  conversion rates drawn from the Urone study.  $\text{SO}_2$  concentrations ranged from 8-14 ppm; particulate loadings ranged from 16-30 mg; UV exposure time ranged from 0 to 180 min and total time of reactants ranged from 4 to 1145 minutes.

The rates for chromium trioxide and vanadium pentoxide were surprisingly low, since they are known to catalyze the oxidation of  $\text{SO}_2$  at higher temperatures. The rates for calcium oxide may have been higher due to moisture acquired under the experimental conditions.

Table 8. Summary of experiments involving SO<sub>2</sub> reactions in the presence of different particulates<sup>a</sup>

SO <sub>2</sub> conc (ppm)	RH (%)	Particulate Species conc (mg)	UV Exposure (min)	Total Time in Flask (min)	SO <sub>2</sub> Reaction rate (%/hr.)
14		NaCl 21.0	0	1000	-.11
13	50	NaCl 38.2	20	385	1.25
14		CaCO <sub>3</sub> 30.3	0	1100	.23
13		CaCO <sub>3</sub> 36.1	20	140	4.29
18		Fe <sub>2</sub> O <sub>3</sub> 20.0	0	22	270
8		Fe <sub>3</sub> O <sub>4</sub> 14.0	0	4	255
14		Cr <sub>2</sub> O <sub>3</sub> 11.0	0	1030	.52
17		PbO 11.0	0	15	104
18		PbO <sub>2</sub> 12.0	0	9	353
18		V <sub>2</sub> O <sub>5</sub> 17.2	0	800	.70
8		V <sub>2</sub> O <sub>5</sub> 16.2	180	810	-.67 <sup>b</sup>
8	50	V <sub>2</sub> O <sub>5</sub> 19.1	180	815	.88 <sup>b</sup>
12		CaO 19.7	0	30	106
12		CaO 22.7	10	20	183
14		Al <sub>2</sub> O <sub>3</sub> 33.1	0	1145	2.4
10		Al <sub>2</sub> O <sub>3</sub> 19.8			
		CaO 16.6	0	30	158
10		Al <sub>2</sub> O <sub>3</sub> 17.7			
		CaO 17.7	10	30	146

<sup>a</sup>From Urone et al. (1968)

<sup>b</sup>Experimental problems encountered due to the absorption and release of SO<sub>2</sub> by V<sub>2</sub>O<sub>5</sub> in the presence of moisture and UV exposure.

The weights of particulates used in the experiments were from 100 to 200 times the weight of SO<sub>2</sub>. In polluted air the total weight of suspended particulates is much smaller compared to SO<sub>2</sub> and other pollutants and heterogeneous reactions of this type, although very rapid, could be limited by available particulate.

The results of Urone et al. (1968) compare well qualitatively with the results of Corn and Cheng (1972) who reported high reactivity for Fe<sub>2</sub>O<sub>3</sub> and low reactivity for CaCO<sub>3</sub> and V<sub>2</sub>O<sub>5</sub>.

Dyson and Quon (1976) studied the reactivity of zinc oxide fume with sulfur dioxide in air using the method described by Chun and Quon (1973). Zinc oxide fume was exposed to 10 ppm  $\text{SO}_2$  at 15, 25 and 35° C and 2-95% RH. Hydrated zinc sulfite was determined to be the major product. The reactivity of zinc oxide was found to be  $110 \mu\text{g SO}_3^-/\text{mg ZnO}$  at 25° C, 50% RH and 4.0 to 17.6 ppm  $\text{SO}_2$ . The reactivity increased to  $760 \mu\text{g SO}_3^-/\text{mg ZnO}$  at 25° C and 91% RH. The reactivity was found to increase with decreasing temperature at all humidity levels. Sharp increases in reactivity occurred at humidity levels corresponding to the equilibrium phase transition of zinc oxide to zinc hydroxide.

Smith et al. (1969) studied the adsorption of  $\text{SO}_2$  on submicron particles (0.01-0.1  $\mu\text{m}$ ) of  $\text{Fe}_3\text{O}_4$ ,  $\text{Al}_2\text{O}_3$ ,  $\text{PbO}$ , and platinum using an exploding-wire technique and radio-labeled  $\text{SO}_2$ . Sorption of  $\text{SO}_2$  by  $\text{Fe}_3\text{O}_4$  reached about 3% at an initial  $\text{SO}_2$  concentration of 6.2 ppm and  $1.8 \times 10^5$  particles per  $\text{cm}^3$ ; sorption on  $\text{Al}_2\text{O}_3$  was about 50% with an initial  $\text{SO}_2$  concentration of 1 ppm. Lead oxides caused complete removal of gaseous  $\text{SO}_2$  almost immediately (within 5 minutes) after mixing. The results showed that preferential chemisorption was observed at low  $\text{SO}_2$  concentrations (up to 2 ppm) followed by multi-layered physical adsorption at higher  $\text{SO}_2$  concentrations (up to 66 ppm). Although significant adsorption of  $\text{SO}_2$  occurred on the  $\text{Fe}_3\text{O}_4$ ,  $\text{Al}_2\text{O}_3$ ,  $\text{PbO}$ , and platinum surfaces, oxidation rates were not presented in the study.

Low et al. (1971) and Goodsel et al. (1972) studied the adsorption and conversion of  $\text{SO}_2$  by  $\text{CaO}$  and  $\text{MgO}$  using infrared spectroscopy as part of the research effort directed at removing  $\text{SO}_2$  from power plant stacks by adding limestone or dolomite.  $\text{MgO}$  and  $\text{CaO}$  were first degassed and then

$\text{SO}_2$  was added incrementally at  $25^\circ \text{C}$ . Both studies showed the formation of sulfites which are converted to sulfate in the  $\text{CaO-SO}_2$  system on heating to  $550^\circ \text{C}$ . The surface sulfites were not converted to sulfate upon heating in the  $\text{MgO-SO}_2$  system at temperatures up to  $775^\circ \text{C}$ ; however, heating in the presence of oxygen did produce a stable sulfate product.

Lin and Lunsford (1975) also studied the  $\text{SO}_2\text{-MgO}$  system at both high temperatures and ambient temperatures. Electron paramagnetic resonance (EPR) and infrared spectroscopic analysis of  $\text{SO}_2$  (at 25 torr) adsorption by  $\text{MgO}$  and  $\text{Mg(OH)}_2$  revealed the presence of sulfite ions.

Davis and Lunsford (1976) studied the surface oxidation of  $\text{SO}_2$  to sulfate by nitrogen dioxide on hydrated silica gel using x-ray photo-electron spectroscopy (XPS). The studies showed that neither  $\text{SO}_2$  nor  $\text{NO}_2$  alone were strongly adsorbed on the silica gel surface (allowed reaction time: several hours at  $25^\circ \text{C}$ ). When  $\text{SO}_2$  and  $\text{NO}_2$  (25 torr  $\text{SO}_2$ , 25 torr  $\text{NO}_2$ ) were introduced into the reaction chamber and allowed to react at  $25^\circ \text{C}$  on silica gel in either light or darkness, the result indicated that the  $\text{SO}_2$  was oxidized to sulfate by  $\text{NO}_2$  over a period of several hours. Oxidation rates were not presented in this study.



## SULFUR DIOXIDE CONVERSION FIELD STUDIES

The conversion of sulfur dioxide has been investigated for plumes of power plants, urban areas, and smelters. The studies encompass a variety of sampling, analytical and modelling techniques. The methods and results of these investigations are discussed in the following section. Table 8 located at the end of this section summarizes the SO<sub>2</sub> oxidation field studies.

### Power Plants

#### Colbert Power Plant

Gartrell et al. (1963) conducted the classic investigation of airborne plume sampling at the 800 megawatt (MW) (4-200 MW units, each with a 300 ft stack) Colbert coal-fired power plant in Alabama. The power plant was relatively dirty; furnaces were fired with pulverized coal and mechanical collectors removed only 70% of the fly ash. Sampling was conducted under a wide variety of meteorological conditions using a helicopter equipped with a sampling train consisting of a millipore filter to collect sulfuric acid mist followed by two peroxide bubblers to collect sulfur dioxide (the instrumentation for measuring acid mist was not reliable at the time of this study). Additional equipment included an altimeter, spring wound clock, and in some tests, wet and dry temperature probes. All sample runs were made during inversion conditions during the early morning hours for easy plume detection and maximum SO<sub>2</sub> plume concentrations. The flight pattern close to the stacks (1-2 miles) consisted of longitudinal flights along the plume centerline with repetitive cross-sections. Further away (>2 miles) the pattern consisted of flights across the plume centerline until 30-40 ft<sup>3</sup> of air had been sampled. Instrumentation was disconnected when the heli-

copter passed outside of the plume.

The results of the tests pointed to a strong dependence of oxidation rate on humidity. During periods of low humidity (<70% RH), the oxidation was slow, increasing slightly from 2% at one mile (12 minutes plume travel time) to 3% at 6 miles (60 minutes plume travel time) on October 14. The slight increase in oxidation was not evident in two other runs.

During periods of moderately high humidity (about 75% RH), the oxidation was initially rapid at one mile (12 minutes) increasing to 32% at 8 miles (96 minutes) on October 11. The average rate during the 1st 12 minutes of plume travel was  $120\% \text{ hr}^{-1}$  decreasing to about  $6\% \text{ hr}^{-1}$  during the next 84 minutes of plume travel.

The highest oxidation of 55% was determined in a slight mist on August 19 at 9 miles (108 minutes). There was complete cloud cover and fog during the sampling period; an average rate of about 30%/hr was calculated over the 108 minute travel time. The data indicated that under mist conditions, the initial rate was slow but overall a relatively high rate was sustained.

Oxidation rates were calculated by dividing the percent oxidation by plume travel time; common starting times for calculating the rates were not utilized. The authors stated that the limited data obtained in their study do not provide a basis for accurate estimation of the absolute rate of  $\text{SO}_2$  oxidation after emission from the source. The investigators postulated that moisture in the plume was the dominant factor controlling the oxidation rate, especially at relative humidities greater than 75%. Newman et al. (1975b) suggested that the relative humidity dependence postulated by Gartrell et al. (1963) was not clear and that the high oxidation rates were related to high concentrations of particulates in the plume.

Frankfurt/Main Power Plant, Germany

Weber (1970) determined the lifetime of  $\text{SO}_2$  in power plant plumes by simultaneous ground-based monitoring of  $\text{CO}_2$  and  $\text{SO}_2$  using ambient data taken during a four-year period at three sampling sites in Frankfurt/Main. Weber made the assumption that the ratio of  $\text{CO}_2$  to  $\text{SO}_2$  remained constant while the plume traveled through the atmosphere. The results of the study indicated that almost 70% of the initial  $\text{SO}_2$  concentration had been oxidized or absorbed within the first three kilometers of a power plant stack (travel time, 15 minutes); this corresponds to an average rate of about 250%/hour. Overall, oxidation rates of 18 to 180% per hour were measured depending on meteorological conditions. Plume travel times ranged from 20 minutes to three hours. The average loss of  $\text{SO}_2$  was about 50% of the initial concentrations. The data showed an increase in oxidation rates with increasing humidity. In addition, a longer travel time caused by slower wind speed, greater distance or higher stability class resulted in an increase in oxidation during time of travel to the sampling station. The assumption that the ground based station was recording  $\text{SO}_2$  and  $\text{CO}_2$  peaks that can be attributed solely to the power plant has been questioned.

Crystal River Power Plant

Stephens and McCaldin (1971) investigated plume characteristics at the Florida Crystal River power plant (375 MW, 500 ft stack) using an aircraft equipped with a light-scattering particle counter,  $\text{SO}_2$  bubbler and  $\text{SO}_2$  continuous analyzer. Flights were made during the early morning hours and followed longitudinal and cross sectional patterns. Sulfur dioxide decay was differentiated from decreases in  $\text{SO}_2$  concentration due to diffusion using a conservative tracer technique.  $\text{SO}_2$  decay was determined based

on the ratio of  $\text{SO}_2$  concentration to a conservative tracer concentration consisting of sub-micron particulates emitted from the stack. The ratio of particulates to  $\text{SO}_2$  would approximate a constant as the plume aged and diffused, and would increase as the plume aged if the  $\text{SO}_2$  decayed to a measurable extent. Data taken from three atmospherically stable days are summarized. Half-life determinations indicated the reaction obeyed a first-order rate equation and was humidity dependent.  $\text{SO}_2$  losses varied from negligible at low humidity (35% RH) to a half-life of about 140 minutes at medium humidity (50% RH) and 70 minutes at high humidity (80% RH). Rate constants were calculated using a gaussian diffusion equation and were reported to be 0, 28%/hr and 59%/hr for low, medium and high humidity. A major uncertainty in these data recognized by the authors was that light scatter counters of the type used in the experiment are humidity dependent (Lundgren and Cooper, 1968) and this could explain the differences observed in particle to  $\text{SO}_2$  ratios.

Friend (1972) reported that particles could not be used as a conservative tracer since the sulfate particles formed as a result of the oxidation of  $\text{SO}_2$  could contribute significantly to the total mass, resulting in an overestimation of conversion.

#### Morgantown Power Plant

Davis et al. (1974) and Davis and Klauber (1975) reported on the Morgantown power plant field studies which were designed to determine the extent to which  $\text{SO}_2$  and  $\text{NO}_x$  chemistry occurs as a function of distance from the source. The 1000 MW plant, located about 40 miles south of Washington, D.C., is equipped with two stacks (each 200 meters high) and controlled by electrostatic precipitators (99.5% efficient). During the study

period (October 1973 to August 1974), the Morgantown power plant burned a fuel mixture of 75% oil and 25% coal. The studies were conducted using an aircraft equipped with a flame photometric  $\text{SO}_2$  analyzer, a chemiluminescence  $\text{O}_3$  analyzer, and a chemiluminescence  $\text{NO-NO}_2\text{-NO}_x$  analyzer, in addition to meteorological instrumentation. The flight pattern consisted of passes through the plume perpendicular to the centerline of the plume from 200 to 900 m altitude.

The authors reported that the plume had a significant effect on  $\text{O}_3$  concentrations. Ozone, which had an ambient concentration of 60 ppb, was totally depleted in the plume out to 5 km from the plant. On another flight  $\text{O}_3$  depletion was observed out to 24 km followed by an increase in ozone concentration. The plume ozone concentration from 24 to 56 km was higher than the ambient level by 20 ppb. The observed ozone bulges and concurrent decreases in plume  $\text{SO}_2$  are shown in Figure 1.

The authors found that the ozone generation observed during the summer months was greatly reduced during the winter months and totally absent at night, providing strong evidence to the importance of homogeneous gas phase free radical chemistry in power plant plumes during summertime conditions.

$\text{SO}_2$  oxidation during the daytime in the summer was proposed to be in the range of 4.2-8.3%/hr.

Ozone depletion in the plume was explained by the rapid reaction between nitrous oxide and ozone:

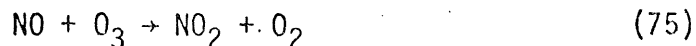

The authors propose a homogeneous mechanism based on the chemical oxidation

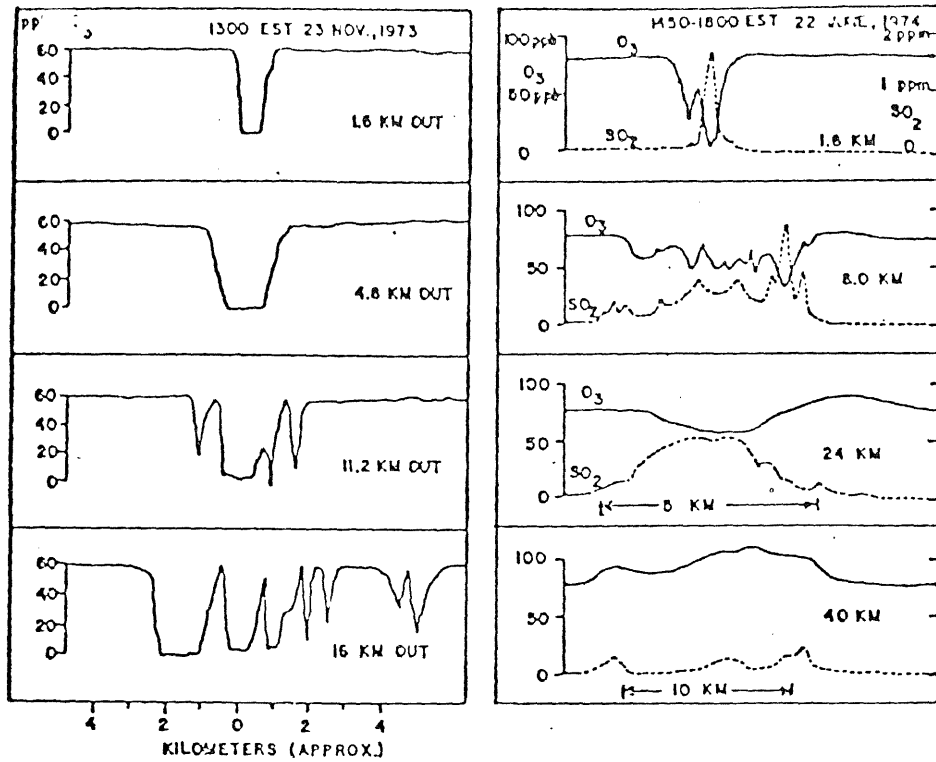
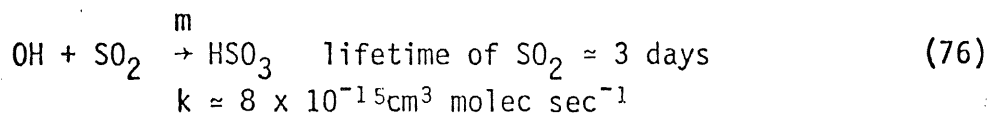
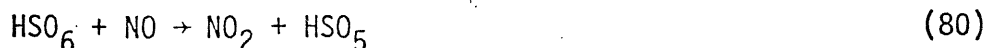

Figure 1. Crossplume  $O_3$  and  $SO_2$  variations in the Morgantown power plant plume at several downwind distances (Davis et al. 1974)

of  $\text{SO}_2$  by hydroxyl to explain the ozone generation or "bulge" in the plume. The authors consider nine possible initiating steps and conclude that the most important is the reaction of hydroxyl free radicals with  $\text{SO}_2$ .



The mechanism is completed in the following steps.



In steps 80 and 78 the  $\text{NO}_2$  formed would photolyze to yield an  $\text{O}_3$  molecule.



and



For each cycle of reactions 79, 80 and 78 two ozone molecules are generated.

The most important chain termination steps are thought to be reactions



The authors also postulated a step which would change the end products from 2 molecules ozone to one molecule ozone and one molecule sulfuric acid.

The combination 79, 80, 78 and 85 would generate ozone and catalytically convert  $\text{SO}_2$  to sulfuric acid.



Very little reaction rate data or experimental verification of the existence of some of the  $\text{HSO}_x$  species is available to verify this mechanism.

Keystone and Northport Power Plants

Newman et al. (1975a, 1975b) conducted plume studies on the Northport oil fired power plant (two 380 MW units each with 183 m stack; particulate control equipment 85% efficient) and the Keystone coal-fired power plant (two 900 MW units each with 244 m stack; particulate control equipment 99.5% efficient) using a technique based on measuring and interpreting changes of the isotopic ratio,  $^{32}\text{S} : ^{34}\text{S}$ , in the  $\text{SO}_2$  gas stream as the  $\text{SO}_2$  is oxidized. An airplane equipped with a high volume sampler filter pack and sign-X electroconductivity  $\text{SO}_2$  analyzer sampled the oil-fired plant plume by repeated cross wind traverses for distances up to 25 km from the stack. The filter pack consisted of a glass fiber pre-filter for particulate removal followed by two treated cellulose filters to remove  $\text{SO}_2$ . A total of six runs during a variety of meteorological conditions were completed for the oil-fired power plant. Since the isotope ratio technique measured sulfur originating in the fuel, it could, in theory, discriminate between sources. Small deviations from standard isotopic sulfur ratios were expressed by a "del value",

$$\delta S = \left[ \frac{^{32}\text{S}/^{34}\text{S} \text{ (standard)}}{^{32}\text{S}/^{34}\text{S} \text{ (sample)}} - 1 \right] \times 1000 \quad (87)$$

It was assumed that  $\text{SO}_2$  and  $\text{SO}_3$  attained an isotopic equilibrium, and the equilibrium constant was expressed in terms of  $\delta\text{SO}_2$  and  $\delta\text{SO}_3$ .

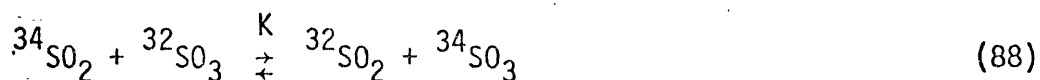

$$K = \frac{1000 + \delta\text{SO}_3}{1000 + \delta\text{SO}_2} \quad (89)$$



The fraction of  $\text{SO}_2$  converted to  $\text{SO}_3$ ,  $1-f$ , was then calculated at the measurement points downwind of the stack from the following equation:

$$(1-f) = \frac{\delta \text{SO}_2 (\text{fuel}) - \delta \text{SO}_2}{\alpha \cdot 1000} \quad \text{where } \alpha = K-1. \quad (90)$$

The authors compared measured oxidation to oxidation calculated with the isotope data. The measured converted  $\text{SO}_2$  ranged from 0 to 18% while the conversion based on isotope data ranged from 2 to 28%. The authors felt the sulfate data in general were not precise enough (high background compared to measured values) to use as valid percent  $\text{SO}_2$  converted and used the isotope data for further calculations. A conversion rate of  $1 \text{ ppm}^{-1} \text{ hr}^{-1}$  was determined for the proposed pseudo second-order mechanism. This rate corresponds to an  $\text{SO}_2$  half-life of 10 hr at 0.1 ppm  $\text{SO}_2$  and 100 hr at 0.01 ppm  $\text{SO}_2$ . No dependency on RH was observed in the range 40-95%.

The mechanism proposed for the oil-fired plume consists of  $\text{SO}_2$  in equilibrium with water which is associated with the particulates; the  $\text{SO}_2$  is immediately catalytically oxidized to sulfate and the sulfate could possibly be neutralized by ammonia. As  $\text{SO}_2$  is oxidized and neutralized, more  $\text{SO}_2$  dissolves and the process continues. Vanadium particulates were proposed as the catalyst; however, the laboratory investigation of Corn and Cheng (1972) cast doubt on the effectiveness of vanadium as a catalyst. The data supported a pseudo second-order mechanism arising from a first-order dependence on  $\text{SO}_2$  and a first-order dependence on particulates. The authors felt that a homogeneous mechanism was inconsistent with the data.

The coal-fired plant plume was sampled up to 16 km; the crosswind traverse method was used in 3 of 11 runs. In the remaining 8 runs, the flight plan was changed to a circular pattern and the plume was approached downwind

from the stack. A new technique employing sulfur hexafluoride as a conservative tracer was used in this study but technical problems with the method precluded definite conclusions. The measured  $\text{SO}_4^{=}$  data is of questionable use in calculating percent  $\text{SO}_2$  converted because of the large variation in background  $\text{SO}_4^{=}$  levels ( $4.0\text{-}34.0 \mu\text{g}/\text{m}^3$ ); at times, the net measured sulfate was less than one-tenth of the background value. The isotope data was also used to calculate the amount of  $\text{SO}_2$  which was converted. Two problems encountered with the isotope data were that the  $^{32}\text{S}:^{34}\text{S}$  ratio in the coal was not constant in this study as it was in the oil-fired plant and that the change in flight pattern gave conflicting results. The studies using the crosswind traverse method showed decreasing  $\text{SO}_2$  with distance; the circular flight pattern did not show an orderly decrease of  $\text{SO}_2$  with distance. Because of these problems, the authors did not calculate a conversion rate but concluded that the extent of oxidation was 5% and that variation in the percent oxidation could be due to the variability of particulate concentration in the plume by factors of 2 to 3. The lower percent oxidation of the coal-fired power plant compared to the oil-fired power plant (2-28%) was attributed to the lower particulate loading of the coal-fired plant ( $0.07 \text{ g}/\text{l SO}_2$  for coal-fired compared to  $0.2 \text{ g}/\text{l SO}_2$  for oil-fired).

Table 10 presents normalized and averaged data from the coal-fired power plant sampling runs. The percents of  $\text{SO}_2$  conversion in this table refer to conversion occurring after  $\text{SO}_2$  leaves the stack.

Table 10. Coal fired power plant normalized and averaged SO<sub>2</sub> conversion data.

Distance (km)	$\delta$ SO <sub>2</sub> <sup>*</sup>	% Converted based on	
		Conc.	$\delta$
0.8	2.5	3.0	1.3
1.6	2.1	4.1	3.6
3.2	1.9	3.6	4.4
4.8	2.2	1.8	3.0
8.1	2.5	1.6	1.5
16.1	2.2	0.3	3.0
48.3	2.1	0.0	3.5

\*Normalized to the average flue value of 2.8.

In some runs the measured sulfate concentrations were significantly lower than expected from the calculations using the  $\delta$  values, particularly at distances farther downwind of the stack. The authors postulated that particulate sulfate was falling out of the plume during the downwind travel of the plume to account for the lower sulfate values.

The mechanism proposed for the oil-fired plant seemed to apply to the coal-fired power plant data; however, the particulate quantity and composition was determined to be rate limiting. The authors also suggested that since the system was severely particulate limited, some of the observed oxidation could have been due to ambient particulates and to the photo-oxidation reaction proposed by Sidebottom et al. (1972). In both studies the oxidation rate was found to be variable and a definite correlation between RH and SO<sub>2</sub> conversion was not demonstrated.

Freiberg (1976b) reanalyzed the data from the oil-fired and coal-fired power plant studies and found a dependence on relative humidity when stability and temperature were taken into consideration. Freiberg commented that the dependence on either RH or T casted doubt on the dependence of the oxidation on the surface of the particles.

Wilson (1976) considered the isotope technique to be erroneous because of the presence of several competing reactions having different isotope effects, but he considered the direct measurement method to be experimentally valid. Wilson concluded that after discarding the isotope data, there was no difference between the oil-fired and coal-fired plumes and that depending on meteorological conditions, conversion rates substantially greater than 1% per hour were possible. Wilson further commented that the sampling technique and flight patterns in the studies precluded an accurate measurement of conversion rate.

James and Foster (1976) questioned the data reliability of Newman et al. (1975a, 1975b) due to the sampling methods used. They suggested that plume entry and exit positions could not be well defined in relation to plume measurements using the technique of an instrument to locate the plume and then starting the primary sampling equipment. The seriousness of this problem would depend on aircraft speed, plume width, and response time of instruments. This technique has been widely used (Gartrell et al., 1963; Davis, Smith, and Klauber, 1974; Stephens and McCauldin, (1971).

James and Foster (1976) also question the reliability of data obtained using the circular flight pattern and ground based vehicle monitoring. The circular technique would affect airflow over the plume and at further distances background air could be included in the sample.

Dittenhofer and de Pena (1977) studied the production and growth of sulfate particles in the Keystone power plant plume (1800 MW, two 244 m stacks, 2% sulfur in coal, 99% efficient electrostatic precipitators, four 99 m natural draft cooling towers). An airplane equipped with a condensation nuclei counter, optical particle counter, electrical aerosol analyzer, continuous pulsed fluorescent  $\text{SO}_2$  analyzer, cascade impactor and meteorological equipment was used to determine pollutant plume concentrations. The flight pattern consisted of a vertical upwind spiral for measured background particulate and  $\text{SO}_2$  and a series of crosswind and longitudinal profiles downwind of the plume. Data from seven flights during 1976-1977 were analyzed. The cooling tower plume (RH = 100%) and the power plant plume merged on one of these flights.

Plume inhomogeneity effects were eliminated by computing ratios of simultaneous concentrations of various pairs of plume components and expressing them as a function of plume travel time.

Results of the study indicated that more than one mechanism acted to convert  $\text{SO}_2$  to sulfate in the plume. Under conditions of low RH (<70%) near-neutral stability and intense solar radiation (clear skies, late morning and afternoon flights), the dominant chemical process was production of new particles (0.0025-0.34  $\mu\text{m}$ ) within the plume. Photochemical reactions involving  $\text{SO}_2$  were probably a major source of these particles.

Within the merged plume (RH = 100%) the dominant mechanism was growth of pre-existing droplets by absorption and oxidation of  $\text{SO}_2$ . These particles grew to 0.3  $\mu$  or greater and were accounted for largely by sulfate production, which was related to the presence of liquid water in the plume.

A  $\text{SO}_2$  conversion rate of 0.5%/hr was calculated for the merging plume flight, assuming the particles to be  $\text{H}_2\text{SO}_4$  at 95% RH and computing the fraction of  $\text{H}_2\text{SO}_4$  to  $\text{SO}_2$  at each location.

The authors also found indications of temperature effects supporting the work of Freiberg (1974). The highest rate of particle growth occurred when the average plume temperature was lowest, and the lowest rate of particle growth occurred when the temperature was highest. More data is needed to evaluate the effect of temperature.

This study shows that more than one mechanism may be responsible for  $\text{SO}_2$  oxidation in a single plume and that the type of mechanism is dependent on the existing meteorological conditions.

#### Four Corners Power Plant

Ursenbach et al. (1977) reported on conversion rates of  $\text{SO}_2$  to submicron sulfate in the plume of the Four Corners coal-fired power plant by direct sulfate analysis. Samples were collected using an aircraft equipped with dual sampling leads containing 0.2 micron Nucleopore filters for particulate collection,  $\text{SO}_2$  bubblers (employing the EPA pararosaniline reference method) and a flame photometric total sulfur analyzer. Meteorological data were obtained both in the aircraft and from the National Weather Service at Farmington, NM. Sampling protocol was divided into close distance sampling and long distance sampling. At close distances one airplane flew a 1-3 mile path down the plume, turned around, and flew back in the other direction. This flight pattern was flown at 50 ft vertical intervals. The total sampling time was about 1 hour.

The plume edge was defined by the total sulfur analyzer and instruments were

turned off as the airplane left the plume. A second airplane followed two mile long elliptical paths oriented along the plume centerline from 11 km to 65 km downwind of the plant. Flight paths were changed by about 50 ft elevations to minimize airplane exhaust interference; sampling time was from 3 to 5 hours. Background samples were also taken about 5 miles upwind of the stack at plume elevation. SO<sub>2</sub> bubbler samplers were stored in cold chests and analyzed at the end of each day. Filters were stored at < 30% RH before SEM analysis.

The number concentration, mass concentration, and extinction coefficients were calculated for four types of particles (fly ash, soil dust, soot, and sulfate) in the size range 0.1 to 12 μm diameter. Ninety-five percent of the sulfate was collected in the 0.1-0.2 μm size range.

The measured particle size distributions showed that although sulfates represented over 90% of the particulates by number in the background or downwind (2 and 7 miles) sampling sites, they represented only 20% of the upwind particulates by mass and only 1% of the particulates by mass at 2 miles downwind of the plant. The mass median diameter of sulfate which was inferred from the number distributions was calculated to be 0.24 μm.

Conversion rates were calculated by dividing the particulate sulfate to sulfur dioxide ratios by the reaction time; concentrations were corrected for background. Conversion rates were also calculated between the near and far sampling sites. Conversion rates at the individual points in the plume ranged from 0.21%/hr at 1.5 miles downwind of plant (reaction time, 0.24 hours) to 0.84%/hr at 16 miles downwind of plant (reaction time, 0.89 hours).

The conversion rates between the downwind distances ranged from 0.36%/hr between 1.5 and 40 miles downwind to 0.69%/hr. between 1.5 and 16 miles downwind. Relative humidities ranged from 30% and 51% to 16% and 40%, respectively. The average conversion rate over 5 days in 1976 was  $0.55\%/hr \pm 0.14\%/hr$ . Measured  $SO_2$  concentrations in the plume ranged from 0.01-0.06 ppm. A plot of conversion rates vs. distance did not show an increasing or decreasing trend in oxidation rate.

The authors reported that background concentrations of  $NH_3$  are consistent with concentrations required to convert acid mist or  $SO_2$  to sulfate. The authors report that sinks such as dry deposition in the soil and vegetation are likely of greater significance in removing  $SO_2$  from coal-fired power plant plumes in the arid western states than direct conversion to particulate sulfate.

This study possibly provides a more realistic measure of plume  $SO_2$  oxidation rates because the calculated rates are derived from direct sulfate analysis rather than deduced from a comparison of  $SO_2$  loss with plume tracer material.

Pueschel (1977) during 1975-1976 estimated the  $H_2SO_4$  aerosol production rate in the plume from the Four Corners power plant (2175 MW, emissions:  $3.2 \times 10^5$  kg/day  $SO_2$ ,  $1.9 \times 10^5$  kg/day  $NO_x$ ,  $8 \times 10^4$  kg/day particulates). The field study was conducted using an aircraft equipped with instrumentation for measuring cloud condensation nuclei and  $SO_2$ . The  $SO_2$  conversion rate was estimated by differences of  $SO_2$  fluxes through the plume cross-sections at  $L_1$  and  $L_2$  and the ground.

$$SO_2/\text{reac} = F_{L1} - F_{L2} - F_G \quad (91)$$

The conversion rate ranged from 0.8 to 5.46% per hour with an average value



of 2.4% per hour over four days in October. The highest rate was observed at highest relative humidity and lowest temperature; RH values were all less than 20%. The author felt the data supported the accelerated liquid phase oxidation mechanism of Scott and Hobbs (1967).

Pueschel (1977) found that the observed  $\text{SO}_2$  conversion rates were compatible with an observed cloud condensation nuclei (CCN) formation rate of  $10^{15}$  to  $10^{16} \text{ sec}^{-1}$  based on the assumption that CCN are initially composed of  $\text{H}_2\text{SO}_4$ . The observed CCN concentrations could be important in terms of inadvertent modification of clouds and precipitation on a regional scale.

#### Labadie Power Plant

The Labadie power plant plume along with the St. Louis, Mo. urban area has been studied extensively as a part of the Regional Air Pollution Study (RAPS) and the Midwest Sulfur Transport and Transformation Study (MISST) during the summers of 1973-1975 and February 1975 (Wilson et al. 1976; Whitby et al. 1977). Forrest and Newman (1977a) also reported the results of studies during 1974 and 1975.

The MISST studies differed from earlier studies because they challenged the adequacy of the usual technique of calculating the fractional conversion of  $\text{SO}_2$  to sulfate from  $\text{SO}_2$  concentration and sulfate data which was obtained by aircraft flying through the plume by a variety of paths. Wilson et al. (1976) pointed out that  $\text{SO}_2$  conversion rates could be different in parts of the plume, with higher rates occurring at the edges of the plume. The authors felt that conversion rates were best determined using  $\text{SO}_2$  data and sulfate mass flow rates in the plume, and this method was used in the MISST investigations.

Whitby et al. (1977) and Wilson et al. (1976) analyzed SO<sub>2</sub> oxidation in the Labadie power plant plume using data taken during the summer of 1974. St. Louis urban plume data were also reported by Wilson et al. (1976) but are discussed under the topic of urban plumes. The data were collected using an aircraft equipped with a condensation nuclei counter, integrating nephelometer, electrical aerosol analyzer, single particle optical counter, manual filter sampler and a bag sampler system; SO<sub>2</sub>, NO<sub>x</sub>, O<sub>3</sub> sulfate and size particle distributions were measured. Background data were obtained by flying a spiral upwind of the source starting at 10,000 ft and ending at 500 ft; aerosol was sampled at 1000 ft vertical intervals. Plume concentration profiles were obtained from horizontal crosswind measurement passes at several altitudes at different downwind distances. Vertical spirals were also flown at several distances downwind of the source. SO<sub>2</sub> conversion rates were calculated using the change in aerosol flow from one cross-section of the plume to the next and the time it took the plume to traverse the intervening distance. The rate equation has the form:

$$\%/\text{hr} = \frac{\Delta \text{SO}_2}{\Delta t} = \frac{1}{G} \cdot \frac{\Delta Fv}{t} \cdot \rho \cdot P \cdot \frac{\text{MW SO}_2}{\text{MW SO}_4} \quad (92)$$

where G = mass flow of SO<sub>2</sub> in plume

ρ = H<sub>2</sub>SO<sub>4</sub> droplet density

P = weight fraction of H<sub>2</sub>SO<sub>4</sub> in the droplets

ΔFv = aerosol volume flow in plume

MW<sub>SO<sub>2</sub></sub>, MW<sub>SO<sub>4</sub></sub> = molecular weight of SO<sub>2</sub> and SO<sub>4</sub>

The data were taken on August 5 from 2 to 14 km and on August 14 from 10 to 45 km. The weather on August 14 was generally clear with an ESE wind of 4 km/hr at plume height, between 200 and 1500 m.

The conversion rate calculation assumed that excess aerosol found in the plume was sulfuric acid in equilibrium with water vapor at the ambient humidity. The fraction of  $\text{SO}_2$  converted and the conversion rate was determined from the ratio of calculated sulfur in the aerosol to the sulfur flow calculated from the  $\text{SO}_2$  measurements.

The results showed that at 45 km, 8% of the  $\text{SO}_2$  was converted to aerosol and the conversion rate varied from  $1.5\%/hr^{-1}$  at 10 km to  $4.9\%/hr^{-1}$  at 45 km.

The studies showed that sulfate formation was low until  $\text{NO}$  was converted to  $\text{NO}_2$  when sulfate formation increased. This points to the need for measurements at long distances from the stack, since at closer distances (16-32 km) the only sulfate present could be the stack sulfate which arises from the  $\text{SO}_3$  in the combustion process.

Assuming that the aerosol was  $\text{H}_2\text{SO}_4$  in equilibrium with water, the growth of aerosol with distance corresponded to  $\text{SO}_2$  conversion rates of about  $0.5\%/hr^{-1}$  near the stack to  $5\%/hr^{-1}$  at 45 km.

The findings of Whitby et al. (1977) contrast with the findings of Newman et al. (1975a) who estimated a constant rate of conversion of 3 to  $4\%/hr^{-1}$  for the Keystone coal-fired power plant. In later studies Newman et al. (1977a) obtained an average conversion less than 2%, seldom exceeding 5%, which was found to be independent of distance up to 50 km. Newman et al. (1977a) did obtain some indication that the conversion was a maximum at 5 to 10 hr from the stack and then decreased due to  $\text{SO}_4^{=}$  fallout from the plume.

Whitby et al. (1977) concluded that, based on the limited statistics of

his data and on the limited accuracy of the Newman data, the conversion rate is in the range of 0.5 to 5%/hr up to 50 km, but that the dependence of conversion rate on distance is far from certain.

Cantrell and Whitby (1977) evaluated additional data from the Labadie power plant plume taken during the summer of 1976. The sampling protocol was the same as that for the 1974 study.

Data taken on July 5 provided daytime plume characteristics; three plume cross-sections were mapped for plume ages of 0.75 to 2.6 hrs; meteorology was uniform and the plume was well mixed from surface to mixing height. The July 14 experiment was designed to provide night-to-day transition information. Two cross-sections, 29 km and 45 km downwind of the plant, were mapped during the morning when the plume was "trapped" and during the period after the onset of convective mixing. A third cross-section was made 4 km downwind of the plant after the mixing height had stabilized. Both sampling days were clear.

The plumes of the 5th and 14th showed two different dispersion characteristics, evidently due to meteorology. The in-plume aerosol concentrations were enhanced in the "trapped" plume compared with low background values. A comparison of average  $\text{SO}_2$  flows in the plume on the two days to a calculation of  $\text{SO}_2$  source emission showed the  $\text{SO}_2$  flow in plume was being accounted for and that flow calculation uncertainty should be no more than 20%.

A comparison of plume aerosol volume flow of  $80 \text{ cm}^3 \text{ sec}^{-1}$  after 1 hr of plume age on the 5th to a flow of  $250 \text{ cm}^3 \text{ sec}^{-1}$  observed for the 1974 study shows a difference of a factor of about 3 in aerosol growth. Two

factors were different in the two studies. Relative humidity data for 1976 were lower, 51% RH in 1976 compared to 75% RH for 1974. The amount of aerosol in background was lower in 1976 by an order of magnitude. This meant that in 1974 there was a large surface area in the accumulation mode for aerosol volume growth by condensation as background air mixed with plume air. This, in turn, depleted condensable species in the plume to the point when very little homogeneous nucleation could take place. The low amount of nuclei mode aerosol supported this view. In the 1974 study the accumulation mode accounted for nearly all of the aerosol number concentration whereas in the 1976 study, it accounted for only 30% of the number concentration. Regardless of plume dynamics, the general increase in volume flow over the 2-hr. plume age period for 1976 plumes was consistent with other plumes studied.

SO<sub>2</sub> conversion rate was estimated using the method of Whitby, et al. (1977). The data of July 5, 1976 and August 14, 1974 both showed a significant increase in conversion rate with increasing plume age for plumes under relatively uniform meteorological conditions. For the two hours mapped in 1976, the conversion rate increased from  $0.41 \pm 0.2\%/hr^{-1}$  to  $1.2 \pm 0.4\%/hr^{-1}$ . In 1974 the increase over a three-hour period was  $1.5 \pm 0.5\%/hr^{-1}$  to  $4.9 \pm 1.7\%/hr^{-1}$ . On the morning of July 14, 1976, during the AM transition period, there was no significant increase in conversion rate [  $(0.43 \pm 0.2)\%/hr^{-1}$  in the first hour to  $(0.48 \pm 0.2)\%/hr^{-1}$  in the second hour ]. The authors noted that it seemed the more rapid dilution brought about by changing meteorology suppressed volume formation in the plume; hence, the conversion rate.

The authors also felt that results should be reported for individual plume studies or for similar meteorological conditions and that measurements, such as on the plume centerline, which are not adjusted for differences in dispersion on such days would yield different results. Care should be taken in using dispersion models to obtain integral flow in a plume from single measurements.

The number value for conversion was in the same range as reported by other experimenters, Lusi and Wiebe (1976) and Newman et al. (1977a). Newman et al. (1977a), however, found that the conversion rate was independent of distance up to 50 km from the power plant. This is the opposite of the findings of Cantrell and Whitby (1977).

Gillani et al. (1977) analyzed the kinetics of particulate sulfur formation in the plume of the Labadie power plant plume for July 9 and July 18, 1976; the plume on both days was tracked and sampled to 300 km by an airplane equipped for measuring  $\text{SO}_2$ ,  $\text{O}_3$ , bscat, aerosol change, CNC, meteorology,  $\text{NO}_x$ , particulates and sulfur. The plant had a rated output of 2250 MW on July 9 and 1700 MW on July 18. Based on an average sulfur fuel content of 3.17%, sulfur emissions (as  $\text{SO}_2$ ) were 13.6 kg/sec on July 9 and 10.2 kg/sec on July 18. Meteorological conditions on July 18 were strong to moderately unstable and weakly unstable on July 9.

A plot of  $\text{Sp}/\text{S}_{\text{TOT}}$  as a function of plume age showed that the % Sp reached a maximum of 18% on July 18 after 6 hours of transport and a maximum of about 12% on July 9 after about 6 hours of transport and the levels then declined on both days. The authors related the decline to the fact that data for the first 6 hours were measured during the day when solar radiation is significant while the remaining hours were in the evening and at night.

A linear relationship existed between % Sp content and the radiation dose of the sampled plume air parcels on both days. There was little difference in total solar radiation on the two days; for a given radiation dose, the percent Sp was higher on July 18 than on July 9.

Wilson et al. (1976) observed that production of aerosol was enhanced at the edges of the power plant plume and attributed the enhancement to reaction with the entrained air. The authors suggested a relationship between  $O_3$  and  $SO_2$  oxidation.

Ozone concentrations were found to be higher on July 18 than on July 9 for ground level stations. The authors also observed a net production of  $O_3$  in the plume, beyond 30 km from the source on July 18 and after 100 km on July 9, for both days. The same phenomenon has been observed by Davis et al. (1974) and by Whitby et al. (1976) leading to the conclusion that  $O_3$  and  $SO_4^{=}$  formation belong to the same chemical system.

The day with the highest rate of conversion was characterized by lower temperature (about  $30^\circ C$ ), less humidity (about 20%), less haze (3 to 4 times lower bscat) and greater stability. The ozone level and the intensity of atmospheric mixing were higher. Ground removal of  $SO_2$  was greater than conversion on both days, particularly for plume transport beyond 100 km, and caused significant reduction in particulate sulfur formation. Corrections for ground removal resulted in an average rate of particulate sulfur formation during the 1st six hours of transport of  $1.6 \pm 0.4\%/hr^{-1}$  on July 9 and  $2.4\% \pm 0.6\%/hr^{-1}$  on July 18. For nighttime transport, the conversion was estimated to be  $<1\%/hr^{-1}$  on July 18 and  $<0.3\%/hr^{-1}$  on July 9. The data appeared to favor photo-oxidation as the rate controlling mechanism, but other mechanisms cannot be ruled out due to insufficient data.

Forrest and Newman (1977a) investigated the oxidation of  $\text{SO}_2$  in four additional coal-fired power plant plumes (Labadie, MO; West Alton, MO; Muscle Shoals, AL; Charleston, WV). The methodology was the same as reported in Newman et al. (1975 a,b) except that the glass fiber pre-filter in the high-volume filter pack was replaced by neutralized quartz filter. The neutral quartz filter would have reduced any conversion that may have resulted with the glass fiber filter to negligible levels (Pierson et al. 1976).

Most of the sampling runs were made at the Labadie plant (21 of 30). The data showed that the extent of oxidation seldom exceeded 5% for conditions of relative humidity ranging from 32 to 85%, temperatures from 10 to 26<sup>o</sup> C, distances up to 60 km and travel times up to 2 hours. Background corrections applied to the Labadie plume were determined to have a minimal effect on  $\text{SO}_2$  conversion. Data from the remaining three power plants supported the Labadie data and the Keystone data (Newman et al. 1975b). The data indicated that almost all of the oxidation occurred within the first few kilometers of emission. This contrasts with the findings presented by Wilson et al. (1976) and Whitby et al. (1977), suggesting that there is a slow reaction initially followed by a sharply increasing rate at a downwind distance, but the data lend support to one aspect of Frieberg's model (1976a). The authors did not find any distinct correlations of percent  $\text{SO}_2$  converted and temperature, relative humidity, morning and evening runs, travel time, distance or atmospheric stability. There was a slight indication that unstable conditions might yield higher oxidation rates.

The lack of correlation indicates only that the effects, if present, are too subtle to be detected by the methods used. The relative humidity and



temperature data were in the stationary phase of Freiberg's model (1976a) so that conclusions about these aspects of his model cannot definitely be drawn.

The authors also investigated plume dropout and differences in flight patterns. Plume dropout was tested during one run at the Labadie plant; the authors found that sulfate level under the plume was 60% higher than the background level and they attributed this increase to sulfate dropping out of the plume, rather than arising from ground level influences. The 60% increase, however, is equivalent to only  $5 \mu\text{g}/\text{m}^3 \text{SO}_4^-$ .

Sampling flight patterns were tested to determine if significant differences existed between the two methods used (Newman et al. 1975b). The authors concluded that there was no significant difference in the extent of oxidation between the two methods and that reproducibility was within plume variability. The authors could not find any evidence of higher conversion rates at the fringes of the plume or significant variation within the plume. The authors' sampling approach assumed that extent of oxidation was independent of position in the plume which contrasted with the work of Wilson et al. (1976) and Whitby et al. (1977), who assumed that integrated samples were needed for a complete profile of the plume.

Isotope ratio measurements were again used to determine amount of  $\text{SO}_2$  oxidized. Because of isotope ratio variations in the coal and plume, the authors concluded that the isotope technique was not applicable to the Labadie plume and that plume concentrations should be used to determine oxidation rate. Isotope ratios at the remaining three plants were stable, and comparison between this method and the direct measurement method was good.

TVA's Cumberland Power Plant

Meagher et al. (1977b) and Meagher and Sharma (1977a) studied SO<sub>2</sub> conversion rates at TVA's Cumberland Steam plant (2600 MW, total, two 305 m stacks, 99% efficient electrostatic precipitators) during the winter of 1975-76. An airplane was equipped with a flame photometric gaseous sulfur analyzer, a flame ionization total HC analyzer, a 37 mm Fluoropore membrane filter for aerosol, a chemiluminescence ozone analyzer, a chemiluminescence NO-NO<sub>x</sub> analyzer and meteorological equipment. The airplane made passes through the power plant plume perpendicular to the horizontal wind vector; cross-sections were obtained at different altitudes at each of the downwind distances. The ozone monitor was used to locate the plume and instrumentation was turned on when the plume was entered. Sampling began at daybreak and continued until plume breakup; background concentrations were determined upwind of the power plant at plume elevation. A total of 8 flights were made from 10 to 105 km downwind of the plant (plume age time 11 minutes to 11 hours); relative humidities varied from 33 to 65% and temperatures varied from -5 to 13° C.

The 90% response time for the sulfur analyzer was determined to be about 15 seconds which would result in some distortion in the SO<sub>2</sub> plume profiles; distortion would have been worst for narrow passes closest to the plume. Data which would be biased due to this factor were not included in the analysis. The variability of the method tested by duplicate runs was found to be  $\pm 13\%$ .

Sulfate to sulfur dioxide ratios were calculated for each of the downwind distances. No correlation was found between this ratio and plume travel. At 10 to 105 km downwind of the plant 1 to 2% of the sulfur in the plume

was in the form of sulfate aerosol. Sulfate aerosol in the stack averaged 0.25%; this value increased to 1.4% in the plume at 10 km. During conditions of low temperature and low moisture (fall and winter), the oxidation of  $\text{SO}_2$  to  $\text{SO}_4^{=}$  appears to be very slow except in the area next to the stack. The authors offered the following explanations for the production of sulfate before the first sampling point at 10 km:

- 1) The presence of particulate surfaces or catalysts which limit the conversion process become poisoned; suggested by Newman et al. (1975b).
- 2) Sulfate production is controlled by a reaction between a plant effluent ( $\text{SO}_2$ ) and species in the background air resulting in a fast rate nearer the plant and undetectable conversion downwind.

The authors also reported that NO is converted to  $\text{NO}_2$  very rapidly (50% at 30 km) and that  $\text{O}_3$  is responsible for the oxidation because the amount of  $\text{O}_3$  removed approximately equals the amount of NO converted to  $\text{NO}_2$ . The authors reported that the  $\text{O}_3$  bulge observed by Davis, et al. (1974) was not evident in the TVA studies.

The data of Newman et al. (1975b) in which a total of 30 runs performed at 4 power plants resulted in a plume sulfate concentration of 1.8% were in the same range as the TVA data.

The authors determined that the average value for  $\text{NH}_4^+$  to  $\text{SO}_4^{=}$  ratio for all background samples was  $1.67 \pm 0.20$ , and for all plume samples the ratios averaged  $1.16 \pm 0.50$ . Assuming that measured sulfate was derived solely from  $(\text{NH}_4)_2 \text{SO}_4$ ,  $\text{NH}_4\text{HSO}_4$  and  $\text{H}_2\text{SO}_4$ , and that all  $\text{NH}_4^+$  was associated with sulfate, the range of these species could be determined for plume and background. This analysis showed that  $(\text{NH}_4)_2 \text{SO}_4$  was the dominant compound in the background samples and was less prevalent in the plume: There was no

observable correlation between the  $\text{NH}_4^+$  to  $\text{SO}_4^{=}$  ratio and plume travel time, indicating that if aerosol accumulates  $\text{NH}_3$  as it ages, the process is fairly slow.

#### Centralia Power Plant

Dana et al. (1975) developed a model (EPAEC) based on the liquid phase oxidation of Scott and Hobbs (1967) for predicting the reversible washout of  $\text{SO}_2$  emitted from power plant plumes and other sources. The model assumes a first order reaction rate constant, K; five values of K ranging from 0 to 278%/hr along with field monitoring data were used as model inputs. Field data (rainborne  $\text{SO}_2$ , pH, total sulfur, ambient  $\text{SO}_2$  and meteorology) were collected from a network of rain sampling stations around the Centralia power plant in Washington (700 MW, 143 m stack). The best comparison between field  $\text{SO}_2$  scavenging rate and model calculation occurred with a 15 minute half-life for  $\text{SO}_2$  conversion; this is equivalent to a reaction rate constant of 278%/hr.

The authors discuss two possible models for  $\text{SO}_2$  conversion: 1) in-plume oxidation 2) liquid phase (raindrop) oxidation. Predicted rate constants for in-plume oxidation were in the range of 400-570%/hr,  $\text{SO}_2$  half-life about 10 minutes. The in-plume oxidation process is compatible with rapid oxidation near the source and decreasing rate downwind from the source. Predicted rate constants for liquid phase oxidation were in the range of 600-3100%/hr; half life, 1 to 6 minutes.

The authors state that the two models discussed are highly superficial and were intended only to explore possible mechanisms. The data presented in this model were obtained from ground based stations; it would be of

interest to obtain direct in-plume measurements during a rain event.

Although the rates in this study are not intended to be definitive, the study does show that a significant portion of  $\text{SO}_2$  in the plume is converted very close to the stack ( $< 0.4$  km) during rain events.

#### Great Canadian Oil Sands Power Plant

Lusis et al. (1977) studied the plume chemistry of the Great Canadian Oil Sands (GCOS) power plant near Fort McMurray, Alberta, using a helicopter, during a total of four weeks in February and June, 1977. The power plant uses refinery coke (6% sulfur) for fuel and during the study period was emitting about 1.9 - 2.5 kg  $\text{SO}_2$ /sec. The particulate loading was high (about 1 g / 5 g  $\text{SO}_2$ ) and the emission rate of  $\text{NO}_x$  was estimated to be about one-tenth that of  $\text{SO}_2$ . The helicopter was equipped with a sign-X continuous  $\text{SO}_2$  analyzer which was used to locate the plume and to determine dispersion rates.  $\text{SO}_2$  oxidation data was obtained from two parallel filter packs; the first filter in the packs was either a Whatman 40 (cellulose) or Delbag (polystyrene) filter to collect particulates. The polystyrene filters were analyzed for sulfuric acid and sulfur. This was followed by two chemically treated Whatman 41 filters to collect  $\text{SO}_2$ . During the month of June a chemiluminescent  $\text{O}_3$  analyzer was used to investigate  $\text{O}_3$  formation in the plume. Vertical profiles of wind velocities, temperature, and relative humidity were determined at various altitudes during each of the flights.

The flight pattern consisted of cross-wind traverses flown across the plume at various altitudes; sampling periods were one-half to one hour. Sampling points were located near the stack (1-2 km) and farther away (up to 55 km). Background samples were also collected.

Results of this study showed that little oxidation occurred in February or in the early morning periods of June. Rates in February ranged from  $-1.2\%/hr^{-1}$  to  $2.4\%/hr^{-1}$ ; the average rate was  $0.26\%/hr^{-1}$ . Rates in June ranged from  $-0.24\%/hr^{-1}$  to  $9.3\%/hr^{-1}$ ; the average rate was  $1.4\%/hr^{-1}$ . Negative rates were probably caused by random sampling and analysis errors, problems in plume location, and so forth. Temperatures averaged  $-2.3^{\circ}C$  in February and  $15.4^{\circ}C$  in June; relative humidity averaged 79% in February and 61% in June. A plot of total plume sulfur in the particulates as a function of age showed that in February, the fraction of total sulfur in particulates ( $\sim 1.3\%$ ) remained constant for plume travel times of an hour or more. In June the plume contained more particulate sulfur ( $\sim 2\%$ ) and the fraction remained constant with downwind distance for about the first two hours of plume age (before 0700 hours). For the data taken after 0700 hours, a sharp increase in the fraction of sulfur in the particulates occurred after the first 10 minutes with values reaching 3% or more within the first hour. Although sulfuric acid analysis was thought to be of low accuracy, the authors found that in February the percentage of sulfuric acid in the particulates was high and constant, while in June the acid was neutralized downwind of the stack. Particle size analysis showed that near the stack almost all of the particulate sulfur was in the sub-micron range, whereas metals (Mn, Al, V) were associated with particles having a mass median diameter of about  $3\ \mu m$ .

The authors reported the presence of an ozone "bulge" in the plume during June flights;  $O_3$  was depleted near the stack due to chemical scavenging by  $NO$ , while downwind an excess had formed, up to 10 ppb above the background level.

The results of the study suggested that in the absence of sunlight heterogeneous catalysis in aerosol droplets or on particulate surfaces was not important (Foster, 1969; Freiberg, 1975; Newman, et al. 1975a, b; Forrest and Newman, 1977). Conditions of the study such as high particulate loading and high relative humidities should have led to high oxidation rates if the heterogeneous mechanisms proposed by Foster (1969) and Freiberg (1974) were important. The authors found no evidence that essentially all of the oxidation occurs within the first few kilometers (Newman et al. 1975a, b; Forrest and Newman, 1977) after emission or that heterogeneous processes are important.

The authors felt that the data, while not conclusive, did support a photochemical mechanism for the oxidation:

- 1) Spectral measurements supported the hypothesis that significant  $\text{SO}_2$  oxidation occurred in June after 0700 hours due to photochemical processes.
- 2) The observed ozone "bulge" was evidence of photo-chemical activity (Davis et al. 1974, Gillani et al. 1977). The bulge was explained as the result of turbulence during the afternoons in June mixing the  $\text{NO}_x$  in the plume with low level hydrocarbon emissions from the refinery.
- 3) There was no evidence for the dependence of conversion on aerosol pH, based on sulfuric acid data, if heterogeneous mechanisms were important.
- 4) There was no evidence for the temperature and relative humidity dependence which might be expected to occur if a heterogeneous mechanism were important (Foster, 1969; Freiberg, 1974).

The authors pointed out that during all of the runs when appreciable  $\text{SO}_2$  oxidation rates were observed, part of the plume was diffused down to ground level within a few kilometers of the stack, which suggests that sulfate which was removed from the plume by dry deposition at a different rate than  $\text{SO}_2$  could affect the apparent oxidation results. However, rough

calculations using a well-mixed Lagrangian box model with sulfate and SO<sub>2</sub> dry deposition velocities of less than 0.1 cm/sec and 1.5 cm/sec, respectively, showed that the rate of change of the sulfate to total plume sulfur ratio due to dry deposition was less than 0.5%/hr. This conclusion was also supported by the work of Gillani et al. (1977).

### Sour Gas Plant

#### Sour Gas Plant, Calgary, Alberta

Rowe et al. (1977) studied the oxidation (from 0.1-4 km downwind of stack) of SO<sub>2</sub> in a sour gas plant plume near Calgary using gold as a conservative tracer. Gold chloride was impacted as a fine spray at the base of the stack (30 gm/hour). The gold solution was evaporated by the incinerator temperatures producing gold particles in the range 0.1-1 μm.

A helicopter was used to maximize plume sampling time; the aircraft was equipped with SO<sub>2</sub> bubblers, millipore teflon membrane filters (47 mm diameter, 0.5 μm pore size) to collect the gold particles, and a sign-X SO<sub>2</sub> analyzer for locating the plume. The vertical wind velocity and vertical temperature profiles were obtained each day.

The flight sampling pattern consisted of multiple passes through the plume at fixed downwind distances. The total mass of SO<sub>2</sub> and gold were calculated assuming that the initial mass of SO<sub>2</sub> and gold in the bubbler and blank filter were negligible and that background concentrations of SO<sub>2</sub> and gold were constant. The ratio of chemically transformed SO<sub>2</sub> to total diffused SO<sub>2</sub> was determined from the mass calculations for gold and SO<sub>2</sub> emitted from the stack which were measured instrumentally. The data for



two days Sept. 3 and Nov. 2, 1976, are summarized. September 3 was characterized as a warm cloudy day with RH = 50-60%, strong winds, and a ground based inversion of 150 m. Nov. 2 was characterized as a cool, sunny day with RH = 30-40%, moderate winds and near neutral stability. The authors indicated there was no significant chemical transformation of SO<sub>2</sub> within the first 4 km downwind of the sour gas plant stack. A major problem with this study was that the fraction of unreacted SO<sub>2</sub> was greater than one; the authors felt that some of the gold was being depleted somewhere between the incinerator and the stack. The gold tracer method may not be valid after the point of the first plume contact with the ground because of possible difference between gold and SO<sub>2</sub> uptake by the ground.

### Urban and Area Sources

#### Los Angeles Basin

Roberts and Friedlander (1975) determined atmospheric conversion rates and mechanisms in the Los Angeles basin using measurements of the particulate to gas phase sulfur ratio and air trajectory analysis. Ground level total filter and cascade impactor aerosol samples were analyzed for sulfur; sulfur dioxide was also measured. Depending on source and wind direction, SO<sub>2</sub> to total sulfur ratios ranged from 0.88 to 0.98. A pseudo first order rate constant, which depends on the deposition velocities of SO<sub>2</sub> and sulfate aerosol, was calculated. Data from three days listed in the papers gave rate values from 1.2 to 12.8%/hr<sup>-1</sup>. Meteorological data was not included in the report.

#### Tennessee Valley Area

Meagher and Sharma (1977a) reported on TVA point source and area source SO<sub>2</sub>

conversion studies.

The regional transport emissions study encompassed an 800 x 500 km rectangle in the Tennessee Valley. About 50% of all SO<sub>2</sub> emission within the Tennessee Valley originated here. Ground level measurements near the entry and exit boundaries indicated that SO<sub>4</sub><sup>=</sup> concentration increased 25% and total suspended particulates increased 36%. Aircraft measurements indicated that SO<sub>4</sub><sup>=</sup> flux in air masses leaving the study area was 16 mg/m<sup>2</sup> sec greater than SO<sub>4</sub><sup>=</sup> flux in air masses entering the study area.

#### St. Louis Urban Area

Wilson et al. (1976) reported on EPA urban and power plant plume mapping studies in the St. Louis area which were designed to overcome problems of earlier studies by Gartrell et al. (1963), Newman et al. (1975 a, b), Stephens and McCauldin (1971) and others. The field studies were conducted during July and August and September of 1973, 1974, and 1975 using two aircraft, an instrumented van and three mobile single theodolite pilot-balloon units. The parameters measured included gases (O<sub>3</sub>, NO, NO<sub>x</sub>, SO<sub>2</sub>), aerosol (condensation-nuclei, light scattering coefficient and aerosol change), particulate sulfate and meteorological parameters.

The flight pattern consisted of horizontal traverses made in the plume perpendicular to the plume axis at three or more elevations and at several distances downwind of the plume. A van equipped with a correlation spectrometer (COSPEC) made lateral traverses under the plume and measured the integrated burden of SO<sub>2</sub> and NO<sub>2</sub>. The power plant plumes were measured to 60 km and SO<sub>2</sub> conversion in the power plant plumes was reported to vary from 1.5%/hr<sup>-1</sup> at 10 km to 4.9%/hr<sup>-1</sup> at 45 km. Conversion was found to be

slow in the early part of the plume close to the source. As the plume air and ambient air mixed the rate of conversion increased.

The "urban plume" was mapped using the same technique as for the power plant plume. The plume was approximately 40 km wide and 150 km long. The urban plume included the emissions from the Labadie and Portage des Sioux power plants and from a refinery complex near Wood River (Ill.), in addition to emissions from industry and automotive traffic of the St. Louis-East St. Louis urban areas. The urban plume on July 18 was found to have a maximum sulfate concentration of  $20 \mu\text{g}/\text{m}^3$ ; on July 29-30 the plume was followed for 18 hours and AM and PM measurements were made; the maximum sulfate concentration measured was  $60 \mu\text{g}/\text{m}^3$ .

The authors reported that sulfur depletion in the urban plume appeared to be equivalent to an exponential decay rate with a characteristic  $(\frac{1}{e})$  decay distance of 90 km. New sulfate aerosol formation was not detectable up to 50 km and only about 1.3 of original emissions were transported beyond a radius of 100 km. It appeared the sulfate formation in the urban plume began after 1 to 2 hours plume aging time.

The study demonstrated that sulfate may be transported hundreds of km and may cause problems far from sources of pollution. Conclusions drawn about the effect of tall stacks were that tall stacks reduce ground level concentrations of  $\text{SO}_2$  but increase sulfate aerosol formation by reducing surface losses of  $\text{SO}_2$  and increasing atmospheric residence time which increases  $\text{SO}_2$  conversion. In urban plumes which are well mixed to the ground,  $\text{SO}_2$  may be removed by reaction with plants and by deposition.

Alkezweeny and Powell (1977) estimated the  $\text{SO}_2$  transformation rate of the St. Louis urban area by following a tetroon northeast of St. Louis, Mo., on August 10 and 11, 1975. An airplane was equipped with a flame photometric detector for measuring  $\text{O}_2$  concentration and IPC filters (flow rate 50 cfm) were used to determine total sulfur in the aerosol by x-ray fluorescence. Conditions on August 10 were clear to scattered cumulus in the AM and broken altocumulus in the PM; mean wind speed was 7 m/sec; mixing depth was 1400 m; average temperature was  $21^\circ\text{C}$  and average RH was 60%. On August 11 the weather was clear; wind speed was 6 m/sec; mixing depth was 2400 m; average temperature was  $26^\circ\text{C}$  and average RH was 53%.

The data were analyzed assuming that the reaction was first order, that the pollutant was distributed evenly vertically through the mixing layer, and that  $\text{SO}_2$  and  $\text{SO}_4^{=}$  diffusion was the same. The authors calculated the transformation rate by combining the equation for the conservation of sulfur and sulfate masses (method similar to Robers and Friedlander, 1975). The calculated transformation rate was assumed to be independent of time, or averaged over the time period T, and depended upon the deposition velocities of  $\text{SO}_2$  and  $\text{SO}_4^{=}$ .

Assuming a deposition velocity of 1 cm/sec for  $\text{SO}_2$  and 0.1 cm/sec for sulfate, the transformation rates for the urban plumes were 14%/hour and 10%/hour for August 10 and August 11, respectively. August 10, the day with the highest transformation rate, had the highest RH and lowest temperature. If catalytic oxidation is assumed in the plume, then these results are in agreement with RH and T dependence postulated by Freiberg (1974). However, confidence limits for the rate constant show that the two values could have been equal. Confidence limits place the rate constant between  $10\%/\text{hr}^{-1}$  and  $12\%/\text{hr}^{-1}$ . Background corrections result in a rate constant of  $9.3\%/\text{hr}^{-1}$ , assuming the rate is the same for both days.

The rates measured in this study are comparable to rates estimated by Roberts and Friedlander (1975) but are higher than rates estimated by Wilson et al. (1976). Neither of the last two studies included sufficient meteorological data to allow further comparisons.

#### Western Europe

Eliassen and Saltbones (1975) estimated the  $\text{SO}_2$  transformation rates over western Europe using daily  $\text{SO}_2$  and  $\text{SO}_4^{=}$  values from a network of ground based sampling stations, emissions data and trajectories. It was assumed that a parcel of air followed an isobaric trajectory and that decay processes of deposition and chemical transformation were linear. Rates of decay and transformation were estimated from the best agreement between observed and computed concentrations. First order transformation rates were low, ranging from  $0.28\%/hr^{-1}$  to  $1.7\%/hr^{-1}$  (average  $0.8\%/hr^{-1}$ ) over 11 runs from 6 stations. The estimated  $\text{SO}_2$  decay was about  $7\%/hr^{-1}$  corresponding to a residence time of about 12 hours.

#### Atlantic Ocean

Prahm et al. (1976) estimated deposition and transformation rates for  $\text{SO}_2$  and sulfate during atmospheric transport over the Atlantic Ocean using ground level aerosol,  $\text{SO}_2$ , precipitation measurements and air trajectory calculations. Measurements were made at Faroes Islands during a 4-day period with clean Atlantic air and during a 4-day period with long range (1000 km) transport of atmospheric pollutants from the British Isles. The  $\text{SO}_2$  to sulfate transformation rate was about  $1\%/hr^{-1}$  which corresponds to a half life of 60 hours. The deposition velocity for  $\text{SO}_2$  was estimated at  $2 \text{ cm/sec} \pm 50\%$  and  $0.4 \text{ cm/sec} \pm 50\%$  for sulfate. These estimates are average values based on several assumptions including constant decay and transformation rates during transport. The decay rates agree with the data of Eliassen and Saltbones (1975).

### North Sea

Smith and Jeffrey (1975) investigated the long range transport of  $\text{SO}_2$  and sulfate over the North Sea using air trajectory analysis. An airplane equipped with a high-volume sampler filter pack was used to obtain  $\text{SO}_2$  and sulfate data. The results of seven flights from October 1971 to September 1973 showed an increase in oxidation rate with relative humidity above 70% (RH values below 70% were not measured); the rate varied from about  $1\%/hr^{-1}$  at 70% RH to  $12\%/hr^{-1}$  at 88% RH. The relationship appeared to be roughly linear between 70 to 88% RH. The authors found that most of the sulfate was produced close to the source and that sulfate correlated poorly with distance or time of travel. A dry deposition velocity of  $\text{SO}_2$  was estimated to be between 0.8 and 1 cm/sec over land and between 0.6 and 0.8 cm/sec over the sea. The authors found that approximately 75% of the sulfate produced was removed by rain.

### Smelter Studies

#### Nickel Smelter, Sudbury, Ontario

The most extensively studied smelter plume is the Sudbury, Ontario nickel smelter plume. Investigations of this smelter began with a study by Katz in 1950. Katz (1950) studied the atmosphere around the nickel smelter by simultaneously measuring  $\text{SO}_2$  (electroconductivity method) and total sulfur contaminants (starch-iodine method). Total sulfur contaminants were defined as sulfur dioxide, sulfur trioxide and sulfuric acid or sulfates. Katz categorized the data by heavy, medium and mild smoke fumigations. He found that the percent  $\text{SO}_2$  in total sulfur contaminants was highest in the heavy smoke fumigation or condition of highest gas concentration. The ratio ranged from 95% in 2 hours residence time to 65% in 12 hours residence time. Under certain conditions, he found that sulfate ranged as high as 35% of total sulfur contaminants. The data developed by Katz showed qualitatively that sulfur dioxide was oxidized in the atmosphere surrounding the smelter. The U. S. Department of Health and Welfare (1969)

studied the data of Katz (1950) and found that over the narrow range of conditions studied, the rate of decrease in the ratio of  $\text{SO}_2$  to total sulfur contaminants appeared to be independent of concentration of contaminants, temperature and time of day when measurements were made. A calculated rate was determined to be about 2.1%/hour. The data were biased by interferences in the experimental method and the possible effect of contribution from other sources during ground level measurements.

The oxidation rate developed from Katz's data is much smaller than the rate reported by Gartrell et al. (1963) and may be accounted for, in part, by the fact that Gartrell et al. (1963) had a more efficient sulfuric acid collection method by different atmospheric conditions, and by higher concentration of particulates in the plume that Gartrell et al. (1963) studied.

Lusis et al. (1974) determined the rate of  $\text{SO}_2$  oxidation in the plume of the INCO nickel smelter superstack (1200 ft) at Sudbury, Ontario using an airplane equipped with a filter pack-high volume sampler and a sign-X electroconductivity  $\text{SO}_2$  analyzer. The filter pack consisted of a glass fiber (Whatman 81) pre-filter to remove aerosols, followed by two chemically treated cellulose filters to trap  $\text{SO}_2$ . Conversion of  $\text{SO}_2$  to sulfate on the cellulose filters was not considered to be a problem; less than 1% conversion was found when filters were tested before the aerial study. The plume was characterized by  $\text{SO}_2$  concentrations ranging from 7000-8000 ppm, a water content of 3.5% by volume and low  $\text{NO}_x$  concentration (20 ppm); the effluent also contained iron ( $40 \text{ mg/m}^3$ ) and other metals such as manganese, copper, nickel, and lead.

The flight path consisted of collecting the first sample within 5 km of the stack, the second at 20-30 km and the third at 60-100 km; four cross-wind passes followed by four oxidation passes were made at each sampling location and background samples were also collected. Data showed that near the stack about 2-3% of the sulfur was in the form of sulfate and at distances up to 100 km, no more than 10% of the sulfur was in the form of sulfate.

Oxidation rates were calculated by dividing sulfate concentration by plume age intervals. The average conversion rate was found to vary between 0 and  $9\%/hr^{-1}$ . These values are lower than values reported by Gartrell, et al. (1963), Weber (1970), and Stephens and McCaldin (1971). The low values were surprising in view of the catalytic potential of particulates and the water vapor content of the plume.

Although the data showed that oxidation rate appeared to decrease with plume age and to increase with relative humidity and temperature agreeing with other investigators (Gartrell et al. 1963; Stephens and McCaldin, 1971), the authors did not feel these relationships were well defined. The data, in general, did not follow a first-order rate relationship.

Lusis et al. (1975) further analyzed the 1974 data to determine possible sources of error and to determine the extent of sulfate formation due to  $SO_2$  adsorption and reaction on the glass-fiber filter. The authors found that the amount of sulfate formed on the glass fiber filters at a given humidity was independent of the amount of  $SO_2$  passed over the filters which is consistent with a mechanism which defines a small number of active sites for sulfate formation on each filter paper which become



deactivated once the  $\text{SO}_2$  molecule is absorbed and converted. The amount of sulfate formed was found to increase slightly with increasing humidity. About 0.1 mg per filter formed at <50% RH and an average of 2 mg formed at >50% RH. Polystyrene filters were also examined. Although they did not convert as much  $\text{SO}_2$ , they were rejected for use because of the high and variable sulfate content of the filters. The authors concluded that sulfate formation on glass fiber filters could have made an appreciable contribution to total sulfate on some of the flights (high humidity). The 1974 data were recalculated, but the main conclusions of the 1974 report were found to be valid; that is, the oxidation rate in the plume of the INCO super stack is low ( $0-6\%/hr^{-1}$ ). The reevaluation lowered some concentrations: Close to the stack about 1% of the sulfur was in the form of sulfate compared to 2-3% reported in 1974; conversion rates were found to be  $0-6\%/hr^{-1}$  compared to  $0-9\%/hr^{-1}$  in the 1974 report. The decrease in conversion rate with plume age disappeared. The reported values should be considered a maximum due to conversion of  $\text{SO}_2$  when the glass fiber filters.

Expanding on their work in 1974, Lusi and Wiebe (1976) reported  $\text{SO}_2$  oxidation studies in the plume of the INCO nickel smelter superstack for the period June, 1975, in addition to the September, 1977 period. The same sampling protocol was followed. The authors again found that in the first 10 km, usually less than 10% of the sulfur in the plume was in the form of sulfate. Oxidation rates for the 1974 and 1975 studies were similar. The range of values ( $-1.2\%/hr^{-1}$  to  $7\%/hr^{-1}$ ) showed considerable scatter but most values were less than  $3\%/hr^{-1}$  and the average was about  $1\%/hr^{-1}$ . No temperature or humidity effects were found in the range of  $-5$  to  $21^\circ\text{C}$  and 40-90% RH. The data did show a slight decrease in oxidation

rate with plume age but no definite conclusions were drawn. The oxidation rate values reported in this paper were lower than those reported in the two earlier papers (Lusis et al. 1974 and 1975) but they compared well to the 2-3%/hour value calculated (U.S. Department of Health, Education, and Welfare, 1969) using the data of Katz (1950).

Lusis and Wiebe (1976) stated that the most likely mechanism was the oxidation of  $\text{SO}_2$  in droplets or liquid film surrounding particles. The authors explained that the low rate values could have been due to high concentrations of  $\text{SO}_2$  and  $\text{HCl}$  which would lower the pH causing a decrease in the oxidation rate. The authors acknowledged that the lack of temperature and humidity dependence presented a problem in interpreting the mechanism as heterogeneous. Foster (1969) and Freiberg (1974) both reported that oxidation rate is directly proportional to relative humidity and indirectly proportional to temperature.

Lusis and Wiebe (1976) offered the explanation that the INCO plume aerosols could be too acidic initially or that the ranges of temperature and humidity in the study were too narrow to see the effects. The authors also indicated that the efficiency of the electrostatic precipitators improved and 1975 emissions could have been as much as 50% lower as 1974 emissions and that the composition of catalytic particles in the plume could have changed.

Lusis and Wiebe (1976) felt that the homogeneous gas phase oxidation suggested by Davis et al. (1974) would be of little importance in the INCO plume because of low levels of  $\text{NO}_x$  in the plume (20-30 ppm in stack compared to 8000 ppm  $\text{SO}_2$ ).

Forrest and Newman (1977b) commented that Lusic and Wiebe's (1976) interpretation of conversion rates can be misleading. A conversion rate implies constant change per unit of time but this was not verified when the rates were determined by finding the difference in percent conversion between two points. Forrest and Newman (1977b) examined the data of Lusic and Wiebe (1976) and found they did not fit a first-order rate mechanism but they did fit a pseudo second-order mechanism arising from a first order dependence on  $\text{SO}_2$  and a first order dependence on particulate. The authors suggested a new rate order constant of  $0.2 \text{ ppm}^{-1} \text{ hour}^{-1}$ . Acceptance of the pseudo second-order conversion rate would also show that oxidation rate decreased with dilution. Forrest and Newman (1977b) agreed with Lusic and Wiebe (1976) that a heterogeneous catalytic mechanism accounted for the oxidation in the Sudbury plume; they also suggested that the low conversion rates could be due to the relatively low particulate loadings with respect to  $\text{SO}_2$  (0.04 g particulate/ $\text{SO}_2$ ).

The authors concluded that repetitive and multiple runs would be required to compile adequate statistics before generalizations on plume behavior could be made based on a comparison with data from an oil-fired power plant (Newman et al., 1975).

Forrest and Newman (1977b) investigated the oxidation of  $\text{SO}_2$  to sulfate in the Sudbury smelter plume using the methods previously outlined by Newman et al. (1975b). During two runs, the percent  $\text{SO}_2$  converted, based on concentration, ranged from 1.8 to 2.7% during run number 1 (5 points) to 5.2 and 4.7% during run number 2 (2 points). The higher values on the second run could presumably have been due to the result of interaction between fog at ground level and smelter operations using large amounts

of air. Lusic and Wiebe also made a run at the same time and the two measurements taken resulted in percent converted rates of 1.4 and 1.2% which compare favorably with the data of Forrest and Newman.

Non-ferrous Smelter, Puget Sound, Washington

Larson et al. (1975) sampled and analyzed a rainstorm to determine the influence of a non-ferrous smelter on regional precipitation chemistry in the Puget Sound region of Washington. Forty-three rain sampling stations were established; a total of 0.1 m<sup>2</sup> rain was collected at each station. Parameters analyzed included: pH at the time of transfer, NH<sub>4</sub><sup>+</sup>, SO<sub>4</sub><sup>=</sup>, NO<sub>3</sub><sup>-</sup>, Cl<sup>-</sup>, Na, K, Ca, Mg, Zn, Cu, Cd, As, Sb, and Bi. Oxidation of SO<sub>2</sub> occurred in solution and it was assumed that much of the sulfate was collected as dissolved SO<sub>2</sub>. Plume deposition of SO<sub>4</sub><sup>=</sup> was determined for a 60° sector extending radially 60 km NE of the smelter. A background value of 1.5 mg/m<sup>2</sup> SO<sub>4</sub><sup>=</sup> was subtracted from the measured values. The smelter accounted for over 90% of the SO<sub>2</sub> emitted into the sampling area and it was assumed that the sulfate in the rain samples were emitted as SO<sub>2</sub>; about 8% of the total SO<sub>2</sub> in the smelter plume was removed as sulfate by rain in the test sector. The pH and sulfate isopleths indicated a correlation between H<sup>+</sup> and sulfur ion concentration in rain. It appeared that As and Sb were good tracers of the influence of the smelter plume on rain chemistry.

PLUME CHEMISTRY MODELS

Ideally, a model of plume chemistry identifies the chemical changes occurring in the plume and explains the rates of change of the concentrations of the chemical components. A major problem in the development of workable and sufficiently detailed models is the lack of a well-defined experimental data base which describes the complex chemical system.

Research efforts have focused primarily on detailing individual conversion mechanisms and an inclusive chemical reaction dispersion model has not been developed and verified.

Most modelling efforts in the past have concentrated on describing the dispersion and deposition of  $\text{SO}_2$  and particulates. The most frequently used approach has been the Gaussian diffusion formulation (Stern, 1976) where the crosswind plume concentrations are taken to be Gaussian in form. In its basic form, for a continuous point source at height  $H$  and a receptor at ground level ( $z=0$ ), the Gaussian diffusion formulation is given by:

$$\bar{X}(x,y) = \frac{Q}{\pi \sigma_y \sigma_z u} e^{-\left[ \frac{y^2}{2\sigma_y^2} + \frac{h^2}{2\sigma_z^2} \right]} \quad (93)$$

where  $\bar{X}$  is the time-averaged ground level concentration at horizontal coordinates  $(x,y)$ ,  $Q$  is the continuous source strength,  $u$  is the time-averaged magnitude of the wind velocity in the  $\bar{X}$  direction and  $\sigma_y$  and  $\sigma_z$  are the dispersions in the vertical and cross-wind directions. The variables  $\sigma_y$  and  $\sigma_z$  are usually taken to be functions of downwind distance

$\underline{X}$  and are in the form

$$\sigma_y = ax^b \quad (94)$$

$$\sigma_z = cx^d \quad (95)$$

where the constants a, b, c and d depend upon atmospheric stability and are derived empirically. The basic disadvantages of the Gaussian plume approach are:

- 1) Concentrations are not time-dependent
- 2) Spatial variability in meteorological parameters are difficult to incorporate
- 3) Light and ill-defined winds are problems
- 4) The approach does not apply for reactive or secondary pollutants.

The Gaussian model has been validated, however, and is useful for many practical applications.

The basic Gaussian equation has been modified to incorporate the pseudo first-order oxidation of  $SO_2$  in the following equation:

$$X_r(x,y,z,t) = X(x,y,z)e^{-kt} \quad (96)$$

where  $X(x,y,z)$  is the basic Gaussian formulation given by equation and  $k$  is the postulated rate constant.

This formulation implies that dispersion and oxidation are independent of each other and relies on a postulated value of the rate constant,  $k$ . The functional dependencies between  $k$  and other parameters has not been elucidated.

While the gaussian model can be used to predict the fate of emissions at relatively short distances from the source (<20 km), the dispersion of pollutants over longer distances (>20 km) are better approximated by box models.

A modification of this model has been used to characterize sulfur dioxide loadings in the Upper Great Lakes Region (Acres Consulting Services, Ltd., 1975) and in the Sudbury area (Kramer, 1976; Huhn, 1976).

The basic geometry of this model is given by Figure 2.

Figure 2. Basic Geometry of the Box Model

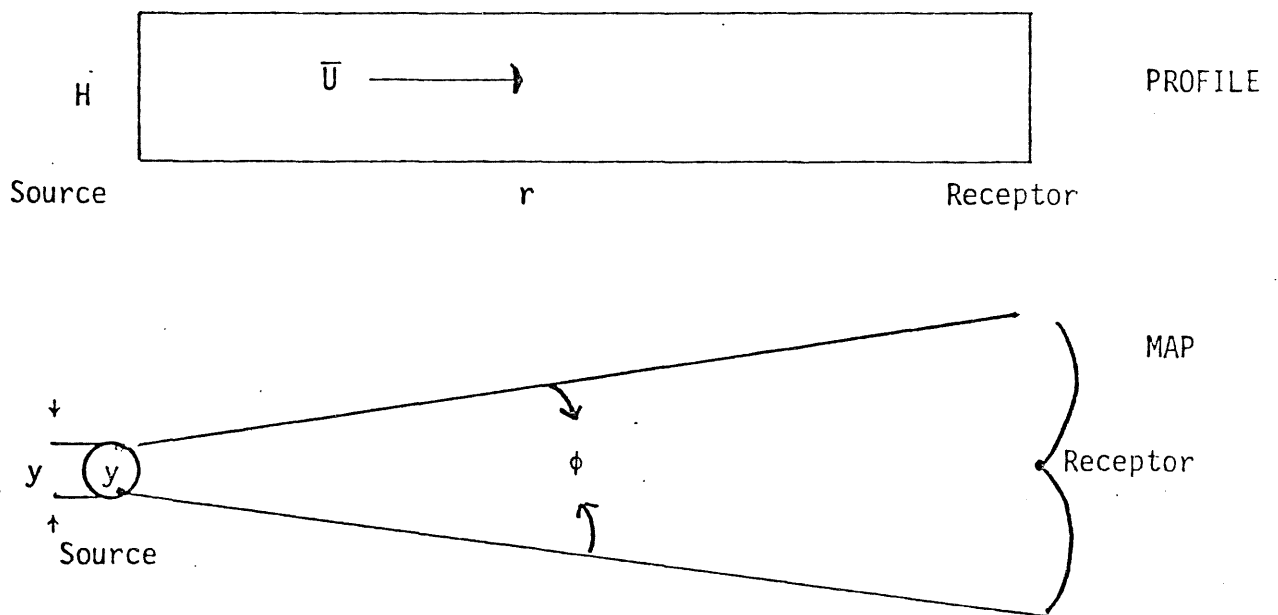

The concentration of pollutant  $j$ , at receptor  $r$ , is given by  $X_r$ :

$$X_r = \frac{QDW}{\bar{U} (\phi r t y) H} \quad (97)$$

where

- $Q$  = source emission strength of  $j$
- $D$  = decay enroute by dry and wet scavenging and chemical reaction,
- $W$  = fraction frequency of the wind direction,
- $\bar{U}$  = average wind speed
- $r$  = distance from source to receptor
- $y$  = diameter of the source region,
- $H$  = mixing height,
- $\phi$  = dispersion angle.
- $t$  = time of travel.

The Box model assumes that the source emissions are uniformly distributed throughout the box from the source to the receptor. Chemistry has been simplified as a first order reaction approximation with specified values for the oxidation rate constant,  $k$ .

More complex formulations which consider plume chemistry along with diffusion have been presented by Baes, Jr. et al. (1976), Freiberg (1976, 1977), Lusi (1976) and Lusi and Phillips (1977).

Baes, Jr. et al. (1976) presented a computer model for power plant plumes that models: 1) the rapid reaction of  $SO_2$  with aerosol droplets to produce the dissolved sulfite species  $H_2SO_3$ ,  $HSO_3^-$  and  $SO_3^{=}$ , 2) the rapid reactions of  $SO_3$  to produce the dissolved sulfate species  $HSO_4^-$  and  $SO_4^{=}$ , 3) the neutralization of the acid by atmospheric ammonia, 4) the formation of particulate ammonium sulfate, 5) the oxidation of  $SO_2$  to sulfate by hydroxyl and 6) the oxidation of  $SO_2$  in aerosol droplets to sulfate by



dissolved ozone and oxygen. The model uses averaged concentrations based on the Gaussian plume model and calculates deposition rates for gases and particulates as a function of several variables (distance from source, wind speed, temperature, relative humidity, meteorological stability class and the ambient concentrations of OH, O<sub>3</sub> and NH<sub>3</sub>). The model has not been validated with field data.

Freiberg (1976) developed a plume model which describes the heterogeneous catalytic oxidation of SO<sub>2</sub> to sulfuric acid in dispersing stack plumes. Freiberg used a Gaussian plume model in which the plume was divided into a number of concentric elliptical rings (Figures 3a and b). Each ring was considered to be a homogeneous gas phase chemical reactor. The rate of chemical reaction and dispersion in each ring was assumed to be uniform. It was assumed that no communication of pollutants occurred between the rings. The model is a valid approximation when concentration changes in the plume due to chemical reactions are very small compared to changes due to dispersion. Chemical reaction in the model is described by Freiberg's (1974, 1975) second order rate reaction of iron catalyzed oxidation of SO<sub>2</sub>.

The variation of concentration with radial position and plume travel time is accounted for through the Gaussian distribution equation in terms of elliptical coordinates by:

$$\rho(r) = \frac{1}{2\pi \sigma_y \sigma_z} e^{(-\frac{1}{2}r^2)} \quad (98)$$

where

$$r^2 = \frac{y^2}{\sigma_y^2} + \frac{z^2}{\sigma_z^2} \quad (99)$$

Figure 3. The elliptical ring plume model.

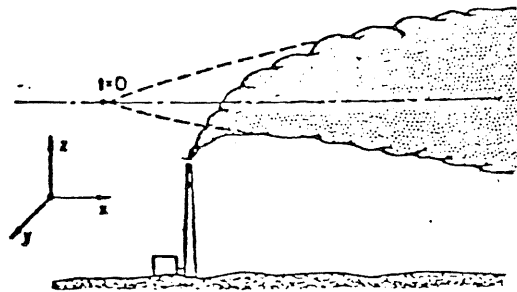

a. The plume model.

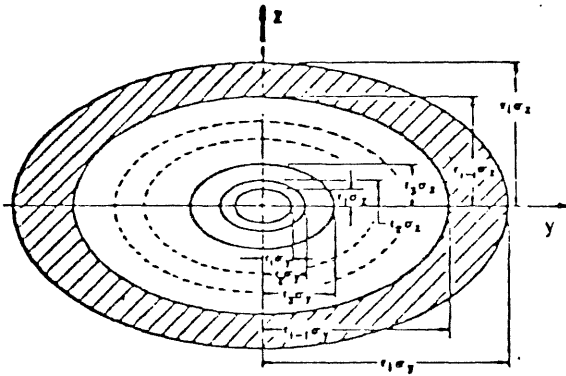

b. A transversal section through the plume depicting the elliptic rings.

Each ring  $i$  has the same amount of  $\text{SO}_2$  such that:

$$\int_0^{2\pi} \int_{r_{i-1}}^{r_i} \rho(r) \sigma_y \sigma_z r dr d\theta = \frac{1}{N} \quad (100)$$

when  $N$  is the total number of rings.

The surface area of each ring,  $A_i$ , is given by:

$$A_i = 2\pi \sigma_y \sigma_z \ln \left( \frac{N - i + 1}{N - i} \right) \quad (101)$$

where the surface area changes with  $\sigma_y$  and  $\sigma_z$  as they change with time which depends on meteorological conditions.

The reaction rate in droplets are coupled with the gas phase parameters in the expanding plume and the amount of  $\text{H}_2\text{SO}_4$  formed ( $\text{SO}_2$  converted) is given by a first-order, nonlinear, ordinary differential equation which must be numerically integrated:

$$\int \frac{dt}{A_i^2} = \int \frac{n_n^3 (1 - rh)^3 d n_a}{K_T K_S^2 \beta_S^2 n_c n_S^2 (n_c \lambda_c + n_a \lambda_a)^3} \equiv Y \quad (102)$$

The model allows the computation of the extent of  $\text{SO}_2$  to  $\text{H}_2\text{SO}_4$  conversion, the pH, the concentration of  $\text{SO}_4^{=}$  in air and the amount of droplets contained in the air and the dependencies of these quantities on the variables of temperature, RH, and mean wind velocity. Freiberg's results show:

- 1) That the rate of oxidation is strongly influenced by temperature and relative humidity.
- 2) That not all of the  $\text{SO}_2$  which is emitted is converted to  $\text{H}_2\text{SO}_4$ .
- 3) That most of the oxidation occurs within the first hour of plume travel. (The work of Gartrell et al. (1964), Weber (1970) and

Stephens and McCaldin (1971) agree with statements 2 and 3. 4) That a maximum  $SO_4^{=}$  is obtained at a downwind distance which depends on atmospheric parameters. 5) That ammonia from air acts as a buffer to enable oxidation to continue in the droplets and that oxidation does not occur to an appreciable extent below pH = 2 as observed by Junge and Ryan (1958). 6) That relative humidity, temperature, ammonia concentration, iron (III) concentration and wind velocity have a selective influence on the oxidation. 7) That  $SO_2$  influences the oxidation regardless of other factors and iron oxides influence the oxidation depending on other factors; this point has implications in the control of conversion.

Lusis (1976) and Lusis and Phillips (1977) presented two models for estimating  $SO_2$  concentration changes in a plume. The first model, based on the work of Friedlander and Seinfeld (1969), considers the Gaussian plume with slow chemical changes. It is assumed that the concentration  $C$  of any reacting constituent in a chemical reaction is given by the Gaussian equation:

$$C = \frac{Q}{2\pi \sigma_y \sigma_z U} \exp \left[ -\frac{1}{2} \left( \frac{y^2}{\sigma_y^2} + \frac{z^2}{\sigma_z^2} \right) \right]. \quad (103)$$

A basic assumption of equation (103) is that the fractional rate of change of concentration due to chemical reaction is small compared to the fractional rate of expansion of the plume (Friedlander and Seinfeld, 1969); i.e., chemical reaction processes are slow compared to diffusion processes.

Considering mass conservation, the variation of  $Q$  with time is related to the reaction rate,  $r$ , by:

$$\frac{1}{U} \frac{dQ}{dt} = \int_{-\infty}^{\infty} \int_{-\infty}^{\infty} r \, dy \, dz \quad (104)$$

For a given  $r$ , equations (103) and (104) can be used to determine the variation of  $Q$  with plume age and finally the concentration of the reacting pollutant. Lusi used field data taken in 1974 and 1975 (Lusi and Wiebe, 1976) to theoretically predict the observed oxidation rates. Since iron was the predominant metal emitted from the Sudbury stack, the reaction rate expression proposed in Freiberg's (1974, 1975) kinetic model for the iron-catalyzed oxidation of  $\text{SO}_2$  was used in the calculations. According to Freiberg's model, the rate of  $\text{SO}_2$  conversion to sulfate at any point in the plume is given by:

$$r = -K_0 \beta_S^2 K_S^2 \left[ \frac{\beta_n K_n \lambda_a}{2(1 - RH) K_w} \right]^3 C_S^2 C_C C_n^3 \quad (105)$$

where  $C_S$ ,  $C_C$ ,  $C_n$  refer to concentration of sulfur dioxide, catalyst ( $\text{Fe}^{+++}$ ) and ambient ammonia respectively,  $RH$  is the relative humidity; the  $K$ 's and  $\beta$ 's are rate, equilibrium and Ostwald constants;  $\lambda_a$  is the vapor pressure lowering coefficient of sulfuric acid.

It is assumed that  $C_n$  is constant throughout the plume and equal to  $6 \times 10^{-7}$  moles/ $\text{m}^3$ .

Equation 105 is then rewritten:

$$r = - \frac{K}{(1 - RH)^3} C_C C_S^2 \quad (106)$$

$$\text{where } K = K_0 \beta_S^2 K_S^2 \left[ \frac{\beta_n K_n \lambda_a}{2 K_w} \right]^3 C_n^3 \quad (107)$$

Equation 103 gives the concentration distribution of both  $\text{SO}_2$  and  $\text{Fe}^{3+}$  catalyst. If  $Q_C$  is the emission rate of catalyst which is not a function of plume age and  $Q_S$  is the emission rate for  $\text{SO}_2$  then substitution of Equations (103) and (106) into equation (104), followed by integration of

the exponential term gives:

$$\frac{dQ_s}{dt} = - \frac{K}{12 (1 - RH)^3} \frac{Q_c}{(\pi \sigma_y \sigma_z U)^2} Q_s^2 \quad (108)$$

By integrating equation (108), the fraction of  $SO_2$  remaining in the plume at age  $t_2$ ,  $(Q_s/Q_s^0)_2$ , can be related to the fraction remaining at  $t_1$ ,  $(Q_s/Q_s^0)_1$ :

$$\left(\frac{Q_s^0}{Q_s}\right)_2 - \left(\frac{Q_s^0}{Q_s}\right)_1 = \frac{K Q_c Q_s^0}{12(1 - RH)^3 (\pi u)^2} \int_{t_1}^{t_2} \frac{dt}{(\sigma_y \sigma_z)^2} \quad (109)$$

where  $Q_s^0$  is the emission rate of  $SO_2$  at the stack.

The model requires as input a known amount of  $SO_2$  converted at some close-in location as a starting point.

A comparison of the predicted and experimental conversions for the INCO smelter plume agree qualitatively in that both predicted and observed fractions of sulfur as sulfate are low. However, a major discrepancy exists between the observed data and the model. The model predicts significant oxidation rates only within the first few minutes of plume age and for low temperatures and/or high relative humidity; however, the field data suggested that the rate is independent of plume age and temperature, humidity effects were not evident (Lusis and Wiebe, 1976).

The authors comment that errors in the predicted values may be due to uncertainties in sensitive input parameters or that Freiberg's kinetic model may not apply to the high pollutant concentrations and wide range of values encountered in the Sudbury plume.

Table 11 provides a comparison of predicted and observed conversion of  $\text{SO}_2$  to sulfate.

Table 11. Comparison of predicted and observed conversion of  $\text{SO}_2$  to sulfate.\*

Date (Sept.)	Temp (° C)	RH (%)	Plume age (min)	%sulfur as sulfate	
				observed	predicted
17	1	40-60	18	1.2	-
			38	1.1	1.2
			107	1.3	1.2
18	0	50-80	18	1.2	-
			56	1.1	1.3
			250	3.2	1.3
21	1	70	7	1.5	-
			110	2.3	2.0
			300	4.3	2.0
22	-5	50-70	3	0.7	-
			67	3.3	6.6
			167	2.8	6.7
25	3	90	2	1.5	-
			38	3.3	5.3
			120	6.5	5.4
26	3	70-80	17	0.9	-
			117	3.9	0.9
	6	80-90	3	1.2	-
			53	7.0	1.9

\*extracted from Lusia and Phillips (1977)

Freiberg (1977) developed a general model of  $\text{SO}_2$  oxidation in expanding plumes for 3 cases:

- 1) A first order direct homogeneous oxidation;
- 2) A heterogeneous catalytic oxidation; and
- 3) A second order homogeneous oxidation.

The model predicts that the first order direct homogeneous reaction proceeds to completion but that for all other oxidation reactions, the conversion proceeds to a fractional asymptotic limit. This phenomenon has been observed by Forrest and Newman (1977) and others in field investigations. The values of the limit and the half life values depend on the ratios of chemical parameters to dispersion parameters. The model predicts that the half life of the reactions are bounded by limits which are constant for any dispersion pattern rather than dependent on rate constants and other chemical parameters. The model also predicts that most of the oxidation will occur early in the plume's life; this has been observed in field studies.

The model and results are based on the assumption that ammonia concentration is constant during plume expansion. In reality, the ammonia concentration is not constant. If the  $[\text{NH}_3]$  is large (little or no  $\text{NH}_3$  penetrating the plume) and the oxidation process is dependent on the buffering influence of  $\text{NH}_3$ , the oxidation will occur only on the periphery of the plume (Wilson, et al. 1976) and the model will not apply. If, however,  $\text{NH}_3$  plays only a small role in buffering the oxidation, the model will apply regardless of the magnitude of the  $\text{NH}_3$  gradient.



Chemical Submodel

1st order catalytic oxidation  
of  $\text{SO}_2$  in a buffered,  
oxygenated aqueous solution

$$\frac{d [\text{SO}_4^{=}]}{dt} = \frac{k_1' [\text{H}_2\text{SO}_3] [\text{Fe}^{3+}]}{[\text{H}^+] \text{ buff.}} \quad (110)$$

1st order homogeneous  
oxidation

$$\frac{d [\text{SO}_4^{=}]}{dt} = k'' [\text{SO}_2] \quad (111)$$

2nd order homogeneous  
oxidation

$$\frac{d [\text{SO}_4^{=}]}{dt} = k_2 [\text{SO}_2]^2 \quad (112)$$

Table 9. Summary of SO<sub>2</sub> oxidation field studies.

Investigator, Year of Publication	Source, length of Plume	Period of Study	Meteorological Plume conditions	Rate of Oxidation	Degree of Oxidation	Mechanism; oxidation rate calculation	Comments
Gartrell et al. (1963)	coal-fired power plant, Colbert, Ala. 9 mi	5-60 8 days	< 70% RH = 75% RH  slight mist	3%/hr 120%/hr during 1st 12 min decreasing to 6%/hr during next 84 min  30%/hr over 108 min		no mechanism rate calculated by dividing % oxidation by travel time	helicopter study, strong dependence on RH; data showed that under mist initial rate is slower, but higher rate is sustained; Newman (1975b) suggested high rates due more to concentration of particulate rather than RH.
Weber (1970)	Power plant, Frankfurt/Main, Germany	4 year period, 3 sites		16-180%/hr overall corresponding to a loss of 50% during 20 min to 3 hr.; 70% of initial SO <sub>2</sub> lost in 1st 17 min of travel - 250%/hr		no mechanism rate calculated from ratio of CO <sub>2</sub> to SO <sub>2</sub>	ground based study, increase in rates with higher RH; longer travel time caused by slower wind speed or greater distance or higher stability class resulted in higher oxidation rates; assumption that ground based station is recording CO <sub>2</sub> + SO <sub>2</sub> peaks due only to power plant is questionable.
Stephens and McCaldin (1971)	Power plant, Crystal River, Fla. 35-80 km	12-19-68 1-2&3-69	atm stable low RH 35% RH med RH 50% RH high RH 80% RH strong inversion on all the days 5.8 to 7.2 m/s ws very cohesive plume	0 28%/hr 59%/hr		1st order mechanism rate calculated from ratio of particulate tracer to SO <sub>2</sub> over plume travel time	airplane study; problems: light scatter counter was humidity dependent (Lundgren and Cooper, 1968) & could explain difference in SO <sub>2</sub> ratios observed; particulates cannot be used as conservative tracer (Friend 1972); rubber tubing for probe; data in general supports Gartrell (1963).
Davis et al. (1974)	Power plant, Morgantown, Va. 96 km	10-73 to '8-74	0.5 ppm NO <sub>x</sub> 2.8 ppm SO <sub>2</sub> 1.4 ppm NO	4.2-8.3%/hr proposed not measured		homogeneous gas phase free radical oxid; (2) OH <sup>m</sup> + SO <sub>2</sub> → HSO <sub>3</sub> (3) HSO <sub>3</sub> + O <sub>2</sub> → HSO <sub>5</sub> (4) HSO <sub>5</sub> + NO → HSO <sub>4</sub> + NO <sub>2</sub> (5) HSO <sub>4</sub> + O <sub>2</sub> → HSO <sub>6</sub> (6) HSO <sub>6</sub> + NO → NO <sub>2</sub> + HSO <sub>5</sub> (7) 2HO <sub>2</sub> + 2hv → 2NO + 2O (8) 2O + 2O <sub>2</sub> → 2O <sub>3</sub> terminating steps (9) HO <sub>2</sub> + HSO <sub>4</sub> → H <sub>2</sub> SO <sub>4</sub> + O <sub>2</sub> (10) HSO <sub>4</sub> + HSO <sub>4</sub> → H <sub>2</sub> S <sub>2</sub> O <sub>8</sub> alternate steps (11) HSO <sub>6</sub> + SO <sub>2</sub> → HSO <sub>5</sub> + SO <sub>3</sub> (12) SO <sub>3</sub> + H <sub>2</sub> O → H <sub>2</sub> SO <sub>4</sub> (13) O <sub>3</sub> + hv → O ('D) + O <sub>2</sub> O ('D) + H <sub>2</sub> O → 2OH O ('D) + N <sub>2</sub> → O (3P) + N <sub>2</sub>	O <sub>3</sub> is generated by proposed mechanism of SO <sub>2</sub> oxidation; last 2 steps would produce 1 O <sub>3</sub> and 1 H <sub>2</sub> SO <sub>4</sub> molecule; during daytime summer flights O <sub>3</sub> depletion and buildup observed; at night no excess O <sub>3</sub> out to 48 km; during daytime winter excess O <sub>3</sub> observed but at lower levels and longer development times than in summer; authors believe seasonal and diurnal variations are due to changes in OH free radical concentration resulting from step 13.
Davis and Klauber (1975)		10-73 to 11-74					

Table 9 (contd.). Summary of SO<sub>2</sub> oxidation field studies.

Investigator, year of Publication	Source, length of Plume	Period of Study	Meteorological, Plume Conditions	Rate of Oxidation	Degree of Oxidation	Mechanism; oxidation rate calculation	Comments
Newman et al. (1975a)	Northport oil-fired power plant 25 km	6 runs May-July, 1974	wide variety of met conditions RH: 40-95% T: 7-21° C plume height 350-900 m morning & evening	1 ppm <sup>-1</sup> hr <sup>-1</sup>	measured data: 0 to 18% isotope data: 2-28%	proposed heterogeneous pseudo 2nd order mechanism dependent on SO <sub>2</sub> and particulate; vanadium as catalyst. rate calculations: 1) isotope ratio of <sup>32</sup> S to <sup>34</sup> S 2) measured conc. of SO <sub>2</sub> and SO <sub>4</sub> <sup>=</sup>	airplane study; authors felt sulfate data were not precise enough (high background compared to measured) to use as valid % of SO <sub>2</sub> converted and used isotope data for further work; no dependency on RH was found in the range 40-95% RH. Freiberg (1976) reanalyzed data and found humidity dependence when stability and temperature were accounted for; vanadium as catalyst is doubtful. Corn and Cheng (1972).
Newman et al. (1975b)	Keystone power plant 16 km		varied		< 5%	Heterogeneous pseudo 2nd order limited by particulates; SO <sub>2</sub> dissolves in H <sub>2</sub> O associated with particulates, it is oxidized and possibly neutralized by NH <sub>3</sub> and additional SO <sub>2</sub> dissolves. Some observed oxidation could be due to ambient particulates & photo-oxidation mechanism proposed by Sidebottom (1972). rate calculation: 1) isotopic ratio 2) sulfur hexafluoride tracer 3) measured concentration of SO <sub>2</sub> and SO <sub>4</sub> <sup>=</sup>	airplane study, measured sulfate data of questionable use in calculating % SO <sub>2</sub> converted because of large variation in background (4-34 µg/m <sup>3</sup> ); at times the net measured sulfate was < 0.1 of bkg values; problems with isotope data were that the <sup>32</sup> S: <sup>34</sup> S not constant in coal & changes in flight patterns; x-wind travel showed decrease in SO <sub>2</sub> with distance but circular pattern did not; because of problems authors did not calculate specific rates; variation in % oxidation could be due to variation of particulates in plume (factors of 2-3); lower oxidation rate of coal-fired plant compared to oil-fired plant attributed to particulate loading; measurement methods criticized by Wilson (1976) and James and Foster (1976).
Dittenhoefer and de Pena (1977)	Keystone power plant 50 km		Flight 4-merging plume; clear - some ground fog; 16.8° C; 95% RH 7.5 m/s; stable	0.5%/hr		authors suggest that more than one mechanism is at work; for near neutral stability and intense solar radiation, the mechanism is homogeneous; for the merged plume conditions of high RH and stable conditions; growth of droplets is favored by absorption and oxidation of SO <sub>2</sub> rate calculated using simultaneous pairs of plume data as a function of plume travel time	airplane study; authors feel that the mechanism at work depends on meteorological and plume conditions; the fact that the highest rate of particulate growth occurred on the day with the lowest temperature may support the work of Freiberg (1974), but the data are insufficient.

Table 9 (contd.) Summary of SO<sub>2</sub> oxidation field studies.

Investigator, Year of Publication	Source, length of Plume	Period of Study	Meteorological, Plume Conditions	Rate of Oxidation	Degree of Oxidation	Mechanism; oxidation rate calculation	Comments	
Urserbach et al. (1977)	Four Corners power plant 65 km	7 days 1975-76	26-51% RH	individual distances: 0.21%/hr at 1.5 mi (0.24 hrs) to 0.84%/hr at 16 mi (0.9 hrs) <u>difference between near and far sites</u> 0.30%/hr between 1.5 and 40 mi. 0.69%/hr between 1.5 and 16 mi		no mechanism rate calculation: $\frac{\text{Part SO}_4^-}{\text{SO}_2} \times$ reaction time corrected for background	airplane study; conversion vs. distance did not show a conclusive trend; low rates may be related to particulate size range examined compared to gross chemical analysis; data does not include conversion on surface of fly ash or soil dust particulates. Other sinks such as dry dep in soil & vegetation expected to be of greater significance than SO <sub>4</sub> <sup>2-</sup> conversion in removing SO <sub>2</sub> in arid western states; the study is important because conversion rates are derived from direct sulfate analysis rather than deduced from a comparison of SO <sub>2</sub> loss with plume tracers	
Pueschel & Van Valin (1977)	Four Corners power plant 8-80 km	Summer 1976		range: 0.8-5.5%/hr ave: 2.4%/hr  10/8 - 1.9 m/sec, 7.8°C, 20% RH at 32 km 10/9 - 1.5 m/sec, 12.2° C, 12% RH at 80 km 10/10 - 2.5 m/sec, 14.4° C, 12% RH at 80 km 10/11 - 7.0 m/sec, 12.2° C, 10% RH	10/8 - 5.5%/hr 10/9 - 0.8%/hr 10/10 - 1.8%/hr 10/11 - 2.0%/hr		2SO <sub>2</sub> + O <sub>2</sub> + 2SO <sub>3</sub> SO <sub>3</sub> + H <sub>2</sub> O + H <sub>2</sub> SO <sub>4</sub> liquid phase oxid. of Scott & Hobbs (1967) rate calculation: Difference of SO <sub>2</sub> fluxes through plume x-section and ground $\frac{\Delta \text{SO}_2}{\Delta t} / \text{reac} =$ $F_{L1} - F_{L2} - F_G$	airplane studies; highest rate observed at highest RH and lowest temperature, RH all < 20%; climatic implications of CCN formation are modifications in the amount, frequency and acidity of rainfall.
Whitby et al. (1977)	Labadie power plant, St. Louis, Mo. 2-45 km	Summer 1973-74		Rate varied from 1.5%/hr at 10 km to 4.9%/hr at 45 km (3 hr period)	at 45 km, 8% SO <sub>2</sub> conversion to aerosol	rate calculated using change in aerosol flow from one x-sect to the next & the time it takes to travel the distance between the points: $\%/\text{hr} = \frac{\Delta \text{SO}_2}{\Delta t}$ $\frac{1}{G} \frac{\Delta F_V}{\Delta t} \rho_p \frac{\text{MW SO}_2}{\text{MW SO}_4}$	Conversion rate calculation assumes aerosol is H <sub>2</sub> SO <sub>4</sub> in equilibrium with H <sub>2</sub> O vapor at ambient humidity; conversion rate increases with distance; contrasts to Newman's findings (1975a) who estimated a constant conversion rate. Whitby concludes that conversion rate is in range 0.5-5%/hr up to 50 km but that dependence of rate on distance is not solved.	

Table 9 (contd.) Summary of SO<sub>2</sub> oxidation field studies.

Investigator, Year of Publication	Source, length of Plume	Period of Study	Meteorological Plume conditions	Rate of Oxidation	Degree of Oxidation	Mechanism; oxidation rate calculation	Comments
Cantrell and Whitby (1977)	Labadie power plant, July 5: 0.75 to 2.6 hrs July 14: 2.9 hrs 45 km	Summer 1976	July 5 - daytime; 51% RH uniform meteorology; well mixed; clear  July 14 - night to day transition; AM inversion, clear	0.41 + 0.2%/hr to 1.2 + 0.4%/hr over 2 hr period  0.43%/hr to 0.48%/hr over 2 hr period		no mechanism oxidation rate calculated as in Whitby et al. (1977)	Plumes of 5th and 14th had different meteorology and dispersion characteristics; SO <sub>2</sub> flow was compared to emission & it was being accounted for; uncertainty of method ± 20%; 1974 & 1976 data compared; 1974 study had aerosol growth 3x's higher than on July 5, 1976. RH in 1976 was lower (75% vs. 51%). General increase in conversion rate with increasing plume age under the relatively uniform meteorological conditions observed in 1974 and July 5, 1976. During July 14 (transition period), no increase was observed due to rapid dilution from change in which meteorology suppresses volume formation, therefore the conversion rate; authors suggest that rates be reported for individual plumes or similar conditions & that dispersion must be taken into account; measurements along plume centerline alone could give erroneous results.
Gillani et al. (1977)	Labadie power plant 300 km	7-9-76 7-18-76	July 9 - weakly unstable AM & PM; 6-8 m/sec, WS increasing to 20 m/sec; 1250 m mixing height; July 18 - strong to mod unstable well-mixed layer capped by inversion; 3-7 m/sec WS increasing to 15 m/sec; 1800 m mixing height; cooler (3° C); less humid (by = 20%); less hazy (3-4x less bscat)	July 9: 1.6 ± 0.4%/hr in AM; < 3%/hr in PM  July 18: 2.4 ± 0.6%/hr in AM; < 1%/hr in PM		Data appear to favor photo-oxidation as rate controlling mechanism, but other mechanisms cannot be ruled out due to insufficient data. Entrainment of ambient air with the plume appeared to occur on July 18; oxidation rate calculated as in Whitby et al. (1977).	A plot of Sp/STot vs. plume age showed that % Sp reached a maximum of 18% on July 18 after 6 hours transport & 12% on July 9 and then levels declined; authors attribute this to the fact that 1st 6 hours were daytime and remainder evening and night; linear relationship exists between % sp and radiation dose on both days. Authors suggest relationship between O <sub>3</sub> & SO <sub>2</sub> oxidation; O <sub>3</sub> higher on July 18; net production of O <sub>3</sub> observed beyond 30 km from source on July 18 and 100 km on July 9. Same phenomenon observed by Davis et al. (1974). Leads to conclusion that O <sub>3</sub> and SO <sub>2</sub> belong to same chemical system; day with the highest rate had lower temperature, less humidity, less haze, and had higher O <sub>3</sub> & more intense mixing.

Table 9 (contd.). Summary of SO<sub>2</sub> oxidation field studies.

Investigator, Year of Publication	Source, length of Plume	Period of Study	Meteorological, Plume Conditions	Rate of Oxidation	Degree of Oxidation	Mechanism; oxidation rate calculation	Comments
Forest and Newman (1977a)	4 coal fired power plant plumes; most work on Labadie 60 km	Summer 1974 July-Dec., 1975	RH: 32-85% T: 10-26° C	no rate calculated	< 5% for travel times up to 2 hrs.	Heterogeneous mechanism with consumption or poisoning of available catalyst rate calculated: 1) isotope method used but not applicable 2) plume concentration of SO <sub>2</sub> and SO <sub>4</sub> <sup>=</sup>	airplane study; SO <sub>2</sub> conversion on filter not a problem; background correction minimal; data indicated that almost all oxidation occurred in 1st few km of emission; contrasts with findings of Whittby et al. (1977) and Husar et al. (1978); supports Freiberg's model in terms of reaction occurring near stack; no correlation of ± SO <sub>2</sub> conversion with temperature, RH, AM & PM, travel time, distance or atmospheric stability; a slight indication that unstable conditions might yield higher rates; tested plume dropout and found that sulfate level under plume was 60% higher than background and attributed it to sulfate dropout; reproducibility of technique ± 20%; authors did not feel integration method of sampling (Wilson, 1976) is necessary for SO <sub>2</sub> oxidation studies; although the isotope technique was not used for Labadie, the other power plants showed good comparison between the direct measurement method & the isotope technique.
Meagher et al. (1977b)	coal-fired power plant, Cumberland, Tenn. 10-105 km	8 flights fall-winter, 1976	RH: 33 to 65% T: 5 to 13° C		average ratio of SO <sub>4</sub> <sup>=</sup> to SO <sub>2</sub> was 1.4% S as aerosol for the plume and 0.25% S as aerosol for the stack.	Mechanism for production of SO <sub>4</sub> before 1st sampling point at 10 km postulated by: 1) presence of particulate surface or metal (at Newman et al. 1975b) 2) SO <sub>4</sub> <sup>=</sup> is controlled by reaction between SO <sub>2</sub> and species in background air resulting in fast rate near the plant & undetectable conversion downwind.  rate calculated: [SO <sub>4</sub> <sup>=</sup> ] at each [SO <sub>2</sub> ] downwind distance	airplane study, no correlation was observed between S ratio and plume tracer time; maximum oxidation occurred within 1st 10 km of plant. Biased data due to instrument response time and narrow plume not included; variability of method + 13%. Data of Newman et al. (1975b) with plume SO <sub>4</sub> <sup>=</sup> concentration of 1.8% are in same range. (NH <sub>4</sub> ) <sub>2</sub> SO <sub>4</sub> dominant in background but less in plume; no observable correlation between NH <sub>4</sub> <sup>+</sup> /SO <sub>4</sub> <sup>=</sup> and plume age indicating aerosol accumulates NH <sub>3</sub> ; process is slow.

Table 9 (contd.) Summary of SO<sub>2</sub> oxidation field studies.

Investigator, year of Publication	Source, length of Plume	Period of Study	Meteorological, Plume Conditions	Rate of Oxidation	Degree of Oxidation	Mechanism; oxidation rate calculation	Comments
Dana et al. (1975)	Power plant, Centralia, Wash. 4½ mi. to last sampling line	5 periods Feb-March 1972	rain	278%/hr predicted values of 400-570%/hr.		mechanism 1) In-plume oxidation: all SO <sub>4</sub> <sup>=</sup> is formed from SO <sub>2</sub> as it disperses before being scavenged by rain; qualitative agreement with data 2) Liquid phase (raindrops) oxidation: SO <sub>2</sub> does not react in plume but waits until it is incorporated into a falling raindrop before oxidation begins  rate calculation: comparison between field scavenging rates and model calculations; model assumes 1st order oxidation	ground based sampling during rainfall; authors developed model (EPAEC) for predicting reversible washout of SO <sub>2</sub> ; in plume oxidation proceeds rapidly as plume leaves source and rate decreases as distance increases; liquid plume oxidation cannot be excluded; high measured rate may be artifact.
Lusis et al. (1977)	GCOS power plant, Alberta, Canada 55 km	2-77 6-77	Feb.: 2.3°C, 79% RH  June: -15.4°C, 61% RH	Feb. range: -1.2%/hr to 2.4%/hr ave. of 0.26%/hr  June range: -0.24%/hr to 9.3%/hr ave. of 1.4%/hr	Feb. 1.3% for 1 hr  June 2% for 1st 2 hrs- which increased to 3%	photochemical oxidation postulated  rate calculation: % oxidation between two points = plume travel time	airplane study, very little oxidation observed in Feb. or early AM in June; no correlation to temperature or RH; oxidation did not occur in first few km from stack; ozone bulge present during June flights; probable mechanism photochemical oxidation (Davis et al. 1974, Gillani et al. 1977) rather than heterogeneous catalysis (Foster 1969, Freiberg 1974, Newman et al. 1975a,b, Forest and Newman 1977).
Rowe et al. (1977)	Sourgas plant, Calgary, Alberta 0.1 to 4 km	9 runs 9-3-76 11-2-76	Sept. 3. warm, cloudy day, 50-60% RH, ground based inversion of 150 m  Nov. 2. cool sunny day, 30-40% RH, moderate winds, near neutral stability	no significant oxid measured from 0.1-4 km		no mechanism  rate calculation based on total mass of SO <sub>2</sub> and gold; ratio of oxidized SO <sub>2</sub> to total diffused SO <sub>2</sub> is calculated from the mass calculation.	helicopter study; major problem with the study is that the fraction of unreacted SO <sub>2</sub> was greater than one; the authors felt that some of the gold was depleted somewhere between the incinerator and the stack.

Table 9 (contd.). Summary of SO<sub>2</sub> oxidation field studies.

Investigator, Year of Publication	Source, length of Plume	Period of Study	Meteorological, Plume Conditions	Rate of Oxidation	Degree of Oxidation	Mechanism; oxidation rate calculation	Comments
Roberts and Friedlander (1975)	Los Angeles Basin	3 days July 1973		12-12.8%/hr		pseudo 1st order mechanism; dependent on other parameters such as O <sub>3</sub> , free radicals, olefin & RH rate calculation: pseudo 1st order rate calculation which depends on deposition velocity of SO <sub>2</sub> & sulfate aerosol; particulate to gas sulfur ratio & air trajectory	ground based study
Meagher and Sharma (1977a)	TVA areas 500 x 800 km rectangle	Feb- March, 1976				ground level measurements indicate that SO <sub>4</sub> <sup>=</sup> increased 25% and TSP increased 36% from entry to exit boundaries; aircraft data shows that SO <sub>4</sub> <sup>=</sup> flux leaving area is 16 µg/m <sup>2</sup> /sec greater than air mass entering	airplane and ground based study
Wilson et al. (1976)	St. Louis, Mo. urban plume 150 km	July 18 July 29-30			July 18: max SO <sub>4</sub> <sup>=</sup> was 20 µg/m <sup>3</sup> July 29-30: max SO <sub>4</sub> <sup>=</sup> was 60 µg/m <sup>3</sup>	airplane and ground based study; S depletion = to 1/2 decay distances of 90 mi.; new SO <sub>4</sub> formation not detectable up to 50 km and only about 1/3 emission were transported beyond 100 km radius Daytime formation begins after plume aging time of 1-2 hours. Tall stacks reduce ground-level concentrations of SO <sub>2</sub> but increasing SO <sub>4</sub> aerosol by decreasing surface losses of SO <sub>2</sub> and increasing atmospheric residence time which increases SO <sub>2</sub> conversion; in urban plumes SO <sub>2</sub> removed by reaction with plants and deposition.	



Table 9 (contd.). Summary of SO<sub>2</sub> oxidation field studies.

Investigator, Year of Publications	Source, length of Plume	Period of Study	Meteorological, Plume Conditions	Rate of Oxidation	Degree of Oxidation	Mechanism; oxidation rate calculation	Comments
Alkezweeny and Powell (1977)	St. Louis, Mo. Urban plume	8-10-75 8-11-75	Aug. 10: clear to scat clouds AM & PM 7 m/sec ws, 60% RH, 21° C, 1400 m mixing ht.  Aug. 11: clear, 6 m/sec ws, 53% RH, 26° C, 2400 m mixing ht.	Aug. 10: 14%/hr  Aug. 11: 10%/hr  ave rate after background subtracted: 9%/hr		catalytic oxidation mechanism. results agree with temperature and RH dependence of Freiberg (1974). conversion rate calculated by combining equation for conservation of mass for SO <sub>2</sub> and SO <sub>4</sub> <sup>2-</sup> ; rate is assumed independent of temperature and depends on deposition velocity of SO <sub>2</sub> & SO <sub>4</sub> <sup>2-</sup>	airplane study, day with highest ratio had highest RH and lowest temperature. Confidence limits on oxidation rate do not distinguish between the 2 days. Rates are comparable to Roberts & Friedlander (1975) but higher than Wilson et al. (1976); O <sub>3</sub> increased slightly with distance; assumed deposition velocity of 1 cm/sec for SO <sub>2</sub> and 0.1 cm/sec for SO <sub>4</sub> <sup>2-</sup> .
Eliassen and Saltbones (1975)	Western Europe area source; quadratic grid of 127 km at 60° W	2 months of data in 1973, 11 periods each		range: 0.3-1.7%/hr  ave: 0.8%/hr	3-11.7%	assumed 1st order deposition and oxidation. rate calculation: used emissions data, air data and trajectories; obtained best agreement between observed & calculated data	ground based study, decay and transformation rates showed some variation; the transformation rate was about 1 order magnitude smaller than decay rate; mean residence time for SO <sub>2</sub> from decay rate is about 1/2 day (crude method); deposition velocity of 2 cm/sec calculated for SO <sub>2</sub> .
Prahm et al. (1976)	Atlantic Ocean, 1000 km transport distance from British Isles to Faroes Islands	4 days for clean and dirty air Feb, 1975	no precipitation; stable mixing layer	1%/hr		assumed 1st order oxidation and deposition rate calculation: trajectory analysis and from deposition velocity of SO <sub>2</sub> and SO <sub>4</sub> <sup>2-</sup> and measured data	ground based study, decay data agrees with Eliassen & Saltbones (1975); results are one of the 1st direct measurement of decay during distant sulfur transport; deposition for SO <sub>2</sub> greater than Smith & Jeffrey (1975); calculation of 2 cm/sec ± 50% for SO <sub>2</sub> deposition velocity and 0.4 cm/sec ± 50% for SO <sub>4</sub> <sup>2-</sup> deposition velocity.

Table 9 (contd.). Summary of SO<sub>2</sub> oxidation field studies.

Investigator, Year of Publication	Source, length of Plume	Period of Study	Meteorological, Plume Conditions	Rate of Oxidation	Degree of Oxidation	Mechanism: oxidation rate calculation	Comments
Smith and Jeffrey (1975)	North Sea of the east coast of England 160 km air mass sampled	7 flights Oct. 1971 Sept. 1973	near neutral, slightly unstable	1%/hr at 70% RH to 12%/hr at 88% RH		no mechanism oxidation rate calculated from air data, emissions & trajectory analysis	airplane study, data show increase in oxidation rate independent of emissions with RH above 70% RH; most of the oxidation occurred close to source within 1st 50 km; oxidation did not correlate well with distance or time; in rain oxidation high and about 75% of sulfate removed by washout. Results imply that about 30% SO <sub>2</sub> lost by dry deposition; 50-60% emissions leave as SO <sub>2</sub> & remainder as sulfate. Calculated 0.8-1 cm/sec. SO <sub>2</sub> deposition velocity over land and 0.6-0.3 cm/sec SO <sub>2</sub> deposition over sea
Katz (1950)	nickel smelter, Sudbury, Ontario	June-Aug., 1946	heavy, med, and mild smoke fumigations		ratio of SO <sub>2</sub> /total sulfur ranged from 95% in 2 hrs residence time to 65% in 12 hrs. under some conditions sulfate was up to 35% of total sulfur	Oxidation catalyzed by sun and fine particles (metal oxides)	ground based study, % SO <sub>2</sub> in total S was highest in heavy smoke fume; showed qualitatively that SO <sub>2</sub> is oxidized in air; factors that were important: duration of exposure and number of oxide particles; high RH; weaknesses of study: interferences in analysis; contributions of other ground level sources.
U.S. Dept. of Welfare (1960)	nickel smelter, Sudbury, Ontario data of Katz			2.1%/hr			analyzed data of Katz (1950) and found that over narrow range of conditions studied, the ratio of SO <sub>2</sub> to total S contaminants appeared to be independent of concentration temperature and time of day. Rate less than Gattrell et al. (1963) and may be due to greater H <sub>2</sub> SO <sub>4</sub> collection efficiency; different atmospheric conditions; greater concentration of particulates in plume in the Gattrell study
Luis et al. (1974)	INCO nickel smelter, Sudbury, Ontario	Sept., 1974	variable; 40 to 90% RH, -5 to 6° C temp.; 30-100% cloud cover	0-9%/hr average	near stack 2-3% S as SO <sub>4</sub> <sup>=</sup> at distances up to 100 km less than 10% S as SO <sub>4</sub>	1st order mechanism assumed although data did not, in general, follow a 1st order relationship rate calculation: [SO <sub>4</sub> <sup>=</sup> ] = plume age	Conversion of SO <sub>2</sub> to SO <sub>4</sub> <sup>=</sup> on cellulose not considered a problem; less than 1% conversion found when filters tested before study. Low oxidation rates surprising in view of catalytic potential of particulates and water vapor content of plume although data showed that rate appeared to decrease with RH and temperature. Authors did not feel relationships were well defined.

Table 9 (contd.). Summary of SO<sub>2</sub> oxidation field studies.

Investigator, Year of Publication	Source, length of Plume	Period of Study	Meteorological, Plume Conditions	Rate of Oxidation	Degree of Oxidation	Mechanism; oxidation rate calculation	Comments
Lusis et al. (1975)	INCO nickel smelter, recalculation of 1974 results			recalculated rate of 0-6%/hr.	near stack, 1% S as SO <sub>4</sub> <sup>=</sup>		Further analyzed 1974 data to determine sources of error & extent of SO <sub>4</sub> <sup>=</sup> formation due to SO <sub>2</sub> absorption and reaction on glass fiber filters; SO <sub>4</sub> <sup>=</sup> formation is limited by number of sites on filter and increases slightly with RH; at less than 50% RH - 0.1 mg sulfate/filter; at greater than 50% RH - an average of 2 mg sulfate/filter; main conclusion is that 1974 data were valid (oxidation rate of 0 to 6%/hr); the decrease in conversion rate with plume age disappeared; reported values are maximum due to any conversion of SO <sub>2</sub> on filter.
Lusis & Wiebe (1976)	INCO nickel smelter, Sudbury, Ontario	Sept. 1974 June 1975	-5 to 21° C 40-90% RH	range - 1.2 to 7%/hr most values < 3%/hr ave: 1%/hr	1st 10 km: less than 10% S as SO <sub>4</sub>	most likely mechanism is oxidation of SO <sub>2</sub> in droplets or liquid film surrounding particles; low rates may be due to high SO <sub>2</sub> & HCl which would lower pH causing decrease in oxidation rate; authors acknowledge that lack of temperature or RH dependence presents problem in heterogeneous interpretation; authors explain that INCO plume could be too acidic or that ranges of temperature & RH were too narrow; also 1975 emissions may be 50% less than 1974 and composition of catalytic particles in plume may have changed. rate calculated as Lusis et al. (1974)	Oxidation rates for 1974 and 1975 similar; no temperature or humidity effect found in range studied; data did show slight decrease in rate with plume age; data compares well to U.S. Department of Health, Education, and Welfare (1969) calculation for data of Katz (1950): 2 to 3%/hr. Authors feel that homogeneous gas phase oxidation suggested by Davis et al. (1974) not important. Forrest and Newman (1977) comment that Lusis & Wiebe's interpretation of conversion rate can be misleading -- constant change per unit time; propose a 2nd order mechanism dependent on SO <sub>2</sub> & particulates and suggest a new rate constant of 0.2 ppm <sup>-1</sup> m <sup>-1</sup> ; new rate also shows decrease of rate with distance; authors agree that heterogeneous mechanism at work and suggest that low rates could be due to low particulate loading (0.4 g part/1 SO <sub>2</sub> ).
Forrest and Newman (1977)	INCO nickel smelter, Sudbury, Ontario Run 1 - 8 km Run 2 - 1-8 km Run 3 - 3-11 km		Run 2: 62% RH, thick fog at ground with 99% RH		Run 1 1.8-2.7% (2.2-67 minutes) (1.6-48 km) Run 2 5.2 & 4.7% (2.7-13.3 minutes) (1.6-8 km) Run 3 Lusis & Wiebe 1.4 and 1.2%	rate calc. based on measured % of SO <sub>2</sub>	Higher values on Run 2 could be due to interaction between fog at ground level and smelter operation which uses a lot of air; data of Lusis & Wiebe (1976) compare favorably.

REFERENCES

- Acres Consulting Services - Earth Sciences Consultants. 1975. Atmospheric Loading of the Upper Great Lakes. Vo. II, III. CCIW Report.
- Alkezweeny, A.J. and D.C. Powell. 1977. Estimation of transformation rate of  $\text{SO}_2$  to  $\text{SO}_4$  from atmospheric concentration data. Atm Env. 11:179-182.
- Altshuller, A.P. and J.J. Bufalini. 1965. Photochemical aspects of air pollution: a review. Photo-Chem Photobiol. 4:97-146.
- Baes, Jr., C.F., J. T. Holdeman, and W.M. Culkowski. 1976. SULCAL: A model of sulfur chemistry in a plume. ORNL/NSF/EATC-21. Oak Ridge, Tennessee.
- Barrie, L.A. and H.W. Georgii. 1976. An experimental investigation of the absorption of sulphur dioxide by water drops containing heavy metal ions. Atm Env. 10:743-749.
- Bassett, Henry and William G. Parker. 1951. The oxidation of sulphurous acid. J. Chem. Soc. 47:1540-1560.
- Bielke, S. and G. Gravenhorst. 1977. Heterogeneous  $\text{SO}_2$  oxidation in the droplet phase. Presented at the Intl. Symp. on Sulfur in the Atm. Sept. 7-14, 1977. Dubrovnik, Yugoslavia.
- Bielke, S., D. Lamb and J. Miller. 1975. On the uncatalyzed oxidation of atmospheric  $\text{SO}_2$  by oxygen in aqueous systems. Atm. Env. 9:1083-1090.
- Brimblecombe, P. and D.J. Spedding. 1974. The catalytic oxidation of micromolar aqueous sulphur dioxide - I. Oxidation in dilute solutions containing iron (III). Atm. Env. 8:937-945.
- Brimblecombe, P. and D.J. Spedding. 1975. The dissolution of iron from ferric oxide and pulverized fuel ash. Atm. Env. 9:835-838.
- Calvert, Jack G. and Robert D. McQuigg. 1975. The computer simulation of the rates and mechanisms of photochemical smog formation. Intl. J. Chem. Kin. Symp No. 1., Proc. of the Symp on Chem Kin. Data for the Upper and Lower Atmosphere. Sept. 15-18, 1974. pp. 113-154.
- Calvert, Jack G., Fu Su, Jan W. Bottenheim and Otto P. Strausz. 1977. Mechanism of the homogeneous oxidation of sulfur dioxide in the troposphere. Presented at the Intl. Symp. on Sulfur in the Atm. Sept. 7-14, 1977. Dubrovnik, Yugoslavia.
- Cantrell, B.K. and K.T. Whitby. 1977. Aerosol size distributions and aerosol volume formation for a coal-fired power plant plume. Paper No. III. Particle Technology Laboratory Publication No. 335. Progress Report on Sulfur Aerosol Research of the Particle Technology Laboratory, University of Minnesota, Minneapolis, Minn. July, 1977.

- Castleman, Jr., A.W., Richard E. Davis, H.R. Munkelwitz, I.N. Tang and William P. Wood. 1975. Kinetics of association reactions pertaining to  $H_2SO_4$  aerosol formation. Intl. J. Chem. Kin. Symp. No. 1., Proc. of the Symp. on Chem. Kin. Data for the Upper and Lower Atmosphere, Sept. 15-18, 1974. pp. 629-640.
- Chen, Tsung - I and Charles H. Barron. 1972. Some aspects of the homogeneous kinetics of sulfite oxidation. Ind. Eng. Chem. Fund. 11(4): 466-470.
- Cheng, Robert T., John O. Frohlinger and Morton Corn. 1971. Aerosol stabilization for laboratory studies of aerosol-gas interactions. J. Air Poll. Cont. Assoc. 21(3): 138-142.
- Cheng, Robert T., Morton Corn and John O. Frohlinger. 1971. Contribution to the reaction kinetics of water soluble aerosols and  $SO_2$  in air at ppm concentrations. Atm. Env. 5:987-1008.
- Chun, Kyong C. and James E. Quon. 1973. Capacity of ferric oxide particles to oxidize sulfur dioxide in air. Env. Sci. Tech. 7(6): 532-538.
- Corn, Morton and Robert T. Cheng. 1972. Interactions of sulfur dioxide with insoluble suspended particulate matter. J. Air Poll. Cont. Assoc. 21 (11): 870-875.
- Cox, R.A. and S.A. Penkett. 1970. The photo-oxidation of sulfur dioxide in sunlight. Atm. Env. 4:425-433.
- Cox, R.A. and S.A. Penkett. 1971a. Photo-oxidation of atmospheric  $SO_2$ . Nature. 229: 486-488.
- Cox, R.A. and S.A. Penkett. 1971b. Oxidation of atmospheric  $SO_2$  by products of the ozone-olefin reaction. Nature. 230: 321-322.
- Cox, R.A. 1972. Quantum yields for the photo-oxidation of sulfur dioxide in the first allowed absorption region. J. Phys. Chem. 76(6):814-820.
- Cox, R.A. and S.A. Penkett. 1972. Aerosol formation from sulfur dioxide in the presence of ozone and olefinic hydrocarbons. J. Chem. Soc. Faraday Trans. 68: 1735-1753.
- Cox, R.A. 1975. The photolysis of gaseous nitrous acid - a technique for obtaining kinetic data on atmospheric photo-oxidation reactions. Intl. J. Chem. Kin. Symp. No. 1, Proc. of the Symp. on Chem. Kin. Data for the Upper and Lower Atmosphere, Sept. 15-28, 1974. pp. 379-398.
- Crutzen, P.J. and Fishman, J. 1977. Average concentrations of OH in the northern hemisphere, and the budgets of  $CH_4$ , CO and  $H_2$ . Geophys. Res. Letters. 4(8): 321-324.

- Dana, M.T., J.M. Hales and M.A. Wolf. 1975. Rain scavenging of SO<sub>2</sub> and sulphate from power plant plumes. J. of Geophysical Research 80:4119-4129.
- Daubendiek, Richard L. and Jack G. Calvert. 1973. A photochemical study involving SO<sub>2</sub>, O<sub>2</sub>, SO<sub>3</sub> and O<sub>3</sub>. Presented at the 165th National Meeting of the American Chemical Society. Physical Section, Paper No. 19. Dallas, Texas.
- Daubendiek, Richard L. and Jack G. Calvert. 1975. A study of the N<sub>2</sub>O<sub>5</sub> - SO<sub>2</sub>-O<sub>3</sub> reaction system. Env. Letters. 8(2): 103-116.
- Davis, D.D., G. Smith, and G. Klauber. 1974. Trace gas analysis of power plant plumes via aircraft measurements: O<sub>3</sub>, NO<sub>x</sub> and SO<sub>2</sub> chemistry. Science. 186:733-736.
- Davis, D.D. and Gary Klauber. 1975. Atmospheric Gas Phase Oxidation Mechanisms for the Molecule SO<sub>2</sub>. Intl. J. Chem. Kin. 1:543-556.
- Davis, S.M. and J.H. Lunsford. 1976. Surface reactions of SO<sub>2</sub> with NO<sub>2</sub> on hydrated silica gel. J. Environ. Sci. Health. A11(12): 735-741.
- Davis, D.D., J. Prusaczyk, M. Dwyer and P. Kim. 1974. A stop-flow time-of-flight mass spectrometry kinetics study. Reaction of ozone with nitrogen dioxide and sulfur dioxide. J. Phys. Chem. 78 (18): 1775-1779.
- Demerjian, Kenneth L., J. Alistair Kerr and Jack G. Calvert. 1974. The mechanism of photochemical smog formation. Adv. Env. Sci. Tech. Edited by James N. Pitts, Jr. and Robert L. Metcalf. 4:1-262.
- Dittenhoefer, Allen C. and Rosa G. de Pena. 1977. A study of production and growth of sulfate particles in coal operated power plant plumes. Presented at the International Symposium on Sulfur in the Atmosphere. Sept. 7-14, 1977. Dubrovnik, Yugoslavia.
- Dyson, William L. and James L. Quon. 1976. Reactivity of zinc oxide fume with sulfur dioxide in air. Env. Sci. Tech. 10(5): 476-481.
- Eliassen, Anton and Jorgen Saltbones. 1975. Decay and transformation rates of SO<sub>2</sub>, as estimated from emission data, trajectories and measured air concentrations. Atm. Env. 9:425-429.
- Endow, N., G.J. Doyle and J.L. Jones. 1963. The nature of some photochemical aerosols. J. Air Poll. Cont. Assoc. 13(4): 141-147.
- Forrest, J. and L. Newman. 1977a. Further studies on the oxidation of sulfur dioxide in coal-fired power plant plumes. Atm. Env. 11: 465-474.
- Forrest, J. and L. Newman. 1977b. Oxidation of sulfur dioxide in the Sudbury smelter plume. Atm. Env. 11:517-520.

- Foster, L.L. 1969. The oxidation of sulphur dioxide in power station plumes. Atm. Env. 3:157-175.
- Freiberg, Johnny. 1974. Effect of relative humidity and temperature on iron-catalyzed oxidation of SO<sub>2</sub> in atmospheric aerosols. Env. Sci. Tech. 8(8):731-734.
- Freiberg, Johnny. 1975. The mechanism of iron catalyzed oxidation of SO<sub>2</sub> in oxygenated solutions. Atm. Env. 9:661-672.
- Freiberg, Johnny. 1976a. The iron catalyzed oxidation of SO<sub>2</sub> to acid sulfate mist in dispersing plumes. Atm. Env. 10:121-130.
- Freiberg, Johnny. 1976b. Discussions. The application of an isotopic ratio technique to studies of the atmospheric oxidation of sulfur dioxide in the plumes from an oil-fired and coal-fired and coal-fired power plant - I and II. Atm. Env. 10:672-673.
- Friedlander, S.K. and J.H. Seinfeld. 1969. A dynamic model of photochemical smog. Env. Sci. and Tech. 3(11):1175-1181.
- Friend, J.P. 1972. Attenuation of power plant plumes as determined by instrumented aircraft. Env. Sci. and Tech. 6:172-173.
- Friend, James P., Robert Leifer and Morris Trichon. 1973. J. Atm. Sci. 30(1): 465-479.
- Fuller, E.C. and R.H. Crist. 1941. The rate of oxidation of sulfite ions by oxygen. J. Am. Chem. Soc. 63: 1644-1650.
- Gartrell, F.E., F.W. Thomas, S.B. Carpenter. 1963. Atmospheric oxidation of SO<sub>2</sub> in coal-burning power plant plumes. Am I. Hyg. Assoc. J. 29: 113-120.
- Gerhard, Earl R. and H.F. Johnstone. 1955. Photochemical Oxidation of sulfur dioxide in air. Ind. Eng. Chem. 47(5): 972-976.
- Gillani, N.V., R.B. Husar, J.D. Husar, D.E. Patterson, W.E. Wilson, Jr. 1977. Project MISTT: Kinetics of particulate formation in a power plant plume out to 300 km. Presented at the International Symposium on Sulfur in the Atmosphere. Sept. 7-14, 1977. Dubrovnik, Yugoslavia.
- Goodsell, Arthur J., M.J.D. Low and Nobutsune Takezawa. 1972. Reactions of gaseous pollutants with solids. II. Infrared study of sorption of SO<sub>2</sub> on MgO. Env. Sci. Tech. 6(3): 268-273.
- Harkins, John and Stephen W. Nicksic. 1965. Studies on the role of sulfur dioxide in visibility reduction. J. Air Poll. Cont. Assoc. 15(5): 218-221.
- Huhn, F.J. 1976. A predictive model for sulfur dioxide loading in the Sudbury area. Dept. of Geology, McMaster University, Hamilton, Ontario.

- Jaffe, Sigmund and Fritz S. Klein. 1966. Photolysis of  $\text{NO}_2$  in the presence of  $\text{SO}_2$  at 3660 Å. Trans. Far. Soc. 62: 2150-2157.
- James, K.W. and P.M. Foster. 1976. Discussions. The application of an isotopic ratio technique to studies of the atmospheric oxidation of sulfur dioxide in the plumes from an oil-fired and a coal-fired power plant - I and II. Atm. Env. 10:671.
- Johnstone, H.F. and D.R. Coughanowr. 1958. Absorption of sulfur dioxide from air. Ind. Engr. Chem. 50(8): 1169-1172.
- Katz, M. 1950. Photoelectric determination of atmospheric sulfur dioxide. Anal. Chem. 22(8): 1040-1047.
- Katz, M. and S. B. Gale. 1970. Mechanism of photooxidation of sulfur dioxide in atmosphere. 2nd Intl. Clean Air Congress. Dec. 6-11, 1970, Washington, D.C. pp. 336-343.
- Koch, Robert C., W. Gale Biggs, Paul H. Hwang, Irving Leichter, Kenneth E. Pickering, Eric R. Sawdey, and John L. Swift. 1977. Power plant stack plumes in complex terrain. An appraisal of current research. EPA - 600/7-77-020.
- Kramer, James R. 1976. Fate of Atmospheric Sulphur Dioxide and related substances as indicated by chemistry of precipitation. Dept. of Geology, McMaster University, Hamilton, Ontario.
- Larson, Timothy V. and Robert J. Charlson, Eric J. Knudsen, Gary D. Christianson and Halstead Harrison. 1975. On the rain chemistry of a single storm in the Puget Sound Region. Water, Air and Soil Pollution 4:319-328.
- Levy, H., II. 1971. Normal atmosphere: Large radical and formaldehyde concentrations predicted. Science 173: 141-143.
- Levy, A., D.R. Drewes, and J.M. Hales. 1976.  $\text{SO}_2$  oxidation in plumes: A review and assessment of relevant mechanistic and rate studies. EPA-450/3-76-022.
- Lin, M.J. and J.H. Lunsford. 1975. Photooxidation of sulfur dioxide on the surface of magnesium oxide. J. Phys. Chem. 79(9): 892-897.
- Low, M.J.D., A.J. Goodsel and T. Nobutsune. 1971. Reactions of gaseous pollutants with solids. I. Infrared study of the sorption of  $\text{SO}_2$  on  $\text{CaO}$ . Env. Sci. Tech. 5(12): 1191-1195.
- Lundgren, D.A. and D.W. Cooper. 1968. Effect of humidity on light-scattering methods of measuring particle concentration. APCA paper no. 69-107. 61st Annual Meeting of the Air Pollution Control Association, St. Paul, MN.
- Lusis, M. 1976. Mathematical modelling of chemical reactions in a plume. Presented at the 7th International Technical Meeting on Air Pollution Modelling and its Applications, September 7-10. Airlie, Virginia.



- Lusis, M.A. and K.G. Anlauf, L.A. Barrie and H.A. Wiebe. 1977. Plume chemistry studies at a northern Alberta power plant. Presented at the Alberta Sulphur Gas Research Workshop III. Nov. 17-18, 1977. University of Alberta, Edmonton, Alberta.
- Lusis, M.A. and C.R. Phillips. 1977. The oxidation of SO<sub>2</sub> to sulfates in dispersing plumes. Atm. Env. 11: 239-241.
- Lusis, M.A. and H.A. Wiebe. 1976. The rate of oxidation of sulfur dioxide in the plume of a nickel smelter stack. Atm. Env. 10:793-798.
- Lusis, M., H.A. Wiebe, K.G. Anlauf, R.D.S. Stephens and H.P. Sanderson. 1974. The rate of oxidation of sulfur dioxide to sulfuric acid and sulfates in the plume of the INCO superstack at Sudbury, Ontario. September 17-26, 1974. Report ARQA 14-74, Atmospheric Environment Service, Downsview, Ontario, Canada.
- Lusis, M., H.A. Wiebe, and J.M.L. Gray. 1975. Further work on the measurement of the oxidation and dispersion of sulfur dioxide in chimney plumes. Report ARQA 17-75. Atmospheric Environment Service, Downsview, Ontario, Canada.
- Matteson, Michael J., Werner Stöber and Horst Luther. 1969. Kinetics of the oxidation of sulfur dioxide by aerosols of manganese sulfate. 1969. Ind. Eng. Chem. Fund. 8(4): 677-687.
- McKay, H.A.C. 1971. The atmospheric oxidation of sulfur dioxide in water droplets in the presence of ammonia. Atm. Env. 5(1): 7-14.
- Meagher, James F., Ozzie Huff, Leonard Stockburger III, and Gary Shannon. 1977a. Chemical Interaction in coal-fired power plant plumes. I. Sulfur dioxide to sulfate conversion. TVA publication I-AQ-77-5. Muscle Shoals, Alabama.
- Meagher, James F. and Vinaya Sharma. 1977b. Transport and transformation of sulfur oxides in the Tennessee Valley Region. Presented at the Second National Conference on the Interagency Energy/Environment R&D program. June 6-7, 1977. Washington, D.C.
- Miller, D.F. 1977. Precursor effects on SO<sub>2</sub> oxidation. Presented at the Intl. Symp. on Sulfur in the Atmosphere. Sept. 7-14, 1977. Dubrovnik, Yugoslavia.
- Miller, J.M. and Rosa G. de Pena. 1972. Contribution of scavenged sulfur dioxide to the sulfate content of rain water. J. Geophysical Research. 77(30): 5905-5916.
- Newman, L., J. Forrest, and B. Manowitz. 1975a. The application of an isotopic ratio technique to a study of the atmospheric oxidation of sulfur dioxide in the plume from an oil-fired power plant. Atm. Env. 9:959-968.

- Newman, L., J. Forrest, and B. Manowitz. 1975b. The application of an isotopic ratio technique to a study of the atmospheric oxidation of sulfur dioxide in the plume from a coal-fired power plant. Atm. Env. 9: 969-977.
- Novakov, T., S.G. Chang and A.B. Harker. 1974. Sulfates as pollution particulates: Catalytic formation on Carbon (soot) particles. Science. Vol.186 pp. 259-261.
- Payne, W.A., L.J. Stief, and D.D. Davis. 1973. A kinetics study of the reaction of  $\text{HO}_2$  with  $\text{SO}_2$  and  $\text{NO}$ . J. Amer. Chem. Soc. 95(23): 7614-7619.
- Penkett, S.A. 1972. Oxidation of  $\text{SO}_2$  and other atmospheric gases by ozone in the aqueous phase. Nature Physical Science. 240:105-106.
- Penkett, S.A. and J.A. Garland. 1974. Oxidation of sulphur dioxide in artificial fogs by ozone. Tellus 26(1-2): 284-289.
- Pierson, William R., Robert H. Hammerle and Wanda W. Brachaczek. 1976. Sulfate formed by the interaction of sulfur dioxide with filters and aerosol deposits. Anal. Chem. 48(12): 1808-1811.
- Prahn, L.P.: U. Torp and R.M. Stern. 1976. Deposition and transformation rates of sulphur oxides during atmospheric transport over the Atlantic. Tellus. 28(4): 355-372.
- Prager, Manfred J., Edgar R. Stephens, and William E. Scott. 1960. Aerosol formation from gaseous air pollutants. Ind. Engr. Chem. 52(6): 521-524.
- Pueschel, Rudolf F. 1977. Cloud nuclei generation by a sulfur gas-to-particle conversion process. Presented at the 2nd National Conference on the Interagency Energy Environment R&D program. Washington, D.C., June 6-7.
- Renzetti, N.A. and George J. Doyle. 1960. Photochemical aerosol formation in sulfur-dioxide-hydrocarbon systems. Int. J. Air Poll. 2:327-345.
- Roberts, Paul. T. and Sheldon K. Friedlander. 1975. Conversion of  $\text{SO}_2$  to sulfur particulate in the Los Angeles atmosphere. Environ. Health Perspectives. 10: 103-108.
- Roberts, Paul T. and Sheldon K. Friedlander. 1976. Photochemical aerosol formation  $\text{SO}_2$ , 1-heptene, and  $\text{NO}_x$  in ambient air. Env. Sci. Tech. 10(6): 573-580.
- Rowe, R.D., M.F. Mohtadi, J.J. Havlena, D.I. Exall, S.F. Benjamin and T. Vysnianskas, 1977. A field study of  $\text{SO}_2$  oxidation rates in a sour gas plant plume using neutron activation of a gold particulate tracer. APCA paper No. 77-9.7. Presented at the 70th Annual Meeting of the Air Pollution Control Association, June 20-24, 1977. Toronto, Ontario, Canada.

- Sethi, Dhanwant S. 1971. Photo-oxidation of sulfur dioxide. J. Air Poll. Cont. Assoc. 21(7): 418-420.
- Sidebottom, H.W., C.C. Badcock, G.E. Jackson, J.G. Calvert, G.W. Reinhardt, and E.K. Damar. 1972. Photo-oxidation of sulfur dioxide. Env. Sci. and Tech. 6:72-79.
- Sie, B.K.T., R. Simonaitis and J. Heicklen. 1976. The reaction of OH with CO. Intl. J. Chem. Kin. 8:85-98.
- Smith, F.B. and G.H. Jeffrey. 1975. Airborne transport of sulphur dioxide from the U.K. Atm. Env. 9:643-659.
- Smith, Jerome P. and Paul Urone. 1974. Static studies of sulfur dioxide reactions. Effects of NO<sub>2</sub>, C<sub>3</sub>H<sub>6</sub> and H<sub>2</sub>O. Env. Sci. Tech. 8: 742-746.
- Smith, Benjamin M., Jack Wagman and Birney R. Fish. 1969. Interaction of airborne particles with gases. Env. Sci. Tech. 3(6): 558-562.
- Stephens, N. Thomas and Roy O. McCaldin. 1971. Attenuation of power station plumes as determined by instrumented aircraft. Env. Sci. Tech. 5(7): 615-621.
- Takahashi, Kanji and Mikio Kasahara. 1976. Aerosol particle formation from photo-oxidation of sulfur dioxide vapor in air. Fine Particles Aerosol Generation, Measurement, Sampling and Analysis. Ed., Benjamin Y.H. Liu. London, 1976. pp. 278-284.
- Urone, Paul, Helmut Lutsep, Claudia M. Noyes, and Jon F. Parcher. 1968. Static studies of sulfur dioxide reactions in air. Env. Sci. Tech. 2(8): 611-618.
- Urone, Paul, William H. Schroeder and Steven R. Miller. 1970. Reactions of sulfur dioxide in air. 2nd Intl. Clean Air Congress. Dec. 6-11, 1970. Washington, D.C. pp.370-375.
- Ursenback, Wayne O., A. Clyde Hill, W.H. Edwards, Steven M. Kunen and John A. Taylor. 1977. Conversion rates of SO<sub>2</sub> to submicron sulfate in the plume of a coal-fired power plant in the western United States. Paper No. 77-39.1. Presented at the 70th Annual Meeting of the Air Pollution Control Association. June 20-24, 1977. Toronto, Ontario, Canada.
- U.S. Department of Health, Education and Welfare. 1969. Air quality criteria for sulfur oxides. National Air Pollution Control Administration Publication No. AP-50. Washington, D.C.
- Van den Heuvel, H.P. and B.J. Mason. 1963. The formation of ammonium sulphate in water droplets exposed to gaseous sulfur dioxide and ammonia. Quart. J. Roy. Meteor. Soc. 89: 271-275.
- Wang, Charles C., L.I. Davis, Jr., C.H. Wu, S. Japar, H. Niki and B. Weinstock. 1975. Hydroxyl radical concentrations measured in ambient air. Science 189: 799-800.

- Weber, Erich. 1970. Determination of the life time of SO<sub>2</sub> by simultaneous CO<sub>2</sub> and SO<sub>2</sub> monitoring. Proc. 2nd Intl. Clean Air Congress. Washington, D.C. pp. 477-481.
- Whitby, K.T., B.K. Cantrell, R.B. Husar, N.V. Gillani, J.A. Anderson, D.L. Blumenthal and W.E. Wilson. 1977. Aerosol formation in a coal-fired power plant plume. Paper No. II. Particle Technology Laboratory Publication No. 335. Progress Report on Sulfur Aerosol Research of the Particle Technology Laboratory, Univ. of Minn., Minneapolis, Minn. July, 1977.
- White, W.H., H.A. Anderson, D.L. Blumenthal, R.B. Husar, N.V. Gillani, J.D. Husar, W.E. Wilson, Jr. 1976. Formation and transport of secondary air pollutants: ozone and aerosols in the St. Louis urban plume. Science. 194: 187-189.
- Wilson, William E., Robert J. Charlson, Rudolf B. Husar, Kenneth T. Whitby, and Donald Blumenthal. 1976. Sulfates in the atmosphere. Presented at the 69th Annual Meeting of the Air Pollution Control Association. June 27-July 1, 1976. Paper No. 30.06. Portland, Oregon.
- Wilson, Jr., Wm. E. and Arthur Levy. 1970a. A study of sulfur dioxide in photochemical smog. I. Effect of SO<sub>2</sub> and water upon concentrations in the 1-butene/NO<sub>x</sub>/SO<sub>2</sub> system. J. Air Poll. Cont. Assoc. 20(6): 385-396.
- Wilson, Jr., Wm. E. and Arthur Levy. 1970b. A study of sulfur dioxide in photochemical smog. II. Effect of sulfur dioxide on oxidant formation in photochemical smog. APCA Paper #70-115. Presented at the 63rd Annual Meeting of the Air Pollution Control Association. June 14-18, 1970. St. Louis, Missouri.
- Wood, William P., A.W. Castleman, Jr., and I.N. Tang. 1974. Mechanisms of Aerosol formation from SO<sub>2</sub>. APCA Paper #74-153. Presented at the 67th Annual Meeting of the Air Pollution Control Association. June 9-13, 1974, Denver, Colorado.