

TAILINGS BASIN DESIGN

William A. Ryan

Regional Copper-Nickel Study
Minnesota Environmental Quality Board
June 1978

PRELIMINARY DRAFT REPORT, SUBJECT TO REVIEW

TAILING BASIN DESIGN

INTRODUCTION

- I. Tailings Ponds
 - A. Basic Functions
 - B. Basic Considerations
 - C. Design Analysis
 - D. Construction Supervision
 - E. Problems Encountered
 - F. Factors Affecting Stability
- II. Size of Tailings Area
 - A. Pool Size
- III. Physical Properties of Tailings
- IV. Site Selection
 - A. Site Investigation
 - B. Soil and Construction Material Investigations
 - C. Site Preparation
- V. Tailings Embankment Design
- VI. Starter Dam Construction
 - A. Previous Starter Dam
 - B. Impervious Starter Dam
- VII. Drainage
 - A. Blanket Drain
 - B. Pipe Drain
 - C. Strip Drain
- VIII. Sand Yield
 - A. Sources of Materials
 - B. Waste Quantities
- IX. Construction During Operation

PRELIMINARY DRAFT REPORT, SUBJECT TO REVIEW

- X. Tailings Embankment Construction
- XI. Changes in Water Level Within the Embankment
- XII. Winter Conditions
- XIII. Runoff Control
- XIV. Embankment Freeboard and Wave Protection
- XV. Water Reclaim System
 - A. Decant System
 - B. Barge Pump System

Costs

Capital total + unit
Operating unit

References

INTRODUCTION

This tailings disposal guide has been prepared to show how tailing ponds are designed, constructed, and operated as well as some of the different methods used in performing these tasks.

The mining and processing of low-grade metallic ores result in large quantities of waste which leave the plant as a slurry with a 30- to 50-percent pulp density containing as much as 30 to 80 percent material of minus 200-mesh size. This slurry is retained in the tailings ponds, allowing the solids to settle out. The decant may be recycled or allowed to discharge into a watercourse. Mining operations of 30,000 to 100,000 tons per day are not uncommon with 95+ percent being waste which has to be stored in tailings ponds. The size of these ponds has increased tremendously in the last 10 years; for example, in 1938, 1 ton of ore produced 27 pounds of copper; 1947--18 pounds; 1960--14.4 pounds; and 1971--11 pounds. This trend will probably continue, but at a reduced rate. The disposal problem will get worse in the future as larger tonnages are milled and land becomes more costly. The height of the dams will have to be increased, compounding the stability problems.

An efficient design for waste embankments must consider the cost of alternative methods of waste disposal and of alternative construction material for the retaining dams. Construction procedures regarded as standard practice in producing stable highway, dam and other embankments in civil engineering may represent a substantial item of cost when applied to mine waste embankments. However, the increasing size of embankments in current mining operations makes it important that stabilization procedures, such as compaction and seepage control, be used to the necessary extent.

I. TAILINGS PONDS

As used in this guide, tailings ponds comprise embankments placed on the ground surface that are required to retain slurries of waste and water; they are constructed from tailings, borrow material, or some of each.

An idealized mine model can be seen in Figure 1 showing a typical mine waste disposal system. Some mines used deslimed tailings for underground fill, leaving only the finer material to be impounded on the surface. The materials range from chemically stable quartz to unstable feldspars which can alter to micrometer-size clay.

An adequate or satisfactory tailings embankment is defined as one that has a good factor of safety, will retain solids, and will control the liquid waste. Prevention of pollution by both solids and liquid must be incorporated in the design plans, together with shapes and stable slopes that will enhance rehabilitation of the area after it has been abandoned.

A. Basic Functions

The prime function of both mine waste piles and mine tailings ponds is to store solids. However, tailings ponds usually must provide temporary storage of a certain minimum volume of water for clarification prior to reclaim for plant use or discharge to adjacent streams.

(When the water contains a serious pollutant, the tailings dam must be designed to retain the water for longer periods until the harmful chemicals have degraded or until the water evaporates. A completely closed system is preferred in all such cases, not only for conservation of water, but as a necessity to prevent the pollutant from being discharged. The seepage water from this type of dam must be controlled, treated, and pumped back to the mill for reuse.)

(If this is not practicable, it may be necessary to treat the water prior to its release from the pond.)

B. Basic Considerations

(Economics continue to be of prime importance in the design of tailings embankments, including site selection, pumping requirements, length of pipe line, and capital versus operating cost. The annual tonnage versus site acreage, physical properties of tailings, type of embankment, method of waste disposal, availability of construction materials, climate, terrain, hydrology, geology, and nature of the foundation at alternative sites are all important factors. The consequences of failure should be fully considered in establishing the factor of safety (FS) of the embankment design.)

Embankments in remote areas can have a lower FS than needed in urban areas. Operating costs for tailings disposal can be a big item in a mining operation, and much thought should go into the study of capital versus operating cost.

(In some cases, the plan with the lowest capital cost can be the most expensive when the operating cost is added, and vice versa.) Probably the least expensive operation possible would be one where a few water-type dams could be constructed to enclose a large area, allowing the operator to merely dump the tailings; this would completely eliminate operating labor except for pump operation and periodic inspections.

Two extreme approaches are therefore possible in the design of mine tailings embankments - to make the embankment relatively impervious, or to make it relatively pervious. Whether one of these, or an intermediate approach is taken, the embankment must be adequately stable and necessary provisions must be made to control seepage through and under the embankment, and to control surface run-off into the pond.

C. Design Analysis

1. Economic Comparison

Alternative preliminary waste embankment designs should be made and the capital and operating costs of waste disposal over the life of the mine estimated for the alternatives studied.

2. Seepage Analyses

Seepage analyses should be made of tailings embankments to determine the probable location of the water table and the measures required for seepage control.

3. Stability Analyses

Static stability analyses should be made. Earthquake deformations, and the possibility of liquefaction due to earthquake shocks, should be considered if the embankment is located in a seismically active area (zones 1, 2 and 3 defined by the National Building Code).

4. Settlement Analyses

If the foundation soils investigations indicate that there are strata of substantial compressibility in the embankment foundation, settlement analyses should be made to determine: the expected settlement of the embankment; the possible extent of embankment cracking due to this settlement; and the amount of settlement of any drainage or decant culverts to be installed under the embankment.

5. Hydrological Analyses

For tailings embankments, analyses should be made to determine the probable influences of evaporation and runoff on pond water levels. Initially these should be based on available records of evaporation, precipitation and stream flows in areas near the embankment site and on information on the proposed rates of disposal into, and reclaim and seepage from, the pond. The results of these design analyses will usually indicate the
PRELIMINARY DRAFT REPORT, SUBJECT TO REVIEW necessity for

further climatic and hydrological investigations, if any.

D. Construction Supervision

For tailings embankments, foundation preparation and fill placement should be supervised continuously. For all high waste embankments, there should also be periodic site inspections by a competent person to review the general status of the embankment.

E. Problems Encountered

There have been many serious waste embankment failures and stability against sliding of embankment slopes is a major consideration in the design of waste piles and tailings embankments. Such sliding failures (Figure 2) can be caused by weak foundations, placement of the waste materials at slopes that are too steep (or of too great a height) and high piezometric water levels within the embankments or their foundations. Breaching of tailings embankments can occur as a result of over-topping by water in the pond, or by piping of fine materials under the action of seepage through the embankment or its foundation. A common problem had been the piping of tailings into decant and other culverts installed under tailings embankments.

F. Factors Affecting Stability

The resistance to sliding along potential failure surfaces within the embankment and its foundation is a prime factor affecting the stability of an embankment. This resistance is governed by the shear strength of the materials, both cohesive and frictional, and the pore water pressures at the failure surface. The shear strength of the materials can be reduced by weathering and by softening by water; it can be increased by compaction and, sometimes, by chemical cementing of the waste materials. Water pressures will vary from point to point within the embankment and its foundation, de-

PRELIMINARY DRAFT REPORT, SUBJECT TO REVIEW

pending on the source of seepage water and the relative permeability of the various materials in the embankment.

Cracking of embankment caused by differential settlements can reduce the shearing resistance along potential failure surfaces. Where such cracking occurs in a tailings embankment, excess seepage may develop leading, ultimately, to piping.

II. SIZE OF TAILINGS AREA

(The size of the tailings embankment necessary for each 1,000 tons of milling capacity for a safe and efficient operation is governed to some extent by the size of the grind, but mostly by the terrain within the tailings area. A relatively level area is an ideal site because of the large volume of tailings placed per foot of elevation rise.)

The ultimate volume of waste material will be a principal factor in selecting disposal area. When it is necessary to build a perimeter dam on a flat area, the largest area with the lowest dam will provide the maximum ratio of storage volume/dam volume. The ratio storage volume/dam volume is an indication of the efficiency of a tailings disposal system. If only a small flat area is available and a complete perimeter dam is required, the ratio will be low. Alternatively, in rugged terrain where it is only necessary to construct a dam across one end of a valley, the ratio can be very high. (Points of discharge can affect storage volume.) If the tailings are discharged at a remote point from the dam, in some cases the tailings may be stored to heights considerably above the crest of the dam.

With tailings embankments, an important influence on the design may be the relationship between the volume of fill required in the retaining embankment and the volume available in the pond for storage of the tailings.

A long embankment requiring a large volume of fill will usually mean that

the embankment crest cannot be kept much above the level of the rising pond and there will be a tendency for free water always to be close to the downstream face of the embankment. A short embankment having a low volume relative to the pond capacity may allow the embankment crest to be kept always well above the pond surface, thus keeping the free water well back from the downstream face, reducing seepage, improving stability and reducing the possibility of overtopping.

(A starter dam constructed from borrow material is a very important part of the entire impoundment.) The purpose of this dam is to contain the sand and provide a pond large enough to insure sufficient water clarification at the start of operations. The steeper the terrain within the embankment area, the higher the starter dam must be to supply the storage necessary for the sand and water until the embankment can be raised with the beach sand. (It is far better to make the starter dam a bit higher than required because of the unknown factors at startup of an impoundment.) These unknowns are (1) the efficiency of segregation of the sand and slime on the beach, (2) the angle of the beach area, and (3) most important, the retention time in the pond to get clean water. A capacity curve plotting the volume against elevation should be made, as well as a time-capacity curve to get the elevation rise per year through the life of the impoundment.

Where the maximum annual rise is limited to less than 8 feet per year, the active disposal area must be at least 20 acres per 1,000 tons of daily capacity. Operating at this upper limit of rise per year for continuous operation might be safe, but this depends on the grind, pulp density, and type of material being impounded. From an operating and safety point of view, a figure of 30 acres per 1,000 tons of daily capacity is much better for the lower limit of a mature pond.

(There is no established rate that an embankment can be raised, but for a given material, gradation, and pulp density there is a definite maximum rate of rise above which stability becomes a problem.

(If the tailings cannot drain as fast as they are placed in the pond, the phreatic surface rises and comes out the face above the toe dam.) When this occurs, seepage and piping take place, lowering the safety factor to the danger point. Possible solutions are to allow time for drainage and to place a filter and rock surcharge on the toe. A rapid annual rise is undesirable because the material does not have time to properly drain, consolidate, and stabilize, nor is there time to raise the peripheral dam.

(The principal climatic effects on the design of a tailings dam are the short-term peak flood flows from rainfall and runoff, and the extent of possible frost damage.) A tailings basin should be designed to handle peak flood flows and to maintain a minimum depth of water in the pool to settle the solids. (In winter it is necessary to increase the depth of the pool by an amount slightly in excess of the expected ice thickness to maintain the necessary depth of water for clarification.)

Pond Size

The area of the tailings pond required for adequate clarification of the water prior to reclaim or discharge to local streams is difficult to determine by theoretical means. Although the settlement velocities of various types and grain sizes of solids can be determined theoretically and experimentally, many factors influence the effectiveness of the pool. Basically, the problem is to provide sufficient retention time to permit the very fine fractions

to settle before they reach the point of decantation. Factors affecting the settling time are the size of grind, the tendency to slime (clay type minerals), the pH of the water, wave action and depth of water.

The size of grind required for liberation of the metal is usually sufficiently fine to produce particle sizes whose settling rate is governed by Stokes' Law, with a high percentage under 200 mesh. Particles in the range of 300 mesh or 50 microns with a settlement rate of 0.05 inches per second can be affected by wind action, but will settle in a reasonable time. The major problem is caused by the small percentage of particles in the range of 2 microns or less which produce turbidity. These particles have settlement rates less than 0.01 inch per second in still water and, under conditions prevalent in most tailings ponds, require some days to settle below the turbulence caused by wave action.

Various rules for clarification have been accepted as a result of observation in existing ponds. Among these are:

- 1) the pool should be sized to allow 5 days' retention time,
- 2) the area of the pool should be sized to provide 10 acres to 25 acres of pond area for each 1,000 tons of tailings solids delivered per day. An average of .15 acres per 1,000 tons is usually considered adequate, unless some unusual conditions are present.

The quality of the water returned to the mill or the watershed will determine the retention time for any particular mine.

The time required may be as low as 2 days and as high as

10 days, with an average of about 5.

III. PHYSICAL PROPERTIES OF TAILINGS

The field density of a tailings pond increases with time and depth below the surface. A typical example of the density change, in a copper tailings pond that is in an area with a highly permeable base and where two ponds are used alternately, is shown in Figure 3. The density ranges from 90 to 95 pounds per cubic foot at the surface to 100 to 105 pounds per cubic foot at the 45-foot depth. In this example the inactive pond is allowed to dry so the dike can be raised for the next 10-foot fill. These tailings are discharged at 48+ percent pulp density and contain 58 percent minus 200-mesh material, resulting in a very poor segregation of coarse and fine material in the pond.

The increase in density with depth depends somewhat on the mineralogy, screen size, and specific gravity, but of more importance is the ability of the water to drain through either drains or a permeable base. Typical permeabilities and permeability versus density are shown in Table 1 and Figure 4.

An important physical property of mill tailings is their shear strength. This property is expressed by the angle of internal friction, ϕ , and apparent cohesion, c . Typical values for the ϕ angle are 20° to 35° , increasing with increased percentage of sand in the tailings. Apparent cohesion is the function of mineralogy, moisture, and particle spacing; typical values range from 0 to 5 psi.

IV. SITE SELECTION

(The selection of a site for tailings disposal has to be made when the plant

and mine sites are selected. In the feasibility study of a new property, a tentative tailings site must be picked. It should be within a radius of 10 miles, preferably as close to the mill as possible, and downstream from the mill for gravity flow of the tailings. It must be of adequate size to accommodate the annual tonnage of tailings without too rapid rise in the height of the embankment each year.)

In a new area and early in the mine exploration period (as soon as it becomes apparent that a mine is in the making), data should be gathered in the area. All climatic data should be gathered, and onsite measurements of stream flow and evaporation should be made. Sedimentation characteristics, turbidity, pH, metallic ion count, etc., on the proposed waste should be determined. U.S. Geological Survey (USGS) topographical maps are usually available. Detailed contour maps of the impoundment area are necessary for the planning and design of mine waste embankments. Aerial photographs are useful for locating geological features that may not be discernible by surface reconnaissance and mapping and for locating potential sources of construction materials.

The USGS maps are valuable for reconnaissance surveys, for choosing a site, for measuring area and volume, and for general geology, drainage area, creeks, etc. Major faults should be avoided in the tailings area and especially in the dam area. (By the time of site selection, there should be enough geological information available to eliminate potential tailings sites on any mineralized areas, vein extensions, potential shaft sites, pit access, or possible pit extensions. The site should be far enough from the projected mining to preclude seepage, spills, or runs into the mine through faults, shafts, or fractures from mining operations.)

Habitation downstream from a potential tailings dam would affect the design in that a higher factor of safety would be necessary than in a remote area.

A. Site Investigations

Topographic maps necessary for planning a mine waste embankment can be obtained from the USGS. These topographic maps are available in various scales: 1:125,000 at 100-foot contour intervals; 1:62,500 at 50-foot and 40-foot intervals; 1:24,000 at 40-, 20-, and 10-foot intervals; and 1:12,000 at 40- and 20-foot intervals. When an area has been chosen, more detailed topographic mapping may have to be done locally, especially where the toe dam and drains are to be built.

Aerial photos of most of the United States are available from USGS in Menlo Park, California. They are a help in geological mapping because faults, different types of rock, ground cover, etc., are noticeable. Local detailed geology will probably have to be done by the company building the embankment or by a consultant hired to do this work. It is essential that this be done well and in great detail to be sure there are no weak or incompetent soil or rock, no major faults, and no ore deposits in the immediate area.

The extent of geological investigation necessary for a tailings impoundment will depend on the height to which it is to be built and the complexity of the foundation material. (The foundation must be firm enough to prevent undue settlement, strong enough to withstand the shear stresses, and of a nature that seepage can be controlled.)

For a major tailings impoundment a logical sequence of geological investigation should include:

PRELIMINARY DRAFT REPORT, SUBJECT TO REVIEW

1. Location and study of geological reports, maps, and photographs.
2. Field reconnaissance, including surveying and mapping of surface deposits, their extent and mode of occurrence, any outcrops, etc.
3. If overburden is deep, geophysical surveys may be necessary to determine the depth.
4. Measurement of ground water levels, which may also include pumping tests.
5. Location of all seeps and springs within the tailings area and especially in the dam area.
6. Core drilling for location of faults, planes of weakness, mineralization, and ground water. The main reason for core drilling is to check for mineralization. Any other information is a bonus and may be very helpful.
7. Laboratory testing of samples of rocks and soils including mineralogical analyses.
8. Availability of suitable construction materials.
9. Evidence of buried channels: evidence of instability.

The geological history of the surface deposits in and near the embankment site can often dictate the design and construction of the initial dam. The origin of the deposits and whether they have been subjected to consolidation pressures since their formation will indicate the physical properties that might be expected. Highly compacted and consolidated soils which demonstrate good shear strength are generally ample foundation for an embankment. Bedrock makes an excellent foundation, provided there are no extensive soft seams, or the material is not soft weathered shale, mudstone, schist, etc. If the overburden is shallow, the bedrock

essentially becomes the foundation, and under these conditions it should have more than ample strength.

B. Soils and Construction Material Investigations

Site investigation for low embankments of 50 feet or less on sites where bedrock is at shallow depths can be assessed by auger holes and test pits. For plants with large daily tonnages, where land and capital costs for tailings disposal are high, design must be for large areas with up to 200-foot-high embankments. This requires careful and detailed study of the foundation materials, especially if clay, silt or peat is present. Extensive foundation drilling, sampling, and testing may be necessary. Soil samples should be tested for in-place density, gradation, shear strength, consolidation, and moisture content. These tests are also needed for location and availability of borrow material for toe dam construction.

The depth of foundation boring will depend on: size of the loaded area, magnitude of loading and the subsoil profile. As a general rule, the borings should be deep enough to determine the subsoil profile within the depth significantly affected by the structure. However, if bedrock or relatively incompressible soil deposits occur within the significant depth, then the borings need only define the upper boundary of rock or incompressible soil. In the case of a tailings embankment, at least one borehole in the foundation soil should extend to a depth equal to 1.5 times the ultimate embankment height.

A common error is in defining the bedrock surface. Often large boulders occur in the foundation well above the bedrock surface and provide cores

that seem to be compatible with bedrock. If the bedrock surface is flat, the type of rock and the approximate depth to rock are known, it may be adequate to limit coring to 5 ft. (1.5 -3.0m) into rock; however, where bedrock is irregular and where large boulders may be overlying the bedrock coring should be 15-20 ft. (4.5 - 6.0m) into rock for low embankments and may have to extend 50 feet (15.1 meters) into rock for high embankments.

Organic soils are generally very compressible, have low shear strength, and should be removed from embankment foundations. When saturated or under load, they could act as a lubricant and cause a failure.

Solid bedrock has more than adequate compressive and shear strength to support mine waste impoundments. Where dams are to be constructed on or near bedrock, surface springs or artesian water can be a danger. Faults or fault gouge can affect the stability of an embankment.

The extent of investigation will vary depending on embankment height and complexity of the foundation. For all waste embankments, sufficient information should be obtained to: define and assess the presence of weak zones in the foundation, determine whether the foundation is strong enough to withstand the shear stresses, and evaluate methods of controlling seepage.

Subsequent steps will depend on the size of the embankment and the character of the soil profile. The importance of the structure and results of the exploratory drillholes will indicate the extent of the detailed drilling program. At sites where the subsoil profile is erratic, it

will be necessary to define the pattern of dissimilar soils and characteristics of the various strata. Probing with a cone penetrometer can provide rapid identification of the density of subsoils.

The preliminary investigation of an area will usually disclose a number of deposits of material that may be suitable for constructing an embankment. Further investigation is necessary to determine the extent and characteristics of the material in the deposits. The physical properties of glacial tills and similar soil mixtures depend on their densities and gradations. The amount and type of fines are important. Finally, alternative sources of material can be compared in terms of volume, characteristics and delivered cost.

Digging test pits with mobile equipment is an expedient method of investigating borrow materials. To provide a competent seal and internal drainage system for a tailings dam, it is necessary to locate a source of both impervious and pervious material. Sampling and testing should be sufficiently extensive to confirm an adequate quantity of each. Normally, testing would include determining in situ moisture content, gradation, optimum moisture content and optimum density for compaction of the borrow materials, shear strength, and permeability of the materials.

C. Site Preparation

The foundation investigation and sampling will dictate what has to be done to prepare for dam construction; site preparation will vary considerably

depending on whether the dam is to be high or low (>100' or <100') and whether it is to be a true water-type dam or not. If it is to be a true water-type dam, consultants familiar with dam construction are a necessity.

If the tailings dam is to be on or near bedrock which is relatively impervious, an inspection of the bedrock may be warranted to check for open fissures that must be sealed to prevent piping. Coarse foundation soils and buried coarse rock should be removed. Excavation of all vegetation, surface growth, pockets of peat, and zones of weak and pervious soil should be performed, resulting in competent foundation material. Consolidation testing may be necessary and foundation scarifying and compaction of foundation soil may be required to attain a sufficiently strong foundation.

(Where the entire tailings area is on deep alluvium with a permeability (K) of 10^{-2} to 10^{-3} centimeters per second, the seepage cannot be stopped by the dam because most of the seepage water goes through the subsoil and not through the base of the dam. A cutoff trench is sometimes used in the construction of a starter dam where conditions warrant its use, such as a pervious foundation extending to a shallow depth.) The cutoff trench can intersect a relatively impervious layer to reduce the downstream seepage. A cutoff trench may also be used where the foundation is on bedrock and a cutoff and anchor are needed. (The cutoff trench would more probably be used with the centerline or downstream method where seepage through the starter dam is not wanted. It would not be used where a blanket or strip (gravel) drain was to be used extending upstream from and completely beneath the starter dam, but it could be used where pipe drains extend through the starter dam.)

V. Tailings Embankment Design

(The design of tailings embankments depends on the method of construction, particularly when the primary embankment material is sand obtained from the tailings slurry. In this case, construction is basically a part of the tailings disposal operation. The embankment design may be influenced strongly by the need to arrive at the most economical overall system.)

Embankment construction methods are described after the Design section. An overriding factor will be the need to keep the embankment crest above the pond surface. This can affect the entire design and basic construction methods. Where tailings sand is the principal embankment material, one of three basic placement procedures can be used. These, and the types of embankment cross-sections resulting from their use, are shown in Fig. 5. When other borrow or dry-waste material is incorporated in the embankment, many alternative types of embankment are possible. Some of these are illustrated in Figs. 6 to 9.

(Designing a tailings embankment is a process of successive trials and refinements. Generally, the steps required to develop the final cross-section are as follows:

- a. determine the long-term storage volume and schedule of storage requirements,
- b. investigate alternative disposal areas from topographic data and use the potential ratio of storage volume/dam volume for preliminary site selection.
- c. determine other possible types and quantities of construction materials available,
- d. assess major constraints relating to property acquisition

- and environmental regulations,
- e. determine the proposed method of tailing disposal, k.e., select a point of discharge removed from the dam, spigots and hydrocyclones,
 - f. select a trial embankment section incorporating the most economic and readily available fill material,
 - g. make a stability analysis for the trial section to determine the factor of safety. The stability analysis should take into account shear strength and density of the material comprising both the foundation and the embankment as well as the expected pore water pressures within the embankment and the foundation. Pore water pressures resulting from steady seepage within the embankment and within pervious foundations can be estimated from flow nets. If compressible foundation strata are located beneath the embankment, foundation pore pressures estimated on the basis of consolidation theory should be taken into account in the analysis and should be checked by field measurements during and after construction. If the stability analysis for the trial embankment indicates that the section is unsafe, or that the factor of safety is unduly high, the section should be modified and the stability analysis repeated until a satisfactory section is developed, and
 - h. prepare detailed construction drawings and specifications for foundation treatment, fill placement and waste disposal.

The design of mine waste embankments is particularly dependent on the methods utilized for waste disposal, as these establish the condition and distribution of the materials in the embankments. For tailings embankments, the methods and locations of slurry disposal and water reclaim are major factors to be considered. (By locating disposal points near the embankment crest and the reclaim water intake on the far side of the pond, the pond water can often

be maintained at a location well back from the upstream face of the embankment. This will reduce seepage through the embankment, lower the level of the phreatic surface within the embankment and allow greater freedom in selection of the type of embankment.) Embankments of tailing sands alone are more likely to be stable under these conditions than they are with the pond located close to the upstream face of the embankment.

Barge-pump reclaim systems are likely to be more economical than decant or siphon systems when the pond is located distant from the embankment, because of the culvert lengths involved. Decant culverts should be conservatively designed, because of the danger of piping into collapsed sections and open joints and along the outside of the culvert - a common type of failure in the past. Siphons have several serious operating disadvantages.

Mine waste embankments are usually raised to full height over a period of many years and during this time, many factors can develop to influence the stability of the embankments. (High embankments should be instrumented to monitor movements in the embankment and its foundation, and to measure changes in piezometric levels and seepage flows.) Data obtained by these instruments, and construction and waste disposal procedures, should be recorded and periodically reviewed to ensure the safety of the embankment throughout its life.

VI. STARTER DAM CONSTRUCTION

When the dam site excavation is complete and has been constructed through the base of the dam, the dam construction itself can proceed.

The first step in constructing any dam is to prepare the foundation for the proposed embankment. In some instances it may be desirable to build a coffer dam. In the case of a tailings dam, a starter dam will usually

serve the dual purpose of cofferdam and provide sufficient storage capacity to retain the tailings until the first stage of the embankment is complete. The required storage capacity will dictate the minimum height of the starter dam to schedule closure of the first stage construction.

The planning, design and construction of the effluent or reclaim water system from the tailings basin must be consist with the schedule for the starter dam and the first stage construction.

It should be noted that the height of the starter dam will depend on: (a) the area and volume of the tailings basin, (b) the volume and schedule of the tailings disposal, (c) the necessary depth of water in the pool to maintain a clear effluent, (d) the height, details and sc hedule of stage one construction and, (e) details and scheduling of the effluent or reclaim system.

The embankment construction schedule is related to the rate of rise of the pond. The elevation of the crest of the starter dam, the volume of rock fill or borrow material in the embankment, and the stage boundaries are established so that successive berms are ready for the tailings piplines before the tailings in the basin rise to the level of the construction berm.

The excavating and hauling of material from the various borrow areas must be closely supervised so that each zone in the starter dam receives the proper material, the layers are placed on the dam in proper thickness, and the moisture and compaction are up to specifications. Moisture and density samples must be taken frequently to insure proper density.

It has been stated previously, but it cannot be overemphasized, that the starter dam using the upstream method of construction should be relatively permeable, whereas with the downstream method it should be relatively

impermeable. See Figs. 10 and 11 for typical detail of starter dam construction. Each area has its distinct problems, and these figures merely illustrate some of the detail necessary for proper construction.

A. Pervious Starter Dam

Excavation for the base of the starter dam should be down to a competent soil that will withstand the weight contemplated. All the organic soil, trees, and brush should be removed. On a smooth rock foundation with a 5- to 10-percent slope, a trench cut into bedrock may be needed to key the dam to the rock. Foundation defects such as open cracks in the bedrock, clay seams, buried coarse talus deposits, or pervious foundation soils should all be remedied. *PROVEN ROCK AT BOTTOM OF VALLEY* Loose and pipable material should be excavated, and open cracks should be filled to prevent piping under the dam.

All the possible problems and conditions for all situations cannot be contemplated. Actual treatment of the foundation depends on conditions exposed in the field and must be solved there. Seepage through or beneath the starter dam in this case is not bad except that it must be controlled so that it does not lead to piping. On deep alluvium most of the seepage would go out the bottom of the pond with part of it flowing under the dam.

A pervious starter dam should have a permeability of 10^{-2} to 10^{-3} centimeters per second, but the main criterion is that it have a higher permeability than the sands it is retaining. It is necessary that the starter dam not retain water so that the phreatic surface hits as low as possible on the upstream face and does not emerge on the downstream face. All the water that reaches the starter dam must go freely through it to a collection pond below the downstream toe. The sand-gravel mix must be placed in thin layers and compacted to 95 percent of Proctor to insure stability while *COMPACTED TEST*
PRELIMINARY DRAFT REPORT, SUBJECT TO REVIEW

construction of the dam should be tested for permeability in the laboratory at Standard Proctor density and the material should be placed in the dam so that the permeability increases downstream and the overall permeability is greater than that of the sand being impounded.

B. Impervious Starter Dam

If all or most of the borrow available for construction within economical hauling distance of the site is a relatively impervious material, or if the "downstream method" of placing tailings is to be used, an impervious starter dam should be built.

The method of construction for the impervious starter dam is the same as for the pervious dam. Compaction should be 95 percent of Standard Proctor, and the foundation excavation and preparation should be the same. For the ordinary upstream method of placing sands, the starter dam should have drains to catch all the seepage water and let it pass freely under the starter dam in pipe or blanket drains. Under no conditions should the starter dam retain water against its upstream face because it would become saturated and unstable. Under these conditions the seepage could emerge high on the sand face above the top of the starter dam, and remedial measures would be necessary. These remedial measures are described elsewhere but are no substitute for proper drainage, design, and construction. The ultimate height that the dam could be built is materially reduced if a high phreatic line is generated.

With the downstream method, the starter dam is at the upstream toe of the completed dam. It can and should be impervious relative to the sand and

retain water as much as possible. The seepage that eventually goes through and over the top of the starter dam will move down through the more pervious sand and into the drains between the starter and downstream toe dam (figure 12). The stability of this starter dam is not a problem because it eventually is completely surrounded by tailings sand on its top and downstream and by slimes upstream.

The area between the upstream starter dam and the downstream toe dam must have blanket or strip drains to catch all the seepage and drain it out to a holding pond where it can be recycled or discharged. These drains would not be necessary if the cyclone sand were > 100 times the permeability of the starter dam.

VII. DRAINAGE

Seepage will occur whenever there is a differential head of water across an earth dam; however, the quantity can be controlled within reasonable limits.

(From the designer's viewpoint, it is desirable to promote drainage of water from the tailings dam in order to keep the phreatic surface as low as possible and help the consolidation and stability of the embankment. For this reason, the relatively pervious tailings dam is the most common design used.) It is also the cheapest because it can be built from the coarse fraction of tailings or from readily available borrow material. The impervious tailings dam is the least common type and is used only where it is necessary to retain polluted water or low-density solids that are slow to consolidate. In either type of dam, the stability of the dam is of paramount importance and necessary provisions must be made to control seepage through and under the embankment and to control surface runoff into the pond.

Unwanted seepage through the bottom of a tailings pond in a relatively level area with deep pervious alluvium can be tremendous at the clear water-soil contact. A layer of slimes reduces this seepage considerably, but with a normal spigoting operation the slime is below the area of contact, leaving a water-soil contact 50 to 100 feet or more wide unless special effort is made to place a slime layer over the entire area first.

Seepage through a natural soil or rock mass depends not only on the coefficient of permeability of the homogeneous material but also on local variations such as fissures, joints, lenses of open-work talus and gravel. The voids in a homogeneous soil, without fissures, can be measured in fractions of a millimeter. The dimensions of open fissures which exist in natural soil or rock masses and in embankments, can often amount to several centimeters. The seepage flow through such fissures can exceed by hundreds of times the flow through the homogeneous soil or rock itself. Where potential seepage is important, which is the case with tailings embankments, the existence of such fissures should be considered. They can occur in the foundation, at the contact surfaces between the embankment fill and the underlying foundation and abutments, within the fill itself in the form of segregated seams of stony material between compacted layers, and at contact points between conduits and walls incorporated in the fill.

Economic considerations frequently dictate that the tailings embankment be constructed using the most readily available fill material commensurate with adequate stability of the structure. The position of the phreatic

surface or water table within an embankment has a marked influence on the slope angle required for stability. If the permeability of the embankment fill is of the same order of magnitude or less than the tailings adjacent to the embankment, drains should be provided beneath the downstream zone to lower the phreatic surface. The drainage system may consist of chimney drains, blanket drains, finger drains, toe drains, drainage pipe or a combination of internal drainage methods.

(Suitable drainage provides the following advantages: (a) the phreatic surface will be lowered in the downstream zone of the dam, thereby avoiding the problem of sloughing along the downstream slope at a point where seepage might otherwise exit; (b) lowering the phreatic surface reduces the pore water pressure and increases stability of the embankment section, thereby permitting steeper downstream slopes and requires less fill to achieve the desired factor of safety, and (c) the internal drainage system can be designed to permit seepage water to drain below the frost line, reducing the possibility of ice lensing (which creates an impervious layer and causes buildup of pore water pressures) and surface sloughing with subsequent thawing. Figures 13 and 14 illustrate the effectiveness of underdrains and pervious foundations in lowering the phreatic surface.)

The choice of drains depends on the availability of suitable drainage materials, drainage capacity required, cost of construction and foundation conditions. Permeability of the drain material should be at least 100 times greater than the permeability of the adjacent embankment material and its gradation must satisfy filtering requirements.

Pipe drains should be avoided if the foundation beneath the tailings embankment is compressible and significant differential settlement is anticipated.

27

pated. The lateral strains associated with differential settlements may result in opening of pipe joints, loss of fine material into the pipes and internal embankment erosion that may be impossible to control.

Where pipe drainage is used, the pipes should be designed to withstand the maximum anticipated loads, including those imposed by settling of the overlying fill. If perforated pipes are used, the perforations should not be at the top or at the bottom so as to minimize the entry of solids and prevent loss of seepage water once it has entered the pipe. The perforations should not be larger than half of the 85% size of the drainage material surrounding the pipe. Larger pipe perforations can be used if the pipe is wrapped with a woven nylon mesh of filter specification. Pipe drains can seldom be repaired. In view of the serious consequences resulting from the collapse of pipe sections, or opening of joints, pipe drainage systems should be avoided; finger drains and blanket drains with suitable graded filters are preferable.

Finger drains consist of strips of pervious drainage material placed on the foundation, and in some cases at higher levels also, prior to placing overlying embankment fill. The arrangement and alignment of strip drains will be governed by contours of the foundation surface. The drains should be provided with adequate fill to outlets located beyond the downstream toe of the embankment.

Designers have to determine thickness of the drainage blanket or the dimensions of finger drains, to ensure that their capacity is greater than the calculated rate of seepage through the embankment.) The lower limit of the probable range of coefficients of permeability of the drain materials should be used in these calculations. Where the foundation strata are relatively permeable and the natural groundwater table is high, the design capacity of the drainage system should take into account any seepage that

PRELIMINARY DRAFT REPORT, SUBJECT TO REVIEW

may enter the drainage system from the foundation strata. (Where the natural groundwater table is at an appreciable depth, some of the seepage through the embankment may drain into the foundation strata, thereby reducing the required capacity of the drainage system.) If the foundation strata contain layers or laminations of relatively impervious material, loss of seepage into the foundation may be severely restricted, in which case an impermeable foundation should be assumed. Dimensions of the drains should be as generous as practicable commensurate with the quality and cost of the material available and the need to construct the drains without constrictions, gaps, or segregation of material. The construction of all internal drainage systems for earth dams should be rigidly controlled to assure the quality of this component. The thickness of blanket and finger drains should be at least 12 in. (30 cm), and the width of the drain should not be less than 10% of the difference in elevation between the pond surface and the drain.

Blanket and strip drains should be designed to accommodate full design flow when the phreatic surface within the drain is below the upper surface of the drainage material.

A. Blanket Drain.

This type of drain would be used in a cross-valley dam with either a pervious or impervious starter dam, where bedrock or a relatively imper-

vious base is close below natural ground level and where the upstream method of dam building is to be used utilizing the tailing sands. The purpose of this blanket drain is to intercept the water that moves downward out of the tailings as well as any springs or artesian water that may come up from below. If springs are found in site investigation or artesian water in drill holes, either from the rock or below a stratum of impervious clay, the blanket drains should have capacity to remove all this water plus additional capacity for that which may not have been discovered. It is very important that this water be removed because in mountainous areas it could have a high head and if trapped below the slime layer in a tailings pond it could exert tremendous upward pressure and greatly reduce the factor of safety of the embankment.

The drain consists of a layer of clean gravel up to 18 inches thick extending from above the upstream toe to below the downstream toe and wide enough to cover the main valley bottom. This gravel drain is protected by a 9- to 12-inch filter layer of clean sand and gravel both above and below. An additional drain of unprocessed sand and gravel up to 3 feet deep is also placed upstream to extend the drain area as far as deemed necessary to catch all the seepage.

These drains must have a catchment ditch filled with cobbles to intercept the drainage and prevent erosion on the downstream face. Where the downstream slope of an embankment is composed of fine-grained materials, water should not be allowed to flow out of this slope. Lowering the phreatic surface increases the stability, permitting the use of steeper slopes, and reduces the volume of construction material needed. In cold climates it

is especially important that the drain water be directed through a drainage blanket below the compacted soil so that it will not freeze and raise the phreatic surface causing the entire embankment to become saturated behind a frozen blanket of soil on the downstream face of the starter dam.

B. Pipe Drain

Where drainage pipes are to be used, the pipes should be designed to withstand the maximum anticipated load of the overlying tailings. When perforated pipe is used, it should be perforated on the bottom half only and laid with the perforations down, with a bed of gravel both top and bottom and graded filter surrounding the gravel (Fig. 14). The diameter of the perforations should not be larger than one-half of the 85-percent size of the drainage material surrounding the pipe. (Pipe drains can be very satisfactory with a good foundation and careful construction, but the blanket or strip drains may be more fail-safe.) Various arrangements of pipe drains can be made. A perforated pipe parallel to the upstream toe of the starter dam with one or more solid pipes through the dam to the downstream toe is the simplest. This same arrangement can be used as a collection for drains up to 600 feet long running parallel to the valley at right angles to the dam axis and spaced at 50- to 100-foot intervals along the valley floor and walls (Fig. 15). Pipes through the starter dam should not be perforated and should have at least three cutoff collars that extend at least 2 feet from the pipe to prevent "piping".

If the foundation beneath a tailings embankment is compressible and differential settlement is possible, pipe drains should be avoided. The stress may result in opening pipe joints or breaking the pipe, which might allow internal erosion.

C. Strip Drain

Strip drains are the same as blanket drains in design and construction except that they are narrow strips of drain material laid in the foundation prior to dam construction. They are laid out to carry drainage through the dam and to outlets beyond the downstream toe of the embankments. The drains are laid out in strategic locations to catch the drainage and must be arranged according to the contours of the foundation. Strip drains can be used upstream from the starter dam in the same manner as blanket or pipe drains.

In areas where the bedrock is 100 to 500+ feet deep and the soil is very pervious (10^{-2} to 10^{-4} centimeters per second) the blanket, strip, or pipe drains extending upstream from the starter dam would not be used because the seepage through the bottom would go down toward bedrock and not follow the drain. (Nearly every mine has a different set of conditions, and each tailings area must be designed accordingly.)

Because of the layering in a spigoted embankment, the permeability in the horizontal direction may be as much as 5 to 10 times that in a vertical direction, especially if the grind is coarse and the pulp density is low. To determine the seepage from the pool and from the spigoting on the beach, a flow net should be used to estimate the seepage rate to the drains. The quantity of seepage will depend on the permeability values, hydraulic gradient, and area of flow. In some embankments and possibly all of them, the piezometric head from the downstream toe up and under the beach (on a large dam 500 to 600+ feet distance) is determined more by the water flowing on the beach during disc charge than by the water escaping from the pond area. The water in the pond is contained in a saucer of slime with

the permeability lowest at the center of the pond and increasing toward the beach.

Calculating the thickness and width of blanket and strip drains is probably worth the effort from a cost standpoint because the difference of cost between 1 foot and 2 feet of gravel over a large area could be considerable. The drains should be as large as practicable considering the cost and availability of materials. They should be uniform and continuous and constructed of the proper gradation of materials, without which they could become useless.

Granular materials incorporated in underdrainage systems should be compatible with the properties of the seepage water they are designed to carry. Drainage materials composed of carbonate rocks are unsuitable if the seepage collected by the system is acidic.

Blanket drains and strip drains should be designed to be capable of passing full design flow when the phreatic surface within the drain is at or below the upper surface of the drainage material.

VIII. SAND YIELD.

The yield of suitable sand obtained in separating the coarser fraction from the raw tailings affects the design and construction of the embankments.

The yield of acceptable sand from cyclones can be calculated from the gradation of the raw tailings and the characteristics of the cyclones. The rate of embankment construction will depend on the amount of available sand, the length of the embankment being built, and the weather, or the number of months a year that it is possible to construct embankment. Using cyclones

and the downstream method, each foot of rise takes longer and requires more sand than the previous foot. The use of cyclones with the centerline method is clearly as bad.

(In planning any tailings site, the active time for embankment utilization is far below 100 percent. The time required to build embankment and replace spigots or cyclones and the time necessary to raise the entire line to a new berm are times when the pond is not available for discharging tailings unless they can be "dumped" at some other spot in the pond.) For this reason, it is better to have two complete and separate dams. This is especially important at the start of a new operation. With two dams there can be a complete shutdown of an area so that the sand beach can be drained, dike built, and pipes or cyclones replaced. By alternating sites, a regular schedule of maintenance and operation can be set up; also the annual rise of the embankment is reduced, which improves slope stability. Where the winters are severe, dike building can be done only in the 6 to 8 warmer months to prevent the formation of ice lenses in the beach area. Enough sand must be available to build enough dike in the summer to last through the winter months. Where tailings sand is used for mine stope fill, the amount of sand available for embankment construction is further reduced; of course, the total volume to be impounded is also reduced by this amount.

(When the grind is such that the proportion of minus 200-mesh tailings is more than 55 to 60 percent, the use of cyclones is almost mandatory in order to save the entire volume of sand for dam building.) Under certain conditions, a water-type dam should be considered even though the capital cost is high. For these dams the operating cost is very low. Conditions that may warrant water-type dams are high percentage of slimes, harmful

chemicals in the tailings, and, for phosphate clay, slimes with no sand in the tailings.

A. Sources of Materials

A fundamental consideration in the design of any earth embankment is that of the sources of material from which the embankment can be built. Because of the relatively large quantities of fill involved, it is desirable to locate borrow pits close to the embankment. (The cost of hauling borrow materials more than one or two miles is usually prohibitive. In the case of embankments required to retain mine wastes, the low costs of waste materials available for use as fill will often dictate that these materials be used to the maximum possible extent for embankment construction and that more costly borrow materials be kept to a minimum.) If the quantity of sands from the tails are not sufficient to build all the dam needed, then fill will be brought from the mine or borrow pits.

B. Waste Quantities

Together with the topography and geology of sites available for the disposal of waste materials, the overall quantity of waste will establish the extent and height of waste embankments. A lower but more extensive waste pile may ensure a greater degree of stability at some sites but may be less economical than one of greater height and more limited extent. (The required rate of disposal may affect the method of disposal, also, and consequently the design of the embankment.)

IX. CONSTRUCTION DURING OPERATION

The beach formed from tailings containing 38 to 40 percent minus 200-mesh material discharged at 30 percent pulp density is a relatively clean sand with 10 to 15 percent minus 200 mesh and makes a good dike-building material.

It will drain rapidly and can be moved with a dragline or dozer from the beach to build the dike when the moisture content is optimum for good compaction. Tests should be made on this material to determine the optimum moisture, depth of each layer to be compacted, and method of compaction. Care should be taken that the moisture of the sand does not get into the bulking range where it is virtually impossible to get good density. The permeability of this beach material can be in the range of 1×10^{-2} to 1×10^{-3} centimeters per second.

Carefully controlled cyclones can produce a very uniform product, but when they are on a tailings embankment with all the variables there is a great difference in the product. The pulp density, feed rates, pressure, and wear on the cyclone orifice all make a difference in the cyclone underflow, and there is little that can be done on the short term to change the cyclone adjustment to compensate for it.

The gradation of the tailings from the mill is entirely dependent on the grind necessary to free the ore minerals from the gangue. This is determined first in the laboratory and then in a pilot mill during the design phase of a new mine. When a suitable grind has been determined in the pilot mill, tests can be made to determine the types and sizes of cyclones and the number of stages necessary to provide a suitable underflow. Spigoting tests of the sands can also be made to simulate the segregation on the beach to determine if this method can be used. From this same material a probable range of permeabilities of the sand can be determined and will enable the designer to incorporate suitable seepage control provisions into the design. The tailings produced by the cyclones may be adjusted during early stages of operation to get the proper sand for embankment construction. (The sand separation and placement should be carefully watched.) An attempt to recover

PRELIMINARY DRAFT REPORT, SUBJECT TO REVIEW

additional metals could make a change in the mill circuit and also affect the tailings pond.

X. TAILINGS EMBANKMENT CONSTRUCTION

The vast majority of mine concentrators use a wet process to separate the valuable minerals and the tailings material is in the form of a slurry for convenience of disposal. Therefore, when tailings are used to construct a tailings dam, it is frequently constructed by hydraulic means using one of two common methods - by hydrocycloning and by spigotting - to separate the relatively coarse-grained sand which is useful for building purposes from the fine-grained slurry.

The three common construction methods illustrated in Fig. 5 are the downstream method, the upstream method, and the fixed centreline method.

(To regulate expenditures for tailings disposal, embankments are frequently raised in stages as required to maintain the desirable freeboard of the dam above the pool surface. The most practical method of raising the embankment in stages will be governed by such considerations as: the design of the dam, materials available for construction, methods and distribution of tailings sand production, and on the volume of sand required in the embankment cross-section.)

Downstream

In the downstream method the crest of the embankment is raised in successive stages by placing tailings sand on the downstream side of the starter dam. The starter dam forms the upstream toe of the ultimate dam and should be impervious to restrict seepage. This method provides major structural advantages by facilitating installation of internal drainage at the base of the dam beneath successive stages of construction, enabling the total structural section to be built with competent material, and permitting an

engineered upstream seal to be included in the embankment. (Fig. 5)

In the downstream method, the total embankment section lies outside the boundaries of the sedimented tailings slimes. Material incorporated in subsequent stages of the embankment may consist of the coarse fraction of the tailings separated by cycloning, waste rock from the mining operation, or natural soils from nearby borrow pits. When cyclones are used, the overflow, or slimes product, is discharged beyond the upstream toe of the embankment. The downstream method of construction permits controlled placement of the embankment materials and compaction can be included when it is desirable to increase the shear strength of the construction materials. The inclusion of internal drainage and an upstream seal will result in a low phreatic surface within the embankment. The downstream method is an inherently safer procedure than the upstream method of construction.

Hydrocyclones, or cyclones, can be used to separate sands from the slimes.

A series of cyclones can be placed along the crest of the embankment as shown in Figs. 16, 17, 18, (19) ^{SPIGOTTING}, 20, or a group of cyclones ^{FIG 17} can be mounted in parallel as a mobile unit which travels parallel to the longitudinal axis of the dam.

It is possible to construct an embankment or a stage of the embankment to any desirable height in a single lift, using a mobile cyclone unit without the assistance of other machinery. Also, the tailings header can be laid along successive berms with a series of cyclones mounted on raised movable platforms or the tailings header can be mounted on trestles or towers with lateral takeoffs for each cyclone to construct the next stage.

It is necessary to elevate the cyclones to provide temporary storage for the cyclone underflow sand prior to spreading and compacting. The overflow from the cyclones is discharged upstream into the slimes basin.

Cyclones are usually used for the downstream method or the fixed centreline method. The limitation on the application of cyclones for building tailings dams is often dictated by freezing weather or the limited amount of sands in the tailings slurry. Generally, it is not practical to construct a tailings dam by the downstream or centreline methods if the tailings contain more than 75% slimes. When the tailings sands are used for back-fill underground and the remaining tailings directed to the tailings basin, it is not practical to use cyclones for dam building. Cycloned tailings sands are pervious and therefore it is essential to provide an upstream impervious seal to restrict the flow of seepage water from the tailings basin.

UPSTREAM

In the upstream method of construction, the crest of the embankment is raised in stages by placing tailings sand in successive dykes above the upstream side of the starter dam, or the upstream side of a preceding dyke. The successive stages form a relatively thin structural shell on the downstream slope, and it is generally necessary to improve stability of the dam by including berms at the stages to flatten the overall effective slope. The initial starter dam forms the downstream toe of the ultimate dam. It must be pervious to prevent the buildup of pore water pressures which may permit more seepage than desired. This problem can be reduced by providing a low starter dam with a wide base of pervious material, sealing the upstream slope with a limited amount of impervious material. The second stage is built above the crest of the wide starter dam (Fig. 5).

Spigots are frequently employed in the upstream method of construction. As the tailings slurry is discharged from a series of spigots along the crest of the dam, the slurry meanders in a random manner depositing sands and

and slimes in a series of loose, discontinuous, horizontal stratifications. To provide the required freeboard on the crest of the dam, it is necessary to reclaim the tailings adjacent to the crest with mechanical equipment such as draglines or dozers. It is difficult to provide a competent seal above the base of the settling pool and the line of saturation within the embankment varies as the elevation of the pool surface is increased. A major portion of the structural section of the embankment is composed of loose material with a relatively high phreatic surface and low shear strength. Therefore, to provide an adequate factor of safety for the embankment, the downstream slope must have a relatively flat angle or berms must be included to provide a desirable overall effective slope. Owing to the wide variation in permeability and the possibility of high porewater pressures, low relative density and low shear strength, the upstream method of construction may be unsuitable for areas subject to intense seismic activity.

The sand characteristics from the cyclone underflow are relatively constant for a particular set of operating conditions, whereas the characteristics of the spigot product vary widely from one location to another depending on velocity of the meandering discharge and location of the sedimented particles within the stream. An embankment which has been constructed by spigotting usually consists of a series of horizontal discontinuous stratifications of sand and slimes.

Centerline ??

XI. CHANGES IN WATER LEVEL WITHIN THE EMBANKMENT

Changes in the level of the water table in a waste embankment will change the pore pressures and consequently the resistance of the pile to sliding. Increases in level can be caused by surface water seeping into a waste pile, springs located under the pile and not effectively drained, seepage

PRELIMINARY DRAFT REPORT; SUBJECT TO REVIEW

water from settlement ponds constructed on the pile, blockage of drainage culverts beneath or around the waste pile and changes in the characteristics of the waste materials placed in the pile.

In tailings embankments, increases in the level of the water table can be caused by blocking of drainage and filter layers within or below the embankment, freezing of surface layers of material on the downstream slope of the embankment and changes in methods being used to construct the embankment.

Alteration of the permeability of foundation materials below waste embankments caused by strains induced by mining subsidence can also affect the level of the water table.

(XII. WINTER CONDITIONS)

(Freezing can affect tailings embankment design in several ways. Spigotting or cycloning operations may be impracticable during the winter, thus preventing raising of the embankment crest during this season. Meanwhile, with continued disposal of tailings into the pond, the pond level will continue to rise. Particularly with embankments constructed by spigotting, the freeboard available at the end of the winter for storage of the spring, snow-melt runoff may be very small, involving a real danger of overtopping or piping failures. This seasonal variation in disposal procedures may also affect the distribution of tailings materials in the pond, winter dumping of tailings at points distant from the embankment sometimes causing the fine "slimes" fractions to settle near the face of the embankment. Subsequent raising of the embankment crest over these slimes may then lead to instability of the embankment.

Snow layers incorporated in the embankment, or the freezing of saturated materials on the downstream face, can also affect its stability. Freezing of the downstream face, which is aided by high pond water levels, can cause instability by blocking natural drainage, thereby raising the water table in the embankment. Freezing of the pond water surface can also cause difficulties with water reclaim, thus affecting pond levels.

XIII. RUNOFF CONTROL

Tailings basins and waste piles should preferably not be located in natural water courses. If it is necessary to locate a disposal area in a stream bed, the stream must be diverted around the disposal area.

There will always be some catchment area contributing runoff into a tailings basin or waste embankment. This may vary from a minimum area encompassing the perimeter of the tailings basin to a substantial watershed above the tailings dam.

The tailings basin effluent system must be designed to have sufficient capacity to handle the maximum inflow into the basin and maintain a minimum freeboard on the dam during the peak flow. It should therefore be designed to handle the peak 24-hour flood flow, with a recurrence interval of 100 years, plus the maximum production flow from the tailings system. In some instances, the production flow may only represent 5% of the peak flood flow. The common methods of handling tailings effluents are by decant tower and conduit through the dam, a weir spillway, and reclaim pump-barge on the tailings pond.

The minimum desirable freeboard on the dam should be maintained during

conditions for peak flood flow. To minimize design capacity of the tailings effluent system, an emergency spillway can be installed in the crest of the dam to handle the flood runoff capacity for the tailings basin watershed. As an alternative to an emergency spillway, the dam can be redesigned with excess freeboard to accommodate the total flood runoff below the minimum desirable freeboard elevation. In many instances, after water diversion, the watershed for the tailings basin is only slightly larger than the tailings basin itself, making it relatively easy to accommodate the flood runoff with extra freeboard. The most critical period will usually occur during the early years of waste disposal when the storage capacity behind the dam is relatively small. Evaporation is not a critical factor in the maximum design capacity because the peak flood occurs during a relatively short period. (It is important to make provision for runoff after abandoning a tailings basin.)

(The effects of runoff can include: overtopping and potential failure of a tailings dam when sufficient freeboard or decant capacity have not been provided, surface erosion or waste piles with resulting down stream pollution, and a decrease in stability of waste piles and tailings embankments resulting from an increase in pore water pressure or erosion from runoff.)

Methods for the design of diversion channels and spillways are described in readily available hydraulics handbooks. Usually, the most critical point in their design is avoiding erosion affecting the safety of the embankment. For this reason, the gradients of diversion and spillways channels should be kept sufficiently flat that erosive velocities will not occur near the embankments. Alternatively, channels may be protected against erosion with various kinds of lining or with stone paving. The magnitude of permissible flow velocities for various classes of natural soils and the

SIZE OF PAVING STONES REQUIRED TO PREVENT EROSION ARE GIVEN
PRELIMINARY DRAFT REPORT, SUBJECT TO REVIEW in Table 3

and Fig. 21, 22. To be effective in preventing erosion of underlying fine soils, paving stones should be founded on a layer of filter gravel graded as described previously.

XIV. EMBANKMENT FREEBOARD AND WAVE PROTECTION

In addition to the freeboard required for the maximum flood flow and maximum tailings capacity, minimum freeboard should be provided on tailings embankments to prevent overtopping of the embankment by waves. The height of wave depends on wind velocity, duration of wind, the fetch or distance over which the wind can act on the water and depth of water. For most tailings ponds, the maximum wave height is governed by the fetch distance.)

If a broad, flat beach is maintained on the upstream side of an embankment, waves will break and their energy will be dissipated on the beach, thereby providing some protection against overtopping by breaking waves. On steep upstream slopes, riprap will limit the uprush of the waves to approximately 1.5 times the height of the waves and will prevent erosion of the face by wave action. Riprap could be necessary on tailings embankments constructed across the bays of natural lakes or on completed embankments which impound a substantial pond of water. The approximate wave height for various values of wind velocity and fetch, and the necessary freeboard and riprap gradation for 3:1 riprapped slopes, are given in Table 4. For 2:1 slopes, the nominal thickness should be increased by 6 in. (15 cm). With fine-grained embankment material, a layer of filter gravel should be placed beneath the riprap.

The minimum freeboard should be measured from the maximum projected flood water level to the crest of the embankment. The maximum flood level will be a function of the type and capacity of the decant system or spillway

PRELIMINARY DRAFT REPORT, SUBJECT TO REVIEW

provided to accommodate the runoff flows.

XV. WATER RECLAIM SYSTEMS

Decant Pipe and Towers--The most common method of reclaiming water from a tailings pond is through decant tower and lines. (Fig. 23). These can vary from a simple 8-inch pipeline laid along the ground from the downstream toe to the clear water area and extended as the dam is raised, to large steel and reinforced-concrete conduits with reinforced-concrete towers. The former is used for small operations, and the latter is designed for a 500-foot-high embankment. In this system the clear water near the surface of the pond flows through closely spaced openings on top of the pipe or in the tower through the conduit under the starter dam to waste or to a holding pond where it is pumped back to the concentrator water storage pond. ~~The openings in~~

The use of barge pumps as a method of reclaiming water from a tailings pond is becoming more popular because of its versatility and lower cost, especially in the larger operations where high dams are planned. The cost of long decant pipes of heavily reinforced concrete may be many times the cost of a barge and pump. The barge pump gains considerable static head over the decant lines with pumps. This results in a reduction in required power and cost. (Figs. 24, 25).

A. Decant System

The system has the following advantages:

1. Mechanical and electrical failures do not stop discharge from the pond.
2. The operation is extremely simple.

3. If decants are designed with sufficient capacity, they can serve as permanent drains and handle runoff to keep the pond empty, or maintain a constant pond elevation after the tailings operation has been abandoned.

The system has the following disadvantages:

1. The pumping head is higher if water is collected at the downstream toe of the embankment and pumped up to the mill.
2. High decant towers are susceptible to wind damage and are also susceptible to damage by tailings solids surrounding them. This is especially true where tailings are dumped into the pond at various places and might slump in a large mass against the tower. There is also danger from ice damage in cold climates. If spigoting along the crest of the embankment is the only method of discharge, there is less danger of damage.
3. The decant lines and towers must be designed to withstand the full hydrostatic pressure of saturated tailings to prevent failure.
4. Foundation settlements are likely to crack or open joints in decant culverts, leading to piping into and through the culvert. For this reason monolithic reinforced-concrete culverts are preferred over pre-cast concrete sections.
5. Pipes that have collapsed or cracked are nearly impossible to repair, and leaks are almost impossible to stop.
6. Culverts and towers are more expensive to construct than barge pumps.

B. Barge Pump System

The system has the following advantages:

1. It is easy to operate in the cross-valley embankment where the terrain is steep, the grind is relatively coarse, and the clear water pool is deep.
2. The power consumption is less than for the decant system.
3. The cost of a barge and pump is much less than that of a decant system for large-tonnage operations.

The disadvantages are:

1. Barge pumps cannot be used in relatively flat terrain with a fine grind (keeping them out of the mud becomes a problem).
2. Pumps must be raised periodically as the pond rises.
3. Freezing is a problem in cold climates. (Low-pressure air bubbling from submerged pipes can keep the barge free of ice.)
4. Pumps cannot be designed to handle the 100-year flood, so enough freeboard must be provided for this emergency.

Syphon System
Not a system that will work
in Minnesota.

Table 1 Permeability classification of soils

Degree of permeability	Value of k, cm/sec
High	Over 10^{-1}
Medium	10^{-1} to 10^{-3}
Low	10^{-3} to 10^{-5}
Very low	10^{-5} to 10^{-7}
Practically impermeable	Less than 10^{-7}

Table 2 Typical values of effective cohesion and
angle of internal friction for soils

Soil	Effective cohesion		Effective angle of internal friction ϕ degrees
	psf	c' kPa	
Bentonite shale	300	14.3	7
Muddy sand	400	19.1	30
Shale (fill cemented)	1000	47.9	34
Sandstone (fill)	-	-	35- 45
Soft clay	400	19.1	Variable depending on rate of load application
Very soft-clay	200-370	9.5-17.7	
Stiff clay	1500-2000	71.8-95.7	
Silt (non-plastic)- medium dense			28-32
Silt (non-plastic)-dense			30-34
Uniform fine to medium sand-medium dense			30-34
Uniform sand - dense			30-40
Well-graded sand- medium dense			38-46*
Well-graded sand - dense			36-42*
Sand and gravel - medium dense			40-48*
Sand and gravel -dense			40-55*
Tailings sand - loose			30-36

* Higher values occur at low confining pressures and such high angles require confirmation by thorough and extensive testing.

TABLE 3 - Embankment freeboard and wave protection

APPROXIMATE WAVE HEIGHTS		
Fetch, miles	Wind velocity, miles per hour	Wave height, feet
1.....	50	2.7
1.....	75	3.0
2.5.....	50	3.2
2.5.....	75	3.6
2.5.....	100	3.9
5.....	50	3.7
5.....	75	4.3
5.....	100	4.8
10.....	50	4.5
10.....	75	5.4
10.....	100	6.1

FREEBOARD REQUIRED FOR WAVE ACTION		
Fetch, miles	Normal freeboard, feet	Minimum freeboard, feet
Less than 1.....	4	3
1.....	5	4
2.5.....	6	5
5.....	8	6
10.....	10	7

RIPRAP REQUIRED ON 3:1 SLOPES FOR PROTECTION AGAINST WAVES						
Reservoir fetch, miles	Nominal thickness, inches	Gradation, percentage of stones of various weights (pounds)				
		Maximum size	25 percent greater than--	45 to 75 percent		25 percent less than ¹ --
				From	To	
1 and less.....	18	1,000	300	10	300	10
2.5.....	24	1,500	600	30	600	30
5.....	30	2,500	1,000	50	1,000	50
10.....	36	5,000	2,000	100	2,000	100

¹Sand and rock dust less than 5 percent.

Source: U.S. Bureau of Reclamation.

Table 4: Embankment freeboard and wave protection

Fetch		Approximate wave heights		Wave height	
		Wind velocity		feet	m
miles	km	miles/hr	km/hr		
1	1.6	50	80	2.7	0.8
1	1.6	75	120	3.0	0.9
2.5	4.0	50	80	3.2	1.0
2.5	4.0	75	120	3.6	1.1
2.5	4.0	100	160	3.9	1.2
5	8.0	50	80	3.7	1.1
5	8.0	75	120	4.3	1.3
5	8.0	100	160	4.8	1.5
10	16.1	50	80	4.5	1.4
10	16.1	75	120	5.4	1.6
10	16.1	100	160	6.1	1.9

Freeboard required for wave action

Fetch		Normal freeboard		Minimum freeboard	
miles	km	feet	m	feet	m
<1	<1.6	4	1.2	3	0.9
1	1.6	5	1.5	4	1.2
2.5	4.0	6	1.8	5	1.5
5	8.0	8	2.4	6	1.8
10	16.1	10	3.0	7	2.1

Note: Freeboard should be calculated above maximum design flood-level in the reservoir.

Riprap required on 3:1 slopes
for protection against waves

Reservoir fetch		Nominal thickness		Gradation, per cent of stone of various weights (lbs)			
miles	km	ft	m	maximum size	25% greater than	45% to 75% from to	25% less than*
<1	<1.6	1.5	0.45	1,000	300	10- 300	10
2.5	4.0	2.0	0.61	1,500	600	30- 600	30
5	8.0	2.5	0.76	2,500	1,000	50-1,000	50
10	16.0	3.0	0.91	5,000	2,000	100-2,000	100

Note: *Sand and rock dust less than 5 per cent.

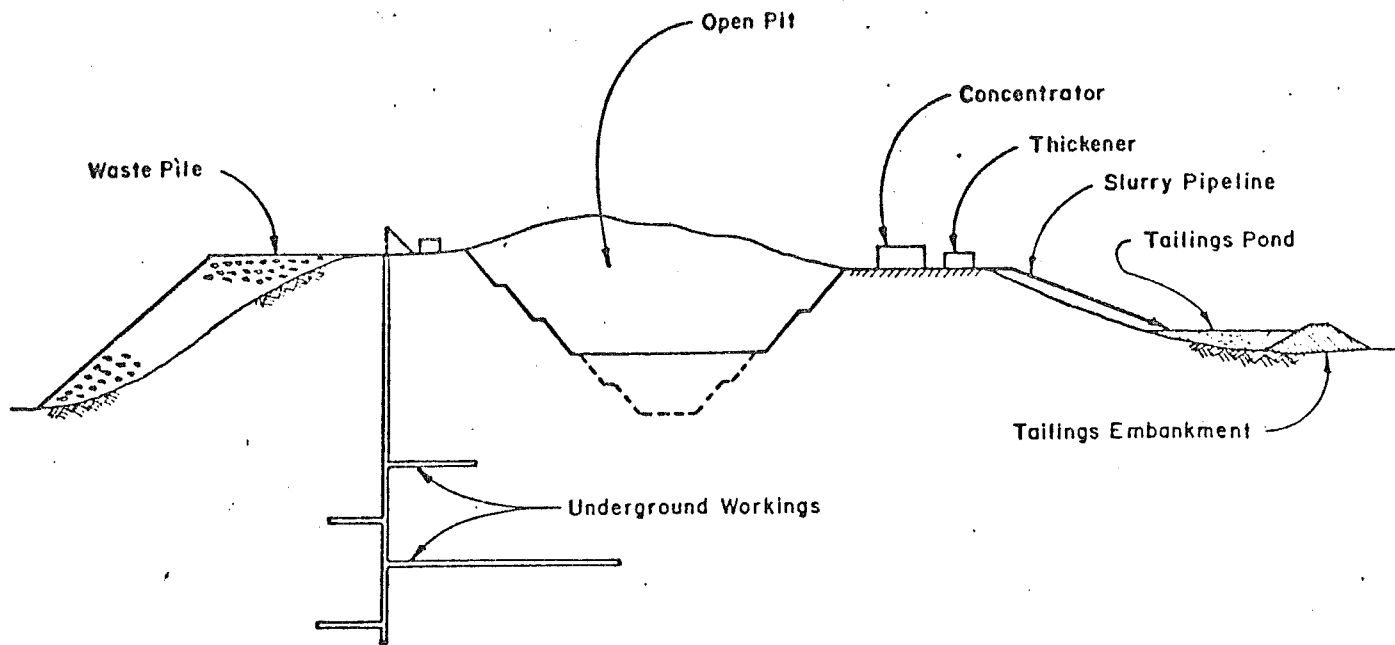

Fig 1 - Typical mine waste disposal system

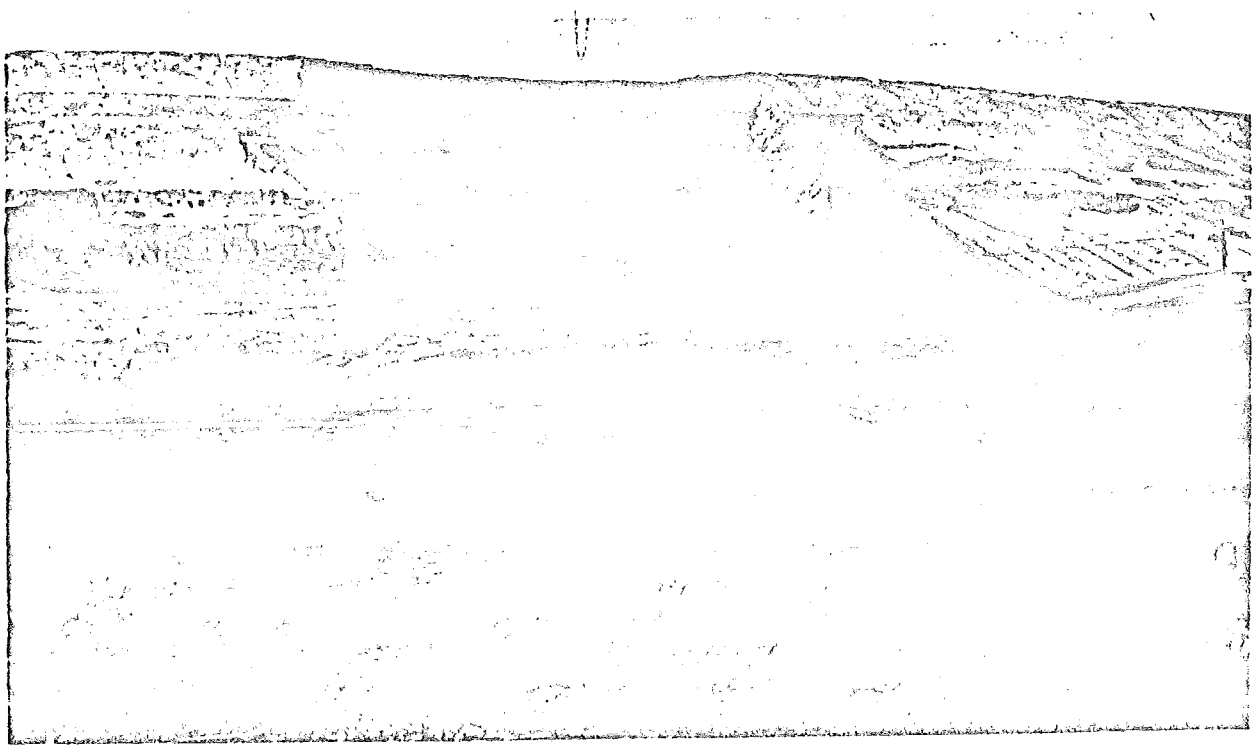
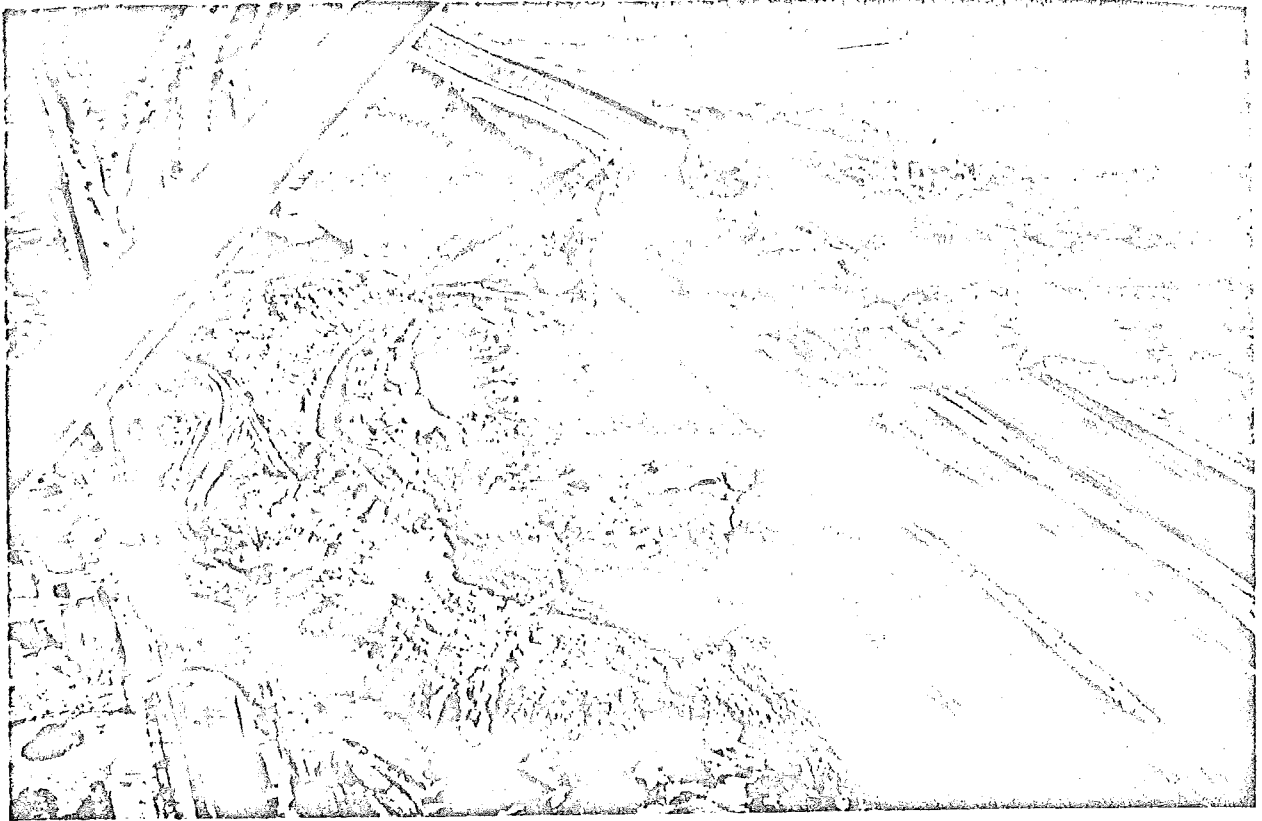

FIGURE 2 . - Rotational slide.

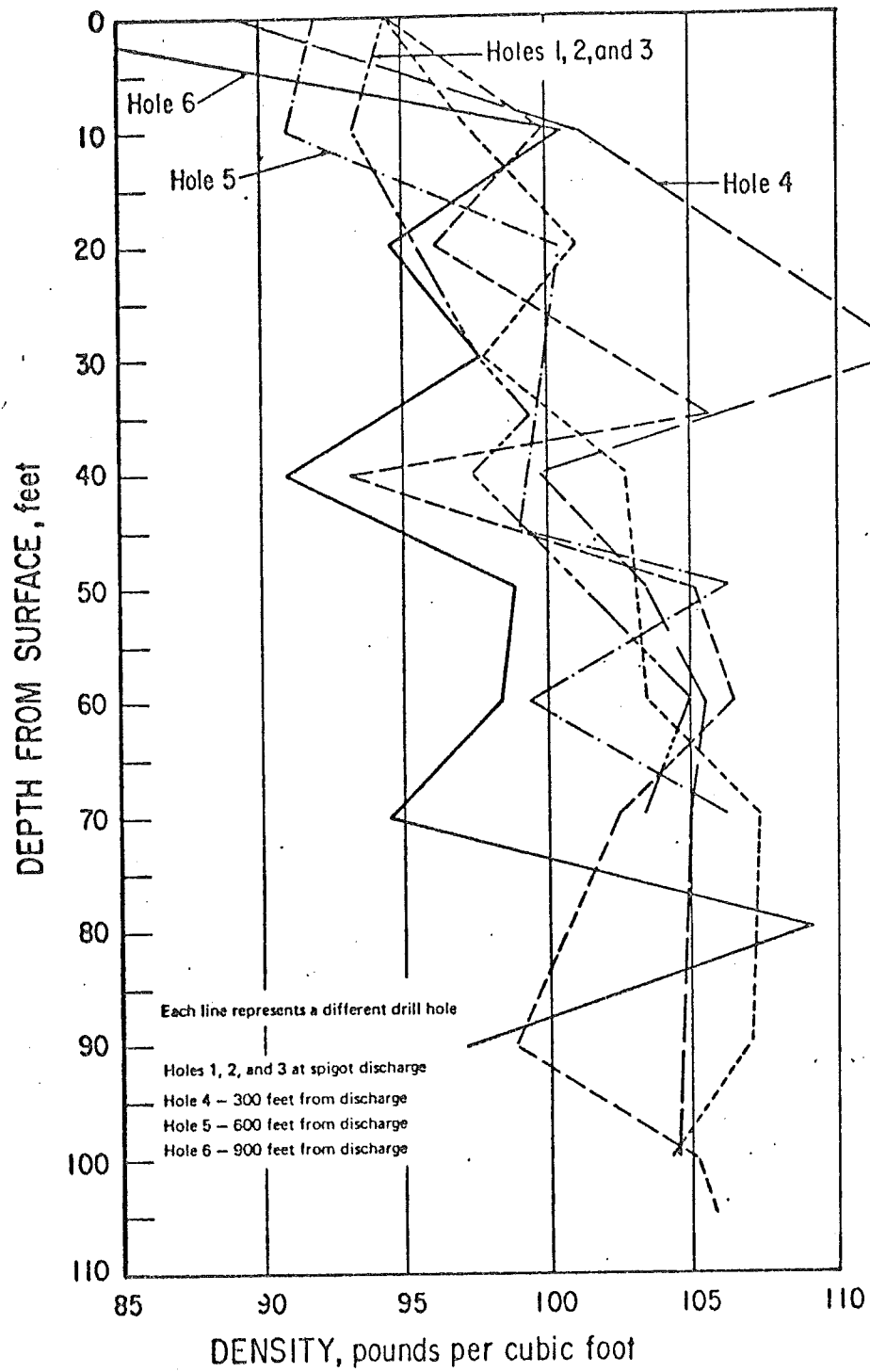

FIGURE 3- Increased density with depth.

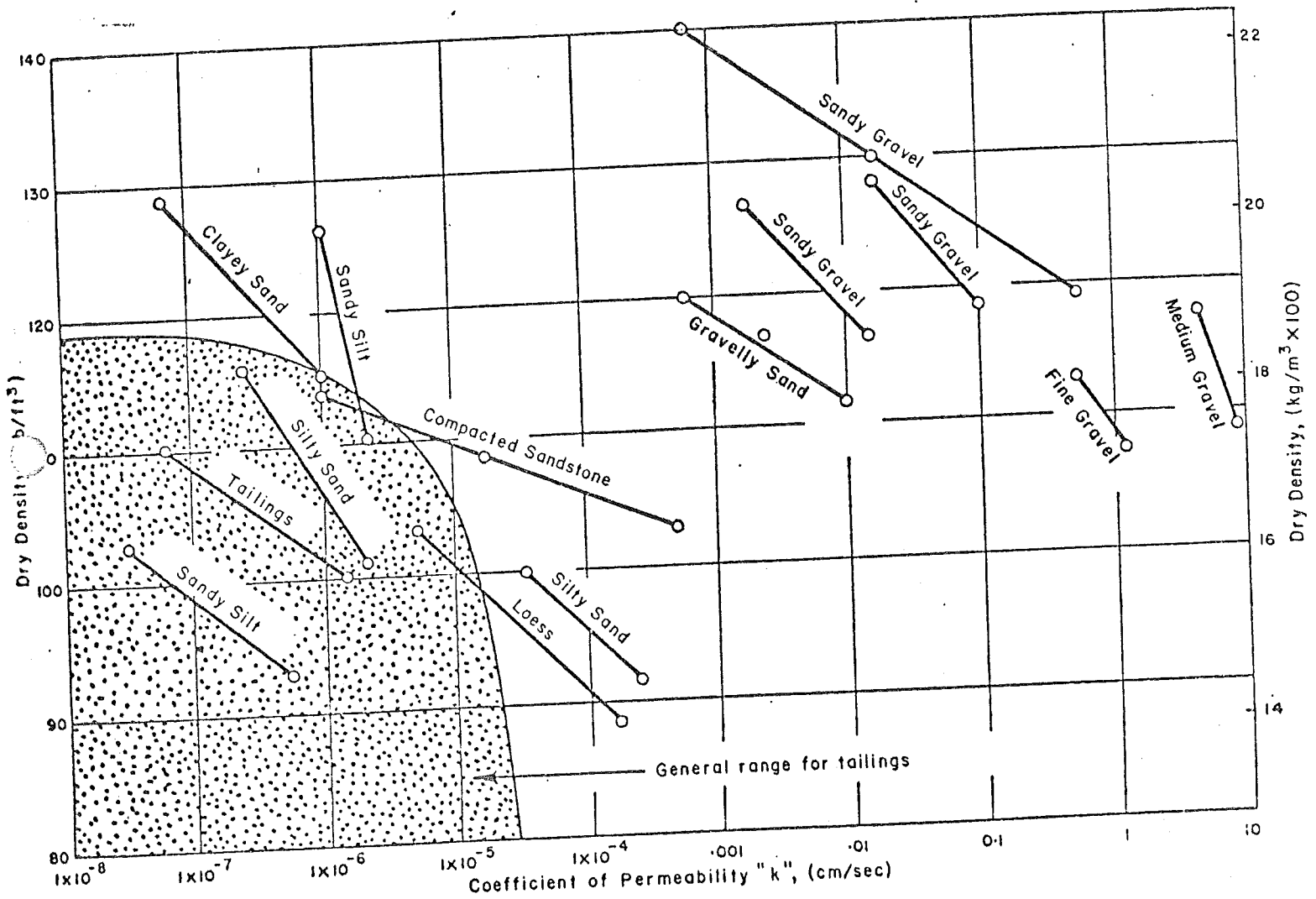
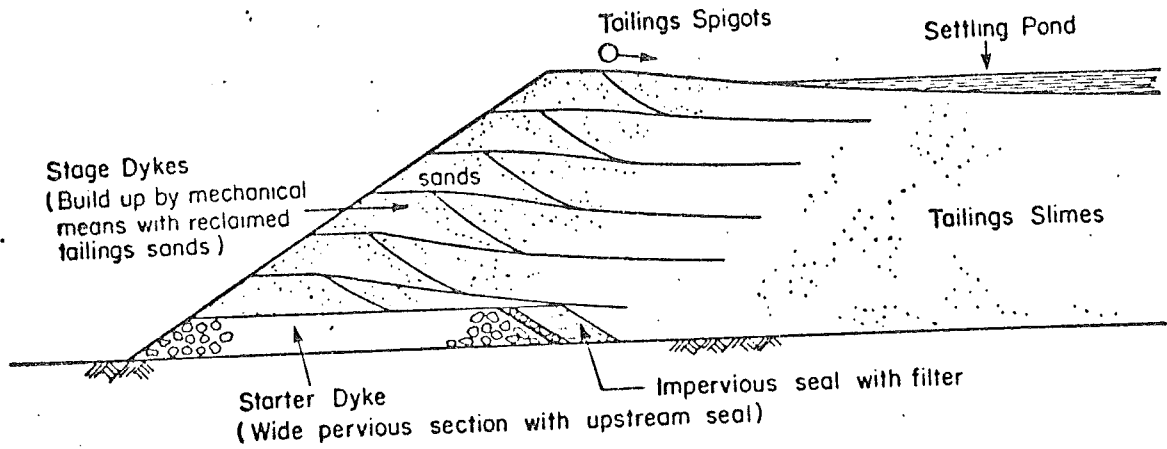
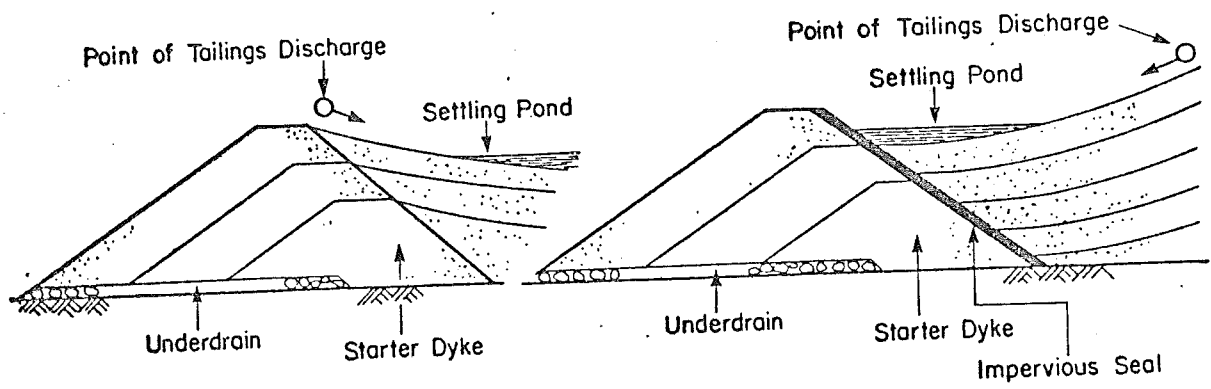

Fig 4 - Permeability vs density (21)



UPSTREAM METHOD
(of stage construction)



DOWNSTREAM METHOD
(of stage construction)

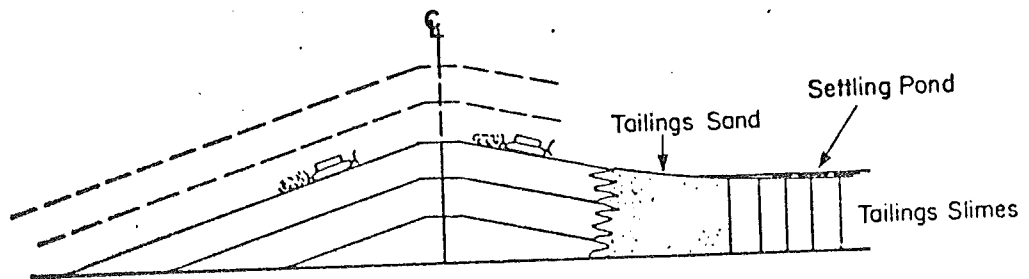

FIXED CENTRELINE METHOD
(of stage construction)

Figure 5

- Tailings embankment construction methods

Figure 6

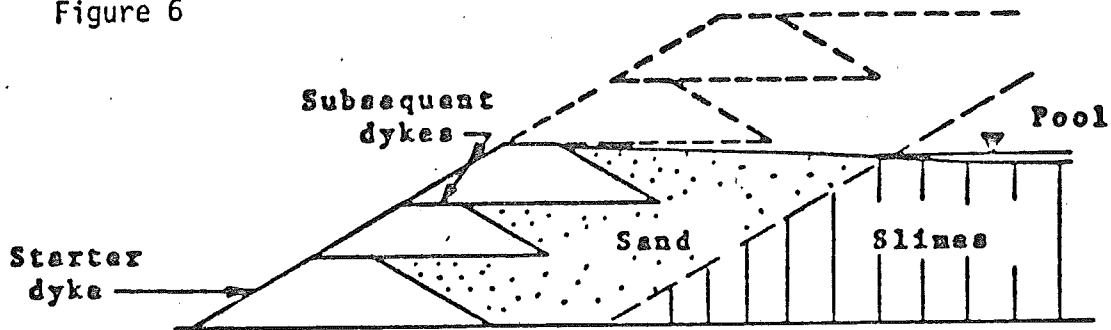

Upstream Method

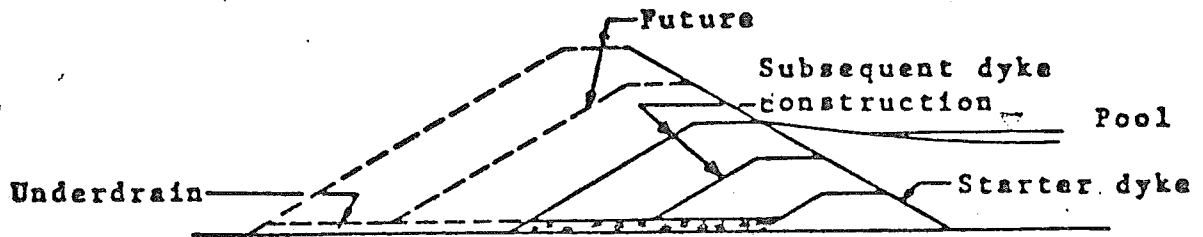

Downstream Method

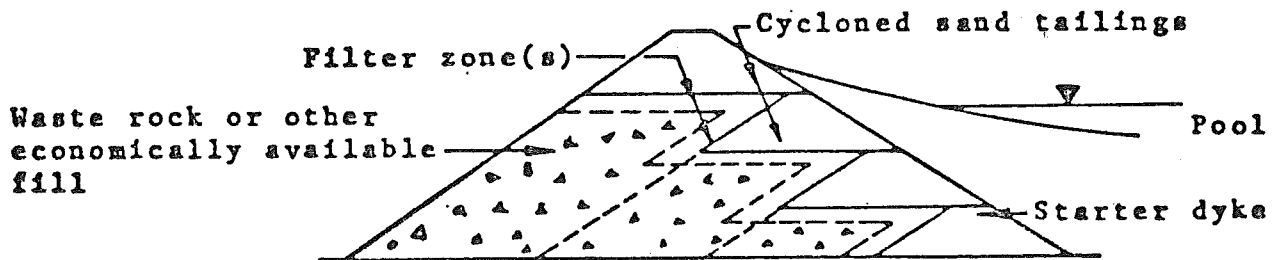

Downstream Method

(Supplementary fill incorporated within embankment section because rate of production of suitable cycloned tailings is limited).

Figure 7

**TYPES OF TAILINGS DAMS
ON IMPERVIOUS FOUNDATIONS**

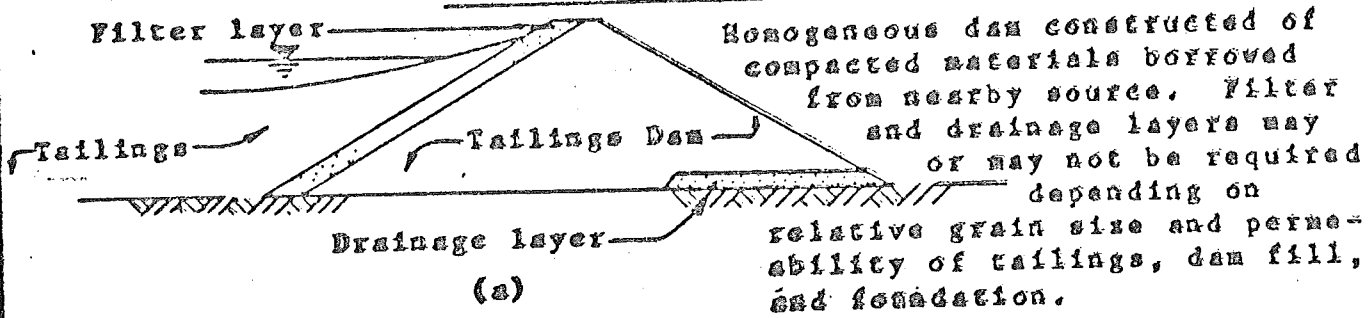

Homogeneous dam constructed of compacted materials borrowed from nearby source. Filter and drainage layers may or may not be required depending on relative grain size and permeability of tailings, dam fill, and foundation.

(a)

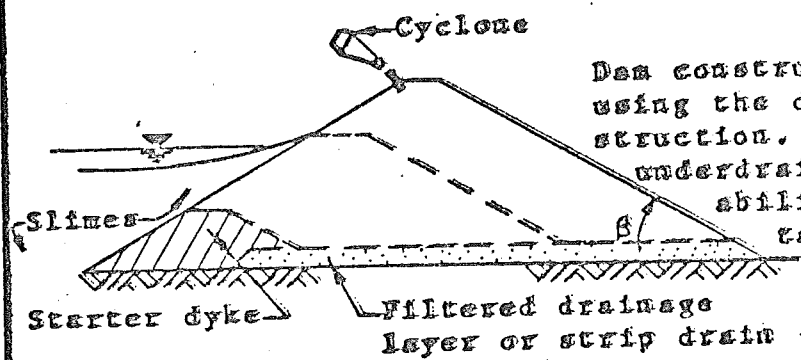

Dam constructed of cycloned tailings using the downstream method of construction. Requirements for filtered underdrain depend on relative permeabilities of slimes and cycloned tailings. Cotangent β usually greater than 2.0.

(b)

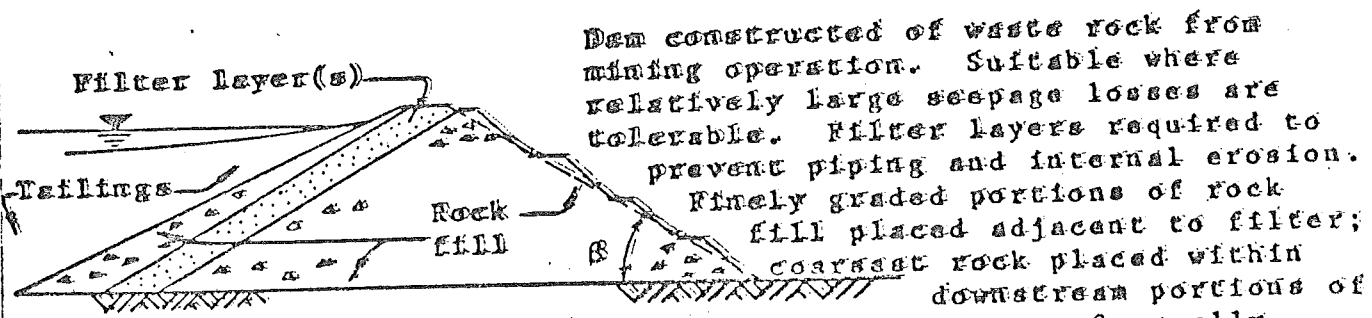

Dam constructed of waste rock from mining operation. Suitable where relatively large seepage losses are tolerable. Filter layers required to prevent piping and internal erosion. Finely graded portions of rock fill placed adjacent to filter; coarsest rock placed within downstream portions of section. Cotangent β usually greater than 1.5. Slopes between bents at angle of repose.

(c)

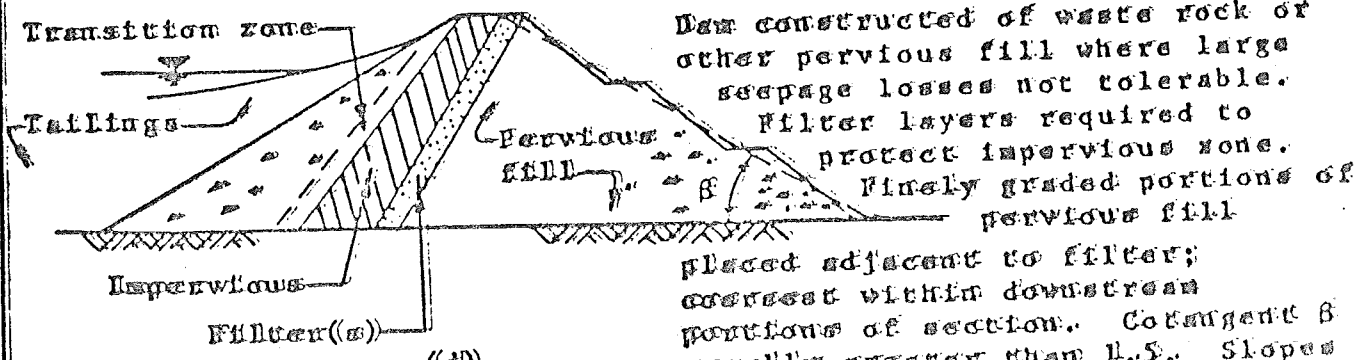

Dam constructed of waste rock or other pervious fill where large seepage losses not tolerable. Filter layers required to protect impervious zone. Finely graded portions of pervious fill placed adjacent to filter; coarsest within downstream portions of section. Cotangent β usually greater than 1.5. Slopes between bents at angle of repose.

(d)

Figure 8

TAILINGS EMBANKMENTS ON PERVIOUS FOUNDATIONS

CONTROL OF SEEPAGE LOSSES

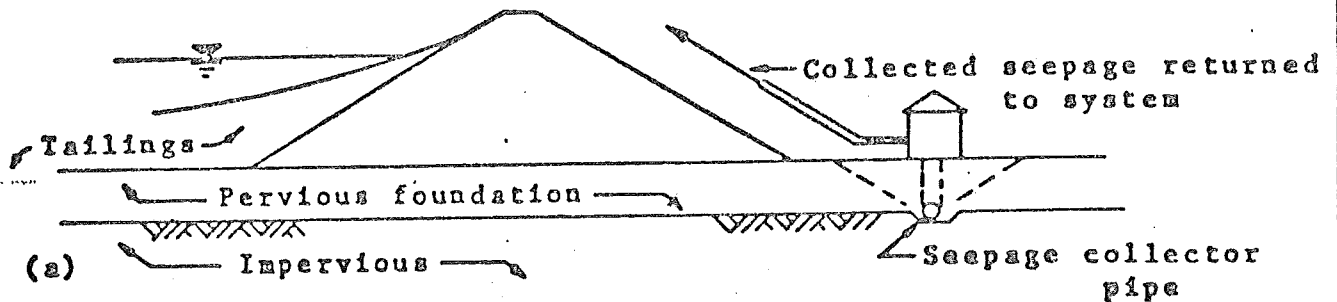

(a)

Closed System. Suitable where lower boundary of pervious foundation within practicable depth for installation of seepage collector pipe.

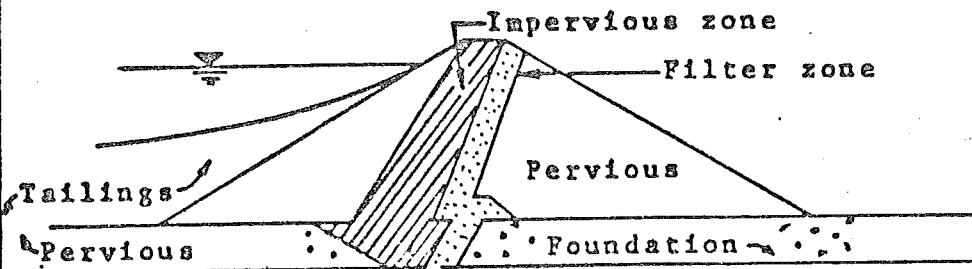

(b)

Core trench through pervious foundation - Suitable where pervious foundation extends to shallow depth.

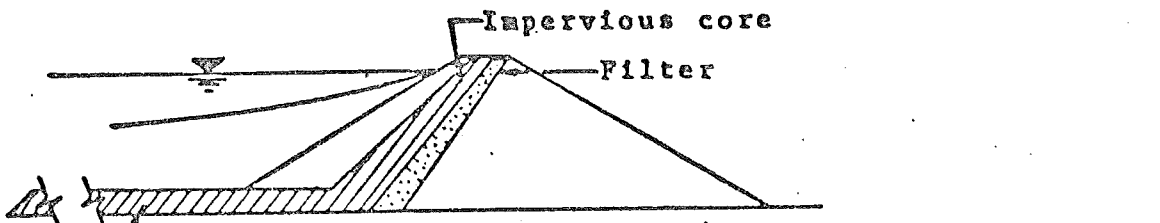

(c)

Upstream blanket or membrane reduces leakage by increasing length of seepage path.

Hydraulic barrier formed by injection and pumping wells precludes migration of pond seepage past line of pumping wells.

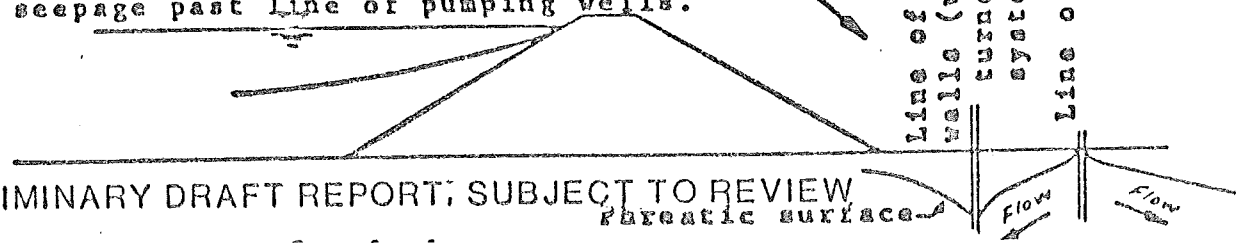
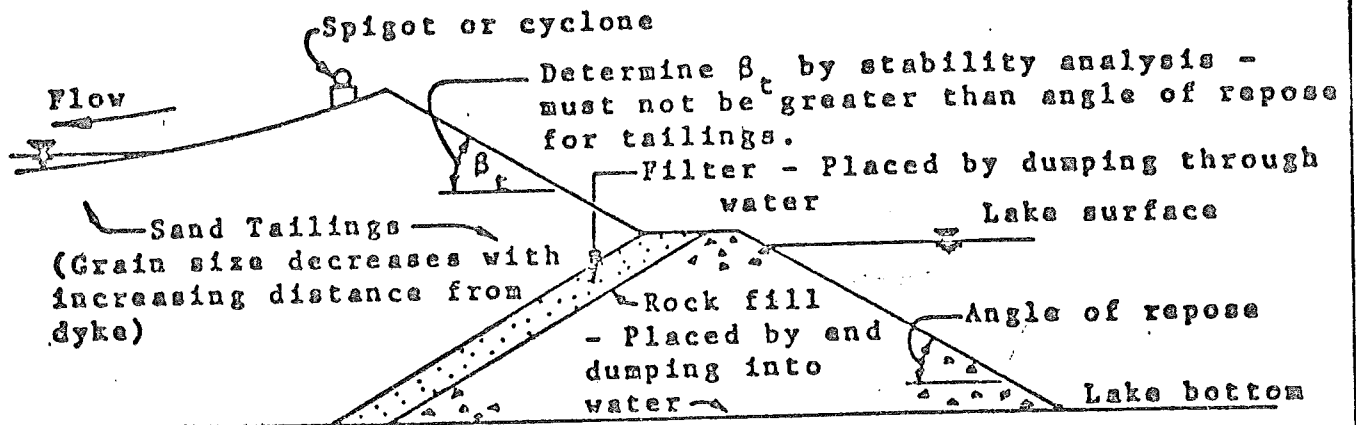
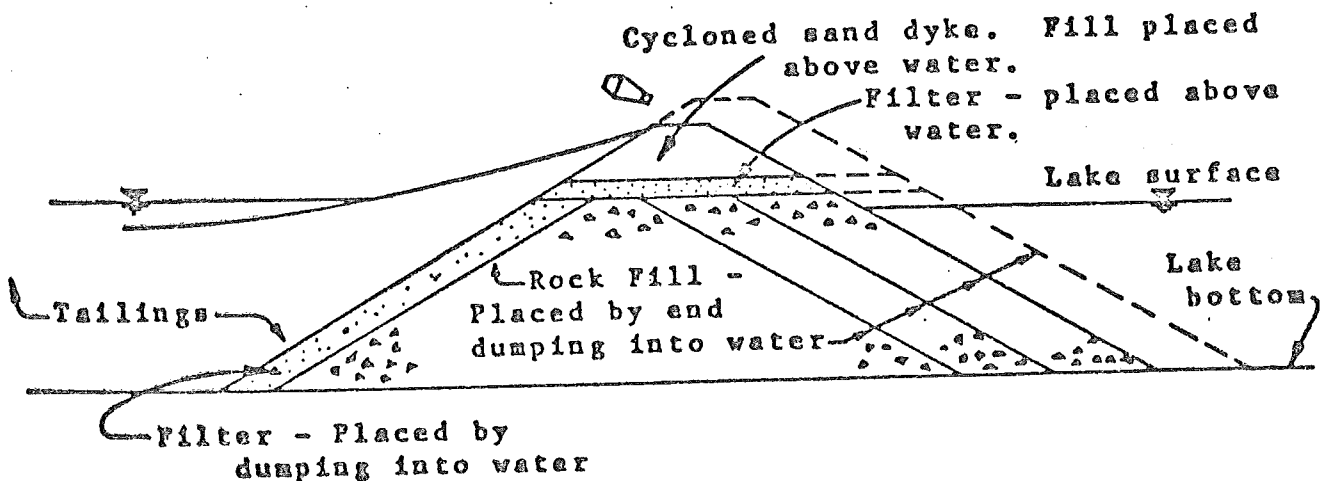

Figure 9

TAILINGS DAMS CONSTRUCTED IN WATER



Tailings Dam Constructed in Water
- Upstream Method



Tailings Dam Constructed in Water
- Downstream Method

(Suitable where large quantities of rock fill readily available)

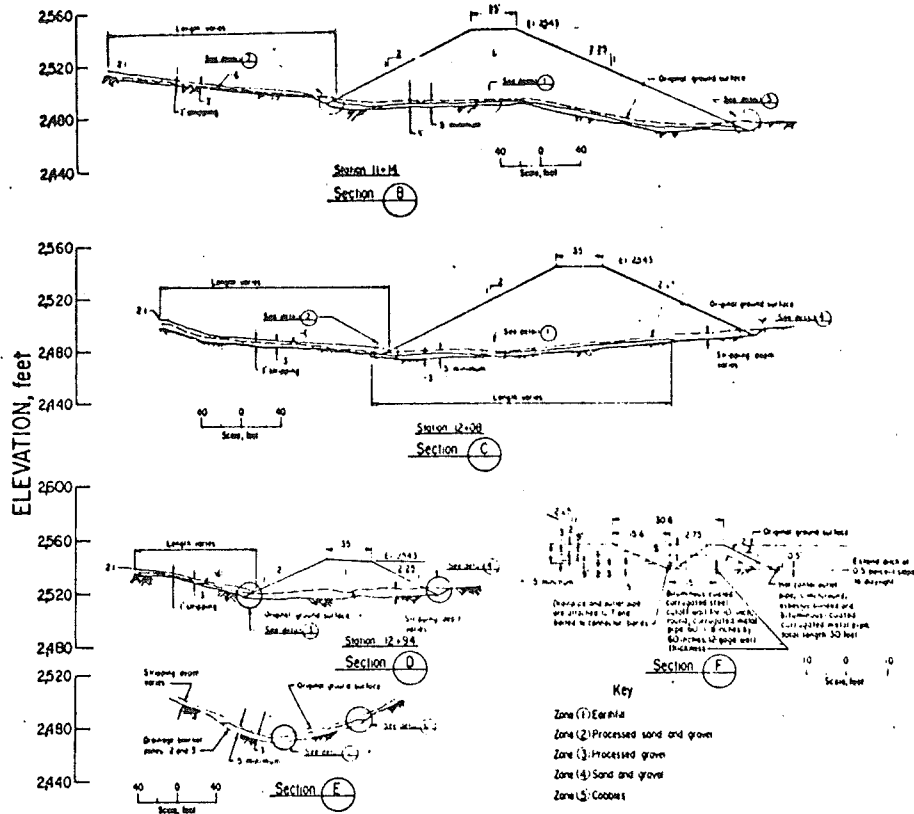
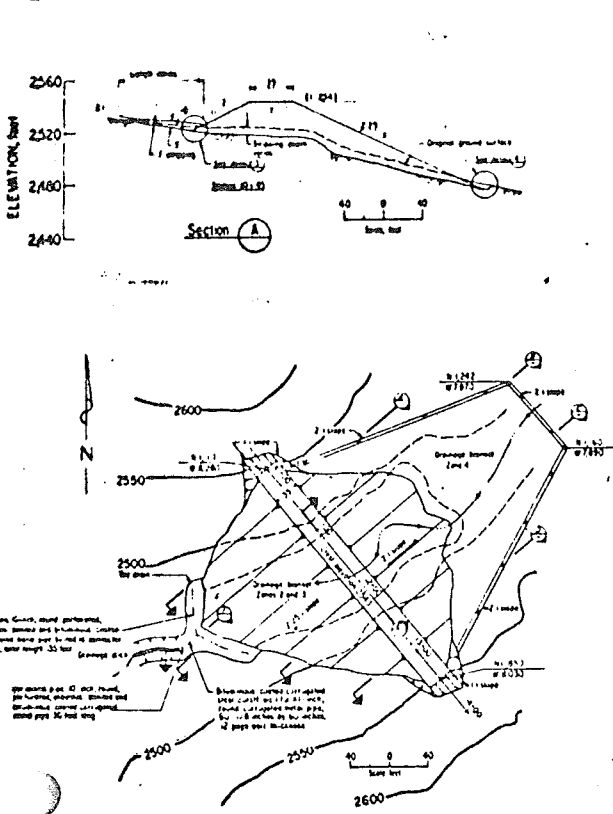
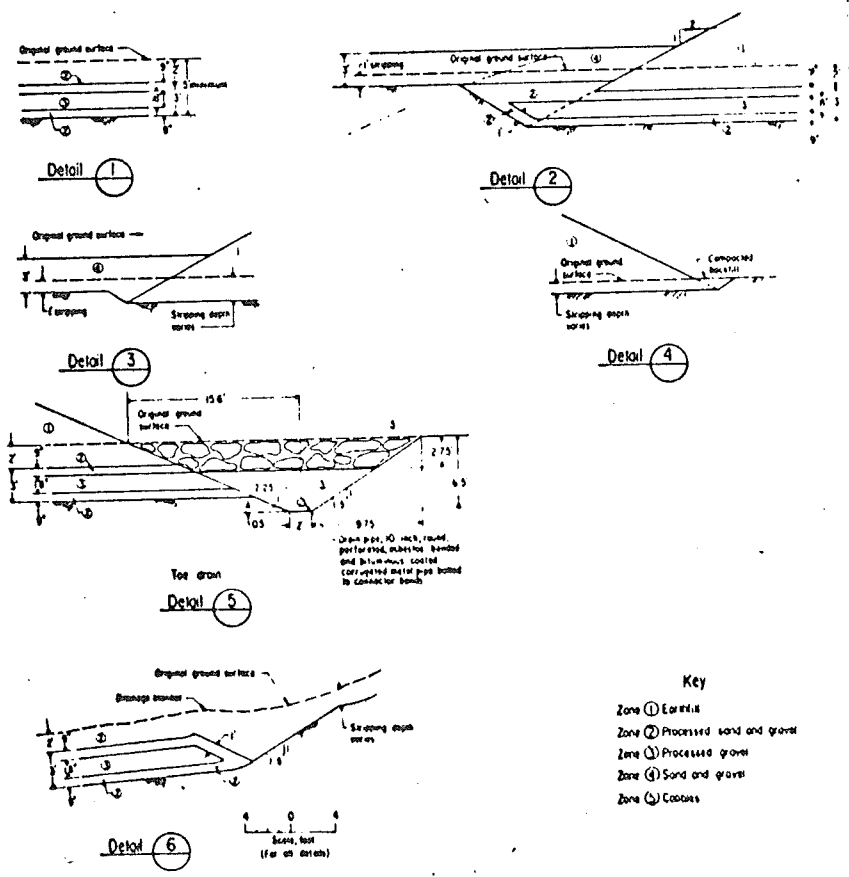
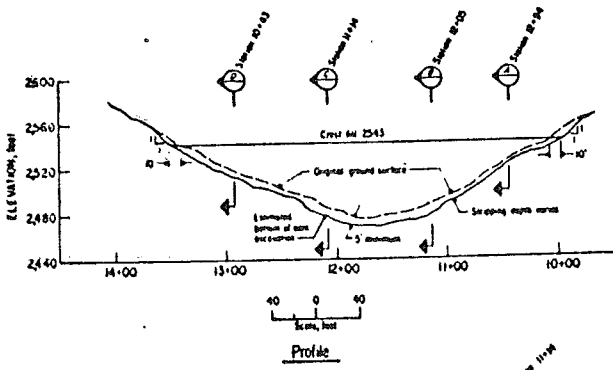

FIGURE 10 - Starter dam construction—detail.



PRELIMINARY DRAFT REPORT, SUBJECT TO REVIEW

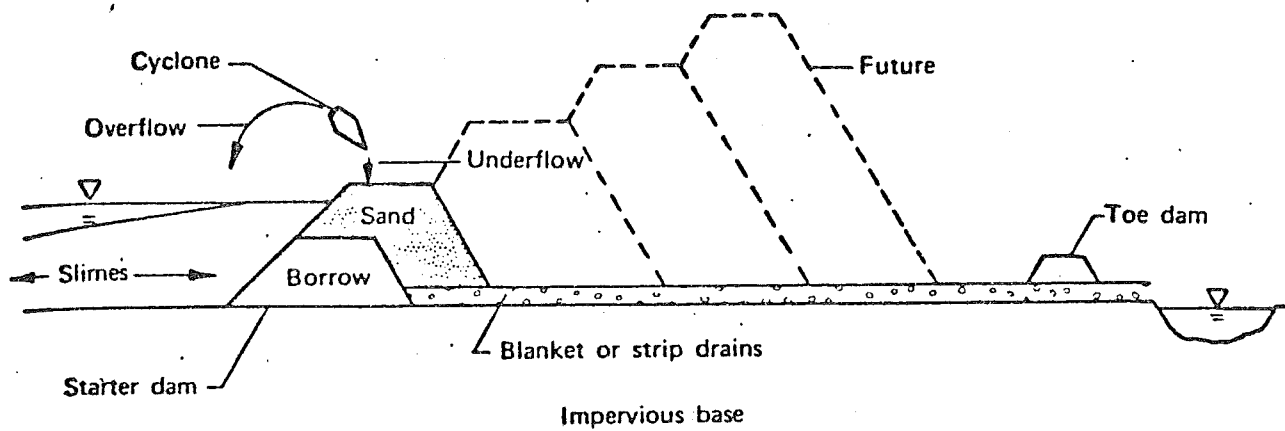

FIGURE 12 - Downstream method showing both dams.

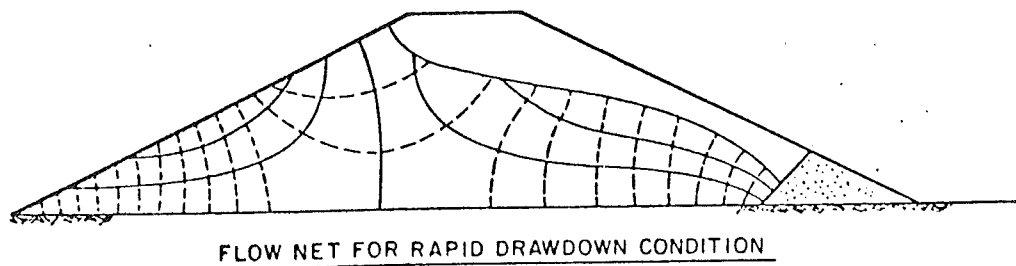
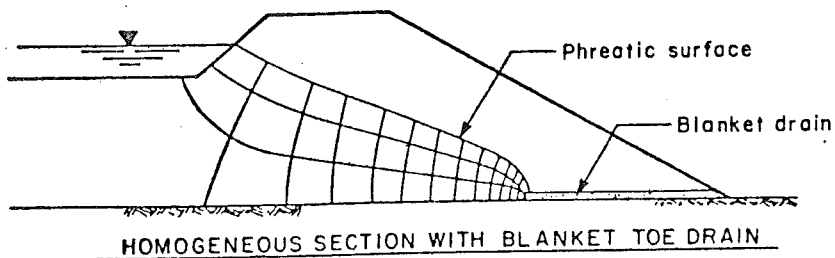
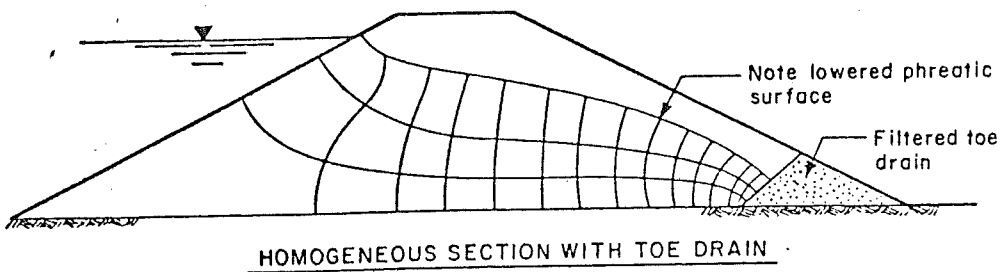
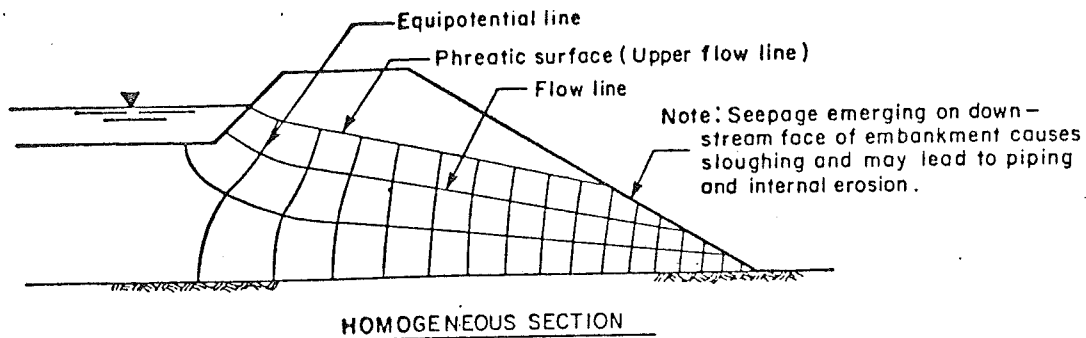
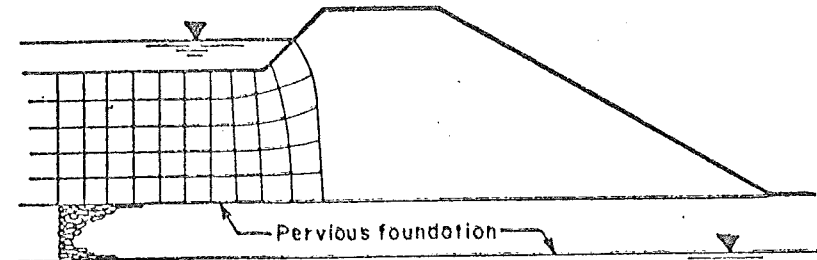
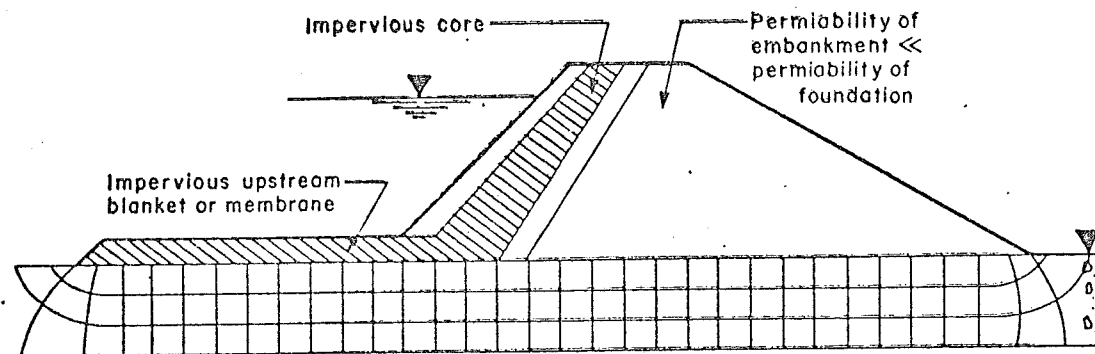

Fig 13- Flow nets for embankments on impervious foundations



FLOW NET FOR TAILINGS EMBANKMENT AND POND UNDERLAIN BY PERVIOUS FOUNDATION



FLOW NET FOR SEEPAGE THROUGH PERVIOUS FOUNDATION IMPERVIOUS-UPSTREAM BLANKET OR MEMBRANE USED TO INCREASE LENGTH OF SEEPAGE PATH

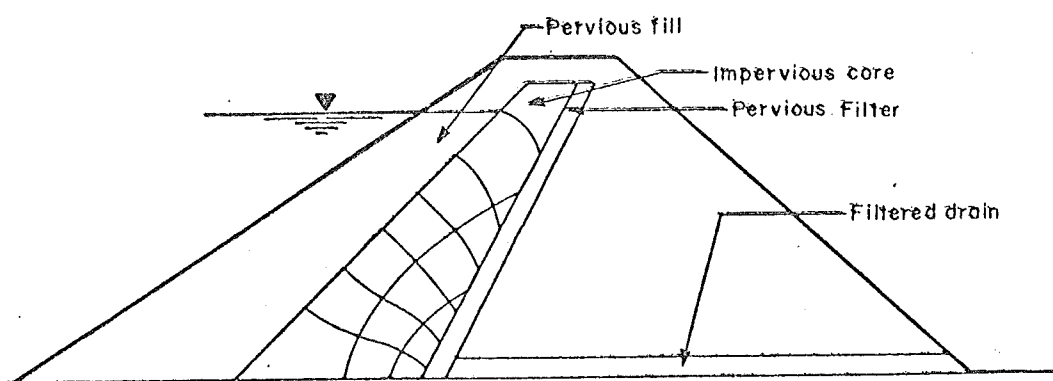

APPROXIMATE FLOW NET FOR SEEPAGE THROUGH IMPERVIOUS CORE

Fig 14 .Examples of tailings embankment flow nets

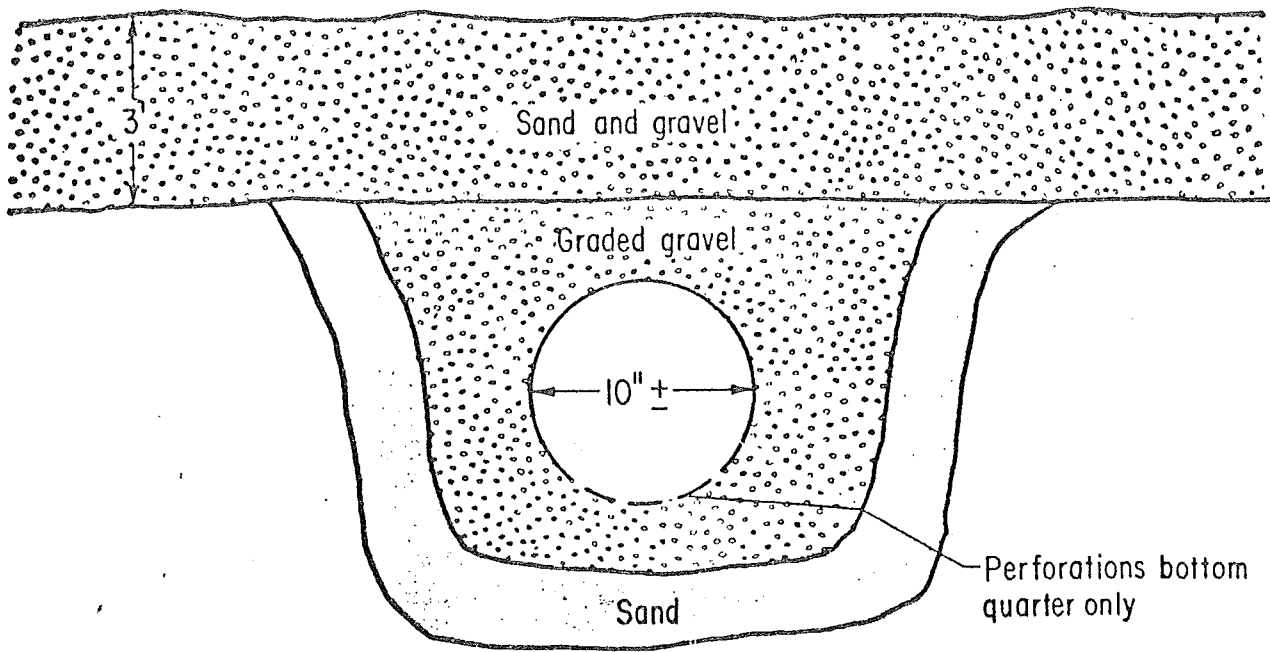

FIGURE 14. - Pipe drain.

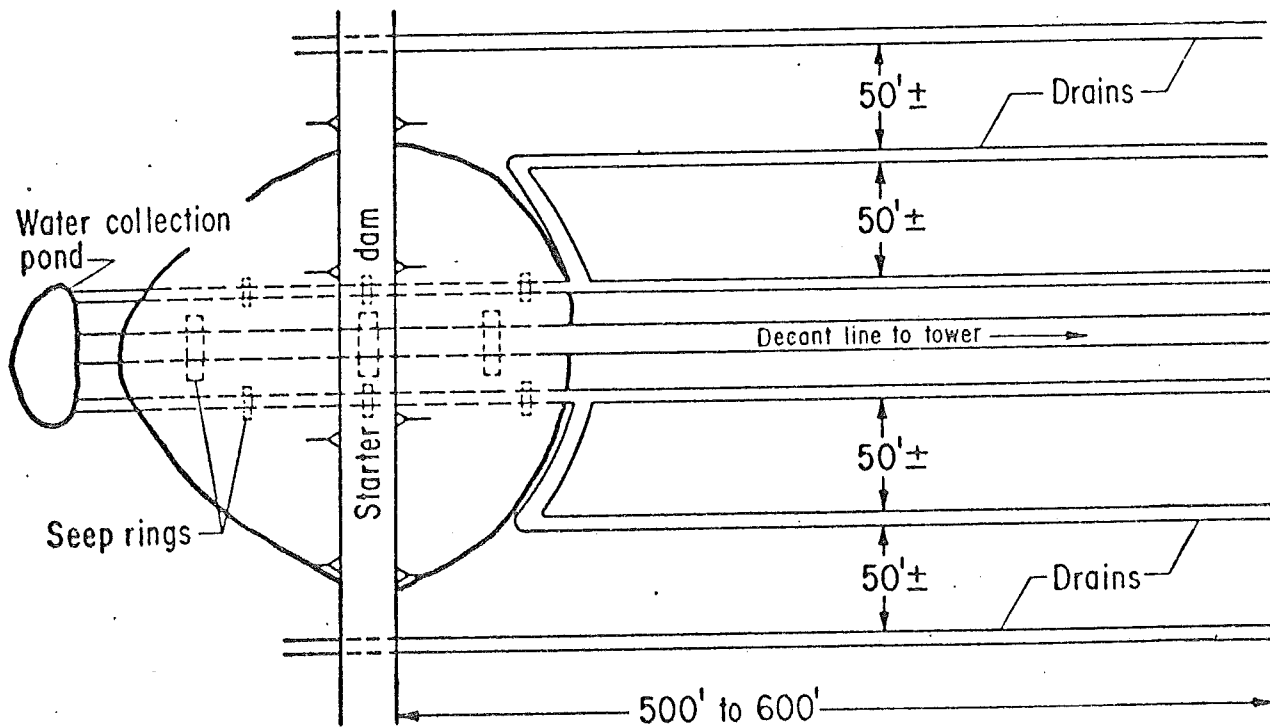

FIGURE 15. - Pipe drain layout.

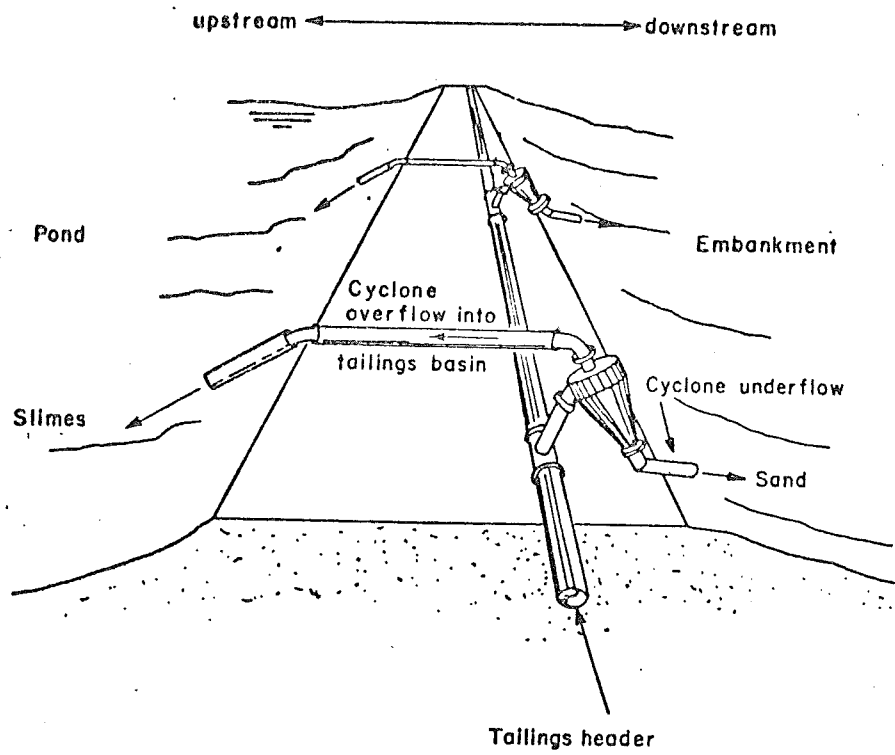

Fig 16 - Typical cycloning arrangement

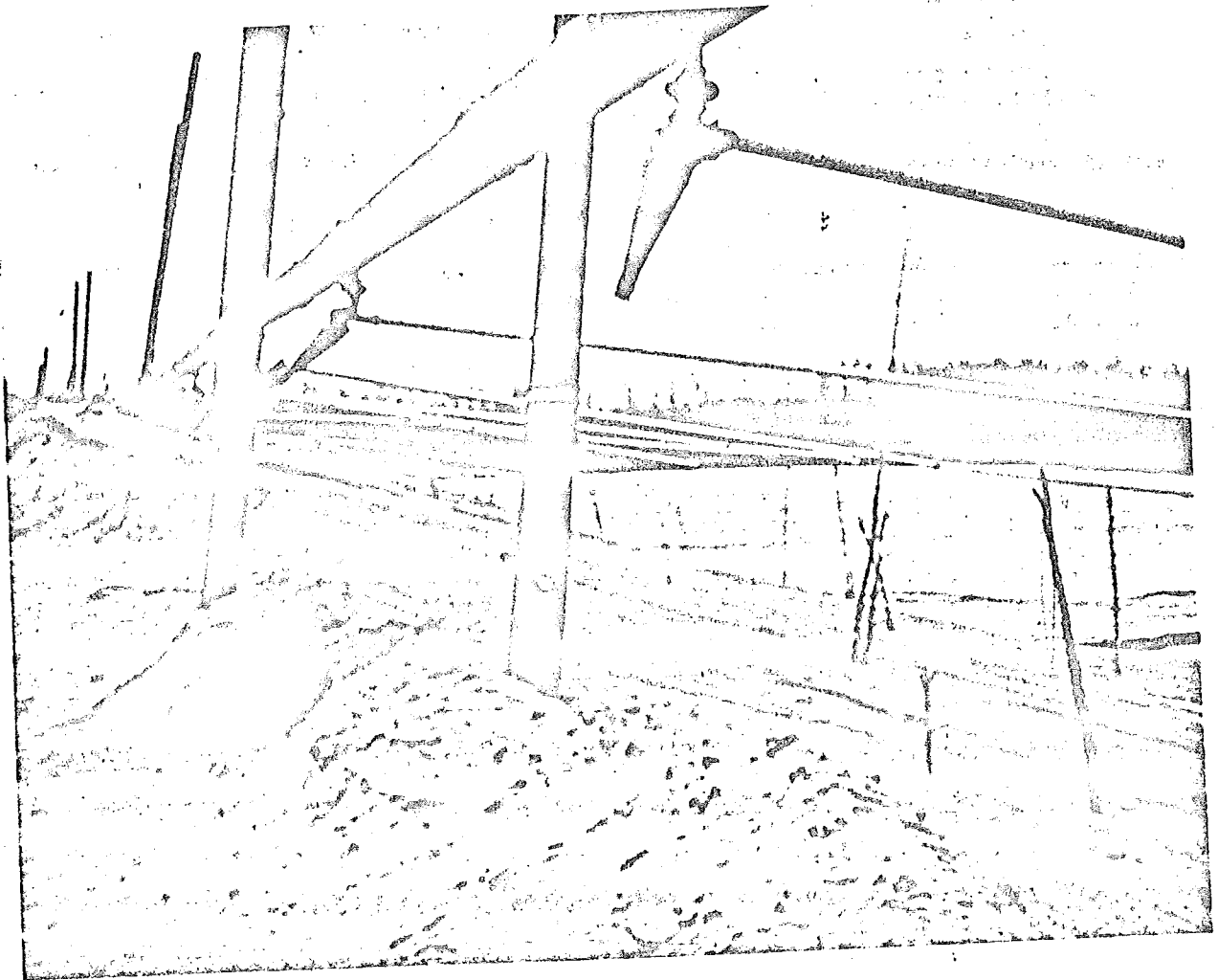

FIGURE 18 - Cyclones on centerline method of dam building in small operation.

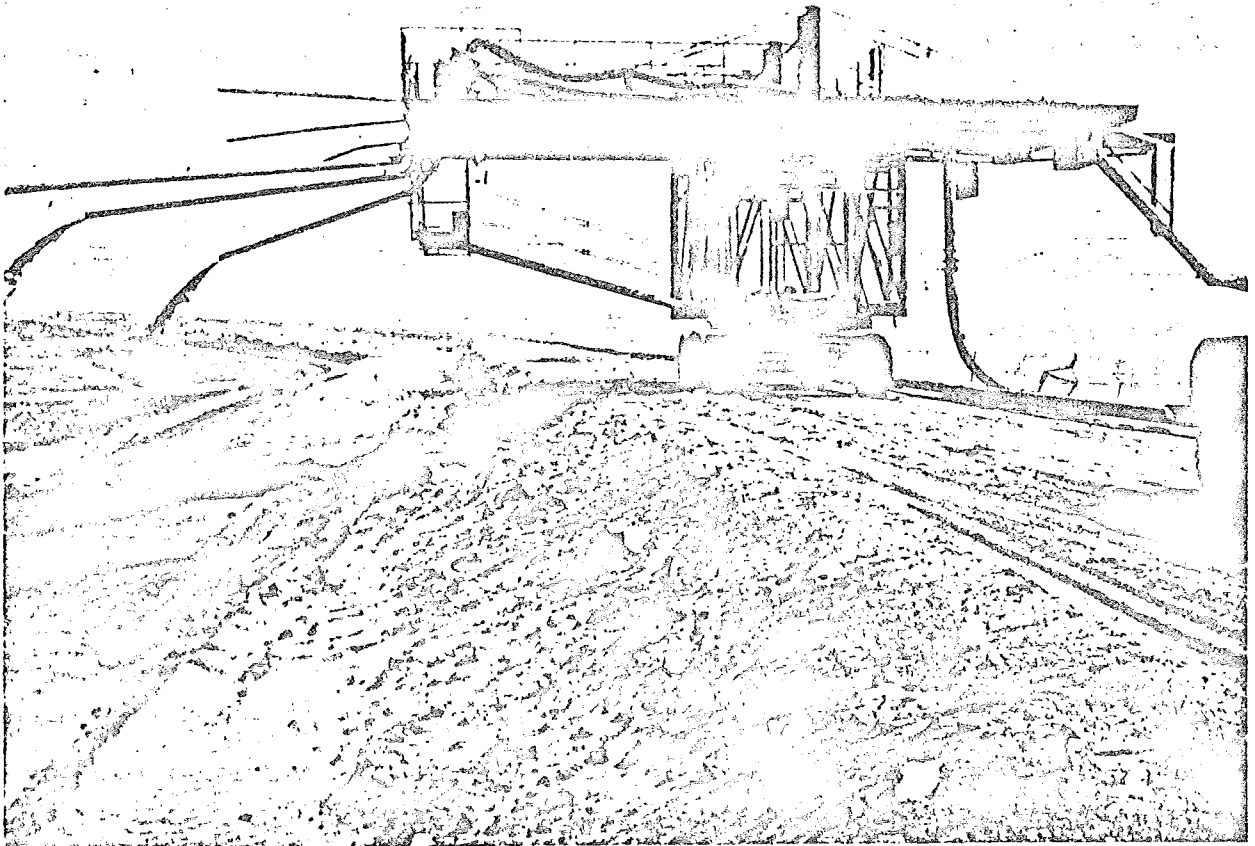

FIGURE 17. - Downstream method with cyclones. (Courtesy, White Pine Copper, Michigan.)

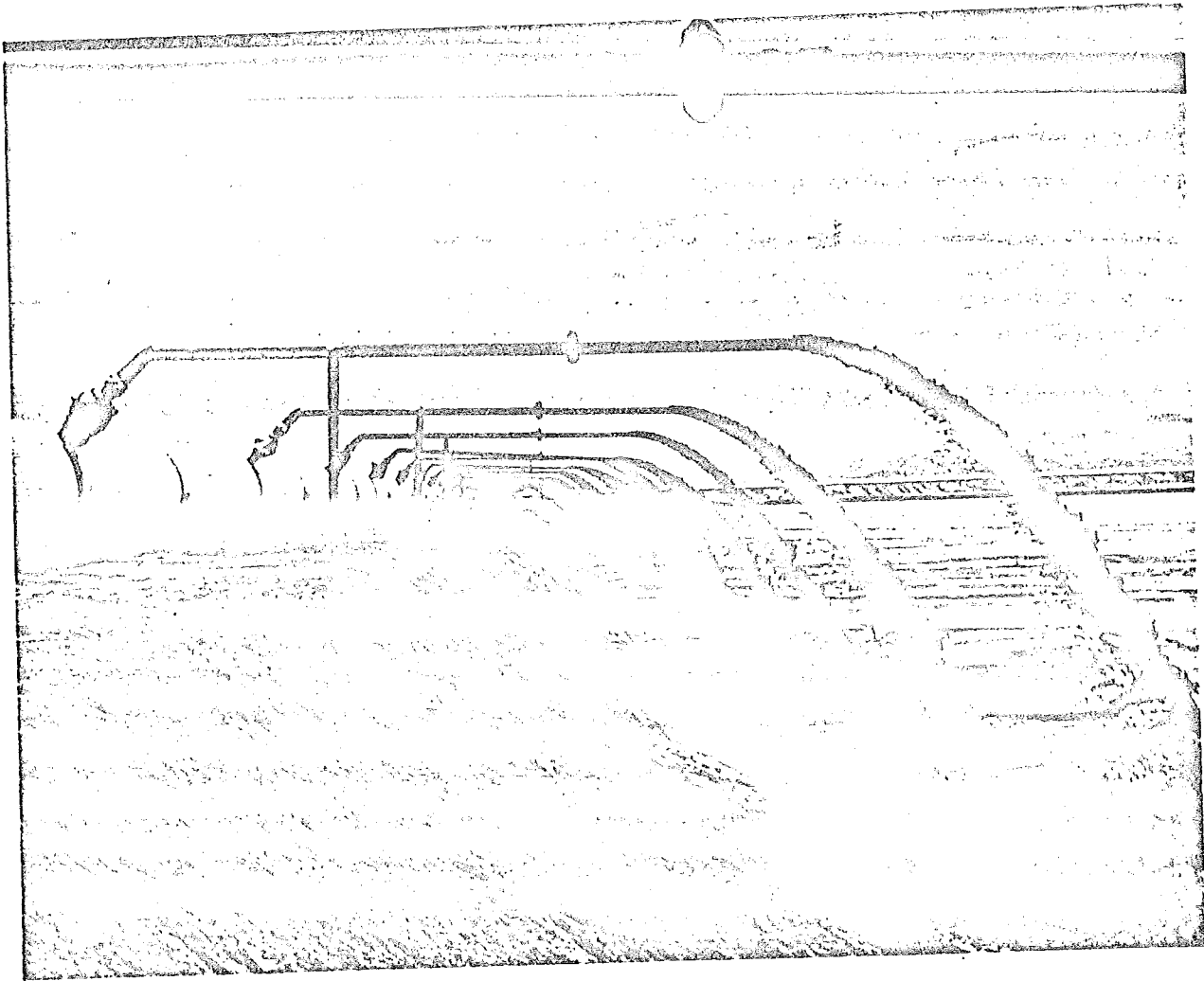

FIGURE 19: - Spigoting around periphery of dike—upstream method.

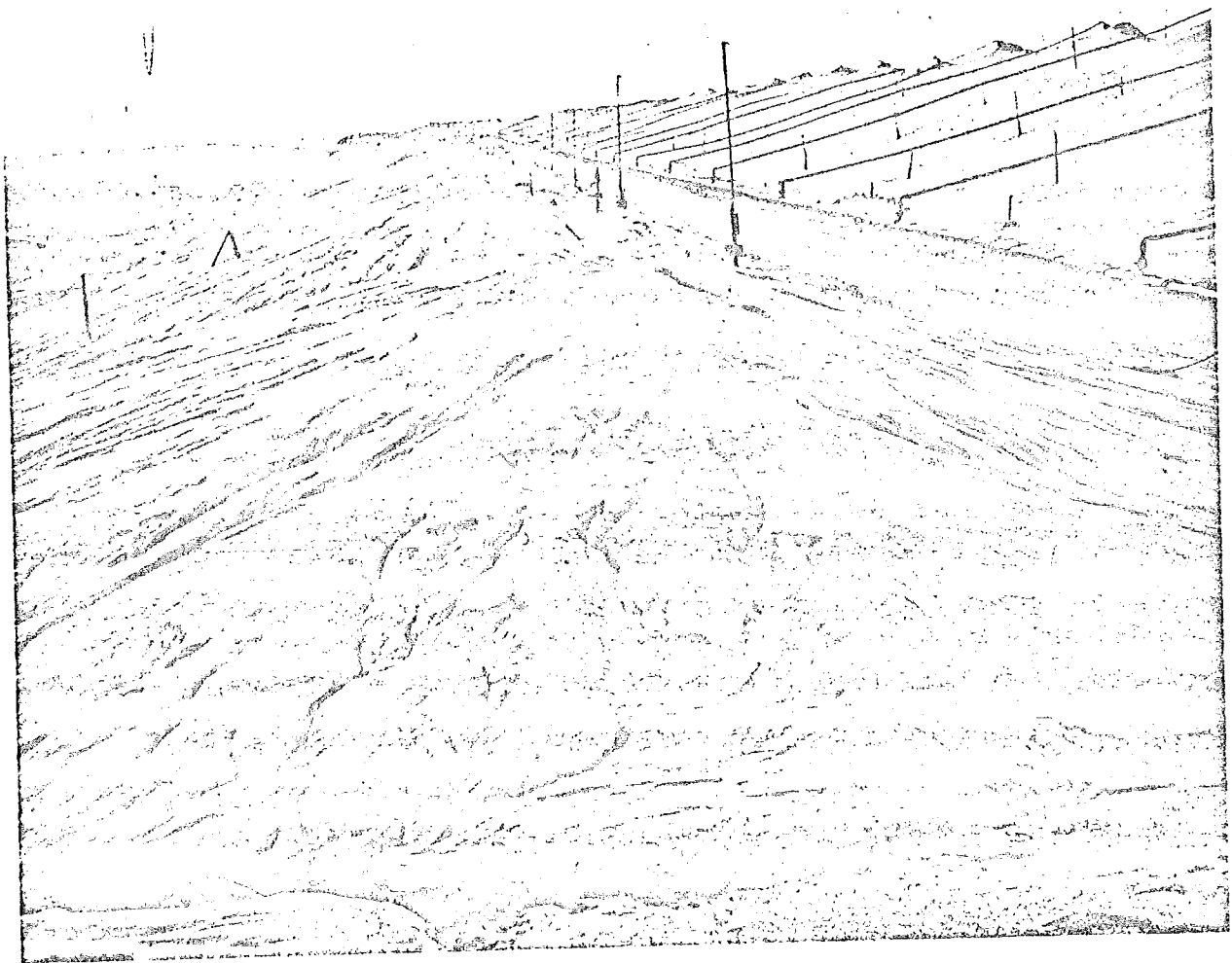
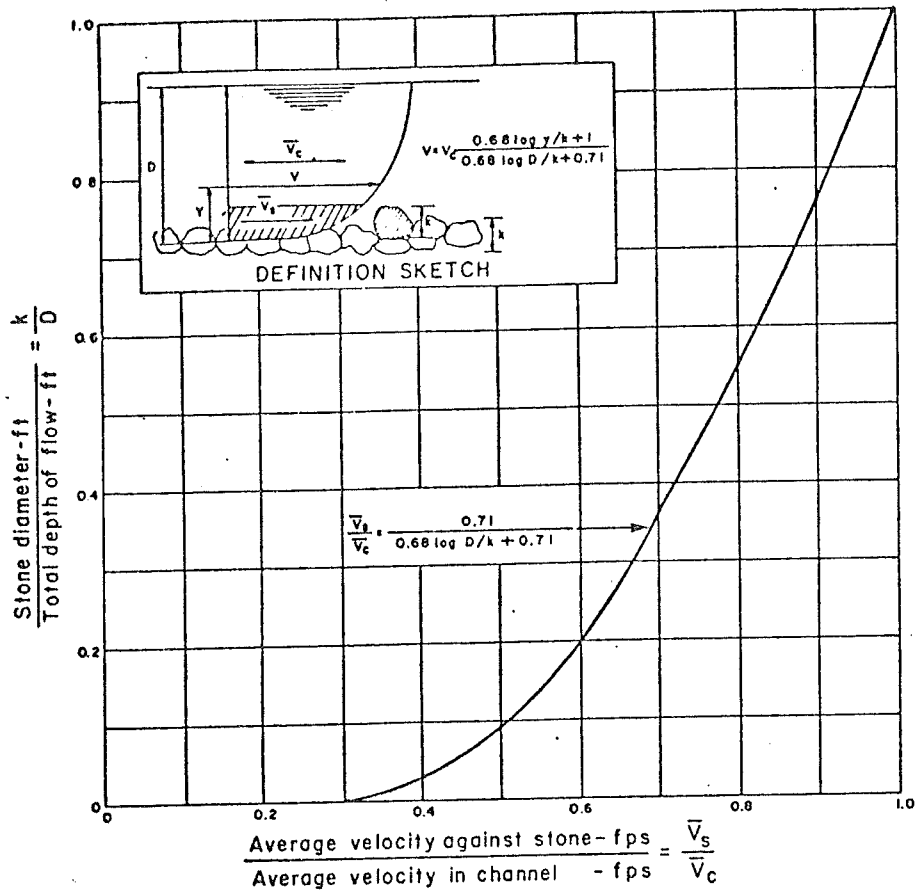

FIGURE 20: - Upstream method with cyclones. (*Courtesy, Magma Copper, Arizona.*)



Notes:

Equations apply to two-dimensional flow

\bar{V}_s = Average velocity against stone - fps

\bar{V}_c = Average velocity in channel - fps

D = Total depth of flow - ft

k = Stone diameter - ft

Equation developed from velocity distribution over rough boundary given in Engineering Hydraulics, edited by Rouse, 1950, Wiley and Sons.

Fig 21- Average velocity against stone paving on a channel bottom

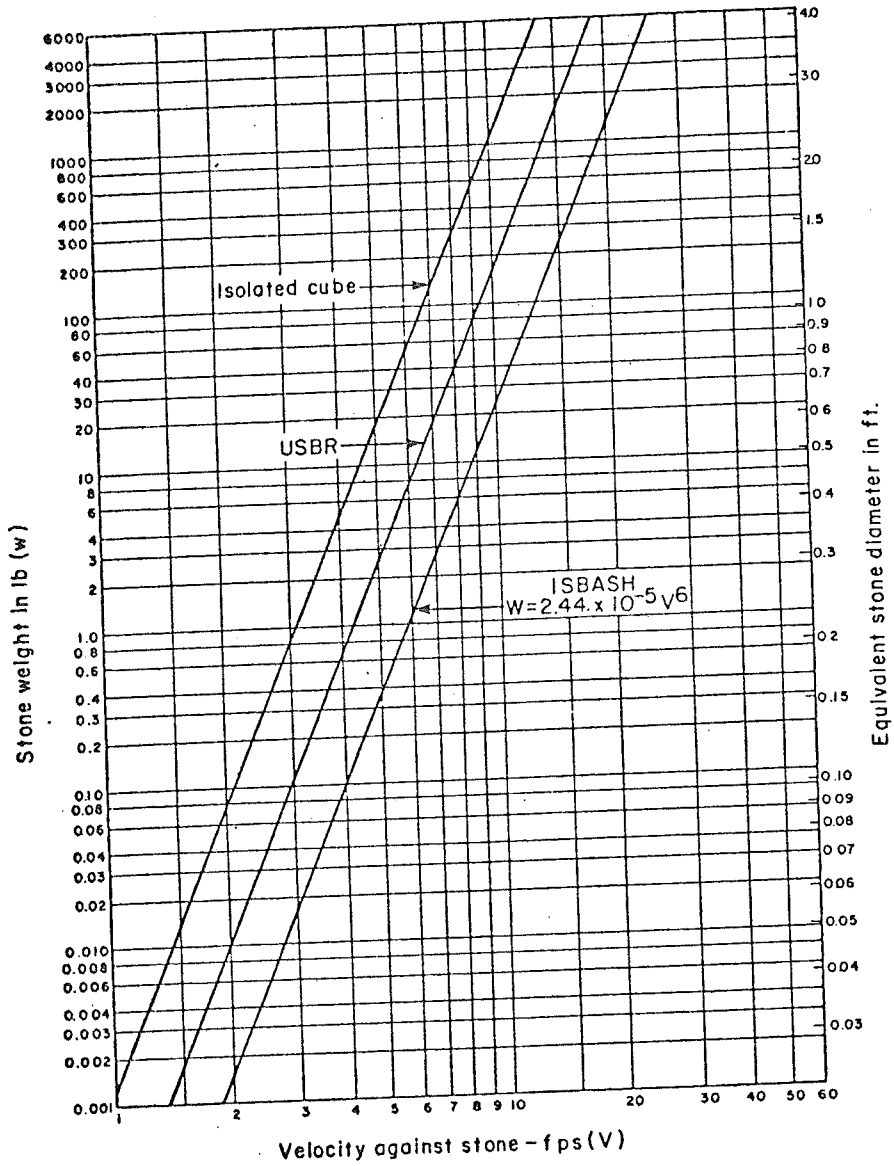

Note:
 Specific weight of rock = 165 lb/cu ft (2642 kg/m³)

Fig 22- Stone paving velocity vs stone weight (US Army Corps of Engineers)

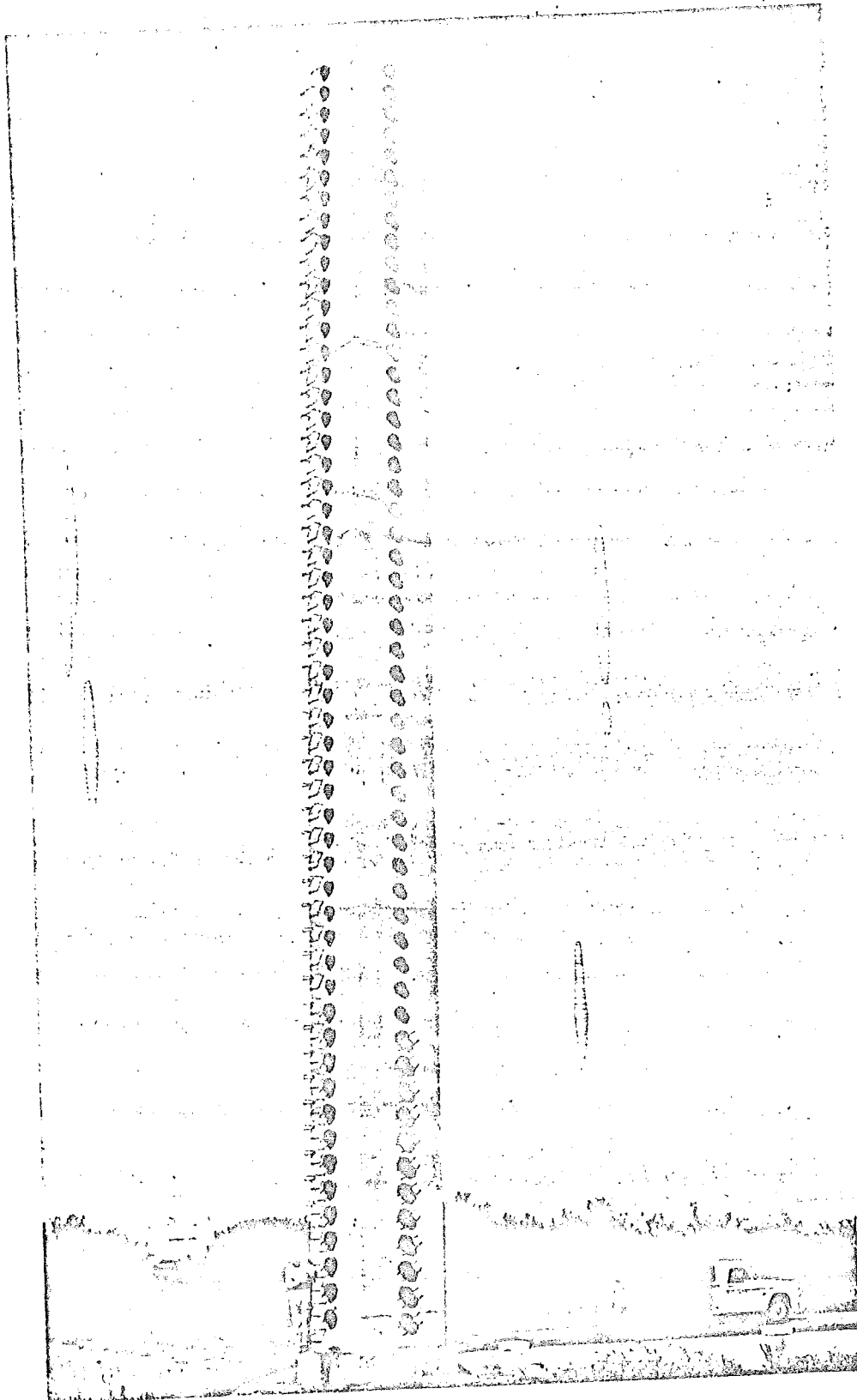

FIGURE 23. - Decant tower with 6-inch outlets at 4-1/2 inches center-to-center.

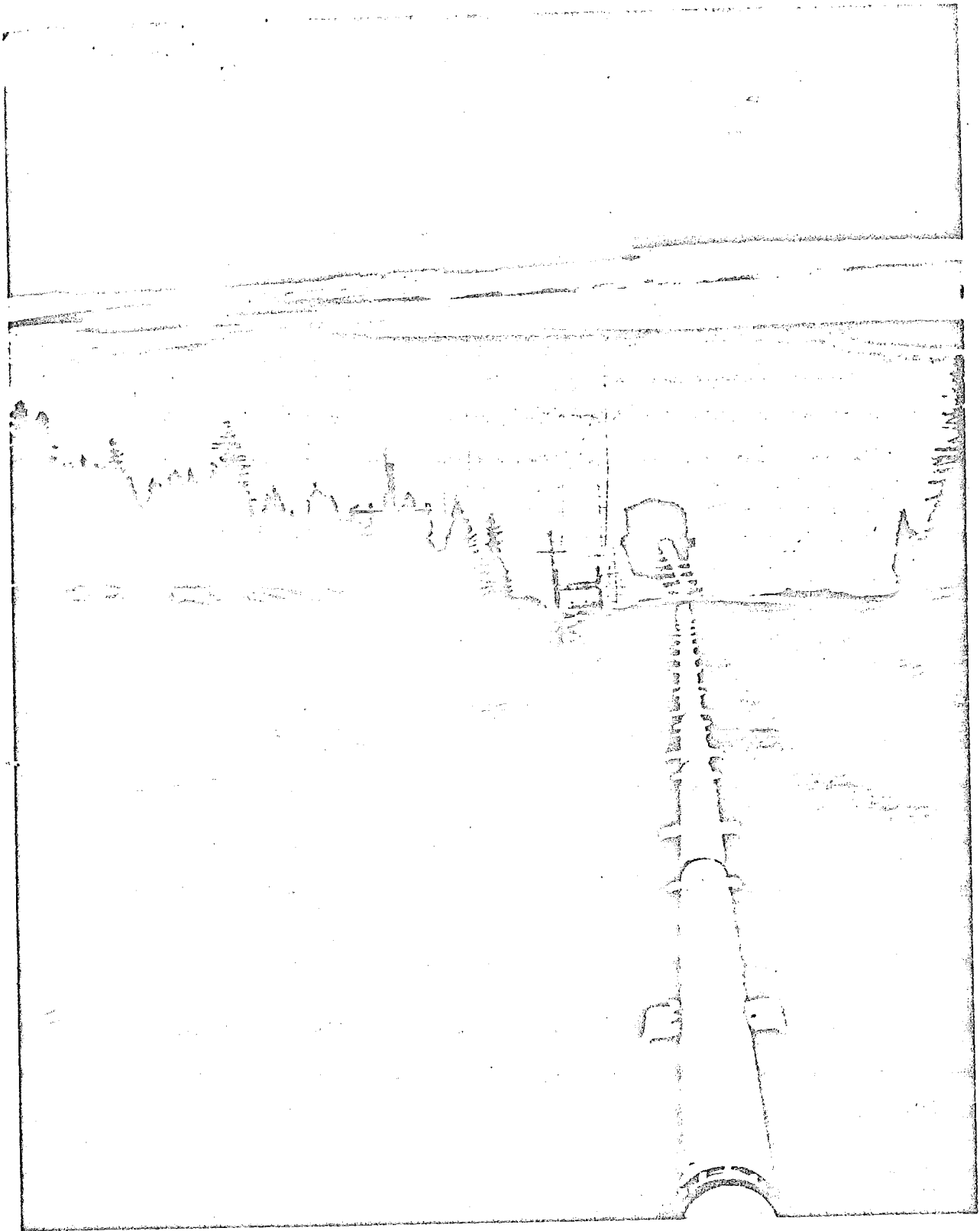

FIGURE 24. - Barge pump and line--steep terrain.

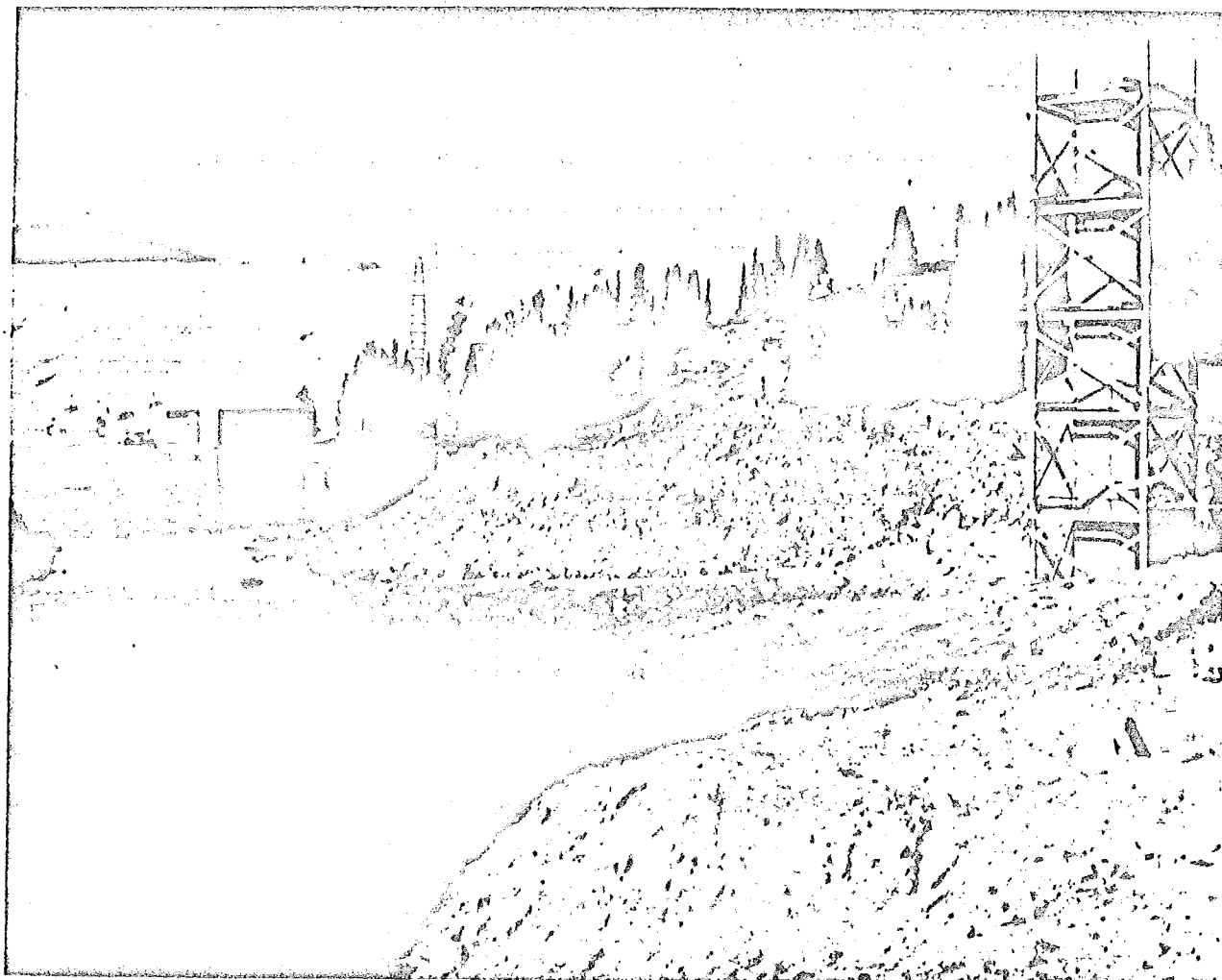

FIGURE 25. - Barge pump and decant tower in the same pond.

REFERENCES CITED

- Report to State of Minnesota Environmental Quality Board on Copper-Nickel Project--Engineering Aspects of Tailing Disposal. By Golder, Brawner, and Associates Ltd. 224 West 8th Avenue, Vancouver, B.C. V57 IN5 Canada.
- Design Guide for Metal and Non-metal Tailings Disposal--Bureau of Mines Information Circular/1977. I.C. 8755. By Roy L. Soderberg and Richard A. Busch.
- Pit Slope Manual--Chapter 9: Environmental Planning. Canada Centre for Mineral and Energy Technology.
- Processes, Procedures, and Methods to Control Pollution from Mining Activities. United States Environmental Protection Agency, Washington, D.C. EPA-430/9-73-011.
- Pit Slope Manual--Chapter 10: Environmental Planning. Canada Centre for Mineral and Energy Technology.
- Tentative Design Guide for Mine Waste Embankments in Canada. Prepared for the Mines Branch--Mining Research Centre.
- SME Mining Engineering Handbook, Volume 1. Seeley W. Mudd Memorial Fund of AIME. Society of Mining Engineers of AIME. U.S. Bureau of Mines, Dept. of the Interior.
- Evaluation of Mill Tailings Disposal Practices and Potential Dam Stability Problems in Southwestern United States. General Report, United States Department of the Interior--Bureau of Mines, Washington, D.C. U.S.B.M. Contract No. 50110520. Volume 1 to 5. December, 1974. W.A. Wahler and Associates.
- Mine and Mill Wastewater Treatment. Economic and Technical Review Report, EPS 3-WP-75-5. Water Pollution Control Directorate. December, 1975.