

CHARACTERISTICS AND ORIGINS OF COARSE PARTICLES
IN THE AIR OF NORTHEASTERN MINNESOTA

A Report by
the Particle Technology Laboratory
of the University of Minnesota

Prepared by

James Charles Wilson
Kenneth T. Whitby
Virgil A. Marple
James E. McCormack

Submitted by

Virgil A. Marple and Kenneth T. Whitby
Principal Investigators
State Planning Agency Contract No. 8023
"Particulate Air Sampling
for Minnesota Regional Copper-Nickel Study"

and

Kenneth T. Whitby, Principal Investigator
EPA Research Grant R 803851-03
"Formation of Atmospheric Aerosols"

Submitted to

State of Minnesota Regional Copper-Nickel Study Project
and
United States Environmental Protection Agency

April, 1979

Particle Technology Laboratory Publication No. 390

ABSTRACT

A brief study of particles suspended in the air of northeastern Minnesota was conducted in July, 1977 with the University of Minnesota Mobile Laboratory. Measurements were made of the concentration, size distribution, and, in some cases, the elemental composition of the aerosol. Studies of coarse particles (i.e., particles larger than $1\ \mu\text{m}$ in diameter) from sources such as gravel roads and mining operations were done.

Weather conditions were wetter than usual, and so the study probably does not represent typical conditions in the region. Dust concentrations were certainly lower during the study than during the dusty episodes of the previous year. However, the results, summarized below, provide valuable insights into the sources and processes affecting the coarse particle concentration in the study area.

1. In a taconite mine, coarse particles were emitted by individual operations such as loading, crushing, or transporting ore. Measured concentrations near these activities reached $600\ \mu\text{m}^3/\text{cm}^3$ on a day when light rain was falling. A few hundred meters from such activity, concentrations near background were observed. The ore processing complex acted as a continuous source, with concentrations over $60\ \mu\text{m}^3/\text{cm}^3$ seen $\sim 500\ \text{m}$ downwind. Resuspension of dust by the wind from open areas such as tailings ponds and dumps was not observed. This lack of resuspension was expected, since wind velocities were generally below $22\ \text{km/hr}$ and conditions were wet. Coarse particles were seen in the pelletizing furnace plume near the stack, but were not observed in the plume $6.5\ \text{km}$ downwind.

2. Winds having velocity of about $17\ \text{km/hr}$ were strong enough to resuspend dust previously deposited on broad-leaf trees. This redistribution mechanism may be significant in keeping the coarse particles suspended even in the absence of winds strong enough to resuspend dust from the ground.

3. X-ray fluorescence analysis of filter samples revealed variations in the ratio of iron to silicon concentrations according to source. Ground-level dust sources in mines produced an average ratio of iron to silicon concentration of 3.5, whereas those outside of the mine produced an average ratio of .51.

4. Road dust suspended by motor vehicles contributes significantly to the coarse particle concentration in the area. Even under moist conditions, vehicles are capable of suspending large quantities of dust. For example, an average dust concentration of $1000\ \mu\text{m}^3/\text{cm}^3$ was observed for 298 seconds at a distance of $110\ \text{m}$ from a gravel road after the passage of a single passenger car at $40\ \text{mph}$. This measurement implies that similar plumes from 40 such vehicles would cause the 24-hour average of total suspended particulates to exceed the Clean Air Act primary standard of $260\ \mu\text{g}/\text{m}^3$ at a distance of $110\ \text{m}$ from the road. The dust levels decreased rapidly with distance from the road and depended strongly on the vehicle velocity. On the streets of towns, the coarse particle concentrations were observed to be increased by a factor of two or three over background levels due to dust resuspended by automobile traffic. This increase was observed in a rainy period.

CONTENTS

Abstract.	ii
Contents.	iii
Figures	iv
Tables.	vii
INTRODUCTION.	1
Background	1
Brief Description of the Study	1
Summary of Results	2
EXPERIMENTAL.	4
The Mobile Laboratory.	4
Description of the Data.	4
Weather Conditions	10
Sampling Sites	10
RESULTS AND DISCUSSION.	14
Introduction	14
Background Aerosol	14
Mine-Related Measurements.	19
Measurements on Dunka Road downwind of Reserve Mining	19
Measurements in and near the Erie Mine Processing Complex	19
Measurements near Loading Operations in the Erie Mine	20
The Plume of the Erie Mine Pelletizing Furnace.	21
Road-Related Measurements.	21
Dust Suspended by Vehicles Moving on Gravel Roads	21
Coarse Particle Levels on Roads in Towns.	26
Dust Resuspended from Tree Leaves.	26
Filter Measurements.	28
SUGGESTED STUDIES	33
Acknowledgements.	33
References.	34
APPENDIX A. University of Minnesota Particle Technology Laboratory Mobile Laboratories.	35
APPENDIX B. The Apparent Truncation of the Coarse Particle Mode Measurements	54
APPENDIX C. Tabulation of Results for Measured Size Distributions.	56
APPENDIX D. Results of Air Parcel Trajectory Analysis.	60

LIST OF FIGURES

1.	Volume-weighted size distribution measured in the dust plume generated by a car on a gravel road. The UMML was 200 m downwind of the road. The coarse particle mode ($D_p > 1 \mu\text{m}$) contains most of the aerosol volume. DGV_c is the geometric volume mean diameter, σ_g is the geometric standard deviation, and V_c is the volume concentration of this mode.	5
2.	Surface-weighted size distribution of a dust plume measured 200 m downwind of the gravel road. The accumulation mode is seen between .1 μm and 1 μm , and is essentially unaffected by the coarse particle plume. V_f is the mass concentration of submicron particles, and ANC is the Aitken nuclei count. V_f for this run is typical of background measurements for the same day.	7
3.	Correlation between coarse particle volume, V_c , determined from optical particle counter size distributions and the ratemeter reading, RTM. The curve is used to determine coarse particle volume concentrations from RTM for times when size distributions were not measured. These correlated coarse particle volume concentrations are designated CV_c	8
4.	Example of ratemeter output. Measurements made on July 25 at site B on Figure 5. From time A to time B, the UMML was among trees. From time C to time D, the UMML was in a cleared area. The arrows mark bursts of dust generated by gusts of wind in nearby trees.	9
5.	Principal sampling sites.	11
6.	Sampling sites near Erie Mine Processing Complex. Sites E and F were downwind of the crusher and processing complex. Sites G and H were downwind of the tailings pond and processing complex.	13
7.	Volume weighting of background size distribution measured east of C on Figure 5 on July 25, 1977. The σ_g for the coarse particle mode is much smaller than the typical value of 2.2 reported by Whitby.	16
8.	Volume weighting of background size distribution measured at site D on Figure 5 on July 26, 1977.	17
9.	Volume weighting of background size distribution measured near site C on Figure 5 on July 27, 1977.	18
10.	Ratemeter output recorded as dust plumes passed the UMML. Dust plumes were generated by vehicles on a gravel road. Measurements were made downwind of the road at site D on Figure 5.	22

LIST OF FIGURES (cont.)

11. Coarse particle volume concentrations measured in plumes generated by vehicles moving on a gravel road. Measurements were made 110 m and 265 m downwind of the road. The wind was perpendicular to the road. Dust concentrations depend strongly on vehicle velocity and the distance traveled by the plume. 24

12. Estimated amounts of dust generated by vehicles on a gravel road and transported downwind. The vertical axis is total estimated aerosol volume per unit length of road transported past the indicated distance. This depends strongly on distance of transport and vehicle velocity. 27

13. Cumulative distribution of ratemeter readings for two intervals involving dust resuspended from tree leaves by the wind. In the interval from 14:26:30 through 14:28:00, the ratemeter reading was below 300 cps 90% of the time, and above 1000 cps 9% of the time. Thus, elevated ratemeter readings, and presumably resuspension, occurred about 10% of the time. In the earlier interval, resuspension occurred during about 8% of the interval. 29

14. Cumulative distribution of wind speed for the two time intervals analyzed for resuspension of dust from tree leaves. For the interval from 14:26:30 through 14:28:00, the wind velocity exceeded 17.7 km/hr about 10% of the time. This wind velocity seems sufficient to resuspend dust from tree leaves. 30

A1. University of Minnesota Mobile Laboratory (UMML) as configured for the Los Angeles Roadway Study in 1976. Note upper and lower sampling intakes and towed generator. 37

A2. UMML roof layout as configured up to 1978. A meteorology mast mounting base is now located just forward of the right inlet. . . 38

A3. Interior photograph of the UMML showing the instruments on the left side of the vehicle. There are two laboratory benches mounted in the center on top of the generator housing and wheel wells. All instruments are mounted so that they can easily be removed for repair and calibration. All wiring and plumbing is in the open for easy repair or change. 39

A4. Schematic of the bag sampling system used up to 1978. Places where aerosol may be lost in the system are marked. Also shown is a schematic of the bag sampling electronic control system. . . 40

A5. Calculated transport efficiency for the sampling system shown in Figure A4. The losses considered are shown in Figure A4. The size range labeled "range of usable data" is the data range that is good without correction. With correction, data may be used to the size where the efficiency is about 30%, corresponding to about 7 μm 41

LIST OF FIGURES (cont.)

A6. Schematic of the new bag sampler constructed in the spring of 1978. In addition to somewhat reduced losses, this system permits direct sampling from straight above the UMML. 43

A7. Sampling efficiencies of the UMML sampling system used in 1978. Efficiencies were measured experimentally using monodisperse aerosol. "Direct Sampling" refers to drawing the sample through the horizontal tube and directly down to the instruments at a flow of 53 lpm. "Bag Sampling" refers to drawing a sample into the bag through the horizontal tube at about 780 lpm, and then drawing the sample from the bag at 6.8 lpm. The inside of the bag was coated with a thin soap film to reduce particle losses due to electric fields. 44

A8. Interior schematic of the right side of the UMML showing the instrumentation as used during the 1976 Los Angeles Roadway Study. 45

A9. Interior schematic of the left side of the UMML showing the instrumentation as used during the 1976 Los Angeles Roadway Study. 45

D1. Air parcel trajectory analysis and corresponding fine particle volume concentrations measured on July 25, 1977 during the Copper-Nickel Study. 62

D2. Air parcel trajectory analysis and corresponding fine particle volume concentrations measured on July 26, 1977 during the Copper-Nickel Study. 63

D3. Air parcel trajectory analysis and corresponding fine particle volume concentrations measured on July 27, 1977 during the Copper-Nickel Study. 64

LIST OF TABLES

1. Background Runs	15
2. Coarse Particle Volume Upwind and Downwind of the Erie Mine Processing Complex.	19
3. Ratemeter Readings and Volume Concentrations Measured Downwind of Mining Operations in the Erie Mine on 7/27/77.	20
4. Summaries of Size Distributions Measured Downwind of Mining Operations.	21
5. Results and Interpretation of Vehicle Dust Plume Measurements . .	23
6. Size Distribution Parameters for Road Dust Measured at Varying Distances from a Gravel Road as Automobiles Passed at Several Different Speeds on July 26	25
7. Elemental Concentration Determined by X-Ray Fluorescence Analysis of Filter Samples.	31
8. Iron to Silicon Ratio Determined by X-Ray Fluorescence Analysis of Filter Samples	32

INTRODUCTION

BACKGROUND

Northeastern Minnesota is rich in natural resources. The taconite mined from open pits in the region contributes a significant fraction of the iron used to make steel in the United States. Forest products and recreation are important to the economy of the area, and the Boundary Waters Canoe Area is a unique wilderness resource. In addition, copper-nickel ore may soon be mined in the area. The use of these resources in a harmonious and environmentally sound fashion presents challenging problems in resource management. The Minnesota State Legislature funded the Regional Copper-Nickel Study to assess the possible impacts of developing the copper-nickel resource. A characterization of the present state of the region forms an important part of this broad inquiry into geology, water resources, atmosphere, aquatic and terrestrial life, and socio-economic environment.

The present study, done at the request of the Regional Copper-Nickel Study, concerns the origins and characteristics of dust in the air of the region. Complaints by residents and measurements of total suspended particulates have indicated that coarse particles are a problem. However, the stationary, integrated samples afforded by the Hi-Vol samplers used to measure the dust concentrations have not yielded information concerning the origins or size distributions of the dust. The University of Minnesota Mobile Laboratory (UMML), with its complement of rapid response instruments, was used in this brief study to characterize, with high spatial and temporal resolution, the dusts from particular sources and particle generating events.

BRIEF DESCRIPTION OF THE STUDY

The study took place from July 25 through July 29, 1977, with most of the data being taken in the vicinity of Babbitt and Aurora, Minnesota. The study utilized the UMML, developed under USEPA sponsorship by the Particle Technology Laboratory for air pollution research. The UMML allows for rapid measurement of size distributions and concentrations of aerosols in the .01 μm to 38 μm diameter range. For this study, the lab also contained a filter sampler with a ten-minute sampling time, a high sensitivity SO_2 monitor, wind, temperature, and humidity sensors.

Measurements were made inside the Erie Mine in order to characterize aerosol generated by taconite mining operations such as the loading and transport of ore and overburden. The suspended dust downwind of the taconite processing complex and tailings ponds was also characterized. Ground-level sampling was done in the plume of the pelletizing furnace near to the stack and 6.5 km downwind. The mobile laboratory was operated two to three miles downwind of the temporarily inactive Reserve Mining pit to measure dust transport. The resuspension of dust from leaves by the wind was observed, and dust plumes of cars on a gravel road were studied. The background aerosol was measured and scattered observations were made of coarse particle concentrations in towns. Filter samples were collected near various sources for elemental analysis by X-ray fluorescence to characterize the aerosols by elemental composition.

The weather conditions before and during the study were not favorable for the study of wind-blown dust, but the strike by the United Steel Workers which started August 1, 1977 made it necessary to do the study in the moist period, just before the strike. Precipitation in the nearby town of Babbitt was 9.6 inches for the months of June and July, whereas the long-term average for those two months is 7.95 inches. Intermittent rain fell on July 27 during the UMML operations in the Erie Mine. These wet conditions reduced suspension of dust from bare surfaces by the wind and reduced the amount generated by vehicular traffic. In addition, the observed wind velocities, which were less than 22 km/hr during the study, would not be expected to resuspend much dust. Residents of the area said that the dusty episodes which caused complaint during 1976 were absent during June and July of 1977.

SUMMARY OF RESULTS

The results reported here may not be characteristic of typical weather conditions and certainly are not characteristic of the dusty episodes of the previous year. The moist conditions and moderate winds most certainly limited the observed dust concentrations both inside and outside the mine. In addition, the Erie Mining Company and Pickens-Mather Company have been cited by USEPA and others for excellence in land reclamation, and are well-known for efforts on behalf of dust control. Also, blasting did not occur during the study period and so was not observed. Consequently, the levels of dust observed in the Erie Mine are probably not typical of what might be found in other mines in north-eastern Minnesota.

There is evidence from other studies and detailed analysis of our size distribution data which suggests that the actual coarse particle concentrations were higher than those measured in this study. This evidence is discussed in the Results section and in Appendix B.

The following results are to be considered in the light of the reservations cited above:

1. Road dust suspended by motor vehicles contributes significantly to the coarse particle concentration in the area. Even under moist conditions, vehicles are capable of suspending large quantities of dust. For example, average dust concentration of $260 \mu\text{m}^3/\text{cm}^3$ was observed for 211 seconds at a distance of 265 m from a gravel road after the passage of a single jeep at 30 mph. The dust levels decreased rapidly with distance from the road and depended strongly on the vehicle velocity. On the streets of towns, the coarse particle concentrations were observed to be increased by a factor of two or three over background levels due to dust resuspended by automobile traffic. This increase was observed in a rainy period.

2. In a taconite mine, coarse particles were emitted by individual operations such as loading, crushing, or transporting ore. Measured concentrations near these activities reached $600 \mu\text{m}^3/\text{cm}^3$ on a day when light rain was falling. A few hundred meters from such activity, concentrations near background were observed. The ore processing complex acted as a continuous source, with concentrations over $60 \mu\text{m}^3/\text{cm}^3$ seen ~ 500 m downwind. Resuspension of dust by the wind from open areas such as tailings ponds and dumps was not observed. This lack of resuspension was expected, since wind velocities were generally below 22 km/hr and conditions were wet. Coarse particles were seen in the pelletizing plume near to the stack, but were not observed in the plume 6.5 km downwind.

3. Winds having velocity of around 17 km/hr were strong enough to resuspend dust previously deposited on broad-leaf trees. This redistribution mechanism may be significant in keeping the coarse particles suspended even in the absence of winds strong enough to resuspend dust from the ground.

4. X-ray fluorescence analysis of filter samples revealed variations in the ratio of iron to silicon concentrations according to source. Ground-level dust sources in mines produced an average ratio of iron to silicon concentration of 3.5, whereas those outside of the mine produced an average ratio of .51.

EXPERIMENTAL

THE MOBILE LABORATORY

A description of the UMML is found in Appendix A. For this study, the UMML was equipped to make rapid size distribution measurements of suspended particles in the diameter range from $.01 \mu\text{m}$ to $38 \mu\text{m}$. This was accomplished with an electrical aerosol analyzer (EAA) (TSI, Inc. Model 3030) for the $.01 \mu\text{m}$ to $1 \mu\text{m}$ range, a modified optical particle counter (OPC) (Royco 220) for the $.5 \mu\text{m}$ to $5 \mu\text{m}$ range, and another modified OPC (Royco 245) for the $5 \mu\text{m}$ to $38 \mu\text{m}$ range. The modifications to the OPC's are described by Willeke and Liu (1976). Size distribution measurements required periods of approximately two minutes and were made frequently. The aerosol was sampled at a height of approximately 3 m. An Aitken nuclei counter (Environment/One) provided a continuous measure of the number concentrations of fine particles. A ratemeter connected to the output of the Royco 245 provided a continuous measure of the number concentration of particles in the range from $5 \mu\text{m}$ to $38 \mu\text{m}$. The time response of this measurement was 5 s or faster. A Meloy SA 285 measured SO_2 , and O_3 was measured with a Dasibi ozone monitor. Wind speed and wind direction were measured at a height of 5 m. Temperature and dewpoint temperature were measured at the UMML, and radiosonde measurements were made at regular intervals by the Copper-Nickel meteorologist. Filter samples were collected on 37 mm Nuclepore filters at a flow rate of 48 lpm, and on 37 mm Millipore cellulose filters at a flow rate of 35 lpm. The filters were analyzed by X-ray fluorescence for elemental abundance in USEPA laboratories. This technique is sensitive to elements heavier than aluminum. Collection times were usually around ten minutes.

DESCRIPTION OF THE DATA

Size distributions were measured and analyzed following the methods described by Whitby (1978). Number, surface, and volume weightings were considered and the parameters of interest for each size range were determined. Figure 1 shows the volume weighting of a size distribution measured in a dust plume generated by a car on a gravel road (Run 57). Most of the aerosol mass is found in the coarse particle range ($D_p > 1 \mu\text{m}$), and the volume distribution shows a distinct mode in this size range. Atmospheric size distributions often show a similar coarse particle mode. The particles in this mode are frequently generated by mechanical means, for example, wind or human activity; their chemical composition is dominated by compounds found in the earth's crust, and, due to their large size, they are removed rapidly by sedimentation. Thus, coarse particles are not often transported more than a few kilometers. Measurements of total suspended particulates (TSP) are usually dominated by the concentration of coarse particles. In this study, the volume concentration of the coarse particle mode, V_c , is used to characterize the amount of dust in the air. The geometric mean volume diameter, DGV_c , and the geometric standard deviation, σ_g , are reported for the coarse particle modes of the measured size distributions.

Size distributions of atmospheric aerosols usually consist of additive modes that can be described by log-normal distributions whose geometric means and geometric standard deviations fall within a certain range of values. The coarse particle volume distributions measured in this study have geometric standard deviations on the order of 1.75. This value is significantly less than the value of 2.2, which was found to be typical of atmospheric coarse particle modes

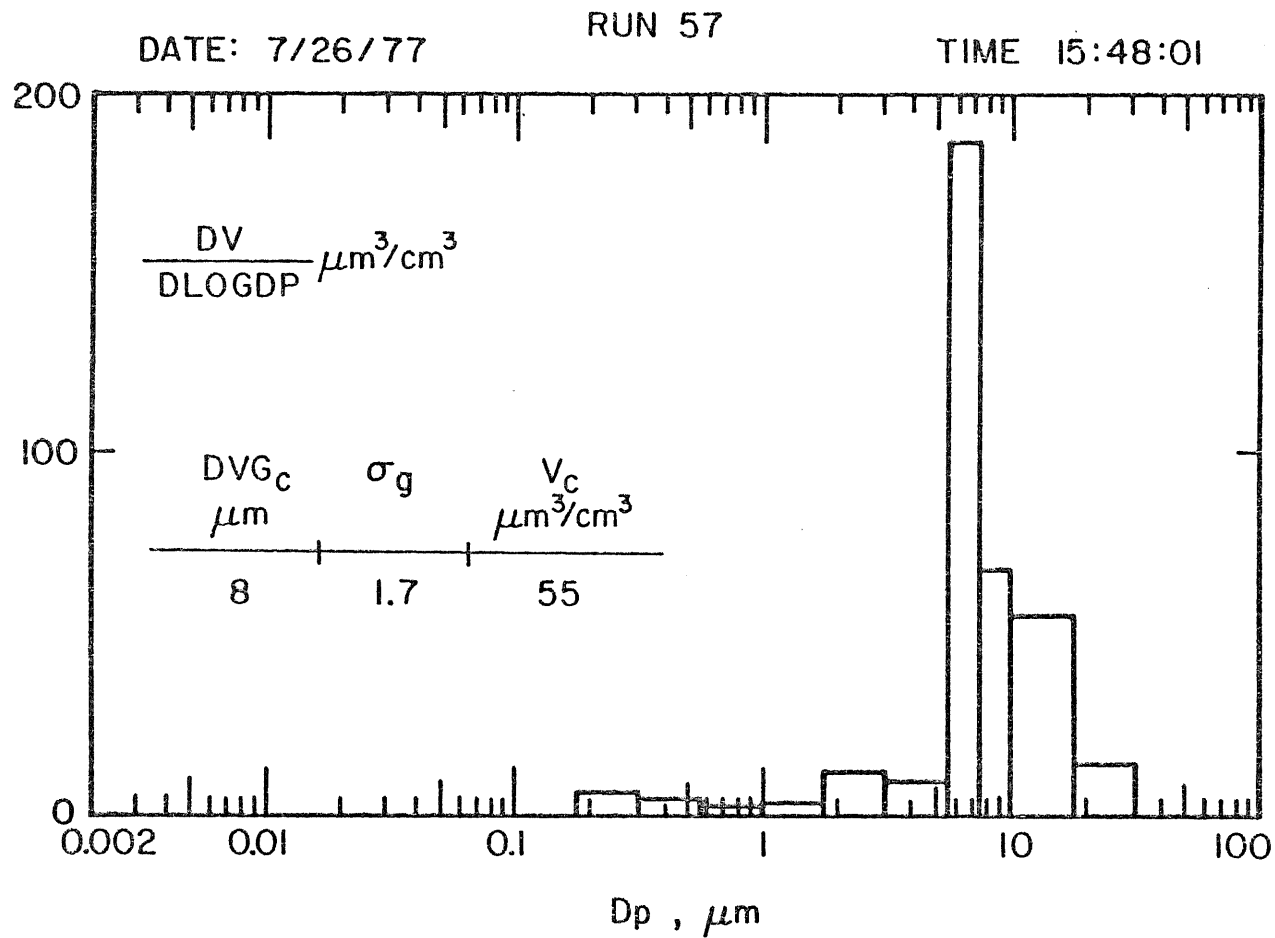

Figure 1. Volume-weighted size distribution measured in the dust plume generated by a car on a gravel road. The UMLL was 200 m downwind of the road. The coarse particle mode ($D_p > 1 \mu\text{m}$) contains most of the aerosol volume. DVG_c is the geometric volume mean diameter, σ_g is the geometric standard deviation, and V_c is the volume concentration of this mode.

by Whitby (1978). This suggests that the actual coarse particle modes were less narrow than the measurements indicate. Thus, in some cases, the actual volume concentrations may be larger than the measured values by a factor of 10 or more. This truncation of the measured values is discussed further in Appendix B. The numbers reported in the body of the report are calculated directly from the measured values independent of assumptions concerning the mathematical form of the distributions.

Figure 2 shows the surface weighting for Run 57. The mode in the range between $.1 \mu\text{m}$ and $1 \mu\text{m}$ is commonly called the accumulation mode. This mode usually contains aged photochemical or combustion aerosols generated by a condensation process. Due to their negligible settling velocity, these particles are usually transported long distances and are removed from the atmosphere primarily by precipitation processes. In this report, the accumulation mode is represented by V_f , the volume concentration of the particles with diameters less than $1 \mu\text{m}$. Particles with $D_p < 1 \mu\text{m}$ are known as fine particles.

The nuclei mode consists of particles with $D_p < .1 \mu\text{m}$, which are freshly formed by combustion or photochemistry. These particles often dominate the number distribution but do not contribute much mass. Particles in the nuclei mode usually grow into the accumulation mode by condensation or coagulation within a few hours after they are formed. Hence, the nuclei mode concentration is usually determined by nearby sources. This mode is characterized in this report by the Aitken nuclei count, ANC. Rapidly fluctuating values of ANC are often used as an indicator of aerosol from nearby internal combustion engines. The parameters, V_c , DGV_c , σ_g , V_f , and ANC for Run 57 are listed on Figures 1 and 2.

A ratemeter connected to the output of the Royco 245 provided a continuous measure of the rate at which particles were sampled in the range from $5 \mu\text{m}$ to $38 \mu\text{m}$. The ratemeter reading, RTM, correlates with the coarse particle volume concentration, V_c , as shown in Figure 3. The values of V_c were determined from measured size distributions, and the corresponding values of RTM were determined by averaging the ratemeter signal over the time required to measure V_c . This correlation allows the volume concentration of the coarse particle mode to be determined from the ratemeter reading. The correlated coarse particle volume concentration is designated CV_c . Using the curve in Figure 3 to determine CV_c from RTM allows the coarse particle volume concentration to be determined for times when size distributions were not measured and allows average concentrations to be determined over extended time periods, for example, during the passage of a dust plume.

Fluctuations in the ratemeter readings provide some indication of the distance and nature of the coarse particle aerosol sources. Figure 4 is a strip chart illustrating characteristics and interpretations of the ratemeter reading. Time interval C through D indicates a background reading of around 10 c/s. The lowest quasi-steady readings observed while operating upwind of the source were taken to characterize the background coarse particle aerosol. Time interval A through B is an example of an elevated but relatively steady reading near 100 c/s. Such quasi-steady readings elevated above the background are interpreted to indicate an extended or steady source. Nearby coarse particle generating events caused large and rapid fluctuations in the ratemeter readings. Examples of this are indicated by the arrows on the figure. During the period from A to B, the UMML was among trees. The peaks marked with arrows were

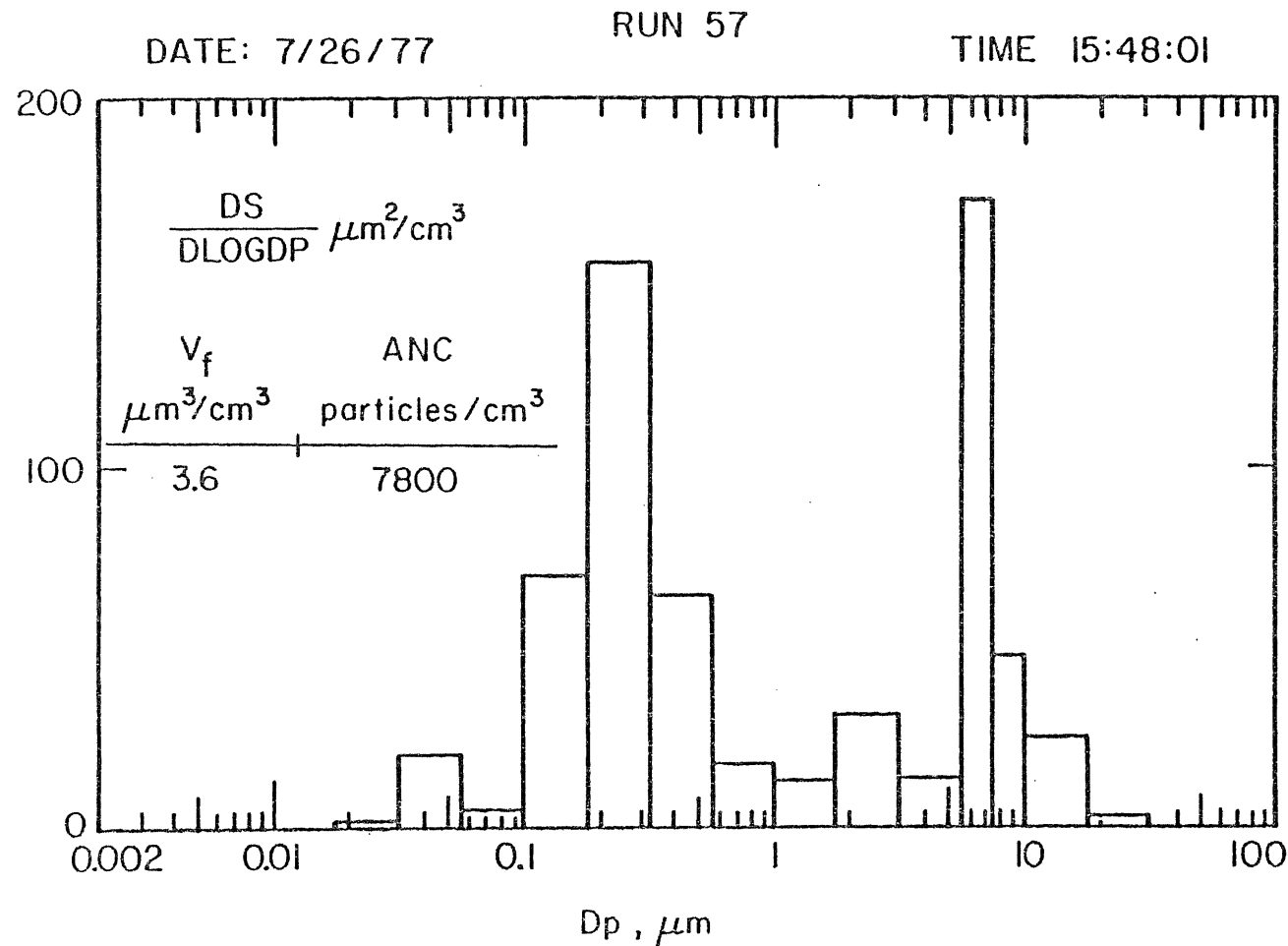

Figure 2. Surface-weighted size distribution of a dust plume measured 200 m downwind of the gravel road. The accumulation mode is seen between .1 μm and 1 μm , and is essentially unaffected by the coarse particle plume. V_f is the mass concentration of submicron particles, and ANC is the Aitken nuclei count. V_f for this run is typical of background measurements for the same day.

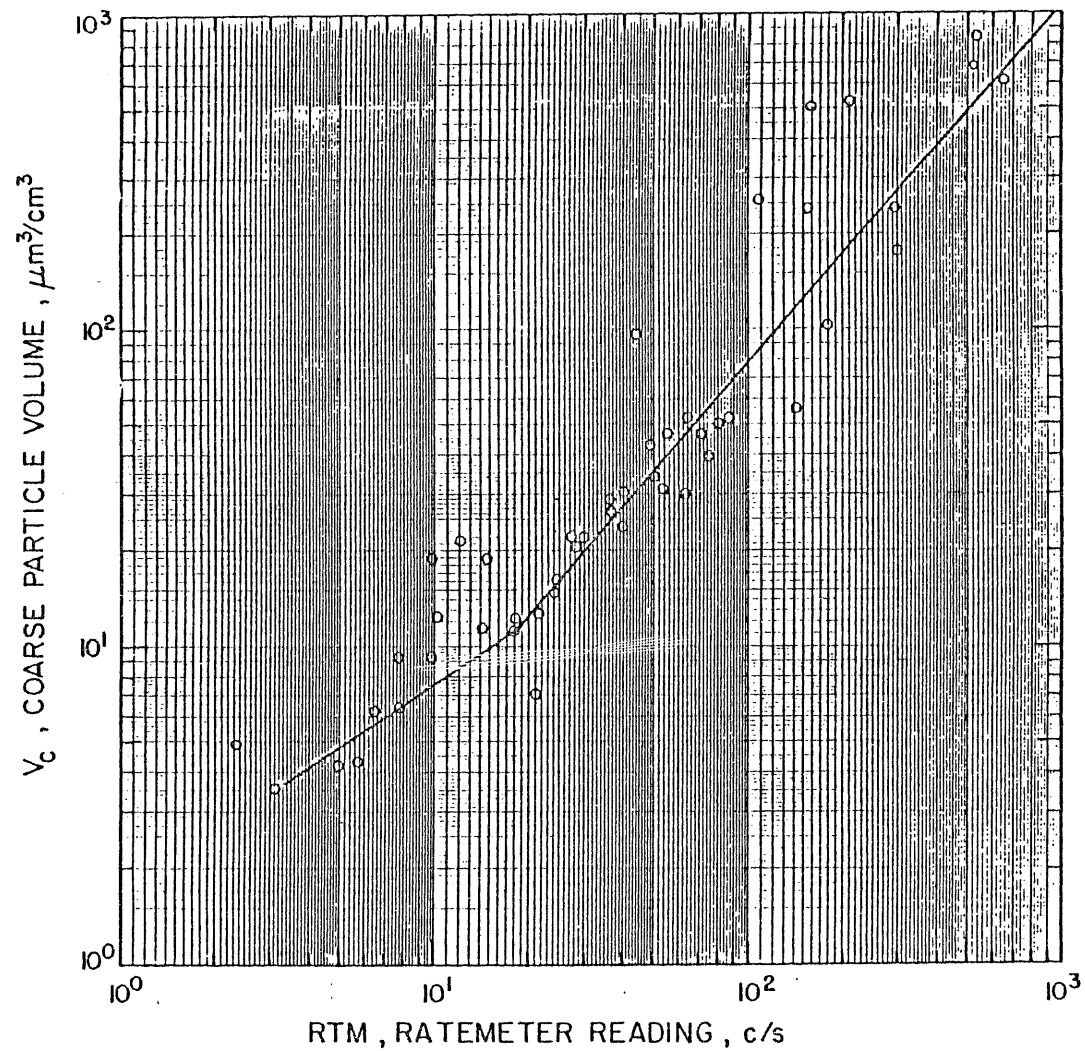

Figure 3. Correlation between coarse particle volume, V_c , determined from optical particle counter size distributions and the ratemeter reading, RTM. The curve is used to determine coarse particle volume concentrations from RTM for times when size distributions were not measured. These correlated coarse particle volume concentrations are designated CV_c .

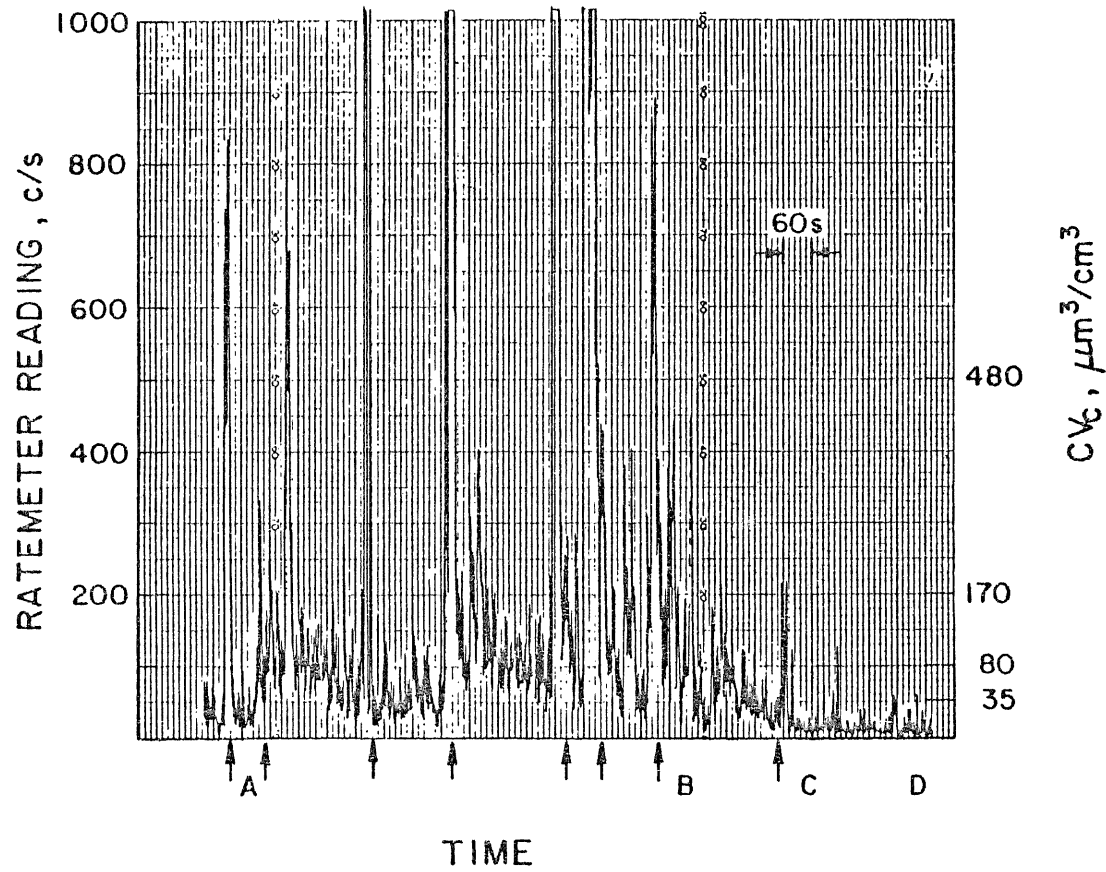

Figure 4. Example of ratemeter output. Measurements made on July 25 at site B on Figure 5. From time A to time B, the UML was among trees. From time C to time D, the UML was in a cleared area. The arrows mark bursts of dust generated by gusts of wind in nearby trees.

puffs of dust generated by wind agitating the tree leaves. The period from C to D coincides with the movement of the UMML into a large cleared area.

Continuous measurements of SO_2 concentration, wind speed and direction, dewpoint and ambient temperature, and O_3 concentration were made at the UMML. Elevated SO_2 concentrations often indicate the presence of plumes from combustion sources.

DGV_c , σ_g , V_c , V_f , ANC, and RTM are tabulated for all runs in Appendix C.

In addition to the weather data taken at the van, radiosonde measurements were made. National Weather Service data was used to calculate the trajectories of the air parcels which were present during the study. The calculations indicated the paths followed by air in the 36 hours prior to their arrival in the study region. Examples of trajectory calculations are presented in Appendix D.

WEATHER CONDITIONS*

Most of the sampling was done on July 25, 26, and 27, 1977 near Babbitt and Aurora, Minnesota. The weather during the previous two months had been wetter than average. Precipitation in Babbitt was 9.6 inches for June and July, whereas the long-term average for those two months is 7.95 inches.

A large high-pressure system pushed into Minnesota from the northwest on July 25 and was centered over the state by July 26. The high moved over the southern Great Lakes by July 27 and set up a southerly flow across Minnesota.

On July 25, daytime winds were moderate to strong and gusty from the northwest. It was partly cloudy on July 26, and the winds were light and variable, west to northwest; on July 27, winds were variable from the south with light intermittent rain falling throughout the afternoon.

Calculations of air parcel trajectories indicate that the air masses present on July 25 arrived from the north. The calculations for July 26 show air arriving from the northwest. The air mass present on July 27 in the morning and afternoon originated north of the study area, but first passed over central and southern Minnesota before returning to the Iron Range. See Appendix D for additional discussion of trajectories.

SAMPLING SITES

Figures 5 and 6 indicate the principal sampling sites used during the study. On July 25, the UMML was operated along Dunka Road from point A to point C (Figure 5). Site B was visited on the way from A to C, and was located in the midst of a stand of broad-leaf trees. This was in contrast to the Dunka Road, the sides of which are fairly free of tall vegetation. Dunka Road has a gravel surface. Measurements were also made on July 25 approximately 6.5 km southwest of C in the plume of the pelletizing furnaces located at C. A traverse of this plume was made along a road through heavy woods, and measurements were made in an open meadow.

* Data supplied by William Enderson of the State of Minnesota Regional Copper-Nickel Study and Perry J. Samson at the University of Wisconsin.

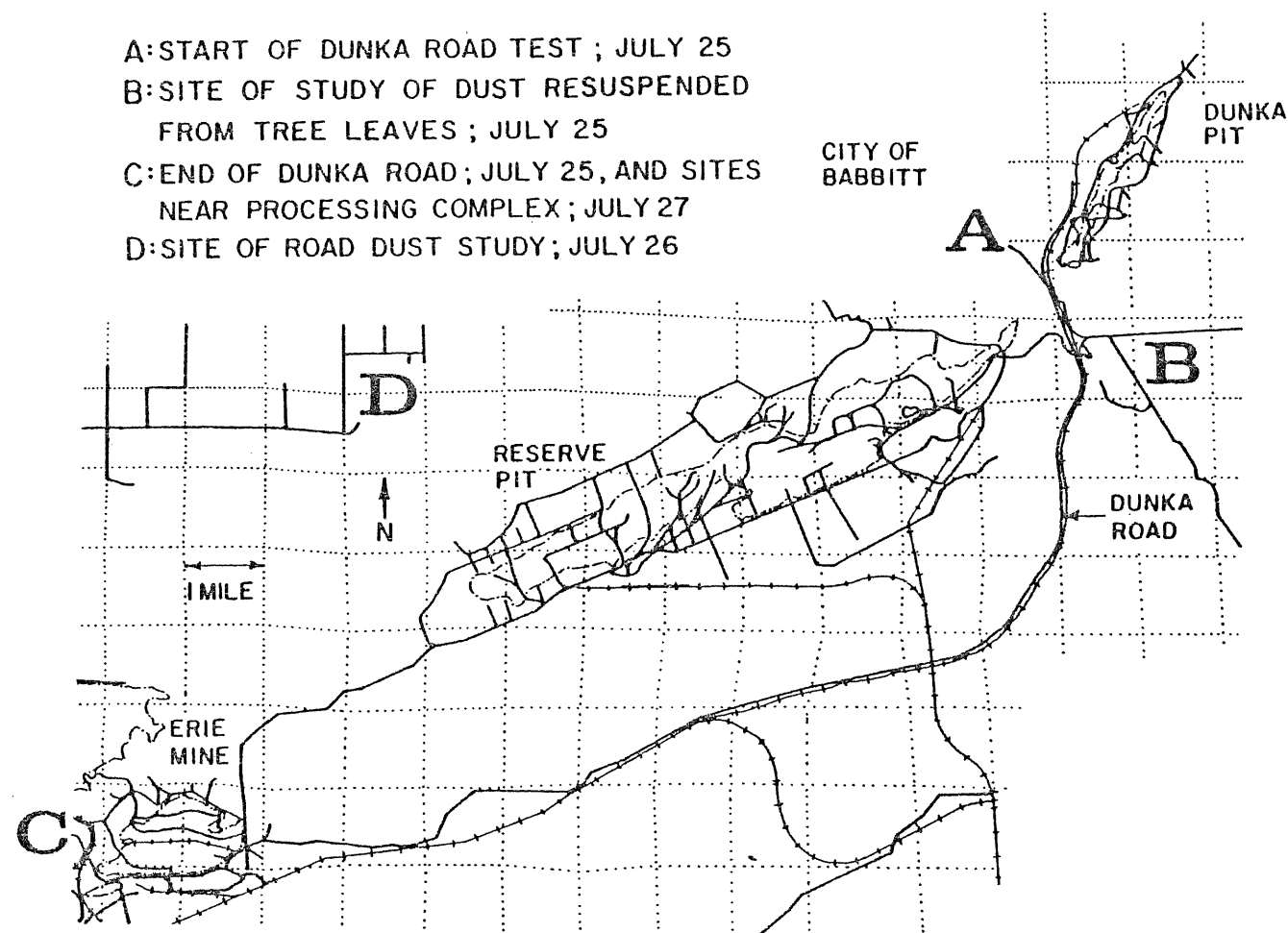

Figure 5. Principal sampling sites.

Site D on Figure 5 was located in a farmer's field adjacent to the north-south road indicated on the map. Measurements of road dust plumes were made on July 26 at this location. The road has a gravel surface, and the field was covered with short vegetation.

Figure 6 shows the processing complex which is located at C on Figure 5. Measurements were made on July 27 in this area. Sites E and F were downwind of the processing complex and crusher. Sites G and H were downwind of the tailings pond. Sampling was also done upwind of the processing complex, and near a shovel loading operation and a loading pocket operation in the mine. In these operations, 85-ton trucks were loaded by a shovel (shovel operation) or unloaded into railroad cars (loading pocket).

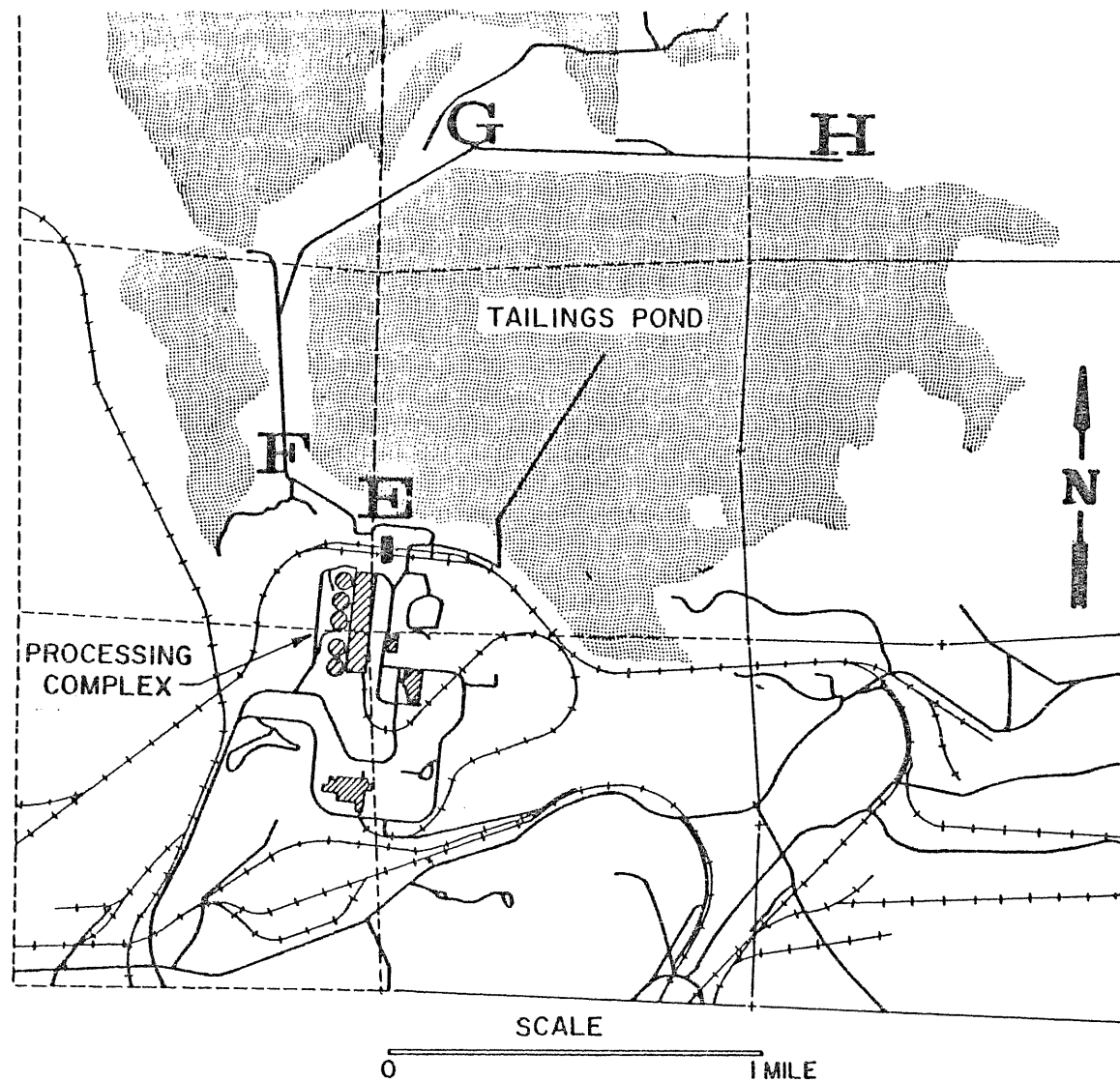

Figure 6. Sampling sites near Erie Mine Processing Complex. Sites E and F were downwind of the crusher and processing complex. Sites G and H were downwind of the tailings pond and processing complex.

RESULTS AND DISCUSSION

INTRODUCTION

In this section, background aerosol measurements are reported and compared with typical values; measurements downwind of the inactive Reserve Mining pit, near the Erie mine processing complex, and near loading operations in the Erie mine are reported. Results of the road dust studies are shown, and an effort is made to estimate the amount of dust transported in the plume generated by a vehicle on a gravel road. The elemental composition of certain aerosols was determined, and the iron-to-silicon concentration ratio is reported and serves as an indicator of the origin of the dust. The plume from the pelletizer furnace at the Erie mine and coarse particle levels in towns are also discussed.

BACKGROUND AEROSOL

The ambient aerosol concentration can be affected by nearby and distant sources. Accumulation mode aerosol concentrations are often determined by emissions from distant sources and by conditions along the trajectory followed by the air parcel. Nuclei mode concentrations are often determined by nearby sources, since these small particles grow rapidly by coagulation and do not remain in the nuclei mode. Coarse particle concentrations are also usually determined by sources within a few kilometers of the site, since these particles are removed rapidly by sedimentation.

Consequently, the concept of background aerosol must be understood differently for each of these modes. The accumulation mode background aerosol is characteristic of the air mass present at the time and is usually understood by considering the prior trajectory of the air mass. The background values for the accumulation mode will not change with small changes in location.

Since coarse particle concentrations are primarily determined by local sources, the background coarse particle aerosol is essentially that concentration present upwind of the source being studied. However, the details of the transport of coarse particles in the atmosphere remain unknown, so separating the contribution from relatively proximate sources presents difficulties. Fortunately in this study, the coarse particle concentrations upwind of the sources being studied were usually relatively steady and were not dependent on position. Thus, the increments in concentration downwind of the source over the background concentrations were attributable to the sources.

Table 1 lists background values measured on July 25, 26, and 27. Coarse particle distributions are characterized by the geometric mean diameter of the volume weighted distribution, DGV_c , and the geometric standard deviation of the distribution, σ_g . The ratemeter values, RTM, are one-minute averages taken over the sample time. V_c is the coarse particle volume, V_f is the volume in the fine fraction, and ANC is the total number measured by the Aitken nuclei counter.

Runs 30, 31, and 32 were measured in the afternoon of July 25 east of site C in Figure 5. Typical clean continental background values are $V_c = 5 \mu\text{m}^3/\text{cm}^3$ and $V_f = 1.5 \mu\text{m}^3/\text{cm}^3$ (Whitby, 1978), and agree quite well with the measured values.

TABLE 1. BACKGROUND RUNS

Date	Run	$V_c, \frac{\mu\text{m}^3}{\text{cm}^3}$ ¹	$V_f, \frac{\mu\text{m}^3}{\text{cm}^3}$ ¹	ANC particles/cm ³	O ₃ ppm	RTM c/s	Coarse Particles ¹	
		(D _p > 1 μm)	(D _p < 1 μm)				DGV _c μm	σ _g
July 25	30	4.2	1.1	9.6 x 10 ⁴	.025	4.9	4.9	1.5
	31	4.4	1.7	12 x 10 ⁴	.015	5.8	7.8	1.9
	32	3.9	1.7	12.2 x 10 ⁴	.004		5.1	1.3
July 26	52	9.4	4.0	7 x 10 ³	.03	10	6.2	1.7
	62	12.9	4.1	5.7 x 10 ³	.03	10	7.7	1.7
July 27	72	21.3	5.5	2.4 x 10 ⁴	.024	12	7.0	1.8

¹Determined from size distributions.

However, the measured value of ANC exceeds the typical value for clean continental background by two orders of magnitude. The elevated ANC readings were one to two orders of magnitude higher than the concentration measured by the EAA. The large ANC readings may indicate that very small particles were being formed from detectable levels of gaseous sulfur emitted by the dust suppressant which was applied to the road, or they may indicate the presence of unobserved motor vehicles.

Runs 52 and 62 were made in the afternoon of July 26 at point D on Figure 5. Values of V_f , V_c , and ANC are higher than expected for clean continental background, as are the background values measured on the morning of July 27 in the Erie mine (Run 72). V_c for Run 72 is 21.3 μm³/cm³, and the ratemeter value is 11.9 c/s. This value of RTM implies a background value of CV_c of less than 10 μm³/cm³, or about one-half of V_c . This difference is not large when considered in the light of the known variability of coarse particle concentrations. Figures 7, 8, and 9 show the volume distributions for Runs 32, 52, and 72.

The trajectory calculations explain the differences between the values of V_f measured for July 25 and July 27. The parcels of air arriving on July 25 passed over the Quetico Provincial Park and the Boundary Waters Canoe Area in the twelve hours before reaching the site. It is not surprising that they are clean. However, the air mass sampled on July 27 had passed near the urban areas of Minneapolis, St. Paul, and Duluth in the previous twelve hours, and the background value of V_f for that day reflects the presence of aged, anthropogenic aerosol.

The values of σ_g for the coarse particle mode are surprisingly small. Whitby (1978) reports typical values to be on the order of 2.2. This supports

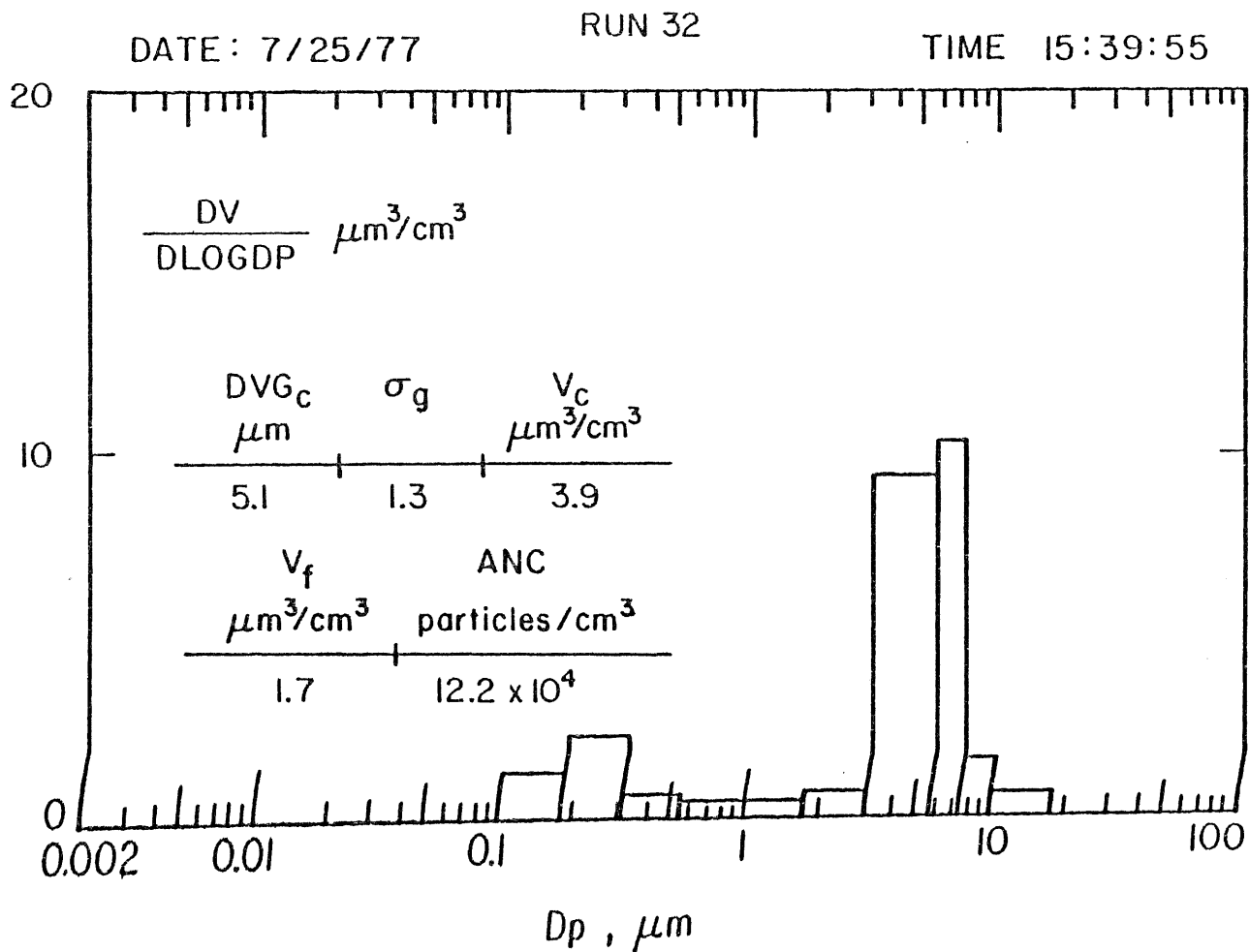

Figure 7. Volume weighting of background size distribution measured east of C on Figure 5 on July 25, 1977. The σ_g for the coarse particle mode is much smaller than the typical value of 2.2 reported by Whitby.

DATE: 7/26/77

RUN 52

TIME 14:52:07

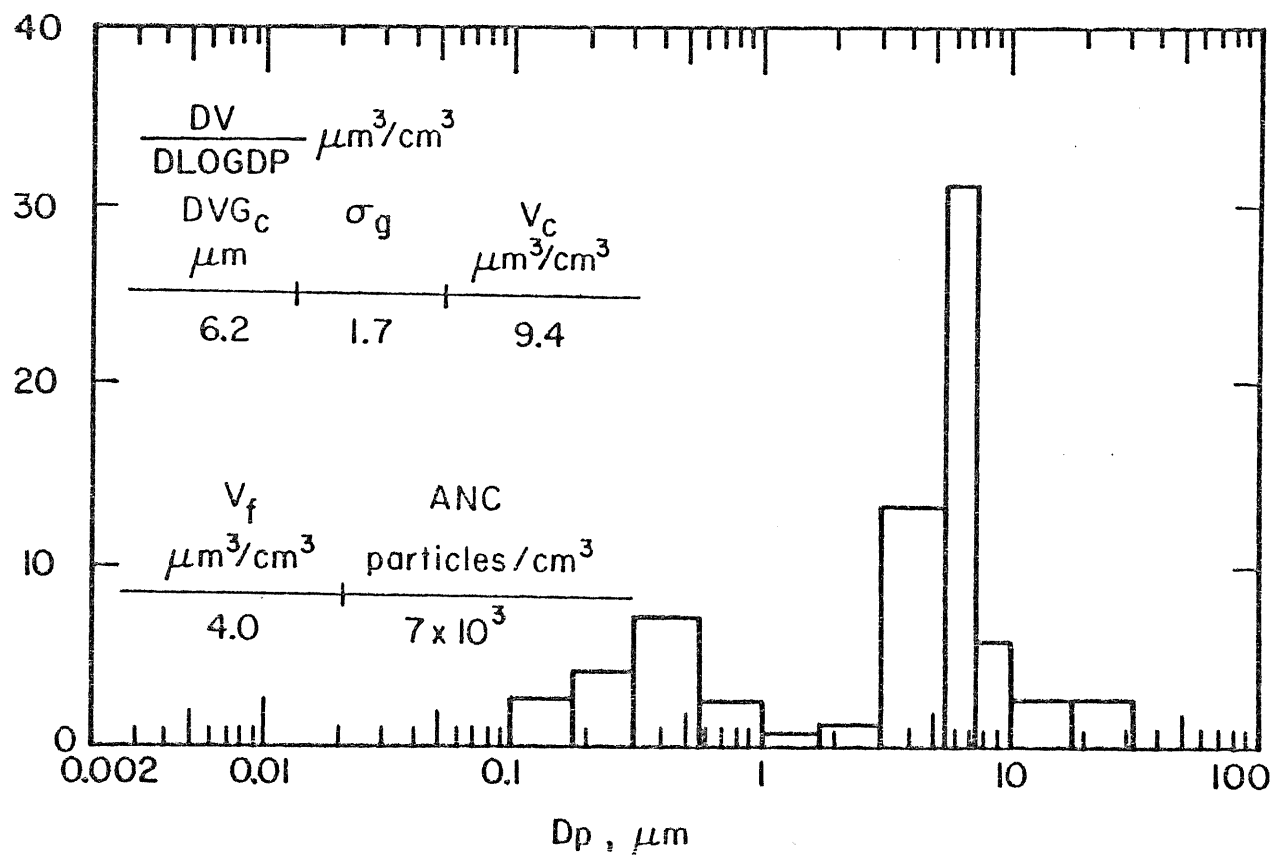

Figure 8. Volume weighting of background size distribution measured at site D on Figure 5 on July 26, 1977.

DATE: 7/27/77

RUN 72

TIME 10:45:54

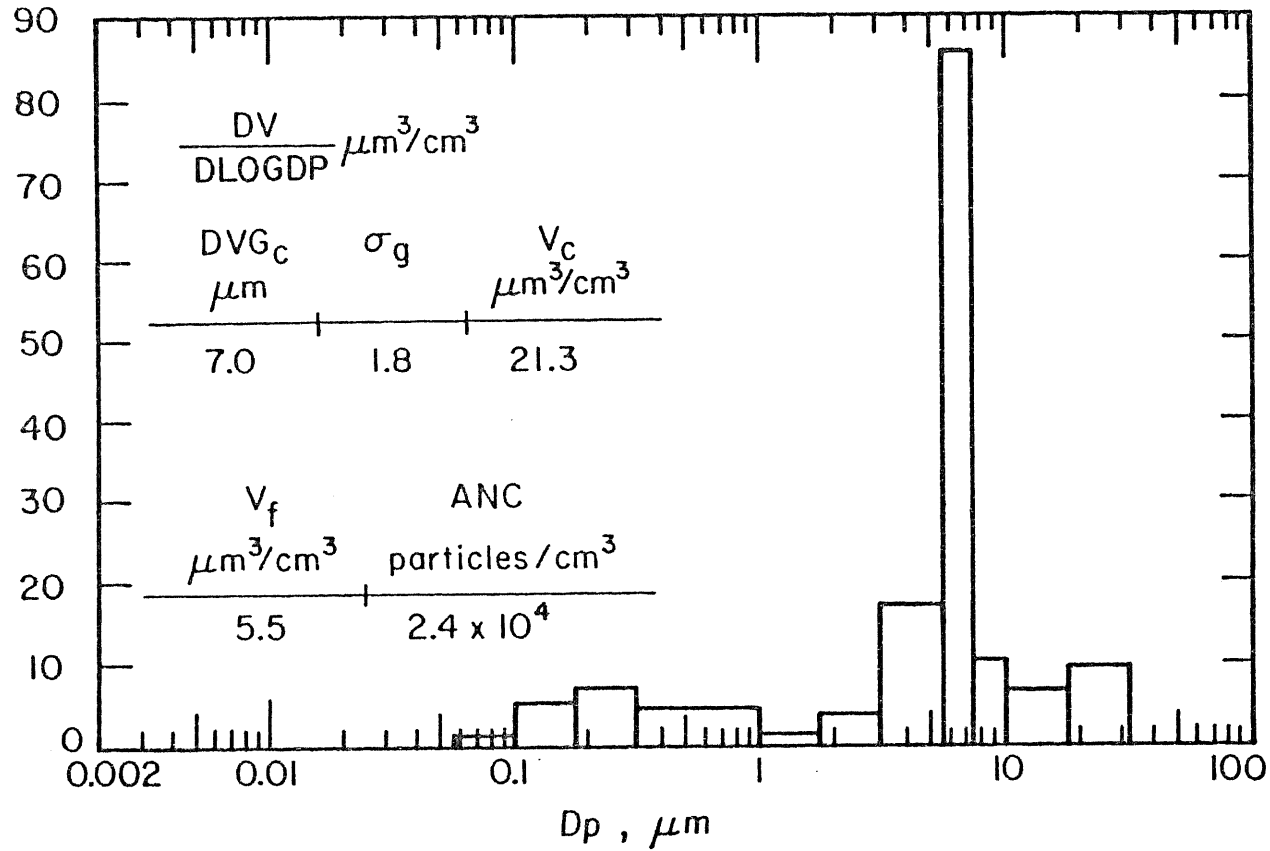

Figure 9. Volume weighting of background size distribution measured near site C on Figure 5 on July 27, 1977.

the idea, discussed in Appendix B, that the measurements of the coarse particle mode were perhaps truncated by the cutoff characteristics of the sampling system.

MINE-RELATED MEASUREMENTS

Measurements on Dunka Road Downwind of Reserve Mining. The UMML was operated on July 25 while passing to the south and southeast of the Reserve Mining pit along Dunka Road. As shown in Figure 5, the route goes from A to B to C. Surface winds were from 330° at 14 to 22 km/hr. At this time, the Reserve mine was inactive except for maintenance operations.

The ratemeter reading was usually at background levels (10 c/s or less), except when passing vehicles or trains. Thus, on a day with minimal mining activity, there was no clear evidence of dust transported from the Reserve Mining pits to Dunka Road.

Measurements in and near the Erie Mine Processing Complex. On July 27, the UMML was operated around the processing complex and the tailings pond at the Erie Mining Company mine to determine if they were acting as continuous sources of coarse particles. Winds were variable and from the south, and light rain fell intermittently during the afternoon.

Measurements were made upwind and downwind of the sources to determine if they contributed steadily to the coarse particle concentration. Quasi-steady ratemeter readings taken over periods ranging from 10 to 26 minutes are reported in Table 2, along with CV_c, the correlated coarse particle volume concentration from Figure 3.

TABLE 2. COARSE PARTICLE VOLUME UPWIND AND DOWNWIND OF THE ERIE MINE PROCESSING COMPLEX

Location of measurement	Average ratemeter reading, RTM (c/s)	Correlated coarse particle volume, CV _c (μm ³ /cm ³)	Duration of measurement (minutes)
Upwind (SW) of processing complex	15	10	12
Upwind (SW) of processing complex	17	12	10
Upwind (SW) of processing complex	10	7.5	17
Downwind of processing complex and tailings pond (moving from G to H to G in Figure 6)	25	16	20
Downwind of processing complex (moving from G to F in Figure 6)	25 increasing to 80	16 increasing to 60	15
Downwind of crusher - in operation (F in Figure 6)	150	125	14
Downwind of crusher - idle (E in Figure 6)	50	35	26

The quasi-steady ratemeter readings upwind of the complex range from 10 to 20 c/s. These readings were observed several times that morning and imply a background value of CV_c near $10 \mu\text{m}^3/\text{cm}^3$, which is half the background value of C_v measured for the same day in Run 72. Since the ratemeter served as the basis of comparison in this test, $10 \mu\text{m}^3/\text{cm}^3$ is taken as the background value of the coarse particle concentration.

Downwind of the processing complex and tailings pond, RTM readings increased to about 25 c/s, thus increasing CV_c to about $16 \mu\text{m}^3/\text{cm}^3$. Downwind of the crusher (F in Figure 6), steady RTM values of 150 c/s were observed. The corresponding CV_c of $125 \mu\text{m}^3/\text{cm}^3$ is an order of magnitude above background. This observation was made while a trainload of ore was being crushed.

The varying winds on this day made it impossible to judge the trajectories of the air parcels arriving at the UMML. Therefore, it is impossible to apportion the observed dust among the several sources. For example, measuring upwind and downwind of the tailings pond did not serve to isolate its contribution, since due to the varying winds, unknown amounts of the plume from the processing complex were mixed in both measurements. It is possible to conclude from the measurements, however, that the tailings pond did not increase the coarse particle concentration by more than a factor of two and may not have increased at all. It is also possible to conclude that the dust concentration downwind of the processing complex was steadily higher than that upwind, although it is not clear over what distance this effect is maintained.

Measurements near Loading Operations in the Erie Mine. Measurements were made on July 27 in the vicinity of a shovel-loading operation. After being loaded, 85-ton trucks passed approximately 10 meters from the UMML. As the dust plumes passed the UMML, CV_c went from background values of $10 \mu\text{m}^3/\text{cm}^3$ to peaks of 10^3 to $5 \times 10^3 \mu\text{m}^3/\text{cm}^3$. Averages were made over the duration of the peaks and are tabulated in Table 3.

Later in the same day, measurements were made approximately 100 m downwind of a loading pocket during a light rain while 85-ton trucks dumped ore from a platform into railroad cars. CV_c was steady between $10 \mu\text{m}^3/\text{cm}^3$ and $20 \mu\text{m}^3/\text{cm}^3$ and rose to values of 200 to $1000 \mu\text{m}^3/\text{cm}^3$ when the dust from individual dumps passed the UMML. Averages were made over the duration of the peaks and are tabulated in Table 3.

TABLE 3. RATEMETER READINGS AND VOLUME CONCENTRATIONS MEASURED DOWNWIND OF MINING OPERATIONS IN THE ERIE MINE ON 7/27/77

Event	Duration of measurement, s	Ratemeter average, c/s	Correlated coarse particle volume, $CV_c, \mu\text{m}^3/\text{cm}^3$
Truck passes van	60	610	600
Truck passes van	45	403	375
Truck passes van	38	385	355
Truck dumps	88	190	160
Truck dumps	152	288	256
Truck dumps	35	387	358

Size distribution data are tabulated in Table 4.

TABLE 4. SUMMARIES OF SIZE DISTRIBUTIONS MEASURED DOWNWIND OF MINING OPERATIONS

Run	Volume, $\mu\text{m}^3/\text{cm}^3$		Coarse particle mode		Ratemeter average, c/s
	V_c	V_f	DGV, μm	σ_g	
88 Truck passes	495	9.9	6.9	1.6	161
89 Truck dumps	243		7.2	1.6	152
90 Lull in activity at pocket	34		6.2	1.6	49

The Plume of the Erie Mine Pelletizing Furnace. Ground measurements were made in the plume on July 25 late in the afternoon. Large ANC and SO_2 concentrations were observed near the plant downwind of pelletizing furnace stacks. SO_2 peaks of around 100 ppb were noted with average values of 40 ppb recorded. The background level of SO_2 was not significantly different from zero. A peak in the ratemeter output coincided with the SO_2 peak used to identify the plume. The ratemeter peak was two minutes in duration, reached a maximum of 1000 c/s, and had an average value of 140 c/s, corresponding to $120 \mu\text{m}^3/\text{cm}^3$ of coarse particle volume. These particles seem to be associated with the plume from the furnace.

Approximately 6.5 km downwind of the stacks, another traverse of the plume was made. The plume was identified by simultaneous increases in EAA total current (fine particles), ANC, and SO_2 . The average value of SO_2 in the plume was about 3 ppb. The plume was detected while driving along a Forest Service road through a broad-leaf tree forest. The elevated readings persisted over a period of ten minutes, during which time the UMML traveled 5 km. No coarse particles above background were associated with the second plume measurement.

ROAD-RELATED MEASUREMENTS

Dust Suspended by Vehicles Moving on Gravel Roads. The dust plumes of passenger vehicles moving at various speeds on a gravel road were measured on July 26. The UMML was parked at 110 m and 265 m downwind from the road in a level, mowed field. The dust plume was transported by winds perpendicular to the road. Wind velocity was measured approximately 3 m off the ground and varied from 2 to 11 km/hr.

Figure 10 shows examples of the ratemeter output for the passage of dust plumes. By averaging the ratemeter reading over the duration of the plume passage, it is possible to assign an average coarse particle volume concentration to the plume. Such values are given in Table 5 and plotted as a function of car speed and distance from the road in Figure 11. The concentration of dust in the plume is a strong function of vehicle velocity and distance from the road.

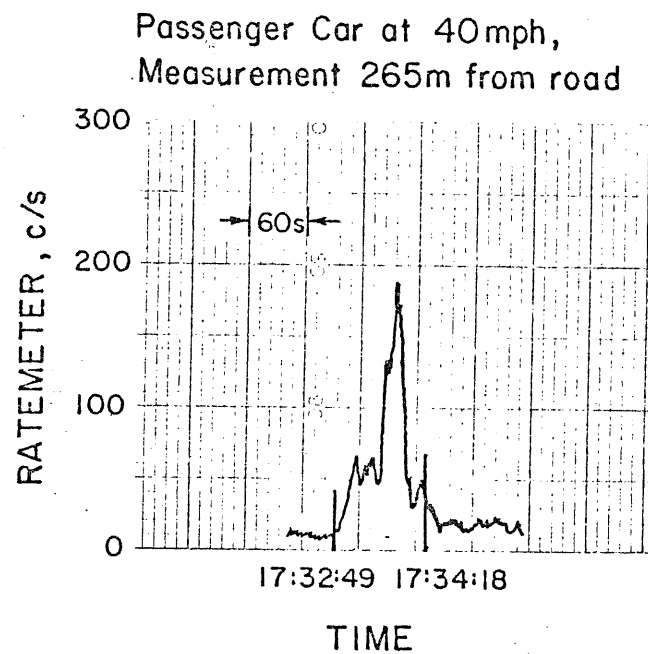
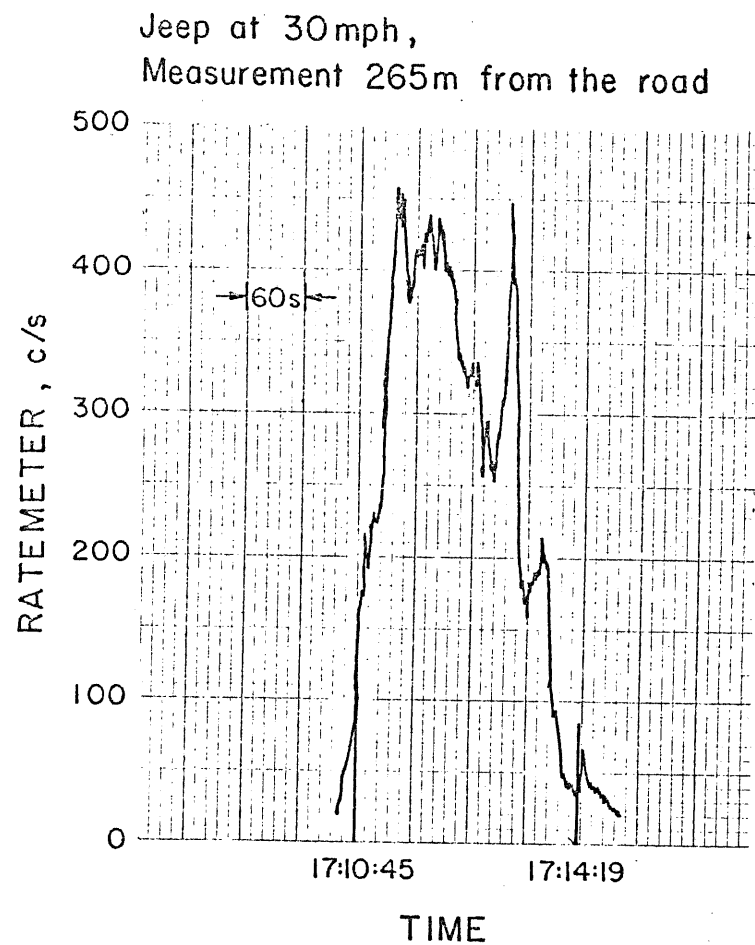

Figure 10. Ratemeter output recorded as dust plumes passed the UMML. Dust plumes were generated by vehicles on a gravel road. Measurements were made downwind of the road at site D on Figure 5.

TABLE 5. RESULTS AND INTERPRETATION OF VEHICLE DUST PLUME MEASUREMENTS

Distance m	Vehicle speed, mph	Duration of measurement ¹ Δt , s	Ratemeter average, c/s	Correlated coarse particle volume CV_c , $\mu\text{m}^3/\text{cm}^3$	Estimated plume height H, m	Plume width $v_x \Delta t$, m	Estimated dust emission V_L , cm^3/m
265 m	30 mph (Jeep)	211	293	260	110	400	11.
265 m	30 mph (Pasgr)	127	23.5	15	110	160	.26
265 m	40 mph (Pasgr)	88	65	47	110	110	.56
110 m	40 mph (Pasgr)	298	974	1000	60	200	12.
110 m	40 mph (Pasgr)	333	637	640	60	210	7.7
110 m	20 mph (Pasgr)	298	79	60	60	220	.78
110 m	10 mph (Pasgr)	123	32	21	60	140	.17
110 m	10 mph (Pasgr)	219	31	21	60	160	.20

¹Actual time for passage of the dust cloud past the UMML.

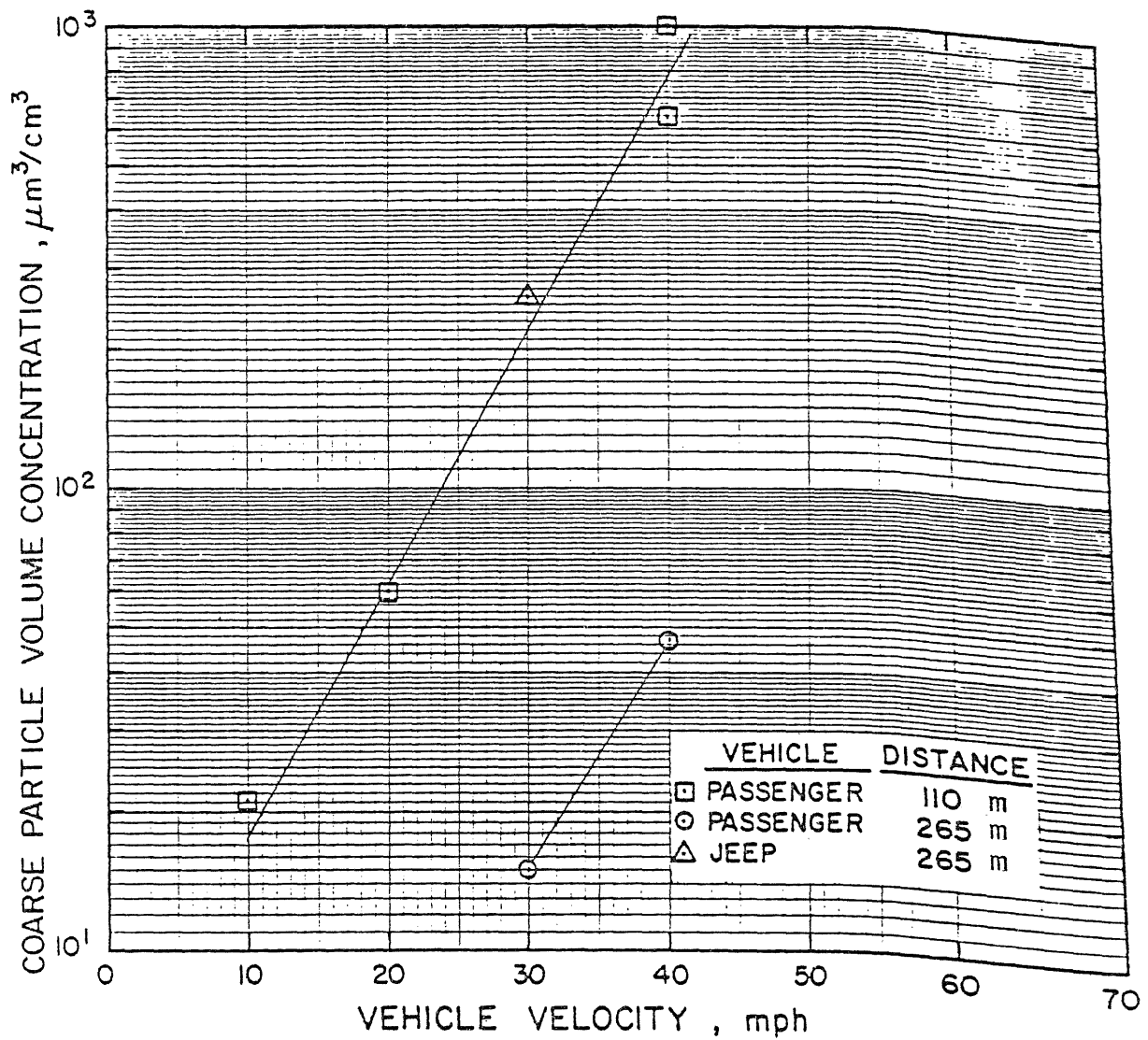

Figure 11. Coarse particle volume concentrations measured in plumes generated by vehicles moving on a gravel road. Measurements were made 110 m and 265 m downwind of the road. The wind was perpendicular to the road. Dust concentrations depend strongly on vehicle velocity and the distance traveled by the plume.

The average concentration in the plume of a passenger car passing at 40 mph drops from about 800 $\mu\text{m}^3/\text{cm}^3$ to about 50 $\mu\text{m}^3/\text{cm}^3$ as the distance from the road increases from 110 to 265 m. Also, at the distance of 110 m, the concentration drops from about 800 $\mu\text{m}^3/\text{cm}^3$ to 60 $\mu\text{m}^3/\text{cm}^3$ as vehicle velocity is decreased from 40 to 20 mph.

Size distribution parameters are presented in Table 6. These more or less instantaneous values of volume need not necessarily agree with the longer averages presented in Table 5.

TABLE 6. SIZE DISTRIBUTION PARAMETERS FOR ROAD DUST MEASURED AT VARYING DISTANCES FROM A GRAVEL ROAD AS AUTOMOBILES PASSED AT SEVERAL DIFFERENT SPEEDS ON JULY 26

Run	Distance from UMML, m	Car velocity, mph	Coarse particle mode		
			$V_c, \mu\text{m}^3/\text{cm}^3$	DGV, μm	σ_g
55	0	---	52	6.4	2
57	0	---	97	5.8	1.7
58	0	---	5190	9.5	1.8
63	265	40	51	7.4	1.9
64	110	40	649	6.6	1.6
65	110	approx. 15	179	7.3	1.6
66	110	40	863	6.4	1.6
67	110	20	31	7.6	1.9
68	110	10	23	10.3	2.0

It is possible to estimate the amount of dust generated and transported per unit length of road. In order to make the estimate, plume height must be estimated, and the concentration, measured at one point, must be assumed constant throughout the plume. The plume width is calculated from wind speed and the duration of the plume measurement, and the plume is assumed to be rectangular. Thus:

$$V_L = (vx\Delta t) \times H \times C$$

where V_L is the estimated volume of coarse particle aerosol emitted per unit length of road and transported to the measuring point, H is the plume height, C is the average coarse particle volume concentration, Δt is the duration of plume measurement, and v is the wind velocity perpendicular to the road.

The plume height H has been estimated by Whitby based on roadway studies using gas tracers. Modifications were made in an effort to account for settling of coarse particles. Table 5 shows the values of H, v, Δt , and V_L . The results are plotted in Figure 12.

The estimate of dust transported in the plume is dominated by the measured concentrations, and depends strongly on automobile velocity and distance from the road.

The primary standard for airborne particulate matter concentration is $260 \mu\text{g}/\text{m}^3$ over a 24-hour averaging period. In order to be in compliance with the Clean Air Act provisions designed to protect health, TSP levels must not exceed this value more than once per year, and the annual geometric mean of TSP concentration must not exceed $75 \mu\text{g}/\text{m}^3$.

Assuming a density of $2.5 \text{ g}/\text{cm}^3$ for the road dust, $1 \mu\text{m}^3/\text{cm}^3$ corresponds to $2.5 \mu\text{g}/\text{m}^3$. Thus, a monitor of TSP at site D, 110 m downwind of the road on July 27, 1977 would have shown an average value of over $260 \mu\text{g}/\text{m}^3$ if 40 cars had passed at 40 mph during the day.

It seems obvious that any discussion of TSP in northeastern Minnesota must include discussion of the many gravel roads and their ability to produce dust even during moist periods.

Coarse Particle Levels on Roads in Towns. While moving from site to site, the UMML was frequently driven through towns, such as Mountain Iron and Ely, with the instruments running. Although there was not time to pursue the matter in detail, it was observed that often the coarse particle level on busy streets was several times higher than that observed on the highway outside of the town. For example, when driving east into Mountain Iron on July 29 on a hard-surfaced highway, the ratemeter hovered around 20 c/s. Upon entering the town, however, the baseline moved up to around 55 c/s. This suggests an increase in coarse particle concentration from about $12 \mu\text{m}^3/\text{cm}^3$ to about $30 \mu\text{m}^3/\text{cm}^3$. The source of this increase is likely to be the greater frequency of automobile traffic in town. It should be noted that over 1/2" of rain fell in the neighboring town of Virginia on July 28, and nearly 1/10" fell on July 29.

DUST RESUSPENDED FROM TREE LEAVES

On July 26, an investigation was made at site B indicated on Figure 5. The site is surrounded by broad-leaf trees. Figure 4 shows some of the ratemeter output at this site. The ratemeter baseline was elevated to values of 100 c/s ($80 \mu\text{m}^3/\text{cm}^3$) as compared to background values of 10 c/s ($7 \mu\text{m}^3/\text{cm}^3$). Also, sharp peaks in ratemeter output occurred in the absence of known local sources.

The reduction of the baseline at time C coincided with the departure from site B and entry of the UMML into the large cleared area around Dunka Road.

Leaving the site among the trees resulted in the reduction of the more or less constant baseline ratemeter reading, as well as the elimination of the sharp peaks. Mechanical disturbance of the trees (beating them with a broom in front of the UMML) during calm periods produced spikes very similar to those seen in Figure 4 during period A to B.

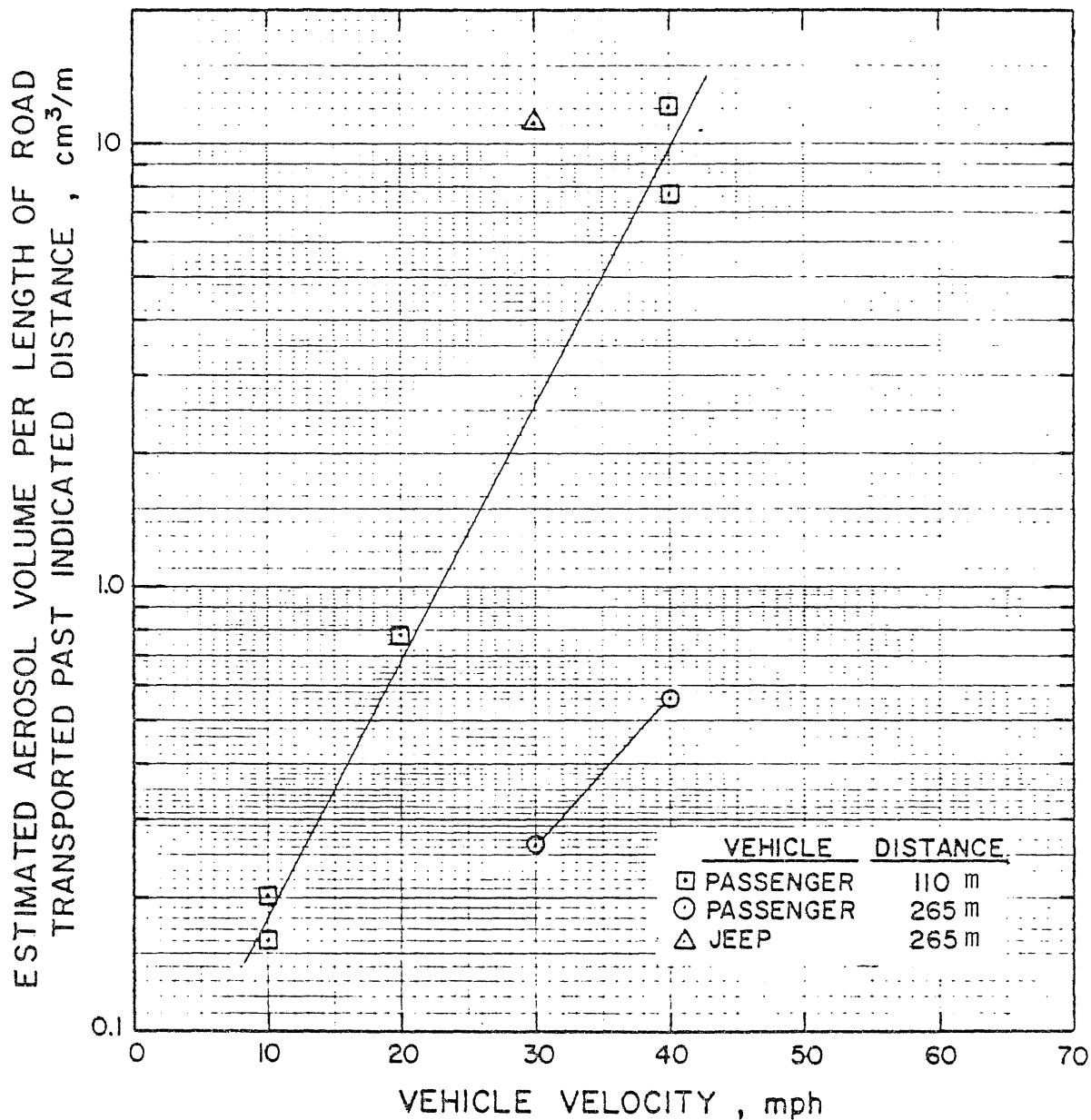

Figure 12. Estimated amounts of dust generated by vehicles on a gravel road and transported downwind. The vertical axis is total estimated aerosol volume per unit length of road transported past the indicated distance. This depends strongly on distance of transport and vehicle velocity.

This led to the conclusion that the wind was resuspending dust which had been previously deposited on the leaves. Thus, gusts disturbing leaves near the UMML were responsible for the peaks in the ratemeter output, and the result of more distant disturbances was to raise the baseline level.

Two time intervals were analyzed to determine what wind velocity was necessary to resuspend the dust. The distribution of wind speed over time was compared with the distribution of ratemeter readings. Cumulative distributions of ratemeter readings and wind speeds were plotted for the two intervals. Natural break points in cumulative ratemeter plots (Figure 13) occur at 92% for the earlier time and 90% for the later time. Thus, resuspension can be considered to have occurred during 8% of the time interval in the former case and during 10% of the time interval in the latter. From Figure 14, the cumulative plots of wind speed, it is seen that in the earlier interval, the wind speed exceeded 16 km/hr 8% of the time. In the later interval, the wind speed exceeded 17.7 km/hr 10% of the time. These wind speeds then seem sufficient to resuspend the dust from the leaves.

This mechanism occurs at wind velocities much lower than that required to resuspend the dust from a bare surface. In addition, it provides a means of resuspending and distributing dust which was originally resuspended by vehicles on gravel roads. Thus, it may contribute significantly to dust levels in the study area.

FILTER MEASUREMENTS

X-ray fluorescence analysis was carried out on filter samples by the EPA Environmental Sciences Research Laboratory. The result is elemental analysis for elements heavier than fluorine. The technique is described by Wagman et al. (1977). The results of the measurements are presented in Table 7.

The ratio of iron to silicon was calculated for each of the filters, and a clear pattern emerges. The results are shown in Table 8. The ratio exceeds one in cases where iron would be expected to dominate (Filters 26, 28, and 30) and is less than one in the case of road dust (Filter 16). Using these results, it can be argued that the dust resuspended from the trees at site B (Figure 5) south of the Dunka pit originated from the roads.

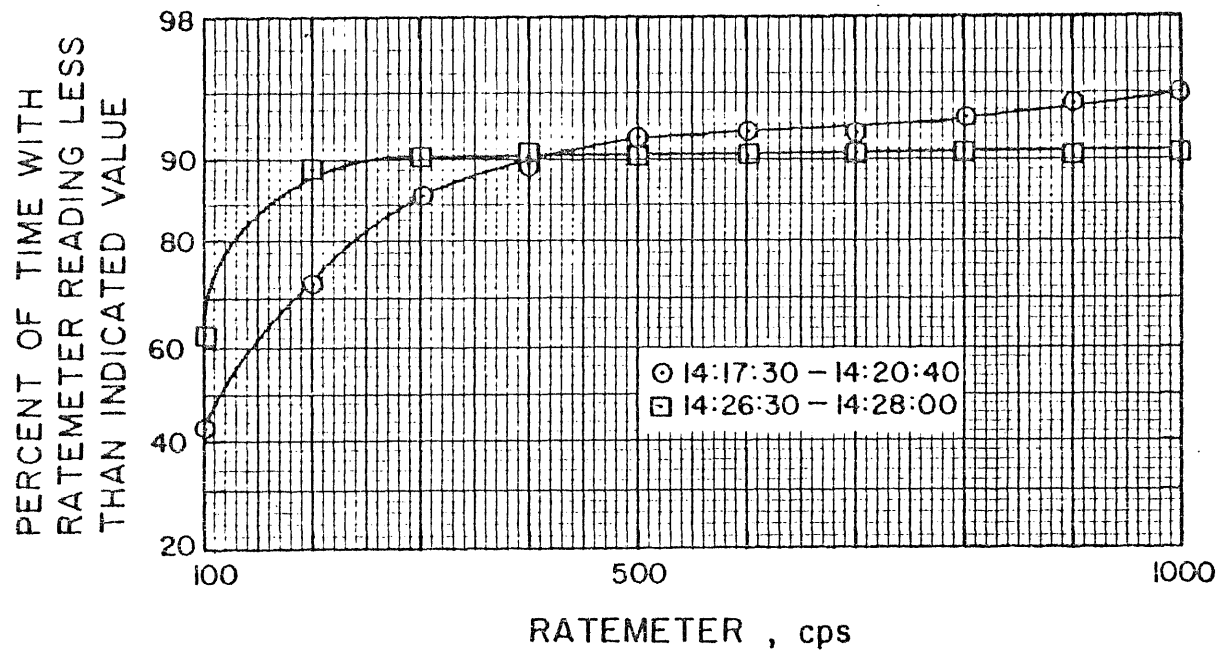

Figure 13. Cumulative distribution of ratemeter readings for two intervals involving dust resuspended from tree leaves by the wind. In the interval from 14:26:30 through 14:28:00, the ratemeter reading was below 300 cps 90% of the time, and above 1000 cps 9% of the time. Thus, elevated ratemeter readings, and presumably resuspension, occurred about 10% of the time. In the earlier interval, resuspension occurred during about 8% of the interval.

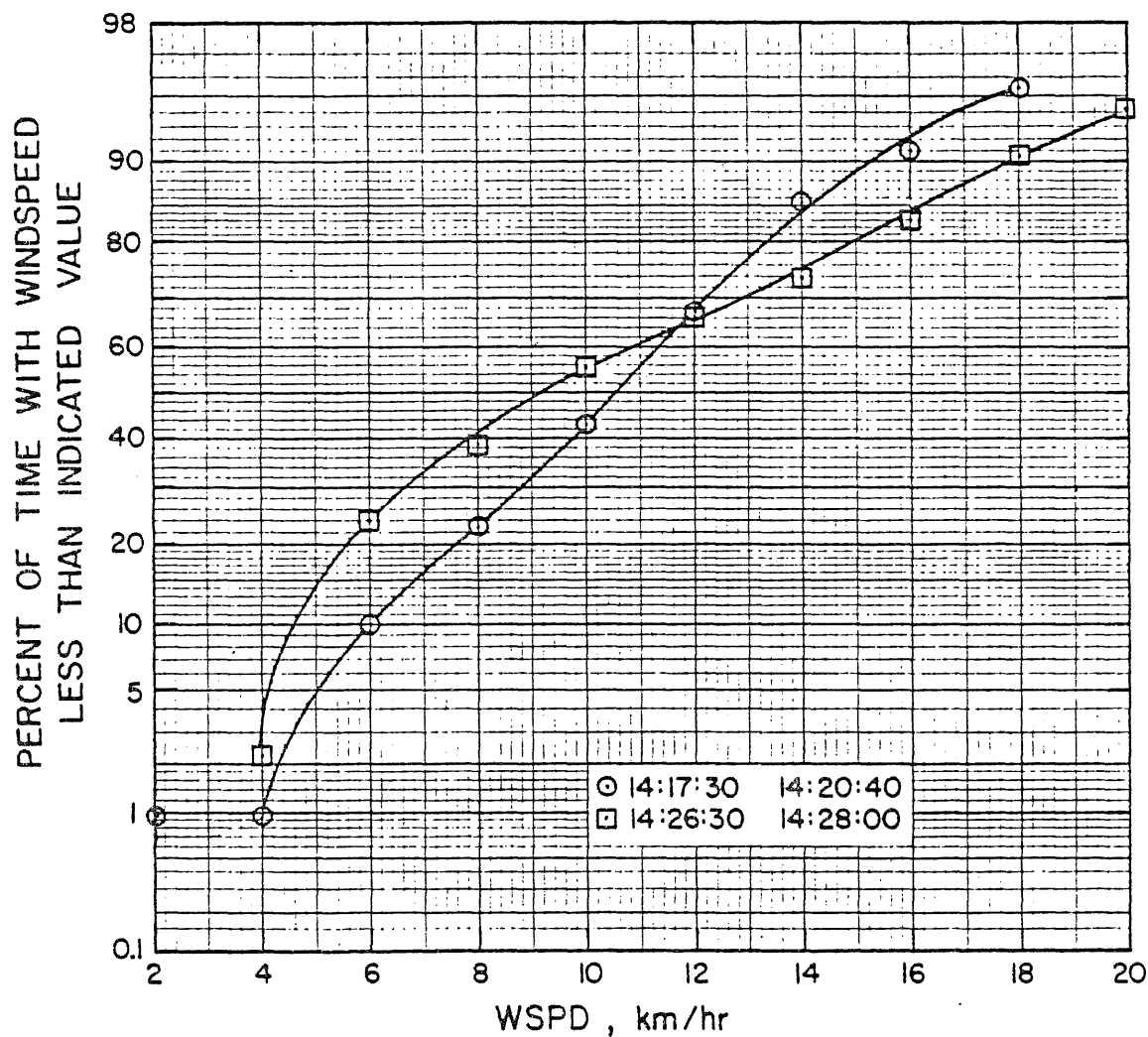

Figure 14. Cumulative distribution of wind speed for the two time intervals analyzed for resuspension of dust from tree leaves. For the interval from 14:26:30 through 14:28:00, the wind velocity exceeded 17.7 km/hr about 10% of the time. This wind velocity seems sufficient to resuspend dust from tree leaves.

TABLE 7. ELEMENTAL CONCENTRATION DETERMINED BY X-RAY FLUORESCENCE ANALYSIS OF FILTER SAMPLES

Aerosol Source	Filter #	Fe μg/m ³	Si μg/m ³	Ca μg/m ³	K μg/m ³	Pb μg/m ³	Additional elements with meaningful signal (μg/m ³)
Dust resuspended from trees	3	6.3	11.6	3.2	1.9	.045	Mn, Ti (.99), As (.05)
Tailings pond and plant	26	9.3	6.06	--	--	.23	Mn, Br
Downwind of pelletizer and plant	28	31.2	4.8	2.8	--	.32	Br, Mn, S (1.6), Ni (.19), Zn (.19), As (.15)
Downwind of loading pocket in mine	30	42.7	17.9	--	--	--	Mn, S (3.3)
Shaft furnace plume	7	36.4	78.7	18.9	16.2	--	Al
Road dust	16	10.6	22.1	3.86	3.09	.58	Al, S (.46), Cl, Ti (1.2), Zn (.25), Cu (.47)

TABLE 8. IRON TO SILICON RATIO DETERMINED BY
X-RAY FLUORESCENCE ANALYSIS OF FILTER SAMPLES

Aerosol Source	Filter	Fe/Si Concentration Ratio
Resuspended from trees	3	.54
Tailings pond	26	1.53
Downwind of pelletizer	28	6.5
Downwind of pocket	30	2.4
Pelletizing furnace plume	7	.46
Road dust	16	.48

SUGGESTED STUDIES

The generation and transport of dust associated with mining in a dry, windy period need to be examined. Resuspension from tailings ponds and dumps does occur, but was not seen in this study. Generation and transport of dust from blasting needs to be investigated. Resuspension from tree leaves at low wind velocity may increase the importance of such occasional sources.

Plumes from vehicles on gravel roads need to be examined in more depth. Plume height and the variation in concentration with height need to be examined to allow modeling of the contribution of gravel roads to the total coarse particle burden of the study area. The contribution of roads in dry periods needs also to be examined.

Although this study provides valuable insight into sources and processes affecting the coarse particle concentration in the study area, each of the things investigated here needs to be studied under different conditions if the origins of the coarse particle aerosol in northern Minnesota are to be understood.

Acknowledgements

Dr. Daryle Thingvold and Mr. William Enderson of the Regional Copper-Nickel Study participated in the field work.

This work was supported in nearly equal proportions by EPA Research Grant No. R803851-03 and Minnesota State Planning Agency Contract No. 8023.

REFERENCES

Wagman, J., R. L. Bennet and K. T. Knapp, "Simultaneous Multiwavelength Spectrometer for Rapid Elemental Analysis of Particulate Pollutants", in X-Ray Fluorescence Analysis of Environmental Samples (T. G. Dzubay, ed.), pp. 35-56, Ann Arbor Science Publishers, Ann Arbor, MI (1977).

Whitby, K. T., "The Physical Characteristics of Sulfur Aerosols", Atmos. Environ. 12:135-159 (1978).

Willeke, K. and B. Y. H. Liu, "Single Particle Optical Counter: Principle and Application", in Fine Particles: Aerosol Generation, Measurement, Sampling, and Analysis (B. Y. H. Liu, ed.), pp. 697-729, Academic Press, New York (1976).

Wolf, J. L., "The Design of a Mobile Air Pollution Research Laboratory", M.S. Thesis, Univ. of Minn., Minneapolis, MN (March, 1978).

APPENDIX A

UNIVERSITY OF MINNESOTA PARTICLE TECHNOLOGY LABORATORY
MOBILE LABORATORIES

by

K. T. Whitby

INTRODUCTION

Back in the late 1960's, the author was involved in one of the old national Air Pollution Control Administration (NAPCA) study sections which had the job of reviewing air pollution research proposals. Familiarity with the research at that time made it clear to those of us on that study section that advances in our understanding of the physical-chemical-meteorological complexities of air pollution could only result from a greater application of the latest research instruments to the measurement of pollution, where the pollution was.

This thinking generated the first intensive experiment at California Institute of Technology in 1969.¹ This experiment, which has now become a classic, was one of the first in which the latest in aerosol and gas instrumentation was brought to bear in a collaborative state-of-the-art investigation of smog aerosols. However, this experiment showed that although much could be learned from a fixed site, more could be learned if the instruments could be moved around from site to site.

This idea was implemented by the University of Minnesota Particle Technology Laboratory in 1972, when the first large movable laboratory was constructed by the Particle Laboratory and its subcontractors for the ACHEX program in the state of California.² A similar laboratory was constructed in 1973 for EPA and operated in the St. Louis area and other places.

As successful as these laboratories were in bringing the latest in research instrumentation to different locations, it became apparent to us that much greater surface mobility was desirable in order to make similar measurements on roadways, in plumes, and in other locations. This led to the construction of a special instrumented car which participated in the General Motors Sulfate Study,³ and in the following year, to the construction of the University of Minnesota Mobile Laboratory (UMML), which is the main subject of this report.⁴ The UMML was first operated in 1976 in Los Angeles on roadways, and also in 1976 in St. Louis.

Several years of operation of the UMML showed that it needed a tender, not only for overflow experiments, but also to carry along necessary supplies and a data reduction computer. Thus, a Winnebago motor home was purchased in 1978 to be used as a support vehicle for the UMML. This pair of vehicles now permits us to take a great variety of advanced gas and aerosol measuring instruments into the field, and to carry with us complete data reduction facilities. This self-contained research facility can operate anywhere in the country, both in a semi-fixed mode and in motion through plumes and on roadways. This report describes the current state of development of these two vehicles.

Purpose

The University of Minnesota Mobile Laboratory (UMML) and the University of Minnesota Mobile Home (UMMH) were developed to make possible physical and chemical aerosol and gas measurements of an advanced nature anywhere there are roads

passable to medium-sized trucks and motor homes. These vehicles are not intended for long-term monitoring, but rather for intensive measurement.

The vehicles have been designed so that all the electrical power and necessary support hardware is built in. All instruments are in racks that can be easily removed, since we have found that practically no two studies are alike, and that the complement of instruments is always somewhat different for each study.

The emphasis has been on continuous real-time measuring instruments, although a reasonable assortment of filter, virtual impactor, and cascade impactor samplers may be used.

The data logger used is capable of sampling all electrical signals every 0.6 seconds. Nine-track magnetic tapes recorded by this data acquisition system (DAS) can be reduced in the field on a PDP 11/10 mini-computer that is carried along. This off-line mode of operation has been found to be more satisfactory than on-line data acquisition directly into the computer. On-line data acquisition was tried in 1976 during the early operation of the UMML, but was found to be too slow and too cumbersome in its state of development at that time. Recent developments of on-line data acquisition computers now make it feasible to return to an on-line computer sometime in the near future.

MOBILE LABORATORY DESCRIPTIONS

UMML Description

The UMML (Figure A1) is a 1975 General Motors 15-1/2 foot Step-Van constructed of aluminum. The body is 16 feet from the driver's seat to the rear, 8 feet wide, and 80 inches high. Into this shell have been built two Onan generators, one on each side. Two electrical systems have been installed, one delivering power to instruments and the other delivering power to two 13,000 BTU air conditioners in the forward part of the vehicle. An additional 13,000 BTU air conditioner is installed towards the rear, powered by the vehicle engine. Provisions have also been made for external power of up to 50 amperes at 220 volts to be plugged in from the side. The heavy-duty towing package has been installed so that trailers or, as has often been done, an additional generator can be towed. When extra power is required, a 15 kw generator may be towed.

A double roof has been installed to provide a sturdy surface on which to walk and also a suitable mounting surface for instruments. The roof layout is shown in Figure A2. Wolf⁴ has described the UMML in detail.

Figure A3 shows the left side interior of the UMML. Two laboratory benches with drawers for supplies are mounted above the generators and wheel wells, one on each side. Instruments are mounted by bolting to the bench, bolting to laboratory strips mounted vertically, or by strapping to logistic strips mounted horizontally on the walls at several heights.

Electrical System

Two 6.5 kw Onan generators are built in, one on each side. The left-hand generator supplies power for the instruments and the right-hand, for the air conditioners, pumps, and lights. An external connection on the right side also can be plugged into line power or a towed generator. Operating on internal generators, a total of 13 kw is available, and while operating with an external generator, a total of 21.5 kw of power is available.



Figure A1. University of Minnesota Mobile Laboratory (UMML) as configured for the Los Angeles Roadway Study in 1976. Note upper and lower sampling intakes and towed generator.

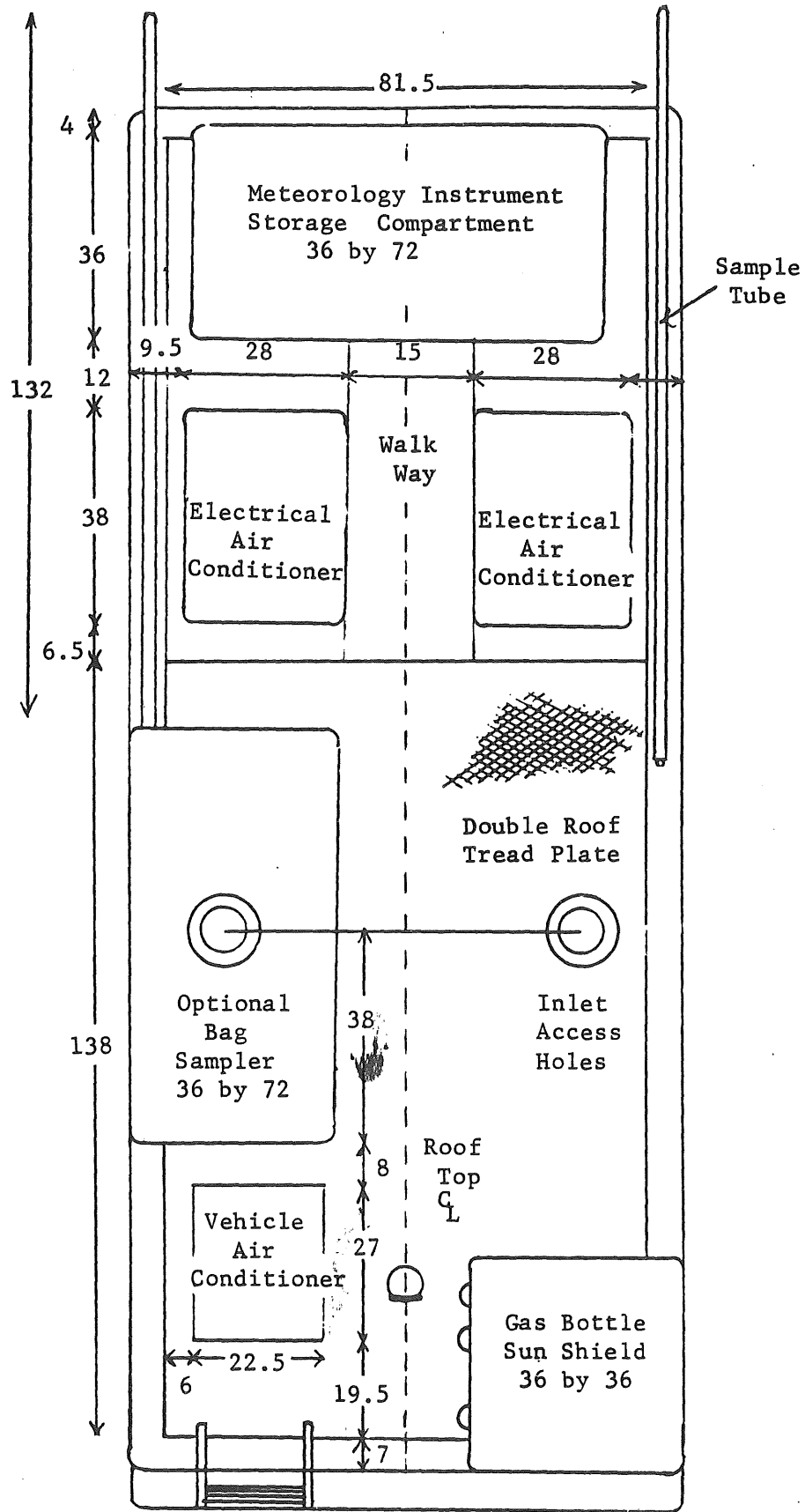

Figure A2. UMML roof layout as configured up to 1978. A meteorology mast mounting base is now located just forward of the right inlet.

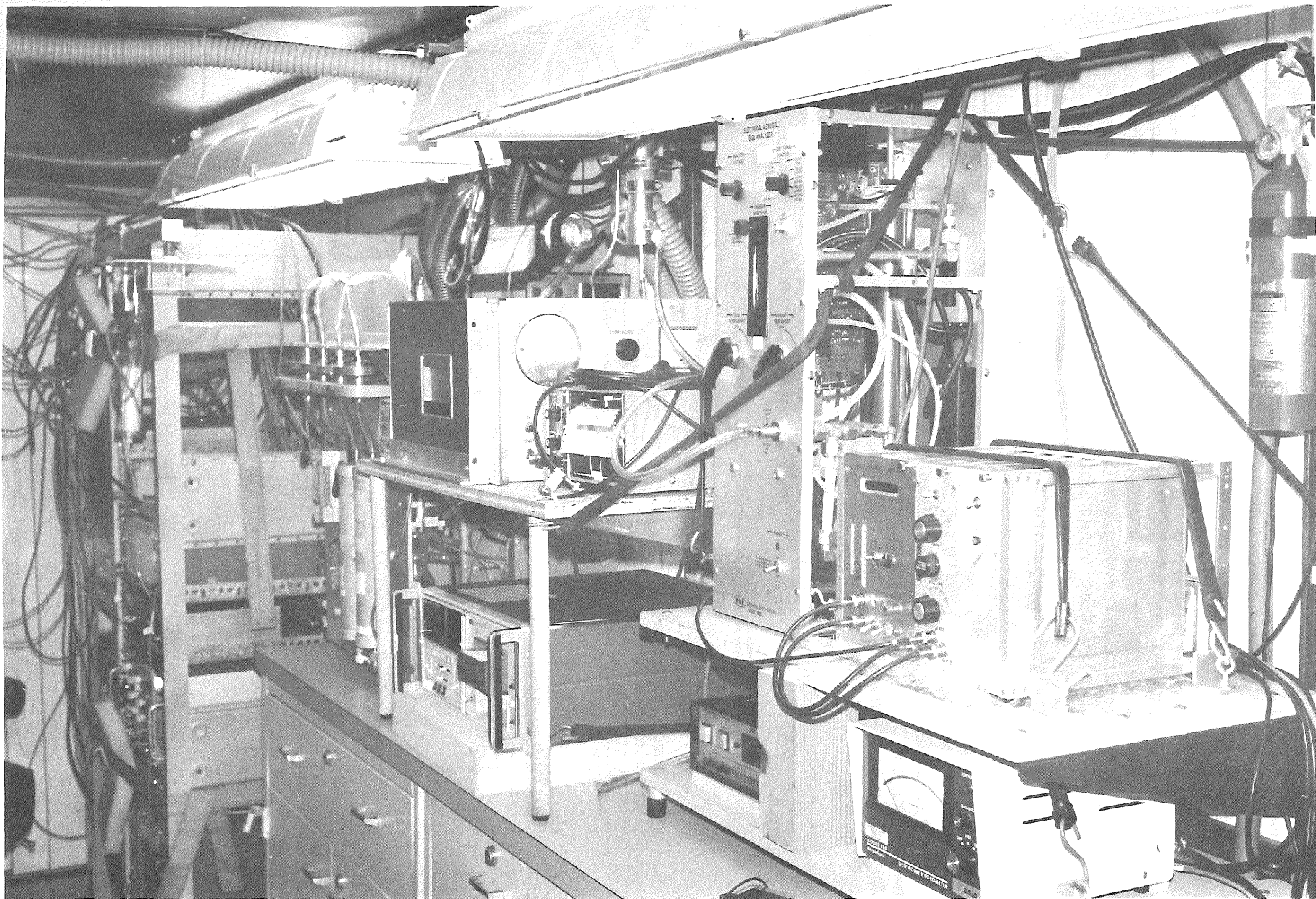

Figure A3. Interior photograph of the UMML showing the instruments on the left side of the vehicle. There are two laboratory benches mounted in the center on top of the generator housing and wheel wells. All instruments are mounted so that they can easily be removed for repair and calibration. All wiring and plumbing is in the open for easy repair or change.

a virtual impactor located below it on the laboratory bench. In addition, some gas sampling inlets may be fed through the upper center part of the front of the vehicle for more direct access to the instruments.

From Figures A1 and A2, it will be noted that there are sampling probes extending forward of the vehicle on both sides and arranged so that they can sample at either the roof level or from a level of about 1 meter above the ground. The roof-level sampling is used for most sampling, and the lower-level sampling, when it is desired to simulate what a driver of a vehicle on a roadway would inhale through the intake of an automobile.

Bag Sampling System

Figure A4 shows the first bag sampling system, the one that was used in 1976 and 1977. A bag sampler is necessary when making aerosol measurements under non-steady conditions on roadways because the electrical aerosol analyzer requires that the aerosol concentration be stable through its operating cycle of about two minutes.

The bag sampler has an electronic control which automatically empties it, fills it, and holds an aerosol in it for the required two-minute measurement cycle. This automatic system can be either set to operate automatically with sampling times from two minutes to an hour, or the bag sampling cycle can be initiated by pushing a button.

Figure A5 shows the calculated transport efficiency of the system shown in Figure A4.

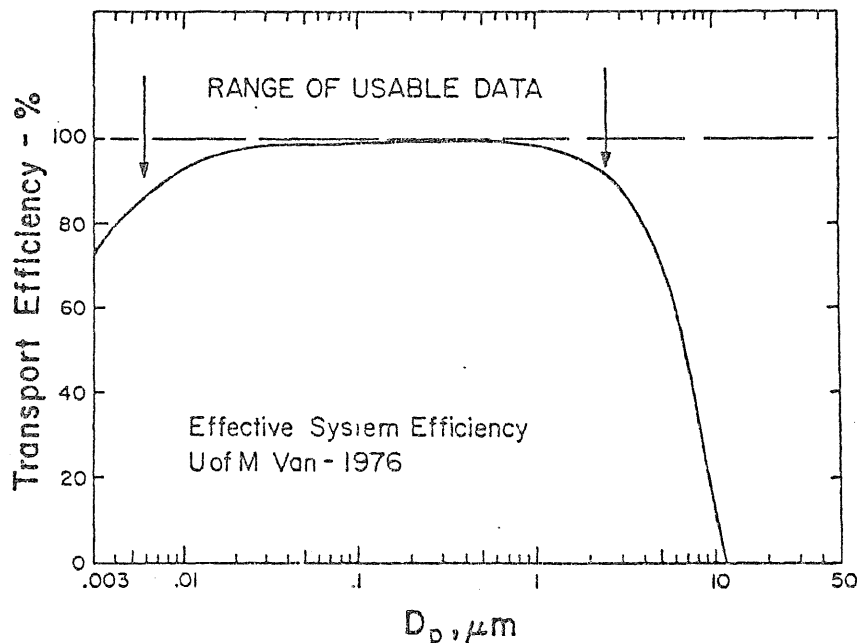

Figure A5. Calculated transport efficiency for the sampling system shown in Figure A4. The losses considered are shown in Figure A4. The size range labeled "range of usable data" is the data range that is good without correction. With correction, data may be used to the size where the efficiency is about 30%, corresponding to about 7 μm .

In 1978, the bag system was re-constructed to permit easier sampling from the front of the vehicle, and also straight in through the top. The new system is more flexible in the way in which sampling can be carried out, and also, the plumbing has been re-designed to reduce particle losses.

A sketch of the new system is shown in FigureA6 and the experimental sampling transport efficiency curve is shown in Figure A7.

Instrument Complement

The instrument complement varies from study to study. FigureA8 and Table A1 give the instrument complement as it was used for a roadway study in Los Angeles in 1976 for the right side of the vehicle. FigureA9 and TableA2 are the same information for the left side of the vehicle.

In 1977, a Royco 245 optimized for particle counting in the 5 to 40 μm range was mounted on a platform in front of the storage trunk shown in FiguresA8 and A9 at the front of the vehicle.

Table A3 is a listing of the current complement of instruments as it was operated during the STATE program in Tennessee and Alabama during the summer of 1978 and for the 1978 diesel emissions sampling studies.⁵

In addition to the instruments listed in TableA3, it is planned to operate a micro-orifice impactor and a low-pressure impactor aboard the UMML in the summer of 1979.

Data Acquisition

The present data acquisition system is a modified Metrodata 640 data logger recording on nine-track magnetic tape. The unit has been modified to accept 0.1, 1 and 10 volt signals. Normally, the data logger is operated at its fastest scan rate of about 0.6 seconds per scan in order to catch the flags from the aerosol analyzing system. However, the scan rate can be slowed down during periods in which monitoring over long periods must be done.

Eight or more channels of strip chart recording are also provided. There are enough strip charts and visual indicators on all instruments, as well as several digital volt meters aboard, so that if the data system logger is inoperative, all instruments can be operated and data recorded, albeit at a lower frequency.

Data Reduction

Because the only way to determine whether data recording is satisfactory is to reduce the data on a computer, a Digital Equipment Corp. PDP 11/10 with 32 K of memory and two floppy discs is ordinarily brought along, unless we are operating close to our home base.

Meteorology Equipment

Wind speed and direction and outside temperature are measured with a Meteorology Research, Inc. meteorological package. The meteorology mast is arranged so that it can be erected in about one minute. Thus, wind direction and velocity can be obtained if the vehicle is stationary for as little as ten minutes.

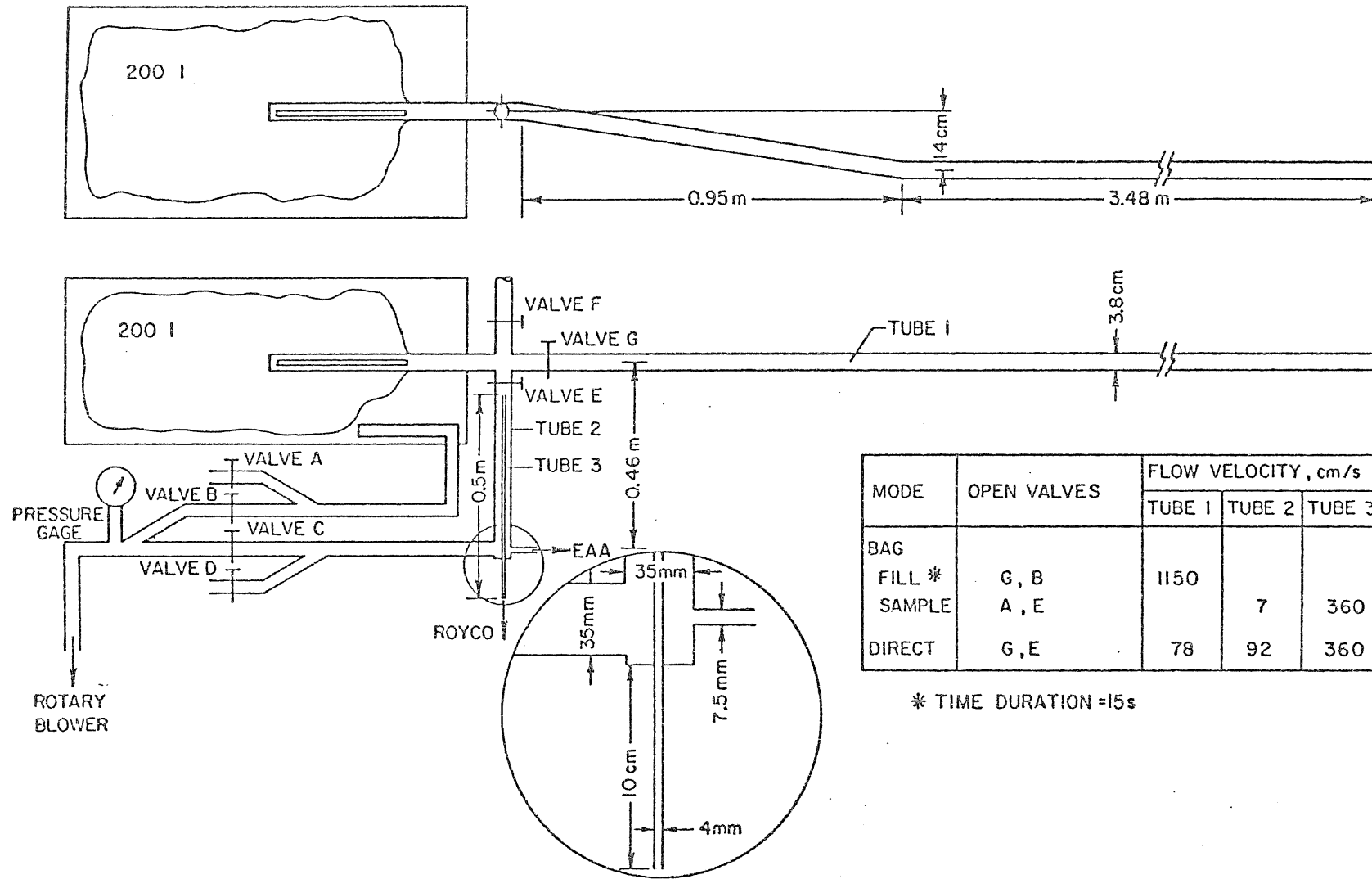

Figure A6. Schematic of the new bag sampler constructed in the spring of 1978. In addition to somewhat reduced losses, this system permits direct sampling from straight above the UMML.

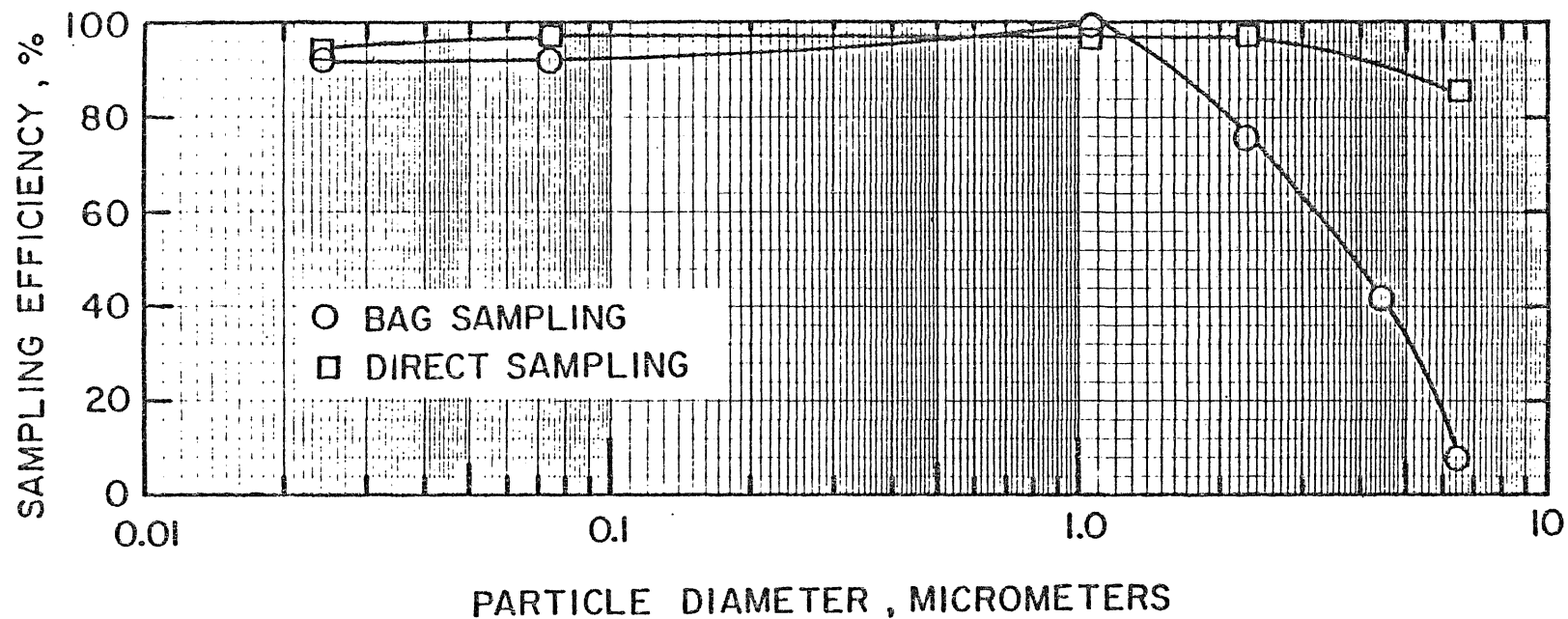

Figure A7. Sampling efficiencies of the UML sampling system used in 1978. Efficiencies were measured experimentally using monodisperse aerosol. "Direct Sampling" refers to drawing the sample through the horizontal tube and directly down to the instruments at a flow of 53 lpm. "Bag Sampling" refers to drawing a sample into the bag through the horizontal tube at about 780 lpm, and then drawing the sample from the bag at 6.8 lpm. The inside of the bag was coated with a thin soap film to reduce particle losses due to electric fields.

VEHICLE RIGHT SIDE

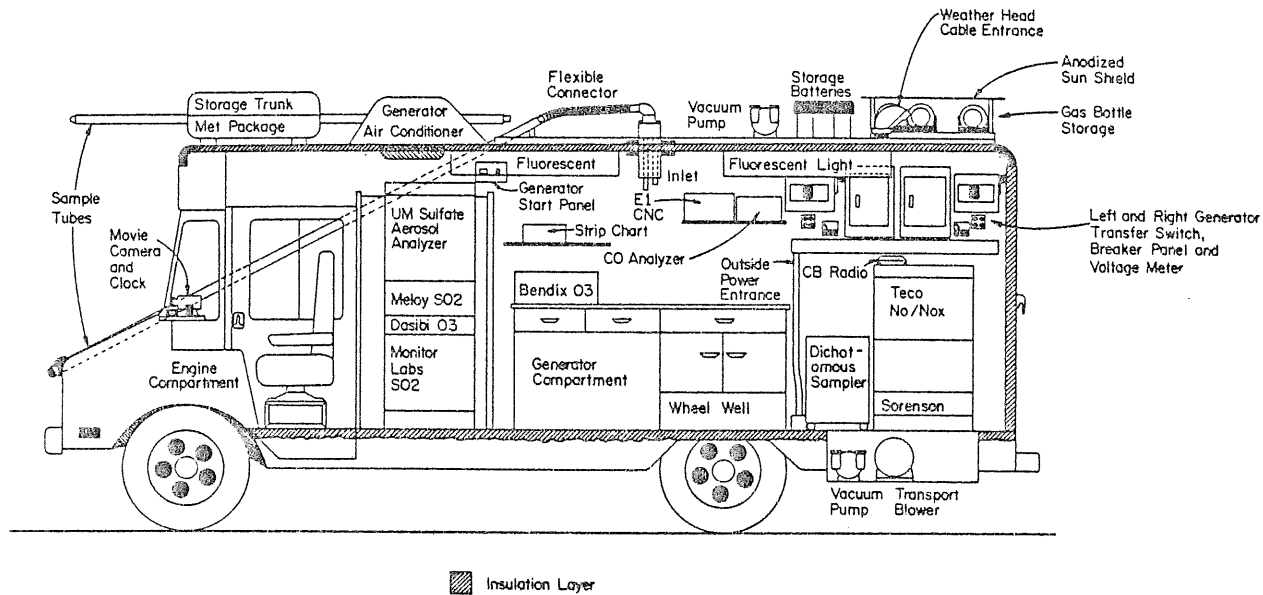

Figure A8. Interior schematic of the right side of the UMML showing the instrumentation as used during the 1976 Los Angeles Roadway Study.

VEHICLE LEFT SIDE

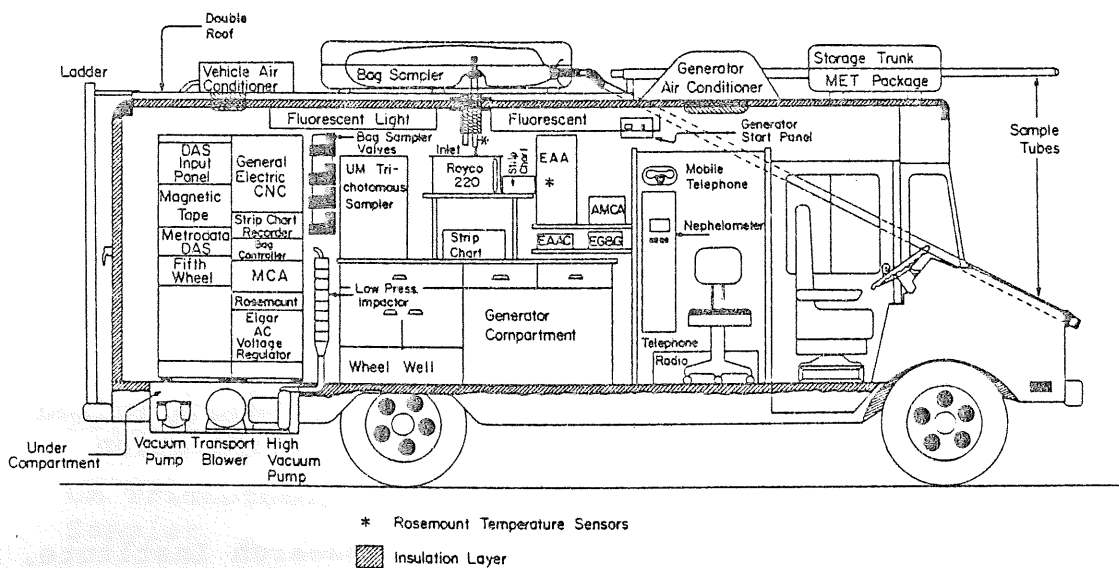

Figure A9. Interior schematic of the left side of the UMML showing the instrumentation as used during the 1976 Los Angeles Roadway Study.

Table A1

Description of instruments used in the Los Angeles
Roadway Study, right side of van

<u>Illustration Legend</u>	<u>Instrument</u>
Teco NO/NO _x	Thermo Electron Chemiluminescent NO/NO ₂ /NO _x Analyzer, Series 14
Sorenson	Sorenson, Model ACR3000, Line Voltage Regulator
Dichotomous Sampler	Lawrence Berkely Labs Automatic Dichotomous Air Sampler
CO Analyzer	Ecolyzer Carbon Monoxide Monitor
El CNC	Environment One, Model Rich 100, Condensation Nuclei Counter
Bendix 03	Bendix Corp. Chemiluminescent Ozone Analyzer
Strip Chart	Linear Instruments, Model 385 Strip Chart Recorder
Monitor Labs SO ₂	Monitor Labs, Model 8450 Sulfur Analyzer
Dasibi O ₃	Dasibi, Model 1003-AH Ozone Analyzer
Meloy SO ₂	Meloy Labs, Model SA-285 Sulfur Analyzer
UM Sulfate Aerosol Analyzer	University of Minnesota Pulsed Electrostatic Precipitation Sulfur Detector
Met Package	Meteorology Research Institute, Model 840-1 Temperature Sensor, Model 1074, Wind Speed and Wind Direction Sensor

Table A2

Description of instruments used in the Los Angeles
Roadway Study, left side of van

<u>Illustration Legend</u>	<u>Instrument</u>
DAS Input Panel	Input connections to the Data Acquisition System
Magnetic Tape	Dig-Data Corporation, Model 1300 Magnetic Tape Deck
Metrodata DAS	Metrodata, Model 640 Data Acquisition System
Fifth Wheel	Labeco, Model DD-1.1 Velocity Readout, Model DD-2.1 Distance Readout, and D/A Converter
General Electric CNC	General Electric Condensation Nuclei Counter
Strip Chart Recorder	Honeywell Model 196, Strip Chart Recorder
Bag Controller	University of Minnesota Automatic Valve Sequence
MCA	Nuclear Data, Model 1100 Multi-Channel Analyzer
Rosemount	Rosemount Engineering Temperature Sensors
Elgar AC Voltage Regulator	Elgar, Model 3000B AC Line Conditioner
UM Trichotomous Sampler	University of Minnesota Combined Virtual Impactor and Electrical Size Classifier
Royco 220	Royco, Model 220 Optical Particle Counter

TABLE A2 (cont'd)

<u>Illustration Legend</u>	<u>Instrument</u>
EAA, EAAC	Thermo-Systems Inc. Model 3030 Electrical Aerosol Analyzer System
AMCA	University of Minnesota, Model 1, Analog Multi-Channel Analyzer
EG&G	EG&G, Model 880, Dew Point Hygrometer
Nephelometer	MRI, Model 1561, Integrating Nephelometer
Low Pressure Impactor	California Institute of Technology, Keck Laboratories Low Pressure Impactor

Table A3

UMML/UMMH Instrumentation

The following instrumentation will be available for use on the UMML/UMMH during the summer of 1979.

<u>Variable or Function</u>	<u>Instrument</u>
<u>Position</u> - maps - speed and location - distance traveled	SPACEKOM, Inc. Auto Company
<u>Meteorology</u>	
Inside temperature	Rosemount Engineering Temperature Sensors
Dew point	EG & G, Model 820 Hygrometer
Wind speed & direction (stationary) and outside temperature	MRI, Model 840-1 T sensor Model 1074 WSPD & WDIR
Visibility, b_{scat}	Model 840 Aspirated Temperature Sensor Modified MRI, Inc. Model 1561 Integrating Nephelometer
<u>Gas Chemistry</u>	
SO ₂ (gaseous S)	Meloy SA 285
NO, NO ₂ , NO _x	TECO Series 14
O ₃	Dasibi, Model 1003 - AH
CO	Energetics Science Inc. 2000 Series
<u>Aerosol Size Distribution</u>	
Aitken Nuclei	General Electric GE-1 Condensation Nuclei Counter Environment/One Rich 100 or TSI Model 3020
0.0056 - 1 μ m	TSI Model 3030 EAA
0.056 - 6 μ m	Royco 220, MCA and Ratemeter
5.6 - 40 μ m	Royco 245, MCA and Ratemeter
30 +	Filter & Microscope
<u>Aerosol Chemistry</u>	
X-ray fluorescence	50 l/min dichotomous virtual impactor - collection on filters - cut at 2.5 μ m
Sulfur	Low pressure impactor
X-ray fluorescence	Micro-orifice impactor - cuts at 0.1, 0.3, 1 and 2.5 μ m - collection on 37 mm filter
Carbon analysis	47 mm filters for carbon analysis
Aerosol sulfur	Pulsed Meloy SA 285 - continuous
Aerosol growth with humidity	TDMA - TSI Model 3020 CNC
Single particle XFL	Filter analysis at Penn State

Table A3 (cont.)

Data

Data acquisition	Metro Data Model 640 DL
Data recording	Digi Data Corp. Model 1309-8-B2 9-track magnetic tape
Data reduction	DEC PDP 11/10 Minicomputer - off-line
Strip charts	Two Chessel 3-channel, one Linear 3-channel, one Linear 2-channel

Communication

ground	40-channel CB in UMML & UMMH
air	Genave Model 720 p 720 channel aircraft radio in UMML

Miscellaneous

Telephotometer	(Provided by EPA)
Sun photometer	5 band Voltz sun photometer - modified
Photography	35 mm camera
Time lapse	Super 8 movie camera

Calibration

O ₃ , SO ₂ , NO _x	Monitor Labs. Model 8500 gas calibrator
Flow	TSI Model 1352 and 1050 mass flow meters
OPC's	Aerosolized PSL & Polystyrene

Vehicle Position

Vehicle position has been determined by the use of a fifth wheel which feeds data directly to the data acquisition system and by marking times and position on maps. Position data from the county maps is then digitized and merged with the other data in our home laboratory. This system, although workable, has been cumbersome. Therefore, a new built-in speed and distance measuring package has been purchased and will be operational in 1979. This semi-manual system has been chosen rather than a more complex completely automatic navigation system because of the cost and maintenance problem with the more complex system.

Crew and Operation

Normally, three or four people are required to operate the UMML in motion. Two people can operate it satisfactorily when stationary and during long runs overnight; it has been found that one person can operate all the instruments, although at a reduced frequency.

When the two vehicles are operating together in the field, normal crew is five or six, with three or four in the UMML and two in the UMMH.

Detailed checklists for starting up and shutting down the labs have been developed and found to work quite well.

UNIVERSITY OF MINNESOTA MOBILE HOME (UMMH)

The UMMH is a Winnebago 28-foot motor inn with one 6.5 kw generator installed. Two air conditioners, one forward and one aft, have been installed. The electrical system has been rebuilt so that it can operate on either 220 volt internal generator or 110 or 220 volt external power. Both air conditioners can only be operated on external power. The UMMH has a refrigerator, stove, toilet, shower, and considerable storage built in. In addition, a standard four-drawer file cabinet has been installed for project records and supplies. Other than the file cabinet, no other furniture has been built in. Experience has shown that it is best to strap in the facilities needed for each study. Instruments and facilities are secured by means of logistic strips placed at several levels on each side.

Communications

Both the UMML and UMMH have a CB radio installed. In addition, the UMML has a 720-channel aircraft radio. During some field studies, such as the STATE study in Alabama and Tennessee, an additional ground communication radio was installed in each vehicle. Thus, in the STATE program, it was possible to communicate between vehicles and with aircraft with the base station. For some studies, a standard radio telephone has also been installed, as is shown in Figure A8.

MEASUREMENT PROJECTS PERFORMED WITH UMML/UMMH

Following is a brief summary of the measurement programs that have been completed, and the two that are planned in 1979, with the UMML and UMMH. Also given are a few comments about the major objectives and results of each study.

1. St. Louis, August, 1976: In St. Louis in August, 1976, the UMML made its first measurements of the Labadie power plant plume as part of the MISTT program. Because this was the first trip, only a modest amount of useful data was produced. Because the operating speed of the PDP/11-10 computer as a data acquisition system was too slow, the use of the on-board computer was discontinued, and the Metrodata 640 data logger was used for data acquisition in all subsequent studies.

2. Los Angeles Roadway Study, October, 1976: Under EPA sponsorship, the UMML was equipped with a variety of instruments aimed at determining the amount of sulfuric acid from a catalyst-equipped car that might be seen on major freeways. Although useful data on roadway aerosol was obtained, the study showed that there were no significant concentrations of H_2SO_4 .

3. State of Minnesota Regional Copper-Nickel Project, Summer, 1977: In the summer of 1977, under the sponsorship of the State of Minnesota Regional Copper-Nickel Project and EPA, measurements were made of the mine and road dust concentrations found around several iron mines in northern Minnesota. The most important conclusion was that dirt roads contributed significant amounts of dust, perhaps even more dust than the mines. This study showed the feasibility of measuring dust size particles in real time with the UMML.

4. Diesel exhaust studies, June, 1978: Under General Motors sponsorship, the UMML was used to measure diesel exhaust aerosols behind diesel cars. Size distributions and concentrations were measured and found to agree reasonably well with laboratory measurements.

5. Sherco project, June, 1978: In June of 1978, the Sherburne County NSP Sherco power plant was studied in collaboration with the University of Washington, EPA, EPRI, NSP, and Midwest Research Institute. The purpose of this project was to characterize a clean power plant equipped with scrubbers operating on low sulfur coal.

6. Pine Bend Refinery, July, 1978: In July of 1978, a one-day study of the Pine Bend refinery in Minnesota was made. High concentrations of pollutants are observed in the shallow valley where this refinery is located. Some very high sulfuric acid aerosol concentrations were found.

7. STATE Program, Summer, 1978: The major study of 1978 was participation in the EPA-sponsored STATE program in Tennessee and Alabama. Measurements on the Cumberland and Widow's Creek power plants were made. Also, a large amount of data was collected on the hazes of the east central United States, both in western Tennessee and the Great Smoky Mountains.

8. Diesel exhaust studies, December, 1978: In December, 1978, additional diesel exhaust plume studies were done under Coordinating Research Council sponsorship. The UMML was mounted on a flatbed trailer which was towed behind a Cummins diesel-powered tractor. Aerosol samples were obtained at various positions in the exhaust plume.

9. VISTTA Program, Summer, 1979: In the summer of 1979, it is planned to participate in the EPA VISTTA visibility program in the Four Corners area (Utah, Colorado, New Mexico, Arizona) of the southwestern United States. The major objective will be detailed physical and chemical characterization of the haze aerosols in that area.

10. Bureau of Mines, Summer, 1979: Following the VISTTA study, it is planned to make a dust study for the U. S. Bureau of Mines at a coal mine near Craig, Colorado. The objective will be to characterize the size distribution and concentration of dust generated around this mine.

11. Other projects, Summer, 1979: Before and after the VISTTA and Bureau of Mines studies, additional studies of diesel aerosols over roadways will be made.

References

1. Journal of Colloid and Interface Science, Volume 39, 1972 (various authors).
2. ACHEX Hutchinson Memorial Volume on the California Aerosol Characterization Experiment, 1979 (various authors).
3. Whitby, K. T., D. B. Kittelson, B. K. Cantrell, N. J. Barsic and D. F. Dolan, "Aerosol Size Distributions and Concentrations Measured During the General Motors Proving Grounds Sulfate Study", presented before the Division of Environmental Chemistry, American Chemical Society, San Francisco, California (August, 1976).
4. Wolf, J. L., "The Design of a Mobile Air Pollution Research Laboratory", M.S. Thesis, University of Minnesota, Minneapolis, Minnesota (March, 1978).
5. Dolan, D. F. and D. B. Kittelson, "Roadway Studies of Diesel Exhaust Aerosols", SAE Paper No. 790492 (1979).

APPENDIX B

THE APPARENT TRUNCATION OF THE COARSE PARTICLE MODE MEASUREMENTS

Comparison of the coarse particle measurements made in this study with measurements reported by Whitby (1978) indicates that the size of the coarse particle modes may be underestimated in this study. The values of σ_g reported in Appendix C range from 1.3 to 2.6, with only two values greater than 2. Whitby reports that σ_g 's for coarse particle modes typically range from 2.1 to 2.7. The smaller values of σ_g found here might result from underestimating the concentration of particles larger than 10 μm . A few size distributions were studied in detail for evidence of underestimation.

The investigations were based on two assumptions. First, it was assumed that the volume weighting of the coarse particle mode can be accurately described by a log-normal distribution. It was also assumed that the measured concentrations between 1 μm and 10 μm are accurate and that any underestimation of concentration occurred for larger particle sizes. Log-normal distributions were found which match the measured volume concentration data between 1 μm and 10 μm and which extend beyond 10 μm . These fitted distributions are characterized by a geometric mean diameter, $FDGV$, a geometric standard deviation, σ_{fg} , and a total volume concentration, FV_c . These fitted values are then compared with the measured values.

The fitted distributions were found by the following method. The measured volume concentration was expressed in four geometric diameter intervals: 1-1.78 μm , 1.78-3.16 μm , 3.16-5.62 μm , and 5.62-10 μm . A value of σ_{fg} was assumed and a simplex minimization routine was run on a computer. The routine determined the values of $FDGV$ and FV_c , which minimized the value of χ^2 calculated for the fitted distribution and measured concentrations in the four intervals from 1 μm to 10 μm . Thus, for a given run and a given σ_{fg} , the program finds the log-normal distribution which best fits the measured data in the range from 1 μm to 10 μm but extends beyond this range. The technique is called partial fitting. Several values of σ_{fg} were tried for each run, and the results are listed in Table B1.

The partial fits on Run 64 show a minimum in χ^2 . From the table, it is seen that the log-normal distribution which best fits the measured data in the range from 1 μm to 10 μm has a geometric standard deviation of between 2.15 and 2.2, a geometric mean volume diameter between 23 and 27 μm , and a volume concentration between 5300 and 6700 $\mu\text{m}^3/\text{cm}^3$. The measured values for Run 64 are $DGV_c = 6.6 \mu\text{m}$, $\sigma_g = 1.6 \mu\text{m}$, and $V_c = 649 \mu\text{m}^3/\text{cm}^3$. Therefore, the assumption of log-normality for the coarse particle volume distribution, and the data in the range from 1 μm to 10 μm imply that the coarse particle mode was broader and contained more mass than is indicated by the measurements. Runs 63 and 66 show that the values resulting from the partial fits are very sensitive to small changes in χ^2 , and Run 63 fails to show a minimum.

It is not possible to reconstruct the entire coarse particle mode from concentrations measured in the 1 μm to 10 μm range. Such extrapolation is not intended here. However, the analysis suggests that the measured values may underestimate the actual concentrations.

TABLE B1. RESULTS OF PARTIAL FITS ON RUNS 63, 64, AND 66

σ_{fg}	χ^2	Run 63		χ^2	Run 64		χ^2	Run 66	
		FDGV μm	FV $\mu\text{m}^3/\text{cm}^3$		FDGV μm	FV $\mu\text{m}^3/\text{cm}^3$		FDGV μm	FV $\mu\text{m}^3/\text{cm}^3$
1.7	.014	11.2	127	.0098	11.0	1,651	.011	11.1	2,330
1.9	.0074	15.5	215						
2.0	.0055	18.3	279	.0042	17.8	3,510	.0038	18.	5,010
2.15				.0036	23	5,320			
2.2	.0034	26.2	484	.0036	27	6,750			
2.3							.0023	31.6	11,920
2.4	.0025	38.2	852						
2.5				.0039	44.5	13,800	.0021	45.3	20,000
2.7							.0025	66.5	35,080
3.0	.00203	121	4,670	.0051	115	55,190	.0027	119	81,220
3.2	.00211	180	81,100						

APPENDIX C

TABULATION OF RESULTS FOR MEASURED SIZE DISTRIBUTIONS

DGV_c is the geometric mean diameter of the volume distribution of the coarse particle mode. σ_g is the geometric standard deviation for this mode, and V_c is the volume concentration of coarse particles ($D_p > 1 \mu m$). V_f is the volume concentration of the fine particles ($D_p < 1 \mu m$). ANC is the Aitken nuclei count averaged over the time period for the EAA cycle, and RTM is the ratemeter reading averaged over the time for the Royco 245 measurement.

Run No.	Description	DGV _c μm	σ _g	V _c μm ³ /cm ³	V _f μm ³ /cm ³	ANC x10 ⁴ particles/cm ³	RTM c/s
7/25:Dunka Road							
2	Vehicle dust plume	7.7	1.9	1640.	1.78	11.	396
3	Vehicle exhaust	12.6	1.9	22.4	1.7	19.	---
4	Vehicle exhaust	11.5	1.8	8.41	1.3	7.6	---
5	---	8.0	1.9	11.6	1.7	10.7	18.4
6	Vehicle exhaust	9.6	2.0	5.83	2.02	18.9	54.1
7	Vehicle dust plume	14.5	1.9	257	1.09	18.9	108
8	Coarse particle background	5.8	1.6	3.69	1.89	9.9	3.1
9	---	5.7	1.6	32.4	1.63	4.3	55
10	Near vehicle plume	5.3	1.6	39.1	1.45	4.0	75.3
11	Spray truck plume	8.0	1.9	20.8	1.5	5.8	21.3
12	Vehicle dust plume	10.6	1.8	817.	2.3	5.5	513
13	Vehicle dust plume	6.6	1.8	10.9	2.8	6.0	14.1
14	Vehicle dust plume	6.9	1.6	12.6	1.9	8.9	18.2
15	---	8.6	1.9	29.5	3.6	7.1	35.8
16	---	7.0	1.8	46.4	1.3	10.3	70.2
17	---	7.7	1.9	185.	4.01	7.4	21.6
18	Dust from leaves	8.2	1.9	104	1.7	11.1	182.
19	Dust from leaves	6.7	1.8	18.6	1.6	4.8	14.4
20	Among trees	5.7	1.5	6.2	2.0	12.1	7.8
22	Dust from trees	9.4	2.0	161.	1.74	8.5	44.9
24	Dust from trees	12.1	1.8	43.6	1.3	---	---
25	Among trees	6.96	1.8	9.1	1.1	19.8	7.5
26	Among trees	12.2	2.6	3.3	8.6	14.3	2.3
27	Among trees	9.7	1.8	6.1	1.9	17.9	6.33
30	Background	4.9	1.5	4.2	1.1	9.96	4.88
31	Background	7.8	1.9	4.3	1.7	12.0	5.8
32	Background	5.1	1.3	3.8	1.7	12.2	.32
33	---	7.5	1.9	6.6	1.4	5.97	---
34	---	5.9	1.5	28.6	4.6	7.8	55.8

Run No.	Description	DGV _c μm	σ _g	V _c μm ³ /cm ³	V _f μm ³ /cm ³	ANC x10 ⁴ particles/cm ³	RTM c/s
7/26:							
50	Road dust plume	10.2	1.8	19	5.2	.061	9.9
51	Road dust plume	5.8	1.7	97	2.9	.94	47
52	Background	6.2	1.7	9.4	4.0	.70	10
53	Road dust plume	7.3	1.5	15	3.8	.81	23.8
54	Road dust plume	6.9	1.7	12.4	4.9	.78	21.3
55	Road dust plume	6.4	1.7	52	5.3	2.1	63.9
56	Road dust plume	6.3	1.7	21.1	4.6	1.9	27.2
57	Road dust plume	8.0	1.7	55	3.6	1.5	142
58	Road dust plume	9.5	1.8	5190	4.1	2.3	2990
62	Background	7.7	1.7	12.9	4.1	.59	10.2
63	Road dust plume	7.4	1.9	51.2	3.7	.58	81
64	Road dust plume	6.6	1.6	649	3.2	--	510
65	Road dust plume	7.3	1.6	177	4.1	--	--
66	Road dust plume	6.4	1.6	863	4.2	--	1130
67	Road dust plume	7.6	1.9	31.5	3.2	.39	54
68	Road dust plume	10.3	2.0	22.9	4.0	--	30
69	Road dust plume	7.2	1.7	174	4.3	--	300

Run No.	Description	DGV _c μm	σ _g	V _c μm ³ /cm ³	V _f μm ³ /cm ³	ANC x10 ⁴ particles/cm ³	RTM c/s
7/27: Erie Mine							
71	Mine truck dust plume	--	--	243	6.8	5.5	292
72	Background	7.0	1.8	21.3	5.5	2.4	11.9
73	Truck dust plume	--	--	3339	21.1	6.1	3670
74	Truck dust plume	5.6	1.5	1809	6.0	4.1	1024
75	Truck dust plume	6.6	2.0	630	4.7	2.4	639
80	Tailings pond	5.1	1.6	27.5	5.5	3.5	37.2
81	Tailings pond	7.7	2.0	31	6.0	3.1	41.3
82	Tailings pond	5.7	1.7	21.2	5.1	3.5	28.3
83	Tailings pond	5.3	1.5	16.2	5.4	2.9	24.9
84	Processing complex	4.5	1.6	23.9	5.8	2.8	40
85	Processing complex	6.3	1.9	42.4	6.5	4.7	49.4
86	Processing complex	5.5	1.6	30	6.6	4.0	61.7
87	Processing complex	6.9	2.1	52.4	6.6	4.5	85.8
88	Truck dust plume	7.2	1.6	495	9.9	10.2	161
89	Truck dumps	8.3	1.7	243	3.9	18.9	152
90	--	6.2	1.6	34	7.8	6.6	48.7

APPENDIX D

RESULTS OF AIR PARCEL TRAJECTORY ANALYSIS

The trajectories of the air parcels present at Hoyt Lakes, Minnesota on July 25, 26, and 27 were calculated by P. J. Samson, and are presented in Figures D1, D2, and D3. The trajectories show the path followed by the air between the top of the surface layer inversion and the top of the mixed layer during the time prior to its arrival at Hoyt Lakes. Trajectory A arrived at Hoyt Lakes at 0100 CDT, B at 0700 CDT, C at 1300 CDT, and D at 1900 CDT. The distance between arrowheads represents twelve hours of travel.

Fine particle volume concentrations at a given time frequently depend upon the trajectory followed by the air parcels during the previous 24 to 72 hours. These concentrations were measured frequently during the study. Averages of the concentrations measured between the trajectory arrival times are listed on the figures. The fine particle volume concentration represents the amount of aerosol in the accumulation mode. This mode is found between $.1 \mu\text{m}$ and $1 \mu\text{m}$, and usually contains aged combustion and photochemical aerosols. These aerosols usually require several hours to form, are transported long distances, and are only removed by precipitation processes. Therefore, the fine particle volume concentration often depends upon emissions and conditions along the prior trajectory of the air parcel.

The fine particle volume concentration averages reported for July 25 are $1.7 \mu\text{m}^3/\text{cm}^3$ and $2 \mu\text{m}^3/\text{cm}^3$. These values are typical for clean continental background (Whitby, 1978). Trajectories B, C, and D passed over a sparsely populated region of western Ontario, the Quetico Provincial Park, and the Boundary Waters Canoe Area during the 24 hours prior to their arrival at Hoyt Lakes. The parcels also passed near the town of Ely.

The fine particle volume concentrations reported for July 26 between 1300 CDT and 1900 CDT are higher than those expected for clean continental background. These parcels followed a slower, more westerly trajectory and passed near towns like Kenora, Fort Frances, and International Falls. Their paths cross more communities and major roads than do the trajectories of the previous day, and they do so at smaller velocity. This may explain the larger concentration in the accumulation mode.

The trajectories for July 27 pass near the urban areas of Duluth and Minneapolis-St. Paul in the 24 hours prior to their arrival at Hoyt Lakes. Thus, the measured fine particle volume concentration for this day is greater than for the previous two days.

These results are consistent with the suggestion of Samson (1979) and others that the amount of aerosol in the accumulation mode is related to the upwind emissions burden, wind speed, and mixing height. The observed concentrations are expected to increase as the parcels pass over populated areas and decrease as the wind speed increases.

References

Samson, Perry J., "Ensemble Trajectory Analysis of Summertime Sulfate Concentrations in the Eastern United States", presented at Symposium/Workshop on the Planning of Regional-Scale Programs, Durham, NC (March, 1979).

Whitby, K. T., "The Physical Characteristics of Sulfur Aerosols", Atmos. Environ. 12:135-159 (1978).

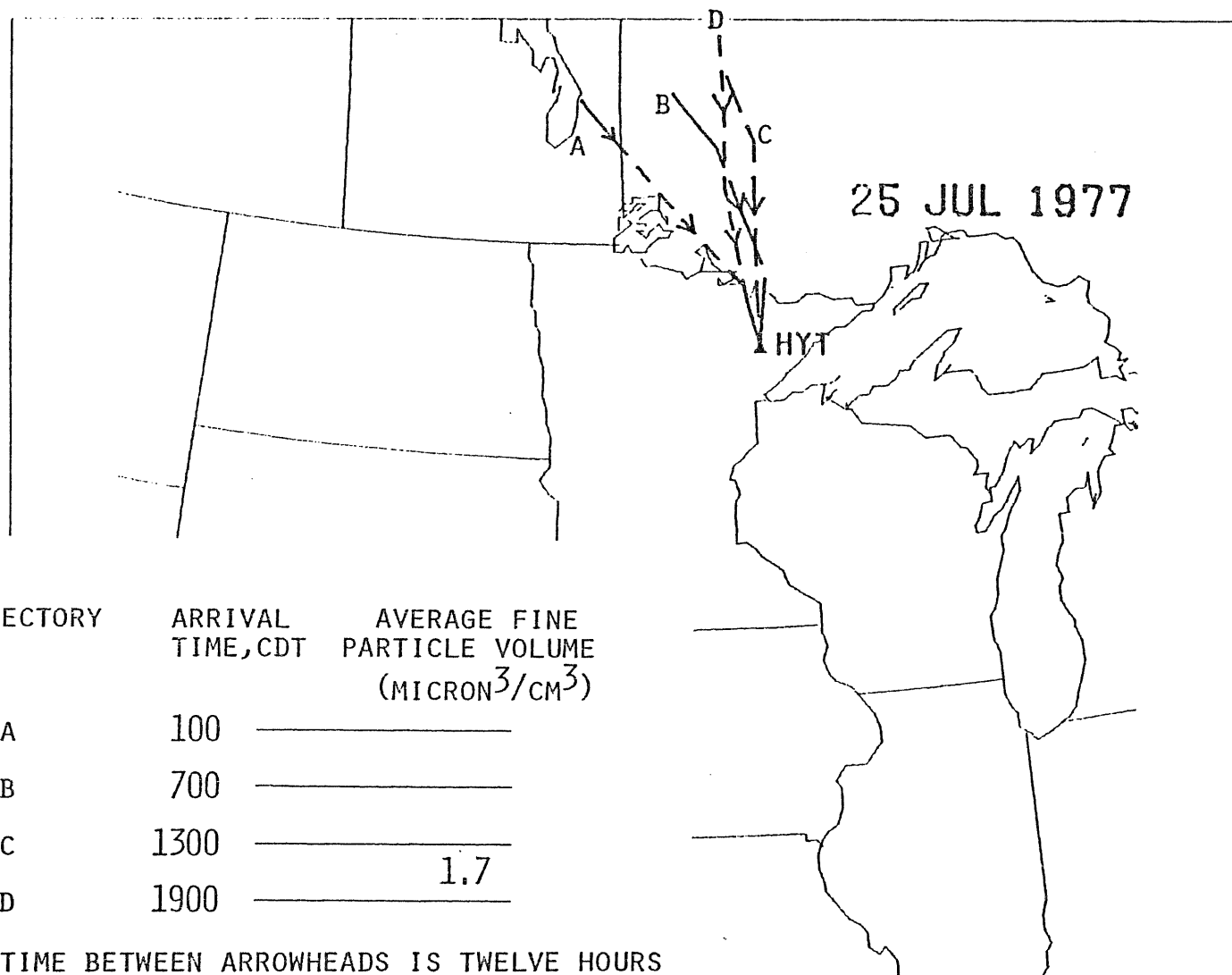

Figure D1. Air parcel trajectory analysis and corresponding fine particle volume concentrations measured on July 25, 1977 during the Copper-Nickel Study.

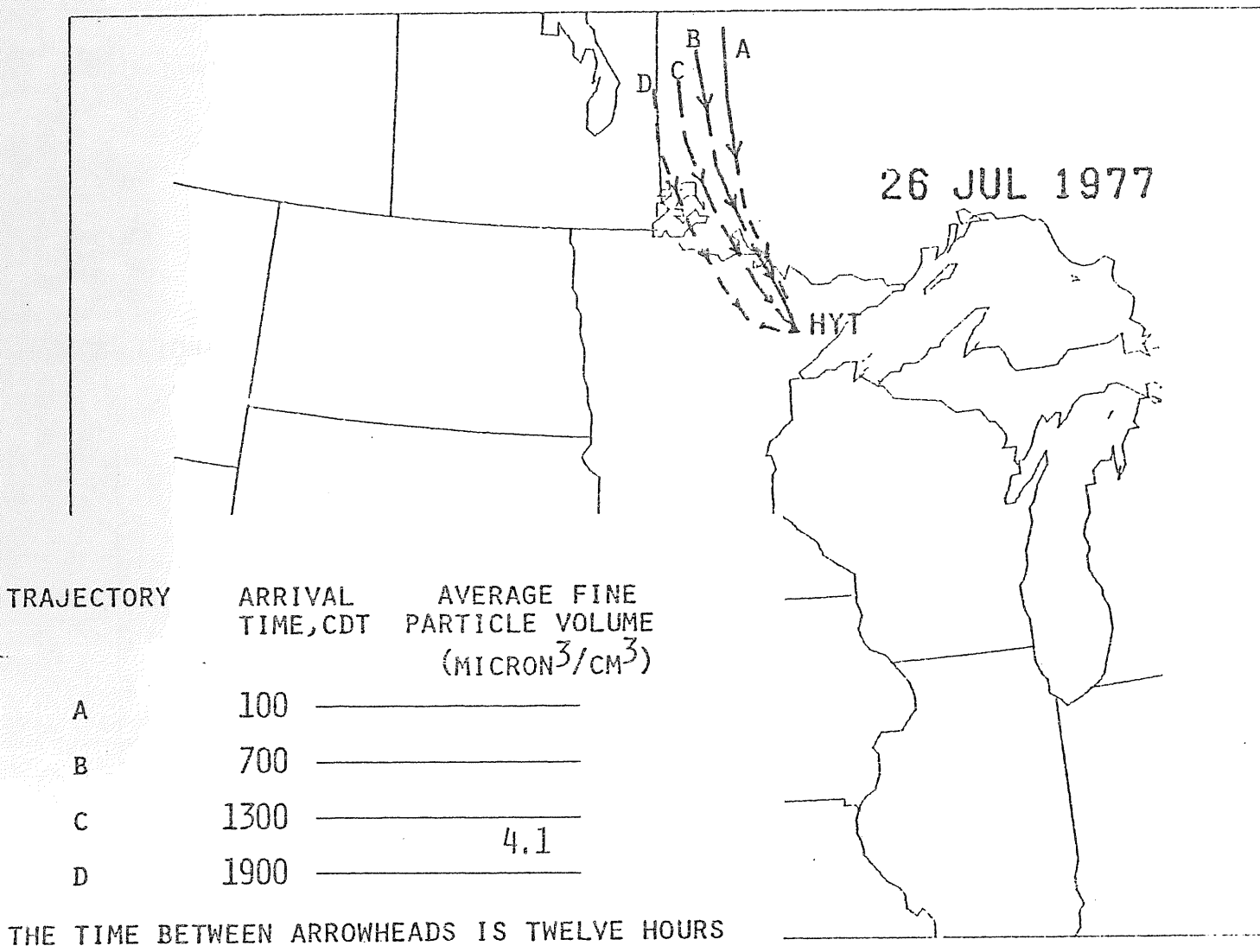

Figure D2. Air parcel trajectory analysis and corresponding fine particle volume concentrations measured on July 26, 1977 during the Copper-Nickel Study.

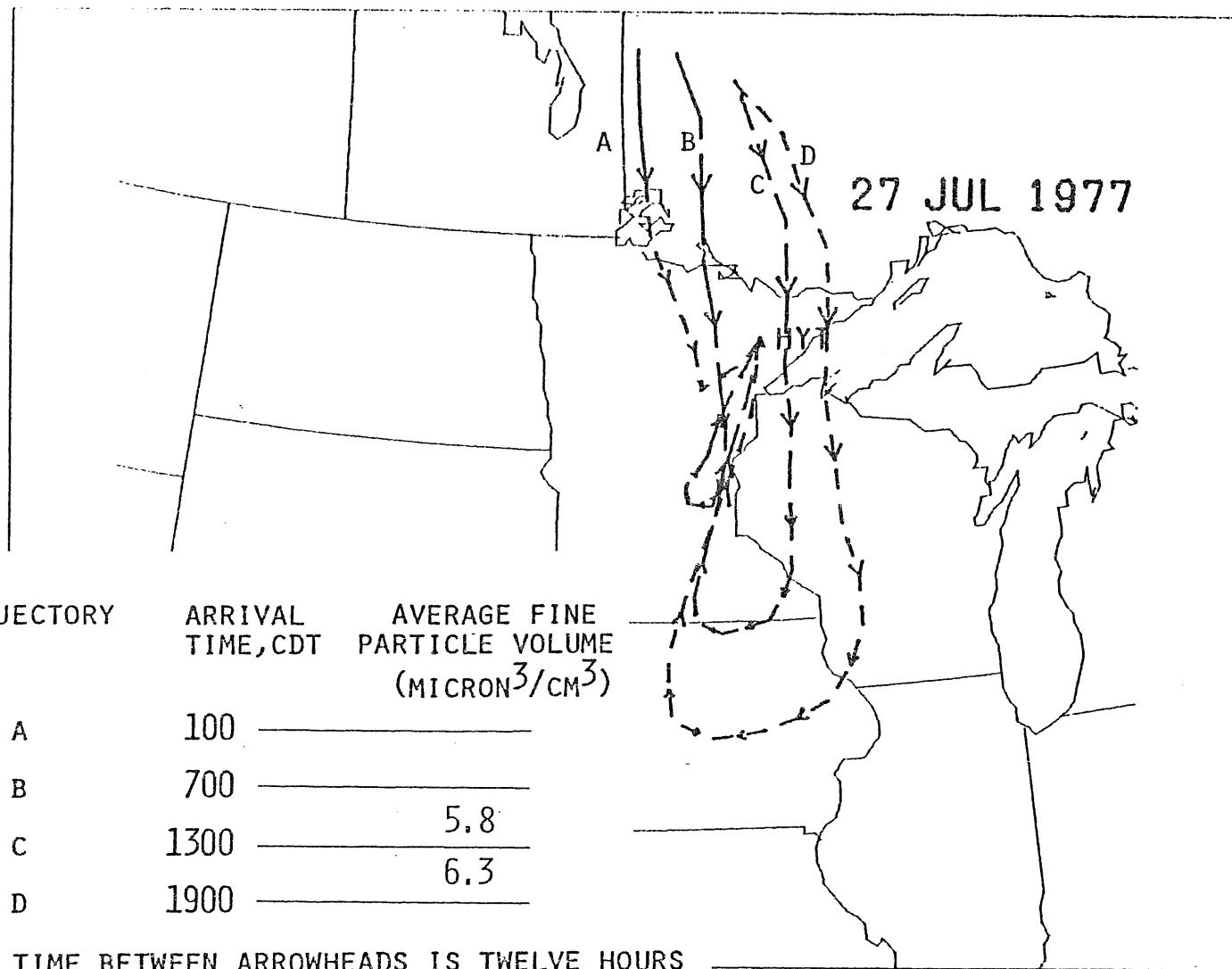

Figure D3. Air parcel trajectory analysis and corresponding fine paraticle volume concentrations measured on July 27, 1977 during the Copper-Nickel Study.