



DEFENSE

**ISRAEL**  
**DIRECTORY**  
**2015/16**

ISRAEL MINISTRY OF DEFENSE

*סיב"ט* *סיב"ט*

INTERNATIONAL DEFENSE COOPERATION

# ISRAEL DEFENSE DIRECTORY 2015-16

© Copyright 2015 by SIBAT

All rights reserved. No part of this book may be reproduced, stored in a retrieval system, or transmitted in any form or by any means - electronic, mechanical, photocopy, recording or otherwise - without the prior written consent of SIBAT.

First published in 1972

22<sup>nd</sup> Edition 2015

ISSN 2221-7657

Published under the Authority of: 

The Israel Ministry of Defense, SIBAT - International Defense Cooperation

## Compiled and Edited by:

SIBAT - Marketing Communications Division

Hakiryia, Tel Aviv 6473424, Israel

Tel: 972-3-6975916, 6975515

Fax: 972-3-6934639

E-mail: [sibat\\_marcom@mod.gov.il](mailto:sibat_marcom@mod.gov.il)

Web Site: [www.sibat.mod.gov.il](http://www.sibat.mod.gov.il)

## Production

Hoffen Publishing House Ltd.

Tel: 972-3-9793006

E-mail: [hanni@hoffen.co.il](mailto:hanni@hoffen.co.il)

E-mail: [yael@hoffen.co.il](mailto:yael@hoffen.co.il)

Web Site: [www.hoffen.co.il](http://www.hoffen.co.il)

## Production Team

Yael Pozniack-Hoffen, Hanni Hoffen-Nir

E-mail: [yael@hoffen.co.il](mailto:yael@hoffen.co.il)

## Graphics

Inbar Gal

## Cover and Sections Design

Studio Smadar

## Introductory Texts

Tamir Eshel

E-mail: [tamir.eshel@gmail.com](mailto:tamir.eshel@gmail.com)

## Printing

Keter Press

Jerusalem

**2015**

## HOW TO USE THIS DIRECTORY

Israel's Defense Directory 2015-16, brought to you by SIBAT, enables you to establish contact with the Israeli defense manufacturers engaged in the specialization that would be of interest to you. For your convenience, the Directory is divided into eleven sections, each comprising of several sub-sections, as listed in the Table of Contents. Within each section you will find your relevant manufacturers, listed alphabetically. Except in cases where double spread insertions made this impossible.

In order to facilitate tracing of a company or a specific product, two indices have been prepared: The first lists the various defense manufacturers and consultants, as well as basic and relevant information concerning the organization and its areas of activities. The second index lists the products by their brand name, acronym or abbreviated form. Both indices are alphabetically arranged.

We would also like to draw your attention to the fact that this Directory will be presented in the special internet website: [www.sibat.mod.gov.il/catalog](http://www.sibat.mod.gov.il/catalog), in which all the companies advertising in the directory will be included and briefly described.

At the time of the publication (May 2015), the companies included in the Directory held M.O.D approval to offer their products and services. However, this authorization is valid for one year only and subject to renewal. According to Israeli law, special permits and authorizations govern all defense-related sales, and the fact that a company appears in this Directory does not necessarily mean that the company is entitled by law to export its products at any given time other than the date of publication. Moreover, each transaction requires an export license.

As the Israeli defense industry is extensive, and as manufacturers are not compelled to advertise in the Directory, we do not claim that the Directory includes all the companies, all items of defense equipment that are being manufactured, or all of the services offered by Israeli companies.

Although we have done our utmost to insure that the information herein is correct, it is the companies that are responsible for the accuracy of the information they submit.

We, therefore, cannot be held responsible for any inconsistency or inconvenience caused by discrepancies in the information.

The Directory will be current for 24 months, with the next one due to be published in May 2015.

In the event that you find it difficult to contact a company due to change of address, telephone or fax number, please call us. We will be happy to assist.

Please refer to the Directory as your source of information when contacting a company or SIBAT.

Please turn to page 471 to order additional copies of the Directory.

# ISRAEL'S GLOBALLY RECOGNIZED DEFENSE INDUSTRY

Israel is recognized the world over for its pioneering, operationally-proven defense systems—delivering advanced capabilities to meet today's increasingly sophisticated threats.

Developed by the country's defense industries – and utilized by defense and security forces around the globe – these ground-breaking systems are backed by a combination of cutting-edge technologies, a skilled and militarily experienced multi-disciplinary workforce, and a well-developed infrastructure. Together, they ensure Israel's national security – and support its worldwide customer base.

Israel's defense industry – which plays a leading role in the development of the country's industrial and technological capabilities – is open to cooperation, technology transfer, and the sharing of know-how through international initiatives.

As the authority responsible for defense export and international cooperation within Israel's Ministry of Defense (IMOD), SIBAT is your link to the technological knowledge and expertise of Israel's defense industries.

## Israel Ministry of Defense - Organization Chart

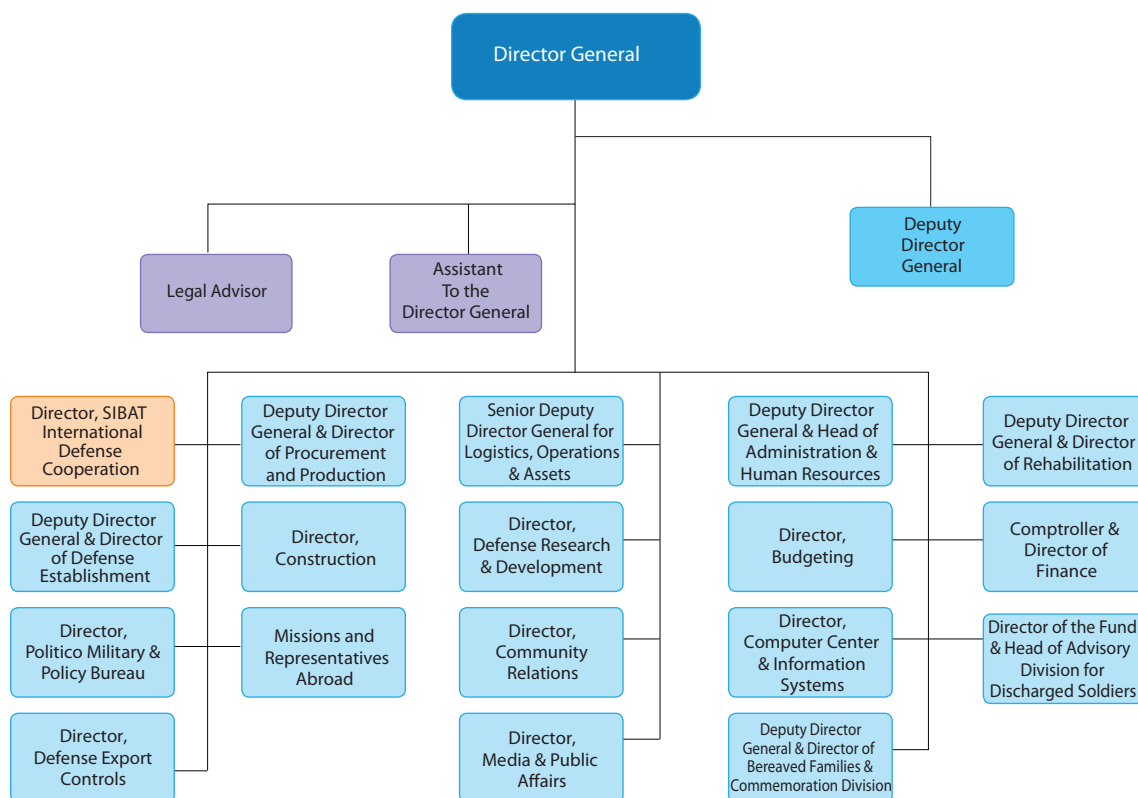

# SIBAT AT THE CROSSROADS OF ISRAEL'S DEFENSE INDUSTRY

Occupying a key position in Israel's defense sector – SIBAT is both an essential directorate within the IMOD, while at the same time, enjoying a close relationship with Israel's defense industry.

SIBAT's responsibilities include:

- Assisting in the expansion of international defense cooperation.
- Acting as the primary source of detailed information about Israel's versatile, dynamic defense industry.
- Participating in the formulation of Israel's defense export policy, coordinating all export-related activities, and promoting Israel's defense technologies abroad.
- Managing the marketing and sales of defense inventory.

Due to its unique position within Israel's defense ecosystem, SIBAT:

- Receives ongoing updates regarding the wide variety of technologies and solutions being developed by Israeli defense companies.
- Handles a steady stream of critical input concerning the IDF's evolving operational requirements.
- Continuously enhances and expands its understanding of defense concepts – and the relationship between the IDF's field experience and the development of industry solutions.

## SIBAT - Organization Chart

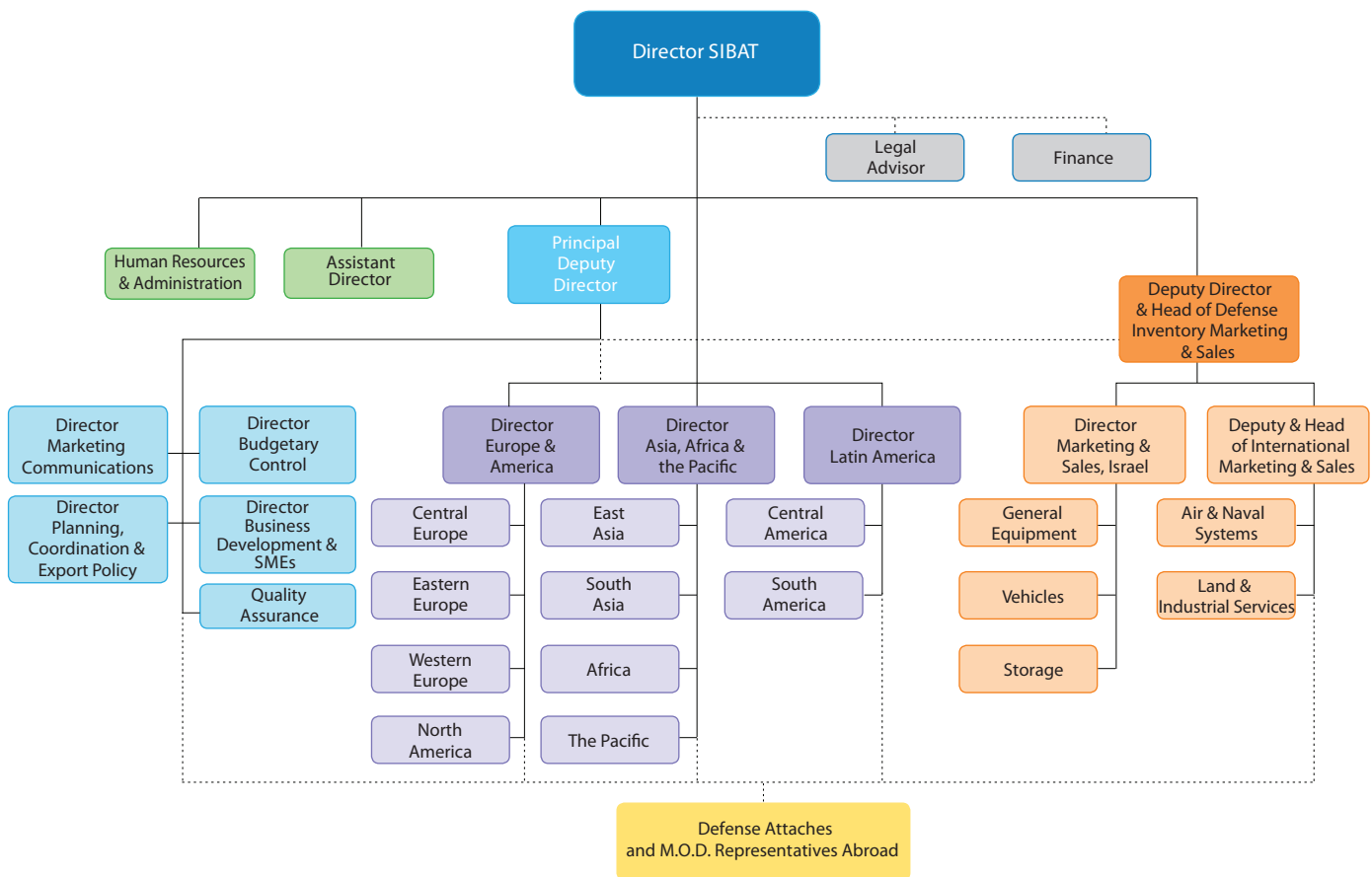

# FACILITATING INTERNATIONAL COOPERATION

Among the activities designed to facilitate international cooperative initiatives, SIBAT:

- Generates and supports Government-to-Government agreements.
- Initiates and coordinates visits to Israel by foreign delegations and representatives from around the world.
- Organizes the visits of Israeli defense delegations abroad.
- Establishes collaborative ventures and long-term partnerships.
- Assists in the creation of joint ventures between Israeli defense industry manufacturers and foreign partners.
- Identifies the needs of potential customers, matches these requirements with appropriate technological solutions, and establishes connections between customers and relevant Israeli defense companies.

## International Cooperation

International cooperation is divided into three regional divisions:

1. Europe & North America
2. Asia, Africa & the Pacific
3. Latin America

### EUROPE & NORTH AMERICA DIVISION

UNITS	TEL.	FAX
Director of Europe & North America	972-3-697-7936	972-3-697-5097
Central Europe	693-7937	
Eastern Europe	697-7905	
Western Europe	697-7930	
North America	697-6586	

E-mail: [sibat\\_euam@mod.gov.il](mailto:sibat_euam@mod.gov.il)

### ASIA, AFRICA & THE PACIFIC DIVISION

UNITS	TEL.	FAX
Director of Asia, Africa & the Pacific	972-3-697-7921	972-3-697-7959
East Asia	697-7928	
South Asia	697-7964	
Africa	697-7912	
The Pacific	697-7920	

E-mail: [sibat\\_aap@mod.gov.il](mailto:sibat_aap@mod.gov.il)

### LATIN AMERICA DIVISION

UNITS	TEL.	FAX
Director of Latin America	972-3-697-7925	972-3-697-5097
South America	697-7698	
Central America	697-7949	

E-mail: [sibat\\_latinam@mod.gov.il](mailto:sibat_latinam@mod.gov.il)

# EXPANDING GLOBAL DEFENSE COOPERATION

## Supporting Israel's High-End SME's

SIBAT attaches great importance, and allocates significant management resources, to the support of small and medium-sized defense enterprises. SIBAT has become an exceptional source of information for Israel's flourishing SME community – appreciated for its nurturing of innovative startups, as well as its matching of mid-sized and large firms with global partners. These industries rapidly provide flexible solutions to meet urgent needs, constitute a wellspring of technological innovation, contribute to the enhancement of competitiveness, and possess specialized knowledge and expertise.

The division is organized as follows:

UNITS	TEL.	FAX
Director of Business Development and SMEs	972-3- 697-7938	972-3-697-6843
SMEs	697-6461	
Business Information	693-4073	

E-mail: [sibat\\_bic@mod.gov.il](mailto:sibat_bic@mod.gov.il)

## Supporting Global Customers and Defense Exporters

Tasked with expanding global cooperation with Israel's defense industry, SIBAT disseminates information regarding the country's cutting-edge, combat-proven technologies, and supports global customers as well as defense exporters.

Activities include:

- Comprehensive quality assurance and technical support services as required by Government-to-Government agreements.
- Advanced training seminars in Israel and abroad, and training for foreign forces around the world in the effective use of Israel's technologies and know-how.
- Publication of the Israel Defense Directory every two years, covering Israel's Defense and Homeland Security Industries.
- Organizing the Israel National Pavilion at defense-related exhibitions around the world, where Israel's technologies and capabilities are showcased under one roof; producing local conferences; attending global fairs and exhibitions.

These services are headed by the Principal Deputy Director of SIBAT and provided by the following units:

UNITS	TEL.	FAX	E-MAIL
Principal Deputy Director	972-3-697-7906	972-3-697-6843	<a href="mailto:Itamar_graff@mod.gov.il">Itamar_graff@mod.gov.il</a>
Marketing Communications	697-5515	693-4639	<a href="mailto:sibat_marcom@mod.gov.il">sibat_marcom@mod.gov.il</a>
Planning, Coordination & Export Policy	697-7942	697-7093	<a href="mailto:sibat_expolicy@mod.gov.il">sibat_expolicy@mod.gov.il</a>
Quality Assurance	693-4189	693-4640	<a href="mailto:anordan@mailto.mod.gov.il">anordan@mailto.mod.gov.il</a>

# MARKETING AND SALES OF DEFENSE INVENTORY

SIBAT manages the marketing and sales of Israel's entire defense Inventory, which is released by the IDF and the IMOD. Inventory sales, handled by SIBAT, includes main platforms (aircraft, tanks, ships and armored vehicles), weapon systems (guns, missiles, light weapon systems), spare parts (air, ground, sea), and vehicles. All sales are carried out either through tenders or by negotiation. A selection of currently available Inventory can be found on SIBAT's website.

## The Defense Inventory & Sales Division

The Defense Inventory & Sales Division is headed by the Deputy Director & Head of Defense Inventory Marketing & Sales Division, and consists of the following professional areas:

UNITS	TEL.	FAX
Deputy Director & Head of Defense Inventory Marketing & Sales	972-3- 697-5754	972-3- 697-6724
Deputy & Head of International Marketing & Sales	697-7207	697-6724
Air & Naval Systems	697-7991	697-6864
Land & Industrial Services	697-7333	697-6864

E-mail: [sibat\\_definventory@mod.gov.il](mailto:sibat_definventory@mod.gov.il)



# LIST OF ISRAEL'S DEFENSE ATTACHES AND M.O.D. REPRESENTATIVES ABROAD

## AUSTRALIA

EMBASSY OF ISRAEL  
M.O.D. Representative  
6 Turrana Street  
Yarralumla Act 2600  
Canberra, AUSTRALIA  
Tel: +61-2-62733497  
Fax: +61-2-62732874  
E-mail: defenceattache@canberra.mfa.gov.il

## BRAZIL

EMBASSY OF ISRAEL  
Defense Attache  
Ses, Avenida Das Nacoes, Q809 Lote 38  
Brazilia-Df, 70424-900 BRAZIL  
Tel: +55-61-21050502  
Tel/fax: +55-61-21050561  
E-mail: militaryatt@brasilia.mfa.gov.il

## CANADA

EMBASSY OF ISRAEL  
Defense Attache  
O'Connor St., Suite 1005,50  
Ottawa, Ontario  
K1P 6L2, CANADA  
Tel: + 1-613-567-6450 Ext. 520  
Fax: +1-613-567-2411  
E-mail: defence-att@ottawa.mfa.gov.il

## CHILE

EMBASSY OF ISRAEL  
Defense Attache  
San Sebastian 2812, Piso 5  
Casilla 146 Correo 35  
Santiago de Chile, CHILE  
Tel: +56-27500516  
Fax: +56-2-2316626  
E-mail: militaryatt@santiago.mfa.gov.il

## COLOMBIA

EMBASSY OF ISRAEL  
M.O.D. Representative  
Calle 35 No.7-25, Piso 14  
Bogota, COLOMBIA  
Tel: +57-1-3236935  
Fax: +57-1-2870340  
E-mail: mod@bogota.mfa.gov.il

## FRANCE

M.O.D.  
EUROPEAN MISSION  
3, Rue Rabelais  
75008 Paris, FRANCE  
Tel: +33-1-40765407  
Fax: +33-1-40765347  
E-mail: paris\_adg@mod.gov.il

## EMBASSY OF ISRAEL

Defense Attache  
Tel: +33-1-40765478  
Fax: +33-1-40765404  
E-mail: idf@paris.mfa.gov.il

## GERMANY

M.O.D. MISSION  
Auguste-Viktoria-Str. 74  
D-14193 Berlin, GERMANY  
Tel: +49-30-89045602  
Fax: +49-30-89045639  
E-mail: mod-berlin@mod.gov.il

## EMBASSY OF ISRAEL

Defense Attache  
Auguste-Viktoria-Str. 74  
D-14193 Berlin, GERMANY  
Tel: +49-30-89045630  
Fax: +49-30-89045639  
E-mail: berlin\_attache@mod.gov.il

## GREECE

EMBASSY OF ISRAEL  
Defense Attache  
1, Marathonodromon Str. 15452  
Paleo Psychico  
Athens, GREECE  
Tel: +30-210-6705505  
Fax: +30-210-6705555  
E-mail: defense-attache@athens.mfa.gov.il

## INDIA

EMBASSY OF ISRAEL  
Defense Attache  
3, Aurangzeb Road  
New Delhi 110011 INDIA  
Tel: +91-11-30414500/19  
Fax: +91-11-23015166  
E-mail: mod-def@newdelhi.mfa.gov.il  
SIBAT Representative:  
mod-sibat-rep@newdelhi.mfa.gov.il  
mod-isd@newdelhi.mfa.gov.il

## ITALY

EMBASSY OF ISRAEL  
Defense Attache  
Via M. Mercatti 14,  
00197 Roma, ITALY  
Tel: +39-06-36198537  
Fax: +39-06-36198596  
E-mail: defense-attache@roma.mfa.gov.il

## KOREA

EMBASSY OF ISRAEL  
Defense Attache  
18th Fl., Cheonggye Bldg.  
149 Seolin-Dong, Jongro-Ku  
Seoul, 110-726 KOREA  
Tel: +82-2-7392575  
Fax: +82-2-7399962  
E-mail: defense@seoul.mfa.gov.il

## MEXICO

EMBASSY OF ISRAEL  
M.O.D. Representative  
Sierra Madre 215, Lomas de Chapultepec  
México D.F. 11000  
Tel: +52-55-52011531  
Fax: +52-55-52011555  
E-mail: defenseattache@mexico.mfa.gov.il

## NETHERLANDS

EMBASSY OF ISRAEL  
Defense Attache  
Buitenhof 47  
2513 AH The Hauge,  
NETHERLANDS  
Tel: +31-70-3760547, 3630334  
Fax: +31-70-3760588  
E-mail: mod@hague.mfa.gov.il

## POLAND

EMBASSY OF ISRAEL  
Defense Attache  
24 L. Krzywickiego Street  
Warsaw 02-078, Poland  
Tel: +48-22-59705151  
Fax: +48-22-8251550  
E-mail: zhl@warsaw.mfa.gov.il

## People's Republic of CHINA

EMBASSY OF ISRAEL  
Defense Attache  
No. 17 Tian Ze Lu  
Chaoyang District  
Beijing, 100600 P.R.C.  
Tel: +86-10-85320673  
Fax: +86-10-85320616  
E-mail: military@beijing.mfa.gov.il

## RUSSIA

EMBASSY OF ISRAEL  
Defense Attache  
Bolshaya Ordynka Street 56  
Moscow 113095  
RUSSIAN FEDERATION  
Tel: +7-495-6602716  
Fax: +7-495-6602786  
E-mail: military@moscow.mfa.gov.il

## SINGAPORE

EMBASSY OF ISRAEL  
Defense Attache  
58 Dalvey Road  
Singapore 259463, SINGAPORE  
Tel: +65-6-2350793, 8349234/5  
Fax: +65-6-7338559  
E-mail: defenceatt@singapore.mfa.gov.il

## THAILAND

EMBASSY OF ISRAEL  
M.O.D. Representative  
Ocean Tower II, 25th Floor  
75 Sukhumvit Soi 19 Road  
Soi Wattana, Klongtoey  
Bangkok 10110, THAILAND  
Tel: +66-2-2049250/1  
Fax: +66-2-2049225  
E-mail: defence@bangkok.mfa.gov.il

## UNITED KINGDOM

EMBASSY OF ISRAEL  
Defence Attache  
2A Palace Green  
London W8 4QB U.K.  
Tel: +44-207-4168198/9  
Fax: +44-207-4168196  
E-mail: defence-attache@london.mfa.gov.il

## USA

EMBASSY OF ISRAEL  
M.O.D. Representative  
3514 International Dr. N.W.  
Washington, D.C., 20008, USA  
Tel: +1-202-3645608  
Fax: +1-202-3645491  
E-mail: mod@israeemb.org

## DEFENSE TECHNOLOGY AT THE SERVICE OF NATIONAL SECURITY

Nations around the world are at work adapting their military forces, strategy and tactics to cope with an increasingly unstable world. Preparing to meet new threats military forces must be more flexible and ready. Planning for the unexpected requires the best intelligence, mobile and responsive forces capable to deliver more efficient and decisive effects and the latest command and control systems to manage and maintain those forces.

This transformation is extremely challenging in western militaries, at a time when nations continue to tighten their budget to meet fiscal constraints that have hampered growth and prosperity in west for almost a decade.

Investing in military modernization, customers throughout the world rely on Israel's broad portfolio of sophisticated, combat proven defense equipment, comprehensive training, logistical support, as well as expert advice. Such systems are available for export as new equipment, supplied as part of modernization, refurbishment and upgrading of existing systems or as hardware delivered from operational or surplus military stock.

By developing a sophisticated array of innovative and advanced defense systems, based on unique technologies, Israel is confident to maintain its national security against superior military odds. Through the years, Israel's defense industries have excelled in offering Israel's Defense Forces (IDF) and foreign customers the ability to acquire new operational capabilities, by fielding advanced systems and to modernize existing platforms to assume new roles. In addition, Israel's defense exports also include comprehensive systems for intelligence, command and control and cyber defense.

Some of these systems are presented in this biennial directory, demonstrating the best of what Israel's defense industries can offer. It represents Israel's foremost technologies, know-how and expertise, refined into unique products - complete weapon systems, subsystems, hardware and software.

This directory provides a comprehensive review of Israel's defense industry's capabilities. It does not attempt to be complete. The companies listed have voluntarily decided to include a selection of their product listing, therefore, this directory does not contain Israel's entire list of defense driven companies, or all products available for export.

We hope you will find it informative, and convenient to use.

# TABLE OF CONTENTS FOR DEFENSE DIRECTORY 2015-16

## 1 Aerospace

- Aircraft Manufacturing, Maintenance, Upgrading & Retrofit 14-23
- Aircraft Parts & Subcontracting 24-35      ■ Avionics & Airborne Equipment 36-47
- Helicopters - Upgrade, Modernization, Maintenance & Avionics 48-49
- Weapon Systems & Missiles 50-58      ■ Simulation, Training & Pilot Training Solutions 59-63
- Electronic Warfare & Countermeasures 64-71      ■ C<sup>4</sup>I 72-80      ■ Ground Support 81-82
- Space Technology 83-87      ■ Ballistic Missile Defense 88

## 2 Naval Forces

- Naval Craft & Shipborne Equipment 92-97      ■ C<sup>4</sup>I 98
- Naval Defense & Attack Systems 99-105      ■ Electronic Warfare & Countermeasures 106-109
- Simulation & Training 110-111      ■ Sonar Systems 112

## 3 Land Forces

- Tanks & Armored Combat Vehicles 116-138      ■ Force Protection - Armor Protection 139-145
- Force Protection - Active Protection 146-151
- Force Protection - Personal Protective Gear 152-161      ■ Border Protection 162-173
- C<sup>4</sup>I 174-179      ■ Artillery 180-192      ■ Military Vehicles 193-198
- Dry Storage 199      ■ Demolition, Explosive Ordnance Disposal & Mine Clearing 200-207
- Electronic Warfare & Countermeasures 208-211      ■ Infantry Equipment 212-227
- Small Arms 228-230      ■ Simulation & Training 231-233
- Air Defense Systems 234-238      ■ Aerostat Systems 239

## 4 Unmanned Systems & Robotics

- UAV 242-265      ■ UGV 266-267      ■ Robots 268

## 5 C<sup>4</sup>I (Command, Control, Communications, Computing & Intelligence) (Other C<sup>4</sup>I products & systems are also listed under chapters 1-3)

- Military Communications - Systems & Equipment 272-284      ■ C<sup>4</sup>I 285-295      ■ Intelligence 296-312

## 6 Optronics

- Day/Night E.O. Systems & Lasers 316-328      ■ Missile Components 329
- Airborne E.O. Pods 330-335      ■ Thermal Imaging 336-343
- Test, Measurement & Evaluation 344      ■ General Capabilities 345

## 7 Electronic Components & Sub-Systems

- Navigation 348-351

## 8 Military Inventory

- General 354-355      ■ Ground Forces 356-357      ■ Air Force 358-369      ■ Scrap 370      ■ Navy 371

## 9 Civil Defense & CBRN Preparedness

- (Other Civil Defense equipment & services are also listed in the Homeland Defense Directory)
- NBC 374-385      ■ Non-lethal 386-387

## 10 Services

- Defense Consultants & Training 390-399      ■ Export & Marketing Services 400-403
- Design, Engineering & Planning 404-406      ■ Test Center 407      ■ Quality Assurance 408

## 11 Indices

- Companies 410-458      ■ Products Brand Names 459-470      ■ Purchasing additional Directory 471



**AEROSPACE**

## **Air Supremacy Gained by Excellence and Innovation**

Considered the mainstay of Israel's defense, Israel's Air and Space Force (IAF) relies on the superb technical skills, technological resources, know-how and innovation provided by the country's aerospace and defense companies to meet its constant challenges.

These innovative systems include advanced aerostructures, weapon systems, and wide range of sensors and avionics including EO, radar and electronic surveillance, used for targeting, reconnaissance and self-defense. All are integrated into the world's most advanced fighter aircraft, including Lockheed Martin F-35 and F-16, Boeing F-15 and F/A-18, Sukhoi Su-30, Dassault Mirage 2000, Eurofighter Typhoon, Saab Gripen and more.

The IAF and many foreign air forces rely on Israel's aerospace industries to supply a wide range of systems and services, ranging from satellite and satellite services, to the modification of existing aircraft and helicopters, delivery of unmanned aircraft systems, aerial weaponry, air defense systems, and advanced, network centric command, control and communications, computing, intelligence, surveillance and reconnaissance (C<sup>4</sup>ISR) systems.

In addition to supplying new equipment, Israeli companies have successfully completed numerous projects upgrading and modernizing existing platforms and systems. Supporting the IAF, as well as customers throughout the world, Israeli companies are successfully extending the useful lifespan and operational capabilities of existing platforms, enabling users to capitalize on past defense investments over longer periods. Encompassing combat, intelligence, transport, special-mission aircraft and helicopters, Israeli modernization plans were implemented with western and eastern aircraft in Europe, Asia, Latin America, North America, Africa and the Middle East.

# AIRBORNE MISSION SOLUTIONS

*The Experts Behind The Aircraft*

*AS 9100 Approved*

*Certificate No. 72929*

*AEC Code: 21/34*



**DYNAMIC JET ENGINEERING LTD.  
(DJE)**

1 Abba-Eban Blvd. DIROM Bldg. Fl.1  
P.O.Box 12832,  
Herzliya 4672519, Israel  
Tel: 972-9-9514731  
Fax: 972-9-9514733  
E-mail: [info@dynamicjet.com](mailto:info@dynamicjet.com)  
Web Site: [www.dynamicjet.com](http://www.dynamicjet.com)

***Dynamic Jet Engineering Ltd. (DJE)*** was founded in 2004 as an aerospace company offering upgrades, modifications and conversions of military and civil aircraft.

***DJE*** has extensive and proven experience in execution of conversions and aircraft upgrades in the field of special mission aircrafts and modernization projects. Its competences encompass all the disciplines applied for integration of:

- *Communications & Avionics*
- *Various Payloads*
- *Weapon Systems*
- *Protection & Survival Suits*

***DJE*** offers high value turn key projects from concept development to serial production. These include design, analyses, testing, integration, installation, production, training and certification of various airborne systems.

***DJE*** maintains a steady staff of professionals who gained their experience in the aerospace industry in Israel and abroad.

***DJE*** applies design tools like UNIGRAPHICS, SOLID WORKS, CATIA V, ENOVIA, NASTRAN etc. to meet the highest aviation industry standards.

***DJE*** is AS 9100 certified, recognized contractor for international aerospace companies.



# ELBIT SYSTEMS - CYCLONE MILITARY AEROSTRUCTURES SOLUTIONS



ELBIT SYSTEMS - CYCLONE LTD.

P.O.Box 114

Bar Lev Industrial Zone,

2015600 Karmiel, Israel

Tel: 972-4-9568465

E-mail: cyclone@elbitsystems.com

Web Site:

www.elbitsystems.com/cyclone



Various Composite & Metallic Structural Parts  
& Assemblies, Pylons & External Fuel Tanks.

## **Elbit Systems - Cyclone**

Elbit Systems - Cyclone (Cyclone), a wholly-owned Israeli subsidiary of Elbit Systems, is a design and production center for metal and composite aerostuctures components and assemblies and parts for leading aerospace prime contractor and OEMs.

Cyclone also provides Standard Depot Level Maintenance and other services to fixed and rotary-wing aircraft customers worldwide, including systems installation and integration services. Cyclone is certified for AS 9100Rev-C, ISO9001, ISO14000 and NADCAP for various processes.

## **Military Aerostructures**

Cyclone's military aerostructures product line covers a wide variety of products such as horizontal stabilizers, leading edge flaps, rudders, ventral fins, leading edge extensions, access doors, gun bay doors, weapon bay doors, landing gear doors and a variety of covers and skins.

Cyclone products can be found in many of today's western military aircraft from fixed wing (F-35, F-15, F-16, F18 and more), to helicopters (CH-148, Ch-53, UH-60, AH-1 and more) and UAVs.

## **Unique Solutions**

*Cyclone unique solutions for military aircraft include:*

Unique Solutions

- External Fuel (drop) Tanks (EFTs) for F-16, F-15, F-18, CH-53 and several other aircraft
- Pylons for weapons, EFTS & special stores.
- Various payloads and pods structural design and manufacturing

Cyclone has designed, certified and is manufacturing a unique indigenous 600 gallon EFT for the F-16, transforming the aircraft into a strategic fighter.

Cyclone also is in the process of developing, in cooperation with Lockheed Martin, a new type of EFT.

# AEROSUPPORT



***AeroSupport encompasses a wide range of services such as Contractor Logistics Support (CLS), Performance Based Logistics (PBL) and Private Finance Initiative (PFI) programs in which the contractor owns, maintains and operates aircraft, equipment and structures and is reimbursed according to flight hours.***

**ELBIT SYSTEMS LTD.**

P.O.Box 539  
 Advanced Technology Center  
 Haifa 3105301, Israel  
 Tel: 972-4-8315315  
 E-mail: aerospace@elbitsystems.com  
 Web Site: www.elbitsystems.com



Elbit Systems' experience with military aircraft upgrades & CLS programs yields innovative solutions to grounded fleet situations. We determine the needs to keep aircraft operational, identify spares requirements, acquire spares, repair or replace faulty equipment, refurbish and return the aircraft to service and provide follow-on support. A typical CLS program is a 'window in the wall' operation with guaranteed spares availability, component repair, on-site technical assistance and maintenance, training & documentation.

**Snunit Aviation Ltd.** is a certified operator of the GROB 120A-I for the IAF Flight School. A fully owned subsidiary of Elbit Systems Ltd., Snunit's main purpose is to provide 100% of the screening sorties for the IAF Flight School. Snunit operates GROB 120A-I trainer aircraft in accordance with civil regulations and laws. All technical/ logistical and maintenance tasks are done in-house together with Elbit Systems' Cyclone subsidiary.

**Cyclone Aviation Products Ltd.** offers numerous capabilities including design and manufacture of fixed and rotary wing metal and composite structural assemblies. Cyclone's services are performed domestically and internationally. They include overhauls, maintenance, systems installation, integration and upgrades. Cyclone has earned the citation of "Preferred Supplier" from Boeing, Inc.

**Elbit Systems and its service-related subsidiaries provide:**

Elbit Systems can guarantee aircraft readiness and availability on the flight line, while taking care of all maintenance and operation activities.

- **Maintenance Activities (Outsourcing)** - Performance of maintenance activities
- **Overhauls & Refurbishments** - Return to service & upgrades for aircraft and helicopters.
- **R & R - Repair & Return** - "D" Level Product Support
- **CLS Contractor Logistic Support** - "I" & "D" Levels Availability of Spares, Logistics Management
- **PBH Power By the Hour** - "O", "I" & "D" Levels Availability of Aircraft





# AIRCRAFT UPGRADES



*Elbit Systems' proven capabilities in design, manufacture and integration of advanced avionics in numerous Eastern and Western platforms, trainers and front-line fighter aircraft ensure enhanced performance and operational capabilities.*

## ELBIT SYSTEMS LTD.

P.O.Box 539  
Advanced Technology Center  
Haifa 3105301, Israel  
Tel: 972-4-8315315  
E-mail: [aerospace@elbitsystems.com](mailto:aerospace@elbitsystems.com)  
Web Site: [www.elbitsystems.com](http://www.elbitsystems.com)



### Avionics Key Features:

- Open, modular architecture
- Core Avionics with complete redundancy
- New standards in Man-Machine-Interface
  - True Glass Cockpit
  - Display and Sight Helmet
  - HOTAS, HUD and UFCP
  - Digital Moving Map Generator (DMG)
- Advanced systems integration
  - Multimode RADARs
  - 4th generation weapons
  - Reconnaissance and Targeting pods
  - Data Link system

### Tailored to customers' needs

- Integration of legacy and new weapons
- Integration of Eastern and Western armament
- NATO and ICAO compatibility

### Operational Benefits:

- All weather, day/night capabilities
- Improved situational awareness
- Navigation and weapon delivery accuracy
- Increased safety and survivability
- Inherent growth potential and provisions
- Embedded debriefing capability

### Long Term Support:

- Complete ILS package
- Proven CLS, PBH and PFI operation concepts
- On-site assistance
- Structural reinforcements and improvements



Eastern and Western Platforms

# AEROSTRUCTURES AND ELECTRICAL HARNESSSES

## Build-to-Print / Build-to Spec



**LAHAV DIVISION  
MILITARY AIRCRAFT GROUP**  
Israel Aerospace Industries Ltd.  
Ben-Gurion Int'l Airport 7010000, Israel  
Tel: 972-3-9353163, 9358198  
Fax: 972-3-9353687, 9357010  
E-mail: lahav\_marketing@iai.co.il  
Web Site: www.iai.co.il

Lahav has over 30 years experience in the design, development, manufacture, assembly, and testing of aircraft structures. Lahav has the infrastructure, skilled personnel, and fully equipped facilities to meet the demands of the production of quality aerostructures:

- Engineers specializing in design, structures, materials, testing, production, tooling & liaison, for advanced manufacturing and assembly methodologies
- Manufacturing capabilities: for machined parts, forged parts, sheet-metal parts, welded structures, bonded structures, and composite parts
- Proven management and control tools for assembly optimization, procurement management, quality control, lean initiatives with constant improvement

Lahav supplies key aerostructures for the F-15 and F-16 aircraft, and recently started production of Wings for the F-35 aircraft.

### ELECTRICAL HARNESSSES

- Design and production using IAI's unique HarnesSys / CEED system
- Fully computerized harness production and testing
- Aircraft and helicopter rewiring
- Supplier of helicopter and aircraft wiring harnesses including the rewiring kit for the USAF F-15C/D aircraft



*F-15 Conformal Fuel Tank  
Production at Lahav*



*F-16 Wings Production at Lahav*



*Total Electrical Harnesses Capability*



*F-16 Vertical Fin Production at Lahav*

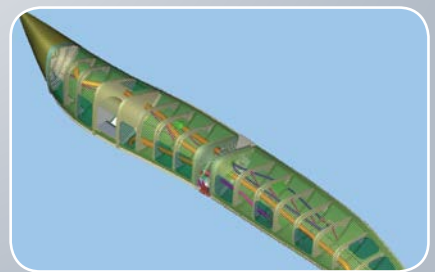

*F-16 Conformal Fuel Tank Detailed  
Design & Production at Lahav*

# MILITARY AIRCRAFT AND HELICOPTERS UPGRADE AND MAINTENANCE



**LAHAV DIVISION  
MILITARY AIRCRAFT GROUP**  
Israel Aerospace Industries Ltd.  
Ben-Gurion Int'l Airport 7010000, Israel  
Tel: 972-3-9353163, 9358198  
Fax: 972-3-9353687, 9357010  
E-mail: lahav\_marketing@iai.co.il  
Web Site: www.iai.co.il

Lahav provides a single address for military aircraft and helicopter maintenance, overhaul, refurbishment, retrofit, modernization and upgrade. Lahav has the in-house infrastructure to transform all types of military aircraft and helicopters to meet today's and tomorrow's mission requirements. Lahav has successfully implemented numerous programs on a wide range of Western and Eastern platforms. Programs offered by Lahav include comprehensive integrated logistic support packages, to ensure the efficient long-term operation of the new systems.

Lahav's typical upgrade programs include integrating advanced systems for improved performance and mission success. Key features of Lahav upgrades include:

- Reduced pilot workload with "Glass Cockpit" and optimized system displays and controls
- Integration of advanced sensors and weapons
- Adaptations for day/night missions
- EW packages for enhanced survivability
- Weapon integration

To meet specific Customer requirements, Lahav tailors the upgrade packages offered with systems such as:

- Advanced Net Centric Computer
- Data Link
- Fire Control Radar
- Electro Optic Payload
- Navigation and Communication systems
- Digital Moving Map
- Mission Planning and Debriefing systems

In addition to Lahav's upgrade capabilities, Lahav also has the infrastructure to support military aircraft and helicopter maintenance, overhaul, and return to service. These capabilities include:

- Maintenance, repair, overhaul & structural life extension
- Solutions for obsolete systems & aging aircraft
- Safety improvements
- Airframe and structural modifications
- Engineering support and services



*Upgraded Kfir with Glass Cockpit*



*Lahav Upgraded Multi-Role Aircraft*



*Mi-17 Helicopter with Lahav Avionics & Glass Cockpit*



*Lahav Aircraft Maintenance Center*

# FIGHTER AIRCRAFT UPGRADE SUITE



**IAI ELTA SYSTEMS LTD.**

P.O.Box 330, Ashdod 7710202, Israel

Tel: 972-8-8572410

Fax: 972-8-8561872

E-mail: [market@elta.co.il](mailto:market@elta.co.il)

Web Site: [www.elta-iai.com](http://www.elta-iai.com)

## Advanced Self Protection Systems

**ELL-8212/22 (Pod), ELL-8247/8 RWJS (Internal)**

The Power-Managed Self Protection System (SPS) increases fighter aircraft survivability during operations in hostile electromagnetic weapon system environments. The ELL-8212/22 and ELL-8247/8 perform electronic countermeasures against radars classified as threats and suppress the effectivity of hostile weapon systems. The systems are flight line reprogrammable for diverse threats, ECM techniques, and mission data. The SPS can be integrated with active reaction systems such as Chaff and Flares dispensers.



## Multimode Fire Control Radar

**ELM-2032**

The ELTA ELM-2032 is an advanced Multimode Fire Control Radar for multi-mission fighters. It is designed for air-to-air, air-to-ground and air-to-sea missions. Modular hardware design, full software control and flexible avionic interfaces, ensure that the radar can be installed in most fighter aircraft and may be customized to meet the most stringent user requirements. The ELM-2032 radar design combines ELTA's technical expertise with extensive operational experience gained by the Israeli Air Force.

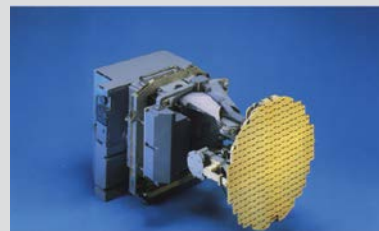

## RTP - Radar Targeting Pod

**ELM-20600**

The ELTA ELM-20600 RTP is a unique Radar Targeting Pod featuring high performance Synthetic Aperture Radar (SAR) Imaging, Ground Moving Target Indication (GMTI) and Precision Target Tracking. The RTP is a complete All-Weather, Autonomous Real Time System. Data from the RTP is instantaneously displayed to the air-crew, significantly shortening Sensor-to-Shooter loops. The RTP provides high quality radar images of ground targets and terrain from Stand-Off ranges, even through clouds, rain, fog, battlefield smoke and man-made camouflage.



## AESA Airborne Fire Control Radar

**ELM-2052**

The ELTA ELM-2052 is an advanced Airborne Fire Control Radar (FCR) designed for air-to-air superiority and advanced strike missions. The FCR is based on fully solid-state active phase array technology. This new technology enables the radar to achieve a longer detection range, higher mission reliability and a multi-target tracking capability of up to 64 targets. The ELM-2052 radar introduces new dimensions to the Air-to-Air, Air-to-Ground and Air-to-Sea operation modes of the aircraft by incorporating ELTA's decades of field-proven experience and operational feedback from Israeli Air Force combat pilots.

# AVIONICS SYSTEMS AND AIRCRAFT UPGRADES

## ISR Mission Aircraft Upgrade



**RADA Electronic Industries LTD.**

P.O.Box 8606  
7 Giborei Israel Blvd.,  
Netanya 4250407, Israel  
Tel: 972-9-892-1111  
Fax: 972-9-885-5885  
E-mail: [mrkt@rada.com](mailto:mrkt@rada.com)  
Web Site: [www.rada.com](http://www.rada.com)



RADA offers affordable ISR Mission Aircrafts upgrade suits for any medium size military cargo airborne platform. Upon request RADA can provide the platform as well.

The ISR Mission Aircraft is a strategic asset that can detect hostile activities near and beyond the nation's borders from distant ranges (up to 50 kilometers, depending on the sensor), in day/night and almost all-weather scenarios. It is highly effective in low-intensity conflicts as in wartime. Using a special sensor suit, it provides a solution tailored for detection of rainforest illegal activities.

The combination of high-end sensors with the affordable costs of light commercial style aircrafts offers a low-cost alternative to UAVs and gives an easy access to the world of real time on demand intelligence.

Among the threats and illegal activities that the ISR Mission Aircraft System can survey, detect, isolate and designate are the following:

- Troops (Vehicles, Personnel, etc.)
- Human-Made Objects (Tunnels, Footpaths, Fabrics, Mines, Roads)
- Illegal agriculture, Water contamination, Stem Counting in forests
- Radio Communication monitoring and position fixing at frequencies between 30MHz to 3,000MHz (with the ability of accurate geographical fixing of any satellite communication)
- Changes detection compared to previous ISR missions

RADA's ISR sensors suit includes the following categories:

- Imaging Intelligence (IMINT) Systems (FLIR, High-resolution Digital Camera, Hyper Spectral Camera)
- Communication Intelligence (COMINT) Systems (including direction finding/position fix)
- Communication with Command & Control Units (Data Link, Satellite Communication, Radio, etc.)
- Mission Command & Control over the sensors suit and other platforms onboard the aircraft

RADA's ISR Mission Aircraft includes a ground infrastructure providing ISR mission planning, post-mission data analysis and mission data archiving able to network with any Command & Control station.

# ***ELECTRO-OPTIC INTELLIGENCE, SURVEILLANCE AND RECONNAISSANCE (ISR)***

## ***Litening - Targeting & Navigation Pod***

Litening is an innovative airborne infra-red targeting and navigation pod for fighter aircraft with high accuracy and reliability, day and night precision strike capability. Litening reduces pilot workload during targeting and tracking. It is easily integrated on any aircraft and possesses high growth potential.

In use in the Israeli Air Force, USAF, ANG, AFRES, Marines, German AF, Swedish AF, Spanish Navy & AF, Greek AF, and others, the Litening flies on F-16 , F-15, A-10, B-52, AV8-B, Gripen, Tornado, F-5, F-4, Mig-21, Mirage 2000, Jaguar and others.



## ***Toplite EO System - Electro-Optical Surveillance, Observation & Targeting System***

The Toplite family of electro-optic systems is an advanced multi-sensor, multi-purpose, highly stabilized EO systems for homeland security and defense applications, for aerial, maritime and ground based platforms.

## ***RecceLite- Real Time Tactical Reconnaissance System***

The RecceLite System consists of an E-O pod, a ground exploitation station and a data link. It is capable of collecting images day & night from 300 ft to 40,000 ft in all directions forwards, nadir, backwards, oblique - all down hemisphere and even when the aircraft is maneuvering in high G.

The Ground Exploitation Station (GES) is capable of generating targets in real-time with exceptionally high accuracy due to state-of-the-art algorithms and technology.

The data-link connects between the sensors and the GES and enables the images to be downloaded to the GES in real time. When your task is to close the attack cycle on many "time-critical targets" in less than 10 minutes, there is only one system - RecceLite.

## ***Recce-U - Real-Time Persistent ISR System for UAVs***

Recce-U is a self-contained, multi-sensor ISR system (based on the RecceLite Tactical Reconnaissance Pod). The Recce-U enables automatic photography, according to a mission plan prepared in advance, or updated mission plan uplinked in real-time, however the operator can initiate manual scanning for targets of opportunity.



***Litening -on-Gripen***



***Toplite EOS***



***RecceLite System***



***Recce-U***

**RAFAEL**  
**ADVANCED DEFENSE SYSTEMS**  
 P.O.Box 2250 (19)  
 Haifa 3102102, Israel  
 Tel: 972-73-3354714  
 Fax: 972-73-3354657  
 E-mail: intl-mkt@rafael.co.il  
 Web Site: www.rafael.co.il

**SpotLite Family**  
**Electro-Optic Enemy Fire Detection System**

The SpotLite family consists of electro-optical systems that detect and locate enemy fire in stationary positions as well as on the move. Rapid detection and precise location information provide forces with the capability to quickly neutralize the enemy, maintaining the upper-hand on the battlefield.

The **SpotLite P** is a portable electro-optic system carried by two soldiers for day and night detection and location of small arms fire.



**SpotLite P on Tripod**

**SpotLite M** is a mobile electro-optic system installed on vehicles and AFV's that enables the detection and location of enemy fire sources from small arms, RPG rockets, ATGM and tank shells, on the move, day and night, up to 360° coverage.



**SpotLite M on vehicle**

**Imilite - Multi-Source Multi-Task ISR Exploitation System / Command and Control System**

Imilite is an intelligence system designed to receive process and exploit multiple standalone imagery video and other intelligence data in a centralized and a unified way.

Main system capability includes the reception, processing and exploitation of EO, IR, SAR/GMTI and VIDEO, in various formats, over one desktop. In order to enhance the exploitation process, Imilite further combines non-imagery data such as targets, threats, COMINT detection and mission status within the system workflow. Imilite generates a variety of standard and customer tailored ISR reports and IMINT products such as alphanumeric reports, annotated maps, GIS data layers and visual aids, and disseminates them to external information and operation systems over standard and tailored protocols.

Imilite's multi-source data integration and automation capabilities improve the efficiency of utilizing available collection and exploitation assets. The system GIS capabilities provide immediate accessibility to relevant imagery and intelligence data, thus shortening the ISR collection and exploitation cycle.

The Imilite is based on Rafael's combat-proven ISR and C4I systems already in service worldwide. Imilite is designed for use by Defense forces (air, ground) and police forces exercising various observation means for border patrol or coping with urban crime.



**Imilite**



# MOTION & POWER SYSTEMS



## BENTAL INDUSTRIES LTD.

Merom-Golan 1243600, Israel  
Tel: 972-4-6960199  
Fax: 972-4-6960187  
E-mail: [Bental\\_marketing@bental.co.il](mailto:Bental_marketing@bental.co.il)  
Web Site: [www.bental.co.il](http://www.bental.co.il)

Bental Industries Ltd. specializes in design and manufacturing of innovative power and motion systems which are integrated into various ground, marine and aerial platforms.

### Applications

- Electric Motors
- Servo Actuators
- Blowers & Dust Scavengers
- Alternators & Starter Alternator

The company main capability is to tailor cutting edge technologies and innovative solutions into a specific project with the most challenging requirements.

See also page: 120  
Land Forces - Tanks and Armored Combat Vehicles





# JET ENGINES AND GAS TURBINE ENGINES



*Bet Shemesh Engines Ltd.*

**Bet Shemesh Engines Ltd. (BSEL) is Israel's creative center for developing, manufacturing, overhauling, and repairing jet engines for aircrafts and helicopters, and investment castings for aerospace and general industry.**

## **BSEL MANUFACTURES VARIOUS ENGINES PARTS:**

- Rotating machined parts such as disks, rings, seals, spacers, axial wheels
- Sheet metal parts and welded parts such as nozzles, combustion chambers, flameholders and shrouds
- Housings, pump covers
- BSEL produces parts for various engines, e.g. F100, J79, PW4000, PWC306, PWC307, PWC545, PWC530, V2500, CF6, CF34, PW1200, PW1500.

## **BSEL OVERHAULS, UPGRADES AND REPAIRS THE FOLLOWING ENGINES:**

- PW-F100, 229  
Overhaul, upgrade and repair of subassemblies, modules and engines
- GE-T700/CT7  
Overhaul and repair
- J79-GE-J1E and J79-GE-17  
Overhaul and repair of main assemblies
- RR 250 C20 & C30  
Repair and overhaul of the engines
- PT6A, PT6T  
Repair and overhaul of the engine

## **F100 engine in Bet Shemesh Engines' test cell**

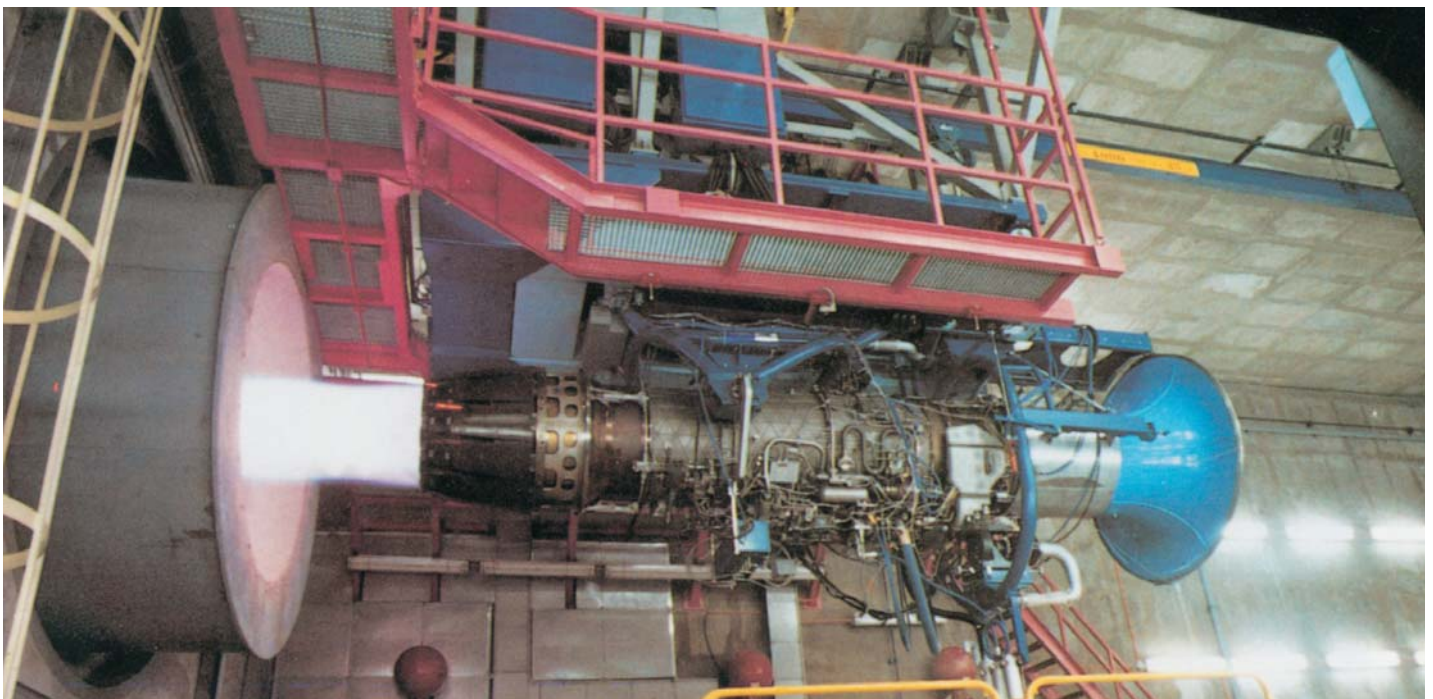

## **BET SHEMESH ENGINES LTD.**

1 Virginia Avenue  
Western Industrial Zone  
Bet Shemesh 9905529, Israel  
Tel: 972-2-9909486/7  
Fax: 972-2-9911970  
E-mail: [info@bssel.co.il](mailto:info@bssel.co.il)  
Web Site: [www.bssel.co.il](http://www.bssel.co.il)

## **BSEL'S FOUNDRY SUPPLIES THE AEROSPACE INDUSTRY WITH:**

- Gas turbine blades, vanes and integral wheels
- Aircraft engine components
- Airframe structural and integrated parts

## **R&D**

The Division designs and develops small turbojet engines for UAVs.

## **CUSTOMERS**

BSEL boasts a variety of customers, mainly engine manufacturers and users. They include Pratt & Whitney, GE Aviation, Hamilton Sundstrand, MTU Aero Engines, Israel Air Force, US Air Force, other air forces and navies around the world.

## **QUALITY ASSURANCE CERTIFICATIONS:**

**ISO 9001:2008 - AS 9100**

**Nadcap**

**FAA B7EY748J**

**EASA.145.0031**

Bet Shemesh Engines' Quality Assurance system has all the above Standards as well as being approved by major OEMs such as Pratt & Whitney, GE Aviation, Hamilton Sundstrand, MTU Aero Engines, Israel Air Force and others. The Q.A. Department maintains complete inspection facilities, ranging from first article layout to final inspection. The company's laboratories provide nondestructive testing chemical analysis.

# AEROSPACE & MILITARY SUPPLIES

i.s.p. industry sales promotion ltd



## I.S.P. INDUSTRY SALES PROMOTION LTD.

1 Lishansky St., P.O.Box 500  
New Industrial Zone  
Rishon-Lezion 7510401, Israel  
Tel: 972-3-9513333  
Fax: 972-3-9514444  
E-mail: ariel.goldman@isp-aero.com



Bearings



Sprocket



Control Wheel



Fuel Pump



K-MAX Helicopter

## AEROSPACE SYSTEMS AND COMPONENTS (COMMERCIAL AND MILITARY)

### I.S.P. - INDUSTRY SALES PROMOTION LTD. IS ACTING IN THE FOLLOWING FIELDS:

- Over 35 years in the market
- Supply of military and aerospace equipment including Hydraulic, pneumatic, fuel, structural, electronic and electrical systems, components and hardware
- Weapon systems and components
- Overhaul and repair of aviation and military systems and components
- Hardware, Spare parts for aerospace and military equipment
- Participation in upgrading programs
- Border defense projects
- HLS- Airports Security
- Small arms, artillery and various types of ammunition
- Composite materials

### I.S.P. - INDUSTRY SALES PROMOTION LTD. IS AN EXCLUSIVE REPRESENTATIVE AND CONSULTANT OF THE FOLLOWING COMPANIES:

- **KLX AEROSPACE SOLUTIONS (former B/E Aerospace)** - Hardware, bearings, spare parts for the aerospace industry including aircraft, helicopters and military equipment.
- **ITT AEROSPACE CONTROL** - actuators, regulators, solenoid and motor operated valves, airborne switches.
- **KAMAN** - Manufactures of the K-MAX helicopter.
- **PNEUDRAULICS** - hydraulic and pneumatic components and systems for the aerospace industry. Utility and solenoid valves, reservoirs, actuators.
- **NHBB** - ball bearings, rod end bearings, spherical and thin section bearings, ceramic and special bearings.
- **CRISSAIR** - special miniature self- retained check and relief valves, restrictors, inline and cartridge valves for aerospace and military.
- **CROUZET** - Pilot's control wheels, electrical limit switches, proximity switches and circuit breakers for military and aerospace industries.
- **BTL** - CNC Machining in large scale.
- **SENIOR AEROSPACE** - Metal Bellows: Maintenance free Accumulators, Bellows Reservoirs, Bellows Compensators, Heat Exchangers, and more.
- **GEAR TECHNOLOGY INC** - Manufactures of Spur Gears, Helical Gears, Serrations and Spines, plus Bevel Gears in Hy-Poid, Curvic Couple, Straight and Spiral configurations.
- **CUTTING DYNAMICS** - Specializes hydroformed & hot-formed components and assemblies for the aircraft industry.



Valves



Reservoir Assembly



Thermal Actuator

# COMPOSITE MATERIALS AND METALLIC APPLICATIONS FOR AEROSPACE AND MEDICAL DEVICES INDUSTRIES



## KANFIT LTD.

4 Shaul Amor Avenue,  
Ramat Gabriel Industrial Zone,  
Migdal Haemek 2353004, Israel  
Tel: 972-4-6547461  
Fax: 972-4-6441065  
E-mail: shachar@kanfit.com  
Web Site: www.kanfit.com

Specializing in the combination and integration of composite and metal production for aerospace structures under one roof, Kanfit is a built to spec / print aerospace engineering development and production company. We offer turnkey solutions from customer product specifications to serial production. Kanfit manufactures primary detailed parts, sub-assemblies and ready to mount assemblies from composite materials and metals. Among our core competencies are advanced RTM manufacturing technology and hybrid structures manufacturing.

Kanfit quality system is AS9100C certified, we have Nadcap certifications for Heat treatment of aluminum alloys and chemical conversion. We are also certified by Boeing, AgustaWestland and UTC.

Our projects include parts and assemblies for: Gulfstream G150 & G280, 7X7, A320, F15, F16, F18, F35, Eurofighter Typhoon, Heron, Eitan, Hermes 450 & 900 UAVs, UH60, V22, RTM chaff and flare magazines, Missiles and munitions parts, Airborne RTM antennas, Space Antennas, tools, fixtures, jigs, etc. Among our customers are Israel Aerospace Industries, Elbit Systems, Senior Aerospace, Rafael, Symetrics Industries, BAE systems and more.

Kanfit is active in the medical device industry where there is a growing demand for hybrid structures.

### Description of offered products and services:

#### Composite parts and integrated assemblies:

- Resin Transfer Molding
- Liquid Resin Infusion
- Prepreg - oven & vacuum
- Wet lay up
- Autoclave

#### Plastic:

- Hot forming
- Vacuum forming
- Transparencies

#### Sheet Metal & Blocks, Primary parts & assemblies:

- Machining
- Forming
- Welding
- Processes (heat treatment, chemical conversion, etc)
- Painting

#### Space:

- Manufacturing and assembly of jigs and deployable antennas

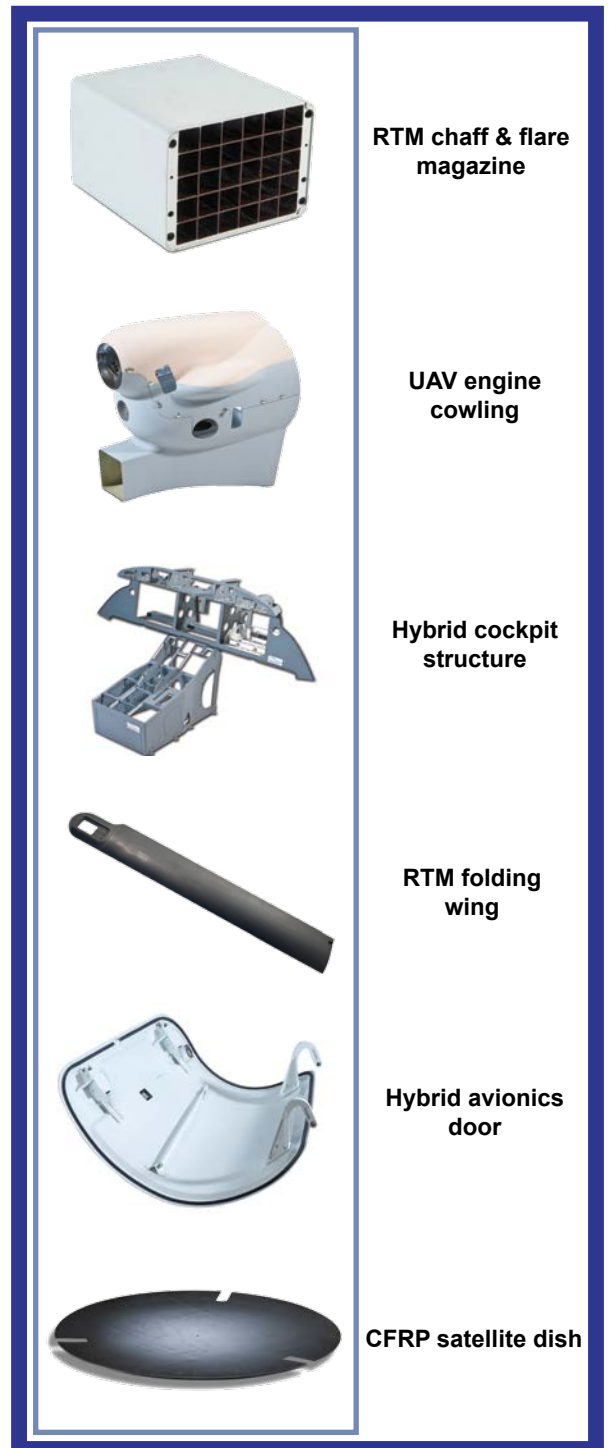

# ***ELECTRO-OPTIC INTELLIGENCE, SURVEILLANCE AND RECONNAISSANCE (ISR)***

## ***Litening - Targeting & Navigation Pod***

Litening is an innovative airborne infra-red targeting and navigation pod for fighter aircraft with high accuracy and reliability, day and night precision strike capability. Litening reduces pilot workload during targeting and tracking. It is easily integrated on any aircraft and possesses high growth potential.

In use in the Israeli Air Force, USAF, ANG, AFRES, Marines, German AF, Swedish AF, Spanish Navy & AF, Greek AF, and others, the Litening flies on F-16, F-15, A-10, B-52, AV8-B, Gripen, Tornado, F-5, F-4, Mig-21, Mirage 2000, Jaguar and others.



## ***Toplite EO System - Electro-Optical Surveillance, Observation & Targeting System***

The Toplite family of electro-optic systems is an advanced multi-sensor, multi-purpose, highly stabilized EO systems for homeland security and defense applications, for aerial, maritime and ground based platforms.

## ***RecceLite- Real Time Tactical Reconnaissance System***

The RecceLite System consists of an E-O pod, a ground exploitation station and a data link. It is capable of collecting images day & night from 300 ft to 40,000 ft in all directions forwards, nadir, backwards, oblique - all down hemisphere and even when the aircraft is maneuvering in high G.

The Ground Exploitation Station (GES) is capable of generating targets in real-time with exceptionally high accuracy due to state-of-the-art algorithms and technology.

The data-link connects between the sensors and the GES and enables the images to be downloaded to the GES in real time. When your task is to close the attack cycle on many "time-critical targets" in less than 10 minutes, there is only one system - RecceLite.

## ***Recce-U - Real-Time Persistent ISR System for UAVs***

Recce-U is a self-contained, multi-sensor ISR system (based on the RecceLite Tactical Reconnaissance Pod). The Recce-U enables automatic photography, according to a mission plan prepared in advance, or updated mission plan uplinked in real-time, however the operator can initiate manual scanning for targets of opportunity.



***Litening -on-Gripen***



***Toplite EOS***



***RecceLite System***



***Recce-U***

**RAFAEL**  
**ADVANCED DEFENSE SYSTEMS**  
 P.O.Box 2250 (19)  
 Haifa 3102102, Israel  
 Tel: 972-73-3354714  
 Fax: 972-73-3354657  
 E-mail: intl-mkt@rafael.co.il  
 Web Site: www.rafael.co.il

**SpotLite Family**  
**Electro-Optic Enemy Fire Detection System**

The SpotLite family consists of electro-optical systems that detect and locate enemy fire in stationary positions as well as on the move. Rapid detection and precise location information provide forces with the capability to quickly neutralize the enemy, maintaining the upper-hand on the battlefield.

The **SpotLite P** is a portable electro-optic system carried by two soldiers for day and night detection and location of small arms fire.



**SpotLite P on Tripod**

**SpotLite M** is a mobile electro-optic system installed on vehicles and AFV's that enables the detection and location of enemy fire sources from small arms, RPG rockets, ATGM and tank shells, on the move, day and night, up to 360° coverage.



**SpotLite M on vehicle**

**Imilite - Multi-Source Multi-Task ISR Exploitation System / Command and Control System**

Imilite is an intelligence system designed to receive process and exploit multiple standalone imagery video and other intelligence data in a centralized and a unified way.

Main system capability includes the reception, processing and exploitation of EO, IR, SAR/GMTI and VIDEO, in various formats, over one desktop. In order to enhance the exploitation process, Imilite further combines non-imagery data such as targets, threats, COMINT detection and mission status within the system workflow. Imilite generates a variety of standard and customer tailored ISR reports and IMINT products such as alphanumeric reports, annotated maps, GIS data layers and visual aids, and disseminates them to external information and operation systems over standard and tailored protocols.

Imilite's multi-source data integration and automation capabilities improve the efficiency of utilizing available collection and exploitation assets. The system GIS capabilities provide immediate accessibility to relevant imagery and intelligence data, thus shortening the ISR collection and exploitation cycle.

The Imilite is based on Rafael's combat-proven ISR and C4I systems already in service worldwide. Imilite is designed for use by Defense forces (air, ground) and police forces exercising various observation means for border patrol or coping with urban crime.



**Imilite**

# ROCK WINGS

**Rock Wings Ltd.** is an aeronautical and commercial company serving the needs of its military, police and civil customers by providing technical services for Rotary and Fix Wing aircraft.

## Rock Wings offers:

- Aircraft modifications:
  - Night Vision Capabilities
  - Airborne day and night compatible Armament systems
  - Armor Protection for Aircraft and pilots
  - Installation and integration of systems and instruments such as Day and Night reconnaissance systems, avionics, chaff and flare and more.
- Law enforcement systems installation and integration
- Services:
  - Technical expert's consultant at customer's premises
  - Engineering
  - Mechanical and electrical parts production.
  - Pilots training (IFR, VFR, NVG, Search & Rescue, Cargo, Firefight, and special missions)
- Spare parts production

**Rock Wings** has conducted projects for western and eastern aircraft such as:

- Helicopters night vision illumination system modification (Turn key project)
- Helicopters Ballistic Bullet Proof suit design, fabrication and installation
- Machine guns and rocket launchers installation including design, kit fabrication installation and training
- Special systems installation and integration
- Pilots training (day and night NVG)
- Spare parts production
- Aircraft technical inspection and evaluation

**Rock Wings** is ISO 9001 certified, all its employees and subcontractors are certified to carry out aviation works. The company is a recognized contractor for various Defense Ministries around the globe and is Israeli MOD approved military exporter.

# BALLISTIC ARMOR PROTECTION



## ROCK WINGS LTD.

54 Harimonim St.,  
Renatya 7316500, Israel  
Tel: 972-52-2862428  
Fax: 972-2-5713241  
E-mail: [rockwings@rockwings.net](mailto:rockwings@rockwings.net)  
Web Site: [www.rockwings.net](http://www.rockwings.net)

Flying into combat?

Concerned about being strafed by ground fire?

Do you want to give your pilots and aircrew the greatest amount of shielding?

Rock Wings Ltd. will provide you with practical solutions designed to secure your aircrew and passengers with the highest levels of protection and survivability.



MI 17 HELICOPTER



AS350B3 HELICOPTER

By offering "tailor-made" Armor Protection kits that use the most advanced, light-weight, battle-proven shielding panels comprised of Polyethylene composites, ceramics and other materials, Rock Wings Ltd. assures your aircrew and aircraft a maximum protection with a minimum weight penalty.

The Armor Protection kits are modular and can thus be easily removed from one aircraft and attached to another similar one thereby facilitating mission requirements. The panels are designed to fit the individual and unique needs of the customer in a cost effective way.

Recommended surfaces for protection kit application are pilot's seats, cockpit floor, passenger's seats etc.



LAMA HELICOPTER

# ARMAMENT SYSTEMS

Most helicopters can be converted into a very effective Gun-Ship by adding compatible weapon systems.

Rock Wings Ltd. offers a pilot-operated Armament System for day- and night-time operations with machine guns, rocket launchers and other weapon platform that can be installed on both sides of the fuselage.

Our system fit not only helicopters but most Western and Eastern fixed- and rotary-winged multi-role aircraft and is custom designed to match customer's particular requirements.

**Helicopter systems main components are:**

**1. External mount and 14" release units**

An external mount is attached to the helicopter's fuselage providing stability for the weapons platform. 14" NATO release units are incorporated in the mount creating a carrying position for armaments or any other payload.



MI-17 Armament System

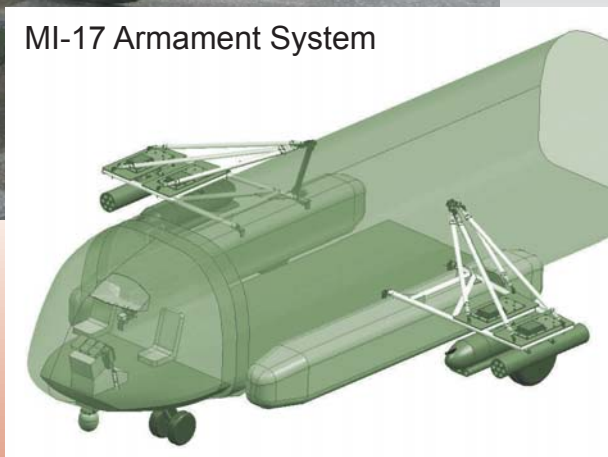



**ROCK WINGS LTD.**

54 Harimonim St.,  
 Renatya 7316500, Israel  
 Tel: 972-52-2862428  
 Fax: 972-2-5713241  
 E-mail: rockwings@rockwings.net  
 Web Site: www.rockwings.net



**2. Reflex Sight**

The system is equipped with an electro-optical reflex sight used for axial weapons operations such as machine guns and rockets. The aiming reticle image is collimated to infinity and then reflected by a semi-transparent mirror that overlays it upon the target. An Electronic Control Unit controls the sight from the panel or from a switch located on the pilot's stick.

**3. Laser Designator**

Night aiming is accomplished by using a Long Range Infra-Red Laser Aiming Device which is installed parallel to the weapon allowing night targeting while using Night Vision Goggles.

**4. Firing Control Box**

The firing control box is located in front of the pilot, enabling the pilot numerous actions including control of the weapon type, choosing the firing side (LH, RH), number of rockets, laser designator, re-cocking and jettison in case of emergency. The system is secured by a safety pin which is removed prior to take off.



**2.75" Rocket Launchers**



**5. Rocket Launchers and Rockets**

Rock Wings Ltd. offers 2.75" FFAR & Wrap Around rocket launchers with single or ripple firing options.

# NIGHT VISION GOGGLE (NVG) COMPATIBLE CAPABILITIES



## ROCK WINGS LTD.

54 Harimonim St.,  
Renatya 7316500, Israel  
Tel: 972-52-2862428  
Fax: 972-2-5713241  
E-mail: [rockwings@rockwings.net](mailto:rockwings@rockwings.net)  
Web Site: [www.rockwings.net](http://www.rockwings.net)



Rock Wings Ltd. provides Night Vision Goggles (NVGs) capabilities. Our company excels in modifying aircraft lighting to comply with NVG requirements, trains pilots and technical staff in the new technology and supplies NVG and helmets.



### Lighting Modifications

Rock Wings Ltd. offers a wide range of aircraft NVG compatible external and internal lighting modifications based on the cost-effective premise of modifying existing equipment. With the help of our own skilled and experienced NVG pilots and engineers, we offer our customers optimal NVG lighting adaptation. Our tailor-made options cover a range of customer specific requirements from mission needs and tactical environment considerations to budget issues and flight safety concerns.

### Training

Flying with NVG is not just a matter of "Buy and Fly" - an instruction and training program is a must. Rock Wings Ltd. NVG instructor pilots - reserve officers of the Israel Air Force - offer the most advanced and focused NVG flight instruction program available.

### Goggles

Rock Wings Ltd. offers a variety of lightweight and user-friendly binoculars mounted on a selection of helmets using a mounting adapter. The ANVIS are available with 2nd or 3rd generation, as well as XD-4 or XR5 intensifier tubes.

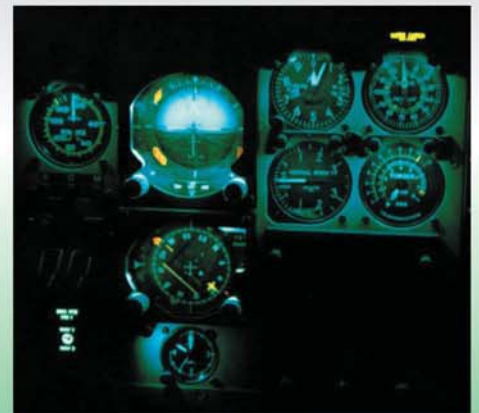

# SPARE PARTS FOR THE MIRAGE AND KFIR FIGHTERS



## ROCK WINGS LTD.

54 Harimonim St.,  
Renatya 7316500, Israel  
Tel: 972-52-2862428  
Fax: 972-2-5713241  
E-mail: rockwings@rockwings.net  
Web Site: www.rockwings.net

**Rock Wings Ltd.** is a well-known supplier of spare parts for the Mirage and Kfir fighters. Among the items that we have available are parts required for 'I, O and Depot Level' for Atar 9, Atar 9C, Atar 9K50 and Atar K50 engines. Our sources for supply have thousands of items which are available to our customers at competitive prices and dependable delivery. All parts are carefully inspected by highly qualified Quality Assurance Inspectors prior to shipment and are delivered with all the appropriate Serviceable Tags and Certificates of Conformance.



# TRAINING AND INFRASTRUCTURE

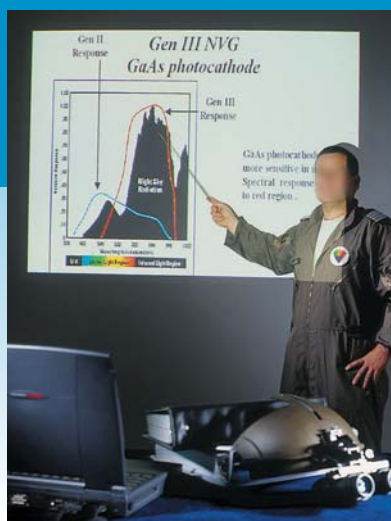

Operating an aircraft fleet in a professional way and being able to carry out every mission at all times requires great piloting skills, training, experience and a high level of maintenance.

Rock Wings Ltd. instructors, all former Israel Air Force pilots, have amassed hundreds of flight hours training pilots globally and are capable of instructing on a variety of aircraft in multiple languages.

Our training programs include (actual training program is outlined according to the customer's unique requirements):

1. Ground school - Theoretical training (ground school establishment if required can be offered)

2. In-flight training - Visual Flight Rules (VFR), Instrument Flight Rules (IFR), NVG flights, Cargo operations, SAR operations including rescue hoist, Medical evacuations, Firefighting and special missions.

In addition we offer **technical staff training** and **infrastructure establishment** which consists of:

1. Basic and theoretical training
2. Professional training as per customer requirements
3. Maintenance shops establishment including tooling, fixtures, publication etc.
4. Quality control, logistics and management

All training is done at operator's site.

# AIRBORNE PLATFORMS UPGRADES

## Full glass cockpit configuration



ASTRONAUTICS C.A. LTD.

### Astronautics C.A. LTD.

P.O.Box 3351, Kiryat Arie  
Petah Tikva 4951207, Israel  
Tel: 972-3-9251555  
Fax: 972-3-9251550  
E-mail: astro@astro.co.il  
Web Site: www.astronautics.co.il

### C-130 Modernization

The Astronautics solution is flexible, affordable and features an FAA certified avionics to comply with civil and military modern aviation regulations and most demanding mission requirements

Terrain / Traffic  
Surveillance

Weather Radar

EFB w/ Digital Map

Dual Autopilot /  
Flt Dir.

Dual INS

Dual Transponder

Digital FDR & CVR

6"x8"  
EFIS / EICAS

Dual FMS with  
embedded GPS

Standby Attitude  
Indicator

Dual CADC

Dual HF

Dual VHF / UHF

Dual VOR

Dual ADF

Dual DME

Dual DME



Countermeasures  
Dispenser System

Missile Warning  
System



#### Tactical Fighter



#### Trainers



#### Transporters



#### Helicopters



# AIRBORNE SYSTEMS



ASTRONAUTICS C.A. LTD.

## Advanced Avionics Products

- **Mission and Display Computers**
- **Airborne Displays & MFCDs**
- **Digital 2D/3D moving Map**
- **Smart-I Electronics Instruments**
- **Air Data Computers**
- **Cockpit Instruments**
- **EFIS**
- **EICAS**

## Astronautics C.A. LTD.

P.O.Box 3351, Kiryat Arie  
 Petah Tikva 4951207, Israel  
 Tel: 972-3-9251555  
 Fax: 972-3-9251550  
 E-mail: [astro@astro.co.il](mailto:astro@astro.co.il)  
 Web Site: [www.astronautics.co.il](http://www.astronautics.co.il)

Born out of necessity of the Israeli defense forces requirements, most of Astronautics' products are battlefield proven. Astronautics' Airborne products are suitable for use onboard fixed wing (fighters, trainers & transporters) and rotary wing aircraft. Astronautics' provides a single source of products and complete avionics solutions for aviations.

### Mission & Display Computers (MDP)

Open Architecture, modular, re-configurable, easily tailored to any avionics requirements. Embedded digital map, Helmet Mounted Display (HMD) electronics and advanced image processing/image compression.

### Airborne Displays & MFCDs

Astronautics include a wide variety of sizes (from 3" to 10"x10" display size), video, Smart Displays, EFI (Electronics Flight Instrument) and Engine Displays (EICAS).

**Digital Moving Map** with the unique 3D enhancement. Astronautics' Digital Map system provides state of the art 2D/3D situation awareness view, to be provided as stand-alone, or embedded into MFCD or Mission Computer.

### Smart-I Mini Electronic Instruments.

Based on advanced technology, Astronautics is offering 3ATI Engine Displays, Electronic Flight Instrument (EFI), Electronic warfare (EW) displays and others. All share Astronautics' SMART-I technology, including wireless communication.

**Air data Computers** for UAV and tactical fighters, trainers and transporters among them F-16, F-5, F-4, A-4, L-159, MIG-21, Mirage III/V C-130 and others. Tailoring to specific aircraft is possible.



**Cockpit Instrument** A variety of over 100 types of instruments such as Attitude Indicator, Horizontal Situation indicator etc. All products designed and manufactures to the highest standards of the aviation industry, and certified by ISO-9001, as well as major industry manufacturers (Boeing, Lockheed, Bell helicopters and others). We are committed for a long term to support our customers, and have all the required infrastructure to implement such long-term commitment. Astronautics' Airborne products are currently onboard a wide range of aircraft, including F-16, F-5, C-130, F-4, A-4, MB-339 C/D, L-159, Mig-21, A-7, UH-1, CH-53, TORNADO and many other airborne platforms.



**EFIS** (Electronics Flight Instruments System), FAA certified avionics based on Astronautics computers and smart displays.



**EICAS** (Engine Instruments & Crew Alert System). Advanced replacement for electro-mechanical engine instruments with Astronautics FAA Certified application, conversion unit and displays.



# C-130 SOLUTIONS - MISSION CAPABLE FOR DECADES TO COME



**ELBIT SYSTEMS LTD.**

P.O.Box 539

Advanced Technology Center

Haifa 3105301, Israel

Tel: 972-4-8315315

E-mail: [aerospace@elbitsystems.com](mailto:aerospace@elbitsystems.com)

Web Site: [www.elbitsystems.com](http://www.elbitsystems.com)



Backed by over 25 years of experience in developing and integrating complex aerospace systems, and worldwide presence on C-130s, Elbit systems' C-130 solutions offer a winning blend of advanced avionics with best-of-breed mission systems, sensors, defense capabilities and more.

Suited explicitly for the C-130 flight deck, Elbit Systems offer effective performance at tactical environments, while enabling a safer and more effective mission execution as well as greater situational awareness.

Elbit systems' C-130 Avionic solutions fully complies with modern civil airspace regulations, including CNS/ATM\*, RNP\*\* and B-RNAV and D-GPS approach capabilities.

## ***C-Suite Tactical - Enhanced mission and safety solution for the C-130***

A flexible, modular solution providing accurate, real-time information projected on the Head-Up, Head-Down or Helmet-Mounted display enabling a safer and better mission execution as well as greater situational awareness.

C-Suite Tactical is made up of several unique systems based on a Digital Terrain Elevation Database (DTED) and real time sensors, all aimed to enhance mission capabilities of low altitude tactical flight using Elbit Systems' Head Up Display.

\* *Communication Navigation Surveillance / Air Traffic Management*

\*\* *Required Navigation Performance*

# DISPLAYS

**Elbit Systems**

Aerospace

*Elbit Systems' displays meet today's complex combat challenges through cutting-edge technologies assuring unmatched performance. The Company's comprehensive display family is fielded in a variety of fighter aircraft, helicopters, tanks and fighting vehicles.*

## ELBIT SYSTEMS LTD.

P.O.Box 539

Advanced Technology Center

Haifa 3105301, Israel

Tel: 972-4-8315315

E-mail: aerospace@elbitsystems.com

Web Site: www.elbitsystems.com



## Major Advantages

- All AMLCD displays
- High brightness and contrast
- Excellent readability in direct sunlight
- Full Night Vision Goggles compatibility
- Direct sunlight readability with various touchscreens
- Large variety of screen sizes and orientations
- Low power consumption
- Adaptable to various video sources and standards, analog and digital
- Compact and lightweight

### **6x8" High Performance Airborne AMLCD Multifunction Color Display**

- High brightness and contrast, excellent resolution, readability and clarity
- Outstanding contrast ratio and brightness greater than 230 FL

- Available in both Landscape and Portrait orientations
- High resolution SVGA / XGA
- Available with integral pointing device and touchscreen
- Fully compatible with NVG class A/class B for night mode operation
- Installed on Puma, Super Puma and Blackhawk helicopters as well as on F-5 and ALX fighter and C-130 aircraft

### **5x7" High Performance AMLCD Multifunction Color Display**

- Portrait display for the F-16 aircraft
- Available also in Landscape orientation for the OH-58 helicopter, and Portrait orientation for the IA-63 aircraft
- High resolution SVGA full color gray scale images. High brightness and contrast levels. NVG compatible for night mode operation

- Computer display interface is via LVDS digital video and RS-422 serial communication

### **5x5" Color MFD family**

- Operational in F-5, F-4, AMX, MiG-21, F-15 aircraft, and chosen for A-10 aircraft upgrade
- Very high (120ppi) resolution. high brightness, extra-wide viewing angles, full color gray scale video images, variety of mechanical envelopes

### **6x8" Color AMLCD family**

- For main battle tank applications, internal & external use
- Features high resolution SVGA displays, high brightness, landscape viewing angles, full color gray scale video images
- Extra slim envelope (only 40 mm deep), no forced cooling
- Available with integral pointing device and touchscreen
- Clearly readable in extreme ambient illumination conditions

# HELMET MOUNTED DISPLAYS



## ELBIT SYSTEMS LTD.

P.O.Box 539  
 Advanced Technology Center  
 Haifa 3105301, Israel  
 Tel: 972-4-8315315  
 E-mail: aerospace@elbitsystems.com  
 Web Site: www.elbitsystems.com



JHMCS II, Day version



Digital JHMCS, NVG module

### Targo® and JHMCS II

Targo® and JHMCS II bring the power of advanced avionics to your helmet. For the first time, the most important operational systems' information is displayed directly on the helmet in packages tailored specifically to our customers' needs.

Helmet Mounted Avionics (HMA) technology is now accessible to fighters, training, airlifting and emergency services aviators, providing a low cost solution and improved mission success

#### Stand-Alone to Fully-Integrated Configurations:

- Click-On Day Display Module
- Off-the-Visor, Safe Display
- Color and Video Display
- Supports Virtual Training Display
- Minimal Integration, Low Power Consumption, No Electronics Box

### Digital JHMCS

The legacy JHMCS' successor takes fighter aircraft to new horizons with advanced additions such as night capability, color and video display, all based on improved logistics and maintainability. These new capabilities are achieved cost effectively while retaining aircraft installed equipment.

#### Installed on or Selected for (partial list)

- Boeing F-15
- Lockheed F-16
- Dassault RAFALE
- IAI Kfir
- C-130
- Grob120
- Cessna 152



DASH Night



DASH Day

### DASH - Display and Sight Helmet

The DASH family of helmets is operational in numerous international programs. Over 1,000 DASH systems have been fielded on F-4, F-5, F-15, F-16, F/A-18, MiG-21, IAR-99, Mirage 2000, LCA and MiG29. Mature and proven, DASH is a monocular, visor projected HMD, with complete HMD electronics, including an advanced digital electro-magnetic helmet tracker for day and night use. DASH and JHMCS are world leaders in number of systems fielded, number of users (over 30 international Air Forces ) and level of operational experience. DASH -IV, the latest generation, is currently operational and in production for new and follow-on programs.



# ROTORCRAFT HMDs



## ELBIT SYSTEMS LTD.

P.O.Box 539  
Advanced Technology Center  
Haifa 3105301, Israel  
Tel: 972-4-8316244  
E-mail: aerospace@elbitsystems.com  
Web Site: www.elbitsystems.com

### JEDEYE™

Elbit systems' JEDEYE™ is ideal for Apache and other rotorcraft. JEDEYE™ lets pilots take in the entire scene: wider than ever areas of ground and sky are displayed with crystal clear, high resolution and crisp focus.

The improved display features high resolution combined with a wide FOV increasing flight awareness, improving recognition of flight obstacles and mitigating risks. The sharp image scenery eliminates "tunnel effect", vertigo and other visual illusions. The head tracker accuracy minimizes spatial disorientation.



### ANVIS/HUD®

#### Line-of-Sight (LOS) with Tracking Capability

Elbit Systems' day/night ANVIS/HUD® assures safe head-out flight and 24-hour operational capabilities from a single, integrated system.

The ANVIS/HUD® combines the standard Night Vision Goggles (NVG) scene with aircraft flight data. Adding the Day HUD "plug and play" module, fitted on any standard NVG helmet-mount, the same flight data information is displayed during daytime.

Addition of the LOS module is a vital feature not only for attack helicopter pilots but also for utility and assault helicopter flight crews. It improves situational awareness and crew coordination. With the LOS module there is complete correlation with what the pilot views and the outside world. The system provides the invaluable advantage of allowing each crew member to track the other's field of view, eliminating the need for verbal communication and improving mission performance.

The ANVIS/HUD® system can be installed on any type of helicopter - Eastern or Western, modern or legacy, and can support various A/C systems. Operational on over 6000 helicopters and 25 different types of platforms, the system is a performance-proven off-the-shelf solution.



ANVIS/HUD® - Day HUD



ANVIS/HUD® - Night HUD

# HEAD-UP DISPLAYS



F-16 HUD



MiG-29 HUD



## ***HUDs for Combat Aircraft***

Elbit Systems Electro-optics Elop has developed an array of modern HUDs and Up Front Control Panels (UFCP) for combat aircraft. The HUDs can be configured as a single LRU or as two LRUs (with or without display processor / symbol generator and color cockpit TV sensor).

Our HUDs are compatible with T-6B, T-45, MiG-21, IDF, MiG-29, Su-30, F-5, Mirage, Su-25, F-4, F-16 and others.

Over the last 30 years, Elop has supplied more than 3,800 HUDs, in thirteen different models, for more than 20 different aircraft types.

**Lockheed Martin certified and selected Elop's HUD-DU as standard F-16 production equipment.**

## ***Upgrades for Legacy HUD-DUs***

Elop offers an upgrade of the F-16 legacy HUD-DU to a high performance Form Fit Function and Interface (FFF&I) HUD-DU.

Combining the advanced electronics of Elop's Combat Proven F-16/I HUD-DU with the optical module of your legacy system yields the following main operational and maintenance advantages:

- Significant increase in field MTBF
- Significant improvement in mission readiness
- Optimized symbology

**ELBIT SYSTEMS**  
**ELECTRO-OPTICS - ELOP LTD.**  
P.O.Box 1165,  
Rehovot 7611101, Israel  
Tel: 972-8-9386211  
Fax: 972-8-9386010  
Web Site: [www.elbitsystems.com/elop](http://www.elbitsystems.com/elop)

## ***HUDs for Military Utility Aircraft***

### ***Digital Air Transport HUD***



The digital air transport model is a technologically advanced overhead-mounted digital HUD, optimized for both military and commercial aircraft:

Military transport, airlift, tanker and maritime aircraft, including:  
C-17, C-130, KC-135, C-295, C-27J, C-235

Commercial aircraft, including:

MD-10, MD-11, Airbus 300, Airbus 310, B-757, B-737

This line of products is designed with growth capacity to support emerging technologies, such as SVS (Synthetic Vision Systems). Combined with an Enhanced Visual System (EVS), the HUD's system enables reduction of landing and takeoff minima, as well as improved situational awareness, increased safety and enhanced operational capabilities. Among its features is a foldaway combiner with a specially designed breakaway position for pilot safety.

A smaller (mini) version of the HUD is available for regional and business jets.



### ***Baby HUD***

Elop's Baby HUD is a technically advanced state-of-the-art compact HUD, suitable for all military aircraft and trainers, as well as commercial aircraft.

The Baby HUD is capable of displaying high brightness cursive (stroke) symbology and raster with or without stroke symbology overlaid. It contains a customer-tailored UFCP, including provisions for CCTVS.

Among its other features and advantages: FOV of 20°/30°, improved symbol positioning accuracy, reduced power consumption/heat dissipation, reliable CRT protection circuitry, intensive Built-In Test (BIT).



# ILLUMINATED DISPLAY & CONTROL SYSTEMS



## AEROMAOZ LTD.

Tel: 972-3-6095003

Fax: 972-3-6095033

E-mail: [info@aeromaoz.com](mailto:info@aeromaoz.com)

Web Site: [www.aeromaoz.com](http://www.aeromaoz.com)

**AEROMAOZ** Ltd. established in 1980, is a world renowned designer and manufacturer of Illuminated Display and Control Systems. **AEROMAOZ** products can be found in the air, on the ground and at sea, in both military and commercial applications.

Utilizing its expertise in Human-Machine Interface applications and Night Vision Imaging Systems (NVIS) lighting compatibility, **AEROMAOZ** had participated in prestigious projects throughout the world.

### AEROMAOZ products include:

- Illuminated Panels
- Advisory Panels
- Electronic Control Boxes
- Dimming Controllers
- Integrated Control Panels
- Multi-Function Display Panels
- Multi-Function Keyboard Panels
- Bezels and Bezel Displays
- External / Internal Lighting
- Joysticks
- NVIS Conversions and Full Cockpit Conversions.
- Technologies include LED, EL and Conventional Lighting.

**AEROMAOZ** products are being integrated into the systems of organizations such as:

- IMI
- Lockheed Martin
- Augusta Westland
- Zodiac Group
- Embraer
- Bombardier
- Gulfstream
- Dassault

### AEROMAOZ is the holder of the following certifications:

USG QPL -AS7788, ISO 9001:2008, AS9100

**AEROMAOZ** will work with you from initial design and development, prototype production and evaluation through serial production, testing and qualification.



Lighting the Way...

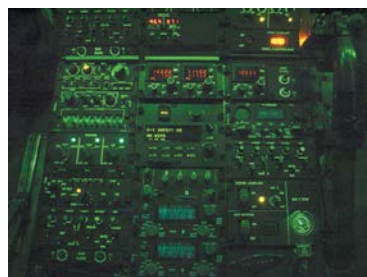
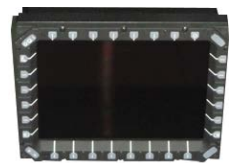

# AVIONICS SYSTEMS AND UPGRADES

## Innovative Defense Electronics



**RADA Electronic Industries LTD.**  
P.O.Box 8606  
7 Giborei Israel Blvd.,  
Netanya 4250407, Israel  
Tel: 972-9-892-1111  
Fax: 972-9-885-5885  
E-mail: [mrkt@rada.com](mailto:mrkt@rada.com)  
Web Site: [www.rada.com](http://www.rada.com)



RADA Electronic Industries Ltd. (Nasdaq: "RADA") is a Defense Electronics System House specializing in sophisticated, military-oriented electronic systems for airborne and land applications. RADA, a developer and manufacturer of core avionics systems for over 30 years offers a wide spectrum of military avionics systems and upgrades, designed primarily for the aerospace and defense market. RADA's core avionics are installed onboard of a wide variety of manned and unmanned aircraft.

### RADA's Aircraft Avionics Solutions:

- Integrated Avionics Upgrade Suits
- Mission Data Recorders
- Debriefing Solutions
- Mission and Display Computers
- Weapon Management Systems
- Data Interface and Processing Computers
- HUD Video Cameras
- Air Data Computers

### RADA's UAV Avionics Family:

- All-in-one Modular Avionics and INS – including flight control (MAVINS)
- Interface Control Processors (ICP)
- Engine Control Computers (ECC)
- Payload Management Computers (PMC)
- Payload Interface Units (PIU)
- Electrical Power Management Units (EPMU)



# ***ELECTRO-OPTIC INTELLIGENCE, SURVEILLANCE AND RECONNAISSANCE (ISR)***

## ***Litening - Targeting & Navigation Pod***

Litening is an innovative airborne infra-red targeting and navigation pod for fighter aircraft with high accuracy and reliability, day and night precision strike capability. Litening reduces pilot workload during targeting and tracking. It is easily integrated on any aircraft and possesses high growth potential.

In use in the Israeli Air Force, USAF, ANG, AFRES, Marines, German AF, Swedish AF, Spanish Navy & AF, Greek AF, and others, the Litening flies on F-16, F-15, A-10, B-52, AV8-B, Gripen, Tornado, F-5, F-4, Mig-21, Mirage 2000, Jaguar and others.



## ***Toplite EO System - Electro-Optical Surveillance, Observation & Targeting System***

The Toplite family of electro-optic systems is an advanced multi-sensor, multi-purpose, highly stabilized EO systems for homeland security and defense applications, for aerial, maritime and ground based platforms.

## ***RecceLite- Real Time Tactical Reconnaissance System***

The RecceLite System consists of an E-O pod, a ground exploitation station and a data link. It is capable of collecting images day & night from 300 ft to 40,000 ft in all directions forwards, nadir, backwards, oblique - all down hemisphere and even when the aircraft is maneuvering in high G.

The Ground Exploitation Station (GES) is capable of generating targets in real-time with exceptionally high accuracy due to state-of-the-art algorithms and technology.

The data-link connects between the sensors and the GES and enables the images to be downloaded to the GES in real time. When your task is to close the attack cycle on many "time-critical targets" in less than 10 minutes, there is only one system - RecceLite.

## ***Recce-U - Real-Time Persistent ISR System for UAVs***

Recce-U is a self-contained, multi-sensor ISR system (based on the RecceLite Tactical Reconnaissance Pod). The Recce-U enables automatic photography, according to a mission plan prepared in advance, or updated mission plan uplinked in real-time, however the operator can initiate manual scanning for targets of opportunity.



***Litening -on-Gripen***



***Toplite EOS***



***RecceLite System***



***Recce-U***

**RAFAEL**  
**ADVANCED DEFENSE SYSTEMS**  
 P.O.Box 2250 (19)  
 Haifa 3102102, Israel  
 Tel: 972-73-3354714  
 Fax: 972-73-3354657  
 E-mail: intl-mkt@rafael.co.il  
 Web Site: www.rafael.co.il

**SpotLite Family**  
**Electro-Optic Enemy Fire Detection System**

The SpotLite family consists of electro-optical systems that detect and locate enemy fire in stationary positions as well as on the move. Rapid detection and precise location information provide forces with the capability to quickly neutralize the enemy, maintaining the upper-hand on the battlefield.

The **SpotLite P** is a portable electro-optic system carried by two soldiers for day and night detection and location of small arms fire.



**SpotLite P on Tripod**

**SpotLite M** is a mobile electro-optic system installed on vehicles and AFV's that enables the detection and location of enemy fire sources from small arms, RPG rockets, ATGM and tank shells, on the move, day and night, up to 360° coverage.



**SpotLite M on vehicle**

**Imilite - Multi-Source Multi-Task ISR Exploitation System / Command and Control System**

Imilite is an intelligence system designed to receive process and exploit multiple standalone imagery video and other intelligence data in a centralized and a unified way.

Main system capability includes the reception, processing and exploitation of EO, IR, SAR/GMTI and VIDEO, in various formats, over one desktop. In order to enhance the exploitation process, Imilite further combines non-imagery data such as targets, threats, COMINT detection and mission status within the system workflow. Imilite generates a variety of standard and customer tailored ISR reports and IMINT products such as alphanumeric reports, annotated maps, GIS data layers and visual aids, and disseminates them to external information and operation systems over standard and tailored protocols.

Imilite's multi-source data integration and automation capabilities improve the efficiency of utilizing available collection and exploitation assets. The system GIS capabilities provide immediate accessibility to relevant imagery and intelligence data, thus shortening the ISR collection and exploitation cycle.

The Imilite is based on Rafael's combat-proven ISR and C4I systems already in service worldwide. Imilite is designed for use by Defense forces (air, ground) and police forces exercising various observation means for border patrol or coping with urban crime.



**Imilite**

## AERONAUTICS LTD.

P.O.Box 169  
Yavne 8110101, Israel  
Tel: 972-8-9433600  
Fax: 972-8-9328912  
E-mail: [info@aeronautics-sys.com](mailto:info@aeronautics-sys.com)  
Web Site: [www.aeronautics-sys.com](http://www.aeronautics-sys.com)



### AISR (Aerial Intelligence Surveillance & Reconnaissance)

Aeronautics AISR is the ultimate solution for expanding existing aerial platforms operations. Aeronautics provides robust interoperable solutions by using state of the art versatile components installed onboard fixed wing aircraft or helicopter.

By integrating the most advances sensors, data-link systems and mission management tools, Aeronautics' AISR systems are operational worldwide, expanding capabilities for intelligence gathering, reconnaissance, search & rescue and target acquisition missions.





# HELICOPTER SYSTEMS AND SOLUTIONS

*Elbit Systems is unique in its ability to provide total solutions encompassing long-term maintenance, technical support, full integration, installation and systems training.*



**ELBIT SYSTEMS LTD.**

P.O.Box 539  
Advanced Technology Center  
Haifa 3105301, Israel  
Tel: 972-4-8316244  
E-mail: [aerospace@elbitsystems.com](mailto:aerospace@elbitsystems.com)  
Web Site: [www.elbitsystems.com](http://www.elbitsystems.com)



In these large scale programs Elbit Systems often partners with local industries. Our range of core technologies, systems and products features Mission Computers, Helmet Mounted Display Systems, Digital Map Systems, Cockpit Displays, and Command, Control and Communication - HeliC<sup>3</sup>om capabilities including conversion of utility helicopters into day and night, multirole combat platforms and elevating **Eastern and Western** assault and attack helicopters to new performance levels.

Elbit systems has years of experience in upgrading platforms, both Eastern and Western. In these programs, legacy platforms are given the ability to perform as new ones, and new platform capabilities are enhanced.

The improved platforms enable the crews to reduce the workload in the cockpit, improve crew coordination, flight safety and situational awareness.

The modern technology Elbit Systems provides its customers also increase survivability and mission efficiency.



**UH-60**



**Mi-24**

# YOUR SOURCE FOR HIGH-END FLIGHT ALGORITHMS AND ADVANCED FLIGHT SYSTEMS

**AERODAN**  
www.aerodan.com

**AERODAN SYSTEMS (1993) LTD.**

17 Kaplan St.,  
Tel-Aviv 6473418, Israel  
Tel: 972-3-6961099  
Fax: 972-3-6966343  
E-mail: maerav@aerodan.com  
Web-Site: www.aerodan.com

## ■ 120mm mortar guidance kit

GPS-based, the 120mm guidance kit withstands a launch impact of 10,000g. Initial flight tests demonstrated 5m CEP capability. This kit was originally designed and tested by Aerodan for a global defense industry.

## ■ High roll measurement module

This high roll-rate gyro-less measurement module, designed for an Israeli defense industry, is an autonomic unit to be incorporated into a smart munitions' system.

## ■ Fire-control computer for naval platforms

The fire-control computer is a general-purpose real-time firing control unit, suitable for any rocket/missile launch from a moving or anchored naval platform. The first computer was developed for an Israeli defense industry.

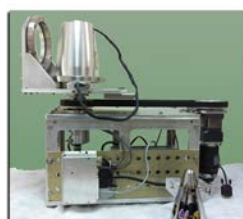
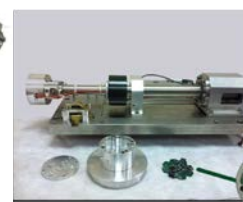

## System Engineering and Integration

Using our vast experience accumulated over the years in the integration of systems. Aerodan provides its integration skills to support system engineering for smart munitions while making the best trade-offs between the mechanical, electronic, aerodynamics, GNC and budget considerations, to create the best-suited solution. Putting to use its extensive know-how, Aerodan has built several real-time based hybrid labs for various projects.

## Simulations

Aerodan has designed a series of system simulations, 3, 3.5 & 6 DOF among them, which have been verified over the years by both flight tests and hybrid labs. These simulations are being used in the various smart munitions, be it rockets, missiles, satellite launchers or any other.

## peruse-munitions at hand.

Aerodan has also developed and is maintaining the generic digital simulation of ballistic missile trajectories for the Israel MOD. Aerodan can provide a tailor-made system-simulation for any ballistic projectile.

## GNC systems

Well experienced in the design and development of various GNC systems. Aerodan has lately designed a unique GNC platform, which combines high-end algorithms with COTS components, creating a sophisticated cost-affective platform that can be utilized in the design and engineering of smart munitions.

## Safety, Footprints and Trajectories

Using its in-house designed simulation tools, Aerodan provides a full solution, including test trajectories, flight envelopes, safety maps, fragment dispersion analysis, foot-prints, lethality and more for any purpose specified by the customers.

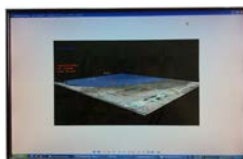
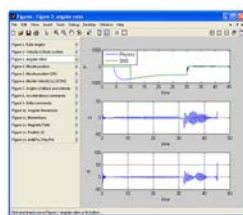
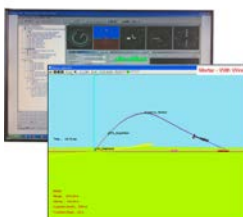

# PRECISION GUIDED WEAPON KITS

## Modular Guidance Kits for Precision Strike Capabilities Against a Full Spectrum of Threats



### ELBIT SYSTEMS LTD.

P.O.Box 539  
Advanced Technology Center  
Haifa 3105301, Israel  
Tel: 972-4-8315315  
E-mail: aerospace@elbitsystems.com  
Web Site: www.elbitsystems.com

### STAR

#### Smart Tactical Advanced Rocket

STAR is a Laser Guidance Kit installed on 68/70/80 mm rockets to convert them into metric precision guided weapons. STAR is employed for Air-to-Ground or Ground-to-Ground missions, against soft or lightly armored, stationary or fast moving targets. An optimal solution for today's dynamic battlefield, STAR can be launched from a variety of platforms, providing high kill probability and very low collateral damage, at an affordable cost.



**LIZARD** is a family of modular guidance kits offering the option of Laser-Seeker (LIZARD2 and LIZARD3) or dual mode (GPS/INS and Laser, LIZARD4) guidance. All kits convert "dumb" general purpose bombs into smart munitions. They increase the capability to counter any target, any threat, from motorized vehicles and ships to power plants, infrastructures and radars. The LIZARD family provides a complete arsenal of capabilities to seek, attack and destroy a full spectrum of targets, just by switching seekers.

#### Key Advantages and Features

- NATO standard equipment
- Enhanced hit accuracy
- Day and night operation
- Compatible with all GBU certified and other A/Cs
- Aerodynamics; guidance; modular replaceable seekers; common LRUs and ILS

#### LIZARD-2 Laser

- Effective against any designated target
- Unique guidance technique assures superior accuracy over comparable systems
- Higher kill probability; fewer bombs per target
- Improved jamming rejection
- Compatible with all laser designators
- Targets: bunkers, airfields, power plants and others
- Optional-enhanced penetration capability

#### LIZARD-3 Laser

- Proportional navigation guidance
- Improved hit accuracy against moving targets
- Improved jamming rejection
- Controllable AOA for enhanced penetration
- Upgrades GEN 1, GEN 2 LGBs to GEN 3 LGB

#### GAL - LIZARD-4 GPS/INS Aided Lizard

- All weather GPS/INS guided bomb.
- Extended-range delivery envelopes
- Trajectory shaping capabilities.
- Optional terminal laser-homing to retain Lizard 2/3 CEP's
- MIL-STD 1760 A/C interface (or alternative)
- Controllable AOA for enhanced penetration



LIZARD 2-3



LIZARD 4 (GAL)

# LAHAT



Israel Aerospace Industries Ltd.  
Systems Missiles & Space Group

## LAHAT - LAser Homing ATtack Missile

Prime candidate for enhancing the fire power for your MBT

### AIR & MISSILE DEFENSE DIVISION

P.O.Box 105  
Yehud Industrial Zone  
5610002, Israel  
Tel: 972-3-5315699  
Fax: 972-3-5315830  
E-mail: [marketing@iai.co.il](mailto:marketing@iai.co.il)  
Web Site: [www.iai.co.il](http://www.iai.co.il)



### Advanced light weight laser homing missile

- Pinpoint accuracy for day and night operations
- Effective against both static and moving targets
- Low collateral damage
- LOS (Line of Sight) and Non LOS firing capability
- Simple to operate, easily integrated
- Same missile can be launched from various platforms:
  - Canister launch: vehicles, helicopters, ships, remote installations for borders or bases protection
  - Tanks gun launch (105 mm and 120 mm)
  - Lofted and flat trajectories for effective penetration
  - Cost effective

# AEROSPACE

## Fire Power Systems



ISRAEL MILITARY INDUSTRIES LTD. (IMI)

P.O.Box 1044, 64 Bialik Blvd.  
Ramat Hasharon 4711001, Israel  
Tel: 972-3-5485222  
Fax: 972-3-5486125  
E-mail: [imimrktg@imi-israel.com](mailto:imimrktg@imi-israel.com)  
Web Site: [www.imi-israel.com](http://www.imi-israel.com)

### **MPR 500**

MPR 500 is a 500lbs. Multi-Purpose Rigid bomb with MK-84 effectiveness in MK-82 dimensions, part of a family of next-generation (250, 1000, 2000 lb) GP bombs. Optimized for operation against challenging targets, MPR 500 penetrates 1 meter thick double-reinforced concrete or four double-reinforced concrete walls/floors 200mm thick each. The bomb guarantees controlled fragmentation focused on target lethality and minimal collateral damage. MPR 500 is certified with JDAM and fully compatible with all guidance kits.

### **MARS**

MARS (Multi-Purpose Air-Launched Rocket System) is a 1000lb. supersonic precision weapon for

long range air-to-ground strike missions. MARS features high survivability and operational flexibility, and enables salvo strikes against high value targets. The weapon comprises a launch booster, warhead and GPS/INS guidance system. It can be fitted to a variety of fighter jets.

### **DELILAH**

DELILAH is a combat-proven advanced, high-subsonic, long range, loitering E/O stand-off missile with precision hit capabilities against high value mobile, fixed and relocatable targets. DELILAH can be launched from various platforms: fixed-wing aircraft, helicopters, ground or naval platforms.

### **WHIP SHOT**

WHIP SHOT is a small-size (30lb.), low-cost precision guided weapon for engaging high-priority targets, including maritime, ground and lightly armored targets, while minimizing the risk of collateral damage. WHIP SHOT can also be used in Close Air Support (CAS) and COIN missions. The system combines a highly lethal fragmentation warhead, coupled with a GPS/INS guidance system, enabling launch from Light Combat Aircraft (LCA) and Light Attack Armed Reconnaissance (LAAR) aircraft, as well as additional aerial platforms.



# MTC INDUSTRIES & RESEARCH



**Complete Engineering Solutions  
Under One Roof**

**MTC**  
Industries & Research Carmiel Ltd.  
P.O. Box 232, Karmiel 2161102, Israel  
Tel: 972-4-9987772  
Fax: 972-4-9981189  
E-mail: [marketing@mtcind.com](mailto:marketing@mtcind.com)  
Web Site: [www.mtcind.com](http://www.mtcind.com)



GYROSCOPES

CANARD FIN ACTUATION SYSTEMS

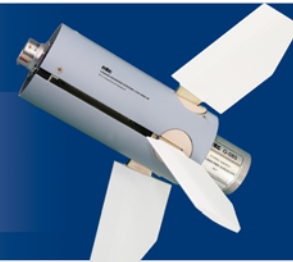

ELECTRIC MOTORS, LVDT, RVDT and RESOLVERS

SERVO ACTUATORS



HIGH PRESSURE VESSELS

SLIP RINGS



SOLENOIDS



MTC designs, develops and customizes a wide range of products for the Aerospace, Defense and Medical industries worldwide. Visit MTC's website for a full range of products and services including: Engineering Solutions and Thermal Spray Coatings. MTC is AS9100C certified and conforms to MIL-STD.

## Typical Applications

UAV

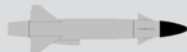

Missiles



Tanks



Ships

# FUZE SYSTEMS FOR AERIAL MUNITIONS

**Orion**  
Advanced Systems Ltd.

**ORION  
ADVANCED SYSTEMS LTD.**

P.O.Box 156  
Yavne 8110101, Israel  
Tel: 972-8-3770100  
Fax: 972-8-3770101  
E-mail: [marketing@orion-as.com](mailto:marketing@orion-as.com)



## FUZE Systems for Aerial Munitions

Orion Advanced Systems Ltd., formerly the Government Electronics Department (GED) at Motorola Israel Ltd., is a world leader with over 35 years experience in the design and manufacture of fuzes for aerial munitions. Orion's fuzes have been qualified by the Israeli Air Force for use with their aircraft and weapons systems and meet their rigorous standard safety requirements. The fuzes are renowned for their outstanding operational reliability.

Orion's product range covers the full spectrum of fuzes for aerial munitions:

- ID260MF Impact/Delay Fuze – Orion's flagship fuze specially designed for integration with Precision Guided Munitions.
- High-Altitude Proximity Fuzes and Sensors for Dispensing Munitions.
- Low-Altitude Proximity Fuzes and Sensors.
- Custom fuzes and Safe & Arm units tailored for specific bombs and rockets.



# RAFAEL'S MISSILES

**Rafael has extensive experience in missile development and production, and offers a variety of missiles in a broad range of areas.**

## ***Air-to-Air Missiles:***

### **PYTHON**

The Python-5 is an air-to-air missile that provides the pilot engaging an enemy aircraft with a full sphere launch capability. The missile can be launched from very short to beyond-visual ranges with greater kill probability, excellent resistance to countermeasures, irrespective of evasive target manoeuvres or deployment of countermeasures.



### **DERBY**

The Derby is an active radar air-to-air missile that provides fighter aircraft with outstanding and effective performance in both short ranges and Beyond Visual Range (BVR) intercepts.

The missile enables operational flexibility and multi-shot capability. It can be launched at an enemy aircraft day or night and in all-weather conditions.

Additional Derby capabilities include look-down/shoot-down, sophisticated fire-and-forget mode and an advanced ECCM tailored to the customer's operational requirements. Derby's light weight allows it to be adapted to various modern fighter aircraft.



## ***Air-to-Ground Weapon Systems:***

### **POPEYE**

Air-to-Ground Standoff missile POPEYE is effective against high-value ground targets such as power plants, missile sites, bridges and bunkers.

### **SPICE**

Smart, Precise Impact and cost-effective guidance kit.

The SPICE integrates an electro-optical guidance kit onto an inexpensive standard general-purpose bomb, creating a sophisticated, affordable precision-guided munition.

### **SPARROW Targets**

Surrogate Ballistic Target. The BLACK SPARROW is designed to simulate short-range ballistic threats. It was selected as the Israeli Theater Missile Defense (TMD) target for use with the US/Israeli Arrow program. The BLUE SPARROW is designed to simulate medium-range ballistic threats.





## Multi Purpose Weapon Systems:

### SPIKE FAMILY

The SPIKE Family consists of missiles suited for land, air and sea platforms, multiple ranges and a variety of targets. The missiles in this family have sophisticated electro-optic CCD or IIR sensors for day/night all-weather operation, as well as a tandem warhead. Their lofted trajectories enable the warhead to strike the target at its most vulnerable location with pinpoint precision and minimal collateral damage. All of the SPIKE Family members have a low life-cycle cost, due to high reliability and operational and logistic support and production commonality between members.

Designation	Max. Range	Application
Spike-SR	1,000m	Infantry and Special Forces
Mini-Spike	1,500m	Infantry and Special Forces
Spike-MR	2,500m	Infantry and Special Forces and Combat Vehicles
Spike-LR	4,000m	Infantry and Special Forces and Combat Vehicles
Spike-ER	8,000m	Infantry, LCV, Helicopters
Spike-NLOS	up to 25km	Multi-Purpose ,Multi-Platform

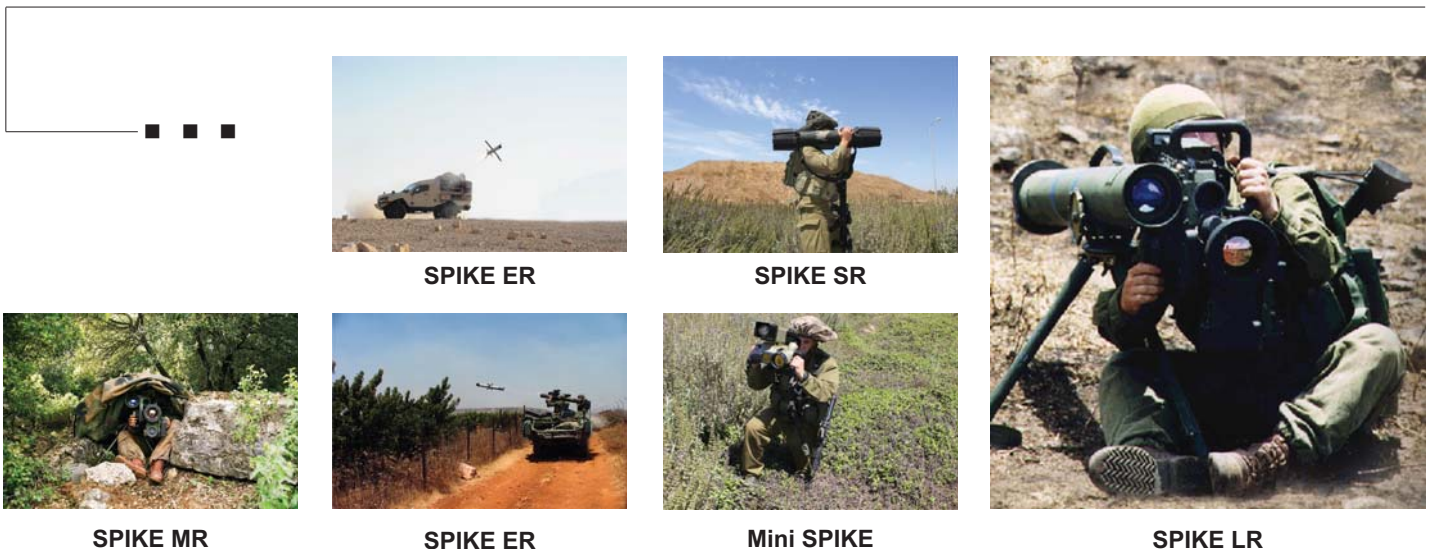

# AIR DEFENSE SYSTEMS

## IRON DOME

## SPYDER-SR/MR



**RAFAEL**  
**ADVANCED DEFENSE SYSTEMS**  
P.O.Box 2250 (19)  
Haifa 3102102, Israel  
Tel: 972-73-3354714  
Fax: 972-73-3354657  
E-mail: [intl-mkt@rafael.co.il](mailto:intl-mkt@rafael.co.il)  
Web Site: [www.rafael.co.il](http://www.rafael.co.il)

### Air Defense

*Rafael has extensive experience in missile development and production, and offers a variety of missiles in a broad range of areas.*

#### IRON DOME

The Iron Dome is the only dual mission system in the world that provides an effective defense solution for countering rockets, artillery & mortars (C-RAM) as well as aircraft, helicopters, UAVs, PGMs. The system is an effective system for countering C-RAM threats with ranges of up to 70 km and for VSHORAD protection (up to 10 km). The system operates in all weather conditions, including low clouds, rain, dust storms or fog.



#### SPYDER-SR/MR

##### Short/Medium Range Mobile Air Defense Systems.

SPYDER (Surface-To-Air Python & DERBY) is a quick reaction, low level surface-to-air missile system designed to counter attacks by aircraft, helicopters UAVs and precision guided munitions. The system provides effective protection of valuable assets, as well as first-class defense for forces located in the combat area. SPYDER incorporates RAFAEL's most advanced, proven performance air-to-air missiles - the Derby active radar (RF) missile and Python-5, a dual waveband Imaging Infra Red (IIR) missile. The SPYDER family includes SPYDER-SR (Short Range) and SPYDER-MR (Medium Range) systems.



# MILITARY PILOT TRAINING SOLUTIONS



**ELBIT SYSTEMS LTD.**

P.O.Box 539  
Advanced Technology Center  
Haifa 3105301, Israel  
Tel: 972-4-8315315  
E-mail: [aerospace@elbitsystems.com](mailto:aerospace@elbitsystems.com)  
Web Site: [www.elbitsystems.com](http://www.elbitsystems.com)



***Elbit Systems offers modern and cost effective solutions for military pilot training, which draws on the Company's vast experience in providing avionics, simulation and innovative training solutions utilizing cutting edge technology.***

Managing the entire training process - from initial candidate screening, to primary, basic and advanced training, Elbit Systems' main focus is on providing a comprehensive, classroom-to-cockpit training solution incorporating:

- curriculum development - flexible, customer tailored syllabus
- experienced flight instructors and qualified ground school teachers
- ground-based training facilities
- advanced ground based training systems (GBTS)
- training aids and debriefing
- aircraft operation

Our modular syllabus is tailored to meet various customer requirements. In addition, we offer advanced operational courses for qualified pilots, such as,

helicopter landing tactics and maneuvers, NVG flights, formation flight training, Live Virtual Constructive (LVC) training and others.

The Company combines its world-leading training facilities, among which are the Israeli Air Force's training academy, support and services to U.S. government fleets and hundreds of other aircraft operated in Private Finance Initiatives, with know-how and expertise in designing and developing pilot training programs, thus setting new standards for quality, value and efficiency in military aircrew training.

Elbit Systems' various and flexible financing options for fleet operation offer:

- selection, acquisition and support of aircraft and training assets
- cost-effective aircraft operation and maintenance
- Maintaining aircraft readiness and availability

# FLIGHT SIMULATORS



## Tactical Training

### SkyBreaker™ - Airborne Mission Training Center



Elbit Systems' SkyBreaker enables linked training between various trainees and platforms. Teams train in formations of pairs and foursomes in all aspects of the operational mission. The sessions are fully supervised by flight instructors, who are central to the training process. The system integrates with other training systems, and connects to various training centers that are geographically separated. The system's high quality and its near to eye visual capability allows training sorties onboard the trainers, rather than using fighter jets, and maximizes use of existing resources.

SkyBreaker - unlimited access to the sky

## Live Training

### EHUD™ AACMI - Autonomous Air Combat Maneuvering Instrumentation



EHUD is a complete and fully Autonomous Air Combat Maneuvering Instrumentation (AACMI) system offering a combination of airborne combat training coupled with advanced ground-based capabilities. For Air-to-Air, Air-to-Ground and EW training/debriefing. EHUD supports a virtually unlimited number of live participants networked through a patented datalink protocol. Packaged in an Air-to-Air training missile shell, which can be easily transferred from aircraft to aircraft, EHUD has been operational since 1994 and has been delivered to numerous air forces worldwide. Over 500 airborne pods, and more than 100 ground debriefing and real-time monitoring stations have been successfully deployed with over 1 million flying hours logged.



### **EVA - Embedded Virtual Avionics for Trainer Aircraft**

EVA, is installed in basic or advanced trainer aircraft, transforming the aircraft into a virtual advanced fighter while maintaining the hourly training costs of a trainer. Designed to reduce the large training gap between trainer and modern fighter aircraft. EVA is manufactured in a minimal integration configuration, thus cutting integration costs within the aircraft virtually to zero. EVA simulates radar that provides Air-to-Air and Air-to-Ground modes as well as simulated weapons, IR sensors, situation awareness and simulated electronic warfare. An advanced datalink network connects the participants and ground station for real-time monitoring and control.

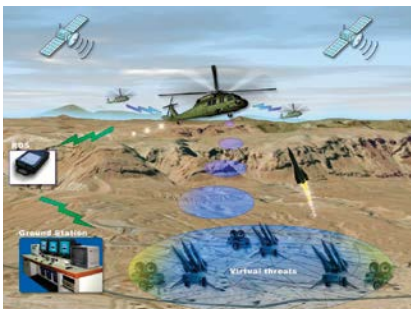

### **IFEWS - In Flight Electronic Warfare Simulator**

IFEWS, is a complete, autonomous, on-board threat-environment training and safety suite, capable of simulating the EW suite and virtual threats range. The IFEWS on-board simulation system maintains a virtual range of ground, naval and airborne threats. During flight, the virtual and the real threats are presented to the pilot through the real or simulated EW suite. Threats are placed on the terrain and behave according to smart doctrines and aircraft actions (maneuver, decoys dispensing etc.) The IFEWS standard package consists of the IFEWS airborne unit and the IFEWS PC ground station. IFEWS is operational in leading air forces worldwide.



## **Virtual Training**

### **F-16 Full Mission Simulators**

Elbit Systems supplies all F-16 simulators to the Israel Air Force. These include the F-16 Block 15, F-16 Block 52, and F-16 Block 40. The advanced F-16 Full Mission Simulator simulates all aircraft systems, emergencies and weapon deliveries. It also supports A/G, A/A and other mission types and features an integrated Instructor Operating Station (IOS) and After Action Review (AAR) capabilities.

### **Mi-8/17/24 Full Motion Simulators**

The Mi-8/17 and Mi-24 full motion simulators provide cost-effective, initial and recurrent training based on full modeling of the actual helicopter, mission environment, accurate and synchronized cue generation. The simulators cover every aspect of helicopter routine, emergency and mission operations in diverse scenarios, including day and night missions, with powerful cue generators maximizing realism and minimizing the transition to complex, actual missions. Simulators are equipped with an electrical 6 DoF motion system and a powerful visual system.



# FROM VISION

# TO REALISM



**HARTECH TECHNOLOGIES LTD.**

22 Maskit St.,  
Herzliya 4673322, Israel  
Tel: 972-74-7200800  
Fax: 972-9-9549394  
E-mail: [marketing@hartech.co.il](mailto:marketing@hartech.co.il)  
Web Site: [www.hartech.co.il](http://www.hartech.co.il)

**HarTech Technologies** is an innovative and dynamic private company specialized in development, integration and setting to work of advanced command and control systems and simulation infrastructure solutions.

Our main projects and product lines include:

**Command and Control** systems for Air, Land, Naval and Special Forces as well as for intelligence and Homeland security applications. Our command and control systems make use of advanced state of the art data fusion algorithms as well as utilize modern multi-channel datalink systems.

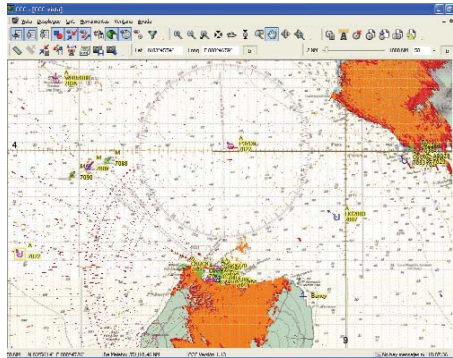

**Simulation infrastructure solutions** for large scale wargaming systems and tactical simulation systems. Our **SSG** (Smart Scenario Generator) is an advance scenario generation framework which enables the development and execution of large scale high fidelity simulation scenarios covering single platforms to a complete wargame.

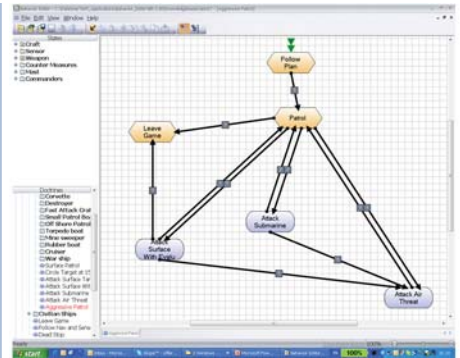

**Situational Awareness 3-D system** for use in urban areas, municipalities, complex plants, hazardous materials industries, environmental organizations and more. The **GEM** (Geospatial Management) our site management and protection solution provides a complete solution for all safety, environmental and security needs.

**HarTech Technologies** performs Turn-Key-Projects and provides services throughout the entire lifespan of a project starting from the operational specification definitions and solution design, system development, project management, management of procurement and installation process, setting the system to work and providing ongoing support to the project in the system assimilation and maintenance life cycle.

### HarTech's main projects include:

- Coastal surveillance solutions (Command and control system and overall integration)
- Air surveillance systems (Command and control and mission planning)
- Naval Command and Control systems
- The Smart Scenario Generator (SSG) development framework
- Tactical simulation solutions



# **SIMULATION AND TRAINING - EMBEDDED TRAINING**



## **IAI MLM DIVISION**

P.O.Box 45  
Beer-Yaakov 7035001, Israel  
Tel: 972-8-9272520  
Fax: 972-8-9272890  
E-mail: [mlm\\_marketing@iai.co.il](mailto:mlm_marketing@iai.co.il)  
Web Site: [www.iai.co.il](http://www.iai.co.il)

**MLM offers advanced training solutions for fighter aircrafts, helicopters, Navy and Air Defense. MLM embedded training is the essence of joint force training as it allows air land and naval forces to train and debrief together.**

**MLM is expanding towards LVC (Live Virtual Constructive) solutions by allowing a mixture of live training, simulators and computer generated forces - all training together**

### ***AACMI - Embedded training for fighter jets***

Autonomous Air Combat Maneuvering Instrumentation (AACMI) Training System- MLM's EHUD is a unique real time air combat, training, debriefing and safety system for fighter aircraft pilots. The system enhances live training with the ability to fire simulated armaments and receive real time hit/miss assessments as well as high level post exercise debriefing. The fighters can train jointly with ships, helicopters and air defense

### ***Helicopter Training and Safety (HTS) System***

HTS - Helicopter Training and Safety system enriches live helicopter training by offering high-value embedded pilot training with maximized safety features. The enhanced debriefing capabilities facilitate optimum utilization of flight hours and other valuable resources. HTS system provides high fidelity simulation for helicopter weapons and tactical flight training in a hostile environment that includes live and virtual EW threats

### ***ADTS - Air Defense Training System***

The ADTS offers a full solution for air defense crews and pilots for training in live exercise engagements against live and embedded virtual targets.



# BAE SYSTEMS ROKAR

*BAE Systems Rokar is a leading provider of navigation and guidance systems for guided munitions, GPS and GPS Anti Jam solutions, and Chaff and Flares Dispensing systems for aerial platform.*

**BAE SYSTEMS**

## **BAE SYSTEMS ROKAR**

Har Hotzvim Industrial Park  
P.O.Box 45049  
Jerusalem 9777511, Israel  
Tel: 972-2-5329888  
rokar.marketing@baesystems.com  
Web Site: www.baesystems.com

Based in Jerusalem, Rokar is a fully owned subsidiary of BAE Systems Inc. BAE Systems Rokar's solutions are ITAR FREE, field proven with unmatched operational maturity. Rokar is focused on affordable products, which have saved many lives on the battlefield. With in-house engineering and manufacturing capabilities, Rokar is certified to AS9100 C.

### **Silver Bullet**

Silver bullet is an affordable, ITAR Free, precision guidance kit for 155mm projectiles, with full 2D guidance. Silver Bullet transforms statistical 155mm shells into precise munitions to enable the operational user to hit in the first shot, with exceptional demonstrated accuracies, high correction capability and minimal drag. Silver Bullet accuracy significantly reduces collateral damage.

Silver bullet receives target information, as well as mission parameters, corrects the actual trajectory based on GPS measurements, and can be fired from both 39 and 52 caliber guns.

### **Navigation and Guidance Systems**

Rokar develops and manufactures ITAR Free GPS and GPS Anti Jam solutions for defense applications. Rokar's affordable systems are ideal for air, ground and naval platforms and munitions, with unique capabilities of high accuracy, operation under high dynamics, fast acquisition, GNSS, DGPS solutions and various GPS anti-jam technologies. These systems include:

- GPS Anti-Jam - Satellite Navigation Immune Receivers (SNIR.) Family of Off the Shelf products to confront the most challenging jamming scenarios. SNIR is available in the following configurations:
  - GPS Anti Jam receiver
  - GNSS Anti Jam receiver - GPS/Glonass anti Jam
  - GPS Anti Jam Add-On solution - to immune existing GPS receivers without changing existing navigation systems. SNIR Add-On can immune SAASM GPS receivers, C/A code GPS receivers and Glonass receivers.
- Integrated GPS/INS for projectiles and guided munitions
- GPS for missiles, for air to ground munitions and for guided mortars
- Flight computer for guided rockets
- Space qualified GPS for Low Earth Orbit (LEO) applications

### **Chaff and Flares Dispensing systems**

Rokar is renowned for its Advanced Countermeasure Dispensing Systems (ACDS). Rokar's systems are ITAR Free, combat proven with thousands of operational systems installed on a wide range of rotary and fixed wing platforms. These systems include:

- Advanced Countermeasure Dispensing System for advanced threats
- Support and training equipment
  - SBPA - Smart Breech Plate adaptor
  - CDT - Countermeasure Dispenser Tester
  - FAST - Functional and Stray Voltage Tester for armament stations
  - SWS - Smart Weapon Embedded Simulator for training aircrews





# AMPS - AIRBORNE MISSILE PROTECTION SYSTEMS



## BIRD AEROSYSTEMS LTD.

10 Hasadnaot St., P.O.Box 4038  
Herzliya 4614001, Israel  
Tel: 972-9-9725700  
Fax: 972-9-9579613  
E-mail: [info@birdaero.com](mailto:info@birdaero.com)  
Web Site: [www.birdaero.com](http://www.birdaero.com)



AMPS provided in cooperation with AIRBUS DS, is designed to automatically detect, identify and foil missile attacks.

AMPS is fully operational on military and VIP aircraft and is certified by leading aircraft manufactures including AIRBUS Helicopters and MIL Design Bureau that has issued several Service Bulletins for the installation on Mi-8/17.

The system provides all around coverage along with an unprecedented practical zero False Alarm Rate (FAR) enabling optimal deployment of countermeasures and DIRCM while ensuring highest aircraft survivability.

### AMPS Main Capabilities

- Fully autonomous system from detection to protection
- Practically zero false alarm rate
- Small number of compact, light-weight units
- Stand alone configuration
- Additional integration with RWR, LWR, MACS, DIRCM
- Combat proven

**AMPS is currently protecting hundreds of aircraft in many of the leading conflict zones around the world.**

# AIRCRAFT PROTECTION SOLUTIONS



**ELBIT SYSTEMS**  
**ELECTRO-OPTICS - ELOP LTD.**  
 P.O.Box 1165,  
 Rehovot 761101, Israel  
 Tel: 972-8-9386211  
 Fax: 972-8-9386010  
 Web Site: [www.elbitsystems.com/elop](http://www.elbitsystems.com/elop)



Elbit's Multi Spectral Infrared Countermeasure (MUSIC™) systems are a **family of DIRCM solutions** for protecting aircraft against MANPADS. These systems integrate an **advanced fiber laser** technology together with a **high rate thermal camera** and a **small, highly dynamic mirror turret** to provide effective, reliable and affordable protection to all types of aircraft and under all operational conditions. The systems are designed in an open architecture and can easily be integrated on any type of aircraft and with different types of Missile Warning Systems. The systems have been successfully tested in various countries and are under full scale production for numerous customers around the world - for a large variety of Military, VIP and Commercial aircraft.

**We currently introduce four solutions for the various aircraft:**

## MUSIC™

MUSIC is a DIRCM system for the protection of helicopters and small fixed wing turboprop aircraft. The System has been supplied to various customers.

## J - MUSIC™

J - MUSIC is a DIRCM system for the protection of medium and large jet aircraft (Transports, Tankers, MPAs, VIP jets etc.).

## C-MUSIC™

A complete self-protection solution including the jamming and IR Missile warning System - installed in a POD, especially designed for the protection of large jets from MANPADS. This system was selected by the Israeli government for the protection of the entire commercial fleet and meets the requirements of both commercial certification and protection of large aircraft.

## mini - MUSIC™

mini - MUSIC is the newest member of the MUSIC family, is an advanced flight tested DIRCM system, in a compact and lightweight package, that protects small and medium rotary and fixed wing aircraft.



# AIRBORNE ELECTRONIC WARFARE & INTELLIGENCE SOLUTIONS



**ELBIT SYSTEMS**  
**EW & SIGINT - ELISRA LTD.**  
48 Mivtza Kadash St.,  
Bene Beraq 5121701, Israel  
Tel: 972-3-6179798  
Fax: 972-3-6175880  
E-mail: ew-sigint@elbitsystems.com  
Web Site: www.elbitsystems.com



Integrating electronic warfare (EW) and intelligence systems such as Radar Warning Receivers (RWR), Laser Warning Systems (LWS), Infra-Red Missile Warning Systems (IR MWS), Radio Frequency (RF), Electronic Counter Measures (ECM) and Counter Measures Dispenser Systems (CMDS), Elbit Systems EW and SIGINT - Elisra is a primary source of EW suites for the Israel Air Force and many other air forces around the world. A leader in sophisticated combat-proven EW solutions, Elisra's EW suites are deployed on-board over 30 types of fixed and rotary-wing aircraft of both western and eastern origin.

**All-in-Small™** is an airborne EW self-protection suite for evolving threats in a single LRU. It comprises an embedded EW controller, advanced digital RWR, IR MWS, LWS and chaff/flare dispensing system. All-in-Small is a modular, cost-effective, lightweight and compact solution with multiple interfaces and an open architecture. It can also be integrated with Directed Infra-Red Counter Measures (DIRCM) and various future systems.

The only operational system of its kind, **IR-CENTRIC™**, is a unique measurable self-protection force multiplier solution offering multi-function, multi-usage capabilities and interoperable unity along with the freedom to define, redefine, reconsider and reconfigure mission objectives and outcomes. By enabling the redefining of mission parameters and significantly shortening the sensor to weapon loop, IR-CENTRIC boosts survivability of crew and platform.

**PAWS™ Family** - A cross-platform family of IR Passive Airborne Warning Systems (PAWS) provides a comprehensive, turn-key solution. The sophisticated IR MWS enhance airborne platform survivability by providing advance warning of the presence of threatening missiles - and by automatic management of all types of applicable countermeasures available on-board.

The **COMINT/DF and COMJAM** families for manned and unmanned platforms tackle the range of airborne communications systems being used today, including conventional, cellular and satellite. This family of systems includes Unmanned Aircraft Systems (UAS) specific Communications Intelligence/Direction Firing (COMINT/DF) and Communications Jammers (COMJAM) systems that are created as modular building blocks able to fit any UAS on the market.

These solutions meet the requirements of any EW or Signal Intelligence (SIGINT) payload, offering tactical intelligence reception in real time, over wide areas both rural and urban.

The **ESM/ELINT Family** is a highly sensitive, operational, and field-proven family of systems for all types of manned and UAS platforms. Designed for the densest and most complex electromagnetic environments, these systems deliver sophisticated intelligence gathering capabilities for the detection and analysis of all types of radars - ground-based, airborne, and shipborne.

**ALL-in-SMALL™**

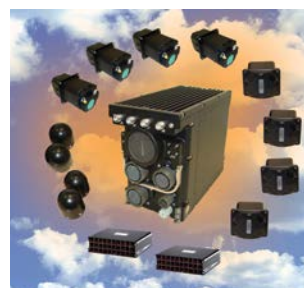

**COMINT& COMJAM for UAS**



# SELF PROTECTION AND FORCE PROTECTION SOLUTIONS



**IAI ELTA SYSTEMS LTD.**

P.O.Box 330, Ashdod 7710202, Israel

Tel: 972-8-8572410

Fax: 972-8-8561872

E-mail: [market@elta.co.il](mailto:market@elta.co.il)

Web Site: [www.elta-iai.com](http://www.elta-iai.com)

## **Integrated EW Self Protection Suite**

### **ELL-8260/2 INEW-SPS**

The ELTA integrated EW Self Protection Suite was designed to enhance the survivability of helicopters and fixed wing aircraft operating in hostile multi-spectral threat environments. Upon detection and identification of lethal threats by the warning subsystems, effective countermeasures can be automatically initiated. This modular system's configuration comprises of a selection, among the following elements: Radar Warning Receiver (RWR), Laser Warning Receiver (LWR), Missile Approach Warning Systems (MAWS), Electromagnetic Jammer, DIRCM, Advanced Chaff & Flare Dispenser and an EW Central Processor.



## **Missile Approach Warning System**

### **ELM-2160 MAWS**

The ELTA airborne radar-based Missile Approach Warning System greatly enhances the survivability of airborne platforms.

The system is operational on various types of transport aircraft, VIP and special mission aircraft and helicopters. It is based on a Pulse Doppler Radar, designed to detect all types of approaching missiles providing timely, accurate and reliable warning to the crew, and automatically activating Chaff/Flare dispensing for reliable and efficient missile deception. The system provides all weather capability and very low false alarm rates.



## **EW System Escort Jammer**

### **ELL-8251**

ELTA's ELL-8251 Escort Jammer (EJ) is an advanced EW system that suppresses all types of enemy Air Defense Surveillance and Fire Control Radars along the prescribed mission flight path. The system is designed for either an internal or external (pod configuration) installation supporting the Airborne Electronic Attack (AEA) missions. It significantly increases the survivability of the carrier aircraft and the entire attacking force. The Jammer is designed to operate automatically with minimal pilot intervention.

## **Green Rock Tactical C-RAM system**

### **ELM-2138M**

The Green Rock is a mobile autonomous tactical Counter Rockets, Artillery & Mortars (C-RAM) radar system. The Green Rock is designed to support a variety of ground force protection missions, including fire source location, friendly forces warning, friendly fire correction and low RCS & slow flying airborne targets (such as UAVs, gliders and hovering platforms) detection. The system's mission is to locate fire squad positions, distribute selective warning alarms and enable an effective fire response. The Green Rock system can be installed on various mobile or stationary platforms such as APC, HMMWV, ATV, etc. It includes a phased array pulse Doppler Radar which acquires and tracks trajectories of ballistic munitions, such as rockets, artillery and mortars, calculates the launching point and predicts the impact location.



# AEROSPACE

## Survivability & Protection



ISRAEL MILITARY INDUSTRIES LTD. (IMI)

P.O.Box 1044, 64 Bialik Blvd.  
Ramat Hasharon 4711001, Israel  
Tel: 972-3-5485222  
Fax: 972-3-5486125  
E-mail: imimrktg@imi-israel.com  
Web Site: www.imi-israel.com

### RED SKY-2

RED SKY-2 is a fast-deployable, compact VSHORAD system for protection of stationary sites, mobile dismounted and rapid-deployed peacekeeping forces. By integrating advanced, passive sensors with a remotely controlled operation, RED SKY-2 extends the capabilities and effective range of existing MANPAD missiles, which are limited by human factors, to their maximum potential (beyond 15 km). The system is mounted on man-portable pedestals, with sensors and C<sup>3</sup> capabilities. RED SKY-2 can be deployed in locations previously inaccessible to heavier air defense systems, such as mountainous terrain or urban environments.

### ATALD

ATALD (Advanced Tactical Air launched Decoy) is an active decoy used in SEAD missions, enhancing the survivability of friendly aircraft and guided munitions by saturating enemy

air defense systems with multiple false targets. ATALD's modular design enables the use of the vehicle as a target drone for different scenarios depending on the payload selection (RF and/or IR).

### AIRMOR

AIRMOR is a fully autonomous, modular self-protection suite designed for helicopters and transport aircraft. Its core components are: a Management Control Unit (MCU), which processes information from EW sensors and aircraft avionics - generating the optimal response to a particular threat; a Control & Display Unit (CDU), which provides situational awareness and the controls for operating the system. AIRMOR also employs a passive UV Missile Warning Sensor (MWS) and a Counter Measure Dispensing System (CMDS) with various expendables.

### MINI-SAMP

Mini Countermeasures Dispenser

System and Mini IR Decoy Flare, capable of defeating most modern IR-seeking MANPADS and air-to-air missiles using 1/3 the weight and length of standard flares/chaff. The system offers protection of previously undefended light helicopters (overcoming weight constraints) and improved protection of medium-size helicopters (a larger amount of flares/chaff). MINI-SAMP is available as a complete system installed on aircraft or as an upgrade kit to existing Countermeasures

### ADVANCED SPECTRAL IR FLARES

IMI's ADVANCED SPECTRAL IR FLARES provide combat aircraft with increased survivability against most advanced MANPADS in today's battlefield. The state-of-the-art flares can be dispensed from AN/ALE-39/40/47, ADDS SAMP 60/120/240A or equivalent dispensers and are in use and combat-proven by the Israel Air Force (IAF) and other customers.

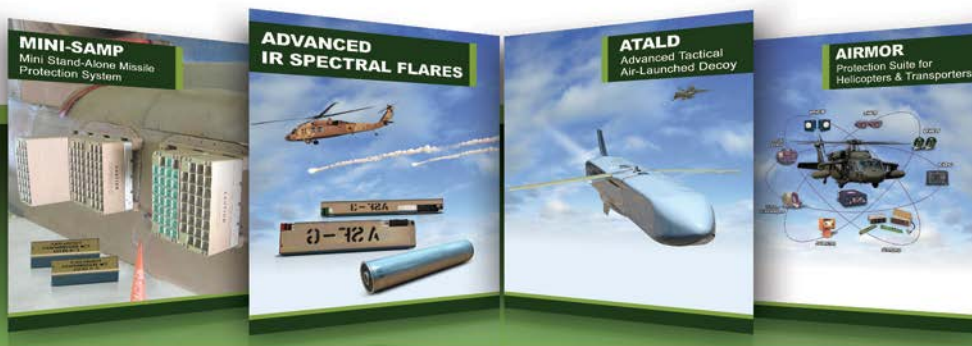

# ELECTRONIC WARFARE SYSTEMS



## Platform Self-Protection Suites

**Naval EW System:** Based on cutting-edge technology and combat proven, these unique products include ESM (**C-PEARL**) systems both compact and comprehensive with automatic detection and identification of signals, wide-band with accurate measurements, ECM (**SHARK**) with very high effective radiation power (ERP) using Multi-Beam Array Transmitters (MBAT) and DRFM based technique generators for effective jamming, and various Integrated EW suites (**SEWS**) tailored to any specific vessel and requirements.

**C-GEM** Off-board RF Active Decoy. Modern tracking radars and missiles exploit the principles of Mono-pulse & Lock On Receive-Only (LORO) techniques to track marine platforms. Many of these radars incorporate chaff identification and avoidance capabilities. **C-GEM** is the best solution with Wide-band frequency range, extended spatial coverage, high ERP, solid state active beam steering array, very fast response and installation options for all types of launchers: fixed, trainable and stabilized.

**Airborne EW Systems:** Critical means to enhance information superiority and survivability of aerial platforms, including Airborne ELINT/ESM systems (**TOP-SCAN**) suitable also for UAVs, Airborne Support Jammers (**SKY-SHIELD**) for Suppression of Enemy Air Defense (SEAD) missions providing comprehensive countermeasures against enemy threats, and Towed Decoy (**X-GUARD**) designed to provide maximum protection against modern missiles.

**Airborne EW System for Helicopters:** Rafael develops, manufactures and sells an electronic warfare self-protection system known as the Jam-Air.

The system includes a Directed Infra-Red Counter-Measures (DIRCM) turret and a Missile Warning System (MWS), detecting the threatening missiles and automatically and swiftly directing the DIRCM turret towards the threat, in order to disrupt its guidance and homing.

**RAFAEL**  
**ADVANCED DEFENSE SYSTEMS**  
 P.O.Box 2250 (19)  
 Haifa 3102102, Israel  
 Tel: 972-73-3354714  
 Fax: 972-73-3354657  
 E-mail: intl-mkt@rafael.co.il  
 Web Site: www.rafael.co.il



Jam Air



C-GEM



SEWS

X-GUARD



# MORE

## Shed new light on the EW arena



MILITARY OPTICAL RF EQUIPMENT Ltd.

**MORE**

**Military Optical RF Equipment Ltd.**

18 Hasivim St., P.O.Box 7551

Kiryat Matalon, Petach-Tikva 4959376, Israel

Tel: 972-3-9208200

Fax: 972-3-9215010

E-mail: [meir@eimmore.co.il](mailto:meir@eimmore.co.il)

Web Site: [www.eimmore.co.il](http://www.eimmore.co.il)

### Four main area activities:

#### ▶ ECM solutions

The core technology is based on RF-Photonic capabilities.

This new approach is based on completely analog RF-Photonic design, that provides the possibility for creating complex multi target scenarios for any radar waveforms.

The MORE solution main features include: full analog design, Ultra Wide Immediate BW, Coherent and multiple overlapping targets generation, Wide Band amplitude and phase manipulation, Multiple emitters engagement simultaneously.



#### ▶ Ultra Wide BW spectrum sensing

MORE capabilities, give a huge advantage to intercept, investigate and derive the features of complex RF signals in wide frequency BW (100MHz - 40GHz).

The application includes: RWR, ESM, ELINT.

#### ▶ RADAR & ECM simulators

MORE core capabilities enables applications for: RADAR Target Simulator for testing and calibrating of coherent RADAR systems, Test Equipment for acceptance test and maintenance, and ECM technique simulator for ECCM technique validation.

#### ▶ RF and Data over fiber connectivity

MORE line of solutions includes also RF Over Fiber (RADOF). The RADOF (TX & RX) is a complete solution for remote RF controlled systems over optical fiber, with unique feature, RF BW supporting up to 18GHz, High Dynamic Range, Built In monitoring and control, multi module connectivity option over single fiber (Point to Multi-Point).



# ASIO - SPECIAL MISSION AIRCRAFT SOLUTION



## BIRD AEROSYSTEMS LTD.

10 Hasadnaot St., P.O.Box 4038  
Herzliya 4614001, Israel  
Tel: 972-9-9725700  
Fax: 972-9-9579613  
E-mail: [info@birdaero.com](mailto:info@birdaero.com)  
Web Site: [www.birdaero.com](http://www.birdaero.com)



## AIRBORNE SURVEILLANCE, INTELLIGENCE AND OBSERVATION (ASIO) SOLUTION

ASIO supports military forces operating in the most demanding environments as they perform a range of surveillance missions including Ground and Maritime surveillance, anti-submarine warfare, search and rescue and environmental control.

ASIO is highly customizable and is supplied on a selection of aircraft with a wide range of sensors and subsystems such as Radar, EOP, AIS, SPS, COMINT that provide a unified real-time situation awareness picture.

In order to achieve maximum mission effectiveness BIRD has developed the MSIS, mission management system, that integrates and manages the airborne sensors and provides the airborne and ground users with a common operational picture.

ASIO is based on BIRD extensive operational experience and the understanding of mission-critical requirements. ASIO has been delivered to customers worldwide in diverse configurations and on both fixed wing aircraft and helicopters.





# BATTLE RESOURCE OPTIMIZATION SOLUTION (BRO)

*The Innovative Solution for Operational Mission  
Performance Enhancement*



## OMNISYS LTD.

13 Ha'amal St., Park Afek  
Rosh Ha'ayin 4809174, Israel  
Tel: 972-3-5377006  
Fax: 972-3-5377008  
E-mail: [fredit@omnisys.co.il](mailto:fredit@omnisys.co.il)  
Web Site: [www.omnisys.co.il](http://www.omnisys.co.il)

The operational mission challenges of the 21<sup>st</sup> century battlefield are greater than ever before - complex environment, unpredictable developing conflict conditions, rapidly evolving threats as well as multiple missions, systems, sensors and users

Our innovative solution provides extensive tools to meet these challenges by maximizing operational performance of tactical and strategic systems

**BRO - Online Decision Support System, provides improved operational mission performance through optimal resources utilization**



## BRO System

**Battle Resource Optimization (BRO) System provides:**

- **Planning the optimal operational resource allocation**, taking into consideration system performance, deployment, current system status, intelligence data, physical environment effects, terrain conditions (DTM/DSM) and available infrastructure, as well as issues such as **mutual interference**, redundancy, survivability and safety.
  - **Deployment and path optimization**
  - **Optimal assignment of missions, mission priorities and operational parameters to each system**
- **Online mission performance monitoring, estimation and gap analysis** based on on the massive data analysis produced by the sensors and systems in the arena
  - **Performance estimation**
  - **Performance degradation alerts**
  - **Enemy CONOPS change alerts**
- **Online operational recommendations for performance maximization**
  - **Policy updates**
  - **Missions and operational modes priority update**
  - **Update of significant systems parameters**, such as system deployment, spatial coverage and transmission frequencies

# SENSORS FOR MARITIME PATROL AIRBORNE PLATFORMS



**IAI ELTA SYSTEMS LTD.**

P.O.Box 330, Ashdod 7710202, Israel  
Tel: 972-8-8572410  
Fax: 972-8-8561872  
E-mail: [market@elta.co.il](mailto:market@elta.co.il)  
Web Site: [www.elta-iai.com](http://www.elta-iai.com)

## Maritime Surveillance Radar Family ELM-2022

The ELTA ELM-2022 Maritime Surveillance Radar (MSR) family includes radars for all types of Mission Aircraft, Helicopters and UAVs. Key features include detection of small targets, long range Surveillance, target Rang-Profiling, SAR and ISAR Classification Modes, Search & rescue location and support, moving target indication (MTI), and navigation and weather modes. The MSR provides a cost-effective force multiplier solution for Maritime Surveillance and EEZ Patrol, Surface and Littoral Warfare, Search and Rescue, Drug interdiction and prevention of illegal immigration and terrorist activities, Coast Guard and Fisheries Patrol, and Image Intelligence Operations

The ELM-2022ES AESA implements the proven operating modes of the ELM-2022 family, together with additional modes derived from the unique capabilities of Active Electronically Scanned Array (AESA) technology, providing improved detection, particularly at high sea states, and enabling efficient use of the radar in air/air and air/surface modes. The ELM-2022ML uses a unique front-end design in which most of the radar components are installed directly on the mechanical antenna array. Weighing only 50kg, this radar is suitable for the growing market of small to medium UAVs as well as light reconnaissance aircraft.

## Airborne SIGINT Systems: ESM/ELINT, CSM/COMINT ELL-8385, ELK-7071

The ELTA ELL-8385 & ELK-7071 are state-of-the-art ESM/ELINT and CSM/COMINT SIGINT systems designed for tactical and strategic Maritime Patrol Aircraft missions. The system performs Anti-Surface Warfare (ASuW), Anti-Submarine warfare (ASW), and Search and Rescue missions. These missions are enabled through surveillance, geo-location and tracking of all radar and communication emitters in the arena. In addition, continuous SIGINT data collection and analysis are performed throughout the mission. The system automatically generates a reliable and accurate Electronic-Order-of-Battle for all radar types, including Low Probability of Intercept radars. Additionally, an Innovative patented compact 3-Dimensional HF Direction Finder for airborne Instantaneous 3D geo-location of HF enabling small airborne platforms to perform HF COMINT missions.

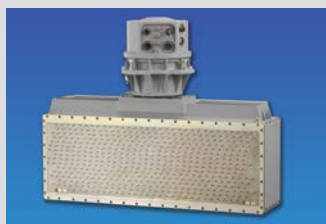

Maritime Surveillance Radar



Maritime Patrol Mission Aircraft



Maritime Patrol Helicopter



Maritime UAV Radar

# SPECIAL MISSION AIRCRAFT



## IAI ELTA SYSTEMS LTD.

P.O.Box 330, Ashdod 7710202, Israel  
Tel: 972-8-8572410  
Fax: 972-8-8561872  
E-mail: [market@elta.co.il](mailto:market@elta.co.il)  
Web Site: [www.elta-iai.com](http://www.elta-iai.com)

### Multi-Mission Airborne Reconnaissance & Surveillance System (MARS<sup>2</sup>)

#### ELI-3150

MARS<sup>2</sup> is a Multi-Role Airborne System designed to operate as a fast-deployment, all-in-one task force. It enables complete Ground Situational Awareness for the theater under surveillance. MARS<sup>2</sup> comprises a high performance aircraft (business jet or similar) equipped with a powerful Sensor-Suite and with the means to integrate the sensors' data effectively. An internal Command & Control and Communication (C<sup>3</sup>) Station translates intelligence and situational awareness into battle management.



### CAEW - Conformal Airborne Early Warning & Control

#### ELW-2085

ELW-2085 is ELTA's third generation of Conformal Airborne Early Warning & Control (CAEW) systems. The system is mounted on a modified long-range, highperformance and low operating cost Gulfstream 550 business jet. ELTA's onboard integrated Sensor Suite, with a powerful Communication System, supports a variety of operational missions.



### MPA - Maritime Patrol Aircraft

#### ELI-3360

The ELTA MPA is a multi-role airborne system designed to operate as a fast-deployment independent asset, providing comprehensive situational awareness and maritime domain superiority. The MPA comprises of a high performance aircraft equipped with a powerful Sensor-Suite and a Mission System to effectively integrate the sensors' data. An on board Command & Control and Communication (C<sup>3</sup>) System derives intelligence and situational awareness for the maritime arena management and disseminates the information to operational users and to the NCW infrastructure.

### Compact Multi-Mission Aircraft

#### ELI-3120

The ELI-3120 Aircraft is designed to cope with the challenges of present and future operational theatres. Utilizing an airborne multi-sensor system installed onboard, this Intelligence, Surveillance and Reconnaissance Aircraft provides tactical and strategic intelligence to a variety of users. The ELI-3120 system may be installed either on a customer provided aircraft or supplied on a suitable aircraft preferred by the customer.



# DATA LINK COMMUNICATION & NETWORKS



**Rafael provides communication products that include data links, airborne relay systems, communication networks & voice radios**

## C<sup>4</sup>I-ConNeCT

**Voice Communication System for Air Force C&C**

- Voice Communication System designed for the specific needs of air force command & control
- Tactical, IP & VoIP based Communication System
- Seamless connectivity from anywhere to anywhere
- Scalable solution to support a broad range of systems
- Converge different types of voice communication systems – Various legacy & IP Radios, Satcom, telephony – to a single system
- **Field proven in Israeli IAF**



## RAVNET 300

**Airborne Voice & Data Communication Radio Network**

- Air-to-Air, Air-to-Ground, instantaneous high data rate
- Highly advanced Voice & Data Networks
- High Availability: Long range communication, auto relay via multi hops
- High efficiency utilization of V/UHF spectrum
- Legacy radios support for practical evolution
- **Field proven in Israeli IAF**



## RAFAEL

**ADVANCED DEFENSE SYSTEMS**

P.O.Box 2250 (19)

Haifa 3102102, Israel

Tel: 972-73-3354714

Fax: 972-73-3354657

E-mail: intl-mkt@rafael.co.il

Web Site: www.rafael.co.il

## DLV-53 MF<sup>TM</sup>

**ISTAR Wideband Data Link**

- Ultra Wide Band data-link providing communication solutions for UAVs/ USVs/ UGVs & Airborne Reconnaissance pod systems
- Use of a single, small & light - weight unit for PTP LOS/SatCom, one hop LOS Relay & CAS waveforms simultaneously
- Supports data rates from 200Kb/s to 274 Mb/s - selectable from the Ground Station
- Growth capability up to 548Mbps without HW change
- Full spectrum support (L, S, C, X, Ku, MMW), highly immune
- Seamless secured connection between standard Airborne IP LAN and Ground IP LAN over a Gigabit WAN



## AIR STAR

**Multi-Sensor Aerostat based system for Extended ISR**

- The most advanced field proven Aerostat based IAR system
- Expands early warning and surveillance capabilities
- Supports air dominance
- Consists of multiple sensors: Radar, ELINT, COMINT & Receivers/Transmitters
- Communication to Command and Control & to Targets Interceptors
- High availability



# IMILITE



***Multi-Source Multi-Task ISR Exploitation System / Command and Control System Imilite is an intelligence system designed to receive process and exploit multiple standalone imagery video and other intelligence data in a centralized and a unified way.***

**RAFAEL**  
**ADVANCED DEFENSE SYSTEMS**  
P.O.Box 2250 (19)  
Haifa 3102102, Israel  
Tel: 972-73-3354714  
Fax: 972-73-3354657  
E-mail: intl-mkt@rafael.co.il  
Web Site: www.rafael.co.il



## **System capabilities:**

data reception, processing and display of Video, imagery, targets, threats, mission status, force locations, SIGINT detection and others.

The system GIS capabilities provide synchronized display of all the data as overlays on maps, video and images.

Imilite improves the Command-and-Control process by various automated image processing algorithms such as geo-referencing, change and motion detection, video/image enhancement, video stabilization and others.

Imilite can disseminate operational data, tactical mission reports, targets and treats to other forces, to facilitate close support operations, targeting and platform/sensor management.

ImiLite allows scalable Command and Control solutions and adaption to specific operational needs, both in mobile and stationary configurations for Command and Control centers, deployable operational units.

## **Benefits:**

- Centralized and unified workflow and data display
- Improved efficiency utilizing all available collection assets
- Shortened exploitation cycle
- Efficient Command and Control workflow
- Immediate accessibility to relevant data
- Real-time mission command-and-control workflow
- SR and mission product sharing with external operational users

## **Features:**

- Multi-source data reception in various formats
- GIS capabilities: image/video geo-referencing, data overlays, Geo data retrieval
- Advanced Image Processing Algorithms: change and motion Detection, image/video enhancement, video stabilization and others
- ISR and mission products and reports generation and dissemination
- Scalability and Adaptability
- Stationary, Mobile or Airborne configurations

# ***ELECTRO-OPTIC INTELLIGENCE, SURVEILLANCE AND RECONNAISSANCE (ISR)***

## ***Litening - Targeting & Navigation Pod***

Litening is an innovative airborne infra-red targeting and navigation pod for fighter aircraft with high accuracy and reliability, day and night precision strike capability. Litening reduces pilot workload during targeting and tracking.

It is easily integrated on any aircraft and possesses high growth potential.

In use in the Israeli Air Force, USAF, ANG, AFRES, Marines, German AF, Swedish AF, Spanish Navy & AF, Greek AF, and others, the Litening flies on F-16 , F-15, A-10, B-52, AV8-B, Gripen, Tornado, F-5, F-4, Mig-21, Mirage 2000, Jaguar and others.

■ ■ ■

## ***Toplite EO System - Electro-Optical Surveillance, Observation & Targeting System***

The Toplite family of electro-optic systems is an advanced multi-sensor, multi-purpose, highly stabilized EO systems for homeland security and defense applications, for aerial, maritime and ground based platforms.

## ***RecceLite- Real Time Tactical Reconnaissance System***

The RecceLite System consists of an E-O pod, a ground exploitation station and a data link. It is capable of collecting images day & night from 300 ft to 40,000 ft in all directions forwards, nadir, backwards, oblique - all down hemisphere and even when the aircraft is maneuvering in high G.

The Ground Exploitation Station (GES) is capable of generating targets in real-time with exceptionally high accuracy due to state-of-the-art algorithms and technology.

The data-link connects between the sensors and the GES and enables the images to be downloaded to the GES in real time. When your task is to close the attack cycle on many "time-critical targets" in less than 10 minutes, there is only one system - RecceLite.



***Litening -on-Gripen***



***Toplite EOS***

**RAFAEL**  
**ADVANCED DEFENSE SYSTEMS**  
 P.O.Box 2250 (19)  
 Haifa 3102102, Israel  
 Tel: 972-73-3354714  
 Fax: 972-73-3354657  
 E-mail: intl-mkt@rafael.co.il  
 Web Site: www.rafael.co.il

***Recce-U - Real-Time Persistent ISR System for UAVs***

Recce-U is a self-contained, multi-sensor ISR system (based on the RecceLite Tactical Reconnaissance Pod). The Recce-U enables automatic photography, according to a mission plan prepared in advance, or updated mission plan uplinked in real-time, however the operator can initiate manual scanning for targets of opportunity.



*RecceLite System*

*Recce-U*

***SpotLite Family***

***Electro-Optic Enemy Fire Detection System***

The SpotLite family consists of electro-optical systems that detect and locate enemy fire in stationary positions as well as on the move. Rapid detection and precise location information provide forces with the capability to quickly neutralize the enemy, maintaining the upper-hand on the battlefield.

The **SpotLite P** is a portable electro-optic system carried by two soldiers for day and night detection and location of small arms fire.

**SpotLite M** is a mobile electro-optic system installed on vehicles and AFV's that enables the detection and location of enemy fire sources from small arms, RPG rockets, ATGM and tank shells, on the move, day and night, up to 360° coverage.



*SpotLite P on Tripod*



*SpotLite M on vehicle*



# MIC<sup>4</sup>AD



**RAFAEL  
ADVANCED DEFENSE SYSTEMS**

P.O.Box 2250 (19)  
Haifa 3102102, Israel  
Tel: 972-73-3354714  
Fax: 972-73-3354657  
E-mail: [intl-mkt@rafael.co.il](mailto:intl-mkt@rafael.co.il)  
Web Site: [www.rafael.co.il](http://www.rafael.co.il)

MIC<sup>4</sup>AD is an advanced, unified, integrated C<sup>4</sup>I system that commands and controls the operation of both air and missile defense, including air-superiority missions. MIC<sup>4</sup>AD provides a total solution for multi-system, multi-layer and multi-range air and missile defense, traditionally operated as separate commands.

MIC<sup>4</sup>AD correlates real-time data from distributed sensors/platforms (radars, IFF system, data links, electro-optics), all connected to the air traffic control picture and mission planning system. The data is analyzed to deliver a real-time, coherent national Air Situation Picture (ASP).

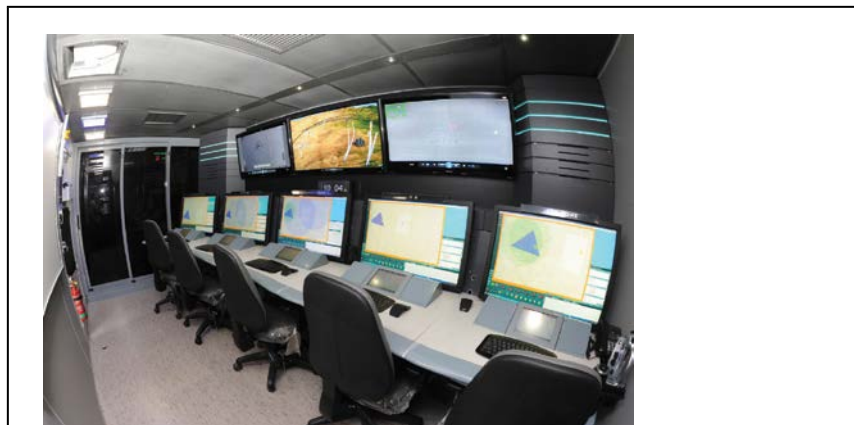

Simultaneously, MIC<sup>4</sup>AD performs threat assessment and hostile target classification, generating an interception plan for threats at any command level (national, regional, tactical). MIC<sup>4</sup>AD optimizes resource management and swiftly allocates the most appropriate defense system, such as SPYDER, David's Sling, Iron Dome or other customer systems to the type of challenge. Response includes target allocation to weapon systems (TAWA - Threat Assessment Weapon Allocation) with full, semi-automatic or manual fire control according to customer doctrine.

MIC<sup>4</sup>AD open, modular architecture can be adapted to customer operational needs. The system can be integrated with a customer's existing or future air and missile defenses. This flexibility allows incorporating new technologies and systems with the existing arrangement. MIC<sup>4</sup>AD can serve as an add-on to the customer's current C<sup>4</sup>I setup, or replace existing systems entirely.

Highly automated, easy-to-use and with advanced interactive displays, MIC<sup>4</sup>AD is a true force-multiplier. Enabling unified command and fire control of multiple air and missile defense systems, MIC<sup>4</sup>AD delivers multi-mission, multi-layer and multi-range C<sup>4</sup>I capabilities that ensure end-to-end air and missile protection.



# **B.L. ADVANCED GROUND SUPPORT SYSTEMS**



## **Best Solution on Time**

### **B.L. Advanced Ground Support Systems LTD.**

18 Hasivim St., Kiryat Matalon  
Petach-Tikva 4959376, Israel  
Tel: 972-3-9210404  
E-mail: sales@bl-il.com  
Web Site: www.bl-il.com



**BL Advanced Ground Support Systems Ltd.** has been in the business for more than 30 years developing multi-discipline advanced products for the defense industry.

### **BL offers development, production, sales and after sales service in two main areas:**

- Advanced ground support systems
- Advanced military products for ground forces

BL's strength is comprised of its ability to develop new and smart solutions rapidly and cost effectively.

### **Line of Products:**

- Bomb Loaders
- Aircraft Towbarless Tug
- HPU - computerized hydraulic power supply

## MAGAM SAFETY LTD.

6 Hasadna St.,  
Ziporit Industrial Zone 1789020, Israel  
Tel: 972-73-2665800  
Fax: 972-4-6412118  
E-mail: [info@magam-safety.com](mailto:info@magam-safety.com)  
Web Site: [www.magam-safety.com](http://www.magam-safety.com)

Magam Safety Ltd. designs, manufactures and distributes a wide range of rescue, survivability and protective equipment for over 80 years.

Magam Safety products are developed in close relationship and constant feedback from the Israeli Defense Forces (IDF). The company is the sole supplier of Anti-G suits and fuel tanks to the IDF.

Magam's R&D and production facility is located in northern Israel and employs top-line professionals.

Magam Safety offers comprehensive solutions - from research and development, product design, materials consultation, rapid prototyping trial, serial and mass production, product test reporting and certification, and complete after-sale support throughout the products' life cycle.

### Areas of Activity

- Rescue and survivability equipment.
- Parachutes for paratroopers, pilots, cargo, and brake parachute.
- Anti-G suits.
- Life-saving jackets.
- Rubber and self-sealing fuel tanks for Aircrafts, UAVs, Armored fighting vehicles (AFVs) and Battle tanks.
  - Rubber self-sealing solution - self-sealing rubber coating of metal containers.
- Inflatable equipment.
  - Inflatable life rafts and boats.
  - Sealed bags.
  - Inflatable Decoys.

Magam Safety provides both off-the-shelf as well as custom made products & solutions tailored to meet customer's specific needs and requirements.

The company's products encompass a variety of combat proven solutions and are made from state-of-the art materials.

### Quality Assurance

Magam Safety complies with strict quality control procedures according to international standards, from performing acceptance tests of raw materials till full scale inspection of the finalized product.

Magam Safety is approved to perform self-inspection processes to Israel's major military institutions; Israeli Ministry of Defense (IMoD), Israeli Air Force (IAF), Israeli Aircraft Industries (IAI), Israel Military Industry (IMI), The Ground Forces Command and RAFAEL.

The company's products are designed, manufactured and tested in accordance with international standards: ISO 9001:2008 Quality Managements Systems, and are under the control of the Standards Institution of Israel.



# SPACE SYSTEMS TOP PERFORMANCE IN SMALL AND MEDIUM PACKAGES



Israel Aerospace Industries Ltd.  
Systems Missiles & Space Group

## IAI SPACE DIVISION Systems Missiles & Space Group

P.O.Box 105  
Yehud Industrial Zone  
5610002, Israel  
Tel: 972-3-5315699  
Fax: 972-3-5315830  
E-mail: [marketing@iai.co.il](mailto:marketing@iai.co.il)  
Web Site: [www.iai.co.il](http://www.iai.co.il)



Opsat 2000

Opsat 3000

TECSAR

IAI's OFEQ, EROS optical observation and TECSAR SAR imaging satellites provide top notch performance in a small, lightweight package.  
The AMOS family of GEO communication satellites provides very high tailored performance in small to medium size satellites.  
IAI provides comprehensive turnkey solutions, including ground stations and related services.  
IAI welcomes governmental and industrial participation and partnerships.

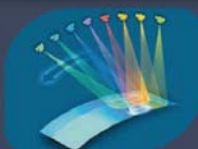

Mosaic Mode



# SPACE PROGRAMS



This picture was taken by Eros-B / ImageSat International

Elop is among a select group of manufacturers worldwide incorporating under one roof the complete infrastructure for carrying out a wide variety of cutting-edge space projects, in cooperation with high-tech companies and defense authorities.

Our cameras provide high spatial resolution earth imaging and mapping for a wide range of governmental, commercial and scientific applications.

Elop's advanced facilities, considered a national asset, include latest generation design tools, clean rooms, controlled chambers for testing under space-simulating thermal-vacuum conditions, set-ups for alignment of large aperture optics, detectors, thermal control systems and other cutting edge equipment for camera testing.



## **URANUS - MSC**

### *Multi-Spectral Space Camera - Payload System*

The URANUS Multi-Spectral Space Camera (MSC), a high resolution panchromatic and multi-spectral payload system, is a complete end-to-end spaceborne remote-sensing payload originally designed for the KOMPSAT II satellite developed by the Korea Aerospace Research Institute (KARI) for multi-purpose use. KOMPSAT II was launched in July 2006.

**ELBIT SYSTEMS  
ELECTRO-OPTICS - ELOP LTD.**

P.O.Box 1165,  
Rehovot 7611101, Israel  
Tel: 972-8-9386211  
Fax: 972-8-9386010  
Web Site: [www.elbitsystems.com/elop](http://www.elbitsystems.com/elop)



**NEPTUNE**

*High Resolution Remote Sensing Camera*

The high resolution NEPTUNE remote-sensing camera provides real-time, detailed panchromatic images. NEPTUNE, integrated in the EROS B satellite launched in April 2006 and still fully operational, has proved its high reliability. The EROS B satellite is the second in a family of Earth Global Monitoring systems, operated by ImageSat International N.V.



**Jupiter**

*Very High Resolution Remote Sensing Camera*

The JUPITER camera is a top-end performance earth observation system for government and commercial applications and missions. JUPITER, our next generation camera, will be integrated in the OPTSAT 3000 satellite. JUPITER contains panchromatic and optional multi-spectral (MS) imaging capabilities sharing a common optical assembly and is capable of simultaneous operation and the creation of pan, MS and pan-sharpened images.

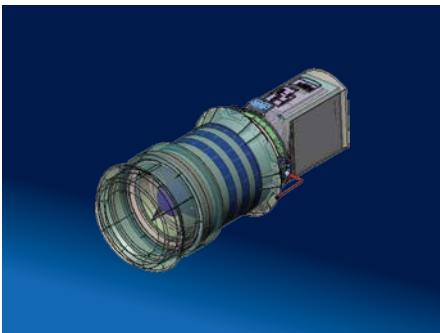

**VEN $\mu$ S**

*Super-Spectral Remote Sensing Camera*

The VEN $\mu$ S camera was developed and manufactured by Elop for a joint effort between the French Centre National d'Etudes Spatiales (CNES) and the Israeli Space Agency (ISA). Ven $\mu$ s is lightweight and low in power consumption and can easily be integrated into small/micro, lightweight buses. With 12 narrow spectral bands in the visible and near infra-red spectral regions and 5.3 meter ground resolution, the Ven $\mu$ s camera introduces a new level of superspectral high spatial resolution earth imaging for a wide range of commercial and scientific applications.



**MERCURY**

*Earth Global Monitoring System*

The MERCURY remote sensing camera provides real-time, detailed high resolution, panchromatic images of broad geographical areas. The reliable and proven MERCURY is integrated in the EROS A satellite that was launched in December 2000 and is still fully operational. The EROS A satellite is the first in a family of Earth Global Monitoring systems, operated by ImageSat International N.V. MERCURY is a modular, lightweight, low power camera which is easily integrated in LEO small/micro, lightweight satellites.

# SOLID ROCKET PROPULSION



**ISRAEL MILITARY INDUSTRIES LTD. (IMI)**

P.O.Box 1044, 64 Bialik Blvd.  
Ramat Hasharon 4711001, Israel  
Tel: 972-3-5485222  
Fax: 972-3-5486125  
E-mail: [imimrktg@imi-israel.com](mailto:imimrktg@imi-israel.com)  
Web Site: [www.imi-israel.com](http://www.imi-israel.com)

- IMI is Israel's National Center of Excellence for Solid Rocket Propulsion

- Main Activities:

- Rocket Motors for Interceptor Missiles
- Boosters for Satellite Launchers
- UAV Boosters
- Thruster Kit for Attitude Control

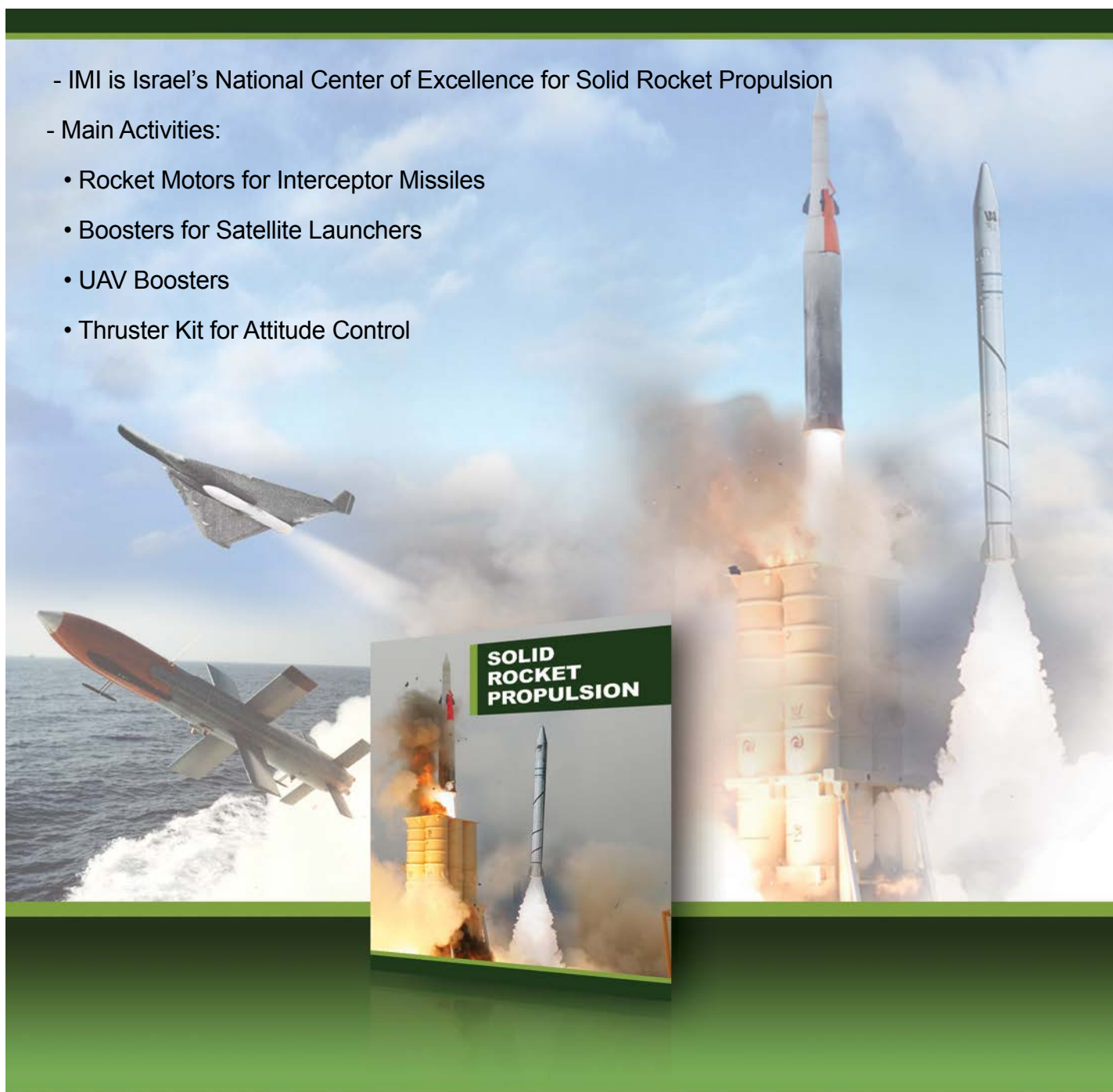

# SPACE TECHNOLOGIES



**RAFAEL**  
**ADVANCED DEFENSE SYSTEMS**  
P.O.Box 2250 (19)  
Haifa 3102102, Israel  
Tel: 972-73-3354714  
Fax: 972-73-3354657  
E-mail: [intl-mkt@rafael.co.il](mailto:intl-mkt@rafael.co.il)  
Web Site: [www.rafael.co.il](http://www.rafael.co.il)

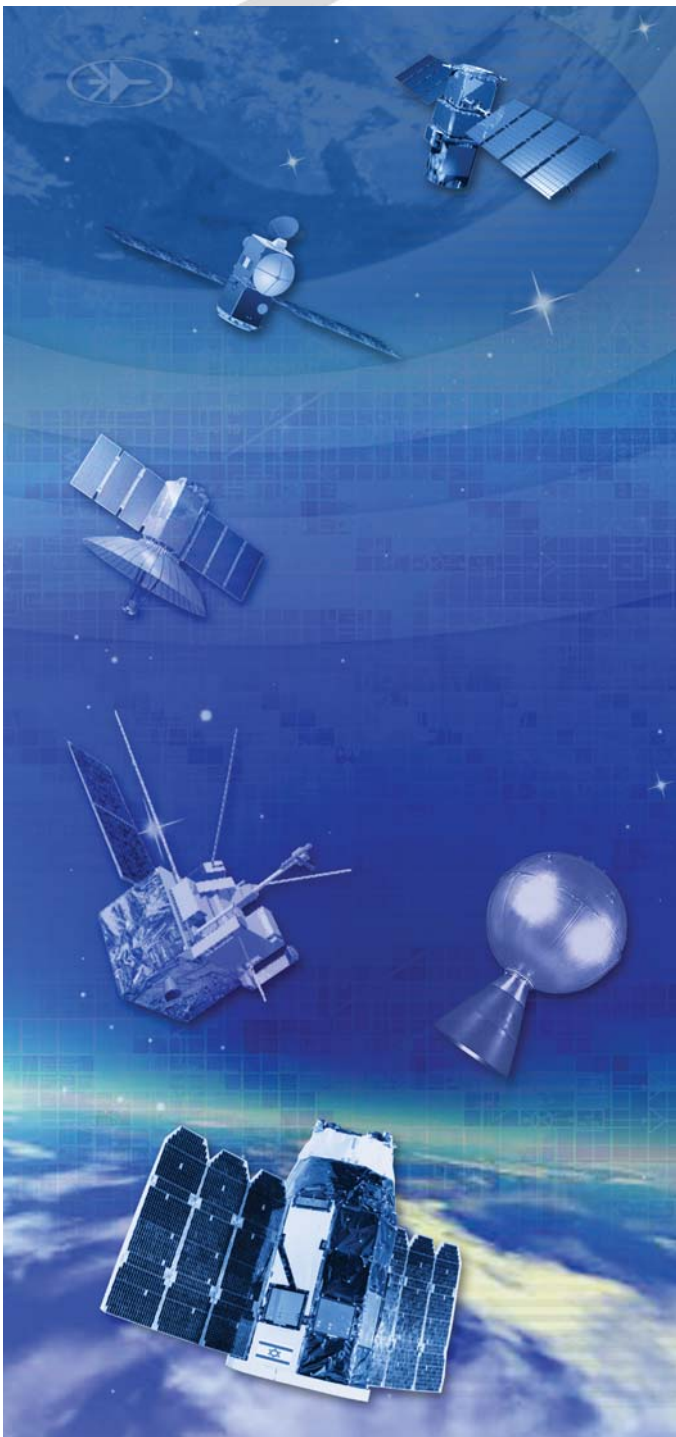

Rafael continues to expand its space activities to include micro-satellite technologies and systems, complete propulsion systems for satellites and satellite launchers and airborne satellite launchers. It offers affordable and highly-effective advanced solutions for both military and commercial Low Earth Orbit (LEO) missions.

The propulsion systems include attitude control and orbital transfer propulsion modules for the Ofek, Eros and TecSAR satellite series, attitude control systems for satellite launchers, electric propulsion systems and cold-gas reaction control systems for micro-satellites. In addition, Rafael supplies propellant tanks, thrusters and valves for hydrazine propulsion systems, as well as third-stage solid propellant rocket motors.

Rafael's components are presently in orbit, on numerous Israeli and European satellites.

Rafael is a partner in the Israeli Joint Venture (together with IAI) which is building the Joint French-Israeli Venus scientific micro-satellite.

# AIR DEFENSE SYSTEMS

## IRON DOME

## SPYDER-SR/MR



**RAFAEL**  
**ADVANCED DEFENSE SYSTEMS**  
P.O.Box 2250 (19)  
Haifa 3102102, Israel  
Tel: 972-73-3354714  
Fax: 972-73-3354657  
E-mail: [intl-mkt@rafael.co.il](mailto:intl-mkt@rafael.co.il)  
Web Site: [www.rafael.co.il](http://www.rafael.co.il)

### Air Defense

*Rafael has extensive experience in missile development and production, and offers a variety of missiles in a broad range of areas.*

#### IRON DOME

The Iron Dome is the only dual mission system in the world that provides an effective defense solution for countering rockets, artillery & mortars (C-RAM) as well as aircraft, helicopters, UAVs, PGMs. The system is an effective system for countering C-RAM threats with ranges of up to 70 km and for VSHORAD protection (up to 10 km). The system operates in all weather conditions, including low clouds, rain, dust storms or fog.



#### SPYDER-SR/MR

##### Short/Medium Range Mobile Air Defense Systems.

SPYDER (Surface-To-Air Python & DERBY) is a quick reaction, low level surface-to-air missile system designed to counter attacks by aircraft, helicopters UAVs and precision guided munitions. The system provides effective protection of valuable assets, as well as first-class defense for forces located in the combat area. SPYDER incorporates RAFAEL's most advanced, proven performance air-to-air missiles - the Derby active radar (RF) missile and Python-5, a dual waveband Imaging Infra Red (IIR) missile. The SPYDER family includes SPYDER-SR (Short Range) and SPYDER-MR (Medium Range) systems.







# NAVAL FORCES



## Naval Dominance – from the Littorals and EEZ

Naval operations in the littorals and the protection of the national Economic Exclusion Zone (EEZ) are becoming significant new requirements for planning, operational readiness and deterrence capability of modern navies.

Maintaining a modern fleet of surface vessels, optimized for littoral warfare, Israel's Navy is also tasked with countering terror threats from the sea and securing the national maritime interests. Relying on indigenous weapons and equipment developed by Israel's defense industries, this surface fleet, along with Israel's strong submarine force, has constantly sought to gain superiority over its opponents by introducing technological innovation based on indigenous capabilities.

Since the 1970s Israel pioneered the concept of layered defense and sea-skimming anti-ship missiles - a strategy that led to a perfect score during the 1973 war. After four decades, Israel's home grown technologies are also positioned to lead in naval air- and missile-defense, with equally capable defensive systems. Along with the local defense industries, Israel is also leading the 21st century technology of 'networked operations', introducing fully-integrated combat systems, comprising a wide range of domestic and foreign weapons, sensors and processing systems.

The Israeli industry is also building and equipping the manned and unmanned platforms used by navies around the world, to maintain offensive and defensive naval capability, providing situational awareness, command and control for the combat systems and naval special operations. Specific Israeli systems are also integrated into combat suites designed by other navies and prime contractors, as part of international teaming and cooperation.

For coastal and EEZ security missions Israel offers a wide range of solutions, from manned and unmanned aerial and surface vehicles to integrated naval, land based and aerial platforms, protecting and securing national interests along the coastlines and offshore.

# C-MAN

## Computerized Maritime Navigation system

For surface and sub-surface vessels  
Features Monolithic Ring Laser Gyro INS/GPS navigation sensors or MEMS based INS sensors for Coastguard and littoral Patrol Boat



- **Turn key system solution for Integrated** Navigation and inertial Data Distribution.
- **Data computation** and data distribution to all shipboard sub-systems of all directions motion sensing, attitude and position.
- **Interface** to Command & Control, Weapons, Electro Optical Directors, Radar Antennas and all ship's inertial data users.
- **High accuracy, high reliability** inertial sensor with embedded GPS, accurate positioning at minimal drift rates.
- **System redundancy:** Designed for full MEMS or RLG INS/GPS sensors redundancy architecture. Multiple outputs of Synchro and/or digital signals to support multiple-outputs redundancy.
- **Flexibility and Modularity**
  - Modular architecture allowing the use of any combination of sensors (INS/GPS, EM/Doppler Log, Echo sounder, Metrological center, etc.).
  - From basic low cost small vessels single sensor system to high-end large surface vessels and advanced EP-Extended Performance Lowest Drift submarines applications.
  - Multiple outputs – supporting modern digital format sub-systems as well as analog/Synchro shipboard systems.
- **Advanced Processing-utilizing Kalman Filters** optimized for naval navigation data, incorporates accurate compensation and data filtering, taking into account latency and utilizing unique prediction algorithm considering the characteristics of naval vessels.



ASTRONAUTICS C.A. LTD.

### ASTRONAUTICS C.A. LTD.

P.O.Box 3351, Kiryat Arie  
Petah Tikva 4951207, Israel  
Tel: 972-3-9251555  
Fax: 972-3-9251550  
E-mail: astro@astro.co.il  
Web Site: www.astronautics.co.il

### C-MAN System Characteristics

#### Navigation Data Generation & Distribution

- Heading
- Attitude (Roll, Pitch)
- Heading, Roll, Pitch rates
- Velocity and speed (Relative to Water Mass)
- Accelerations
- Water depth
- Wind speed and direction (Absolute and Relative)
- Barometric Pressure
- Relative Humidity
- Air temperature

#### Reliability

The C-MAN actual MTBF, per typical naval mission profile is over 10,000 hours

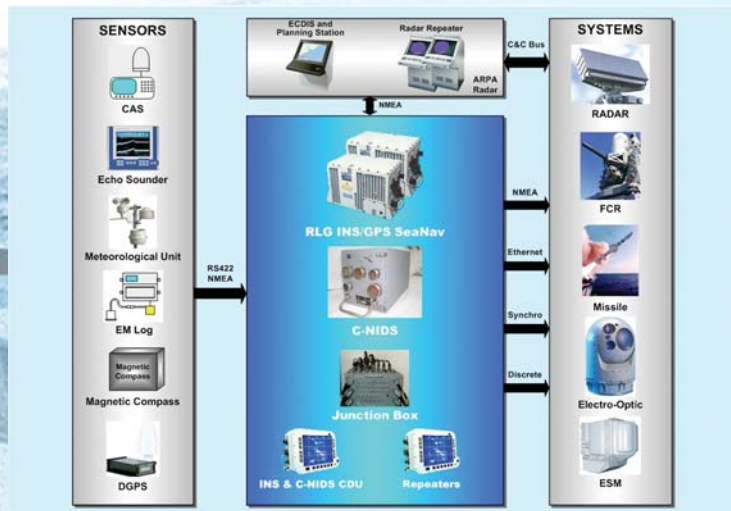

### Operating and Control Consoles (OCC)

- Displays multiple video inputs
  - High-speed synthetic graphics
  - Networked display system
  - Built-in self-tests
  - Excellent ergonomic configuration
- Designed to withstand harsh Naval environment conditions



# USV PROTECTOR®



## RAFAEL ADVANCED DEFENSE SYSTEMS

P.O.Box 2250 (19)  
Haifa 3102102, Israel  
Tel: 972-73-3354714  
Fax: 972-73-3354657  
E-mail: intl-mkt@rafael.co.il  
Web Site: www.rafael.co.il

### PROTECTOR® USV

El vehículo no tripulado de superficie (USV) PROTECTOR® es un sistema no tripulado e integrado de Inteligencia, Vigilancia, Adquisición de Blancos y Reconocimiento (ISTAR).

El PROTECTOR está equipado con un conjunto completo de sensores y puede alojar una variedad de módulos de misión. El Director Electro-óptico TOPLITE y un sistema de radar permiten ejecutar misiones diurnas y nocturnas de detección, identificación y seguimiento de blancos. Los subsistemas del TOPLITE incluyen un sensor FLIR de visión IR delantera de 3ª Generación, una cámara CCD en colores, un telémetro láser (LRF) de seguridad ocular y un avanzado seguidor de correlación.

La carga útil Anti-terror y de Protección de Fuerzas incluye el Director Electro-óptico (EOD) TOPLITE, la Estación de Armamento Estabilizado MINI-TYPHOON, un Sistema de Cañón de Agua y sensores auxiliares. El MINI-TYPHOON es una montura estabilizada de cañón de elevada precisión con capacidades de control de tiro, brindando excelente precisión de fuego. El Sistema de Cañón de Agua permite ejecutar acciones menos letales a cortas distancias junto con capacidades de combate de incendios.

El PROTECTOR es operado desde una Estación de Control, que incluye dos consolas de operación, una para el comandante del USV y una para el operador de los sistemas de la carga útil.

La Estación de Control recibe a través de los enlaces de comunicaciones, todos los datos del sistema, las imágenes de video y el audio requeridos para componer eficazmente el panorama de conciencia situacional y para operación del sistema. El PROTECTOR puede ser incorporado fácilmente a formaciones más amplias de defensa a través de una interfase estándar con un sistema C<sup>4</sup> externo.

Basado en una plataforma de alta maniobrabilidad, este USV tiene excelentes capacidad de maniobra. La plataforma opera impulsada por motores diesel propulsores de chorros de agua. Los sistemas de la plataforma incluyen el control de la propulsión, de las maniobras y de la navegación.

El elemento núcleo del PROTECTOR es un avanzado sistema de control que opera interfaseado con todos los subsistemas del USV y suministra al operador remoto la capacidad de planificar, priorizar y ejecutar misiones navales de día y de noche, y en condiciones climáticas adversas sin exponerse a riesgos.

El diseño modular del PROTECTOR facilita al cliente la selección de aquellos subsistemas que mejor se asimilan a sus requerimientos operacionales particulares.

Instalando medios de acción activa, el PROTECTOR puede cerrar con eficacia el círculo de fuego de una solución integral del ciclo "sensor-tirador".



### Ventajas Operacionales del USV PROTECTOR®

- Ejecuta tareas peligrosas sin arriesgar vidas humanas.
- Ejecuta misiones fatigosas y prolongadas tales como patrullaje y tareas corrientes de seguridad.
- Transmite datos y video en tiempo real desde la arena de acción a las jefaturas.
- Puede operar en mar bravo sin tripulaciones afectables por las severas condiciones.
- El sistema de Comando y Control del PROTECTOR puede integrarse con sistemas C<sup>4</sup> externos, convirtiéndose en una parte integral de formaciones de defensa.
- El PROTECTOR puede ser utilizado para acercarse a naves sospechosas, verificar sus intenciones y distinguir si se trata de un elemento amigo o enemigo sin poner en peligro la seguridad de las tripulaciones.
- Un conjunto sensor de elevada eficacia permite detectar e identificar blancos y amenazas desde grandes distancias.
- El conjunto integrado de combate facilita el cierre rápido del ciclo sensor-tirador.
- Equipado con una Estación de Armamento estabilizado de elevada precisión y performance demostrada en acción, tiene capacidad para eliminar amenazas a distancia.
- Equipado con un Cañón de Agua de alta presión, sirve para disuasión no letal y tareas de control de multitudes.
- El PROTECTOR tiene capacidades para grabar datos de video y audio de sus inmediaciones con fines de análisis ulterior, propósitos legales y otras consideraciones.
- El PROTECTOR puede ser desplegado en cualquier escenario marino, desde plataformas de perforaciones de petróleo, naves nodriza o instalaciones costeras, maximizando su alcance de acción y versatilidad.
- La carga útil portada a bordo puede ser reemplazada para suplir los requerimientos de diferentes tareas, confiriendo así capacidades para conducir una amplia gama de misiones con una misma plataforma.
- Totalmente probado, en producción en serie y operacionalmente desplegado en armadas de todo el mundo.

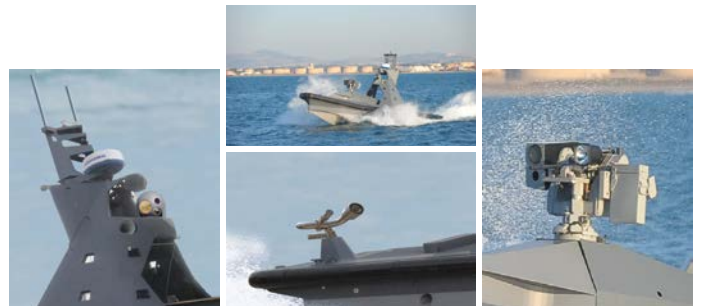

# "NIRIT"

## UPGRADED SA'AR 4.5 CLASS

### In active service in the Israeli Navy



Our experience Your benefit

#### ISRAEL SHIPYARDS LTD.

P.O.Box 10630  
Haifa Bay 2611702, Israel  
Tel: 972-4-8460246  
Fax: 972-4-8418744  
E-mail:  
marketing@israel-shipyards.com  
Web Site: www.israel-shipyards.com



The "Nirit" type Fast Attack Missile Boat is a direct descendant of the Sa'ar 4.5 combat-proven vessels developed by Israel Shipyards in close cooperation with the Israeli Navy.

The upgrading of the Sa'ar 4 and Sa'ar 4.5 series is a cost-effective modernization program that extended the boat's life and enhanced significantly their operational capabilities.

The addition of 32 vertical launched "Barak" antimissile missiles and new electronic and electro-optic equipment imposed a complete replacement of the mast and C.I.C. room as well as changes in the internal arrangements, electric and auxiliary systems.

The hull and the propulsion systems remain the same well proven components as in the previous Sa'ar 4.5 class boats that are serving in the Israeli Navy.

The "Nirit" is a modern missile boat with an unmatched ratio of fire power to displacement and an outstanding survivability due to major improvements of the E.C.M. and the "hard kill" capability.

Similar upgrading concepts can be implemented on many other types of Naval vessels, Israel Shipyards has the know-how and technical skills to design and carry out such cost effective modernization programs on existing Naval platforms.

#### Technical Data

Displacement	488.0 Tons
L.O.A.	61.7 M.
Beam	7.6 M.
Draft	2.7 M.
Fuel capacity	116.0 Tons
Speed (max.)	32 Knt
Endurance	3000 N.M.

#### Armament

- 8 x "Harpoon" Long range SSM.
- 6 x "Gabriel" Middle range SSM.
- 32 x "Barak" Anti-Missile missiles.
- 1 x "Vulcan Phalanx" CIWS.
- 1 x 76/62 Oto-Melara gun.
- 6 x 20 mm or 0.5" machine guns.

# OFFSHORE PATROL VESSEL (OPV)



Our experience Your benefit

## ISRAEL SHIPYARDS LTD.

P.O.Box 10630  
Haifa Bay 2611702, Israel  
Tel: 972-4-8460246  
Fax: 972-4-8418744  
E-mail:  
marketing@israel-shipyards.com  
Web Site: www.israel-shipyards.com

## The most cost effective OPV available today

### General Description

Based on the combat proven SAAR 4 and SAAR 4.5 missile corvettes, Israel Shipyard's 400- 500 tons OPV is the most cost effective OPV concept available today.

The 400 tons OPV has been selected by the Hellenic Coast Guard as a significant part of the Naval security forces for the Athens 2004 Olympic Games.

The 500 tons model can support a light marine helicopter.

### The OPV missions

- Open sea patrolling and Surveillance operations
- Seaborne terrorism / smuggling / illegal activities interdiction
- Launch and recovery of light marine helicopter (up to 5 tons).
- Off-Shore facilities protection
- Support of special operations forces.
- Search and Rescue operations
- Fishing control.
- Anti pollution missions.

### The OPV can accommodate advanced weapon configurations

- Up to 76 mm remotely controlled gun
- 2 x 0.5" / 7.62 mm stabilized gun mounts
- Command and Control system
- ESM
- Search Radar
- Most advanced day and night vision system
- ARPA Navigation Radar
- ECDIS
- Optional - Short range missiles.

The OPV is certified by Lloyd's and complies with international regulations regarding stability, Hull construction, navigation systems etc.



### The OPV main specifications

	400 tons	500 tons
<b>Model</b>		
<b>Length Overall</b>	58 m	62 m
<b>Beam, Moulded</b>	7.6 m	7.6 m
<b>Draught</b>	2.65 m	2.70 m
<b>Flight Deck</b>	N/A	7 x 7.7m
<b>Displacement</b>	400 tons	470 tons
<b>Maximum Speed</b>	33 knots	32 knots
<b>Sustained Speed</b>	30 knots	30 knots
<b>Cruising Speed</b>	18 – 20 knots	18 – 20 knots
<b>Range at 18 Knots</b>	2200 NM	3200 NM
<b>Endurance</b>	10 – 12 days	14 – 20 days
<b>Crew</b>	20 – 30	20 – 30

# "SAAR S-72" CORVETTE



Our experience Your benefit

## A New Generation Of SAAR Class Vessels

The new design of the modern SAAR S-72 is available now.

This new generation of the famous SAAR class Fast Attack Mini Corvettes, is a larger vessel.

It is a multipurpose vessel at the length of 72 meter and full displacement of about 800 tons.

As the existing Naval vessels of Israel Shipyards, the new corvette will also reach the speed of above 30kn with an extended endurance.

The S-72 can operate a medium size marine helicopter. It also supports unique possibilities of deploying Special Forces units.

### The main improvements of the S-72 include:

- Significant upgrade of the SAAR 4.5 combat capabilities
- Major improvement of signatures
- State-of-the-art weapon and electronic systems (can be Tailor-Made to customer specific requirements)

### The S-72 missions include:

- Open Sea Patrolling and Surveillance operations
- Maritime Sovereignty protection
- Off - Shore facilities protection
- EEZ protection
- Anti terror / smuggling / illegal activities interdiction
- Minimize illegal immigration transits
- Search and Rescue operations in coordination with SAR Helicopters
- Participation in Naval combat operations
- Fishing protection and control
- Support of boarding / landing and intervention forces
- Sea Pollution containment activities

The S-72 is offered as a missile corvette or in an OPV version.  
The S-72 is the most cost effective corvette available today.

### ISRAEL SHIPYARDS LTD.

P.O.Box 10630

Haifa Bay 2611702, Israel

Tel: 972-4-8460246

Fax: 972-4-8418744

E-mail:

marketing@israel-shipyards.com

Web Site: www.israel-shipyards.com



### The S-72 can accommodate advanced weapon configurations, including:

- Launchers for anti-missiles defense missiles
- Surface-to-surface missiles launchers
- Up to 76 mm Naval gun
- Remotely controlled stabilized Naval gun system up to 30mm
- Command and Control system
- ESM
- Advanced Multifunction Search Radar
- Heavy machine guns – 0.5" / 7.62 mm
- Most advanced day and night vision system

The S-72 complies with international regulations regarding stability, full construction, navigation systems, etc.

## SAAR S-72 Particulars

Length Overall	72.00 m
Beam, Molded	10.25 m
Draught	2.92 m
Flight Deck	10 × 15.3 m
Displacement	Abt. 800 tons
Engines	2×MTU 16V1163M94
Max. Speed	Above 30 Knots
Sustained Speed	28 Knots
Cruising Speed	18 Knots
Range at 18 Knots	Above 3000 NM
Endurance	21 Days
Crew	50 + 20 special troops



# "SHALDAG" FAST PATROL BOAT



Our experience Your benefit

## ISRAEL SHIPYARDS LTD.

P.O.Box 10630  
Haifa Bay 2611702, Israel  
Tel: 972-4-8460246  
Fax: 972-4-8418744  
E-mail:  
marketing@israel-shipyards.com  
Web Site: www.israel-shipyards.com

**The best solution for interdiction of seaborne terrorism / smuggling and illegal activities**

**The new SHALDAG MK III is operational in the Israeli Navy**

### General Description

The SHALDAG Fast Patrol Boat series are multi mission combat proven all aluminium vessels for security tasks where high intercept speeds are required.

Operational experience gained from several Navies was implemented in the new SHALDAG MK III Model.

### The boat's special characteristics are:

- High speed in rough seas.
- Good seakeeping.
- Outstanding maneuverability.
- Exceptionally low slamming in all sea states.
- Dry decks at all speeds.
- Minimal draft, allowing operation in shallow waters.
- Very spacious and accessible internal arrangements.
- Low vibrations and accelerations.



### Various Weapon

#### Configurations are available:

- Remotely controlled gun systems - up to 30 mm (SS missiles are optional)
- Stand alone guns - 20 - 23 mm Twin or single barrel
- Heavy machine guns - 0.5" / 7.62 mm
- Most advanced day and night vision system

### Dimensions

**Length Overall**  
**Beam Max.**  
**Draft Max.**  
**Displacement**  
**Engines**  
**Waterjets Propulsors**  
  
**Max Speed**  
**Sustained Speed**  
**Range at 32 Knots**

	SHALDAG MK II	SHALDAG MK III
Length Overall	24.80 m	26.30 m
Beam Max.	6.00 m	6.00 m
Draft Max.	1.20 m	1.20 m
Displacement	abt. 58 tons	abt. 66 tons
Engines	MTU	MTU
Waterjets Propulsors	LIPS / KAMEWA / MJP	LIPS / KAMEWA / MJP
Max Speed	48 Knots.	45 Knots
Sustained Speed	Over 40 Knots.	40 Knots
Range at 32 Knots	650 Nm	700 Nm

**RAFAEL**  
**ADVANCED DEFENSE SYSTEMS**  
 P.O.Box 2250 (19)  
 Haifa 3102102, Israel  
 Tel: 972-73-3354714  
 Fax: 972-73-3354657  
 E-mail: intl-mkt@rafael.co.il  
 Web Site: www.rafael.co.il

■ **DEEP LINK - Low Probability of Intercept Acoustic Communication Network**

DeepLink's dimensions enable the system to be carried by small underwater vehicles or divers.

Using CDMA communication with MIMO (Multi-Input, multi-Output) techniques, DEEPLINK overcomes.

The multipath interferences of the UWAC, ensuring high reliability in various environments such as deep Water, shallow water, harbors and etc. DEEPLINK is designed as an ad-hoc network including a multi-hop mechanism. Both built-in message distribution protection and multi-hop mechanisms increase the reliability of the network and the connectivity between nodes, providing solution for non-line-of-sight scenarios.

DEEPLINK supports both SMS and navigational control messages, allowing the user to create his own Mission status. Each node contains a user interface which includes virtual keyboard (for SMS writing), navigation system and network display.

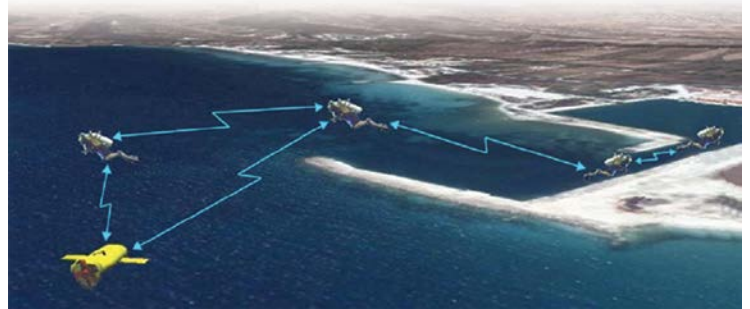

■ **SEA-COM - IP/VoIP Shipborne Communication System**

Sea-Com provides a full, modular, IP based Naval Ships & Submarines communication suite. Full integrates internal communication: voice, data, video & external communication Systems: HF, V/UHF and Satcom. Easy mission planning & allocation of the ships radio and antenna Distributed architecture provides high availability & scalability Meets harsh naval environmental conditions.



# NAVAL RADARS



## IAI ELTA SYSTEMS LTD.

P.O.Box 330, Ashdod 7710202, Israel  
Tel: 972-8-8572410  
Fax: 972-8-8561872  
E-mail: [market@elta.co.il](mailto:market@elta.co.il)  
Web Site: [www.elta-iai.com](http://www.elta-iai.com)

### Multi-Function Surveillance, Track and Guidance Radar

#### ELM-2248 MF-STAR

The MF-STAR (ELM-2248) is a multi-function solid-state active conformal phased array radar system for the new generation of military ships. The radar system delivers a high quality arena situation picture and weapons support, under the toughest target and environmental conditions, in the current and future naval arena. The MF-STAR antenna includes 4 faces of active arrays in S-band frequency. The antenna can be tailored to fit even relatively small ship sizes (such as corvettes).



### ALPHA - Advanced Lightweight Phased Array Naval Radar

#### ELM-2258

The ELM-2258 ALPHA is a multi-function solid-state active phased array radar system for the new generation of medium sized combat ships. The ALPHA Radar antenna consists of a rotating/scanning, two-dimensional active array in the S-band that is suited for installation on-board a variety of ship classes such as corvettes, frigates and larger vessels. The radar system delivers high quality naval theater situation awareness pictures and supports the ship's weapon systems, under the toughest target and environmental conditions in the current and future naval arena.

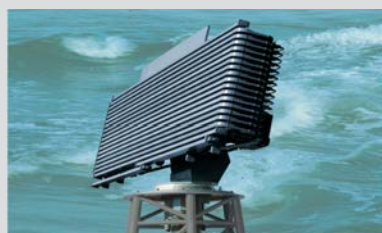

### Surveillance & Threat Alert Radar

#### ELM-2238 STAR

The STAR is a fully coherent S-band Pulse Doppler 3D multi-beam and multimode search radar. The radar performs simultaneous Long Range Air Surveillance combined with surface surveillance providing fast detection and automatic threat alert of air targets with an extremely low false alarm rate. STAR supports surface gunnery engagements through a unique splash-spotting capability and anti-air warfare through target designation to the fire control system. The STAR's azimuth and elevation tracking accuracy and its high update rate makes it an excellent choice for Anti-Air & Anti-Missile weapon systems.

### Search, Track & Guidance Radar

#### ELM-2221

The STGR is an advanced light weight shipboard coherent Pulse Doppler dual-band (X/Ka) monopulse tracking radar, optimized for operation in adverse sea, clutter and electromagnetic environmental conditions. The multimode STGR performs Surface-to-Air Missile (SAM) guidance, Surface-to-Surface Missile (SSM) guidance, and automatic gun fire control against surface and air targets and has several search modes as a backup to the vessels main search radar. The STGR comes in both X and X/Ka configurations.



# BARAK-8

## NAVAL AND LAND BASED



Israel Aerospace Industries Ltd.  
Systems Missiles & Space Group

### BARAK-8 Air & Missile Defense System

Naval & Land-based, Short to long Range, Point & Area

#### AIR & MISSILE DEFENSE DIVISION

P.O.Box 105  
Yehud Industrial Zone  
5610002, Israel  
Tel: 972-3-5315699  
Fax: 972-3-5315830  
E-mail: [marketing@iai.co.il](mailto:marketing@iai.co.il)  
Web Site: [www.iai.co.il](http://www.iai.co.il)

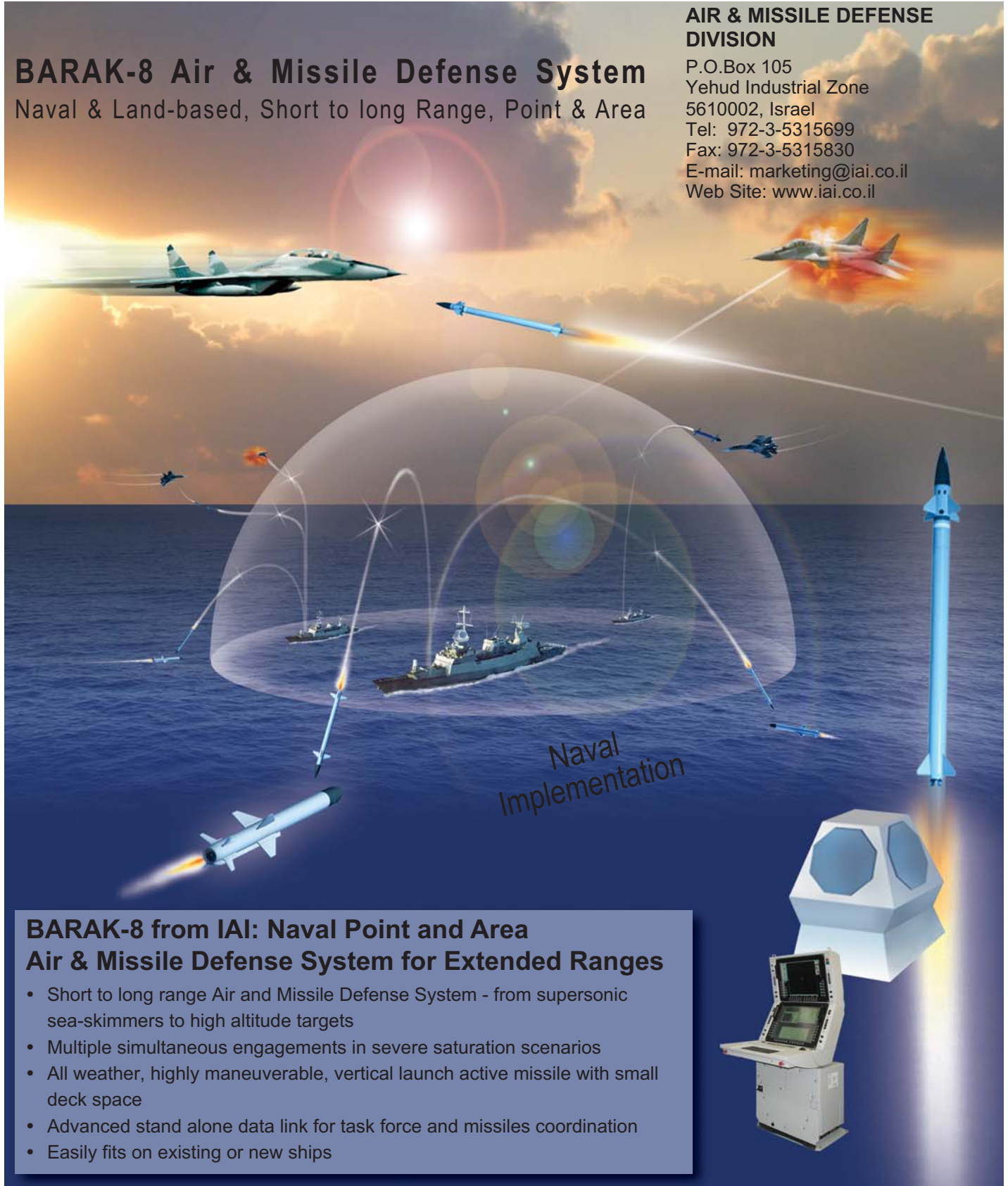

Naval  
Implementation

### BARAK-8 from IAI: Naval Point and Area Air & Missile Defense System for Extended Ranges

- Short to long range Air and Missile Defense System - from supersonic sea-skimmers to high altitude targets
- Multiple simultaneous engagements in severe saturation scenarios
- All weather, highly maneuverable, vertical launch active missile with small deck space
- Advanced stand alone data link for task force and missiles coordination
- Easily fits on existing or new ships



# NAVAL FORCES

## Fire Power & Protection



ISRAEL MILITARY INDUSTRIES LTD. (IMI)

P.O.Box 1044, 64 Bialik Blvd.  
Ramat Hasharon 4711001, Israel  
Tel: 972-3-5485222  
Fax: 972-3-5486125  
E-mail: imimrktg@imi-israel.com  
Web Site: www.imi-israel.com

### CIDS

An advanced Coast & Islands Defense System for the protection of critical infrastructure and key assets in sea and coastal areas. The missile-based solution offers a comprehensive and synergistic system of elements and supporting capabilities designed to address naval and ground forces, strategic and operational needs. CIDS' multi-functional solution enables simultaneous firing of several extremely versatile missiles which are all capable of defeating a wide range of naval targets.

### TRIGON

TRIGON is a naval version of the 306mm EXTRA rocket system. The rocket system provides precise long range capability by either day or night and under all weather conditions. Its equipment allows for a reduced crew for accomplishing a complete fire mission including loading and unloading operations.

TRIGON guarantees increased naval independence and enhanced naval value in joint force operations. The system has a maximum range of 150 km and a Circular Error of Probability (CEP) of 10 meters.

### DELILAH SL

DELILAH SL is an advanced Ship-Launched version of the combat-proven DELILAH missile. The long range, high-subsonic stand-off missile is designed to defeat high value mobile, fixed and relocatable targets at extended ranges, with pinpoint accuracy. The missile includes an E/O seeker for target discrimination at day, night and during adverse weather. Additional features include real time video imagery for man-in-the-loop, autonomous navigation, pre-programmed mission with post launch update and target selection.

### BALLISTIC PROTECTION FOR MARITIME VESSELS

IMI offers advanced ballistic protection for maritime vessels. Based on a hybrid composite of metals and ballistic ceramics, the add-on armor protects vital areas, such as the Command Bridge, fuel tanks and ammunition stores, and provides protection against up to 14.5mm ammunition. The lightweight armor significantly minimizes the weight penalty and is easy to install.

### ASA35A1 FLOATING PERSONAL BODY ARMOR

The ASA35A1 is a lightweight, floating personal body armor designed for use by marines, sailors and coast guard personnel. The body armor provides Level IIIA bullet-resistant protection, in accordance with NIJ Standard 0101.04. It comes in a variety of sizes and can be tailored with front and rear pockets for add-on Level III/IV body armor.

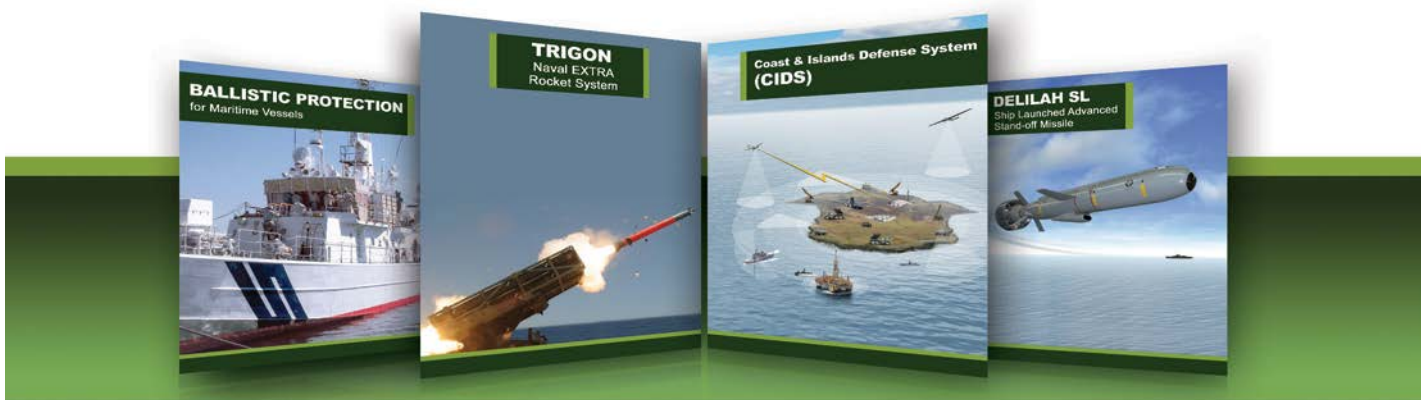

# NAVAL ATTACK SYSTEMS



## RAFAEL ADVANCED DEFENSE SYSTEMS

P.O.Box 2250 (19)  
Haifa 3102102, Israel  
Tel: 972-73-3354714  
Fax: 972-73-3354657  
E-mail: [intl-mkt@rafael.co.il](mailto:intl-mkt@rafael.co.il)  
Web Site: [www.rafael.co.il](http://www.rafael.co.il)

### ■ TYPHOON FAMILY - Naval Weapon Station for Anti-Terror / Force Protection

The TYPHOON is remotely operated from an operator console. Operation sequence includes surveillance, target identification, automatic tracking and engagement. The TYPHOON can be operated as a stand-alone system relying on its own sensors and controls, or alternatively through integration to other onboard combat systems. The built-in ballistic computer calculates a firing solution based on target and own-ship data, as well as environmental factors, feeding the gun mount with lead angle and super-elevation that result in high hit probability. An electro-optical director, coupled with the fire control computer and automatic tracker, maintain on-going engagement until mission success.



The Typhoon family has set the standards for stabilized, remotely controlled, small caliber, naval gun systems. The TYPHOON can serve as a secondary gun for large vessels, as well as main gun for patrol boats. Firepower can be boosted with on-mount integration of various missile types.

The MINI-TYPHOON is a lightweight, naval, stabilized and remote operated machine gun system.

The MINI-TYPHOON is an optimal solution as perimeter protection for large vessels. The MINI-TYPHOON can also function as main gun for small, fast patrol boats, significantly enhancing hit probability under rough conditions.



### ■ SPIKE NLOS - Rafael's Ultra - Long Range, High-Impact SPIKE Missile

SPIKE NLOS is an electro-optically guided multipurpose missile for ranges of up to 25 km with pinpoint accuracy and midcourse navigation. The weapon system can be launched from land, air and naval platforms.

#### SPIKE-ER – Multi-Purpose Missile System for Combat Vehicles, Helicopters and Naval Vessels

The SPIKE-ER is an extended-range, multi-purpose anti-armor missile system designed for mounting on various platforms, including helicopters, fast boats and combat vehicles. It can also be dismounted to a ground position and fitted onto a tripod. SPIKE-ER is capable of defeating tanks at a range of up to 8 kilometers.



# NAVAL DEFENSE SYSTEM

*Rafael is a world class provider of Naval Combat Systems, offering a wide range of naval systems, which have been developed based on the company's extensive experience and know-how in defense technology.*

*Rafael's naval systems provide solutions for any capability gap in naval surface warfare, ship defense, anti-submarine and underwater warfare, and costal defense.*

## Ship Defense systems:

Integrating soft-kill and hard-kill systems. These includes the PROTECTOR unmanned surface vehicle integrated with MINI-TYPHOON stabilized weapon station or non-lethal weapon provide an effective solution for anti-terror force protection (AT/FP) tasks, C-PEARL DV ESM and SHARK ECM, IDS WIZARD (corner reflector), C-GEM active RF decoy and BARAK air-defense missiles.

## Underwater systems:

### ■ TORBUSTER

Combined Soft Kill/Hard Kill Torpedo Decoy

The TORBUSTER is a fourth generation torpedo decoy for submarines. It provides effective defence against all types of acoustic homing torpedoes. Upon detection of an incoming torpedo (external to the system), the TORBUSTER system will launch a decoy from an external launcher. The decoy will propel itself to a safe distance from the submarine, and seduce the incoming torpedo by transmitting specific acoustic signals using a technology based on the Scutter, reactive acoustic decoy.



### ■ DEEP LINK - Low Probability of Intercept Acoustic Communication Network

DeepLink's dimensions enable the system to be carried by small underwater vehicles or divers.

Using CDMA communication with MIMO (Multi-Input, multi-Output) techniques, DEEPLINK overcomes .The multipath interferences of the UWAC, ensuring high reliability n various environments such as deep Water, shallow water, harbors and etc.

DEEPLINK is designed as an ad-hoc network including a multi-hop mechanism. Both built-in message distribution protection and multi-hop mechanisms increase the reliability of the network and the connectivity between nodes, providing solution for non-line-of-sight scenarios.

DEEPLINK supports both SMS and navigational control messages, allowing the user to create his own

Mission status. Each node contains a user interface which includes virtual keyboard (for SMS writing), navigation system and network display.



## RAFAEL ADVANCED DEFENSE SYSTEMS

P.O.Box 2250 (19)  
Haifa 3102102, Israel  
Tel: 972-73-3354714  
Fax: 972-73-3354657  
E-mail: intl-mkt@rafael.co.il  
Web Site: www.rafael.co.il

### ■ SCUTTER - Reactive Expendable Acoustic Torpedo Countermeasure

SCUTTER is a self-propelled, third generation reactive, expendable torpedo Countermeasure, capable of Protect a submarine from passive and active acoustic homing torpedoes. Scutter has a threat library, based on intelligence programmed by the user, which is used to select the appropriate response. Designed to respond simultaneously to multiple torpedoes of various types. SCUTTER is self-destructs at the end of its mission.

An effective defense for surface ships in addition to submarines, SCUTTER is operational in several World-class navies.



### ■ LESCUT - Torpedo Countermeasure for Surface Ships

LESCUT is an intelligent, third generation reactive Countermeasure, designed to identify the incoming threat and provide a customized response. Surface vessel-launched, LESCUT is designed to respond simultaneously to multiple torpedoes of various types , and programmed to defeat all types of modern torpedo logic, including range gates, Doppler shift, pulse discrimination, AGC/DVG, and more.

LESCUT requires no pre-launch input or tests, shortening the response time and eliminating errors due to incorrect settings or Operator mistakes. Lescut is based on the Ultra Electronic Oceans Systems hardware and Rafael's proven Reactive acoustic module electronics and software.



# NAVAL DEFENSE SYSTEM

Rafael is a world class provider of Naval Combat Systems, offering a wide range of naval systems, which have been developed based on the company's extensive experience and know-how in defense technology.

Rafael's naval systems provide solutions for any capability gap in naval surface warfare, ship defense, anti-submarine and underwater warfare, and coastal defense.

These combat systems, stand-alone as well as integrated combat suite, are the optimal solution for both newly constructed and upgraded naval vessels.

Rafael's naval combat systems have been successfully tested, and proven in real combat situations, and are currently in service with numerous navies around the world.

## **Rafael's Naval Combat Systems includes:**

### **Naval Surface systems:**

**PROTECTOR®USV** - is an unmanned integrated system for Intelligence, Surveillance, Target Acquisition and Reconnaissance (ISTAR). The PROTECTOR®USV is fitted with a comprehensive sensor suite and can accommodate a variety of mission modules.

Based on a highly maneuverable platform the USV has excellent maneuvering capabilities. The platform has water jet propulsion systems powered by diesel engines. The platform systems include control over propulsion, maneuvering, and navigation.

The PROTECTOR's core element is an advanced control system, which interfaces with all of the PROTECTOR's sub-systems and provides a remote operator with the ability to plan, prioritize and execute naval missions by day and night, under adverse weather conditions, without exposure to risk.

The PROTECTOR's modular design enables the Customer to select those sub-systems that will best meet his own particular operational requirements.

When mounting effectors, the PROTECTOR can effectively close the fire circle for an all-round "sensor-to-shooter" solution.

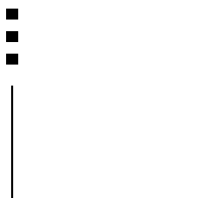

## **TYPHOON Family - Naval Weapon Station for Anti-Terror / Force Protection**

The TYPHOON is remotely operated from an operator console. Operation sequence includes surveillance, target identification, automatic tracking and engagement. The TYPHOON can be operated as a stand-alone system relying on its own sensors and controls, or alternatively through integration to other onboard combat systems. The built-in ballistic computer calculates a firing solution based on target and own-ship data, as well as environmental factors, feeding the gun mount with lead angle and super-elevation that result in high hit probability. An electro-optical director, coupled with the fire control computer and automatic tracker, maintain on-going engagement until mission success.

The TYPHOON family has set the standards for stabilized, remotely controlled, small caliber, naval gun systems. The TYPHOON can serve as a secondary gun for large vessels, as well as main gun for patrol boats. Firepower can be boosted with on-mount integration of various missile types.

The MINI-TYPHOON is a lightweight, naval, stabilized and remote operated machine gun system.

The MINI-TYPHOON is an optimal solution as perimeter protection for large vessels. The MINI-TYPHOON can also function as main gun for small, fast patrol boats, significantly enhancing hit probability under rough conditions.

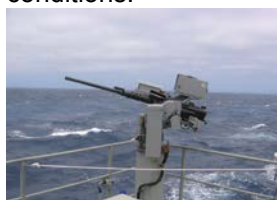



**RAFAEL**  
**ADVANCED DEFENSE SYSTEMS**  
P.O.Box 2250 (19)  
Haifa 3102102, Israel  
Tel: 972-73-3354714  
Fax: 972-73-3354657  
E-mail: intl-mkt@rafael.co.il  
Web Site: www.rafael.co.il

## TOPLITE

### Electro-Optical Surveillance, Observation & Targeting System

TOPLITE is RAFAEL's advanced high performance stabilized sight system operational in several navies worldwide.

TOPLITE EOS (electro-optical system) provides advanced day/night all-weather observation and precision targeting in a compact, high-stability multi-sensor payload. COMBAT-PROVEN, TOPLITE EOS delivers maximum performance in minimum space on aircraft, helicopters, naval vessels and land vehicles. TOPLITE EOS is a derivative of Rafael's state-of-the-art LITENING targeting and navigation pod.

The TOPLITE is used for target detection, identification, tracking and engagement. The Mini-Typhoon or the Water Cannon can be slaved to the TOPLITE Line of Sight.



## SEA SPOTTER IRS<sup>2</sup>T

### Naval IR Staring and Tracking System

The Sea Spotter is an advanced Naval IRST system that will enable a naval vessel to automatically locate and pinpoint threats and targets located around it without being exposed to enemy systems.

The system, dubbed Sea Spotter, is a new generation (third generation) infrared staring system that is capable of automatically locating both surface and airborne targets, supersonic and slow, very small targets above and around the vessel, from horizon to zenith and transferring the data to the ship's combat system for interception.

Based on infrared sensors, the Sea Spotter is a completely passive system. Unlike electromagnetic radar systems, it does not emit any signals, so that as part of its situational awareness, it can "see" but not be seen without emitting any beams and without giving away the ship's position.

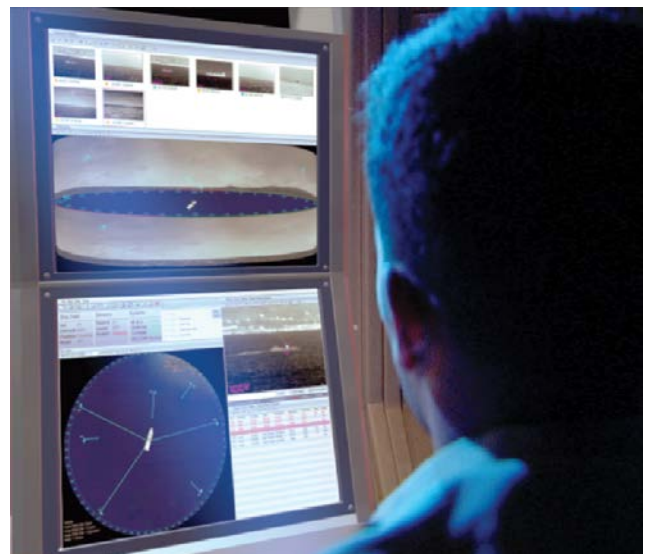

# NAVAL ELECTRONIC WARFARE SOLUTIONS FOR LATEST GENERATION SURFACE VESSELS AND SUBMARINES

**Elbit Systems**

*EW and SIGINT - Elisra*

**ELBIT SYSTEMS  
EW & SIGINT - ELISRA LTD.**

48 Mivtza Kadash St.,  
Bene Beraq 5121701, Israel  
Tel: 972-3-6179798  
Fax: 972-3-6175880  
E-mail: [ew-sigint@elbitsystems.com](mailto:ew-sigint@elbitsystems.com)  
Web Site: [www.elbitsystems.com](http://www.elbitsystems.com)



Elbit Systems EW and SIGINT Elisra's **Aqua Marine** is an integrated all-digital naval RESM/CESM/LWS and ECM, combat-proven, modular family of advanced naval EW suites. Fully integrable and interoperable, these fifth generation lightweight and small-footprint systems provide situational awareness, electronic attack, ship self-defense, and electronic intelligence. The Aqua Marine suite is designed to operate in littoral and blue water environments, handles very high pulse rates including POP (Pulse on Pulse), and deals simultaneously with advanced threats. Exceptionally sensitive, maintaining a frequency wide open mode, Aqua Marine detects radar threats in advance, including over-the-horizon threats. The uniquely flexible and modular solution is suitable for all types of surface vessels and submarines.

**NATACS 2020** is an advanced naval tactical COMINT/DF system delivering a full naval picture through sophisticated handling of agile communications. A new generation of naval EW systems, this fully integrated system is capable of coping with advanced frequency communication radios. Equipped with ultrafast, wide band receivers and direction finding systems, NATACS 2020 is the only on-board COMINT/DF system of its kind. With outstanding scanning rates, the system is capable of handling extremely dense electromagnetic environments in the HF/VHF/UHF/HUHF frequency bands, characterized by frequency hopping, burst and other agile transmissions.

The system's COMINT antenna can be integrated with an ESM antenna - thus allowing maximum utilization of the vessel's mast, as well as enabling significant space savings and completion of the mission-critical tactical naval picture

Operating optimally in the densest electromagnetic environments, the **TIMNEX II ESM/ELINT** system for submarines and surface ship supports fast and efficient detection, bearing information, identification and tracking of electromagnetic emissions. TIMNEX II is a modular systems that can be configured as a stand-alone system or fully integrated with the platform Combat Management System (CMS).

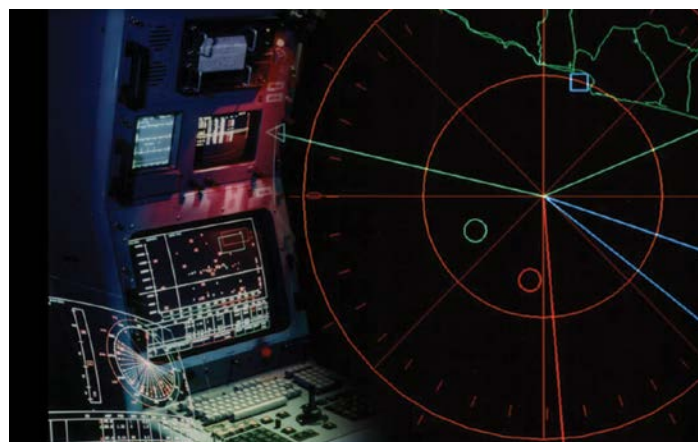

# MORE



MILITARY OPTICAL RF EQUIPMENT Ltd.

## Shed new light on the EW arena

**MORE**

**Military Optical RF Equipment Ltd.**

18 Hasivim St., P.O.Box 7551

Kiryat Matalon, Petach-Tikva 4959376, Israel

Tel: 972-3-9208200

Fax: 972-3-9215010

E-mail: [meir@eimmore.co.il](mailto:meir@eimmore.co.il)

Web Site: [www.eimmore.co.il](http://www.eimmore.co.il)

### Four main area activities:

#### ▶ ECM solutions

The core technology is based on RF-Photonic capabilities.

This new approach is based on completely analog RF-Photonic design, that provides the possibility for creating complex multi target scenarios for any radar waveforms.

The MORE solution main features include: full analog design, Ultra Wide Immediate BW, Coherent and multiple overlapping targets generation, Wide Band amplitude and phase manipulation, Multiple emitters engagement simultaneously.



#### ▶ Ultra Wide BW spectrum sensing

MORE capabilities, give a huge advantage to intercept, investigate and derive the features of complex RF signals in wide frequency BW (100MHz - 40GHz).

The application includes: RWR, ESM, ELINT.

#### ▶ RADAR & ECM simulators

MORE core capabilities enables applications for: RADAR Target Simulator for testing and calibrating of coherent RADAR systems, Test Equipment for acceptance test and maintenance, and ECM technique simulator for ECCM technique validation.

#### ▶ RF and Data over fiber connectivity

MORE line of solutions includes also RF Over Fiber (RADOF). The RADOF (TX & RX) is a complete solution for remote RF controlled systems over optical fiber, with unique feature, RF BW supporting up to 18GHz, High Dynamic Range, Built In monitoring and control, multi module connectivity option over single fiber (Point to Multi-Point).



# ***ELECTRONIC WARFARE AND COUNTERMEASURES***

## ■ **SEA SPOTTER IRS<sup>2</sup>T - Naval IR Staring and Tracking System**

The Sea Spotter is an advanced Naval IRST system that will enable a naval vessel to automatically locate and pinpoint threats and targets located around it without being exposed to enemy systems.

The system, dubbed Sea Spotter, is a new generation (third generation) infrared staring system that is capable of automatically locating both surface and airborne targets, supersonic and slow, very small targets above and around the vessel, from horizon to zenith and transferring the data to the ship's combat system for interception.

Based on infrared sensors, the Sea Spotter is a completely passive system. Unlike electromagnetic radar systems, it does not emit any signals, so that as part of its situational awareness, it can "see" but not be seen without emitting any beams and without giving away the ship's position.

## ■ **SCUTTER - Reactive Expendable Acoustic Torpedo Countermeasure**

SCUTTER is a self-propelled, third generation reactive, expendable torpedo Countermeasure, capable of Protect a submarine from passive and active acoustic homing torpedoes. Scutter has a threat library, based on intelligence programmed by the user, which is used to select the appropriate response. Designed to respond simultaneously to multiple torpedoes of various types. SCUTTER is self-destructs at the end of its mission.

An effective defense for surface ships in addition to submarines, SCUTTER is operational in several World-class navies.



■ ■ ■

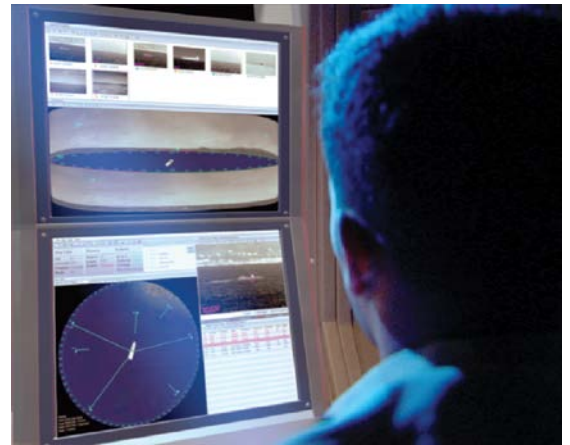

## ■ **TORBUSTER - Combined Soft Kill / Hard Kill Torpedo Decoy**

The TORBUSTER is a fourth generation torpedo decoy for submarines. It provides effective defence against all types of acoustic homing torpedoes.

Upon detection of an incoming torpedo (external to the system), the TORBUSTER system will launch a decoy from an external launcher. The decoy will propel itself to a safe distance from the submarine, and seduce the incoming torpedo by transmitting specific acoustic signals using a technology based on the Scutter, reactive acoustic decoy.



**RAFAEL  
ADVANCED DEFENSE SYSTEMS**

P.O.Box 2250 (19)  
Haifa 3102102, Israel  
Tel: 972-73-3354714  
Fax: 972-73-3354657  
E-mail: intl-mkt@rafael.co.il  
Web Site: www.rafael.co.il

■ **LESCUT - Torpedo Countermeasure for Surface Ships**

LESCUT is an intelligent, third generation reactive Countermeasure, designed to identify the incoming threat and provide a customized response. Surface vessel - launched, LESCUT is designed to respond simultaneously to multiple torpedoes of various types, and programmed to defeat all types of modern torpedo logic, including range gates, Doppler shift, pulse discrimination, AGC/DVG, and more. LESCUT requires no pre-launch input or tests, shortening the response time and eliminating errors due to incorrect settings or Operator mistakes. Lescut is based on the Ultra Electronic Oceans Systems hardware and Rafael's proven Reactive acoustic module electronics and software.



■ **C-PEARL-DV - Compact, High Performance Digital ESM System**

C-Pearl-DV is a digital naval Electronic Support Measures (ESM) system that enables automatic detection, data measurement and identification of threats. Designed to fit on-board all types of ships, including OPVs, frigates and destroyers.

The C-Pearl-DV meets naval standard requirements. Operated by a single crew member, C-Pearl-DV features high reliability and low maintenance, as well as full modularity, enabling expansion According to user requirements. The C-Pearl family of ESM systems is fully qualified and operational in conjunction with on-board radars and can be integrated with Rafael's Digital Shark ECM system and to the ship's Combat Management System (CMS) and other on-board combat and data systems.



■ **SEWS - Digital Shipborne Electronic Warfare Suite**

SEWS-DV is a naval EW suite comprised of digital receivers and digital technique generators, Optimized to handle very dense electromagnetic environments. Capable of threat identification and simultaneous jamming and deception of multiple threats, the SEWS-DV is designed for both ESM and ECM applications.

The system features high effective radiated power (ERP), an advanced DRFM-based technique generator and sophisticated power management techniques. From real-time detection and analysis in a complex electromagnetic environment to the identification, jamming and deceiving of surface ships, attacking missiles, aircraft and radar sites, the SEWS-DV is the system of choice, whatever the threat.

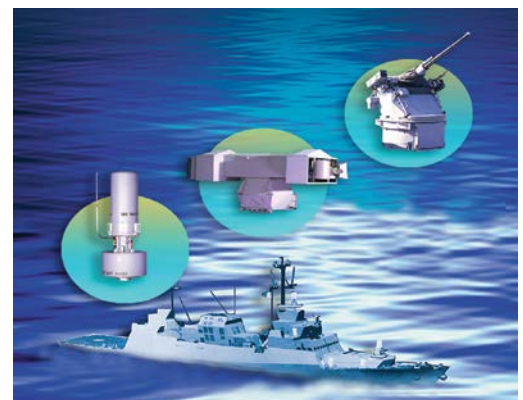

# NAVAL TRAINING & SIMULATION SYSTEMS

**Elbit Systems**

**ELBIT SYSTEMS LTD.**

P.O.Box 539

Advanced Technology Center

Haifa 3105301, Israel

Tel: 972-4-8315315

E-mail: [aerospace@elbitsystems.com](mailto:aerospace@elbitsystems.com)

Web Site: [www.elbitsystems.com](http://www.elbitsystems.com)

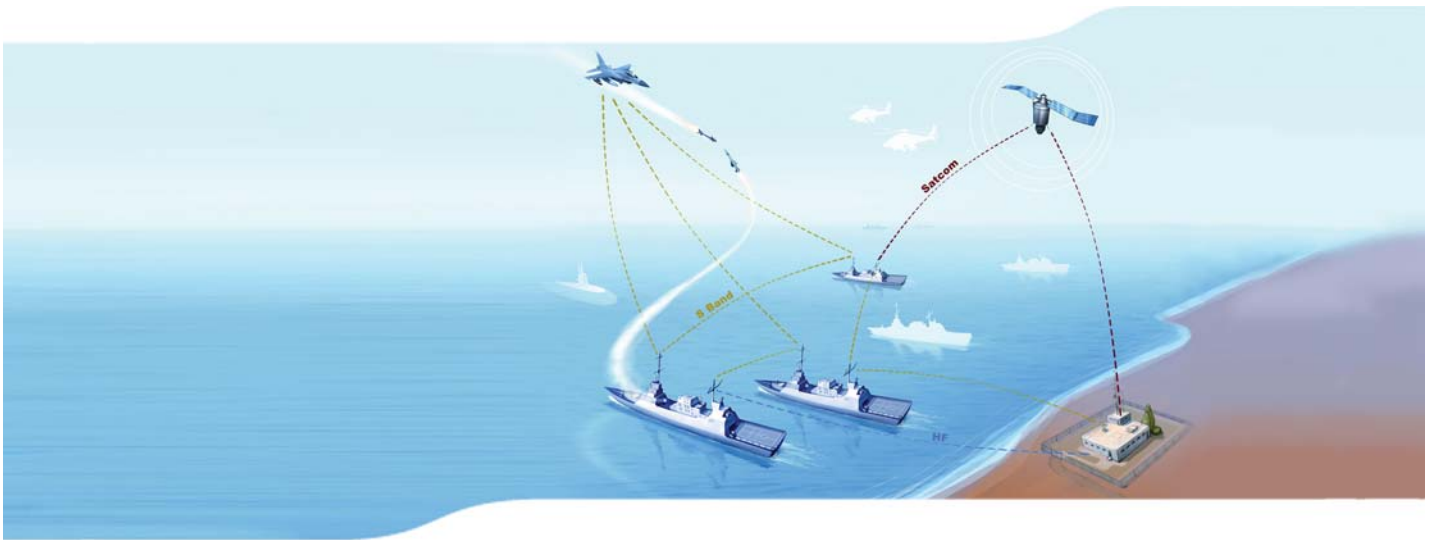

## **NTT - Naval Tactical Trainer**

The NTT is an advanced tactical and procedural warfare training system, covering multi-threat scenarios including anti-surface warfare, anti-submarine warfare, anti-air warfare, counter-terrorism operations, littoral warfare, electronic warfare, and others. It allows training to be performed with worldwide multi-threat scenarios from subunit to force levels. It can expand to support operators' training at console level allowing simulation and stimulation of specific combat systems.

Trainees benefit from a realistic, up-to-date naval operations environment, in which they draw upon their theoretical knowledge and undertake naval operations in real-time with the objective of improving abilities, and testing and evaluating new tactics. NTT architecture enables the connection and sharing of the training scenario with other tactical training systems thus supporting joint force tactical training.

## **NCMI - Naval Combat Maneuvering Instrumentation system**

Modern naval combat requires a high level of expertise in all modes of littoral and maritime warfare.

The NCMI system instruments the different combat systems and stimulates superimposed detections of virtual targets while displaying actual detections on the operational systems.

The coherent exercise situation is distributed via a dedicated simulation Data Link network to all participants.

The NCMI solution was designed by naval officers in order to achieve high level naval warfare training. It is a full scale ready-to-run onboard training system that enables advanced onboard training both ashore and at sea.

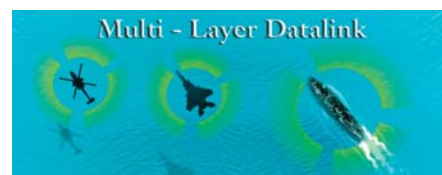

## **NTC - Naval Training Center**

The NTC is a unique training facility. It includes a Naval Tactical Trainer (NTT), Navigation Simulator and Close Range Weapon Trainer (CRWT). It enables individual training using each of the individual modules as well as combined and large scale exercises at all exercise posts. It is an ideal solution for all vessels, from utility through patrol boats and up to modern frigates. Designed for operator proficiency training as well as large scale naval combat scenarios from littoral and asymmetric warfare up to blue water warfare, its high-fidelity simulation software features advanced autonomous Computer Generated Forces (CGF) and physics based motion, sensor and weapon algorithms implemented through intuitive Graphic User Interface (GUI).



# NCMI - NAVAL EMBEDDED



## IAI MLM DIVISION

P.O.Box 45  
Beer-Yaakov 7035001, Israel  
Tel: 972-8-9272520  
Fax: 972-8-9272890  
E-mail: [mlm\\_marketing@iai.co.il](mailto:mlm_marketing@iai.co.il)  
Web Site: [www.iai.co.il](http://www.iai.co.il)



NCMI is a networked, on board training system that offers embedded training at sea using the warship's integral systems.

The NCMI embedded training solution allows the naval task force to exercise and rehearse its mission on the way to the location or at the location itself. This ability is extremely important nowadays as missions vary.

The system provides positive training as the training is performed on the real systems and the real environment, hence on the ship at sea.

The training system offers value to blue water navies as the navies can train "just on time" on the way to the mission, according to the relevant scenario, regardless of its distance from the home port simulators.

NCMI Provides federated (single ship) and confederated (multi ship) tactical training at sea. It presents the operators with a hybrid tactical environment composed of real and virtual targets. The entire ship, task force of even

the whole navy can train together according to the same scenario.

Various scenarios can be trained via the system, including anti symmetric warfare, anti piracy missions and traditional naval combat.

The ship can train against virtual entities (ships, submarines, helicopters, aircrafts). These entities are generated in high fidelity.

NCMI offers full Interoperability between ships, helicopters, aircrafts and ground based systems - regardless of distance between them and the home port.

NCMI is integrated with the combat systems via the combat LAN (other solutions are available for legacy platforms). High Fidelity virtual entities are displayed as real entities to the combat system operators. The combat system suite reacts to the virtual entities in a similar manner to its reaction to real targets. For example, a simulated missile fired towards the ship will be viewed by the trained crew as a real one.

# Advanced Sonar and Acoustic Applications



## DSIT SOLUTIONS LTD.

2 Rechavam Zeevi St.,  
Givat Shmuel 5401777, Israel  
Tel: 972-3-5313333  
Fax: 972-3-5313322  
E-mail: [marketing@dsit.co.il](mailto:marketing@dsit.co.il)  
Web Site: [www.dsit.co.il](http://www.dsit.co.il)

### ▼ AquaShield™ Diver Detection Sonar (DDS)

DSIT Solutions Ltd. provides highly accurate and effective underwater security systems for the protection of critical waterside and offshore assets. Our fully automatic Shield™ family of diver detection sonar (DDS) systems includes the long range AquaShield™ DDS and the light, portable PointShield™ PDDS.

### ▼ Static Active Sonar (SAS)

The SAS is a powerful surveillance system that guards the coastline against approaching enemy submarines and other smaller submersible intruders.

### ▼ Portable Acoustic Range (PAR)

Accurately measures the radiated noise of submarines and ships at significantly reduced costs to enable shipyards and navies to reduce vessel noise.

### ▼ Underwater Acoustic Signature Analysis (UASA)

A system that analyzes all types of acoustic signals from submarine sonars, towed arrays, fixed bottom moored sonar systems, etc. to derive the platforms' acoustic signatures.

### ▼ Submarine Simulators and Trainers

DSIT offers a wide range of sonar simulation solutions for all levels of sonar operations: Operator, Team, and Tactical. The company's flagship trainer is a full mission Submarine Tactical Trainer, a trainer that accurately simulates all sonar and weapon systems present on board a submarine.



### Portable Acoustic Range



## COMPANY DESCRIPTION

DSIT develops and produces advanced sonar systems for the defense, commercial, energy and homeland security markets. Our systems provide customers with state of the art underwater technologies for site security as well as acoustic measurement & analysis and sonar training & simulation. The company is a subsidiary of Acorn Energy Inc. (NASDAQ: ACFN).





# LAND FORCES



## Advanced Technology for Modern Land Systems

Modern land warfare has shifted from the massive deployment of large military formations, using heavy firepower, to the use of agile and effective 'hybrid' forces. They are relying on smaller, better-protected forces equipped to deliver more effective firepower to achieve decisive and measured effects.

The Israel Defense Force (IDF) land forces have adapted this concept for many years, employing advanced, battle-proven systems developed in Israel and designed to perform effectively in both low- and high-intensity battlespace. From the Merkava Mk4 and Namer Armored Infantry Fighting Vehicles, to precision missiles and guided projectiles, Israeli-made systems are providing the IDF with the battle-winning technological advantages which its soldiers rely upon.

Based on the know-how that accumulated with such sophisticated platforms, Israel's defense industries are also offering equipment-upgrading solutions meeting evolving military requirements.

Such systems support numerous domestic and foreign modernization programs, extending the life span of tanks, armored personnel carriers, mortar and artillery systems and wheeled armored vehicles of western and eastern origin. Programs often comprise armor improvements, integration of remotely controlled weapon stations, optronic and battle management systems, threat detection and countermeasures systems including active protection systems. Most upgrades also address logistical improvements, implementing integrated testing-and-fault isolation, embedded training and support.

The modern infantry equipment offered by Israel's defense industries includes a wide range of life saving kits, appliances and systems, including robotic systems, advanced electronic systems, sophisticated weapons and ammunition and more. Integrated into the Future Infantry Ensemble, such gear enables the dismounted leader to perform as an integrated element of the army-wide network-centric domain.

# MERKAVA Mk. 4

**The Merkava Mk. 4 Tank is the fourth generation of the Merkava family of tanks. Like its older generations, it represents the same basic design concept. It has many new systems and innovations in Protection, Mobility and Fire Power.**

## **Basic description:**

**Protection:** The Merkava family of tanks represents an aggregated approach regarding the protection concept. Top priority is assigned to protection and survivability. This is why the engine is located at the front end of the tank, utilizing its considerable weight to enhance the crew ballistic protection. The same idea applies to many other systems.

The Mk. 4 provides all-around protection, including "Trophy" – active protection system. The enhanced survivability is achieved also by the state of the art Laser Warning System.

**Mobility:** the Mk. 4 is equipped with a 1500 HP modern power-pack and a durable mechanical suspension. The automotive system enables the tank to negotiate rough terrain while maintaining crew comfort and suspension durability.

**Fire-Power:** The upgraded 120 mm main gun is capable of firing high power ammunition, to achieve better penetration capability from longer distances.

The advanced Fire Control System is capable of tracking, locking and hitting moving targets like tanks and helicopters.



**SIBAT - Israel Ministry of Defense**  
International Defense Cooperation  
Hakiryia, Tel Aviv 6473424, Israel  
Tel: 972-3-6975916  
Fax: 972-3-6934639  
E-mail: [sibat\\_bic@mod.gov.il](mailto:sibat_bic@mod.gov.il)  
Web Site: [www.sibat.mod.gov.il](http://www.sibat.mod.gov.il)

## **Many other modern systems were incorporated into the Merkava Mk. 4, including:**

- Advanced thermal imaging and TV systems.
- A new technology was utilized for the electrical turret control which enhances the first round hit probability.
- Modern Commander's stabilized Sight, Thermal and TV channels.
- An integrated command system, easily operated by the crew to control the tank systems.
- Rearward looking camera.
- An upgraded internal mortar, increased firing range.
- An auxiliary Battle Management System, including navigation capability.

The Merkava project has generated a considerable expansion of Israel's industrial and technological potential. Improved technologies related to tank manufacturing include welding and machining of large armor bodies, casting of ballistic steels, manufacturing guns, as well as electro-optical industries that utilize laser technology.

The Merkava project has enabled the export of many systems based on Merkava technology which have also been used to upgrade other tanks.



# MERKAVA Mk.-4

## Main Contractors



**סיבט** **SIBAT**

### SIBAT - Israel Ministry of Defense

#### International Defense Cooperation

Hakirya, Tel Aviv 6473424, Israel

Tel: 972-3-6975916

Fax: 972-3-6934639

E-mail: sibat\_bic@mod.gov.il

Web Site: www.sibat.mod.gov.il

**Achidatex Nazareth Elite (1977) Ltd.**

- Ballistic Shield

**Agam Maalot**

- Battery compartments
- General metal products

**Amcoram Ltd.**

- Periscope ballistic drive
- Peritelescope mount

**Ardonan Elec. Packing Industries Ltd.**

- Metal Works

**Ashot Ashkelon Industries Ltd.**

- Automotive suspension system
- Track Tension Mechanism
- Final drive
- Automatic transmission
- Navigation Systems

**Azimuth Tech. Ltd.**

**Bental Ind. Ltd.**

- Electrical Motors, Blowers for Air Filters

**Beth-EI Zikhron Yaaqov Ind.**

- Air Filtration Systems

**Blumstein Metal Works Ltd.**

- Metal Works

**Dynamica Design Ltd.**

- Noise and Vibration Control

**Elbit Systems Ltd.**

- Fire Control System
- Commander Panoramic Sight
- All Electric gun & Turret drive & stabilization System
- Battle Management System
- Laser Warning System
- Turret Vetronics
- Drivers Control Panel & Display

**Eltam Ein Hashofet**

- IDLS - Intelligent Dome Light System

**Fermet**

- Armor Castings

**I.A.I.-Ramta**

- Ballistic Armor
- Turret floor

**I.A.I.-Tamam**

- Inertial Measurement Unit (IMU)

**IDC Imco Industries Ltd.**

- Revolving Magazine
- Distribution, relay and control boxes
- Delay relays
- Headlights
- Electric cables & harnesses

**I.M.I.- Israel Military Industries Ltd.**

- 120 mm gun & ammunition
- Ballistic Armor
- Wire Race Turret bearing

**Isra-laser**

- Metal cutting, General metal products
- Optic Systems

**ITL Optronics Ltd.**

**Karmiel Ltd.**

**Kinetics Ltd.**

- General metal products
- Air Conditioning System
- NBC Protection System
- Transmission & Braking System Components
- Hydraulic Track Tensioning Mechanism
- Auxiliary Power Unit-APU
- Fuel System
- Engine Sensors

**Magam MER MTLM Mechanics Nir - Or Ltd.**

- Rubber fuel tanks
- Digital Communication
- Air duct deflecting and sealing system
- Controller Systems
- TCP/IP Communication Interface
- Optic Systems
- Water systems

**Opgal Oran-heating products Orlite OSG Palbam Pladot**

- Ammunition Containers
- afety Glass
- Fuel containers
- Air inlet and exhaust system
- Emergency Brake
- General Mechanical Items

**Peretz Yerushalmi Rada Elec. Ind. Rafael Ltd.**

- Ballistic Shield
- Optic Systems
- Ballistic Armor Components
- Trophy

**Reshef Tech. Ltd.**

**Ronen Metal Works Ltd.**

- Ammunition Fuzes
- Commander's mechine gun mount
- Gunner's Seat
- Machine Gun Mounts
- NBC system

**Shalon Chemical Ind. Simat Ltd.**

- Cooled NBC Garments
- Loader's and driver's hatches
- Crew seats
- General metal products
- Support wheels
- Road Wheel Hubs
- 60 mm internal mortar & ammunition
- Electrical Commander's Hatch
- Road Wheels

**Soltam Systems Ltd.**

- Fire extinguishing and suppression system
- Communication system
- V.R.C-120
- Inter communication system Vic

**Spectronix Ltd.**

**Tadiran Communications Ltd.**

- Fuel tank system
- Drinking water system
- Support wheels
- Fuel tank vent valve

**Tamor S.M.R. LTD.**

**T.A.T. Tec. Ltd.**

**Tefen**

- Precision castings

**Casting Ltd.**

- General metal products

**Tool Metal Ltd.**

- General Mechanic System
- Periscopes

**Uni-Scope Optical Sys. Ltd.**

**Urdan Industries Ltd.**

- Hull, front and deck castings
- Turret main body castings
- Road -idler and sprocket wheels, hubs, track shoes
- Various castings for suspension
- hydraulic bumpers.

**Vidco Ltd.**

- Thermal Sleeve

**Yail Noa**

- Air inlet selector
- Peritelescope mount
- Braking, steering
- Gearshift and accelerator systems

# NAMER - MERKAVA APC



**SIBAT - Israel Ministry of Defense**  
International Defense Cooperation  
Hakiryia, Tel Aviv 6473424, Israel  
Tel: 972-3-6975916  
Fax: 972-3-6934639  
E-mail: [sibat\\_bic@mod.gov.il](mailto:sibat_bic@mod.gov.il)  
Web Site: [www.sibat.mod.gov.il](http://www.sibat.mod.gov.il)

## General

The Merkava APC is built to meet a variety of combat missions and is planned as a common chassis to a family of vehicles (recovery, command, medical and more)

The Merkava APC is capable of carrying up to 12 people. Three crewmembers (commander, machine-gunner and driver) 8 infantrymen and an option for an additional crewmember.

The vehicle is equipped with advanced systems and has a high level of human engineering, based on the IDF experience in a variety of combat situations.

The APC was fielded late 2008 and took part in actual battle and peace-keeping operations since January 2009.

## Ballistic Protection & Survivability

Advanced armor technology based on modular special armor combined with active protection, roof and belly protection and emphasis armor coverage. The basic design concepts of the Merkava tank are applied: using the vehicle systems as extra protection to the crew, eliminating combustible materials from the crew compartment. NBC protection combined with air-conditioning system. The energy-absorbing crew seats are isolated from

the chassis thus eliminating shock-wave hazard. The rear ramp system enables fast and safe boarding and dismounting of the infantrymen.

## Fire Power

The APC is fitted with a remote controlled weapon system, using 0.5", 7.62mm or grenade launcher. The system is combined with day and night TV viewer. The APC is also equipped with additional 7.62mm machine gun, mechanically remote controlled and a 60mm mortar operated by the commander.

The commander's control system includes all-round day and night cameras, two of them are located in the crew compartment serving the crew. The commander also has a protected post for safe observation through his hatch.

An advanced control & communication system enabling efficient operation in the battlefield.

## Mobility

The running gear is similar to the Merkava Mk. 3, namely: 1200 Hp AVDS engine, Automatic RK304 transmission, external mechanical suspension with independent road arms and rotary shock absorbers.



# ASHOT ASHKELON INDUSTRIES LTD.



## *Drive train, suspension and mobility solutions for Tanks & APC's; tungsten based armor penetrators and fragments manufacturer*

### ASHOT ASHKELON INDUSTRIES LTD.

P.O.Box 21  
Ashkelon 7810001, Israel  
Tel: 972-8-6721511  
Fax: 972-8-6721711  
E-mail: info@ashot.co.il  
Web Site: www.ashot.co.il

Ashot provides build to print & build to specification, design and manufacturing of Suspensions Systems, Main Automatic Transmissions, Final Drives, Transfer Boxes, Drop Boxes, PTO's and wide range of Gear based assemblies and Shafts for Main Battle Tanks such as the Merkava and Abrams, Heavy & light Armored Personal Carriers (Tracked & Wheeled) such as the Namer, M113 and various of defense applications.

### Your Natural Partner

Ashot is a potential partner for innovative design and large scale production for your Main Battle Tanks and APC's global programs. Ashot combines sophisticated engineering and high quality production capabilities to meet its customer's needs.

### A one of its kind Combat Experience

Ashot engineers and program managers possess extensive and high ranked military background in the field of armored vehicle requirements and design. Ashot's design teams use their unique specialties, based on their vast experience and know-how in mobility and armored vehicles design, to define performance and requirements needed

in combat areas and at the battle field; these in-sights are translated into Ashot products designs and sustain a common language and a long term relationship with our end costumers, the fighting forces.

### In-House Development and Manufacture Synergy

Ashot is a vertically integrated company which owns full facilities and state-of-the-art equipment needed for design, manufacture, assemble and test of the myriad of military components produced under a single roof.

### References

Ashot solutions and products have been purchased by various international defense customers. All products had been tested and used by dozens of armed forces in the most demanding battlefields.

### Why Ashot

With both build to-print and total design capabilities, Ashot offers gear-based systems assemblies and components for existing products, for new programs and for upgrade programs, including all stages of design, production and delivery. Ashot has full capabilities to upgrade or provide life extension programs to a variety of Tanks, Armored Personnel Carriers, various Tracked & Wheeled Vehicles of Western or Eastern Bloc design.

**Well experienced engineering skills along with high capacity production capabilities, in addition to strong financial strength, is positioning Ashot as a leader in new design or upgrade programs for Tanks and tracked and wheeled APC's.**



# MOTION & POWER SYSTEMS



## BENTAL INDUSTRIES LTD.

Merom-Golan 1243600, Israel  
Tel: 972-4-6960199  
Fax: 972-4-6960187  
E-mail: [Bental\\_marketing@bental.co.il](mailto:Bental_marketing@bental.co.il)  
Web Site: [www.bental.co.il](http://www.bental.co.il)

Bental Industries Ltd. specializes in design and manufacturing of innovative power and motion systems which are integrated into various ground, marine and aerial platforms.

### Applications

- Electric Motors
- Servo Actuators
- Blowers & Dust Scavengers
- Alternators & Starter Alternator

The company main capability is to tailor cutting edge technologies and innovative solutions into a specific project with the most challenging requirements.

See also page: 24  
Aerospace Aircraft Parts and Subcontracting





# ARMOR DIVISION



## CARMOR

P.O.Box 639  
Nazareth Elite 1710502, Israel  
Tel: 972-4-6410641  
Fax: 972-4-6418555  
E-mail: gabid@carmor.co.il  
Web Site: www.carmor.co.il

## EXPECT MORE WITH CARMOR

Carmor, formerly known as Hatehof, was founded in Israel in 1947 and played a key role since then in equipping the state and other worldwide customers with specialized, dedicated and armor vehicles.

This highly respected international brand now manufactures vehicles for the IDF, NATO and United Nations forces, as well as civilian administrations, homeland security and military customers.

### Carmor specializes in providing tailor-made Armored vehicles by use of:

- Protective levels (STANAG 1-5) against bullets, mines and IEDs
- Passive add-on armoring
- High performance automotive systems and power lines
- Complete range of In-House services: concept, design, ballistic & antimine certification, inspection, manufacture, assembly, professional literature & maintenance.

Our Armored Vehicles typical applications range from Personnel carrier through Law-enforcement, Logistics, Tactical command & patrol, Defense missions, Peacekeeping, Ambulance, General utility, Reconnaissance and more.

Through housing both R&D department as well as production facilities, **Carmor can provide the client the most cost-effective Tailor-made solution.**

Carmor is ISO 9001 and ISO14001 certified manufacturer of armored and designated vehicles. As such, we maintain a rigid quality-oriented process designed for after sales services supplied by atehof, among which are:  
Pre-delivery QA inspection and CoC, Three degrees maintenance service, Spare parts contract, provided literature and warranty.



**Xstream** – A 16 Ton all terrain 4X4 MRAP, up to 7 people, KE Stanag 2 and Mine protection Stanag 3a+2b



**Wolf** – A 9 Ton multi purpose 4X4 APC, up to 8 people, KE Stanag 2 and Mine protection up to Stanag 1



**Hurricane** – An 8 Ton all terrain 4X4 APC, up to 7 people, KE Stanag 2 and Mine protection Stanag 3a+2b



**Navigator** – An 18.5 Ton all terrain 4X4 MRAP, up to 13 people, KE Stanag 3 and Mine protection Stanag 4a+4b

# INTEGRATED SIGHTS



Elbit Systems Electro-optics Elop's Combat Vehicle Systems unit specializes in providing turnkey and tailor-made integrated gunner and commander sight solutions for virtually every MBT and AFV in service today.

The integrated sights' modular design combines direct view observation, TV channels, eyesafe laser rangefinders and a wide variety of night

vision technologies with LOS stabilization and hunter-killer solutions.

Elop's battle-proven integrated sights feature modular upgradable designs which are tailored to our customers' requirements, all weather 24/7 observation and aiming capability, advanced image processing and fast, accurate target acquisition.



#### **COAPS:** *Commander Open Architecture Panoramic Sight*

- 3<sup>rd</sup> generation modular sight for AFVs, easily adaptable to sensor additions/changes
- Facilitates long-range target acquisition day and night, from stationary positions as well as on the move
- Wide range of advanced sensors, including 3-5 $\mu$ m or 8-12 $\mu$ m thermal imager, color zoom camera, eyesafe laser range finder (ELRF) and color TV day channel with continuous zoom



#### **Merkava MK IV:** *Commander Panoramic Day/Night Sight*

- 3<sup>rd</sup> generation advanced panoramic sight for MBT
- Facilitates long-range target acquisition day and night, from stationary positions as well as on the move
- Dual-axis independent stabilized mirror head
- 360° x N panoramic observation
- 3-5 $\mu$ m staring array dual FOV thermal channel
- TV day channel – B/W or color



**Merkava MK IV: Gunner Stabilized Sight**

- Advanced, modular sight
- Facilitates long-range target acquisition day and night, from both stationary and mobile positions
- Dual-axis independent stabilized mirror head with mechanical backup
- 8-12 $\mu$ m dual FOV thermal channel with 480 x 4 TDI detector
- ELRF with direct view optics
- TV day channel – B/W or color, unity vision WFOV channel



**M-60: Gunner Stabilized Sight**

- Advanced modular sight for MBTs
- Facilitates long-range target acquisition day and night, from stationary positions as well as on the move
- Dual-axis independent stabilized mirror head
- 8-12 $\mu$ m dual FOV thermal channel with 480 x 4 TDI detector
- ELRF with direct view optics
- TV day channel – B/W or color, unity vision WFOV channel



**T-72: Thermal Imaging Stand Alone System (TISAS)**

- Modular drop-in TI (night) sight for all T- family tank solutions
- Can be adapted to a ballistic computer for full FCS solution
- Single-axis electrical mirror head
- 8-12 $\mu$ m dual FOV thermal channel with 256 x 4 TDI detector
- Biocular display units for gunner and commander



**T-55: Day/Night Sight**

- Modular, compact drop-in day and night solution for T- family tanks
- Can be adapted to a ballistic computer for full FCS solution
- Single-axis electrical / mechanical mirror head
- ELRF including day channel with dual FOV and day color TV channel
- Dual FOV 3-5 $\mu$ m thermal night channel



**BMP: Day/Night Sight**

- Modular, compact drop-in day and night solution for BMP 1 & BMP 2 AFVs
- Can be adapted to a ballistic computer for full FCS solution
- Single-axis electrical / mechanical mirror head
- ELRF including day channel with dual FOV and day color TV channel
- Dual FOV 3-5 $\mu$ m thermal night channel

# LAND SYSTEMS



**A total-solution concept, covering the entire spectrum of combat vehicles, from complete modernization and training to maintenance depots and life-cycle support services, providing a full-suite of net-centric solutions enhancing combat effectiveness, lethality and survivability.**



## **Unmanned Turret UT30**

**Combat-proven firepower for armored personnel carriers; fully overhead without compromising troops safety**

Encompassing a broad range of weapon systems, countermeasures and advanced electro-optics, the system can be configured with all types of cannons (25 or 30 mm), coaxial machine guns (7.62 mm/0.3") and guided anti-tank missiles. Featuring a high first-round hit probability, the dual-axis stabilized UT30 is designed for firing on-the-move and at moving targets. Fully overhead with no deck penetration, the UT30 does not compromise the vehicle's armor protection and preserves existing space within the vehicle.



## **Overhead Remote Controlled Weapon Stations (ORCWS)**

**Adaptable, effective and field-proven range of ORCWS – leveraging over 30 years of experience and in-house development**

With dual-axis stabilization, the weapon stations provide a high first-round hit probability while shielding the operator from danger. Offering unparalleled performance in battlefield conditions, the ORCWS product range includes weapons of different types and calibers including 5.56 mm (0.22"), 7.62 mm (0.3") and 12.7 mm (0.5") in addition to 40 mm automatic grenade launchers.

**ELBIT SYSTEMS  
LAND AND C<sup>4</sup>I LTD.**

2 Ha'machshev St.,  
Netanya 4250712, Israel  
Tel: 972-9-8898080  
Fax: 972-9-8898231  
E-mail: [landc4i@elbitsystems.com](mailto:landc4i@elbitsystems.com)  
[www.elbitsystems.com/landc4i](http://www.elbitsystems.com/landc4i)



## **Surveillance, Reconnaissance and Targeting**

### **Fully-customizable ground and mobile solutions for real intelligence collection and dissemination**

Comprised of a broad array of lightweight network-ready sensors and C<sup>4</sup>I systems, the various system components can be fully customized to deliver effective intelligence in a broad range of operational scenarios. The solution provides day and night observation, target detection and recognition, radar, and identification of friendly forces. All sensors are fully controlled from the commander terminal, with digital maps for navigation and orientation.



## **Comprehensive Protection for Fighting Vehicles**

### **Supports effective and timely responses to laser and radar-guided threats**

Offering 360-degree threat coverage, the range of systems can be tailored to provide the required degree of accuracy and meet an extensive array of threats. Whether installed as a stand-alone system or integrated with countermeasures, the systems can be easily fitted to all AFVs. The systems detect, categorize and pinpoint laser and radar/RF sources. Using a combination of decoys, smoke, electro-optical signals, infrared or laser jamming, the systems effectively neutralize incoming missiles.



## **Warning Systems**

### **Fully customizable; detecting laser and radar-guided threats**

Elbit Systems' Laser Warning System (E-LAWS) and Threat Detection System (TDS) accurately detect, categorize and pinpoint laser sources such as rangefinders, designators, beam riders, infrared illuminators and trainers. In addition to laser sources, the Multi Threat Detection System (MTDS) detects, categorizes and pinpoints radar/RF sources. An essential component of the vehicle's defensive capabilities, the systems feature audio and visual warnings, high detection probability, and a low false-alarm rate.



## See-Through-Armor (STA)

### 360-degree situational awareness under closed hatches

A revolutionary, panoramic observation system, enabling operators to understand and experience their environment from a single image. Using algorithms that electronically join imagery collected by video cameras installed around the vehicle, the STA provides a seamless 360-degree real-time panoramic view.



## Fire Control Systems (FCS)

### Highly accurate, modular and reliable. Battle-proven and adaptable to a wide range of AFVs and tanks

Features long-range, day and night, on-the-move high first-round hit probability against moving targets. Reliable and cost-effective, the systems range from simplified FCS for one-man light turrets to high-performance hunter-killer FCS for front-line main battle tanks (MBTs). Every FCS is configurable with battle management systems used in net-centric warfare.

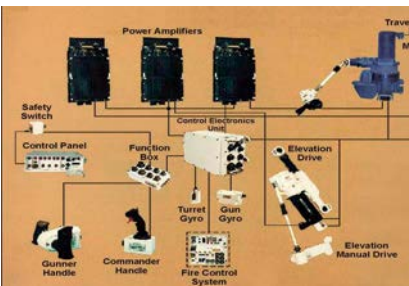

## Electric Gun and Turret Drive System (EGTDS)

### Improved fire control capabilities for heavy turrets and guns

Elbit Systems' EGTDS significantly enhances turret stabilization and firing on the move. The system provides smooth target tracking at high-speeds and in all firing positions, even for heavy guns and turrets. In addition the system improves safety by eliminating the need for the highly flammable hydraulic fluid used in conventional systems.



## Driver Thermal Vision System

### Uncooled thermal imaging kit

Fully ruggedized and suitable for a wide range of vehicle-mounted applications. The vision system includes a thermal imaging camera based on an uncooled detector and a ruggedized LCD display installed inside the vehicle.

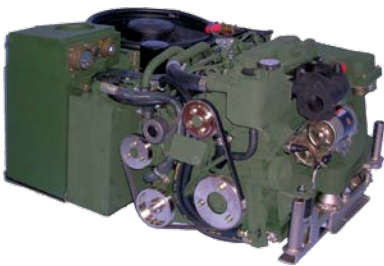

## **Kinetics Auxiliary Power Unit (APU)**

### **For MBTs and AFVs**

Improves the crew's performance and safety by reducing fatigue and minimizing exposure to noise, heat and vibrations. The APU allows the vehicle to operate in silent mode while reducing the thermal signature. The unit also supports the increased power demand for sophisticated electronic equipment.



## **Kinetics Life Support Systems (LSS)**

### **For AFVs and MBTs**

Includes chemical, biological, radiological and nuclear (NBC/CBRN) protection and detection. The system also includes Heating, Ventilation and Air Conditioning (HVAC), Water Generation and Fire Suppression Systems. The LSS can be powered by the platform engine or can be self-propelled when it includes an APU.



## **Kinetics Individual Crew and Equipment Cooling System (ICECS)**

### **Optimal crew performance in extreme conditions**

Available as a standalone system or as part of a comprehensive Life Support System (Kinetics-LSS), the Kinetics ICECS is an ideal solution when cooling is required for several crewman in spite of open hatches or ramps. The system's air-conditioner provides cooled, dried filtered air and NBC/CBRN protection to Air-Cooled Overalls and NBC Facemask. In addition, spot cooling is available for specific equipment..

**For a range of C<sup>4</sup>I solutions for AFV's please see page 286.**

# LAND FORCES

## AFV Upgrading, Survivability & Fire Power



ISRAEL MILITARY INDUSTRIES LTD. (IMI)

P.O.Box 1044, 64 Bialik Blvd.  
Ramat Hasharon 4711001, Israel  
Tel: 972-3-5485222  
Fax: 972-3-5486125  
E-mail: imimrktg@imi-israel.com  
Web Site: www.imi-israel.com

### **MBT & IFV MODERNIZATION**

Conversion, upgrading and modernization of MBTs and IFVs, enabling customers to maximize the use of existing inventories and extend the lifespan of in-service systems by improving lethality, survivability and mobility. Such programs include replacing and upgrading guns and weapons, new fire control systems, armor and automotive enhancements, remote controlled weapon stations, active protection systems and more. IMI has upgraded 170 M60A3 MBTs, in what is considered to be the largest tank upgrade program in recent years.

### **PLATFORMS PROTECTION & SURVIVABILITY**

IMI develops, manufactures and installs various passive, reactive and active (APS) ballistic armor kits for MBTs, AFVs, heavy earth moving equipment and light tactical vehicles. Among these are IRON WALL passive protection kit against

medium-sized IEDs (e.g EFP & SFF) and BREAKWATER reactive armor kit for protection against large EFPs with copper liners, including RPG-7. Both armor kits provide STANAG 4569 Level 4 small arms protection. IMI's family of APSs for ground forces and other applications include the IRON FIST APS for light to heavy AFVs and the BRIGHT ARROW combined 'Soft', 'Hard-Kill' APS and remote controlled weapon station, for light/medium armored vehicles.

### **IFVS FOR DEFENSE & SECURITY MISSIONS:**

COMBATGUARD: a rigid and efficient 4X4 "Monocoque" capsule based vehicle providing a high level of protection. It allows for efficient operation in a variety of combat missions and terrains, and can be equipped with various weapon systems and RCWS. The WILDCAT is a 4x4 all-terrain armored wheeled vehicle. This multi-role vehicle

provides modular protection against RPGs, IEDs and up to 14.5mm AP cartridges. Other solutions include affordable modernization programs for APCs, such as the URBAN FIGHTER up-armored M113, optimized for asymmetric warfare scenarios.

### **TANK AMMUNITION**

IMI develops and manufactures combat-proven tank cartridges of various calibers (100,105,120 & 125mm). These include Multi-Purpose High-Explosive (MP-HE), APFSDS-T, HEAT, HESH, Training and Less-Than-Lethal cartridges. IMI's MP cartridges provide tank crews with a highly-effective solution for engaging bunkers, vehicles and fortifications, as well as AT squads and infantry in the open. IMI's Tank Ammunition is in use with the IDF, NATO and various armies worldwide.

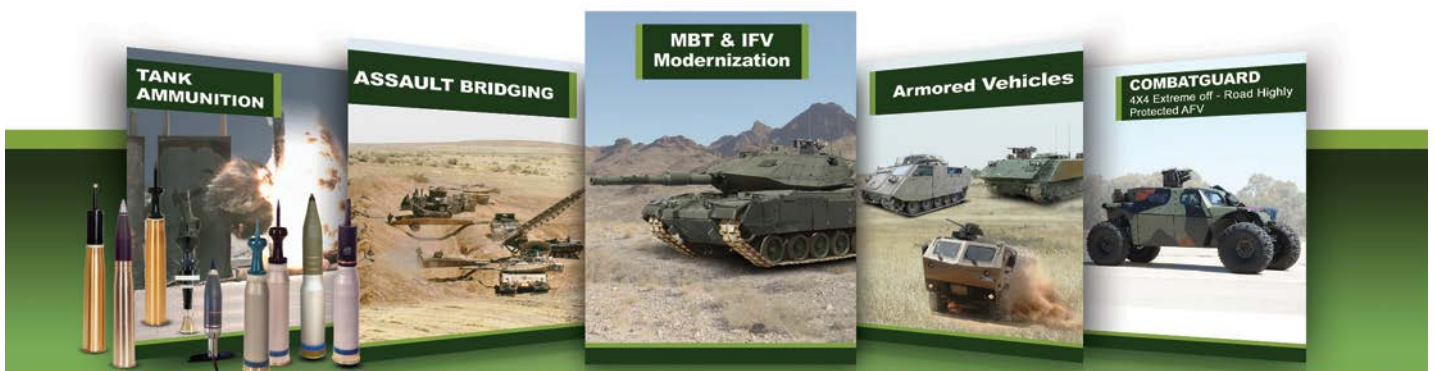



# NIMDA CO.

**More than 40 years of modernization and upgrading programs for tanks, APC(S) military trucks and naval propulsion. Proven technology.**

## NIMDA CO. MAIN PROJECTS:



### NIMDA CO.

P.O.Box 768  
Lod 7110604, Israel  
Tel: 972-8-9781111  
Fax: 972-8-9781137  
E-mail: [info@nimda.co.il](mailto:info@nimda.co.il)  
Web Site: [www.nimda.co.il](http://www.nimda.co.il)



#### T-72M4 CZ

Upgrading T-72 MBT & T-72 Recovery Tank with New westernized Power Pack.



#### T-72 N-2000

Manufacturing Allison transmission model XTG 411 6N 1000 HP Rating, For T-72 and M107/109 SPG.



#### ACHZARIT-X3A-1-2

IDF "Achzarit" Heavy APC With new Power Pack, DDC 8V92T(N) 710 HP engine, and Allison XTG411-5(N) transmission.



#### M-113 A3 / N-2000

M-113 N-2000 heavy armor protection with new Power Pack, up to 300 HP DDC engine, and Allison automatic transmission.



#### T-55

T-55 Upgrading with new Power Pack, upgraded, western gun and new fire control system.



#### M-41

M-41/M-42 Upgrading & Modernization program with new diesel Power unit, Allison CD-500 transmission, DDC 8V71T / 8V92T engine, and new 90mm Gun/Air defence turret electronic control.



#### BTR-50 / PT-76

The BTR-2000 / PT-76-2000 is Nimda upgrade of the old BTR-50 / PT-76 including new engine, new gun, F.C.S, Etc.



### World Leader

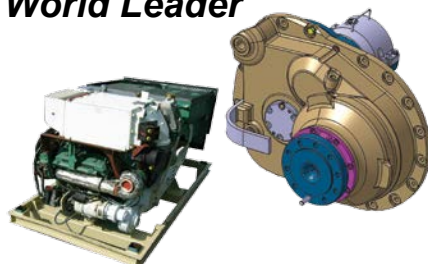

**in innovation of military Power Pack applications**



#### BMP-II

BMP-II APC Upgrading program with Western new Power Pack, Allison X-200 Transmission, and 360 HP Engine. Wide range of engines are optional.



# ADD ON ARMOR



## Rafael's Add On Armor Products

Rafael is a major and unique armor company dealing with all protection technologies: passive, reactive, hybrid and Active Protection systems. Rafael conducts development, design, integration and production of the most advanced armor systems to enhance the protection level of armored vehicles.

Rafael uses its extensive past experience to provide high level of protection, lightweight and low cost enhancements integrated on all types of combat platforms. All armor products are modular and capable to protect combat vehicles from a broad range of threats such as small and medium kinetic energy (KE) armor piercing (AP) projectiles, high energy anti-tank Shaped Charges (SC), high speed fragments of artillery and Improvised Explosive Devices (IEDs) and Explosive Forming Projectiles (EFPs).

The performance and specifications of the systems meet the protection requirements and standards of the Israel Defense Forces (IDF), the US Army, USMC and NATO force standards. The systems have been tested, qualified and approved for application by the customers worldwide and are combat proven. Rafael had eight different add-on armor systems, served in the Iraqi / Afghan theater with the coalition forces.

## Reactive Armor

Rafael is the world leading company in the application of the reactive armor technology. It was the first company to develop, design and integrates reactive armor systems on combat vehicles. The reactive armor is the most effective add-on armor technology to protect Armored Fighting Vehicles (AFV's), Armored Personal Carriers (APC's) and Main Battle Tanks (MBT's) against shaped charge threats of Rockets and ATGMs.

For light armored vehicles, Rafael developed Hybrid armor which combines reactive and passive elements to provide complete, 360 degrees protection against anti-tank rockets, medium KE AP projectiles and high speed fragments. Upgraded multi-threat hybrid armor, Multi-Threat Armor Protection (MTAP) system has recently been developed to defeat also EFPs and IEDs.

Rafael's reactive and hybrid system have been fitted to many combat vehicles worldwide. In the US, Rafael, together with its partner General Dynamics ATP, integrated produced and supplied reactive / hybrid armor systems for the Bradley AFV and the Stryker vehicles.



*M60*



*Bradley*



*M113*

**RAFAEL**  
**ADVANCED DEFENSE SYSTEMS**  
 P.O.Box 2250 (19)  
 Haifa 3102102, Israel  
 Tel: 972-73-3354714  
 Fax: 972-73-3354657  
 E-mail: intl-mkt@rafael.co.il  
 Web Site: www.rafael.co.il

**Passive Armor**

Rafael has developed and applied various passive armor technologies to protect combat vehicles, including ceramic, metallic, shaped, laminated and perforated technologies. The passive add-on armor is modular, lightweight and easily installed by the crew. It is maintenance-free and combat-proven.

The systems provide protection against 14.5 mm AP projectiles, high speed fragments of artillery shells and IED (STANAG 4569, Level 4 and beyond). Rafael has recently developed passive add-on lightweight, effective modular armor to defeat EFPs.

Rafael's armor systems are in use by the IDF, USMC, Italian Army, New Zealand Army, Czech Army and others. They are combat proven and received excellent reports about their performance in the Operation Iraqi Freedom and peace keeping missions worldwide. Rafael's Enhanced Appliqué Armor Kit (EAAK) add-on armor system was selected by the USMC as a sole source, for the AAV7 amphibious APC.

RAFAEL's Reactive Armor installed on the US Bradley AFV (left) and Passive Armor installed on the USMC AAV7 APC (right).



*AAV7*

*M113*

*Rosomak*

■ **Certificates from the US Army and USMC to Rafael for its reactive and passive armor systems, installed on the Bradley, Stryker and AAV7** ■



# FORCE PROTECTION - ACTIVE PROTECTION



## TROPHY – Situational Awareness and Active Protection Systems

The Trophy is a situational awareness and active protection hard kill system that operates in three major stages: Threat detection and threat tracking followed by hard kill countermeasure (Multiple Explosive Formed Penetrators – MEFP) activation and threat neutralization. The neutralization process takes place only if the threat is about to hit the platform.

### Trophy-HV

The Trophy was declared operational by the IDF in August 2009 and is currently in full production. Merkava 4 tanks integrated with Trophy active protection systems are presently being deployed in combat areas along Israel's borders.

### Exceptional Capabilities

- 360° protection, while permitting sectors of the vehicle-mounted system to be rendered inactive when necessary for the protection of troops on the ground
- 360° situational awareness by detecting all incoming threats and identifying their launch position
- Extremely high elevation protection
- Neutralizes threats fired from very short range
- Neutralizes simultaneous threats arriving from one or more directions
- Minimum collateral damage
- Suitable for multiple platforms
- High kill probability while static or on the move
- Reduces platform weight

The Trophy system is adaptable to any combat platform. Once a platform is chosen, a short trade study is completed to work out any integration issues that may arise. Numerous elements are taken into consideration for each vehicle variant or type. For vehicles with relatively basic or light armor, e.g. the Stryker, the Trophy provides full protection against all types of RPG (as well as other threats) due to the fact that the Trophy destroys these types of threats without detonation. Currently, the full Trophy HV system weighs 800kg. Since space and weight will continue to be major issues on combat platforms, not only for current forces, but also for new vehicle programs, i.e. FCS / FRES, great efforts to miniaturize the electronics of the Trophy have been made.



**RAFAEL  
ADVANCED DEFENSE SYSTEMS**

P.O.Box 2250 (19)  
Haifa 3102102, Israel  
Tel: 972-73-3354714  
Fax: 972-73-3354657  
E-mail: [intl-mkt@rafael.co.il](mailto:intl-mkt@rafael.co.il)  
Web Site: [www.rafael.co.il](http://www.rafael.co.il)

■ **The result is additional systems for lighter vehicles:**

**Trophy-MV**

The Trophy-MV offers the same hard kill capabilities as the Trophy-HV and includes built-in soft kill capabilities as well. The Trophy-MV (previously Trophy II) is at TRL 7 and the first prototype is currently undergoing enhanced field testing. Trophy-MV a 450kg APS, for light - and medium-weight (10-30 ton) vehicles.

**Trophy-LV**

This active protection hard kill system for light armored vehicles utilizes the same superior operating principles as the Trophy-HV and Trophy-MV at a fraction of the weight. Trophy-LV's high kill probability against advanced threats, including the most sophisticated shoulder-launched AT rocket propelled grenades, makes it a significant force-multiplier at shorter ranges on the modern battlefield.

The Trophy-LV's dimensions are specially designed for easy integration and installation onto smaller platforms without impairing system performance. This ensures 360° protection including the vehicle's windows and doors with minimal risk of collateral damage. The Trophy-LV is an all-round efficient, affordable, and cost-effective solution that is currently undergoing field testing in a variety of operational scenarios.

**Operational Concept**

- Radar identifies and tracks incoming threat/s and delivers the exact threat launching point to a battle management system or weapon station
- The computer identifies the threat, determines whether it will hit the vehicle, and if so a ballistic cover opens
- A countermeasure head slews to the proper location
- The computer continues to track, acquire, and plot the best intercept solution
- The countermeasure is launched and neutralizes the threat



The Trophy systems have a very high kill probability and testing has shown them to be successful against all known CE threats (RPG, ATGM, tank-fired CE, etc.) The systems' average collateral damage is estimated at a <1% chance of a dismounted soldier being injured by Trophy or an incoming threat.

# UNIQUE DEFENSE PATENTED SYSTEMS



## TAL & HADAS LTD.

P.O.Box 1011  
Afula Elite 1855010, Israel  
Tel: 972-4-6408400  
Fax: 972-4-6408401  
E-mail: info@tal-and-Hadas.com  
Web Site: www.tal-and-Hadas.com

**Tal & Hadas. A privately owned Company established in 1982. We provide real time solutions according to customers' specific requirements. From the design of systems through development and testing to the manufacture of end products.**

We design, manufacture and market for vehicle, railway, truck and military industries. Our engineering department provides top-standard quality design, using error proof manufacturing methods.

Tal & Hadas Ltd. works in compliance with the TS16949 and ISO 9001 standards. The company holds international patents on many exclusive and innovative products, which have both military and civilian applications.

Our unique designs and over 25 years of experience with both military and transportation industries, allows us to supply customers with systems, "tailored" according to their requirements.

Our key costumers include: GM, VW, Siemens, IDF, General Dynamics

### **R.U.F - Rescue Under Fire products**

**R.U.F system provides rapid under fire extraction for damaged or disabled vehicles, APC's and tanks without having to expose the crew to the external hostile environment.**

- The R.U.F system can be mounted quickly on any platform using Extraction hooks which already mounted on the vehicle.
- The R.U.F system does not require any special driving skills or extensive training. Allowing you to quickly hook up and tow your platform to a safer environment for maintenance.
- System can handle 8 - 80Ton weight range.



In use by Israel Defense Forces

### **Samson system - load reduction system**

- Designed for up to 60kg loads.
- Reduced more than 80% of the load on the soldiers' back, hence allows carrying extra weight (ammunition, supply, water, and stretcher) in extreme terrains.
- Does not diminish the soldier ability to fight.
- Our unique solution in a real-time, provide the best solution at the battlefield with unique sophisticated mechanical systems.



### **Parachuted systems**

#### **EAPS - Energy Absorbing Pallet System for parachuted/air drop equipment**

The pallet allows safe parachute dropping of loads/supplies from the air, including sensitive and fragile equipment with ease. Without causing damage to the equipment.

#### **SWALLOW - An automatic parachute disconnecting system**

Enabling better equipment/supply drop with precision and accuracy to ground forces. Eliminating equipment damage from being dragged by the parachute.

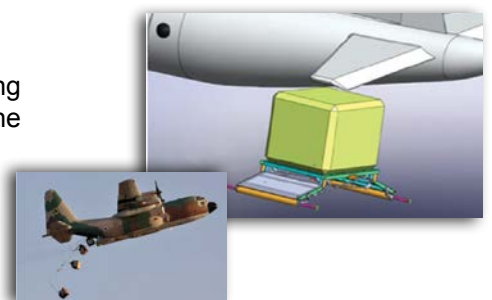

# TURNKEY SYSTEMS



## *Tactical Mobility and Versatility On All Terrains*

### TECHNOLOGY IN MOVEMENT

Southern Industrial Zone  
P.O.Box 19, 6 Hacharoshet St.,  
Migdal Haemek 2310001, Israel  
Tel: 972-4-6546735  
Fax: 972-4-6546738  
E-mail: [main@tamor.co.il](mailto:main@tamor.co.il)  
Web Site: [www.tamor.co.il](http://www.tamor.co.il)



Manufacturer of **Turnkey Systems**, Subsystems, Kits, Assemblies and Components for Wheeled and Tracked Vehicles per customer specification

#### **SYSTEMS, SUBSYSTEMS, KITS, ASSEMBLIES**

- Traversing Machine Gun Mount Systems
- Armored Hatches and Mechanisms
- Fuel Tanks and Water Tanks
- Equipment Compartments, External, Internal
- Structural Kits

#### **CHASSIS AND SUSPENSION SYSTEMS**

- Wheels Solid Rubber
- Track Shoe Parts and Track Assemblies
- Track Tension Adjusters
- Sprockets and Carriers
- Supporting Road Arms
- Hydraulic Bumpers
- Brake Systems

#### **DEFENSE VEHICLES**

- Main Battle Tanks (MBTs)
- Armored Fighting and Recovery Vehicles (AFVs, ARVs)
- Armored Personnel Carriers (APCs)
- Amphibious Vehicles
- Land Recovery Vehicles
- Heavy Military Trucks

#### **INDUSTRIAL VEHICLES**

- Rolling Stock
- Agriculture
- Mining
- Construction
- Forestry and Logging
- Specialized Heavy Vehicles

The Tamor factory's versatility in implementing in-house multi-process technologies in metalwork and rubber vulcanization is particularly suitable for modernization programs, comprehensive upgrading solutions and improvements to proven field tested standards.

Quality Assurance: ISO 9001:2008, AQAP 2110, U.S. ARMY TACOM QSL-01, QSL-03, QSL-04

# OUR TECHNOLOGY LIGHTENS THE MOBILITY OF HEAVY VEHICLES



## TECHNOLOGY IN MOVEMENT

Southern Industrial Zone  
P.O.Box 19, 6 Hacharoshet St.,  
Migdal Haemek 2310001, Israel  
Tel: 972-4-6546735  
Fax: 972-4-6546738  
E-mail: [main@tamor.co.il](mailto:main@tamor.co.il)  
Web Site: [www.tamor.co.il](http://www.tamor.co.il)





## DEFENSE - INDUSTRIAL - CIVIL

- **WHEELS**
- **TRACK SHOES**
- **FUEL TANKS**
- **RUBBER ANTIVIBRATION**



### TECHNOLOGY IN MOVEMENT

Southern Industrial Zone  
P.O.Box 19, 6 Hacharoshet St.,  
Migdal Haemek 2310001, Israel  
Tel: 972-4-6546735  
Fax: 972-4-6546738  
E-mail: [main@tamor.co.il](mailto:main@tamor.co.il)  
Web Site: [www.tamor.co.il](http://www.tamor.co.il)

### TAMOR S.M.R. PRODUCTS

#### *\*built to customer specification*

- Wheels Solid Rubber: Road, Single / Double Support, Tension, Idlers, Rollers, Sprockets, Forklifts
- Track Shoe Parts and Track Assemblies with: Pads, Bushings, Pins, Connectors, Parts
- Fuel Tanks and Water Tanks: Steel, Stainless Steel, Aluminum
- Antivibration Rubber Products: Vibration Dampening, Shock Absorbing Rubber
- Chassis and Suspension Components and Assemblies: Control Arms, Cross Members, Primary Suspension
- Body Frame Components and Assemblies
- Large Heavy Metalwork Products: Specialized Transport and Storage Containers
- Other Rubber / Metal Products: Portable Signposts, Asphalt Paving Machine Pads, Full tracks, Endless Rubber Bands, Exercise Ammunition, Ladders, Other custom-made items

### IN-HOUSE TECHNOLOGIES

- Metalwork: CNC machining, deep drawing, forming, welding, cutting, stamping, shot peening, painting, preservation
- Rubber Vulcanization: rubber bonded to metal and rubber molding using compression, transfer and injection molding



### DEFENSE APPLICATIONS

- Tanks
- Armored Fighting and Recovery Vehicles (AFVs, ARVs)
- Heavy Military Trucks
- Land Recovery Vehicles
- Armored Personnel Carriers (APCs)
- Amphibious Vehicles

Tamor manufactures for the Abrams, Bradley M-1, M-2, M-24, M47, M-48, M-51, M-107, M-109, M-113, M-60, M-88, Sherman, AMX-10, AMX-13, AMX-30, Leopard I, Leopard II, LVTP-7, Half trucks, BMP-1, BMP-2, BMP-3, Leonidas, T-80, T-54, T-55, T-72, HUMVVV, Merkava, Namer and others.

Reconditioning of track shoe assemblies in compliance with field-tested standards.

### CIVIL & INDUSTRIAL APPLICATIONS

Tamor SMR manufactures diverse products for Rolling Stock, Mining, Construction, Agricultural, Forestry and Logging and Other Specialized Heavy Vehicles (asphalt pavers). Products include fuel tanks for dynamic (trains, trucks) and static (power generating units, central heat units) applications, antivibration and shock absorbing rubber products, potable water tanks.

### QUALITY ASSURANCE

- ISO and IQ Net 9001:2008
- Welding: AWS D 17.1, AWS D1.1, European EN 15085-2 Class 1
- NATO AQAP-110
- U.S. Army TACOM: QSL-03, QSL-01, QSL-04  
Wheeled Vehicle Components (QSL-03) Tracked Combat Vehicle Suspension Components and Padded Cushions (QSL-01, QSL-04)
- Field-testing under actual operating conditions

# ***SURVIVABILITY STARTS WITH PLASAN***

***Advanced solutions and materials***



## **PLASAN**

Kibbutz Sasa M.P.  
Merom Hagalil 1387000, Israel  
Tel: 972-4-6809000  
Fax: 972-4-6809001  
E-mail: [plasan@plasan.com](mailto:plasan@plasan.com)  
Web Site: [www.plasan.com](http://www.plasan.com)



- ▶ **Leading the industry with best protection, high mobility armored vehicle solutions**
- ▶ **End to end in house capabilities: full design, development, testing and integration under a single roof**
- ▶ **Innovation in survivability solutions**
- ▶ **Deployed in armed forces and security organizations worldwide**



Plasan is a global provider of mission ready solutions for military and security applications. From platform survivability through to mission ready vehicles, our solutions translate extensive operational experience into enhanced mission capabilities. Plasan offers full design, development, engineering, testing and integration under a single roof. Plasan has designed more than 150 armored hulls and delivered more than 30,000 armored vehicles to armed forces and security organizations worldwide.

- Integrated and add on armor solutions for tracked and wheeled ground vehicles, airborne platforms and personal protection.
- Blast protection solutions including: Energy absorbing seats and foot pads.
- HSF™ and FlexFence™ RPG defeat solutions.
- Plasan **mission specific vehicle solutions** designed to address a wide range of defense and homeland security missions featuring exceptional maneuverability, superior armor protection and fully integrated ISR, command, control and communication technologies.
- VETRONICS solution.
- Plasan SANDCAT™ family of multi-purpose 4X4 armored vehicle, designed for optimized mobility, maneuverability and operational versatility in any terrain. Over 400 vehicles deployed in more than 10 countries.
- GUARDER™ - High protection, high performance 4X4 armored vehicle, carries up to 24 troops. Outstanding mobility and maneuverability on all-terrains. Equipped with the most advanced survivability systems.

# OSG - VISION THROUGH GLASS



## OSG - ORAN SAFETY GLASS

Kibbutz Palmach Zova  
D.N. Harei Yehuda 9087000, Israel  
Tel: 972-2-5706100  
Fax: 972-2-5706101  
E-mail: [info@osg.co.il](mailto:info@osg.co.il)  
Web Site: [www.osg.co.il](http://www.osg.co.il)



Innovation, quality, excellent service and experience-based expertise: That's what you can expect from OSG. Whatever it is - OSG can do it. From automotive and architectural glass systems to glass for rail, heavy engineering machinery and transparent armor for the military and civilian sectors, OSG is a leading expert in these fields.

### 35 YEARS OF EXPERIENCE

Today OSG is a global company with large production facilities in Israel as well as the United States and offices worldwide. Size, experience and global presence give OSG great manufacturing flexibility and this means the company can easily handle all your needs. All OSG's production lines are ISO 9001-2008 and ISO 14001-2004 certified and are equipped with the latest technology.

OSG's highly skilled engineers are at your service and ready to consult with you, from the design phase to manufacturing. OSG's in-house laboratories and testing facilities are designed to streamline manufacturing and deliver the best possible product.

### TRANSPARENT ARMOR

OSG's transparent armor complies with the highest industry standards. OSG's products meet ATPD-2352 (current rev.) as well as STANAG 4569 standards (Levels 1 to 4) plus equivalent US National Institute of Justice (NIJ), European, German, Spanish, DoD UFC performance criteria and other standards for all threat levels. Blast, fragmentation and environmental tests, in accordance with STANAG, the US Army and USMC specifications are conducted at OSG's

in-house laboratories. OSG's state-of-the art research and development facilities include ballistic laboratories for the full range of small arms kinetic and FSP fire testing.

OSG's transparent armor is made for both military and civilian applications and it involves vehicles as well as buildings (such as Governmental Offices and Embassies) plus naval applications.

OSG produces and installs transparent ballistic armor for almost any threat at a quick turnaround time and at competitive prices and can custom-build to all requirements.

### *Below is the list of some of OSG's transparent armor applications:*

- Ballistic protection solutions
- Advanced transparent armor add-on system
- Emergency egress window system
- Ceramic window and Crystallized Material technology
- Silk-light integrated light indicator system
- Rock-strike glass shield
- ADI no-spall technology

### GLASS SOLUTIONS FOR THE TRANSPORTATION INDUSTRY

We handle transportation glass process from beginning to end and currently our glass products are available in more than 50 countries around the world. We focus on remaining at the forefront of technology, bringing new developments, compositions and technologies for all transportation vehicles: ground, naval and airplanes.

# MIFRAM'S MULTI-PURPOSE PROTECTION SOLUTIONS

**ISO 9001:2008**  
IQC  
Quality Management System

**MSC**  
Multipurpose Bulletproof security containers

**Dry Storage**  
Humidity controlled dry storage facilities. Save maintenance costs and be ready for the moment of truth

**Modular Antenna Tower**  
Prefabricated and portable Antenna tower

**Sentinel/Priest 4000**  
Lightweight, prefabricated observation tower

**Mobile Sky Guard**  
Overhead rapid fortification protection from light rockets and mortars

**Defense Walls**  
Modular blast and fragmentation protected precast walls

**AMI/TAMI**  
360° vision, bullet proof combat post/tower

**MBS**  
Modular NBC, B.P./light rocket/mortars protected mobile shelter

**Millennium**  
Multi-purpose, bullet proof & 360° vision combat post

**MVB/Carmen**  
Modular Vehicle Barrier

**Guard Post**  
Bulletproof mobile guard post

**Body Guard**  
Lightweight, bulletproof, portable guard post

**Scarlet**  
Portable and flexible VIP protection

**Check Post**  
Screening module entrance post. Fully protected from suicide bomber.

**Gabriel**  
Fully-protected (NBC & Bullet-proof) autonomous, mobile Command and Control shelter

**MIFRAM LTD.**

Tel: 972-4-8808800

E-mail: sales@mifram.com

Web Site: www.miframsecurity.com

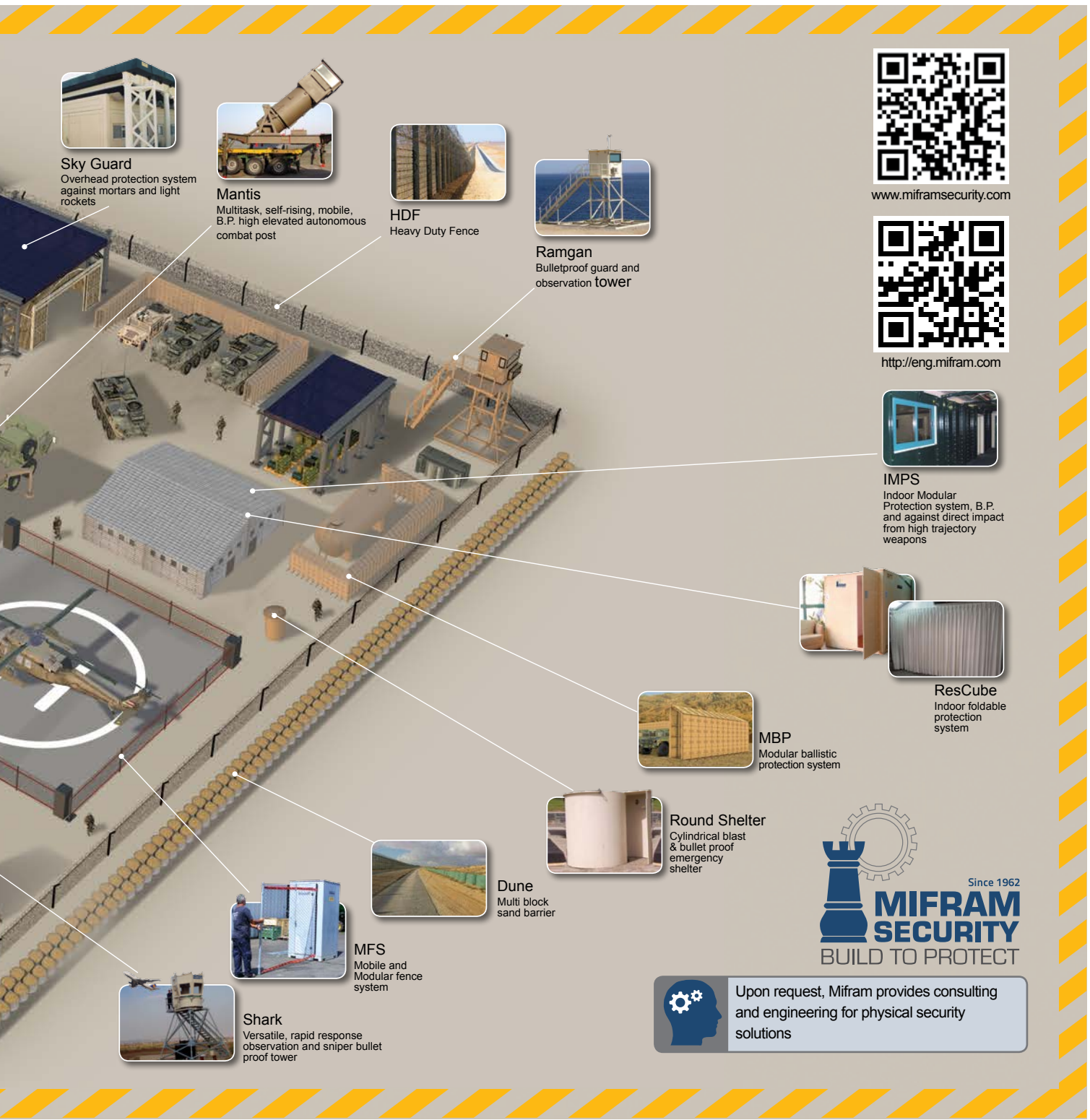

**Sky Guard**  
Overhead protection system against mortars and light rockets



**Mantis**  
Multitask, self-rising, mobile, B.P. high elevated autonomous combat post



**HDF**  
Heavy Duty Fence



**Ramgan**  
Bulletproof guard and observation tower



[www.miframsecurity.com](http://www.miframsecurity.com)

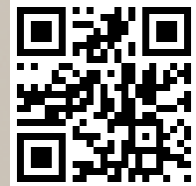

<http://eng.mifram.com>



**IMPS**  
Indoor Modular Protection system, B.P. and against direct impact from high trajectory weapons



**ResCube**  
Indoor foldable protection system



**MBP**  
Modular ballistic protection system



**Round Shelter**  
Cylindrical blast & bullet proof emergency shelter



**Dune**  
Multi block sand barrier



**MFS**  
Mobile and Modular fence system



**Shark**  
Versatile, rapid response observation and sniper bullet proof tower



Upon request, Mifram provides consulting and engineering for physical security solutions

# BULLET PROOF OBSERVATION TOWERS



## MIFRAM LTD.

6 Josef Levi St., P.O.Box 1165  
Ind. Zone Kiriya Bialik  
Zur Shalom 2711101, Israel  
Tel: 972-4-8808800  
Fax: 972-4-8745745  
E-mail: sales@mifram.com  
Web Site: www.miframsecurity.com



[www.miframsecurity.com/Guard%20Tower/](http://www.miframsecurity.com/Guard%20Tower/)



Ramgan

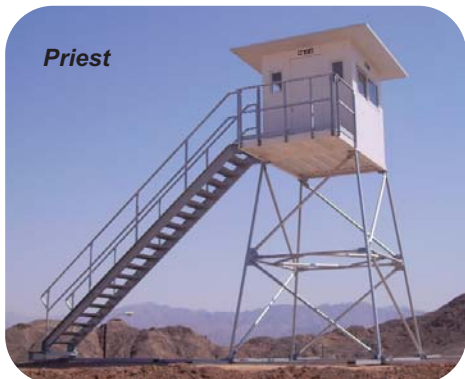

Priest



Shark



Mantis

**Mifram** has accumulated vast professional experience in the development and production of protective structures and barriers. The company is the exclusive manufacturer of several unique bullet proof watch towers and observation structures and defense posts which are designed to protect against the changing threats of our times. The towers and guard posts provide protection to meet the customer's specific defense and security needs.

### **Sentinel Milspec Observation Tower (PRIEST)**

Lightweight observation tower for security and protection missions withstands harsh environmental conditions (sand, dust, corrosion, heat).

### **RAMGAN Observation Tower**

Bullet-proof observation tower meets NIJ Types III and IV standards plus mortar protection, and comes with machine gun stands, shooting slits, and a protected observation porch.

### **Mantis Autonomous Self-Rising Mobile Watch Tower**

World's first truck-borne fast-response observation tower, suitable for a range of security applications (C<sup>2</sup> missions, border control, special ops) and civilian uses (mass events, major sports events, crowd control).

#### **Features**

- Autonomous self-rising bullet-proof watch tower
- Bulletproof - 5.56SS109/M16 7.62M80/AK47 AP
- World's first truck-borne fast-response observation tower
- Ideal operational solution to quick response missions
- Can be made operational within 30 minutes
- All weather conditions
- Standard container size

### **Shark Rapid Response Sniper Post**

Highly versatile rapid response observation and sniper tower offering 300 degree visibility and 270 degree firing angle. Designed for use in airports and other sensitive locations.

#### **Features**

- Rapid response observation and sniper tower
- Highly versatile functionality
- Robust construction for constant use
- 300 degree visibility
- 270 degree firing angle
- Canopy opens in 1.5 seconds
- Searchlight is activated automatically when unit in use
- Table/shelf runs round the circumference of the cabin
- AC unit
- 25W light installed at floor level
- Thermally insulated cabin (when closed)
- Windows close slowly

# MOBILE BALLISTIC SHELTERS



## MIFRAM LTD.

6 Josef Levi St., P.O.Box 1165  
 Ind. Zone Kiriath Bialik  
 Zur Shalom 2711101, Israel  
 Tel: 972-4-8808800  
 Fax: 972-4-8745745  
 E-mail: sales@mifram.com  
 Web Site: www.miframsecurity.com

### Gabriel Mobile NBC Shelter

Fully-protected autonomous C<sup>2</sup> shelter. Designed for security and emergency authorities, offers battle-proven protection for up to 20 people against conventional threats and all known types of chemical and biological warfare agents.

### MSC Multi-Purpose Security Container/Shelter

Bullet proof and blast proof versatile 20' container that withstands NIJ Type III threats, ideal as armory, cashier's office, mobile control post, mobile first-aid post and accommodation unit.

### MBS Modular Ballistic Shelter

Designed for use in open public spaces, attached to buildings and homes, or mounted on a truck, this mobile shelter provides ballistic protection of 5.56/7.62 and against direct impact from a light missile or rocket.

### Turtle

Multi-purpose (personnel, equipment) rapid fortification kit for constructing guard posts for personnel and equipment, meets NIJ IV standard for the ballistic resistance of personal body armor.

### Phalanx

Quickly assembled multi-purpose rapid fortification kit for constructing a protective wall in fluid combat conditions. The wall protection elements meet the NIJ IV standard for the ballistic resistance of personal body armor.

### Sky Guard

Roof and housing protection system that meets ballistics threats from 120-160 mm mortars and light missiles. Ideal for civilian housing, federal buildings, military bases, border installations, and key infrastructure facilities.

### IMPS - Indoor Modular Protection System

Unique patented indoor protection solution against the threat of direct impact from high trajectory weapons such as Quassam II and Katyusha 122mm rockets. Suitable for apartments, houses, offices and other facilities.



TURTLE



PHALANX



GABRIEL



MBS



[www.miframsecurity.com/Portable%20shelters](http://www.miframsecurity.com/Portable%20shelters)

[www.youtube.com/watch?v=zbcCA0VEN7w](http://www.youtube.com/watch?v=zbcCA0VEN7w)



MSC



IMPS



SKY GUARD

# ARMOR PROTECTION



## Rafael's Add On Armor Products

Rafael is a major and unique armor company dealing with all protection technologies: passive, reactive, hybrid and Active Protection systems. Rafael conducts development, design, integration and production of the most advanced armor systems to enhance the protection level of armored vehicles.

Rafael uses its extensive past experience to provide high level of protection, lightweight and low cost enhancements integrated on all types of combat platforms. All armor products are modular and capable to protect combat vehicles from a broad range of threats such as small and medium kinetic energy (KE) armor piercing (AP) projectiles, high energy anti-tank Shaped Charges (SC), high speed fragments of artillery and Improvised Explosive Devices (IEDs) and Explosive Forming Projectiles (EFPs).

The performance and specifications of the systems meet the protection requirements and standards of the Israel Defense Forces (IDF), the US Army, USMC and NATO force standards. The systems have been tested, qualified and approved for application by the customers worldwide and are combat proven. Rafael had eight different add-on armor systems, served in the Iraqi / Afghan theater with the coalition forces.

## Reactive Armor

Rafael is the world leading company in the application of the reactive armor technology. It was the first company to develop, design and integrates reactive armor systems on combat vehicles. The reactive armor is the most effective add-on armor technology to protect Armored Fighting Vehicles (AFV's), Armored Personal Carriers (APC's) and Main Battle Tanks (MBT's) against shaped charge threats of Rockets and ATGMs.

For light armored vehicles, Rafael developed Hybrid armor which combines reactive and passive elements to provide complete, 360 degrees protection against anti-tank rockets, medium KE AP projectiles and high speed fragments. Upgraded multi-threat hybrid armor, Multi-Threat Armor Protection (MTAP) system has recently been developed to defeat also EFPs and IEDs.

Rafael's reactive and hybrid system have been fitted to many combat vehicles worldwide. In the US, Rafael, together with its partner General Dynamics ATP, integrated produced and supplied reactive / hybrid armor systems for the Bradley AFV and the Stryker vehicles.



*M60*



*Bradley*



*M113*



**RAFAEL**  
**ADVANCED DEFENSE SYSTEMS**  
 P.O.Box 2250 (19)  
 Haifa 3102102, Israel  
 Tel: 972-73-3354714  
 Fax: 972-73-3354657  
 E-mail: intl-mkt@rafael.co.il  
 Web Site: www.rafael.co.il

**Passive Armor**

Rafael has developed and applied various passive armor technologies to protect combat vehicles, including ceramic, metallic, shaped, laminated and perforated technologies. The passive add-on armor is modular, lightweight and easily installed by the crew. It is maintenance-free and combat-proven.

The systems provide protection against 14.5 mm AP projectiles, high speed fragments of artillery shells and IED (STANAG 4569, Level 4 and beyond). Rafael has recently developed passive add-on lightweight, effective modular armor to defeat EFPs.

Rafael's armor systems are in use by the IDF, USMC, Italian Army, New Zealand Army, Czech Army and others. They are combat proven and received excellent reports about their performance in the Operation Iraqi Freedom and peace keeping missions worldwide. Rafael's Enhanced Appliqué Armor Kit (EAAK) add-on armor system was selected by the USMC as a sole source, for the AAV7 amphibious APC.

RAFAEL's Reactive Armor installed on the US Bradley AFV (left) and Passive Armor installed on the USMC AAV7 APC (right).

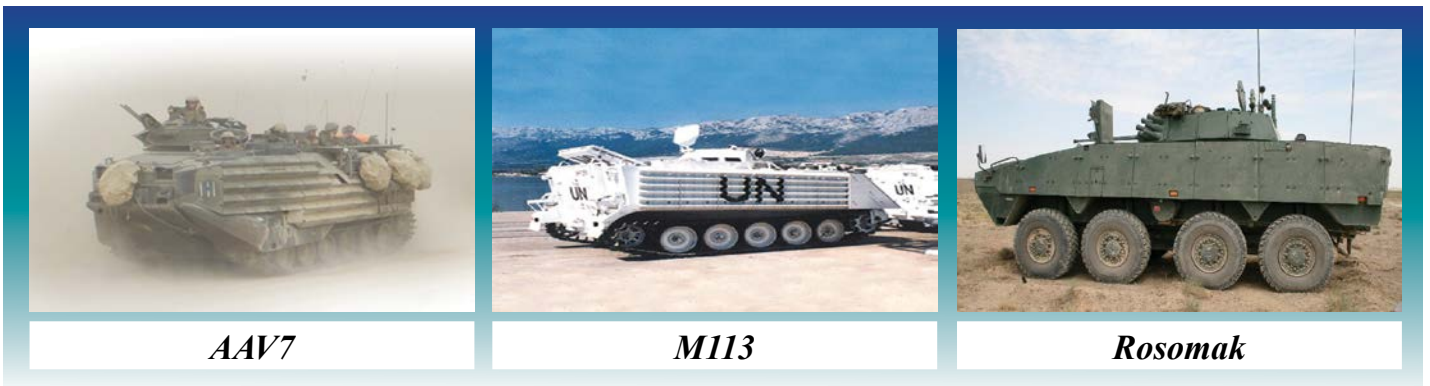

*AAV7*

*M113*

*Rosomak*

■ **Certificates from the US Army and USMC to Rafael for its reactive and passive armor systems, installed on the Bradley, Stryker and AAV7** ■



# EOSHIELD

## Vehicle Infra-Red Counter-Measure System (VIRCM) for Protection Against Anti-Tank Ground Missiles



**ELBIT SYSTEMS**  
**ELECTRO-OPTICS - ELOP LTD.**  
P.O.Box 1165  
Rehovot 7611101, Israel  
Tel: 972-8-9386211  
Fax: 972-8-9386010  
Web Site: [www.elbitsystems.com/elop](http://www.elbitsystems.com/elop)



### Main Advantages & Features:

- Multiple, simultaneous ATGM jamming
- 360° platform protection
- Low-profile, low-signature
- Adaptable to a variety of combat vehicles
- Automatic operation without crew intervention
- High system reliability

### Platforms:

- AFVs and MBTs
- Helicopters
- Maritime vessels

### Applications:

- Interface with a missile warning system
- Integration with ATGM hard-kill solution
- Full soft-kill solution

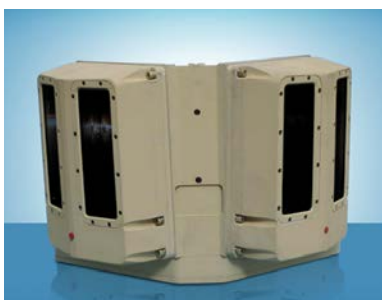

### Technical Data:

Coverage:	360° x 23°
Power:	28VDC, MIL-STD 1275A(AT)
Power consumption:	2.5 kW (omni-directional coverage)
Weight:	35 kg x 2 units (omni-directional coverage)
Dimensions (cm):	29 x 41 x 41 (H x W x D)
MTBF:	> 4,000 Hours
Environmental conditions:	MIL-STD-461D, MIL-STD-810F

# LDS - LASER DETECT SYSTEMS LTD.



Established in 2004, Laser Detect Systems (LDS) is a world-leading developer of standoff laser-based detection technology, based on advanced laser spectrometry. Utilizing this technology, LDS has commercialized patented, groundbreaking detection systems for homeland security, law enforcement, military and environmental safety.

## LDS - Laser Detect Systems

14 Abba Hillel Silver St.,  
Ramat Gan 5250607, Israel  
Tel: 972-3-970-5000  
Fax: 972-3-605-4566  
E-mail: [info@laser-detect.com](mailto:info@laser-detect.com)  
Web Site: [www.laser-detect.com](http://www.laser-detect.com)

## G-SCAN<sup>PRO</sup> - Hand Held Explosives and Narcotics Detector

LDS G-SCAN<sup>PRO</sup> is a state of the art laser Handheld Raman Spectroscopy Detector provides law enforcement, military and security agencies a powerful sensitive, low false-positive and low false-negative tool for detecting a wide-variety of explosive substances, suspicious drugs and hazardous materials in forms of liquid, bulk or powder.



## R-Scan - Remote Scan

LDS Remote Scan (R-Scan) line of products presents a new approach in the remote standoff explosives detection of Improvised Explosive Devices (IED's). LDS's R-Scan explosive detection technology proved to detect explosive materials against most common background materials such as metals, glass, cloth, wood, paint and soil at distances of up to tens of meters. This approach offers advantages in the detection of explosives, not available by any other means. R-Scan has been field tested successfully and is undergoing integration with additional detection technologies as an integrated system.

## B-Scan - Bottle Liquid Scanner

The LDS B-Scan offers a cost effective, interactive, high sensitive bottled liquid scanner (BLS) that detects hazardous substances in liquids or powder forms contained in glass, transparent or translucent plastics bottled containers. LDS' BLS introduces a unique method, enabling rapid analysis of liquid containers, accelerating airport security checks, improving passenger service, while increasing the probability of detection and efficiency of security measures.



# FORCE PROTECTION - ACTIVE PROTECTION



## TROPHY – Situational Awareness and Active Protection Systems

The Trophy is a situational awareness and active protection hard kill system that operates in three major stages: Threat detection and threat tracking followed by hard kill countermeasure (Multiple Explosive Formed Penetrators – MEFP) activation and threat neutralization. The neutralization process takes place only if the threat is about to hit the platform.

### Trophy-HV

The Trophy was declared operational by the IDF in August 2009 and is currently in full production. Merkava 4 tanks integrated with Trophy active protection systems are presently being deployed in combat areas along Israel's borders.

### Exceptional Capabilities

- 360° protection, while permitting sectors of the vehicle-mounted system to be rendered inactive when necessary for the protection of troops on the ground
- 360° situational awareness by detecting all incoming threats and identifying their launch position
- Extremely high elevation protection
- Neutralizes threats fired from very short range
- Neutralizes simultaneous threats arriving from one or more directions
- Minimum collateral damage
- Suitable for multiple platforms
- High kill probability while static or on the move
- Reduces platform weight

The Trophy system is adaptable to any combat platform. Once a platform is chosen, a short trade study is completed to work out any integration issues that may arise. Numerous elements are taken into consideration for each vehicle variant or type. For vehicles with relatively basic or light armor, e.g. the Stryker, the Trophy provides full protection against all types of RPG (as well as other threats) due to the fact that the Trophy destroys these types of threats without detonation.

Currently, the full Trophy HV system weighs 800kg. Since space and weight will continue to be major issues on combat platforms, not only for current forces, but also for new vehicle programs, i.e. FCS / FRES, great efforts to miniaturize the electronics of the Trophy have been made.



**RAFAEL  
ADVANCED DEFENSE SYSTEMS**

P.O.Box 2250 (19)  
Haifa 3102102, Israel  
Tel: 972-73-3354714  
Fax: 972-73-3354657  
E-mail: [intl-mkt@rafael.co.il](mailto:intl-mkt@rafael.co.il)  
Web Site: [www.rafael.co.il](http://www.rafael.co.il)

■ **The result is additional systems for lighter vehicles:**

**Trophy-MV**

The Trophy-MV offers the same hard kill capabilities as the Trophy-HV and includes built-in soft kill capabilities as well. The Trophy-MV (previously Trophy II) is at TRL 7 and the first prototype is currently undergoing enhanced field testing. Trophy-MV a 450kg APS, for light - and medium-weight (10-30 ton) vehicles.

**Trophy-LV**

This active protection hard kill system for light armored vehicles utilizes the same superior operating principles as the Trophy-HV and Trophy-MV at a fraction of the weight. Trophy-LV's high kill probability against advanced threats, including the most sophisticated shoulder-launched AT rocket propelled grenades, makes it a significant force-multiplier at shorter ranges on the modern battlefield.

The Trophy-LV's dimensions are specially designed for easy integration and installation onto smaller platforms without impairing system performance. This ensures 360° protection including the vehicle's windows and doors with minimal risk of collateral damage. The Trophy-LV is an all-round efficient, affordable, and cost-effective solution that is currently undergoing field testing in a variety of operational scenarios.

**Operational Concept**

- Radar identifies and tracks incoming threat/s and delivers the exact threat launching point to a battle management system or weapon station
- The computer identifies the threat, determines whether it will hit the vehicle, and if so a ballistic cover opens
- A countermeasure head slews to the proper location
- The computer continues to track, acquire, and plot the best intercept solution
- The countermeasure is launched and neutralizes the threat



The Trophy systems have a very high kill probability and testing has shown them to be successful against all known CE threats (RPG, ATGM, tank-fired CE, etc.) The systems' average collateral damage is estimated at a <1% chance of a dismounted soldier being injured by Trophy or an incoming threat.

# ***SURVIVABILITY STARTS WITH PLASAN***

***Advanced solutions and materials***



## **PLASAN**

Kibbutz Sasa M.P.  
Merom Hagalil 1387000, Israel  
Tel: 972-4-6809000  
Fax: 972-4-6809001  
E-mail: [plasan@plasan.com](mailto:plasan@plasan.com)  
Web Site: [www.plasan.com](http://www.plasan.com)



- ▶ **Leading the industry with best protection, high mobility armored vehicle solutions**
- ▶ **End to end in house capabilities: full design, development, testing and integration under a single roof**
- ▶ **Innovation in survivability solutions**
- ▶ **Deployed in armed forces and security organizations worldwide**



Plasan is a global provider of mission ready solutions for military and security applications. From platform survivability through to mission ready vehicles, our solutions translate extensive operational experience into enhanced mission capabilities. Plasan offers full design, development, engineering, testing and integration under a single roof. Plasan has designed more than 150 armored hulls and delivered more than 30,000 armored vehicles to armed forces and security organizations worldwide.

- Integrated and add on armor solutions for tracked and wheeled ground vehicles, airborne platforms and personal protection.
- Blast protection solutions including: Energy absorbing seats and foot pads.
- HSF™ and FlexFence™ RPG defeat solutions.
- Plasan **mission specific vehicle solutions** designed to address a wide range of defense and homeland security missions featuring exceptional maneuverability, superior armor protection and fully integrated ISR, command, control and communication technologies.
- VETRONICS solution.
- Plasan SANDCAT™ family of multi-purpose 4X4 armored vehicle, designed for optimized mobility, maneuverability and operational versatility in any terrain. Over 400 vehicles deployed in more than 10 countries.
- GUARDER™ - High protection, high performance 4X4 armored vehicle, carries up to 24 troops. Outstanding mobility and maneuverability on all-terrains. Equipped with the most advanced survivability systems.

# TACTICAL RADARS FOR FORCE AND BORDER PROTECTION

## The Ultimate Combat Threat Management

**RADA**  
ELECTRONIC INDUSTRIES LTD.

**RADA Electronic Industries LTD.**

P.O.Box 8606  
7 Giborei Israel Blvd.,  
Netanya 4250407, Israel  
Tel: 972-9-892-1111  
Fax: 972-9-885-5885  
E-mail: [mrkt@rada.com](mailto:mrkt@rada.com)  
Web Site: [www.rada.com](http://www.rada.com)



RADA's tactical radars for the maneuver force provide critical real-time threat information that dramatically enhances survivability and mission success.

**The Compact Hemispheric Radar (CHR) family is designed for combat vehicles and short-range protection:**



- **RPS-10** Radar Sensor for Active Protection Systems (APS)
- **RPS-15** Hostile Fire Management System for Combat Vehicles

**The Multi-mission Hemispheric Radar (MHR) family is designed for force and border protection:**



- **RPS-40** Hostile Fire Management (C-RAM)
- **RPS-42** Tactical Air Surveillance (C-UAS)
- **RHS-44** 3D Comprehensive Perimeter Surveillance

Both are Pulse Doppler radars, Software-Defined, with AESA antenna & GaN amplifiers, 90° elevation coverage, compact and mobile, highly reliable, and introduce superior performance-to-price ratio.

# HAGOR INDUSTRIES LTD.

- HUMAN ENGINEERING
- ADVANCED DEVELOPMENT
- TOP QUALITY
- RELIABILITY



**hagor**

MILITARY EQUIPMENT MANUFACTURING

HAGOR INDUSTRIES LTD.

P.O.Box 3211, Kiryat-Ariye  
Petach-Tikva 4951393, Israel  
Tel: 972-3-9248990  
Fax: 972-3-9243996  
E-mail: [michal@hagor.co.il](mailto:michal@hagor.co.il)  
Web Site: [www.hagor.com](http://www.hagor.com)

Hagor Industries Ltd. was established in 1956 and it is a Family-owned company.

Hagor is a major authorized supplier of the Israel Defense Force, Police, Special Anti-Terror Units, Elite military units and worldwide law enforcement agencies.

For more than 50 years Hagor is known for its innovative solutions and lifesavings personal gear, Bullet proof vests According to NIJ STD 0101.04 / 0101.06 offering protection levels IIA, II, IIIA, III, IV, and full range of high performance Body-Armor.

Hagor is standing on the forefront of the Future- Soldier Specialized gear, offering significant core to the company's vision.

Our experience and Production facilities allows us to produce also all military gear, rucksacks, bags, tents, sleeping bags, etc. According to customer's requirements and specifications as follows:

**Protective Bulletproof Vests:** Hagor produce numerous models of ballistic vests with protection levels according to customer requirements. Our products are manufactured with the latest high-tech solutions and raw materials.

**Combat Harness:** single-unit combat harness distributes the weight of combat fighting gear proportionally over the body, providing comfort and greater mobility with maximum load.

**Personal Gear:** Kitbag, rucksacks, field cots, sleeping bags, etc.

**Military Tents:** from personal tents up to camp tents, giant tents, Hospital and dining room tents etc.

**Versatile Covering:** to suit all different types of vehicles, weapon systems, cannons, tanks, SUV etc.



**Hagor quality control system complies with the Quality Management Standard ISO-9001-2008, standard and IQnet.**



# ISRAGOR PROTECTIVE GEAR & SYSTEMS LTD.



**ISRAGOR PROTECTIVE GEAR & SYSTEMS LTD.**

3 Hagesher St.,  
Hod-Hasharon 4526603, Israel  
Tel: 972-9-7493105  
Mobile: 972-50-3227997  
Fax: 972-9-7493834  
E-mail: isragor@zahav.net.il

**ISRAGOR Ltd.** has become a leader in development, manufacturing and marketing Protective vests due to a synergy of advantages including practical Experience and the utilization of development and manufacturing technologies.

**ISRAGOR** utilizes the most advanced forms of ballistic materials.

**ISRAGOR** products are custom made, adding Value to the product, relative to its price.

**ISRAGOR** has developed expertise in the manufacturing of protective vests for V.I.P. anti terror, seals, s.w.a.t. teams paratroops from level I up to IV.

**ISRAGOR** manufactures its products in Israel in accordance with the standards stipulated by the I.D.F yet has the flexibility to meet customer specifications.

**ISRAGOR** manufactures military gear such as: battle vests, Bags, Tents, dry storages systems etc... and facilitates all stages Involved in supplying them.

**ISRAGOR** has the power to be your liaison to the Israeli military industries as well. For any of your requirements contact us.

***We keep a supply of tents for immediate shipment, in case of emergencies such as floods, earthquakes etc.***



**Gendarme Vest**



**Tactical Anti Terror Vest**



**Pasgat Vest**



**V.I.P Vest**



**Combat Harness**



**Police Vest**

The ISPRa logo is displayed in a bold, white, sans-serif font. The letters 'i' and 'p' are lowercase, while 's', 'r', 'a', and 'a' are uppercase. The logo is set against a dark blue background that features a large, stylized red arrow pointing upwards and to the right.

[www.isprald.com](http://www.isprald.com)

A black and white photograph showing a line of riot police. They are wearing helmets with visors and holding large, clear shields. Some are holding batons. The background is slightly blurred, suggesting a crowd or a street scene.

Founded in 1969, **ISPRa** is a global leader in developing, manufacturing and marketing of Less Lethal devices for riot control, crowd management, anti terror equipment and police gear.

## ISPRa LESS LETHAL

By combining our technical knowhow with practical field experience, ISPRa manages to deliver smart Less Lethal solutions to its clients, helping them deal with the growing challenges of crowd management. ISPRa's Innovative product line has kept us in the forefront of Less Lethal ammunition throughout the years. We are developing today smart solutions for the problems of tomorrow.



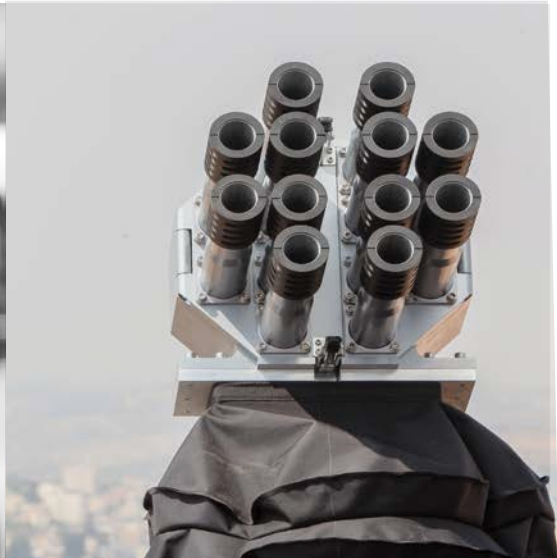

**ISPRA**  
**Israel Product Research Co. LTD.**  
 20A Galgaley Haplada St.,  
 P.O.Box 2086  
 Herzelya 4672220, Israel  
 Tel: 972-9-9555464  
 Fax: 972-9-9559146  
 E-mail: [isptra@netvision.net.il](mailto:isptra@netvision.net.il)  
 Web Site: [www.ispraltd.com](http://www.ispraltd.com)

# RIOT CONTROL SOLUTIONS



Sentinel Tactical Gear provides top-quality equipment for law enforcement, military and homeland security agencies. Providing them with the tools to complete their missions safely and effectively.

Sentinel Tactical Gear product line includes a full range of police duty gear, protective gear and tactical equipment. These products are of the highest quality in terms of materials, construction and durability. Sentinel Tactical Gear products are tested and approved by our product development team with collaboration and field testing by our security force partners.



# LIOR TEXTILE INDUSTRIES LTD.

## Protecting People™ since 1976



### Standards:

NIJ Standard, HOSDB  
 NFPA, CGSB, NSN, ASTM,  
 IDF Mil-spec, US Mil-std.



### Quality Assurance:

- ISO 9001:2008
- "Level A" of the Israeli MOD

### LIOR TEXTILE INDUSTRIES LTD.

P.O.Box 11, Dora Ind. Zone  
 Shlomi 2283201, Israel  
 Tel: 972-4-9808815  
 Fax: 972-4-9808816  
 E-mail: info@lior-protective.com  
 Web Site: www.lior-protective.com

For the last 40 years, LIOR has been a licensed vendor of the I.D.F,  
 Israel Police & special anti-terror units.

### Areas of Activity

Development, Design, Manufacture & global marketing of personal protective gear:

- Body armor for the army, police & V.I.P use.
- Ballistic shields & Inserts.
- Ballistic helmets.
- E.O.D - Bomb Suits.
- Tactical Vests.
- CBRN protective suits & Coveralls.
- Extended Cold Weather Clothing System (ECWCS).
- Backpacks & Carrying systems.
- Fire brigade suits, Nomex pilot & tanker coveralls, underwear.
- Work wear outdoor clothing: including reflective rain suits.
- Inflatable tent & stretcher.
- Dry storage solutions.



Concealed Body Armors



External Body Armors



Carrying systems



ECWCS



Helmets & H.A.P



CBRN Clothing



Dry Storage Solutions

# MAROM DOLPHIN

## Dedicated to Highest Standards

[www.MAROM-DOLPHIN.com](http://www.MAROM-DOLPHIN.com)



### MAROM DOLPHIN LTD.

Industrial Zone Alon Tavor  
P.O.Box 1126  
Afula 1811101, Israel  
Tel: 972-4-6400797  
Fax: 972-4-6403074  
E-mail: [info@marom-dolphin.com](mailto:info@marom-dolphin.com)

**Marom Dolphin Ltd.**, founded in 1993 develops, manufactures and markets top quality personal military supplies for armed forces, police units, security services and civilians around the world.

Each of the founders of **Marom Dolphin Ltd.** comes from an army combat background having served in different fighting units in the Israeli Defense Forces (IDF). Together, we are a dynamic and flexible team. Combining our knowledge and experience, we have dedicated ourselves to developing safe, ergonomic products essential for any and all security tasks. The wide range of military and security products are of the highest quality and meet the demands of all service standards.

Our products are manufactured and tested in accordance with the Quality Assurance standards of military forces world wide, as well as in strict adherence to ISO 9002 Standards, awarding them worldwide recognition for their high quality and durability.

Among our customers are military, paramilitary, law enforcement and security organizations across the globe. We are the main authorized supplier of tactical and bulletproof vests to the Israeli Military and to the Israeli Ministry of Defense, as well as many other customers, world wide.

**Marom Dolphin Ltd.** maintains the highest manufacturing standards in strict adherence to ISO 9001:2008 international standards.

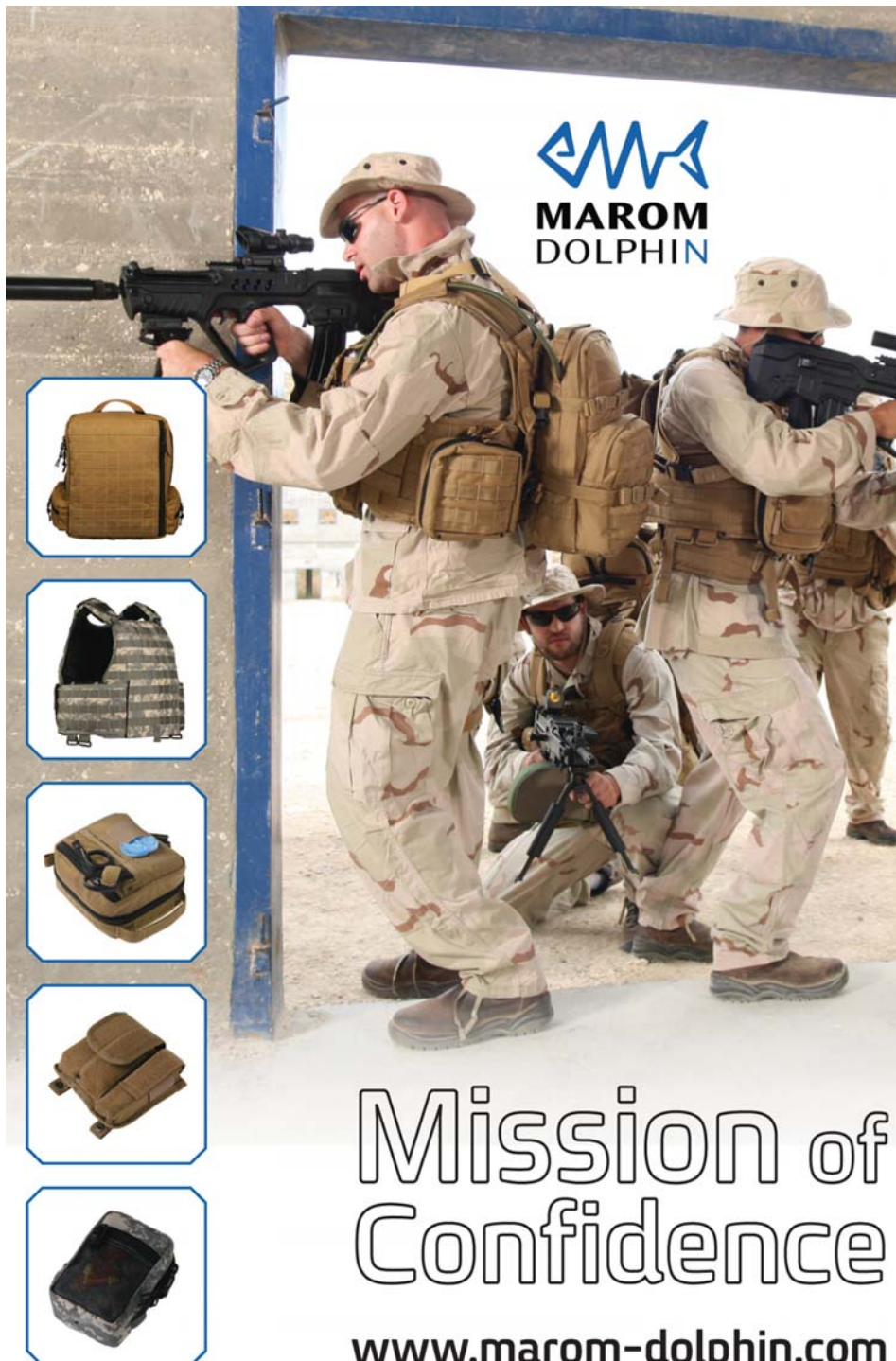

# Mission of Confidence

[www.marom-dolphin.com](http://www.marom-dolphin.com)

# MYFORM

## Defense • Define & Develop

- *Body armor and carrying vest*
- *Concealable Protection vests*
- *Riot control suits, helmets and detachable visors*
- *Protection suits and equipment for Krav Maga training*
- *Personal protection gear for NBC (nuclear, biologic, chemical)*
- *Dry Storage solutions for deferent kinds and sizes of army vehicles*
- *Customized equipment for combatants and security forces*

**MYFORM**

DEFENSE • DEFINE & DEVELOP

### MYFORM LTD.

9 Lincoln St.,  
P.O.Box 14233  
Tel Aviv 6114102, Israel  
Tel: 972-3-6244488  
Fax: 972-3-6244499  
E-mail: [myform@myform.co.il](mailto:myform@myform.co.il)  
Web Site: [www.myform-security.com](http://www.myform-security.com)

**MYFORM Defense Define & Develop** was established at 1996 and is one of the leading companies in Israel for Unique solutions of personal protections gear for combatants, Defense Force personnel and VIP's, as well as Chemical protective Clothing, anti-riot equipment and dray storage solutions.

**MYFORM** management members have all served in the Israeli IDF special elite units and in Senior positions in various governmental Agencies, and have worked in the most challenging security environments around the world and put this experience and vast practical know-how in developing, manufacturing and customizing its products.

**MYFORM** is well known for its tailor-made solutions and developments, Manufactured at our factory in Northern Israel, and is an authorized supplier of the IDF, Israeli Police and Prison Authorities and governmental Agencies.

**MYFORM** provides solutions that are compatible with international quality standards, and is certified by the Institute of Standards. (ISO 9001:2008).



# NOGA EINAT ARMY DIVISION



**NOGA-EINAT SHOE INDUSTRIES LTD.**

Kibbutz Givat Hashlosha 4880000, Israel

Tel: 972-3-9030150

Fax: 972-3-9030151

E-mail: [info@nogaeinat.co.il](mailto:info@nogaeinat.co.il)

Web Site: [www.nogaeinat.co.il](http://www.nogaeinat.co.il)

Since 1950 the major supplier to the I.D.F. Noga-Einat Shoe Industries is an Israeli manufacturer and supplier of military, safety and working shoes, serving both local and foreign markets.

Product lines include: army boots and shoes, products for unusual conditions and special forces, police boots and shoes, and boots for anti-terror units and anti-rioting units.

Drawing on its close working relationship with the R&D unit of the Israeli Defense Forces, Noga-Einat engineers constantly strive to design better, more comfortable, and more durable footwear. In addition, Noga-Einat also offers customized products to meet special requirements of customers.

Noga-Einat products are manufactured using the most durable, top-quality materials available.

Shoes and boots are typically composed of: leather/canvas uppers; non-woven, anti-perspiration leather insoles; and nitrite rubber/polyurethane soles. Most models offer optional fittings such as double-density soles, special removable insoles, built-in air cushioning, fur lining, etc.

Noga-Einat products meet or surpass the requirements of the IDF and other armies. The company has earned ISO 9001:2008 certification.

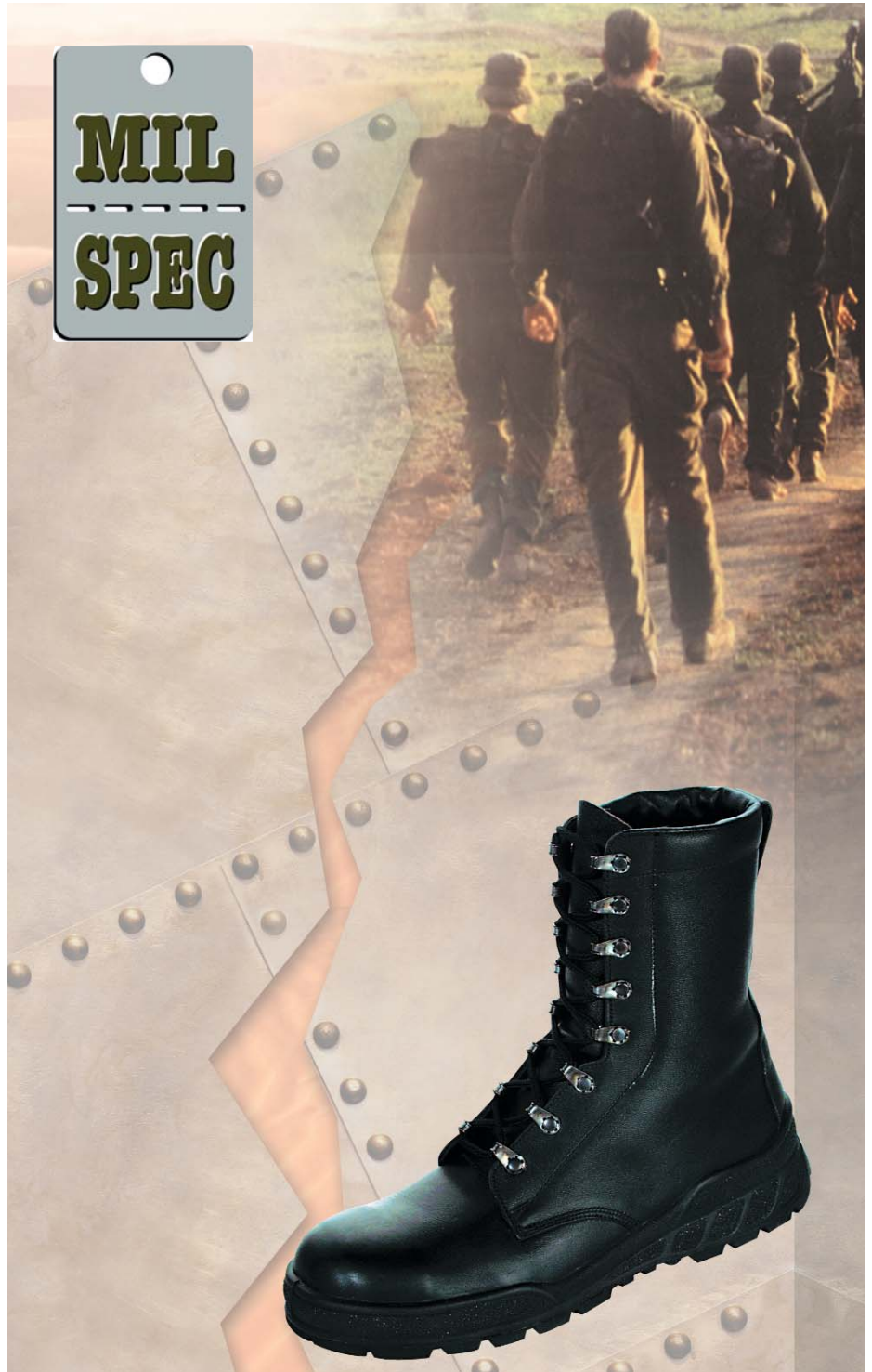

# PERSONAL PROTECTIVE GEAR



## RAFAEL ADVANCED DEFENSE SYSTEMS

P.O.Box 2250 (19)  
Haifa 3102102, Israel  
Tel: 972-73-3354714  
Fax: 972-73-3354657  
E-mail: [intl-mkt@rafael.co.il](mailto:intl-mkt@rafael.co.il)  
Web Site: [www.rafael.co.il](http://www.rafael.co.il)

### Ceramic Ballistic Protection

RAFAEL has developed a unique cost-effective technology for manufacturing boron carbide products for ballistic protection, offering high performance, lightweight, multi-hit capability properties.

Boron carbide combines high ballistic efficiency with high mass efficiency, and therefore suits all applications in which a low weight, high ballistic protection is required. (Personal body armor, armor for helicopters, airplanes, vehicles, military posts etc).

RAFAEL's patented technology is based on pressure less sintering. This process provides lower production costs (low than hot press technology), thus offering a combination of high performance, light weight, flexibility in shape, design and low cost.

RAFAEL's infrastructure, with its high in-house production capacity is able to supply bare ceramic products in large quantities.

RAFAEL can supply the boron carbide products in various shapes: Flat tiles, multi-curve tiles, hexagonal tiles of various sizes and others.

RAFAEL's boron carbide products provide NIJ level IV protection and withstand all requirements of E-SAPI.

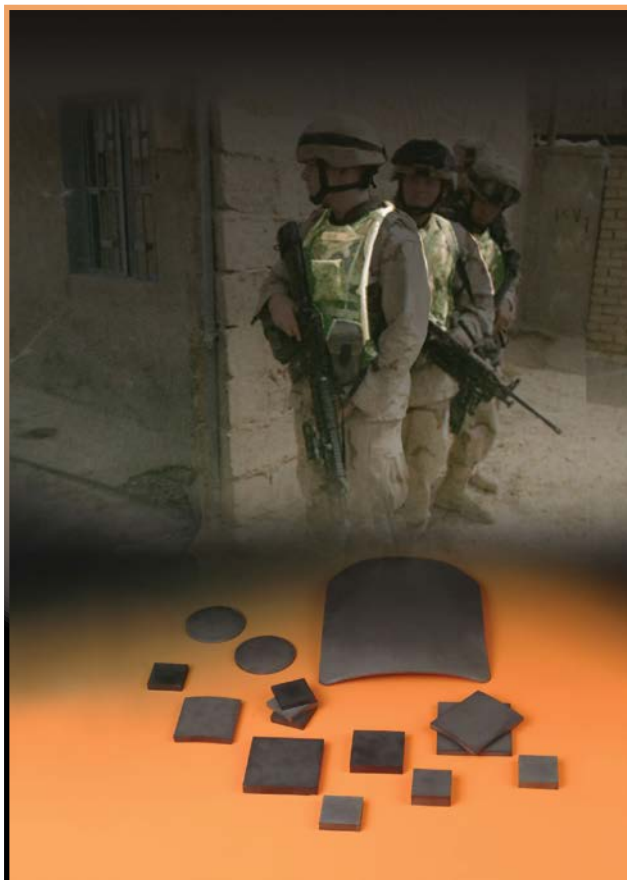



# **EPS 21™**

## **THE NEW GENERATION IN EYE PROTECTION**

### **Advanced combat goggles for ballistic, sun, wind, dust and laser eye protection**



**SHALON CHEMICAL INDUSTRIES LTD.**

Head Office: 2 Kaplan St., 10<sup>th</sup> Floor,  
Tel-Aviv 6473403 Israel  
Tel: 972-3-6957191, Fax: 972-3-6957980  
Plant: Kiryat Gat 8202501, Israel  
Tel: 972-8-6879111, Fax: 972-8-6811115  
E-mail: shalon@shalon.co.il  
Web Site: www.shalon.co.il

Shalon Chemical Industries, world leader in designing and manufacturing of personal protective equipment, has developed new combat goggles

 EPS-21™, which are approved by the Israel Defense Forces as its standard combat goggles.

 EPS-21™ is based on a key design concept of a basic platform that provides ballistic, dust and wind protection, which can accommodate different types of secondary lenses as filters against solar and laser radiation.

The modular product design incorporates special features:

- Peripheral and frontal ballistic protection while keeping full field of vision.
- One size fits all.
- Good fit to user's face prevents dust penetration while insuring maximum comfort.
- Improved interface with optical sighting equipment.
- Labyrinth design of ventilation ports insures ventilation without filtration elements.
- Donning and removing while wearing a helmet.
- Secondary snap-on lens protects against solar or laser radiation, only when required.
- Integral adaptor for prescription lenses frame.
- Very attractive appearance.

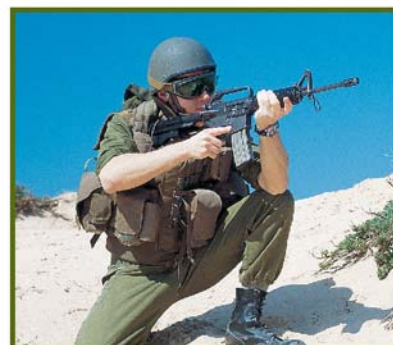

U.S patent pending

# CONTROP'S LAND SYSTEMS FOR BORDER PROTECTION

**CONTROP is a world leader in EO / IR technologies and systems, providing innovative day / night EO / IR solutions for air, land and sea surveillance, defense and Homeland Security applications worldwide.**

**CONTROP**  
Turning Vision Into Reality

**CONTROP  
Precision Technologies LTD.**

P.O.Box 611  
Hod Hasharon 4510502, Israel  
Tel: 972-9-7440661, Fax: 972-9-7440662  
E-mail: sales@controp.com  
Web Site: www.controp.com

## Unique qualities and features about CONTROP's EO / IR Land Systems:

- EO / IR cameras for observation missions providing CCD, IR video and panoramic imagery.
- Fast panoramic EO / IR scanning.
- EO / IR "radar" for Automatic Intruder Detection and Recognition – providing a Virtual Fence.
- Variety of capabilities – from short range systems (1 km) to very long range systems (25 km).
- Gyro-stabilized systems for long range capabilities and for tall mast mounting.
- Light weight, gyro-stabilized, ruggedized EO / IR systems for mobile applications.
- Unique EO / IR payloads for use on aerostats / balloons for persistent surveillance - high performance systems with very low weight including stabilization in pitch, yaw and roll.
- EO / IR payloads for use on SUAVs for day and / or night applications.
- Systems for 24/7 missions.

## CONTROP's EO / IR Land Systems Sensors:

- IR Camera for Observation and Scanning.
- CCD Camera for Observation and Scanning.
- Laser Range Finder (Optional).
- Laser Pointer for Target Marking (Optional).



## Applications for CONTROP's EO / IR Land Systems:

- Security of High-value Sensitive Installations (Airports, Power Plants, Fuel Storage Depots, Oil Refineries, Water Reservoirs, Armed Forces Facilities etc).
- Coastal Surveillance (including small boat detection, swimmer detection, etc).
- Border Surveillance (smuggling, illegal immigration etc).
- Perimeter Surveillance.
- Military Bases/Port Security.
- Force Protection and Ground Troops Security.
- Virtual Fence from short to long ranges.

## Platforms for CONTROP's EO / IR Systems:

- UAVs
- SUAVs
- Aerostats / Balloons
- High masts, poles and towers
- Patrol Vehicles
- Armored Vehicles
- Armed Combat Vehicles
- Surveillance Vehicles



# LONG VIEW - CR



**ELBIT SYSTEMS**  
**ELECTRO-OPTICS - ELOP LTD.**  
P.O.Box 1165,  
Rehovot 7611101, Israel  
Tel: 972-8-9386211  
Fax: 972-8-9386010  
Web Site: [www.elbitsystems.com/elop](http://www.elbitsystems.com/elop)



The capability to operate at day/night under severe vision conditions is a quality advantage in an overall combat scenario as well as in a limited conflict.

**LONG VIEW CR** is a versatile and combined day/night system for long-range observation and target acquisition capabilities for different applications. The system is integrative and relatively compact to fit various dismounted observation units.

**LONG VIEW CR** is a highly integrated system for day and night observation and target acquisition including long-range zoom FLIR, long-range day channel, eye safe laser range finder, GPS and magnetic compass. The system is versatile for pedestrian back-carry operation, for mounting on vehicles or for fixed observation posts. **LONG VIEW CR** is a very light weight solution weighing less than 12.5 kg (27.5 pounds).

## Main Features

- long-range high resolution thermal channel
- Long-range monochrome day camera
- Wide FOV color day camera
- High performance eye-safe laser range finder
- Digital magnetic compass
- GPS receiver
- High resolution color dual OLED display, binocular viewer
- Day/night target acquisition capability
- Electronic goniometer
- Video recording capability > 8 hours
- Integral target data bank
- Complete interface to C4I applications
- Battery operated - man portable

## Configurations

- Man portable
- For observation systems/platforms

# GROUND BASED TACTICAL RADARS



**IAI ELTA SYSTEMS LTD.**

P.O.Box 330, Ashdod 7710202, Israel

Tel: 972-8-8572410

Fax: 972-8-8561872

E-mail: [market@elta.co.il](mailto:market@elta.co.il)

Web Site: [www.elta-iai.com](http://www.elta-iai.com)

## Advanced Tactical Acquisition Radar ELM-2106 ATAR

The ELTA ELM-2106 ATAR is a fourth generation Tactical Air Defense Radar. The System is a 3D target positioning, solid state L-band medium range tactical radar with Active Electronically Steering Array (AESA). The radar detects a wide variety of low Radar Cross Section (RCS) targets such as low flying fighter aircraft, hovering helicopters, low speed ultra-lights and UAVs.

The ATAR can be deployed as a local Air Defense system providing warning and target designation to Surface-to-Air weapon systems such as MANPADS. The system can also be deployed as local air defense gap filler supporting en-route and Air Traffic Control (ATC) Centers.



## Very Short Range Air Defense Radar (VSHORAD) ELM-2026B

The ELM-2026B VSHORAD is a fifth generation 3D Tactical Air Defense Radar. It is a lightweight transportable, X-band, solid-state electronically scanned, Pulse-Doppler radar. This cost-effective radar delivers early warning and target data for support of surface-to-air missile weapon systems. The radar employs multi-beam elevation coverage by applying Digital Beam Forming (DBF) and 360° azimuth coverage by antenna rotation. It detects a wide variety of low RCS targets such as low flying fighter aircraft, low velocity ultra-lights and UAVs. The ELM-2026B VSHORAD can be deployed as a local Air Defense system providing early warning and target track for surface-to-air weapon systems.



## Persistent Surveillance Radar Family ELM-2112

The ELM-2112 is a new family of advanced high resolution radars with unique and outstanding capabilities. Featuring simultaneous multi-beam technology, the radar provides persistent surveillance and instantaneous target detection and tracking. The radars are designed for ground and sea surface surveillance.

The radars feature up to 4 stationary planar antennas, covering a sector of 90°, and enabling a 360° instantaneous coverage. The radars cover detection ranges up to 22 Km for a person or rubber boat and up to 44 Km for a moving vehicle or sailboat.



## Ground Surveillance Radar Family ELM-2105

The ELTA ELM-2105 is a family of tactical Ground Surveillance Radars (GSR), designed to provide 360° coverage by mechanical rotating of the radar. It is a lightweight, all-weather, movement detection radar designed to detect, alert and monitor intruders' movements in protected and selected areas of interest. Featuring high target update rate, the radar delivers high probability of target interception and supports military and para-military law enforcement missions. The radar can be either locally or remotely controlled as standalone unit or integrated in a larger ground surveillance network.

# BORDER PROTECTION



## **RAFAEL ADVANCED DEFENSE SYSTEMS**

P.O.Box 2250 (19)  
Haifa 3102102, Israel  
Tel: 972-73-3354714  
Fax: 972-73-3354657  
E-mail: [intl-mkt@rafael.co.il](mailto:intl-mkt@rafael.co.il)  
Web Site: [www.rafael.co.il](http://www.rafael.co.il)

**Rafael Advanced Defense Systems**, as a designer and developer of multi-disciplinary, field-proven "system-of-systems", is well-versed in complex large-scale integration and development of solutions for critical asset protection programs, both for Israel and for various countries around the world.

Rafael Advanced Defense Systems provides an end-to-end solution for today's challenges in critical asset protection and well into the future, with its vast experience and based on extensive knowledge gained over the last 60 years.

Rafael's tailor-made solutions address the customer's unique requirements, after conducting an in-depth geographical review of the area, as well as analysis of all the major potential threats, including the motivation and the ability of an attacker to carry out hostile acts.

Rafael's solution supports connectivity with **Customer-defined** sensors.

### **Ground-Based Sensors (Stationary and Mobile), including:**

- **Terra-Sonic**- a passive warning and detection system designed to alert to possible threats on or in the vicinity of the pipeline
- **Toplite**- an advanced day/night Electro-Optic System (EOS) mounted on a mast to provide large area continuous surveillance.
- **Stalker**- a multi-sensor system mounted on a Customer-furnished vehicle for efficient surveillance, based on an advanced day/night Electro-Optic Pod and radar, mounted on an electrically-operated telescopic mast.
- **SpotLite-P**- tripod-mounted system for the detection of small arms fire sources.

### **Airborne Sensors, including:**

- **RecceLite** - a self-contained self-cooled multi-sensor tactical reconnaissance system, consisting of an airborne pod based on the Litening Targeting and Navigation Pod and a ground exploitation station. The RecceLite simultaneously collects Infra-Red (IR) and Visual (VIS and near IR) digital images within a very wide field of regard, in accordance with an automatic mission plan and/or manual operation. The images and the data annotation are recorded on a solid state recorder and transmitted to the exploitation station via the RecceLite data link. The Images are then interpreted at the ground exploitation station.
- **Recce-U** - a self-contained, multi-sensor ISR system (based on the RecceLite Tactical Reconnaissance Pod). In addition to the persistent ISR payload, the system also comprises of a Ground Data Link Station (GDLS) and Ground Exploitation Station (GES). Recce-U simultaneously collects high-resolution infrared and visual digital images, day and night, within a very wide field of regard, in accordance with an automatic mission plan and/or manual operation, and transmits the images, which are then viewed and interpreted at the GES.
- **Toplite** - an advanced day/night Electro-Optic System (EOS) mounted on a mast to provide large area continuous surveillance.

### **USV/UAV/UGV, including:**

- **Unmanned Airborne Vehicle (UAV)**: a tactical surveillance system, which consists of a stabilized day/night electro-optical payload mounted on a Customer-furnished UAV.
- **Protector USV** - unmanned integrated system for Intelligence, Surveillance, Target Acquisition and Reconnaissance (ISTAR).

### **C<sup>4</sup>I, including:**

- **IMILITE** Situational Awareness Command and Control Centers that act as the command and control operational hubs, and used to connect all the sensors and to allow video and data transfer between the IMILITE centers and the ground forces.
- **Mobile and deployable IMILITE** Surveillance, Command and Control systems: installed in a vehicle that can be deployed to strategic locations to closely manage and control specific events and operations.

■ ■ ■

# ***ELECTRO-OPTIC INTELLIGENCE, SURVEILLANCE AND RECONNAISSANCE (ISR)***

## ***Litening - Targeting & Navigation Pod***

Litening is an innovative airborne infra-red targeting and navigation pod for fighter aircraft with high accuracy and reliability, day and night precision strike capability. Litening reduces pilot workload during targeting and tracking. It is easily integrated on any aircraft and possesses high growth potential.

In use in the Israeli Air Force, USAF, ANG, AFRES, Marines, German AF, Swedish AF, Spanish Navy & AF, Greek AF, and others, the Litening flies on F-16 , F-15, A-10, B-52, AV8-B, Gripen, Tornado, F-5, F-4, Mig-21, Mirage 2000, Jaguar and others.



## ***Toplite EO System - Electro-Optical Surveillance, Observation & Targeting System***

The Toplite family of electro-optic systems is an advanced multi-sensor, multi-purpose, highly stabilized EO systems for homeland security and defense applications, for aerial, maritime and ground based platforms.

## ***RecceLite- Real Time Tactical Reconnaissance System***

The RecceLite System consists of an E-O pod, a ground exploitation station and a data link. It is capable of collecting images day & night from 300 ft to 40,000 ft in all directions forwards, nadir, backwards, oblique - all down hemisphere and even when the aircraft is maneuvering in high G.

The Ground Exploitation Station (GES) is capable of generating targets in real-time with exceptionally high accuracy due to state-of-the-art algorithms and technology.

The data-link connects between the sensors and the GES and enables the images to be downloaded to the GES in real time. When your task is to close the attack cycle on many "time-critical targets" in less than 10 minutes, there is only one system - RecceLite.

## ***Recce-U - Real-Time Persistent ISR System for UAVs***

Recce-U is a self-contained, multi-sensor ISR system (based on the RecceLite Tactical Reconnaissance Pod). The Recce-U enables automatic photography, according to a mission plan prepared in advance, or updated mission plan uplinked in real-time, however the operator can initiate manual scanning for targets of opportunity.



***Litening -on-Gripen***



***Toplite EOS***



***RecceLite System***



***Recce-U***

**RAFAEL**  
**ADVANCED DEFENSE SYSTEMS**  
P.O.Box 2250 (19)  
Haifa 3102102, Israel  
Tel: 972-73-3354714  
Fax: 972-73-3354657  
E-mail: intl-mkt@rafael.co.il  
Web Site: www.rafael.co.il

### **SpotLite Family** **Electro-Optic Enemy Fire Detection System**

The SpotLite family consists of electro-optical systems that detect and locate enemy fire in stationary positions as well as on the move. Rapid detection and precise location information provide forces with the capability to quickly neutralize the enemy, maintaining the upper-hand on the battlefield.

The **SpotLite P** is a portable electro-optic system carried by two soldiers for day and night detection and location of small arms fire.



**SpotLite P on Tripod**

**SpotLite M** is a mobile electro-optic system installed on vehicles and AFV's that enables the detection and location of enemy fire sources from small arms, RPG rockets, ATGM and tank shells, on the move, day and night, up to 360° coverage.



**SpotLite M on vehicle**

### **Imilite - Multi-Source Multi-Task ISR Exploitation System / Command and Control System**

Imilite is an intelligence system designed to receive process and exploit multiple standalone imagery video and other intelligence data in a centralized and a unified way.

Main system capability includes the reception, processing and exploitation of EO, IR, SAR/GMTI and VIDEO, in various formats, over one desktop. In order to enhance the exploitation process, Imilite further combines non-imagery data such as targets, threats, COMINT detection and mission status within the system workflow. Imilite generates a variety of standard and customer tailored ISR reports and IMINT products such as alphanumeric reports, annotated maps, GIS data layers and visual aids, and disseminates them to external information and operation systems over standard and tailored protocols.

Imilite's multi-source data integration and automation capabilities improve the efficiency of utilizing available collection and exploitation assets. The system GIS capabilities provide immediate accessibility to relevant imagery and intelligence data, thus shortening the ISR collection and exploitation cycle.

The Imilite is based on Rafael's combat-proven ISR and C<sup>4</sup>I systems already in service worldwide. Imilite is designed for use by Defense forces (air, ground) and police forces exercising various observation means for border patrol or coping with urban crime.



**Imilite**

# IMILITE



***Multi-Source Multi-Task ISR Exploitation System / Command and Control System Imilite is an intelligence system designed to receive process and exploit multiple standalone imagery video and other intelligence data in a centralized and a unified way.***

**RAFAEL**  
**ADVANCED DEFENSE SYSTEMS**  
P.O.Box 2250 (19)  
Haifa 3102102, Israel  
Tel: 972-73-3354714  
Fax: 972-73-3354657  
E-mail: [intl-mkt@rafael.co.il](mailto:intl-mkt@rafael.co.il)  
Web Site: [www.rafael.co.il](http://www.rafael.co.il)



## **System capabilities:**

data reception, processing and display of Video, imagery, targets, threats, mission status, force locations, SIGINT detection and others.

The system GIS capabilities provide synchronized display of all the data as overlays on maps, video and images.

Imilite improves the Command-and-Control process by various automated image processing algorithms such as geo-referencing, change and motion detection, video/image enhancement, video stabilization and others.

Imilite can disseminate operational data, tactical mission reports, targets and treats to other forces, to facilitate close support operations, targeting and platform/sensor management.

ImiLite allows scalable Command and Control solutions and adaption to specific operational needs, both in mobile and stationary configurations for Command and Control centers, deployable operational units.

## **Benefits:**

- Centralized and unified workflow and data display
- Improved efficiency utilizing all available collection assets
- Shortened exploitation cycle
- Efficient Command and Control workflow
- Immediate accessibility to relevant data
- Real-time mission command-and-control workflow
- SR and mission product sharing with external operational users

## **Features:**

- Multi-source data reception in various formats
- GIS capabilities: image/video geo-referencing, data overlays, Geo data retrieval
- Advanced Image Processing Algorithms: change and motion Detection, image/video enhancement, video stabilization and others
- ISR and mission products and reports generation and dissemination
- Scalability and Adaptability
- Stationary, Mobile or Airborne configurations



# MIC<sup>4</sup>AD



## RAFAEL ADVANCED DEFENSE SYSTEMS

P.O.Box 2250 (19)  
Haifa 3102102, Israel  
Tel: 972-73-3354714  
Fax: 972-73-3354657  
E-mail: [intl-mkt@rafael.co.il](mailto:intl-mkt@rafael.co.il)  
Web Site: [www.rafael.co.il](http://www.rafael.co.il)

MIC<sup>4</sup>AD is an advanced, unified, integrated C<sup>4</sup>I system that commands and controls the operation of both air and missile defense, including air-superiority missions. MIC<sup>4</sup>AD provides a total solution for multi-system, multi-layer and multi-range air and missile defense, traditionally operated as separate commands.

MIC<sup>4</sup>AD correlates real-time data from distributed sensors/platforms (radars, IFF system, data links, electro-optics), all connected to the air traffic control picture and mission planning system. The data is analyzed to deliver a real-time, coherent national Air Situation Picture (ASP).

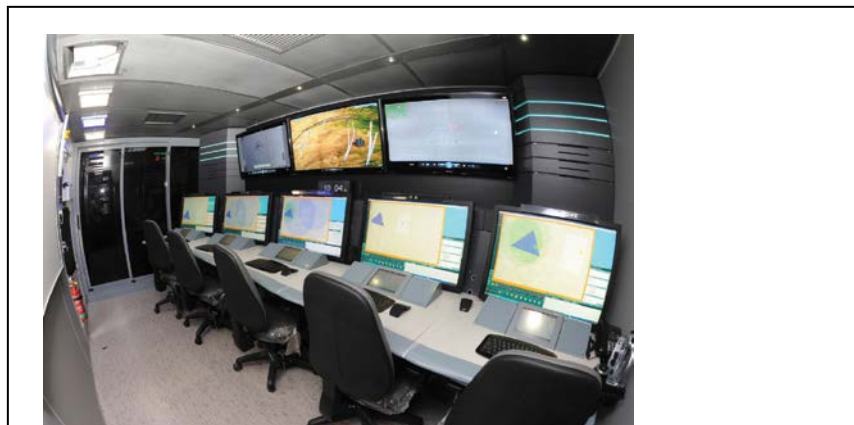

Simultaneously, MIC<sup>4</sup>AD performs threat assessment and hostile target classification, generating an interception plan for threats at any command level (national, regional, tactical). MIC<sup>4</sup>AD optimizes resource management and swiftly allocates the most appropriate defense system, such as SPYDER, David's Sling, Iron Dome or other customer systems to the type of challenge. Response includes target allocation to weapon systems (TAWA - Threat Assessment Weapon Allocation) with full, semi-automatic or manual fire control according to customer doctrine.

MIC<sup>4</sup>AD open, modular architecture can be adapted to customer operational needs. The system can be integrated with a customer's existing or future air and missile defenses. This flexibility allows incorporating new technologies and systems with the existing arrangement. MIC<sup>4</sup>AD can serve as an add-on to the customer's current C<sup>4</sup>I setup, or replace existing systems entirely.

Highly automated, easy-to-use and with advanced interactive displays, MIC<sup>4</sup>AD is a true force-multiplier. Enabling unified command and fire control of multiple air and missile defense systems, MIC<sup>4</sup>AD delivers multi-mission, multi-layer and multi-range C<sup>4</sup>I capabilities that ensure end-to-end air and missile protection.

# PROTECTOR® USV



## RAFAEL ADVANCED DEFENSE SYSTEMS

P.O.Box 2250 (19)  
Haifa 3102102, Israel  
Tel: 972-73-3354714  
Fax: 972-73-3354657  
E-mail: intl-mkt@rafael.co.il  
Web Site: www.rafael.co.il

## PROTECTOR® USV

Is an unmanned integrated system for Intelligence, Surveillance, Target Acquisition and Reconnaissance (ISTAR).

The **PROTECTOR® USV** is fitted with a comprehensive sensor suite and can accommodate a variety of mission modules. The TOPLITE Electro-optical director and a radar system provide day/night detection, identification and tracking of targets. TOPLITE subsystems include a third-generation Forward-Looking Infra-Red (FLIR) sensor, color Charge-Coupled Device (CCD) camera an eye-safe laser rangefinder (LRF), and an advanced correlation tracker.

The Anti Terror/Force Protection payload includes the TOPLITE Electro-Optical Director (EOD), MINI-TYPHOON Stabilized Weapon Station, a Water Cannon System and auxiliary sensors. The MINI-TYPHOON is a stabilized gun mount that is highly accurate and includes fire control capabilities, yielding excellent shooting accuracy. The Water Cannon system provides less-lethal engagement at close range as well as firefighting capabilities.

**PROTECTOR** is operated from a Control Station. The Control Station includes two control consoles, one for the USV commander and one for the Payload Systems operator.

The Control Station receives, via communications links, all the system data, video imagery and audio required to effectively build a situational awareness picture and operate the system. The system can be easily incorporated in a wider defense array via a standard interface to an external C4I system.

Based on a highly maneuverable platform the USV has excellent maneuvering capabilities. The platform has water jet propulsion systems powered by diesel engines. The platform systems include control over propulsion, maneuvering, and navigation.

The **PROTECTOR's** core element is an advanced control system, which interfaces with all of the **PROTECTOR's** sub-systems and provides a remote operator with the ability to plan, prioritize and execute naval missions by day and night, under adverse weather conditions, without exposure to risk.

The **PROTECTOR's** modular design enables the Customer to select those sub-systems that will best meet his own particular operational requirements.

When mounting effectors, the **PROTECTOR** can effectively close the fire circle for an all-round "sensor-to-shooter" solution.

## PROTECTOR® USV Operational Advantages

- Performs dangerous tasks without risking human lives.
- Performs long and wearisome missions such as patrolling and ongoing security tasks.
- Provides Real-time data and video transmission from the field to the headquarters.
- Can operate at high seas without a crew that is affected from the harsh conditions.
- The **Protector® USV** Command and Control system can be integrated with external C4I systems, making it an integral part of the defense array.
- The **Protector® USV** can be used to approach suspicious vessels and verify their intentions, thus distinguishing friend from foe without having risking crew safety.
- A highly effective sensor suite, capable of detecting and identifying targets and threats from a great distance.
- Integrated combat suite that enables a rapid "sensor to shooter" response.
- Equipped with a highly accurate combat proven stabilized Weapon Station capable of eliminating threats from afar.
- Equipped with high pressure Water Cannon for non-lethal deterrence, and crowd control tasks.
- The **Protector®USV** has the ability to record video and audio data of its surrounding for debriefing, legal purposes and other considerations.
- The **Protector®USV** can be deployed anywhere at sea, from oil rigs, mother ships or shore installations, thus maximizing its range of action and versatility.
- Onboard payload can be replaced to fit different designated missions, thus providing the ability to conduct a wide range of missions using a single platform.
- Fully-tested, serially-produced and operationally deployed in navies' world-wide.

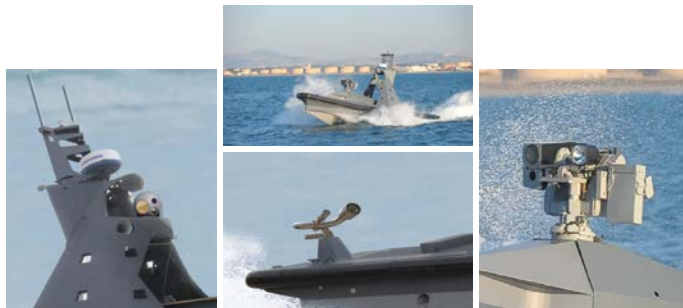

# SPOTLITE FAMILY



**RAFAEL  
ADVANCED DEFENSE SYSTEMS**

P.O.Box 2250 (19)  
Haifa 3102102, Israel  
Tel: 972-73-3354714  
Fax: 972-73-3354657  
E-mail: [intl-mkt@rafael.co.il](mailto:intl-mkt@rafael.co.il)  
Web Site: [www.rafael.co.il](http://www.rafael.co.il)

## **Spotlite Family**

### **In-motion Or Portable enemy fire source Detection, positioning and classification system**

Mechanized warfare is particularly complex. Sniper fire, RPG rockets, and in particular anti-tank missiles are lethal threats to the various types of ACVs moving in the battle field. Inability to detect threats and locate the position of the firing enemy causes numerous casualties, massive, inaccurate, and wasteful fire by our forces. Most importantly it lets the enemy retain the initiative in the battle field. Spotlite is a family of electro-optical products that quickly and accurately detect and locate enemy fire and swiftly close the sensor-to-shooter loop so as to neutralize the enemy and to keep initiative on the battle field in our hands.

The first product unveiled about two years ago was the Spotlite P, formerly MK2. This is a man-portable system that detects and locates enemy shooting small arms. It immediately investigates the target to verify that it is indeed a terrorist and quickly sends the target data to snipers or any other relevant shooters that can neutralize the source of fire. Since the system is man-portable and battery-operated it has great operational flexibility and can be positioned inside buildings as well as in areas impassible by vehicle.

An additional product, Spotlite – M, has recently joined the family. Spotlite – M is an electro-optical system installed on ACVs and other vehicles that detects and locates an enemy that is firing small arms, RPG bombs, anti-tank missiles, and rockets, in motion, day and night, at a range of up to 360°.



# STALKER FAMILY



**RAFAEL**  
**ADVANCED DEFENSE SYSTEMS**  
P.O.Box 2250 (19)  
Haifa 3102102, Israel  
Tel: 972-73-3354714  
Fax: 972-73-3354657  
E-mail: [intl-mkt@rafael.co.il](mailto:intl-mkt@rafael.co.il)  
Web Site: [www.rafael.co.il](http://www.rafael.co.il)

## STALKER FAMILY - Mobile Observation Multi Sensor Systems for Security Missions

STALKER Family has two new members: the STALKER-URBAN and STALKER-PATROL. Both are designed to support urban security missions from a stand-off distance. Equipped with day/night electro-optical sensors, long-range laser range finding capabilities and GPS, STALKER provides the information required for effective security decision-making.

The STALKER systems allow operational flexibility in multiple, simultaneous scenarios during both routine and special situations. Routine missions can include monitoring crime zones and controlling crowds. In addition, during special situations like mega sporting events, the STALKERS play an active role in securing vital infrastructures (stadiums, governmental buildings, and tourist facilities), monitoring access routes, and protecting VIPs. Where required, STALKER-furnished information is shared with other network elements to provide a complete situation picture for decision-makers.

### Benefits:

- Specially designed for mobile security missions
- Kit configuration for easy installation and disassembly on any Customer-defined 4x2/4x4 vehicle
- Continuous, 10hr surveillance, target acquisition, reconnaissance and intelligence collection, with GPS positioning with self-rechargeable power
- Stand-alone operation or networking via integrated Command & Control (C<sup>2</sup>) System
- Intuitive operation and quick training cycle
- Enables quick response to evolving events



# TERRA SONIC



**RAFAEL**  
**ADVANCED DEFENSE SYSTEMS**  
P.O.Box 2250 (19)  
Haifa 3102102, Israel  
Tel: 972-73-3354714  
Fax: 972-73-3354657  
E-mail: [intl-mkt@rafael.co.il](mailto:intl-mkt@rafael.co.il)  
Web Site: [www.rafael.co.il](http://www.rafael.co.il)

## TERRA SONIC - Pipeline Integrity Monitoring System

Rafael's Terra Sonic is an operational, field-proven monitoring and protection system for oil pipelines. It is a passive system employing an array of sensors to detect, classify and localize seismic sound waves propagated through the pipe and/or the oil. These sound waves are generated by occurrences or vents such as hitting, digging, leaks, and third-party action in or near the pipeline and its vicinity. The system provides valuable early warning while maintaining maximum sensitivity and minimizing nuisance alarms.



Terra Sonic uses patented algorithms and unique signal processing to analyze seismic and acoustic signals. The algorithms enable the system to distinguish between different events. These algorithms make it possible to overcome ambiguity, multi-event interference and provide high probability of interception. The system provides automatic detection, classification, and localization of activities in the vicinity of the pipeline including digging, hits to the pipe and leaks.

The system's modularity offers the capability to satisfy varied security policies and requirements.

## Rafael Provides Communication Products that Includes Data Link, Airborne Relay Systems, Communication Networks & Voice Radio

**RAFAEL**  
**ADVANCED DEFENSE SYSTEMS**  
P.O.Box 2250 (19)  
Haifa 3102102, Israel  
Tel: 972-73-3354714  
Fax: 972-73-3354657  
E-mail: intl-mkt@rafael.co.il  
Web Site: www.rafael.co.il

### DLV-53 MFTM - ISTAR Wideband Data Link

- Ultra Wide Band data-link providing communication solutions for UAVs/ USVs/ UGVs & Airborne Reconnaissance pod systems
- Use of a single, small & light - weight unit for PTP LOS/SatCom, one hop LOS Relay & CAS waveforms simultaneously
- Supports data rates from 200Kb/s to 274 Mb/s - selectable from the Ground Station
- Growth capability up to 548Mbps without HW change
- Full spectrum support (L, S, C, X, Ku, MMW), highly immune
- Seamless secured connection between standard Airborne IP LAN and Ground IP LAN over a Gigabit WAN



### BNET - Broadband MANET IP Software Defined Radio

- Ultra high data rate software defined radio (SDR)
- Tactical Voice, Video & Data on the move
- Mobile Ad-hoc network (MANET)
- Unique spectral efficiency features
- IP Radio
- Immune and secured
- Vehicular and hand-held formations



### TACMAX - Tactical 4G Cellular Broadband Network for Ground Forces

- Fast deployable
- Secured and immune
- Soldier and vehicle radio
- Up to 45 Mbps per cell
- Mesh capability
- Standard IP backhaul



### RAVNET 300 - Airborne Voice & Data Communication Radio Network

- Air-to-Air, Air-to-Ground, instantaneous high data rate
- Highly advanced Voice & Data Networks
- High Availability: Long range communication, auto relay via multi hops
- High efficiency utilization of V/UHF spectrum
- Legacy radios support for practical evolution
- Field proven in Israeli IAF



### AIR STAR - Multi-Sensor Aerostat based system for Extended ISR

- The most advanced field proven Aerostat based ISR system
- Expands early warning and surveillance capabilities
- Supports air dominance
- Consists of multiple sensors: Radar, ELINT, COMINT & Receivers/Transmitters
- Communication to Command and Control & to Targets Interceptors
- High availability



# IMILITE



***Multi-Source Multi-Task ISR Exploitation System / Command and Control System Imilite is an intelligence system designed to receive process and exploit multiple standalone imagery video and other intelligence data in a centralized and a unified way.***

**RAFAEL**  
**ADVANCED DEFENSE SYSTEMS**  
P.O.Box 2250 (19)  
Haifa 3102102, Israel  
Tel: 972-73-3354714  
Fax: 972-73-3354657  
E-mail: [intl-mkt@rafael.co.il](mailto:intl-mkt@rafael.co.il)  
Web Site: [www.rafael.co.il](http://www.rafael.co.il)



## **System capabilities:**

data reception, processing and display of Video, imagery, targets, threats, mission status, force locations, SIGINT detection and others.

The system GIS capabilities provide synchronized display of all the data as overlays on maps, video and images.

Imilite improves the Command-and-Control process by various automated image processing algorithms such as geo-referencing, change and motion detection, video/image enhancement, video stabilization and others.

Imilite can disseminate operational data, tactical mission reports, targets and treats to other forces, to facilitate close support operations, targeting and platform/sensor management.

ImiLite allows scalable Command and Control solutions and adaption to specific operational needs, both in mobile and stationary configurations for Command and Control centers, deployable operational units.

## **Benefits:**

- Centralized and unified workflow and data display
- Improved efficiency utilizing all available collection assets
- Shortened exploitation cycle
- Efficient Command and Control workflow
- Immediate accessibility to relevant data
- Real-time mission command-and-control workflow
- SR and mission product sharing with external operational users

## **Features:**

- Multi-source data reception in various formats
- GIS capabilities: image/video geo-referencing, data overlays, Geo data retrieval
- Advanced Image Processing Algorithms: change and motion Detection, image/video enhancement, video stabilization and others
- ISR and mission products and reports generation and dissemination
- Scalability and Adaptability
- Stationary, Mobile or Airborne configurations

# ***ELECTRO-OPTIC INTELLIGENCE, SURVEILLANCE AND RECONNAISSANCE (ISR)***

## ***Litening - Targeting & Navigation Pod***

Litening is an innovative airborne infra-red targeting and navigation pod for fighter aircraft with high accuracy and reliability, day and night precision strike capability. Litening reduces pilot workload during targeting and tracking. It is easily integrated on any aircraft and possesses high growth potential.

In use in the Israeli Air Force, USAF, ANG, AFRES, Marines, German AF, Swedish AF, Spanish Navy & AF, Greek AF, and others, the Litening flies on F-16, F-15, A-10, B-52, AV8-B, Gripen, Tornado, F-5, F-4, Mig-21, Mirage 2000, Jaguar and others.



## ***Toplite EO System - Electro-Optical Surveillance, Observation & Targeting System***

The Toplite family of electro-optic systems is an advanced multi-sensor, multi-purpose, highly stabilized EO systems for homeland security and defense applications, for aerial, maritime and ground based platforms.

## ***RecceLite- Real Time Tactical Reconnaissance System***

The RecceLite System consists of an E-O pod, a ground exploitation station and a data link. It is capable of collecting images day & night from 300 ft to 40,000 ft in all directions forwards, nadir, backwards, oblique - all down hemisphere and even when the aircraft is maneuvering in high G.

The Ground Exploitation Station (GES) is capable of generating targets in real-time with exceptionally high accuracy due to state-of-the-art algorithms and technology.

The data-link connects between the sensors and the GES and enables the images to be downloaded to the GES in real time. When your task is to close the attack cycle on many "time-critical targets" in less than 10 minutes, there is only one system - RecceLite.

## ***Recce-U - Real-Time Persistent ISR System for UAVs***

Recce-U is a self-contained, multi-sensor ISR system (based on the RecceLite Tactical Reconnaissance Pod). The Recce-U enables automatic photography, according to a mission plan prepared in advance, or updated mission plan uplinked in real-time, however the operator can initiate manual scanning for targets of opportunity.



***Litening -on-Gripen***



***Toplite EOS***



***RecceLite System***

***Recce-U***



**RAFAEL**  
**ADVANCED DEFENSE SYSTEMS**  
 P.O.Box 2250 (19)  
 Haifa 3102102, Israel  
 Tel: 972-73-3354714  
 Fax: 972-73-3354657  
 E-mail: intl-mkt@rafael.co.il  
 Web Site: www.rafael.co.il

**SpotLite Family**  
**Electro-Optic Enemy Fire Detection System**

The SpotLite family consists of electro-optical systems that detect and locate enemy fire in stationary positions as well as on the move. Rapid detection and precise location information provide forces with the capability to quickly neutralize the enemy, maintaining the upper-hand on the battlefield.

The **SpotLite P** is a portable electro-optic system carried by two soldiers for day and night detection and location of small arms fire.



**SpotLite P on Tripod**

**SpotLite M** is a mobile electro-optic system installed on vehicles and AFV's that enables the detection and location of enemy fire sources from small arms, RPG rockets, ATGM and tank shells, on the move, day and night, up to 360° coverage.



**SpotLite M on vehicle**

**Imilite - Multi-Source Multi-Task ISR Exploitation System / Command and Control System**

Imilite is an intelligence system designed to receive process and exploit multiple standalone imagery video and other intelligence data in a centralized and a unified way.

Main system capability includes the reception, processing and exploitation of EO, IR, SAR/GMTI and VIDEO, in various formats, over one desktop. In order to enhance the exploitation process, Imilite further combines non-imagery data such as targets, threats, COMINT detection and mission status within the system workflow. Imilite generates a variety of standard and customer tailored ISR reports and IMINT products such as alphanumeric reports, annotated maps, GIS data layers and visual aids, and disseminates them to external information and operation systems over standard and tailored protocols.

Imilite's multi-source data integration and automation capabilities improve the efficiency of utilizing available collection and exploitation assets. The system GIS capabilities provide immediate accessibility to relevant imagery and intelligence data, thus shortening the ISR collection and exploitation cycle.

The Imilite is based on Rafael's combat-proven ISR and C4I systems already in service worldwide. Imilite is designed for use by Defense forces (air, ground) and police forces exercising various observation means for border patrol or coping with urban crime.



**Imilite**



# MIC<sup>4</sup>AD



**RAFAEL  
ADVANCED DEFENSE SYSTEMS**

P.O.Box 2250 (19)  
Haifa 3102102, Israel  
Tel: 972-73-3354714  
Fax: 972-73-3354657  
E-mail: [intl-mkt@rafael.co.il](mailto:intl-mkt@rafael.co.il)  
Web Site: [www.rafael.co.il](http://www.rafael.co.il)

MIC<sup>4</sup>AD is an advanced, unified, integrated C<sup>4</sup>I system that commands and controls the operation of both air and missile defense, including air-superiority missions. MIC<sup>4</sup>AD provides a total solution for multi-system, multi-layer and multi-range air and missile defense, traditionally operated as separate commands.

MIC<sup>4</sup>AD correlates real-time data from distributed sensors/platforms (radars, IFF system, data links, electro-optics), all connected to the air traffic control picture and mission planning system. The data is analyzed to deliver a real-time, coherent national Air Situation Picture (ASP).

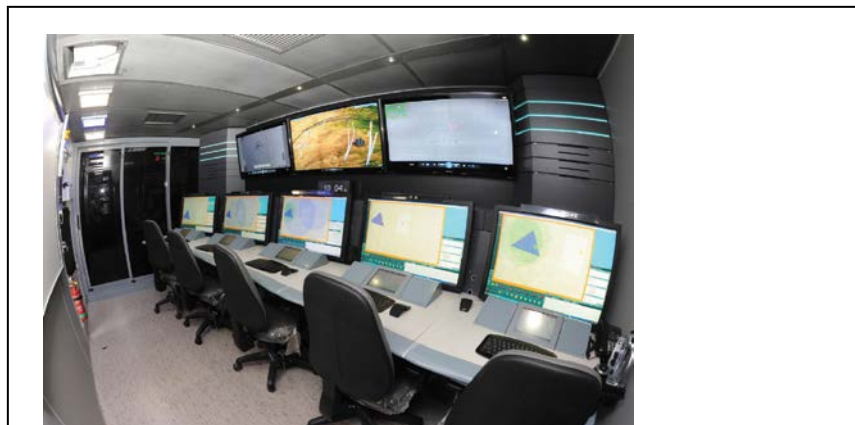

Simultaneously, MIC<sup>4</sup>AD performs threat assessment and hostile target classification, generating an interception plan for threats at any command level (national, regional, tactical). MIC<sup>4</sup>AD optimizes resource management and swiftly allocates the most appropriate defense system, such as SPYDER, David's Sling, Iron Dome or other customer systems to the type of challenge. Response includes target allocation to weapon systems (TAWA - Threat Assessment Weapon Allocation) with full, semi-automatic or manual fire control according to customer doctrine.

MIC<sup>4</sup>AD open, modular architecture can be adapted to customer operational needs. The system can be integrated with a customer's existing or future air and missile defenses. This flexibility allows incorporating new technologies and systems with the existing arrangement. MIC<sup>4</sup>AD can serve as an add-on to the customer's current C<sup>4</sup>I setup, or replace existing systems entirely.

Highly automated, easy-to-use and with advanced interactive displays, MIC<sup>4</sup>AD is a true force-multiplier. Enabling unified command and fire control of multiple air and missile defense systems, MIC<sup>4</sup>AD delivers multi-mission, multi-layer and multi-range C<sup>4</sup>I capabilities that ensure end-to-end air and missile protection.

# SPOTLITE FAMILY



**RAFAEL**  
**ADVANCED DEFENSE SYSTEMS**  
P.O.Box 2250 (19)  
Haifa 3102102, Israel  
Tel: 972-73-3354714  
Fax: 972-73-3354657  
E-mail: [intl-mkt@rafael.co.il](mailto:intl-mkt@rafael.co.il)  
Web Site: [www.rafael.co.il](http://www.rafael.co.il)

## **Spotlite Family**

### **In-motion Or Portable enemy fire source Detection, positioning and classification system**

Mechanized warfare is particularly complex. Sniper fire, RPG rockets, and in particular anti-tank missiles are lethal threats to the various types of ACVs moving in the battle field. Inability to detect threats and locate the position of the firing enemy causes numerous casualties, massive, inaccurate, and wasteful fire by our forces. Most importantly it lets the enemy retain the initiative in the battle field. Spotlite is a family of electro-optical products that quickly and accurately detect and locate enemy fire and swiftly close the sensor-to-shooter loop so as to neutralize the enemy and to keep initiative on the battle field in our hands.

The first product unveiled about two years ago was the Spotlite P, formerly MK2. This is a man-portable system that detects and locates enemy shooting small arms. It immediately investigates the target to verify that it is indeed a terrorist and quickly sends the target data to snipers or any other relevant shooters that can neutralize the source of fire. Since the system is man-portable and battery-operated it has great operational flexibility and can be positioned inside buildings as well as in areas impassible by vehicle.

An additional product, Spotlite – M, has recently joined the family. Spotlite – M is an electro-optical system installed on ACVs and other vehicles that detects and locates an enemy that is firing small arms, RPG bombs, anti-tank missiles, and rockets, in motion, day and night, at a range of up to 360°.



# ASTRONAUTICS ARTILLERY MODERNIZATION SYSTEMS



ASTRONAUTICS C.A. LTD.

## Astronautics C.A. LTD.

P.O.Box 3351, Kiryat Arie  
Petah Tikva 4951207, Israel  
Tel: 972-3-9251555  
Fax: 972-3-9251550  
E-mail: astro@astro.co.il  
Web Site: www.astronautics.co.il

### ASTRONAUTICS MAFCS:

- **Astronautics** together with Astronautics Corp. of America subsidiary **Kearfott Guidance and Navigation Corporation (KGN)** has developed the **Modular Artillery Fire Control System (MAFCS)** to provide an inexpensive, highly adaptive solution for the upgrade of Self-Propelled and Towed Artillery Guns and Mortars, so as to enhance their responsiveness and survivability in contemporary and future battlefield environments, comprising full navigation and control capabilities to the individual vehicle.
- The **MAFCS** enables autonomous gun Navigation and Pointing and provides ballistic computation capabilities to enhance weapon operation.
- The **System Ability** to perform rapid changes of position, as well as its high responsiveness, enables the crew to Shoot and Scoot and thus gains the force-multiplier advantage, which is essential for better situational awareness and effective / rapid response, in the modern battlefield.

### The MAFCS consists of the following main elements:

- Vehicle Reference Unit (VRU)- Kearfott's MILNAV<sup>®</sup>, KN-4053, three axis Monolithic Ring Laser Gyro (MRLG). The VRU is a fully integrated inertial navigation unit with an optional GPS receiver, which may either be embedded, or external (PLGR). The VRU is installed on the elevating mass of the Gun and provides a continuous high precision output of position and attitude of the weapon.
- Commander's Modular Processing, Control & Display Unit (MPCDU). The MPCDU provides overall control, management and fire control computation within the system. It includes advanced & powerful processor, communication ports, a high brightness/high resolution color Liquid Crystal Display and software programmable keys, to provide a state-of-the-art flexible multi-function computer & tactical display.
- Muzzle Velocity Radar (MVR). The MVR allows real time monitoring of the gun wear effect. Based on the MVR output the MPCDU improves the ballistic computation, in a predictive manner, utilizing proprietary Astronautics algorithm.

### MAFCS Applications

M109



120mm Mortar



SB155/52



### ASTRONAUTICS CONTROL & DISPLAY UNITS (CDU'S)

- Field Proven & Fully Ruggedized CDU's
- Sunlight Readable Displays
- Powerful Processor
- Full Mil-Spec.
- Display: 8.4", 10.4", 12.1" and 15" AMLCD (VGA, SVGA, XGA)
- I/O Capabilities: - Serial RS232, RS422, RS485 & CAN BUS  
- Ethernet 10/100/1000Mbps  
- Wireless Port
- Options: - PAL/NTSC Video Input  
- Touch Screen  
- Detachable Ruggedized Large Capacity Storage Device

CDU for C<sup>3</sup>  
Applications

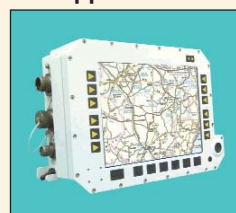

CDU for Artillery  
Applications

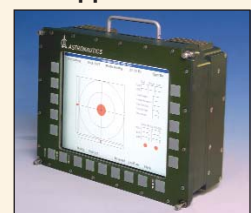

# PARACHUTE SYSTEMS FOR ILLUMINATING FLARES AND TEXTILE ARTICLE FOR ALL MILITARY APPLICATIONS



**D. YOLAND LTD.**

17 Hamasger St.,  
P.O.Box 13518  
Old industrial zone  
Natanya 4237927, Israel  
Tel: 972-9-8616103  
Fax: 972-9-8847221  
E-mail: info@yolandcorp.com  
Web Site: www.yolandcorp.com

***D. Yoland is a private company established in 1976 and has a vast experience in the production of military textile articles.***

D. Yoland is a major parachutes producer in Israel and its parachutes are assembled in munitions that are in service by foreign armies, including the US Army.

**Yoland Corporation** Inc., a small business located in Brooklyn, NY Is a subsidiary of D. Yoland. Yoland Corp has the capabilities to produce all type of military textile article.

During the last 4 years Yoland corp has delivered hundreds of thousands parachutes for artillery and mortar illum ammunitons.

***Illumination flares parachutes for:***

- Artillery - 155 mm, 105mm
- Mortars – 120mm, 81mm, 60mm
- Rockets – Hydra 70
- Grenades - 40 mm grenade (M203)
- Air delivered: LUU-19 B/B, LUU-2 D/B

***Bags for artillery, mortar and tank:***

- M4A2
- M67
- M3A1
- M119A1
- M203

***Propelling charges made from special fabric:***

- 60 mm
- 81 mm
- 120 mm
- 160 mm

***Special military and commercial products such as:***

- Lifting straps and banderoles
- Self-destruct ribbons for cargo munitions
- Body Armor
- Carrier and backpack
- Seat covers for: aircraft, trains and buses

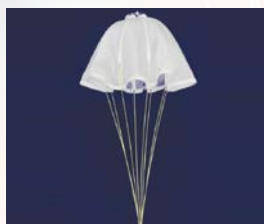

# ARTILLERY



Elbit Systems Land and C<sup>4</sup>I, including the Soltam artillery product line, is able to offer a comprehensive range of fully integrated, modular artillery and mortar solutions, incorporating C<sup>4</sup>I, fire control systems and platform upgrades as well as a complete range of artillery and mortar ammunition.



## Artillery Platform Upgrades

### Support for multiple firing platforms using existing infrastructure

Providing upgrades for the full range of firing platforms including towed, tracked, truck-mounted and self-propelled guns as well as rocket launchers our artillery platform upgrades enable rapid and accurate execution of fire mission together with full command and control (C<sup>2</sup>) capabilities.



## Autonomous Mortar Platform Upgrades

### Comprehensive platform upgrade - fully integrated C<sup>2</sup>, fire control systems, navigation, positioning and communication

Adaptable to a wide range of wheeled and towed platforms, the autonomous mortar is battle-proven and is in service globally.

## Guns



### **Soltam ATMOS**

#### **155mm, Computerized Autonomous Truck Mounted Self-Propelled Gun**

Meeting the need for light, long-range and fast moving artillery on the battlefield and offering the advantages of high fire power, mobility and short response time, the ATMOS is rapidly deployed and operable in rugged terrain. Highly adaptable, the modular ATMOS system is available with various qualified in-service trucks and gun calibers. The combination of an embedded electronic suit, an automatic laying system and automatic loading system provides exceptional benefits including accurate navigation and autonomous operation, reduced crew size, increased fire power and accuracy. The artillery systems are equipped with fire control systems (FCS), muzzle velocity radar (MVR), an inertial navigation system (INS) and a target acquisition system (TAS).



### **Soltam ATMOS D-30**

#### **Advanced tactical computation and sensors in a wheeled, self-propelled 122mm howitzer**

The ATMOS D-30 is a wheeled, self-propelled 122mm howitzer which can be mounted on almost any modern 6X6 or 8X8 truck. An upgraded version of the in-service 122mm D-30 gun system, the ATMOS D-30 currently features a modified cabin, APU-driven hydraulic systems, on-board ammunition storage and semi-automatic loading systems. The ATMOS D-30 can be fully integrated with an electronic suit, enabling accurate and semi-autonomous operation, reduced crew size and increased fire power. The artillery systems are equipped with FCS, MVR an INS and TAS.



### **Soltam ATHOS**

#### **155mm Autonomous Towed Howitzer System**

Providing operational efficiency combined with highly versatile advanced towed gun concept, the 155 mm 52 caliber Autonomous Towed Howitzer - ATHOS - towed independent gun features autonomous operation and automatic laying capabilities. The gun's low center-of-gravity, overall length and tandem wheels mounted on the walking beams supports smooth travel at all speeds and on rough terrain, enhancing the towing vehicle's speed and capabilities. The gun can also maneuver in and out of position under its own power. The artillery systems are equipped with FCS, MVR an INS and a TAS.



### **Soltam M-46S 130mm**

**Upgraded version of 130mm field gun, substantially increasing firing range**

The M-46S is a hybrid of a 155mm 45 caliber cannon assembly. The upgraded version is comprised of a new 155mm barrel, breech assembly and muzzle brake that is mounted on the undercarriage and recoil systems of the battle-proven 130mm M-46 field gun. The upgrade kit has significantly increased its firing range with a conventional ERFB/BB projectile. The artillery systems are equipped with FCS, MVR, an INS and a TAS.



### **Soltam M-114S 155mm**

**Upgraded version of 155mm 33 caliber assembly with significant increase in range**

The M-114S is a hybrid of a 155mm 33 caliber cannon assembly. The upgraded version is comprised of a new 155mm barrel and muzzle brake that is integrated with the original M-114 breech mechanism. It is mounted on the battle-proven undercarriage and recoil systems of the 155mm M114 field gun. The upgrade kit has significantly extended the gun's firing range with advanced ammunition.

## **Mortars**

**A wide range of mortars designed to suit a variety of battlefield scenarios**



### **Soltam CARDOM**

**Unique self-propelled recoiling mortar capable of firing in the full range of conditions and at every angle (360 degrees)**

81/120mm autonomous, self-propelled recoiling mortar mounted on a tracked or wheeled vehicle the Soltam CARDOM provides significant advantages including fast deployment, accuracy, area coverage, tactical mobility flexibility and survivability. Equipped with cutting edge navigation, command control and communication (C<sup>3</sup>) devices, the Soltam CARDOM offers infantry and mortar commanders enhanced operational capabilities, quick response time and automatic laying features. Battle-proven and NATO-qualified, the Soltam CARDOM system is currently employed in the U.S. Army and in the Israel Defense Forces (IDF).





**ELBIT SYSTEMS  
LAND AND C4 LTD.**

2 Ha'machshev St.,  
Netanya 4250712, Israel  
Tel: 972-9-8898080  
Fax: 972-9-8898231  
E-mail: [landc4i@elbitsystems.com](mailto:landc4i@elbitsystems.com)  
[www.elbitsystems.com/landc4i](http://www.elbitsystems.com/landc4i)

### Soltam 60mm mortars

**Weapon of choice for special forces, commando units and infantry forces**

The lightweight 60mm mortar is an effective support weapon for close, medium, long and extended-range shooting. User-friendly, quickly deployed and reliable in all weather conditions, it is operated with a light handheld FCS - SOLMAC PDA. The mortar systems come with all auxiliary equipment necessary for field operation including a fire control computer and target acquisition systems. Possible configurations include:

Soltam C-03 (1,000m) ,Soltam C-576 (1,600m) ,Extended-range mortar Soltam C-06A1 (6,000m )



### Soltam 81mm mortars

**Effective support weapon for short, medium, long and extended-ranges**

Available as both dismounted and vehicle-mounted, the 81mm mortars are easy to operate and reliable in all weather conditions. The systems come with all auxiliary equipment necessary for field operation including a FCS and target acquisition systems.

Possible configurations include:

Soltam B-502 split barrel (6,500m),Soltam B-433 lightweight mortar (4,100m),Soltam B-599 Extended-range (7,000m)



### Soltam SPEAR

**120mm autonomous soft recoil mortar system for light-wheeled platforms; unprecedented tactical mobility and accuracy.**

Equipped with a patent pending recoil system that reduces the 120mm barrel's firing loads from 120 tons to less than 10 tons, SPEAR can be mounted on a variety of high-mobility light vehicles.



## Ammunition

### Soltam Mortar Ammunition – 60mm, 81mm and 120mm



Providing quick response fire support at the platoon and company level for infantry or mechanized infantry Elbit Systems' range of high-quality mortar ammunition is used to provide effective fire support to all types of combat units. It can be fired from all suitable and qualified smooth bore mortars in the customer's inventory. High explosive, WP and smoke mortars are available in 60mm, 81mm and 120mm calibers, and are equipped with point detonating, proximity and electronic time fuses. Training and illuminating bombs are also available.

# LORA - PRECISION STRIKE TACTICAL MISSILE



## IAI MLM DIVISION

P.O.Box 45  
Beer-Yaakov 7035001, Israel  
Tel: 972-8-9272520  
Fax: 972-8-9272890  
E-mail: [mlm\\_marketing@iai.co.il](mailto:mlm_marketing@iai.co.il)  
Web Site: [www.iai.co.il](http://www.iai.co.il)

MLM Division is the system integration house of Israel Aerospace Industries Ltd. (IAI). As a multifaceted design, development, and system engineering organization, MLM has the experience, knowledge, and capabilities to leverage its cutting-edge technologies to deliver systems that are among the most advanced in the world.

MLM specializes in a variety of disciplines, which enables it to act as prime contractor and leading system architect for governments and armed forces around the world.

MLM offers its partners and customers uncompromising performance, reliability and quality. MLM provides full service from the earliest stages of concept analysis, through development, production and installation, and culminating in integration and life-cycle support.

**A surface - to - surface precision strike missile system answering Army as well as Navy requirements.**

**LORA is an effective solution for destroying targets deep in enemy territory. LORA provides outstanding response time and precision without any weather or visibility constraints.**

**LORA has great in flight survivability due to supersonic velocity and shaped trajectory.**

Operational Requirements	LORA Specifications
Range	Up to 400 km
Maintenance	No missile preventive maintenance (one check each 5 years)
Fast Reaction	Minutes from command-to-target hit
Guidance	GPS/INS
Compact	4 sealed missiles on a regular 16 ton flat-bed truck
Weight	1600 kg
Length	5.2 m
Diameter	0.624 m
Angle of impact	60 - 90
Angle of attack	0 + 2
Reliability	Single stage, solid rocket motor All solid state electronics All electric drives (no hydraulics) The missile is sealed in its canister



# LAND FORCES

## Artillery Fire Power



ISRAEL MILITARY INDUSTRIES LTD. (IMI)

P.O.Box 1044, 64 Bialik Blvd.  
Ramat Hasharon 4711001, Israel  
Tel: 972-3-5485222  
Fax: 972-3-5486125  
E-mail: imimrktg@imi-israel.com  
Web Site: www.imi-israel.com

### LYNX

LYNX is an autonomous, multi-purpose artillery rockets and missiles launching system. The system can launch various artillery rockets and tactical missiles from 122mm to 370mm, including IMI's 160mm ACCULAR GPS guided rocket, 306mm EXTRA extended-range rocket and the 370mm PREDATOR HAWK. LYNX features fully autonomous ballistic calculation and launch capabilities and includes an advanced fire control system, INS and C4I for network centric operations as an element of larger artillery formations. LYNX automatically identifies the munitions on board and can be reloaded in less than 10 minutes. The system is operational and has been successfully deployed in several armies worldwide. LIGHT-LYNX is a HUMVEE type platform, suitable for operating IMI's ACCULAR artillery rockets providing capability to accurately and lethally engage targets at ranges of up to 40 km, with four launching tubes.

### ACCULAR

ACCULAR is a 160mm autonomous, surface-to-surface GPS-guided artillery rocket with a range of 14-40 km and a CEP of 10 meters. The rocket can be launched from LYNX, LIGHT-LYNX and similar launching platforms.

### EXTRA

EXTRA is a 306mm extended-range, GPS-guided artillery rocket system. The rocket system provides precise long range capability by either day or night and under all weather conditions. EXTRA has a maximum range of 150 km and a Circular Error of Probability (CEP) of 10 meters.

### PREDATOR HAWK

A long-range tactical missile system for up to 250 km, with high precision and maneuverability. The system is comprised of the "Predator Hawk" missile and pod, the LYNX launcher, a C4I system, and a battery command unit.

### 155mm M454 S-HE

The M454 is a 155mm Super - High-Explosive (S-HE) artillery projectile for use against infantry and LAVs. The projectile introduces a unique solution based on a pre-fragmented drogue parachuted warhead, guaranteeing up to five times more lethality than standard HE projectiles. The M454 joins IMI's family of 155mm artillery projectiles. These include various Extended-Range (ER), HE, Smoke and Illumination projectiles.

### UMACS / BMACS

The UMACS/ BMACS are uni and bi-modular artillery charge systems. The charges are designed to replace all existing 155mm artillery bag charges, which typically differ in size, shape, weight and nature of propellant. UMACS/BMACS are interoperable with all 155mm gun systems (39, 45, 52 cal.) and comply with NATO JBMoU.

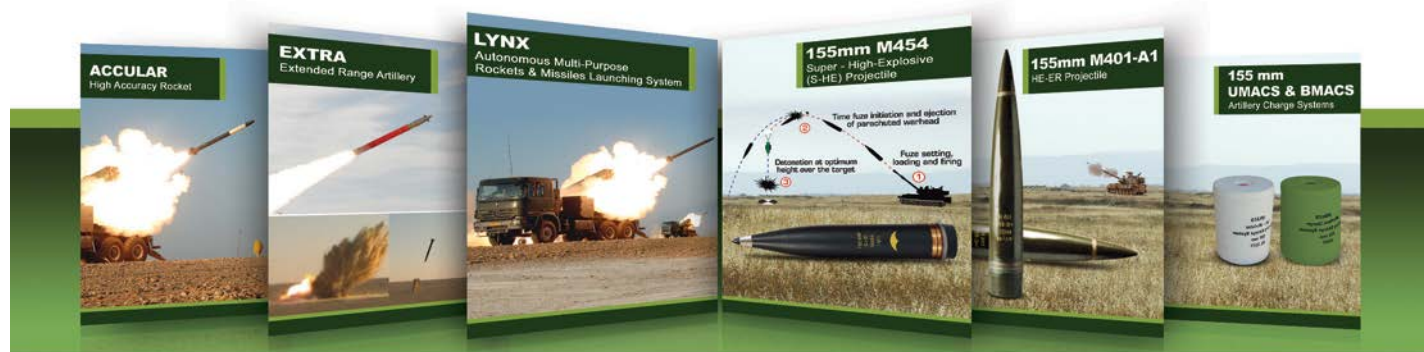

# SAMSON FAMILY



## **SAMSON RWS**

Rafael's Remote Weapon Station (RWS) Family Globally integrated on thousands of fielded ground and naval platforms, Rafael's Samson family of advanced remote weapon stations (RWS) capitalizes on extensive combat experience with a deep understanding of emerging military needs.

Designed for high performance and survivability on land and at sea, the Samson RWS have been adapted to a wide variety of main battle tanks, trucked and wheeled armored personnel carriers and marine craft.

The Samson Family is offered in six land configurations and two naval configurations. Samson RWS support diverse, interchangeable weapons and sensors including 5.56/7.62/12.7 mm machine guns, 40mm automatic grenade launchers, anti-tank missiles, observation pods, and non lethal capabilities.

Deployed in over 25 countries under rigorous combat and environmental conditions, these robust weapon stations are a dependable force multiplier and trusted partner for the most challenging missions.

Battle-proven land applications include thousands of RWS for the Israel Defense Forces (IDF), the Czech Republic Army, the UK Royal Armed Forces, and many others. Rafael is currently the sole supplier of RWS to the IDF.

## **Breakthroughs in RWS Development**

### ***Under-Armor Reloading***

The superior capabilities and performance of Rafael's RWS have been further enhanced by various ingenious force survivability multipliers, including in-hull ammunition reloading which enables uninterrupted operation while minimizing the crew's exposure to life-threatening battlefield dangers. The patented system is loaded from under the deck, and in addition to its operational benefit, is ergonomically designed for loader convenience and operation with minimum effort and maximum consideration of physical health.

### ***Non-Lethal Capabilities***

The newest addition to the Samson RWS family is its Non-Lethal (NL) capability which bases its response on all human biological senses. Whether employed for crowd control or other urban scenarios, the Samson NL capability provides the symmetrical response required to alleviate potentially explosive situations.

Samson NL concept is based on a five-sense response and the dual use of the RWS; interchangeable for NL and L use.

### ***Samson Jr.***

The lightest of the Samson RWS family, the Samson Jr. is intended for wheeled, tracked, and naval platforms which mandate minimum deck load and silhouette. Designed for defensive fire in military and paramilitary operations, the Samson Jr. mounts a variety of crew-exchangeable small caliber armaments, including 7.62mm or 5.56 machine guns, sharpshooter rifles and non-lethal weapons.

**RAFAEL  
 ADVANCED DEFENSE SYSTEMS**

P.O.Box 2250 (19)  
 Haifa 3102102, Israel  
 Tel: 972-73-3354714  
 Fax: 972-73-3354657  
 E-mail: intl-mkt@rafael.co.il  
 Web Site: www.rafael.co.il

**SAMSON MINI**

The Samson Mini dual-axis, gyro-stabilized RWS is designed for use on light wheeled or tracked combat vehicles, fast attack boats and other platforms requiring improved offensive capabilities. The system enables target engagement with enhanced accuracy, while maximizing crew protection from enemy fire.

This single-weapon RWS accommodates a variety of armaments including a 5.56mm SAW and LMG, 7.62mm GPMG and Gatling gun, 12.7mm HMG, 14.5mm, 40mm AGL, ATGM launcher, ASM, fed by high-capacity magazines. Supported by a ballistics-protected multi-sensor Sight Pod, with an optional mechanism for super elevation ballistic angle calculations, the Samson Mini provides a 'round-the-clock response to high-maneuvering battlefield challenges.

**SAMSON DUAL**

The Samson Dual is a dual-axis, gyro-stabilized RWS that simultaneously mounts two weapons. Developed originally to carry a 25-30mm lightweight weapon as main armament and 7.62mm secondary weapon for short range engagements, the Samson Dual enables multiple-threat handling in high-mobility scenarios. Much more robust than equivalent systems, the Samson Dual is also strong enough to incorporate an ATGM Launcher as a force multiplier. Featuring a special mode that decouples the weapons from the sight pod, this Samson configuration is also ideal for reconnaissance and peace-keeping missions.

**NEW SAMSON 30MM MKII**

The new Samson 30mm MKII is a 30mm Weapon RWS designed for use on any modern light-armored, high-mobility fighting vehicle, new or upgraded, without modifications. It mounts main and secondary armaments, of Eastern and Western origins, including a 30/40 mm automatic cannon, 40 mm AGL (optional), and 7.62 mm coaxial machine gun. Additional mountable force multipliers include ATGM launchers, ASM, and SGL obscurants.

Equipped with a dual-axis, gyro-stabilized, retractable, dual-sight, weapon mounting system, and the system's configuration provides the commander with full "hunt-kill" capabilities without interfering with the Gunner's current missions.

**Main Advantages of the Samson RWS family:**

- Commonality and Affordability
- Optimized Survivability Design
- Environmental Compliance
- Precision and Lethality
- High Versatility
- Viable Alternative to the Traditional Turret
- Lighter in weight and more compact, rendering better overall platform mobility and maneuverability
- Safer - No gas emissions or rotating mechanical parts in the hull
- No RWS deck penetration, providing more space in the hull
- Plug-and-play fire control system - Same main computer unit (MCU) for all systems
- Superior 360° situational awareness
- Higher reliability, availability, maintainability, and durability
- Ability to interface with C<sup>4</sup>I and external sensors including hostile fire indicators



# SPIKE FAMILY



**RAFAEL**  
**ADVANCED DEFENSE SYSTEMS**  
 P.O.Box 2250 (19)  
 Haifa 3102102, Israel  
 Tel: 972-4-8794714  
 Fax: 972-4-8794657  
 E-mail: [intl-mkt@rafael.co.il](mailto:intl-mkt@rafael.co.il)  
 Web Site: [www.rafael.co.il](http://www.rafael.co.il)

## Multi Purpose Weapon Systems:

### SPIKE FAMILY

The SPIKE Family consists of missiles suited for land, air and sea platforms, multiple ranges and a variety of targets. The missiles in this family have sophisticated electro-optic CCD or IIR sensors for day/night all-weather operation, as well as a tandem warhead. Their lofted trajectories enable the warhead to strike the target at its most vulnerable location with pinpoint precision and minimal collateral damage. All of the SPIKE Family members have a low life-cycle cost, due to high reliability and operational and logistic support and production commonality between members.

Designation	Max. Range	Application
Spike-SR	1,000m	Infantry and Special Forces
Mini-Spike	1,500m	Infantry and Special Forces
Spike-MR	2,500m	Infantry and Special Forces and Combat Vehicles
Spike-LR	4,000m	Infantry and Special Forces and Combat Vehicles
Spike-ER	8,000m	Infantry, LCV, Helicopters
Spike-NLOS	up to 25km	Multi-Purpose ,Multi-Platform



# SPOTLITE FAMILY



**RAFAEL**  
**ADVANCED DEFENSE SYSTEMS**  
P.O.Box 2250 (19)  
Haifa 3102102, Israel  
Tel: 972-73-3354714  
Fax: 972-73-3354657  
E-mail: [intl-mkt@rafael.co.il](mailto:intl-mkt@rafael.co.il)  
Web Site: [www.rafael.co.il](http://www.rafael.co.il)

## **Spotlite Family**

### **In-motion Or Portable enemy fire source Detection, positioning and classification system**

Mechanized warfare is particularly complex. Sniper fire, RPG rockets, and in particular anti-tank missiles are lethal threats to the various types of ACVs moving in the battle field. Inability to detect threats and locate the position of the firing enemy causes numerous casualties, massive, inaccurate, and wasteful fire by our forces. Most importantly it lets the enemy retain the initiative in the battle field. Spotlite is a family of electro-optical products that quickly and accurately detect and locate enemy fire and swiftly close the sensor-to-shooter loop so as to neutralize the enemy and to keep initiative on the battle field in our hands.

The first product unveiled about two years ago was the Spotlite P, formerly MK2. This is a man-portable system that detects and locates enemy shooting small arms. It immediately investigates the target to verify that it is indeed a terrorist and quickly sends the target data to snipers or any other relevant shooters that can neutralize the source of fire. Since the system is man-portable and battery-operated it has great operational flexibility and can be positioned inside buildings as well as in areas impassible by vehicle.

An additional product, Spotlite – M, has recently joined the family. Spotlite – M is an electro-optical system installed on ACVs and other vehicles that detects and locates an enemy that is firing small arms, RPG bombs, anti-tank missiles, and rockets, in motion, day and night, at a range of up to 360°.



# MOST POPULAR ELECTRONIC FUZES

**RELIABLE, SAFE AND ACCURATE -  
RESHEF'S ELECTRONIC FUZES DELIVER  
TOP PERFORMANCE**



**RESHEF TECHNOLOGIES LTD.**

7 Haplada St.,  
P.O.Box 5035  
Or-Yehuda 6055001, Israel  
Tel: 972-3-5388604  
Fax: 972-3-5339223  
E-mail: info@resheffuzes.com  
Web Site: www.resheffuzes.com

**Reshef** offers experience and leading edge know-how in development and production of latest-generation electronic fuzes for all types of Mortar bombs, Artillery projectiles, Tank rounds and Artillery Rockets.

**Reshef's** modern facilities and production techniques assure effective implementation of the company's comprehensive R&D experience to match customer demands. Broad and multidisciplinary capabilities enable Reshef to meet every special requirement.

All the fuzes are qualified for safety and environmental conditions, according to the Military Standards (MIL-STD and STANAG).



**THETA M788**

## **THETA M788**

- Dual-option Electronic Proximity fuze for Mortar bombs, with a Point-Detonating (PD) mode by selection or as a backup. Dual safe without safety pull-wire.
- Compatible with 60mm, 81mm, 82mm & 120mm Mortar bombs, HE & WP smoke types, all charges and all muzzle & terminal velocities.

## **LAMBDA M760**

- Highly accurate Electronic Time (ET) fuze for Mortar bombs, dual safe without safety pull-wire.
- Compatible with 60mm, 81mm, 82mm & 120mm Mortar bombs, illumination, smoke & cargo types.

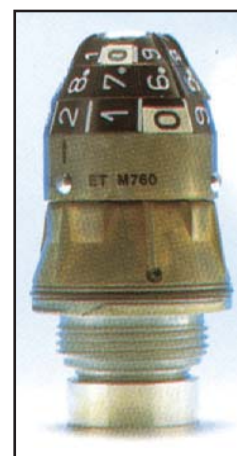

**LAMBDA M760**

## **OMICRON M180**

- Time gated Electronic Proximity fuze based on FMCW RF Sensor.
- Compatible with all types of HE & WP Artillery projectiles of 105mm, 155mm & 203mm (8") Howitzer and 130mm & 175mm Field Gun projectiles.



**OMICRON M180**

## **ZETA M138**

- Highly accurate Electronic Time (ET) fuze for Artillery projectiles. Accuracy better than 0.1 sec over entire time-set range of 200 sec.
- Compatible with 105mm, 155mm & 203mm (8") Howitzer ammunition and 130mm & 175mm Field Gun projectiles. Produced in both expelling and detonating modes.

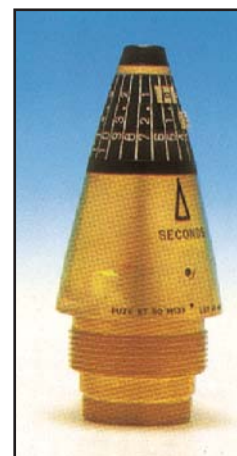

**ZETA M138**



# IMCO

## “A Sterling Reputation is the Best Recommendation”



**IMCO INDUSTRIES LTD.**

8 Hataasia St., P.O.Box 188

Tel-Hanan 3660102, Israel

Tel: 972-4-8213322

Fax: 972-4-8210508

E-mail: [marketing@imco-ind.com](mailto:marketing@imco-ind.com)

Web Site: [www.imco-ind.com](http://www.imco-ind.com)

IMCO Industries Ltd. (TASE: IMCO), and its subsidiaries Advanced Defense Technologies Inc. (ADT) in Baltimore, USA, Atena Ltd. and Nir-Or (Israel) Ltd. in Israel provide a full line of military and commercial electrical harnesses, control boxes, assemblies and electromechanical devices to the global defense and aerospace markets. Imco Group is a market leader in military and commercial applications, ranging from airborne, missiles, naval, ground vehicles and UAV to custom and off-the-shelf commercial systems for automotive, medical and industrial markets.

Imco's top-level manufacturing teams continue to provide reliable industry-leading electrical harnesses and a variety of electromechanical devices for customers in the defense industry:

- **Airborne Products and Systems:** Aircraft and helicopters systems such as Nomex® coated cable harnesses, control boxes (including illuminated panels), power boxes, pilot sticks and throttles, PITOT tubes, fuse boxes, contactor boxes, thermocouples for jet engines and test equipment for airborne fuel systems and drop tank universal testing apparatus.
- **Missiles and Unmanned Aerial Vehicles (UAV):** Test equipment, control systems and cable harnesses for missile launchers, special harnesses, gimbals, control boxes, relay boxes and fuse boxes.
- **Land Systems (Battle Tanks, Combat and Armored Vehicles, Artillery Systems, Tracked and Wheeled Vehicles, Combat Engineering, Mine Clearance Equipment): Automotive control and electrical systems, including:** cable harnesses, driver and commander control panels, tank commander and gunner turret control handles, smoke grenade launching (SGL) systems, slip rings, front LED headlamps and rugged, military-grade cabin LED lighting systems for battle tanks and armored personnel carriers (APC), tactical LED lighting systems inside and outside of vehicle with blackout function and low-battery indication as well as control boxes for heating, ventilation - and air-conditioning (HVAC) systems.
- **Naval applications:** Electrical harnesses, electromechanical and electronic boxes, as well as LED Lights for submarines, OPVs, Corvettes and Frigates.

With manufacturing capability on two continents, the company is well positioned to respond quickly to customer requirements. Designed-in flexibility allows rapid product customization to meet specific customer requirements.

All Imco facilities are ISO 9001:2008 certified. Imco complies with IPC-WHMA-A-620, AS-9100 and US MIL-STD requirements. Our design, manufacturing and quality assurance functions are integrated under Imco's global organization, ensuring our customers a fast time-to-market with our products.



# ADD ON ARMOR



## Rafael's Add On Armor Products

Rafael is a major and unique armor company dealing with all protection technologies: passive, reactive, hybrid and Active Protection systems. Rafael conducts development, design, integration and production of the most advanced armor systems to enhance the protection level of armored vehicles.

Rafael uses its extensive past experience to provide high level of protection, lightweight and low cost enhancements integrated on all types of combat platforms. All armor products are modular and capable to protect combat vehicles from a broad range of threats such as small and medium kinetic energy (KE) armor piercing (AP) projectiles, high energy anti-tank Shaped Charges (SC), high speed fragments of artillery and Improvised Explosive Devices (IEDs) and Explosive Forming Projectiles (EFPs).

The performance and specifications of the systems meet the protection requirements and standards of the Israel Defense Forces (IDF), the US Army, USMC and NATO force standards. The systems have been tested, qualified and approved for application by the customers worldwide and are combat proven. Rafael had eight different add-on armor systems, served in the Iraqi / Afghan theater with the coalition forces.

## Reactive Armor

Rafael is the world leading company in the application of the reactive armor technology. It was the first company to develop, design and integrates reactive armor systems on combat vehicles. The reactive armor is the most effective add-on armor technology to protect Armored Fighting Vehicles (AFV's), Armored Personal Carriers (APC's) and Main Battle Tanks (MBT's) against shaped charge threats of Rockets and ATGMs.

For light armored vehicles, Rafael developed Hybrid armor which combines reactive and passive elements to provide complete, 360 degrees protection against anti-tank rockets, medium KE AP projectiles and high speed fragments. Upgraded multi-threat hybrid armor, Multi-Threat Armor Protection (MTAP) system has recently been developed to defeat also EFPs and IEDs.

Rafael's reactive and hybrid system have been fitted to many combat vehicles worldwide. In the US, Rafael, together with its partner General Dynamics ATP, integrated produced and supplied reactive / hybrid armor systems for the Bradley AFV and the Stryker vehicles.



*M60*



*Bradley*



*M113*

**RAFAEL**  
**ADVANCED DEFENSE SYSTEMS**  
 P.O.Box 2250 (19)  
 Haifa 3102102, Israel  
 Tel: 972-73-3354714  
 Fax: 972-73-3354657  
 E-mail: intl-mkt@rafael.co.il  
 Web Site: www.rafael.co.il

**Passive Armor**

Rafael has developed and applied various passive armor technologies to protect combat vehicles, including ceramic, metallic, shaped, laminated and perforated technologies. The passive add-on armor is modular, lightweight and easily installed by the crew. It is maintenance-free and combat-proven.

The systems provide protection against 14.5 mm AP projectiles, high speed fragments of artillery shells and IED (STANAG 4569, Level 4 and beyond). Rafael has recently developed passive add-on lightweight, effective modular armor to defeat EFPs.

Rafael's armor systems are in use by the IDF, USMC, Italian Army, New Zealand Army, Czech Army and others. They are combat proven and received excellent reports about their performance in the Operation Iraqi Freedom and peace keeping missions worldwide. Rafael's Enhanced Appliqué Armor Kit (EAAK) add-on armor system was selected by the USMC as a sole source, for the AAV7 amphibious APC.

RAFAEL's Reactive Armor installed on the US Bradley AFV (left) and Passive Armor installed on the USMC AAV7 APC (right).



*AAV7*

*M113*

*Rosomak*

■ **Certificates from the US Army and USMC to Rafael for its reactive and passive armor systems, installed on the Bradley, Stryker and AAV7** ■



# SAMSON FAMILY



## **SAMSON RWS**

Rafael's Remote Weapon Station (RWS) Family Globally integrated on thousands of fielded ground and naval platforms, Rafael's Samson family of advanced remote weapon stations (RWS) capitalizes on extensive combat experience with a deep understanding of emerging military needs.

Designed for high performance and survivability on land and at sea, the Samson RWS have been adapted to a wide variety of main battle tanks, trucked and wheeled armored personnel carriers and marine craft.

The Samson Family is offered in six land configurations and two naval configurations. Samson RWS support diverse, interchangeable weapons and sensors including 5.56/7.62/12.7 mm machine guns, 40mm automatic grenade launchers, anti-tank missiles, observation pods, and non lethal capabilities.

Deployed in over 25 countries under rigorous combat and environmental conditions, these robust weapon stations are a dependable force multiplier and trusted partner for the most challenging missions.

Battle-proven land applications include thousands of RWS for the Israel Defense Forces (IDF), the Czech Republic Army, the UK Royal Armed Forces, and many others. Rafael is currently the sole supplier of RWS to the IDF.

## **Breakthroughs in RWS Development**

### ***Under-Armor Reloading***

The superior capabilities and performance of Rafael's RWS have been further enhanced by various ingenious force survivability multipliers, including in-hull ammunition reloading which enables uninterrupted operation while minimizing the crew's exposure to life-threatening battlefield dangers. The patented system is loaded from under the deck, and in addition to its operational benefit, is ergonomically designed for loader convenience and operation with minimum effort and maximum consideration of physical health.

### ***Non-Lethal Capabilities***

The newest addition to the Samson RWS family is its Non-Lethal (NL) capability which bases its response on all human biological senses. Whether employed for crowd control or other urban scenarios, the Samson NL capability provides the symmetrical response required to alleviate potentially explosive situations.

Samson NL concept is based on a five-sense response and the dual use of the RWS; interchangeable for NL and L use.

### ***Samson Jr.***

The lightest of the Samson RWS family, the Samson Jr. is intended for wheeled, tracked, and naval platforms which mandate minimum deck load and silhouette. Designed for defensive fire in military and paramilitary operations, the Samson Jr. mounts a variety of crew-exchangeable small caliber armaments, including 7.62mm or 5.56 machine guns, sharpshooter rifles and non-lethal weapons.

**RAFAEL  
 ADVANCED DEFENSE SYSTEMS**

P.O.Box 2250 (19)  
 Haifa 3102102, Israel  
 Tel: 972-73-3354714  
 Fax: 972-73-3354657  
 E-mail: intl-mkt@rafael.co.il  
 Web Site: www.rafael.co.il

**SAMSON MINI**

The Samson Mini dual-axis, gyro-stabilized RWS is designed for use on light wheeled or tracked combat vehicles, fast attack boats and other platforms requiring improved offensive capabilities. The system enables target engagement with enhanced accuracy, while maximizing crew protection from enemy fire.

This single-weapon RWS accommodates a variety of armaments including a 5.56mm SAW and LMG, 7.62mm GPMG and Gatling gun, 12.7mm HMG, 14.5mm, 40mm AGL, ATGM launcher, ASM, fed by high-capacity magazines. Supported by a ballistics-protected multi-sensor Sight Pod, with an optional mechanism for super elevation ballistic angle calculations, the Samson Mini provides a 'round-the-clock response to high-maneuvering battlefield challenges.

**SAMSON DUAL**

The Samson Dual is a dual-axis, gyro-stabilized RWS that simultaneously mounts two weapons. Developed originally to carry a 25-30mm lightweight weapon as main armament and 7.62mm secondary weapon for short range engagements, the Samson Dual enables multiple-threat handling in high-mobility scenarios. Much more robust than equivalent systems, the Samson Dual is also strong enough to incorporate an ATGM Launcher as a force multiplier. Featuring a special mode that decouples the weapons from the sight pod, this Samson configuration is also ideal for reconnaissance and peace-keeping missions.

**NEW SAMSON 30MM MKII**

The new Samson 30mm MKII is a 30mm Weapon RWS designed for use on any modern light-armored, high-mobility fighting vehicle, new or upgraded, without modifications. It mounts main and secondary armaments, of Eastern and Western origins, including a 30/40 mm automatic cannon, 40 mm AGL (optional), and 7.62 mm coaxial machine gun. Additional mountable force multipliers include ATGM launchers, ASM, and SGL obscurants.

Equipped with a dual-axis, gyro-stabilized, retractable, dual-sight, weapon mounting system, and the system's configuration provides the commander with full "hunt-kill" capabilities without interfering with the Gunner's current missions.

**Main Advantages of the Samson RWS family:**

- Commonality and Affordability
- Optimized Survivability Design
- Environmental Compliance
- Precision and Lethality
- High Versatility
- Viable Alternative to the Traditional Turret
- Lighter in weight and more compact, rendering better overall platform mobility and maneuverability
- Safer - No gas emissions or rotating mechanical parts in the hull
- No RWS deck penetration, providing more space in the hull
- Plug-and-play fire control system - Same main computer unit (MCU) for all systems
- Superior 360° situational awareness
- Higher reliability, availability, maintainability, and durability
- Ability to interface with C<sup>4</sup>I and external sensors including hostile fire indicators



# VEHICLES ARMORING & PATENTED SPECIAL PERSONAL UNIVERSAL ARMORING KIT FOR PASSENGERS INSIDE SOFT VEHICLES



TOP CAR ARMORING Ltd.

10 Amsterdam St.,  
Sderot 8714401, Israel  
Tel: 972-8-6496192  
Fax: 972-8-6483494  
Mobile: 972-54-4957184  
E-mail: dorontopcar@012.net.il  
Web Site: www.topcar-armor.com



**TOP CAR ARMORING Ltd.** specializes in vehicle armoring and is a manufacturer of civilian type armored vehicles. such armored vehicles as SUV, sedans, commercial vehicles, VIP cars, pick-ups, trucks, buses and vans.

**TOP CAR ARMORING** has certified QMS ISO 9001: 2008 the standards institutions of israel. The company is an official supplier of the israeli mod (Number: 0011008980) and the company has the israeli ministry of transportation approval for armoring cars.

The founder of Top Car Ltd. is in this business for over 30 years and has armored hundreds of cars for governments, security companies, policeforces, embassies and VIPs in countries all around the world.

**TOP CAR ARMORING** has developed the most advanced car armoring technologies.

**TOP CAR ARMORING** is a company with the most advanced know-how and experience in armoring of passengers cars with High-Tech and Light Weight composite armor materials, (more protection and survivability) and supplies all international markets.

**TOP CAR ARMORING** has unique knowledge and experience on international standards (USA, Europe and Israel) including extensive knowledge in producing materials to get the best ballistic solution.

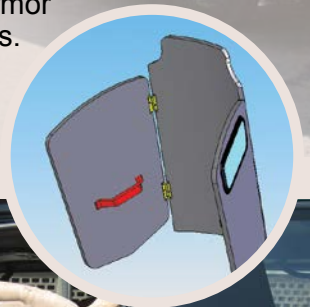

# DRY STORAGE SYSTEMS

*(Save time - save money and stay operational ready)*

**Mifram Ltd.**

**The developers and suppliers of creative physical security solutions**



**MIFRAM LTD.**

6 Josef Levi St., P.O.Box 1165  
Ind. Zone Kiriath Bialik  
Zur Shalom 2711101, Israel  
Tel: 972-4-8808800  
Fax: 972-4-8745745  
E-mail: sales@mifram.com  
Web Site: www.miframsecurity.com



[www.miframsecurity.com/drystorage](http://www.miframsecurity.com/drystorage)

[www.mifram.com/eng/dry\\_storage/](http://www.mifram.com/eng/dry_storage/)



Our dry storage buildings are developed to protect military/commercial equipment and vehicles against damage caused by humidity and corrosion leaving them operational ready at all times.

**The dry storage facilities can accommodate all type of important equipment and machines that may be needed on an instant notice, such as:**

- Tanks
- Mobile canons
- Radar weapons
- APVS
- Missiles
- Optical electronics
- Associated ammunitions

When utilizing our dry storage buildings you can reduce your maintenance and service costs for such equipment by about sixty percent.

Equipment can be stored for up to two years without the need for periodic maintenance; as an additional benefit you are increasing the life of such equipment .That's a major impact on over all operational costs.

### **Principles of our storage concepts:**

The customized shed becomes a barrier developed to keep humidity and dirt from reaching stored equipment. Temperatures are controlled by a sophisticated insulation system. This is accomplished by the installation of custom developed dehumidifiers keeping the average humidity levels under 35 % RH. The lack of moisture, dust and dirt ensures that all stored equipment and goods remain in the same condition they were at time of storage.

### **Additional available monitoring devices:**

- Fire detection
- Intrusion detection
- Hydrogen level

### **Benefits of a dry shed:**

Keeps machinery clean, preserves paint, protects rubber parts and keeps vehicles disc brakes shiny and rust free due to ultraviolet light. Ozone fresh air with oxygen and moisture is eliminated from the storage environment

### **Storage sheds are needed if:**

- Machinery receives moisture during storage.
- Machinery must remain clean and operational ready.
- Corrosion needs to be reduced on vehicles and machinery.

### **The Mifram Group:**

For over 40 years we have been developing simple cost effective and efficient engineering solutions in the ever changing environment of the security and protection arenas. Solutions are developed to the client's individual needs in the most effective and cost effective manner possible.

**With our specially developed storage systems you are always operational ready and your savings in time and money are an additional benefit.**



# ANTI PERSONAL MINE SAFETY SHOES

## PATENTED

The MFC CHECKMATE Safety Shoes (MATRAMINE) - Minefield-shoes NSN: 8430-15-121-9857. NSN: 1385-14-508-8844/5. are the culmination of years of research: designed and developed by a team who have tested and used them in the field.

A totally unique concept: inflatable and deflatable in seconds.

The MFC CHECKMATE Safety Shoes enable the soldier, sapper, commando, to traverse a minefield over mud, over water, over any terrain in safety, simply by slipping the compact unit out of his regulation pack, inflating the air cushions and continuing on his way. In seconds.

The MFC CHECKMATE Safety Shoes is the successful result of research and testing.

The shoes has been in use succesfully for more than 10 years as part of regulatory equipment of IDF army - French army and most of the NATO forces.

The MFC CHECKMATE Safety Shoes are built on the theory of air-cushions, which support the body while reducing the pressure in relationship to the minefield.

The CHECKMATE is completely portable, folds up into a small lightweight object and easily slipped into a regulation army pack.

It has an exceptional lifespan of 25 kilometers, which can be traversed by a soldier carrying a weight of up to 250 kilos: his own weight, that of a full pack and a wounded comrade- the minimum requirement.

---

# D.T.E

---

## D.T.E. CO. LTD.

P.O.Box 41, Industrial Zone,  
Ashkelon 7810001, Israel  
Tel: 972-8-6750342, 972-50-5236865  
Fax: 972-8-6751045  
E-mail: [dte\\_com@netvision.net.il](mailto:dte_com@netvision.net.il)  
Web Site: [www.minefield-shoes.com](http://www.minefield-shoes.com)

The CHECKMATE is made of sturdy nylon, nylon-reinforced PVC, coated aluminum and steel alloys, the five air cushions are of specially-designed, patented material created for maximum strength and resiliency.

The fully inflatable CHECKMATE can be used to float 25 kilos of equipment across water. The marine commando simply places his equipment on it, floats it across the water, then uses the CHECKMATE himself upon landing. Even if there should be a loss of air, or a puncture, it is still possible to traverse tens of meters before inflating the air-cushions again. And this can be accomplished in a matter of a few seconds.

---

## FEATURES

- Fully inflatable and deflatable in seconds.
- Foldable into a small 350x160x120 mm pack.
- Lightweight - 2.3 kilos.
- Completely portable.
- Made of tough nylon, nylon-reinforced PVC; air cushions of PVC-type L 152.
- Upper rigid frame of aluminum and steel alloys. Self-locking error-proof device with no moving parts - eliminates maintenance problems.
- Metallic parts will not interfere with mine detector apparatus.
- Can be used to traverse any terrain: water, mud, swamp, brush will not decrease the efficiency.
- Designed to adapt to the conformation necessary to overcome obstacles with maximum safety.
- An much safer, more effective, easier to use.

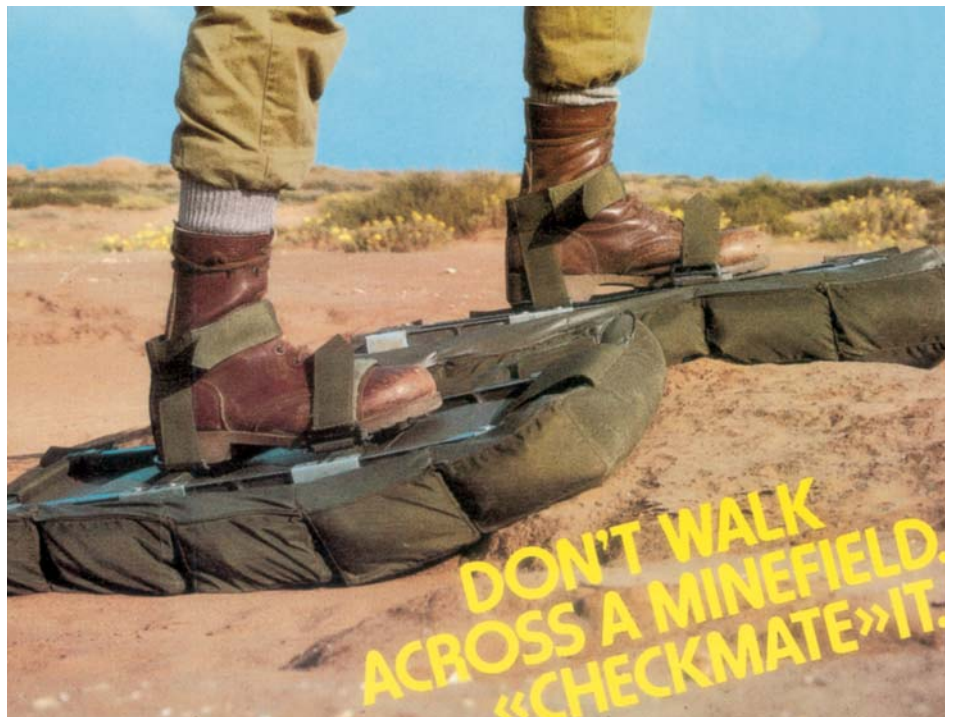



# HBA SYSTEMS INTEGRATORS



## Integrative Security Solutions

### HBA SYSTEMS INTEGRATORS

Oasis Towers  
77 Herzl St.,  
Ramat Gan 5244350, Israel  
Tel: 972-3-6722226  
Fax: 972-3-6722193  
E-mail: [manuel.bar-gil@hba.co.il](mailto:manuel.bar-gil@hba.co.il)  
Web Site: [www.hba.co.il](http://www.hba.co.il)

A professional team of veterans from the Israeli IDF Special Forces and Police Special units, experts in the field of homeland security and anti terror, with 30 years' experience and exceptional achievements. The company specializes in providing full security solutions for governmental and private sectors worldwide.



### Robotics & E.O.D.

Management and supply of EOD robot fleets, bomb technicians' units and EOD equipment with advance and diverse deployment.

**Disrupters and binary explosives** - The Perfect solution for bomb disposal operations and explosions in safe environment and transportation.

**Electronic initiation systems** - Complete, safe and cost effective initiation systems for long/short range which can be used in a wide range of applications: civil, military, EOD, off/on shore.



### Training & Simulation

Designated anti-terror training & unique counter measures:

- Tactical ammunition for training
- Equipment, non-lethal weapons and ammunition for riot control
- Advanced multi magazine shot gun for counter terrorism use

### Forensics

Full deployment for forensics and crime scene equipment, supporting laboratories and professionals for civil, military and police sections.

# BRIDGING THE GAP BETWEEN REQUIREMENTS AND TECHNOLOGY WORLDWIDE



## KARIL INTERNATIONAL MARKETING LTD.

6 Maskit St.,  
Herzliya 4614002, Israel  
Tel: 972-9-9568212  
Fax: 972-9-9568141  
E-mail: karil@mistralgroup.com  
Web Site: www.karil.com

Karil International is a member of the Mistral Group; a team of independent companies, each operating in different markets worldwide, while collectively sharing the mission of Bridging Strategic gaps in defense and law enforcement markets with practical and innovative technology. Our trusted relationships allow us to connect our customers' operational needs to our world's most advanced technologies.

Karil's activities are in the fields of **Tactical ground platforms, C<sup>4</sup>ISR, Dismounted Soldier, Combat Engineering EOD**. Karil also offers products in the fields of **Underwater Navigation Systems, Omni-Vision Systems, Wet Chemistry Detection Solutions and Blast Containment Vessels**.

### Wet Chemistry Detection & Identification



*Drugs, Explosives & Forensics*

### Blast Containment Vessels



*Semi & Fully confined  
w & w/o Repeatable detonation  
w & w/o Gas tight*

### Underwater Systems



*Underwater Navigation,  
Sonar & C<sup>4</sup>I systems*

### Omni-Directional Vision



*EyeBall™  
Eye Drive™  
ODR™*

# SANSOLO

## Explosives, Demolition & Combat Pyrotechnics



**SANSOLO Security Consulting,  
Development & Manufacturer Ltd.  
Special Operations Equipment -  
Explosive Entry**

19 Harel St.,  
Ashkelon 7864919, Israel  
Tel: 972-54-7886261  
972-52-3843758  
Fax: 972-8-6780986  
E-mail: [info@sansolo.co.il](mailto:info@sansolo.co.il)  
Web Site: [www.sansolo.co.il](http://www.sansolo.co.il)

The SANSOLO Security Consulting, Development & Manufacturer Ltd. Company is an Israeli company that specializes in Security Consulting, Explosives, Demolition, Combat Pyrotechnics & new products development (Patent Protected).

Arie Sansolo, the company founder and president has a 25 year of experience in a variety of the Israeli top combat units, while in the last 15 years specialized as the head of an Israeli bomb disposal unit in a top anti-terrorist unit.

### Main products / services:

#### Products

- Custom design development.
- Defensive/Offensive demolition products.
- Variety of combat pyrotechnics products & development.
- Specializes in unique tactical marking products.

#### Consulting Specialist

- Bomb disposal expert.
- Writing procedures, guidelines and safety instructions.
- Security & Special units consultant.

#### Training Specialist

- Courses on various aspects of demolition.
- Training on working methods for defensive and offensive demolition.



**A TELESCOPIC HEIGHT ELEMENT  
FOR MARKETING SL-076**



**BREAK-IN/ASSAULT KIT  
SL-056**



**RAPID DEPLOYMENT ELECTRICAL  
DETONATION KIT SL-020**



**SANSOLO KIT  
SL-030**



**BURSTMASTER  
SL-015**



**BANG BUFFER  
SL-012**



**DUAL PURPOSE  
SLEEVE SL-003**



**DETONATION SIMULATOR  
SL-010**

# Quadro Projects & Technologies Ltd.

## Disposal of Dangerous War Remnants Division

Quadro is a part of selected group of Israeli companies which are authorized by the Israeli "MOD" (Israeli Ministry of Defense) -"MOD" No. 83924941& 39170621, "Sibat" No. 100-62814. To operate world wide (In Israel and around the Globe) in the field of :

***Humanitarian Mine Clearance & UXO Disposal Projects/Operations.***

***Humanitarian Mine Clearance & EOD/UXOD,IEDD,IEOD UXO Projects/Operations.***

***EOD – Explosives Ordinance Disposal.***

***IEOD – Improvised Explosives Ordinance Disposal.***

***UXOD – Un Exploded Ordinance Disposal.***

***IEDD – Improvised Explosives Disposal Devices.***

### **WHO ARE WE?**

Our Team consists group of former senior Officers and NCO's From the Corps of Combat Engineers/I.D.F (Israel Defense Forces) with De-Mining and EOD background.

These Experts are backed by many years of extensive field experience, and have retained strong links with the Mine Clearance and the EOD communities.

In addition we are updated with the latest developments in those highly specialized fields.

We have a list of authorized and dedicated Personnel for International Mine Clearance and UXO disposal Projects.

### **WHAT DO WE DO?**

- ❑ Consulting services for mine clearance and UXO disposal.
- ❑ Global humanitarian de-mining projects.
- ❑ Disposal of unexploded ordnance.
- ❑ Disposal of dangerous war remnants in urban zones.
- ❑ Treatment/handling of dangerous materials (Chemical and others).
- ❑ Inspection of Vessels for "Non Explosive" load (Ammunition verification).
- ❑ Disposal of classified material (For governmental organizations/offices).
- ❑ Blasting services for construction projects, roads, tunnels and airfields.
- ❑ Designing & manufacture/production of instruction auxiliaries, Cross sections & models.
- ❑ Training - establishment of de-mining & UXO centers/school.
- ❑ Mine & explosives detection dogs services.
- ❑ Educating communities - awareness teams.
- ❑ Assistance to victims -medical centers & rehabilitation.
- ❑ Supervision/inspection & quality control for de-mining/ EOD projects.
- ❑ Environmental consulting services.
- ❑ Breaching technologies/techniques.





**Quadro Projects & Technologies LTD.**  
 33 Arik Einstein St.,  
 Or Yehuda 6037533, Israel  
 Tel: 972-3-9413010  
 Mobile: 972-50-8818886  
 Fax: 972-3-9410743  
 E-mail: [quadro@quadro.co.il](mailto:quadro@quadro.co.il)  
 Web Site: [www.quadro.co.il](http://www.quadro.co.il)

### EOD (Explosive Ordnance Disposal) Capabilities

- Transportation.
- Disassembly.
- Destruction techniques.  
 (Explosion Burning, Plasma, Crushing, Grinding).
- Burning Disposal.  
 ("Red Termite" special Powder ... and more).
- Design and Manufacture of Instruction Auxiliaries and Cross Sections.



# Quadro Projects & Technologies Ltd.

Disposal of Dangerous War Remnants Division



## **Mine Clearance Capabilities & Techniques**

- Manual Technique.
- Mechanical Technique/Technology.
- Dogs Technique.
- Destruction Techniques.  
(Burning, Explosion, Crushing/Grinding).





**Quadro Projects & Technologies LTD.**  
 33 Arik Einstein St.,  
 Or Yehuda 6037533, Israel  
 Tel: 972-3-9413010  
 Mobile: 972-50-8818886  
 Fax: 972-3-9410743  
 E-mail: [quadro@quadro.co.il](mailto:quadro@quadro.co.il)  
 Web Site: [www.quadro.co.il](http://www.quadro.co.il)



**Mine Clearance & EOD - R & D (Research & Development)**

- EDS - Explosive Destruction Systems
- CCAS - Cleaning Contaminated Areas Solutions
- CMAT - Crossing Mined Areas Technologies
- DMTS - Dangerous Material Treatment Systems
- BTUZ - Breaching Techniques in Urban Zones

**Breaching in Urban Zones - Technologies, Techniques and Training**

I E O D Capabilities

(Integration with/in Swat Teams)

- Hot Breaching Technologies.
- Cold Breaching Technologies.
- Training - Courses/Seminars (from 1 week to 6 weeks for all levels).



# ELBIT SYSTEMS - ELISRA'S ELECTRONIC WARFARE SOLUTIONS FOR LAND FORCES



**ELBIT SYSTEMS**  
**EW & SIGINT - ELISRA LTD.**  
 48 Mivtza Kadash St.,  
 Bene Beraq 5121701, Israel  
 Tel: 972-3-6179798  
 Fax: 972-3-6175880  
 E-mail: ew-sigint@elbitsystems.com  
 Web Site: www.elbitsystems.com



**Elbit Systems EW and SIGINT - Elisra**, a world leader in the development and manufacture of a variety of operationally proven electronic warfare (EW) and signal intelligence (SIGINT) solutions, is a major supplier to tri-service defence forces worldwide. Its ground EW and SIGINT solutions include:

**Integrated Electronic Warfare Suite**, based on cutting-edge technologies of receiving, processing, jamming and countermeasures activation, enabling efficient operation in future combat scenarios. The system includes SIGINT and communication jamming (COMJAM) capabilities as well as electronic countermeasures (ECM) and handles communication and non-communication advanced signals.

**ESM/ELINT** systems are a highly sensitive, modular, operational and field-proven family of solutions for comprehensive radar detection. These systems deliver cutting-edge intelligence gathering capabilities for all mobile and stationary ground platforms for the detection of all types of radars - ground-based, airborne and shipborne.

**COMINT/DF** systems include advanced signal demodulators, classifiers, fast wide band receivers and activity detectors, that work together to ensure smart, swift and pinpointed detection, identification and interception of the most sophisticated signals spanning the full frequency band.

**COMJAM** capabilities are engineered to withstand the harshest combat environments - tough and ready to go where the action is. They are adaptable to all platforms including AFVs, where they can be positioned close to front line forces - an invaluable tactical asset.

**Ground Radars** are an array of specialized ground surveillance Radar.

**Foxtrack™** is lightweight, compact, man-portable radar that is installed on a vehicle mast, or as a tripod-mounted configuration. **FPR-10** is a radar system that provides long-range, accurate, high-resolution detection of vehicles and personnel behind foliage.

The **MRJ** miniature reactive jammer family, the latest generation of protection systems against remote controlled improvised explosive devices (RC-IEDs), has been developed to protect ground forces, HLS entities, special forces, penetration units, small vehicular convoys, border patrols and forces entering into hostile areas. The systems can be configured either as reactive or active modes, or a combination of the two, working simultaneously.

**SPID - Spark Passive IR Detection** is a passive, IR-based (infrared), electro-optical threat detection system for the protection of national borders, high-value infrastructure, forward operating bases and rapid deployment forces. Incorporating the latest IR technologies, SPID enables ultra-fast, high-precision, day and night detection of anti-tank guided missiles (ATGM) and mortar launches.

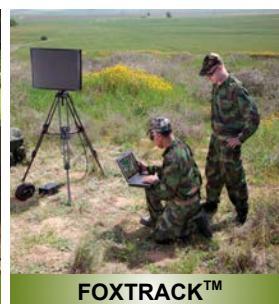
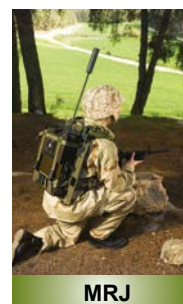



# CUTTING EDGE SPECTRUM DOMINANCE SOLUTIONS

Netline Communications Technologies (NCT) Ltd. develops and manufactures cutting edge EW and spectrum dominance solutions: advanced COMMINT & SIGINT, counter IED & communication jamming, and wireless intrusion protection systems to the global defense and homeland security markets.



## NETLINE COMMUNICATIONS TECHNOLOGIES (NCT) LTD.

Azrieli Circular Tower  
132 Menachem Begin Rd.  
Tel Aviv 6701101, Israel  
Tel: +972-3-6068100  
Tel: +972-3-6068100  
Fax: +972-3-6068101  
E-mail: [info@netlinetech.com](mailto:info@netlinetech.com)  
Web Site: [www.netlinetech.com](http://www.netlinetech.com)

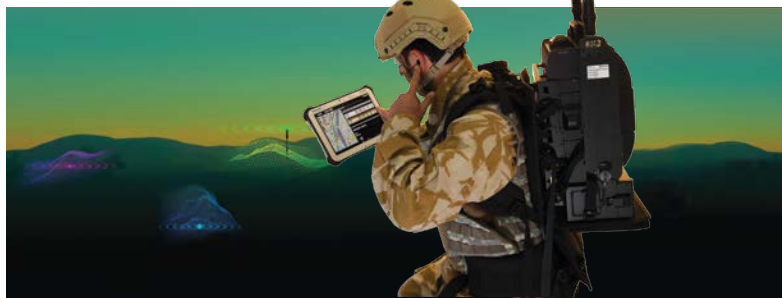

## COUNTER IED JAMMING

Netline's C-Guard active and reactive counter IED jamming systems protect troops, bases and convoys from remote radio detonation of IEDs. Robust jamming systems installed in vehicles, trolley/briefcases, ManPacks, miniaturized and stationary applications can be equipped with pre-initiation, hybrid active/reactive capabilities and other advanced features.

## COMMUNICATION JAMMING

Netline communication jamming systems block RF communications and isolate arenas targeting cellular & satellite phone, WiFi/Bluetooth, walkie/talkie and all other wireless communication frequencies from 20 MHz - 6 GHz. Systems deploy in a variety of platforms including land, naval and airborne vehicles and UAVs.

## COMMINT & SIGINT SOLUTIONS

Netline's communications intelligence solutions integrate a variety of tactical SIGINT & COMMINT capabilities including spectral analysis, signal classification and demodulation, cell phone monitoring and location/direction finding - all tailored per customer specifications. Tactical cell phone interception systems include both active (man-in-the-middle) and passive systems enabling competent authorities to intercept and manage cellular voice, data and WiFi communications. Systems can be deployed in scenarios not usually accessible for traditional SIGINT solutions like marine, land and airborne vehicles and UAVs.

## WIRELESS INTRUSION DETECTION

Netline radio frequency (RF) detection systems prevent potentially hostile information surveillance, uncovering unauthorized use of radio frequencies by cyber, cellular and other information leakage threats in military, government, corporate and other sensitive compartmented information facilities.

# ADVANCED JAMMING SOLUTIONS



## PHANTOM TECHNOLOGIES LTD.

68 Amal St.,  
Petach Tikva 4951366, Israel  
Tel: 972-3-9215720  
Fax: 972-3-9215434  
E-mail: sales@phantom.co.il  
Web Site: www.phantom.co.il



### Company Profile

Since 1996, Phantom Technologies Ltd. has specialized in developing and manufacturing special Jamming systems for both cellular and RF communication bands.

Phantom Technologies Ltd. employs a highly skilled and qualified R&D team to engineer high-end jammers, using the most advanced components available.

We design custom jamming systems and supply to the I.D.F, special police forces, prison authorities, special protection groups, elite units, VIP protection, local authorities etc. Our customers highly value the reliability and quality of our products.

Phantom Technologies Ltd. provides excellent post-sale technical support and provides a full 12-month warranty on all products.

### Our main product lines include:

- Cell Phone Jammers
- RF Communication Jammers
- RF Components (Power Amplifiers and antennas)
- Counter Surveillance Equipment



# MILITARY TACTICAL GPS JAMMER

**EW1600 Jammer**  
**High Output Power**  
**1,200 Watts (Modular System)**



**PHANTOM TECHNOLOGIES LTD.**

68 Amal St.,  
Petach Tikva 4951366, Israel  
Tel: 972-3-9215720  
Fax: 972-3-9215434  
E-mail: sales@phantom.co.il  
Web Site: www.phantom.co.il

Phantom Technologies Ltd. features the high-end **Military Tactical GPS Jammer EW1600**; a vehicle mounted high power jammer designed for blocking satellite communication.

System modularity allows flexible usage in different applications.

## Main Features:

- Output power up to 1,200W per band
- Jammer Modules of operated separately
- Separate switch ON/OFF and switch Operation Modes
- Remote control by PC
- Specific signal source per band for maximum jamming efficiency

## Applications:

- Special Military Units
- Special Police Units
- Government Agencies

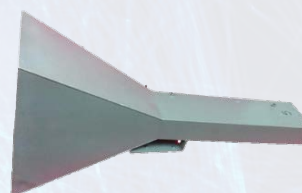

# WORLD LEADER IN THE DEVELOPMENT & MANUFACTURING OF "SEE THROUGH WALL" IMAGING RADARS



## CAMERO-TECH ISRAEL LTD.

Grand Netter Industrial Zone,  
Intergama Building P.O.Box 3521  
Kfar Netter 4059300, Israel  
Tel: 972-73-7172333  
Fax: 972-73-7172323  
E-mail: [info@camero-tech.com](mailto:info@camero-tech.com)  
Web Site: [www.camero-tech.com](http://www.camero-tech.com)



Xaver™ 800

### Company Profile

Founded in 2004, Camero is a world leader in the development and manufacturing of "See Through Wall" Imaging Radars. Camero's Products are fully operational and are successfully used in more than 30 countries worldwide. Our unique and innovative technology is recognized by a vast customer base and by leading scientific institutes worldwide for its multidisciplinary technology portfolio, Camero is a member of SK Group, a leading global defense and security group of companies comprising: Israel Weapon Industries - IWI Ltd. - firearms manufacturer, Meprolight Ltd. - electro - optic, lasers and night vision systems, Israel Shipyards Ltd. - ship manufacturing and repair, Uni-Scope Ltd. - optical periscopes VisionMap Ltd. - digital mapping systems, and more.

Camero's "Xaver™" family of through-wall imaging systems are currently in use by numerous Military and Law Enforcement Agencies throughout the world. The Xaver™ products include:

### Xaver™ 100

<http://www.camero-tech.com/product.php?ID=38>

The Xaver™ 100, provides a groundbreaking solution for modern militaries facing the difficulties of urban warfare. The Xaver 100 is a "must have" gear for every soldier in an urban combat scenario where the ability to detect the enemy is obstructed by houses and walls. The Xaver™ 100 is a light weight hand held battery operated "Sense Through Wall Imaging" system which gives instant indication of presence of life behind the wall or any other barrier. The Xaver™ 100 is also successfully used by numerous Special Forces units and First Responders worldwide.

### Xaver™ 800

<http://www.camero-tech.com/product.php?ID=40>

The Xaver™ 800, is a state of the art 3D "Sense Through Wall Imaging" system designed for full ISR (Intelligence Surveillance & Reconnaissance). The Xaver™ 800 provides a full three dimensional image of the entire volume behind the wall or barrier in real-time. The Xaver™ 800 is used by Anti-Terror units and hostage rescue teams worldwide. The Xaver™ 800 provides these units with a reliable image of the number of people inside the room and their movement patterns. The Xaver™ 800 provides the operators with a situational awareness picture for better mission planning and decision making. The Xaver™ 800 increases action synchronization between the forces and leads to successful mission.

### Xaver™ 400

<http://www.camero-tech.com/product.php?ID=39>

The Xaver™ 400, is a tactical "Sense Through Wall Imaging" system which provides Militaries and Law Enforcements Agencies around the world with immediate and reliable location information of people behind walls. The Xaver™ 400 is used intensively by military forces in Urban Warfare, where the ability to understand in real time the location of both live and static objects, helping to increase the soldiers survivability and effectiveness in the battle field. In addition, the Xaver™ 400 is successfully deployed by law Enforcement agencies in anti-terror, hostage rescue and anti-drug trafficking activities.



Xaver™ 400

Xaver™ 100

For further information, videos and technical data, please visit our web site: <http://www.camero-tech.com/>

# BUILD TO SPEC

**Manufacturers of:**  
**MDVR, Thermal Beacons and**  
**Lasers for Pointing & Illumination.**



**GOLDTEC TECHNOLOGIES LTD.**

10 Rival St.,  
Tel Aviv 6777845, Israel  
Tel: 972-3-5377870  
Fax: 972-3-5377868  
E-mail: info@goldtec.co.il  
Web Site: www.goldtec.co.il

## Digital Video, Data & Audio Recorders

*specifically built and qualified for extreme conditions and security applications.*



Observation units



Missiles units

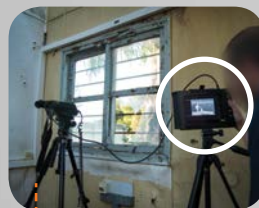

Stakeouts

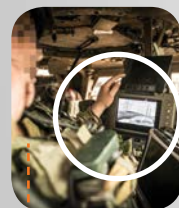

Observation / Weapon stations



## OPTICAL IFF - (Identification Friend or Foe) patented by thermal beacon.

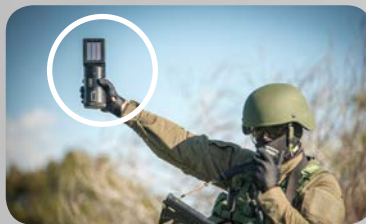
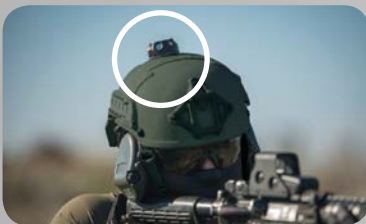

## LASER - High power visible and infrared laser illuminators and pointers for OEM and tactical operation.

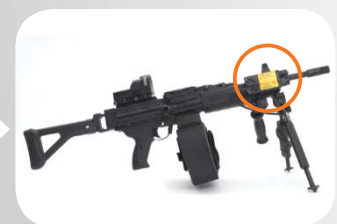
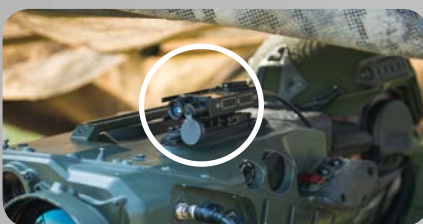

# LAND FORCES

## Infantry Fire Power



ISRAEL MILITARY INDUSTRIES LTD. (IMI)

P.O.Box 1044, 64 Bialik Blvd.  
Ramat Hasharon 4711001, Israel  
Tel: 972-3-5485222  
Fax: 972-3-5486125  
E-mail: imimrktg@imi-israel.com  
Web Site: www.imi-israel.com

### SMALL CALIBER AMMUNITION

IMI is a world-leading manufacturer and supplier of high-quality small caliber ammunition. This includes various 5.56, 7.62, 9, 12.7mm and 0.338" Lapua cartridges. The 5.56 and 9mm cartridges are NATO qualified. IMI also offers GREEN Lead-free cartridges, which are identical in performance to Lead-based cartridges, minimize muzzle burnout and meet international standards. IMI is the leading supplier of small caliber ammunition to the Israel Defense Forces (IDF). Other customers include the U.S. Army, armed forces of major NATO members, law enforcements, special units and customers in commercial markets worldwide.

### GMM120

GMM120 is a 120mm GPS guided mortar bomb designed for engaging and defeating personnel inside

buildings, LAVs or out in the open. The mortar bomb has a CEP of 10m. The bomb has an increased range of 7 to 9 km and is suitable for firing from any 120mm smoothbore mortar.

### MPRS

The MPRS (Multi-Purpose Rifle System) also known as TALON is a powerful force-multiplier for the modern and future infantry warrior, enabling improved lethality, incapacitation and target suppression effectiveness through the use of advanced 40mm multi-purpose, airburst grenades.

The system features a choice between Air Burst (AB) and Point Detonation (Super Quick/Time Delay) modes of operation and also incorporates a self-destruct mechanism. In AB mode, the appropriate elevation is transferred to the grenade's fuze while the grenade is still in the launcher. In Time Delay (TD) mode, the fuze can be set to explode at a preset delay after impact, enabling

engagement of soft targets, such as a window. MPRS can be integrated on a wide range of assault weapons and multiple grenade launchers.

### SHIPON FFE

SHIPON FFE (Fire From Enclosure) is a man-portable, lightweight, disposable shoulder-launched weapon system for close-range combat.

The weapon system is fitted with a tandem multi-purpose warhead for engaging and defeating buildings, earth and timber bunkers or LAVs. The weapon system can be fired from enclosed spaces. Its multi-purpose warhead can penetrate up to 8" reinforced concrete and triple-brick wall. The weapon system meets the potential U.S. Army's Individual Assault Munition (IAM) requirements.

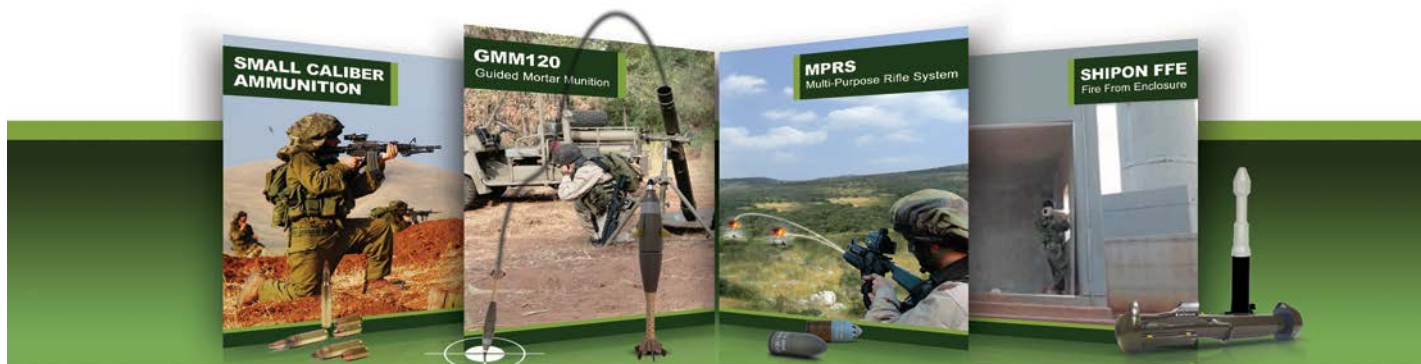

# LAND FORCES

## Infantry Survivability & Protection



ISRAEL MILITARY INDUSTRIES LTD. (IMI)

P.O.Box 1044, 64 Bialik Blvd.  
Ramat Hasharon 4711001, Israel  
Tel: 972-3-5485222  
Fax: 972-3-5486125  
E-mail: imimrktg@imi-israel.com  
Web Site: www.imi-israel.com

### SHOCK ABSORBER

SHOCK ABSORBER is a man-portable Active Protection System (APS) designed to protect dismounted troops and stationary sites from ATGM threats.

The lightweight system offers dismounted troops an effective portable 360° situational awareness and E/O directional jammer-based 'Soft-Kill' protection against second generation ATGMs. SHOCK ABSORBER provides accurate detection of the enemy launch position as well as an immediate alarm of launched threats and small arms bursts. The system can easily be deployed on the ground within minutes and can be integrated on vehicles and naval vessels as well.

SHOCK ABSORBER is based on IMI's IRON FIST APS technologies.

### SPB/FMAB

SPB/FMAB is a combat-proven, lightweight, aluminium alloy, tactical, man-portable Sectional Personnel

Bridge, designed to enable fully equipped infantry to cross wet or dry obstacles, up to 50 meters long. The bridge is in use and combat proven by the United States Marine Corps (USMC) in Afghanistan. Recently, IMI has been awarded the United States Department of Defense (DoD) Defense Contract Management Agency (DCMA) Certificate of Appreciation for its outstanding industry partnership in producing the FMAB, a variant of the SPB, for the USMC.

### BODY ARMOR

IMI offers a wide range of body armor solutions for military, law enforcement and security personnel. The lightweight armor is based on a hybrid composite of metals and ballistic ceramics, guaranteeing enhanced survivability and operational flexibility in close combat conditions over long periods of time. The body armor comes in a variety of types and weights according to ballistic threat and user needs.

Body armor vests vary by size and are offered with optional groin, shoulders and neck protection. IMI offers the X3 - an advanced lightweight ballistic insert, which guarantees multi-hit protection against up to 7.62mm AP and Ultra High Hardness (UHH WC Core) cartridges.

### IM Safe & Arm Mechanism

IMI offers an Insensitive Munition (IM) Safe & Arm Mechanism for hand grenades, designed to prevent detonation if the grenade is shot or set on fire. The IM Safe & Arm Mechanism is designed for use in any existing hand grenade, providing enhanced safety and reliability, and ensuring size, capabilities and lethality similar to the standard variant.

The mechanism complies with the latest safety requirements for IM, in accordance with MIL-STD 2105: up to 0.5" bullet impact, fast cook-off, slow cook-off and sympathetic detonation.

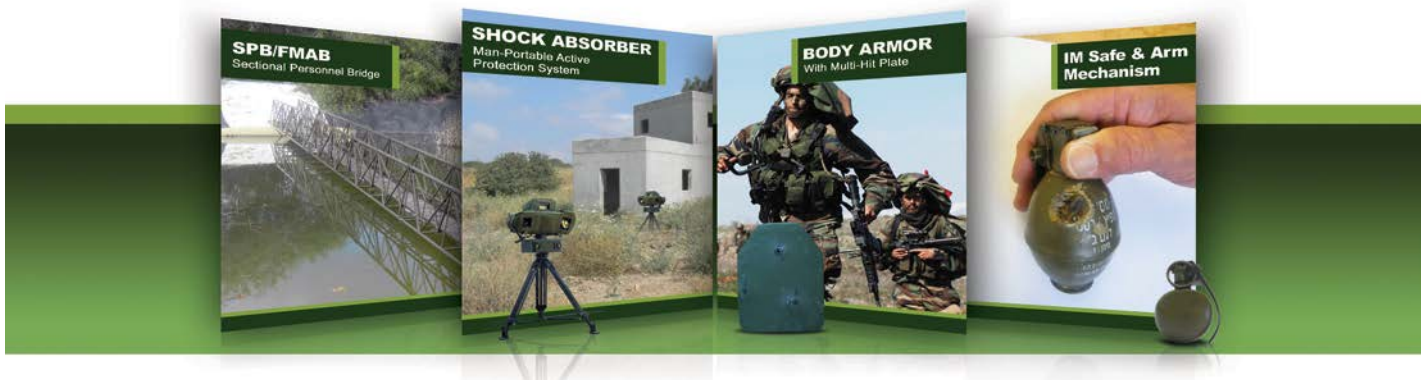

# MEPROLIGHT - Years of Bright Ideas

**Optics • N.V • Thermal • Tritium • LRF**



## MEPROLIGHT (1990) LTD.

P.O.Box 26  
4 Hahadas St.  
Or Akiva Industrial Park  
Or Akiva 3065001, Israel  
Tel: 972-4-6244111  
Fax: 972-4-6244123  
E-mail: sales@meprolight.com  
Web Site: www.meprolight.com

Meprolight is an Electro-Optics company, developing, manufacturing and marketing systems for infantry, armed forces, law enforcement agencies and civilian markets since 1990.

Meprolight provides comprehensive solutions with a wide array of combat-proven products:

- Optics - electro-optical and optical sights and devices.
- Night Vision - Night Vision Sights and Observation Systems.
- Thermal - uncooled thermal weapon sights.
- Tritium - a variety of self-illuminated night sights and other tritium products.
- LRF - innovative OEM Laser Rangefinders, hand-held LRFs and Fire Control Systems.

All of Meprolight's products undergo meticulous quality assurance according to international standards. The company is certified to ISO-9001:2008, complying with NATO and US military specifications and International MIL Standards. State-of-the-art technology combined with high reliability and simplicity of use have made Meprolight the vendor of choice among military forces, law enforcement agencies, defense agencies and weapon manufacturers.

### SK GROUP

Meprolight is a member of SK Group, a leading global defense and security group of companies comprising -IWI (Israel weapon industries), Camero-Tech Ltd. (Through-the-Wall sensing), Israel Shipyards Ltd. (Ship manufacturing and repair), Uni-scope Ltd. (Optical periscopes), VisionMap (Airborne imaging system) and more.



**MEPRO MESLAS** - sniper's fire-control riflescope  
10 x 40 with fully integrated laser rangefinder



**MEPRO X4** - day scope with x4 magnification



# BREACHING



## RAFAEL ADVANCED DEFENSE SYSTEMS

P.O.Box 2250 (19)  
Haifa 3102102, Israel  
Tel: 972-73-3354714  
Fax: 972-73-3354657  
E-mail: [intl-mkt@rafael.co.il](mailto:intl-mkt@rafael.co.il)  
Web Site: [www.rafael.co.il](http://www.rafael.co.il)

### BREACHING & URBAN WARFARE DEVICES

Rafael's breaching solutions provide a modern spectrum of operational solutions for military forces to surprise the enemy and reduce risk to friendly forces, eliminate collateral damage and ensure that innocent people will not be hurt.

Rafael has developed a variety of breaching products – rifle launched, shoulder launched and static hand emplaced munitions - to assist in urban warfare confrontations. These products can solve door entry problems, create mobility corridors through walls and structures as well as defeat urban structures, bunkers and light armored vehicles.

Rafael's breaching systems family includes:

### MATADOR FAMILY

#### Matador (RGW 90) AS - Anti-Structure Munition

The MATADOR AS is a combat proven shoulder launched, multipurpose munition, based on a ballistic rocket carrying an innovative tandem warhead. It can operate in two modes: emplacement against structures and fortified positions and mouse holing against walls and light armor vehicles.

It is fully disposable, cost effective, low maintenance weapon. Its effective range is from 14m to 400m, and its weight is 10kg (22lbs).

#### Matador AS Breaching Objectives:

- Fortified positions
- Timber bunkers
- Urban structures
- Light armored vehicles

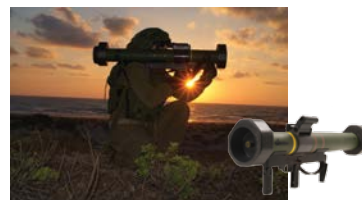

#### Matador WB - Wall Breaching Munition

The MATADOR (RGW 90) WB (Wall Breaching) is a shoulder-launched wall breaching munition, based on a ballistic rocket carrying an innovative Explosively Formed Ring (EFR) warhead. Its weight is 13kg (28.7lbs) and its operational distance is 20m to 120m.

#### Matador WB Breaching Objectives:

- Urban walls
- Double brick walls
- Triple brick walls
- Double reinforced concrete
- Walls



### SIMON (GREM) - Rifle-launched entry breaching grenade for urban & anti-terrorist warfare

SIMON rifle launched grenade is a stand-off & surprise-attack type weapon; it Replaces older breaching methods, which involved loss of surprise and the risking of assault troops in directly breaching doors by mechanical means or by attaching explosive charges.

#### Simon Benefits:

- Stand-off door breaching
- Increases the element of surprise
- Increases force survivability
- Minimizes collateral damage
- Simple to operate
- Easily adaptable to a variety of rifles
- Effective against variety types of doors



# ADD ON ARMOR



## Rafael's Add On Armor Products

Rafael is a major and unique armor company dealing with all protection technologies: passive, reactive, hybrid and Active Protection systems. Rafael conducts development, design, integration and production of the most advanced armor systems to enhance the protection level of armored vehicles.

Rafael uses its extensive past experience to provide high level of protection, lightweight and low cost enhancements integrated on all types of combat platforms. All armor products are modular and capable to protect combat vehicles from a broad range of threats such as small and medium kinetic energy (KE) armor piercing (AP) projectiles, high energy anti-tank Shaped Charges (SC), high speed fragments of artillery and Improvised Explosive Devices (IEDs) and Explosive Forming Projectiles (EFPs).

The performance and specifications of the systems meet the protection requirements and standards of the Israel Defense Forces (IDF), the US Army, USMC and NATO force standards. The systems have been tested, qualified and approved for application by the customers worldwide and are combat proven. Rafael had eight different add-on armor systems, served in the Iraqi / Afghan theater with the coalition forces.

## Reactive Armor

Rafael is the world leading company in the application of the reactive armor technology. It was the first company to develop, design and integrates reactive armor systems on combat vehicles. The reactive armor is the most effective add-on armor technology to protect Armored Fighting Vehicles (AFV's), Armored Personal Carriers (APC's) and Main Battle Tanks (MBT's) against shaped charge threats of Rockets and ATGMs.

For light armored vehicles, Rafael developed Hybrid armor which combines reactive and passive elements to provide complete, 360 degrees protection against anti-tank rockets, medium KE AP projectiles and high speed fragments. Upgraded multi-threat hybrid armor, Multi-Threat Armor Protection (MTAP) system has recently been developed to defeat also EFPs and IEDs.

Rafael's reactive and hybrid system have been fitted to many combat vehicles worldwide. In the US, Rafael, together with its partner General Dynamics ATP, integrated produced and supplied reactive / hybrid armor systems for the Bradley AFV and the Stryker vehicles.



*M60*



*Bradley*



*M113*

**RAFAEL**  
**ADVANCED DEFENSE SYSTEMS**  
 P.O.Box 2250 (19)  
 Haifa 3102102, Israel  
 Tel: 972-73-3354714  
 Fax: 972-73-3354657  
 E-mail: intl-mkt@rafael.co.il  
 Web Site: www.rafael.co.il

**Passive Armor**

Rafael has developed and applied various passive armor technologies to protect combat vehicles, including ceramic, metallic, shaped, laminated and perforated technologies. The passive add-on armor is modular, lightweight and easily installed by the crew. It is maintenance-free and combat-proven.

The systems provide protection against 14.5 mm AP projectiles, high speed fragments of artillery shells and IED (STANAG 4569, Level 4 and beyond). Rafael has recently developed passive add-on lightweight, effective modular armor to defeat EFPs.

Rafael's armor systems are in use by the IDF, USMC, Italian Army, New Zealand Army, Czech Army and others. They are combat proven and received excellent reports about their performance in the Operation Iraqi Freedom and peace keeping missions worldwide. Rafael's Enhanced Appliqué Armor Kit (EAAK) add-on armor system was selected by the USMC as a sole source, for the AAV7 amphibious APC.

RAFAEL's Reactive Armor installed on the US Bradley AFV (left) and Passive Armor installed on the USMC AAV7 APC (right).



*AAV7*

*M113*

*Rosomak*

■ **Certificates from the US Army and USMC to Rafael for its reactive and passive armor systems, installed on the Bradley, Stryker and AAV7** ■



# ***ELECTRO-OPTIC INTELLIGENCE, SURVEILLANCE AND RECONNAISSANCE (ISR)***

## ***Litening - Targeting & Navigation Pod***

Litening is an innovative airborne infra-red targeting and navigation pod for fighter aircraft with high accuracy and reliability, day and night precision strike capability. Litening reduces pilot workload during targeting and tracking. It is easily integrated on any aircraft and possesses high growth potential.

In use in the Israeli Air Force, USAF, ANG, AFRES, Marines, German AF, Swedish AF, Spanish Navy & AF, Greek AF, and others, the Litening flies on F-16 , F-15, A-10, B-52, AV8-B, Gripen, Tornado, F-5, F-4, Mig-21, Mirage 2000, Jaguar and others.



## ***Toplite EO System - Electro-Optical Surveillance, Observation & Targeting System***

The Toplite family of electro-optic systems is an advanced multi-sensor, multi-purpose, highly stabilized EO systems for homeland security and defense applications, for aerial, maritime and ground based platforms.

## ***RecceLite- Real Time Tactical Reconnaissance System***

The RecceLite System consists of an E-O pod, a ground exploitation station and a data link. It is capable of collecting images day & night from 300 ft to 40,000 ft in all directions forwards, nadir, backwards, oblique - all down hemisphere and even when the aircraft is maneuvering in high G.

The Ground Exploitation Station (GES) is capable of generating targets in real-time with exceptionally high accuracy due to state-of-the-art algorithms and technology.

The data-link connects between the sensors and the GES and enables the images to be downloaded to the GES in real time. When your task is to close the attack cycle on many "time-critical targets" in less than 10 minutes, there is only one system - RecceLite.

## ***Recce-U - Real-Time Persistent ISR System for UAVs***

Recce-U is a self-contained, multi-sensor ISR system (based on the RecceLite Tactical Reconnaissance Pod). The Recce-U enables automatic photography, according to a mission plan prepared in advance, or updated mission plan uplinked in real-time, however the operator can initiate manual scanning for targets of opportunity.



***Litening -on-Gripen***



***Toplite EOS***



***RecceLite System***



***Recce-U***

**RAFAEL**  
**ADVANCED DEFENSE SYSTEMS**  
P.O.Box 2250 (19)  
Haifa 3102102, Israel  
Tel: 972-73-3354714  
Fax: 972-73-3354657  
E-mail: intl-mkt@rafael.co.il  
Web Site: www.rafael.co.il

### **SpotLite Family** **Electro-Optic Enemy Fire Detection System**

The SpotLite family consists of electro-optical systems that detect and locate enemy fire in stationary positions as well as on the move. Rapid detection and precise location information provide forces with the capability to quickly neutralize the enemy, maintaining the upper-hand on the battlefield.

The **SpotLite P** is a portable electro-optic system carried by two soldiers for day and night detection and location of small arms fire.



**SpotLite P on Tripod**

**SpotLite M** is a mobile electro-optic system installed on vehicles and AFV's that enables the detection and location of enemy fire sources from small arms, RPG rockets, ATGM and tank shells, on the move, day and night, up to 360° coverage.



**SpotLite M on vehicle**

### **Imilite - Multi-Source Multi-Task ISR Exploitation System / Command and Control System**

Imilite is an intelligence system designed to receive process and exploit multiple standalone imagery video and other intelligence data in a centralized and a unified way.

Main system capability includes the reception, processing and exploitation of EO, IR, SAR/GMTI and VIDEO, in various formats, over one desktop. In order to enhance the exploitation process, Imilite further combines non-imagery data such as targets, threats, COMINT detection and mission status within the system workflow. Imilite generates a variety of standard and customer tailored ISR reports and IMINT products such as alphanumeric reports, annotated maps, GIS data layers and visual aids, and disseminates them to external information and operation systems over standard and tailored protocols.

Imilite's multi-source data integration and automation capabilities improve the efficiency of utilizing available collection and exploitation assets. The system GIS capabilities provide immediate accessibility to relevant imagery and intelligence data, thus shortening the ISR collection and exploitation cycle.

The Imilite is based on Rafael's combat-proven ISR and C<sup>4</sup>I systems already in service worldwide. Imilite is designed for use by Defense forces (air, ground) and police forces exercising various observation means for border patrol or coping with urban crime.



**Imilite**

# IMILITE



***Multi-Source Multi-Task ISR Exploitation System / Command and Control System Imilite is an intelligence system designed to receive process and exploit multiple standalone imagery video and other intelligence data in a centralized and a unified way.***

**RAFAEL**  
**ADVANCED DEFENSE SYSTEMS**  
P.O.Box 2250 (19)  
Haifa 3102102, Israel  
Tel: 972-73-3354714  
Fax: 972-73-3354657  
E-mail: intl-mkt@rafael.co.il  
Web Site: www.rafael.co.il



## **System capabilities:**

data reception, processing and display of Video, imagery, targets, threats, mission status, force locations, SIGINT detection and others.

The system GIS capabilities provide synchronized display of all the data as overlays on maps, video and images.

Imilite improves the Command-and-Control process by various automated image processing algorithms such as geo-referencing, change and motion detection, video/image enhancement, video stabilization and others.

Imilite can disseminate operational data, tactical mission reports, targets and treats to other forces, to facilitate close support operations, targeting and platform/sensor management.

ImiLite allows scalable Command and Control solutions and adaption to specific operational needs, both in mobile and stationary configurations for Command and Control centers, deployable operational units.

## **Benefits:**

- Centralized and unified workflow and data display
- Improved efficiency utilizing all available collection assets
- Shortened exploitation cycle
- Efficient Command and Control workflow
- Immediate accessibility to relevant data
- Real-time mission command-and-control workflow
- SR and mission product sharing with external operational users

## **Features:**

- Multi-source data reception in various formats
- GIS capabilities: image/video geo-referencing, data overlays, Geo data retrieval
- Advanced Image Processing Algorithms: change and motion Detection, image/video enhancement, video stabilization and others
- ISR and mission products and reports generation and dissemination
- Scalability and Adaptability
- Stationary, Mobile or Airborne configurations

# SPIKE FAMILY



**RAFAEL**  
**ADVANCED DEFENSE SYSTEMS**  
 P.O.Box 2250 (19)  
 Haifa 3102102, Israel  
 Tel: 972-4-8794714  
 Fax: 972-4-8794657  
 E-mail: [intl-mkt@rafael.co.il](mailto:intl-mkt@rafael.co.il)  
 Web Site: [www.rafael.co.il](http://www.rafael.co.il)

## Multi Purpose Weapon Systems:

### SPIKE FAMILY

The SPIKE Family consists of missiles suited for land, air and sea platforms, multiple ranges and a variety of targets. The missiles in this family have sophisticated electro-optic CCD or IIR sensors for day/night all-weather operation, as well as a tandem warhead. Their lofted trajectories enable the warhead to strike the target at its most vulnerable location with pinpoint precision and minimal collateral damage. All of the SPIKE Family members have a low life-cycle cost, due to high reliability and operational and logistic support and production commonality between members.

Designation	Max. Range	Application
Spike-SR	1,000m	Infantry and Special Forces
Mini-Spike	1,500m	Infantry and Special Forces
Spike-MR	2,500m	Infantry and Special Forces and Combat Vehicles
Spike-LR	4,000m	Infantry and Special Forces and Combat Vehicles
Spike-ER	8,000m	Infantry, LCV, Helicopters
Spike-NLOS	up to 25km	Multi-Purpose ,Multi-Platform



# SAMSON FAMILY



## **SAMSON RWS**

Rafael's Remote Weapon Station (RWS) Family Globally integrated on thousands of fielded ground and naval platforms, Rafael's Samson family of advanced remote weapon stations (RWS) capitalizes on extensive combat experience with a deep understanding of emerging military needs.

Designed for high performance and survivability on land and at sea, the Samson RWS have been adapted to a wide variety of main battle tanks, trucked and wheeled armored personnel carriers and marine craft.

The Samson Family is offered in six land configurations and two naval configurations. Samson RWS support diverse, interchangeable weapons and sensors including 5.56/7.62/12.7 mm machine guns, 40mm automatic grenade launchers, anti-tank missiles, observation pods, and non lethal capabilities.

Deployed in over 25 countries under rigorous combat and environmental conditions, these robust weapon stations are a dependable force multiplier and trusted partner for the most challenging missions.

Battle-proven land applications include thousands of RWS for the Israel Defense Forces (IDF), the Czech Republic Army, the UK Royal Armed Forces, and many others. Rafael is currently the sole supplier of RWS to the IDF.

## **Breakthroughs in RWS Development**

### ***Under-Armor Reloading***

The superior capabilities and performance of Rafael's RWS have been further enhanced by various ingenious force survivability multipliers, including in-hull ammunition reloading which enables uninterrupted operation while minimizing the crew's exposure to life-threatening battlefield dangers. The patented system is loaded from under the deck, and in addition to its operational benefit, is ergonomically designed for loader convenience and operation with minimum effort and maximum consideration of physical health.

### ***Non-Lethal Capabilities***

The newest addition to the Samson RWS family is its Non-Lethal (NL) capability which bases its response on all human biological senses. Whether employed for crowd control or other urban scenarios, the Samson NL capability provides the symmetrical response required to alleviate potentially explosive situations.

Samson NL concept is based on a five-sense response and the dual use of the RWS; interchangeable for NL and L use.

### ***Samson Jr.***

The lightest of the Samson RWS family, the Samson Jr. is intended for wheeled, tracked, and naval platforms which mandate minimum deck load and silhouette. Designed for defensive fire in military and paramilitary operations, the Samson Jr. mounts a variety of crew-exchangeable small caliber armaments, including 7.62mm or 5.56 machine guns, sharpshooter rifles and non-lethal weapons.



**RAFAEL**  
**ADVANCED DEFENSE SYSTEMS**  
 P.O.Box 2250 (19)  
 Haifa 3102102, Israel  
 Tel: 972-73-3354714  
 Fax: 972-73-3354657  
 E-mail: intl-mkt@rafael.co.il  
 Web Site: www.rafael.co.il

### **SAMSON MINI**

The Samson Mini dual-axis, gyro-stabilized RWS is designed for use on light wheeled or tracked combat vehicles, fast attack boats and other platforms requiring improved offensive capabilities. The system enables target engagement with enhanced accuracy, while maximizing crew protection from enemy fire.

This single-weapon RWS accommodates a variety of armaments including a 5.56mm SAW and LMG, 7.62mm GPMG and Gatling gun, 12.7mm HMG, 14.5mm, 40mm AGL, ATGM launcher, ASM, fed by high-capacity magazines. Supported by a ballistics-protected multi-sensor Sight Pod, with an optional mechanism for super elevation ballistic angle calculations, the Samson Mini provides a 'round-the-clock response to high-maneuvering battlefield challenges.

### **SAMSON DUAL**

The Samson Dual is a dual-axis, gyro-stabilized RWS that simultaneously mounts two weapons. Developed originally to carry a 25-30mm lightweight weapon as main armament and 7.62mm secondary weapon for short range engagements, the Samson Dual enables multiple-threat handling in high-mobility scenarios. Much more robust than equivalent systems, the Samson Dual is also strong enough to incorporate an ATGM Launcher as a force multiplier. Featuring a special mode that decouples the weapons from the sight pod, this Samson configuration is also ideal for reconnaissance and peace-keeping missions.

### **NEW SAMSON 30MM MKII**

The new Samson 30mm MKII is a 30mm Weapon RWS designed for use on any modern light-armored, high-mobility fighting vehicle, new or upgraded, without modifications. It mounts main and secondary armaments, of Eastern and Western origins, including a 30/40 mm automatic cannon, 40 mm AGL (optional), and 7.62 mm coaxial machine gun. Additional mountable force multipliers include ATGM launchers, ASM, and SGL obscurants.

Equipped with a dual-axis, gyro-stabilized, retractable, dual-sight, weapon mounting system, and the system's configuration provides the commander with full "hunt-kill" capabilities without interfering with the Gunner's current missions.

### **Main Advantages of the Samson RWS family:**

- Commonality and Affordability
- Optimized Survivability Design
- Environmental Compliance
- Precision and Lethality
- High Versatility
- Viable Alternative to the Traditional Turret
- Lighter in weight and more compact, rendering better overall platform mobility and maneuverability
- Safer - No gas emissions or rotating mechanical parts in the hull
- No RWS deck penetration, providing more space in the hull
- Plug-and-play fire control system - Same main computer unit (MCU) for all systems
- Superior 360° situational awareness
- Higher reliability, availability, maintainability, and durability
- Ability to interface with C<sup>4</sup>I and external sensors including hostile fire indicators



# SPOTLITE FAMILY



**RAFAEL**  
**ADVANCED DEFENSE SYSTEMS**  
P.O.Box 2250 (19)  
Haifa 3102102, Israel  
Tel: 972-73-3354714  
Fax: 972-73-3354657  
E-mail: [intl-mkt@rafael.co.il](mailto:intl-mkt@rafael.co.il)  
Web Site: [www.rafael.co.il](http://www.rafael.co.il)

## **Spotlite Family**

### **In-motion Or Portable enemy fire source Detection, positioning and classification system**

Mechanized warfare is particularly complex. Sniper fire, RPG rockets, and in particular anti-tank missiles are lethal threats to the various types of ACVs moving in the battle field. Inability to detect threats and locate the position of the firing enemy causes numerous casualties, massive, inaccurate, and wasteful fire by our forces. Most importantly it lets the enemy retain the initiative in the battle field. Spotlite is a family of electro-optical products that quickly and accurately detect and locate enemy fire and swiftly close the sensor-to-shooter loop so as to neutralize the enemy and to keep initiative on the battle field in our hands.

The first product unveiled about two years ago was the Spotlite P, formerly MK2. This is a man-portable system that detects and locates enemy shooting small arms. It immediately investigates the target to verify that it is indeed a terrorist and quickly sends the target data to snipers or any other relevant shooters that can neutralize the source of fire. Since the system is man-portable and battery-operated it has great operational flexibility and can be positioned inside buildings as well as in areas impassible by vehicle.

An additional product, Spotlite – M, has recently joined the family. Spotlite – M is an electro-optical system installed on ACVs and other vehicles that detects and locates an enemy that is firing small arms, RPG bombs, anti-tank missiles, and rockets, in motion, day and night, at a range of up to 360°.



# TAR - YOUR ONE STOP SHOP



**TAR IDEAL CONCEPTS LTD.**

5 Ma'avar Yabok St.,  
Tel-Aviv 6744007, Israel  
Tel: 972-3-6914564  
Fax: 972-3-6914567  
E-mail: [webinquiry@tarideal.com](mailto:webinquiry@tarideal.com)  
Web Site: [www.tarideal.com](http://www.tarideal.com)



## YOUR ONE STOP SHOP.

**VISIT US AT**  
**ISDEF**  
THE 7<sup>TH</sup> INTERNATIONAL DEFENCE & HLS EXPO

JUNE 2-4  
**2015**  
**ISRAEL**



# **BUL PISTOLS WATCH YOUR SIX!**



## **BUL LTD.**

10 Rival St.,  
Tel-Aviv 6777845, Israel  
Tel: 972-3-6392911  
Fax: 972-3-6874853  
E-mail: [info@bultransmark.com](mailto:info@bultransmark.com)  
Web Site: [www.bultransmark.com](http://www.bultransmark.com)

**BUL LTD.** was established in 1990 as a private company specializing in the development, construction and maintenance of shooting ranges in Israel and abroad.

With a desire to expand its line of activities, and with a clear understanding of the market needs for a polymer gun with 1911 mechanism, quality, great - and not particularly expensive Bul Ltd. has begun to develop the **BUL M-5**.

**BUL LTD.** currently exports over 95% of its products to almost all over the world.

The M5 series is a lightweight Hi-Capacity pistol. Its simplicity, reliability and ease of use makes it the natural choice of Military, Police and civilian market.

**The BUL CHEROKEE** Series are the ultimate day-to-day carry pistol for those looking for a compact, Light weight pistol - yet with a high 9 mm magazine capacity. It has a great slim and ergonomic grip no one can ignore.



## **The SAS Series**

**The SAS is our latest and hottest polymer hi-cap 1911 pistol series.**

SAS pistols are somewhat similar to our M-5 line as far as the upper slide and barrel design is concerned. However, the noticeable difference between the two is the frame construction. Unlike the M-5, the SAS has a separate steel Insert and fiber-reinforced polymer frame, which provides a firm grip due to its noticeable checkering throughout the side.

Panels, front strap and mainspring housing. A feature many shooters favor.



# MILITARY AND SECURITY EQUIPMENT



## CONTACT INTERNATIONAL (KALIA) LTD.

P.O.Box 18434  
Jerusalem 9118301, Israel  
Tel: 972-2-5354565, 5354057  
Fax: 972-2-5354566  
E-mail: [contintl@netvision.net.il](mailto:contintl@netvision.net.il)

### **CONTACT INTERNATIONAL (KALIA) SPECIALIZING IN THE SUPPLY OF SURPLUS AND NEW MILITARY EQUIPMENT.**

Established in 1979, CONTACT INTERNATIONAL (KALIA) is one of the leading suppliers of surplus and new manufacture military equipment in Israel, with an international reputation for service and reliability.

CONTACT INTERNATIONAL (KALIA) has the advantage of its own storage facilities and an expert staff qualified in refurbishing and processing ordnance and other equipment.

We can offer our customers quality products from our own inventory and from a variety of local and foreign sources.

#### **Ground Forces**

Arms and Ammunition,  
Weapon Parts and Accessories,  
Personal Equipment,  
Combat Vehicles and Spare Parts,  
Optics and Communications,  
Riot Control and  
Less Lethal Weapons

#### **Air Force**

Engines and Spare Parts,  
Ground Support Equipment  
And Ordnance

#### **Navy**

Vessels, Weapons and Ammunition

#### **Rescue and Survival Equipment**

Gas Masks,  
Blankets,  
Stretchers etc.



# OVER 80 YEARS OF EXPERIENCE AND EXCELLENCE



IWI

Israel Weapon Industries (IWI) Ltd.

64 Bialik Blvd., P.O.Box 63  
Ramat Hasharon 4710001, Israel  
Tel: 972-3-7606000  
Fax: 972-3-7606001  
E-mail: [info@iwi.net](mailto:info@iwi.net)  
Web Site: [www.iwi.net](http://www.iwi.net)

## Company Profile

Israel Weapon Industries (IWI), located in the center of Israel, has been a world leader in small arms for over 80 years. IWI is a member of the SK Group, which is composed of companies that develop and manufacture a wide array of military products for governmental entities, armies, and law enforcement agencies around the world. IWI's best-known products include the **TAVOR®** and **GALIL® ACE®** families of Assault Rifles, the **NEGEV™** Light Machine Gun, the legendary **UZI®** SMG (Mini, Micro and UZI® PRO), the **JERICHO®** family of pistols and the **GALIL® SNIPER** Rifle and the new **DAN®** Bolt Action Sniper Rifle - which have all been considered weapons of choice by military units and top law enforcement agencies around the world. The company's firearms are developed in close collaboration with the Israel Defense Forces (IDF). IWI and the IDF join forces in developing these weapons, whose final configurations are the product of ongoing interaction, field tests, and modifications, resulting from combat requirements and experience. All IWI weapon systems are in compliance with the most stringent military standards (MIL-STD) and ISO 9000 standards.

## About SK Group:

IWI is a member of SK Group, a leading global defense and security group of companies comprising Meprolight Ltd. (electro-optic systems, lasers and night vision systems), Camero-Tech Ltd. (through-the-wall sensing), Israel Shipyards Ltd. (ship manufacturing and repair), Uni-Scope Ltd. (optical periscopes), VisionMap Ltd. (airborne imaging systems) and more.

\*Weapons are available in different calibers



\*NEGEV NG7 LMG



\*X95 Flattop with Mepro M5 Red Dot  
Weapon Sight



\*ACE 22 N with Mepro 21 Reflex Sight

# LAND OPERATIONS TRAINING SYSTEMS

**Elbit Systems**

**ELBIT SYSTEMS LTD.**

P.O.Box 539  
Advanced Technology Center  
Haifa 3105301, Israel  
Tel: 972-4-8315315  
E-mail: [aerospace@elbitsystems.com](mailto:aerospace@elbitsystems.com)  
Web Site: [www.elbitsystems.com](http://www.elbitsystems.com)



## **TBT - TACTICAL BATTLE GROUP TRAINER**

Elbit Systems' Tactical Battle Group Trainer (TBT) is the ideal solution for training commanders and crew from Company level to Battalion/Battle Group and Brigade-sized operations. Combining tactical battlefield simulation with actual C<sup>4</sup>I systems, the TBT's unique concept enables Battle Group leaders to acquire tactical reasoning methods, skills and procedures. It facilitates developing and learning doctrines, situational awareness, and C<sup>4</sup>I usage.



TBT

## **ATCT - APPENDED TANK CREW TRAINER**

### **A mobile training system that transforms tanks into simulators**

The Appended Tank Crew Trainer (TCT) is a portable training system enabling training and mission rehearsal onsite, with minimum risk and logistics effort, and resulting in maximum combat readiness. The system connects to the actual combat vehicle and systems, providing a complete simulation environment for the crew. ATCT is one example of Elbit systems robust line of training solutions for platforms and weapons operators.



ATCT

## **CLTS - COMBAT LIVE TRAINING SYSTEM**

The CLTS is a complete tactical combined arms, two sided, live training system. It combines infantry and armored vehicles laser suites, independent field communication and control capabilities into an integrated, realistic live training solution, operating according to specific doctrines. CLTS is fully independent and deployable with no need for external infrastructures.



CLTS

## **CST - COMMAND AND STAFF TRAINER**

Elbit Systems' CST is designed to improve the operational readiness of headquarters personnel up to division echelons. It simulates complex, joint operations in both high and low intensity conflicts (HIC/LIC) as well as operations other than war.

# INTEGRATED TRAINING SOLUTIONS



## ELTEL TECHNOLOGISTICS LTD.

7 Martin Gehl St., Kiryat Arye  
Petach Tikva 4951254, Israel  
Tel: 972-3-9205253  
Fax: 972-3-9205200  
E-mail: meirh@eltel.co.il  
Web Site: www.eltel.co.il

*Eltel Technologists Ltd. is a leading defense provider of technological and logistics solutions that specializes in the field of training and simulation.*

### Areas of activity:

#### Tactical Defense Training



- ▶ **Advanced live fire training**  
computerized pop-up and moving targets for both infantry and armour units.
- ▶ **Digital shooting ranges**  
shooting simulator for marksmanship training of infantry and armour units and decision making situations. Systems are available for both indoor and outdoor solutions.
- ▶ **Scenario Simulation**  
various simulation equipment for creating authentic scenarios for the training, including urban combat training, pyrotechnics, smoke, etc.
- ▶ **Exercise monitoring, debriefing and performance analysis**  
Advanced control and monitoring systems that allow complete and accurate review of the trainees' performance for debriefing and improvement purposes.

#### Synthetic Arena Simulation (SAS)



- ▶ The system is based on military doctrine, physical and operation models to simulate a realistic combat environment.
- ▶ SAS features a full and operational interface with various C<sup>4</sup>I systems.
- ▶ Operational plan examination and decision support system (DSS).

#### Competence and Readiness Performance Management (CRPM)



- ▶ An advanced BI system that supports the decision making process along the chain of command.
- ▶ The system maintains an up-to-date status of the various units and displays the current availability of the operational crews.
- ▶ The system interfaces with the client's information systems and databases in order to access the most updated status reports.
- ▶ CRPM enables the users to better allocate their resources in order to keep their operating efficiency high while minimizing costs.



# YOU SEE US! *Day and night*

## No External Power Source



**RVTT** RESHEF TECHNOLOGY LTD.

### RVTT

Reshef Visual Thermal Technology

P.O.Box 4298

Rosh-Ha'ayin 4856156, Israel

Tel: 972-3-9382804

Fax: 972-3-9383702

E-mail: resh@inter.net.il



### Targets

- Constructing a battlefield scenario for ground forces
- Enemy target Construction during ground battle simulation
- Ground forces training during day/night simulations
- Improvement of night warfare skills
- Training of ground counter intelligence gathering during day/night

### Mission Statement

We want to improve capabilities of the simulated battlefield using our **visual reality™** solutions for day and night (using passive thermal signatures).

We are dedicated to enhancing our customers training scenarios under CPI (Continuous Process Improvement).

### Identification and Marking

- Friendly / foe identification capabilities for the ground and air forces
- Safety marking of forces during training to prevent friendly fire
- Road direction signs night/day and ranging aids



# AIR DEFENSE RADARS



## IAI ELTA SYSTEMS LTD.

P.O.Box 330, Ashdod 7710202, Israel  
Tel: 972-8-8572410  
Fax: 972-8-8561872  
E-mail: [market@elta.co.il](mailto:market@elta.co.il)  
Web Site: [www.elta-iai.com](http://www.elta-iai.com)

### MMR - Multi Mission Radar ELM-2084

The ELTA ELM-2084 Multi Mission Radar is an advanced phased-array radar able to detect a wide range of low RCS airborne objects - including missiles, artillery shells and rockets. The objects can be detected even in the presence of ground clutter and electromagnetic interference. When encountering ballistic motion type targets, the radar rapidly detects and pinpoints the location of the adversary weapon launching point and calculates the anticipated impact points.



### AD-STAR - Air Defense and Air Traffic Control Radar ELM-2288

The ELTA AD-STAR ELM-2288 is an advanced 3D target position, solid-state long-range S-Band family of transportable radars designed to support Air Defenses, Early Warning and Traffic Control activities. Featuring fully digital beam forming in elevation (receiving and transmitting) the AD-STAR provides high accuracy 3D data on detected targets, while initiating automatic target tracking based on preprogrammed target parameters. Including multiple transmitters and digital receivers, the AD-STAR ensures high redundancy and reliability, and high availability. The radar system can be integrated with a compatible IFF (SSR) system features mounted on the primary antenna.



### GREEN PINE ELM-2080

ELM-2080 is a search, acquisition and fire control radar that can simultaneously detect and track dozens of ballistic missiles in a wide array of ranges and altitudes. The modern signal processor embedded in the system enables flexibility in waveform generation and data processing. The large power aperture, combining state-of-the-art solid state modules, provides a long detection range, even in adverse weather conditions, land and sea clutter, or chaff.



### APR - Aerostat Programmable Radar ELM-2083

ELTA and TCOM L.P. have combined their capabilities to provide an efficient and affordable Aerostat-Mounted Airborne Early Warning Radar. The radar provides continuous long range and low altitude coverage on a 24 hour basis. The Phase Array Radar normally operates in a 360° coverage search mode, and can be switched to sector scan mode for extended range and improved tracking capability. The system provides 3D coverage for air defense operations and simultaneous surface target detection.

# BARAK-8

## LAND-BASED AND NAVAL



Israel Aerospace Industries Ltd.  
Systems Missiles & Space Group

### BARAK-8 Air & Missile Defense System

Land-based, Short to Long Range, Point & Area

#### AIR & MISSILE DEFENSE DIVISION

P.O.Box 105  
Yehud Industrial Zone  
5610002, Israel  
Tel: 972-3-5315699  
Fax: 972-3-5315830  
E-mail: [marketing@iai.co.il](mailto:marketing@iai.co.il)  
Web Site: [www.iai.co.il](http://www.iai.co.il)



Land Based  
Implementation

#### BARAK-8 from IAI: Point and Area Air & Missile Defense System for Extended Ranges

- Advanced Air & Missile Defense System
- From short to long ranges - low to high altitude targets
- Multiple simultaneous engagements in severe saturation scenarios
- Active seeker enables all-weather operation
- Missiles vertical launch and high maneuverability supports 360° coverage
- Advanced 2 way data link supports missiles and batteries coordination

# AIR DEFENSE SYSTEMS

## IRON DOME

## SPYDER-SR/MR



**RAFAEL**  
**ADVANCED DEFENSE SYSTEMS**  
P.O.Box 2250 (19)  
Haifa 3102102, Israel  
Tel: 972-73-3354714  
Fax: 972-73-3354657  
E-mail: [intl-mkt@rafael.co.il](mailto:intl-mkt@rafael.co.il)  
Web Site: [www.rafael.co.il](http://www.rafael.co.il)

### Air Defense

*Rafael has extensive experience in missile development and production, and offers a variety of missiles in a broad range of areas.*

#### IRON DOME

The Iron Dome is the only dual mission system in the world that provides an effective defense solution for countering rockets, artillery & mortars (C-RAM) as well as aircraft, helicopters, UAVs, PGMs. The system is an effective system for countering C-RAM threats with ranges of up to 70 km and for VSHORAD protection (up to 10 km). The system operates in all weather conditions, including low clouds, rain, dust storms or fog.

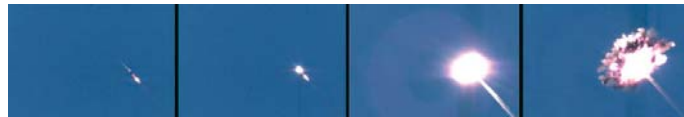

#### SPYDER-SR/MR

##### Short/Medium Range Mobile Air Defense Systems.

SPYDER (Surface-To-Air Python & DERBY) is a quick reaction, low level surface-to-air missile system designed to counter attacks by aircraft, helicopters UAVs and precision guided munitions. The system provides effective protection of valuable assets, as well as first-class defense for forces located in the combat area. SPYDER incorporates RAFAEL's most advanced, proven performance air-to-air missiles - the Derby active radar (RF) missile and Python-5, a dual waveband Imaging Infra Red (IIR) missile. The SPYDER family includes SPYDER-SR (Short Range) and SPYDER-MR (Medium Range) systems.



# MIC<sup>4</sup>AD



**RAFAEL  
ADVANCED DEFENSE SYSTEMS**

P.O.Box 2250 (19)  
Haifa 3102102, Israel  
Tel: 972-73-3354714  
Fax: 972-73-3354657  
E-mail: [intl-mkt@rafael.co.il](mailto:intl-mkt@rafael.co.il)  
Web Site: [www.rafael.co.il](http://www.rafael.co.il)

MIC<sup>4</sup>AD is an advanced, unified, integrated C<sup>4</sup>I system that commands and controls the operation of both air and missile defense, including air-superiority missions. MIC<sup>4</sup>AD provides a total solution for multi-system, multi-layer and multi-range air and missile defense, traditionally operated as separate commands.

MIC<sup>4</sup>AD correlates real-time data from distributed sensors/platforms (radars, IFF system, data links, electro-optics), all connected to the air traffic control picture and mission planning system. The data is analyzed to deliver a real-time, coherent national Air Situation Picture (ASP).

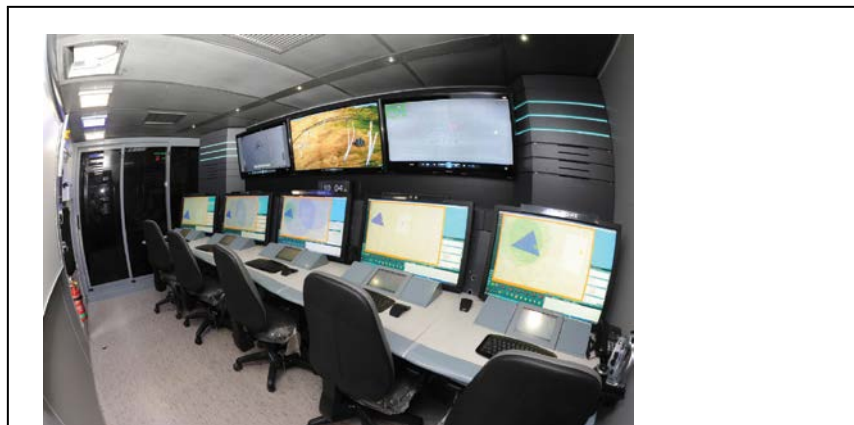

Simultaneously, MIC<sup>4</sup>AD performs threat assessment and hostile target classification, generating an interception plan for threats at any command level (national, regional, tactical). MIC<sup>4</sup>AD optimizes resource management and swiftly allocates the most appropriate defense system, such as SPYDER, David's Sling, Iron Dome or other customer systems to the type of challenge. Response includes target allocation to weapon systems (TAWA - Threat Assessment Weapon Allocation) with full, semi-automatic or manual fire control according to customer doctrine.

MIC<sup>4</sup>AD open, modular architecture can be adapted to customer operational needs. The system can be integrated with a customer's existing or future air and missile defenses. This flexibility allows incorporating new technologies and systems with the existing arrangement. MIC<sup>4</sup>AD can serve as an add-on to the customer's current C<sup>4</sup>I setup, or replace existing systems entirely.

Highly automated, easy-to-use and with advanced interactive displays, MIC<sup>4</sup>AD is a true force-multiplier. Enabling unified command and fire control of multiple air and missile defense systems, MIC<sup>4</sup>AD delivers multi-mission, multi-layer and multi-range C<sup>4</sup>I capabilities that ensure end-to-end air and missile protection.

# LAND FORCES

## Air Defence



ISRAEL MILITARY INDUSTRIES LTD. (IMI)

P.O.Box 1044, 64 Bialik Blvd.  
Ramat Hasharon 4711001, Israel  
Tel: 972-3-5485222  
Fax: 972-3-5486125  
E-mail: imimrktg@imi-israel.com  
Web Site: www.imi-israel.com

### RED SKY-2

is a fast-deployable, compact VSHORAD system for protection of stationary sites, mobile dismounted and rapid-deployed forces. By integrating advanced passive sensors with a remotely controlled operation, RED SKY-2 extends the capabilities and effective range of existing MANPAD missiles, which are limited by human factors, to their maximum potential. The system is mounted on man-portable pedestals, with sensors and C<sup>3</sup> capabilities. RED SKY-2 can be deployed in locations previously inaccessible to heavier air defense systems, such as mountainous terrain and urban environments.

### Anti-Aircraft Artillery (AAA) Modernization & Upgrading

IMI offers a modernization package for AAA systems already in use. The modernization package is intended for towed or self-propelled AAA systems, such as ZSU23-2, ZSU23-4 (SHILKA), M163A/M167A VADS (Vulcan Air Defense System) and BOFORS 40mm L60/70. IMI's AAA upgrading solutions provide increased accuracy and lethality as well as enhanced survivability and mobility.

### TSR

#### Target Simulation Rockets

A family of low-cost, high-performance target simulators for realistic threat emulation of incoming missiles and rockets. Designed for training, testing and development of air defense systems and their components. Can be launched from various platforms such as fixed or mobile ground launchers, as well as naval vessels. variants:

- TSR-160, based on IMI's LAR 160 rocket.
- TSR-306, based on IMI's EXTRA rocket (equipped with FTS and telemetry unit).

AAA Upgrading



RED SKY-2  
Protection Suite for  
Helicopters & Transporters

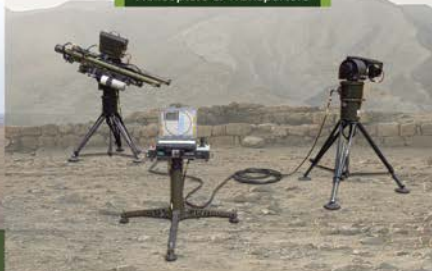

TSR  
Target Simulation Rockets



# ADVANCED AEROSTAT SYSTEMS



## RT LTD.

10 Nahal Snir St.,  
Yavne 8122447, Israel  
Tel: 972-8-9433616  
Fax: 972-8-9433607  
E-mail: [info@rt.co.il](mailto:info@rt.co.il)  
Web Site: [www.rt.co.il](http://www.rt.co.il)



## RT Company Profile

**RT LTA Systems LTD** is a world class designer, developer and manufacturer of the **Skystar™ Aerostat Family** proven for use in intelligence, surveillance, reconnaissance and communications applications.

Users active in prevent - prepare - respond - recover settings requiring continuous and compact aerial support are a natural fit for Skystar™ products.

The Skystar systems have more than **700,000** proven flight operation hours in battle zones all around the world.

**RT LTA Systems LTD** delivers self-contained, versatile, easily transportable, cost effective tactical systems comprised of a mobile control station, ground system module, a tether, lighter-than-air platform, stabilized payload platform and sophisticated sensor suite including camera, communication relays, cellular, radars.

Skystar™ systems are easy to operate, rapidly deployed and customized for a range of operating conditions in high performance worldwide in various military and civilian missions.

## Skystar Applications

- Unmanned Aerial ISR and target acquisition
- Border and coastal security
- Crisis and emergency management
- Law enforcement and public safety
- Search and Rescue
- Communication relay
- Offshore/onshore business continuity recovery
- Event management/crowd control
- VIP protection
- Environmental measurement
- Situational awareness
- Perimeter security
- Intruder detection





# **UNMANNED** SYSTEMS & ROBOTICS



## From Autonomous Aircraft to Land and Naval Robotic Systems

Israel pioneered the field of unmanned aerial systems (UAS) in the 1970s and is now considered a world leader in this field. Today, Israeli-developed UAS are offered along with avionics, mission payloads and support systems. Expanding robotics technologies to support land and maritime applications, Israel's now offers unmanned systems for military, homeland security and civil use.

Israeli unmanned systems have been operationally proven for decades, enduring hot, cold and high-altitude conditions, tropical and desert climates, as well as the maritime environment. In addition to supporting the IDF, these vehicles, sensors and mission systems have operated routinely in all recent conflicts, from Afghanistan and Iraq in the Middle East to Mali, Libya in Africa, proving essential intelligence support, reconnaissance and counter-explosive device (C-IED) capabilities that are saving the lives of soldiers and civilians alike.

The Israel Air Force operates several UAS squadrons equipped with Israeli made Medium Altitude Long Endurance (MALE) platforms. The ground forces also utilize Tactical and mini-UAVs. The Israel Defense Force (IDF) also became the first army to deploy a robotic, unmanned patrol vehicle as part of regular operational forces.

The Israel Navy has been employing Unmanned Surface Vessels (USV). These agile and persistent platforms are assuming a growing responsibility for the country's port, coastal and offshore security.

Aerostats and hovering tethered platforms have become an important element supporting the ground forces, providing persistent, wide area surveillance and high-fidelity imaging from standoff range. In addition, typical missions include electronic surveillance, ground and air surveillance and communications support services.

Israeli unmanned vehicles are also operating in Latin America, the Indian Ocean, Europe, Asia, Africa and the South Pacific. Patrolling vast areas of desert, rural countryside, jungles or the open sea, Israeli made UAS are securing borders, oil and gas infrastructure, monitoring maritime traffic in littorals, deterring piracy and assist in emergency response.

# AEROSTAR TACTICAL UAS



---

# Aeronautics

---

## AERONAUTICS LTD.

P.O.Box 169  
Yavne 8110101, Israel  
Tel: 972-8-9433600  
Fax: 972-8-9328912  
E-mail: [info@aeronautics-sys.com](mailto:info@aeronautics-sys.com)  
Web Site: [www.aeronautics-sys.com](http://www.aeronautics-sys.com)



### Aerostar Tactical UAS

The Aerostar Tactical Unmanned Air System (TUAS) provides reliable, high quality real time intelligence gathering capability.

The system has accumulated thousands of operational hours, giving the system its maturity, reliability and credibility.

The Aerostar system is cost-effective, user friendly, and can be deployed in a very short time due to its small logistics footprint.

Among the system's customers are the IDF, U.S. Navy, and other customers around the globe.

### Performance

Service Ceiling ..... 18,000 ft  
Endurance ..... 12 hours  
LOS Datalink Range ..... Over 200 km

### Technical Data

Wingspan ..... 8.7 m (28.5 ft)  
Length ..... 4.5 m (14.7 ft)  
Height ..... 1.3 m (4.2 ft)  
MTOW ..... 230 kg (507 lb)  
Max Payload Weight ..... 50 kg (110 lb)



# **DOMINATOR<sup>®</sup> MALE UAS**



# Aeronautics

## AERONAUTICS LTD.

P.O.Box 169  
 Yavne 8110101, Israel  
 Tel: 972-8-9433600  
 Fax: 972-8-9328912  
 E-mail: [info@aeronautics-sys.com](mailto:info@aeronautics-sys.com)  
 Web Site: [www.aeronautics-sys.com](http://www.aeronautics-sys.com)



### Dominator® MALE UAS

The Dominator MALE UAS is a strategic asset providing comprehensive situational awareness at ranges beyond line of sight. Carrying multiple sensors and payloads, the Dominator is capable of performing a wide range of operational missions.

The Dominator MALE UAS is based on the DA42 platform. The system combines the remarkable performance of the DA42, a fully certified aircraft, with over 640 units produced since 2005 and over 360,000 hours of accumulated operating experience, and the proven unmanned technology by Aeronautics, which has logged over 80,000 operational flight hours onboard UAVs worldwide.

### Performance

Service Ceiling .....	27,000 ft.
Endurance .....	over 20 hours
LOS Datalink Range .....	250 km (155 miles)
Service Ceiling.....	30,000 ft

### Technical data

Wingspan .....	13.5m (44ft)
Length .....	8.6 m (28 ft)
Height .....	2.5 m (8.2 ft)
Max T/O Weight .....	1,900 kg (4,188 lb)
Max payload weight .....	370 kg (815 lb)



# **ORBITER<sup>®</sup> 3 SMALL UAS**



---

# Aeronautics

---

## AERONAUTICS LTD.

P.O.Box 169  
Yavne 8110101, Israel  
Tel: 972-8-9433600  
Fax: 972-8-9328912  
E-mail: [info@aeronautics-sys.com](mailto:info@aeronautics-sys.com)  
Web Site: [www.aeronautics-sys.com](http://www.aeronautics-sys.com)



### **ORBITER® 3** small UAS

The Orbiter 3 Small Tactical Unmanned Aerial System (STUAS) combines the advantages of an impressive performance envelope and radically reduced logistical and operational requirements, making it a remarkably capable yet efficient solution for Intelligence, Surveillance, Target-Acquisition and Reconnaissance (ISTAR) purposes.

#### Performance

Operational Altitude .....	1500-5,000 ft
Endurance .....	7 hours
LOS Datalink Range .....	100+ km
Operational Speed .....	30-70 kt
Service Ceiling.....	18,000 ft

#### Technical data

Wingspan .....	4.4 m (14.4 ft)
Length .....	1.5 m (5 ft)
Max T/O Weight .....	30 kg (66 lb)



# ORBITER<sup>®</sup> MINI UAS





---

# Aeronautics

---

## AERONAUTICS LTD.

P.O.Box 169  
Yavne 8110101, Israel  
Tel: 972-8-9433600  
Fax: 972-8-9328912  
E-mail: [info@aeronautics-sys.com](mailto:info@aeronautics-sys.com)  
Web Site: [www.aeronautics-sys.com](http://www.aeronautics-sys.com)



### Orbiter® Mini UAS

The Orbiter Mini UAS System Is a compact and lightweight system designed for use in Military and Homeland security missions.

The system presents the ultimate solution for Over The Hill reconnaissance missions, Low Intensity Conflicts and Urban warfare operations as well as any close range mission.

### Performance

Operational Altitude .....	500-5,000 ft
Endurance .....	4 hours
LOS Datalink Range .....	40/100 km
Operational Speed.....	35-75 kt
Service Ceiling.....	18,000 ft

### Technical Data

Wingspan.....	3 m (9.8 ft)
Length.....	1 m (3.2 ft)
Max Payload Weight.....	1.5 kg (3.3 lb)

# MINI UAV DEVELOPMENT

**AeroTactiX** LTD  
Advanced UAS Solutions

## AEROTACTIX LTD.

68 Amal St.,  
Petach Tikva 4951368, Israel  
Tel: 972-3-9215720  
Fax: 972-3-9215434  
E-mail: [info@aerotactix.com](mailto:info@aerotactix.com)  
Web Site: [www.aerotactix.com](http://www.aerotactix.com)



**AeroTactiX (Israel) LTD.** Develops and manufactures mini UAS and sub-systems including Autopilots, Communication systems and ground control stations, and offers integration for various Payloads and components.

**AeroTactiX (Israel) LTD.** Delivers high-end, cost effective, mini UAS solutions for various applications.

Our mini-UAS is based on the latest technology available on the market, and is also based on the experience and knowledge accumulated in thousands of operational missions.

Turn Key solutions precisely matched to our customer's requirements is our business philosophy.

When a tailor made system is required AeroTactiX will do its best effort to optimize all technical aspects and to provide the best suitable solution for our client.



# TACTICAL UNMANNED AERIAL SYSTEMS



## Unleashing the True Power of UAVs

Bluebird Aero Systems Ltd. is a dominant player in the Tactical Unmanned Aerial Systems (UAS) industry, specializes in design, development and production of micro, mini, small tactical UAS, small aerostats and peripheral equipment. BlueBird delivers combat proven solutions to meet the challenges of the military, HLS and civilian UAS markets.

### BLUEBIRD AERO SYSTEMS LTD.

P.O.Box 5041, Industrial Park  
Kadima 6092000, Israel  
Tel: 972-9-8999335  
Fax: 972-9-8999345  
E-mail: info@bluebird-uav.com  
Web Site: www.bluebird-uav.com

### Micro B

**On-demand precision situational awareness for Special Forces and first responders**

- Operational
- Hand Held, light weight launcher
- Covert operation - low acoustic & visual signatures
- Secondary emergency backup control link
- Real time day or night, gimbale & stabilized payloads
- Easy & fast operational readiness



Wing Span	99 cm
MTOW	1.5 kg
Endurance	up to 1 hour
Communication Range	up to 10 km
Best Operational Altitude	up to 1000 m AGL
Flight Ceiling	3000 m/10,000 ft. ASL

<b>HLS</b>
<b>CIVIL</b>
<b>MILITARY</b>

### SpyLite

**Combat proven, Unmatched Performance Mini UAV**

- Accumulated over 10,000 operational sorties
- World records for range, endurance, flight ceiling in the MINI UAV category
- Covert operation - low acoustic & visual signatures
- Secondary emergency backup control link
- Dual sensor, CCD & IR, real time day & night, gimbale & stabilized payload with optional laser pointer
- Optional RGB, multi spectral or IR photogrammetric mapping payloads



Wing Span	275 cm
MTOW	9.5 kg
Endurance	up to 4 hours
Communication Range	up to 50 km (can be extended up to 80 km)
Best Operational Altitude	up to 1000 m AGL
Flight Ceiling	9000 m/30,000 ft. ASL

<b>HLS</b>
<b>CIVIL</b>
<b>MILITARY</b>

### ThunderB

**Long Endurance, Rapidly Deployed Tactical UAS**

- Full autonomous from take-off to landing
- Unprecedented Performance: 16-24 hours mission time, up to 150 km control range
- Covert operation- low acoustic & visual signatures
- Secondary emergency backup control link
- Dual CCD & cooled/uncooled IR with optional laser pointer
- Optional RGB, multi spectral or IR photogrammetric mapping payloads



Wing Span	410 cm
MTOW	24 kg
Endurance	16-24 hours
Communication Range	up to 100 km (can be extended up to 150 Km)
Best Operational Altitude	up to 1000 m AGL
Flight Ceiling	4800 m/16,000 ft. ASL

<b>HLS</b>
<b>CIVIL</b>
<b>MILITARY</b>

### Spy-i

**Affordable, High-performance Aerostat system**

- 360° day & night surveillance capability
- Dual sensor (CCD/IR) real time gimbale & stabilized payload
- Ease of operation: Quick deployment and retrieval time, operated by a two men crew
- Deployment in any terrain - No prepared area required
- Long Mission time
- Co-exists with Bluebird's UAVs



Aerostat Length/ Diameter	~8 m / ~2.8 m
Aerostat volume	~24 m <sup>3</sup>
Best Operational altitude	up to 150 m
Deployment time	up to 20 minutes
Retrieval time	up to 20 minutes
Payload	Dual CCD/IR

<b>HLS</b>
<b>CIVIL</b>
<b>MILITARY</b>

# DATA LINK SOLUTIONS

# Commcontact

## COMMTACT LTD.

P.O.Box 169  
Yavne 8110101, Israel  
Tel: 972-8-9433602  
Fax: 972-8-9433603  
E-mail: [info@commcontact.co.il](mailto:info@commcontact.co.il)  
Web Site: [www.commtact.co.il](http://www.commtact.co.il)

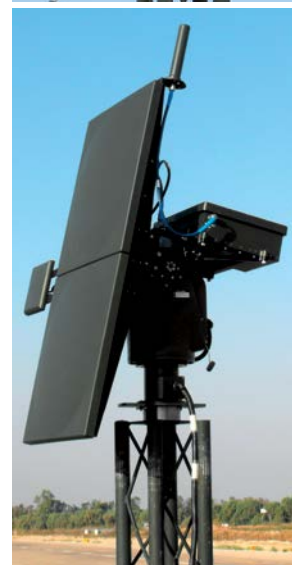
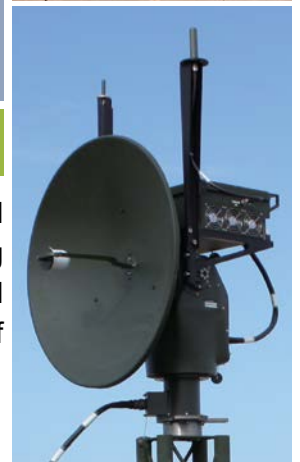

## Data Link Solutions

**Commcontact** is a leading provider of advanced wireless communication systems and tactical data link solutions for various applications and platforms. **Commcontact's** products are being operated successfully onboard fixed wing aircrafts, helicopters, UAVs and in a variety of naval and ground platforms. **Commcontact's** systems are operationally proven in a broad range of short/medium/long range of portable and mobile application.

**Commcontact** product families include:



### IDLS-MKII:

- Up to 300Km Range
- Designed for Medium and large UAVS, Mission aircraft and Helicopters



### AMLS:

- Up to 100Km Range
- Designed for medium range applications, mini-UAVs
- Weights approx. 300g



### MDLS:

- Up to 40Km Range
- Weights less than 100g
- Designed especially for VTOLs, quad copters and mid/short range guided missile applications



### UVR:

- Up to 100Km Range
- Open architecture UHF/VHF radio
- Variable application:
  - ATC for UAVs
  - Ground to Ground Networking
  - Radio Communication Relay

# UAV PAYLOADS



## IAI ELTA SYSTEMS LTD.

P.O.Box 330, Ashdod 7710202, Israel  
Tel: 972-8-8572410  
Fax: 972-8-8561872  
E-mail: [market@elta.co.il](mailto:market@elta.co.il)  
Web Site: [www.elta-iai.com](http://www.elta-iai.com)

### UAV Maritime Patrol Radar System ELM-2022U

The ELM-2022U Maritime Patrol Radar (MPR) System consists of a UAV Maritime Surveillance Radar Payload, and a Ground Radar Operator Station that controls the radar's operation and processes the data sent by the Radar Payload via the UAV's dedicated data link. The MPR System provides a cost-effective force multiplier solution for Maritime Surveillance and EEZ Patrol, Surface and Littoral Warfare, Search and Rescue, Drug Interdiction and prevention of Illegal Immigration and Terrorist activities, Coast Guard and Fisheries Patrol, and Image Intelligence Operations.

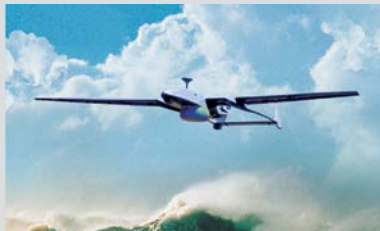

### SAR/GMTI UAV Reconnaissance System ELM-2054/2055

The ELM-2054/55 is a family of a high performance Synthetic Aperture Radar (SAR) and Ground Moving Target Indication (GMTI) all weather Reconnaissance System, for Unmanned Air Vehicles (UAVs). The system consists of the UAV payload, a radar sensor and the Ground Exploitation Segment (GES). The ELM-2055 produces radar images which approach photographic quality, and operates as a true all-weather, day and night sensor capable of penetrating clouds, rain, smoke, smog, fog and man-made camouflage. The SAR Imagery and GMTI plots generated on board are transmitted via the UAV's dedicated data link to the Ground Exploitation Segment (GES) for interpretation and extraction of intelligence data.



### Integrated UAV ESM/ELINT System (IUELIS) ELL-8385

The ELTA ELL-8385 is a UAV Integrated Electronic Support Measures (ESM) and Electronic Intelligence (ELINT) System. The system disseminates intelligence reports, including real-time Electronic Order of Battle (EOB). The system's tasks include search, interception, measurement, location, analysis, classification and monitoring of ground, airborne and naval radar transmissions- which are characterized by high mobility, short duration, modern signals forms and frequent changes in signal parameters.



### Integrated UAV COMINT/DF System (IUCOMS) ELK-7071

The ELTA ELK-7071 is a UAV Integrated Communication Intelligence (COMINT) System. The system disseminates intelligence reports including, real-time Electronic Order of Battle (EOB) of communication transmissions. The system's tasks include search, interception, measurement, location, analysis, classification and monitoring of ground, airborne and naval radar transmissions- which are characterized by high mobility, short duration, and frequent changes in signal parameters.

# UNMANNED AIRCRAFT SYSTEMS (UAS)

***Elbit Systems is a world leading supplier of advanced tactical and medium altitude long endurance (MALE) UAS. Our UAS have accumulated over 500,000 operational flight hours demonstrating outstanding reliability, superior performance and smaller ground footprint***



## The **SKYLARK™** Family:

- Real-time Reconnaissance (ISTAR)
- Silent operation with electric propulsion
  - Counter-terror oriented
  - Convoy airborne escort
- Fully autonomous flight with high level control easy and rapid field deployment  
On-the-move operation
- Interoperability

### **SKYLARK™ I-LE**

- Takeoff weight: 7.5 kg
- Payload weight: 1.2 kg
- Endurance: up to 3 hours
- Service ceiling: 15,000 ft.



**ELBIT SYSTEMS LTD.**

P.O.Box 539

Advanced Technology Center

Haifa 3105301, Israel

Tel: 972-4-8315315

E-mail: [uas@elbitsystems.com](mailto:uas@elbitsystems.com)Web Site: [www.elbitsystems.com](http://www.elbitsystems.com)**The HERMES™ Family:**

- Inhouse major system building blocks and technologies
- C<sup>4</sup>I oriented system- of -systems approach
- Highly reliable, fully autonomous.
- Commonality - avionics ,payloads, datalink, GCS
- Long endurance and high payloads capability
- Growth potential - weight, volume, power

**HERMES 900**

- Highly autonomous & mission effective.
- Multiple hard points & 250 kg modular installation bay.
- Satellite communication & LOS data link.
- Adverse weather capabilities.
- Designed for minimal maintenance.
- Wide variety of cutting edge payloads
- Takeoff weight - 1,180 kg
- Max payload - 350 kg
- Max Endurance > 33 hours
- Service Ceiling - 30,000 ft

**HERMES 450**

- Backbone of Israel's UAS fleet and operational with users worldwide.
- Fully redundant flight avionics and electronics.
- Highly mobile and deployable.
- Wide variety of cutting edge payloads
- Takeoff weight - 550 kg
- Max payload - 150 kg
- Endurance - 17 hours
- Service Ceiling - 18,000 ft

**HERMES 90**

- Highly autonomous with mission-effective flight modes
- Best-in-class endurance combined with extensive payload capabilities
- Runway independent point-launch and recovery in harsh field conditions (traditional wheeled configuration available)
- Takeoff weight - 125 kg
- Max payload - 30 kg
- Endurance - 15 hours
- Service ceiling - 15,000 ft

# PROTECTOR® USV



## RAFAEL ADVANCED DEFENSE SYSTEMS

P.O.Box 2250 (19)  
Haifa 3102102, Israel  
Tel: 972-73-3354714  
Fax: 972-73-3354657  
E-mail: intl-mkt@rafael.co.il  
Web Site: www.rafael.co.il

## PROTECTOR® USV

Is an unmanned integrated system for Intelligence, Surveillance, Target Acquisition and Reconnaissance (ISTAR).

The **PROTECTOR® USV** is fitted with a comprehensive sensor suite and can accommodate a variety of mission modules. The TOPLITE Electro-optical director and a radar system provide day/night detection, identification and tracking of targets. TOPLITE subsystems include a third-generation Forward-Looking Infra-Red (FLIR) sensor, color Charge-Coupled Device (CCD) camera an eye-safe laser rangefinder (LRF), and an advanced correlation tracker.

The Anti Terror/Force Protection payload includes the TOPLITE Electro-Optical Director (EOD), MINI-TYPHOON Stabilized Weapon Station, a Water Cannon System and auxiliary sensors. The MINI-TYPHOON is a stabilized gun mount that is highly accurate and includes fire control capabilities, yielding excellent shooting accuracy. The Water Cannon system provides less-lethal engagement at close range as well as firefighting capabilities.

**PROTECTOR** is operated from a Control Station. The Control Station includes two control consoles, one for the USV commander and one for the Payload Systems operator.

The Control Station receives, via communications links, all the system data, video imagery and audio required to effectively build a situational awareness picture and operate the system. The system can be easily incorporated in a wider defense array via a standard interface to an external C<sup>4</sup>I system.

Based on a highly maneuverable platform the USV has excellent maneuvering capabilities. The platform has water jet propulsion systems powered by diesel engines. The platform systems include control over propulsion, maneuvering, and navigation.

The **PROTECTOR's** core element is an advanced control system, which interfaces with all of the **PROTECTOR's** sub-systems and provides a remote operator with the ability to plan, prioritize and execute naval missions by day and night, under adverse weather conditions, without exposure to risk.

The **PROTECTOR's** modular design enables the Customer to select those sub-systems that will best meet his own particular operational requirements.

When mounting effectors, the **PROTECTOR** can effectively close the fire circle for an all-round "sensor-to-shooter" solution.

## PROTECTOR® USV Operational Advantages

- Performs dangerous tasks without risking human lives.
- Performs long and wearisome missions such as patrolling and ongoing security tasks.
- Provides Real-time data and video transmission from the field to the headquarters.
- Can operate at high seas without a crew that is affected from the harsh conditions.
- The **Protector® USV** Command and Control system can be integrated with external C<sup>4</sup>I systems, making it an integral part of the defense array.
- The **Protector® USV** can be used to approach suspicious vessels and verify their intentions, thus distinguishing friend from foe without having risking crew safety.
- A highly effective sensor suite, capable of detecting and identifying targets and threats from a great distance.
- Integrated combat suite that enables a rapid "sensor to shooter" response.
- Equipped with a highly accurate combat proven stabilized Weapon Station capable of eliminating threats from afar.
- Equipped with high pressure Water Cannon for non-lethal deterrence, and crowd control tasks.
- The **Protector®USV** has the ability to record video and audio data of its surrounding for debriefing, legal purposes and other considerations.
- The **Protector®USV** can be deployed anywhere at sea, from oil rigs, mother ships or shore installations, thus maximizing its range of action and versatility.
- Onboard payload can be replaced to fit different designated missions, thus providing the ability to conduct a wide range of missions using a single platform.
- Fully-tested, serially-produced and operationally deployed in navies' world-wide.

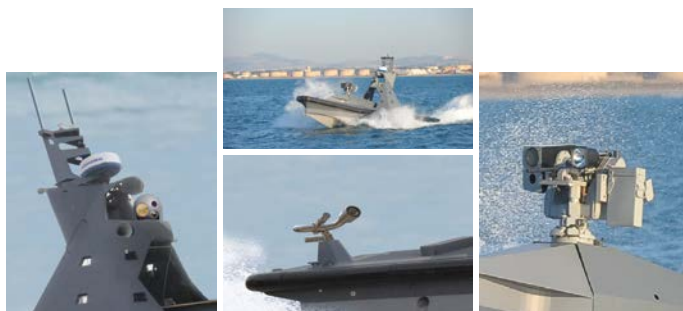



# IAI - MALAT DIVISION



Israel Aerospace Industries Ltd.  
Military Aircraft Group, MALAT Division

## ISRAEL

Tel: (972)3-9358169 Fax: (972)3-9355781

## USA

Tel: (1)703-8753722 Fax: (1)703-8753770

## EUROPE

Tel: (33)1-46404747 Fax: (33)1-46404748

E-mail: [malat@iai.co.il](mailto:malat@iai.co.il)

Web Site: [www.iai.co.il](http://www.iai.co.il)

**1,300,000 Operational UAS Flight Hours**

*at Your Service*

## Whatever your needs, IAI brings you total battlefield UAS solutions

With an unsurpassed track record of **over 1,300,000 operational flight hours** for 50 customers on five continents, IAI is a global leader in comprehensive UAS-based solutions - offering the widest range of combat-proven systems.

E-mail: [malat@iai.co.il](mailto:malat@iai.co.il) | [www.iai.co.il](http://www.iai.co.il)



## ISRAEL

Tel: (972)3-9358169 Fax: (972)3-9355781

## USA

Tel: (1)703-8753722 Fax: (1)703-8753770

## EUROPE

Tel: (33)1-46404747 Fax: (33)1-46404748

E-mail: malat@iai.co.il

Web Site: www.iai.co.il

## MULTI-ROLE MALE UAS

### Missions

Deep-penetration, strategic multiple operational missions: surveillance, reconnaissance, target acquisition and specific electronic tasks for theater commanders.

### Payloads

Simultaneous multi-payload capability

- Electro Optical (TV&IR combi or TV/IR/LD triple sensor)
- Synthetic Aperture Radar (SAR)
- Maritime Patrol Radar (MPR)
- COMINT & ESM
- Customer furnished sensor suites
- Communication relay package
- Integrated ATC radio



## Heron TP

### Launch & Recovery

- Automatic Take-off & Landing (ATOL)

### Datalinks

- Direct line of sight (LOS) data-link
- UAV airborne data relay for beyond LOS missions
- Ground-based data relay for beyond LOS missions
- Satellite data-link capability (SATCOM)

### Performance

Endurance	36 hr
Range (with SATCOM)	Beyond LOS
Altitude	45,000 ft



### Technical Data

Weights	
Max take-off weight	4,650 kg
Max payload weight	1,000 kg
Dimensions	
Overall length	14 m
Wingspan	26 m

### Missions

Deep-penetration, wide-area, multi-role surveillance, reconnaissance, target acquisition and fire adjustment missions for national agencies, theater commanders and lower echelons.

### Payloads

- Electro Optical (TV & IR Combi or Triple Sensor TV/IR/LD)
- Synthetic Aperture Radar (SAR)
- Maritime Patrol Radar (MPR)
- COMINT & ESM capability
- Customer furnished sensor suites
- Communication relay package
- Integrated ATC Radio

### Datalinks

- Direct Line-of-Sight (LOS) data link
- UAV airborne data relay for beyond LOS missions
- Ground-based data relay for beyond LOS missions
- Satellite datalink capability (SATCOM)

### Launch & Recovery

- Automatic wheeled take-off & landing

## Heron

### Performance

Endurance	20-45 hr
Range	350 km
Range (with SATCOM)	BLOS
Altitude	30,000 ft



### Technical Data

Weights	
Max take-off weight	1,250 kg
Max payload weight	250kg
Dimensions	
Overall length	8.5 m
Wingspan	16.60 m

# IAI - MALAT DIVISION



Israel Aerospace Industries Ltd.  
Military Aircraft Group, MALAT Division

## ISRAEL

Tel: (972)3-9358169 Fax: (972)3-9355781

## USA

Tel: (1)703-8753722 Fax: (1)703-8753770

## EUROPE

Tel: (33)1-46404747 Fax: (33)1-46404748

E-mail: malat@iai.co.il

Web Site: www.iai.co.il

## MULTI-ROLE MALE UAS

### Missions

- Deep penetration, wide area, land and maritime surveillance & reconnaissance
- Target acquisition and fire adjustments missions
- Airborne relay for various means of communication

### Payloads - up to six payloads operating simultaneously

- EO/IR/LRF/Laser designator
- SAR/MPR
- Hyper spectral
- ELINT, COMINT
- COM Relay, COMJAM, COMINT GSM
- Scanner, Mapping
- Customer furnished sensor suits

Naval Super Heron



## Super Heron

### Launch & Recovery

- Automatic Take-off & Landing (ATOL)

### Datalinks

- Direct line of sight (LOS) data-link
- Airborne and ground-based data relay for Beyond Line of Sight (BLOS) missions
- Satellite communication (SATCOM) capability for BLOS missions

### Performance

Endurance	up to 45 hr
Range without/with SATCOM	350 km/BLOS
Altitude (AGL)	>30,000 ft
Loiter speed	60-80 knots
Max. speed	>150 knots

### Technical Data

Weights	
Max take-off weight	1,450 kg
Max payload weight	450 kg
Dimensions	
Overall length	17 m
Wingspan	Heavy fuel, 200HP



## MULTI-ROLE MALE UAS

### Missions

- Surveillance, reconnaissance, target detection and recognition
- Target acquisition and fire adjustments missions
- Battle damage assessment

### Payloads - capability to carry and operate two full size payloads simultaneously

- EO/IR/LRF/Laser designator
- SAR
- ESM/COMINT
- EO Scan
- Air Data Relay

### Launch & Recovery

- Automatic Take-off & Landing (ATOL)

### Datalinks

- Direct Line-of-Sight (LOS) data link
- Airborne and ground-based data relay for Beyond Line of Sight (BLOS) missions

## Tactical Heron

### Performance

Endurance	up to 24 hr
Range	250 km
Range with ADR	350 km
Altitude (AGL)	24,000 ft
Max. speed	120 knots



### Technical Data

Weights	
Max take-off weight	760 kg
Max payload weight	150 kg
Dimensions	
Length	7.34 m
Wingspan	12 m
Powerplant	Rotax 912, 100HP





Israel Aerospace Industries Ltd.  
Military Aircraft Group, MALAT Division

## ISRAEL

Tel: (972)3-9358169 Fax: (972)3-9355781

## USA

Tel: (1)703-8753722 Fax: (1)703-8753770

## EUROPE

Tel: (33)1-46404747 Fax: (33)1-46404748

E-mail: malat@iai.co.il

Web Site: www.iai.co.il

## MULTI-ROLE TACTICAL UAS

### Missions

- Surveillance, reconnaissance, target-acquisition, artillery adjustment and damage assessment

### Payloads

- Electro Optical (TV & IR Combi or Triple Sensor TV/IR/LD)
- Synthetic Aperture Radar (SAR)
- COMINT & ESM Integration Capability
- Customer furnished payloads

### Datalinks

- Direct Line-of-Sight (LOS) data link
- UAV airborne data relay for beyond LOS missions
- Ground-based data relay for beyond LOS missions

### Launch & Recovery

- Automatic take-off & landing

## Searcher MK III

### Performance

Endurance	18 hr
Range	350 km
Altitude	23,000 ft
Four Strokes, silent engine	



### Technical Data

Weights	
Max take-off weight	436 kg
Max payload weight	120 kg
Dimensions	
Overall length	5.85 m
Wingspan	8.55 m

## LONG-ENDURANCE MINI UAS

### Missions

- Reconnaissance (ISTAR)
- Urban operation
- Counter-terrorism
- Patrol and convoy escort
- Radio relay

### Payloads

- Stabilized day/night electro-optical payloads:
  - TAMAM: Minipop
  - TAMAM: Micropop
  - Controp: T-Stamp
- Undisclosed electronic payloads

### Launch & Recovery

- Automatic Take-off & Landing (ATOL)
- Mini-launcher for take-off and flip-over with airbag and parachute for landing

## Bird-Eye 650D

### Technical Data

- Direct Line-of-Sight (LOS) data link

### Performance

Endurance	>20 hr
Range	>50 km
Altitude (AGL)	3,000 ft
Loiter speed	40 knots
Max. speed	80 knots

### Technical Data

Weights	
Max take-off weight	30 kg
Max payload weight	10 kg
Dimensions	
Overall length	4 m
Powerplant	
	Gasoline



# IAI - MALAT DIVISION



Israel Aerospace Industries Ltd.  
Military Aircraft Group, MALAT Division

## ISRAEL

Tel: (972)3-9358169 Fax: (972)3-9355781

## USA

Tel: (1)703-8753722 Fax: (1)703-8753770

## EUROPE

Tel: (33)1-46404747 Fax: (33)1-46404748

E-mail: malat@iai.co.il

Web Site: www.iai.co.il

## MINI UAS

### General

The Bird-Eye 650 system is equipped in 2 backpacks and consists of:

- 3 UAV platforms
- EO&IR payloads
- Portable Ground Control System (PGCS)
- Data Link
- Power source and repair kit
- It is man-portable with fast field deployment by a team of two

### Missions

- Real-time day/night imagery intelligence gathering for low echelon forces
- "Over the hill" Intelligence, reconnaissance and surveillance (ISR)
- Urban Operation
- Counter Terrorism
- Silent Observation and Stakeout
- Law enforcement
- Patrol and Convoy Escort

## Bird-Eye 650

### Payloads

- Gimballed, plug-in, lightweight day/night stabilized observation system (TAMAM's Micro-Pop)

### Launch & Recovery

- Mini launcher take-off, unique patented turn-over landing

### Data Links

- Direct Line-of-Sight (LOS) data link



### Performance

Endurance	3 hr
Range	20 km
Altitude (AGL)	1,500 ft
Loiter speed	40 knots

### Technical Data

Weights	
Max take-off weight	11 kg
Max payload weight	1.2 kg
Dimensions	
Overall length	1.07 m
Wingspan	3 m
Powerplant	
	Electrical

## Bird-Eye 400

### Missions

Real time day / night imagery data for law-enforcement and "Over-the-Hill" reconnaissance and surveillance.

### Payloads

- Gimballed video camera - day/night

### Launch & Recovery

- Hand or bungee launch

### Performance

Endurance	90 min
Range	10 km
Altitude (AGL)	1,000 ft

### Technical Data

Weights	
Take-off weight	5.6g
Payload weight	1.2 kg
Dimensions	
Overall length	0.8 m
Wingspan	2.2 m
Powerplant	
	Electrical





## ISRAEL

Tel: (972)3-9358169 Fax: (972)3-9355781

## USA

Tel: (1)703-8753722 Fax: (1)703-8753770

## EUROPE

Tel: (33)1-46404747 Fax: (33)1-46404748

E-mail: malat@iai.co.il

Web Site: www.iai.co.il

## TACTICAL VTOL UAS

### Missions

- Covert special operation missions
- Ship Deck Operation
- Intelligence, Surveillance and Reconnaissance Missions (ISR)
- Silent Observation and Stakeout Missions
- Convoy escort and protection
- Border and Coastal Surveillance Missions
- Law enforcement Missions
- Emergency Response and Support Missions

### Payloads

- Mini POP EO/IR/LP Payload (day/night)

### Launch & Recovery

- Automatic Vertical Take Off & Landing Capability

### Data Links

- Direct Line-of-Sight (LOS) data link

## Panther



### Performance

Endurance	6 hr
Range	60 km
Altitude (AGL)	3,000 ft
Loiter speed	40 knots

### Technical Data

Weights	
Take-off weight	65 kg
Payload weight	10 kg
Dimensions	
Overall length	2.85 m
Wingspan	8 m
Powerplant	
	Electrical



### Missions

- Covert special operation missions
- Ship Deck Operation
- Intelligence, Surveillance and Reconnaissance Missions (ISR)
- Silent Observation and Stakeout Missions
- Convoy escort and protection
- Border and Coastal Surveillance Missions
- Law enforcement Missions
- Emergency Response and Support Missions

### Payloads

- Micro POP EO/IR/LP Payload (day/night)

### Launch & Recovery

- Automatic Vertical Take Off & Landing Capability

### Data Links

- Direct Line-of-Sight (LOS) data link

## Mini Panther



### Performance

Endurance	90 min
Range	20 km
Altitude (AGL)	1,500 ft
Loiter speed	30-40 knots

### Technical Data

Weights	
Max Take-off weight	12 kg
Max Payload weight	2 kg
Dimensions	
Overall length	1.3 m
Wingspan	2.5-3.5 m
Powerplant	
	Electrical



# IAI - MALAT DIVISION



Israel Aerospace Industries Ltd.  
Military Aircraft Group, MALAT Division

## ISRAEL

Tel: (972)3-9358169 Fax: (972)3-9355781

## USA

Tel: (1)703-8753722 Fax: (1)703-8753770

## EUROPE

Tel: (33)1-46404747 Fax: (33)1-46404748

E-mail: [malat@iai.co.il](mailto:malat@iai.co.il)

Web Site: [www.iai.co.il](http://www.iai.co.il)

## ROTARY MINI UAS

### General

Versatile, highly maneuverable rotary mini UAS.

### Missions

- Support ISR missions in urban warfare
- Silent observation and stakeout missions
- Covert special operations missions

### Main Features

- Automatic vertical take-off and landing in any terrain
- Silent electrical propulsion
- Low acoustic signature
- Day and night operation
- Quick and easy assembly and disassembly



## Ghost

### Performance

Endurance	30 min
Operational speed	0-35 kts

### Technical Data

MTOW	4 kg
Dimensions	
Length	145 cm (106 cm folded)
Width	75 cm (11 cm folded)
Powerplant	Electrical
Payload	E/O day or night
Data link	Line of Sight (LOS) and Non Line of Sight (NLOS) data link for urban scenarios



## HAS (HOVERING AERIAL SYSTEMS)

### General

- One click operation
- Deployment within seconds
- Operator free/full automation
- Low signature
- Operational in extreme weather conditions
- Unlimited hovering time (with ground source of energy)
- Easily integrated on a ground vehicle or on a vessel

### Missions

- Ad-hoc observation for unlimited time from a stationary or a moving platform
- Coastal and border protection
- Emergency response operation
- Special forces operation

## ETOP (Electrical Tethered Observation Platform)

### Payloads

- POP 300

### Deploy time to 100m

- 30 sec

### Performance

Hovering time	Unlimited with ground energy source
Altitude (AGL)	100 m



### Technical Data

weight	
Payload weight	20 kg
Dimensions (cm)	160L X 160W X 20H
Powerplant	Electrical

# Top I Vision- Tactical Surveillance Systems



## TOP I VISION LTD.

25 Hathiya St.,  
Holon 5840245, Israel  
Tel: 972-3-9335469  
Fax: 972-3-9339327  
E-mail: [info@topivision.com](mailto:info@topivision.com)  
Web Site: [www.topivision.com](http://www.topivision.com)

**Top I Vision Ltd., develops and manufactures Tactical Airborne Surveillance solutions such as: mini UAV's, Tactical Aerostat Systems (TAS) as well as Ground Control Stations and stabilized payloads for military or civil uses.**



The TAS is an advanced aerial surveillance system, based on super-light stabilized payloads, mounted on a small and easy to operate tethered Aerostat. The TAS I is operational with several governmental entities in Israel and world wide



The Casper 250 Mini UAV system is specially designed to provide "over the next hill" intelligence as a cost effective and simple to operate system.





# UVISION

INNOVATION • TECHNOLOGY • VISION



## UVISION AIR LTD.

4 Bazelet St.,  
Sapir Industrial Park  
Zur Igal 4486200, Israel  
Tel: 972-9-7496822  
Fax: 972-9-7496823  
E-mail: [uvision@uvisionuav.com](mailto:uvision@uvisionuav.com)  
Web Site: [www.uvisionuav.com](http://www.uvisionuav.com)



**UVision** designs, develops, and manufactures unique UAS solutions, ISR and loitering munition systems. UVision offers extensive experience, highly innovative aerodynamic platform configurations, advance airborne guidance and navigation systems and command and control stations.

**UVision** provides unique cutting edge technology as demonstrated by its innovative development of the Hero systems family.

The Hero ISR System's unique cruciform configuration enables high maneuverability to maintain 'eyes-on-target' in constrained battle scenarios.

The beyond line-of-sight Hero system, which is intended for units operating on the front lines, provides:

- Quick-reaction capabilities for pop-up threats and combat uncertainties.
- Fast deployment by an individual soldier, and with ability to obtain immediate crucial and precise situational awareness, in the vicinity of the unit.
- Highly automated ease of operation.
- High speeds and extreme maneuverability to accommodate a variety of complex combat scenarios.
- Real-time live video imagery using a compact stabilized day and night electro-optical payload with auto tracker.
- Easy launch directly from its storage/transport canister with a small safe, non-pyrotechnic booster.



# THE WORLD'S FIRST OPERATIONAL AUTONOMOUS UGV



**GNIUS**  
UNMANNED GROUND SYSTEMS (UGS) LTD.  
Beit Tavor 3, 2 Fl.  
Yokneam Industrial Park  
P.O. Box 370  
Yokneam 2069205, Israel  
Tel: 972-77-3184402  
Fax: 972-77-3184420  
E-mail: [marketing@g-nius.co.il](mailto:marketing@g-nius.co.il)  
Web Site: [www.g-nius.co.il](http://www.g-nius.co.il)



**G-NIUS** - A world leader in the development and fielding of unmanned ground vehicle systems.

**G-NIUS** Unmanned Ground Systems already logs thousands of UGV operational hours and extensive experience in the development, integration, operation, fielding, training and field-support of autonomous unmanned ground vehicles system.

Already deployed and operational system, the Guardium UGV revolutionize the effectiveness and utility of perimeter security and represent a long awaited breakthrough in combat & HLS applications such as:

- Force/Site protection
  - Route proving
  - Observation, detection and surveillance
  - Combat and maneuver support, convoy leader
  - First responding and investigation
  - Logistics support
- 
- Modular combinations of payloads
  - Fix and mobile OCU – Operation Command Unit
  - Simple integration with User's available C<sup>4</sup>I infrastructure
  - **4 modes of operation:**  
tele-operated, semi-autonomous, full autonomy, manned driven
  - High level of safety
  - Obstacle detection and avoidance

The autonomous capability can be modified and integrated in almost any customer vehicle in service.



**Guardium MK I**



**Guardium MK II**



**Guardium MK III**



**AvantGuard MK II**



**HMV**

# DOMINATE THE UNKNOWN



## ROBOTTEAM

14 HaAhim Mislavuta  
Tel Aviv 6701025, Israel  
Tel: 972-3-6870008  
Fax: 972-3-5717327  
E-mail: [info@robo-team.com](mailto:info@robo-team.com)  
Web Site: [www.robo-team.com](http://www.robo-team.com)



### MTGR (Micro Tactical Ground Robot)

The MTGR platform is a unique and robust lightweight, tactical vehicle with high maneuverability in all types of terrains, both indoors and outside. The MTGR system, which includes the MTGR platform, ROCU control unit and relevant payload, is a high-performance system featuring a simple and intuitive control interface.

The MTGR was specially designed to aid military, law enforcement and public safety units in various combat situations around the world. Whether it is for an EOD unit or Special Ops, tactical missions or monitoring public safety - The MTGR dominates the unknown.



### IRIS (Individual Robotic Intelligence System)

The IRIS is an ultra-light weight, fast deployable, extremely ruggedized hand-carried unmanned system. It is designed to support several units such as SWAT Teams, public safety, military and law enforcement. The IRIS can enter small and confined spaces, above or underground, to explore dangerous areas relaying intelligence and reconnaissance information in real time. Using cameras and the microphone, suited for day and night operations, the IRIS operators are able to quickly assess the hazards of dangerous situations from a safe distance, allowing the IRIS to be our first line of defense ahead of human or canine forces.



### PROBOT™ Professional Robot

The PROBOT is the only tactical logistic platform for indoor and outdoor operations. Its unique abilities include carrying heavy payloads while maintaining high speeds, sound maneuverability over various obstacles and performing semi-autonomous missions. It is extremely versatile and can carry up to 550lbs., climb stairs and maneuver directly to a point of interest, even in confined areas, enhancing the capabilities and effectiveness of small ground forces.



### TAC-SA (Tactical Situational Awareness)

Cutting edge Windows and Android based software paired with ruggedized hardware that delivers critical tactical command, control, communication and computers with intelligence, surveillance and reconnaissance (Situation Awareness) capabilities. This unique product integrates with existing systems to shorten the Sensor-to-Shooter Loop, reduce fratricide, civilian casualties, and expedite effective critical response to emergencies.



### ROCU-7 (Ruggedized Operator Control Unit) and ROCU-5

The ROCU-7 (Ruggedized Operator Control Unit - 7" Screen) and ROCU-5 (5" screen) are generic, hand-held, operating units that enable a single operator to control several unmanned systems (land, air or maritime) with one device. The ROCU-7 is Windows 7 based, while the ROCU-5 uses an Android Operation system. Both provide complete operational and tactical control, overall mission management and enhanced force coordination.

#### Main Applications:

- Generic Controller for Land, Air or Maritime Systems
- Mission Management and Full Situational Awareness for Tactical Intelligence (C<sup>4</sup>ISR)
- Real Time Feed for Enhanced Force Coordination



# LAHAV ROBOTICS CENTER



## Center of Excellence & Innovative Robotic Solutions

**LAHAV DIVISION  
MILITARY AIRCRAFT GROUP**  
Israel Aerospace Industries Ltd.  
Ben-Gurion Int'l Airport 7010000, Israel  
Tel: 972-3-9353163, 9358198  
Fax: 972-3-9353687, 9357010  
E-mail: lahav\_marketing@iai.co.il  
Web Site: www.iai.co.il

Lahav's robotics center is at the cutting edge of robotics technology in autonomous navigation, C<sup>4</sup>I, sensor integration, communications, high and low level control, and micro robotics. Lahav's robotics development methodology is integrated with operational experience, creating practical robotic solutions for a wide variety of operational fields and missions.



G-NIUS

*GUARDIUM- Unmanned Patrol System*

### LAHAV's IN-HOUSE ROBOTICS BUILDING BLOCKS:

- World Modeling Technology
- Localization & Navigation Technology
- Command & Control
- Decision Support
- Communication Systems
- Platforms



*REX- Infantry Robotic Porter*

### STAGES IN DEVELOPING SOLUTIONS:

- Operational Needs and Threat Characterization
- Requirements Definition
- Demonstrator Prototype Design
- Integration and Tests
- Demonstration Delivery



*SAHAR- Autonomous CIED System*

### LAHAV EXPERTISE AND SKILLS

- Project Management
- JAUS Standard
- Design & HMI Engineering
- Systems Engineering
- Software/Algorithms Engineering
- Network Engineering
- Mechanical/Electrical Engineering
- Scientists



*Micro Hovering Aerial Vehicles*



C<sup>4</sup>I



## Networking the Power of Intelligence

Today's military networks are not merely transmitting voice communications. They distribute rich information-video, images or dynamic maps empowering effective command and control of combatants, combat support and service support elements across the military network.

Israel's state of the art network-centric applications are supporting such advanced solutions, with open and adaptable services, thus enabling users to implement systems everywhere they are needed-at the command post, inside combat vehicles or on foot.

These solutions span a wide range of sensors, processors and displays presenting command, control, communications and computing, intelligence, surveillance and reconnaissance solutions (C<sup>4</sup>ISR). Innovative communications security and encryption techniques, along with comprehensive cyber defense capabilities complement Israel's C<sup>4</sup>ISR offerings.

Advanced visualization of information in rich, geographically oriented 3D presentation enables commanders to better assess complex situations, and gain battlespace awareness for better decision making, focusing on critical problems and opportunities.

An important foundation of these systems is advanced communications equipment offering more capabilities, higher reliability, and better utilization of the spectrum, at a lower weight and smaller form factor. Israeli companies are fielding the military networks of the 21st century employing the latest locally developed Software Defined Radios (SDR) and ad-hoc networking. Harnessing commercial standards and technologies into systems designed to meet military standard, such networking tools are utilizing terrestrial, satellite and datalink systems to carry voice, data and video over Internet protocol (IP) networks.

In addition, Israeli companies are offering comprehensive sensor-based systems integrating radar, electronic signal intelligence (ESM, ELINT, COMINT), electro-optical, magnetic, acoustic, seismic and more. Designed to support matter experts, these networks provide instant access to all-source intelligence by fusing multiple information sources into an integrated, multi-layered situational picture. These entire systems, from the sensor to the centre, rely on unique Israeli know how and expertise.

# ACCUBEAT LTD.

**A world-leading designer and manufacturer of customized, ruggedized Frequency and Timing solutions.**



**ACCUBEAT LTD.**  
5 Ha'Marpeh St., P.O.Box 45102  
Har Hotzvim Industrial Zone  
Jerusalem 9777405, Israel  
Tel: 972-2-5868330  
Fax: 972-2-5868550  
E-mail: [marketing@accubeat.com](mailto:marketing@accubeat.com)  
Web Site: [www.accubeat.com](http://www.accubeat.com)

**A**ccuBeat is a leading provider of exceedingly accurate Frequency and Timing solutions (Atomic Clocks) suitable for Aerospace, Defense, Telecommunications, Research and other applications. Based on our patented Rubidium Atomic Clock or OCXO (Oven Controlled Crystal Oscillator) technology with optional GPS disciplining, AccuBeat's products achieve the highest levels of accuracy and reliability. Our products and platforms are deployed in sensitive Military and Government programs worldwide and have earned the trust of the IDF, the USAF, Project Galileo and others.

In the commercial field our equipment can be found in Telecommunications equipment, SDH networks, research facilities as well as in calibration and testing solutions worldwide.

AccuBeat provides COTS and customized, ruggedized products and solutions and we work closely with the customer to provide the exact requirements for each project.

AccuBeat's Time and Frequency centers are battle-proven

## Q.A System

AS9100 Rev C  
ISO 9001:2008

## AccuBeat's Product Line

- Rubidium Frequency Standards
- GNSS Disciplined Rubidium/OCXO Time & Frequency Centers
- NTP/PTP Time Servers
- Redundancy Switches & Distributors
- Oven Controlled Crystal Oscillators

## AccuBeat's Leading Products

- **AR133A Product Range**
  - Disciplined Rubidium Frequency Standard
  - Outputs: 10MHz and 1PPS
  - Short term stability:  $<3E-12$  @ 100s
  - The smallest size in the market



in numerous tactical applications, including combat planes, UAVs, transport aircraft, helicopters, ships, missile platforms and ground mobile vehicles.

AccuBeat's products are designed to meet the most stringent MIL STDs, and are essential in environments prone to GPS jamming, spoofing, blocking and EMI interference.

AccuBeat's highly professional and experienced team of managers, PhDs, engineers and technicians provide on-time solutions to all our customers' needs, applying years of know-how and experience to the development and manufacture of the most demanding and most accurate Rubidium based clocks.

*"Fast is fine, but accuracy is everything"*  
(Xenophon, 430-354 BC)

- **AR51A Product Range**

- GPS Disciplined Rubidium Clock
- C/A or P(Y) code, SAASM GPS Receiver
- Frequency Accuracy:  $< 1E-12$
- 1PPS Accuracy: Typ. 20ns (RMS)
- Full MIL-STD

- **AR76A Product Range**

- GPS Disciplined Rubidium Clock
- Frequency Accuracy:  $< 1E-12$
- Multiple Configurable Inputs/Outputs
- IRIG-B, LAN, NTP/PTP, Have Quick, RS-232, 10MHz, 1PPS
- Rack Mounted (1U)



# COMMUNICATION SYSTEMS



## IAI ELTA SYSTEMS LTD.

P.O.Box 330, Ashdod 7710202, Israel  
Tel: 972-8-8572410  
Fax: 972-8-8561872  
E-mail: [market@elta.co.il](mailto:market@elta.co.il)  
Web Site: [www.elta-iai.com](http://www.elta-iai.com)

### Airborne Wideband SATCOM Data Link ELK-1894

The ELTA's ELK-1894 "On-The-Move" SATCOM system is designed to enable bi-directional wideband communications data link for airborne, maritime and ground vehicle platforms typically deployed for government, military or commercial uses.

The mobile terminal is particularly suited for special mission platforms such as Reconnaissance Aircraft, Maritime Patrol Aircraft, Airborne Warning & Control Systems (AWACS), airborne SAR platforms and UAVs.



### TAC4G - Tactical 4G Broadband Cellular Network ELK-1888

The TAC4G military and para-military broadband cellular network is a secure, encrypted and threat-immune, on-the-move multimedia military network. It enables the battle group to present all sensors and human intelligence in the battlefield on a single, accessible and easy to use hand held or other display unit. The system provides an On-The-Move Local 4G LTE Cloud with Backhaul Capability using a compact "Network-in-a-box" unit which can be carried by the individual soldier or in any combat vehicle. The TAC4G provides the combat unit, company or battalion on-the-move advanced broadband multimedia network capabilities.



### SDR - Software Defined Radio ARC 840D

The ARC-840D is a state-of-the-art multi-band, multi-channel Software Defined Radio (SDR) featuring Software Communication Architecture (SCA). The advanced SDR communication system is designed for simultaneous transmission and reception of voice and data, by Line-Of-Sight or Satellite Communications. A growing demand for a wide range of communication applications requiring minimal resources make the ELTA's ARC-840D Software Defined Radio set the perfect solution for today's multi-band communication needs.



### Manpack Tactical SATCOM Terminal ELK-1895

The ELTA ELK-1895 is a lightweight tactical SATCOM terminal, carried and operable by a single soldier. The tactical SATCOM terminal enables communication with all network subscribers within the satellite footprint, by sending and receiving, via a secured communication link - voice, data and compressed video. The ELK-1895 is a tripod mounted, ruggedized, self-contained communication terminal that enables fast SATCOM deployment.

The terminal can be locally or remotely operated through a laptop computer or by a Personal Digital Assistant (PDA).

# COMMUNICATIONS

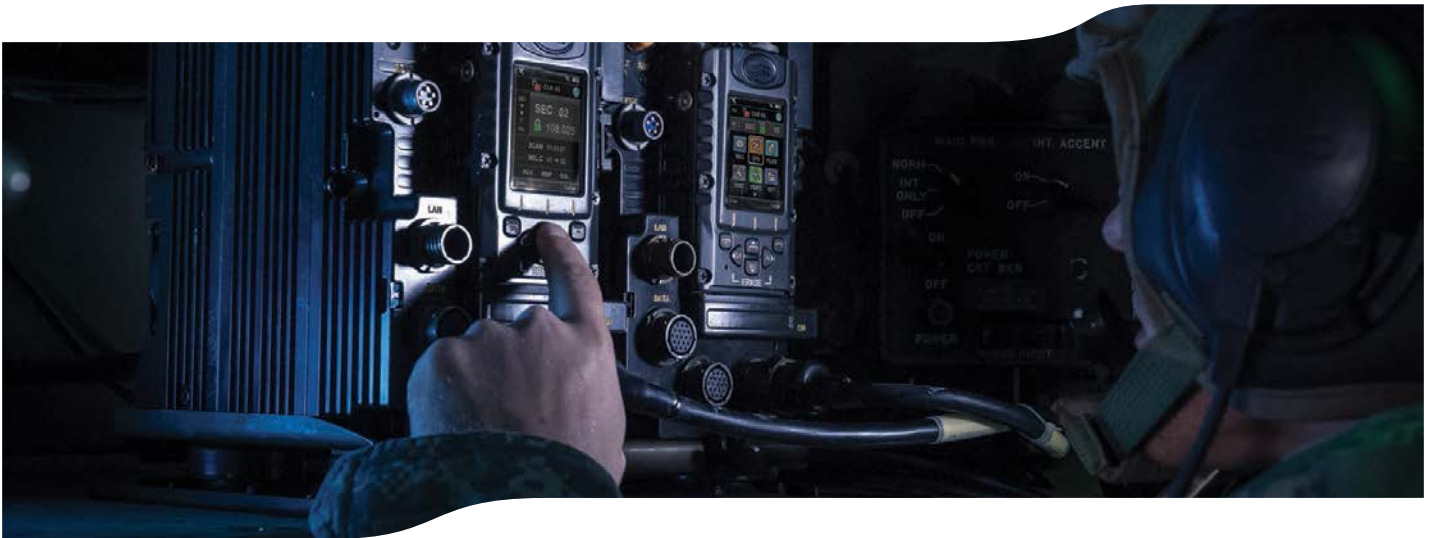

**A complete range of tactical radio, IP and satellite communication solutions that meet the requirements of the individual soldier through to large systems required by HQ.**

## **Military IP Radio (MIPR)**

**Next-generation tactical IP radio delivering high-speed broadband data communications to the battlefield**



The MIPR is a mounted lightweight (4kg) tactical IP radio delivering ultra-high bandwidth (up to 5.5Mbps), real-time high resolution data, voice and video. IP data packets are delivered in accordance with a configurable QoS scheme. The MIPR provides connectivity for dozens of members per network. The system supports a variety of configurations including point-to-point (PtP), point to multipoint (PtMP) and mobile ad-hoc networks (MANET). Information security is assured with cutting edge encryption technology.

## **Tadiran MCTR-7200**

### **Family of tactical software-defined radios offering superior operational versatility for maneuvering platforms and dismounted soldiers**

The Tadiran MCTR-7200 are multi-band and multi-waveform tactical IP radios that feature a uniquely designed software communications architecture, an intuitive user interface and multiple configuration options. This multi-use, single platform contains powerful programmable hardware that offers advanced MANET capabilities along with reliable triple play services - voice, video and data - simultaneously over a single narrowband tactical 25KHz channel as well as high speed data over wideband channels.



## **Tadiran CNR-9000HDR**

### **Multi-adaptive, VHF/FM radio systems for tactical voice and high-speed data communication**

Driven by combat experience and featuring advanced capabilities, the Tadiran CNR-9000HDR is the latest in a line of combat-proven tactical communication systems offering high-speed data in addition to reliable voice communication.



## **Tadiran CNR-9000**

### **Advanced multi-mode VHF/FM COMSEC/ECCM radio systems**

Reliable communications are critical to mission success. The compact and lightweight Tadiran CNR-9000 radio systems feature powerful encryption and ECCM and provide reliable communications even in densely jammed environments. The Tadiran CNR-9000 is available in a variety of manpack and vehicular/fixed station configurations.



# COMMUNICATIONS



## **Tadiran CNR-710MB**

### **Multi-band radio family for multi-mission communications**

An advanced, multi-band, handheld radio, the Tadiran CNR-710MB is ideal for military voice and data communication. Specifically designed to meet the growing demand for versatile and highly-reliable communication in operations involving multiple forces, it provides ground-to-ground, ground-to-air and ground-to-sea communication. Exceptional frequency band coverage and multiple waveforms enable seamless communications among various forces, units and stations, all through a single, handheld radio unit. Available configurations are: Manpack, Vehicular, Base, Marine and Airborne.



## **Tadiran CNR-710**

### **A highly advanced, lightweight handheld VHF/FM voice and data COMSEC/ECCM radio**

The lightest radio in its class, the Tadiran CNR-710 offers robust voice and message security. The radio features advanced capabilities including unique ECCM, powerful error detection and correction codes as well as an innovative user interface.



## **Tadiran HF-8000**

### **Multi-adaptive HF radio systems for continuous long-range communication**

Expanding the traditional boundaries of HF communication, while maintaining user-friendliness and operational efficiency, this HF SSB/2-LSB radio system features cutting-edge technology, ensuring robust and reliable communication even in the harshest battlefield conditions.



### **Tadiran HF-6000**

**Combat-proven, multi-adaptive HF radio system for reliable long-range communication**

Delivering highly advanced HF operations to the modern battlefield, the Tadiran HF-6000 offers advanced COMSEC/ECCM functions to assure reliable HF voice and data operations.



### **Micom-3 Family**

**Field-proven, delivering long-range radio communication in fixed and mobile configurations**

The software-based Micom-3 radios deliver unmatched, cost-effective and reliable HF communication. This comprehensive product portfolio along with many available configurations supports a broad range of communication solutions. The Micom family of transceivers has delivered long-range wireless communication to thousands of organizations worldwide for over 30 years.



### **Tadiran VIC-500**

**Advanced, reliable and customizable digital intercommunication system for fighting vehicles**

An advanced 4<sup>th</sup> generation digital vehicular intercommunication system, meeting the most demanding operational scenarios and easily tailored to specific requirements, the Tadiran VIC-500 offers crew members reliable voice and data communication both inside and outside the vehicle.



### **Tadiran PNR-1000s**

**Lightweight personal network radio (PNR) with automatic voice and data relay**

The Tadiran PNR-1000s IP radio is the ultimate solution for dismounted soldiers. The radio offers 64-member ad-hoc networking including automatic voice and data relay, significantly enhancing the soldier's situational awareness and operational effectiveness. Supporting the full NATO RF spectrum (225-512 MHz), the radio is the lightest of its kind in the market.

# COMMUNICATIONS



## **Tadiran PNR-500**

**Personal network radio (PNR) – tactical conference communication for maximum mission coordination**

Deployed at the platoon or company level, the Tadiran PNR-500 provides voice and data communication over a 1500 meter range. The PNR's light weight, long range and comprehensive set of features are rarely found in similar equipment of its class, making it an important component for effective C<sup>4</sup>I.



## **Tadiran GRC-2000**

**The most advanced line-of-sight frequency hopping, multi-channel, radio relay system in its class**

Providing full-band IV orthogonal fast frequency hopping for simultaneous, interference-free communications, the Tadiran GRC-2000 is field-proven under harsh combat conditions and includes advanced error correction and interleaver to ensure high quality communications.



## **Tadiran GRC-408E**

**High-capacity, multi-interface IP and TDM radio relay**

The latest generation of the high-capacity line-of-sight (HCLOS) broadband radio relay systems, the Tadiran GRC-408E is designed to meet present and future tactical communication requirements. The software-defined radio relay systems support the latest IP and legacy communication protocols. The Tadiran GRC-408E is ECCM-capable, enabling interference-free communication.



### **Tadiran GRX-4000**

#### **Ultra-high capacity, dual-band IP and multi-interface radio relay system for tactical communications**

Featuring simultaneous dual-band and dual-mode operation, the Tadiran GRX-4000 software defined radio (SDR) relay system supports the latest IP and legacy communications protocols. Battle-proven as a high-capacity line-of-sight means of communications, the GRX-4000 offers high-quality, interference-free communications.

### **ELSAT MSR-2000**

#### **Low-Profile, high-throughput military SATCOM on-the-move Antennas**



The ELSAT MSR-2000 series is a family of advanced military SATCOM on-the-move (SOTM) antennas that offer best-in class RF performance to mobile and maneuvering air, sea and ground forces. The antennas support high data rates and deliver seamless broadband satellite communications motion in the most challenging conditions and environments. The antennas are designed to be fully integrated with all types of broadband satellite communication platforms, enabling decision-makers, commanders and field units on the move to maximize C2 effectiveness and situational awareness in real time.



### **IRCS**

#### **Field-proven integrated radio communication system**

IRCS enables all echelons – from high-ranking commanders down to the individual soldier in the field – to directly communicate with anyone in the military network. IRCS facilitates direct communication amongst a broad range of radios and communication devices including VHF, HF and multi-channel radios, LAN, WAN, PABX, satellite and cellular networks.

# COMMUNICATIONS



**ELBIT SYSTEMS  
LAND AND C<sup>4</sup>I LTD.**  
2 Ha'machshev St.,  
Netanya 4250712, Israel  
Tel: 972-9-8898080  
Fax: 972-9-8898231  
E-mail: [landc4i@elbitsystems.com](mailto:landc4i@elbitsystems.com)  
[www.elbitsystems.com/landc4i](http://www.elbitsystems.com/landc4i)



## **Multimedia Routing Solutions**

### **Transforming NCW from concept to reality**

Our routing solutions pave the way for tactical level commanders to enhance situational awareness and collaboration by having access to advanced voice, data and video services. Routing between IP broadband to non-IP narrowband mobile adhoc radio networks creates tactical internet connectivity and interoperability. Our MRS product family comprises a range of versatile tactical multimedia routers (Elbit TMR™ MAX), including TMR™ Core, mTMR™ and TMR™ Max. These solutions enable dismounted soldiers, armored vehicles and deployed command post users to benefit from realtime multimedia information sharing.



## **InterSKY™ 4M**

### **Tactical broadband satellite military communications system**

InterSKY 4M delivers highly reliable, real-time broadband voice, video and data capabilities to static and mobile forces in all weather conditions. Comprised of a central military satellite hub ground station, remote military satellite routers and an advanced management system, the InterSKY 4M is fully interoperable with C<sup>4</sup>I systems and supports both over-the-horizon (OTH) and beyond- line-of-sight (BLOS) two-way communications.



# MISSION-CRITICAL COMMUNICATION SYSTEMS



ORBIT Communication Systems Ltd. is a leading global provider of mission-critical communication solutions for Land, Sea and Air Platforms.

**ORBIT  
COMMUNICATION SYSTEMS LTD.**

8D Hatzoran St., P.O.Box 8657  
New Industrial Zone  
Netanya 4250608, Israel  
Tel: 972-9-8922777  
Fax: 972-9-8855944  
E-mail: info@orbit-cs.com  
Website: www.orbit-cs.com

ORBIT has been fulfilling the communication needs of commercial, defense and government customers for more than 60 years. Its advanced solutions support applications in the areas of Mobile Satellite Communications, Communication Management Systems, Aeronautical Telemetry, UAV Command & Control LOS and B-LOS, Satellite Tracking (GEO and non-GEO) and Earth Observation (LEO and MEO). ORBIT's international network of sales/customer support and technical service centers covers the United States, Europe, Brazil and the Far East.

## ORBIT's portfolio includes:



### Mobile SatCom Systems and Services

ORBIT's Mobile Satellite Communication solutions consist of stabilized broadband antennas (VSAT) for continuous communications with moving platforms.

These proven systems are deployed on thousands of marine vessels and platforms, trains and aircrafts. ORBIT's Mobile SatCom systems empower the broadband infrastructure required for critical services and applications, including global Internet connectivity for voice, video and data.

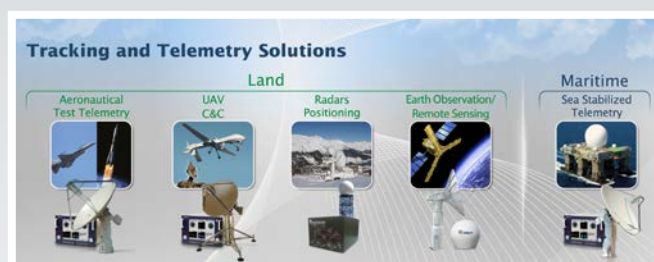

### Tracking & Telemetry

ORBIT's Tracking & Telemetry systems enable uninterrupted communication from static and moving platforms to a moving target. These systems are used for flight telemetry in aircraft, missile testing, UAV C&C, LEO/MEO satellite ground stations and data download.

ORBIT's highly dynamic digital tracking systems deliver pinpoint accuracy under extreme weather and environmental conditions. Supporting antennas from 1-11 meters (3-36 ft) and featuring breakthrough multi-band feed technology, ORBIT's solutions reduce CAPEX and the need to maintain multiple tracking systems.

### Communication Management Systems

ORBIT provides innovative digital Communication Management Systems for airborne, maritime and ground platforms.

These solutions include audio, video and network based systems and applications that enable seamless internal and external communication.

ORBIT's CMS solutions meet the most demanding requirements for flexible and secure audio and video management systems, and are customized to comply with each customer's needs.

# COMMUNICATION SURVIVABILITY

*Tactical communication  
under extreme conditions*



**PERYPHON DEVELOPMENT LTD.**  
23 Hamelacha St., New Industrial Park,  
Rosh-Haayin 4809173, Israel  
Tel: 972-3-9025682  
Fax: 972-3-9025684  
E-mail: sales@peryphton-dev.com  
Web Site: www.peryphon-dev.com



For more than three decades, Peryphon Development Ltd has been a leading provider of communication solutions handling tactical challenges. At Peryphon Development, we guarantee to support you from the operational requirements analysis, through designing and planning, to production of our qualified state-of-the-art products.

Peryphon specializes in three main aspects of communications equipment:

- ▶ **Endurance and survivability:** our field-proven solutions are designed upon our ability to create rugged telecommunication products suitable for extreme conditions. Our engineering and R&D professionals focus on the product housing and its durability, enabling our products to pass any types of MIL-STD test. Our ruggedized product set includes routers, switches, and gateways, both COTS or tailored to your needs.
- ▶ **Tactical communications:** Peryphon's products cover all types of operational communications, including naval, aerial and ground vehicles intercommunication platforms and field telephony. We comply with any type of network from analog to VoIP, for a personal use or any size of team.
- ▶ **Solving the noise obstacle:** we gained vast experience handling extreme noise conditions with our versatile set of solutions. Our audio accessories include a large variety of headsets, handsets, loudspeakers and unique solutions, which are integrated with our innovative ANR developments. Our solutions handle extremely noisy (110-130 dB) environments, such as helicopter rotors, engine rooms, runways and other locations with loud monotonic noise, flexible to allow the use with wireline or wireless means, and for any amount of people.

Our professionals combine engineering know-how with hands-on military expertise, enabling us to offer both off-the-shelf and customized tactical communication solutions to match your needs.

# SOURCE OF SOUND

## Leading Military Communication



### SOURCE OF SOUND LTD.

P.O.Box 8628, 19 Yad-Harutzim St.,  
Netanya 4250519, Israel  
Tel: 972-9-8658370  
Fax: 972-9-8658373  
E-mail: [sos@s-o-s.co.il](mailto:sos@s-o-s.co.il)  
Web Site: [www.s-o-s.co.il](http://www.s-o-s.co.il)

## 24 / 7 Combat Proven

### MAIN ACTIVITIES - ARMY AND SECURITY AUDIO ACCESSORIES

Communication supplier to IDF ground forces and provider to US army, Special Forces, Marines, FBI and many more.

Manufacture of combat proven ruggedized headsets for communication in:

- Combat
- CBRN
- Submersible Maritime Headsets
- Security-Covert and VIP guard operations
- Extreme noise with Ear protection



### COMBAT HEADSETS

Waterproof, combat proven and reliable headsets in ruthless conditions. Helmet clip attachment or headband wear with ear tip option in both configurations. Feature fast adaptation character in ever-changing warfare situations.



### IN EAR NOISE REDUCTION HEADSETS

#### Clarus- Smart Tactical in-ear headsets system designed for infantry.

Keeping active noise reduction, comprehension in high noise and impulse noise protection.

Enhanced hearing and sound localization while keeping full situational awareness. Support full duplex radio. Dual radio capabilities.

Clarus can be also used by: Special forces, Infantry, Military heavy vehicles crew, Artillery etc.



### MARITIME DEEP WATER HEADSETS

Unique low weight headsets which endure water pressures of more than 20 m.

SOS radio Bags which convert hand held radios of any size, into deep-water items.

### SECURITY

VIP guards and miniaturized Secret hidden Communication including digital wireless miniaturized earphones.

# MILITARY GRADE SWITCHES, ROUTERS & REDUCED SWaP ETHERNET COMMUNICATION DEVICES



## TECHAYA

P.O.Box 1500  
Pardes-Hanna 3711401, Israel  
Tel: 972-4-6377741  
Fax: 972-4-6377761  
E-mail: [info@techaya.com](mailto:info@techaya.com)  
Web Site: [www.techaya.com](http://www.techaya.com)



### Tri-Service Communications Devices - Off-the-Shelf or Tailor-Made

TECHAYA is a leading designer, developer and manufacturer of rugged MIL-STD communications solutions for ground, air and naval applications with the lowest SWaP in the industry. Designed specifically for harsh environments TECHAYA's products have been widely adopted and are operational in many programs throughout the world including dismounted soldiers, unmanned systems both large and small, fixed and rotary aircraft, AFVs, missiles and naval vessels. TECHAYA's rugged communications systems are perfect for any application involving extreme conditions and ultra-small mechanical constraints.

TECHAYA provides high-performing COTS Ethernet switches (managed and unmanaged), USB systems, media converters, routers and more. In addition to their off-the-shelf offering, TECHAYA is also capable of adapting and customizing its products to meet to customer's specifications. AS9100C certified.

### The smallest products of its kind

In the defense market, where reduction of size and weight of platforms and systems is top priority, TECHAYA's solutions are the most compact solutions of its kind, allowing for the integration of cutting-edge communications capabilities in the smallest of platforms and systems.

### Ethernet Switch and a Computer - All-in-One

Applicable for every C4ISR system and devices on the battlefield, TECHAYA's unique MILTECH 9012X rugged military 1G router combines full- featured L2/L3 network switching and routing with a fully programmable Linux-based computer – all in a single, super-compact device. Providing unprecedented communications and computing capabilities, the device can transmit voice, video and sensor data, as well as integrate networking and vehicle management software, unique encryption and security measures and robotic limb control using JAUS.

The 9012X is a member of the MILTECH 9012 family that offers flexible alternatives for LAN, LAN/WAN, and customizable networking. All family members are MIL-STD, fully managed, and military grade, with 12 triple-speed (10/100/1000Mbps) ports.



# COMPREHENSIVE C<sup>4</sup>ISR SOLUTIONS

**Elbit Systems**

EW and SIGINT - Elisra

**ELBIT SYSTEMS  
EW & SIGINT - ELISRA LTD.**

48 Mivtza Kadash St.,  
Bene Beraq 5121701, Israel  
Tel: 972-3-6179798  
Fax: 972-3-6175880  
E-mail: ew-sigint@elbitsystems.com  
Web Site: www.elbitsystems.com

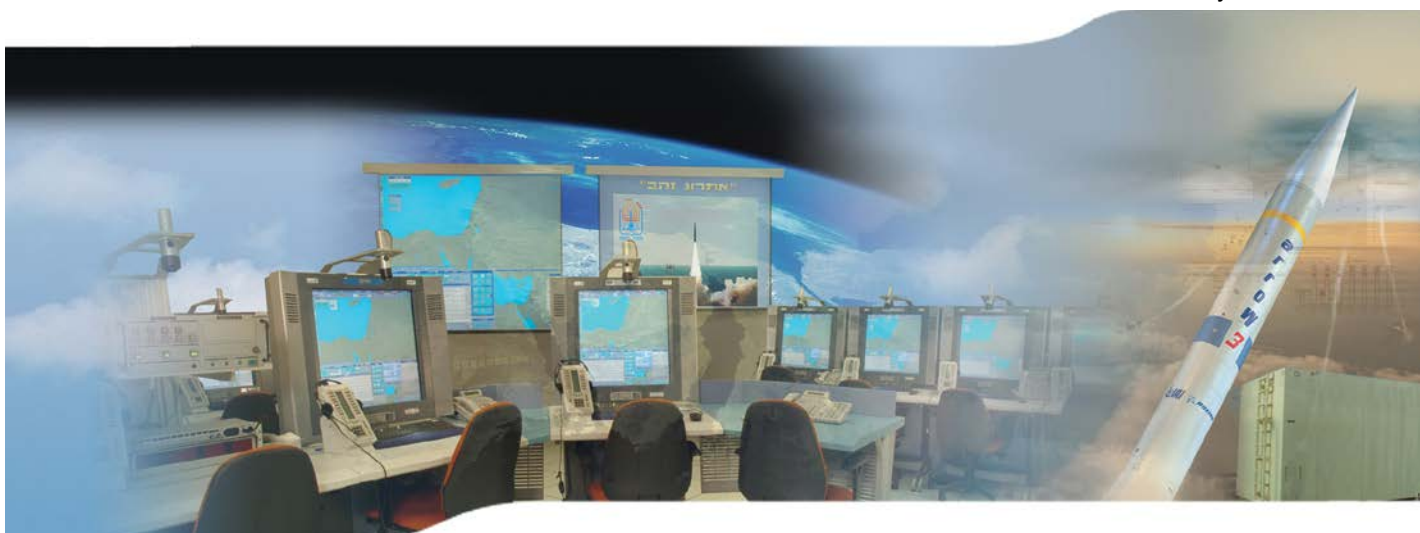

Elbit Systems EW and SIGINT-Elisra's **Net-Centric C<sup>4</sup>ISR solutions** provide a comprehensive line of operations support and intelligence applications, creating a horizontal operational arena that supports top down and bottom-up intelligence gathering, management and distribution. The C<sup>4</sup>ISR solutions maximize firepower, increase survivability and generate an accurate real-time situation picture in both traditional High Intensity Conflicts (HIC), as well as asymmetric Low Intensity Conflicts (LIC).

**BMD - a Family of advanced Ballistic Missile Defense solutions** - based on more than two decade of experience in the development of missile defense systems, the company has achieved field-proven expertise and technological superiority of Ballistic Missile Defense Command, Control, Battle Management, Communications, Fire Control, Simulation and Training solutions. The company is the prime contractor for major BMD programs, including the Israel National Upper Tier and Lower Tier BMD Command, Control, Battle Management, and Communications (C<sup>2</sup>BMC) Centers; the Arrow Weapon System's (AWS) and the David's Sling Weapon System's Fire Control Centers; and the Israel BMD Battle Lab.

**DACCS and Bombard** artillery command and control systems are ideal for divisional and battalion-level fire support operations. All facets of the fire process are supported, resulting with a sensor-to-shooter short time response and with a high precision and effective fire process.

**TIVT - A Family of Tactical Intelligence, Video, and Telemetry systems** (TIVT) meets the need for a real-time situational awareness and intelligence gathering for tactical units. Bringing

on-the-spot the information from the sensor directly to the warfighter, the TIVT systems are enabling the forces to act independently.

**AMTS** is an **Active Man-Pack Transceiving System** - an active control unit optimized for controlling airborne and ground sensors, such as EO and FLIR payloads, without compromising flight safety. Via an RF link, AMTS remotely provides a real-time unified Situation Awareness picture enables reconnaissance, surveillance, target acquisition, and fire adjustment.

The latest generation **MRS-2000M** is an all-digital, ruggedized, transportable intelligence system for precise, 3-D situation awareness picture build-up of the battlefield, providing an "over-the-hill" view of the enemy while avoiding danger of exposure. By bringing mission-critical information to the front, the MRS enables all armed forces to make the most of real-time information while assuring greater accuracy and safety.

**Real Time Data Link Communications** - advanced, field-proven, fourth generation wireless communications systems designed for deployment onboard all airborne platform types, including tactical and micro/mini-UAS. These comprehensive video and data networking solutions correspond with all modern payload systems, providing high-rate digital and analog data communications, enabling the download and dissemination of real-time video and telemetry directly to ground, airborne and naval forces.



MRS- 2000M™

# C<sup>4</sup>I

## Systems and Solutions

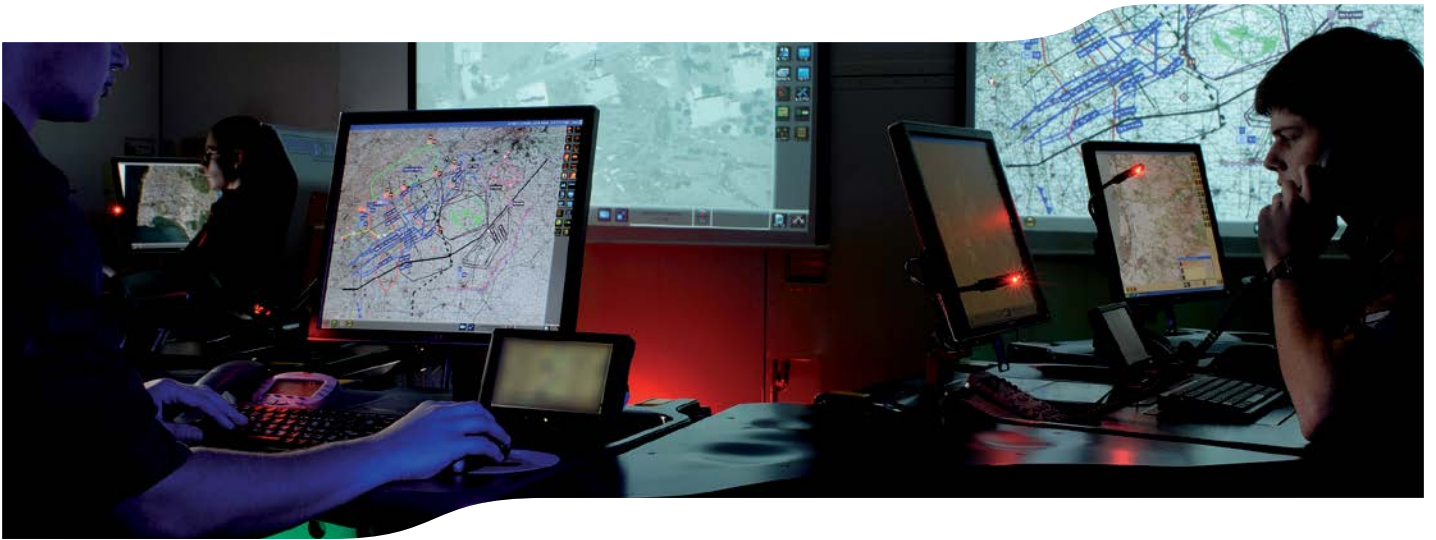

A major supplier of command, control, communication, computers and intelligence (C<sup>4</sup>I) systems, delivering mission-critical information and situational awareness to all levels of command.

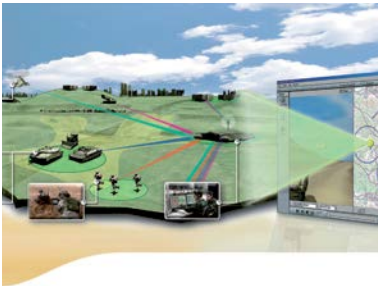

### C<sup>4</sup>ISTAR

A powerful force multiplier, C<sup>4</sup>ISTAR connects and coordinates all land, air, and sea forces - from the highest echelon HQs to the individual platform, sensor and soldier. C<sup>4</sup>ISTAR implements advanced combat concepts that increase operational effectiveness and connectivity throughout all echelons - in all combat situations - under a unified operational doctrine.

Elbit Systems Land and C<sup>4</sup>I is the lead system integrator behind the development and integration of the world's first fully deployed and operational C<sup>4</sup>ISTAR system in the Israeli Defence Forces - The Digital Army Program (DAP).



### Combat-NG

Fire control and command solutions for artillery and air defense enable accurate delivery of lethal firepower.

With vastly enhanced C<sup>2</sup> capabilities, Combat-NG improves the artillery forces' ability to destroy and degrade enemy targets. Combat-NG integrates advanced C<sup>2</sup> applications, tactical computers, FCS, advanced radio communication.



## **WINBMS**

### **Advanced networked battle management**

Integrating the entire sensor-to-shooter loop, WINBMS (Weapon-Integrated Battle Management System) enables real-time coordination between fighting vehicles, thereby providing universal situational awareness, in-depth collaborative mission, planning and management, and a continuously updated common operational picture.



## **ELBIT TIGER™**

### **Tactical Intranet Geographic dissemination in Real-time**

This powerful information grid delivers relevant data instantly, with optimum message transfer flow and guaranteed delivery. This state-of-the-art tactical communication system is based on the company's in depth knowledge of real battlefield conditions. Harnessing the entire infrastructure and integrating all communication media including legacy narrow-band channels, TIGER creates an end-to-end, unified, flexible, and continuously learning Intranet.



## **TORC<sup>2</sup>H™**

### **All-in-one C<sup>4</sup>I system**

covers all army branches and echelons, enabling universal situational awareness as well as in-depth collaborative mission planning and management based on real-time information, and an always-updated common operational picture. TORC<sup>2</sup>H is the only C<sup>4</sup>I solution to be fully deployed and operational in a major military organization, the IDF.



## **Infantry Combat Systems (DOMINATOR™)**

An integrated infantry combat system enabling full situational awareness from the infantry battalion level down to the individual soldier. DOMINATOR dramatically shortens the sensor-to-shooter loop, enhancing the combat effectiveness of the dismounted soldier.

# TACTICAL COMPUTERS

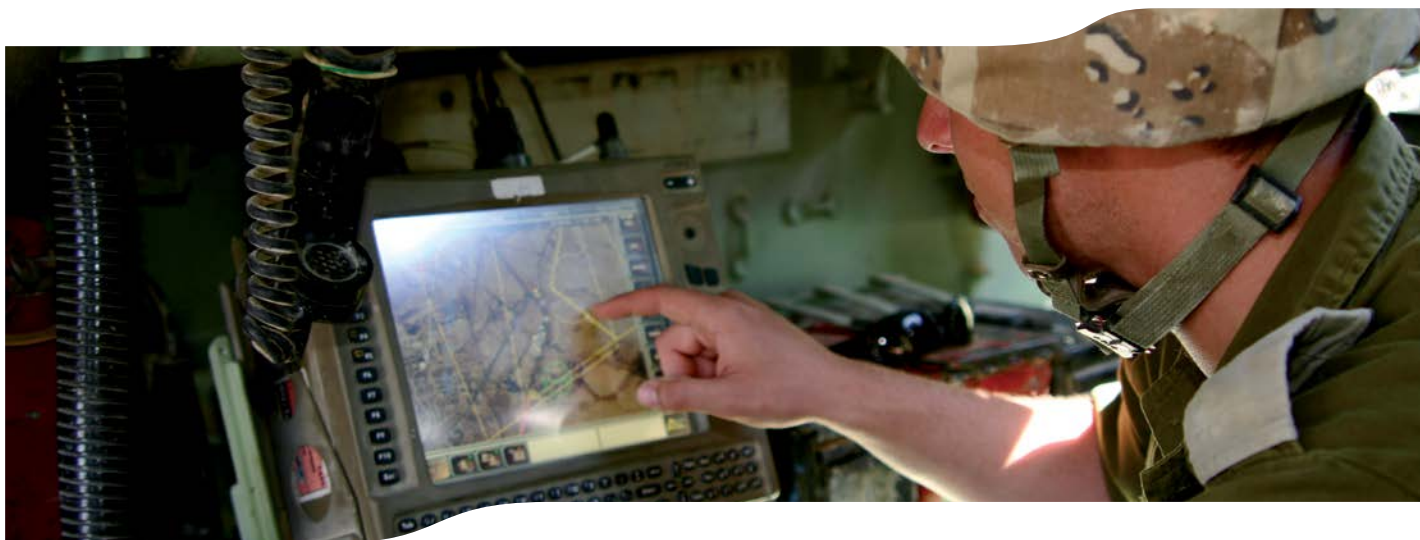

A range of versatile, rugged and battle-proven tactical computers and displays, delivering C<sup>4</sup>I applications to the modern battlefield.



## Enhanced Tactical Computers (ETC)

Ultra rugged, battle-proven, high-performance tactical computing for combat vehicles

Providing state-of-the-art C<sup>4</sup>I capabilities and tactical data dissemination to a broad range of combat, command and reconnaissance vehicles. Designed for success in the harshest conditions, this versatile range of tactical computers is fully battle-proven and currently in use by numerous armed forces around the world.



## Ground Smart Display Unit (GSDU)

Multi-function C<sup>4</sup>I display unit

A high-brightness display unit supporting multiple video formats.

Featuring a customizable front panel, the GSDU is fully ruggedized and compliant with all relevant military standards.





## **TACTER™-31D**

**Versatile tactical computer in a tablet configuration supporting both vehicle mounted and dismounted applications**

An indispensable C<sup>4</sup>I tool for the digital battlefield, ensuring complete continuity across vehicle mounted and dismounted applications. Designed with flexibility in mind, the TACTER-31D's unique vehicular docking station and latch enable seamless operation both in and out of vehicle.

The lightweight tablet configuration and integrated handle allow the unit to be quickly and easily transported.

# **mPrest SYSTEMS - A LEADING SOLUTION AND PLATFORM PROVIDERS FOR C4I SYSTEMS**



## **mPREST SYSTEMS LTD.**

Azorim Park, Kiriat Arie  
94 Em-Hamoshavot Rd. P.O.Box 3027  
Petach-Tikva 4970602, Israel  
Tel: 972-7-3216666  
Fax: 972-7-3216636  
E-mail: [marketing@mprest.com](mailto:marketing@mprest.com)  
Web Site: [www.mprest.com](http://www.mprest.com)

- mPrest serves as a leading C&C system house
- mPrest is a subsidiary of RAFAEL
- Providing “Game-changing Technology” - offering Users and Defense Integrators **new exciting business possibilities**
- mPrest developed a unique generic C&C platform. Which allows:
  - reducing development time while increasing system reliability and reducing project risks
  - making it easier to connect weapons & sensors
  - Adaptive Solution and modular Connectivity
  - Scalable, Integrated and Interoperable Solutions
- Utilizing a flexible and generic Application platform
- Field proven capabilities: Iron Dome and much more
- Commonality of defense applications: National C4I, BMS, Air Defense, Maritime C2, Ground C4I, Intelligence, Training and Simulators



## Rafael Provides Communication Products that Includes Data Link, Airborne Relay Systems, Communication Networks & Voice Radio

**RAFAEL**  
**ADVANCED DEFENSE SYSTEMS**  
P.O.Box 2250 (19)  
Haifa 3102102, Israel  
Tel: 972-73-3354714  
Fax: 972-73-3354657  
E-mail: intl-mkt@rafael.co.il  
Web Site: www.rafael.co.il

### DLV-53 MFTM - ISTAR Wideband Data Link

- Ultra Wide Band data-link providing communication solutions for UAVs/ USVs/ UGVs & Airborne Reconnaissance pod systems
- Use of a single, small & light - weight unit for PTP LOS/SatCom, one hop LOS Relay & CAS waveforms simultaneously
- Supports data rates from 200Kb/s to 274 Mb/s - selectable from the Ground Station
- Growth capability up to 548Mbps without HW change
- Full spectrum support (L, S, C, X, Ku, MMW), highly immune
- Seamless secured connection between standard Airborne IP LAN and Ground IP LAN over a Gigabit WAN

### BNET - Broadband MANET IP Software Defined Radio

- Ultra high data rate software defined radio (SDR)
- Tactical Voice, Video & Data on the move
- Mobile Ad-hoc network (MANET)
- Unique spectral efficiency features
- IP Radio
- Immune and secured
- Vehicular and hand-held formations

### TACMAX - Tactical 4G Cellular Broadband Network for Ground Forces

- Fast deployable
- Secured and immune
- Soldier and vehicle radio
- Up to 45 Mbps per cell
- Mesh capability
- Standard IP backhaul



### RAVNET 300 - Airborne Voice & Data Communication Radio Network

- Air-to-Air, Air-to-Ground, instantaneous high data rate
- Highly advanced Voice & Data Networks
- High Availability: Long range communication, auto relay via multi hops
- High efficiency utilization of V/UHF spectrum
- Legacy radios support for practical evolution
- Field proven in Israeli IAF



### AIR STAR - Multi-Sensor Aerostat based system for Extended ISR

- The most advanced field proven Aerostat based ISR system
- Expands early warning and surveillance capabilities
- Supports air dominance
- Consists of multiple sensors: Radar, ELINT, COMINT & Receivers/Transmitters
- Communication to Command and Control & to Targets Interceptors
- High availability



**RAFAEL**  
**ADVANCED DEFENSE SYSTEMS**  
 P.O.Box 2250 (19)  
 Haifa 3102102, Israel  
 Tel: 972-73-3354714  
 Fax: 972-73-3354657  
 E-mail: intl-mkt@rafael.co.il  
 Web Site: www.rafael.co.il

■ **DEEP LINK - Low Probability of Intercept Acoustic Communication Network**

DeepLink's dimensions enable the system to be carried by small underwater vehicles or divers.

Using CDMA communication with MIMO (Multi-Input, multi-Output) techniques, DEEPLINK overcomes.

The multipath interferences of the UWAC, ensuring high reliability in various environments such as deep Water, shallow water, harbors and etc. DEEPLINK is designed as an ad-hoc network including a multi-hop mechanism. Both built-in message distribution protection and multi-hop mechanisms increase the reliability of the network and the connectivity between nodes, providing solution for non-line-of-sight scenarios.

DEEPLINK supports both SMS and navigational control messages, allowing the user to create his own Mission status. Each node contains a user interface which includes virtual keyboard (for SMS writing), navigation system and network display.



■ **SEA-COM - IP/VoIP Shipborne Communication System**

Sea-Com provides a full, modular, IP based Naval Ships & Submarines communication suite. Full integrates internal communication: voice, data, video & external communication Systems: HF, V/UHF and Satcom. Easy mission planning & allocation of the ships radio and antenna Distributed architecture provides high availability & scalability Meets harsh naval environmental conditions.



# MIC<sup>4</sup>AD



**RAFAEL  
ADVANCED DEFENSE SYSTEMS**

P.O.Box 2250 (19)  
Haifa 3102102, Israel  
Tel: 972-73-3354714  
Fax: 972-73-3354657  
E-mail: [intl-mkt@rafael.co.il](mailto:intl-mkt@rafael.co.il)  
Web Site: [www.rafael.co.il](http://www.rafael.co.il)

MIC<sup>4</sup>AD is an advanced, unified, integrated C<sup>4</sup>I system that commands and controls the operation of both air and missile defense, including air-superiority missions. MIC<sup>4</sup>AD provides a total solution for multi-system, multi-layer and multi-range air and missile defense, traditionally operated as separate commands.

MIC<sup>4</sup>AD correlates real-time data from distributed sensors/platforms (radars, IFF system, data links, electro-optics), all connected to the air traffic control picture and mission planning system. The data is analyzed to deliver a real-time, coherent national Air Situation Picture (ASP).

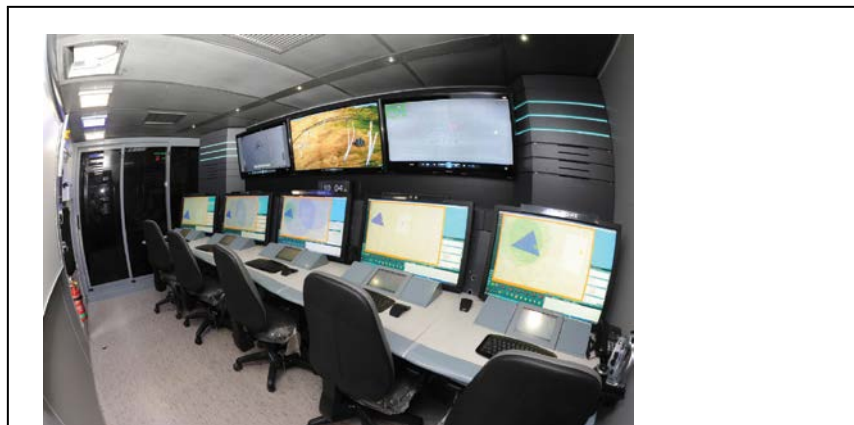

Simultaneously, MIC<sup>4</sup>AD performs threat assessment and hostile target classification, generating an interception plan for threats at any command level (national, regional, tactical). MIC<sup>4</sup>AD optimizes resource management and swiftly allocates the most appropriate defense system, such as SPYDER, David's Sling, Iron Dome or other customer systems to the type of challenge. Response includes target allocation to weapon systems (TAWA - Threat Assessment Weapon Allocation) with full, semi-automatic or manual fire control according to customer doctrine.

MIC<sup>4</sup>AD open, modular architecture can be adapted to customer operational needs. The system can be integrated with a customer's existing or future air and missile defenses. This flexibility allows incorporating new technologies and systems with the existing arrangement. MIC<sup>4</sup>AD can serve as an add-on to the customer's current C<sup>4</sup>I setup, or replace existing systems entirely.

Highly automated, easy-to-use and with advanced interactive displays, MIC<sup>4</sup>AD is a true force-multiplier. Enabling unified command and fire control of multiple air and missile defense systems, MIC<sup>4</sup>AD delivers multi-mission, multi-layer and multi-range C<sup>4</sup>I capabilities that ensure end-to-end air and missile protection.

# TSG IT ADVANCED SYSTEMS LTD.



## TSG

P.O.Box 58180  
Tel Aviv 6158101, Israel  
Tel: 972-3-5483518  
Fax: 972-3-5483700  
E-mail: [tsg@ness.com](mailto:tsg@ness.com)  
Web Site: [www.nesstsg.com](http://www.nesstsg.com)

## C4i Solutions

TSG is a global company, held by Ness, specializing in integration of advanced Command & Control solutions for real-time military and civilian defense, Homeland Security and Telecom applications.

TSG has a dedicated team of multidisciplinary professionals with expertise in system definition and design, system engineering, algorithm development and hardware/software integration. With over four decades of experience, TSG covers a range of fields including C4i, Telecom, Data Fusion, image processing, video transmission, and IP communication.

TSG maintain a diverse international client base of armed forces and defense establishment, organizations and enterprises. Since 1969, TSG has served as a strategic partner of the IDF,

strengthening the IDF's operational advantage by implementing innovative solutions tailored to its unique needs.

TSG offers sophisticated and innovative command and control systems that support military and civilian sectors on land, air and sea.

TSG provide a variety of Command & Control solutions ranging from strategic battlefield management to tactical and special operations force as well as Maritime and Air Defense C<sup>2</sup>. TSG solutions combines advanced Intelligence and communication capabilities providing our customers with all-inclusive solutions.

**TSG systems are field proven and used by military forces, security services and public safety organizations worldwide.**



# ***Xi INFORMATION PROCESSING SYSTEMS***

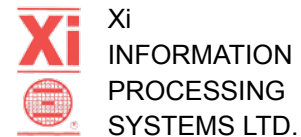

## **Xi INFORMATION PROCESSING SYSTEMS LTD.**

P.O.Box 60  
Savyon 5691501, Israel  
Tel: 972-3-9215891  
Fax: 972-3-5343520  
E-mail: Xi00001@XiSysCorp.com

**X**i is a privately owned company established in 1968. Xi develops geo-referenced systems for defense, homeland security and commercial applications. Main line of products include; command and control, wireless site security access control, remote monitoring and tracking in real time, incorporating multiple sensors terminals. Xi products developed for defense applications particularly for UAV's (Unmanned Aerial Vehicles) and RADAR's were deployed by numerous defenses forces and are field and battle proven.

Xi offers a family of Location Based products and solutions for mobile and security applications; real time command and control, management, tracking and monitoring, guiding and navigation.



**Xi Mobilinx® C4I**



**Xi Hand held Terminals  
Touch screens, 7" and 5"**

### **Among Xi products are:**

- XiPac - Site security wireless access monitoring and control. Integrated LPR (License Plate Recognition)
- Mobilinx® - Geo-Referenced Security Command and Control and management system.
- Pathmarker® AVL - Automatic Vehicle Location system. Pathmarker® AVL system offers real time vehicle and assets monitoring and tracking for variety of applications; fleet management, field operations management and assets management.
- SecurePath™ - Security system. SecuerPath is a geo-referenced wireless security solution enabling real time monitoring of remote sensors, stationary and mobile
- TrainTrack™ - Train cars monitoring and security system
- Nav X info™ - Hybrid navigation system for rural and urban areas navigation on hand held PND's, tablets and desktop computers.

# INTELLIGENCE



**ELBIT SYSTEMS**  
**ELECTRO-OPTICS - ELOP LTD.**  
P.O.Box 1165,  
Rehovot 7611101, Israel  
Tel: 972-8-9386211  
Fax: 972-8-9386010  
Web Site: [www.elbitsystems.com/elop](http://www.elbitsystems.com/elop)



Converting data to intelligence, by enabling personnel to gather, research, comprehend and analyze intelligence data at a multifaceted level.



## **WiT™** **(Wise Intelligence Technology)**

**Technology solutions supporting organizational doctrine and improving the intelligence process**

A comprehensive end-to-end solution for intelligence organizations, WiT™ addresses all phases of the intelligence process including the reception, adaption and conversion of intelligence data from multiple sources as well as processing and disseminating intelligence reports. Fully customizable, WiT™ is one of the few intelligence solutions to be field-proven and fully operational.



## **ICE** **Comprehensive, multi-sensor, field-proven imagery intelligence solution**

A field-proven solution addressing the operational imagery intelligence (IMINT) requirements of numerous armed forces around the world. ICE provides a solution for every phase of the IMINT operational cycle. ICE is sensor independent and can be customized to a specific operational doctrine. ICE's scalable architecture enables seamless implementation of additional sensors and rapid modification of the mission planning and monitoring process.



# UNATTENDED GROUND SENSORS (UGS)



**ELBIT SYSTEMS  
LAND AND C4I LTD.**  
2 Ha'machshev St.,  
Netanya 4250712, Israel  
Tel: 972-9-8898080  
Fax: 972-9-8898231  
E-mail: [landc4i@elbitsystems.com](mailto:landc4i@elbitsystems.com)  
[www.elbitsystems.com/landc4i](http://www.elbitsystems.com/landc4i)



## Unattended Ground Sensors (UGS)

Elbit Systems' TREASURES™ (Tactical Reconnaissance and Surveillance Enhanced System) is a comprehensive system of UGS that enables detection, tracking and identification of human and vehicular targets. Using advanced algorithms and unique communications protocols, the system offers a high probability of detection (PD) and low false alarm rates (FAR). Other UGS for border control and perimeter protection include SAND, which is designed for real-time target tracking using an array of seismic UGS, and TALOS™ Unattended Ground Radar, which is designed for continuous operation using solar energy. The UGS systems easily integrate with existing UGS and are compatible with any C4I system.



# RICENT - REAL-TIME IMAGERY INTELLIGENCE CENTER



**IAI ELTA SYSTEMS LTD.**

P.O.Box 330, Ashdod 7710202, Israel  
Tel: 972-8-8572410  
Fax: 972-8-8561872  
E-mail: [market@elta.co.il](mailto:market@elta.co.il)  
Web Site: [www.elta-iai.com](http://www.elta-iai.com)

## RICent - Real Time Imagery Intelligence Center ELS-8994RT

The ELTA RICent ELS-8994RT is a modular, end-to-end, comprehensive solution for Intelligence, Surveillance and Reconnaissance (ISR) requirements, from Imagery Acquisition to Image Intelligence (IMINT) dissemination. The system is designed to produce all-weather IMINT, 24 hours a day, by real-time processing and integration of the images delivered through a variety of space, airborne and ground based IMINT sensors, such as Electro-Optical sensors (E/O), Infra-Red sensors (IR), Video, Synthetic Aperture Radar (SAR) and Ground Moving Target Indication (GMTI). The exploitation and dissemination processes employ a variety of automatic and semi-automatic tools necessary for quick detection, identification and acquisition of time critical targets. RICent's modularity and open architecture design allows for a wide range of implementation solutions, ranging from a single stand alone tactical station to a whole network based hub serving as either a regional or national strategic IMINT center. The RICent employs ELTA's field-proven technologies and experience in signal and image processing and analysis and features Multi-Sensor Support, Automatic Imagery Geo-referencing, IMINT Data Fusion and Interpretation, On-the-fly Mosaic, Dynamic 3D and Stereo Display, and Intelligence Production Management.

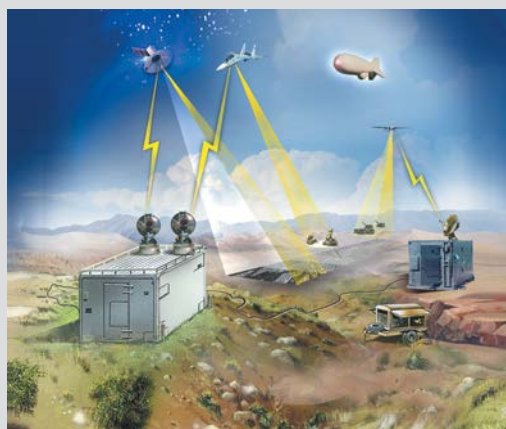

*Imagery Acquisition*

## RICent/VEX Video Exploitation System ELS-8994 VEX

The RICent VEX Video Exploitation System transforms Airborne platforms' sensor video, especially UAV's, into a significant source for geospatial intelligence used in a network-centric environment.

The RICent Vex is designed to be easily incorporated and integrated into existing Ground Stations enabling advanced video archiving and advanced geospatial exploitation, for immediate correlation and cross sensor cueing with other sources and sensors. In addition, geo-referenced annotation on dynamic video and video mosaics allow for advanced reporting and updated production of relevant imagery data. The system features multi-channel recording, real time VOD services, multi-dimensional indexing – both temporal and spatial, and near real-time video mosaic.

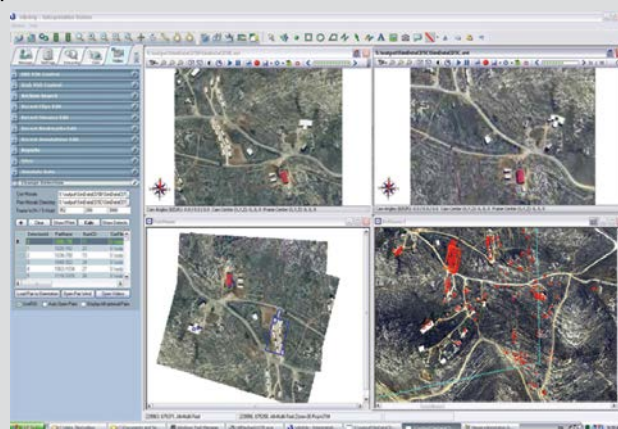

*Video Exploitation*



*Geo-Mosaic*

# SIGINT SYSTEMS



## IAI ELTA SYSTEMS LTD.

P.O.Box 330, Ashdod 7710202, Israel  
Tel: 972-8-8572410  
Fax: 972-8-8561872  
E-mail: [market@elta.co.il](mailto:market@elta.co.il)  
Web Site: [www.elta-iai.com](http://www.elta-iai.com)

### AISIS - Airborne Integrated SIGINT System ELI-3001

The ELTA AISIS ELI-3001 is a multi-platform, multi-role Airborne Integrated Signal Intelligence System. The main purpose of the system is to build-up a real-time Electronic Order of Battle (EOB) picture, and to provide valuable tactical and strategical intelligence which can be seamlessly integrated into the nation's intelligence database. As a secondary mission, part of the airborne segment of the system can be converted into an Airborne Command and Control Center (ACC). The system is designed to cope with the challenges of modern dense non-communication (mostly radars), and communication network environments.

The AISIS performs long-range, high endurance SIGINT missions. The system's tasks are to search, intercept, measure, locate, analyze, classify and monitor ground, airborne and naval transmissions, characterized by short duration, a variety of signal types and frequent changes in signal parameters.



### ELINT Ground System ELL-8382/5

ELTA's ELINT Ground Station receives and analyses all radar type signals within the 0.5-18GHz frequency range. It is designed to operate in a dense electromagnetic environment by combining high sensitivity and high probability of interception. The instantaneous Direction of Arrival measurement is based on DTOA DF Technology. The Ground Station can be remote-operated by a Central Control Station.

### COMINT Ground System ELK-7036

ELTA's COMINT System meets the operational challenges of dense communication environments. It searches, acquires and monitors emissions - even those characterized by short transmissions and frequent changes in network parameters over the 20 to 3000 MHz frequency range. The Ground Station can be remote-operated by a Central Control Station.

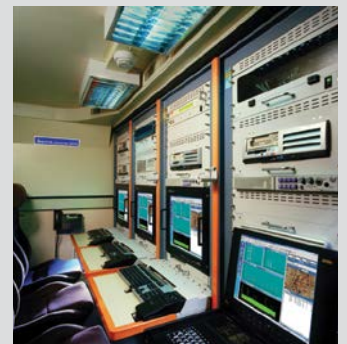
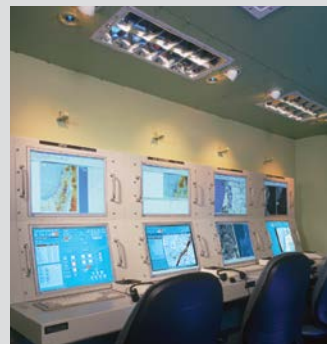

# SYNTHETIC APERTURE RADAR (SAR) SYSTEMS



## IAI ELTA SYSTEMS LTD.

P.O.Box 330, Ashdod 7710202, Israel  
Tel: 972-8-8572410  
Fax: 972-8-8561872  
E-mail: market@elta.co.il  
Web Site: www.elta-iai.com

### SAR Synthetic Family

ELTA's family of high performance Ground Surveillance and Reconnaissance SAR/GMTI systems includes the following members:

- ELM-2060P: A Pod-mounted SAR/GMTI System installed on fighter aircraft.
- ELM-2060T: A SAR/GMTI System installed on Business Jets or transport aircraft.
- ELM-2055/2054: A lightweight SAR/GMTI System installed on UAVs, helicopters or lightweight aircraft.
- ELM-20600: Fighter Aircraft Radar Targeting Pod (RTP).
- TECSAR: A lightweight Satellite SAR Payload.

The systems produce high resolution radar images which approach photographic quality and operate as true all-weather, day and night sensors capable of penetrating clouds, rain, smoke, smog, fog and a variety of man-made camouflage. The images produced onboard are transmitted via a built-in data link to a Ground Exploitation Station (GES) or to an Airborne Exploitation Station (AES) for interpretation and extraction of valuable Image Intelligence (IMINT) data, and may be presented to the operators or air-crew for quick Sensor-to-Shooter cycles.

### Typical Imaging Modes of Operation

**STRIP Mode** allows for quick coverage of large areas at stand-off ranges, while mapping details sufficient for target detection and overall assessment of an entire region. This mode enables detailed examination of a designated area of interest and allows high resolution sub-modes for target classification. In order to focus on an area of interest the systems can operate in a dedicated SPOT Mode. Additionally, a **MOSAIC Mode** is available which can combine images of Spot Modes to achieve large images with high resolutions. In the **Moving Target Indication (GMTI)** modes the system can overlay ground moving targets on top of the SAR Image Strip (SAR/GMTI Mode)

### Ground and Aerial Imagery Exploitation Stations

The Ground and Aerial Imagery Exploitation Stations employ COTS equipment with advanced data processing and user-friendly Man-Machine Interface to provide computer-aided tools for mission planning and management, data exploitation and intelligence reporting.

The stations enable mission planning, mission management and in-flight retasking.

### Typical configurations include:

- Airborne Exploitation Station (AES): includes 1 or 2 operator consoles
- Ground Exploitation Station (GES) in a fixed facility: up to 10 operators
- Mobile GES: large (S-280 or similar) shelter: typically includes 5 operators
- Tactical GES: small shelter, includes 1 or 2 operators

TECSAR



SAR Pod for fighters

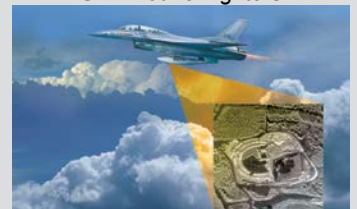

Radar Targeting Pod on fighters



SAR/GMTI UAV



Lightweight SAR/GMTI Aircraft



SAR/GMTI on Business Jet



# VERY HIGH RESOLUTION IMAGING SATELLITES



## IMAGESAT INTERNATIONAL N.V.

6 Yoni Netanyahu St.,  
Or Yehuda 6037604, Israel  
Tel: 972-3-7960600  
Fax: 972-3-5163430  
E-mail: [orders@imagesatintl.com](mailto:orders@imagesatintl.com)  
Web Site: [www.imagesatintl.com](http://www.imagesatintl.com)

ImageSat International N.V. is a commercial provider of Very-High-Resolution (GSD 0.7m), satellite imagery collected by its Earth Remote Observation Satellites EROS-A & EROS-B.

### ImageSat is distinguished by:

- Exclusive service packages, including exclusive use of the EROS satellites over a designated footprint
- Direct independent Tasking and Direct Reception
- Flexible imaging parameters
- Fast image acquisition and delivery
- No Risk - Pay only for services received
- Eros-C Satellite with significantly improved imaging capabilities is in production



EROS-B image: Light Water Reactor Construction, Yongbyon – North Korea

# HAVE AN EAR IN THE RIGHT PLACE



MIPHA INTERNATIONAL LTD.

## MIPHA INTERNATIONAL LTD.

8 Har Nevo St.,  
Ramat Hasharon 4722508, Israel  
Tel: 972-3-5402403  
Fax: 972-3-5490931  
E-mail: [mipha@mipha.co.il](mailto:mipha@mipha.co.il)  
Web Site: [www.mipha.co.il](http://www.mipha.co.il)

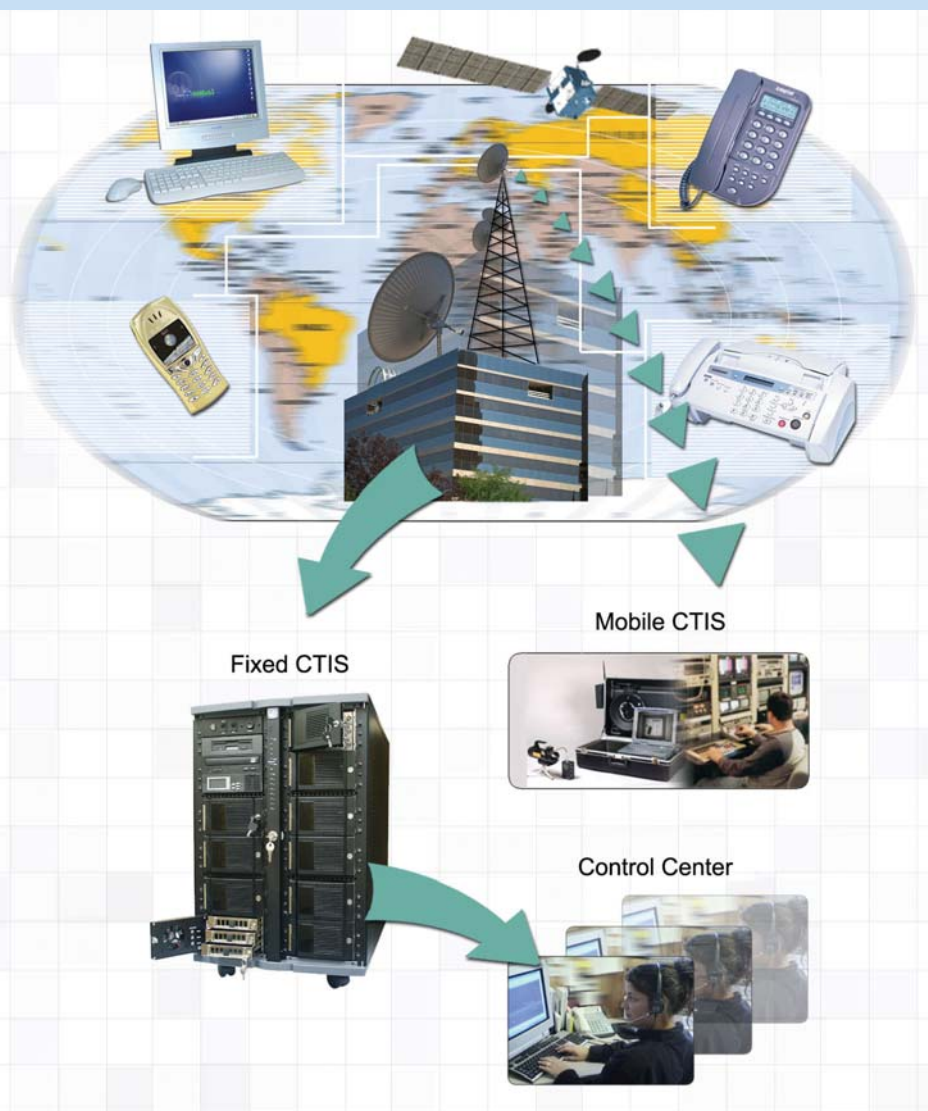

### CTIS - COMPUTERIZED TELEPHONE INTERCEPTION SYSTEM

MIPHA offers a variety of solutions that can meet needs of government agencies, military intelligence, police forces and security services to supervise and intercept all telecom & IP solutions, lawful interception, intelligence gathering, cellphone location tracking and data mining.

We also offer an advanced intelligence inference system for link analysis and inferring intelligence from information coming from different data bases.

These technologies have become crucial nowadays in homeland security in the struggle against terrorism and crime.

### SURVEILLANCE AND COUNTER SURVEILLANCE SYSTEMS

- DATA CRYPTOGRAPHY, PKI and DIGITAL SIGNATURE TECHNOLOGY for information and data security.
- VOICE/FAX, CELLPHONE & SMART-PHONES ENCRYPTION to secure telecommunication lines.
- DATA RECOVERY, passwords recovery, forensic services to discover improper computer use.
- VOICE ANALYSIS SYSTEM as an investigation tool, access control and reliability tool.
- COMMUNICATIONS Jammer to avoid misuse of cellphones and use of any radio transmissions as a monitoring and transmitting device to protect cars or VIP public appearance from detonating a remote controlled bomb.
- COUNTER SURVEILLANCE checks at customer's premises in order to detect eavesdropping, bugging, commercial & industrial espionage, etc.

**MIPHA INTERNATIONAL LTD. is licensed by the Israeli Ministry of Defense to handle international sales of intelligence equipment, consulting in the field of security, including surveillance and counter-surveillance, courses, training and equipment.**

# ***SURVEILLANCE & COUNTER-SURVEILLANCE***

## ***Secure Your Assets & Protect Your Privacy***



MIPHA INTERNATIONAL LTD.

### **MIPHA INTERNATIONAL LTD.**

8 Har Nevo St.,  
Ramat Hasharon 4722508, Israel  
Tel: 972-3-5402403  
Fax: 972-3-5490931  
E-mail: [mipha@mipha.co.il](mailto:mipha@mipha.co.il)  
Web Site: [www.mipha.co.il](http://www.mipha.co.il)

Whether to counter state threats like terror and crime, or to counter commercial and industrial espionage, you need experts to provide you with consultancy, solutions, threat assessment, risk analysis and of course state-of-the-art technologies.

Mipha International Ltd. specializes in the field of surveillance & counter-surveillance; providing consultancy services, planning & performing to governments as well as the private sector (industry, banking and other businesses).

Mipha's qualified management & personnel have vast experience in the fields of intelligence, counter terrorism and security.

### ***We offer:***

- Professional survey and consultancy in risk analysis and threat assessment.
- Counter surveillance checks at customer's premises in order to detect eavesdropping, bugging, commercial & industrial espionage, etc.
- High-end technologies for information & data security (cryptography, PKI, Digital Signature).
- Biometric identification solutions (vein, face, voice, etc).
- Encryption of telecommunication lines (point-to-point up to multipoint & PBX's). Encryption of cellular communication, smart-phones, etc.
- Electronic jamming of communication including cellular phone for protection against remote activated explosive charges for use in military, Special Forces and VIP protection, as well as unauthorized use of cellphones.
- High-end surveillance methods and systems.
- Data Recovery as an investigation tool and forensic applications.
- Voice analysis as an investigation tool and Access Control System.

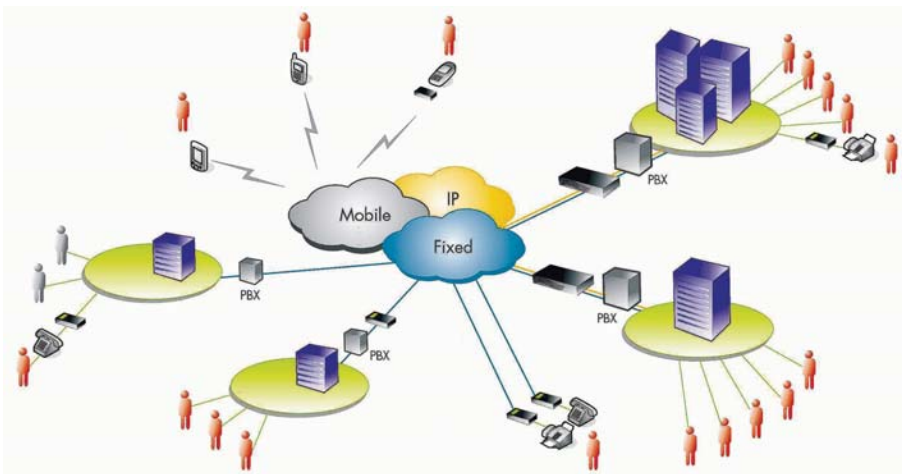

**Encryption network**

***MIPHA INTERNATIONAL LTD. is licensed by the Israeli Ministry of Defense to handle international sales of intelligence equipment, consulting in the security field, including surveillance and counter-surveillance, courses, training and equipment.***

# CUTTING EDGE SPECTRUM DOMINANCE SOLUTIONS

Netline Communications Technologies (NCT) Ltd. develops and manufactures cutting edge EW and spectrum dominance solutions: advanced COMMINT & SIGINT, counter IED & communication jamming, and wireless intrusion protection systems to the global defense and homeland security markets.



## NETLINE COMMUNICATIONS TECHNOLOGIES (NCT) LTD.

Azrieli Circular Tower  
132 Menachem Begin Rd.  
Tel Aviv 6701101, Israel  
Tel: +972-3-6068100  
Tel: +972-3-6068100  
Fax: +972-3-6068101  
E-mail: [info@netlinetech.com](mailto:info@netlinetech.com)  
Web Site: [www.netlinetech.com](http://www.netlinetech.com)

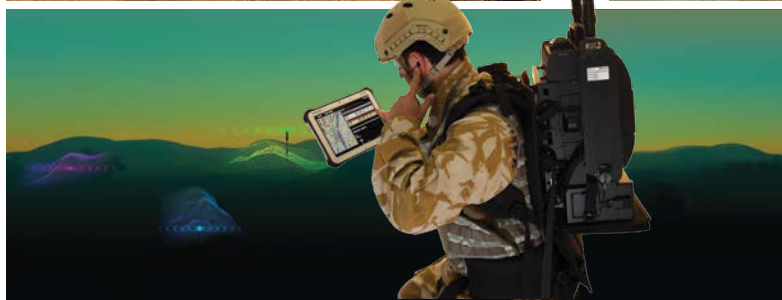

## COUNTER IED JAMMING

Netline's C-Guard active and reactive counter IED jamming systems protect troops, bases and convoys from remote radio detonation of IEDs. Robust jamming systems installed in vehicles, trolley/briefcases, ManPacks, miniaturized and stationary applications can be equipped with pre-initiation, hybrid active/reactive capabilities and other advanced features.

## COMMUNICATION JAMMING

Netline communication jamming systems block RF communications and isolate arenas targeting cellular & satellite phone, WiFi/Bluetooth, walkie/talkie and all other wireless communication frequencies from 20 MHz - 6 GHz. Systems deploy in a variety of platforms including land, naval and airborne vehicles and UAVs.

## COMMINT & SIGINT SOLUTIONS

Netline's communications intelligence solutions integrate a variety of tactical SIGINT & COMMINT capabilities including spectral analysis, signal classification and demodulation, cell phone monitoring and location/direction finding - all tailored per customer specifications. Tactical cell phone interception systems include both active (man-in-the-middle) and passive systems enabling competent authorities to intercept and manage cellular voice, data and WiFi communications. Systems can be deployed in scenarios not usually accessible for traditional SIGINT solutions like marine, land and airborne vehicles and UAVs.

## WIRELESS INTRUSION DETECTION

Netline radio frequency (RF) detection systems prevent potentially hostile information surveillance, uncovering unauthorized use of radio frequencies by cyber, cellular and other information leakage threats in military, government, corporate and other sensitive compartmented information facilities.



**YOUR COUNTRY.  
YOUR CITY.  
YOUR PEOPLE.  
SAFE & SECURE**



**NICE SYSTEMS LTD.**  
22 Zarhin St.,  
P.O.Box 690  
Ra'anana 4310602, Israel  
Tel: 972-9-7753777  
Fax: 972-9-7753222  
Email: info.security@nice.com  
info.intelligence@nice.com  
Web Site: www.nice.com



**NICE's** Security solutions help governments and enterprises anticipate, manage and mitigate security, safety, and operational risks, and make the world a safer place.

The **NICE** security, intelligence and cyber offering empowers organizations to capture, correlate and analyze "big data" generated by multiple sensors and channels.

**NICE** Security solutions are used by thousands of customers worldwide, including government agencies, transportation systems, critical infrastructure, city centers, banks and enterprises, to secure people and leverage their most important business assets.

**NICE Security Solutions:**

- Situation Management
- Video Surveillance & Analytics
- Audio Recording Solution
- Incident debriefing and investigation using complete event reconstruction
- Communications interception and analysis
- Public Safety Emergency Response Optimization
- 3D Mobile Location Tracking
- Web Intelligence
- Social Network Analysis
- Anti-Money Laundering
- Advanced Cyber Solutions

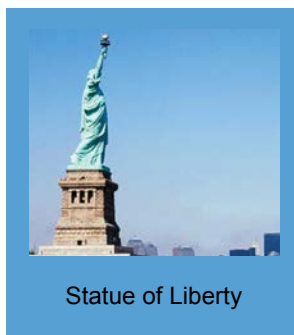

Statue of Liberty

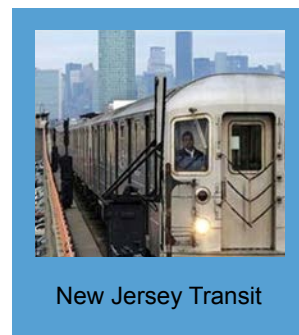

New Jersey Transit



London Underground

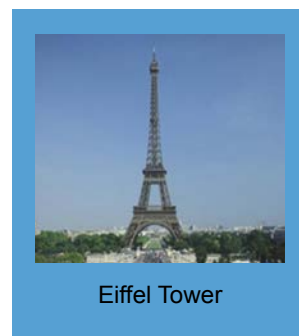

Eiffel Tower

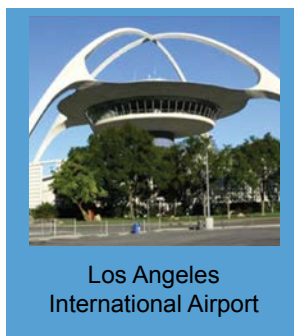

Los Angeles International Airport

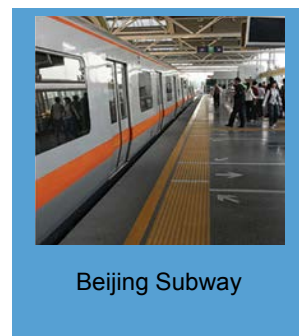

Beijing Subway

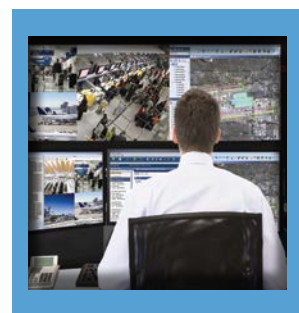

# PICSIX

## The Perfect Interception



### PICSIX LTD.

41 HaMeyasdim St.,  
P.O.Box 6006  
Even Yehuda 4051113, Israel  
Tel: 972-9-8911202  
Fax: 972-9-8911202  
E-mail: sales@pic-six.com  
Web Site: www.pic-six.com

PICSIX LTD. is a designer and manufacturer of interception and counter interception products and solutions. We produce compact passive interception systems that offer the greatest capacity and performance in the market, state of the art active interception systems and unique and sophisticated "Synchronous Transmission" solutions geared to manipulate cellular networks key parameters. In addition we pioneer a line of counter interception equipment designed to detect, locate and sabotage active interception systems in the near vicinity.

### Additional products available from PICSIX include:

- WIFI interception systems that operate in conjunction with PICSIX passive and active cellular interceptors.
- Covert interception systems and vehicles.
- BIG DATA analysis station which connects to all of PICSIX radio interception systems as well as public databases.



Vehicular installation of GSM M.I.T.M and 144CH passive interception systems



PICSIX battery powered Passive 64CH backpack form factor



PICSIX Man-In-The-Middle (M.I.T.M) GSM and UMTS Systems



Pelican 2400 or similar hosting a 128CH passive system, decipherer included



1U high size battery-pack to support 6 hours of Passive system operation



PICSIX Counter Interception Detection and elimination modules

# IMILITE



***Multi-Source Multi-Task ISR Exploitation System / Command and Control System Imilite is an intelligence system designed to receive process and exploit multiple standalone imagery video and other intelligence data in a centralized and a unified way.***

**RAFAEL**  
**ADVANCED DEFENSE SYSTEMS**  
P.O.Box 2250 (19)  
Haifa 3102102, Israel  
Tel: 972-73-3354714  
Fax: 972-73-3354657  
E-mail: [intl-mkt@rafael.co.il](mailto:intl-mkt@rafael.co.il)  
Web Site: [www.rafael.co.il](http://www.rafael.co.il)



## **System capabilities:**

data reception, processing and display of Video, imagery, targets, threats, mission status, force locations, SIGINT detection and others.

The system GIS capabilities provide synchronized display of all the data as overlays on maps, video and images.

Imilite improves the Command-and-Control process by various automated image processing algorithms such as geo-referencing, change and motion detection, video/image enhancement, video stabilization and others.

Imilite can disseminate operational data, tactical mission reports, targets and treats to other forces, to facilitate close support operations, targeting and platform/sensor management.

ImiLite allows scalable Command and Control solutions and adaption to specific operational needs, both in mobile and stationary configurations for Command and Control centers, deployable operational units.

## **Benefits:**

- Centralized and unified workflow and data display
- Improved efficiency utilizing all available collection assets
- Shortened exploitation cycle
- Efficient Command and Control workflow
- Immediate accessibility to relevant data
- Real-time mission command-and-control workflow
- SR and mission product sharing with external operational users

## **Features:**

- Multi-source data reception in various formats
- GIS capabilities: image/video geo-referencing, data overlays, Geo data retrieval
- Advanced Image Processing Algorithms: change and motion Detection, image/video enhancement, video stabilization and others
- ISR and mission products and reports generation and dissemination
- Scalability and Adaptability
- Stationary, Mobile or Airborne configurations

# ***ELECTRO-OPTIC INTELLIGENCE, SURVEILLANCE AND RECONNAISSANCE (ISR)***

## ***Litening - Targeting & Navigation Pod***

Litening is an innovative airborne infra-red targeting and navigation pod for fighter aircraft with high accuracy and reliability, day and night precision strike capability. Litening reduces pilot workload during targeting and tracking. It is easily integrated on any aircraft and possesses high growth potential.

In use in the Israeli Air Force, USAF, ANG, AFRES, Marines, German AF, Swedish AF, Spanish Navy & AF, Greek AF, and others, the Litening flies on F-16, F-15, A-10, B-52, AV8-B, Gripen, Tornado, F-5, F-4, Mig-21, Mirage 2000, Jaguar and others.



## ***Toplite EO System - Electro-Optical Surveillance, Observation & Targeting System***

The Toplite family of electro-optic systems is an advanced multi-sensor, multi-purpose, highly stabilized EO systems for homeland security and defense applications, for aerial, maritime and ground based platforms.

## ***RecceLite- Real Time Tactical Reconnaissance System***

The RecceLite System consists of an E-O pod, a ground exploitation station and a data link. It is capable of collecting images day & night from 300 ft to 40,000 ft in all directions forwards, nadir, backwards, oblique - all down hemisphere and even when the aircraft is maneuvering in high G.

The Ground Exploitation Station (GES) is capable of generating targets in real-time with exceptionally high accuracy due to state-of-the-art algorithms and technology.

The data-link connects between the sensors and the GES and enables the images to be downloaded to the GES in real time. When your task is to close the attack cycle on many "time-critical targets" in less than 10 minutes, there is only one system - RecceLite.

## ***Recce-U - Real-Time Persistent ISR System for UAVs***

Recce-U is a self-contained, multi-sensor ISR system (based on the RecceLite Tactical Reconnaissance Pod). The Recce-U enables automatic photography, according to a mission plan prepared in advance, or updated mission plan uplinked in real-time, however the operator can initiate manual scanning for targets of opportunity.



***Litening -on-Gripen***



***Toplite EOS***



***RecceLite System***



***Recce-U***

**RAFAEL**  
**ADVANCED DEFENSE SYSTEMS**  
 P.O.Box 2250 (19)  
 Haifa 3102102, Israel  
 Tel: 972-73-3354714  
 Fax: 972-73-3354657  
 E-mail: intl-mkt@rafael.co.il  
 Web Site: www.rafael.co.il

**SpotLite Family**  
**Electro-Optic Enemy Fire Detection System**

The SpotLite family consists of electro-optical systems that detect and locate enemy fire in stationary positions as well as on the move. Rapid detection and precise location information provide forces with the capability to quickly neutralize the enemy, maintaining the upper-hand on the battlefield.

The **SpotLite P** is a portable electro-optic system carried by two soldiers for day and night detection and location of small arms fire.



**SpotLite P on Tripod**

**SpotLite M** is a mobile electro-optic system installed on vehicles and AFV's that enables the detection and location of enemy fire sources from small arms, RPG rockets, ATGM and tank shells, on the move, day and night, up to 360° coverage.



**SpotLite M on vehicle**

**Imilite - Multi-Source Multi-Task ISR Exploitation System / Command and Control System**

Imilite is an intelligence system designed to receive process and exploit multiple standalone imagery video and other intelligence data in a centralized and a unified way.

Main system capability includes the reception, processing and exploitation of EO, IR, SAR/GMTI and VIDEO, in various formats, over one desktop. In order to enhance the exploitation process, Imilite further combines non-imagery data such as targets, threats, COMINT detection and mission status within the system workflow. Imilite generates a variety of standard and customer tailored ISR reports and IMINT products such as alphanumeric reports, annotated maps, GIS data layers and visual aids, and disseminates them to external information and operation systems over standard and tailored protocols.

Imilite's multi-source data integration and automation capabilities improve the efficiency of utilizing available collection and exploitation assets. The system GIS capabilities provide immediate accessibility to relevant imagery and intelligence data, thus shortening the ISR collection and exploitation cycle.

The Imilite is based on Rafael's combat-proven ISR and C4I systems already in service worldwide. Imilite is designed for use by Defense forces (air, ground) and police forces exercising various observation means for border patrol or coping with urban crime.



**Imilite**



# MIC<sup>4</sup>AD



**RAFAEL  
ADVANCED DEFENSE SYSTEMS**

P.O.Box 2250 (19)  
Haifa 3102102, Israel  
Tel: 972-73-3354714  
Fax: 972-73-3354657  
E-mail: [intl-mkt@rafael.co.il](mailto:intl-mkt@rafael.co.il)  
Web Site: [www.rafael.co.il](http://www.rafael.co.il)

MIC<sup>4</sup>AD is an advanced, unified, integrated C<sup>4</sup>I system that commands and controls the operation of both air and missile defense, including air-superiority missions. MIC<sup>4</sup>AD provides a total solution for multi-system, multi-layer and multi-range air and missile defense, traditionally operated as separate commands.

MIC<sup>4</sup>AD correlates real-time data from distributed sensors/platforms (radars, IFF system, data links, electro-optics), all connected to the air traffic control picture and mission planning system. The data is analyzed to deliver a real-time, coherent national Air Situation Picture (ASP).

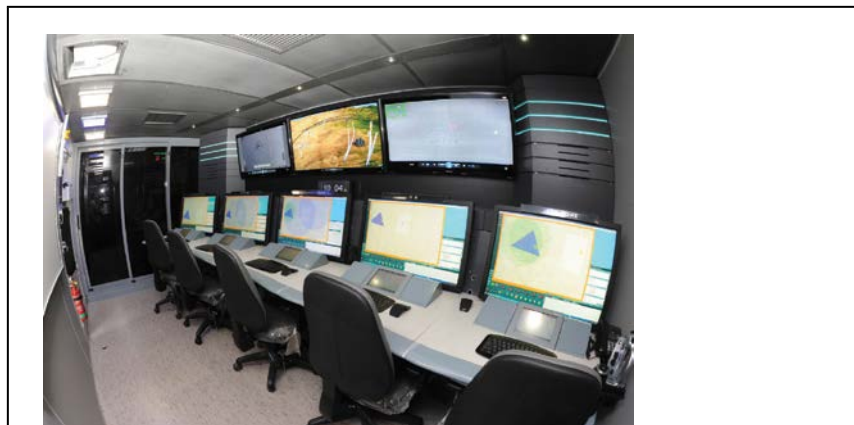

Simultaneously, MIC<sup>4</sup>AD performs threat assessment and hostile target classification, generating an interception plan for threats at any command level (national, regional, tactical). MIC<sup>4</sup>AD optimizes resource management and swiftly allocates the most appropriate defense system, such as SPYDER, David's Sling, Iron Dome or other customer systems to the type of challenge. Response includes target allocation to weapon systems (TAWA - Threat Assessment Weapon Allocation) with full, semi-automatic or manual fire control according to customer doctrine.

MIC<sup>4</sup>AD open, modular architecture can be adapted to customer operational needs. The system can be integrated with a customer's existing or future air and missile defenses. This flexibility allows incorporating new technologies and systems with the existing arrangement. MIC<sup>4</sup>AD can serve as an add-on to the customer's current C<sup>4</sup>I setup, or replace existing systems entirely.

Highly automated, easy-to-use and with advanced interactive displays, MIC<sup>4</sup>AD is a true force-multiplier. Enabling unified command and fire control of multiple air and missile defense systems, MIC<sup>4</sup>AD delivers multi-mission, multi-layer and multi-range C<sup>4</sup>I capabilities that ensure end-to-end air and missile protection.

# VERINT COMMUNICATIONS AND CYBER INTELLIGENCE SOLUTIONS

## ACTIONABLE INTELLIGENCE FOR A SAFER WORLD™



### VERINT SYSTEMS LTD.

33 Maskit St.,  
Herzliya 4673333, Israel  
Tel: 972-9-9624119  
Fax: 972-9-9624747  
E-mail: [marketing.lis@verint.com](mailto:marketing.lis@verint.com)  
Web Site: [www.verint.com/cis](http://www.verint.com/cis)

Verint® Systems Ltd is a leading provider of Actionable Intelligence® solutions that help governments protect people and property and neutralize terror and crime. The Verint Communications and Cyber Intelligence Solutions™ intercept, monitor and analyze huge volumes

of voice, video, and unstructured data communications from a wide array of sources: telephony, SMS, emails, and Internet, including chat, VoIP, social networks, and other Web 2.0 applications.

### Communications and Cyber Intelligence Solutions Portfolio



### The Verint Communications and Cyber Intelligence portfolio features solutions for:

#### Communications Intelligence

Verint Communications Intelligence solutions, intercept, filter and analyze huge volumes of Internet, voice, and satellite communications to helping to uncover critical information in less time.

#### Service Provider Compliance

Verint Service Provider Compliance solutions help communications service providers comply with ETSI, CALEA, and other lawful interception regulations and standards.

#### Mobile Location Tracking

The Verint Mobile Location Tracking solutions provide real-time mobile location tracking, with analytics and workflows to support investigative activities.

#### Tactical Communications Intelligence

Verint Tactical Communications Intelligence solutions provide interception and location tracking capabilities for field operations.

#### Open Source Web Intelligence

Verint Open Source Web Intelligence solutions collect and analyze large volumes of Internet content, increasing the productivity and efficiency of investigations.

#### Cyber Security

Verint Cyber Security solutions protect national assets and organizations from ever-evolving advanced cyber threats.

Law enforcement, national security, national intelligence, national computer emergency response teams (CERTS) and other government agencies can deploy these solutions to generate evidence and intelligence and promote more efficient and productive investigations.

# VISUAL SEARCH ENGINE FOR IMAGERY INTELLIGENCE

**VIDEO** *inform*  
FOR A BRIGHT VISION

## VIDEO INFORM LTD.

100 Jabotinsky St.,  
P.O.Box 3331  
Petah Tikva 4959257, Israel  
Tel: 972-3-6448968  
Fax: 972-3-9210190  
E-mail: [info@video-inform.com](mailto:info@video-inform.com)  
Web Site: [www.video-inform.com](http://www.video-inform.com)

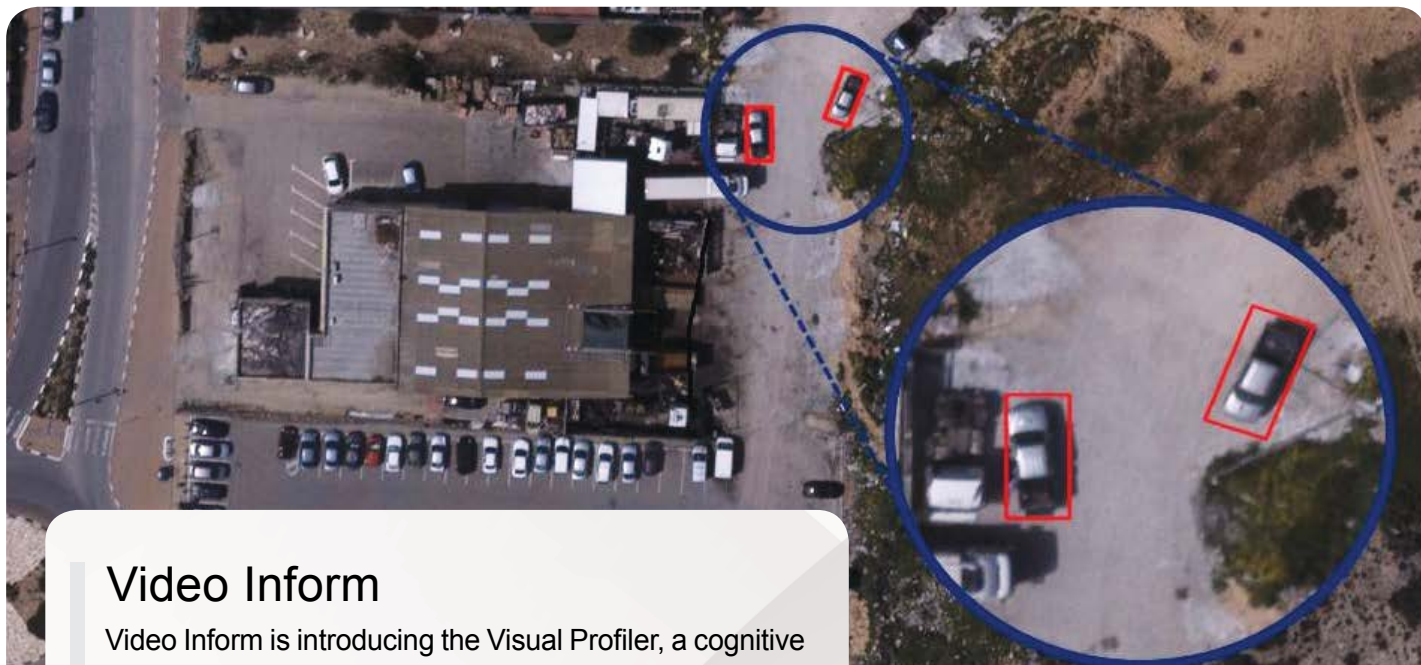

PICKUP TRUCK DETECTION

## Video Inform

Video Inform is introducing the Visual Profiler, a cognitive computer vision analysis solution for Target Acquisition on Aerial/Satellite Imagery. The visual Profiler is designed for operational Geospatial intelligence and Airborne ISR missions and applications. The solution is already in service and fully operational.

Video Inform is looking for business and technological cooperation's with Defense Industries, specifically in the field of Geospatial Intelligence and Airborne ISTAR.

Video Inform is a leading developer of cutting-edge cognitive vision technologies and solutions. Our unique technology is based on real-time video object recognition and understanding. Originally developed for military applications, this breakthrough technology enables Video Inform solutions to deliver new levels of actionable intelligence information with ultra-high precision. Our major customers include the Israeli MOD as well as many other defense industry companies.

## Visual Profiler

Visual Profiler is a visual search engine software for automatic target detection and acquisition. Originating in the defense field, the solution is based on a novel approach, using a unique visual target profiling methodology as opposed to a legacy change-detection approach. The system includes a unique user interactive feedback mechanism for continuous precision level improvements and can adjust rapidly to new operational needs. The Visual Profiler software can be used as an add-on to an existing IMINT exploitation system, such as the SOCET GXP. The intuitive user interface is simple and user-friendly.







**OPTRONICS**

## Superior Electro-Optics for Precision Attack, Force Protection and C<sup>4</sup>ISR

Israel's military oriented Electro-Optical (EO) systems are based on advanced technologies that have evolved at Israel's scientific and defense research establishments for many years. Today, they are positioning Israel's defense industries among the world leaders in EO applications.

Israel's well-established EO industry provides everything ranging from basic components to complete multi-sensor systems. Positioned among the few countries producing advanced thermal imaging sensors, Israeli cooled and uncooled sensors are employing all usable bands of the Infrared (IR) spectrum. Ultimately, these sensors are combined into systems comprising thermal imagers, lasers, and video cameras integrated with gimballed and stabilized payloads to support observation, reconnaissance, targeting and force protection applications.

Israel's optronic industries and academic research centers are at the forefront in the field of laser technology. Typical systems include the latest eyesafe, diode-pumped lasers, fiber-laser and more. Other lasers are developed into target designation systems, or high energy lasers applications including counter rocket, artillery and mortar and counter IED weapon systems. Smaller lasers are miniaturized and integrated into sensor payloads to form compact reconnaissance, observation and targeting systems. More applications include navigation, autonomous navigation and sensing.

In the field of Image Intensification (I<sup>2</sup>) and Thermal Imaging (TI) state-of-the-art Israeli systems are employed with military forces worldwide. These systems are known for their superior visibility, night vision, dust and smoke penetration and high reliability. Such systems provide the core building blocks for a wide range of sighting systems, from weapon sights of all types, and miniature stabilized payloads to large, high-resolution camera payloads for reconnaissance satellites.

# CONTROP'S DAY / NIGHT EO / IR SYSTEMS

**CONTROP**  
Turning Vision Into Reality

*CONTROP is a world leader in EO / IR technologies and systems, providing innovative day / night EO / IR solutions for air, land and sea surveillance, defense and Homeland Security applications worldwide.*

**CONTROP  
Precision Technologies LTD.**

P.O.Box 611  
Hod Hasharon 4510502, Israel  
Tel: 972-9-7440661, Fax: 972-9-7440662  
E-mail: sales@controp.com  
Web Site: www.controp.com



## About CONTROP:

- CONTROP specializes in the development and production of Electro Optical and Precision Motion Control Systems.
- CONTROP's products are used worldwide for Surveillance, Defense and Homeland Security applications on air, land and maritime platforms.
- CONTROP's specialists have over 30 years of experience in electro-optics, electronics, servo-control, precision mechanics and software.
- CONTROP's products have many years of proven operational success and have been the chosen Electro Optical Systems for many national and international requirements.



## CONTROP's main product lines include:

- Thermal Imaging Cameras with high performance and high power Continuous Zoom Lenses.
- High performance Stabilized Observation Payloads of many sizes and weights used for day and night surveillance on board UAVs, small UAVs, aerostats/balloons, helicopters, fixed wing aircraft, maritime boats and ground vehicles.
- EO / IR observation and panoramic scanner systems with unique real time automatic passive intruder detection capability, providing the most cost effective solution for security of sensitive sites, airports, coastal surveillance, port / harbour security, border surveillance, perimeter security and surveillance, force protection and ground troops security.
- Airborne wide-area EO / IR scanner and observation system for day and night (real time) reconnaissance.
- Directional Antenna Pedestals for UAV, A/C and ground applications.
- Two axes Pan & Tilt gimbal systems for cameras, antennas etc. – stabilized or non-stabilized and remote controlled.

**CONTROP's** QA is ISO-9001 certified and the company's products are in daily operational use on many different air, land and maritime vehicles and programs worldwide.



# EO TACTICAL SOLUTIONS



**ELBIT SYSTEMS**  
**ELECTRO-OPTICS - ELOP LTD.**  
P.O.Box 1165,  
Rehovot 761101, Israel  
Tel: 972-8-9386211  
Fax: 972-8-9386010  
Web Site: [www.elbitsystems.com/elop](http://www.elbitsystems.com/elop)



A subsidiary of Elbit Systems, ITL specializes in the development, production, marketing, maintenance and after-sales support of advanced electro-optics tactical systems and OEM solutions. Our products are optimized for the fields of: counter-terrorism, special operations equipment, tactical measures for military and paramilitary solutions.

## **Night Vision Products**

ITL's compact, monocular night vision systems, including the Mini N/SEAS, offer high resolution and a clear, bright image, even under adverse environmental conditions. The newest member of ITL's night vision monocular family, XACT-NV32, is the lightest and smallest monocular in the world, capitalizing on all the advantages of its predecessors without compromising high resolution.



**XACT-NV32**

## **Uncooled Thermal Weapon Sights & Pocket Scopes**

Our Coyote family of uncooled thermal imagers can be used as either hand-held or weapon-mounted sights, for ranges between 0-1500 meters. The family incorporates several different configurations, all providing outstanding target discrimination and recognition capabilities.



**Coyote 45**

## **Target Acquisition Systems (Azimuth)**

The Azimuth product line includes Atlas LT, a target acquisition system for forward observers, artillery fire coordination, close air support coordination, and target intelligence; ATRIS MP, a man-portable remotely controlled day/night observation system; Comet FNS, a north finding system; and ATLAS GUN- LAYING SYSTEM, a portable gun laying system. The products and systems are used by infantry, special forces, armor, artillery and air forces.



**ATLAS LT**

## **OEM Solutions**

Elbit Systems ITL develops and supplies integrated laser range finder solutions for maritime, airborne and ground applications. The Ranger family is a closed-frame line of modules designed for OEM implementations, ideal for integration as part of a multi-sensor suite and/or weapon system, compact, simple and easy to handle, assemble and dismount, under all operational, terrain and weather conditions.

# LASER DESIGNATORS FOR LAND APPLICATIONS



**ELBIT SYSTEMS**  
**ELECTRO-OPTICS - ELOP LTD.**  
P.O.Box 1165,  
Rehovot 7611101, Israel  
Tel: 972-8-9386211  
Fax: 972-8-9386010  
Web Site: [www.elbitsystems.com/elop](http://www.elbitsystems.com/elop)



## PLDR-II

*Portable Lightweight Designator / Rangefinder  
with Built-in Laser See-Spot Camera*

### Main Advantages and Features

- Laser designation for all types of laser-guided munitions
- Can be carried by an individual soldier
- Built-in electronic compass and GPS
- Built-in tactical computer for target location calculations
- Built-in laser spot camera and video display
- Data link to the thermal sight, remote data transmission and test equipment
- Stand-off designation for maximum protection
- Option: add-on thermal camera with laser see-spot for nighttime observation capability



## SERPENT

*Portable Lightweight Designator / Rangefinder  
for Laser-Guided Munitions*

### Main Advantages and Features

- Diode-pumped technology
- Built-in electronic compass, GPS and tactical computer for target location
- Increased designation range
- Reduced life cycle costs, increased system uptime
- Passive cooling for high reliability and silent operation
- Reduced battery consumption
- Extended duty-cycle capability
- Data link to the thermal sight, remote data transmission and test equipment
- Standard external rails for add-on devices



**Applications:** CAS designation and ranging missions; FO operation;  
FAC mission; LIC/urban warfare

# RATTLER™

## Miniature Coded Laser Designator / Marker



**ELBIT SYSTEMS**  
**ELECTRO-OPTICS - ELOP LTD.**  
P.O.Box 1165,  
Rehovot 7611101, Israel  
Tel: 972-8-9386211  
Fax: 972-8-9386010  
Web Site: [www.elbitsystems.com/elop](http://www.elbitsystems.com/elop)



Rattler™ is a miniature, coded diode-pumped laser (DPL) designator /marker developed especially for the requirements of the modern battle field for SWAP (size, weight and power). Featuring ultra-light weight, high performance and high-reliability, the Rattler is based on a unique new pumping architecture. The Rattler can be carried along with all other infantry equipment, or installed on micro-payloads and mini-UAVs.

### **Rattler™ A** for airborne applications

Rattler A provides observation payloads with full targeting capabilities, enabling designation for all laser-guided munitions and coded illumination. Designed to be easily fitted into the smallest available payload (~ 5" diameter), Rattler A is extremely compact and lightweight, with an exceptionally small form factor.



### **Rattler™ H** for ground marking/designation applications

Rattler H offers a new solution for Close Air Support (CAS) enhanced target engagement and ground surface-to-surface precision laser-guided munitions target engagement:

**Marking:** The CAS platform's laser spot tracker can find the reflected laser spot from the target and display that position to the pilot, then slave the weapon system to the laser spot.

**Designation:** Coded target designation for air or gun-fired/mortar laser-guided munitions



# OPTICAL POWER CONTROL SOLUTIONS

## Smart Filters for Laser & Sunlight Protection



### KILOLAMBDA TECHNOLOGIES LTD.

22a Raoul Wallenberg St.,  
Ramat-Hachayal  
Tel-Aviv 6971918, Israel  
Tel: 972-3-6497662  
Fax: 972-3-6497665  
E-mail: [info@kilolambda.com](mailto:info@kilolambda.com)  
Web Site: [www.kilolambda.com](http://www.kilolambda.com)

KiloLambda is an industry leader in passive Optical Power Control. Established in 2001, the company is developing unique optical layers, based on its proprietary, patented nano-technology. These layers are used in industrial, defense and commercial optical systems.

KiloLambda surpassed the traditional techniques of light control by developing its own nano-technology and applying it in an effective manner to everyday applications. The technology controls optical power for all wavelengths and does so in a totally passive way, as opposed to conventional solutions of limiting or blocking specific wavelengths using active components. The company is now applying its breakthrough technology in the development of next-generation non-linear components and devices, to control and regulate optical power, passively.

#### Industry Solutions

The implications of KiloLambda's technology are enormous in their ability to protect the human eye and expensive equipment against damage by destructive light sources, from sunlight to lasers, as well as improving the dynamic range of imaging systems. The inherent passivity and solid state reliability of KiloLambda's solutions make them compatible with almost any IEC, MIL or other industry standard specifications and serves multiple industries such as defense, HLS, ophthalmic, architecture etc.

#### Wideband Laser Protection Filter (WPF)

- Wavelength independent - one filter blocks all lasers
- High transmission - no degradation of the image quality
- Activated only when the threshold power is exceeded
- Fast response time
- Impingement-angle independent



#### Visible Dynamic Sunlight Filter (V-DSF™)

V-DSF™ is a revolutionary photochromic based eye protection layer that works behind UV blockers such as car windshields and aviation cockpits.

Visible DSF™ is an advanced development of KiloLambda's proprietary technology Dynamic Sunlight Filter (DSF™), which dynamically attenuates the intensity of the light passing through it; the light-limiting properties of DSF™ increase with the intensity of the incident light.

Unlike conventional variable sun lenses, whose darkening is triggered by UV alone, VDSF's light darkening is triggered by visual wavelengths as well.

- Works behind UV-absorbing glass such as a cockpit canopy or car windshield
- Ultra-fast dark-to-clear recovery time
- Suitable for glass, plastics and polycarbonates





# YOUR BEST PARTNER FOR EYE SAFE LASER TRANSMITTERS



## OPTITASK LTD.

4/B, Hazoran Str., South Industrial Area  
Netanya 4250604, Israel  
Tel: 972-73-243-6600  
Fax: 972-9-865-67-46  
E-mail: [iv@optitask.net](mailto:iv@optitask.net)  
Web Site: [www.optitask.net](http://www.optitask.net)



OT-19: 1.54 $\mu$ m/1-2mJ/1pps/-32°C to +60°C  
OT-29: 1.54 $\mu$ m/1-2mJ/1pps/-40°C to +75°C  
OT-39: 1.54 $\mu$ m/3-4mJ/1pps/-32°C to +60°C



OT-17: 1.54 $\mu$ m/2-3mJ/1pps/-35°C to +71°C  
OT-27: 1.54 $\mu$ m/2-3mJ/5pps/-32°C to +71°C  
OT-37: 1.54 $\mu$ m/2-3mJ/10pps/-32°C to +65°C



OT-03: 1.54 $\mu$ m/12mJ/10pps/-40°C to +65°C  
OT-20: 1.54 $\mu$ m/10mJ/20pps/-40°C to +65°C

## About OPTITASK

Optitask Ltd develops and manufactures an extensive range of Eye Safe Laser Transmitters for use in different kinds of Laser Rangefinders.

Our wide range of lasers covers a broad spectrum of output energy and repetition rate using passive and active Q-switches.

In all of our facilities and activities, we maintain the highest manufacturing and quality assurance standards in strict adherence to international standard ISO 9001:2008.

Our Laser Transmitters manufacturing facilities include three levels Clean Rooms: ISO 7 (Class 10.000), ISO 6 (Class 1.000) and ISO 5 (Class 100), Laminar Boxes, numerous standard and special Electro-Optical instruments and jigs.

## Worldwide Connections

Germany, Austria, Switzerland:  
[w.reeb@lasercomponents.com](mailto:w.reeb@lasercomponents.com)

Great Britain:  
[matthew.ashton@pacer.co.uk](mailto:matthew.ashton@pacer.co.uk)

USA:  
[stuart.sendall@pacer-usa.com](mailto:stuart.sendall@pacer-usa.com)

India:  
[photonex13@gmail.com](mailto:photonex13@gmail.com)

Israel:  
[iv@optitask.com](mailto:iv@optitask.com)

# ***ELECTRO-OPTIC INTELLIGENCE, SURVEILLANCE AND RECONNAISSANCE (ISR)***

## ***Litening - Targeting & Navigation Pod***

Litening is an innovative airborne infra-red targeting and navigation pod for fighter aircraft with high accuracy and reliability, day and night precision strike capability. Litening reduces pilot workload during targeting and tracking. It is easily integrated on any aircraft and possesses high growth potential.

In use in the Israeli Air Force, USAF, ANG, AFRES, Marines, German AF, Swedish AF, Spanish Navy & AF, Greek AF, and others, the Litening flies on F-16, F-15, A-10, B-52, AV8-B, Gripen, Tornado, F-5, F-4, Mig-21, Mirage 2000, Jaguar and others.



## ***Toplite EO System - Electro-Optical Surveillance, Observation & Targeting System***

The Toplite family of electro-optic systems is an advanced multi-sensor, multi-purpose, highly stabilized EO systems for homeland security and defense applications, for aerial, maritime and ground based platforms.

## ***RecceLite- Real Time Tactical Reconnaissance System***

The RecceLite System consists of an E-O pod, a ground exploitation station and a data link. It is capable of collecting images day & night from 300 ft to 40,000 ft in all directions forwards, nadir, backwards, oblique - all down hemisphere and even when the aircraft is maneuvering in high G.

The Ground Exploitation Station (GES) is capable of generating targets in real-time with exceptionally high accuracy due to state-of-the-art algorithms and technology.

The data-link connects between the sensors and the GES and enables the images to be downloaded to the GES in real time. When your task is to close the attack cycle on many "time-critical targets" in less than 10 minutes, there is only one system - RecceLite.

## ***Recce-U - Real-Time Persistent ISR System for UAVs***

Recce-U is a self-contained, multi-sensor ISR system (based on the RecceLite Tactical Reconnaissance Pod). The Recce-U enables automatic photography, according to a mission plan prepared in advance, or updated mission plan uplinked in real-time, however the operator can initiate manual scanning for targets of opportunity.



***Litening -on-Gripen***



***Toplite EOS***



***RecceLite System***



***Recce-U***

**RAFAEL**  
**ADVANCED DEFENSE SYSTEMS**  
P.O.Box 2250 (19)  
Haifa 3102102, Israel  
Tel: 972-73-3354714  
Fax: 972-73-3354657  
E-mail: intl-mkt@rafael.co.il  
Web Site: www.rafael.co.il

**SpotLite Family**  
**Electro-Optic Enemy Fire Detection System**

The SpotLite family consists of electro-optical systems that detect and locate enemy fire in stationary positions as well as on the move. Rapid detection and precise location information provide forces with the capability to quickly neutralize the enemy, maintaining the upper-hand on the battlefield.

The **SpotLite P** is a portable electro-optic system carried by two soldiers for day and night detection and location of small arms fire.



**SpotLite P on Tripod**

**SpotLite M** is a mobile electro-optic system installed on vehicles and AFV's that enables the detection and location of enemy fire sources from small arms, RPG rockets, ATGM and tank shells, on the move, day and night, up to 360° coverage.



**SpotLite M on vehicle**

**Imilite - Multi-Source Multi-Task ISR Exploitation System / Command and Control System**

Imilite is an intelligence system designed to receive process and exploit multiple standalone imagery video and other intelligence data in a centralized and a unified way.

Main system capability includes the reception, processing and exploitation of EO, IR, SAR/GMTI and VIDEO, in various formats, over one desktop. In order to enhance the exploitation process, Imilite further combines non-imagery data such as targets, threats, COMINT detection and mission status within the system workflow. Imilite generates a variety of standard and customer tailored ISR reports and IMINT products such as alphanumeric reports, annotated maps, GIS data layers and visual aids, and disseminates them to external information and operation systems over standard and tailored protocols.

Imilite's multi-source data integration and automation capabilities improve the efficiency of utilizing available collection and exploitation assets. The system GIS capabilities provide immediate accessibility to relevant imagery and intelligence data, thus shortening the ISR collection and exploitation cycle.

The Imilite is based on Rafael's combat-proven ISR and C4I systems already in service worldwide. Imilite is designed for use by Defense forces (air, ground) and police forces exercising various observation means for border patrol or coping with urban crime.



**Imilite**

# TAMAM HD EO/IR/LASER SYSTEMS

**SEE THE RIGHT WAY  
DETECT, IDENTIFY, DESIGNATE**



M-19 HD



MOSP 3000



POP 300



MINIPOP



MICROPOP

**TAMAM Division of Israel Aerospace Industries Systems Missiles and Space Group is a leading electro optics (EO) and navigation system house.**

TAMAM designs and manufactures gyro-stabilized EO payloads and systems for a wide variety of UAVs, helicopters, fixed wing aircraft, aerostats, marine vessels and ground applications. TAMAM's systems are field and combat proven. Thousands of systems are in service with leading armed and security forces worldwide.

TAMAM provides various observation and targeting solutions for the modern battlefield – covering short, medium and long ranges - for different airborne, naval and ground platforms. These are equipped with state-of-the-art HD sensors and diode pumped laser designators, compatible with US and NATO laser guided weapons.

**Typical applications include:**

- Surveillance, Reconnaissance, Targeting
- Border control
- Coastguard and Customs
- Traffic monitoring and control
- Drug interdiction
- HLS- homeland security

**M-19 HD** - (22", 80Kg) is a state of the art, very long range observation and targeting system based on one LRU ,fully digital stabilized payload. The sensors package includes HD EO , HD IR, SWIR and laser sensors optimized for customer missions. M-19 HD includes unique sensors in-flight bore-sight alignment mechanism and video image enhancement capability that significantly improve observation and targeting performance. The payload's line of sight can be controlled manually, by auto- track or by slaving and scanning modes

**MOSP3000** - (Multi-mission Optronic Stabilized Payload) - 14" OR 15" ball (32 Kg) - MOSP3000 has several sensor configurations of HD CCD and HD IR Cameras together with a Laser Pointer and a Laser Designator Rangefinder.

It is installed on fixed or rotary wing aircraft, unmanned airborne platforms, land vehicles or naval vessels, providing very long ranges of observation and laser targeting capabilities.

Excellent long range performance is achieved by MOSP3000's very high degree of stabilization.

Accurate laser targeting is assured due to MOSP3000's built-in automatic bore-sight mechanism.



GTAS



Israel Aerospace Industries Ltd.  
Systems Missiles & Space Group, TAMAM Division

## TAMAM DIVISION

P.O.Box 75  
Industrial Zone  
Yehud 5610001, Israel  
Tel: 972-3-5315205  
Fax: 972-3-5315140  
E-mail: [infotmm@iai.co.il](mailto:infotmm@iai.co.il)  
Web Site: [www.iai.co.il](http://www.iai.co.il)

**POP300** - (Plug-in Optronic Payload) - 10", 16-20 Kg, compact, stabilized electro optical payload. It includes HD thermal imager, HD TV camera, Laser Pointer and Laser Designator Rangefinder.

POP300 is used on tactical UAVs, fixed wing aircraft, helicopters, on ground platforms and on marine vessels.

**MINIPOP** - is an 8", 6-9 Kg dual axis, gyro-stabilized payload. The system is built on a one line replaceable unit (LRU) open architecture and carries a variety of sensors. The payload includes a continuous zoom IR and color day camera and a laser range finder or designator. An automatic video tracker can also be installed.

**MICROPOP** - is a very small and light (4", 1Kg) dual axis, gyro-stabilized payload, built on a one line replaceable unit (LRU) open architecture carrying a single sensor that can be switched in minutes. Sensors contain either a "da" continuous zoom color camera or a "night" uncooled thermal imaging camera.

**GTAS** (Ground Target acquisition System) - An innovative, portable, tripod mounted, gyrostabilized, observation and laser targeting system for ground missions.

The system is based on TAMAM's MINIPOP and includes also a tactical computer, an eyepiece-joystick, a north finder, a GPS receiver, and a power pack.

GTAS is remotely operated and therefore its functions can be controlled from a protected location thus ensuring operator's survivability.



# NIGHT VISION SYSTEMS & Allied Products

# TCI

## TCI - Technical Consultants International Ltd.

P.O.Box 72  
Hod Ha'Sharon 4510001, Israel  
Tel: 972-9-7462518  
Fax: 972-9-7462519  
E-mail: [tcibarak.net.il](mailto:tcibarak.net.il)  
Web Site: [www.nightvision.org](http://www.nightvision.org)



TCI is an organization devoted to the design and manufacture of a wide range of highly sophisticated Night Vision Systems and Allied Products.

TCI has agents in more than 20 countries worldwide. Military, Law Enforcement and Coast Guards all over the globe work with TCI equipment for both under water and dry land applications.

Our systems are in-use in many different roles, either directly on the battlefield or for anti-terrorist operations, under water inspection of ship hulls or EOD tasks on the seabed and other underwater tasks.

Our long range systems are employed for surveillance of Borders and Coastlines to prevent terrorist incursions. A number of our Systems are also operated on board Patrol Vessels and Helicopters to prevent arms or drug smuggling as well as watching for Illegal Immigrants.

Apart from manufacturing NVS and other Electro-optical Systems, TCI's workshop also undertakes projects for upgrading and Customizing/Modernizing Clients Night Vision Systems etc. TCI Ltd. employs modern CNC equipment in order to attain a high standard of accuracy which is monitored and certifies by strict quality control.

This is all part of our **CCAP 'Client Commitment Attitude Policy'**, a policy of helping the client realize the best possible standards of our Night Vision Systems and Allied Products.

### **TCI Ltd. designs and manufactures:**

- ✓ Underwater Night Vision for Frogmen.
- ✓ Individual Weapon Sights for most small arms.
- ✓ Observation/Photographic Night Vision Systems.
- ✓ Day/Night Closed Circuit Television Systems.
- ✓ Laser Illuminators & I.R Markers for above & below Water.
- ✓ Un-Cooled & Cooled Thermal Imaging Systems.

# ALWAYS AHEAD

*With offices in Israel (Middle East Division) and Italy (Europe Division), TROYA develops and markets Defense, HLS and Tactical products.*

# TROYA

## TROYA

P.O.Box 156  
Kibbutz Negba 7985600, Israel  
Tel: +972-8-6774341  
E-mail: [info@troya-tech.com](mailto:info@troya-tech.com)  
Web Site: [www.troya-tech.com](http://www.troya-tech.com)

TROYA specializes in Night Vision and Thermal Imagery devices and solutions. The company's personnel has an immense understanding in this field, and constantly aims to shape the future uses, platforms and applications for this advanced battlefield capability. With proper assimilation, Night Vision by itself, can provide a great advantage in multiple combat scenarios.

As a part of TROYA's capabilities, the company also develops other various Electro-Optical solutions. This can also take place as a specific customer requirement or inquiry.

In addition, TROYA offers engineering design services and products User Interface consultancy.



## TROYA's main Night Vision products



### STRIX

Aviator Imaging Night Vision System or ANVIS. These Night Vision Goggles are especially designed for rotary/ fixed wing aerial platforms.



### TYTO

A Night Vision Monocular for various applications. Can be head/ helmet/ weapon mounted, and can be joined to another NVM in order to become a binocular when used together.



### ASIO

The world famous Night Vision Goggles in their original form. This device is used around the globe for decades with infinite success. This NVG can be mounted on head/ helmet platforms, and is optionally provided with many beneficial accessories.

TROYA's reach of business partners, associates and relations is spread around the globe. This is thanks to our seasoned management team, with its vast knowledge and with over 30 years of combined experience in the Defense & Security Industry.

### Areas of activity:

Defense & HLS Law Enforcement Business Development UI & Product Development

A Clear View Of The World

**ALL-WAYS AT THE FRONT**  
Technology. Performance. Partnership



UNI-SCOPE  
Optical System Ltd.

SK GROUP MEMBER

**UNI-SCOPE  
OPTICAL SYSTEMS LTD.**

34 H'anapach St., P.O.Box 817  
Carmiel 2161701, Israel  
Tel: 972-4-9887022  
Fax: 972-4-9887023  
E-mail: [dannym@uniscope.biz](mailto:dannym@uniscope.biz)  
Web Site: [www.uniscope.co.il](http://www.uniscope.co.il)

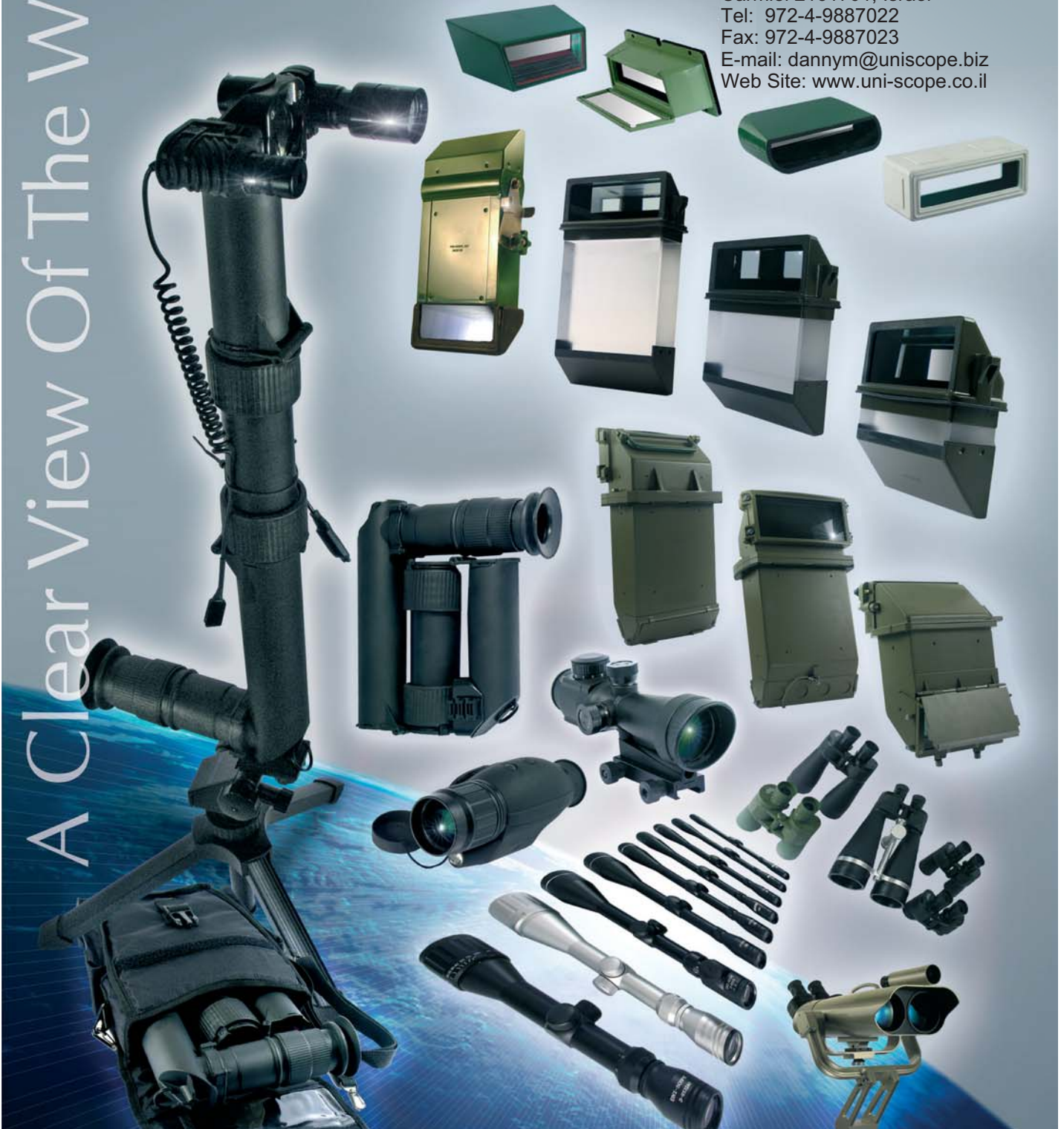



# ROTEM INDUSTRIES - CRYSTALS DIVISION



## ROTEM INDUSTRIES - CRYSTALS DIVISION

ROTEM Industrial Park,  
D.N. Arava P.O.Box 9046  
Beer-Sheva 8419001, Israel  
Tel: 972-8-6564831  
Fax: 972-8-6573186  
E-mail: romank@rotemi.co.il  
Web Site: www.rotemi.co.il/crystals

Rotem Industries' Crystals Division pioneered the development of sapphire single crystal domes more than 45 years. Since then Rotem has been producing sapphire domes & windows for Aerospace, Defense and Optics applications.

Rotem carries out R&D, manufacturing (growth, fabrication and quality control) and marketing activities mainly aimed at the high quality Defense market (smart components) and Optics.



### The Crystals Division at Rotem Industries offers a full range sapphire production:

- Growing** – a complete production line of large boules.
  - Development** – the hyper-hemispherical sapphire dome or above 240° hemisphere in various diameters is specially designed for advanced DIRCM/CIRCM systems.
  - With over 45 years of experience in offering state-of-the-art solutions, Rotem is well known R&D center for the defense and smart high-end optical components markets.
  - Processing** – manufacturing of dome-like products and flat windows using advanced equipment for optical fabrication (standard & CNC).
  - Characterization** – inspection of final product as well as in-process control utilizing advanced methods and tools (interferometry, spectral and non-contact roughness measurements).
  - Coating** – ability to offer advanced coating by local sub-contracting.
- The sapphire-components production line of Rotem is ISO-9001:2000 certified since 1994.

### Main Applications

#### Sapphire domes for:

- Air-to-Air/Air-to-Surface Missiles/ Guided Weapons
- Surface-to-Surface/Anti-Tank Missiles
- Missile warning & protection systems

#### Sapphire windows for:

- Anti-ballistic Missiles
- Targeting & Reconnaissance Pods/UAV payloads
- Missile warning & protection systems/HLS

### A Remarkable Technological Breakthrough by Rotem Industries Hyper Hemi-Spherical Sapphire Dome

Rotem Industries Ltd. is a leading developer and manufacturer of advanced technologies, for growing Sapphire and processing windows and domes for military and civil applications. Rotem has successfully developed remarkable technological breakthrough:

#### The hyper-hemispherical Sapphire dome 240° or above hemisphere in various diameters

This unique technological development was extremely challenging due to its dimensions and geometric characteristics. The hyper-hemispherical dome is specially designed for advanced DIRCM/CIRCM systems due to its wide viewing angle. With over 45 years of experience in offering state-of-the-art solutions, Rotem is a well-known R&D center for the defense and smart high-end optical components markets.



# AMPS

## Advanced Multi-Sensor Payload System



**ELBIT SYSTEMS**  
**ELECTRO-OPTICS - ELOP LTD.**  
P.O.Box 1165,  
Rehovot 7611101, Israel  
Tel: 972-8-9386211  
Fax: 972-8-9386010  
Web Site: [www.elbitsystems.com/elop](http://www.elbitsystems.com/elop)



**AMPS** is a member of our battle-proven family of stabilized airborne EO payloads, providing outstanding top-end, highly stabilized real time imagery. Optimized for airborne applications, AMPS delivers superb day and night intelligence, surveillance, target acquisition and tactical reconnaissance (ISTAR) capabilities in all weather conditions.

By providing long observation ranges, the AMPS enhances the quality and increases the output target intelligence production, while allowing for increased crew survivability.

The AMPS is in operational service with the Israel Navy, Air Force and other customers worldwide.

### Main advantages and features

- Automatic tracking of dynamic targets
- Scanning with choice of automatic patterns
- Autonomous navigation using inertial and GPS sensors
- Highly accurate navigation capabilities including target gathering
- Long range capability or higher resolution in short ranges

### Applications

- Long range, stand-off missions
- Border and maritime patrol
- Force protection
- Homeland security



# CONDOR™ 2



**ELBIT SYSTEMS**  
**ELECTRO-OPTICS - ELOP LTD.**  
P.O.Box 1165,  
Rehovot 7611101, Israel  
Tel: 972-8-9386211  
Fax: 972-8-9386010  
Web Site: [www.elbitsystems.com/elop](http://www.elbitsystems.com/elop)

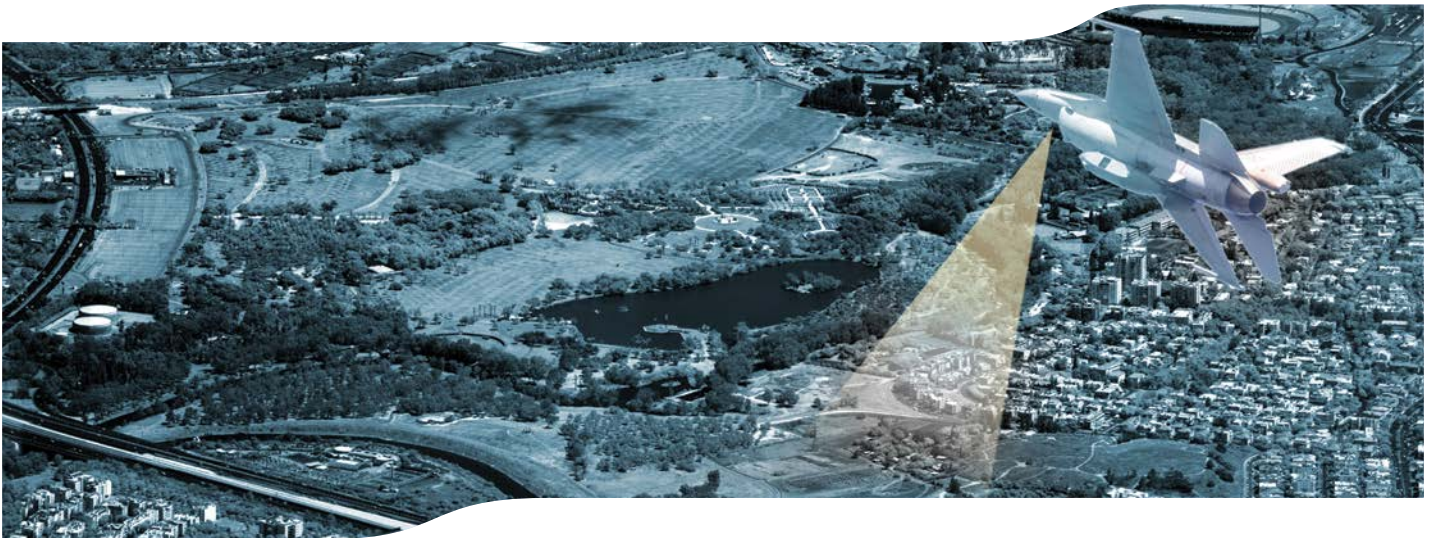

## CONDOR™ 2

### LOROP Airborne Standoff Reconnaissance System

In use by several air forces, CONDOR™ 2 offers real-time data record/transmit capabilities; includes camera, video processing, reconnaissance management, data link transmitter, digital video recorder. Can be mounted in a pod external to the aircraft.

A turnkey system - it can serve as an airborne camera system, ground or airborne mission planning or image exploitation system.

#### Major System Characteristics:

- Day and night standoff missions
- High resolution images at very long distances
- Very large imaging area in short flight time
- Autonomous navigation
- Pilot override for targets of opportunity
- On-board mission data recording
- Wide band data link for real-time image transmission
- Self-contained pod configuration
- Fully complies with the F-16 and other aircraft flight envelopes
- Minimal interface with existing aircraft avionics

## Condor™ TAC

### Dual Band Tactical Photography System

A unique solution for day and night tactical vertical and oblique reconnaissance photography, the Condor™ TAC is a tactical reconnaissance system with autonomous navigation capabilities, providing 24/7 high-res, visible and IR mono/stereo images, from very low to very high altitudes. Operational in five different air forces, it provides continuous rapid wide-area coverage and full-resolution imagery for each EO/IR channel. Available in EO panchromatic or color RGB versions.

#### Main System Characteristics:

- Operational suitability for a wide range of missions
- Very high resolution imagery and large area coverage in high, medium altitudes
- High-precision optics - high-end refractive cameras
- Extremely high V/H ratio
- Platform interface with a wide range of aircraft
- High performance at a wide range of altitudes & mach numbers
- Pilot override for targets of opportunity
- On-board mission data recording
- Wide band data link for real time image transmission

# DCoMPASS™

## Digital Compact Multi-purpose Advanced Stabilized System



**ELBIT SYSTEMS**  
**ELECTRO-OPTICS - ELOP LTD.**  
P.O.Box 1165,  
Rehovot 7611101, Israel  
Tel: 972-8-9386211  
Fax: 972-8-9386010  
Web Site: [www.elbitsystems.com/elop](http://www.elbitsystems.com/elop)



DCoMPASS™ is a highly stabilized, fully digital, lightweight (33-38 kg), single LRU electro-optical 15" class payload, available for fixed and rotary wing aircraft, UAVs, naval and ground platforms.

The DCoMPASS™ is equipped with 5 major EO elements: thermal imager, FHD color TV, laser designator, laser range finder and laser illuminator.

The system delivers superb day and night intelligence, surveillance, target acquisition and tactical reconnaissance (ISTAR) capabilities, in all weather conditions.

### Main advantages and features:

- Highly stabilized crystal clear image on both FHD color TV and thermal imager
- Lightweight, small size payload, made possible by new miniature digital electronics and advanced lightweight materials
- Fully digital system providing open architecture
- Embedded IMU allows for highly accurate navigation capabilities, including target gathering and geo-location
- Highly accurate Line of Sight (LOS) positioning, enabling LOS data for fire control applications
- Automatic multi-target dynamic tracking and area scanning with choice of automatic patterns
- Dual wavelength laser range finder and designator
- Unique in-flight boresight mechanism enables long-range precise laser designator
- Simple integration with HUD system, radar and fire control applications
- Step & Stare capabilities
- Advanced video enhancement package including: haze penetration, color restoration and sharpening features
- Fully operational in the harshest marine and air environmental conditions



# MicroCoMPASS™

## Micro Compact Multi-purpose Advanced Stabilized System



**ELBIT SYSTEMS**  
**ELECTRO-OPTICS - ELOP LTD.**  
P.O.Box 1165,  
Rehovot 7611101, Israel  
Tel: 972-8-9386211  
Fax: 972-8-9386010  
Web Site: [www.elbitsystems.com/elop](http://www.elbitsystems.com/elop)



The MicroCoMPASS™ is a day/night highly stabilized (3 gimbals) surveillance system that includes a 3<sup>rd</sup> generation 3-5 $\mu$ m continuous zoom thermal imager, color TV day camera, eyesafe laser range finder (ELRF), laser illuminator and automatic tracking capabilities. Its small size (8" diameter) and lightweight design (only 9 kg) facilitate easy installation of the MicroCoMPASS™ on UAVs, maritime, rotary wing and ground platforms.

The MicroCoMPASS™ is currently in operational service and provides high-resolution images.

### Main advantages and features

- Lightweight (< 9 kg), compact design (8") with low power consumption
- Long-range continuous zoom thermal imager and zoom color CCD camera
- Unique, miniature, cooled continuous zoom thermal imager
- Equipped with 3 gimbals which provide high stabilization level
- Laser illuminator & eyesafe laser range finder (ELRF)
- Automatic tracking of observed targets
- Multiple communication protocols
- Single LRU configuration and minimum cabling
- Simple and straightforward installation utilizing interface with platforms, fire control and navigation systems
- Meets the most severe operational requirements of marine and low altitude applications.



# ***ELECTRO-OPTIC INTELLIGENCE, SURVEILLANCE AND RECONNAISSANCE (ISR)***

## ***Litening - Targeting & Navigation Pod***

Litening is an innovative airborne infra-red targeting and navigation pod for fighter aircraft with high accuracy and reliability, day and night precision strike capability. Litening reduces pilot workload during targeting and tracking. It is easily integrated on any aircraft and possesses high growth potential.

In use in the Israeli Air Force, USAF, ANG, AFRES, Marines, German AF, Swedish AF, Spanish Navy & AF, Greek AF, and others, the Litening flies on F-16, F-15, A-10, B-52, AV8-B, Gripen, Tornado, F-5, F-4, Mig-21, Mirage 2000, Jaguar and others.



## ***Toplite EO System - Electro-Optical Surveillance, Observation & Targeting System***

The Toplite family of electro-optic systems is an advanced multi-sensor, multi-purpose, highly stabilized EO systems for homeland security and defense applications, for aerial, maritime and ground based platforms.

## ***RecceLite- Real Time Tactical Reconnaissance System***

The RecceLite System consists of an E-O pod, a ground exploitation station and a data link. It is capable of collecting images day & night from 300 ft to 40,000 ft in all directions forwards, nadir, backwards, oblique - all down hemisphere and even when the aircraft is maneuvering in high G.

The Ground Exploitation Station (GES) is capable of generating targets in real-time with exceptionally high accuracy due to state-of-the-art algorithms and technology.

The data-link connects between the sensors and the GES and enables the images to be downloaded to the GES in real time. When your task is to close the attack cycle on many "time-critical targets" in less than 10 minutes, there is only one system - RecceLite.

## ***Recce-U - Real-Time Persistent ISR System for UAVs***

Recce-U is a self-contained, multi-sensor ISR system (based on the RecceLite Tactical Reconnaissance Pod). The Recce-U enables automatic photography, according to a mission plan prepared in advance, or updated mission plan uplinked in real-time, however the operator can initiate manual scanning for targets of opportunity.



***Litening -on-Gripen***



***Toplite EOS***



***RecceLite System***



***Recce-U***

**RAFAEL**  
**ADVANCED DEFENSE SYSTEMS**  
 P.O.Box 2250 (19)  
 Haifa 3102102, Israel  
 Tel: 972-73-3354714  
 Fax: 972-73-3354657  
 E-mail: intl-mkt@rafael.co.il  
 Web Site: www.rafael.co.il

**SpotLite Family**  
**Electro-Optic Enemy Fire Detection System**

The SpotLite family consists of electro-optical systems that detect and locate enemy fire in stationary positions as well as on the move. Rapid detection and precise location information provide forces with the capability to quickly neutralize the enemy, maintaining the upper-hand on the battlefield.

The **SpotLite P** is a portable electro-optic system carried by two soldiers for day and night detection and location of small arms fire.



**SpotLite P on Tripod**

**SpotLite M** is a mobile electro-optic system installed on vehicles and AFV's that enables the detection and location of enemy fire sources from small arms, RPG rockets, ATGM and tank shells, on the move, day and night, up to 360° coverage.



**SpotLite M on vehicle**

**Imilite - Multi-Source Multi-Task ISR Exploitation System / Command and Control System**

Imilite is an intelligence system designed to receive process and exploit multiple standalone imagery video and other intelligence data in a centralized and a unified way.

Main system capability includes the reception, processing and exploitation of EO, IR, SAR/GMTI and VIDEO, in various formats, over one desktop. In order to enhance the exploitation process, Imilite further combines non-imagery data such as targets, threats, COMINT detection and mission status within the system workflow. Imilite generates a variety of standard and customer tailored ISR reports and IMINT products such as alphanumeric reports, annotated maps, GIS data layers and visual aids, and disseminates them to external information and operation systems over standard and tailored protocols.

Imilite's multi-source data integration and automation capabilities improve the efficiency of utilizing available collection and exploitation assets. The system GIS capabilities provide immediate accessibility to relevant imagery and intelligence data, thus shortening the ISR collection and exploitation cycle.

The Imilite is based on Rafael's combat-proven ISR and C4I systems already in service worldwide. Imilite is designed for use by Defense forces (air, ground) and police forces exercising various observation means for border patrol or coping with urban crime.



**Imilite**



# CONTROP'S THERMAL IMAGING PRODUCTS

**CONTROP**  
Turning Vision Into Reality

**CONTROP is a world leader in EO / IR technologies and systems, providing innovative day / night EO / IR solutions for air, land and sea surveillance, defense and Homeland Security applications worldwide.**

**CONTROP  
Precision Technologies LTD.**

P.O.Box 611  
Hod Hasharon 4510502, Israel  
Tel: 972-9-7440661, Fax: 972-9-7440662  
E-mail: sales@controp.com  
Web Site: www.controp.com



In 1995, CONTROP was the first company to supply an IR Camera with a Continuous Optical Zoom Lens and has since then developed a wide variety of IR cameras based on many years of proven field experience.

### Unique qualities about CONTROP's FOX Family of Thermal Imaging Cameras:

- Proprietary highly powerful (up to x36) Continuous Optical Zoom Lens.
- Quality image and focus for all FOVs.
- Unique Image Enhancement features for dynamic battlefield applications ensuring that every picture is perfect, even when there is a "hot spot" (explosion, fire, etc.).
- Cameras are suitable for observation and scanning applications.
- Small volume and light weight.
- Flexibility for new technology modifications.
- May be supplied with an enclosure (FOX-ZE) or without an enclosure (FOX-Z).
- Fixed CG through zoom – Optional.



### Features about CONTROP's FOX Family of Thermal Imaging Cameras:

- 3-5  $\mu\text{m}$  IR Spectral Range.
- Third Generation InSb FPA 320x256 or 640x512 (P) Pixels Standard.
- Various Focal Lengths 250 mm (x12.5), 450 mm (x22), 720mm (x36), 1400mm (x35).
- Housing - Optional.



### Applications for CONTROP's FOX Family of Thermal Imaging Cameras:

- Integration in Observation Systems – Short to Long Ranges.
- Integration into Camera Payloads – Airborne, Maritime and Ground.
- Integration with Weapon Sites and Systems.
- Panoramic Scanning Systems.
- Air Defense Systems.





# FIELD PROVEN DEFENSE SOLUTIONS FOR DEPLOYMENT IN AIR, SEA & LAND



**OPGAL**  
**OPTRONIC INDUSTRIES LTD.**

P.O.Box 462, Industrial Area 5  
Karmiel 2161401, Israel  
Tel: 972-4-9953903  
Fax: 972-4-9953900  
E-mail: [info@opgal.com](mailto:info@opgal.com)  
Web Site: [www.opgal.com](http://www.opgal.com)

**Opgal's thermal-imaging solutions range from thermal camera cores and open frame cameras to completely integrated thermal-imaging cameras, subsystems and systems.**

From external ruggedized cameras to ready-to-integrate systems, Opgal's products provide optimum vision and improved situational awareness for today's 24-hour all-weather battlefield environment.

#### ■ Defense OEM Systems

Opgal's combat proven state-of-the-art technology is suitable for airborne, naval and ground applications. Manufactured to the highest military standards, our solutions are field proven and used by armed forces worldwide.

#### ■ EOS for Remote Control Weapon Stations

Opgal's range of electro-optical systems for observation and Remote Control Weapon Stations (RCWS) are designed to increase hit probability and enhance overall situational awareness.

#### ■ DVEs and Situational Awareness Systems for Armored Vehicles

Designed to enhance the operability of armored vehicles, Opgal provides integrators with a wide range of driving vision enhancement and situational awareness systems that can be incorporated into new and upgraded / refurbished vehicles.

#### ■ Off-the-Shelf Border Surveillance Systems

Dual channel long-range camera systems offer round-the-clock wide area scene awareness or close-up threat assessment.

With more than 30 years of field-proven experience, Opgal partners with leading OEMs and integrators, and works closely with their end users, to develop customized solutions addressing their specific defense and border security requirements.



Multi-Sensor Systems



Driver Viewer Enhancement Systems



Border Surveillance Systems

# CORAL

## Thermal Imaging Cameras



Elbit Systems Electro-optics Elop's CORAL Thermal Imaging Systems have gained significant momentum around the globe in recent years.

The CORAL FLIR family has secured an industry-leading position in the field of hand-held lightweight Thermal Imaging Cameras.

Elop's CORAL dual-FOV Thermal Imaging Cameras are in use by security forces on four continents.

Based on Elop's advanced, proven 3-5 $\mu$ m FPA InSb

detector technology, CORAL can be optimized for a wide range of applications, from infantry, scouts and special units, through night sight and target acquisition, to security and perimeter defense, and target acquisition for infantry commanders.

CORAL produces thermal images of outstanding quality based on Elop's unique image processing circuitry and software algorithms implemented in the system.

### CORAL-CR

*Advanced, Hand-held, 3-5 $\mu$ m Thermal Imaging Binocular Camera with Continuous Optical Zoom and Target Acquisition Capabilities*

- Continuous electronic and IR optical zooms
- Integral eyesafe LRF, day CCD cameras, digital magnetic compass and GPS
- Real-time target acquisition and target coordinates calculation
- Can be used in conjunction with:
  - ATRIS – Man-portable remote-controlled target acquisition system
  - Mini Atlas – Precision electronic goniometer



Atris

Mini Atlas

### **CORAL**

*Hand-held, 3-5 $\mu$ m Thermal Imaging Binocular Camera  
Selected by the USMC*



- Lightweight and compact
- Continuous E-zoom
- High resolution OLED display
- Low acoustic noise
- Adjustable binocular viewer

### **CORAL-LS**

*Hand-held Thermal Imaging Camera with  
Integral 1.06 $\mu$ m Imaging Capability*



- Integral "See-Spot" capability
- Advanced InSb FPA detector
- Lightweight and compact
- Continuous E-zoom
- Adjustable binocular viewer

### **CORAL-Z**

*Advanced, Hand-held, 3-5 $\mu$ m Thermal Imaging  
Binocular Camera with Continuous Optical Zoom*



- Continuous IR optical and digital zoom
- Lightweight and compact
- Advanced high resolution color OLED display
- Advanced high resolution detector
- Adjustable binocular viewer
- Option: Enhanced performance when used with ATRIS – man-portable remote-controlled target acquisition system

### **MINI CORAL**

*Uncooled Hand-held Thermal Imager with Target  
Acquisition Capabilities*



- Dual FOV (thermal imager)
- Continuous E-zoom
- Integral eyesafe LRF
- Color day camera
- Integral digital magnetic compass and GPS
- Built-in real time video recorder (Mpeg compression)

# INTEGRATED THERMAL SYSTEMS



Elbit Systems Electro-optics Elop's Integrated Thermal Systems Business Unit provides optimal operational responses to the present and future challenges facing modern fighting forces:

- from thermal sights and thermal driving solutions
- through upgrades for ATGMs and anti-aircraft and anti-tank guided missile defense systems that optically track and engage targets
- to FLIRs for OEM and MWS, and homeland security applications

Incorporating Elbit's and Elop's extensive technological and integration know-how and experience, we create a complete solution to the challenge, based on the customer's operational requirements.

Using the most advanced electro-optics capabilities and significant R&D investments, we provide 24/7 all-weather solutions to our clients, enabling them to operate in any environment with optimal results.



## IVORY-Z

*Compact 3-5 $\mu$ m Thermal Imaging Camera/Sight for Remote Operation Applications, with Continuous Optical Zoom*

- Lightweight and compact
- Long-range performance
- Excellent image quality
- Full remote control capability
- Add-on x2 telescope (optional)

### **Applications:**

Border/coastal surveillance; air defense; security; target acquisition; tank and AFV weapon stations; radar systems; naval EO clusters

**ELBIT SYSTEMS**  
**ELECTRO-OPTICS - ELOP LTD.**  
 P.O.Box 1165,  
 Rehovot 7611101, Israel  
 Tel: 972-8-9386211  
 Fax: 972-8-9386010  
 Web Site: [www.elbitsystems.com/elop](http://www.elbitsystems.com/elop)



**LIZ**

*Advanced Multi-sensor Day/Night EO Sight for Remote Operations*

- Advanced, grounded TI technology
- Advanced high resolution detector
- Long-range performance
- IR optical zoom
- Telescope magnifier
- Color day camera with continuous zoom
- Integral eyesafe LRF

**Applications:**

Observation & surveillance; security & perimeter defense; stationary & mobile weapon stations



**A-TIM**

*Advanced Clip-on Thermal Imaging Sight for ATGM Launchers*

- Provides full day/night operability, in all weather conditions
- Boresight free – quick installation on standard launcher day sight
- Uses existing eyepiece for both standard & thermal sight
- Lightweight & compact

**Applications:**

Applicable for any ATGM launcher; already operational with FAGOT, FLAME, Konkurs/AT-5 Spandrel



**LOTUS-G/GL**

*Man-Portable Long-Range 3-5µm Thermal Imaging Camera*

- Housed in ruggedized sealed case including display, controls and battery compartment
- Advanced high resolution detector
- Three FOVs
- Day/night operation
- Low power consumption
- Easy integration with host system

**Applications:**

Field observation; border & coastal surveillance; security & perimeter defense; anti-terror operations

# INNOVATIVE COOLER TECHNOLOGY



**RICOR SYSTEMS 2011  
- A.C.S. LTD.**

En Harod Ihud 1896000, Israel  
Tel: 972-4-6530800  
Fax: 972-4-6532424  
E-mail: [marketing@ricor.com](mailto:marketing@ricor.com)  
Web Site: [www.ricor.com](http://www.ricor.com)



**Ricor Systems** is a world-leader in innovative cooling technology for, military defense, homeland security, space and semiconductors, commercial and scientific equipment industries. **Ricor** develops, manufactures and markets a wide range of advanced products and solutions. Based on Stirling Cryogenic Cooling technologies, **Ricor** offer tremendous flexibility, servicing cooling power needs ranging from a fraction of a Watt up to 15W and temperatures from 35K to 200K and input power consumption under 2W.

## Meeting the Needs of an Evolving World



### BATTLE-PROVEN PRODUCTS FOR MILITARY & DEFENSE APPLICATIONS

Ricor's comprehensive range of Miniature Cryocoolers solutions meets the operational needs and challenges of a wide variety of forces and scenarios. From weapon sights and night vision, through coastal security, to aircraft protecting systems and thermal imagers. Ricor's Miniature Cryocoolers are designed for varies devices and application. We provide SWAP cryocoolers for HOT infra-red detectors, long life cryocoolers and robust high-cooling power cryocoolers for high-end systems and detectors. All Ricor products are manufactured according to SWAP – ensuring compact size, weight and low power consumption.

### DE LONG LIFE 24/7 RELIABILITY FOR CONTINUOUS OPERATION HOMELAND SECURITY PRODUCTS

The rising risk of international terrorism and repeated terrorist attacks have prompted calls for greater global security from societies throughout the world. Against this backdrop, new technologies have a key role to play, from systems to ensure security in urban areas with high population density, to the protection of sensitive sites such as museums, military installations and research establishments. Ricor's have developed a set of Miniature Cryocoolers that suite the most advance, reliable and update homeland security solutions.



# SENSO-OPTICS LTD. - VISUAL INFORMATION & THERMAL IMAGING SOLUTIONS

**SENSO**OPTICS  
SENSING YOUR TARGET

## SENSO-OPTICS LTD.

P.O.Box 600  
Hi-Tec Park  
Yokneam 2069207, Israel  
Tel: 972-4-9935527, 972-73-2004450  
Fax: 972-4-9935894, 972-4-9590962  
E-mail: [info@sensio-optics.com](mailto:info@sensio-optics.com)  
Web Site: [www.sensio-optics.com](http://www.sensio-optics.com)

**Sensio-optics Ltd.** is an electro-optical private company, founded in Israel in 2004.

**Sensio-optics** concentrates on uncooled LWIR thermal technology to develop, manufacturing & delivery of advance Electro-Optical IP Products & systems for customers around the world for Day/Night/All-weather vision in the military, HLS & civilian markets (e.g. commercial aviation & automotive markets).

**Sensio-optics** developed and delivers high sensitive, high-End uncooled thermal cameras with NETD  $\leq 15\text{mk}$  (sensitivity performance as good as a Cooled Thermal Camera!), qualified to Military & Aviation standards.

**Sensio-optics** invested substantial resources in the last few years into research & development of its **HOLY-GRAIL - World's first high-resolution thermal ASIC (Thermal "CAMERA-ON-CHIP")** a miniature thermal camera that enables highest performance in lower price & size (SWAP). These unique state-of-the-art systems, based on **Sensio-optics'** thermal ASIC, represents a breakthrough technology and it is an essential step forward to WLP (Wafer-level packaging) technology in the thermal detectors evolution, in order to get lower price tag and higher performance.



# ELECTRO-OPTICAL TEST SYSTEMS FOR FIELD & DEPOT



## CI SYSTEMS LTD.

P.O.Box 147  
Industrial Park Ramat Gabriel  
Migdal Haemek 2310101, Israel  
Tel: 972-4-6448888  
Fax: 972-4-6543570  
E-mail: market@ci-systems.com  
Web Site: www.ci-systems.com

CI Systems develops, manufactures, markets and services sophisticated electro-optical test and measurement systems primarily for the design, testing and maintenance of military electro-optical systems. CI's experience over the years has gained it a reputation as a reliable partner in the Worldwide defense programs.

### ILET (Intermediate Level Electro-optical Tester)

- Compact and ruggedized athermal design.
- Accurate at a wide ambient temperature range.
- Easy to use.
- Capable of automatic operation (with added PC and AFT software).

### FTC - Field Test Colimator

- Objective "0" level Go/No Go FLIR testing.
- Light weight and portable self contained miniature collimator.

### OLT - O Level Laser Tester

- Objective O level laser tests.
- Lightweight and portable.

### CI's products provide:

- Field and depot level maintenance staff with test equipment to ensure maximum operational readiness.
- Developers of night vision equipment, FLIRS, Lasers, day sight, multi spectral systems and other sophisticated electro-optical systems.
- Defense contractors with comprehensive test systems to ensure high quality, repetitive, reliable and fast testing.

**CI's METS (Modular Electro-optical Test System) is a fully integrated system mainly used for depot level.**

### Its main features are:

- Wide spectral range and apertures
- Superior optical quality, temperature resolution and accuracy.
- Modular design to meet the specific needs of customers.
- Easy to operate advanced software package (AFT) to automatically perform MTF, NETD, MRTD, SiTF, etc. tests.
- User friendly optical alignment to Unit Under Test.
- Built to test visible (CCDs) to Far IR FLIR systems.





# EO SENSING SOLUTIONS: INSTRUMENTATION, MEASUREMENTS AND MODELING



**IARD**  
**Sensing Solutions Ltd.**

Yagur 3006500, Israel  
Tel: 972-4-8216402  
Fax: 972-4-8216396  
E-mail: [info@iard.co.il](mailto:info@iard.co.il)  
Web Site: [www.iard.co.il](http://www.iard.co.il)

IARD Sensing Solutions develops manufactures and markets radiometers, proprietary electro-optical instrumentation and custom built electro-optical systems. IARD also provides Research, Development and Measurement services in the fields of EO Signatures, Radiometry and Remote Sensing. The services include development of physical and mathematical models in the fields of heat engineering, gas dynamics of hot multi-phase flows and electro-optics.

## Products:

### Radiometers:

A family of fast multi-channel radiometers which are capable to perform simultaneous radiometric measurements in up to 4 channels to choose from the UV, VIS, NIR, SWIR, MWIR, LWIR with high sensitivity and speed (up to 250K samples per second). It satisfies the requirements of scientists and engineers who need to measure the signatures of fast transients phenomena from close (meters) and large (>100 km) distances. The radiometers are all fully computer controlled via USB interface with 16 bit data acquisition integrated in the radiometer. The family of radiometers includes the following products:

- ◆ **ColoRad**: the perfect tool for performing field measurements with high sensitivity in up to 4 user-defined spectral bands.
- ◆ **Orion**: Dual band, compact, fast radiometer. Used as a stand alone radiometer or as an add-on to slow imaging devices or spectro-radiometers for measurements of fast transients.
- ◆ **MicroRad**: Compact Single channel radiometer. Supports a wide range of spectral bands. The radiometer can be used for EO systems calibration and other various applications.

### OFRI:

Real Time Observation Range Enhancer. Ideal for surveillance systems and all outdoor imaging applications. Compact, simple to use, Stand-alone unit enhances the observation range by up to 3 times in bad weather conditions. Accepts any standard analog video input in the Visible, NIR, SWIR and Thermal IR spectral bands. Based on a sophisticated physical model, OFRI reverses the image degradation caused by atmospheric absorption and path radiance (airlight), thus achieving outstanding results.



### DBS:

Dual band CCD camera for detection applications. The DBS enhances spectral differences between the target and its background. Applications include detection of camouflage nets, missile plumes, water stress in vegetation; authenticity verification and many more.



# ELECTRONIC COMPONENTS & SUB-SYSTEMS



## The Core of Israel's High-Technology Industry

Defense electronics have evolved into a highly sophisticated field of activity in Israel, with defense companies rated among the country's leading high-tech industries. The field is attracting highly experienced engineering and scientific talents from academic, military, intelligence, research and development branches. Some of Israel's defense electronics firms have grown into world-leading enterprises, offering a broad range of high-tech products for defense and security as well as for commercial applications.

Others have specialized in specific fields, including communications security (COMSEC) and encryption, high speed datalinks over terrestrial, aerial and satellite communications, electronic intelligence, navigation, positioning and timing, sensors signal processing and display technology.

Israeli technologies are often integrated into larger systems offered by local defense industries or with foreign system integrators, where Israeli systems are available free of ITAR restrictions.

Israel-bases specialist industries are also providing state-of-the-art subsystems ranging from components for thermal sensors-from detectors and coolers to complete 'engines', and subsystems for imaging systems. Others are specializing in gyro stabilization and servo systems, miniature motion systems and micro-electro-mechanical systems (MEMS). Other product lines include acoustic and seismic sensors, along with rugged electronics, special-purpose displays for ruggedized military systems.

Different components employing high-density batteries miniature, safe-and-arm systems and fuses, hardened electronic assemblies, sensors and power supplies are also available for weapon type applications. Specialized product ranges include space-qualified systems designed to meet the harsh operating conditions in outer space.

All these are only few examples of Israel's wide range of electronic components and subsystems.

**AL CIELO  
INERTIAL SOLUTIONS LTD.**

5 Nahum Hefzadi St.,  
Jerusalem 9548401, Israel  
Tel: 972-2-6595539  
Fax: 972-2-6541221  
E-mail: [info@alcielo.com](mailto:info@alcielo.com)  
Web Site: [www.alcielo.com](http://www.alcielo.com)

## Al Cielo – Navigation and Control Inertial Sensors

Al Cielo applies unique, advanced fiber-optic technologies to a growing range of inertial control and navigation solutions.

Al Cielo's commitment is to exploit significant innovation and manufacturing resources for solutions that deliver a clear competitive edge to customers.

With over 40 patents, world class facilities and a decade of experience in development and manufacturing of

electro and fiber optical systems, Al Cielo now brings measurable advantages to Fiber Optic Gyroscopes (**FOG**), Inertial Measurement Units (**IMU**) and Inertial Navigation Systems (**INS**).

Today, Al Cielo is the only local supplier in Israel for closed loop FOGs with sensors engaged in a variety of navigation and control applications.

### Applications

- ▼ Navigation
- ▼ Missile and torpedoes guidance
- ▼ Flight controls
- ▼ UUV/UAV guidance and control
- ▼ Gyro compassing / Target acquisition systems
- ▼ Camera/Mapping
- ▼ AHRS
- ▼ Motion compensation
- ▼ EO/FLIR/Radar stabilization
- ▼ Line-of-sight tracking / Precision pointing

### Advantages

- ▼ Superior precision
- ▼ True "solid state" system without moving parts, dither or gaseous cavities, ensuring long reliable shelf and usage life.
- ▼ Bandwidth which enables gimbal stabilization and motion Compensation in dynamic environments.
- ▼ Best performance to volume ratio
- ▼ Best performance to price ratio
- ▼ Optional customization for specific applications
- ▼ Utilizes the latest telecommunication technology



# NORTH FINDING SYSTEMS

**arazim**

## ARAZIM LTD.

4 Hamelacha St.,  
P.O.Box 9021  
Lod 7117001, Israel  
Tel: 972-8-9230555  
Fax: 972-8-9230044  
E-mail: info@arazim.com  
Web Site: www.arazim.com

# North Finding Systems

## GNSS-Based

### ArSys®

- ❖ Hybrid GNSS/INS solution for Dynamic Applications
- ❖ Heading Accuracy < 3mRad
- ❖ Roll/Pitch Accuracy < 4mRad
- ❖ Update Rate - 100 Hz
- ❖ Full Mil-Spec compliance



### HPLS®-2G

- ❖ Static Applications
- ❖ Heading Accuracy  
< 0.1° for 1 meter antenna separation  
< 0.05° for 2 meter antenna separation
- ❖ Roll/Pitch Accuracy < 0.25°
- ❖ Update Rate - 20 Hz
- ❖ Full Mil-Spec Compliance



# LAND AND AIRBORNE NAVIGATION SYSTEMS



Israel Aerospace Industries Ltd.  
Systems Missiles & Space Group, TAMAM Division

## TAMAM DIVISION

P.O.Box 75  
Industrial Zone  
Yehud 5610001, Israel  
Tel: 972-3-5315205  
Fax: 972-3-5315140  
E-mail: infotmm@iai.co.il  
Web Site: www.iai.co.il/tamam

### Tamam Portfolio includes:

- Land-navigation and reference systems.
- Strap-down inertial reference and navigation systems.
- Airborne inertial navigation systems.
- Gyros and accelerometers (inertial; semi-inertial) free gyros; rate gyros.

### LAND NAVIGATION SYSTEMS

**AMAPS/TMAPS** - AMAPS and TMAPS are third generation, small-size, integrated, survey and target acquisition systems for autonomous ground indirect fire units, survey, air defense and any other type of military unit that requires continuous and highly accurate azimuth and position data.

AMAPS and TMAPS provide continuous and accurate azimuth, elevation and location data, enabling simultaneous positioning and pointing for Self Propelled Guns (SPG), missiles or rocket launches. AMAPS and TMAPS are compatible with MIL-D-70789A (MAPS) and Tamam's GONS/LANS family of inertial land navigation systems, allowing a smooth transitioning system upgrading.

**VGLPS** - Vehicle Gun Laying & Positioning System VGLPS is a hybrid autonomous high precision land navigation, gun laying and target acquisition system.

The VGLPS performance, which is based upon the TMAPS, is suitable for artillery deployment and forward observation applications.

VGLPS uses the navigation data from the TMAPS so all the inertial data is constantly available. VGLPS provides the vehicle's own position coordinates, the observation line of sight Azimuth and the gun or targets coordinates.

**RNAV/RNAV-IPON** - RLG based Terrain Navigation System. Tamam's Ring Laser Gyro (RLG) based Reference and Navigation System (RNAV) fits all types of tracked and wheeled platforms (Rocked Launchers, tanks, self-propelled air-defense vehicles, Mobile Mortars, APCs etc.). This small lightweight, self-contained and fully qualified system offers Hybrid (Inertial/GPS integrated) Position and Azimuth determination.

**ADNAV** - Advanced Navigation System  
Affordable, FOG based land navigation system for tanks, APC and other land vehicles.

### AIRBORNE NAVIGATION SYSTEM

**TNL-16G** - RLG based Airborne Inertial Navigation system. TNL-16G is a Ring Laser Gyro (RLG) based small, lightweight, GPS aided, inertial navigation system. The TNL-16G utilizes three 16 cm. path length RLG and three high accuracy Accelerometers. The TNL-16G contains and embedded GPS receiver (external GPS is optional).

**TRF-90** - FOG based miniature Inertial Measurement Unit (IMU) A small, lightweight, strap down IMU. Based upon open-loop Fiber Optic Gyro (FOG) technology. The unit's modular design allows for easy adaptation for various configurations.

**TNF** - FOG based miniature attitude, heading and reference system (AHRS) for Aircraft, Helicopters and UAVs.

#### Applications for Airborne Navigation Systems

- Guided missiles and smart munitions
- Guided Artillery projectiles
- Unmanned aerial vehicles
- Optronic and targeting systems
- Instrumentation pods
- Antenna stabilization
- Radar Stabilization
- Vertical Gyro Unit (VGU)



# NAVIGATION SYSTEMS

## INS for Aerial and Land Tactical Vehicles



**RADA Electronic Industries LTD.**

P.O.Box 8606  
7 Giborei Israel Blvd.,  
Netanya 4250407, Israel  
Tel: 972-9-892-1111  
Fax: 972-9-885-5885  
E-mail: [mrkt@rada.com](mailto:mrkt@rada.com)  
Web Site: [www.rada.com](http://www.rada.com)



RADA Electronic Industries Ltd. is offering a broad range of advanced – yet affordable - Inertial Navigation Systems, designed for Aerial and Land Tactical Vehicles. RADA's navigation solutions introduce sophisticated and unique sensor fusion algorithms, and embed modular design principles leading to minimal integration efforts into larger mission systems. The compact, reliable and affordable INS are applicable to manned and unmanned platforms, and to expendable applications. Among RADA's customers are air forces and prime integrators worldwide.

### **RADA's families of navigation solutions are the following:**



#### **The FOG Family:**

A high precision, tactical-grade, Embedded GPS-INS (EGI) solutions, applicable for aircraft, helicopters and ground combat vehicles. The EGI is based on modern, precise and reliable Fiber-Optical Gyro (FOG) sensors.



#### **The MEMS Family:**

An extremely compact, highly reliable and affordable Inertial Navigation System (INS), embedding inertial MEMS sensors, 16-channel GPS, air pressure sensors and 3-axis magnetometer, providing multi-sensor aided navigation solution.



#### **The Inertial Measurement Unit (IMU) Family:**

FOG-Based, state-of-the-art, IMU and AHRS solutions.

# MILITARY INVENTORY





## Affordable Defense- New Life for the Older Weapons

Israel's defense forces (IDF) are prepared for action to meet the challenges presented by any threat. Maintaining such readiness levels requires all weapon systems to undergo constant modernization and upgrading, in order to prolong their lifespan. It also requires stocking large quantities of ammunition and spare parts, to ensure adequate logistic supplies required to support the combat forces in times of war.

When existing hardware is phased out and replaced by newer systems, those original weapons may still be valuable for others. Such systems are offered as military inventory. Recently, the IDF is phasing out earlier generations of weapon systems, releasing relatively advanced Aircraft, Helicopters, Main Battle Tanks and Naval Vessels. Those platforms are offered to friendly nations seeking to obtain such reliable, well-maintained military systems that can meet customer requirements.

These weapon systems and platforms can be exportable as Total Package Approach including spare parts, maintenance, training and repair shops. All systems offered are combat proven and operated by the IDF. Most of the equipment has already been upgraded to the use of modern combat environment. Within the full package provided, equipment can be purchased at its current status, or upgraded to meet the customer's requirements.

Another field of activity offered by the Ministry of Defense and the Israel Air Force are training services. Among these services are simulators and training systems related to all generations of F-16 - from A/B, C/D to the latest block 50/52 versions, and F-15 aircraft, UH-60 and CH-53 type helicopters. Training services are not limited to simulation-foreign air forces visiting Israel are offered combat training, using instrumented ranges that also serve developmental testing of various weapon systems.

# MILITARY EQUIPMENT SALES DIVISION

**סיבט**  
**SIBAT**

**SIBAT - Israel Ministry of Defense**

**International Defense Cooperation**

Hakiryia, Tel Aviv 6473424, Israel

Tel: 972-3-6975754, 6977207

Fax: 972-3-6976724

E-mail: [sibat\\_bic@mod.gov.il](mailto:sibat_bic@mod.gov.il)

Web Site: [www.sibat.mod.gov.il](http://www.sibat.mod.gov.il)

The **Military Equipment Sales Division** in SIBAT is in charge of marketing and sales of military systems and equipment that are either excess inventory, surplus or phased out.

**We offer a Total Package approach:**

- Equipment: Air Force, Navy and Land Forces
- Upgrading of systems
- Spare parts
- Logistic support (ILS)

The Division consists of six professional departments. The first is the Business Development department which is responsible for international marketing, new customers, business information and strategic issues. Two departments are corresponding to the military branches: Land, Air and Naval, Communications and Optronics. They specialize mainly in military equipment. The other two departments specialize in Dual Use equipment as detailed below.

**The departments offer equipment in the following categories:**

- Land -** Tanks, Armored vehicles, Trucks, Infantry weapons, ammunition and medical equipment.
- Air -** Aircraft, Airborne systems, Missiles, Radars, Armament and Ammunition.
- Naval -** Vessels, Weapon systems.
- Communication & Optronic -** Tank Driving Simulator, Tank Gunnery Training System, Armored Combat Vehicle Optics, Personal Optics, Night Vision Magnifiers, Radars, P.R.C. and V.R.C. Flight Simulators, Airborne Systems.
- Scrap -** Metallic (Ferrous and Non - Ferrous), Non - Metallic.
- Dual Use equipment -** Including engines, generators, hardware, tools, petrolume products, construction equipment, office equipment.
- Vehicles -** Variety of Vehicles.

The Division engages in a variety of sales forms including: itemized, negotiation of packages and of main platforms, long - term revolving contracts and Tenders.

**For detailed information, Please refer to the Procedures and Regulations page.**



# PROCEDURES AND REGULATIONS



**SIBAT - Israel Ministry of Defense**  
International Defense Cooperation  
Hakiryia, Tel Aviv 6473424, Israel  
Tel: 972-3-6975754, 6977207  
Fax: 972-3-6976724  
E-mail: [sibat\\_bic@mod.gov.il](mailto:sibat_bic@mod.gov.il)  
Web Site: [www.sibat.mod.gov.il](http://www.sibat.mod.gov.il)

Purchases are executed in accordance with Israeli Ministry of Defense (IMOD) procedures and regulations.

Purchases are subject to the approval of an IMOD internal committee.

A major portion of the purchasable equipment is of non-Israeli origin. Hence, a relevant Re-Export License should be obtained by IMOD before any sale is finalized.

Buyers are required, from time to time and according to the nature and origin of the equipment, to submit to IMOD an original End Use / End User certificate, before sale is finalized.

Purchases are based on a signed contract between IMOD and the Buyer.

Purchasable equipment is usually offered "As is Where is" condition. Nevertheless, inspection visits are welcomed.

Purchases are 'Ex-Base' (INCOTERMS, 2000). Inland transportation and shipping are usually footed by the Buyer.

Purchases can be on the basis of an upgrade program.

Inquiries for items should be made by citing NSN or Part Numbers.

SIBAT's approach is discrete as pertains to security. It adheres to norms binding government employees and commercial confidentiality.

Information concerning the various purchasable items is valid as at the date of publication and is subject to changes.



# ARMY EQUIPMENT FOR SALE

**סיבט** **SIBAT**

**SIBAT - Israel Ministry of Defense**  
International Defense Cooperation  
**Land Sales Division**  
Hakiryia, Tel Aviv 6473424, Israel  
Tel: 972-3-6975754, 6977207  
Fax: 972-3-6976724  
E-mail: [sibat\\_bic@mod.gov.il](mailto:sibat_bic@mod.gov.il)  
Web Site: [www.sibat.mod.gov.il](http://www.sibat.mod.gov.il)

SIBAT is proposing for sale combat-proven equipment and offers:

Combat Ready Tanks -  
Phased Out  
Upgrading - Active & Surplus  
**Total Package Approach:**  
Equipment  
Logistic Support

**Equipment includes:**  
Battle Tanks  
(Western & Eastern origin)  
Armored Vehicles  
Infantry Weapons  
Ammunition  
Communication  
Spare Parts

**For additional information please contact:**

**SIBAT**  
**Land Sales Division**



M60 A1/A3 Patton Battle Tank

# M60A3

## MAIN BATTLE TANK



**SIBAT - Israel Ministry of Defense**  
**International Defense Cooperation**  
**Land Sales Division**  
 Hakiryia, Tel Aviv 6473424, Israel  
 Tel: 972-3-6975754, 6977207  
 Fax: 972-3-6976724  
 E-mail: [sibat\\_bic@mod.gov.il](mailto:sibat_bic@mod.gov.il)  
 Web Site: [www.sibat.mod.gov.il](http://www.sibat.mod.gov.il)

DATA	IDF M60A1	IDF M60A3
<b>General Description</b>		
Combat-Ready Weight (metric ton)	52.5	53
Length (m)	9.44	9.44
Height (m)	3.29	3.29
Width (m)	3.64	3.64
Fuel (liter)	1457	1457
No. of Crew Members	4	4
Armor	Add-on	Add-on

Development of the US built M-60 A3 Main Battle Tank began in the 1970s, with the first production units rolling off the assembly line at the Chrysler Factory (now General Dynamics Land Systems) in 1979. The M-60A3 entered operational service with the IDF in the early 1980s and underwent subsequent upgrading based on the vast experience, which it has accumulated in armored warfare. The upgraded IDF M-60 A3 features an improved fire control system as well as increased armor protection. Moreover, the loader/radio man has been provided with both a mortar and machine gun for enhanced defensive capabilities against infantry tank killing teams.



# AIR FORCE EQUIPMENT FOR SALE

**סיבט** **SIBAT**

**SIBAT - Israel Ministry of Defense**  
International Defense Cooperation  
**Air Sales Division**  
Hakiryia, Tel Aviv 6473424, Israel  
Tel: 972-3-6975754, 6977207  
Fax: 972-3-6976724  
E-mail: [sibat\\_bic@mod.gov.il](mailto:sibat_bic@mod.gov.il)  
Web Site: [www.sibat.mod.gov.il](http://www.sibat.mod.gov.il)

The Israel Air Force is releasing from its active inventory combat-proven equipment and offers:

## Total Package Approach:

Equipment  
Logistic Support

## Equipment includes:

Aircrafts  
Airborne Systems  
Armament / Ammunition  
Missiles  
Radar Systems  
AA Defence Systems  
Spare Parts

## For additional information please contact:

**SIBAT**  
Air Sales Division



MD-500 DEFENDER



AH-1 COBRA



C-130 HERCULES



TZUKIT



KFIR



A-4 SKYHAWK



F-16 FIGHTING FALCON A/B

# TZUKIT

## KFIR



**SIBAT - Israel Ministry of Defense**  
 International Defense Cooperation  
**Air Sales Division**  
 Hakiryia, Tel Aviv 6473424, Israel  
 Tel: 972-3-6975754, 6977207  
 Fax: 972-3-6976724  
 E-mail: [sibat\\_bic@mod.gov.il](mailto:sibat_bic@mod.gov.il)  
 Web Site: [www.sibat.mod.gov.il](http://www.sibat.mod.gov.il)

### TZUKIT

The Tzukit was the standard trainer of the IAF from 1980-2010. It is a fully modified version of the CM-170 Fouga Magister, upgraded for maximum flight and maintenance efficiency.

The Tzukit has a single mid-wing, two cockpits in tandem, three-point landing gear, V-shaped tail assembly and carrier its engines in the wing roots.

This aircraft can be used for primary, basic and advanced training and can also be used for light bombing and ground support missions. Also, the Fouga is cherished as a recreational aircraft and may be sold as such.

Fouga Magister (Tzukit)	
Platforms for Sale	25
Engine Type	Marbore VI



### KFIR

The Israel Aerospace Industries Kfir is an all-weather, multi-role combat aircraft with Israeli avionics and an Israeli-made version of the GE J79 turbojet engine.

The Kfir has outstanding agility, high instantaneous and sustained turn rates, and excellent low speed flight characteristics. It's ruggedness and dependability make the Kfir a tough opponent in the air-to-air combat arena.

The aircraft has been warmly integrated into several air forces around the globe.

Platforms for Sale	25
Engine Type	J-79



# A-4-N/T SKYHAWK

The A-4-N/T SKYHAWK is a multi-role fighter aircraft. Its unique features have been proven in air-to-surface strikes and in air-to-air combats.

One of the best trainer aircraft, Skyhawk is a reliable, low-cost, high performance training platform that operated successfully in many air forces worldwide.

The A-4 was originally designed for air-to-ground strikes. One of its most important features is weight carriage ability, and its ordnance capability.

Its air refueling and tank carrying abilities extend its operational radius and its small dimensions make the airplane very easy to fly and highly maneuverable.

Thousands of young pilots have trained on A-4 during their first years as pilots in the IAF and worldwide. The A-4 was designed for carrier landings as the US Navy aircraft and can withstand very tough landings.

The aircraft also uses a drug chute system, which enable to land on short runways.

The A-4 can also be used as a small tanker and refueling, with the addition of a special fuel tank.

## General Characteristics

**Primary function:** Attack bomber, trainer

**Builder:** McDonnell Douglas

**Crew:** One pilot/Two pilots

## Dimensions

Length	41.72 ft (12.72 m)
Wingspan	27.50 ft (8.38 m)
Height	14.98 ft (4.57 m)
Wing area	260 ft <sup>2</sup> (24.2 m <sup>2</sup> )

## Weights

Empty	10,684 lb (4,808 kg)
Max take off	27,400 lb (12,330 kg)
Fuel capacity	Internal: 807 gallons (5,400 lb) External: 1,000 gallons
Max payload	1000 lb (4,500 kg)

## Propulsion

Power plant	One Pratt & Whitney j-52
A4N	P408 turbo jet engine
A4T	P8 turbo jet engine
Thrust	11,200 lb

## Performance

Max level speed	At altitude: 595 mph (955 km\h) at 34,000 ft At sea level : 700 mph(1,130 km\h)
Max altitude	45,000 ft
Range	Typical : 800 nm(1,480 km) Ferry: 1,790 nm(3,310 km)

## Armament

Gun	Two DEFA 552\553 30-mm cannons (150 rounds each)
Stations	5 external hard points
Air- to-Air Missile	AIM-9 Sidewinder, Shafrir
Air to Surface Ordnance	MK-82 / MK-83

## IAF Improvements

IAF improvements implemented in the A-4 include:

- j-52P408 engines, which are the most powerful engines installed in any A-4 model
- 30mm DEFA cannons
- Unique installation of tail pipe extension against IR missiles. The tail extension reduces the aircraft IR signature making it less vulnerable



**SIBAT- Israel Ministry of Defense  
International Defense Cooperation  
Air Sales Division**

Hakiryia, Tel Aviv 6473424, Israel  
Tel: 972-3-6975754, 6977207  
Fax: 972-3-6976724  
E-mail: sibat\_bic@mod.gov.il  
Web Site: www.sibat.mod.gov.il

**Avionics Systems Upgrade**

The Upgrade avionics package is tailored to the customer’s need and in general can include:

- A glass cockpit, which provides the pilot with the relevant information for the specific mission, displayed on the Head-Up Display (HUD)
- Ring Laser Gyro Inertial System with an embedded GPS  
This allows precise navigation and bombing capability
- Easy operation implementing the Hand-On Throttle and Stick (HOTAS) and Head Up concept

**Support and Potential Improvement**

- Aircrew training
- Technical qualifications training
- Technical documentation
- Operating guidance
- Spare parts package
- Aircraft systems upgrades - Mission planning briefing and debriefing system
- Munitions
- Advanced modification and improvements implemented
- High quality standards in use and maintenance of the platform
- Offering a “package” including training and qualification for aircrews and technical crews, flight simulators, spare parts and potential upgrades



<b>A-4 Skyhawk (Ayt)</b>	
Platforms for Sale	40
Engine Type	J-52
Engines for Sale (in addition to those installed on platform)	10

# C-130 HERCULES

## F-16 FIGHTING FALCON A/B



**SIBAT - Israel Ministry of Defense**  
**International Defense Cooperation**  
**Air Sales Division**  
 Hakiryia, Tel Aviv 6473424, Israel  
 Tel: 972-3-6975754, 6977207  
 Fax: 972-3-6976724  
 E-mail: sibat\_bic@mod.gov.il  
 Web Site: www.sibat.mod.gov.il

### C-130 HERCULES

The Lockheed C-130 Hercules is a four-engine turboprop military transport aircraft designed and built by Lockheed Martin. Capable of using unprepared runways for takeoffs and landings, the C-130 is one of the world's primary troop, medical evacuation, and cargo transport aircraft.

Two of the aircrafts for sale were retired in 2005, and the third in 2009.

Still in use in Israel, in addition to the platforms for sale, the IAF offers engines and spare parts for sale as well.

C-130 Hercules (Karnaf)	
Platforms for Sale	7
Engine Type	T-56

### F-16 FIGHTING FALCON A/B

With over 20 years of service in the IAF, the F-16 A/B Netz is a light multi-role fighter jet. The Fighting Falcon is a dogfighter with numerous features including a frameless bubble canopy for better visibility, side-mounted control to ease control while under high G-forces, and reclined seat to reduce the effect of G-forces on the pilot.

In the IAF, this aircraft has been used for a wide range of tasks and is especially recommended as an aggressor force.

F-16 FIGHTING FALCON A/B	
Platforms for Sale	40
Engine Type	F-100



# AIR DEFENSE SYSTEMS

**סיבט** **SIBAT**

**SIBAT - Israel Ministry of Defense**  
International Defense Cooperation  
**Air Sales Division**  
Hakiryia, Tel Aviv 6473424, Israel  
Tel: 972-3-6975754, 6977207  
Fax: 972-3-6976724  
E-mail: [sibat\\_bic@mod.gov.il](mailto:sibat_bic@mod.gov.il)  
Web Site: [www.sibat.mod.gov.il](http://www.sibat.mod.gov.il)

## HAWK MISSILE SYSTEM

The Hawk System is an all-weather missile system which provides defense on wide ranges or specific targets against fast moving planes in low to medium altitude, suspended helicopters, and short-range ground-to-ground missiles.

- The system receives and transfers aerial images by means of ATDL communication data.
- The system includes a PCP Command Post which commands the process of deployment, CWAR radar detection, HPI Doppler radar, and 6 launching pads – each equipped with 3 missiles.
- Currently 7 systems are available for sale
- All systems include: Control center, search radar & locking and tracking radar, launchers, missiles, spare parts and relevant equipment.



## M-163-A1

lightweight mobile 20mm 6-barrel cannon, effective defense against low - flying aircraft and ground targets.

# HELICOPTERS



**SIBAT - Israel Ministry of Defense**  
International Defense Cooperation  
**Air Sales Division**  
Hakiryia, Tel Aviv 6473424, Israel  
Tel: 972-3-6975754, 6977207  
Fax: 972-3-6976724  
E-mail: [sibat\\_bic@mod.gov.il](mailto:sibat_bic@mod.gov.il)  
Web Site: [www.sibat.mod.gov.il](http://www.sibat.mod.gov.il)

## AH - 1 COBRA

The Bell AH-1 Cobra is a two-bladed, single engine attack helicopter manufactured by Bell Helicopter. Capable of special day and night flight and highly effective in joint operations with land forces.

This helicopter was the backbone of the IAF's combat helicopter forces.

For countries interested in integrating the AH-1 into their forces, it is possible to receive technological upgrades with a local Israeli industry as well as the purchase of engines, spare parts and ILS.



AH-1 Cobra	
Platforms for Sale	8
Engine Type	T-53

## MD-500 Defender

This light multi-role utility helicopter is currently operated in several countries around the globe.

It contributed to Israel's successes in conflicts during the 1970s and 1980s, until its retire in the 1990s.

Today, the IAF still has a large inventory of spare parts.

This helicopter is popular among customers interested in small, capable anti-armor helicopters and for police and emergency response units.



MD-500 Defender	
Platforms for Sale	16
Engine Type	Allison 250 C20R

# SPARE PARTS

**סיבט** **SIBAT**

**SIBAT - Israel Ministry of Defense**  
International Defense Cooperation  
**Air Sales Division**  
Hakiryia, Tel Aviv 6473424, Israel  
Tel: 972-3-6975754, 6977207  
Fax: 972-3-6976724  
E-mail: [sibat\\_bic@mod.gov.il](mailto:sibat_bic@mod.gov.il)  
Web Site: [www.sibat.mod.gov.il](http://www.sibat.mod.gov.il)

## *The IAF has over 350,000 part numbers for sale!*

There are parts for platforms currently in use by the IAF as well as platforms no longer in use such as Bell 212, CH-53, F-4, F-15, F-16, C-130, MD-500, A-4, J-79 (Engine), Bell 206, E2C, HAWK, PATRIOT, M-163-A1 and more!



F-15



BELL 212



C-130



CH-53 (Stallion)



F-16

# ***SIMULATION TRAINING SERVICES***

The Israel Air Force (IAF) offers international air forces a full range of courses and training services on a broad spectrum of simulators. IAF training packages and services are customized to meet individual air force demands, and provide an extremely cost-effective method for preparing pilots and aircrews with optimum pre-mission preparedness. The following is a brief description of the proven performance simulators that are available:

## ***F-16A Simulator (Manufacturer: Link/1987) "NETZ"***

Trainer, simulating the fighter's systems, flight profiles, failures and malfunctions.

## ***F-16 A Simulator (NEW!! Manufacturer: Elbit Systems/Projected Operation: 2006) "NETZ"***

Trainer, simulating the fighter's systems, flight profiles, failures and malfunctions.

### **Functions and Features**

- Configuration and aerodynamic database: F-16A/Block 15, after falcon-up and special Israeli-made improvements
- 150° x 60° FoV (Field of View) finite display system on a partial dome
- Display system based on 3-channel TILTAN PCIG
- Aircraft Common: full avionics, flight instruments, cockpit panels, stick, throttle, pedals
- Full systems training for advanced, complex air-to-air and air-to-ground mission scenarios/ all aircraft malfunctions are simulated.
- Advanced after action review station

## ***F-16C Simulator (Manufacturer: Link/1987) "BARAK"***

Quality trainer, simulating the fighter's flight profiles, failures, malfunctions, and equipment. Veteran trainer, upgraded to conform to high quality performance.

## ***F-16I Simulator (Manufacturer: Lockheed martin) "SUFA"***

Quality trainer, simulating the fighter's flight profiles, failures, malfunctions, and equipment.

## ***F-15 Simulator (NEW!! Manufacturer: Lockheed Martin/2002) "BAZ/RAAM"***

The most advanced trainer for F-15AUP and F-15I fighters, simulating flight profiles, emergency situations, failures and malfunctions, instrumentation flights.

## ***A-4 Skyhawk Simulator (Manufacturer: Link/1970s) "AYIT"***

Trainers, simulating aircraft failures and malfunctions, emergency situations, flight profiles and instrumentation flights. Three simulators are available: two for the A-4 Skyhawk N; one for the A-4 Skyhawk T.

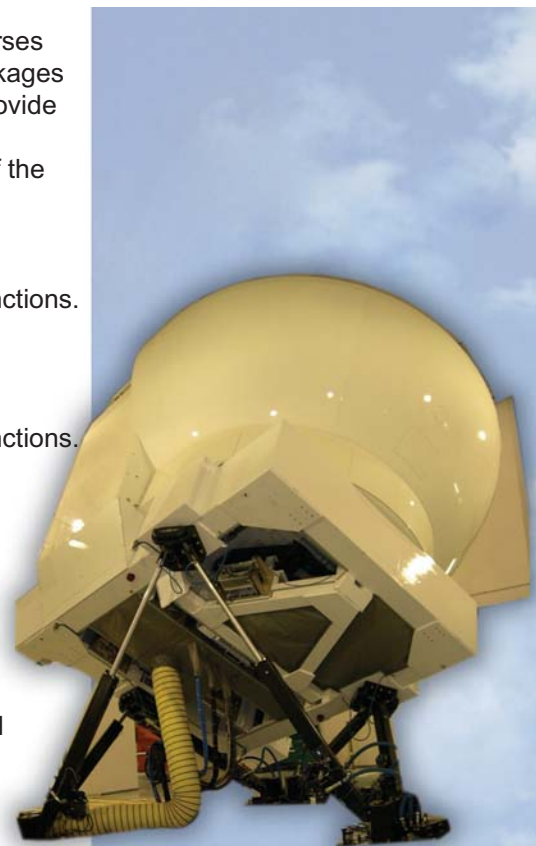

## **Blackhawk/ CH-53 "YASSUR" Simulator (NEW!! Manufacturer: CAE/2003)**

Cutting edge trainer, among the most advanced of its kind, for Blackhawk 3 (UH60) and Sikorsky 2000 (CH53) helicopters, simulating flight profiles, malfunctions, equipment, and providing unique pre-mission preparedness training - including training for mid-air refueling, landings in dust and Collaboration with naval vessels, payload hoists, low altitude flights.

## **Searcher 2 UAV Simulator**

Exceptional capabilities for comprehensive training: flight, deciphering, payload and communications systems operations. The simulator comprises the instructor's portable PC which runs the UAV simulation and includes the user interface, control module (the application that activates the simulator's scenario components), connection to the ground control station, in addition to a fixed display computer (PC) which runs the display application.

The simulator enables control of the UAV's location, atmospheric conditions, and inputting of malfunctions/faults. The special target control module allows real-time control of the target location.

## **EOT Electro-Optical Trainer**

Dedicated simulator provides electro-optical weapon operators with operational skills by presenting them with real battlefield conditions, enabling mission rehearsals for operations in enemy territory.

## **Unique Cognitive Stress Inoculation Training - Empowering Combat Forces, tailored to the specific needs and resources of the target population. Commanders run the program, aided by psychologists.**

instilled and take root, and achievements are generalized beyond a specific situation.

### **Advantages:**

- Helps soldiers deal with stress of war
- Sharpens performance/overcomes negative consequences
- Stress inoculation training can be also applied to work related stress of military personal during peace time



# COURSES



**SIBAT - Israel Ministry of Defense**  
International Defense Cooperation  
**Air Sales Division**  
Hakiryia, Tel Aviv 6473424, Israel  
Tel: 972-3-6975754, 6977207  
Fax: 972-3-6976724  
E-mail: [sibat\\_bic@mod.gov.il](mailto:sibat_bic@mod.gov.il)  
Web Site: [www.sibat.mod.gov.il](http://www.sibat.mod.gov.il)

## **The IAF offers a variety of training exercises and courses:**

Flight (Combat, Helicopter, Transport) Courses

Search and Rescue Courses

Air Traffic Control and CGI Courses

Medical and Stress Inoculation Courses

Other Unique Courses Developed in the IAF

**The IAF can provide courses in many subjects of interest.**

***Please contact us for information on specific training you would like to receive.***



# SERVICES



**SIBAT - Israel Ministry of Defense**  
International Defense Cooperation  
**Air Sales Division**  
Hakiryia, Tel Aviv 6473424, Israel  
Tel: 972-3-6975754, 6977207  
Fax: 972-3-6976724  
E-mail: [sibat\\_bic@mod.gov.il](mailto:sibat_bic@mod.gov.il)  
Web Site: [www.sibat.mod.gov.il](http://www.sibat.mod.gov.il)

## **MAINTENANCE & REFURBISHING**

Diverse capabilities of maintenance and refurbishing aircraft, systems and armament (O - level & D - level).

## **MILITARY EXPERIMENTS & DATA PACKAGES**

Different kinds of armaments (guided and nonguided bombs, rockets or missiles) air defense systems tests, airborne systems and ground systems (communications, radar, etc).

IAF laboratories service (chemical tests, environmental tests, etc).nvolves full cooperation of the IAF - operational, technical & logistical.

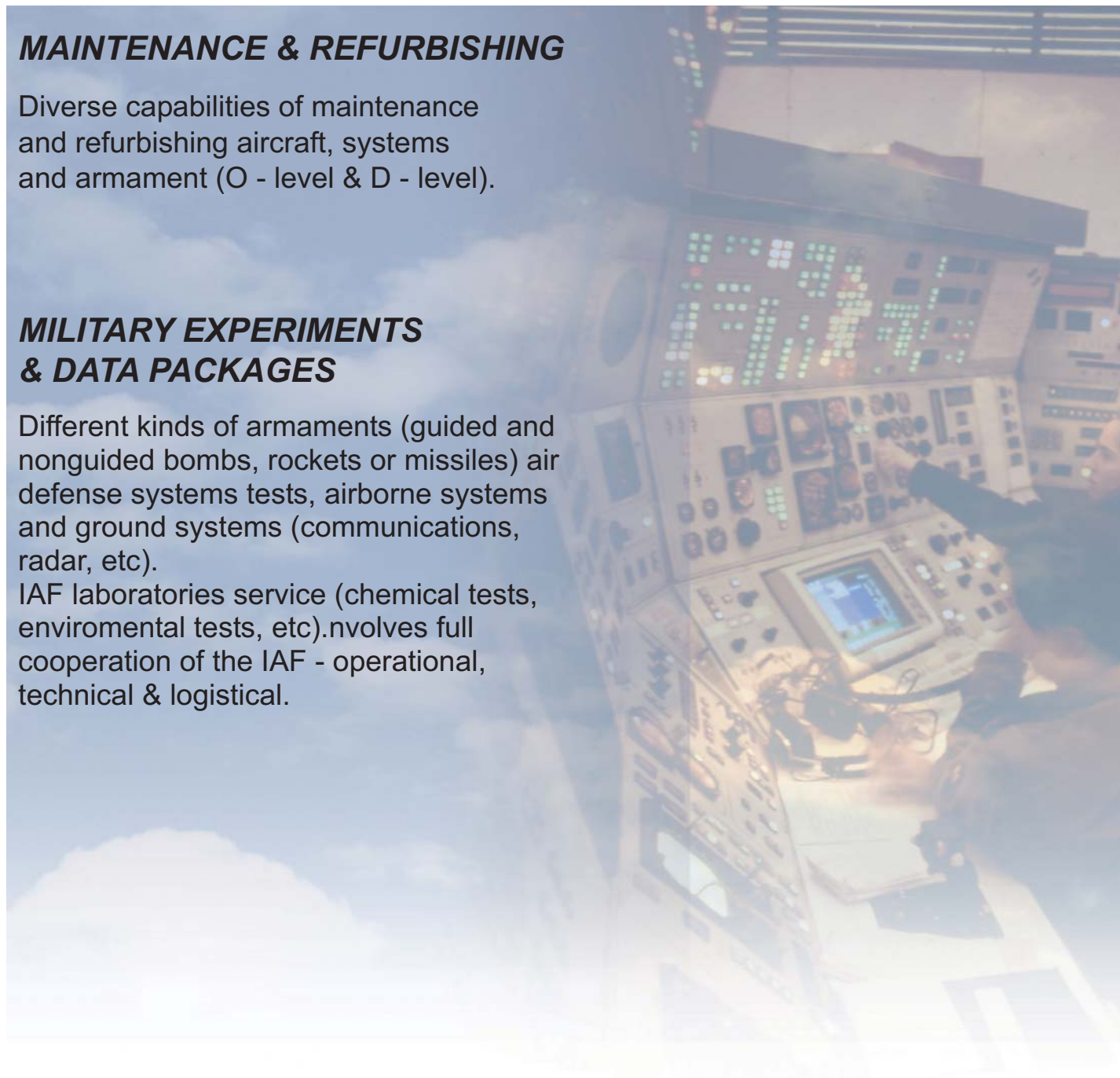

# SCRAP AND GENERAL SURPLUS



**SIBAT - Israel Ministry of Defense**  
International Defense Cooperation  
**General Equipment Division**  
Hakiryia, Tel Aviv 6473424, Israel  
Tel: 972-3-6975754, 6977207  
Fax: 972-3-6976724  
E-mail: [sibat\\_bic@mod.gov.il](mailto:sibat_bic@mod.gov.il)  
Web Site: [www.sibat.mod.gov.il](http://www.sibat.mod.gov.il)

## ***Metaalic scrap (Mostly Mixed)***

### Ferrous scrap

- Casted steel
- Casted iron
- Quality Hardened steel

### Non - Ferrous scrap

- Aluminum
- Copper
- Brass
- Bronze
- Titanium
- Lead
- Light and heavy alloys (Tungsten)

## ***Non - Metallic scrap (Mostly Separated)***

- Rubber
- Textile
- Plastic
- Wood

## ***Useable surplus***

- Cartridge cases (Brass)
- Electric Batteries
- Generators
- Rubber tubes
- Vehicles
- Construction equipment
- Plumbing equipment
- General equipment
  
- Petroleum Products : Oil, lubricant, grease
- Communication equipment
- Computer and peripheral equipment
- Screws
- Metal ring, cylinders and clamps.
- Hardware and Tools (including Electrical)
- Plant and general machinery equipment (Lathes)
- Electrical wiring
- Textile & clothing (Tarpaulin)

# "SAAR 4"

## FAST GUN BOAT



**SIBAT - Israel Ministry of Defense**  
International Defense Cooperation  
**Naval Sales Division**  
Hakiryia, Tel Aviv 6473424, Israel  
Tel: 972-3-6975754, 6977207  
Fax: 972-3-6976724  
E-mail: sibat\_bic@mod.gov.il  
Web Site: www.sibat.mod.gov.il

### General Characteristics

- Developed and built by Israel Shipyards Ltd. Based on the extensive experience of the Israeli Navy.
- Proven operational use by the Israeli Navy.
- ILS support, maintenance and training.
- Long endurance at sea.
- Gabriel Mk II missiles
- Guns- optional
- ASW

### Dimensions

- Overall length 58.1 m
- Maximum beam 7.62 m
- Mean draft (max. load) 2.80 m

### Displacement

- Full load 445 t
- Standard 390 t

### Speed

- Max. 33 kts
- Cruising 19 kts

### Operational range

- At 19 kts 4800 n.m.
- At 30 kts 2200 n.m.
- Seakeeping Up to state 5

### Detection and Navigation

- Surface/air search radar
- C&C system

### Weapon Systems

Optional

### Communication

Full range of HF, VHF, HVHF, UHF

### Machinery

- 4 MTU 16v 538 TB91 engines-
- Max. power- 3380 hp (per engine)
- 4 propellers
- Fuel consumption- 154gr./hp.h

### Anti-Submarine Warfare

VDS(optional)

### Safety and Damage Control

- Fire detection and extinguishing systems and equipment
- Life saving equipment

### Accommodation

- Provides separate quarters for Captain, officers and crew
- Air-conditioned

*Born of necessity*

*Developed by experience*



# CIVIL DEFENSE & CBRN PREPAREDNESS



## Defense Through Preparedness

With the growing risk of unconventional weapons proliferation, defense against Chemical, Biological and Radiological/Nuclear Explosive (CBRNE) threats is becoming more acute than ever before. Israel has been facing such threats for many years, and has established comprehensive means for the protection of its military and emergency units as well as the civilian population against Weapons of mass Destruction (WMD).

Today, Israel maintains one of the world's most advanced defense against unconventional attack.

Advanced protection equipment produced by Israeli CBRNE defense specialist companies includes individual protective systems for soldiers, CBRNE and reconnaissance decontamination specialists. Collective protection systems are produced for mobile applications, equipping combat vehicles of various types. Specialized CBRNE protection is also provided for emergency services such as medical points and emergency rooms in hospitals.

Furthermore, protection equipment is provided for operational facilities in a disaster zone or areas infected by CBRNE or other hazardous materials (HAZMAT), where complete collective ventilation and filtration systems are applied. These systems supply clean, fresh air to shelters, hospitals, schools, nurseries and kindergartens and retirement homes. The military uses such systems to protect command posts, tents and vehicles - allowing people to operate inside protected environments without gas masks or any other type of protective equipment.

In addition to the hardware and systems, local companies are able to provide consultancy, planning and training services to civil defense and homeland security establishments worldwide, based on the extensive experience gained by Israel's civil defense specialists.

More Civil Defense offerings from Israeli companies are available through the "Israel Homeland Defense Directory 2015–2016" also published by SIBAT.

# NBC-FILTRATION & AIR CONDITIONING SYSTEMS, VENTILATION, DUST & TOXIC SHOOTING FUMES FILTRATION



Certified Quality Assurance Program According to AQAP-2110



Beth-El Industries is a world leader in the development, design, and manufacture of filtration, ventilation, air conditioning, integration of turnkey projects, and other technologies for custom implementation into bomb shelters, vehicles, containers, and tents. Founded in 1973, Beth-El has supplied tens-of-thousands of systems to more than 60 armies worldwide, which include most of the NATO states, most of the European countries, as well as a large number of forces in the Far East and North / South America.

In the civil sector, Beth-El has furnished an equally large number of bomb shelter protection systems for critical infrastructure and tens-of-thousands of homes in Israel and abroad. Along with NBC protection, Beth-El produces isolation systems for the medical field and specialized protection systems for fire brigades and other civil services. A few of the key features of the Beth-El systems include coarse and fine dust filtration, carbon monoxide extraction, CAN-bus control, simple interface with Beth-El air conditioning systems, and compliance to all important military standards, such as NATO AEP-54, MIL-PRF-321387, AC 225 (Panel VII) D/251, and German TL standards, amongst others.

Beth-El's extensive experience, within multiple interrelated fields, includes the supply of ventilation & NBC filtration systems to vehicle manufacturers in over 120 different vehicle types. These platforms include the Piranha, Duro, and Eagle vehicles of MOWAG GmbH, the Boxer, Dingo, Mungo, GFF4, and other vehicles of Krauss-Maffei Wegmann GmbH & Co. KG, the Yak and Wiesent vehicles of Rheinmetall Landsysteme, the Cobra vehicle of Otokar, the Zetros, Actos, Unimog, and G-Wagen vehicles of Daimler AG, the TEP 90 vehicle of Iveco, and the Multi vehicle of MAN, just to name a few.



Armoured Vehicles



Ventilation, NBC-Filtration, Toxic Shooting Fume Filtration, Air Conditioning



Container / Mobile Shelters



Ventilation, NBC-Filtration, Air Conditioning



Field Camps, Command Posts, Field Hospitals



Ventilation, NBC Filtration, Complete Turnkey Projects



Heavy Vehicles



Engine Air Cleaners



Bomb Shelters, Buildings, Critical Infrastructure



Ventilation, NBC-Filtration, Blast Protection



Protection during Transport and Care



Biological Protection / Isolation



Beth-El Industries

**BETH-EL ZIKHRON YAAQOV INDUSTRIES LTD.**

1 Avshalom Road, P.O.Box 166  
Zikhron Yaaqov 3095101, Israel  
Tel: +972-4-6299904/05  
Fax: +972-4-6299900  
E-mail: [export@beind.com](mailto:export@beind.com)

Ventilation and NBC-Filtration Systems for Tents and Army Camps



NBC-Filtration and Ventilation Systems for Bomb Shelters and Civil Infrastructure



Engine Air Cleaners for Tanks and Heavy Duty Vehicles



Mobile Medical Isolation Systems for Pandemic Protection, Industrial Clean Rooms, and Mobile Surgical Centres



Ventilation, Air Conditioning, NBC-Filtration, & Weapon's Fire Fume Filtration for Vehicles & Containers



# SYSTEMS DIVISION



## CARMOR

P.O.Box 639  
Nazareth Elite 1710502, Israel  
Tel: 972-4-6410641  
Fax: 972-4-6418555  
E-mail: [gabid@carmor.co.il](mailto:gabid@carmor.co.il)  
Web Site: [www.carmor.co.il](http://www.carmor.co.il)

## EXPECT MORE WITH CARMOR

Carmor, formerly known as Hatehof, was founded in Israel in 1947 and played a key role since then in equipping the state and other worldwide customers with specialized, dedicated and armor vehicles.

This highly respected international brand now manufactures vehicles for the IDF, NATO and United Nations forces, as well as civilian administrations, homeland security and military customers.

Carmor designs a wide range of special purpose vehicles for civilian and law enforcement applications. They are manufactured using a variety of automotive platforms and fitted with storage tanks of different capacities.

Designated vehicles can be customized with extra security features for use in special conditions.

- Riot control vehicles with water tanks and sprays
- Rapid intervention vehicles
- Portable aircraft fueling systems
- Fuel bowsers to support UAV operation
- Tanks for fuel storage
- Firefighting vehicles including airport, forest and urban versions
- Trailers and wagons



Riot Control Vehicles



Aircraft Refuelers



NBC decontamination



# DEA R&D

## Design & Human Engineering

*Many years of activity, specializing in the R&D of life support have contributed to the development of skills and capabilities applicable to military, civilian and industrial protective equipment development.*



### DEA

**Research and Development Ltd.**

P.O.Box 34436

Jerusalem 9134302, Israel

Tel: 972-2-6540878/9

Fax: 972-2-6540885

E-mail: [Dea\\_ltd@netvision.net.il](mailto:Dea_ltd@netvision.net.il)

Web Site: [www.dea-rd.com](http://www.dea-rd.com)

### CAPABILITIES AND SKILLS

Our capabilities are based on a blend of design disciplines in many fields: Human engineering Design, tooling, production and assembly, testing, and management of complex projects. The majority of projects are Turn Key Projects including feasibility studies, design of prototyping, testing and documentation.

DEA is carrying out industrial design and full scale engineering development.

DEA cooperates with research institutes in carrying out a variety of tests as part of feasibility studies and qualification tests.

### HUMAN ENGINEERING

DEA is carrying out theoretical and applied studies in human engineering:

- Product design.
- Man - machine interface.
- Environments and working stations.

# THE HOME FOR HOMELAND SECURITY

Shalon Chemical Industry is internationally recognized as a leading company in the manufacture and design of personal and collective NBC protective equipment for military personnel and civilian population. The company's impressive achievements in respiratory protection is the result of applied state-of-the-art technology together with creative design and high quality. Shalon's quality management system is certified to ISO 9001: 2000. Laboratories and test equipment are certified by IMOD. Strong R&D department engaged in continuous improvement of existing products and design of innovative products in cooperation with the MOD.

## MILITARY NBC PROTECTIVE GEAR

### M15A1T NBC respirator

The IDF standard military mask. A modular design enabling mounting of the filter canister in front or on either side. Including drinking system, main and side voicemitters, and attachment for corrective lenses. Supplied in 3 sizes. NIOSH approved for riot-control.



### Panoramic NBC protective mask



Specially designed for NBC military units, riot-control personnel, first responders and medical assistance personnel. A modular design enabling mounting of the filter canister in front or on either side. A very wide panoramic field of vision. Including drinking system and attachment for corrective lenses. With a central voicemitter. One size fits all. Widely used by industrial and laboratory personnel. "CE" marked.

### M15S80 NBC respirator for armored vehicle crew member

Includes all the features of the M15A1T as well as a built-in dynamic microphone with an external connector. Can be supplied with a corrugated rubber hose and adaptor for connection to the collective filtration system of the vehicle.



### CETER First responder positive pressure NBC protective hood and blower system



A positive-pressure hood system for protection in prolonged exposure to high concentration of NBC agents. Specially designed by Israeli MOD, for NBC military and police units, first responders and medical assistance personnel. A highly effective neck seal and blower unit, affords a high level of protection while ensuring comfort. One size fits all. Allows use of regular optical eyeglasses.



Head Office: 2 Kaplan St., 10<sup>th</sup> Floor  
Tel-Aviv 6473403, Israel  
Tel: 972-3-6957191, Fax: 972-3-6957980  
Plant: 35/2 Israel Pollak Rd.,  
Kiryat-Gat 8202501, Israel  
Tel: 972-8-6879111, Fax: 972-8-6811115  
E-mail: shalon@shalon.co.il  
Web Site: www.shalon.co.il

**NEW!**

**SHALON'S  
NEW  
GENERATION  
OF  
PERSONAL  
FILTER  
CANISTERS**



A wide range of filters providing effective protection in military, police, civil defense/ homeland security, emergency and industrial applications.

**PA12 model:** qualified by Israeli MOD for NBC civil protection.

**CBRN model:** for first responders, meeting NIOSH CBRN standards.

**Tear gas model:** for riot control.

Parallel pleated high-efficiency particulate filter (P100/P3). 40 mm thread compatible with most military & industrial masks. Robust, durable plastic body providing excellent mechanical & chemical protection. Low breathing resistance design that does not compromise filtration

**ACBS Armored vehicle crew member positive pressure NBC protective hood and blower system**



Designed by the Israeli MOD for armoured vehicle crew members, enabling performance of all required tasks on the modern battlefield in prolonged exposure to high concentration of NBC agents. Affording ease of operation and maximum compatibility with other personal safety equipment. Voicemitter and a built-in dynamic microphone system. Drinking system compatible with military canteen threads. One size fits all.

**HOPER Helicopter pilot positive pressure NBC protective hood and blower system**

Specially designed by the Israeli MOD. A highly effective neck seal and blower, affording a high level of protection, ease of operation and maximum compatibility with flight and personal safety equipment. Special holders for use in the cockpit. Providing at least 15 hours of uninterrupted operation. Voicemitter and a built-in dynamic microphone system. Drinking system compatible with military canteen threads. One size fits all.



**BL-90 NBC air supply unit**



A compact and reliable air-supply unit that maintains positive pressure in military and civilian NBC protective hood systems and masks. Developed by the Israeli MOD, the blower draws filtered air from 2 standard personal NBC filters, and supplies up to 90 liter/min. Fits all types of personal filter canisters with a standard (40mm / 1/7") thread. Flat design, allowing access to narrow spaces. Special features for mounting the blower on a waist belt.

**M80 NBC filter canister**



A personal gas particulate filter which provides protection against all chemical and biological warfare agents and radioactive dust. It is manufactured according to IDF specifications and meets all the performance requirements for the US army C-2 canister.

# THE HOME FOR HOMELAND SECURITY

## Air permeable NBC protective suit / overall

Designed to enable specialized units to operate in NBC-contaminated environments, affording chemical and biological protection while reducing heat stress buildup and ensuring relative comfort and ease of operation. Suitable for use by NBC military and police units, first responders and medical assistance personnel. The overall is especially designed for armored vehicle crews. Flame Resistant. 4 sizes: S, M, L, XL. Detachable hood. Compatible with all Shalon's NBC protective masks and hoods.



## CIVIL DEFENSE NBC PROTECTIVE GEAR



## 10A1 NBC Youth respirator

Like the 4A1 NBC Adult respirator. For the protection of youth aged 10 to 16 years.



## RESPRO NBC protective hood for children



For the protection of children aged 3 to 8 years. Positive pressure inside the hood is assured by means of a blower unit with an operation time of 13-15 hours. A drinking system is included.

## 4A1 NBC Adult respirator

For the protection of civilian population. Including drinking system, voicemitter and peripheral sealing lip that assures high protection factor to the wearer.

## INPRO NBC infant protector



Like the Respro, the Inpro is a positive pressure system, especially designed by the Israeli MOD for newborns up to 3 years old. The infant is conveniently placed and safely secured inside the hood. The Infant can be carried and fed through a built-in nipple system.

## CAPS 2000 NBC Civilian Adult Protective System

CAPS is a new respiratory protection device developed by the Israeli MOD. A silicone neck dam around the neck, and a blower system provide high protection and comfort, regardless of donning skill. Can be worn by bearded men. Allows use of regular optical eyeglasses without interference.





## CAHBS NBC Civilian Adult Hood & Blower System

CAHBS is a positive-pressure system designed for civil defense by the Israeli MOD. Two air-supply units makes it suitable for the elderly population and for persons with breathing difficulties. One size fits all. Allows use of regular optical eyeglasses without interference.



## ATROMAT Automatic Injectors

A lightweight, compact and reliable injector for quick and painless intramuscular self-injection of atropine solution, or atropine solution with oxime. Supplied in 3 doses: 2.0 mg for adults, 1.0 mg for children and elderly, 0.5 mg for infants. Complies with IDF and US army specifications.



## BL 45 Mini-blowers



Designed by the Israeli MOD, it fits a standard 40mm x 1/7" thread, for use with different types of personal filters. Suitable for use with different sources of energy.

## COLLECTIVE NBC PROTECTIVE EQUIPMENT

### For Shelters



### Collective NBC filtration systems

A wide range of Collective NBC filtration systems designed and developed by Shalon, providing complete NBC protection to occupants of communal shelters. Meeting Israeli civil defense specifications. The complete purification system is comprised of: Pre-filter, Blast valve, NBC Gas-particulate filter, Fan unit, Flowmeter, Overpressure valve. 5 models available: FA-75 for up to 12 people, FA-150 for up to 25 people, FA-5 for up to 50 people, FA-10 for up to 100 people, FA-900 for up to 150 people.



Head Office: 2 Kaplan St., 10<sup>th</sup> Floor  
Tel-Aviv 6473403, Israel  
Tel: 972-3-6957191, Fax: 972-3-6957980  
Plant: 35/2 Israel Pollak Rd.,  
Kiryat-Gat 8202501, Israel  
Tel: 972-8-6879111, Fax: 972-8-6811115  
E-mail: shalon@shalon.co.il  
Web Site: www.shalon.co.il

A compact and reliable air-supply unit maintaining positive pressure and connecting easily to all civilian NBC protective systems and masks.

### For Armored Vehicles

#### ME4 Merkava tank NBC gas-particulate filter



Designed and developed by Shalon and the IDF. A robust and durable high capacity

filter (3000-5000 LPM). Constructed of stainless steel. Withstand extremely heavy vibrations with no distortion of its charcoal bed or any detrimental effects to its performance. Also suited for use in armoured cars, troop carriers, riot dispersal vehicles and mobile shelters.

#### M48 Gas-particulate filter for Abrams M1A1 tank

Designed by the US army. A compact, lightweight, radial flow filter (100 CFM). Constructed from aluminum alloy and coated with a special chemical resistant paint.

Also suited for use in armoured cars, troop carriers, riot dispersal vehicles and mobile shelters.



# SUPERGUM INDUSTRIES

## Blower BL - 45

The BL-45, originally designed as part of the advanced protection system for children, supplies 45 liters of filtered air per minute, at an overall resistance of up to 35mm water, and operating on 3 volts of power.



## NBC sampling kit

Includes inspection and sampling apparatus for the detection and identification of NBC contaminations.



## BLOWER BL - 45 Type B

The BL-45 type b is multi purpose blower, designed to be integrated with all the civilian NBC protective respirators. Supplies 45 liters of filtered air per minute.



## Blower - BL - 90

The BL-90 blower is designed as part of the group of advanced military protection. The blower is designed to supply 90 liters of air per minute at resistance of up to 65 mm water.



# N.B.C RESPIRATORY PROTECTION

Supergum is Israel's leading manufacturer of protective clothing and protection systems for use by military personnel and the civilian population.

Supergum manufactures high quality rubber, plastic and sealing products for civilian, military and industrial applications. The company's R&D and engineering departments support a wide range of standard and custom-made rubber and plastic products for highly diverse markets.

Rubber technologies: injection molding, compression molding, extrusion and die cutting.

Plastic technologies: heat, H.F. and U.S. sealing, injection molding Certifies to ISO 9000 : 2008.

# SUPERGUM

## SUPERGUM INDUSTRIES LTD.

11 Shontzino St.,  
Tel-Aviv 6721611, Israel  
Tel: 972-3-5622333  
Fax: 972-3-5622345  
E-mail: giladg@supergum.co.il  
Web Site: www.supergum.com

### Children's protective hood



Suitable for infants from day 1 to children 10 years old. New design allows more flexibility, freedom of movement and enhanced wider field of view.

The hood provides a complete respiratory protection and is equipped with blower supplying clean air to the hood making it easy to breath. The blower maintains overpressure thus preventing entry of contaminated air.

### Civilian Adult Hood

This system is intended for relevant civil defense and special military personnel who must function under CW conditions while performing a variety of missions.

C.A.H.-system including 2 blower (BL-45).



### Adult protective hood for civilians

New concept in civilian respiratory NBC protection. The new design allows high degree of comfort with reliable protection.

The new visor enables clear and undistorted field of view. The hood is suitable for all facial structures for adults 10 years or older. The hood is equipped with a blower and a filter and a drinking device.

Supergum with a joint venture with ILC-Dover (USA) is the exclusive distributor for this product in North America and Europe.



### Baby & Child-shield Clean-air Overpressure Module

Clean-air overpressure protection system for infants and toddlers ages 0 to 3 and 3 to 8.



### Pet Protective Kit

The kit protects pets (dogs, cats and pet birds) against NBC hazards by enveloping a standard closed transport cage, creating a protected space around the pet.

The kit has been examined and approved by veterinarians.



# SUPERGUM - N.B.C RESPIRATORY PROTECTION

## Adult protective hood for military personnel



Based on the civilian hood with adaptation to military requirements providing high reliability in the field combined with superior NBC protection. The hood utilizes new design which provides great physical comfort and freedom of movement allowing long periods of wear. The hood is equipped with a dual filter and a blower and a drinking device.

## Adult protective hood for combat soldiers



State of the art NBC protection for the combat soldier, hood includes dual filter system with a blower, communications equipment interface and external drinking system. The hood was developed to answer the most rigid battlefield conditions in terms of NBC protection.

## Armored Vehicle Crew-member Blower System-ACBS

A fully integrated protective system allowing an armored vehicle crew member to perform all the required tasks on the modern battlefield (communication, use of Electrooptics and night vision devices). It is based on an under-the-helmet protective hood and blower unit.



## Chemical Team Respirator - CETER



Soldiers in specialized CW units, -reconnaissance, Decontamination, bomb disposal and medical corps are exposed to high concentrations of chemical agents for long periods. These types of activities require a special system for eye and respiratory protection.

### The system includes:

A nose cup integrated into the hood, providing a platform for the valves, speech membrane, communications and drinking devices, A neck seal serving as the required closure

A blower that provides air through two standard filters and supplies the hood with 90 liters of purified air per minute.



## SUPERGUM INDUSTRIES LTD.

11 Shontzino St.,  
Tel-Aviv 6721611, Israel  
Tel: 972-3-9365692  
Fax: 972-3-9367742  
E-mail: giladg@supergum.co.il  
Web Site: www.supergum.com

### Disposable N.B.C. Protective Suit

The disposable N.B.C. Protective Suit is made of transparent multi-layered plastic and consists of a two piece (blouse and trousers) protective suit. The blouse has a cutout-contoured hood that fits any mask, and a quick fastener for easy closing.

The garment is light and permits freedom of movement. Combines to give excellent barrier properties and strength. The suit stamping and sealing process is done by specially designed equipment, ensuring dependability and based on many years of research and development.



### NBC protective suit

Full body protective suit allows maximum NBC protection; the suit is easy to wear, flexible and low weight. The suit comes in 4 sizes to fit all.

### Over-shoes Type 2

Allow NBC protection per MIL standard, comes in 8 sizes.



### Supplement Kit

The kit is designed for individuals aged 13 years and above. The kit contains all clothing items and footwear necessary for maximum body protection from head to toe. The kit elements are modular and can also be purchased separately.

The Supplemental Kit elements are as follows: Protective Suit, Protective Overshoes and Protective Rubber Gloves.



### SUPERGUM-N.B.C. Multi Purpose Over-Shoes

The multi purpose over-shoes have been designed by Supergum to meet the requirements and approval of the Israel Defence Forces. The over-shoes are made of PVC with minimum 1.3 thickness to provide the optimum Weight / protection ratio for the soldier.

The material ensures an almost unlimited storage shelf life. The over-shoes are available in 3 sizes (small, medium and large), with additional sizes available according to customers' specific requirements.



# **SKUNK NON-LETHAL RIOT CONTROL SOLUTION**

***Innovative, non-lethal riot control.***

***In operational use by the Israel National Police  
and IDF Since 2008.***



***Skunk is an innovative, non-lethal riot control product with proven effectiveness. A pungent, foul-smelling - yet non-toxic - liquid spray, it quickly disperses the most determined of violent demonstrators.***

***Harmless to them, to officers in the field, and to the environment, Skunk is the optimal response for the modern police force.***

***Odortec's eco-friendly Skunk solution was developed to meet its highest operational requirements.***

***And it does so with less manpower, at lower cost and without the use of force required by other riot control tactics.***

## **The Product**

Police departments over the world periodically face an acute dilemma in confrontations with violent civil unrest: the need for effective riot control and the duty to preserve the health and safety of all, including the protesters themselves. Conventional tactics - from physical force all the way to tear gas and water cannons - have been many times proven either ineffective, potentially lethal, or both. Odortec, supported by retired high rank police officers, developed the perfect, if highly pungent, solution: **The Skunk**.

## **There Are No Countermeasures**

A non-lethal, non-toxic liquid spray, the **Skunk** is the most innovative and effective riot control method available. And there simply are no countermeasures.

This harmless deterrent consists of an extremely foul-smelling liquid, with the viscosity of water, which can be sprayed over a large area using standard water cannon or a personal spray systems. The overpowering odor

## TVUNOT 5766 LTD.

9 Brand St.,  
Jerusalem 9387809, Israel  
Cell: 972-52-6000668  
Fax: 972-2-6630011  
E-mail: ay@barak.net.il  
Web Site: www.skunk.co.il



Skunk can be used for facility protection

of the **Skunk** drives rioters away - and keeps them away - effectively shutting down any escalating situation.

Currently in regular use by law enforcement agencies, the **Skunk** has been field tested and proven to disperse even the most determined of violent protests.

### The Most Demanding Standards

The **Skunk** was designed to meet the most demanding operational requirements and the highest ethical standards.

The **Skunk** is not volatile, it's non flammable - it can even be used to put out fires in a pinch. In fact, despite its outrageous smell, the **Skunk** liquid is safe. Even clothes hit with the **Skunk** can be used after simple washing. Deployed in crowd control situations in which standard measures would involve the legal use of force, the **Skunk** is a far preferable alternative for quickly lowering the overall level of violence and breaking adversarial resistance.

### Cost-Effective and Eco-Friendly

In addition, the Israeli experience proves that the **Skunk** is the most cost-effective solution for law enforcement agencies concerned about keeping down budgetary expenses. Deployment of the **Skunk** is far less costly than any special riot control equipment or compliance weapon alternatives. With the **Skunk**, manpower expenses are lowered dramatically, as fewer police officers can quickly and effectively restore order in relatively large area.

The **Skunk** is the result of years of resource-intensive development aimed at producing a law enforcement tool that is inexpensive, safe and effective, while also posing no threat to the environment.

***Skunk is in operational use by the Israel National Police and the IDF since 2008.***



**SERVICES**

## A Token of Quality and Professional Service

Spanning the entire spectrum of Israel's defense industrial base, professional services complete a cycle that addresses all the phases of defense programs—from the definition of requirements and specifications, through research and development (R&D), engineering, testing, production, subcontracting, in-process quality assurance (QA), to the induction training and after-sale and through-life support.

Consultancy services may also require specific know-how in software integration or integrated logistics (ILS) - all in accordance with customer requirements. Such professional services constitute a substantial part of Israel's defense export, supporting foreign customers, partners in research, planning and proposal submission process, as well as setting multi-national cooperation initiatives.

Israel's professional consultants and trade companies representatives are often 'graduates' from various branches of Israel's Defense Forces (IDF), the Ministry of defense (MOD) and industry, where they acquired first-hand knowledge of military disciplines, methodologies and specialized proficiency to their area of expertise.

MOD approved Israeli consultants offer a full spectrum of solutions, specialties and expertise, ranging from the upgrading and modernization process of weapon systems, to concept planning and design of communications networks, aircraft protection systems or training security forces at airports and border crossings.

Israeli consultant experts are intimately familiarized with both Israeli and foreign made systems operated by the IDF and are therefore capable in offering objective recommendations on hardware utilization, based on extended field experience.

Labeled "Made in Israel" is therefore not merely the source identification, but a token representing the quality and professionalism of the service provider.

**DEFENSETECHS**  
**IS YOUR ONE-STOP-PARTNER ...**  
**GET EVERYTHING FROM**  
**ONE SUPPLIER!**



**DEFENSE TECHS**  
P.O.Box 39290  
Tel Aviv 6139201, Israel  
Mobile: 972-50-4551284  
E-mail: [info@defensetechs.com](mailto:info@defensetechs.com)  
Web Site: [www.defensetechs.com](http://www.defensetechs.com)

**We are** an Israeli company with more than 17 years of experience in the field of HLS (Homeland Security), Defense and Civil protection, being part of the group I.B.L.

**DefenseTechs** works in partnership with International top worldwide experts and represents+150 manufacturers worldwide.

**We are** a unique One-Stop-Partner; by difference with others: we supply everything you need and even propose better solutions fitting your needs, and not only one single solution.

We are a one-stop-partner in the security, defense and protection field providing technologies, equipments, full turnkey projects, knowledge and Transfer of technology, consulting and trainings.

We are always updated on the best technologies and solutions as well as new innovations in the different fields.

**We provide** the best quality and very competitive prices as well as new innovations in the field, thus we are constantly looking for new solutions, new technologies, new innovations, in this way we always continue staying one step forward.

**We wish** to meet new local partners, resellers and agents worldwide as well as Integrators, private corporations and Security companies, in order to continue developing new business in new regions and sectors.

**DefenseTechs** is YOUR Partner, try us... because our defense is your best business.



# COUNTERING GLOBAL JIHAD'S WEAPONS OF CHOICE



***IED's, VBIED's and Suicide bombers pose serious threats to your operation.***

***We will train you to prevent, detect and respond to these threats - and we keep it real.***

**DEMOMAN INTERNATIONAL LTD.  
Security & Defense Solutions**

P.O.Box 3896  
Nazareth Illit 1752606, Israel  
Tel: 972-50-5901655  
Fax: 972-4-6561632  
E-mail: [info@demoman.co.il](mailto:info@demoman.co.il)  
Web Site: [www.demoman.co.il](http://www.demoman.co.il)  
[www.suicide-terrorism.com](http://www.suicide-terrorism.com)

## WE OFFER:

### BOMB SECURITY:

- Counter Suicide Terrorism training  
Details: [www.suicide-terrorism.com](http://www.suicide-terrorism.com)
- Bomb security, search, evaluation & first response
- Training in the bomb security field
- Explosives detection - X-Ray, Sniffers, K-9, E.T.K
- VBIED/Car Bomb countermeasures & Blast mitigation
- Strategy and training to deal with WMD's
- Mail bomb security
- Threat assessment



### Who needs it ?

Air & Sea Ports, High Security Facilities, Law Enforcement Personnel, First Response Teams, Security Officers, Customs and Border Crossings, Executive Protection Teams and Special Forces.

### EXPLOSIVE ORDNANCE DISPOSAL:

- Demilitarization - destruction of munitions and explosive waste
- Mobile Disassembly System - a unique cost-effective system which renders various munitions safe, by disassembling them to their primary components
- Special Units - forming new teams to deal with bomb disposal and other explosive devices
- Explosive Entry - tactical pyrotechnics & explosive breaching for Special Forces
- Mines & UXO Clearance - consulting, training and project management
- Supplies - full provision of body armor, professional equipment, and munitions training models



DEMOMAN provides customized services of training, consulting and project management. Our methods are focused on "Hands-On" training. Our E.O.D teams consist of Israeli bomb security experts, Explosive Ordnance Disposal officers and bomb disposal personnel, who are highly trained with extensive field experience from various government agencies.

***Enabling You to Make the Most of Our Experience...***

# TRAINING IS THE KEY TO SUCCESS



## IMI ACADEMY for Advanced Security & Anti Terror Training

64 Bialik Blvd. P.O.Box 1044  
Ramat Hasharon 4710001, Israel  
Tel: 972-8-9357040/1  
Fax: 972-8-9357042  
E-mail: [academy@imi-israel.com](mailto:academy@imi-israel.com)  
Web Site: [www.imi-academy.com](http://www.imi-academy.com)

### About IMI Academy

The IMI Academy for Advanced Security & Anti-Terror Training is a leading integrated solutions provider for military, law enforcement, government agencies and commercial clients worldwide.

Established in 1999 by veterans of the Israeli Security Forces, the Academy specializes in a wide range of comprehensive security training programs, including anti-terrorism, anti-crime and homeland security. It is a subsidiary of Israel Military Industries Ltd. (IMI), a government owned company.

The Academy draws its strength from the accumulated knowledge of the Israeli security establishment. Its facilities, highly-experienced instructors and range of courses and seminars, have positioned the Academy as a model organization of its kind, one that its competitors attempt to emulate.

### Fields of activity:

#### Security:

VIP, Aviation, Maritime, Installation, High-Risk Installation Security.

#### Anti-Terror:

Combat & Firearm Training, KRAV-MAGA (Israeli martial arts), EOD, Operational Driving, Sniping, Rappelling, Rock-Climbing, Rescue, Fire Fighting, First Aid Courses, Operational Planning.

#### Police & Law Enforcement:

Police Readiness Response to mega-terrorist attacks, Comprehensive Disaster Response, Police Intelligence for combating crime, drugs, fraud and white collar crime, Border Crossing Security, Immigration Control, Crowd Dispersion and more.

### Homeland Security:

Search and Rescue, Academic and Practical Homeland Security Training, Crisis Management and Emergency Response (human caused and natural disasters).

### Special Projects & Consulting:

Information and Computer Security, Counter-Intelligence, Police Intelligence, Army Intelligence, Penitentiary Intelligence, Police force upgrading, turnkey security projects, Special Military Training, Sensitive Risk Assessment, Operational Studies, establishment of Special Operation Units, Recruitment Centers, Establishing Security Academies and other security solutions.





# INTELLIGENCE TO ACTION

*IOTT specialize in the establishment of operational intelligence units and the implementation of cutting-edge technological systems in the Defense & HLS sectors.*



## **IOTT LTD.**

18 Aba even St.,  
Hertzelia 4672536, Israel.  
Tel: 972-72-2220770  
Fax: 972-72-2220771  
E-mail: of.ce@i-ott.com  
Web site: www.i-ott.com



As world leading experts of Tactical Intelligence, we are using our relevant background and proven abilities to establish an Operational Intelligence Units with Technological & Doctrine advantage.



## **OUR EXPERIENCE:**

- Vast international experience (over 70 countries).
- Establishment of numerous operational units.
- Cooperation with top manufacturers of defense & HLS technologies.
- World leading experts of SIGINT Tactical intelligence technologies.

All of the training programs approved and licensed by MOD.

# ISDS LTD. INTEGRAL SOLUTIONS FOR HOMELAND SECURITY AND DEFENSE



## INTERNATIONAL SECURITY & DEFENCE SYSTEM

P.O.Box 173, Nir Zvi, 7290500, Israel  
Tel: 972-8-9227699  
Fax: 972-8-9235104  
E-mail: [isds@isds.co.il](mailto:isds@isds.co.il)  
Web Site: [www.isds.co.il](http://www.isds.co.il)

ISDS is a sophisticated security consultant and integrator in areas such as Homeland security (HLS), Defense, Mega Event security, Critical Infrastructure security, Maritime and Aviation security, and the security of Multi-National Enterprises.

Since 1982, ISDS has been providing a vast array of security services to public figures, governmental agencies, non-governmental organizations, corporations, and others who face high-stakes security risks.

The company offers the most cost-effective, responsive, and personalized customer care.

ISDS provides its clients with comprehensive, cost effective, and individual solutions.

### These solutions include:

- Comprehensive Concept of Operation
- Management and Integration of all Security Projects
- Intelligence
- Counter Terrorism
- Vital Infrastructure Security
- Mega-Event Security
- Cyber Security
- Maritime, Airport, and Transportation Security
- Border Protection
- Coastal Protection

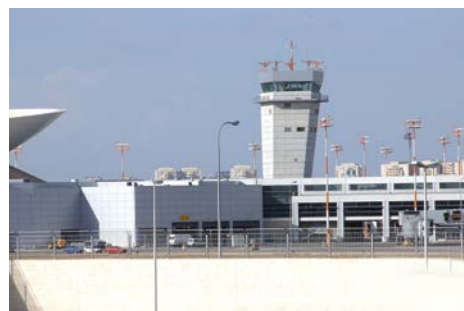
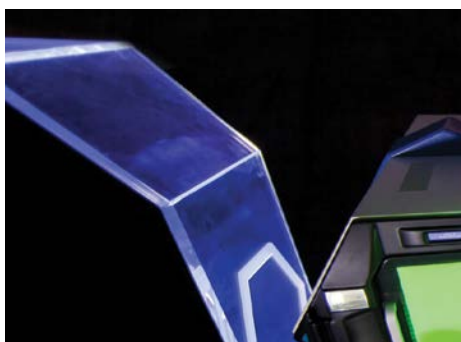

# **ISDS LTD. INTEGRAL SOLUTIONS FOR HOMELAND SECURITY AND DEFENSE**



## **INTERNATIONAL SECURITY & DEFENCE SYSTEM**

P.O.Box 173, Nir Zvi, 7290500, Israel  
Tel: 972-8-9227699  
Fax: 972-8-9235104  
E-mail: [isds@isds.co.il](mailto:isds@isds.co.il)  
Web Site: [www.isds.co.il](http://www.isds.co.il)

**ISDS** provides a strong and integral concept of operation, threat assessment, security planning, operational management and implementation.

**ISDS** works in planning and implementing large scale vital infrastructure security projects for the oil, energy, and mass transportation industries. The company provides solutions and security to large mega events and international recognized figures. It has a solid reputation in providing a safe and secure environment for Olympic Games, sport events, and other large scale events.

**ISDS** offers comprehensive safe city solutions that include fitting technologies and a solid concept of operation.

### **Security Technology**

**ISDS** emphasizes the importance of innovative and specialized security technology and assures effective access to advanced, efficient, and proven technology for defense and homeland security.

The **ISDS** team provides the technology, and the skills and knowledge necessary to apply it effectively.

**ISDS** provides technology suitable for all areas of security operations.

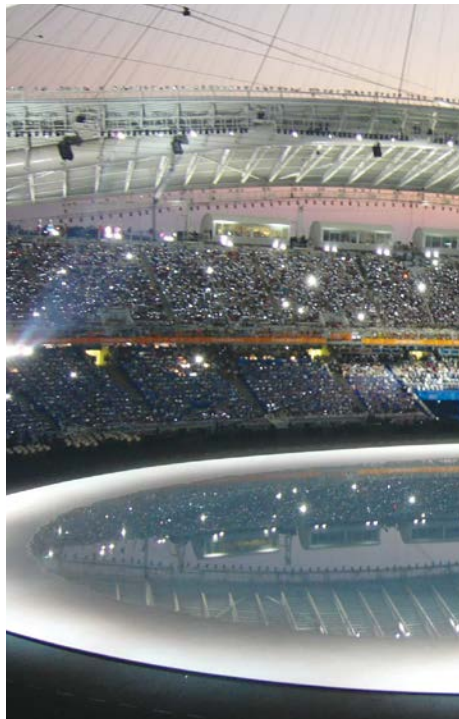

# COMBAT TRAINING & SECURITY TECHNOLOGY



## LUDUS-SECURITY LTD.

14 Grozenberg St.,  
Tel Aviv, 6581117, Israel  
Tel: 972- 54-2103310  
Fax: 972-3-6541216  
E-mail: [info@ludus-security.com](mailto:info@ludus-security.com)  
Web Site: [www.ludus-security.com](http://www.ludus-security.com)



**LUDUS SECURITY** Ltd. Specializes in conducting large scale security oriented projects worldwide: from training your units to equipping them with state of the art combat gear.

**LUDUS SECURITY** benefits from the vast military experience of its founders - veterans of elite IDF Special Forces. Accumulated over dozens of versatile activities, covering the entire span from special operations to large scale military campaigns, our experience and expertise give your forces a decisive edge in a world of growing threats.

**LUDUS SECURITY team** will guide your force throughout the entire process: from defining your security needs to implement our solutions in the field. In this way we give our clients decisive security tools for coping with immediate or future threats.

**LUDUS SECURITY's goal** is to provide high standard security solutions for governmental and commercial organizations worldwide, according to their particular needs and demands.

**LUDUS SECURITY's team** is dedicated to the needs and interests of its clients. We are committed to provide the most innovative and professional world class tactics and gear, with the ultimate aim of decisively facing any challenge or threat in the actual battlefield. In this way, we fulfill our main and primer goal, to make you no less than the best of the best, always ready to spring into action.

### UNDER OUR SERVICE:

- Counter terror training
- Military training
- Law Enforcement training
- Establishment of special units
- Security equipment & technology

# THE KEY TO STRATEGIC ADVANTAGE



**MATRIX**  
**Defense & Consulting Division**  
3 Abba Eban Blvd.,  
Hertzliya 4612001, Israel  
Tel: 972-9-9598000  
Fax: 972-9-9588650  
E-mail: yoramy@matrix.co.il  
Web Site: www.matrix.co.il  
www.matrix-defense.co.il

**Matrix Defense & Consulting Division (MDC)** is part of Matrix IT, Israel's largest IT Company. MDC is a leading defense consulting group with over 25 years of experience and hundreds of successful projects for critical defense systems. Customers include Defense Forces, Government Agencies, Defense Industries and leading civilian industries.

**Matrix Defense & Consulting Division** employs over 170 highly qualified and experienced system engineers, operational experts and analysts, providing comprehensive consulting services to defense forces and industries. A dynamic management style coupled with an extensive reservoir of technical and operation experts enables the company to create effective focus groups or designated task forces, adapted to a specific mission.

**Matrix Defense & Consulting Division** has acquired a strong reputation in the defense community for its ability to innovate and initiate new products and programs for defense industries, Israeli Ministry of Defense and the Israel Defense Forces, especially in ATBM defense, Command and Control, Intelligence, Cyber and Simulation systems development.

## MDC Products & Services

MDC has the skills to perform a complete End-to-End process for strategic defense programs, from the initiation phase through development, testing, operational activation and deployment.

**MDC provides a complete set of integrated products and services:**

- Strategic Planning
- Business Plans
- Technology & Market Studies
- Marketing Presentations
- Competitive Intelligence
- Operational Analysis
- System Requirements Definition
- Operations Research
- System Analysis & Design - Technical & Operational
- Organization Analysis
- Tools for Information Retrieval & Extraction
- System Engineering, including:
  - System Architecture
  - Algorithm Design
  - System-of-Systems Integration
  - System Test Planning & Execution
  - Training & Operational Activation
- Seminars & War Gaming
- Program Development Management
- Program "Red Team"



## Projects

MDC has provided a significant contribution to major defense projects, resulting in a large number of fielded operational systems. The company has played an important role in the research and development of national mission critical projects, amongst them the ARROW active missile defense system, AEW (Airborne Early Warning) systems, SIGINT systems and C<sup>4</sup>ISR systems.



# M.L.M. PROTECTION

## Extending Beyond Technology



### M.L.M - PROTECTION

6 Ha'Choshlim St., 7<sup>th</sup> Floor  
P.O.B 12590, Herzliya 4672406, Israel  
Tel: 972-9-9574377  
Fax: 972-9-9574370  
E-mail: office@mlm-protection.com  
Web Site: www.mlm-protection.com

### ABOUT US - M.L.M. Protection:

M.L.M Protection develops and implements cutting-edge, customized security solutions for various sectors and environments, based on broad expertise and operational experience accumulated within the framework of the Israel General Security Service (Israeli Secret Service), where it's founders and members of its professional staff held senior positions, and subsequently, in civilian security projects carried out in many countries around the world. The company provides modular solutions ranging from specific, ad-hoc services to meet specific needs, to all-inclusive, turn-key security solutions and training programs.

#### CONSULTING

The unique RT™ Model to confront security problem designed by our company is based on continuous development and enhancement aimed at identifying and preempting future threats.

Our company provides Aviation Security, Public Transportation Security, Corporate Security, Securing Events, Securing Sensitive Facilities, VIP Security, Tactical Teams and Police Units.

#### TRAINING

Training programs developed by M.L.M. Protection's training department (TACT system™) are designed to maximize these qualities in order to ensure a continuous process of independent learning, development and growth. Our company provides training in these areas- Security Units (Aviation Security \ VIP and Delegation Security \ Facility Security), SWAT Teams, K-9 units, Intelligence Units, Security Professions (Security Screening, Security Searches and Bomb Sweeping, Security Dialogue), Combat (shooting and marshal arts), Operational Driving and Lectures and Seminars.

#### SECURITY PROVIDERS

M.L.M. Protection supplies world-class security solutions for the civilian market

Our team's professional level is unparalleled in the civilian market.

All members of M.L.M. Protection security staff were trained within the framework of the Israeli governmental security establishment.

All members of the VIP security staff have undergone additional, specialized training in the protection of dignitaries. Our company can provide these services - VIP Security \ Delegation Security \ Securing Events \ Supervision over Security Operations \ K-9 UNITS.

#### TECHNOLOGY & SECURITY EQUIPMENT

Based on its broad know-how and operational experience, M.L.M Protection defines the security equipment and state of the art technology required by various security units to effectively perform their functions in each specific area, such as VIP and executive security, facility security, SWAT teams, intelligence units, etc. The company supplies precise specifications and bills of quantities. If desired by the client, M.L.M Protections specialists can assist in negotiations with potential suppliers, and can also supply all required security equipment on a turn-key basis.



# NIRTAL TRAINING AND SUPPLY OF COMBAT EQUIPMENT LTD.



## NIRTAL TRAINING & SUPPLY OF COMBAT EQUIPMENT LTD.

4 Hahagana St.,  
Or-Yehuda 6022404, Israel  
Tel: 972-73-2262753  
Fax: 972-3-6341176  
E-mail: [nirtal@nirtal.com](mailto:nirtal@nirtal.com)  
Web Site: [www.nirtal.com](http://www.nirtal.com)

**Nirtal is a Global Homeland Security Expert Provider Since 1995.**

**Nirtal provides Combat Training & Equipment for:**

- Law Enforcement & Military
- Counter-Terror
- Intelligence
- Executive protection
- Private & Commercial Sectors.

Nirtal is staffed by experienced officers from the ranks of elite Israeli Defense Forces of anti-terror and Special Forces units.

Nirtal is an international forerunner in the provision of security solutions. Nirtal covers all aspects of security: consulting, training services, acquisition and provision of advanced technology systems all Combining to provide comprehensive Solutions, custom made for each individual client.

### ***Nirtal's Main Expertise:***

- Anti-terror & Anticrime.
- Operational training.
- Armed forces training: Special Forces & regular infantry units.
- V.I.P. & Executive Protection training.
- Supply of various advanced technology systems, (interception, jamming, surveillance, ballistic protection, bomb disposal, explosive detection technologies et al).
- Security combat equipment.
- Spy & anti-spy equipment, investigation and detection equipment.
- Security consulting and training using the most advanced techniques,
- Technologies and combat experienced instructors.
- All aspects of Airport and Aviation, Seaport & Maritime Security.
- Petroleum & Natural gas pipeline infrastructure security.
- Security in the private sector Banking,
- Public transportation,
- Public institutions.
- Surveillance and counter surveillance courses, training of police units for special assignments.
- Crowd control and event management.
- Prison enforcement, special units and technologies.
- "K9"-Task Dog training: explosive and drug sniffing and guard dogs.

Nirtal's technology division provides the most advanced Israeli and worldwide technological Systems, security solutions and combat equipment.

Nirtal has been operating internationally since 1995 in numerous countries around the world.

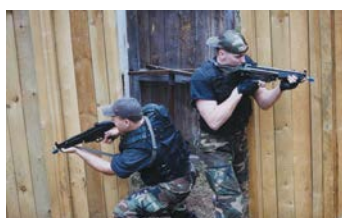

# MILITARY AND SECURITY EQUIPMENT AND TRAINING

FOR GROUND FORCES, AIRFORCE,  
NAVY, POLICE AND GENDARMERIE

**A.D.  
CON LTD.**

## A.D. CONSULTANTS GROUP

7 Golda Meir St.,  
Science Park  
Nes-Ziona 7403650, Israel  
Tel: 972-8-9313600  
Fax: 972-8-9404317  
E-mail: adcon@adcon.co.il



CASA CN235



MI-35



MI-17



C-130



ELAND



RM-70



IGLA-S



RADAR 36D6

**Do you need to set up a project from beginning to end, including:**

Consultancy, Supply, Delivery, Installation,  
Training And Maintenance.

**A.D. Consultants group** has been dealing in military and security consultancy services as well as supplies of new and surplus equipment since 1987.

**A.D. Consultants group** specializes in:

- Security equipment and devices
- Upgrade of Air and Ground Sales and updates systems
- Training of pilots and technicians on various systems
- Ammunition, light and heavy arm
- Police/Gendarmerie equipment and system
- Communication – clear and cryptic
- Monitoring, direction finding and jamming of both HF and U/VHF

**A.D. Consultants group** is experienced in planning and controlling entire project or elements of it and provides high standards of services, professional solutions on “turnkey” basis.

**Worldwide reputation for absolute discretion, highest quality standards and reliability are A.D. Consultants’ most important value.**

Our worldwide network of agents and suppliers enable us to provide special deliveries either by sea or air, to all destinations.



# MILITARY & SECURITY EQUIPMENT

---

**DEXORD** LTD

---

## DEXORD LTD.

P.O.Box 12702  
Ashdod 7760049, Israel  
Tel: 972-8-8681150  
Fax: 972-8-8681169  
E-mail: dxord\_1@netvision.net.il

DEXORD LTD. is a leading supplier of new and surplus equipment, weapons and weapon systems, and security systems.

Internationally renowned for quality, reliability and discretion.

Our expertise is in reconditioning and upgrading of weapons and equipment.

We have our own storage and workshop, which ensure fast delivery and high quality control.

Our range of products covers:

**Ground forces:** arms and ammunition, spare parts and accessories, personal equipment, combat vehicles and parts, optics, night vision and communication equipment.

**AIRFORCE:** Airborne weapons, weapon systems and gunpacks, bomb racks, ammunition, weapon control systems, anti aircraft artillery.

**NAVY:** Vessels, Naval guns and weaponry, parts thereof.



# EBONY ENTERPRISES LTD.

EBONY Enterprises Ltd. is a company with 20 years of experience in providing total defense solutions to several countries in **Africa, Europe, North America, South America and Far East.**

We are involved in several fields of activities: Defense, HLS and Critical Assets, Acquisition Banking Investment, Infrastructure Roads Construction, Telecomm, IT, Energy, Oil and Gas, HR Development, Turn-Key Medical Projects, Environmental and Water Solutions, Agriculture, Waste Management.

**DUE TO OUR ACTIVE FOOHOLD IN THESE SPHERES AND FAMILIARITY WITH INTERNATIONAL MARKETS, EBONY IS ALSO ABLE TO MAXIMIZE UTILIZATION OF ECONOMIC CONDITIONS CREATED BY AGREEMENTS BETWEEN THE COUNTRIES IN WHICH IT OPERATES.**

Ebony Enterprises Ltd. team includes top experts with demonstrated ability to vie for, and capitalize on opportunities. Furthermore, our professional personnel are immersed in the local markets and are often the first to espy and hence profit from the most lucrative business opportunities. Our unique asset is our Intellectual Capital, recruited to analyze the customers' needs, to design turn-key projects, including Knowledge Transfer and Capacity Building together with our customers, our Partners and Vendors.

## OUR EXPERIENCE:

EBONY ENTERPRISES LTD - FROM VISION TO REALITY

EBONY ENTERPRISES LTD - FROM VISION TO REALITY



Military communication



C4I / EW



Advanced artillery weapons



Advanced personal missiles TV and laser guided



Intelligence sensors



Upgrading of all kind of helicopters and fixed wings



Upgrading of all kind of existing fleet



Thermo imaging and night vision



Special vehicles for special forces



Advanced light weapons



Advanced personal carrier



Modernized maintenance center



Training



Special transportations



# From Vision To Reality

# ISREX (94) LTD.



## ISREX (94) LTD.

Clal Building, 5 Droyanov St.,  
P.O.Box 11065  
Tel Aviv 6111001, Israel  
Tel: 972-3-6200611  
Fax: 972-3-5283280 / 6292217  
E-mail: [isrexmng@isrex94.co.il](mailto:isrexmng@isrex94.co.il)  
Web Site: [www.isrex.com](http://www.isrex.com)

OVER 40 YEARS IN THE INTERNATIONAL MARKET



Integrated weapons systems



Electro-optics



Support equipment for the "soldier of the future"



Special vehicles and ballistic protection



Military and civilian communications

**Integration of defense solutions.  
Representation, sales and supply  
of customized solutions.**



Strategic consultancy and competitive intelligence

Identification of business opportunities and risks,  
in the language and culture of the customer

**Subsidiaries in Latin America,  
Spain and England**

# ARAN

## Turn-Key Product Development Services



**ARAN**  
**RESEARCH AND DEVELOPMENT (1982)**  
P.O.Box 3067, 43 Haeshel St.,  
Caesarea Business Park  
3088900, Israel  
Tel: 972-4-623-90-00  
Fax: 972-4-627-32-60  
E-mail: [info@aran-rd.com](mailto:info@aran-rd.com)  
Web Site: [www.aran-rd.com](http://www.aran-rd.com)

ARAN Research and Development Ltd. is a ONE STOP, Turn Key, product development facility. With over 30 years of experience in meeting our customers' challenges, our 140 engineering and production staff is tuned to meeting your performance requirements, reducing product costs and meeting your schedule. ARAN is aimed at GOING THE FULL CYCLE from concept to serial production. Our experience includes airborne and vehicle mounted electronics, control stations, test equipment and complex mechanisms.

### ARAN's Services:

#### Industrial Product Design Studio -

Research, analysis and characterization: product and operator's requirements, human factors, ergonomics, product design, MMI.

#### Product Development, Design and Engineering Services -

- Conceptual design, system engineering, mechanisms, hydraulics, structures and drive systems.
- Board design (analog, digital), control systems design (hardware, signal processing and control, algorithms, firmware & software), low power consumption design.
- Electronic packaging (plastic, metal).
- Test equipment.

#### Program Managements -

Feasibility studies, technologies, product definition, program overseeing from conceptual evaluation to final product. Planning, risk evaluation and mitigation, 2<sup>nd</sup> tier contractors management.

#### Prototypes and Models -

Full size mockups, scale models.

#### Manufacturing -

In-house CNC shop, plastics (molds, RP and RM), integration and assembly, prototypes and serial production, supplementary procurement and QA.

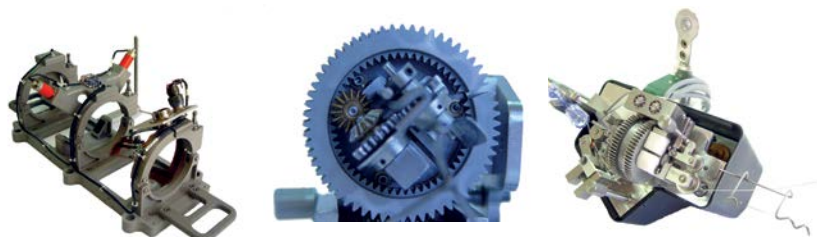

# STRONGER TOGETHER



## DIGNIA SYSTEMS LTD.

9 Shenkar St.,  
Herzlia 4672509, Israel  
Tel: 972-74-7200700  
Fax: 972-9-9612021  
E-mail: [recp-d@dignia.com](mailto:recp-d@dignia.com)  
Web Site: [www.dignia.com](http://www.dignia.com)



### DIGNIA at a GLANCE

Dignia is a global leader and trusted provider of Security and Defence solutions. Our customers include military and internal security organizations, intelligence and law enforcement agencies worldwide. With over 25 years experience we bring reliable field-proven technology, backed by professional expertise and "real world know-how" to any large scale government project.

### OUR MISSION

We deliver mission-critical technology and operational expertise to safeguard national security, increase public safety and protect critical infrastructure.

### PROFESSIONAL EXPERTISE

Dignia brings together world-class military and security experts to address every aspect of your operational needs. Many of our experts are high ranking officers with vast operational experience in air, land and sea combat. Dignia intelligence and security experts are valued advisors to governments and major security forums worldwide.

### CUSTOMER FOCUS

Dignia offers scalable, tailored solutions to meet your operational needs and budget. Dignia makes sure you achieve your objectives, and helps your organization to keep pace with technology innovation and evolving security and intelligence threats.

### OPERATIONAL LIFE CYCLE

Dignia supports the full operational life cycle of any project. From system design and development, to integration, training and assimilation, we are with you every step of the way. Dignia trains and prepares your personnel and delivers full maintenance and technical support services based on recognised international standards.

### HOW WE WORK

Dignia specializes in complex large scale, turn-key projects. Our success is based on TITAS, a proprietary, customer-focused project implementation methodology that covers each stage of your project: Technology; Integration; Training; Assimilation and Support.

### DIGNIA HOLDS A LARGE VARIETY OF PRODUCTS:

- Border control integrated projects
- Forensic laboratories
- Cyber solutions
- Command and control systems
- Intelligence solutions
- Critical infrastructure
- Etc...

### KEY STRENGTHS

- Customized solutions for military, security and intelligence purposes
- Reliable, high performance systems and equipment
- Seamless integration to all mission-critical systems
- Comprehensive project life cycle support.
- Access to world-class military and security experts
- Professional, high quality training programs
- Creative financing and flexible payment terms



# THE DESIGN EDGE



**VERSIA MILITARY DESIGN LTD. (VMD)**

P.O.Box 8220, Tel Aviv 6108102, Israel

Tel: 972-77-5354513

Fax: 972-72-2150087

E-mail: [tamir@versiamilitary.com](mailto:tamir@versiamilitary.com)

Web Site: [www.versiamilitary.com](http://www.versiamilitary.com)



## Leaders in Military Design



**Versia Military Design is a leading international industrial design bureau, specializing in the defense sector.**

Headed by award winning designer Tamir Porat, Versia Military Design has more than 20 years experience in designing Small arms, Automotive, Robotics, Optics, Training Aids and HLS products.

Our methodology allows maximum flexibility taking into account the product

complexity, customer requirements and the development budget.

Versia Military Design offers a variety of services including:

- Design Concepts
- Engineering
- Models & Prototypes
- Research
- Marketing aids



# SERVICES



## ISRAEL MILITARY INDUSTRIES LTD. (IMI)

P.O.Box 1044, 64 Bialik Blvd.  
Ramat Hasharon 4711001, Israel  
Tel: 972-3-5485222  
Fax: 972-3-5486125  
E-mail: [imimrktg@imi-israel.com](mailto:imimrktg@imi-israel.com)  
Web Site: [www.imi-israel.com](http://www.imi-israel.com)

### TEST CENTER

IMI's Test Center is the largest and most advanced test site of its kind in Israel. The Test Center performs comprehensive evaluations and testing of various kinds of explosives, propellants and gun-fired ammunition ordnance, ranging from small caliber to 8" projectiles, mortars, rockets, missiles and aircraft armament warheads, as well as land based ammunition, grenades, mines, and pyrotechnic devices. Testing within the Test Center is carried out in labs and on open firing ranges. The live firing ranges are operated at the IMI Proving Ground, offering live testing of artillery and tank ammunition, at ranges of up to 40 km. IMI's highly-experienced professionals

are constantly focusing on creating the most diverse and rigorous test capabilities, guaranteeing that the customer's systems and munitions meet the test requirements of advanced militaries.

### AMMUNITION REUTILIZATION, DEMILITARIZATION & DISPOSAL

IMI offers advanced environmentally-friendly solutions for obsolete munitions and explosives. The solutions include reuse, recycling and disposal of High-Explosives (HE) propellants, pyrotechnic products, metal parts and other materials. Main activities include: conversion of operational

ammunition for training purposes, disassembly and reuse of components and raw materials ("like new" status) and disposal of ammunition through detonation or burning. IMI's safe and highly-reliable demilitarization facilities have a proven zero-casualties track record. In addition, IMI's Mobile Demiling Recycling Plant (MDRP) offers customers a unique cost-effective solution for overcoming the need of transporting munitions to demilitarization and disassembly sites.



# GOVERNMENT QUALITY ASSURANCE SERVICES FOR FOREIGN COUNTRIES



**SIBAT - Israel Ministry of Defense**  
International Defense Cooperation  
**Quality Assurance Division**  
Hakiryia, Tel Aviv 6473424, Israel  
Tel: 972-3-6934189  
Fax: 972-3-6934194  
E-mail: [anordan@mailto.mod.gov.il](mailto:anordan@mailto.mod.gov.il)  
Web Site: [www.sibat.mod.gov.il](http://www.sibat.mod.gov.il)

*The Quality Assurance Division at IMOD-SIBAT provides Government Quality Assurance services for foreign contracts placed by foreign governments in the Israeli industries.*

## QA SERVICES ARE PROVIDED FOR A WIDE RANGE OF COMMODITIES:

- Aircraft
- Ammunition
- Automotive
- Communication
- Electronics
- Materials
- Chemicals
- Computer Software
- Others

Quality Assurance tasks and activities are based on IMOD/SIBAT Quality Assurance Directives as well as on NATO Standardization Agreement, STANAG No. 4107, and ISO 9001: 2000 Quality Management System.

The QA personnel rely on I.D.F, and on civilian Q.A. specialists. They are well trained, with many years of experience in performing Q.A. functions.

Periodic Audits are performed by first line supervisors on the QARs Q.A. activities.

Technical support is provided (when required), by experienced engineers and specialists.

All of the QARs are certified engineers and technicians, trained and qualified in various QA systems skill areas, like:

- Non Destructive Tests
- Soldering
- Software Quality Assurance
- Preservation, Packing, Packaging and Marking
- Statistical Process Control
- Statistical Sampling
- Calibration

## QUALITY ASSURANCE CONCEPTS OF OPERATION AND METHODOLOGY

- Reviewing the contract and associated technical requirements.
- Generating a Quality Assurance Surveillance Plan based on identification and classification of risks.
- Performing QA Surveillance - Floor level process audits, support process audits and product audits.
- Reviewing Supplier Quality Management System Documentation.
- Establishing and maintaining QA surveillance records.
- Collect and Analyze Data.
- Initiating and processing quality deficiency reports, including validation of corrective and preventive actions.
- Providing risk information feedback.
- Conducting Post-award meetings with the supplier.
- Verifying and validating supplier's quality evidence.
- Verification of prime contractor controls over subcontractors.
- Preparation of product release.





# INDICES

# INDEX OF COMPANIES

## **ACCUBEAT LTD.**

5 Ha'Marpeh St.,  
P.O.Box 45102  
Har Hotzvim Industrial Zone  
Jerusalem 9777405, Israel  
Tel: 972-2-5868330  
Fax: 972-2-5868550  
E-mail: marketing@accubeat.co.il  
Web Site: www.accubeat.com  
President: Dr. Avinoam Stern  
C.E.O: Mr. Benny Levy  
V.P Sales & Marketing: Mr. David Fagelston  
Number of employees: 40  
Date established: 1993  
Ownership: Private

### **Areas of activity**

AccuBeat is a leading provider of Accurate Frequency and Timing solutions for the Aerospace, Defense and Telecommunications industries. Based on Rubidium Atomic Clock or OCXO technology with optional GPS disciplining, AccuBeat's products achieve the highest levels of accuracy and reliability. Our products and platforms are used in many sensitive Military and Government programs worldwide, ensuring optimum results in the most complex environmental conditions.

**See page: 272**

## **A.D. CONSULTANTS GROUP**

7 Golda Meir St.,  
Science Park  
Nes Ziona 7403650, Israel  
Tel: 972-8-9313600  
Fax: 972-8-9404317  
E-mail: adcon@adcon.co.il  
Managing Director: L.T. Col. (R) Gaby Peretz  
Number of Employees: 30  
Date Established: 1987

### **Areas of activity**

A.D. Consultants has been dealing in military and security supplies of new and surplus equipment, as well as consultancy services.

Our worldwide network of agents and suppliers enable us to provide special deliveries either by sea or air, to all destinations.

**See page: 400**

## **AERODAN SYSTEMS (1993) LTD.**

17 Kaplan St.,  
Tel-Aviv 6473418, Israel  
Tel: 972-3-6961099  
Fax: 972-3-6966343  
E-mail: maerav@aerodan.com  
Web Site: www.aerodan.com  
C.E.O: Dr. Elkana Rooz  
C.T.O: Dr. Vladimir Brotskey  
V.P Marketing & Business Development:  
Mrs. Maerav Rooz Michaelson  
Number of employees: 30  
Date established: 1988  
Ownership: Private

### **Areas of activity**

Aerodan has since 1988 become an R&D source and an established provider of high-end engineering based software and hardware integrated solutions for aerospace and avionic applications to customers worldwide. Aerodan specializes in systems engineering and integration. Initially providing aerospace engineering support for the Israel MOD, the company provides aerospace development services and solutions for all the major defense industries in Israel. Today Aerodan is mainly involved in the development of avionic modules, products and systems such as flight systems and fire-control computers.

**See page: 50**

## **AEROMAOZ LTD.**

Tel: 972-3-6095003  
Fax: 972-3-6095033  
E-mail: info@aeromaoz.com  
Web Site: www.aeromaoz.com  
C.E.O: Mr. Yaniv Gadish  
V.P. Sales & Marketing: Mr. Eli Avivi  
Marketing Manager: Mr. Marc Steinberg  
Number of Employees: 90  
Date Established: 1980  
Ownership: Private

### **Areas of activity**

- Internal & External Lighting
- Illuminated Panels Electronic Controls
- Night Vision Imaging System (NVIS) Compatible Products
- NVIS Cockpit Upgrades
- Joysticks & Handgrips
- Bezels/Display Bezels
- Keyboard Bezels
- MFD Bezels
- LED, EL & Conventional Lighting Technologies

**See page: 44**

**AERONAUTICS LTD.**

P.O.Box 169  
Yavne 8110101, Israel  
Tel: 972-8-9433600  
Fax: 972-8-9328912  
E-mail: info@aeronautics-sys.com  
Web Site: www.aeronautics-sys.com  
C.E.O: Mr. Amos Mathan  
V.P. Marketing: Mr. Dany Eshchar  
Number of employees: 680  
Date established: 1997  
Ownership: Private

**Areas of activity**

Aeronautics Ltd. is a global leader in the area of unmanned systems (UAVs). With core technologies in the areas of C<sup>4</sup>I, navigation, communication, and electro-optics, Aeronautics offers its customers a full spectrum of superior ISTAR solutions at air, sea and on the ground.

**See pages:** 48, 242, 243, 244, 245, 246, 247, 248, 249

**AEROTACTIX (ISRAEL) LTD.**

68 Amal St.,  
Petah Tikva 4951368, Israel  
Tel: 972-3-9215720  
Fax: 972-3-9215434  
E-mail: info@aerotactix.co.il  
Web Site: www.aerotactix.co.il  
C.E.O: Mr. Roei Itshakov  
Number of employees: 4  
Date established: 2008  
Ownership: Private

**Areas of activity**

AeroTactiX unmanned solutions develops and provides high end mini UAV systems that are compact, simple to operate, and highly capable.  
The systems are developed according to the experience and knowledge accumulated in thousands of operational missions. Designed for use in military and homeland security missions, AeroTactiX's systems excel in every ISTAR mission.

**See page:** 250

**AL CIELO  
INERTIAL SOLUTIONS LTD.**

5 Nahum Hefzadi St.,  
Jerusalem 9548401, Israel  
Tel: 972-2-6595539  
Fax: 972-2-6541221  
E-mail: info@alcielo.com  
Web Site: www.alcielo.com  
C.E.O: Dr. Arnon Arbel  
C.F.O: Mr. Shahak Moshe  
V.P. Business Development: Mr. Yitzhak Yoselis  
Number of employees: 75  
Date established: 2013  
Ownership: Rafael & Kearfott co.

**Areas of activity**

Al Cielo specializes in the research, development, manufacturing and integration of laser technologies and navigation & control inertial sensors.  
With over 40 patents, world class facilities and a decade of experience in development and manufacturing of electro and fiber optical systems, Al Cielo brings measurable advantages to Fiber Optic Gyroscopes (FOG), Inertial Measurement Units (IMU) and Inertial Navigation Systems (INS).  
Al Cielo is the Only local supplier in Israel for closed loop FOGs with sensors engaged in a variety of navigation and control applications.

**See page:** 348

**ARAN  
RESEARCH AND DEVELOPMENT (1982)**

43 Haeshel St.,  
Caesarea Business Park  
P.O.Box 3067  
Caesarea 3088900, Israel  
Tel: 972-4-623-90-00  
Fax: 972-4-627-32-60  
E-mail: info@aran-rd.com  
Web Site: www.aran-rd.com  
V.P. Defense Division: Mr. Tzahi Ankori  
V.P. Marketing & Sales: Mr. Arie Tulman  
Number of employees: 140  
Date established: 1982  
Ownership: Public

**Areas of activity**

ARAN is a Turn Key product development facility. With over 30 years of experience our staff is tuned to meeting performance requirements, reducing product cost and meeting schedule. ARAN is aimed at GOING THE FULL CYCLE, from concept to serial production. Our experience includes airborne and vehicle mounted electronics, control stations, test equipment and complex mechanisms.

**ARAN's Services:**

- Industrial Design
- Product Development, Design & Engineering
- Program Management
- Prototypes
- Manufacturing

See page: 404

**ARAZIM LTD.**

4 Hamelacha St.,  
P.O.Box 9021  
Lod 7117001, Israel  
Tel: 972-8-9230555  
Fax: 972-8-9230044  
E-mail: info@arazim.com  
Web Site: www.arazim.com  
CEO: Mr. Sason Noama  
Sales Manager: Mr. David Kriheli  
R&D Manager: Mr. Yomtov Elbililia  
Date Established: 1991  
Ownership: Private

**Areas of activity**

Arazim Ltd. develop and manufacturer advanced navigation Systems within 2 main fields of activity and expertise:

**GNSS-Based North Finding Systems**

The HPLS® for static applications and the ArSys® which is hybrid INS/GNSS for dynamic applications are state-of-art highly accurate (down to < 1 mRad) North-Finding Systems , MIL-SPEC compliant for demanding applications.

**Inertial Navigation Systems**

Line of IMU / AHRS / INS systems, MEMS-based miniature, MIL-SPEC rugged for demanding applications with advanced built-in Kalman Filter running on powerful DSP platform. Arazim is ISO-9001 certified company.

See page: 349

**ASHOT ASHKELON INDUSTRIES LTD.**

P.O.Box 21  
Ashkelon 7810001  
Tel: 972-8-6721511  
Fax: 972-8-6721711  
E-mail: info@ashot.co.il  
Web Site: www.ashot.co.il  
President & C.E.O: Mr. Dan Katz  
V.P. Marketing & Business Development: Mr. Yaron Gilboa  
Number of employees: 530  
Date established: 1967  
Ownership: Government 85%, Public 15%

**Areas of activity**

Drive train, suspension and mobility solutions for Tanks & APC's; tungsten based armor Penetrators and fragments manufacturer.

Ashot provides build to print & build to specification, design and manufacturing of Suspensions Systems, Main Automatic Transmissions, Final Drives, Transfer Boxes, PTO's and wide range of Gear based assemblies and Shafts for Main Battle Tanks.

Ashot is AS 9100C & ISO 9001:2008 certified.

See page: 119

### **ASTRONAUTICS C.A. LTD.**

16 Martin Gehl St.,  
P.O.Box 3351  
Kiryat Arie  
Petach-Tikva 4951207, Israel  
Tel: 972-3-9251555  
Fax: 972-3-9251550  
E-mail: astro@astro.co.il  
Web Site: www.astronautics.co.il  
Managing Director: Mr. Zvi Krepel  
V.P. Marketing & Business Development:  
Mr. Benjamin Weiser  
Director, R&D Engineering: Mr. Shachar Kur  
Number of employees: 80  
Date established: 1971  
Ownership: Astronautics Corporation of America

#### **Areas of activity**

Advanced high-technology systems for Airborne, Naval and Land applications.

#### **Main Products:**

##### **Naval:**

Advanced Naval Navigation systems for surface vessels and submarines, Naval Multi Function Consoles and Computerized Displays, Ring Laser Gyro based solutions and advanced MEMS/GPS INS Systems, Wireless Broadband Communication System.

##### **Airborne:**

Full Glass Cockpit Upgrade Solutions, Airborne Mission and Display Computers, Tactix - Tactical Mission System, EICAS-Engine Indication & Crew Alert Systems, EFIS- Electronic Flight Instruments Systems, Displays & MFCDs, Smart Displays, EW Displays, Digital Air Data Computers, Digital Moving Map (2D/3D), Airborne Mission Management systems, Cockpit Instruments (Electro-mechanical and Electronic - EHSI/EADI/EFI).

##### **Land:**

Tactical Computers and Displays, Ground INS/GPS Ring Laser Gyro based Navigation and Fire Control Systems for artillery and heavy rockets launching systems (MLRS), Instant Network-Centric System (INCS).

**See pages:** 36, 37, 92, 180

### **BAE SYSTEMS - Rokar**

11 Hartom St.,  
Har Hotzvim  
P.O.Box 45049  
Jerusalem 9777511, Israel  
Tel: 972-2-5329888  
Fax: 972-2-5822522  
E-mail: rokar.marketing@baesystems.com  
Web Site: www.baesystems.com  
President & General Manager: Mr. Nir Lavi  
Marketing Manager: Mr. Doron Shalev  
Finance Director: Mr. Roi Levy  
Number of employees: 120  
Date established: 1981  
Ownership: BAE Systems North America

#### **Areas of activity**

BAE SYSTEMS Rokar specializes in the development, production, maintenance and technical support of electronic countermeasures dispensing systems, GPS navigation guidance systems and precision guidance systems.

Rokar serves the armed forces and defense industries of Israel and of customers around the world as a leading provider of combat-proven products.

The products of BAE SYSTEMS Rokar meet the highest standards of quality assurance in accordance with ISO 9001:2008 specifications, as well as the standards set by the Israel Defense Forces, the Standards Institution of Israel, and the relevant authorities of the U.S. and many European customers.

**See page:** 64

### **BENTAL INDUSTRIES LTD.**

Merom-Golan 1243600, Israel  
Tel: 972-4-6960199  
Fax: 972-4-6960187  
E-mail: bental\_marketing@bental.co.il  
Web Site: www.bental.co.il  
Chairman: Mr. Gideon Yadin  
CEO: Mr. Uri Bauer  
Date established: 1983

#### **Areas of activity**

Bental industries specializes in design and manufacturing of innovative power and motion systems which integrate into various ground and aerial platforms.

#### ***Application examples***

- Electric Motors
- Servo Actuators
- Alternators and Starter Alternator
- Blowers and dust scavengers

The company main ability is to tailor cutting edge technologies and innovative solutions into specific project requirements.

**See pages:** 24, 120

**BETH-EL ZIKHRON YAAQOV INDUSTRIES LTD.**

1 Avshalom Road  
P.O.Box 166  
Zikhron Yaaqov 3095101, Israel  
Tel: 972-4-6299904/05  
Fax: 972-4-6299900  
E-mail: [export@beind.com](mailto:export@beind.com)  
Web Site: [www.beind.com](http://www.beind.com)  
Managing Director: Mr. Albrecht Fuchs  
Export Director: Mr. Joachim Blind  
Head of International Sales & Marketing: Mr. Jehuda Fehlauer  
Number of employees: 1,000  
Date established: 1973  
Ownership: Private

**Areas of activity**

Beth-El is a major supplier for combined ventilation & NBC filtration systems as well as combined air conditioning, ventilation & NBC filtration systems, Engine Air cleaners, blast valves, fuel pumps and other subsystems. Beth-El systems are installed in numerous platforms like the Merkava MBT, Namer APC, Piranha IIIC, Piranha V, Duro IIP, Eagle IV, new Eagle, Dingo II, Boxer, VAB Mark II, Cobra, YAK and dozens of other vehicle types. Systems for containers, tents, shelters and infrastructure are as well in the scope of the Beth-El product line. Some of the key features of Beth-El systems include: coarse and fine dust filtration; toxic shooting fumes filtration; CAN-bus control; compliance to all the important military standards, such as: NATO AEP-54, MIL – PRF – 321387, AC 225 (PANEL VII) D/251, and German TL Standards, amongst other Standards. Beth-El's systems are in service with more than 60 armies worldwide.

**See pages:** 374, 375

**BET SHEMESH ENGINES LTD.**

1 Virginia Avenue  
Western Industrial Zone  
Bet Shemesh 9905529, Israel  
Tel: 972-2-9909486/7  
Fax: 972-2-9911970  
E-mail: [info@bsel.co.il](mailto:info@bsel.co.il)  
Web Site: [www.bsel.co.il](http://www.bsel.co.il)  
President & C.E.O: Mr. Avner Shacham  
V.P. Marketing & Sales: Mr. Avigdor Hirsch  
Number of employees: 500  
Date established: 1968  
Ownership: Company traded on Tel-Aviv Stock Exchange

**Areas of activity**

- **Maintenance, Repair and Overhaul** of gas turbine engines - PWA F100 series, PWC PT6A, PT6T series, GE Aviation T700 series, Rolls-Royce 250 series and Turbomeca's Marbore II/VI.
- **Manufacture** of various jet engine parts; Spacers, Disks, Airseals.
- **Investment Casting** of hi-temp alloys, mainly gas turbine engines blades and vanes.
- **Design**, development and manufacture of small jet engines for UAVs and missiles.

**See page:** 25

**BIRD AEROSYSTEMS LTD.**

10 Hasadnaot St.,  
P.O.Box 4038  
Herzliya 4614001, Israel  
Tel: 972-9-9725700  
Fax: 972-9-9579613  
E-mail: info@birdaero.com  
Web Site: www.birdaero.com  
Co-CEO: Mr. Ronen Factor  
Co-CEO: Mr. David Dragucki  
VP Marketing: Mr. Shaul Mazor  
Number of employees: 78  
Date established: 2001  
Ownership: Private

**Areas of activity**

BIRD Aerosystems specializes in the development of Special Mission Aircraft Solutions (ASIO) and Airborne Missile Protection Systems (AMPS).

**AMPS** - The Airborne Missile Protection System (AMPS) is provided in cooperation between AIRBUS Defense & Space and BIRD Aerosystems. The system offers the most advanced protection against Surface to Air Missiles (SAM) and has been certified by leading aircraft manufactures such as AIRBUS Helicopters and MIL Design Bureau. AMPS is currently protecting hundreds of aircraft in many of the leading conflict zones around the world.

**ASIO** - The Airborne Surveillance, Intelligence and Observation (ASIO) solution is a complete turnkey special mission aircraft solution. ASIO is highly customizable and can address diverse operational requirements ranging from terrestrial surveillance, maritime patrol and targeted monitoring. The solution is supplied on a selection of aircraft with a wide range of sensors and subsystem and can be offered under direct purchase or dry/wet leasing agreements.

**See pages:** 65, 72

**BL ADVANCED GROUND SUPPORT SYSTEMS LTD.**

Offices:  
18 Hasivim St.,  
Kiryat Matalon  
Petach-Tikva 4959376, Israel  
Mail:  
P.O.Box 7782  
Petach-Tikva 4934829, Israel  
Tel: 972-3-9210404  
Fax: 972-3-9210405  
E-mail: sales@bl-il.com  
Web Site: www.bl-il.com  
C.E.O: Mr. Rafi Bivas  
E-mail: rafi@bl-il.com  
Engineer Manager: Mr. Yoav Koster  
E-mail: yoav@bl-il.com  
Number of employees: 23  
Date established: 2004  
Ownership: Private

**Areas of activity**

BL offers development, production, sales and after sales service in two main areas:

- Advanced ground support systems
- Advanced military products for ground forces

BL's strength is comprised of its ability to develop new and smart solutions rapidly and cost effectively.

Line of Products:

- Bomb Loaders
- Aircraft Towbarless Tug
- HPU - computerized hydraulic power supply

**See page:** 81

#### **BLUEBIRD AERO SYSTEMS LTD.**

8 Hamatechet St.,  
Kadima 6092000, Israel  
Tel: 972-9-8999335  
Fax: 972-9-8999345  
E-mail: info@bluebird-uav.com  
Web Site: www.bluebird-uav.com  
C.E.O: Mr. Ronen Nadir  
V.P Business Development: Mr. Itai Toren  
Marketing: Ms. Natalie Deutsch  
Number of employees: 50  
Date established: 2002  
Ownership: Private

#### **Areas of activity**

**Bluebird Aero Systems Ltd** (established in 2002), is a dominant player in the Tactical Unmanned Aerial Systems (UAS) industry, specializes in design, development and production of Micro, Mini and tactical UAS and peripheral equipment, and delivers exceptional, unprecedented combat proven solutions to meet the challenges of the Military, HLS and civil UAS markets supporting peace keeping, low intensity conflict, security, disaster management, law enforcement and commercial applications.

See page: 251

#### **BUL LTD.**

10 Rival St.,  
Tel-Aviv 6777845, Israel  
Tel: 972-3-6392911  
Fax: 972-3-6874853  
E-Mail: info@bultransmark.com  
Web Site: www.bultransmark.com  
General Manager: Mr. Eli Ozalvo  
General Manager: Mr. Zion Lachiano  
Marketing Manager: Mr. Roy Salem  
Number of employees: 20  
Date established: 1989  
Ownership: Private

#### **Areas of activity**

Manufacturers and distributors of Hi-capacity polymer frame single and double action pistols and accessories:

**BUL M-5:** 1911 based. Models available for carry and competition use. All popular calibers available.

**The New BUL Cherokee:** Double action pistols, extremely lightweight and ergonomic. Reliable and ideal for police, military and self-defense uses.

**BUL Storm:** All-steel Hi capacity double action pistol. Reliable and ideal for police, military and self-defense uses.

**High-Quality 1911 parts:** User friendly, prepped and easy to install metal injection molding parts. **High-Quality Rifle & pistol polymer parts and accessories** for the pro Spec. Ops & Swat members.

See page: 228

#### **CAMERO-TECH ISRAEL LTD.**

Grand Netter Industrial Zone,  
Intergama Building  
P.O.Box 3521  
Kfar Netter 4059300, Israel  
Tel: 972-73-7172333  
Fax: 972-73-7172323  
E-mail: info@camero-tech.com  
Web Site: www.camero-tech.com  
C.E.O: Mr. Amir Beeri  
V.P. Business Development: Mr. Hagay Keller  
Number of employees: 30  
Date established: 2004  
Ownership: Private

#### **Areas of activity**

Camero is a leading provider of Radar based tactical through-wall imaging solutions.

The Xaver™ products have become the solution of choice for military and law enforcement agencies throughout the world, including:

**Xaver™ 800** - high performance 3D imaging solution for ISR applications

**Xaver™ 400** - small and lightweight tactical tool providing mission-critical information

**Xaver™ 100** - a compact handheld through-wall detector

See page: 212

#### **CARMOR - INTEGRATED VEHICLE SOLUTIONS LTD.**

P.O.Box 639  
Ind. Zone Ziporit  
Nazareth Elite 1710502, Israel  
Tel: 972-4-6410641  
Fax: 972-4-6418555  
E-mail: gabid@carmor.co.il  
Web Site: www.carmor.co.il  
C.E.O: Mr. Alon Guttel  
V.P Marketing & Business Development:  
Mr. Gabi Davidson  
C.F.O: Mrs. Sharon Malul  
Number of employees: 150  
Date established: 1947

#### **Areas of activity**

Design and Manufacture of Armored vehicles, Aircraft Refuellers, Tankers, Fire fighting and Rescue vehicles, Riot Control vehicles, Comprehensive solution of NBC vehicles, Tank transporter, Add-on Armor design and solution, Trailers and Wagons.

We have the ability and capability to meet the customer's needs while offering the most cost effective tailor-made solution.

See pages: 121, 376



**CI SYSTEMS LTD.**

P.O.Box 147  
Industrial Park Ramat Gabriel  
Migdal Haemek 2310101, Israel  
Tel: 972-4-6448888  
Fax: 972-4-6543570  
E-mail: market@ci-systems.com  
Web Site: www.ci-systems.com  
C.E.O: Dr. Robert Buckwald  
V.P. General Manager & Haed of Electro-Optic Division:  
Mr. Efraim Tzafrir  
C.F.O.: Mr. Tzvi Hardoon  
Number of employees: 120  
Date established: 1977  
Ownership: Public, Tel-Aviv stock exchange

**Areas of activity**

IR Sources - Blackbodies.  
IR targets.  
FLIR testers.  
Visible sources.  
CCD testers.  
Laser range finder testers.  
Laser designator testers.  
Multi-sensor payload testers.  
Spectro-radiometers and remote sensing.  
Boresight equipment.  
E-O guided missile testing.  
Missile warning systems - testers and simulators.

**See page: 344**

**COMMTACT LTD.**

P.O.Box 169  
Yavne 8122447, Israel  
Tel: 972-8-9433602  
Fax: 972-8-9433603  
Email: info@commtact.co.il  
Web Site: www.commtact.co.il  
C.E.O: Mr. Shai Palti  
Purchase Manager: Mrs. Marina Shtrfoon  
Sales & Marketing: Mr. Sharon Shlomo  
Number of employees: 50  
Date established: 1991  
Ownership: Aeronautics Ltd.

**Areas of activity**

Commtact Ltd. specializes in developing and manufacturing state of the art Data link Solutions and wireless communication systems for defense, homeland security and civil applications.

Commtact offers the following data link solutions:

- UAVs (Unmanned Aerial Vehicles)
- Fixed wing aircraft and helicopters
- Naval platforms and USVs
- Ground vehicles, UGVs
- Missile applications
- Ground to Ground Applications

**See page: 252**

**CONTACT INTERNATIONAL (KALIA) LTD.**

P.O.Box 18434  
Jerusalem 9118301, Israel  
Tel: 972-2-5354565, 5354057  
Fax: 972-2-5354566  
E-mail: contintl@netvision.net.il  
Managing Director: Mr. Zev Kaptowsky  
Export Manager: Ms. Tali Ohayon  
Number of employees: 10  
Date established: 1979  
Ownership: Private

**Areas of activity**

Supply of surplus military equipment for Ground Forces, Air Force and Navy, including:

- Arms and ammunition
- Weapons spare parts and accessories. Personal equipmen
- Combat vehicles and spare parts
- Optronics and communications equipment
- Aircraft spare parts and components
- Own storage and processing facilities

**See page: 229**

**CONTROP PRECISION TECHNOLOGIES LTD.**

P.O.Box 611  
Hod Hasharon 4510502, Israel  
Tel: 972-9-7440661  
Fax: 972-9-7440662  
E-mail: sales@controp.com  
Web Site: www.controp.com  
C.E.O: Mr. Dror Sharon  
V.P. Marketing: Mr. Johnny Carni  
Director, Marketing & Communications: Mrs. Lori Erlich  
Number of employees: 190  
Date established: 1988  
Ownership: Private

**Areas of activity**

Development and manufacture of servo-control and electro-optical systems:

- Electro-optical stabilized payloads for day-night observation on board of light aircraft, helicopters, UAVs, ships and marine patrol aircraft
- Automatic intruder detection systems
- Thermal imaging cameras (FLIR) with continuous zoom lens
- Antenna pedestals and positioners for communication and radar equipment (including satellite communication)
- Reconnaissance film cameras

**See pages:** 162, 316, 336

**DEA****Research and Development Ltd.**

P.O.Box 34436  
Jerusalem 9134302, Israel  
Tel: 972-2-6540878/9  
Fax: 972-2-6540885  
E-mail: Dea\_ltd@netvision.net.il  
Web Site: www.dea-rd.com  
General Manager: Mr. Reuven Fichman  
Number of employees: 10  
Date established: 1980

**Areas of activity**

DEA R&D specialized in research, development, management and design of multidisciplinary Projects. Personal NBC life support equipment for the civilian and military markets, hood blower system, ventilated garments and detectors. Our capabilities are based on a blend of design disciplines: human engineering, tooling, production, assembly, testing and documentation. DEA is carrying out theoretical and studies in human engineering.

**See page:** 377

**DEFENSE TECHS**

P.O.Box 39290  
Tel Aviv 6139201, Israel  
Mobile: 972-50-4551284  
E-mail: info@defensetechs.com  
Web Site: www.defensetechs.com  
General Manager: Mr. Matias Schapiro  
Number of employees: 10  
Date established: 2012  
Ownership: Private

**Areas of activity**

We have over 17 years experience in Homeland Security, Defense and Civil protection. DefenseTechs works in partnership with the leading experts in each of the Security and Defense fields, and represent many technology companies mostly Israelis, as well as providing constant innovations and know how in the field.

**See page:** 390

**DEMOMAN INTERNATIONAL LTD. -  
Security & Defense Solutions**

P.O.Box 3896  
Nazareth Illit 1752606, Israel  
Tel: 972-50-5901655  
Fax: 972-4-6561632  
E-mail: [info@demoman.co.il](mailto:info@demoman.co.il)  
Web Site: [www.demoman.co.il](http://www.demoman.co.il)  
[www.suicide-terrorism.com](http://www.suicide-terrorism.com)

C.E.O: Mr. Tal Hanan  
Head of Strategy Department:  
Col. (Res.) Dr. Hanan Shai (Shchwartz)  
Chief Instructor: Mr. Samuel Bashan  
Date established: 1999  
Ownership: Private

**Areas of Activity:**

**INTELLIGENCE**

- Financial Intelligence
- Intelligence Operations
- Information gathering and Analysis

**STRATEGY DEPARTMENT:**

- Strategic Intelligence
- Strategic, Multi-National, Financial Investigations
- Counter Terrorism Funding and Money Laundering
- Crisis Management and turning Risk into Opportunities
- Rapid Decision-Making and Coping with Uncertainty
- Operational Concepts and Operational Field Solutions

**SUICIDE TERRORISM & BOMB SECURITY  
DEPARTMENT:**

- Counter Suicide Terrorism in HLS environment  
([www.suicide-terrorism.com](http://www.suicide-terrorism.com)) and Bomb Security Training  
and Consulting
- Explosives Detection
- Anti-Sabotage Awareness

**SECURITY DEPARTMENT:**

- Terrorism Awareness, and Countering Terrorism Trends
- Experience Sharing - Rapid Deployment Security Training
- Executive Protection Training and Consulting
- Disaster security and logistical support (Including Medical  
Support and Supplies)
- Defense Systems and Security Supplies

**See page: 391**

**DEXORD LTD.**

P.O.Box 12702  
Ashdod 7760049, Israel  
Tel: 972-8-8681150  
Fax: 972-8-8681169  
E-mail: [dxord\\_1@netvision.net.il](mailto:dxord_1@netvision.net.il)  
President & C.E.O: Mr. G. Arazi  
Chief Q.A.R: Mr. M. Horn  
Number of employees: 5  
Date established: 1984  
Ownership: Private

**Areas of activity**

Supply of military and security equipment to all military,  
police and special forces, new or surplus equipment.  
Representation of foreign manufacturers.

**See page: 401**

**DIGNIA SYSTEMS LTD.**

9 Shenkar St.,  
Herzlia 4672509, Israel  
Tel: 972-74-7200700  
Fax: 972-9-9612021  
E-mail: [recp-d@dignia.com](mailto:recp-d@dignia.com)  
Web Site: [www.dignia.com](http://www.dignia.com)  
C.E.O: Mr. Itzhak Tzadik  
Ownership: Private

**Areas of activity**

Dignia Systems is a global leader and trusted provider of  
Security and Defence solutions. Our customers include military  
and internal security organizations, intelligence and law  
enforcement agencies worldwide. With over 25 years  
experience we bring reliable field-proven technology, backed  
by professional expertise and "real world know-how" to any  
large scale government project.  
Dignia holds a large variety of products such as: Border control  
integrated projects, forensic laboratories, intelligence solutions,  
special forces trainings etc.

**See page: 405**

**DSIT SOLUTIONS LTD.**

2 Rechavam Zeevi St.,  
Givat Shmuel 5401777, Israel  
Tel: 972-3-5313333  
Fax: 972-3-5313322  
E-mail: [marketing@dsit.co.il](mailto:marketing@dsit.co.il)  
Web Site: [www.dsit.co.il](http://www.dsit.co.il)  
C.E.O: Mr. Benny Sela  
V.P Sales & Marketing: Mr. Dan Ben-Dov  
Number of employees: 80  
Date established: 1985  
Ownership: Acorn Energy 84%, Management 16%

**Areas of activity**

DSIT provides sonar & acoustic solutions for naval, HLS and energy markets.  
Our Shield™ family of Diver Detection Sonars considered as world leader, noted for fully automatic operation, excellence of performance and detecting range.  
Other products: SeaShield™ – Submarine Detection Sonar, Sonar Simulators and trainers, Acoustic Signal Analysis systems and Portable Acoustic Ranges.

**See page:** 112

**D.T.E. CO. LTD.**

P.O.Box 41  
Industrial Zone,  
Ashkelon 7810001, Israel  
Tel: 972-8-6750342  
Mobile: 972-50-5236865  
Fax: 972-8-6751045  
E-mail: [dte\\_com@netvision.net.il](mailto:dte_com@netvision.net.il)  
Web Site: [www.minefield-shoes.com](http://www.minefield-shoes.com)  
General Manager: Mr. Shlomo Ringler  
Date established: 1959  
Ownership: Private

**Areas of activity**

**Manufacturer of anti-personal mine protecting shoes, (sapper platform for crossing mine field). MINEFIELD SHOES.**

The MFC CHECKMATE Safety Shoes (NSN: 8430-15-121-9857 ) are built on the theory of air-cushions, which support the body while reducing the pressure in relationship to the minefield. The CHECKMATE is completely portable, folds up into a small lightweight object and easily slipped into a regulation army pack. It has more than ten years of extensive use with most known armies in the world.

**See page:** 200

**DYNAMIC JET ENGINEERING LTD. (DJE)**

1 Abba-Eban Blvd.  
DIROM Bldg. Fl.1  
P.O.Box 12832  
Herzliya 4672519, Israel  
Tel: 972-9-9514731  
Fax: 972-9-9514733  
E-mail: [info@dynamicjet.com](mailto:info@dynamicjet.com)  
Web Site: [www.dynamicjet.com](http://www.dynamicjet.com)  
Persident: Mr. Shalom Lahat (Col. Res)  
V.P. & Head of Engineering: Mr. Chanan Orpaz  
Head of Q.A. & Logistics: Mr. Shuki Abuav  
Number of employees: 14  
Date established: 2004  
Ownership: Private

**Areas of activity**

DJE provides Upgrades, Modifications and Conversions solutions. Its capabilities and performances, reflects decades of experience and qualities, sustained by its staff with extensive knowledge. It has gained expertise and practical experience in the aerospace industry in Israel and abroad, allows the firm to provide tailored solutions for most stringent requirements and needs on a variety of military and civil aircraft platforms.

**CERTIFICATES**

DJE is AS 9100 certified, recognized contractor for international aerospace companies.

**See page:** 14

**D. YOLAND LTD.**

17 Hamasger St.,  
Old industrial zone  
P.O.Box 13518  
Natanya 4237878, Israel  
Tel: 972-9-8616103  
Fax: 972-9-8847221  
E-mail: info@yolandcorp.com  
Web Site: www.yolandcorp.com  
Chairman: Mr. Dani Ginat  
C.E.O: Mr. Roni Ginat  
Marketing Manager: Mr. Adi Ginat  
Date Established: 1976  
Number of employees: 40  
Ownership: Private

***US Subsidiary (100% owned):******Yoland CORPORATION INC.***

235 36<sup>TH</sup> St.,  
Brooklyn, NY 11232  
Tel: 718-499-4803  
Fax: 718-499-4834  
President: Mr. Dani Ginat  
C.E.O: Mr. Tal Ginat  
E-mail: yolandcorp2@gmail.com

**Areas of activity**

Yoland manufactures military textile articles:

Parachutes for:

- Artillery illumination ammunition
- Mortar illumination ammunition
- Air dropped illumination flares
- 40mm illuminating grenades
- Other types

Bags for artillery and mortar charges Body armor.

Seats cover for airplanes, trains and buses.

Yoland also manufactures nonstandard and mil-spec textile products which require high quality production.

**See page:** 181

**EBONY ENTERPRISES LTD.**

14 Shenkar St.,  
Nolton House  
P.O.Box 12358  
Herzliya Pituah 4672514, Israel  
Tel: 972-9-9601300  
Fax: 972-9-9601333  
E-mail: office@ebonyltd.com  
niso@ebonyltd.com  
President: Mr. Niso Bezalel  
V.P Marketing: Mr. David Argov  
Chief of Staff: Mr. Barak Raz  
Number of employees: 15  
Date established: 1994  
Ownership: Private. Niso Bezalel

**Areas of activity**

EBONY is a Professional Entrepreneur, working with leading Israeli and International world-wide enterprises to market, export and deliver solutions, products and services to countries in Africa, Europe, South America and Asia.

EBONY thrives to implement in those countries solutions that are up-to-date, on demand, and personalized to increase productivity and drive know-how.

**See page:** 402

**ELBIT SYSTEMS LTD.**

Advanced Technology Center  
P.O.Box 539  
Haifa 3105301, Israel  
Tel: 972-4-8315315  
Web Site: www.elbitsystems.com  
President & C.E.O: Mr. Bezhael (Butzi) Machlis  
Executive V.P. International Marketing & Business  
Development: Mr. Jacob Gadot  
Senior Director, Marketing Communications:  
Mrs. Roni Ganani  
Number of employees: 12,000  
Date established : 1966  
Ownership: Public Co.  
Major shareholder: Federmann Group  
NASDAQ Global Market: ESLT

**Areas of activity**

- Defense & Commercial Airborne Systems & Simulators
- Unmanned Systems
- C<sup>4</sup>I - Command, Control, Communications, Computers and Intelligence
- ISR & Electro-optical Sysetms
- Combat Vehicle Systems
- Naval Systems
- EW & Countermeasures
- Radio Communication & Data Links
- Homeland Security
- Support & Services

**See pages:** 15, 16, 17, 38, 39, 40, 41, 49, 51, 59, 60, 61, 110, 231, 254, 255,

**ELBIT SYSTEMS****ELECTRO-OPTICS - ELOP LTD.**

Advanced Technology Park  
P.O.Box 1165  
Rehovot 7611101, Israel  
Tel: 972-8-9386211  
Fax: 972-8-9386010  
Web Site: www.elbitsystems.com/elop  
E.V.P. & Managing Director: Mr. Adi Dar  
V.P. Business Development & Marketing: Mr. Roy Zentner  
Number of employees: 1,800  
Date established: 1938  
Ownership: Elbit Systems Ltd.

**Areas of activity**

An industry leader in all aspects of electro-optic products and systems, offering a full spectrum of solutions aimed mainly at the defense market:

laser and thermal imaging systems; head-up displays; ISR systems, including payloads for space, airborne, naval and land-based missions; space and air IMINT systems; ground integrated sights, EO countermeasures (EOCM), Cyber and intelligence and homeland security solutions.

**See pages:** 42, 43, 66, 84, 85, 122, 123, 146, 163, 296, 317, 318, 319, 330, 331, 332, 333, 338, 339, 340, 341

**ELBIT SYSTEMS****EW & SIGINT – ELISRA LTD.**

48 Mivtza Kadash St.,  
Bene Beraq 5121701, Israel  
Tel: 972-3-6179798  
Fax: 972-3-6175880  
E-mail: ew-sigint@elbitsystems.com  
Web Site: www.elbitsystems.com  
Chairman of the Board: Mr. Bezahel (Butzi) Machlis  
C.E.O: Mr. Edgar Maimon  
V.P. Marketing & Business Development: Mr. Irmin Mencher  
V.P C.F.O: Mr. Nir Shani  
Number of Employees: 1,500  
Date Established: 1967  
Ownership: Elbit Systems Ltd.

**Areas of Activity**

- Complete, Integrated Self Protection Suites including RWR, LWS, Jammer, RF and Passive IR Missile Warning System for Fighters, Helicopters, Transport Aircraft, MPA and Combat Vessels
- Intelligence, including ESM/ELINT Systems for MPA, Reconnaissance Aircraft and Helicopters
- ESM and COMINT for UAVs
- EW, COMINT/DF, COMJAM and Integrated
- Communication Systems for Modern Air, Ground and Navies
- Search and Rescue Systems for the most advanced combat and peacetime requirements
- Data Links for various types of UAVs, Guided Weapons and Satellites
- C2 for BMD (Theater Missile Defense, including Test Bed and Battle Management Center for the ARROW Weapon System), C<sup>4</sup>I for Integrated Intelligence, EW, and Land systems for all operational levels
- Network Centric Warfare
- Spectrum Management and Control
- Microwave Components and Subsystems

**See pages:** 67, 106, 208, 285

**ELBIT SYSTEMS LAND AND C<sup>4</sup>I LTD.**

2 Ha'machshev St.,  
Netanya 4250712, Israel  
Tel: 972-9-8898080  
Fax: 972-9-8898231  
E-mail: landc4i@elbitsystems.com  
Web Site: www.elbitsystems.com/landc4i  
Executive Vice President & General Manager:  
Mr. Yehuda Vered  
Vice President Marketing & Business Development:  
Mr. Boaz Cohen  
Number of employees: 2,450  
Date established: 2003  
Ownership: Elbit Systems Ltd.

**Areas of activity**

- Armored Vehicle Systems
- Artillery
- Guns
- Mortars
- Ammunition
- Unmanned Ground Vehicles
- Sensors
- Robotics
- Radio Communication
- C<sup>4</sup>I - Command, Control, Communications, Computers and Intelligence
- Homeland Security
- Intelligence

**See pages:** 124, 125, 126, 127, 182, 183, 184, 185, 274, 275, 276, 277, 278, 279, 280, 286, 287, 288, 289, 297

**ELTEL TECHNOLOGISTICS LTD.**

7 Martin Gehl St., Kiryat Arye  
Petach Tikva 4951254, Israel  
Tel: 972-3-9205253  
Fax: 972-3-9205200  
E-mail: meirh@eltel.co.il  
Web Site: www.eltel.co.il  
C.E.O: Mr. Shmulik Rosental  
V.P. Marketing & Business Development: Mr. Meir Harel  
Number of Employees: 300  
Date established: 1979  
Ownership: Malam Team

**Areas of activity**

Eltel Technologists Ltd. Is a leading defense provider of technological and logistics solutions that specializes in the field of training and simulation:

- Advanced live fire training.
- Digital shooting ranges.
- Scenario simulation (urban combat training, pyrotechnics, smoke, etc.).
- Exercise monitoring, debriefing and performance analysis.
- Synthetic Arena Simulation (SAS).
- Competence and Readiness Performance Management (CRPM) - an advanced BI system that supports the decision making process along the chain of command.

See page: 232

**GOLDTEC TECHNOLOGIES LTD.**

10 Rival St.,  
Tel Aviv 6777845, Israel  
Tel: 972-3-5377870  
Fax: 972-3-5377868  
E-mail: info@goldtec.co.il  
Web Site: www.goldtec.co.il  
Founder & C.E.O: Mr. Gil Goldberg  
Business Development Manager: Mr. Amihai Dekel  
Number of employees: 20+  
Date established: 1989  
Ownership: private

**Areas of activity**

**MDVR** - digital video, data & audio recorders, specifically built and qualified for extreme conditions and security applications. Special models for vessels, vehicles and handheld.

**Thermal Beacon** - patented Optical IFF (Identification friend or foe).

**Laser for OEM**- High power visible and infrared laser illuminators and pointers built to specification into electro optical gimbals.

**Tactical Laser**- Lasers that are applicable on rifles, machine guns, weapon stations, observation cameras', etc.

See page: 213

**G-NIUS****Unmanned Ground Systems (UGS) LTD.**

Beit Tavor 3, 2 Fl.  
Yokneam Industrial Park  
P.O.Box 370  
Yokneam 2069205, Israel  
Tel: 972-77-3184402  
Fax: 972-77-3184420  
E-mail: marketing@g-nius.co.il  
Web Site: www.g-nius.co.il  
C.E.O: Mr. Yoav Hirsh  
Business Development: Mr. Danny Gur  
V.P. R&D: Mr. Zvika Waissbaum  
Number of Employees: 25  
Date Established: 2005  
Ownership: 50% Elbit Systems, 50% IAI

**Areas of activity**

G-NIUS Unmanned Ground Systems Ltd. is a pioneer in unmanned ground vehicle (UGV) systems for defense and security applications.

Founded in 2005, G-NIUS is a joint company between Israel Aerospace Industries Ltd. (IAI) and Elbit Systems Ltd.

See page: 266

**HAGOR INDUSTRIES LTD.****MILITARY EQUIPMENT MANUFACTURING**

13 Shenkar St.,  
P.O.Box 3211  
Kiryat Arie  
Petach-Tikva 4951601, Israel  
Tel: 972-3-9248990  
Fax: 972-3-9243996  
E-mail: michal@hagor.co.il  
Web Site: www.hagor.com  
C.E.O: Mr. Haim Frenkel  
Production Manager: Mr. David Frenkel  
Export Manager: Mrs. Michal Frenkel-Bitton  
Number of employees: 70  
Date established: 1952  
Ownership: Private

**Areas of activity**

Production, marketing and sales of armored vests of many different kinds, battle vests for infantry units, armored corps, demolition squads, medical units, anti-terror units, naval commando, etc. Winter gear - long and short cold parkas and overalls. Rucksacks, kitbags, sleeping bags, stretchers, field cots, carriers, special personal gear. Unique, reinforced PVC vehicle covers for all kinds of trucks, jeeps, command cars etc. All kinds of tents, from personal tents to giant hospital and camp tents.

See page: 152



## **HARTECH TECHNOLOGIES LTD.**

22 Maskit St.,  
Herzliya 4673322, Israel  
Tel: 972-74-7200800  
Fax: 972-9-9549394  
E-mail: marketing@hartech.co.il  
Web Site: www.hartech.co.il  
C.E.O: Mr. Offer har  
Offer@Hartech.co.il  
Director Business Development: Mrs. Rachel Wolstein  
Date established: 2002  
Ownership: Private

### **Areas of activity**

HarTech's products include:

- Command and Control Systems
- High fidelity simulation engine for the generation of high fidelity simulation solutions
- Provision of Constructive Simulation and Training solutions
- Geo Spatial Management System (GEM)
- HarTech's Behavior Editor for Advanced Computer Generated Forces
- Smart Scenario Generation Technology (SSG)

**See page:** 62

## **HBA SYSTEMS INTEGRATORS**

77 Herzel St.,  
Oasis Towers  
Ramat Gan 5244350, Israel  
Tel: 972-3-6722226  
Fax: 972-3-6722193  
E-mail: manuel.bar-gil@hba.co.il  
Web Site: www.hba.co.il  
President & C.E.O: Mr. Haim Ben-Ari  
V.P Marketing & Sales: Mr. Manuel Bar-Gil  
Date established: 1979  
Ownership: Private

### **Areas of activity**

- EOD solutions - EOD Robots, professional training
- Logistic Solutions for Emergency Deployment - Hospitals, Military & Civilian camps
- Unique non-lethal equipment & world wide security consultation services
- Integration of border crossing checkpoints & marine cargo inspection facilities and maritime protection
- Security commercial trade
- Explosives - Binary explosives and disrupters, electronic initiation system
- Forensics equipment

**See page:** 201

## **IAI**

### **AIR & MISSILE DEFENSE DIVISION Systems Missiles & Space Group**

P.O.Box 105  
Industrial Zone  
Yehud 5610002, Israel  
Tel: 972-3-5315699  
Fax: 972-3-5315830  
E-mail: marketing@iai.co.il  
Web Site: www.iai.co.il  
General Manager: Mr. Jacob Galifat

### **Areas of activity**

Point and area advanced air and missile defense systems from short to long ranges - low to high altitude targets fully net centric highly effective naval and land based applications.

**See pages:** 52, 83, 100, 235

## **IAI**

### **ELTA SYSTEMS LTD.**

100 Yitzchak Hanasi Blvd.  
P.O.Box 330  
Ashdod 7710202, Israel  
Tel: 972-8-8572410  
Fax: 972-8-8561872  
E-mail: market@elta.co.il  
Web Site: www.elta-iai.com  
President & C.E.O of IAI, Chairman of the Board of ELTA:  
Mr. Joseph Weiss  
IAI Executive V.P & ELTA President: Mr. Nissim Hadas  
Senior V.P: Mr. Yacob Saraf  
Senior V.P: Mr. Moshe Lippel  
Senior V.P: Mr. Tal Sagee  
V.P., General Manager, Land & Naval Radars and Systems Div.: Mr. Israel Lupa  
V.P., General Manager, Airborne Systems & Radars Div.: Mr. Gideon Landa  
V.P., General Manager, SIGINT, EW & Communication Div.: Mr. Eyal Danan  
V.P., General Manager, Integrated Microwave Systems Div.: Mr. Yosef Fouks  
V.P., General Manager, Technologies Div.: Mr. Ronen Zagoory  
Director, Group Marketing & Sales Div.: Mr. Igo Licht

### **Areas of activity**

Military and Para-Military Systems House based on Electromagnetic Sensors (Radar, Electronic Warfare and Communication) & Advanced Technologies, for Intelligence, Surveillance & Reconnaissance, Early Warning, Air Defense, Weapon Location, Self-Protection, Target Acquisition, Fire Control, Signal Intelligence, Electronic Warfare and Home-Land Security Applications.

**See pages:** 20, 68, 74, 75, 99, 164, 234, 253, 273, 298, 299, 300

## **IAI**

### **LAHAV DIVISION Military Aircraft Group**

Ben-Gurion International Airport  
7010000, Israel

Tel: 972-3-9353163, 972-3-9358198

Fax: 972-3-9353687, 972-3-9357010

E-mail: lahav\_marketing@iai.co.il

Web Site: www.iai.co.il

General Manager: Mr. Benjamin Cohen

Director of Marketing: Mr. Netta Kerem

#### **Areas of activity**

Lahav provides innovative solutions for:

- Military aircraft and helicopter upgrade, refurbishment, overhaul, maintenance, repair, and life extension
- Integrated and NCW Avionics system and software design, development, integration, and testing
- Stand-alone and networked tactical simulators, trainer upgrades with embedded synthetic training
- Design and production of aerostructures, and electrical harnesses
- Robotic solutions for a wide range of operational needs and missions utilizing cutting edge of robotics technology

**See pages:** 18, 19, 268

## **IAI**

### **MALAT DIVISION Military Aircraft Group**

Ben Gurion International Airport, 70100, Israel

Tel: 972-3-9358169

Fax: 972-3-9355781

E-mail: malat@iai.co.il

Web Site:

www.iai.co.il/17800-

en/Groups\_Military\_Aircraft\_MALAT.aspx

On April 2, 2014 MALAT Division was divided into 3 divisions within IAI's Military Aircraft Group (MAG). The 3 divisions are working in full harmony with each other. For simplicity purpose all these 3 new divisions are hereby referred to as "MALAT".

The 3 divisions are:

#### **MALAT TECHNOLOGIES:**

Engineering and production of the UAV systems (UAS).

General Manager: Mr. Yoram Holtzberg.

#### **RAKIA:**

UAS special programs. General Manager: Mr. Moshe Levy.

#### **MALAT:**

UAS business organization. General Manager:

Mr. Baruch Bonen.

#### **Areas of activity**

IAI/MALAT specializes for over 40 years in the design, development, integration, manufacturing and support of UAS (Unmanned Aerial Vehicle Systems) for military, paramilitary and civil applications.

IAI/MALAT's systems have accumulated over 1,300,000 operational flight hours.

IAI/MALAT covers the full spectrum of UAV systems, providing solutions for urban warfare, tactical and strategic missions and comprehensive maritime solutions, using its micro, mini, tactical close range, tactical short range, VTOL systems and Medium Altitude Long Endurance (MALE) systems.

IAI/MALAT provides comprehensive UAV systems with complete ILS (Integrated Logistic Support) and customer support in order to ensure their smooth entry into operational service.

**See pages:** 257, 258, 259, 260, 261, 262, 263

**IAI**  
**MISSILES DIVISION**  
**Systems Missiles & Space Group**

P.O.Box 105  
Industrial Zone  
Yehud 5610002, Israel  
Tel: 972-3-5315699  
Fax: 972-3-5315830  
E-mail: [marketing@iai.co.il](mailto:marketing@iai.co.il)  
Web Site: [www.iai.co.il](http://www.iai.co.il)  
General Manager: Ms. Avital Schrift

**Areas of activity**

- Missile Systems and PGM
- Naval Systems
- Ground Systems
- Air Defense Systems
- Laser weapons

**See pages:** 52, 83, 100, 235

**IAI**  
**MLM DIVISION**  
**Systems Missiles & Space Group**

P.O.Box 45  
Beer-Yaakov 7035001, Israel  
Tel: 972-8-9272520  
Fax: 972-8-9272890  
E-mail: [mlm\\_marketing@iai.co.il](mailto:mlm_marketing@iai.co.il)  
Web Site: [www.iai.co.il](http://www.iai.co.il)  
Director of Marketing & business Development:  
Mr. Amit Haimovich

**Areas of activity**

MLM Division is the system integration house of Israel Aerospace Industries Ltd. (IAI). As a multifaceted design, development, and system engineering organization, MLM has the experience, knowledge, and capabilities to leverage its cutting-edge technologies to deliver systems that are among the most advanced in the world.

MLM specializes in a variety of disciplines, which enables it to act as prime contractor and leading system architect for governments and armed forces around the world.

MLM offers its partners and customers uncompromising performance, reliability and quality. MLM provides full service from the earliest stages of concept analysis, through development, production and installation, and culminating in integration and life-cycle support.

**See pages:** 63, 111, 186

**IAI**  
**SPACE DIVISION**  
**Systems Missiles & Space Group**

P.O.Box 105  
Industrial Zone  
Yehud 5610002, Israel  
Tel: 972-3-5315699  
Fax: 972-3-5315830  
E-mail: [marketing@iai.co.il](mailto:marketing@iai.co.il)  
Web Site: [www.iai.co.il](http://www.iai.co.il)  
General Manager: Mr. Opher Doron

**Areas of activity**

Space Systems, including GEO communication and LEO EO and SAR imaging satellites, ground stations and related services.

**See page:** 52, 83, 100, 235

**IAI**  
**SYSTEMS MISSILES & SPACE GROUP**

P.O.Box 105  
Industrial Zone  
Yehud 5610002, Israel  
Tel: 972-3-5315699  
Fax: 972-3-5315830  
E-mail: [marketing@iai.co.il](mailto:marketing@iai.co.il)  
Web Site: [www.iai.co.il](http://www.iai.co.il)  
Corporate V.P & General Manager Systems Missiles & Space Group: Mr. Boaz Levi  
Director of Marketing: Mr. Yoram Shimoni

**Areas of activity**

Defense Systems, Advanced Weapon Systems and Space:

- Missile Systems and PGM
- Air and Missile Defense Systems
- Naval Systems
- Ground Systems
- Intelligence, Surveillance and Reconnaissance (ISR) Systems
- Anti-Ballistic Missile Defense
- Space Systems - Satellites, Launchers and Ground Stations
- Optronic Payloads

**See pages:** 52, 83, 100, 235

**IAI****TAMAM DIVISION  
Systems Missiles & Space Group**

P.O.Box 75  
Industrial Zone  
Yehud 5610001, Israel  
Tel: 972-3-5315205  
Fax: 972-3-5315140  
E-mail: infotmm@iai.co.il  
Web Site: www.iai.co.il  
General Manager: Mr. Shlomo Gold  
Director of Marketing: Mr. Igal Mevorach

**Areas of activity**

TAMAM Division is an integral part of Israel Aerospace Industries Ltd. (IAI) Systems, Missiles and Space Group. Since its foundation in 1964, TAMAM has been a leader in advanced electro-optical systems and inertial navigation technologies for use on air, land, sea and space platforms. TAMAM leads advanced projects for the Israel Defense Forces (IDF) and other armed forces around the world. Among the company's main products are day/night electro-optical systems for unmanned air vehicles (UAVs), helicopters, fixed-wing aircraft, ground and maritime applications - such as M-19, LOROS, MOSP, POP, MiniPOP, GTAS and MicroPOP. TAMAM supplies an array of land and airborne inertial navigation and reference systems such as NFS, TMAPS, ADNAV, RNAV-IPON and TNL-16, competitively priced strapdown systems for tactical weapons and smart ordnance such as TRF-90 and TNF as well as guidance and reference systems for space platforms.

**See pages:** 324, 325, 350

**IARD****Sensing Solutions Ltd.**

Yagur 3006500, Israel  
Tel: 972-4-8216402  
Fax: 972-4-8216396  
E-mail: info@iard.co.il  
Web Site: www.iard.co.il  
C.E.O: Dr. Yossi Bushlin  
C.T.O: Dr. Adam Devir  
Director of Remote Sensing: Dr. Dan Sheffer  
Number of employees: 30  
Date established: 1998  
Ownership: Private

**Areas of activity****Radiometry, E-O Systems**

Design and construction of unique E-O instrumentation for accurate radiometric measurements. Design, performance and analysis of complicated radiometric field-tests.

**Signature Control**

Multispectral signatures management (measurement, evaluation, and development of suppression measures) for various platforms and installations.

**Modeling and Simulation**

Modeling and simulation of Electro-optical systems. Image processing and algorithms development. Analysis and modeling of aero-optics and heat & mass transfer phenomena.

**See page:** 345

**IMAGESAT INTERNATIONAL N.V.**

6 Yoni Netanyahu St.,  
Or Yehuda 6037604, Israel  
Tel: 972-3-7960600  
Fax: 972-3-5163430  
E-mail: orders@imagesatintl.com  
Web Site: www.imagesatintl.com  
C.E.O: Mr. Noam Segal  
V.P Marketing & Sales: Mr. Noam Zafrir  
V.P Business Development: Mr. Rani Helerman  
Number of employees: 60  
Date established: 1997  
Ownership: IAI, Private Share Holders

**Areas of activity**

ImageSat International N.V. is a commercial provider of Very High Resolution (VHR), satellite earth-imagery from EROS constellation of satellites, principally for intelligence, homeland security and national development purposes worldwide.

The Company also provides imagery to customers for a wide-range of civilian applications, including mapping, disaster assessment and monitoring, infrastructure planning, agricultural monitoring, environmental monitoring etc.

**See page:** 301

**IMCO INDUSTRIES LTD.**

8 Hataasia St.,  
P.O.Box 188  
Tel-Hanan 3660102, Israel  
Tel: 972-4-8213322  
Fax: 972-4-8210508  
E-mail: marketing@imco-ind.com  
Web Site: www.imco-ind.com  
C.E.O: Mr. Efraim Grimberg  
C.F.O: Mr. Dan Sraya  
VP Marketing: Mr. Boaz Weiss  
Number of Employees: 300  
Date Established: 1974  
Ownership: Public Company traded in Tel-Aviv Stock  
Exchange (TASE: IMCO)

**US OFFICE**

4820 Seton Dr.  
Baltimore, MD 21215  
Tel: 410-358-1717  
Fax: 410-358-7707

**SUBSIDIARIES**

ADT - ADVANCED DEFENCE TECHNOLOGIES Inc.  
USA,  
Nir-Or (Israel) Ltd.  
Atena Ltd.

**Areas of Activity**

Engineering and Manufacturing of military and commercial electrical, electro-mechanical and electronic assemblies, cable harnesses, for airborne, land and naval applications.  
LED Lights (interior & exterior) for tanks and armored fighting vehicles Slip-rings, fuel-gauges, smoke grenade launchers.

**See page:** 193

**IMI****ISRAEL MILITARY INDUSTRIES LTD.**

P.O.Box 1044  
64 Bialik Blvd.  
Ramat Hasharon 4710001, Israel  
Tel: 972-3-5485222  
Fax: 972-3-5486125  
E-mail: imimrktg@imi-israel.com  
Web Site: www.imi-israel.com  
Chairman of the Board: Gen. (ret.) Udi Adam  
President & C.E.O: Mr. Avi Felder  
V.P. Marketing: Mr. Avinoam Zafir  
V.P. Finance & Control: Mrs. Zmira Ganani  
V.P. Research & Development and Business Development:  
Dr. Dan Peretz

**Areas of activity**

Established in 1933 and fully owned by the Israeli government, IMI specializes in the development, integration and manufacture of offensive and defensive solutions for the modern battlefield, homeland security and terror threats. IMI's state-of-the-art systems for land, air and naval forces, draw on the extensive experience of the Israel Defense Forces (IDF), most of them are combat-proven and have been type classified by the IDF, US Armed Forces (Army, Air Force & Navy) and various NATO members.

IMI provides full combat solutions, professional training and services, designed to fully respond to specific customer requirements of survivability and protection, firepower and mobility on the modern battlefield.

The company employs 3,400 professional, customer-devoted employees in five divisions. In addition to modern design and development shops, IMI operates production facilities, supported by advanced laboratories and test facilities accounting for 30% of the company's infrastructure. IMI's comprehensive support for its customers includes end-to-end product assistance, from training and integrated logistics to maintenance, mid-life upgrades to the transfer of technology know-how and complete after sales support.

**See pages:** 53, 69, 86, 101, 128, 187, 214, 215, 238, 407

**IMI ACADEMY  
FOR ADVANCED SECURITY  
& ANTI-TERROR TRAINING**

P.O.Box 1044  
64 Bialik Blvd.  
Ramat Hasharon 4710001, Israel  
Tel: 972-8-9357040/1  
Fax: 972-8-9357042  
E-mail: academy@imi-israel.com  
Web Site: www.imi-academy.com  
President & C.E.O: Mr. Amiram Maor  
Professional Director: Mr. Yigal Levin  
V.P. Operation Manager: Mr. Itzhak Agami  
Marketing Director: Mr. Guy Lalush

**Areas of activity**

The IMI Academy for Advanced Security & Anti-Terror Training is a leading integrated solutions provider for military, law enforcement, government agencies and commercial clients worldwide.

Established in 1999 by veterans of the Israeli Security Forces, the Academy specializes in a wide range of comprehensive security training programs, including counter-terrorism, anti-crime and homeland security.

It is a subsidiary of Israel Military Industries Ltd. (IMI), a government owned company.

The Academy draws its strength from the accumulated knowledge of the Israeli security establishment. Its facilities, highly-experienced instructors and range of courses and seminars, have positioned the Academy as a model organization of its kind, one that its competitors attempt to emulate.

See page: 392

**IMI  
ADVANCED SYSTEMS DIVISION (ASD)**

P.O.Box 1044  
64 Bialik Blvd.  
Ramat Hasharon 4710001, Israel  
Tel: 972-3-5486170  
Fax: 972-3-5486633  
E-mail: asdmrkte@imi-israel.com  
Web Site: www.imi-israel.com  
V.P. & Division Manager: Mr. Yuval Sharony  
Director of Marketing & Business Development:  
Mr. Shmulik Geler

**Areas of activity**

ASD develops and manufactures advanced weapon systems, sub-systems and ordnance for aerospace, land and naval platforms. ASD offers a full range of innovative, combat-proven solutions, including electro-optically guided missiles, stand-off offensive weapons, advanced decoys and aerial targets and very short range, low-level air defense integrated systems (VSHORAD).

**IMI  
MUNITION SYSTEM DIVISION (MSD)**

P.O.Box 1044  
64 Bialik Blvd.  
Ramat Hasharon 4711001, Israel  
Tel: 972-3-5486243  
Fax: 972-3-5485365  
E-mail: imiimrktg@imi-israel.com  
Web Site: www.imi-israel.com

**Areas of activity**

MSD develops and manufactures a full range of ammunitions. MSD is renowned for its innovative developments in the fields of:

- Advanced tank ammunition
- Advanced artillery ammunition
- Mortar, aerial land and naval ammunition
- Smart, precise munitions
- Infantry combat systems, such as rifle grenades, hand grenades, demolition and breaching equipment, non-lethal, engineering combat systems, ordnance and ammunition components
- Homeland security products and services
- Self-destruct warheads for various platforms (artillery, tank, mortar and aerial)
- Insensitive Munition (IM) technology

MSD also specializes in:

- Refurbishment and upgrading of all types of munitions
- Ammunition disposal, including a Mobile Demiling and Recycling Plant
- Manufacture of all kinds of metal parts and explosive materials

**IMI  
ROCKET SYSTEMS DIVISION (RSD)**

P.O.Box 1044/6604  
64 Bialik Blvd.  
Ramat Hasharon 4711001, Israel  
Tel: 972-8-9242684  
972-8-9277447/9  
Fax: 972-8-9252896  
E-mail: iweinreb@imi-israel.com  
Web Site: www.imi-israel.com  
V.P. & Division Manager: Mr. Nathan Wechsler  
Director of Marketing: Mr. Israel Weinreb  
R&D Director: Mr. Izhak Bagizada

**Areas of activity**

RSD develops and manufactures rocket motors, from small motors to satellite launchers, artillery rocket systems, anti-tank weapon systems, pyrotechnic and counter measure products, including IR spectral decoy flares, chaff products, as well as protection suites (i.e. AIRMOR) for aircraft, ballistic armor for personnel, aircraft and naval vessels.

**IMI****SLAVIN - LAND SYSTEMS DIVISION**

P.O.Box 1044  
 64 Bialik Blvd.  
 Ramat Hasharon 4711001, Israel  
 Tel: 972-3-5485790  
 Fax: 972-3-5486797  
 E-mail: info\_slavin@imi-israel.com  
 Web Site: www.imi-israel.com  
 V.P. & Division Manager: Mr. Eyal Ben-Haim  
 Director of Marketing & Business Development:  
 Mr. Rami Sokolower  
 Manufacturing Director: Mr. Avi Fuks

**Areas of activity**

SLAVIN LSD specializes in:  
 Upgrade programs and systems for MBTs & AVFs.  
 Development and Production of:

- Guns and Barrels: 120mm (Merkava, M60), 105mm (M60, T55), 90mm, 76mm, 60mm aircraft guns, 106mm recoilless guns
- Ballistic armor protection for MBTs, AVFs and light combat vehicles
- Active Protection Systems for vehicles and other applications
- Remote Controlled Weapon Stations for 5.56, 7.62, 12.7mm/0.5" machineguns and 40mm grenade launchers
- Assault logistic and infantry bridging systems
- Training equipment, inbore sub-caliber training device

**IMI****SMALL CALIBER AMMUNITION DIVISION ("Yitzhak" PLANT)**

P.O.Box 1044  
 64 Bialik Blvd.  
 Ramat Hasharon 4711001, Israel  
 Tel: 972-4-6500700/5  
 Fax: 972-4-6560686/6578058  
 E-mail: israels@imi-israel.com  
 Web Site: www.imi-israel.com  
 V.P. & Division Manager: Mr. Israel Shmilovitz  
 Director of Marketing: Mr. Eldad Sayada  
 E-mail: esayada@imi-israel.com

**Areas of activity**

IMI's Small Caliber Ammunition (SCA) Division specializes in the manufacture of high-quality cartridges, which are supplied in accordance with NATO, MIL-SPEC, IDF, SAAMI and CIP standards. These include 5.56, 7.62, 9, 12.7mm and 0.388" Lapua cartridges. SCA is the leading supplier of small caliber ammunition to the Israel Defense Forces (IDF). Other customers include the U.S. Army, armed forces of major NATO members, law enforcements, special units and customers in commercial markets worldwide.

**IOTT LTD.**

18 Aba Even St.,  
 Herzlia 4672536, Israel  
 Tel: 972-72-2220770  
 Fax: 972-72-2220771  
 E-mail: office@i-ott.com  
 Web Site: www.i-ott.com  
 C.E.O: Mr. Omri Timianker  
 B.D Manager: Mr. Yoav Kovaliker  
 Number of employees: 35  
 Date established: 2011  
 Ownership: Private

**Areas of activity**

IOTT specialize in the establishment of operational intelligence units and the implementation of cutting-edge technological systems in the Defense & HLS sectors.

As world leading experts of Tactical Intelligence, we are using our relevant background and proven abilities to establish an Operational Intelligence Units with Technological & Doctrine advantage.

**Our Experience**

- Vast international experience (over 70 countries)
- Establishment of numerous operational units (more than a hundred governmental, military, police & secret services units)
- Cooperation with top manufacturers of defense & HLS technologies
- World leading experts of SIGINT Tactical intelligence technologies

All of the training programs approved and licensed by MOD.

See page: 393

**ISDS LTD. -****International Security & Defence Systems**

P.O.Box 173  
Nir-Zvi 7290500, Israel  
Tel: 972-8-9227699  
Fax: 972-8- 9235104  
E-mail: isds@isds.co.il  
Web Site: www.isds.co.il  
President: Mr. Leo Gleser  
CEO: Mr. Tomer Fulman  
Vice President: Mr. Ron Shafran  
Number of employees: 15  
Date established: 1982  
Ownership: Private

**Areas of activity**

- ISDS Ltd. specializes in planning, integrating, and managing large scale security and defense projects. The company provides integrated solutions for complex security projects and targeted integrated security solutions to meet our clients' needs and demands.
- ISDS Ltd. provides services to governments, non-governmental organizations, corporations, and private clients.
- ISDS Ltd. core business is securing infrastructure, securing mega and special events, safe cities, airport security, maritime security, coastal protection, and counter crime and terror.
- ISDS Ltd. specializes in the development, procurement, integration and implementation of security technology.

**See pages:** 394, 395

**I.S.P. INDUSTRY SALES PROMOTION LTD.**

1 Lishansky St.,  
New Industrial Zone  
P.O.Box 500  
Rishon-Lezion 7510401, Israel  
Tel: 972-3-9513333  
Fax: 972-3-9514444  
E-mail: ariel.goldman@isp-aero.com  
Pressident: Mr. Ariel Goldman  
Business Development Manager: Mr. Danny Nachmuly  
Sales Manager: Mrs. Smadar Goldman  
Sales Manager: Mr. Ori Yovel  
Number of employees: 8  
Date established: 1977  
Ownership: Ariel Goldman

**Areas of activity**

- Aerospace Systems and components
- Weapon Systems and components
- Small arms, artillery and ammunition
- Spare parts for aerospace and military equipment
- Overhaul and repair of aviation and military systems
- Upgrading programs
- Border defense projects

**See page:** 26

**ISPRA****Israel Product Research Co. LTD.**

20A Galgalei Haplada St.,  
P.O.Box 2086  
Herzeliya 4672220, Israel  
Tel: 972-9-9555464  
Fax: 972-9-9559146  
E-mail: ispra@netvision.net.il  
Web Site www.ispraltd.com  
General Manager: Mr. Jacob Bialy  
V.P. Marketing: Mr. Alon Slonim  
Export Manager: Mrs. Chana Michaeli  
Quality Assurance Manager: Mr. Yohanan Stein  
Number of employees: 30  
Date established: 1969  
Ownership: Dr. A. Jacobson

**Areas of activity**

Development, manufacturing, export of less-lethal ammunition, riot control, anti-terror equipment, police gear, and personal protection devices.  
Tear gas devices for short, medium and long range operation.

**See pages:** 154, 155



**ISRAEL SHIPYARDS LTD.**

P.O.Box 10630  
Haifa Bay 2611702, Israel  
Tel: 972-4-8460246  
Fax: 972-4-8418744  
E-mail: [marketing@israel-shipyards.com](mailto:marketing@israel-shipyards.com)  
Web Site: [www.israel-shipyards.com](http://www.israel-shipyards.com)  
Chairman of the Board: Mr. Samy Katsav  
General Manager: Mr. Avi Shahaf  
V.P for Marketing: Mr. Oded Breier  
Number of employees: 500  
Date established: 1959  
Ownership: Private

**Areas of activity**

Experts in design and construction of Naval and Coastal Defense vessels, Commercial ships and Marine projects:

- Fast Patrol Craft (SHALDAG Class)
- Offshore Patrol Vessels
- Fast Missile Corvettes - SAAR 4, SAAR 4.5 and SAAR S – 72 Class.
- Commercial vessels, Tugs, Floating Docks and multi purpose boats.
- Heavy engineering products - Container cranes, Cranes, desalination plants.
- Ship repairs and maintenance.

**See pages:** 94, 95, 96, 97

**ISRAGOR PROTECTIVE GEAR & SYSTEMS LTD.**

3 Hagesher St.,  
Hod-Hasharon 4526603, Israel  
Mobile: 972-50-3227997  
Tel: 972-9-7493105  
Fax: 972-9-7493834  
E-mail: [isragor@zahav.net.il](mailto:isragor@zahav.net.il)  
President: Mr. Israel Goren

**Areas of activity**

Isragor develops, produces and markets all over the world protective military gear such as bullet proof vests, battle harnesses, covers and camping equipment. Special department of the company specializes in planing and establishing dry storage systems for military and civil uses. The core business of the company supplies all types of bullet proof vests.

**See page:** 153

**ISREX (94) LTD.**

Clal Building  
5 Droyanov St.,  
P.O.Box 11035  
Tel-Aviv 6111001, Israel  
Tel: 972-3-6200611  
Fax: 972-3-5283280  
E-mail: [isrexmng@isrex.com](mailto:isrexmng@isrex.com)  
Web Site: [www.isrex.com](http://www.isrex.com)  
Chairman of the Board: Mr. Danny Biran  
President: Mr. Gad Hitron  
Number of employees: 25  
Date established: 1968

**Areas of activity**

Export of products, systems and Israeli know-how. Police and anti-riot equipment. Electronic systems. Telecommunications. Night vision systems. Special vehicles. Command and control systems (C<sup>4</sup>I). Intelligence systems. Aircraft upgrading, and spare parts. Mobile hospitals and hospital equipment. Airborne and naval surveillance, Electro-optic systems and UAV'S. Wide experience in financing solutions.

**See page:** 403

**IWI****ISRAEL WEAPON INDUSTRIES (IWI) LTD.**

64 Bialik Blvd.  
P.O.Box 63  
Ramat-Hasharon 4710001, Israel  
Tel: 972-3-7606000  
Fax: 972-3-7606001  
E-mail: [info@iwi.net](mailto:info@iwi.net)  
Web Site: [www.iwi.net](http://www.iwi.net)  
V.P. Marketing & Sales: Mr. Ronen Hamudot  
Number of employees: 600  
Ownership: Private

**Areas of activity**

Israel Weapon Industries (IWI) is a world leader in small arms for over 80 years.

IWI's most known products include the **TAVOR**, **X95** & **GALIL ACE** families of Assault Rifles, the **NEGEV LMG**, the legendary **UZI SMG** (Mini, Micro and UZI PRO), the **JERICHO** family of pistols and the **GALIL SNIPER** Rifle and the new **DAN Bolt Action Sniper Rifle**— which have all been considered weapons of choice by military units and top law enforcement agencies around the world. The company's firearms are developed in close collaboration with the Israel Defense Forces (IDF). IWI and the IDF joint forces in developing these weapons, whose final configurations are the product of ongoing interaction, field tests, and modifications, resulting from combat requirements and experience.

**See page:** 230

**KANFIT LTD.**

4 Shaul Amor Avenue,  
Ramat Gabriel Industrial Zone,  
Migdal Haemek 2353004, Israel  
Tel: 972-4-6547461  
Fax: 972-4-6441065  
E-mail: shachar@kanfit.com  
Web Site: www.kanfit.com  
General Manager: Mr. Shai Fine  
Director & Business Development: Mr. Shachar Fine  
Mobile: 972-50-2231729  
Number of employees: 160  
Date established: 1986  
Ownership: Mr. Shai Fine

**Areas of activity**

Specializing in manufacturing, combination and integration of composite and metal products, Kanfit is a built to spec/print, aerospace engineering development and production company. A turn-key, one stop shop solution provider with advanced capabilities in RTM and Hybrid aero-structures. Kanfit manufactures aero-structures; primary detailed parts, sub-assemblies and assemblies ready to mount in the customers' final assembly line, RTM chaff and flare magazine, Munition parts, airborne and space antennas, etc.

See page: 27

**KARIL INTERNATIONAL MARKETING LTD.**

6 Maskit St.,  
Herzliya Pituach 4614002, Israel  
Tel: 972-9-9568212  
Fax: 972-9-9568141  
E-mail: karil@mistralgroup.com  
Web Site: www.mistralgroup.com  
V.P Marketing & Business Development, Israel: Mr. Ran Ofer  
V.P International Marketing & Business Development:  
Mr. Ran Avni  
Date established: 1996  
Ownership: Private; Mr. Eyal Banai

**Areas of activity**

Karil International, a member of Mistral Group, is an Israeli company specializing in HLS & Defense solutions. Karil is a registered and qualified supplier to the Israeli MOD, Military and Law Enforcement agencies, and is a qualified supplier to governments and private customers. Karil provides business development, marketing and operational solutions to clients around the globe and specializes in Blast Containment, Drug and Explosives detection and forensic products, Situational Awareness and Underwater navigation Systems.

See page: 202

**KILOLAMBDA TECHNOLOGIES, LTD.**

22a Raoul Wallenberg St.,  
Tel-Aviv 6971918, Israel  
Tel: 972-3-6497662  
Fax: 972-3-6497665  
E-mail: info@kilolambda.com  
Web Site: www.kilolambda.com  
President & CEO: Mr. Doron Nevo  
Chief Scientist: Dr. Moshe Oron  
VP Marketing: Ms. Karin Golding  
Number of employees: 16  
Date established: 2001  
Ownership: private

**Areas of activity**

KiloLambda's technology protects the human eye and expensive equipment against damage by destructive light sources, from sunlight to lasers, while improving the functionality of various optical systems. It can be applied on small surfaces, or implemented in optical sensors, high-end communications devices and other light conducting applications. The inherent passivity and solid state reliability of KiloLambda's solutions make them compatible with almost any IEC, MIL or other industry standard specifications.

See page: 320

**LDS****Laser Detect Systems (2010) LTD.**

14 Abba-Hillel St.,  
Ramat Gan 5250607, Israel  
Tel: 972-3-9705000  
Fax: 972-3-6054566  
E-mail: info@laser-detect.com  
Web Site: www.laser-detect.com  
Chairman & C.E.O: Mr. Eli Venezia  
Number of employees: 25  
Date established: 2004  
Ownership: Private

**Areas of activity**

LDS is a world-leading developer of stand-off laser-based trace detection technology, based on advanced laser spectrometry. LDS has commercialized patented, ground-breaking systems for homeland security, law enforcement, military and environmental safety. These systems enable the stand-off, real-time sensing and trace detection of a variety of materials which have a distinct spectral signature without the need for sampling. These include explosives, PETN, narcotics, chemicals, biological substances, and other hazardous materials, in powder, bulks or liquid forms.

See page: 147

## **LIOR TEXTILE INDUSTRIES LTD.**

Dora Ind. Zone,  
P.O.Box 11  
Shlomi 2283201, Israel  
Tel: 972-4-9808815  
Fax: 972-4-9808816  
E-mail: info@lior-protective.com  
Web Site: www.lior-protective.com  
www.concordusa-jackets.com  
General Manager: Mr. Itshak Bookris  
Marketing Manager: Mr. Haim Avnaim  
Sales Manager: Mr. Lior Bookris  
Number of employees: 75  
Date established: 1976  
Ownership: Private

### **Areas of activity**

#### **Developing, Designing, Manufacturing and global marketing of protective gear:**

- Body armor for the army, police & V.I.P use
- Ballistic shields & Inserts
- Ballistic helmets
- E.O.D - Bomb Suits
- Tactical Vests
- CBRN protective Suits & Coveralls
- Extended Cold Weather Clothing System (ECWCS)
- Backpacks & Carrying systems
- Fire brigade suits, Nomex pilot & tanker coveralls, underwear
- Work wear outdoor clothing: including reflective rain suits
- Inflatable tent & stretcher
- Dry storage solutions

**See page:** 156

## **LUDUS SECURITY LTD.**

### **COMBAT TRAINING & SECURITY TECHNOLOGY**

14 Grozenberg St.,  
Tel Aviv 6581117, Israel  
Tel: 972-54-2103310  
Fax: 972-3-6541216  
E-mail: info@ludus-security.com  
Web Site: www.ludus-security.com  
C.E.O: Mr. Avishai katz  
Date established: 2013  
Ownership: Private

### **Areas of activity**

Ludus Security specializes in defense and security projects. We provide a comprehensive service that covers the entire span of project phases. Our close connections with the defense industry and our skilled personnel- veterans of elite IDF units with extensive real combat experience , enable us to address our client's needs in a robust, efficient and cost effective manner.

### **Our services:**

- Security consulting
- counter-terror training
- General capabilities training
- Infantry units training
- Establishment of special units
- Supply of cutting-edge security equipment & technology

**See page:** 396

## **MAGAM SAFETY LTD.**

6 Hasadna St.,  
Ziporit Industrial Zone 1789020, Israel  
Tel: 972-73-2665800  
Fax: 972-4-6412118  
E- mail: info@magam-safety.com  
Web Site: www.magam-safety.com  
C.E.O & Marketing: Mr. Moti Eisner  
Purchasing Manager: Mrs. Gila Robinson  
Date established: 1934  
Ownership: Mifne Ltd.

### **Areas of activity**

**Magam Safety Ltd.** designs, manufactures and distributes a wide range of rescue, survivability and protective equipment;

- Personal protection equipment
- Rubber fuel tanks & self-sealing solutions
- Rescue and survivability equipment
- Inflatable equipment

Magam Safety products are developed in close relationship and constant feedback from the Israeli Defense Forces (IDF). The company is the sole supplier of parachutes, Anti-G suits and fuel tanks to the IDF.

**See page:** 82

**MAROM DOLPHIN LTD.**

Industrial Zone Alon Tavor  
P.O.Box 1126  
Afula 1811101, Israel  
Tel: 972-4-6400797  
Fax: 972-4-6403074  
E-mail: info@marom-dolphin.com  
Web Site: www.marom-dolphin.com  
C.E.O: Mr. Yariv Sagi  
International Marketing Manager: Mr. Shlomo Baime  
International Marketing Manager: Mr. Itay Benkuzary  
Number of employees: 45  
Date established: 1993

**Areas of activity**

Since founded in 1993, **Marom Dolphin** has established itself as one of the leading companies for developing, designing, manufacturing and marketing top quality tactical textile solutions such as: Tactical Vests, Body Armor Vests, modular carrying solutions, tactical backpacks and other accessories for armed forces, police units, security services and civilians around the world.

Among our customers are military, paramilitary, law enforcement and security organizations across the globe. We are the main authorized supplier of tactical textile solutions to the Israeli Military, the Israeli Ministry of Defense and many other governmental and private customers, worldwide. Our products are manufactured and tested in accordance to ISO 9001:2008 international standards as well as with the Quality Assurance standards of military forces worldwide, awarding them worldwide recognition for their high quality and durability.

**See page: 157**

**MATRIX DEFENSE & CONSULTING DIVISION**

3 Abba Eban Blvd.,  
Hertzliya 4612001, Israel  
Tel: 972-9-9598000  
Fax: 972-9-9588650  
E-mail: yoramy@matrix.co.il  
Web Site: www.matrix.co.il  
Director: Mr. Yoram Yaron  
Number of Employees: 170  
Date established: 1992  
Ownership: Public

**AREAS OF ACTIVITY**

Defense Consulting, providing Strategic Planning, Operational Analysis & Definition of System Requirements, Operations Research, System Engineering, Algorithm Design, System Test Planning & Execution, System-of-Systems Integration, Training & Operational Activation, Project Management, Organization Analysis.

End-to-End consulting for national mission critical projects, including the ARROW active missile defense system, AEW (Airborne Early Warning) systems, SIGINT systems and C<sup>4</sup>ISR systems.

**See page: 397**

**MEPROLIGHT (1990) LTD.**

P.O.Box 26  
4 Hahadas St.,  
Or Akiva Industrial Park  
Or Akiva 3065001, Israel  
Tel: 972-4-6244111  
Fax: 972-4-6244123  
E-mail: sales@meprolight.com  
Web Site: www.meprolight.com  
C.E.O: Mr. Eli Gold  
V.P. Marketing: Mr. Benny Kokia  
Number of employees: 220  
Date established: 1989  
Ownership: Private

**Areas of activity**

Meprolight is an International Electro-Optics company, developing, manufacturing and marketing systems for infantry, armed forces, law enforcement agencies and civilian markets since 1990. Meprolight provides a wide array of combat-proven products; Electro-optical and Optical sights and devices, night vision sights and devices, uncooled thermal sights and devices, laser rangefinders (LRF), hand-held laser range finders, fire control systems and self-illuminated (tritium) night sights.

The company is certified to ISO9001:2008, ISO14001:2004 and ISO18001:2007.

**See page: 216**

**MIFRAM LTD.**

6 Josef Levi St.,  
P.O.Box 1165  
Ind. Zone Kiriat Bialik  
Zur Shalom 2711101, Israel  
Tel: 972-4-8808800  
Fax: 972-4-8745745  
E-mail: sales@mifram.com  
Web Site: www.miframsecurity.com  
C.E.O & President: Mr. Amos Klein  
V.P. Business Development: Mr. David Noy  
President Assistant: Mr. Ron Fischer  
Number of Employees: 200  
Date established: 1962  
Ownership: Private

**Areas of activity**

Mifram Security (from 1962) handles all types of defense projects.  
Mifram Security specializes in designing, manufacturing and supplying:

**Force Protection Equipment** - Modular Vehicle Barriers, Mobile Observation Towers & Posts, Shelters and Crowd-Control Equipment.

**Ballistic and Blast Protection for Infrastructure** - (Meet the threat level of direct impact by 122mm Katyusha rockets).  
Indoor protection, External Building Cover, Self-Sustaining Protection Systems.  
Dry Storage Solutions.

**All our products have been Combat-Tested and Approved.**  
Among Mifram Security's satisfied customers are Military Forces (USMC, US-Army, MFO, IDF, UN), and Major Integrators & Government Law Enforcement Agencies.

**See pages:** 140, 141, 142, 143, 199

**MIPHA INTERNATIONAL LTD.**

8 Har Nevo St.,  
Ramat Hasharon 4722508, Israel  
Tel: 972-3-5402403  
Fax: 972-3-5490931  
E-mail: mipha@mipha.co.il  
Web Site: www.mipha.co.il  
President & C.E.O: Mr. Michael Itzhar Belachovsky  
V.P. Business Development and Legal Advisor:  
Mr. Yair Itzhar Belachovsky  
Professional Consultant in the field of Hi-Tech:  
Mr. Eran (Dotan) Rosenberg  
Date established: 1983  
Ownership: Private

**Areas of activity**

- Homeland Security and Operations Consultancy
- Security & Surveillance Systems for Borders, Airports, Seaports, Safe & Secure City, Pipelines and Sensitive Installations
- Specialize in Intelligence and Law Enforcement Consultancy and Equipment
- Interception systems for all communication technologies, cellphone location tracking and data mining for government agencies
- Advance Intelligence Inference Systems
- Surveillance and Counter-Surveillance including on-site checks to detect eavesdropping
- Advanced Biometric Identification Systems
- Data Communications, Storage Security and Data Recovery
- GPS Tracking and Fleet Management

**See pages:** 302, 303

### **M.L.M - PROTECTION**

6 Ha'Choshlim St., 7<sup>th</sup> Floor  
P.O.Box 12590  
Herzliya 4672406, Israel  
Tel: 972-9-9574377  
Fax: 972-9-9574370  
E-mail: ofer@mlm-protection.com  
Web Site: www.mlm-protection.com  
C.O - C.E.O & Director: Mr. Ofer Bar  
C.O - C.E.O & Director: Mr. Sharon Botzer  
Number of employees: 15  
Date established: 2002  
Ownership: Private

#### **Areas of activity**

**M.L.M Protection is the leading provider of turn-key security solutions** and one of the few companies able to supply a high degree of services and professionalism in all areas of security and assault, in both the private and public sectors. M.L.M Protection was founded by ex-Israeli security service personnel, who have served in the Israeli "**Dignitary and delegation protection unit**" of the Israeli "shen bet".

**See page:** 398

### **MORE -**

#### **MILITARY OPTICAL RF EQUIPMENT LTD.**

18 Hasivim St.,  
Alon Building 2nd Floor  
Petach Tikva, Israel  
Tel: 972-3-9208200  
Fax: 972-3-9215010  
E-mail: roman@eimmore.co.il  
Web Site: www.eimmore.co.il  
C.T.O: Mr. Roman Rabinovich  
V.P. B.D: Mr. Meir Gilady  
Number of employees: 20  
Date established: 2010  
Ownership: Private

#### **Areas of activity**

Four main businesses lines:

- ECM solutions
- Ultra Wide BW spectrum sensing
- RADAR & ECM simulators
- RF and Data over fiber connectivity

MORE developing and supply Generic solutions for advance EW arena based on RF-Photonic technology. The core of the solution relies on two levels of system design: Robust infrastructure, Generic EW techniques.

The main advantages includes:

- High instantaneous BW
- Negligible inherent min-delay
- Completely coherent and accurate phase/amplitude memory capabilities
- Very high Sensitivity
- High dynamic-range

**See pages:** 71, 107

**mPrest Systems LTD.**

Azorim Park, Kiriat Arieh  
94 Em Hamoshavot Rd.  
Petah Tikva 4970602, Israel  
P.O.Box 3027  
Tel: 972-7-3216666  
Fax: 972-7-3216636  
E-mail: [marketing@mprest.com](mailto:marketing@mprest.com)  
Web Site: [www.mprest.com](http://www.mprest.com)  
C.E.O: Col. (ret.) Natan Barak  
V.P Research & Development: Mr. Eli Arlazoroff  
Chief Software Architect: Mr. Alexander Arlievsky  
Number of employees: over 100  
Date established: 1996  
Ownership: 50% Private, 50% Rafael

**Areas of activity**

mPrest is a leading C<sup>4</sup>I software house, specializing systems for the Defense, Security and Critical Infrastructure sectors. mPrest possesses extremely highly flexible technological capabilities, developing complex reliable systems in a short period.  
mPrest developed a unique platform, infrastructure and generic building blocks for high-performance distributed critical systems.  
mPrest has developed complex software systems for international integrators and customers such as Rafael, IAI, Elisra, IDF, Israel Electricity Corporation (IEC), Israel Water Company (Mekorot), Safe Cities, etc.

**See page:** 290

**MTC****INDUSTRIES & RESEARCH CARMIEL LTD.**

P.O.Box 232  
Karmiel 2161102, Israel  
Tel: 972-4-9987772  
Fax: 972-4-9981189  
E-mail: [marketing@mtcind.com](mailto:marketing@mtcind.com)  
Web Site: [www.mtcind.com](http://www.mtcind.com)  
President: Mr. Yechiel Cohen  
Vice President: Mr. Yair Avni  
Vice President: Mrs. Jemy Gershonovich  
Number of employees: 130  
Date established: 1977  
Ownership: Private

**Areas of activity**

The development and manufacture of gyroscopes, inertial sensors, actuators and servo actuators, motors and servo motors, resolvers, RVDT, LVDT, slip rings, high pressure vessels, solenoids, canard actuation steering units, tachogenerators and other electro-mechanical components for the Aerospace, Defense and UAV industries. Services include engineering and thermal spray coatings. Scientific instruments for the dental field. AS9100C, ISO 9001:2008 and MIL-STD compliant.

**See page:** 54

**MYFORM LTD.**

Factory:  
Kiryat Shmona, Israel  
Main Office:  
9th Lincoln St., Tel-Aviv  
Mail:  
P.O. Box 14233  
Tel-Aviv 6114102, Israel  
Tel: 972-3-6244488  
Fax: 972-3-6244499  
E-mail: myform@myform.co.il  
C.E.O: Mr. Igal Hayoun  
E-mail: igal@myform.co.il  
C.F.O: Mr. Ilan Leybovich  
E-mail: ilan@myform.co.il  
Number of employees: 95  
Date established: 1996  
Ownership: Private

**Areas of activity**

Myform is one of the leading companies in Israel, manufactures and provides unique protection gear and personal security solutions for combatants, Defense forces personnel and VIP's in Israel and overseas.

**Myform is producing and supplying:**

- Body armor and carrying vest
- Concealable Protection vests
- Riot control suits, helmets and detachable visors
- Protection suits and equipment for Krav Maga training
- Personal protection gear for NBC (nuclear, biologic, chemical)
- Dry Storage solutions for deferent kinds and sizes of army vehicles
- Customized equipment for combatants and security forces

See page: 158

**NETLINE COMMUNICATIONS TECHNOLOGIES (NCT) LTD.**

Azrieli Circular Tower  
132 Menachem Begin Rd.  
Tel Aviv 6701101, Israel  
Tel: 972-3-6068100  
Fax: 972-3-6068101  
E-mail: info@netlinetech.com  
Web Site: www.netlinetech.com  
C.E.O: Mr. Ben Te'eni  
General manager: Mr. Gil Israeli  
V.P Marketing: Mr. Yallon Bahat  
Number of employees: 85  
Date established: 1998  
Ownership: Private

**Areas of activity**

Netline Communications Technologies develops and manufactures cutting edge electronic countermeasures and spectrum dominance solutions to the global defense and homeland security markets.

- Counter IED & communication jamming solutions with advanced features such as pre-initiation and hybrid active/reactive capabilities
- Tactical interception and COMINT/SIGINT solutions including spectral analysis, signal classification and demodulation, cell phone monitoring and location/direction finding
- Prison cell phone control solutions including cell phone jamming, detection and managed access systems
- RF monitoring and detection systems to combat cyber and wireless attacks on sensitive information.

See pages: 209, 304



**NICE SYSTEMS LTD.**

22 Zarhin St.,  
P.O.Box 690  
Ra'anana 4310602, Israel  
Tel: 972-9-7753777  
Fax: 972-9-7753222  
E-mail: info.security@nice.com  
info.intelligence@nice.com  
Web Site: www.nice.com  
E.V.P Cyber & Intelligence Solutions: Mr. Yossi Ofek  
E.V.P Surveillance Solutions: Mr. Christopher Wooten  
C.E.O: Mr. Barak Eilam  
Number of employees: 3,600  
Date established: 1986  
Ownership: Public

**Areas of activity**

NICE Systems is a global provider of homeland security and intelligence solutions.

**Our portfolio includes:**

- Communications Interception and Analysis
- Advanced Cyber Intelligence
- Speech Analytics
- Web Intelligence
- Geo Intelligence
- Situation Management
- Video Surveillance & Analytics
- Integrated C<sup>4</sup>I systems
- Incident debriefing and investigation using complete event reconstruction
- Public Safety Emergency Response Optimization

NICE customers include governments, police and intelligence agencies worldwide, as well as leading airports, critical infrastructure, transportation systems, smart/safe cities, banks and enterprises.

**See page:** 305

**NIMDA CO.**

P.O.Box 768  
North Industrial Zone  
Lod 7110604, Israel  
Tel: 972-8-9781111  
Fax: 972-8-9781137  
E-mail: info@nimda.co.il  
Web Site: www.nimda.co.il  
C.E.O: Mr. Nimrod Avni  
President: Mr. Arie Semel  
V.P. Marketing: Mr. Isaac Pery  
Number of employees: 100  
Date established: 1972  
Ownership: Private

**Areas of activity**

Turn-key programs for modernization, integration and production of military vehicles of U.S., British, French and Russian origin. Upgrading of MBTs, APCs, amphibious armored vehicles, such as T-72, M-60, T-55, M-41, M113, Shilka, BMP II, Achzarit HAPC, Puma Engineering MBT. Design and manufacture of power packs and advanced automotive applications, assembly and installation of ground forces Power Trains and marine propulsion systems. Advanced weapon systems integration modernize platforms for anti-tank and air defense use. Building customer's local military shops infrastructure logistic centers and vehicles production plants.

**See page:** 129

**NIRTAL TRAINING & SUPPLY OF COMBAT EQUIPMENT LTD.**

4 Hahagana St.,  
Or-Yehuda 6022404, Israel  
Tel: 972-73-2262753  
Fax: 972-3-6341176  
E-mail: nirtal@nirtal.com  
Web Site: www.nirtal.com  
Chairman: Mr. Nir Shaul  
V.P. Marketing & Business Development: Ms. Shiri Lalezar  
Mobile: 972-54-2226800  
Number of employees: 12 (+ 200 - 300 Temporary workers)  
Date established: 1995  
Ownership: Private

**Areas of activity**

- Counter Terrorism & Anti-crime operational training.
- Armed forces training: Special Forces & regular infantry units.
- V.I.P. & Executive Protection training.
- Supplier of various advanced technology systems & a variety of combat equipment.
- Security consulting and training using most advanced techniques, technologies and combat experienced instructors.
- All aspects of Airport and Aviation, Seaport & Maritime Security.
- Security in the private sector - Banking, Public transportation, Public institutions Petroleum & Natural gas pipeline infrastructure Etc.
- Surveillance and counter surveillance courses, training of police units for special assignments.
- Prison enforcement, special units and technologies.
- Crowd control and event management.
- "K-9" supply & training.
- VIP & Delegations Security Escort.

**See page: 399**

**NOGA EINAT SHOE INDUSTRIES LTD.**

Kibbutz Givat Hashlosha 4880000, Israel  
Tel: 972-3-9030150  
Fax: 972-3-9030151  
E-mail: info@nogaeinat.co.il  
Web Site: www.nogaeinat.co.il  
General Manager: Mrs. Ora Gilad  
Finance Manager: Mrs. Noga Polishuk  
Number of employees: 50  
Date established: 1930  
Ownership: Kibbutz Einat & Kibbutz Givat Hashlosha

**Areas of activity**

Noga-Einat Shoe Industries Ltd. is a manufacturer and supplier of military- and safety shoes.  
Product lines include: army boots, products for unusual conditions and special forces, police boots & shoes and boots for anti-terror and anti-rioting units.

**See page: 159**

**OMNISYS LTD.**

13 Ha'amal St.,  
Park Afek  
Rosh Ha'ayin 4809174, Israel  
Tel: 972-3-5377006  
Fax: 972-3-5377008  
E-mail: fredit@omnisys.co.il  
Web Site: www.omnisys.co.il  
C.E.O: Mr. Ofer Yarden  
V.P & B.D: Mr. Fredi Tzimet  
Number of employees: 70  
Date establishment: 2000  
Ownership: Private

**Areas of activity**

Operational mission performance enhancement by providing breakthrough techno-operational solutions such as System of Systems Technical simulations, Operational Mission Planning Systems, Operational Debriefing Systems, Online Decision Support Systems for Israeli Defense Forces, and leading defense industries.

**See page: 73**

**OPGAL  
OPTRONIC INDUSTRIES LTD.**

P.O.Box 462  
Karmiel 2161401, Israel  
Tel: 972-4-9953903  
Fax: 972-4-9953900  
E-mail: info@opgal.com  
Web Site: www.opgal.com  
President & C.E.O: Mr. Amit Mattatia  
Number of employees: 130  
Date established: 1983

**Areas of activity**

Opgal's broad and varied line of Thermal Imaging and Near-Infrared Illumination products, applications and services for the security, defense, safety, aviation and mobile markets are designed to address all its customers' needs. Opgal's field proven solutions are qualified to the strictest standards and have been deployed in land, sea and air. From external ruggedized cameras to ready-to-integrate systems, Opgal's products provide optimum vision and improved situational awareness for today's 24-hour all-weather battlefield environment. Off-the-shelf border surveillance systems provide round-the-clock wide area scene awareness or close-up threat assessment. With more than 30 years of proven experience, Opgal partners with leading OEMs and integrators, and works closely with their end users, to develop customized solutions addressing their specific requirements.

See page: 337

**OPTITASK LTD.**

4/B, Hazoran St.,  
South Industrial Area  
Netanya 4250604, Israel  
Tel: 972-73-243-6600  
Fax: 972-9-865-6746  
E-mail: iv@optitask.net  
Web Site: www.optitask.net  
C.E.O: Mr. Samuel Weiner  
V.P Marketing & B.D: Mr. Israel Vilenchik  
Number of employees: 22  
Date establishment: 1995  
Ownership: Private

**Areas of activity**

OPTITASK develops and manufactures eyesafe Er:Glass laser transmitters for laser range finders and active vision.

See page: 321

**ORBIT COMMUNICATION SYSTEMS LTD.**

New Industrial Zone,  
P.O.Box 8657  
8D Hatzoran St.,  
Netanya 4250608, Israel  
Tel: 972-9-8922777  
Fax: 972-9-8855944  
E-mail: info@orbit-cs.com  
Web Site: www.orbit-cs.com  
Number of employees: 200  
Date established: 1950  
Ownership: Zeev Stein - 45%,  
Excellence + Phoenix - 5.5%,  
Psagot - 6.5%, Migdal - 8.0%,  
Public - 35.0%

**Areas of activity**

**ORBIT Communication Systems Ltd.** is a global leading provider of mission-critical communication solutions for Land, Sea and Air Platforms. Fulfilling the communication needs of commercial, defense and government customers for over 60 years, ORBIT offers advanced solutions, supporting applications in the areas of Mobile Satellite Communications, Communication Management Systems, Aeronautical Telemetry, UAV Command & Control LOS and B-LOS, Satellite Tracking (GEO and non-GEO) and Earth Observation (LEO and MEO).

See page: 281

**ORION  
ADVANCED SYSTEMS LTD.**

P.O.Box 156  
Yavne 8110101, Israel  
Tel: 972-8-3770100  
Fax: 972-8-3770101  
E-mail: marketing@orion-as.com  
Number of employees: 70  
Date established: 2009  
Ownership: Aeronautics Ltd.

**Areas of activity**

**Orion Advanced Systems Ltd.** specializes in the research, development, manufacturing and integration of advanced fuzes for aerial munitions and custom fuzing systems. Orion's state-of-the-art fuzes are compatible with modern guided bombs and hard penetrator warheads. Orion is the sole supplier of fuzes to the Israeli Air Force and has an outstanding reputation for safety and reliability. Orion also manufactures and customizes fuzes for customers around the globe.

See page: 55

## **OSG - ORAN SAFETY GLASS**

Kibbutz Palmach Zova  
D.N. Harei Yehuda 9087000, Israel  
Tel: 972-2-5706100  
Fax: 972-2-5706101  
E-mail: info@OSG.co.il  
Web Site: www.osg.co.il  
C.E.O: Mr. Daniel Cohen  
V.P. Marketing: Mr. Assaf Karni  
C.F.O: Mr. David Yogev  
Number of employees: 350  
Date established: 1979  
Ownership: Kibbutz Palmach Zova

### **USA: Oran Safety Glass Inc.**

48 Industrial Parkway,  
P.O.Box 126, Emporia, VA 23847, USA  
Tel: 1-301-9139366  
Fax: 1-301-9139369  
E-mail: paul@mistralgroup.com  
Web Site: www.osg-glass.com

### **Representative Office EUROPE:**

IbA Industrieberatung Dirk Abrie  
Koblenzer Str. 33  
D – 66115 Saarbrücken  
Tel: 49-681 9705 8630  
Fax: 49-681 9705 8631  
Mobil D: 49-171-7613467  
Email: info@oranglas.de  
Web Site: www.oranglas.de

### **Areas of activity**

OSG is a leading supplier of Transparent Armor worldwide. Building on 35 years of proven field experience, OSG's products are the result of an intensive R&D program conducted in coordination with the world's foremost militaries including Israel and the US .

#### **OSG unique product line consists:**

- Transparent ballistic armor for almost any threat, both flat and curved
- Advanced transparent armor add-on system
- Emergency egress window system
- Ceramic window with crystallized materials technology
- Rock-strike glass shield
- ADI no-spall technology
- Heating elements (wire, grid, coating)
- Special coatings
- Aluminum or steel frames

OSG operates 3 cutting-edge manufacturing facilities – two located in Israel and one in the USA.

OSG's in-house laboratories and testing facilities are designed to streamline manufacturing and deliver the best possible product.

**See page:** 139

## **PERYPHON DEVELOPMENT LTD.**

23 Hamelacha St.,  
New Industrial Park  
Rosh Ha'ayin 4809173, Israel  
Tel: 972-3-9025682  
Fax: 972-3-9025684  
E-mail: sales@peryphton-dev.com  
Web Site: www.peryphon-dev.com  
C.E.O: Mr. Israel (Aike) Aharoni  
V.P. Marketing: Mr. Omer Landsberg  
Number of employees: 20  
Date established: 1995  
Ownership: Private

### **Areas of activity**

**Peryphon Development Ltd** leading the tactical communication solutions world for more than three decades. **Peryphon Development** offering includes off-the-shelf solutions as well as turnkey projects from design to production. Our products include a large variety of rugged platforms (routers / switches), all sort of telephony and intercommunication solutions for ground, sea and air units and cutting edge audio accessories ; headsets, handsets, loudspeakers designed to extreme noise environment. **Peryphon Development** is certified to ISO-9001:2008.

**See page:** 282

## **PHANTOM TECHNOLOGIES LTD.**

68 Amal St.,  
Petah Tikva 4951368, Israel  
Tel: 972-3-9215720  
Fax: 972-3-9215434  
E-mail: sales@phantom.co.il  
Web Site: www.phantom.co.il  
C.E.O: Mr. Roei Itshakov  
Number of employees: 40  
Date established: 1996  
Ownership: Private

### **Areas of activity**

Ari-Phantom Technologies provides a variety of jamming solutions for all RF based communications applications such as Cellular, Wi-Fi , tactical communications and satellite phones. The company develops and manufactures its systems in all sizes and in multiple configurations – from low power to extreme high power jammers, for stationary, man pack, vehicular/convoy protection and complete compound area coverage. The company offers both off the shelf solutions and customized products to meet special client requirements. The company's line of products includes also internally developed digital receivers used for conditioned jamming systems, counter surveillance systems and SIGINT applications.

**See page:** 210, 211

**PICSIX LTD.**

41 HaMeyasdim St.,  
 P.O.Box 6006  
 Even Yehuda 4051113, Israel  
 Tel: 972-9-8911202  
 Mobile: 972-544-335197  
 Fax: 972-9-8911202  
 E-mail: mk@pic-six.com  
 Web Site: www.pic-six.com  
 V.P Business Development: Mr. Menachem Kenan  
 Number of employees: 9  
 Date established: 2011  
 Ownership: Private

**Areas of activity**

PICSIX LTD. Designs, produces and sells a variety of unique solutions for interception and counter-interception. Our solutions include:

- Advance features Man In The Middle Systems for GSM and UMTS
- IMSI Catchers including DF capabilities
- Smallest form-factor largest capacity PASSIVE INTERCEPTION SYSTEMS in the market facilitating 10s to hundreds of channels per system
- Integrated solutions combining Passive and Active Interception as well as jamming and selective jamming.
- Counter Interception measures detecting a blocking of-the-air interception systems.

See page: 306

**PLASAN**

Kibbutz Sasa  
 M.P.Merom Hagalil 1387000, Israel  
 Tel: 972-4-6809000  
 Fax: 972-4-6809001  
 E-mail: plasan@plasan.com  
 Website: www.plasan.com  
 Number of employees: 700  
 Date established: 1985  
 Ownership: Kibbutz Sasa

**Areas of activity**

Plasan is a leading designer and provider of mission ready solutions for a broad range of military and security survivability solutions for land vehicles, airborne platforms and personal protection. Our range of products and solutions includes: integrated and add-on armors, blast protection kits, RPG defeat solutions, multi-mission armored vehicles designed for optimized mobility and operational versatility. Plasan offers full design, development, engineering, testing and integration under a single roof. Plasan has designed more than 150 armored hulls and delivered more than 30,000 armored vehicles to armed forces and security organizations worldwide.

See pages: 138, 150

**Quadro****Projects & Technologies LTD.**

33 Arik Einstein St.,  
 (Yahadut Canada)  
 Or Yehuda 6037533, Israel  
 Tel: 972-3-9413010  
 Mobile: 972-50-8818886  
 Fax: 972-3-9410743  
 E-mail: quadro@quadro.co.il  
 Web Site: www.quadro.co.il  
 President & C.E.O: Mr. Pini Dagan  
 E.O.D: Mr. Moshe Chaky  
 Number of employees: 12  
 Date of established: 2000  
 Ownership: Private

**Areas of activity****Treatment & Disposal of dangerous War Remnants and other Explosive Obstacles.**

- Consulting ,Planning ,Management and Supervision of Humanitarian Mine Clearance Operations
- Disposal of all Explosive (EOD, IEOD's and UXO)
- Cleaning of "Contaminated Areas"
- Planning, Designing & Manufacturing of Training Aids, Models and Mockups
- Assistance & Support in/of all Ammunition Tests/Experiments
- Mine & Explosives Detection Dogs Services

**Integrated Defense Technologies Solutions.**

- Traffic problem solutions
- Special infrastructure operations
- Permanent disposal services for Government offices (consulting planning & implementation)
- Documents identify recognition systems
- Consulting ,Tests, Supply & Laboratory services for Safety systems for all land Transportation/Vehicles (Air bags, Belts )

**Crisis Solutions / Emergency Preparations****Homeland Security:**

- Integrated security systems for Country Border lines, boundaries and crossing points
- Detection and Identification of Explosives and Narcotics
- Detection of Smuggling operations
- Planning ,conducting & supervision of all national and local emergency exercises

**Safety , Q.A [Quality Assurance] & Risk Analysis Services.****Quadro are conducted under the following standards:**

**ISO 9001:2008 - # 45248**

**ISO 14001:2004 - # 45247**

**OHSAS 18001:2007 - # 44794**

See pages: 204, 205, 206, 207

**RADA  
ELECTRONIC INDUSTRIES LTD.**

7 Giborei Israel Blvd.,  
P.O.Box 8606  
Netanya 4250407, Israel  
Tel: 972-9-8921111  
Fax: 972-9-8855885  
E-mail: mrkt@rada.com  
Web Site: www.rada.com  
President: Mr. Herzle Bodinger  
C.E.O: Mr. Zvi Alon  
Chief Business Development Officer: Mr. Dov Sella  
Number of employees: 110  
Date established: 1970  
Ownership: Public company – Traded on NASDAQ (RADA)

**Areas of activity**

RADA Electronic Industries Ltd. is a Defense Electronics System House specializing in advanced electronic systems for airborne and land systems.

RADA's product lines include:

- **Tactical Land Radars**
- **Inertial Navigation Systems**
- **Avionics Systems and Upgrades**

RADA offers advanced Pulse-Doppler, multi-mission, AESA radars for the maneuver force. The company's INS solutions provide best value solutions for aerial and land tactical vehicles. RADA is a leading provider in the field of airborne video and data recorders, and complete avionic upgrade suits for combat and ISR aircraft.

**See pages:** 21, 45, 151, 351

**RAFAEL  
Advanced Defense Systems Ltd.**

P.O.Box 2250  
Haifa 3102102, Israel  
Tel: 972-73-3354714  
Fax: 972-73-3354657  
E-mail: intl-mkt@rafael.co.il  
Web Site: www.rafael.co.il  
President: VADM (Ret.) Yedidia Yaari  
Executive V.P Business development & Marketing:  
Mr. Oron Oriol  
Number of employees: 7,000  
Date established: 1948  
Ownership: Government of Israel (Since 2002)

**Areas of activity**

Rafael designs, develops, manufactures and supplies a wide range of advanced defense systems. These leading edge products include naval, air and ground precision weapons, electro-optic systems, electronic warfare (EW) systems, C<sup>4</sup>I and unmanned systems, acoustic defense systems, armored protection, breaching munitions and space technologies.

**See pages:** 22, 23, 28, 29, 46, 47, 56, 57, 58, 70, 76, 77, 78, 79, 80, 87, 88, 93, 98, 102, 103, 104, 105, 108, 109, 130, 131, 132, 133, 144, 145, 148, 149, 160, 165, 166, 167, 168, 169, 170, 171, 172, 173, 174, 175, 176, 177, 178, 179, 188, 189, 190, 191, 194, 195, 196, 197, 217, 218, 219, 220, 221, 222, 223, 224, 225, 226, 236, 237, 256, 291, 292, 293, 307, 308, 309, 310, 322, 323, 334, 335

**RESHEF TECHNOLOGIES LTD.**

7 Haplada St.,  
P.O.Box 5035  
Or-Yehuda 6055001, Israel  
Tel: 972-3-5388604  
Fax: 972-3-5339223  
E-mail: info@resheffuzes.com  
Web Site: www.resheffuzes.com  
Managing Director: Mr. Eitan Shemesh  
Plant Manager: Mr. Avner Shamir  
R&D Manager: Mr. Ehud Lahav  
Number of employees: 80  
Date established: 1984  
Ownership: Aryt Industries Ltd.

**Areas of activity**

Reshef manufactures the most sophisticated Electronic Fuzes for ground forces units:

- Proximity, Time and Point Detonating (PD) fuzes for Mortar bombs, Artillery projectiles and Artillery Rockets.
- Time / Distance fuzes and Anti Personnel Anti Material fuzing system (APAM) for Tanks rounds.

**See page:** 192

**RICOR SYSTEMS 2011 -  
A.C.S. LTD.**

En Harod Ihud 1896000, Israel  
Tel: 972-4-6530800  
Fax: 972-4-6532424  
E-mail: marketing@ricor.com  
Web Site: www.ricor.com  
C.E.O: Mr. Nissim Alfasi  
C.F.O: Mr. Simchon Horesh  
Number of employees: 180  
Date established: 1967  
Ownership: private

**Areas of activity**

Ricor Systems is a world-leader in innovative cooling technology for, military defense, homeland security, space and semiconductors, commercial and scientific equipment industries. Ricor develops, manufactures and markets a wide range of advanced products and solutions. Ricor offer tremendous flexibility, servicing cooling power needs ranging from a fraction of a Watt up to 15W and temperatures from 35K to 200K and input power consumption under 2W.

**See page:** 342

**ROBO-TEAM LTD.**

14 HaAhim Mislavuta St.,  
Tel Aviv 6701025, Israel  
Tel: 972-3-6870008  
Fax: 972-3-5717327  
E-mail: info@robo-team.com  
Web Site: www.robo-team.com  
C.E.O: Mr. Yossi Wolf  
C.E.O: Mr. Elad Levy  
V.P. Sales: Mr. Ari Diamond  
Number of employees: 50  
Date established: 2009  
Ownership: private

**Areas of activity**

Roboteam designs, develops and manufactures cutting edge, user-oriented, multi-purpose, unmanned platforms and controllers for Defense, Law Enforcement and Public Safety missions. Our team includes dozens of highly experienced engineers that are dedicated to creating units that provide complete operational and tactical control, overall mission management and enhanced force coordination. We've created a line of lightweight, fast deployable unmanned ground systems that deliver technological and functional breakthroughs for tactical purposes with unmatched reliability. Among our customers are top units in the Military, Special Forces, EOD and SWAT teams of elite forces around the globe.

**See page:** 267

**ROCK WINGS LTD.**

54 Harimonim St.,  
Renatya 7316500, Israel  
Tel: 972-2-5862468  
Mobile: 972-52-2862428  
Fax: 972-2-5713241  
E-mail: rockwings@rockwings.net  
Web Site: www.rockwings.net  
General Manager: Mr. Yitshak Zuckerman  
Operation Manager: Mr. Moshe Shalev  
Administration Manager: Mrs. Yael Greiner  
Number of employees: 5  
Date established: 1997  
Ownership: private

**Areas of activity**

- Aircraft modification:
  - Night vision capabilities
  - Airborne armament systems
  - Armor protection
  - Systems installation and integration
- Law enforcement systems
- Services:
  - Establish customer's own maintenance capabilities
  - Consultants
  - Engineering
  - Mechanical and electrical parts production
- Pilot training
- Spare parts production
- Aircraft technical inspection and evaluation

**See pages:** 30, 31, 32, 33, 34, 35

**ROTEM INDUSTRIES LTD.**

ROTEM Industrial Park,  
D.N. Arava P.O.Box 9046  
Beer-Sheva 8419001, Israel  
Tel: 972-8-6564779  
Fax: 972-8-6555984  
Web Site: www.rotemi.co.il  
President: Mr. Yoram Sadan  
Director, Defense Technologies: Col. (Res.) Mr. Dino Zeev  
Number of employees: 180  
Date established: 1980  
Ownership: Government of Israel

**Areas of activity**

- Radiation monitoring meters and systems for HLS, NPP's, Environmental, Nuclear Medicine & Cyclotron applications
- Crystal growth and fabrication, mainly sapphire domes and windows
- Engineering & Computational Mechanics Center- system development, mechanical design, advanced numerical simulations and experiments
- Green Energy Technological Center - renewable energy test-field, seed project investment mechanism and R&D Industrial Services
- Health & Safety- Import, export, marketing, development and distribution of safety products

See page: 329

**RT LTD.**

10 Nahal Snir St.,  
Yavne 8122447, Israel  
Tel: 972-8-6433616  
Fax: 972-8-6433607  
E-mail: info@rt.co.il  
Web Site: www.rt.co.il  
General Manager: Mr. Rami Shmueli  
Vice President: Mrs. Taly Kosberg Shmueli  
Number of employees: 30  
Date established: 1996  
Ownership: Private

**Areas of activity**

RT Ltd., is a world – class designer, developer and manufacturer of the SkyStar™ aerostat family proven for use in intelligence, surveillance ,reconnaissance, and communication applications.

Users active in prevent-prepare-respond-recover settings requiring continuous and compact aerial support are a natural fit for Skystar™ products.

RT Ltd., delivers self-contained, versatile, easily transportable, cost- effective tactical system comprised of a mobile control station, ground system module, tether, lighter-than-air platform, stabilized payload platform, and sophisticated sensor suite. SkyStar™ systems are easy to operate, rapidly deployed and customized for a range of operating conditions worldwide in various military and civilian missions.

Currently, systems are deployed in countries such as Afghanistan, Israel, Mexico, Thailand, Canada, Africa and Russia.

**Applications:**

Unmanned Aerial ISR and target acquisition, Border and coastal security, Crisis and emergency management, Law enforcement and public safety, Search and Rescue, Communication relay, Offshore/Onshore business continuity recovery, Event traffic/crowd control, VIP protection, Environmental measurement.

See page: 239



**RVTT RESHEF  
TECHNOLOGY LTD.**

P.O.Box 4298  
Rosh-Ha' Ayin 4856156, Israel  
Tel: 972-3-9382804  
Fax: 972-3-9383702  
E-mail: resh@inter.net.il  
C.E.O: Mr. David Reshef  
Operation & Administration  
Director: Mrs. Hadassa Reshef  
Number of employees: 10  
Date established: 1999  
Ownership: David Reshef

**Areas of activity**

RVTT (Reshef Visual Thermal Technology) developed the "Visual Reality™" training concept and based on it, the Multi Spectral Technology (MST).

Using MST in training enables all MST passive signatures: NVG, Thermal, Radar, Laser etc. MST is used for targets (realistic picture with 3D effect), battlefield constructions, live fire MST targets, recognition & marking MST products. All RVTT MST solutions work without power supply and yet function day & night. Quick deployment and cost effective make the MST green products very attractive for the modern forces.

Making armies training simple and innovative is our goal!  
In use by the I.D.F.

**See page:** 233

**SANSOLO Security Consulting, Development & Manufacturer Ltd.**

**Special Operations Equipment - Explosive Entry**  
19 Harel St.,  
Ashkelon 7864919, Israel  
Tel: 972-54-7886261  
972-52-3843758  
Fax: 972-8-6780986  
E-mail: info@sansolo.co.il  
Web Site: www.sansolo.co.il

**Areas of activity**

The SANSOLO Security Consulting, Development & Manufacturer Ltd. Company is an Israeli company that specializes in Security Consulting, Explosives, Demolition, Combat Pyrotechnics & new products development (Patent Protected).

**Main products / services:**

**Products**

- Custom design development.
- Defensive/Offensive demolition products.
- Variety of combat pyrotechnics products & development.
- Specializes in unique tactical marking products.

**Consulting Specialist**

- Bomb disposal expert.
- Writing procedures, guidelines and safety instructions.
- Security & Special units consultant.

**Training Specialist**

- Courses on various aspects of demolition.
- Training on working methods for defensive and offensive demolition.

**See page:** 203

**SENSO-OPTICS LTD.**

P.O.Box 600  
Hi-Tec Park  
Yokneam 2069207, Israel  
Tel: 972-4-9935527, 972-73-2004450  
Fax: 972-4-9935894, 972-4-9590962  
E-mail: [info@senso-optics.com](mailto:info@senso-optics.com)  
Web Site: [www.senso-optics.com](http://www.senso-optics.com)  
President & C.E.O: Mr. Jacob Dagan  
V.P R&D: Mr. Avi Katz  
Number of employees: 26  
Date established: 2001  
Ownership: private

**Areas of activity**

**Senso-Optics** is a leader in R&D, design, production & delivery of innovative thermal imaging technologies and advanced electro-optical solutions for military, law enforcement, search & rescue, homeland security and commercial markets.

**Senso-Optics** offers a wide range of **State-of-the-Art thermal imaging, visual information & targeting solutions, products and systems** for day, night and low visibility missions.

**Senso-Optics** is committed to be at the forefront of thermal Imaging technology such as the world's first **Thermal Camera-on-Chip (ASIC)**.

See page: 343

**SHALON CHEMICAL INDUSTRIES LTD.**

Head Office:  
2 Kaplan St., 10<sup>th</sup> Floor  
Tel-Aviv 6473403, Israel  
Tel: 972-3-6957191  
Fax: 972-3-6957980  
E-mail: [shalon@shalon.co.il](mailto:shalon@shalon.co.il)  
Web Site: [www.shalon.co.il](http://www.shalon.co.il)  
Plant:  
35/2 Israel Pollak Rd.,  
Kiryat Gat 8202501, Israel  
Tel: 972-8-6879111  
Fax: 972-8-6811115  
General Manager: Mr. Michael Barel  
Marketing Manager: Mr. Itai Barel  
Number of employees: 160  
Date established: 1968  
Ownership: private

**Areas of activity**

Shalon Chemical Industries Ltd. is internationally recognized as a leading company specializing in the manufacture and design of personal and collective NBC protective equipment for the military and civilian markets. The company's impressive record of innovations and achievements in respiratory protection is the result of applied state-of-the-art technology together with a firm commitment to creative design and high quality. Production is effected in a high-volume, extensively equipped, vertically integrated manufacturing plant with research laboratories employing the latest high-tech methods, and with comprehensive quality control systems enhanced by application of Total Quality.

See pages: 161, 378, 379, 380, 381

## **SIBAT - ISRAEL MINISTRY OF DEFENSE**

### **International Defense Cooperation**

Hakiryia Tel-Aviv 6473424, Israel

Tel: 972-3-6975585, 6977906

Fax: 972-3-6976359

E-mail: [sibat\\_bic@mod.gov.il](mailto:sibat_bic@mod.gov.il)

Web Site: [www.sibat.mod.gov.il](http://www.sibat.mod.gov.il)

Director: Brig. Gen. (Ret.) Mishel Ben Baruch

Principal Deputy Director: Mr. Itamar Graff

Deputy Director & Head of Defense Inventory Marketing &

Sales: Mrs. Anat Brill

### **Areas of activity**

SIBAT, the Israel MOD International Defense Cooperation Directorate is uniquely positioned within the Israel Ministry of Defense (IMOD), while having a close, ongoing relationship with the defense industry. This combination ensures SIBAT to maintain in-depth and up-to-date knowledge of the defense world's relevant concepts, as well as a clear understanding of the Israel Defense Forces' (IDF) operational needs.

SIBAT facilitates international cooperation through its various services.

- Generating Government-to-Government agreements
- Initiating official foreign delegations
- Identifying industrial cooperation with the Israeli defense industry
- Locating the relevant technological solutions for specific requirements
- Establishing of joint ventures
- Conducting advanced training seminars
- Managing the sales of IDF inventory
- Providing in-depth information on Israel's defense industry through biennial directory and national pavilions

**See pages:** 116, 117, 118, 354, 355, 356, 357, 358, 359, 360, 361, 362, 363, 364, 365, 366, 367, 368, 369, 370, 408

## **SOURCE OF SOUND LTD.**

19 Yad Harutzim St.,

P.O.Box 8628

Netanya 4250519, Israel

Tel: 972-9-8658370\1

Fax: 972-9-8658373

E-mail: [sos@s-o-s.co.il](mailto:sos@s-o-s.co.il)

Web Site: [www.s-o-s.co.il](http://www.s-o-s.co.il)

General Manager: Mr. Nir Klein

V.P Marketing : Mrs. Smadar Nir

Number of employees: 60

Date established: 1989

Ownership: shamrock Israel

Growth fund, Adi Nir & Ruth Nir

### **Areas of activity**

Main activities:

A primary manufacturer and supplier of Communication Headsets to the Israeli Defense Forces.

As well as a provider to US Special Forces, Military, Police and Security forces worldwide.

As such, SOS has acquired considerable expertise in combat proven communication in harsh conditions.

### **In Ear noise reduction headsets**

**Clarus - Smart Tactical in-ear headset** system designed for special forces, infantry Military heavy vehicles crew, Artillery etc.

### **Combat**

Reliable and proven communication in ruthless conditions.

### **Submersible**

20m waterproof for maritime operations.

### **CBRN**

Unconventional, innovative communication in Special conditions.

### **Security**

VIP guards and miniaturized Secret hidden communication.

**See page:** 283

**SUPERGUM INDUSTRIES LTD.**

11 Shoncino St.,  
Tel-Aviv 6721611, Israel  
Tel: 972-3-5622333  
Mobile: 972-50-6659993  
Fax: 972-3-5622345  
E-mail: giladg@supergum.co.il  
Web Site: www.supergum.com  
General Manager: Mr. Yehuda Gescheit  
Head of NBC Division: Mr. Golan Gilad  
Number of employees: 250  
Date established: 1956  
Ownership: Private

**Areas of activity**

Specialization in CBRN protective equipment. Manufacture of high quality rubber, plastic and sealing products for civilian, military and Industrial applications.

R & D and engineering department support a wide range of standard and custom made rubber and plastic products for highly diverse industrial and automotive applications.

Rubber technologies: Injection molding; Compression molding; Extrusion; Die-cutting.

- Plastic technologies; Heat, H.F and U.S sealing; injection molding.

Certified to ISO 9000:2008, QS9000

**See pages:** 382, 383, 384, 385

**TAL & HADAS LTD.**

P.O.Box 1011  
Afula Elite 1855010, Israel  
Alon Tavor Ind. Zone  
Tel: 972-4-6408400  
Fax: 972-4-6408401  
E-mail: info@tal-and-Hadas.com  
Web Site: www.tal-and-Hadas.com  
Owner: Mr. Eli Tayar  
Project Manager: Mrs. Zelevich Ornit  
Number of employees: 60  
Date established: 1982  
Ownership: Private

**Areas of activity**

Tal and Hadas. A privately owned Company established in 1982. We provide real time solutions according to customers' specific requirements. From the design of systems through development and testing to the manufacture of end products. We design, manufacture and market for vehicle, railway, truck and military industries. Our engineering department provides top-standard quality design, using error proof manufacturing methods.

Tal & Hadas Ltd. works in compliance with the TS16949 and ISO 9001 standards. The company holds international patents on many exclusive and innovative products, which have both military and civilian applications.

Our unique designs and over 25 years of experience with both military and transportation industries, allows us to supply customers with systems, "tailored" according to their requirements.

Our key costumers include: GM, VW, Siemens, IDF, General Dynamics.

**See page:** 134

**TAMOR S.M.R LTD.**

Southern Industrial Zone  
 P.O.Box 19  
 6 Hacharoshet St.,  
 Migdal Haemek 2310001, Israel  
 Tel: 972-4-6546735  
 Fax: 972-4-6546738  
 E-mail: main@tamor.co.il  
 Web Site: www.tamor.co.il  
 President: Mr. Moshe Mazor  
 C.E.O: Mr. Ronen Mazor  
 Number of employees: 50  
 Date established: 1988  
 Ownership: Private Corporation

**Areas of activity**

Manufacturer of Turnkey Systems, Subsystems, Kits and Assemblies  
 Production for Wheeled or Tracked Vehicles Prototypes, Low Series, Full Production.

TECHNOLOGYMETALWORK

- Multi-processes in-house

RUBBER VULCANIZATION

- Bonding of rubber and metal
- Rubber molding

PRODUCTION

- Traversing Machine Gun Mount Systems
- Armored Hatches and Mechanisms
- Fuel Tanks and Water Tanks
- Equipment Compartments, External, Internal
- Structural Kits
- Wheels, Solid Rubber
- Track Shoe Parts and Track Assemblies
- Track Tension Adjusters
- Sprockets and Carriers
- Supporting Road Arms
- Hydraulic Bumpers
- Brake Systems

QUALITY ASSURANCE

- U.S. Army TACOM  
 (Tank- Automotive and Armaments Command) QSL-01,  
 QSL-03, QSL-04
- NATO AQAP 2110
- ISO 9001:2008
- European and American Welding Certifications and Compliance

**See pages:** 135, 136, 137

**TAR IDEAL CONCEPTS LTD.**

5<sup>th</sup> Ma'avar Yabok St.,  
 Tel Aviv 6744007, Israel  
 Tel: 972-3-6914564  
 Fax: 972-3-6914567  
 E-mail: webinquiry@tarideal.com  
 Web Site: www.tarideal.com  
 President: Mr. Tomer Avnon  
 C.E.O: Mr. Aviad Matza  
 Number of employees: 12  
 Date established: 1990  
 Ownership: Private

**Areas of activity**

- Military & Police Equipment and Training
- Counter & Anti Terror
- Riot & Crowd Control
- K9: Attack, Drugs / Explosive Detection, Search & Rescue
- CBRN Protective Gear & Detection Devices
- EOD/IED
- Bulletproof & Ballistic Protection
- Professional Consulting
- HLS
- Perimeter Security
- Intelligence

**See page:** 227

**TCI****Technical Consultants International LTD.**

P.O.Box 72  
Hod Ha'Sharon 4510001, Israel  
Tel: 972-9-7462518  
Fax: 972-9-7462519  
Email: tci@barak.net.il  
Web Site: www.nightvision.org  
Managing Director: Mr. Donald C.A Watson  
Operations Manager: Mrs. Yael Hurvitz  
Head of Thermal Imaging Projects: Mr. Eli Cohen  
Date established: 1992  
Ownership: Private

**Areas of activity**

TCI-Technical Consultants International Ltd. designs and manufactures sophisticated Night Vision Systems and other Electro-optical products for the Military and Law Enforcement sectors around the world.

Amongst our range of products we manufacture Surface and Underwater Systems for observation or weapons applications, Maritime Systems for observation & photography. Infrared Markers, Laser Co-Ordinators for above and below water.

Our comprehensive line of Day & Night CCTV encompass Day Systems, Image Intensifier and Thermal Systems (Room temperature & Cooled) for use in such areas as:  
Aircraft hijacking, Coastal monitoring or covert Anti-terrorist applications.

**See page: 326**

**TECHAYA LTD.**

P.O.Box 1500  
Pardes-Hanna 3711401, Israel  
Tel: 972-4-6377741  
Fax: 972-4-6377761  
E-mail: info@techaya.com  
Web Site: www.techaya.com  
Business Development: Mr. Tsahi (Zak) Sucher  
Number of employees: 37  
Date established: 2003  
Ownership: Private

**Areas of activity**

TECHAYA is a prime developer, innovator, and manufacturer of compact military rugged and tailor-made IP based communication solutions, where extreme conditions, minimal SWaP and unique tactical requirements must be met. Developed for military and harsh-environment applications, TECHAYA's product range features mechanical packaging solutions to comply with airborne, marine, and ground environments. Designed for C4ISR applications and battlefield communications, TECHAYA provides unique, top-quality solutions for the battlefield zone.

**See page: 284**

**TOP CAR ARMORING LTD.**

10 Amsterdam St.,  
Sderot 8714401 Israel  
Tel: 972-8-6496192  
Fax: 972-8-6483494  
Mobile: 972-54-4957184  
E-mail: dorontopcar@012.net.il  
Web Site: www.topcar-armor.com  
C.E.O: Mr. Doron Labock  
Number of employees: 7  
Date established: 2012  
Ownership: Private

**Areas of activity**

TOP CAR has developed the most advanced car armoring technologies. TOP CAR is a company with the most advanced know-how and experience in armoring of passengers cars with High-Tech and Light Weight composite armor materials, (more protection and survivability) and supplies all international markets. TOP CAR has unique knowledge and experience on international standards (USA, Europe and Israel) including extensive knowledge in producing materials to get the best ballistic solution.

**See page: 198**

**TOP I VISION LTD.**

25 Hathia St.,  
Holon 5840245, Israel  
Tel: 972-3-9335469/6  
Fax: 972-3-9339327  
E-mail: info@topivision.com  
Web Site: www.topivision.com  
C.E.O: Mr. Nir Shen Tal  
Marketing: Ms. Noa Zafrir  
Director: Mr. Amos Baruchin  
Number of employees: 12  
Date established: 1996  
Ownership: Private

**Areas of activity**

Top I Vision Ltd. develops and manufactures tactical high-performance surveillance systems for customers throughout the world.

In an age of rapid and dynamic event, where intelligence is vital, Top I Vision provides the ability to detect, gather, process, analyze and effectively react in real time.

Top I Vision major business activities includes:

- Unmanned air vehicle (UAV) systems
- Tactical Aerostat system (TAS)
- C<sup>4</sup>I systems
- Electro-optic systems and products
- Technology spin-offs for commercial activities

Our objective is to combine excellence and cost effectiveness with outstanding service and customer support, to deliver high quality turnkey solutions and to improve our Customer's technological and operational capabilities within limited budgets.

**See page:** 264

**TROYA**

P.O.Box 156  
Kibbutz Negba 7985600, Israel  
Tel: 972-8-6774341  
E-mail: info@troya-tech.com  
Web Site: www.troya-tech.com  
C.E.O: Mr. Yacov Galam  
C.M.O: Mr. Tomer Snir  
C.T.O: Roe Cohen  
Number of employees: 10  
Date established: 2013  
Ownership: Private

**Areas of activity**

Established in 2013, with offices in Israel (Middle East Division) and Italy (Europe Division), **TROYA** develops and markets Defense, HLS and Tactical products. The company specializes in Night Vision and Thermal Imagery devices and solutions. In addition, **TROYA** offers engineering design services and products' User Interphase (UI) consultancy. Our reach of business partners is spread around the globe, thanks to our seasoned management team, with its vast knowledge and with over 30 years of combined experience in the Defense Industry.

**See page:** 327

**TSG IT ADVANCED SYSTEMS LTD.**

P.O Box 58010  
Tel Aviv 61581, Israel  
Tel: 972-3-5483518  
Fax: 972-3-54483700  
E-mail: [tsg@ness.com](mailto:tsg@ness.com)  
Web Site: [www.nesstsg.com](http://www.nesstsg.com)  
C.E.O: Mr. Michael Zinderman  
Senior V.P. C4ISR Group: Mr. Ofer Burin  
V.P International Marketing & B.D: Mr. Uri Woldiger  
Marcom Director: Mr. Oleg Guzikov  
Number of employees (Ness Group): Over 4,000  
Data established: 1969  
Ownership: Private

**Areas of activity**

TSG is a global company, held by Ness. TSG provide advanced Command, Control, Communications, Computers, Intelligence, Surveillance, Target Acquisition and Reconnaissance (C4ISTAR) solutions systems for the defense and homeland security sectors.  
With over four decades of experience, TSG specializes and has a proven track record in designing, developing, supplying and integrating advanced, comprehensive and highly innovative solutions and systems.  
Dedicated to delivering cutting-edge, best-of-class solutions, TSG serves a diverse client base of governmental organizations worldwide. The proven record of TSG's deployed systems, combining command and control with intelligence and surveillance systems, enables us to offer unique solutions that bridge effective intelligence processing and operational command and control, providing our customers with incomparable value.

**See page:** 294

**TVUNOT 5766 LTD.**

9 Brand St.,  
Jerusalem 9387809, Israel  
Mobile: 972-52-6000-668  
Fax: 972-2-6630011  
Email: [ay@barak.net.il](mailto:ay@barak.net.il)  
Web Site: [www.skunk.co.il](http://www.skunk.co.il)  
Ceo: Mr. Arik Yakuel  
Date established: 2006  
Ownership: Private

**Areas of activity**

Tvunot 5766 is the exclusive exporting company for Odortec's product, the Skunk.  
The company specializes in providing solutions, consultancy and projects managing in the fields of national security, public security, policing, bomb disposal and bomb scene investigation. We have many years of experience serving as high rank police officers.

**See pages:** 386, 387

**UNI-SCOPE  
OPTICAL SYSTEMS LTD.**

34 H'anapach St.,  
P.O.Box 817  
Carmiel 2161701, Israel  
Tel: 972-4-9887022  
Fax: 972-4-9887023  
E-mail: [dannym@uniscope.biz](mailto:dannym@uniscope.biz)  
Web Site: [www.uni-scope.co.il](http://www.uni-scope.co.il)  
Managing Director: Mr. Danny Marely  
Chairman: Mr. Samy Katsav  
Director: Mr. Arie Bar-Ner  
Number of employees: 32  
Date established: 1991  
Ownership: Oshira Ltd. & Danny Marely

**Areas of activity**

- Design and production of:
  - a. Acrylic and glass periscope for armored vehicles.
  - b. Vision blocks for armored vehicles.
  - c. Handheld periscopes for infantry and special force units
- Comprehensive metal parts machining according
- Comprehensive optical and mechanical assembly
- ISO 9001:2009 and Mil-Spec, Quality Assurance and Quality Control facility
- Field and in-house maintenance and technical support

**See page:** 328



**UVISION AIR LTD.**

4 Bazelet St.,  
 Sapir Industrial Park  
 Zur Igal 4486200, Israel  
 Tel: 972-9-7496822  
 Fax: 972-9-7496823  
 E-mail: [uvision@uvisionuav.com](mailto:uvision@uvisionuav.com)  
 Web Site: [www.uvisionuav.com](http://www.uvisionuav.com)  
 C.E.O: Mr. Yair Dubester  
 V.P. Business Dev., Sales & Marketing: Mr. Oshri Baron  
 Number of employees 30  
 Date established: 1986  
 Ownership: Private

**Areas of activity**

UVision's UAS solutions are unique, cost-effective and tailored to meet the needs of our customers.

UVision's products include precision attack munitions and advanced airborne guidance and navigation systems and command and control stations fully integrated with communication links.

**See page:** 265

**VERINT SYSTEMS LTD.**

33 Maskit St.,  
 Herzliya 4673333, Israel  
 Tel: 972-9-9624119  
 Fax: 972-9-9624747  
 E-mail: [marketing.lis@verint.com](mailto:marketing.lis@verint.com)  
 Web Site: [www.verint.com](http://www.verint.com)  
 President: Mr. Hanan Gino  
 SVP Marketing: Mr. Yoram Zylberberg  
 SVP Sales EMEA: Mr. Adi Weinberger  
 Number of employees: 4,500 worldwide  
 Date established: 1994

**Areas of activity**

Verint® Communications and Cyber Intelligence Solutions™ efficiently collect, monitor, and analyze information from virtually any communications network. Built on decades of experience and hundreds of deployed projects, our portfolio features solutions for communications interception, communications service provider compliance, mobile location tracking, open source Web intelligence, tactical communications intelligence, and cyber security.

**See page:** 311

**VERIA MILITARY DESIGN LTD. (VMD)**

P.O.Box 8220  
 Tel Aviv 6108102, Israel  
 Tel: 972-77-5354513  
 Fax: 972-72-2150087  
 E-mail: [tamir@versiamilitary.com](mailto:tamir@versiamilitary.com)  
 Web Site: [www.versiamilitary.com](http://www.versiamilitary.com)  
 C.E.O: Mr. Tamir Porat  
 Design: Mr. Avihu Sivan  
 Design & Simulations: Mr. Gadi Dudler  
 Number of employees: 8  
 Date established: 2004  
 Ownership: Private

**Areas of activity**

A leading industrial design studio specializing in the defense sector, with a "One Stop Shop" approach from initial concept to final product.

Versia Military Design has more than 15 years of experience specializing within a wide range of areas such as small arms, vehicles, unmanned systems etc.

**Services:**

- **Research:** Market overview, cost feasibility, technologies, materials and processes, ergonomics, safety.
- **Design concepts:** 2D sketches and 3D CAD simulations, configuration, Material, finishes and Colors.
- **Models & prototypes:** Virtual computerized prototyping, full size mock-ups, CNC, STL, LOM, RTV, MMI, UI and GUI.
- **Engineering:** Technology assessment, mechanical design, component Survey, DFM, production and assembly documentation.
- **Marketing aides:** Animated movies, graphic & web design, print, exhibitions, 3D simulations, photography, promotional gifts.

**See page:** 406

**VIDEO INFORM LTD.**

100 Jabotinsky St.,  
P.O.Box 3331  
Petah Tikva 4959257, Israel  
Tel: 972-3-6448968  
Fax: 972-3-9210190  
E-mail: info@video-inform.com  
Web Site: www.video-inform.com  
C.E.O: Mr. Yoram Sagher  
C.T.O: Mr. Ronen Saggir  
V.P. Research: Mr. Moshe Butman Ph.D.  
Date established: 2007  
Ownership: Private

**Areas of activity**

Video Inform is introducing the Visual Profiler, a cognitive computer vision analysis solution for Target Acquisition on Aerial/Satellite Imagery. The visual Profiler is designed for operational Geospatial intelligence and Airborne ISR missions and applications. The solution is already in service and fully operational.

Visual Profiler is a software solution for automatic target detection based on a novel approach, using a unique visual target profiling methodology as opposed to legacy change-detection approach. The system includes a unique user interactive feedback mechanism to continuously increase precision level and can adjust rapidly to new operational needs. The Visual Profiler software can be used as an add-on to an existing IMINT exploitation system, e.g. SOCETGXP. Video Inform is a leading developer of cutting-edge cognitive vision technologies and solutions.

**See page:** 312

**Xi INFORMATION PROCESSING SYSTEMS LTD.**

P.O.Box 60  
Savyon 5691501, Israel  
Tel: 972-3-9215891  
Fax: 972-3-5343520  
E-mail: Xi00001@XiSysCorp.com  
President: Mr. Igal Levy  
Number of employees: 10  
Date established: 1968  
Ownership: Private

**Areas of activity**

Xi designs, develops and produces command and control, telematics and location centric systems for homeland security surveillance, site security wireless access control, assets and vehicle tracking and monitoring.

Xi's expertise and decades of track record in time critical GIS, geolocation, command and control, site security access control, telematics and wireless data communications technologies, enable it to offer its customers professional services and end to end solutions, including end terminals and geolocation C<sup>4</sup>I<sup>2</sup> Center.

Among Xi Products are:

Time Critical location based Command, Control, Communications and Information server, Mobile information, management and navigation, security and surveillance systems, access control, tracking and Automatic Vehicle Location (AVL) system.

**See page:** 295

# PRODUCT BRAND NAMES

BRAND NAME/ ACRONYM/ ABBREVIATION	EXPLANATION	COMPANY	PAGE
<b>A</b>			
10A1	NBC youth respirator	Shalon Chemical Industries	380
A4 SKYHAWK	Fighter aircraft	SIBAT - Israel Ministry of Defense	358, 360, 361
AAA	Anti-Aircraft Artillery	IMI - Israel Military Industries	238
AACMI	Embedded training for fighter jets	IAI - MLM Division	63
ACBS	NBC hood and blower system for tank crews	Shalon Chemical Industries	379
ACBS	Armored vehicle crewmember blower system	Supergum Industries	383
ACCULAR	160mm surface-to-surface artillery rocket	IMI - Israel Military Industries	187
ADNAV	Advanced Navigation System	IAI - Tamam Division	350
ADTS	Air Defense Training System	IAI - MLM Division	63
AES	Airborne Exploitation Station	IAI - Elta Systems	300
AH1 COBRA	Helicopter	SIBAT - Israel Ministry of Defense	358, 364
AIR STAR	Multi-Sensor Aerostat-based system for extended ISR	Rafael	76, 174, 291
AIRMOR	Self-protection suite for helicopters and transport aircraft	IMI - Israel Military Industries	69
AISR	Aerial Intelligence, Surveillance & Reconnaissance	Aeronautics	48
ALL-IN-SMALL	Airborne EW self-protection suite	Elbit Systems - EW & Sigint, Elisra	67
AMAPS/TMAPS	Target acquisition systems	IAI - Tamam Division	350
AMI/TAMI	Bulletproof combat post/tower	Mifram	140
AMLCD	Airborne Multifunction Color Displays	Elbit Systems	39
AMLS	Data link solution	Commtract	252
AMPS	Airborne Missile Protection Systems	Bird Aerosystems	65
AMPS	Advanced Multi-Sensor Payload System	Elbit Systems - Elop	330
AMTS	Active Man-Pack Transceiving System	Elbit Systems - EW & Sigint, Elisra	285
ANVIS/HUD	Line of Sight (LOS) helmet display	Elbit Systems	41
APU	Kinetics Auxiliary Power Unit	Elbit Systems - Land & C <sup>4</sup> I	127
AQUA MARINE	RESM/CESM/LWS and ECM family of advanced naval EW suites	Elbit Systems - EW & Sigint, Elisra	106
AquaShield	Diver Detection Sonar	DSIT Solutions	112
AR133	Rubidium clocks	Accubeat	272
AR51A-09	Rubidium clocks	Accubeat	272
AR76	Rubidium clocks	Accubeat	272
ARC 840D	Software Defined Radio (SDR)	IAI - Elta Systems	273
ARSYS	North finding systems	Arazim	349
ASA35A1	Floating Personal Body Armor	IMI - Israel Military Industries	101
ASIO	Night Vision Goggles	Troya	327
ATALD	Advanced Tactical Air-Launched Decoy	IMI - Israel Military Industries	69
ATCT	Appended Tank Crew Trainer	Elbit Systems	231
ATHOS	155mm Towed Howitzer System	Elbit Systems - Land & C <sup>4</sup> I	183
A-TIM	Advanced Clip-on Thermal Imaging Sight for ATGM Launchers	Elbit Systems - Elop	341
ATLAS LT	Target Acquisition Systems	Elbit Systems - Elop	317
ATMOS	155mm Self-Propelled Gun	Elbit Systems - Land & C <sup>4</sup> I	183

<b>BRAND NAME/ ACRONYM/ ABBREVIATION</b>	<b>EXPLANATION</b>	<b>COMPANY</b>	<b>PAGE</b>
<b>ATROMAT</b>	Automatic atropine injectors	Shalon Chemical Industries	<b>381</b>
<b>AVANTGUARD</b>	Unmanned Ground Vehicle	GNIUS Unmanned Ground Sys.	<b>266</b>
<b>AYIT</b>	A4 Skyhawk Flight simulator	SIBAT - Israel Ministry of Defense	<b>366</b>
<b>B</b>			
<b>BARAK</b>	F16C Flight simulator	SIBAT - Israel Ministry of Defense	<b>366</b>
<b>BARAK-8</b>	Air & Missile Defense System	IAI - Air & Missile Defense Div.	<b>100, 235</b>
<b>BAZ/RAAM</b>	F15 Flight simulator	SIBAT - Israel Ministry of Defense	<b>366</b>
<b>BIRD EYE</b>	Family of Mini UAS	IAI - Malat Division	<b>260, 261</b>
<b>BL-45</b>	Mini blowers	Shalon Chemical Industries	<b>381</b>
<b>BL-45</b>	Blower	Supergum Industries	<b>382</b>
<b>BL-90</b>	NBC air supply unit	Shalon Chemical Industries	<b>379</b>
<b>BL-90</b>	Blower	Supergum Industries	<b>382</b>
<b>BMD</b>	Family of advanced Ballistic Missile Defense solutions	Elbit Systems - EW & Sigint, Elisra	<b>285</b>
<b>BNET</b>	Broadband MANET IP Software Defined Radio	Rafael	<b>174, 291</b>
<b>BOMBARD</b>	Artillery command & control systems	Elbit Systems - EW & Sigint, Elisra	<b>285</b>
<b>BRO</b>	Online Decision Support System	Omnisys	<b>73</b>
<b>B-SCAN</b>	Bottle Liquid Scanner	LDS - Laser Detect Systems	<b>147</b>
<b>C</b>			
<b>C130 HERCULES</b>	Transport aircraft	SIBAT - Israel Ministry of Defense	<b>358, 362</b>
<b>C<sup>4</sup>I CONNECT</b>	Voice Communication System for Air Force C&C	Rafael	<b>76</b>
<b>CAHBS</b>	NBC civilian adult hood & blower system	Shalon Chemical Industries	<b>381</b>
<b>CAPS 2000</b>	NBC civilian adult protective system	Shalon Chemical Industries	<b>380</b>
<b>CARDOM</b>	Self-propelled recoiling mortar	Elbit Systems - Land & C <sup>4</sup> I	<b>184</b>
<b>CASPER 250</b>	Mini UAV	Top I Vision	<b>264</b>
<b>CDU</b>	Control & Display Unit	Astronautics C.A.	<b>180</b>
<b>CETER</b>	NBC hood & blower system	Shalon Chemical Industries	<b>378</b>
<b>CETER</b>	Chemical Team Respirator	Supergum Industries	<b>384</b>
<b>CGEM</b>	Off-board RF Active Decoy	Rafael	<b>70</b>
<b>CHAMELEON 2</b>	Unattended Ground Sensors	Elbit Systems - Land & C <sup>4</sup> I	<b>297</b>
<b>CHECKMATE</b>	Minefield shoes	D.T.E. Co.	<b>200</b>
<b>CHEROKEE</b>	Pistol	Bul	<b>228</b>
<b>CHR</b>	Compact Hemispheric Radar family	Rada Electronic Industries	<b>151</b>
<b>CIDS</b>	Coast & Islands Defense System	IMI - Israel Military Industries	<b>101</b>
<b>CLTS</b>	Combat Live Training System	Elbit Systems	<b>231</b>
<b>C-MAN</b>	Computerized Maritime Navigation system	Astronautics C.A.	<b>92</b>
<b>CMDS</b>	Counter Measure Dispensing System	IMI - Israel Military Industries	<b>69</b>
<b>CNR-710</b>	Handheld VHF/FM voice & data COMSEC/ECCM radio	Elbit Systems - Land & C <sup>4</sup> I	<b>276</b>
<b>CNR-710MB</b>	Multi-band radio family	Elbit Systems - Land & C <sup>4</sup> I	<b>276</b>
<b>CNR-9000</b>	VHF/FM radio systems	Elbit Systems - Land & C <sup>4</sup> I	<b>275</b>
<b>CNR-9000HDR</b>	VHF/FM radio systems	Elbit Systems - Land & C <sup>4</sup> I	<b>275</b>
<b>COAPS</b>	Commander Open Architecture Panoramic Sight	Elbit Systems - Elop	<b>122</b>
<b>COLORAD</b>	Radiometer with 4 user-defined spectral bands	IARD Sensing Solutions	<b>345</b>
<b>COMBAT-NG</b>	Artillery & air defense fire control & command solutions	Elbit Systems - Land & C <sup>4</sup> I	<b>286</b>

<b>BRAND NAME/ ACRONYM/ ABBREVIATION</b>	<b>EXPLANATION</b>	<b>COMPANY</b>	<b>PAGE</b>
<b>COMINT/DF</b>	Communications Intelligence/Direction Firing systems	Elbit Systems - EW & Sigint, Elisra	<b>67</b>
<b>CONDOR 2</b>	LOROP Airborne Standoff Reconnaissance System	Elbit Systems - Elop	<b>331</b>
<b>CONDOR TAC</b>	Dual Band Tactical Photography System	Elbit Systems - Elop	<b>331</b>
<b>CORAL</b>	Thermal Imaging Systems	Elbit Systems - Elop	<b>338, 339</b>
<b>COYOTE 45</b>	Uncooled thermal imagers	Elbit Systems - Elop	<b>317</b>
<b>C-PEARL</b>	ESM systems	Rafael	<b>70, 109</b>
<b>CRPM</b>	Competence & Readiness Performance Management	Eltel Technologicals	<b>232</b>
<b>CST</b>	Command & Staff Trainer	Elbit Systems	<b>231</b>
<b>C-SUITE TACTICAL</b>	Enhanced mission & safety solution for the C-130	Elbit Systems	<b>38</b>
<b>CTIS</b>	Computerized Telephone Interception System	Mipha International	<b>302</b>
<b>D</b>			
<b>DACCS</b>	Artillery command & control systems	Elbit Systems - EW & Sigint, Elisra	<b>285</b>
<b>DAN</b>	Sniper rifle	IWI - Israel Weapon Industries	<b>230</b>
<b>DASH</b>	Display & Sight Helmet	Elbit Systems	<b>40</b>
<b>DCOMPASS</b>	Digital Compact Stabilized EO System	Elbit Systems - Elop	<b>332</b>
<b>DEEP LINK</b>	Low Probability of Intercept Acoustic Communication Network	Rafael	<b>98, 103, 292</b>
<b>DELILAH</b>	E/O stand-off missile	IMI - Israel Military Industries	<b>53, 101</b>
<b>DERBY</b>	Air-to-air missile	Rafael	<b>56</b>
<b>DLV53 MF</b>	ISTAR Wideband Data Link	Rafael	<b>76</b>
<b>DLV-53 MFTM</b>	ISTAR Wideband Data Link	Rafael	<b>174, 291</b>
<b>DOMINATOR</b>	UAS MALE	Aeronautics	<b>244, 245, 286</b>
<b>DUNE</b>	Multi block sand barrier	Mifram	<b>141</b>
<b>E</b>			
<b>EAPS</b>	Energy Absorbing Pallet System for parachuted/air drop equipment	Tal & Hadas	<b>134</b>
<b>ECC</b>	Engine Control Computers	Rada Electronic Industries	<b>45</b>
<b>EFIS</b>	Electronics flight instrument system	Astronautics C.A.	<b>37</b>
<b>EGTDS</b>	Electric Gun & Turret Drive System	Elbit Systems - Land & C <sup>4</sup> I	<b>126</b>
<b>EHUD AACMI</b>	Autonomous Air Combat Maneuvering Instrumentation	Elbit Systems	<b>60</b>
<b>EICAS</b>	Engine Displays	Astronautics C.A.	<b>37</b>
<b>E-LAWS</b>	Laser Warning System	Elbit Systems - Land & C <sup>4</sup> I	<b>125</b>
<b>ELI-3001</b>	AISIS - Airborne Integrated SIGINT System	IAI - Elta Systems	<b>299</b>
<b>ELI-3120</b>	Compact Multi-Mission Aircraft	IAI - Elta Systems	<b>75</b>
<b>ELI-3150</b>	Multi-Mission Airborne Reconnaissance & Surveillance System (MARS2)	IAI - Elta Systems	<b>75</b>
<b>ELI-3360</b>	MPA - Maritime Patrol Aircraft	IAI - Elta Systems	<b>75</b>
<b>ELK-1888</b>	TAC4G - Tactical 4G Broadband Cellular Network	IAI - Elta Systems	<b>273</b>
<b>ELK-1894</b>	Airborne Wideband SATCOM Data Link	IAI - Elta Systems	<b>273</b>
<b>ELK-1895</b>	Manpack Tactical SATCOM Terminal	IAI - Elta Systems	<b>273</b>
<b>ELK-7036</b>	COMINT Ground System	IAI - Elta Systems	<b>299</b>
<b>ELK-7071</b>	Airborne SIGINT Systems: ESM/ELINT, CSM/COMINT	IAI - Elta Systems	<b>74</b>

<b>BRAND NAME/ ACRONYM/ ABBREVIATION</b>	<b>EXPLANATION</b>	<b>COMPANY</b>	<b>PAGE</b>
<b>ELK-7071</b>	Integrated UAV COMINT/DF System (IUCOMS)	IAI - Elta Systems	<b>253</b>
<b>ELL-8212/22</b>	Advanced Self Protection Systems	IAI - Elta Systems	<b>20</b>
<b>ELL-8247/8 RWJS</b>	Advanced Self Protection Systems	IAI - Elta Systems	<b>20</b>
<b>ELL-8251</b>	EW System Escort Jammer	IAI - Elta Systems	<b>68</b>
<b>ELL-8260/2 INEW-SPS</b>	Integrated EW Self Protection Suite	IAI - Elta Systems	<b>68</b>
<b>ELL-8382/5</b>	ELINT Ground System	IAI - Elta Systems	<b>299</b>
<b>ELL-8385</b>	Airborne SIGINT Systems: ESM/ELINT, CSM/COMINT	IAI - Elta Systems	<b>74</b>
<b>ELL-8385</b>	Integrated UAV ESM/ELINT System (IUELIS)	IAI - Elta Systems	<b>253</b>
<b>ELM-2022</b>	Maritime Surveillance Radar Family	IAI - Elta Systems	<b>74</b>
<b>ELM-2022U</b>	UAV Maritime Patrol Radar System	IAI - Elta Systems	<b>253</b>
<b>ELM-2026B</b>	Very Short Range Air Defense Radar	IAI - Elta Systems	<b>164</b>
<b>ELM-2032</b>	Multimode Fire Control Radar	IAI - Elta Systems	<b>20</b>
<b>ELM-2052</b>	Airborne Fire Control Radar	IAI - Elta Systems	<b>20</b>
<b>ELM-2054/2055</b>	SAR/GMTI UAV Reconnaissance System	IAI - Elta Systems	<b>253</b>
<b>ELM-2055/2054</b>	Lightweight SAR/GMTI System	IAI - Elta Systems	<b>300</b>
<b>ELM-20600</b>	Fighter Aircraft Radar Targeting Pod	IAI - Elta Systems	<b>20, 300</b>
<b>ELM-2060P</b>	Pod-mounted SAR/GMTI System	IAI - Elta Systems	<b>300</b>
<b>ELM-2060T</b>	SAR/GMTI System	IAI - Elta Systems	<b>300</b>
<b>ELM-2080</b>	Search, acquisition & fire control Radar	IAI - Elta Systems	<b>234</b>
<b>ELM-2083</b>	APR - Aerostat Programmable Radar	IAI - Elta Systems	<b>234</b>
<b>ELM-2084</b>	MMR - Multi Mission Radar	IAI - Elta Systems	<b>234</b>
<b>ELM-2105</b>	Ground Surveillance Radar Family	IAI - Elta Systems	<b>164</b>
<b>ELM-2106 ATAR</b>	Advanced Tactical Acquisition Radar	IAI - Elta Systems	<b>164</b>
<b>ELM-2112</b>	Persistent Surveillance Radar Family	IAI - Elta Systems	<b>164</b>
<b>ELM-2138M</b>	Green Rock Tactical C-RAM system	IAI - Elta Systems	<b>68</b>
<b>ELM-2160 MAWS</b>	Missile Approach Warning System	IAI - Elta Systems	<b>68</b>
<b>ELM-2221</b>	Search, Track & Guidance Radar	IAI - Elta Systems	<b>99</b>
<b>ELM-2238 STAR</b>	Surveillance & Threat Alert Radar	IAI - Elta Systems	<b>99</b>
<b>ELM-2248 MF-STAR</b>	Multi-Function Surveillance, Track & Guidance Radar	IAI - Elta Systems	<b>99</b>
<b>ELM-2258</b>	ALPHA - Advanced Lightweight Phased Array Naval Radar	IAI - Elta Systems	<b>99</b>
<b>ELM-2288</b>	AD-STAR - Air Defense & Air Traffic Control Radar	IAI - Elta Systems	<b>234</b>
<b>ELS-8994 VEX</b>	RICent/VEX Video Exploitation System	IAI - Elta Systems	<b>298</b>
<b>ELS-8994RT</b>	RICent - Real Time Imagery Intelligence Center	IAI - Elta Systems	<b>298</b>
<b>ELSAT MSR-2000</b>	Military SATCOM antennas	Elbit Systems - Land & C <sup>4</sup> I	<b>279</b>
<b>ELW-2085</b>	CAEW - Conformal Airborne Early Warning & Control	IAI - Elta Systems	<b>75</b>
<b>EOSHIELD</b>	Vehicle Infra-Red Counter-Measure System	Elbit Systems - Elop	<b>146</b>
<b>EOT</b>	Electro-Optical Trainer	SIBAT - Israel Ministry of Defense	<b>367</b>
<b>EPMU</b>	Electrical Power Management Units	Rada Electronic Industries	<b>45</b>
<b>EPS 21</b>	Eye protection systems	Shalon Chemical Industries	<b>161</b>
<b>EROS</b>	Satellite imaging	Imagesat International N.V.	<b>301</b>
<b>ESM/ELINT</b>	Intelligence gathering systems	Elbit Systems - EW & Sigint, Elisra	<b>67</b>
<b>ETC</b>	Enhanced Tactical Computers	Elbit Systems - Land & C <sup>4</sup> I	<b>288</b>
<b>ETOP</b>	Electrical Tethered Observation Platform	IAI - Malat Division	<b>263</b>
<b>EVA</b>	Embedded Virtual Avionics for Trainer Aircraft	Elbit Systems	<b>61</b>
<b>EXTRA</b>	306mm artillery rocket system	IMI - Israel Military Industries	<b>187</b>

<b>BRAND NAME/ ACRONYM/ ABBREVIATION</b>	<b>EXPLANATION</b>	<b>COMPANY</b>	<b>PAGE</b>
<b>F</b>			
<b>F16 FIGHTING FALCON</b>	Fighter aircraft	SIBAT - Israel Ministry of Defense	<b>358, 362</b>
<b>FCS</b>	Fire Control Systems	Elbit Systems - Land & C <sup>4</sup> I	<b>126</b>
<b>FLEXFENCE</b>	RPG defeat solutions	Plasan	<b>138, 150</b>
<b>FOX</b>	Family of Thermal Imaging Cameras	Controp Precision Tech.	<b>336</b>
<b>FTC</b>	Field Test Collimator	CI Systems	<b>344</b>
<b>G</b>			
<b>GABRIEL</b>	Mobile Command & Control shelter	Mifram	<b>140, 143</b>
<b>GAL LIZARD4</b>	All weather GPS/INS guided bomb	Elbit Systems	<b>51</b>
<b>GALIL ACE</b>	Assault rifle	IWI - Israel Weapon Industries	<b>230</b>
<b>GEM</b>	Geospatial Management	Hartech Technologies	<b>62</b>
<b>GES</b>	Ground Exploitation Station	IAI - Elta Systems	<b>300</b>
<b>GHOST</b>	Rotary mini UAS	IAI - Malat Division	<b>263</b>
<b>GRC-2000</b>	Radio relay system	Elbit Systems - Land & C <sup>4</sup> I	<b>278</b>
<b>GRC-408E</b>	IP & TDM radio relay	Elbit Systems - Land & C <sup>4</sup> I	<b>278</b>
<b>GRX-4000</b>	Tactical IP & multi-interface radio relay system	Elbit Systems - Land & C <sup>4</sup> I	<b>279</b>
<b>G-SCANPRO</b>	Hand Held Explosives & Narcotics Detector	LDS - Laser Detect Systems	<b>147</b>
<b>GSDU</b>	Ground Smart Display Unit	Elbit Systems - Land & C <sup>4</sup> I	<b>288</b>
<b>GTAS</b>	Ground Target Acquisition System	IAI - Tamam Division	<b>325</b>
<b>GUARDER</b>	High performance 4X4 armored vehicle	Plasan	<b>138, 150</b>
<b>GUARDIUM</b>	Family of Unmanned Ground Vehicles	GNIUS Unmanned Ground Sys.	<b>266, 268</b>
<b>GUARDIUM</b>	Unmanned Patrol System	IAI - Lahav Division	<b>268</b>
<b>H</b>			
<b>HAS</b>	Hovering Aerial Systems	IAI - Malat Division	<b>263</b>
<b>HAWK</b>	Missile System	SIBAT - Israel Ministry of Defense	<b>363</b>
<b>HDF</b>	Heavy Duty Fence	Mifram	<b>141</b>
<b>HERMES</b>	Family of UAS	Elbit Systems	<b>255</b>
<b>HERO</b>	ISR System	Uvision Air	<b>265</b>
<b>HERON</b>	Family of UAS	IAI - Malat Division	<b>258, 259</b>
<b>HF-6000</b>	HF long-range radio systems	Elbit Systems - Land & C <sup>4</sup> I	<b>277</b>
<b>HF-8000</b>	HF long-range radio systems	Elbit Systems - Land & C <sup>4</sup> I	<b>276</b>
<b>HMV</b>	Unmanned Ground Vehicle	GNIUS Unmanned Ground Sys.	<b>266</b>
<b>HOPER</b>	NBC hood & blower system for helicopter crews	Shalon Chemical Industries	<b>379</b>
<b>HPLS 2</b>	North finding systems	Arazim	<b>349</b>
<b>HSF</b>	RPG defeat solutions	Plasan	<b>138, 150</b>
<b>HTS</b>	Helicopter Training & Safety System	IAI - MLM Division	<b>63</b>
<b>HUD</b>	Head Up Displays	Elbit Systems	<b>42, 43</b>
<b>HURRICANE</b>	8 Ton all terrain 4X4 APC	Carmor	<b>121</b>

<b>BRAND NAME/ ACRONYM/ ABBREVIATION</b>	<b>EXPLANATION</b>	<b>COMPANY</b>	<b>PAGE</b>
<b>I</b>			
<b>ICE</b>	Imagery intelligence solution	Elbit Systems - Elop	<b>296</b>
<b>ICECS</b>	Kinetics Individual Crew & Equipment Cooling System	Elbit Systems - Land & C <sup>4</sup> I	<b>127</b>
<b>ICP</b>	Interface Control Processors	Rada Electronic Industries	<b>45</b>
<b>ID260MF</b>	Impact/Delay Fuze	Orion Advanced Systems	<b>55</b>
<b>IDLS-MKII</b>	Data link solution	Commtact	<b>252</b>
<b>IFEWS</b>	In Flight Electronic Warfare Simulator	Elbit Systems	<b>61</b>
<b>ILET</b>	Electro-optical Tester	CI Systems	<b>344</b>
<b>IMILITE</b>	Multi-Source MultiTask ISR System / Command & Control System	Rafael	<b>23, 29, 47, 77, 165, 167, 168, 175, 177, 221, 222, 307, 309, 323, 335</b>
<b>IMPS</b>	Indoor Modular Protection system	Mifram	<b>141, 143</b>
<b>INPRO</b>	NBC Infant protector	Shalon Chemical Industries	<b>380</b>
<b>INTERSKY 4M</b>	Tactical broadband satellite military communications system	Elbit Systems - Land & C <sup>4</sup> I	<b>280</b>
<b>IRCS</b>	Integrated radio communication system	Elbit Systems - Land & C <sup>4</sup> I	<b>279</b>
<b>IRIS</b>	Individual Robotic Intelligence System	Roboteam	<b>267</b>
<b>IRON DOME</b>	Air defense system	Rafael	<b>58, 88, 236</b>
<b>IVORY-Z</b>	Compact Thermal Imaging Camera/Sight	Elbit Systems - Elop	<b>340</b>
<b>J</b>			
<b>JEDEYE</b>	Helmet mounted display	Elbit Systems	<b>41</b>
<b>JERICHO</b>	Pistol	IWI - Israel Weapon Industries	<b>230</b>
<b>JHMCS</b>	Helmet mounted display	Elbit Systems	<b>40</b>
<b>JUPITER</b>	Very High Resolution Remote Sensing Camera	Elbit Systems - Elop	<b>85</b>
<b>K</b>			
<b>KFIR</b>	Fighter aircraft	SIBAT - Israel Ministry of Defense	<b>358, 359</b>
<b>L</b>			
<b>LAHAT</b>	Laser Homing ATtack Missile	IAI - Air & Missile Defense	<b>52</b>
<b>LAMBDA M760</b>	Electronic Time fuze	Reshef Technologies	<b>192</b>
<b>LESCUT</b>	Torpedo Countermeasure for Surface Ships	Rafael	<b>103, 109</b>
<b>LITENING</b>	Targeting & Navigation Pod	Rafael	<b>22, 28, 46, 78, 166, 176, 220, 308, 322, 334</b>
<b>LIZ</b>	Remote Operation Multi-sensor Day/Night EO Sight	Elbit Systems - Elop	<b>341</b>
<b>LIZARD</b>	Modular rocket guidance kits	Elbit Systems	<b>51</b>
<b>LIZARD 2 LASER</b>	Guided bomb with laser seeker	Elbit Systems	<b>51</b>
<b>LIZARD 3 LASER</b>	Guided bomb with laser seeker	Elbit Systems	<b>51</b>
<b>LONG VIEW CR</b>	Day/night long-range observation & target acquisition system	Elbit Systems - Elop	<b>163</b>



<b>BRAND NAME/ ACRONYM/ ABBREVIATION</b>	<b>EXPLANATION</b>	<b>COMPANY</b>	<b>PAGE</b>
<b>LORA</b>	Precision Strike Tactical Missile	IAI - MLM Division	<b>186</b>
<b>LOTUS-G/GL</b>	Man-Portable Long-Range Thermal Imaging Camera	Elbit Systems - Elop	<b>341</b>
<b>LPR</b>	License Plate Recognition	Xi Information Processing Sys.	<b>295</b>
<b>LSS</b>	Kinetics Life Support Systems	Elbit Systems - Land & C <sup>4</sup> I	<b>127</b>
<b>LVC</b>	Live Virtual Constructive air training solutions	IAI - MLM Division	<b>63</b>
<b>LYNX</b>	Artillery rockets & missiles launching system	IMI - Israel Military Industries	<b>187</b>
<b>M</b>			
<b>M-114S</b>	Upgraded version of the 155mm field gun	Elbit Systems - Land & C <sup>4</sup> I	<b>184</b>
<b>M15A1T</b>	NBC Respirator	Shalon Chemical Industries	<b>378</b>
<b>M15S80</b>	NBC respirator for tank crews	Shalon Chemical Industries	<b>378</b>
<b>M163A1</b>	Lightweight mobile 20mm 6-barrel cannon	SIBAT - Israel Ministry of Defense	<b>363</b>
<b>M-19 HD</b>	Very long range observation & targeting system	IAI - Tamam Division	<b>324</b>
<b>M454 S-HE</b>	155mm Super High-Explosive artillery projectile	IMI - Israel Military Industries	<b>187</b>
<b>M-46S</b>	Upgraded version of the 130mm field gun	Elbit Systems - Land & C <sup>4</sup> I	<b>184</b>
<b>M48</b>	NBC filter for Abrams M1A1 tanks	Shalon Chemical Industries	<b>381</b>
<b>M-5</b>	Pistol	Bul	<b>228</b>
<b>M80</b>	NBC filter canister	Shalon Chemical Industries	<b>379</b>
<b>MAFCS</b>	Modular Artillery Fire Control System	Astronautics C.A.	<b>180</b>
<b>MANTIS</b>	Self-rising, mobile combat post	Mifram	<b>141, 142</b>
<b>MARS</b>	Multi-Purpose Air-Launched Rocket System	IMI - Israel Military Industries	<b>53</b>
<b>MATADOR</b>	Family of Anti-Structure Munitions	Rafael	<b>217</b>
<b>MAVINS</b>	All in one modular avionics & INS system for UAVs	Rada Electronic Industries	<b>45</b>
<b>MBP</b>	Modular ballistic protection system	Mifram	<b>141</b>
<b>MBS</b>	Mobile shelter	Mifram	<b>140, 143</b>
<b>MCTR-7200</b>	Family of tactical software-defined radios	Elbit Systems - Land & C <sup>4</sup> I	<b>275</b>
<b>MD500 DEFENDER</b>	Helicopter	SIBAT - Israel Ministry of Defense	<b>358, 364</b>
<b>MDC</b>	Mission & Display Computers	Astronautics C.A.	<b>37</b>
<b>MDLS</b>	Data link solution	Commtact	<b>252</b>
<b>ME4</b>	NBC filter for Merkava tanks	Shalon Chemical Industries	<b>381</b>
<b>MEPRO MESLAS</b>	Sniper scope	Meprolight (1990)	<b>216</b>
<b>MEPRO X4</b>	Day scope	Meprolight (1990)	<b>216</b>
<b>MERCURY</b>	Earth Global Monitoring System	Elbit Systems - Elop	<b>85</b>
<b>MERKAVA</b>	Main battle tank	SIBAT - Israel Ministry of Defense	<b>116</b>
<b>MFS</b>	Mobile & Modular fence system	Mifram	<b>141</b>
<b>MIC<sup>4</sup>AD</b>	Integrated air & missile defense C <sup>4</sup> I system	Rafael	<b>80, 169, 178, 237, 293, 310</b>
<b>MICOM-3</b>	Family of long-range radio systems	Elbit Systems - Land & C <sup>4</sup> I	<b>277</b>
<b>MICRO B</b>	Precision situational awareness UAV system	Bluebird Aero Systems	<b>251</b>
<b>MICRO DCOMPASS</b>	Digital Compact Stabilized EO System	Elbit Systems - Elop	<b>333</b>
<b>MICROPOP</b>	Very small Plug-in Optronic Payload	IAI - Tamam Division	<b>325</b>
<b>MICRORAD</b>	Compact single-channel radiometer	Iard Sensing Solutions	<b>345</b>
<b>MILLENNIUM</b>	Multi-purpose, bullet proof combat post	Mifram	<b>140</b>
<b>MINIPOP</b>	Small Plug-in Optronic Payload	IAI - Tamam Division	<b>325</b>
<b>MINI-SAMP</b>	Mini Countermeasures Dispenser System & Mini IR Decoy Flare	IMI - Israel Military Industries	<b>69</b>

<b>BRAND NAME/ ACRONYM/ ABBREVIATION</b>	<b>EXPLANATION</b>	<b>COMPANY</b>	<b>PAGE</b>
<b>MIPR</b>	Military IP Radio	Elbit Systems - Land & C <sup>4</sup> I	<b>274</b>
<b>MOBILINX</b>	Geo-Referenced Security Command & Control & management system	Xi Information Processing Sys.	<b>295</b>
<b>MOSP3000</b>	Multi-mission Optronic Stabilized Payload	IAI - Tamam Division	<b>324</b>
<b>MPR 500</b>	Multi-Purpose Rigid bomb	IMI - Israel Military Industries	<b>53</b>
<b>MPRS</b>	Multi-Purpose Rifle System	IMI - Israel Military Industries	<b>214</b>
<b>MRS-2000M</b>	Situation awareness system	Elbit Systems - EW & Sigint, Elisra	<b>285</b>
<b>MSC</b>	Multipurpose Bulletproof security containers	Mifram	<b>140, 143</b>
<b>MTDS</b>	Multi Threat Detection System	Elbit Systems - Land & C <sup>4</sup> I	<b>125</b>
<b>MTGR</b>	Micro Tactical Ground Robot	Roboteam	<b>267</b>
<b>MUSIC</b>	Multi Spectral Infrared Countermeasure systems	Elbit Systems - Elop	<b>66</b>
<b>MVB</b>	Modular Vehicle Barrier	Mifram	<b>140</b>
<b>MWS</b>	Missile Warning Sensor	IMI - Israel Military Industries	<b>69</b>
<b>N</b>			
<b>NAMER</b>	Armored Personnel Carrier	SIBAT - Israel Ministry of Defense	<b>118</b>
<b>NATACS 2020</b>	Naval tactical COMINT/DF system	Elbit Systems - EW & Sigint, Elisra	<b>106</b>
<b>NAV X INFO</b>	Hybrid navigation system	Xi Information Processing Sys.	<b>295</b>
<b>NAVIGATOR</b>	All terrain 4X4 MRAP	Carmor	<b>121</b>
<b>NCMI</b>	Naval Combat Maneuvering Instrumentation system	Elbit Systems	<b>110</b>
<b>NCMI</b>	Naval on board training system	IAI - MLM Division	<b>111</b>
<b>NEGEV</b>	Light machine gun	IWI - Israel Weapon Industries	<b>230</b>
<b>NEPTUNE</b>	High Resolution Remote Sensing Camera	Elbit Systems - Elop	<b>85</b>
<b>NETZ</b>	F16A Flight simulator	SIBAT - Israel Ministry of Defense	<b>366</b>
<b>NIRIT</b>	Fast Attack Missile Boat	Israel Shipyards	<b>94</b>
<b>NTT</b>	Naval Tactical Trainer	Elbit Systems	<b>110</b>
<b>O</b>			
<b>OLT</b>	O Level Laser Tester	CI Systems	<b>344</b>
<b>OMICRON M180</b>	Time gated Electronic Proximity fuze	Reshef Technologies	<b>192</b>
<b>OPTSAT</b>	Imaging satellites	IAI - Space Division	<b>83</b>
<b>OPV</b>	Offshore PatrolVessel	Israel Shipyards	<b>95</b>
<b>ORBITER 3</b>	Small Tactical Unmanned Aerial System	Aeronautics	<b>246, 247</b>
<b>ORBITER MINI</b>	Mini Tactical Unmanned Aerial System	Aeronautics	<b>248, 249</b>
<b>ORCWS</b>	Overhead Remote Controlled Weapon Stations	Elbit Systems - Land & C <sup>4</sup> I	<b>124</b>
<b>ORION</b>	Dual band compact radiometer	Iard Sensing Solutions	<b>345</b>
<b>OT</b>	Family of Eye Safe Laser Transmitters	Optitask	<b>321</b>
<b>P</b>			
<b>PANTHER</b>	Family of VTOL tactical UAS	IAI - Malat Division	<b>262</b>
<b>PAR</b>	Portable Acoustic Range	DSIT Solutions	<b>112</b>
<b>PATHMARKER</b>	Automatic Vehicle Location System	Xi Information Processing Sys.	<b>295</b>
<b>PAWS</b>	Family of IR Passive Airborne Warning Systems	Elbit Systems - EW & Sigint, Elisra	<b>67</b>
<b>PHALANX</b>	Multi-purpose rapid fortification kit	Mifram	<b>143</b>
<b>PIU</b>	Payload Interface Units	Rada Electronic Industries	<b>45</b>

<b>BRAND NAME/ ACRONYM/ ABBREVIATION</b>	<b>EXPLANATION</b>	<b>COMPANY</b>	<b>PAGE</b>
<b>PLDR-II</b>	Portable Lightweight Designator / Rangefinder	Elbit Systems - Elop	<b>318</b>
<b>PMC</b>	UAV Payload Management Computers	Rada Electronic Industries	<b>45</b>
<b>PNR-1000S</b>	Personal network radio (PNR) with automatic voice & data relay	Elbit Systems - Land & C4I	<b>277</b>
<b>PNR-500</b>	Personal tactical conference communication	Elbit Systems - Land & C4I	<b>278</b>
<b>POP300</b>	Plug-in Optronical Payload	IAI TAMAM DIVISION	<b>325</b>
<b>POPEYE</b>	Air-to-Ground standoff missile	Rafael	<b>56</b>
<b>PREDATOR HAWK</b>	Long-range tactical missile system	IMI - Israel Military Industries	<b>187</b>
<b>PRIEST 4000</b>	Lightweight, prefabricated observation tower	Mifram	<b>140, 142</b>
<b>PROBOT</b>	Professional Robot	Roboteam	<b>267</b>
<b>PROTECTOR</b>	Unmanned surface vehicle	Rafael	<b>93, 104, 170, 256</b>
<b>PYTHON</b>	Air-to-air missile	Rafael	<b>56</b>
<b>R</b>			
<b>R.U.F</b>	Rescue Under Fire	Tal & Hadas	<b>134</b>
<b>RADOF</b>	RF Over Fiber solution	More-Military Optical RF Equipment	<b>71, 107</b>
<b>RAMGAN</b>	Bulletproof guard & observation tower	Mifram	<b>141, 142</b>
<b>RATTLER</b>	Miniature Coded Laser Designator / Marker	Elbit Systems - Elop	<b>319</b>
<b>RAVNET 300</b>	Airborne Voice & Data Communication Radio Network	Rafael	<b>76, 174, 291</b>
<b>RICENT</b>	Real Time Imagery Intelligence Center	IAI - Elta Systems	<b>298</b>
<b>R-CENTRIC</b>	Self-protection force multiplier solution	Elbit Systems - EW & Sigint, Elisra	<b>67</b>
<b>RECCELITE</b>	Real Time Tactical Reconnaissance System	Rafael	<b>22, 28, 46, 78, 165, 166, 176, 220, 308, 322, 334</b>
<b>RECCE-U</b>	Real Time Persistent ISR System	Rafael	<b>22, 28, 46, 79, 165, 166, 176, 220, 308, 322, 334</b>
<b>RED SKY-2</b>	Fast-deployable, compact VSHORAD system	IMI - Israel Military Industries	<b>69, 238</b>
<b>RESCUBE</b>	Indoor foldable protection system	Mifram	<b>141</b>
<b>RESPRO</b>	NBC protective hood for children	Shalon Chemical Industries	<b>380</b>
<b>REX</b>	Infantry Robotic Porter	IAI - Lahav Division	<b>268</b>
<b>RNAV/RNAV-IPON</b>	RLG based Terrain Navigation System	IAI - Tamam Division	<b>350</b>
<b>ROCU-7</b>	Ruggedized Operator Control Unit	Roboteam	<b>267</b>
<b>RPS</b>	Radar Protection System	Rada Electronic Industries	<b>151</b>
<b>R-SCAN</b>	Remote Scan Explosives & Narcotics Detector	LDS - Laser Detect Systems	<b>147</b>
<b>S</b>			
<b>SA'AR 4.5 CLASS</b>	Fast Attack Missile Boat	Israel Shipyards	<b>94</b>
<b>SAAR S-72</b>	Fast Attack Mini Corvette	Israel Shipyards	<b>96</b>
<b>SAHAR</b>	Autonomous CIED System	IAI - Lahav Division	<b>268</b>
<b>SAMSON</b>	Load reduction system	Tal & Hadas	<b>134</b>
<b>SAMSON</b>	Family of Remote Weapon Stations	Rafael	<b>188, 189, 196, 197, 224, 225</b>

<b>BRAND NAME/ ACRONYM/ ABBREVIATION</b>	<b>EXPLANATION</b>	<b>COMPANY</b>	<b>PAGE</b>
<b>SANDCAT</b>	Family of multi-purpose 4X4 armored vehicles	Plasan	<b>138, 150</b>
<b>SAS</b>	Static Active Sonar	DSIT Solutions	<b>112</b>
<b>SAS</b>	Pistol series	Bul	<b>228</b>
<b>SAS</b>	Synthetic Arena Simulation	Eltel Technologicals	<b>232</b>
<b>SCARLET</b>	Portable & flexible VIP protection	Mifram	<b>140</b>
<b>SCUTTER</b>	Reactive Expendable Acoustic Torpedo Countermeasure	Rafael	<b>103, 108</b>
<b>SEA SPOTTER IRS<sup>2</sup>T</b>	Naval IR Staring & Tracking System	Rafael	<b>105, 108</b>
<b>SEA-COM</b>	IP/VoIP Shipborne Communication System	Rafael	<b>98, 292</b>
<b>SEARCHER</b>	Tactical UAS	IAI - Malat Division	<b>260</b>
<b>SEARCHER 2</b>	UAV Simulator	SIBAT - Israel Ministry of Defense	<b>367</b>
<b>SecurePath</b>	Geo-referenced Security system	Xi Information Processing Sys.	<b>295</b>
<b>SERPENT</b>	Portable Lightweight Designator / Rangefinder for Laser-Guided Munitions	Elbit Systems - Elop	<b>318</b>
<b>SEWS</b>	Integrated EW suites	Rafael	<b>70, 109</b>
<b>SHALDAG</b>	Fast Patrol Boat	Israel Shipyards	<b>97</b>
<b>SHARK</b>	ECM systems	Rafael	<b>70</b>
<b>SHARK</b>	Observation & sniper bulletproof tower	Mifram	<b>141, 142</b>
<b>SHIPON FFE</b>	Fire From Enclosure system	IMI - Israel Military Industries	<b>214</b>
<b>SHOCK ABSORBER</b>	Active Protection System	IMI - Israel Military Industries	<b>215</b>
<b>SILVER BULLET</b>	Precision guidance kit for 155mm projectiles	BAE Systems Rokar	<b>64</b>
<b>SIMON</b>	Rifle-launched entry breaching grenade	Rafael	<b>217</b>
<b>SKUNK</b>	Non-lethal riot control substance	Tvunot 5766	<b>386</b>
<b>SKY GUARD</b>	Overhead protection system against mortars & light rockets	Mifram	<b>141, 143</b>
<b>SKY SHIELD</b>	Airborne Support Jammers	Rafael	<b>70</b>
<b>SkyBreaker</b>	Airborne Mission Training Center	Elbit Systems	<b>60</b>
<b>SKYLARK</b>	Family of UAS	Elbit Systems	<b>254</b>
<b>SKYSTAR</b>	Aerostat Family	RT LTA Systems	<b>239</b>
<b>SPARROW</b>	Surrogate ballistic target	Rafael	<b>56</b>
<b>SPB</b>	Sectional Personnel Bridge	IMI - Israel Military Industries	<b>215</b>
<b>SPEAR</b>	120mm soft recoil mortar	Elbit Systems - Land & C <sup>4</sup> I	<b>185</b>
<b>SPICE</b>	Electro-optical guidance kit	Rafael	<b>56</b>
<b>SPID</b>	Passive, IR electro-optical threat detection system	Elbit Systems - EW & Sigint, Elisra	<b>208</b>
<b>SPIKE</b>	Family of electro-optic CCD or IIR missiles	Rafael	<b>57, 102, 190, 223</b>
<b>SPOTLITE</b>	Family of Electro-Optic Enemy Fire Detection System	Rafael	<b>23,29, 47, 79, 165, 167, 171, 177, 179, 191, 221, 226, 309, 323, 335</b>
<b>SPYDER SR/MR</b>	Short/Medium Range Mobile Air Defense Systems	Rafael	<b>58, 88, 236</b>
<b>SPY-I</b>	Aerostat system	Bluebird Aero Systems	<b>251</b>
<b>SpyLite</b>	Mini UAV	Bluebird Aero Systems	<b>251</b>
<b>SSG</b>	Smart Scenario Generator	Hartech Technologies	<b>62</b>
<b>STA</b>	See-Through-Armor	Elbit Systems - Land & C <sup>4</sup> I	<b>126</b>
<b>STALKER</b>	Multi-sensor surveillance system	Rafael	<b>165, 172</b>

<b>BRAND NAME/ ACRONYM/ ABBREVIATION</b>	<b>EXPLANATION</b>	<b>COMPANY</b>	<b>PAGE</b>
<b>STAR</b>	Smart Tactical Advanced Rocket	ELBIT SYSTEMS LTD.	<b>51</b>
<b>STRIX</b>	Aviator Imaging Night Vision System	Troya	<b>327</b>
<b>SUFA</b>	F16I Flight simulator	SIBAT - Israel Ministry of Defense	<b>366</b>
<b>SWALLOW</b>	Automatic parachute disconnecting system	Tal & Hadas	<b>134</b>
<b>T</b>			
<b>TACMAX</b>	Tactical 4G Cellular Broadband Network for Ground Forces	Rafael	<b>174, 291</b>
<b>TAC-SA</b>	Tactical Situational Awareness	Roboteam	<b>267</b>
<b>TACTER-31D</b>	Tactical computer	Elbit Systems - Land & C <sup>4</sup> I	<b>289</b>
<b>TALOS</b>	Unattended Ground Sensors	Elbit Systems - Land & C <sup>4</sup> I	<b>297</b>
<b>TARGO</b>	Helmet mounted display	Elbit Systems	<b>40</b>
<b>TAS</b>	Tactical Aerostat System	Top I Vision	<b>264</b>
<b>TAVOR</b>	Assault rifle	IWI - Israel Weapon Industries	<b>230</b>
<b>TBT</b>	Tactical Battle Group Trainer	Elbit Systems	<b>231</b>
<b>TDS</b>	Threat Detection System	Elbit Systems - Land & C <sup>4</sup> I	<b>125</b>
<b>TECSAR</b>	Imaging satellites with SAR payload	IAI - Space Division	<b>83, 300</b>
<b>TERRA-SONIC</b>	Passive warning & detection system	Rafael	<b>165, 173</b>
<b>THETA M788</b>	Electronic Proximity fuze	Reshef Technologies	<b>192</b>
<b>ThunderB</b>	Tactical UAS	Bluebird Aero Systems	<b>251</b>
<b>TIGER</b>	Tactical Intranet Geographic dissEmination in Real-time	Elbit Systems - Land & C <sup>4</sup> I	<b>286</b>
<b>TIMNEX II</b>	ESM/ELINT system for submarines & surface ships	Elbit Systems - EW & Sigint, Elisra	<b>106</b>
<b>TIVT</b>	Tactical Intelligence, Video, & Telemetry systems	Elbit Systems - EW & Sigint, Elisra	<b>285</b>
<b>TNF</b>	FOG-based miniature attitude, heading & reference system for Aircraft, Helicopters & UAVs	IAI - Tamam Division	<b>350</b>
<b>TNL-16G</b>	RLG based Airborne Inertial Navigation system	IAI - Tamam Division	<b>350</b>
<b>TOP SCAN</b>	ELINT/ESM system	Rafael	<b>70</b>
<b>TOPLITE</b>	Electro-Optical Surveillance, Observation & Targeting System	Rafael	<b>22, 28, 46, 78, 105, 165, 166, 176, 308, 322, 334</b>
<b>TORBUSTER</b>	Fourth generation torpedo decoy for submarines	Rafael	<b>103, 108</b>
<b>TORC2H</b>	All-in-one C <sup>4</sup> I system	Elbit Systems - Land & C <sup>4</sup> I	<b>286</b>
<b>TrainTrack</b>	Train & cars monitoring & security system	Xi Information Processing Sys.	<b>295</b>
<b>TREASURES</b>	Tactical Reconnaissance & Surveillance system	Elbit Systems - Land & C <sup>4</sup> I	<b>297</b>
<b>TRF-90</b>	Miniature Inertial Measurement Unit	IAI - Tamam Division	<b>350</b>
<b>TRIGON</b>	Naval version of the EXTRA 306mm rocket system	IMI - Israel Military Industries	<b>101</b>
<b>TROPHY</b>	Situational Awareness & Active Protection Systems	Rafael	<b>132, 148, 149</b>
<b>TSR</b>	Target Simulation Rockets	IMI - Israel Military Industries	<b>238</b>
<b>TURTLE</b>	Multi-purpose rapid fortification kit	Mifram	<b>143</b>
<b>TYPHOON</b>	Family of Naval Weapon Stations	Rafael	<b>102, 104</b>
<b>TYTO</b>	Night Vision Monocular	Troya	<b>327</b>
<b>TZUKIT</b>	Training aircraft	SIBAT - Israel Ministry of Defense	<b>358, 359</b>

<b>BRAND NAME/ ACRONYM/ ABBREVIATION</b>	<b>EXPLANATION</b>	<b>COMPANY</b>	<b>PAGE</b>
<b>U</b>			
<b>UASA</b>	Underwater Acoustic Signature Analysis	DSIT Solutions	<b>112</b>
<b>UGS</b>	Unattended Ground Sensors	Elbit Systems - Land & C <sup>4</sup> I	<b>297</b>
<b>UMACS / BMACS</b>	Uni & bi-modular artillery charge systems	IMI - Israel Military Industries	<b>187</b>
<b>URANUS</b>	Multi-Spectral Space Camera - Payload System	Elbit Systems - Elop	<b>84</b>
<b>UT30</b>	Unmanned Turret	Elbit Systems - Land & C <sup>4</sup> I	<b>124</b>
<b>UVR</b>	Data link solution	Commtact	<b>252</b>
<b>UZI</b>	Submachine gun	IWI - Israel Weapon Industries	<b>230</b>
<b>V</b>			
<b>V-DSF</b>	Visible Dynamic Sunlight Filter	Kilolambda Technologies	<b>320</b>
<b>VEN<math>\mu</math>S</b>	Super-Spectral Remote Sensing Camera	Elbit Systems - Elop	<b>85</b>
<b>VGLPS</b>	Vehicle Gun Laying & Positioning System	IAI - Tamam Division	<b>350</b>
<b>VIC-500</b>	Intercommunication system for fighting vehicles	Elbit Systems - Land & C <sup>4</sup> I	<b>277</b>
<b>W</b>			
<b>WHIP SHOT</b>	Precision guided weapon	IMI - Israel Military Industries	<b>53</b>
<b>WINBMS</b>	Advanced networked battle management	Elbit Systems - Land & C <sup>4</sup> I	<b>286</b>
<b>WIT</b>	Wise Intelligence Technology	Elbit Systems - Elop	<b>296</b>
<b>WOLF</b>	9 Ton multipurpose 4X4 APC	Carmor	<b>121</b>
<b>WPF</b>	Wideband Laser Protection Filter	Kilolambda Technologies	<b>320</b>
<b>X</b>			
<b>XACT-NV32</b>	Monocular night vision systems	Elbit Systems - Elop	<b>317</b>
<b>XAVER</b>	Family of "Sense Through Wall Imaging" systems	Camero-Tech Israel	<b>212</b>
<b>X-GUARD</b>	Towed Decoy	Rafael	<b>70</b>
<b>XI PAC</b>	Site security wireless access monitoring & control	Xi Information Processing Sys.	<b>295</b>
<b>XTREAM</b>	16 Ton all terrain 4X4 MRAP	Carmor	<b>121</b>
<b>Y</b>			
<b>YASSUR</b>	Blackhawk/CH53 Flight simulator	SIBAT - Israel Ministry of Defense	<b>367</b>
<b>Z</b>			
<b>ZETA M138</b>	Electronic Time fuze	Reshef Technologies	<b>192</b>

# ISRAEL DEFENSE DIRECTORY 2015-16

This official publication is the visiting card of the Israeli Defense Industry, characterized by battle-proven products featuring unrivalled know-how and reliability, designed to meet the challenges of the 3rd. millennium. Over 200 companies engaged in defense manufacture and services are listed in this Directory.

**The Directory has been produced both as this book and as a CD. The price of the book & CD is - USD100.**

For purchasing additional Directory, please contact:

## **Marketing Communications Division**

Sibat\_marcom@mod.gov.il

Tel: +972-3-6975515

+972-3-6975529

Fax: +972-3-6934639