

- 1510.01 General
- 1510.02 Policy
- 1510.03 ADA Requirements by Project Type
- 1510.04 Pedestrian Circulation Paths
- 1510.05 Pedestrian Access Routes
- 1510.06 Linear Pedestrian Facilities (New Section 2023)
- 1510.07 Sidewalks (Section Rewritten 2023)
- 1510.08 Curb Ramps
- 1510.09 Pedestrian Crossings
- 1510.10 Raised Medians/Traffic Islands
- 1510.11 Intersection Design (New Section 2023)
- 1510.12 Pedestrian Pushbuttons
- 1510.13 At-Grade Railroad Crossings
- 1510.14 Pedestrian Grade Separations (Structures)
- 1510.15 Other Pedestrian Facilities
- 1510.16 Illumination and Signing
- 1510.17 Work Zone Pedestrian Accommodation
- 1510.18 References

- Exhibit 1510-1 Pedestrian Level of Traffic Stress (PLTS) in mixed traffic (no marked bicycle lane, with or without shoulder) (New Exhibit 2023)
- Exhibit 1510-2 Pedestrian Level of Traffic Stress (PLTS) based on Sidewalk Width (New Exhibit 2023)
- Exhibit 1510-3 Pedestrian Level of Traffic Stress (PLTS) based on Buffer Type (New Exhibit 2023)
- Exhibit 1510-4 Refined PLTS treatment list (New Exhibit 2023)
- Exhibit 1510-5 Pedestrian Circulation Paths
- Exhibit 1510-6 Relationship Between Pedestrian Circulation Paths and Pedestrian Access Routes
- Exhibit 1510-7 Obstructed Pedestrian Access Route
- Exhibit 1510-8 Beveling Options
- Exhibit 1510-9 Surface Discontinuities (Noncompliant)
- Exhibit 1510-10 Suggested Sidewalk and Buffer Widths* (New Exhibit 2023)

- Exhibit 1510-11 Sidewalks with Buffers
- Exhibit 1510-12 Typical Sidewalk Designs
- Exhibit 1510-13 Typical Driveways
- Exhibit 1510-14 Driveway Approach Designs (New Exhibit 2023)
- Exhibit 1510-15 Perpendicular Curb Ramp
- Exhibit 1510-16 Perpendicular Curb Ramp Common Elements
- Exhibit 1510-17 Parallel Curb Ramp
- Exhibit 1510-18 Parallel Curb Ramp Common Elements
- Exhibit 1510-19 Combination Curb Ramps
- Exhibit 1510-20 Typical Curb Ramp Drainage
- Exhibit 1510-21 Unmarked Crosswalks
- Exhibit 1510-22 Marked Pedestrian Crossing
- Exhibit 1510-23 Essential Signal Operations at a Location That Does Not Support the Pedestrian Crossing (New Exhibit 2023)
- Exhibit 1510-24 Midblock Pedestrian Crossing
- Exhibit 1510-25 Raised Crosswalk Cross-Section
- Exhibit 1510-26 Obstructed Line of Sight at Intersection
- Exhibit 1510-27 Improved Line of Sight at Intersection
- Exhibit 1510-28 Curb Extension Examples
- Exhibit 1510-29 Mountable Truck Apron Design Elements (New Exhibit 2023)
- Exhibit 1510-30 Raised Islands with Curb Ramps and Pedestrian Cut-Throughs
- Exhibit 1510-31 Clear Space for Pedestrian Pushbutton
- Exhibit 1510-32 Perpendicular Ramp Concurrent Clear Space Examples
- Exhibit 1510-33 Parallel Ramp Concurrent Clear Space Examples
- Exhibit 1510-34 Reach Range for Pedestrian Pushbuttons
- Exhibit 1510-35 Pedestrian Railroad Crossings
- Exhibit 1510-36 Pedestrian Railroad Warning Device
- Exhibit 1510-37 Pedestrian Bridges
- Exhibit 1510-38 Pedestrian Tunnel
- Exhibit 1510-39 Access Ramp with Accessible Handrails
- Exhibit 1510-40 Work Zones and Pedestrian Facilities

1510.01 General

Pedestrian travel is a vital transportation mode. Nearly everyone uses it at some point in every trip and it is a critical link to everyday life for many. Designers must be aware of the various physical needs and abilities of pedestrians in order to ensure facilities provide universal access.

The pedestrian facilities included in a project are determined during the planning phase based on:

- access control of the highway;
- local transportation plans;
- comprehensive plans and other plans (such as Walk Route Plans developed by schools and school districts);
- the roadside environment;
- adherence to the Complete Streets legislation;
- pedestrian volumes; user age group(s); and
- the continuity of local walkways along or across the roadway.

Section 504 of the Rehabilitation Act and the Americans with Disabilities Act of 1990 (ADA) require pedestrian facilities to be designed and constructed so they are readily accessible to and usable by persons with disabilities. This chapter provides accessibility criteria for the design of pedestrian facilities that meet applicable state and federal standards.

When developing pedestrian facilities within a limited amount of right of way, designers can be faced with multiple challenges. It is important that designers are trained to understand the ADA accessibility criteria to appropriately balance intersection design with the diversity of pedestrians and other roadway users' needs.

Similar to the roadway infrastructure, pedestrian facilities (and elements) require periodic maintenance in order to prolong the life of the facility and provide continued usability. Title II of the ADA requires that all necessary features be accessible and maintained in operable working condition for use by individuals with disabilities.

1510.02 Policy

1510.02(1) General

WSDOT seeks to provide appropriate pedestrian facilities along and across sections of state routes as an integral part of the transportation system. Federal Highway Administration (FHWA) and WSDOT policy is that bicycle and pedestrian facilities be given full consideration in the planning and design of new construction and reconstruction highway projects, except where bicycle and pedestrian use is prohibited. Use a performance-based approach to select and design the appropriate solution to address the need to accommodate pedestrian uses, including those uses associated with projects that are providing for a Complete Streets facility. See Section 1510.02(5).

1510.02(2) Jurisdiction

Proposed projects in public rights of way must address ADA compliance as described in this chapter. (See Section 1510.03 for ADA requirements by project type.) Regardless of which public agency has jurisdiction within the right of way, the public agency that is sponsoring the project is responsible for ensuring ADA compliance is addressed on its project.

On all state routes outside of incorporated cities and on those with limited access (full, partial, and modified) within incorporated cities, jurisdiction remains with the state unless modified by a maintenance agreement. In turnback areas where the turnback agreement has not been completed, the state maintains full jurisdiction (see Chapter 510, Chapter 520, and Chapter 530).

When project work occurs on a managed access state route inside an incorporated city that has jurisdiction beyond the curbs (RCW 47.24.020), design pedestrian facilities using the city design standards adopted in accordance with RCW 35.78.030 and the most current ADA requirements. Document the coordination with the city in the Basis of Design (BOD). Refer to Chapter 300 for information about the documentation.

1510.02(3) Transition Planning

Section 504 of the Rehabilitation Act and the ADA require all public entities to conduct a self-evaluation of their programs and activities, including sidewalks, curb ramps, and other pedestrian facilities and elements within the public right of way, to determine if barriers exist that prevent people with disabilities from being able to access programs, services, and activities.

If barriers are identified, agencies with 50 or more employees must develop and implement a transition plan that describes the barriers, the modifications needed, and a schedule for when the needed work will be accomplished. Questions about ADA transition plans should be directed to the ADA compliance team in the Office of Equity & Civil Rights (OECR).

1510.02(4) Maintenance (Section Rewritten 2023)

Similar to the roadway infrastructure, pedestrian facilities (and elements) require periodic maintenance in order to prolong the life of the facility and provide continued usability. Title II of the ADA requires that all necessary features be accessible and maintained in operable working condition for use by individuals with disabilities. Designers must coordinate with the appropriate maintenance disciplines and consider maintenance input as outlined in [Chapter 301](#).

1510.02(5) Design Performance Metrics – Level of Traffic Stress (New Section 2023)

The Level of Traffic Stress performance metric applies to Complete Streets projects. When selecting the cross-section layout and dimensions for a Complete Street, first determine the level of traffic stress (LTS) and Route Directness Index (RDI) in both the existing and design (final) condition. The design goal is to provide for LTS of 1 or 2, and a maximum RDI value of 2. See Section [1520.03\(3\)\(a\)](#) for guidance on Bicycle Level of Traffic Stress (BLTS).

1510.02(5)(a) Pedestrian Level of Traffic Stress (New Section 2023)

Use the following tables to determine the existing Pedestrian Level of Traffic Stress (PLTS) for the project vicinity, and to determine the type and dimension of pedestrian facilities and buffers or separations required for the design to achieve PLTS 1 or 2. This is called the Level of Traffic Stress. Note that speed referred to in the tables is target speed.

To achieve the required LTS, provide a separated pedestrian facility where the existing or proposed target speed is greater than 30 mph. Separation can be provided by adding a physical barrier such as curb or traffic barrier or providing a separate facility for pedestrians such as a shared use path. See Section [1520.03\(3\)\(a\)](#) for guidance on Bicycle Level of Traffic Stress (BLTS)

Exhibit 1510-1 Pedestrian Level of Traffic Stress (PLTS) in mixed traffic (no marked bicycle lane, with or without shoulder) (New Exhibit 2023)

PLTS in mixed traffic (no pedestrian facility)								
Lanes	AADT	Target Speed						
		≤20	25	30	35	40	45	50+
1 thru lane per direction (or 1 lane one-way street)	0 - 750	1	1	3	4	4	4	4
	751 - 1500	1	2	3	4	4	4	4
	1501 - 3000	2	2	3	4	4	4	4
	> 3000	2	3	3	4	4	4	4
2 thru lanes per direction	0 – 6000	3	3	3	4	4	4	4
	> 6000	3	3	4	4	4	4	4
3+ thru lanes per direction	Any ADT	4	4	4	4	4	4	4

Exhibit 1510-2 Pedestrian Level of Traffic Stress (PLTS) based on Sidewalk Width (New Exhibit 2023)

Greater than Minimum Sidewalk Present (6' or greater)								
Lanes	AADT	Target Speed						
		≤20	25	30	35	40	45	50+
1 thru lane per direction (or 1 lane one-way street)	0 - 750	1	1	2	2	3	4	4
	751 - 1500	1	1	2	2	3	4	4
	1501 - 3000	1	1	2	2	3	4	4
	> 3000	2	2	2	2	3	4	4
2 thru lanes per direction	0 - 6000	2	2	2	2	3	4	4
	> 6000	2	2	2	2	3	4	4
3+ thru lanes per direction	Any ADT	2	2	2	3	3	4	4

Minimum Sidewalk Present (5')								
Lanes	AADT	Target Speed						
		≤20	25	30	35	40	45	50+
1 thru lane per direction (or 1 lane one-way street)	0 - 750	1	1	2	4	4	4	4
	751 - 1500	1	1	2	4	4	4	4
	1501 - 3000	1	1	2	4	4	4	4
	> 3000	2	2	2	4	4	4	4
2 thru lanes per direction	0 - 6000	2	2	2	4	4	4	4
	> 6000	2	2	3	4	4	4	4
3+ thru lanes per direction	Any ADT	2	2	3	4	4	4	4

Exhibit 1510-3 Pedestrian Level of Traffic Stress (PLTS) based on Buffer Type (New Exhibit 2023)

Sidewalk protected by robust physical barrier								
Lanes	AADT	Target Speed						
		≤20	25	30	35	40	45	50+
1 thru lane per direction (or 1 lane one-way street)	0 - 750	1	1	1	2	2	2	2
	751 - 1500	1	1	1	2	2	2	2
	1501 - 3000	1	1	1	2	2	2	2
	> 3000	2	2	2	2	2	2	2
2 thru lanes per direction	0 - 6000	2	2	2	2	2	2	2
	> 6000	2	2	2	2	2	2	2
3+ thru lanes per direction	Any ADT	2	2	2	2	2	2	2

Wide sidewalk or sidewalk with buffer								
Lanes	AADT	Target Speed						
		≤20	25	30	35	40	45	50+
1 thru lane per direction (or 1 lane one-way street)	0 - 750	1	1	2	2	3	3	4
	751 - 1500	1	1	2	2	3	3	4
	1501 - 3000	1	1	2	2	3	3	4
	> 3000	2	2	2	2	3	3	4
2 thru lanes per direction	0 - 6000	2	2	2	2	3	3	4
	> 6000	2	2	2	2	3	3	4
3+ thru lanes per direction	Any ADT	2	2	2	2	3	3	4

1510.02(5)(b) Refined Pedestrian Level of Traffic Stress (New Section 2023)

Once the Basic PLTS for a project is determined per the tables in Section 1510.02(5) and a design is selected that meets the required PLTS 1 or 2, examine the additional issues in the list below to consider the need to provide design treatments in addition to those described in the Basic PLTS solutions. Most of the issues in the list do not provide a quantitative basis for examining the existing or proposed (design) condition. Therefore, work with Subject Matter Experts to consider each category listed and determine options for addressing each issue in order to reduce travel stress in the design for bicycles and pedestrians.

The refined PLTS is considered complete when a design approach to addressing the travel stress issues listed below have been determined and documented through a collaborative process (normally during pre-design), with the intention that those approaches will be incorporated into the design. The designer documents that the Basic PLTS has now been upgraded to the Refined (and final) PLTS for the design.

Exhibit 1510-4 Refined PLTS treatment list (New Exhibit 2023)

Characteristic	Target / Treatment
Operating speeds	Lowest acceptable vehicle travel speed (target speed)
Driveways (especially commercial)	Minimize number of accesses, provide smooth transitions for the PAR
Turn lanes	Only when necessary, seek alternatives
Parking lanes	Prioritize roadside parking as an additional buffer
Crossing distances	Reduce distances using bulbouts and median islands
Crossing barriers (e.g., median channelization)	Minimize the use of traffic barriers
Large (e.g., freight) vehicle traffic	Encourage slower travel speeds and turning movements by minimizing curb radii at intersections.
Minor pinch points (culverts, drain grates, offroad gravel intrusion, etc.)	Minimize
Surface	smooth and free of abrupt changes in vertical elevation
Grade and cross slope	minimized grade and linear distance of slope
Walkway width	Choose width appropriate for expected pedestrian volumes, provide buffer distance from traffic and obstacles.
Roadway width	minimized to reduce crossing distances
Separation	maximized by using shoulders, bike lanes, landscaped buffers, parking (urban contexts only)
Sight distance	maximized for drivers and pedestrians by using curb extensions and removing obstructions including parking near intersections
Traffic conditions	speeds are managed and lane numbers are minimized
Intersections/crossings	perpendicular, small turn radii, no slip lanes, protection islands, curb extensions, raised crossings
Conflict points	eliminated, reduced, or spread out
Access to adjacent land use	provide maximum route directness
Lighting	specifically designed for pedestrian conspicuity and personal security
Exposure to the elements	frequent shelters and shade

1510.02(5)(c) Route Directness Index for Pedestrians (New Section 2023)

Route directness is measured in terms of a Route Directness Index (RDI). Major roadways present crossing barriers for active travelers that can impose significant out of direction travel burdens. An RDI of one means direct travel is possible. An RDI of 2 means the traveler must go twice the line-of-sight distance to reach a destination because of a lack of crossing opportunities (or because an available crossing is high PLTS and/or imposes undo delay).

Research shows that pedestrians are unwilling to travel far out of direction to reach a destination. RDI's greater than 2 strongly reduce the utility of active trips by increasing the travel time, physical effort, and weather exposure a traveler experiences. A minimum RDI threshold value of 2 for state routes is proposed in the WSDOT Active Transportation Plan. While this threshold for RDI has been established in the Active Transportation Plan, the process for evaluating it is still in development. In the meantime, consult Subject Matter Experts (SMEs) on the best approach to incorporating RDI concepts into the project design.

1510.03 ADA Requirements by Project Type

Wherever pedestrian facilities are intended to be a part of the transportation facility, federal regulations ([28 CFR Part 35](#)) require that those pedestrian facilities meet ADA guidelines.

All new construction or alteration of existing transportation facilities must be designed and constructed to be accessible to and usable by persons with disabilities. FHWA is one of the federal agencies designated by the Department of Justice to ensure compliance with the ADA for transportation projects.

1510.03(1) New Construction Projects

New construction projects address the construction of a new roadway, interchange, or other transportation facility where none existed before. For these projects, pedestrians' needs are assessed and included in the project. All pedestrian facilities included in these projects must fully meet the accessibility criteria when built.

1510.03(2) Alteration Projects

Any project that affects or could affect the usability of a pedestrian facility is classified as an alteration project. Alteration projects include, but are not limited to, renovation; rehabilitation; reconstruction; historic restoration; resurfacing of circulation paths or vehicular ways; and changes or rearrangement of structural parts or elements of a facility. Where existing elements or spaces are altered, each altered element or space within the limits of the project shall comply with the applicable accessibility requirements to the maximum extent feasible.

The following are some examples of project types that are classified as alteration projects and can potentially trigger a variety of ADA requirements:

- HMA overlay or inlay
- Traffic signal installation or retrofit
- Roadway widening
- Realignment of a roadway (vertical or horizontal)
- Sidewalk improvements
- PCCP panel repair/replacement
- Bridge replacement
- Raised channelization

The following are not considered alterations:

- Spot pavement repair
- Liquid-asphalt sealing, chip seal (BST), or crack sealing
- Lane restriping that does not alter the usability of the shoulder

If there is uncertainty as to whether a project meets the definition of an alteration project, consult with the Regional ADA Liaison.

The following apply to alteration projects:

- All new pedestrian facilities included in an alteration project that are put in place within an existing developed right of way must meet applicable accessibility requirements to the maximum extent feasible.
- All existing pedestrian facilities disturbed by construction of an alteration project must be replaced. The replacement facilities must meet applicable accessibility requirements to the maximum extent feasible.

- An alteration project shall not decrease or have the effect of decreasing the accessibility of a pedestrian facility or an accessible connection to an adjacent building or site below the ADA accessibility requirements in effect at the time of the alteration.
- Within the construction impact zone of an alteration project, any existing connection from a pedestrian access route to a crosswalk (marked or unmarked) that is missing a required curb ramp must have a curb ramp installed that meets applicable accessibility requirements to the maximum extent feasible. (See Section 1510.08(2) for curb ramp accessibility criteria.)
- A crosswalk served by a curb ramp must also have an existing curb ramp in place on the receiving end unless there is no curb or sidewalk on that end of the crosswalk (RCW 35.68.075). If there is no existing curb ramp in place on the receiving end, an accessible curb ramp must be provided. This requirement must be met regardless of whether the receiving end of the crosswalk is located within the project's limits.
- Within the construction impact zone of an alteration project, evaluate all existing curb ramps to determine whether curb ramp design elements meet the accessibility criteria. (See Section 1510.08(2) for curb ramp accessibility criteria.) Modify existing curb ramps that do not meet the accessibility criteria to meet applicable accessibility requirements to the maximum extent feasible. This may also trigger modification of other adjacent pedestrian facilities to incorporate transitional segments in order to ensure specific elements of a curb ramp will meet the accessibility criteria.
- Within the construction impact zone of an alteration project that includes hot mix asphalt overlay (or inlay) of an existing roadway and *does not* include reconstruction, realignment, or widening of the roadway, evaluate all existing marked and unmarked crosswalks. (See Section 1510.09(2) for crosswalk accessibility criteria.) If it is not possible to meet the applicable accessibility requirements for crosswalks, document this in the DDP.
- Within the construction impact zone of an alteration project that includes reconstruction, realignment, or widening of the roadway, evaluate all existing crosswalks (marked or unmarked) to determine whether crosswalk design elements meet the accessibility criteria. (See Section 1510.09(2) for crosswalk accessibility criteria.) Modify crosswalk slopes to meet the applicable accessibility requirements to the maximum extent feasible.

It may not always be possible to fully meet the applicable accessibility requirements during alterations of existing facilities.

If such a situation is encountered, consult with the Regional ADA Liaison to develop a workable solution to meet the accessibility requirements to the maximum extent feasible. Cost is not to be used as a justification for not meeting the accessibility criteria. Physical terrain or site conditions that would require structural impacts, environmental impacts, or unacceptable impacts to the community in order to achieve full compliance with the accessibility criteria are some of the factors that can be used to determine that the maximum extent feasible is achieved.

If it is determined to be virtually impossible to meet the accessibility criteria for an element, document the decision in one of the following ways, as applicable:

- Within the construction impact zone of an alteration project that does not include reconstruction, realignment, or widening of the roadway, document the following deficient elements in the DDP:
 - Perpendicular curb ramp or parallel curb ramp landing cross slope that is constrained by the existing roadway gutter profile and exceeds 2%, but is less than or equal to 5%, that cannot be constructed to fully meet applicable accessibility requirements.

- Flared side of a perpendicular curb ramp that is constrained by the existing roadway gutter profile and has a slope that exceeds 10%, but is less than or equal to 16.7%, that cannot be constructed to fully meet applicable accessibility requirements.
- For any deficient element that does not match the preceding description, document the decision via a stamped and signed Maximum Extent Feasible (MEF) document. The MEF document will be reviewed by the appropriate Assistant State Design Engineer (ASDE) and the Headquarters (HQ) ADA Compliance Manager. If acceptable, the MEF document will be approved and included in the DDP. See Exhibit 300-3 for the approvers of a Maximum Extent Feasible (MEF) document.

1510.03(2)(a) Requirements for Crossings with Pedestrian Pushbuttons

Coordinate sidewalk and curb ramp work with signal system work so that signal poles with pedestrian equipment meet accessibility requirements for APS pushbuttons to the maximum extent feasible. See Section [1510.11](#) for additional information on pedestrian pushbutton accessibility.

For existing signal systems only, the work required for each signal system location is determined as follows:

1. If no sidewalk ramp work is being performed at a signal system location, no work is required for that signal system as part of the project.
2. If any ramp is being reconstructed at a signal system location, and the traffic signal system is owned by WSDOT, then all poles with pedestrian equipment shall be made accessible for the entire traffic signal system at that location. This may require new or relocated poles, as well as additional ramp and sidewalk work beyond that previously described in Section [1510.03\(2\)](#).
3. If any ramp is being reconstructed at a signal system location, and the traffic signal system is owned by another agency, only poles with pedestrian pushbuttons serving a crossing served by a ramp that is being reconstructed are required to be made accessible as part of the project. This may require reconstruction of the ramps, landings, or sidewalk areas at both ends of the crossing. The remaining crossings and poles may be addressed if the owning agency wishes to provide funding for the additional work.

If APS pushbuttons are not being installed as part of a project, any revised pole locations shall be designed to meet accessibility requirements with a conventional pushbutton installed and with an APS pushbutton installed, so that the pole does not have to be relocated when the conventional pushbutton is replaced with an APS pushbutton. Typically, a location that is accessible with an APS pushbutton installed will be accessible with a conventional pushbutton installed, but verification is required.

Locations where these requirements cannot be fully met shall follow the procedures for maximum extent feasible documentation as previously described.

1510.04 Pedestrian Circulation Paths

Pedestrian Circulation Paths (PCP) are prepared exterior or interior ways of passage provided for pedestrian travel. They include independent walkways, sidewalks, shared-use paths, and other types of pedestrian facilities. Pedestrian circulation paths can either be immediately adjacent to streets and highways or separated from them by a buffer. PCPs that are continuous allow pedestrians to connect to destinations and do not require them to make multiple street crossings due to incomplete facilities. Examples of PCP are shown in [Exhibit 1510-5](#).

When the PCP is located behind guardrail, address protruding bolts. Installing a rub rail or a “W-beam” guardrail on the pedestrian side of the posts can mitigate potential snagging and also serve as a guide for sight-impaired pedestrians.

Provide a smooth finish to vertical surfaces adjacent to a PCP to mitigate potential snagging or abrasive injuries from accidental contact with the surface. Where adjacent walkway segments diverge, such as can occur if a parallel curb ramp does not occupy the entire width of a PCP, any resulting drop-offs must be protected to prevent trips or falls.

When relocation of utility poles and other fixtures is necessary for a project, determine the impact of their new location on all PCP. Look for opportunities to relocate obstructions, such as existing utility objects, away from the PCP.

Exhibit 1510-5 Pedestrian Circulation Paths



Highway shoulders are an extension of the roadway and are not typically considered pedestrian facilities. Pedestrians are allowed to use many state highways. Although pedestrians are allowed to travel along the shoulder in these cases, its main purpose is to provide an area for disabled vehicles, a recovery area for errant vehicles, and positive drainage away from the roadway.

Shoulders may serve as a pedestrian facility when sidewalks are not provided. If pedestrian generators, such as bus stops, are present and pedestrian usage is evident, a 4-foot-wide paved shoulder is adequate. Note that detectable warning surfaces should not be installed where a sidewalk ends and pedestrians are routed onto a shoulder since the shoulder is not a vehicular traveled way.

Where pedestrian traffic is evident, consider a separate PCP during the planning and programming of the project. Consult with the State Bicycle and Pedestrian Coordinator.

1510.04(1) Accessibility Criteria for Pedestrian Circulation Paths

The following criteria apply across the entire width of the PCP, not just within the pedestrian access route.

1510.04(1)(a) Vertical Clearance

- The minimum vertical clearance for objects that protrude into or overhang a pedestrian circulation path is 80 inches.
- If the minimum vertical clearance cannot be provided, railings or other barriers shall be provided. The leading bottom edge of the railing or barrier shall be located 27 inches maximum above the finished surface for cane detection.

Note: Per the [MUTCD](#), the vertical clearance to the bottom of signs is 7 feet (84 inches.)

1510.04(1)(b) Horizontal Encroachment

- Protruding objects on PCPs shall not reduce the clear width of the pedestrian access route to less than 4 feet, exclusive of the curb.

Note: If an object must protrude farther than 4 inches into a PCP at a height that is greater than 27 inches and less than 80 inches above the finished surface, then it must be equipped with a warning device that is detectable by a vision-impaired person who navigates with a cane. The minimum clear width of the PAR must still be provided.

1510.04(1)(c) Post-Mounted Objects

- Objects mounted on posts, at a height that is greater than 27 inches and less than 80 inches above the finished surface, shall not protrude more than 4 inches into a pedestrian circulation path.

Note: If an object must protrude farther than 4 inches into a pedestrian circulation path at a height that is greater than 27 inches and less than 80 inches above the finished surface, then it must be equipped with a warning device that is detectable by a vision-impaired person who navigates with a cane. The minimum clear width of the pedestrian access route must still be provided.

- Where a sign or other obstruction on a pedestrian circulation path is mounted on multiple posts, and the clear distance between the posts is greater than 12 inches, the lowest edge of the sign or obstruction shall be either 27 inches maximum or 80 inches minimum above the finished surface.

1510.05 Pedestrian Access Routes

All PCPs are required to contain a continuous Pedestrian Access Route (PAR) (see [Exhibit 1510-6](#)) that connects to all adjacent pedestrian facilities, elements, and spaces that are required to be accessible. PARs consist of one or more of the following pedestrian facilities: walkways/sidewalks, crosswalks, curb ramps (excluding flares), landings, pedestrian overpasses/underpasses, access ramps, elevators, and platform lifts.

Exhibit 1510-6 Relationship Between Pedestrian Circulation Paths and Pedestrian Access Routes

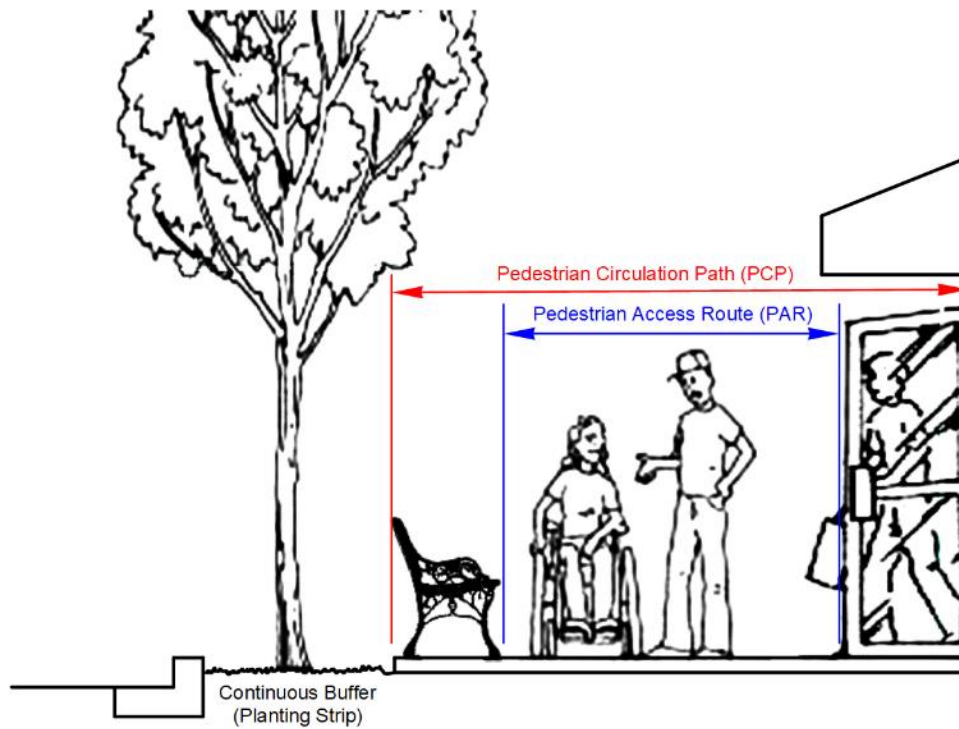

With Continuous Buffer

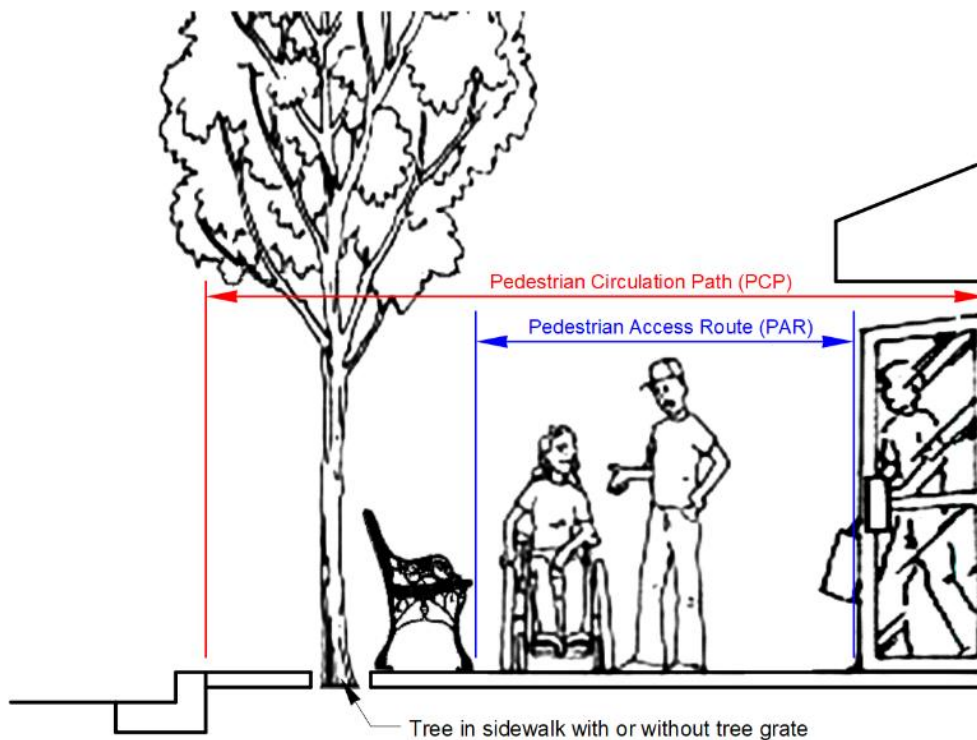

Without Continuous Buffer

1510.05(1) Accessibility Criteria for Pedestrian Access Routes

1510.05(1)(a) Clear Width

The minimum continuous and unobstructed clear width of a Pedestrian Access Route (PAR) within a Pedestrian Circulation Path (PCP) shall be 4 feet, exclusive of the width of the curb. PARs that are less than 5 feet in clear width, exclusive of the width of the curb, shall provide passing spaces at intervals no farther apart than 200 feet. Passing spaces shall be at least 5 feet wide, for a minimum distance of 5 feet.

Exhibit 1510-7 Obstructed Pedestrian Access Route



Provide wheel stops or a wider sidewalk to address encroachments into the PAR.

1510.05(1)(b) Cross Slope and Grade

The cross slope of a PAR shall be 2% maximum.

Note: It is recommended that cross slopes be designed to be less than the allowed maximum to allow for some tolerance in construction. For example: design for a maximum 1.5% cross slope (rather than 2% maximum).

Exceptions:

1. Midblock crosswalks – The cross slope of the crosswalk and any connected curb ramp is permitted to match street or highway grade.
2. Crosswalks without stop sign control – The cross slope of the crosswalk can be up to 5% maximum.

Where a PAR is contained within the highway right of way, its grade shall not exceed the general grade established for the adjacent roadway.

Exception: The maximum grade in a crosswalk (marked or unmarked) is 5%, measured parallel to the direction of pedestrian travel in the crosswalk.

Where a PAR is not contained within the highway right of way, the maximum running slope allowed is 5% unless designed as an access ramp. (See Section [1510.15\(2\)](#) for access ramp accessibility criteria.)

For additional criteria when a PAR is supported by a structure, see Section [1510.14](#).

1510.05(1)(c) Surface

The surface of the PAR shall be firm, stable, and slip resistant. Use hard surfaces like cement concrete or asphalt concrete. Crushed gravel and other non-pavement surfaces are not considered a firm or stable surface.

Vertical alignment shall be planar within curb ramps, landings, and gutter areas within the PAR and within clear spaces for accessible pedestrian signals, street furniture, and operable parts.

Grade breaks shall be flush.

Surface discontinuities (see Exhibit 1510-8 and Exhibit 1510-9) on existing surfaces in the pedestrian access route (such as at the joints of settled or upheaved sidewalk panels) may not exceed 1/2 inch maximum. Vertical discontinuities between 1/4 inch and 1/2 inch maximum shall be beveled at 2H:1V or flatter. Apply the bevel across the entire level change.

Exception: No surface discontinuity is allowed at the connection between an existing curb ramp or landing and the gutter. This grade break must be flush.

Exhibit 1510-8 Beveling Options

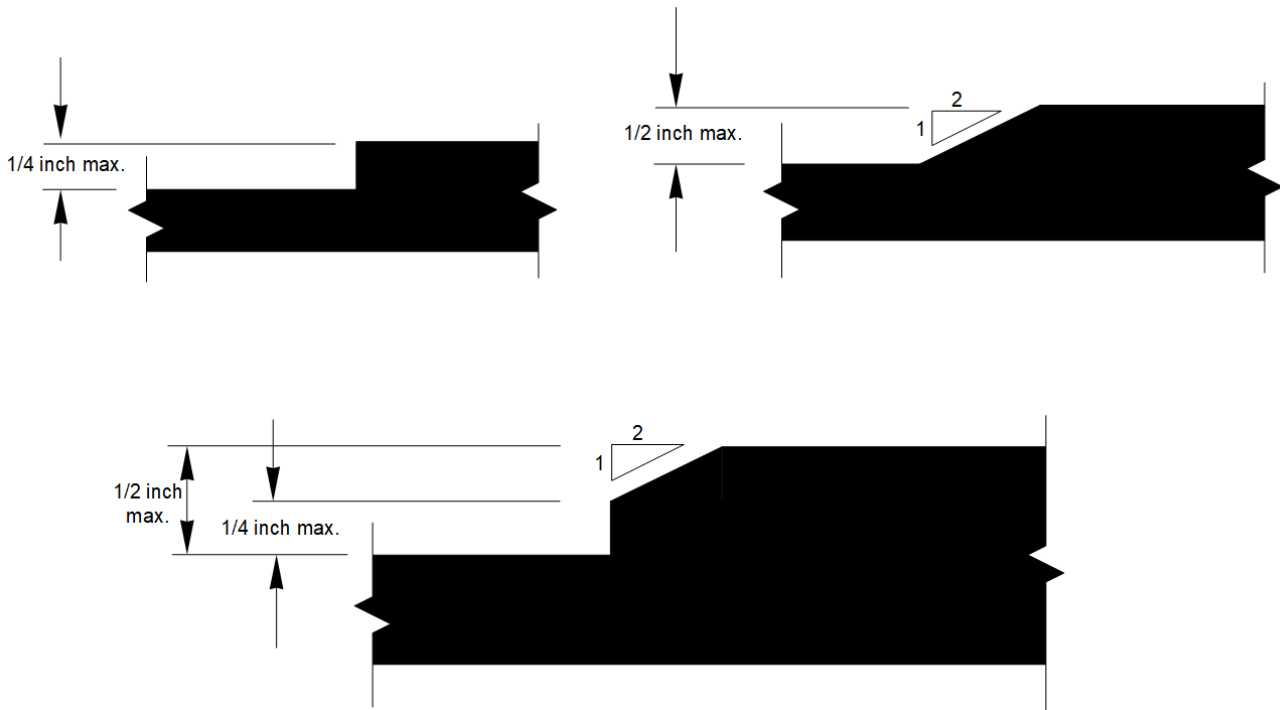

Exhibit 1510-9 Surface Discontinuities (Noncompliant)

Gratings, access covers, utility objects, and other appurtenances shall not be located on curb ramps, landings, or gutters within the PAR.

Locate gratings, access covers, utility objects, and other appurtenances outside the PAR on walkways and sidewalks. Where this is not possible, ensure covers, grates, and lids are designed to be slip resistant and are installed flush with the surrounding surface (see the [Standard Plans](#)).

1510.05(1)(d) Horizontal Openings

Any sidewalk joints or gratings that are in the PAR shall not permit passage of a sphere more than ½ inch in diameter.

Elongated openings shall be placed so that the long dimension is perpendicular to the dominant direction of travel.

Openings for wheel flanges at pedestrian crossings of nonfreight rail track shall be 2½ inches maximum (3 inches maximum for freight rail track).

For additional requirements when a PAR crosses a railroad, see Section [1510.13](#).

1510.06 Linear Pedestrian Facilities (New Section 2023)

Pedestrian facilities refer to constructed features built to accommodate pedestrian travel that run generally along the same direction as the vehicle route or street. They typically serve as the Pedestrian Circulation Path (See Section [1510.04](#) for PCP accessibility criteria). Sidewalks, at-grade walkways with biofiltration swale, and shared-use paths are three standard types of linear pedestrian facilities. Shared-use paths may have “trail” in their names, but they are not trails. Trails, (Exp. the Pacific Crest Trail), are intended to provide and support recreational experiences and do not provide the necessary infrastructure for ADA accessibility. Parts of trails might be accessible, but trails don't need to be accessible. Trails do not usually have a firm, stable, or slip resistant surfaces, nor do they usually have accessible cross slopes, or running slopes. See Section [1710.05\(17\)](#) Trails. Shoulders may provide pedestrian access, but because of the nature of the shared use with vehicles, they are not considered dedicated pedestrian facilities.

Pedestrian facilities (sidewalks and shared-use paths) are selected to provide the required level of traffic stress as well as connections to a network of facilities in order to access travel destinations. In addition to PLTS, vehicle speed, volume, and number of travel lanes are also indicators that, in combination with input from subject matter experts, help inform the selection of facility type. The following table provides a summary of these factors and likely candidates for facilities to consider in consultation with the project advisory committee and subject matter experts.

1510.07 Sidewalks (Section Rewritten 2023)

A sidewalk is an independent constructed facility along a highway, road, or street intended for use by pedestrians, which is usually elevated above the vehicle travelled way, and may or may not include a buffer. Sidewalks are one type of Pedestrian Circulation Path (PCP). (See Section 1510.04 for PCP accessibility criteria.) Plan the design of sidewalks carefully to include a PAR that provides universal access. (See Section 1510.05 for PAR accessibility criteria.) Sidewalk design elements are found in Exhibit 1510-12 and details for raised sidewalks are shown in the *Standard Plans*. Wherever appropriate, make sidewalks continuous and provide access to side streets. TA buffer is a space between the edge of the edge of pavement or back of curb and sidewalk that separates vehicle and pedestrian traffic and may be used to reduce the Pedestrian Level of Traffic Stress (PLTS) of the facility. Buffers often contain plantings, alternative type pavement, drainage treatments, and/or utilities.

1510.07(1) Designing Sidewalks and Buffers

When designing sidewalks, first determine the required sidewalk and buffer widths to achieve the required level of pedestrian level of traffic stress (PLTS) (see Section 1510.02(5)).

Plan the design of sidewalks to include a Pedestrian Circulation Path (PCP) (see Section 1510.05) and a Pedestrian Access Route (see Section 1510.05) enabling universal access. (See Section 1510.05 for PAR accessibility criteria.) Sidewalk design elements are found in Exhibit 1510-12 and details for raised sidewalks are shown in *Standard Plans*.

Exhibit 1510-10 Suggested Sidewalk and Buffer Widths* (New Exhibit 2023)

Land Use	Urban Core	10 ft sidewalk + 2 ft offset + parking OR 10 ft sidewalk + 4 ft buffer	10 ft sidewalk + 2 ft offset + parking OR 10 ft sidewalk + 6 ft buffer				
	Urban	8 ft sidewalk + 2 ft buffer + parking OR 8 ft sidewalk + 4 ft buffer	8 ft sidewalk + 6 ft buffer				
	Suburban	6 ft sidewalk + 2 ft offset + parking OR 6 ft sidewalk + 4 ft buffer	6 ft sidewalk + 6 ft buffer				
Vehicle posted speed (mph)		≤15	20	25	30	35	≥40

* If the dimensions shown exceed the dimensions given by the PLTS tables, then use the values in the PLTS table as the minimum allowable dimensions.

The WSDOT minimum sidewalk width is 5 feet (excluding the curb), but providing wider sidewalks is encouraged. Wider sidewalks are desirable on major arterials, in central business districts, and along parks, schools, and other major pedestrian generators. See Exhibit 1510-2.

When sidewalks abut storefronts, provide additional width to accommodate window-shoppers and to avoid conflicts with opening doors and pedestrians entering or leaving the buildings.

When a buffer (vegetated as well as alternate pavement) is provided, the buffer should be at least 3 feet wide (excluding the curb). Document the decision to reduce a buffer width to less than 3 feet in the DDP. If trees or shrubs are included in a buffer, coordinate with the region or HQ Landscape Architect. Follow Design Clear Zone (see [Chapter 1600](#)) and Sight Distance (see [Chapter 1260](#)). Design subsurface infrastructure (such as structural soils) and select plants whose root systems do not cause sidewalks to buckle or heave. Coordinate buffer planting with maintenance personnel.

Where possible, strive to accommodate snow storage while keeping the pedestrian route free of snow accumulation. Make sure maintenance access is not obstructed. Shoulders, bike lanes, and on-street parking are not considered buffers, but they do offer the advantage of further separation between vehicles and pedestrians.

Exhibit 1510-11 Sidewalks with Buffers

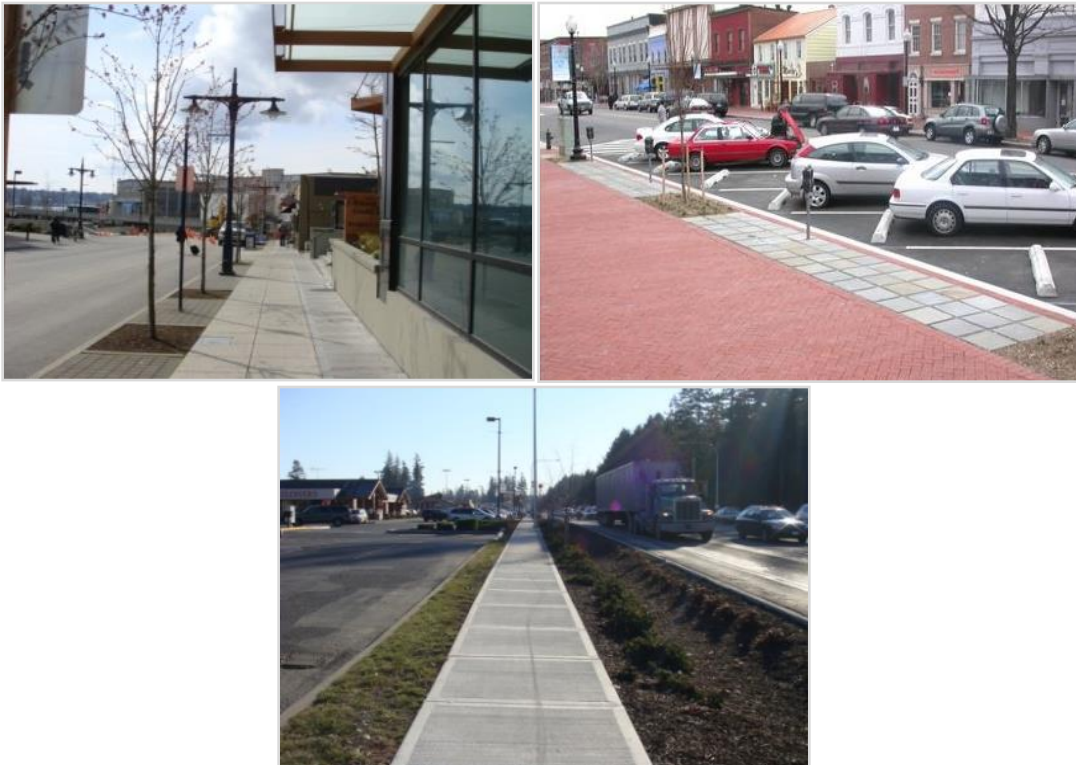
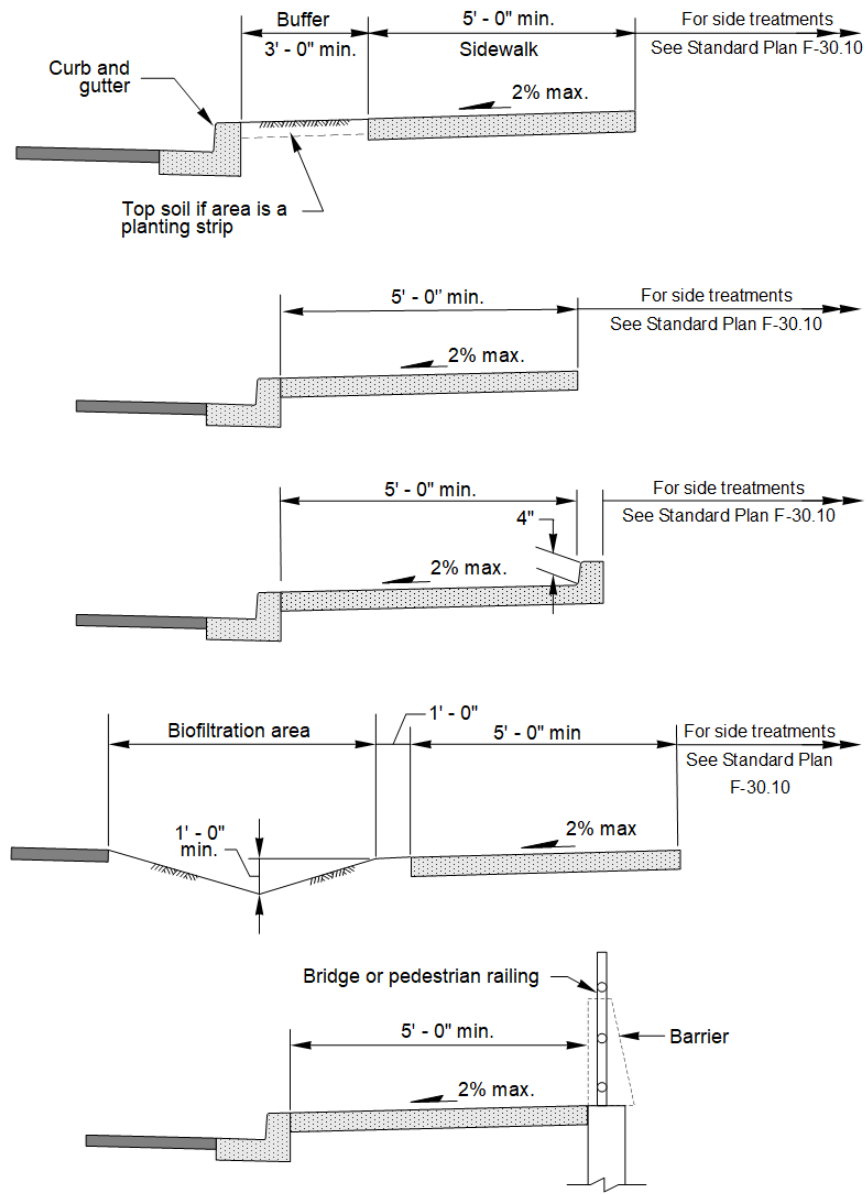

Exhibit 1510-12 Typical Sidewalk Designs



Notes:

If vertical drop is within the Design Clear Zone and the posted speed is > 35 mph, then barrier may be needed (see [Chapter 1600](#)).

If vertical drop is > 2 feet 6 inches and barrier is not needed, then railing is indicated.

If vertical drop is < 2 feet 6 inches and barrier is not needed, then a 4-inch curb at back of sidewalk is adequate.

General:

See the [Standard Plan F-30.10](#) for details on slopes at back of sidewalk.

See [Section 1239.03](#) for selecting side slopes.

Sidewalks may be sloped away from the roadway for stormwater treatment (see the [Highway Runoff Manual](#)).

1510.07(2) Sidewalks at Driveways

Provide a Pedestrian Access Route (PAR) where driveways intersect a Pedestrian Circulation Path (PCP) (see [Exhibit 1510-13](#)). The Standard Plan F-80.10 shows details of driveway designs that provide a PAR. (See Section [1510.04](#) and Section [1510.05](#) for accessibility criteria.) When a driveway is signalized as part of an intersection, contact the Region ADA Liaison for guidance.

Exhibit 1510-13 Typical Driveways

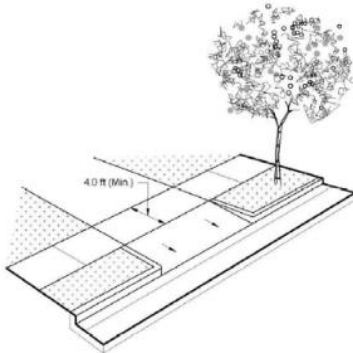

There are several types of driveway approach designs such as: drop curb (left picture), using a buffer (center picture), and a radius turnout (right picture).

Exhibit 1510-14 Driveway Approach Designs (New Exhibit 2023)

Sidewalks behind the buffer zone are the preferred design. This places the driveway's grade transition within a buffer so the sidewalk path can remain free of grade changes along its course.

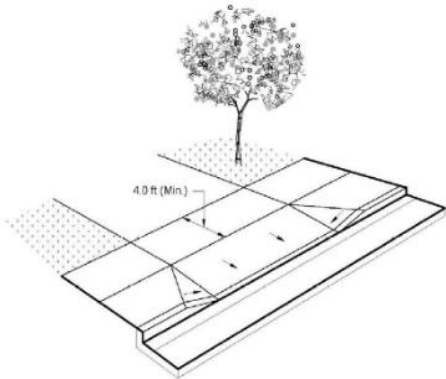

Wide sidewalks can function similar to sidewalks with buffers if they have sufficient room to accommodate a driveway ramp and also allow a full PAR width.

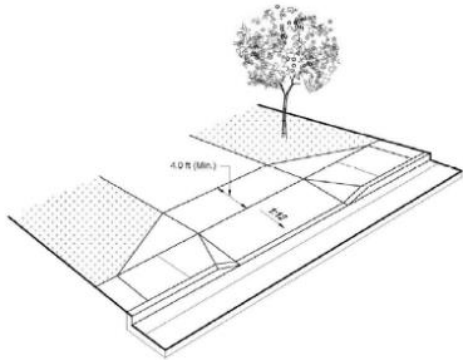

Where buffers or wide sidewalks can't be provided, the sidewalk alignment can go around the sloped part of the driveway to maintain the running slope and the cross slope, although the deviation from the straight path is less convenient for pedestrians. Verify that the widths of the diagonal parts are at least as wide as the sidewalk.

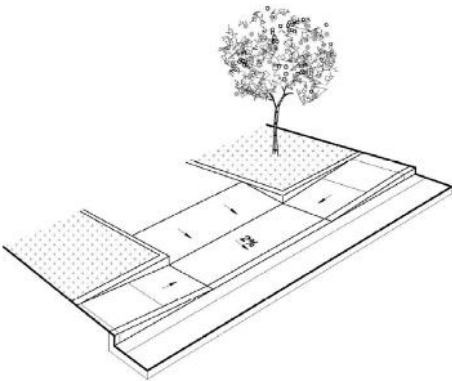

Depressed sidewalks are the least desirable option as the pedestrian needs walk down and then back up. This design may be necessary in some locations due to local ordinances, or right-of-way or grade constraints.

1510.07(2)(a) Radius Turnout Driveways (New Section 2023)

Driveways serving larger developments and commercial centers frequently function more like roadway intersections in terms of volume and complexity of turning movements. The curbs often turn in to the adjacent parcel at these locations similar to roadway intersections. Sidewalks intersecting radius turnout driveways must either provide a raised crosswalk (preferred) or descend to the level of the driveway via a curb ramp (See Section 1510.04 and Section 1510.05 for accessibility criteria). When a driveway is signalized as part of an intersection, contact the Region ADA Liaison for guidance.

The characteristics of a radius turnout driveway may increase the PLTS of the PAR at that location, even if the PLTS along the rest of the route is low. Consult with the project advisory team to determine if an intersection crossing treatment (e.g., RRFBs, protection islands, etc.) may be used to maintain a low PLTS at these locations.

1510.07(3) Shared-Use Paths (New Section 2023)

A shared-use path is a pedestrian facility designed for both transportation and recreation purposes and are used by pedestrians, bicyclists, skaters, equestrians, and other users. See Chapter 1515 for more information about designing shared-use paths.

1510.07(4) Shoulders (New Section 2023)

Highway shoulders are not pedestrian facilities; they are an extension of the roadway cross section with several functions (see exhibit 1239-2). Shoulders are not usually considered accessible due to typical cross slopes and profile grades; however, pedestrians can use shoulders where they're not explicitly restricted.

1510.08 Curb Ramps

Curb ramps provide an accessible connection from a raised sidewalk down to the roadway surface. A curb ramp, or combination of curb ramps, is required to connect PAR to crosswalks (marked or unmarked) where curbs and sidewalks are present, except where pedestrian crossing is prohibited. (See Section 1510.09(2)(c) for guidance on closed crossings and Exhibit 1510-24 for an example.)

For new construction projects, provide a curb ramp oriented in each direction of pedestrian travel within the width of the crosswalk it serves. For alteration projects, a curb ramp oriented in each direction of pedestrian travel within the width of the crosswalk it serves is desirable.

Every curb ramp must have a curb ramp at the other end of the crosswalk it serves unless there is no curb or sidewalk on that side (RCW 35.68.075).

Curb ramps are also required at midblock crossings where curbs and sidewalks are present.

1510.08(1) Types of Curb Ramps

Different types of curb ramps can be used: perpendicular, parallel, and combination. Carefully analyze and take into consideration drainage patterns, especially when designing a parallel or combination curb ramp installation.

1510.08(1)(a) Perpendicular Curb Ramp

Perpendicular curb ramps (see [Exhibit 1510-15](#) and [Exhibit 1510-16](#)) are aligned to cut through the curb and meet the gutter grade break at a right angle. The landing is to be located at the top of the curb ramp.

1510.08(1)(a)(i) Advantages

- Having the path of travel aligned to cross the gutter grade break at a right angle facilitates usage by individuals with mobility devices.
- The height of the ramp run relative to the gutter elevation may facilitate drainage.
- The height of the ramp run relative to the gutter elevation discourages vehicular traffic from cutting across the corner.
- On small-radius corners, the ramp alignment may be more closely aligned with the alignment of the crosswalk markings, which facilitates direction finding for the visually impaired.

1510.08(1)(a)(ii) Disadvantages

- The ramp run and landing might not fit within available right of way.
- On small-radius corners, the flares may not fit between closely spaced perpendicular curb ramps.
- On larger-radius corners, there will be less facilitation of direction finding for the visually impaired due to the requirement that the path of travel cross the gutter grade break at a right angle.

Exhibit 1510-15 Perpendicular Curb Ramp

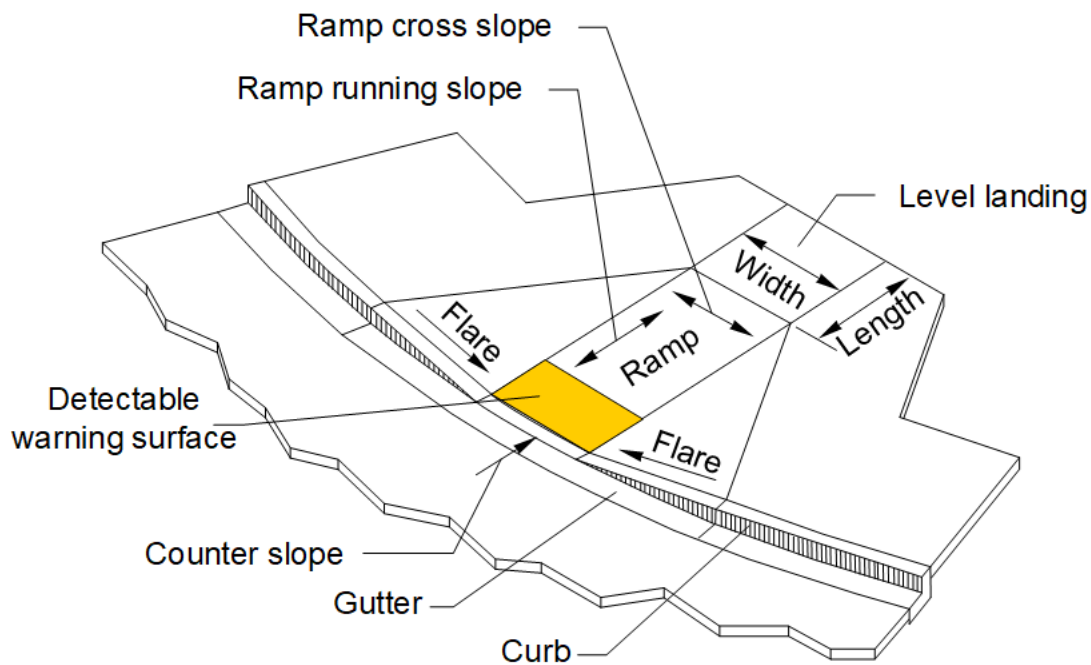

Exhibit 1510-16 Perpendicular Curb Ramp Common Elements

**1510.08(1)(b) Parallel Curb Ramp**

Parallel curb ramps (see [Exhibit 1510-17](#) and [Exhibit 1510-18](#)) are aligned with their running slope in line with the direction of sidewalk travel, parallel to the curb. The landing is located at the bottom of the curb ramp.

1510.08(1)(b)(i) Advantages

- Requires minimal right of way.
- Allows ramps to be extended to reduce ramp grade within available right of way.
- Provides edges on the side of the ramp that are detectable to vision-impaired pedestrians who navigate with a cane.

1510.08(1)(b)(ii) Disadvantages

- Depending on the style of parallel curb ramp, pedestrian through traffic on the sidewalk may need to negotiate two ramp grades instead of one, possibly making it more difficult to traverse for some.
- The installation of additional drainage features in the upstream gutter line may be necessary to prevent the accumulation of water or debris in the landing at the bottom of the ramp.

Exhibit 1510-17 Parallel Curb Ramp



Exhibit 1510-18 Parallel Curb Ramp Common Elements

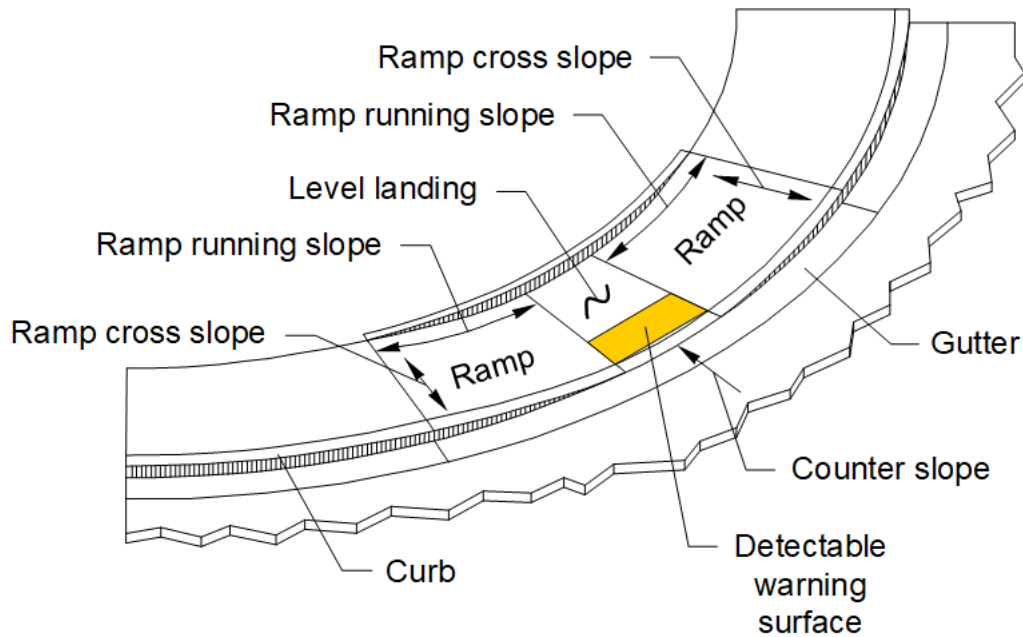

Note: The pedestrian curb shown on the back of the curb ramp is intended to retain material in a cut section and is not required if there is no material to retain due to the nature of the roadside topography.

1510.08(1)(c) Combination Curb Ramp

Combination curb ramps (see [Exhibit 1510-19](#)) combine the use of perpendicular and parallel types of curb ramps. Landings may be shared by multiple ramps in this application. Buffer areas and pedestrian curbing that define the pedestrian path of travel are inherent design elements for this type of curb ramp.

1510.08(1)(c)(i) Advantages

- Allows the elevation difference between the sidewalk and the gutter line to be transitioned with multiple ramps. This can help achieve compliant ramp running slopes.
- Provides additional locations in the gutter line along the radius where drainage structures can be placed outside the pedestrian access route due to the well-defined pedestrian paths of travel.
- Can be constructed within available right of way when the right of way boundary is located at the back of the existing sidewalk, provided sufficient buffer width is available on the roadway side of the sidewalk.
- Provides a way to avoid the relocation of existing features such as utility poles, fire hydrants, and signal poles by incorporating those features into the buffer areas.
- The pedestrian curbing that defines the buffer areas and forms the curb returns for the perpendicular ramp connections facilitates direction finding for a vision-impaired person who navigates with a cane.

1510.08(1)(c)(ii) Disadvantages

- Has a higher construction cost than other curb ramp types due to extensive use of curbing and a larger footprint.
- Due to generally flatter ramp grades and multi-tiered ramp elements, inadequate drainage and accumulation of debris can occur.

Exhibit 1510-19 Combination Curb Ramps



1510.08(2) Accessibility Criteria for Curb Ramps

The accessibility criteria for PCPs and PARs described in Section 1510.04 and Section 1510.05 also apply to curb ramps, except where superseded by the following additional accessibility criteria specifically for curb ramps.

1510.08(2)(a) Clear Width

The clear width of curb ramps and their landings shall be 4 feet minimum, excluding flares.

1510.08(2)(b) Running Slope

The running slope of curb ramps shall not exceed 8.3% maximum.

Note: It is recommended that running slopes be designed to be less than the allowed maximum to allow for some tolerance in construction. For example, design for a maximum 7.5% curb ramp running slope (rather than the 8.3% maximum).

The running slope of a perpendicular curb ramp shall intersect the gutter grade break at a right angle at the back of curb.

If the maximum running slope of 8.3% cannot be achieved due to existing physical constraints, the ramp shall be as flat as possible, but the ramp length is not required to exceed 15 feet.

1510.08(2)(c) Cross Slope

The cross slope of curb ramp shall not be greater than 2%, measured perpendicular to the direction of travel.

Note: It is recommended that cross slopes be designed to be less than the allowed maximum to allow for some tolerance in construction. For example, design for a maximum 1.5% cross slope (rather than the 2% maximum).

Exception: The cross slopes of curb ramps at midblock crossings are permitted to match the street or highway grade.

1510.08(2)(d) Landing

A level landing is required either at the top of a perpendicular ramp or the bottom of a parallel curb ramp, as noted in Section 1510.08(1)(a) and Section 1510.08(1)(b) for the type of curb ramp used.

Provide a landing that is at least 4 feet minimum length by 4 feet minimum width.

The running and cross slopes of a curb ramp landing shall be 2% maximum.

Note: It is recommended that cross slopes be designed to be less than the allowed maximum to allow for some tolerance in construction. For example, design for a maximum 1.5% cross slope (rather than 2% maximum).

Exception: The running and cross slopes of landings for curb ramps at midblock crossings are permitted to match the street or highway grade.

1510.08(2)(e) Flares

Flared sides are to be used only where a PCP crosses the curb ramp from the side.

Flared sides are to have a slope of 10% maximum, measured parallel to the back of curb.

1510.08(2)(f) Counter Slope

The counter slope of the gutter or street at the foot of a curb ramp or landing shall be 5% maximum.

1510.08(2)(g) Detectable Warning Surfaces

Detectable warning surfaces are required where curb ramps or landings connect to a roadway. (See the [Standard Plans](#) for placement details and other applications.) They are also required where commercial driveways are provided with yield or stop control.

Detectable warning surfaces shall contrast visually (either light-on-dark or dark-on-light) with the adjacent walkway surface, gutter, street, or highway.

Note: Federal yellow is the color used to achieve visual contrast on WSDOT projects. Within cities, other contrasting colors may be used if requested by the city.

1510.08(2)(h) Surfaces

Surfaces of curb ramps shall be firm, stable, and slip resistant.

Gratings, access covers, utility objects, and other appurtenances shall not be located on curb ramps, landings, or gutters within the pedestrian access route.

1510.08(2)(i) Grade Breaks

Vertical alignment shall be planar within curb ramp runs, landings, and gutter areas within the PAR.

Grade breaks at the top and bottom of curb ramps shall be perpendicular to the direction of travel on the ramp run.

Surface slopes that meet at grade breaks shall be flush.

1510.08(2)(j) Clear Space

Beyond the curb face where the bottom of a curb ramp or landing meets the gutter, a clear space of 4 feet minimum by 4 feet minimum shall be provided in the roadway that is contained within the width of the crosswalk and located wholly outside the parallel vehicle travel lane.

Note: Clear space is easily achieved when a separate curb ramp is provided, oriented in each direction of pedestrian travel within the width of the crosswalk it serves.

1510.08(3) Curb Ramp Drainage

Surface water runoff from the roadway can flood the lower end of a curb ramp. Provide catch basins or inlets to prevent ponding at the base of curb ramps and landings. [Exhibit 1510-20](#) shows examples of drainage structure locations. Verify that drainage structures will not be located in the PAR.

Exhibit 1510-20 Typical Curb Ramp Drainage

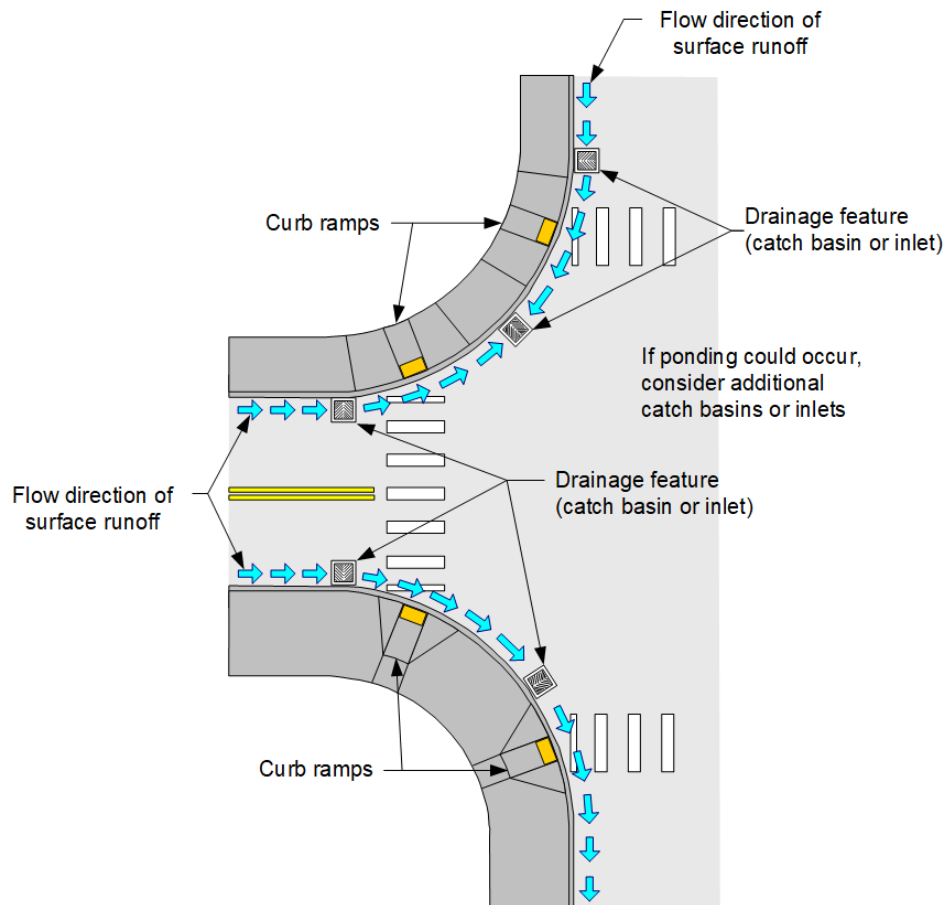
**1510.09 Pedestrian Crossings****1510.09(1) Designing Crossing Facilities**

Evaluate the following for crossing facilities to address the needs of all user modes:

- Minimize turning radii to keep speeds low. (See [Section 1510.09\(5\)\(a\)](#) for mountable truck apron and [Chapter 1300](#) for design vehicle guidance.)
- Place crosswalks so they are visible and connect to the adjacent pedestrian facilities.
- Provide sight distance (driver to pedestrian; pedestrian to driver).
- Use a separate left-turn phase along with a "WALK/DON'T WALK" signal.
- Restrict or prohibit turns.
- Shorten crossing distance.
- Use a raised median/cut-through island for a pedestrian refuge.
- Use accessible pedestrian signals (APS).
- Use signing and delineation as determined by the Region Traffic Engineer.
- Place crosswalks as close as practicable to the intersection traveled way.
- Provide pedestrian-level lighting.
- Provide crosswalks in the direct path of travel to transit stops.
- Provide a PAR that meets the accessibility criteria at all pedestrian crossings.

1510.09(2) Crosswalks at Intersections

Provide a PAR within marked and unmarked pedestrian crossings. (See Section 1510.05 for accessibility criteria for PAR.)

Crosswalks are provided on all legs of an intersection, except in rare cases. There are normally three crosswalks at a “T” intersection and four crosswalks at a “four-leg” intersection. For pedestrian route continuity, the minimum number of crosswalks is two at “T” intersections and three at “four-leg” intersections. One example where crosswalks might not be provided on all interaction legs is a diamond interchange with heavy left-turn movements from the off-ramp approach. (See Section 1510.09(2)(c) for Closed Crossings policy.)

The *Traffic Manual* provides recommendations for determining pedestrian markings based on lane configuration, vehicular traffic volume, and speed. However, coordinate with the Region Traffic Engineer early on with any existing or proposed crosswalks. The Region Traffic Engineer makes the final determination on appropriate signing and delineation.

1510.09(2)(a) Unmarked Crossings

Legal crosswalks exist at all intersections, whether marked or not, regardless of the number of legs at the intersection of lack of prepared crossing treatments. An unmarked crosswalk (see Exhibit 1510-21) is the portion of the roadway behind a prolongation of the curb or edge of the through traffic lane and a prolongation of the farthest sidewalk connection or, in the event there are no sidewalks, between the edge of the through traffic lane and a line 10 feet from there (RCW 46.04.160).

Exhibit 1510-21 Unmarked Crosswalks

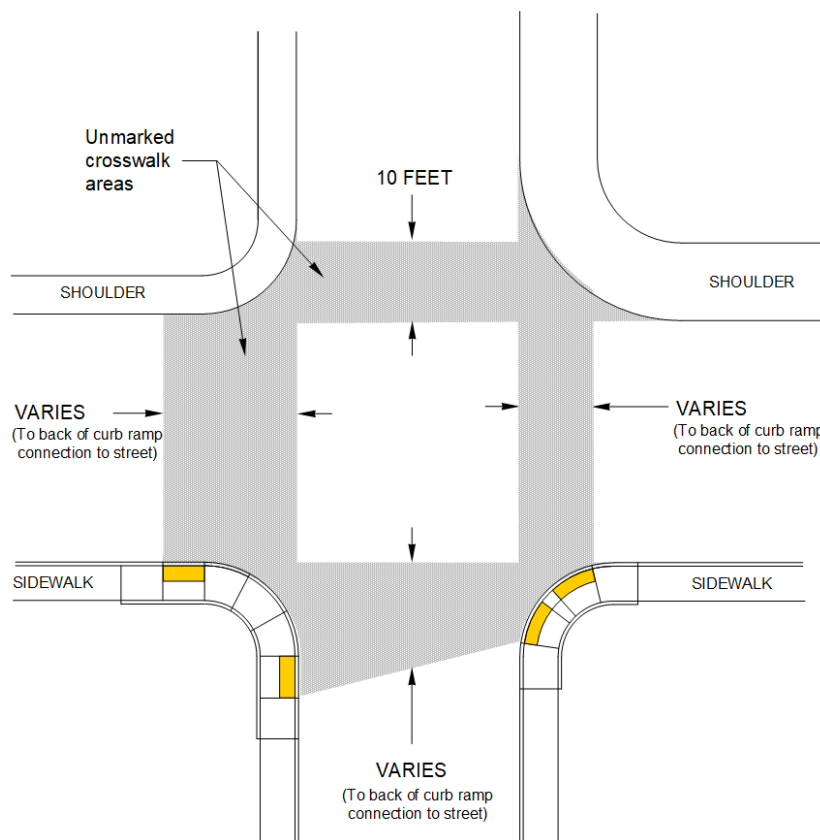

1510.09(2)(b) Marked Crossings

Marked crosswalks are used at intersections or midblock crossing and are provided at all signalized intersections except where pedestrians are prohibited, or the crossing is closed (see Section 1510.09(2)(c)). Marked Crossings should not be used indiscriminately but considered based on a thorough evaluation of site conditions.

Maintenance agreements and RCW 47.24.020 provide jurisdictional authority for decisions to mark crosswalks based on a population threshold of 30,000 and should be consulted prior to a decision to mark a crosswalk. Consult the Region Transportation Operations Office for “best practices” for marking crosswalks. The MUTCD, the AASHTO Guide for the Planning, Design, and Operation of Pedestrian Facilities, and the NACTO Urban Street Design Guide are all good resources to use when evaluating locations for marked crosswalks.

Standard marked crosswalks are at least as wide as the walkway leading to the crossing or 10 feet wide, whichever is greater. The preferred type of marked crosswalk is a longitudinal pattern known as a Ladder Bar, which is shown in the Standard Plans and Exhibit 1510-22. Stop and yield line dimensions and placement must conform to the MUTCD and are shown in the Standard Plans.

Some decorative crosswalk materials (such as colored pavement or bricks) may cause confusion for visually impaired pedestrians and can create discomfort for wheelchair users. Supplement decorative crosswalks with pavement markings to enhance visibility and delineate the crosswalk. Refer to the MUTCD and the Local Agency Crosswalk Options website: www.wsdot.wa.gov/design/standards/plansheet/pm-2.htm

A marked crosswalk may be provided at unsignalized or uncontrolled intersections with public streets or highways, or at private drives with a high volume of vehicle traffic during significant hours of the day.

Consult with the Region Transportation Operations Office for “best practices” for marking crosswalks.

Exhibit 1510-22 Marked Pedestrian Crossing

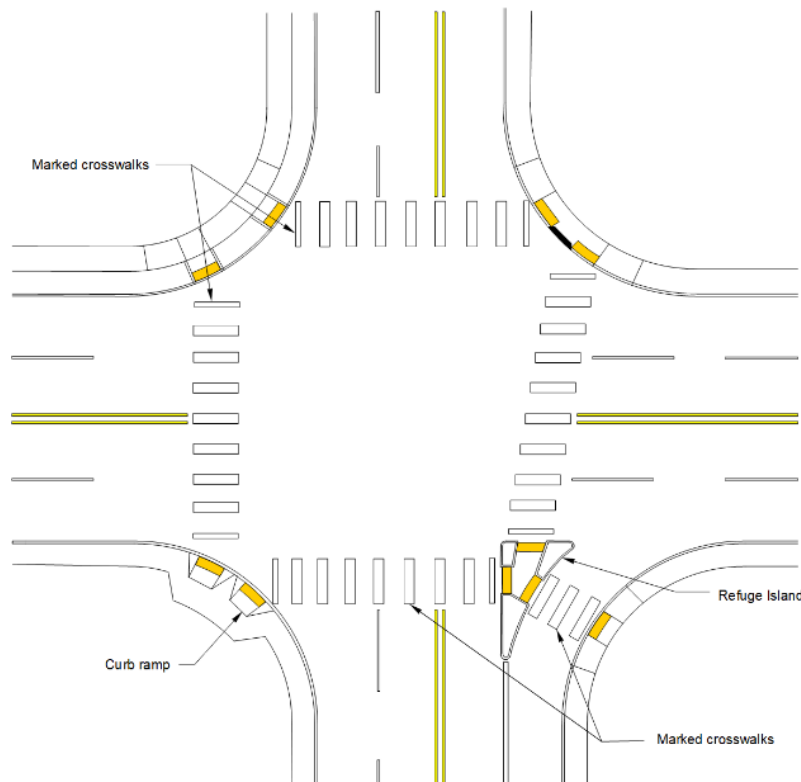

1510.09(2)(c) Closed Crossings (Rewritten 2023)

Choosing to close a crossing is a last resort and must remain infrequent. Formally closed crossings apply to all non-motorized users. The decision to close a crossing requires approval of the WSDOT Region Traffic Engineer with concurrence from the HQ ADA compliance manager and is documented in the DDP using the Pedestrian Crossing Memorandum with a copy sent to the Headquarters' ADA Data Steward (ADASTeward@WSDOT.WA.GOV). WSDOT must also ensure that affected communities are informed of any substantial impact or changes to pedestrian access resulting from a closure.

Exhibit 1510-23 Essential Signal Operations at a Location That Does Not Support the Pedestrian Crossing (New Exhibit 2023)

- Signalized ramp terminal intersection
- No land use, origins, destinations, or transit stops that support a pedestrian crossing
- Marked and signal-controlled crosswalks within approximately 70 ft of the legal crossings



1510.09(3) Midblock Crosswalks

On roadways with pedestrian crossing traffic caused by nearby pedestrian generators, a midblock crossing may be appropriate. (See Section 1510.09(2) for crosswalk criteria and the *Traffic Manual* for marked crosswalk recommendations at unsignalized intersections.) The approval authority is the Region Traffic Engineer.

Engineering judgment of conditions that might increase the value of a midblock crossing includes the following:

- High pedestrian crossing volume present with long block spacing.
- Evidence of pedestrian-vehicular midblock conflicts (site observations, law enforcement reporting, and City Traffic Engineers).
- Proposed crossing with a realistic opportunity to channel multiple pedestrian crossings to a single location.
- Sight lines that enable sufficient eye contact between motorists and pedestrians.
- Community commitment for a successful outcome.
- Ability to mitigate risks associated with the location using proven countermeasures such as, but not limited to, refuge islands, rectangular rapid flashing beacons, and/or pedestrian hybrid beacons.
- Modal interchange points where high volumes crossing pedestrians occur (e.g., transit stop to apartment complex).

To meet the accessibility criteria, the PAR in the crosswalk may have a cross slope that matches the grade of the roadway. An example of a midblock crossing is shown in [Exhibit 1510-24](#). (See [Chapter 530](#) for further information on pedestrian access and paths on limited access facilities.)

Exhibit 1510-24 Midblock Pedestrian Crossing



1510.09(3)(a) Raised Crosswalks (New Section 2023)

Raised crosswalks are a specialized traffic calming device and pedestrian crossing. The vertical deflection slows down motorists, increases conspicuity of crossing pedestrians, and allows pedestrians to cross the street at sidewalk level. Typical installations are mid-block crossings, roundabouts, and right-turn slip lanes that lead to a pedestrian island. Raised crosswalk use at intersections is permitted so long as the entrance and exit ramps do not encroach on crossing traffic. Placement should be considered based on the criteria for Marked Crossings (see [Section 1510.09\(2\)\(b\)](#)) in addition to the following roadway characteristics:

- Low traffic volumes (< 9,000 AADT)
- Speed limits no greater than 35 mph
- Minimal use by heavy or long wheelbase vehicles (less than 5%)

Raised Crosswalks are not allowed in the following locations:

- Streets with more than three lanes
- Truck or primary emergency vehicle routes without coordination with local emergency services and stakeholders
- Proximity to bus stops, as the vertical deflection may be unnerving to riders that have just boarded the bus and have yet to find a seat

Design

- Existing guidelines for marked crossings, including accessibility criteria, should be followed (see Section [1510.09\(2\)\(b\)](#) - Marked Crossings).
- The width of the tabletop must be a minimum 10 feet with detectable warning surfaces on both ends.
- The entrance and exit ramp length must be a minimum of 6 feet or 4% to 8.3% slope (whichever is longer) with a parabolic cross section.

Exhibit 1510-25 Raised Crosswalk Cross-Section

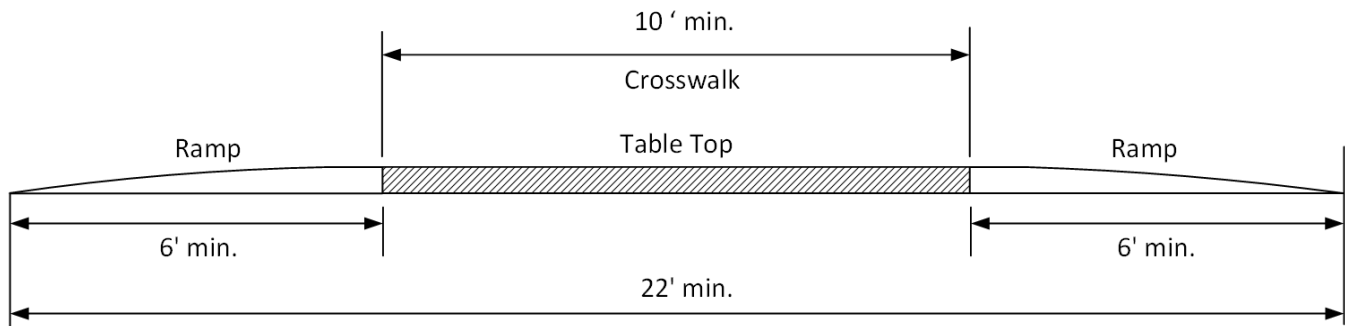

- For streets with existing curb and sidewalk:
 - The height should match the sidewalk so pedestrians can cross at a constant grade.
 - If on-street parking is present, include a curb extension to make waiting pedestrians and the raised crosswalk itself more visible (see Section [1510.09\(5\)](#) – Curb Extensions).
- For streets without existing curb and sidewalk:
 - The height should be 3-4 inches.
 - Ramps meeting the accessibility criteria must be installed on both ends of the tabletop.
 - Flexible delineators should be considered to prevent vehicles from swerving into the shoulder to avoid the speed table.
- Signage and pavement markings should follow Section [1510.09\(2\)\(b\)](#) – Marked Crossings and MUTCD guidelines, specifically Section 3b.26 – Speed Hump Markings.

Other Considerations

- Changes in drainage the raised crosswalk will cause should be accommodated. Additional drainage structures such as inlets or catch basins may be required.
- Consider heavy snowplow routes and work with local maintenance to determine how to best mitigate the change in grade.
- No alteration in design for bicycle lanes should be required, as bicyclists can typically navigate raised crosswalks without disruption.
- Avoid textured or decorative surfaces for the tabletop, as a smooth surface is preferable for ADA compliance.
- Raised crosswalks may increase traffic noise.

1510.09(4) Sight Distance at Crosswalks

Whenever an intersection crossing (marked or unmarked) or a midblock crossing is improved, provide stopping sight distance for the vehicles for pedestrians. Shrubbbery, signs, parked cars, and other roadside elements can block motorists' and pedestrians' views of each other. Exhibit 1520-18 illustrates these sight distance concerns. See Section 1260.03(1)(a) for design stopping sight distance.

Consider the need for advanced cueing strategies (e.g., flashing beacons) where sight lines are limited.

Exhibit 1510-26 Obstructed Line of Sight at Intersection

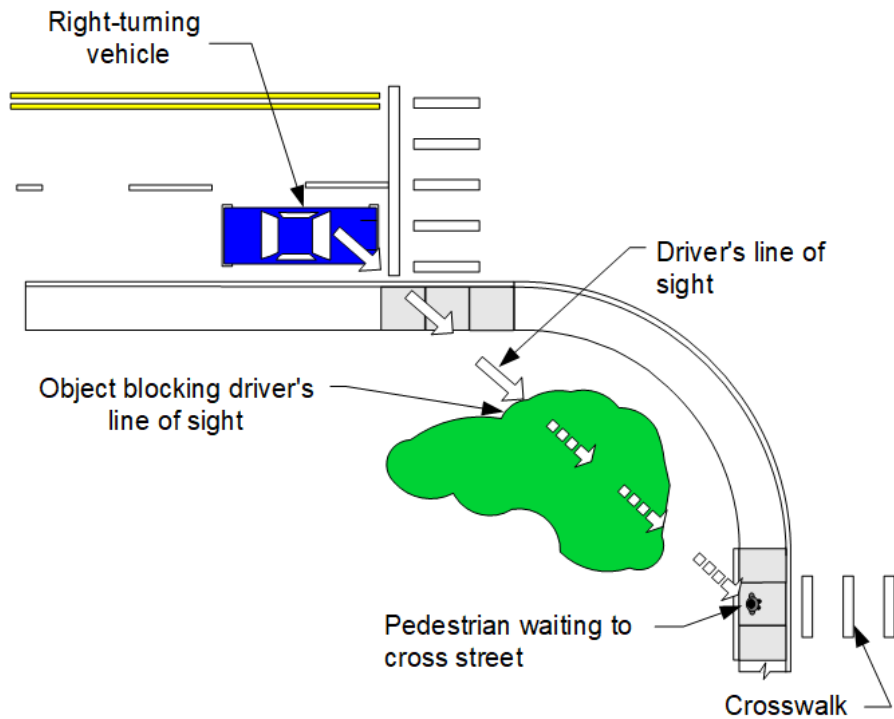
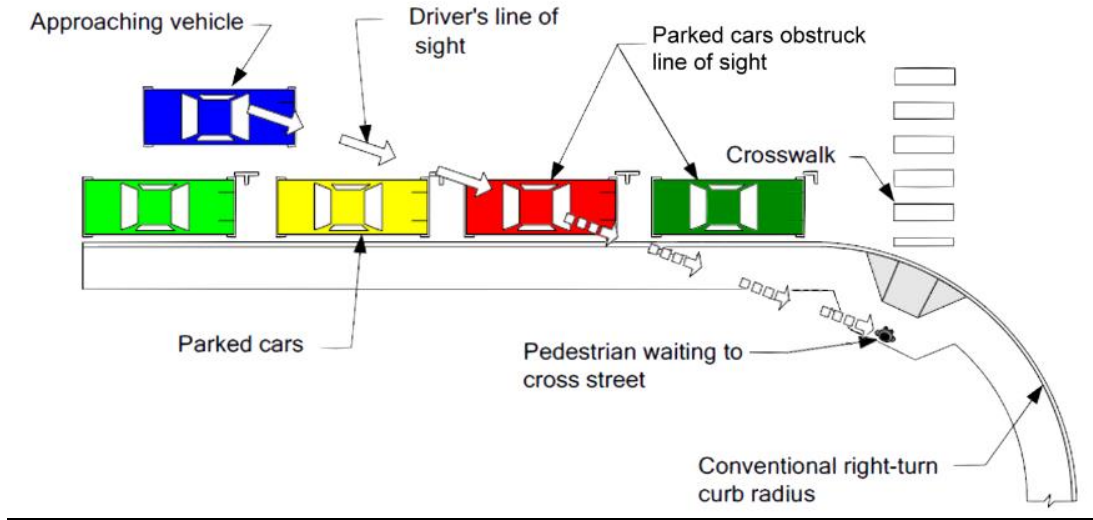

1510.09(5) Curb Extensions

Curb extensions are traffic calming measures that may improve sight distance and reduce pedestrian crossing times, which limits pedestrian exposure. Installing a curb extension can help reduce the sight distance problem with parked cars that limit driver/pedestrian visibility. Curb extensions may allow for better curb ramp design as well as provide more space for pedestrians. *Note:* Curb extensions are not an option on streets with posted speeds of ≥ 40 mph or without on-street parking because drivers would be confronted with sudden changes in roadway width. Extend the curb no farther than the width of the parking lane. (See [Chapter 1230](#), and [Chapter 1520](#) for shoulder/bike lane width guidance.)

Design the approach nose to ensure adequate setback of vehicles to provide visibility of pedestrians. At intersections with traffic signals, the curb extensions can be used to reduce pedestrian signal timing. Examples of sidewalk curb extensions are shown in [Exhibit 1510-19](#) and [Exhibit 1510-20](#).

Exhibit 1510-27 Improved Line of Sight at Intersection

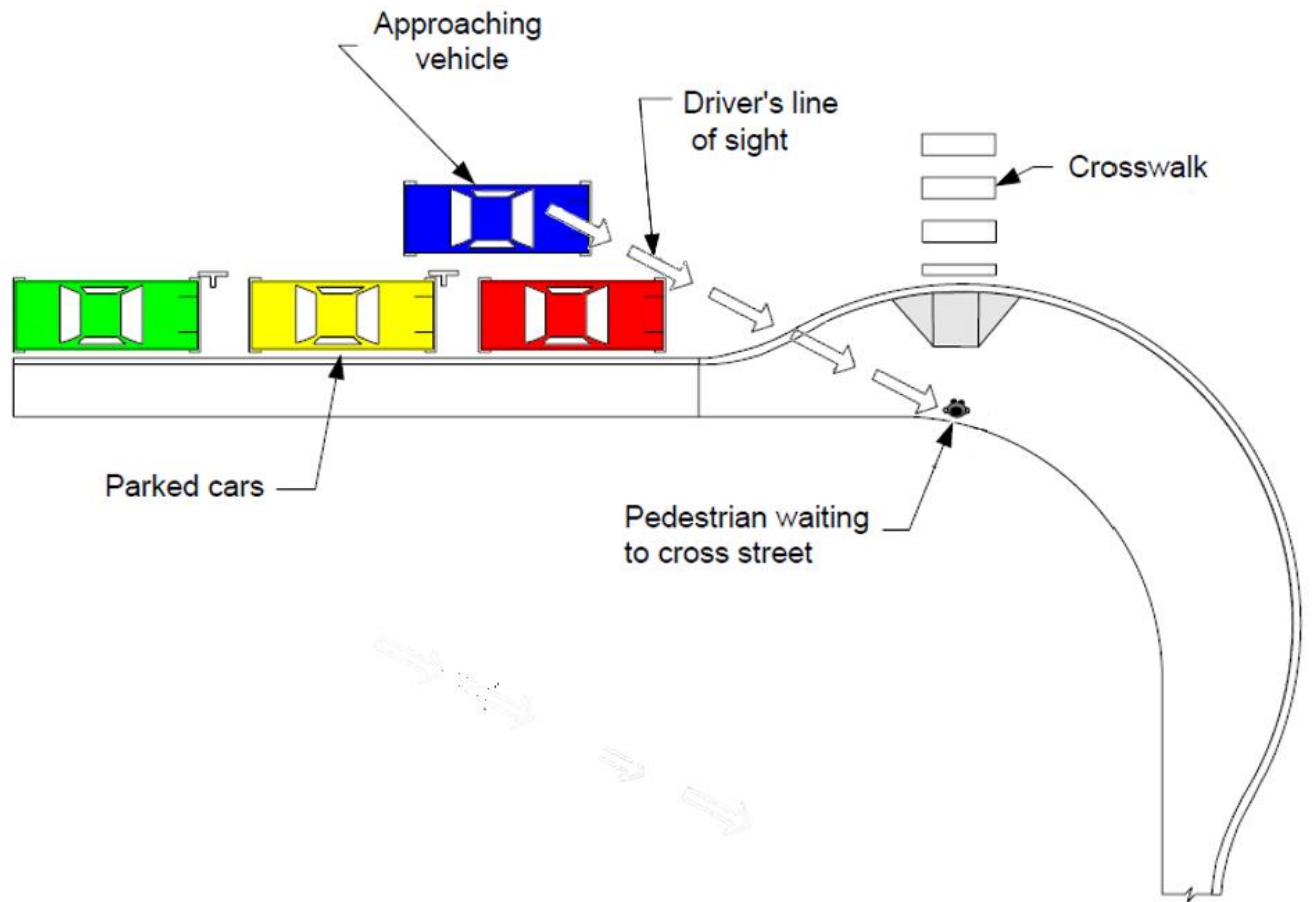

Exhibit 1510-28 Curb Extension Examples



The right-turn path of the design vehicle is a critical element in determining the size and shape of the curb extension. Sidewalk curb extensions tend to restrict the width of the roadway and can make right turns difficult for large trucks. Ensure the geometry of the curb extension is compatible with the turn path for the design vehicle selected.

Avoid interrupting bicycle traffic with curb extensions.

Do not use curb extensions on state highways when:

- The design vehicle (see [Chapter 1300](#)) encroaches on curbs or opposing lanes, and other solutions will not improve the circumstances.
- On-street parking is not provided/allowed.
- The posted speed is above 35 mph.

Site features such as landscaping, cabinets, poles, benches, planters, bollards, newspaper stands, and sandwich boards should be selected and placed so they do not obstruct the vision of pedestrians or drivers within curb extension areas, as shown in [Exhibit 1510-20](#). Take into account motorist and pedestrian visibility and Design Clear Zone guidelines (see [Chapter 1600](#)).

1510.09(5)(a) Mountable Truck Apron (New Section 2023)

Minimizing curb radius is a design tool for reducing turning vehicle speeds, which provides advantages and improved comfort for bicyclists and pedestrians. However, minimizing the curb return radius may result in the rear wheels of large (accommodated) vehicle tracking over the curb and encroaching on space where pedestrians and bicyclists may be queuing to cross. These encroachments can also damage curb and sidewalk structure. Provide a mountable truck apron that define the edge of the accommodated vehicle wheel path, while continuing to encourage reduced speed for the design vehicle (often a passenger car) (see [Exhibit 1510-33](#)).

Design bicycle stop bars, detectable warning surfaces, traffic signal equipment, and other intersection features so that they are behind the mountable surface area. Provide a visually distinct surface for the apron as compared to the surface of the adjacent travel lane, sidewalk, and bike facility. Slope the apron from flush to the vehicle lane to 3 inches high at the curb.

Exhibit 1510-29 Mountable Truck Apron Design Elements (New Exhibit 2023)

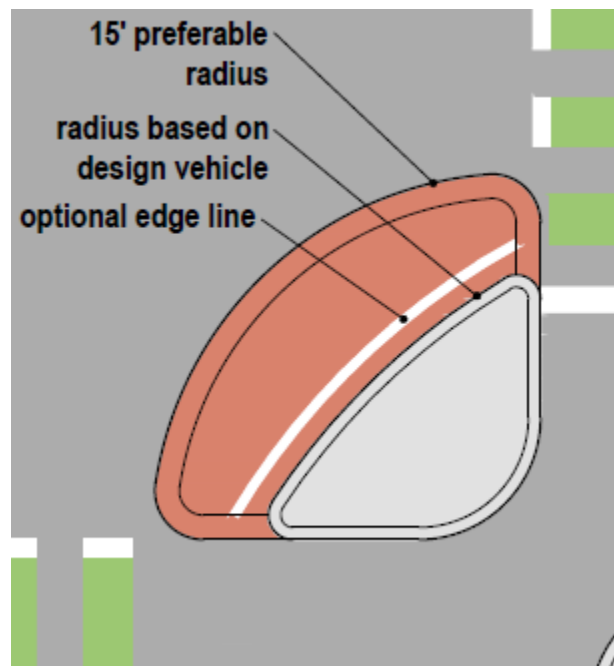

1510.10 Raised Medians/Traffic Islands

Wide multilane streets are often difficult for pedestrians to cross, particularly when there are insufficient gaps in vehicular traffic because of heavy volumes. Consider raised medians and traffic islands with a pedestrian refuge area (see [Exhibit 1510-30](#)) on roadways with the following conditions:

- Two-way arterial with speeds of greater than 35 mph,
- Moderate to high average daily traffic (ADT),
- High pedestrian volumes.
- Significant pedestrian crash history.
- Near a school or other community center.
- Crossing distance exceeds 30 feet.
- Complex or irregularly shaped intersections.

A traffic island used for channelized right-turn slip lanes can provide a pedestrian refuge, but the slip lanes may promote faster turning speeds. Where feasible, eliminate slip lanes. If the slip lane cannot be eliminated, minimize the turning radius of the slip lane to keep speeds as low as feasible. Also, to keep speeds low, consider ending the slip lane as a yield condition instead of a merge condition. Always keep the slip lane as narrow as practicable and design a crosswalk alignment that is at a right angle to the face of curb. (See [Chapter 1310](#) for turn lanes, [Chapter 1360](#) for interchange ramps, and [Chapter 1320](#) for pedestrian accommodations in roundabouts.)

The PAR through a raised median or traffic island can be either raised with curb ramps or a cut-through type (see [Exhibit 1510-30](#)). Curb ramps in medians and islands can add difficulty to the crossing for some users. The curbed edges of cut-throughs can be useful cues to the visually impaired in determining the direction of a crossing, especially on an angled route through a median or island.

1510.10(1) Accessibility Criteria for Raised Medians and Traffic Islands

There are many design considerations when deciding whether to ramp up to the median or island grade or create a cut-through median or island matching the roadway grade. These considerations may include the profile grade and cross slope of the road, drainage patterns, and the length or width of the median or island.

The following accessibility criteria apply:

- Each raised median or traffic island shall contain a PAR connecting to each crosswalk (see Section [1510.05](#)).
- A passing space shall be provided that is at least 5 feet wide for a distance of at least 5 feet for each PAR in a raised median or on a traffic island (see [Exhibit 1510-30](#)).

Note: It is recommended that cut-throughs be designed to have a minimum width of 5 feet to ensure a passing space is provided.

- Medians and pedestrian refuge islands shall be 6 feet minimum in length in the direction of pedestrian travel.
- Detectable warning surfaces are to be separated by 2 feet minimum length in the direction of pedestrian travel.
- Detectable warning surfaces are located at each curb ramp or roadway entrance of a PAR through a raised median or traffic island. The detectable warning surface shall be located at the back of the curb (see [Exhibit 1510-30](#)).
- PARs of shared-use paths that go through raised medians or traffic islands shall be the same width as the shared-use path (see [Chapter 1515](#)).

Exhibit 1510-30 Raised Islands with Curb Ramps and Pedestrian Cut-Throughs



Island Cut-Through

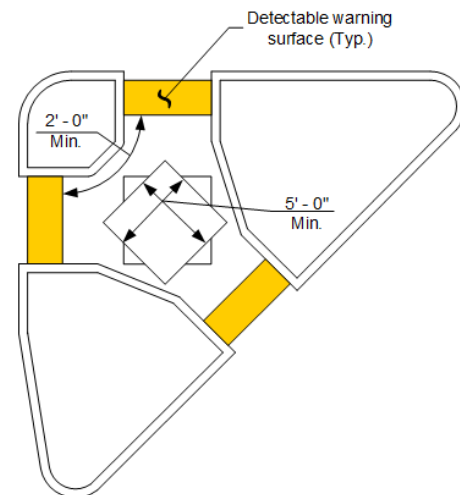

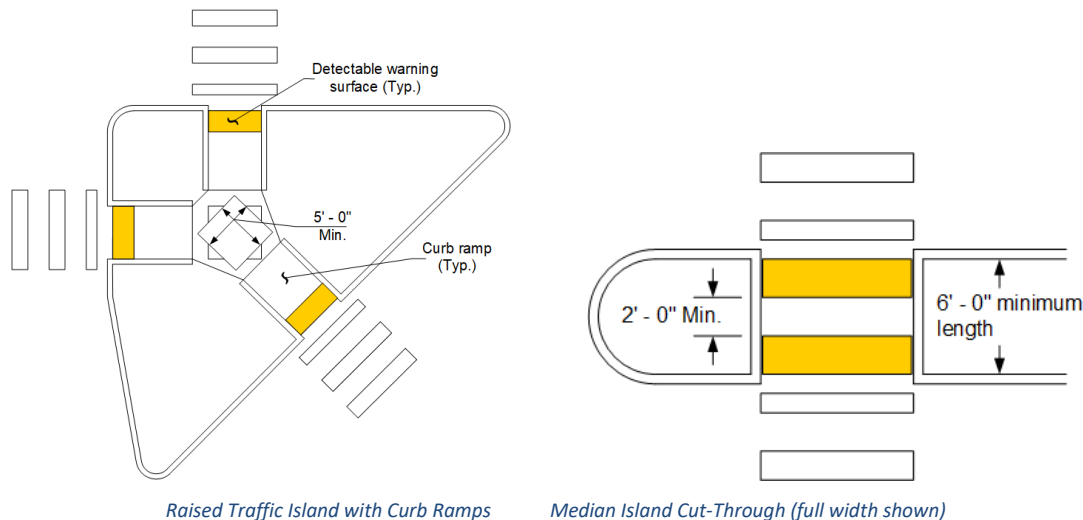

(See Section [1510.10\(1\)](#) for minimum accessibility criteria.)

See the *Standard Plans* for details.

1510.11 Intersection Design (New Section 2023)

Provide accommodation for pedestrian movement at and through intersections on facilities where pedestrians are allowed. Design elements to evaluate include pedestrian crossings (Section [1510.09](#)), curb ramps (Section [1510.10](#)), pedestrian signals and pushbuttons (Section [1510.11](#)), curb extensions (Section [1510.09\(3\)\(a\)](#)), and raised medians and traffic islands (Section [1510.09](#)). See Section [1310.03](#) for design examples, additional design elements beyond those listed in this chapter, the appropriate configurations and dimensions of those elements, and criteria for determining suitable designs for a given intersection location.

1510.11(1) Protected Intersections (New Section 2023)

Protected intersections are part of Pedestrian Circulation Paths (PCPs) where a set of treatment countermeasures are provided that improve a crossing for pedestrians and bicyclists.

These include:

- Advance stop bars,
- Corner protection islands, and
- Specialized signal phasing.

The combination of features reduces vehicle turning speeds, increases pedestrian conspicuity at the crossings, and decreases pedestrian exposure by reducing the crossing distances. See Section [1310.03\(2\)](#).

1510.11(2) Roundabouts (New Section 2023)

Roundabouts can incorporate designs (such as marked crossings through splitter islands) that are effectively part of the Pedestrian Circulation Path (PCP). The features of a roundabout that reduce vehicle speeds, increase pedestrian conspicuity, and decrease pedestrian exposure can improve the Pedestrian Level of Traffic Stress (PLTS) for pedestrians. Single-lane roundabouts are preferred when optimizing a crossing for pedestrians as there are fewer conflict points for vehicles, bicyclists, and pedestrians. Some roundabouts will require additional crossing enhancements such as Rectangular Rapid Flash Beacons (RRFBs) in order to achieve the threshold refined Pedestrian Level of Traffic Stress (PLTS).

For roundabouts that do not incorporate a PCP, but where pedestrians may legally use the roadway and crossing, the design must include an obvious pedestrian path, like a break in a painted splitter island. See [Chapter 1320](#) for roundabout design.

1510.11(3) Interchanges (New Section 2023)

There are many different configurations of interchanges, but all of them require pedestrians to cross ramp terminal intersections where they meet with cross streets. Using roundabouts for ramp terminal intersections can achieve a low Pedestrian Level of Traffic Stress (PLTS) by reducing vehicle speeds, increasing pedestrian conspicuity, and reducing crossing distances.

In general, the PLTS of a ramp terminal crossing can be improved for pedestrians by considering the following treatments:

- Configuration (reduce/remove skews and slip lanes)
- Turn radius (reduce)
- Control (use stop control versus signalization)
- Speed (reduce local/crossroad speed)
- Lanes (reduce local/crossroad lane number)
- Volume (reduce local/crossroad volumes)
- Crossing Features (implement a suite of active transportation crossing features)

Consult with subject matter experts for appropriate application of these treatments.

1510.12 Pedestrian Pushbuttons

Pedestrian pushbuttons are an operating control with their own accessibility requirements. All pedestrian pushbuttons, regardless of the type of system they are part of, require a level clear space located so that users of all types can reach the button to actuate the associated system.

1510.12(1) Accessibility Criteria for All Pedestrian Pushbuttons (including APS)

1510.12(1)(a) Location Requirements

See Section [1330.04\(4\)](#) for pushbutton location requirements. These location requirements limit the potential locations for the pedestrian pushbutton clear space.

1510.12(1)(b) Clear Space Requirements

- Grade: 2% maximum running and cross slopes.
- Clear space dimensions:
 - a. Standard: 48 inches in width by 60 inches in length, with the pushbutton located along one of the long sides of the clear space.
 - b. Minimum: 48 inches minimum width by 48 inches minimum length. Although the ADA minimum required clear space for an operational control is 30 inches by 48 inches, the narrow dimension is increased to 48 inches to allow for maneuvering, similar to a curb ramp landing (see [Exhibit 1510-31](#)). If the clear space is constrained on three sides, such that the clear space is set back 15 inches or more from the PAR, then the clear space shall be 48 inches minimum width by 60 inches minimum length, to allow for maneuvering within the constrained space. (See [Exhibit 1510-31](#)).
- Additional unobstructed or traversable space of 12 inches on either end of the clear space should be provided if possible, to allow for protruding equipment such as foot rests to extend beyond the clear space. This helps mobility assistance device users get their shoulder line closer to the pushbutton (see [Exhibit 1510-31](#)).
- Clear space is allowed to overlap other PAR elements (i.e., sidewalk/curb ramp landing) ([Exhibit 1510-32](#) and [Exhibit 1510-33](#)).
- Clear space must be connected to the crosswalk served by the pedestrian pushbutton with a PAR.

Exhibit 1510-31 Clear Space for Pedestrian Pushbutton

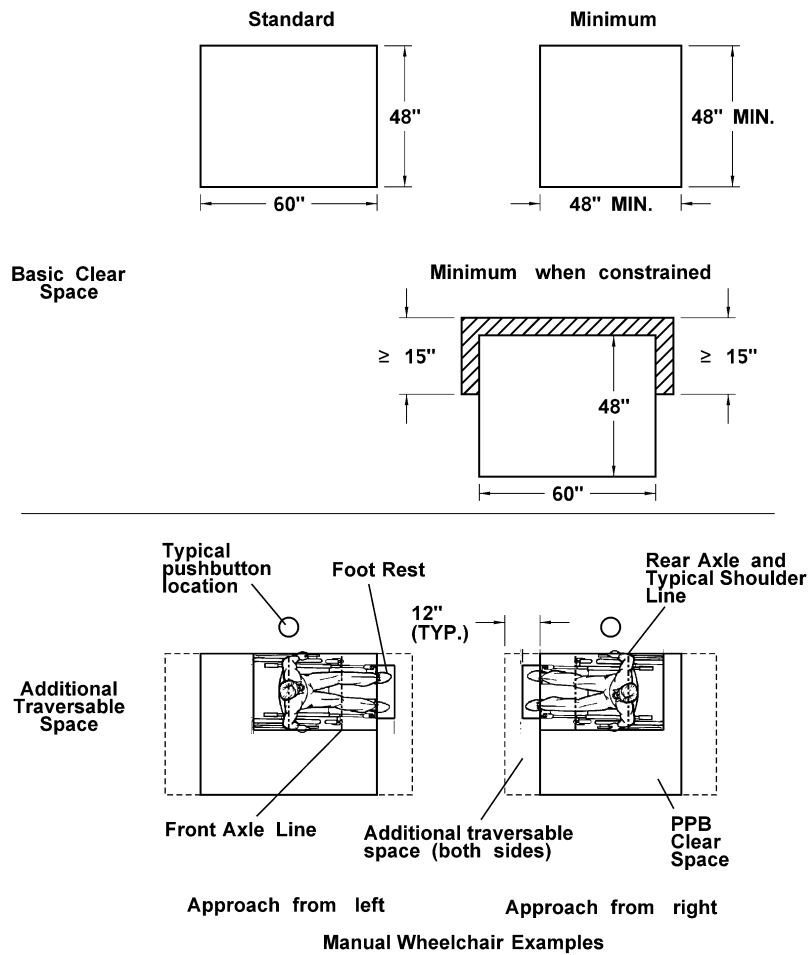
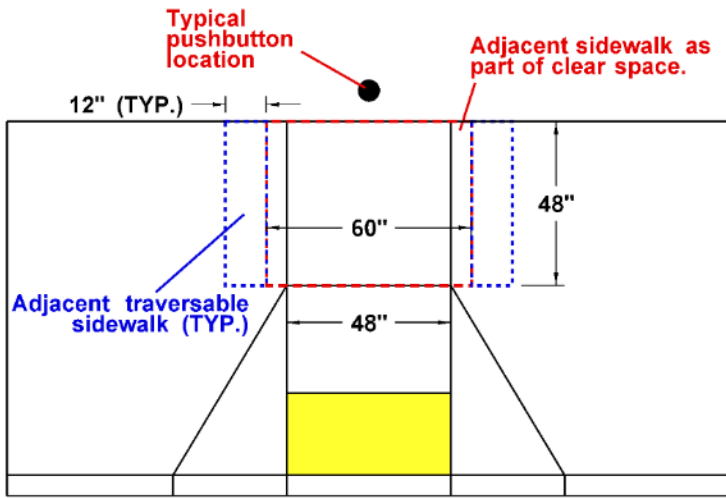

Exhibit 1510-32 Perpendicular Ramp Concurrent Clear Space Examples

Perpendicular Ramp Option:
Use Adjacent Level Sidewalk
(Not to scale)



Crosswalk Marking



Crosswalk Direction

Perpendicular Ramp Option:
Widen Ramp and Landing
(Not to scale)

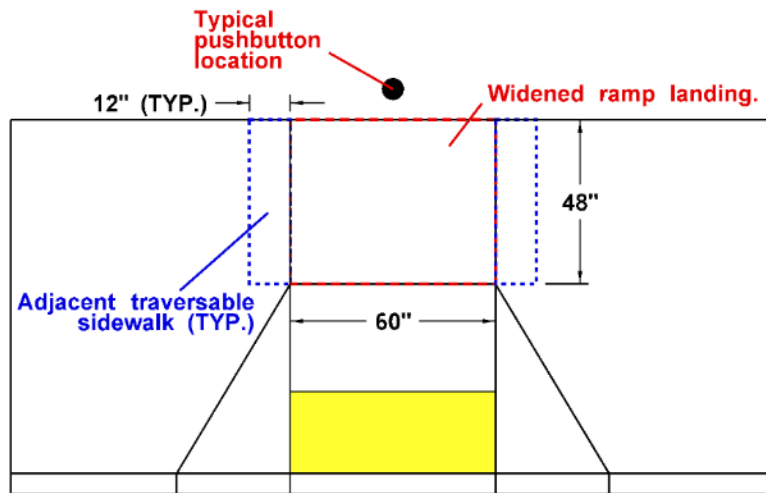

Crosswalk Marking



Crosswalk Direction

Exhibit 1510-33 Parallel Ramp Concurrent Clear Space Examples

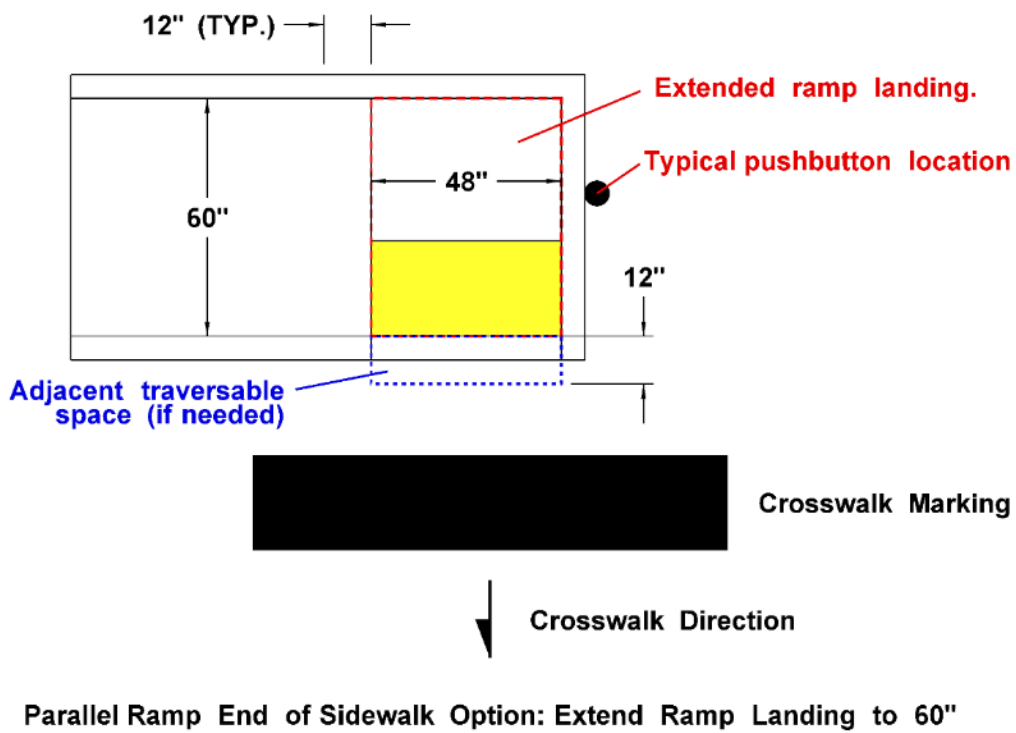
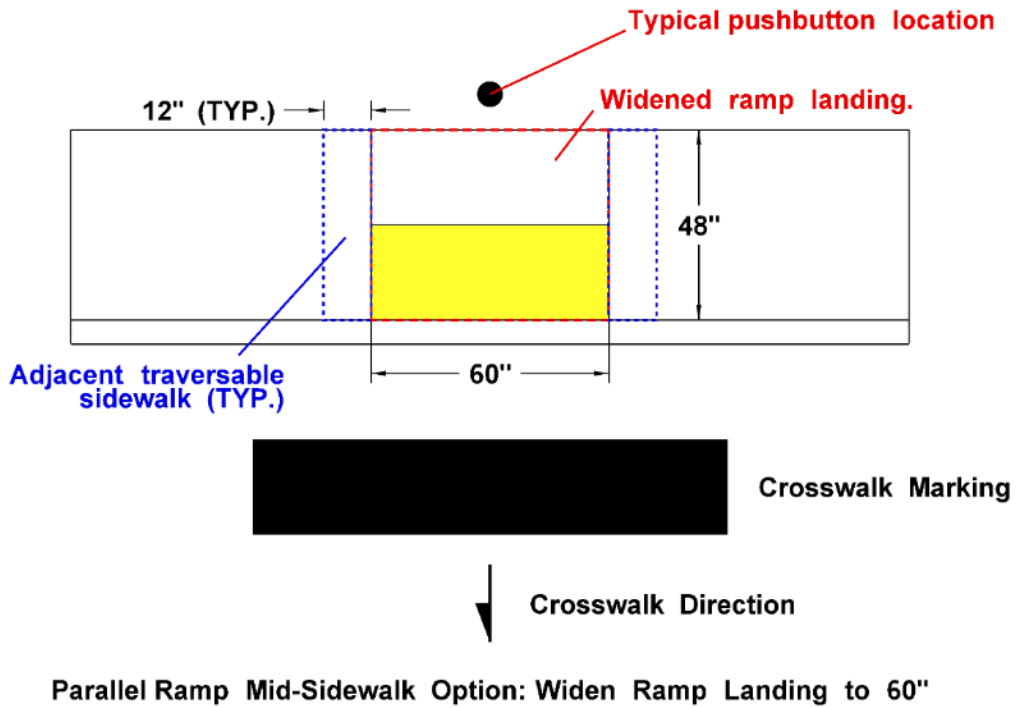

1510.12(1)(c) Reach Range Requirements

Pushbuttons are in locations considered unobstructed and follow the allowable unobstructed reach distance requirements of the ADA accessibility requirements. This manual designs clear space for pushbuttons based on a parallel approach, due to difficulties in both accessibility and design when attempting to accommodate a forward reach.

- The provided clear space must be within reach range of the pedestrian pushbutton.
- The reach range is 10 inches maximum, as measured from the edge of the clear space to the center of the physical pushbutton (not just the housing).
- For new construction, the center of the physical pushbutton shall be no more than 9 inches from the edge of the clear space. It is preferable to locate the pushbutton as close to the edge of the clear space as possible.
- Different types of pushbuttons (front mount H-frame type versus side mount Accessible Pedestrian Signal type) will have different reach ranges on the same pole. Generally, designing for a side mount pushbutton will result in a front mount pushbutton also being within the required reach range. This is generally not true the other way around. (See [Exhibit 1510-34](#))
- The center of the physical pushbutton shall be 42 inches above the surface of the clear space. Existing installations may remain if they are within a range of 36 inches minimum to 48 inches maximum above the surface of the clear space.
- The pushbutton shall be a minimum of 12 inches in from both ends of the clear space and should be at least 24 inches in from both ends of the clear space. Ideally, the pushbutton should be centered along one side of the clear space. If the clear space is rectangular, the pushbutton shall be located along one of the long sides of the clear space.

Exhibit 1510-34 Reach Range for Pedestrian Pushbuttons

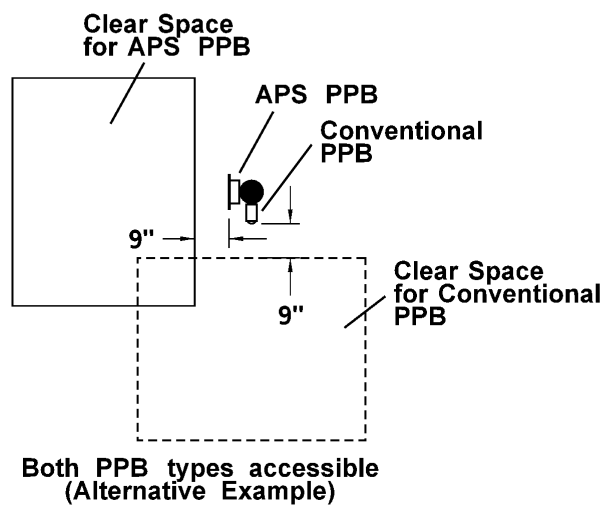
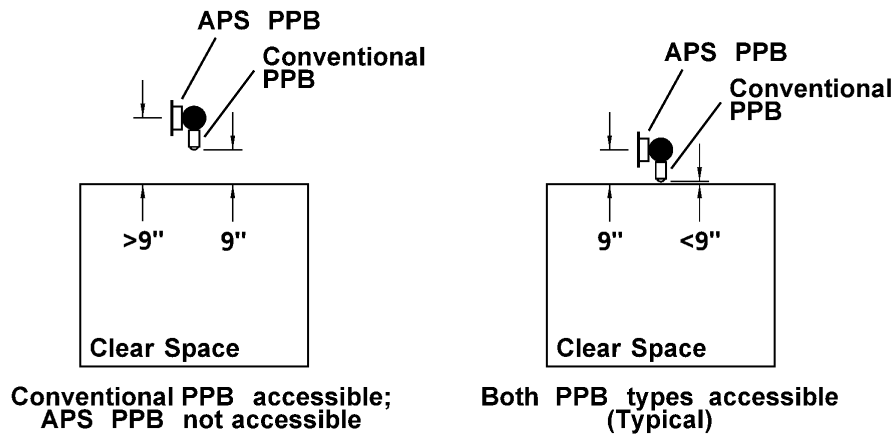
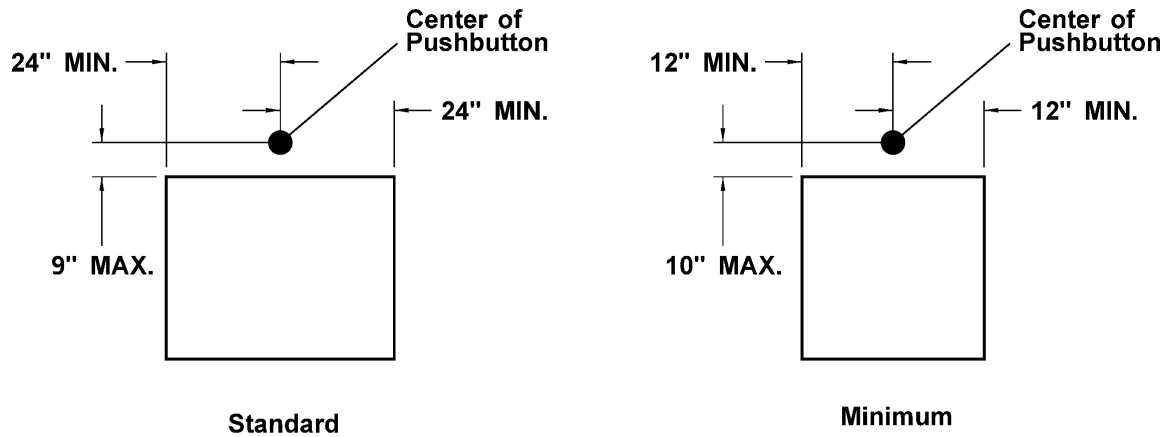

Note: See [Exhibit 1330-19](#) and [Exhibit 1330-20](#) for pole setback limits.

1510.12(2) Accessible Pedestrian Signals

Accessible Pedestrian Signals (APS) are only installed where there is a pedestrian traffic signal display (walking person / hand). APS are not installed as part of crosswalk flashing beacon systems. See [Chapter 1330](#) for additional information on APS equipment.

1510.13 At-Grade Railroad Crossings

The design of pedestrian facilities that cross railroad tracks (see [Exhibit 1510-35](#)) often presents challenges due to the conflicting needs of pedestrians and trains. In particular, the flangeway gap for trains to traverse a crossing surface may create a significant obstacle for a person who uses a wheelchair, crutches, or walking aids for mobility. Whenever practicable, align pedestrian crossings perpendicular to the tracks in order to minimize potential problems related to flangeway gaps. Crossing surfaces may be constructed of timber planking, rubberized materials, or concrete. Concrete materials generally provide the smoothest and most durable crossing surfaces. When detectable warning surfaces are used at railroad crossings, place them according to the [MUTCD](#) stop line placement criteria.

Exhibit 1510-35 Pedestrian Railroad Crossings



Undesirable

Recommended

There are a number of railroad crossing warning devices (see [Exhibit 1510-36](#)) intended specifically for pedestrian facilities (see the [MUTCD](#)). When selecting warning devices, factors such as train and pedestrian volumes, train speeds, available sight distance, number of tracks, and other site-specific characteristics should be taken into account. Coordinate with the HQ Design Office Railroad Liaison early in the design process so that all relevant factors are considered, and an agreement may be reached regarding the design of warning devices and crossing surfaces.

Exhibit 1510-36 Pedestrian Railroad Warning Device

Except for crossings located within the limits of first-class cities*, the Washington Utilities and Transportation Commission (WUTC) approves proposals for any new railroad at-grade crossings or changes to warning devices or geometry at existing crossings. Additionally, any project that requires the railroad to perform work such as installation of warning devices or crossing surfaces must obtain a railroad construction and maintenance agreement. Contact the HQ Design Office Railroad Liaison to coordinate with both the WUTC and the railroad company.

*[RCW 35.22.010](#): A first class city is a city with a population of ten thousand or more at the time of its organization or reorganization that has a charter adopted under Article XI, section 10, of the state Constitution.

Note: There are very few first-class cities in the state of Washington. Verify with the HQ Design Office Railroad Liaison.

1510.14 Pedestrian Grade Separations (Structures)

On the approach to a bridge that has a raised sidewalk, provide a ramp that transitions to the sidewalk from the paved shoulder. A ramp that transitions from a paved shoulder to a sidewalk on a bridge is to have a slope of 5% maximum and be constructed of asphalt or cement concrete. In addition to aiding pedestrian access, the ramp also serves as a roadside safety feature to mitigate the raised blunt end of the concrete sidewalk. If a PCP (such as a raised sidewalk or shared-use path) is located near the bridge, consider eliminating the gap between the bridge sidewalk and the PCP by extending the bridge sidewalk to match into the nearby PCP.

At underpasses where pedestrians are allowed, it is desirable to provide sidewalks and to maintain the full shoulder width. When bridge columns are placed on either side of the roadway, it is preferred to place the walkway between the roadway and the columns for pedestrian visibility and security. Provide adequate illumination and drainage for pedestrian safety and comfort.

In cases where there is a pedestrian crash history, and the roadway cannot be redesigned to accommodate pedestrians at grade, planners should consider providing a grade-separated pedestrian structure (see [Exhibit 1510-37](#) and [Exhibit 1510-38](#)). When considering a grade-separated pedestrian structure, determine whether the conditions that require the crossing are permanent. If there is likelihood that pedestrians will not use a grade separation, consider less-costly solutions.

Locate the grade-separated crossing where pedestrians are most likely to cross the roadway. A crossing might not be used if the pedestrian is required to deviate significantly from a more direct route.

It is sometimes necessary to install fencing or other physical barriers to channel the pedestrians to the structure and reduce the possibility of undesired at-grade crossings.

Note: The HQ Bridge and Structures Office is responsible for the design of pedestrian structures.

Consider a grade-separated crossing where:

- There is moderate to high pedestrian demand to cross a freeway or expressway.
- There are large numbers of young children, particularly on school routes, who regularly cross high-volume roadways with speeds ≥ 40 mph.
- The traffic conflicts that would be encountered by pedestrians are considered unacceptable (such as on wide streets with high pedestrian volumes combined with speeds ≥ 40 mph).
- There are documented crashes or close calls involving pedestrians and vehicles.
- One or more of the conditions stated above exists in conjunction with a well-defined pedestrian origin and destination (such as a residential neighborhood across a busy street from a school).

1510.14(1) Pedestrian Bridges

Pedestrian grade-separation bridges (see [Exhibit 1510-37](#)) are more effective when the roadway is below the natural ground line, as in a cut section. Elevated grade separations in cut sections, where pedestrians climb stairs or use long approach ramps, tend to be underused. Pedestrian bridges need adequate right of way to accommodate accessible ramp approaches leading up to and off of the structure. The bridge structure must comply with ADA requirements and meet the accessibility criteria for either a pedestrian circulation path (if the grade is 5% or less) or an access ramp (if the grade is greater than 5% but less than or equal to 8.3%), and must include a pedestrian access route. (See Section [1510.04](#) and Section [1510.05](#) for PCP and PAR accessibility criteria; see Section [1510.15\(2\)](#) for access ramp accessibility criteria.)

For the minimum vertical clearance from the bottom of the pedestrian structure to the roadway beneath, see [Chapter 720](#). The height of the structure can affect the length of the pedestrian ramp approaches to the structure. When access ramps are not feasible, provide both elevators and stairways.

Provide railings on pedestrian bridges. Bridge fence is sometimes desirable to deter pedestrians from throwing objects from an overhead pedestrian structure (see Section [720.03\(13\)](#)).

The minimum clear width for pedestrian bridges is 8 feet. Consider a clear width of 14 feet where a pedestrian bridge is enclosed or shared with bicyclists, or equestrians, or if maintenance or emergency vehicles will need to access.

Exhibit 1510-37 Pedestrian Bridges



1510.14(2) Pedestrian Tunnels

Tunnels are an effective method of providing crossings for roadways located in embankment sections. Well-designed tunnels can be a desirable crossing for pedestrians. When feasible, design the tunnel with a nearly level profile to provide an unobstructed line of sight from portal to portal (see [Exhibit 1510-38](#)). People may be reluctant to enter a tunnel with a depressed profile because they are unable to see whether the tunnel is occupied. Law enforcement also has difficulty patrolling depressed profile tunnels.

Provide vandal-resistant daytime and nighttime illumination within the pedestrian tunnel. Installing gloss-finished tile walls and ceilings can enhance light levels within the tunnel. The minimum overhead clearance for a pedestrian tunnel is 10 feet. The minimum width for a pedestrian tunnel is 12 feet. Consider a tunnel width between 14 and 18 feet depending on usage and the length of the tunnel.

Exhibit 1510-38 Pedestrian Tunnel



Pedestrian tunnels need adequate right of way to accommodate accessible approaches leading to the tunnel structure. The tunnel structure must comply with ADA requirements and meet the accessibility criteria for either a pedestrian circulation path (if the grade is less than or equal to 5%) or an access ramp (if the grade is greater than 5% and less than or equal to 8.3%) and must include a pedestrian access route. (See Section [1510.04](#) and Section [1510.05](#) for PCP and PAR accessibility criteria; see Section [1510.15\(2\)](#) for access ramp accessibility criteria.)

1510.15 Other Pedestrian Facilities

1510.15(1) Transit Stops and School Bus Stops

The location of transit stops is an important element in providing appropriate pedestrian facilities. (Coordinate with the local transit provider.) Newly constructed transit stops must conform to ADA requirements. Design newly constructed transit stops so that they are accessible from the sidewalk or paved shoulder. A transit stop on one side of a street usually has a counterpart on the opposite side because transit routes normally function in both directions on the same roadway. Provide adequate crossing facilities for pedestrians.

When locating a transit stop (see [Traffic Manual 7.9](#)), consider transit ridership and land use demand for the stop. Also, take into account compatibility with the following roadway/traffic characteristics:

- ADT
- Traffic speed
- Crossing distance
- Crash history
- Sight distance
- Connectivity to a pedestrian access route
- Traffic generator density

If any of these suggests an undesirable location for a pedestrian crossing, consider a controlled crossing or another location for the transit stop. (See [Chapter 530](#) for further information on bus stops on limited access facilities.)

When analyzing a transit stop location with high pedestrian crash frequency, take into account the presence of nearby transit stops and opportunities for pedestrians to cross the street in a reasonably safe manner. At-grade midblock pedestrian crossings may be effective at transit stop locations on roadways with lower vehicular volumes. Pedestrian grade separations are appropriate at midblock locations when vehicular traffic volumes prohibit pedestrian crossings at grade. (See the [Traffic Manual](#) for recommendations for marked crosswalks at unsignalized intersections.)

School bus stops are typically adjacent to sidewalks in urban areas and along shoulders in rural areas. Determine the number of children using the stop and provide a waiting area that allows the children to wait for the bus. Coordinate with the local school district. Because of their smaller size, children might be difficult for motorists to see at crossings or stops. Determine whether utility poles, vegetation, and other roadside features interfere with motorists' ability to see the children. When necessary, remove or relocate the obstructions or move the bus stop. Parked vehicles can also block visibility, and parking prohibitions might be advisable near the bus stop. Coordinate transit and school bus stop locations with the Region Transportation Operations Office.

1510.15(2) Access Ramps Serving Transit Stops, Park & Ride Lots, Rest Areas, Buildings, and Other Facilities

An access ramp (see [Exhibit 1510-39](#)) provides an accessible pedestrian route from a pedestrian circulation path to a facility such as a transit stop, park & ride lot, rest area, pedestrian overcrossing/undercrossing structure, or building. When the running slope is 5% or less, it can be designed as a pedestrian circulation path that includes a pedestrian access route. When the running slope is greater than 5% to a maximum of 8.3%, it must be designed as an access ramp. (See [Section 1510.04](#) and [Section 1510.05](#) for PCP and PAR accessibility criteria; see [Section 1510.15\(2\)\(a\)](#) for access ramp accessibility criteria.)

1510.15(2)(a) Accessibility Criteria for Access Ramps

Access ramps are composed of one or more ramp segments interconnected by level landings. Unless superseded by the following specific accessibility requirements for access ramps, the accessibility requirements for pedestrian access routes also apply:

- Ramp segments shall have a maximum running slope of 8.3%.
- The cross slope of ramp segments shall be 2% maximum.
- The minimum clear width of ramps is 4 feet; however, it is desirable to match the width of the connecting pedestrian facility.
- The rise for any ramp segment shall be 30 inches maximum.
- A level landing (2% maximum running and cross slopes) shall be provided at the top and bottom of each access ramp segment.
- An access ramp landing's clear width shall be at least as wide as the widest ramp segment leading to the landing.
- An access ramp landing's length shall be 5 feet minimum.
- Access ramps that change direction between ramp segments at landings shall have a level landing 5 feet minimum width by 5 feet minimum length.
- All access ramp segments with a rise greater than 6 inches shall have ADA-compliant handrails (see [Section 1510.15\(3\)](#) for handrail accessibility criteria).

Provide edge protection complying with one of the two following options on each side of access ramp segments:

- The surface of the ramp segment and landing shall extend 12 inches minimum beyond the inside face of the handrail.
- A curb or barrier shall be provided that does not allow the passage of a 4-inch-diameter sphere, where any portion of the sphere is within 4 inches of the ramp/landing surface.

Exhibit 1510-39 Access Ramp with Accessible Handrails



1510.15(3) Railings and Handrails for Pedestrian Facilities

Accessible handrails are required on stairs and also on access ramps that have a rise greater than 6 inches (see Section [1510.15\(2\)\(a\)](#) for access ramp accessibility criteria). If the height of a drop-off (typically greater than 30 inches) adjacent to a pedestrian facility necessitates the need to protect pedestrians from falls, then a more robust railing system designed for fall protection should be used. If the drop-off is adjacent to either a stairway or an access ramp with a rise greater than 6 inches, then a combined railing system that meets the requirements for both accessibility and fall protection must be used.

1510.15(3)(a) Fall Protection Railing

Railing designed for fall protection alone is typically placed adjacent to pedestrian facilities other than stairs or access ramps to prevent pedestrians or bicyclists from falls. For pedestrian-only facilities, the minimum railing height for fall protection is 42 inches. For facilities where bicycle traffic is anticipated, see Section [1520.05\(4\)](#).

1510.15(3)(b) Accessible Fall Protection Railing

When fall protection is needed adjacent to stairs or an access ramp that has a rise greater than 6 inches, then a combined railing system that meets both the accessibility criteria for handrail outlined in Section [1510.15\(3\)\(d\)](#) and the requirements for fall protection must be used. The minimum railing height for pedestrian fall protection is 42 inches.

1510.15(3)(c) Accessible Handrail

Accessible handrail meeting the accessibility criteria listed in Section [1510.15\(3\)\(d\)](#) that is not designed to provide fall protection is to be used adjacent to stairs or access ramps that have a rise greater than 6 inches at locations where robust fall protection is not needed.

1510.15(3)(d) Accessibility Criteria for Handrail

The following accessibility criteria apply to all handrail installations provided at stairs and access ramps that have a rise greater than 6 inches.

1510.15(3)(d)(i) Height

- The top of handrail gripping surfaces shall be 34 inches minimum and 38 inches maximum vertically above walking surfaces, stair nosings, and ramp surfaces.
- The mounting height of the handrail shall also be at a consistent height.

1510.15(3)(d)(ii) Gripping Surface

- Clearance between handrail gripping surfaces and adjacent surfaces shall be 1½ inches minimum.
- Handrail gripping surfaces shall be continuous along their length and shall not be obstructed along their tops or sides.
- The bottoms of handrail gripping surfaces shall not be obstructed for more than 20% of their length.
- Where provided, horizontal projections shall be located 1½ inches minimum below the bottom of the handrail gripping surface.
- Handrail gripping surfaces with a circular cross section shall have an outside diameter between 1¼ inches minimum and 2 inches maximum.
- Handrail gripping surfaces with a noncircular cross section shall have a perimeter dimension between 4 inches minimum and 6¼ inches maximum, and a cross section dimension of 2¼ inches maximum.
- Handrail gripping surfaces and the surfaces adjacent to them shall be free of sharp or abrasive elements and shall have rounded edges.
- Handrails shall not rotate in their fittings.

1510.15(3)(d)(iii) Placement and Continuity

- Handrails shall be provided on both sides of access ramps and stairs.
- Handrails shall be continuous within the full length of each access ramp run or stair flight.
- Inside handrails on switchback or dogleg access ramps and stairs shall be continuous between runs or flights.

1510.15(3)(d)(iv) Extensions

- Access ramp handrails shall extend horizontally above the landing for 12 inches minimum beyond the top and bottom of ramp runs.
- At the top of a stair flight, handrails shall extend horizontally above the landing for 12 inches minimum beginning directly above the first riser nosing.
- At the bottom of a stair flight, handrails shall extend at the slope of the stair flight for a horizontal distance at least equal to one tread depth beyond the last riser nosing.
- Handrail extensions shall return to a wall, guard, or the landing surface, or shall be continuous to the handrail of an adjacent access ramp run or stair flight.
- Exception: Handrail extensions shall not be required for continuous handrails at the inside turn of switchback or dogleg access ramps or stairs.

1510.15(4) Other Pedestrian Facilities, Features, and Elements

This chapter covers the accessibility criteria for the most commonly encountered pedestrian design elements in the public right of way. However, there are ADA requirements that apply to any feature or element for pedestrian use, such as doorways, elevators, stairs, call boxes, and drinking fountains. For accessibility criteria for less commonly encountered pedestrian design elements, consult the applicable federal design guidance listed in Section [1510.18\(2\)](#).

1510.16 Illumination and Signing

In Washington State, the highest number of crashes between vehicles and pedestrians tends to occur during November through February, when there is poor visibility and fewer daylight hours. Illumination of pedestrian crossings and other walkways is an important design consideration because lighting has a major impact on a pedestrian's safety and sense of security. Illumination provided solely for vehicular traffic is not always effective in lighting parallel walkways for pedestrians. Consider pedestrian-level (mounted at a lower level) lighting for PCPs, intersections, and other pedestrian crossing areas with high nighttime pedestrian activity, such as shopping districts, transit stops, schools, community centers, and other major pedestrian generators or areas with a history of pedestrian crashes. (See [Chapter 1040](#) for design guidance on illumination, and [Chapter 1020](#) and the [MUTCD](#) for pedestrian-related signing.)

1510.17 Work Zone Pedestrian Accommodation

While Title II of the ADA requires that a public entity maintain its pedestrian facilities in operable working condition, including maintenance of their accessibility features, construction and maintenance activities often temporarily disrupt these facilities. When this occurs, provide access and mobility for pedestrians through and around work zones (see [Exhibit 1510-40](#)). Address this in the traffic control plans if the project occurs in a location accessible to pedestrians. The designer must determine pedestrian needs in the proposed work zone during the public input process and through field visits.

Detailed guidance on work zone pedestrian accommodation can be found in the WSDOT *Field Guide for Accessible Public Rights of Way*, the MUTCD, and [Chapter 1010](#).

Some work zone considerations include:

- Separate pedestrians from conflicts with work zone equipment and operations.
- Separate pedestrians from traffic moving through or around the work zone.
- Provide pedestrians with alternate routes that have accessible and convenient travel paths that duplicate, as closely as feasible, the characteristics of the existing pedestrian facilities.

Provide walkways that are clearly marked and pedestrian barriers that are continuous, rigid, and detectable to people with reduced vision who navigate with a cane. Also, keep:

- The pedestrian head space clear.
- Walkways free from holes, debris, protruding objects, slick surfaces, unstable surfaces, and abrupt changes in grade or terrain.
- Access along sidewalks clear of obstructions such as construction traffic control signs.
- A minimum clear width path throughout: 4 feet for pedestrians or 10 feet for pedestrians and bicyclists.

Temporary pedestrian facilities within the work zone must meet accessibility criteria to the maximum extent feasible. (See Section [1510.04](#) and Section [1510.05](#) for pedestrian circulation path and pedestrian access route accessibility criteria.)

Consider the use of flaggers if pedestrian generators such as schools are in the work zone vicinity. Consider spotters who are prepared to help pedestrians through the work zone.

Provide for advance public notification of sidewalk closures in the contract special provisions and plans.

Where transit stops are affected or relocated because of work activity, provide an accessible route to temporary transit stops.

Exhibit 1510-40 Work Zones and Pedestrian Facilities



Meets ADA requirements

Does not meet ADA requirements

1510.18 References

1510.18(1) Federal/State Laws and Codes

[ADA](#) – 28 Code of Federal Regulations (CFR) Part 35, as revised September 15, 2010

[23 CFR Part 652](#), Pedestrians and Bicycle Accommodations and Projects

[49 CFR Part 27](#), Nondiscrimination on the Basis of Disability in Programs or Activities Receiving Federal Financial Assistance (Section 504 of the Rehabilitation Act of 1973 implementing regulations)

[49 CFR Part 37](#), Transportation Services For Individuals With Disabilities (ADA).

[49 CFR Part 38](#), Americans With Disabilities Act (ADA) Accessibility Specifications For Transportation Vehicles

[49 CFR Part 39](#), Transportation For Individuals With Disabilities: Passenger Vessels

[Revised Code of Washington \(RCW\) 35.68](#), Sidewalks, gutters, curbs and driveways – All cities and towns

[RCW 35.68.075](#), Curb ramps for persons with disabilities – Required – Standards and Requirements

[RCW 46.04.160](#), Crosswalk (definition)

[RCW 46.61](#), Rules of the Road

[RCW 47.24.020](#), City streets as part of state highways – Jurisdiction, control

1510.18(2) Design Guidance

ADA Standards for Accessible Design, U.S. Department of Justice (USDOJ), 2010; consists of 28 CFR parts 35 & 36
ADA and Architectural Barriers Act (ABA)

Accessibility Guidelines for Buildings and Facilities (ADA-ABAAG; also referred to as the 2004 ADAAG), July 23, 2004, U.S. Access Board as modified by USDOT for entities receiving USDOT funding per 49 CFR Part 27. (Applies to new construction or alterations as of November 29, 2006, for entities receiving USDOT funding per 49 CFR Part 27.) [accessibility_guidelines_for_buildings_and_facilities_ada.pdf \(nacto.org\)](#)

ADA Standards for Transportation, USDOT, 2006; consists of 49 CFR, Subtitle A, Parts 37, 38, & 39

[eCFR: Title 49 of the CFR -- Transportation](#)

ADA Accessibility Guidelines for Transportation Vehicles, September 6, 1991

[About ADAAG for Transportation Vehicles \(access-board.gov\)](#)

[www.access-board.gov/guidelines-and-standards/transportation/vehicles/adaag-for-transportation-vehicles](#)

Department of Justice/Department of Transportation Joint Technical Assistance on the Title II of the Americans with Disabilities Act Requirements to Provide Curb Ramps when Streets, Roads, or Highways are Altered through Resurfacing, USDOJ and USDOT, July 2013

[www.ada.gov/doj-fhwa-ta.htm](#)

[www.ada.gov/doj-fhwa-ta-glossary.htm](#)

[www.ada.gov/doj-fhwa-ta-supplement-2015.html](#)

Manual on Uniform Traffic Control Devices for Streets and Highways, USDOT, FHWA; as adopted and modified by [Chapter 468-95 WAC](#) "Manual on uniform traffic control devices for streets and highways" (MUTCD)

[www.wsdot.wa.gov/publications/manuals/mutcd.htm](#)

Revised Draft Guidelines for Accessible Public Rights-of-Way (PROWAG), November 23, 2005, U.S. Access Board,

<https://www.wsdot.wa.gov/publications/fulltext/design/ADA/PROWAG-2005.pdf>

Standard Plans for Road, Bridge, and Municipal Construction (Standard Plans), M 21-01, WSDOT

[www.wsdot.wa.gov/publications/manuals/m21-01.htm](#)

The current best practices for evaluation and design of pedestrian facilities in the public right of way per the following FHWA Memoranda:

Public Rights-of-Way Access Advisory

[www.fhwa.dot.gov/environment/bicycle_pedestrian/resources/prwaa.cfm](#)

1510.18(3) Supporting Information

1991 ADA Standards for Accessible Design, USDOJ; consists of 28 CFR parts 35 & 36 and the *ADA Accessibility Guidelines for Buildings and Facilities (ADAAG)*, July 1991, U.S. Access Board. (For buildings and on-site facilities: Expired for new construction and alterations. To be used only for evaluating the adequacy of new construction or alteration that occurred prior to November 29, 2006, for entities receiving USDOT funding per 49 CFR Part 27.) *Adaag 1991 2002* ([access-board.gov](#))

A Policy on Geometric Design of Highways and Streets (Green Book), AASHTO, Current version adopted by FHWA

Field Guide for Accessible Public Rights of Way, WSDOT, November 1, 2012

<https://wsdot.wa.gov/engineering-standards/all-manuals-and-standards/manuals/ada-field-guide-accessible-public-rights-way>

Guide for the Planning, Design, and Operation of Pedestrian Facilities, AASHTO, 2004. Provides guidance on the planning, design, and operation of pedestrian facilities along streets and highways. Specifically, the guide focuses on identifying effective measures for accommodating pedestrians on public rights of way. It can be purchased through the AASHTO website.

Highway Capacity Manual, Transportation Research Board (TRB), 2000

Pedestrian Facilities Users Guide – Providing Safety and Mobility, FHWA, 2002. Provides useful information regarding walkable environments, pedestrian crashes and their countermeasures, and engineering improvements for pedestrians.

www.fhwa.dot.gov/publications/research/safety/01102/01102.pdf

Proposed Accessibility Guidelines for Pedestrian Facilities in the Public Right-of-Way, July 26, 2011, U.S. Access Board. Federal Notice of Proposed Rule Making that gives a preview of potential future revisions to the PROWAG, <https://www.wsdot.wa.gov/publications/fulltext/design/ADA/PROWAG-2005.pdf>

“Special Report: Accessible Public Rights-of-Way – Planning & Design for Alterations,” Public Rights-of-Way Access Advisory Committee, July 2007, <https://www.wsdot.wa.gov/publications/fulltext/design/ADA/PROWAG-2005.pdf>

Understanding Flexibility in Transportation Design – Washington, WSDOT, 2005

www.wsdot.wa.gov/research/reports/600/638.1.htm

Terminal Design Manual, Chapter 300 Accessibility, WSDOT, Washington State Ferries Division

www.wsdot.wa.gov/publications/manuals/m3082.htm