



HOW TO NOT FAIL LEMONS TECH INSPECTION

v.3 update—May 2017

No, these aren't the only ways to not fail a LEMONS Tech inspection. While they are the most common, you've still got to read the whole LEMONS Rulebook and work down through the LEMONS Safety Checklist. That said, the things in this book should keep you from doing half the dumb stuff that we see. Get to it.

ROLLCAGE - FIG. 1A

MAIN HOOP TYPE - MANDATORY COMPONENTS

These are the members your cage has to have. For the same bits arranged in a halo design see Rollcage Figure 1B, and for easy add-ons to make the cage even safer (add-ons we very strongly recommend for your miserable junkheap), see Rollcage Figure 2.

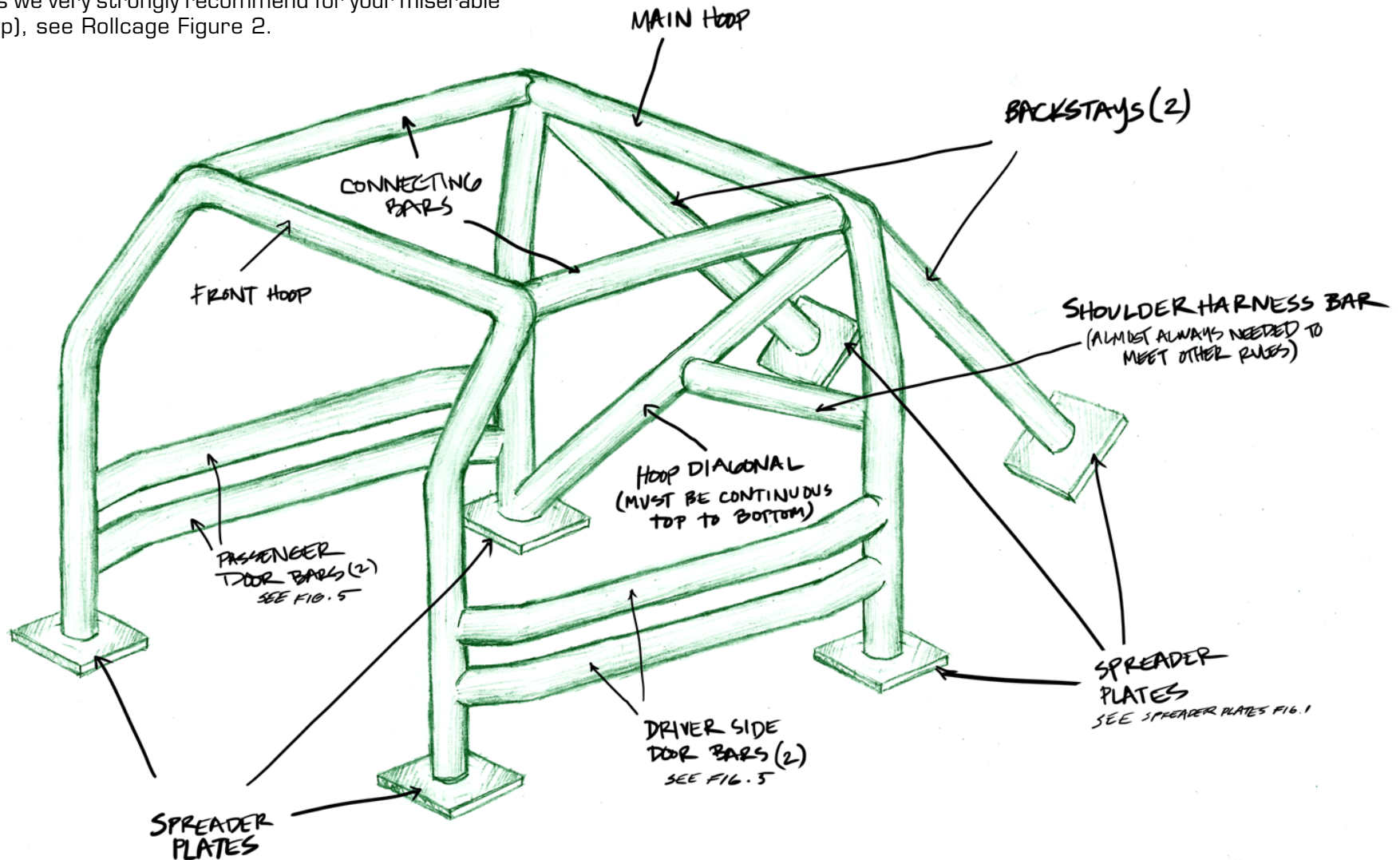

ROLLCAGE - FIG. 1B
HALO TYPE - MANDATORY COMPONENTS

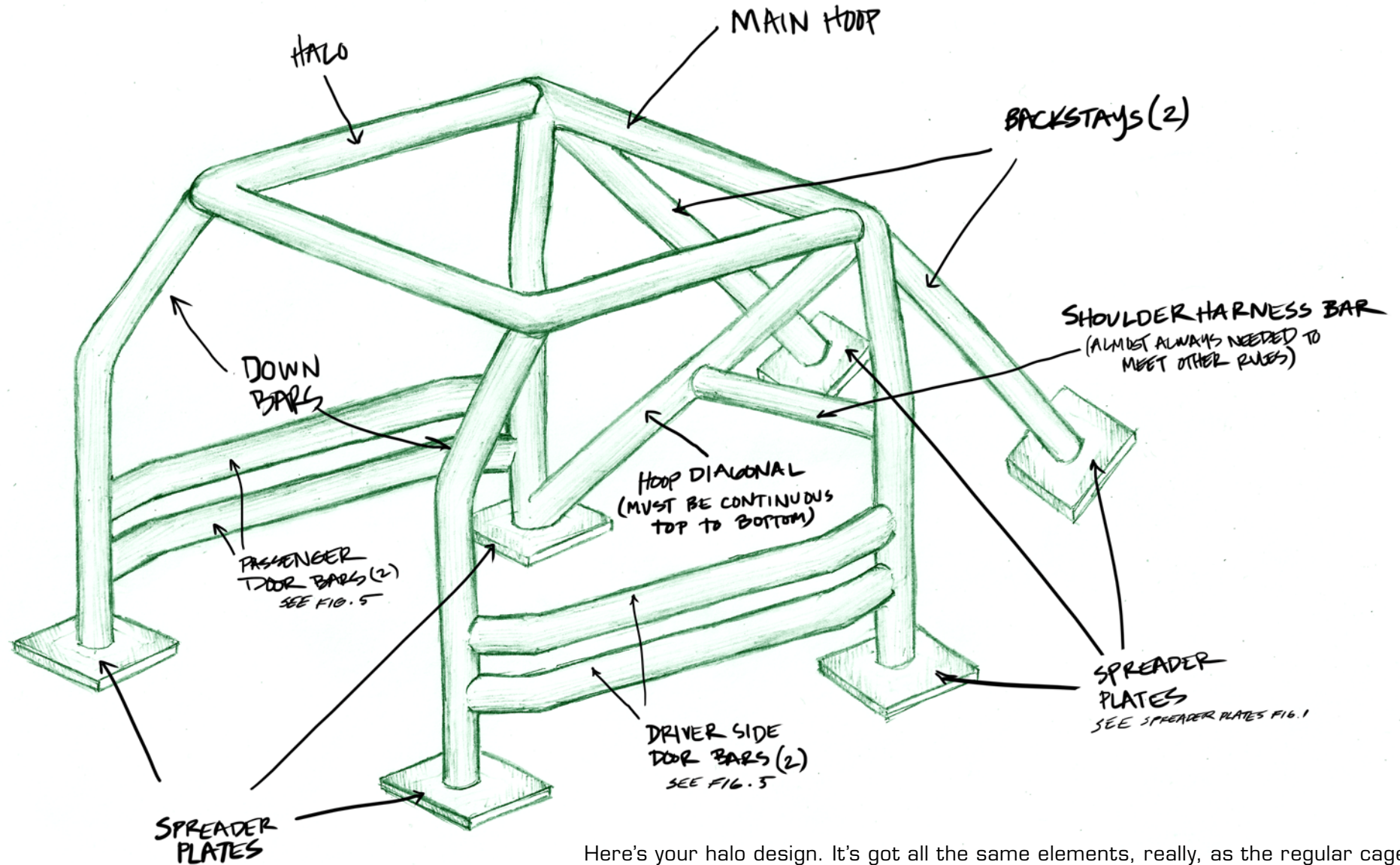

Here's your halo design. It's got all the same elements, really, as the regular cage in Figure 1A, they're just arranged a bit differently. Halo cages are fine.

ROLL CAGE - FIG. 1C
LEFT/RIGHT TYPE - MANDATORY COMPONENTS

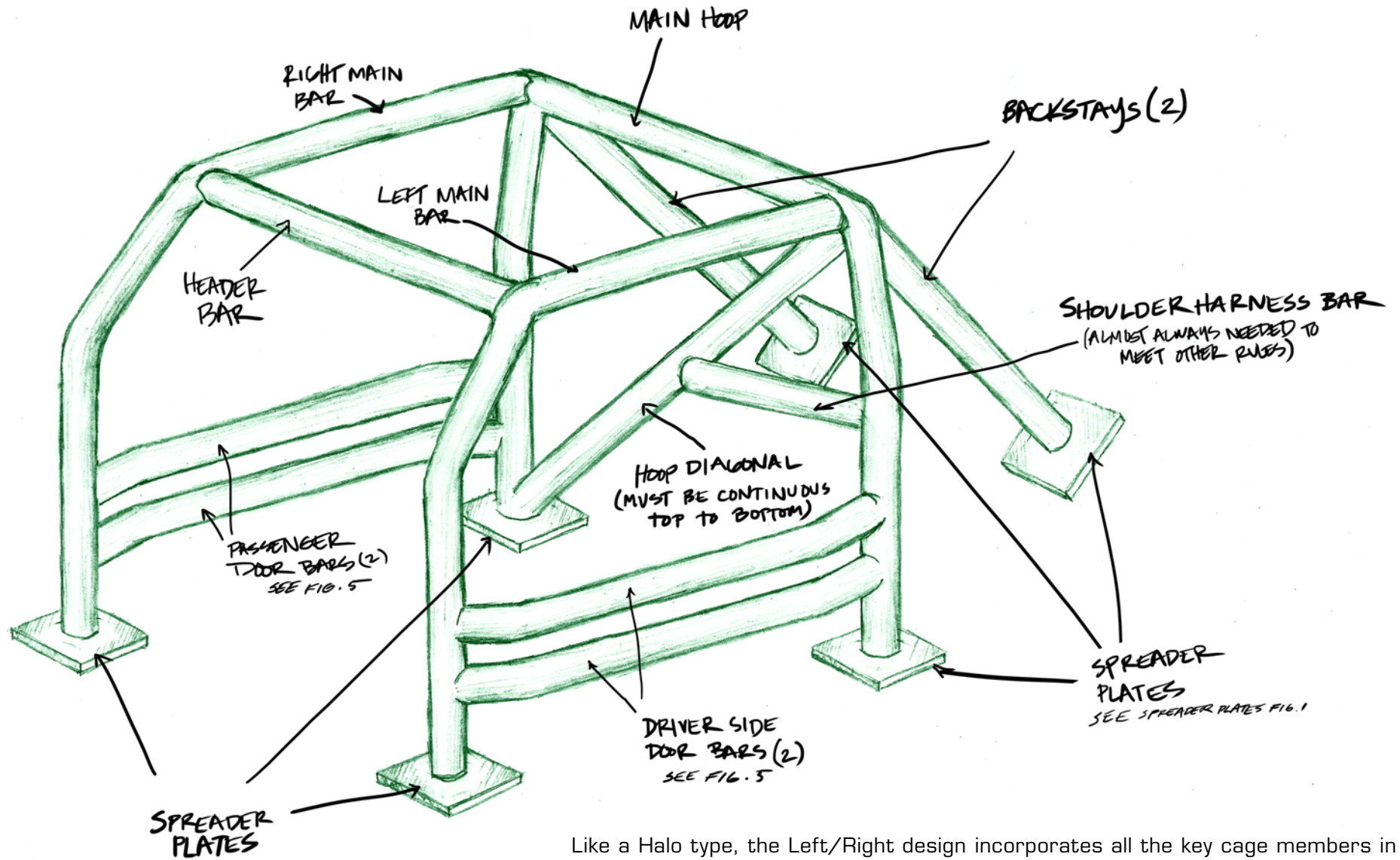

Like a Halo type, the Left/Right design incorporates all the key cage members in a slightly different order. This is a good, strong, totally acceptable arrangement.

ROLLCAGE-FIG. 2
HIGHLY RECOMMENDED

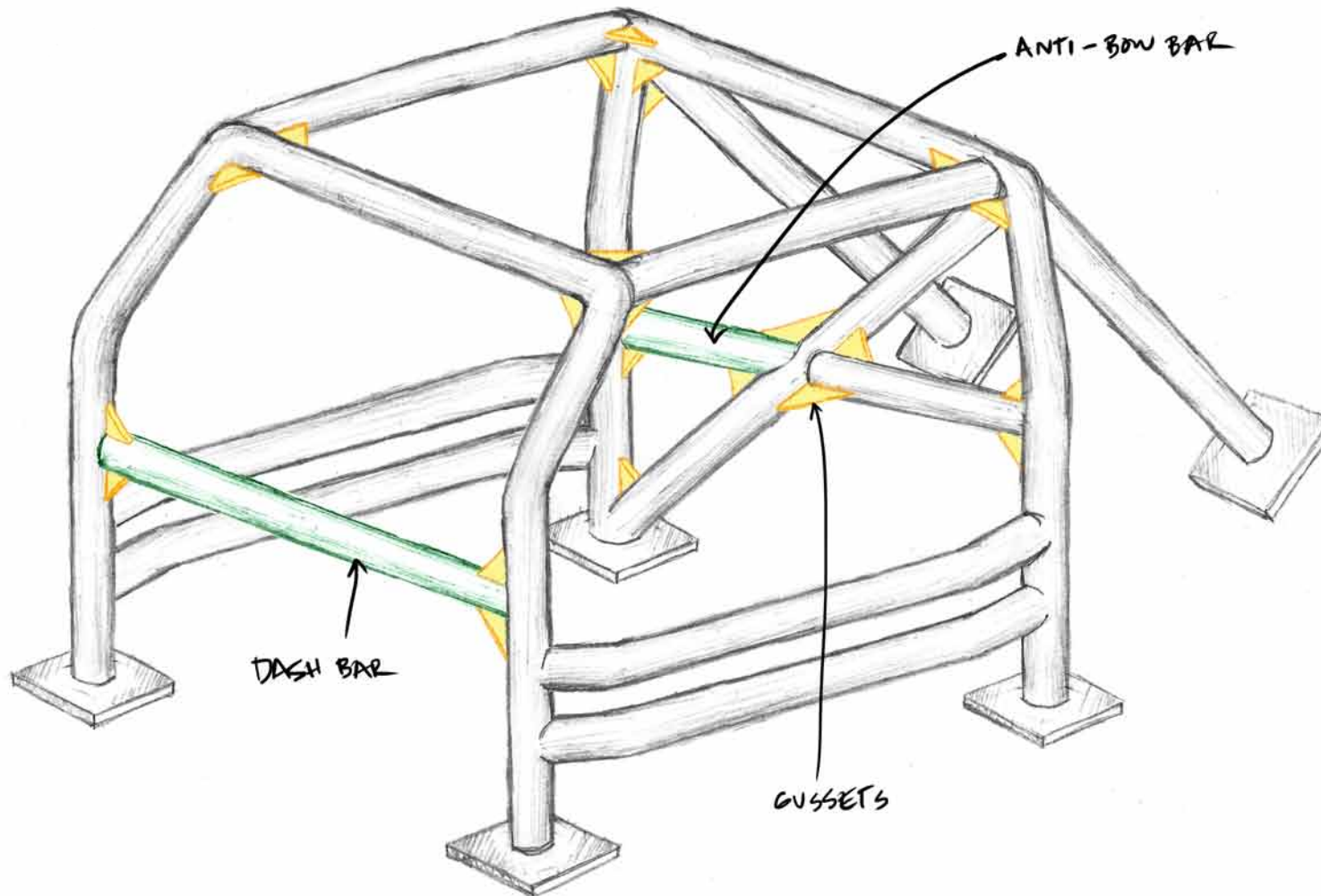

These add-ons give a lot more protection for very little extra work. We don't 100% demand these pieces in every cage, but the more of these extras you include, the safer you'll be. (And the more likely to pass with no heartburn.)

ROLL CAGE - FIG. 3
FRONT HOOP BENDS

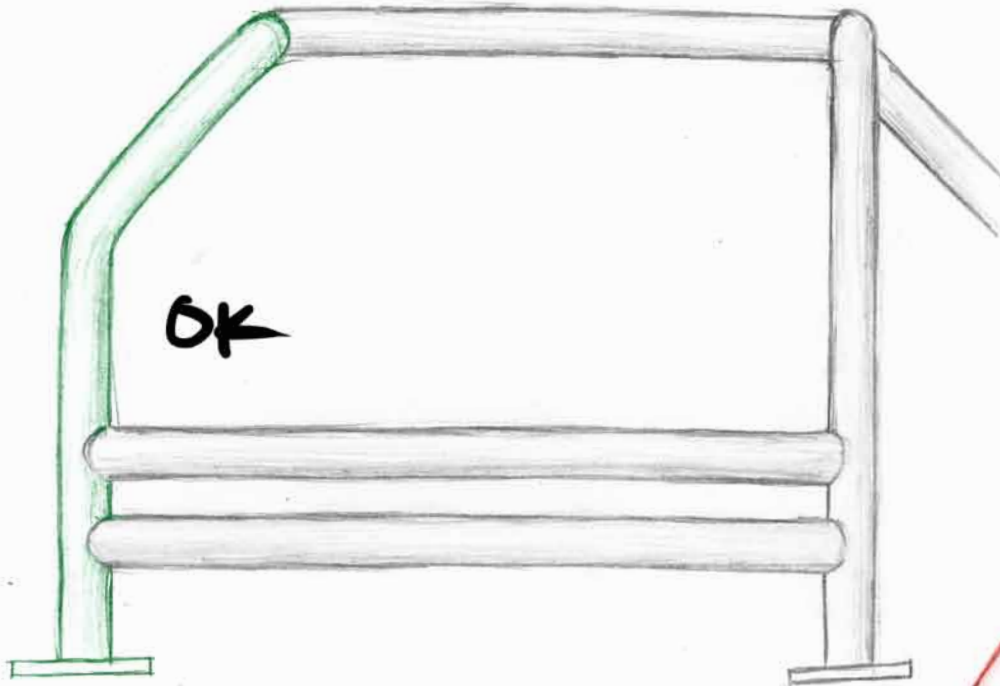

Tube bends just create more places to fail, so don't use any more than necessary; don't make them any sharper than necessary; and never create a reverse bend that would let a tube bow out or fold under stress.

FRONT HOOP SHOULD NOT
HAVE ANY EXTRA BENDS.

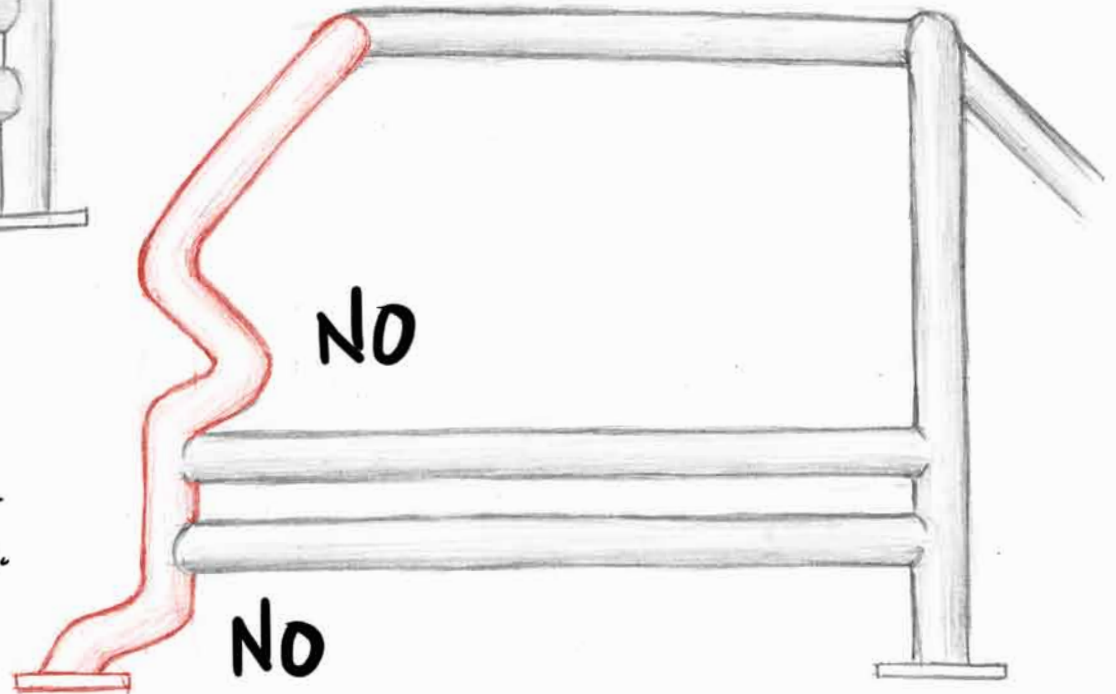

ROLLCAGE-FIG. 4
HELMET CLEARANCE

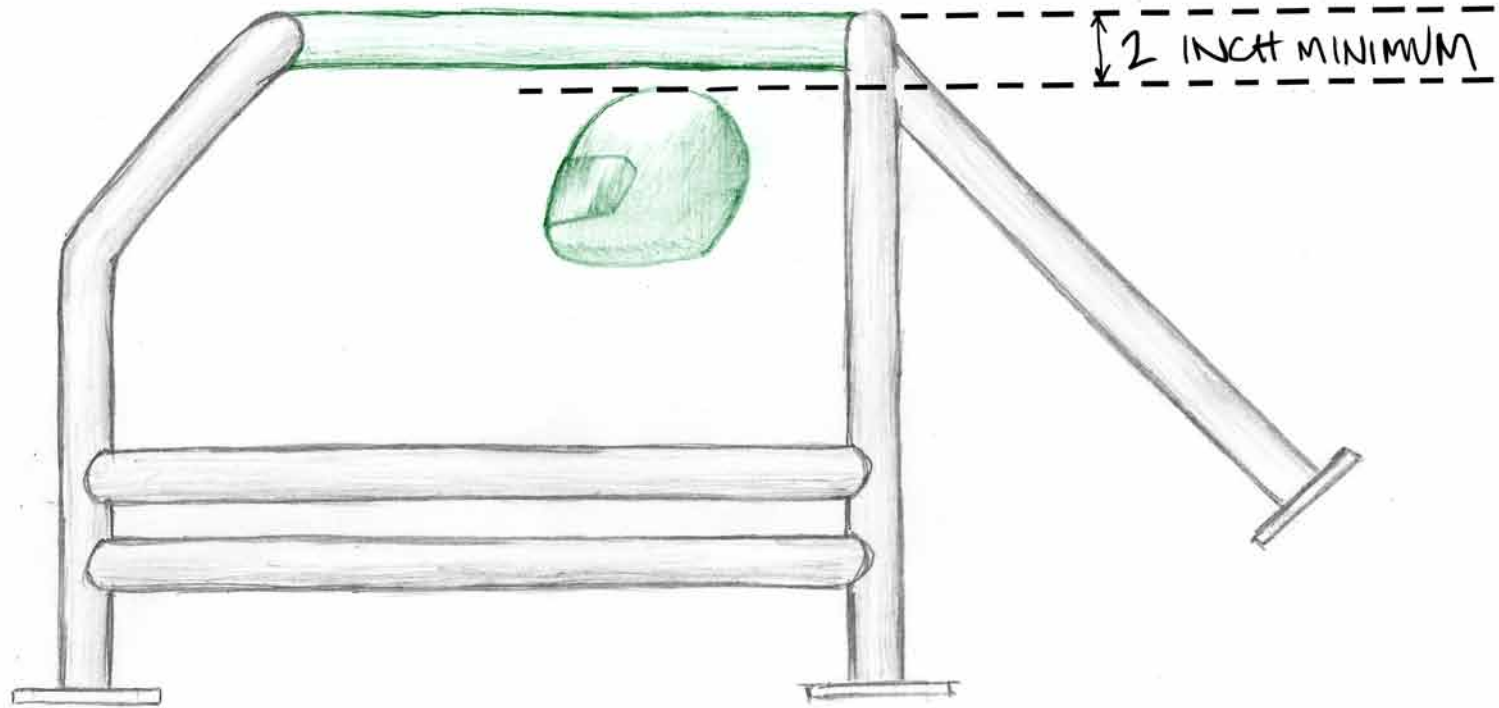

If—sorry, *when*—you roll, the cage flexes down while your body flies up. That's why you need at least two inches of clearance between the top of the tallest guy's helmet and the area enclosed by the cage.

ROLLCAGE-FIG. 5 DOOR BAR TYPES

The door bars keep Billy Jo's Pontiac out of your lap in a T-bone. Ideally, use tube of the same size and grade as your main bars or better. For extra protection, you can tie them together and down to the sills with some vertical members; for more safety and added comfort, you can also put the driver's door and bow these bars into that area.



OR

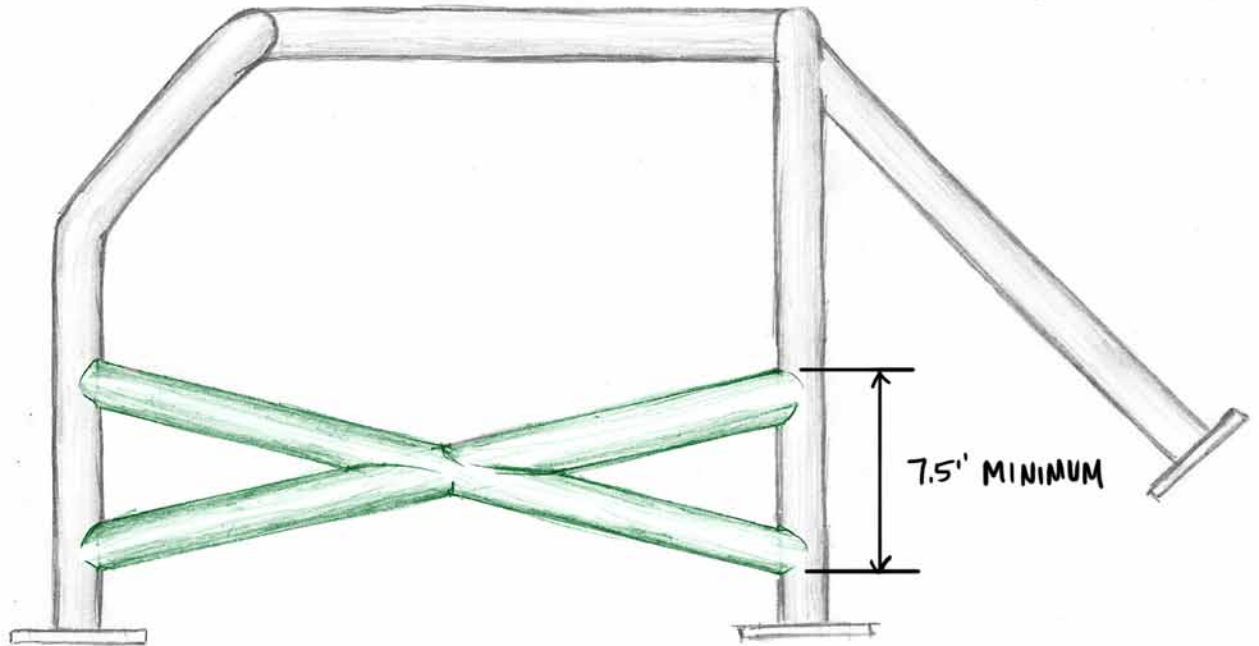
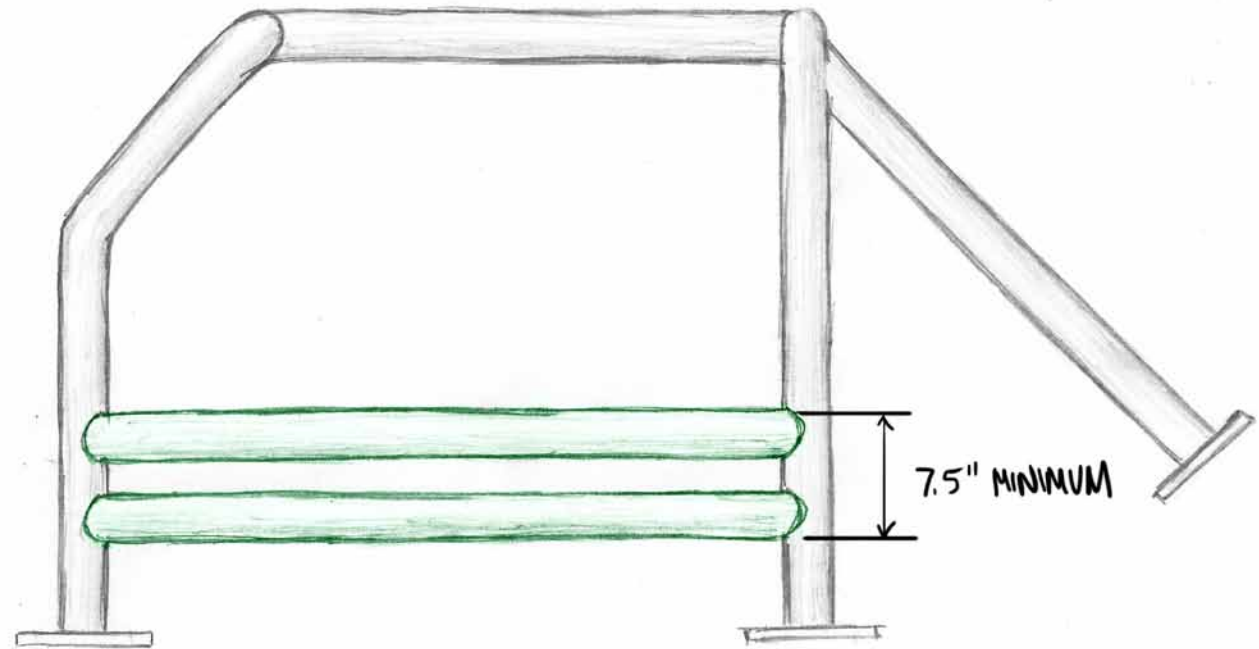

ROLL CAGE - FIG. 6
WELDS

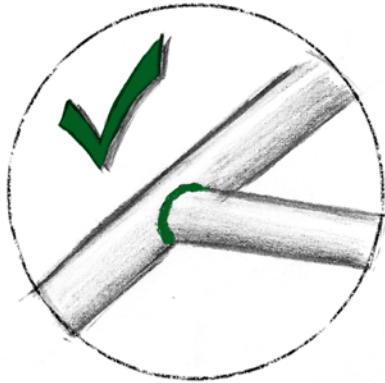

CONTINUOUS WELD
ALL THE WAY AROUND
THE JOINT

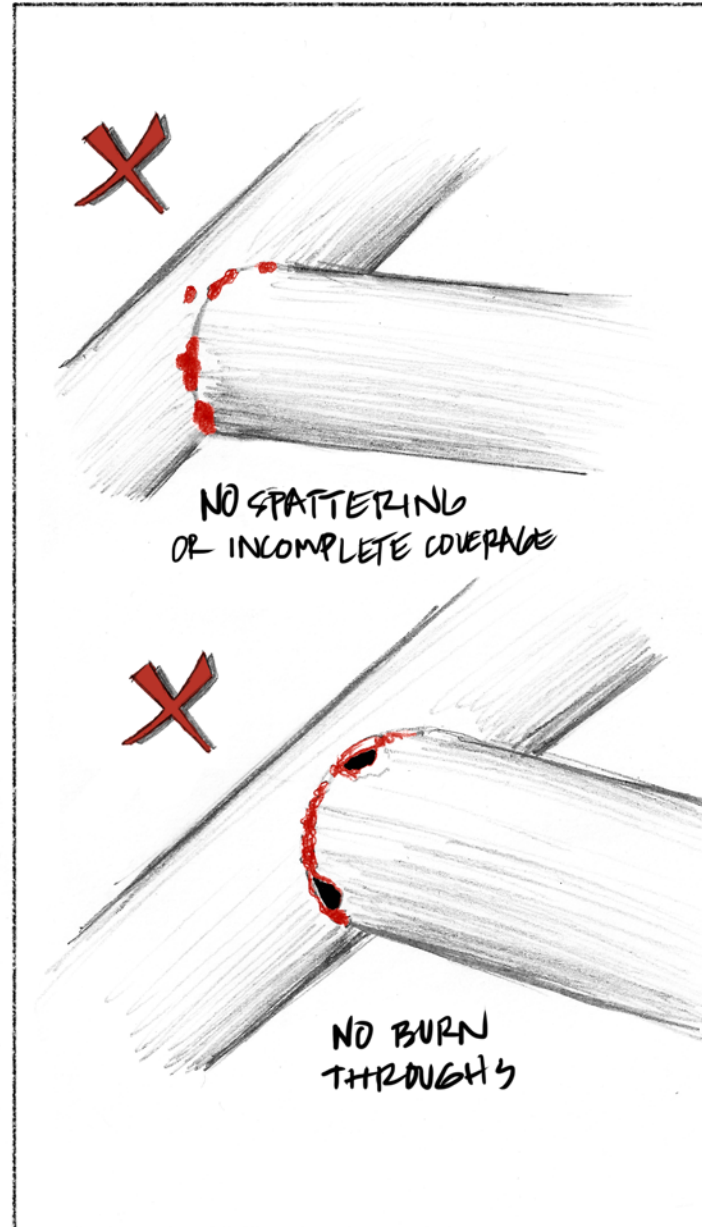

NO SPATTERING
OR INCOMPLETE COVERAGE

NO BURN
THROUGHS

Not a great welder? Then just stick to fixing old lawn chairs. We need to see smooth, nicely penetrated, unburned, 360-degree welds at each joint, not something slapped together by a jittery raccoon on Dexedrine.

ROLLCAGE-FIG.7 SPREADER PLATES

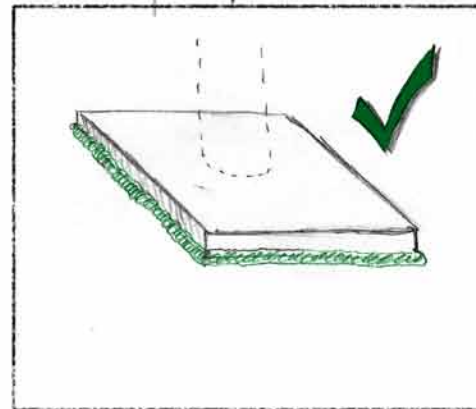
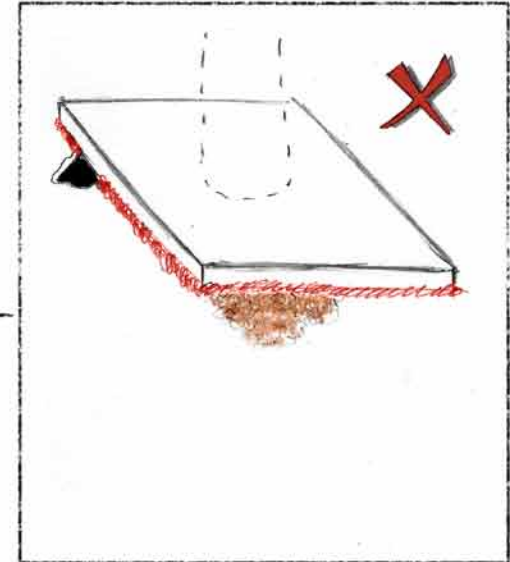
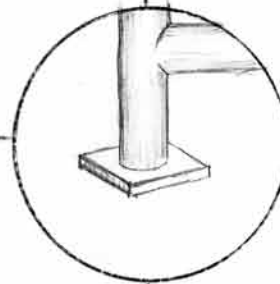
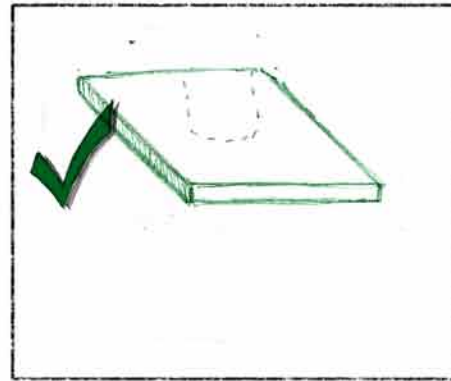
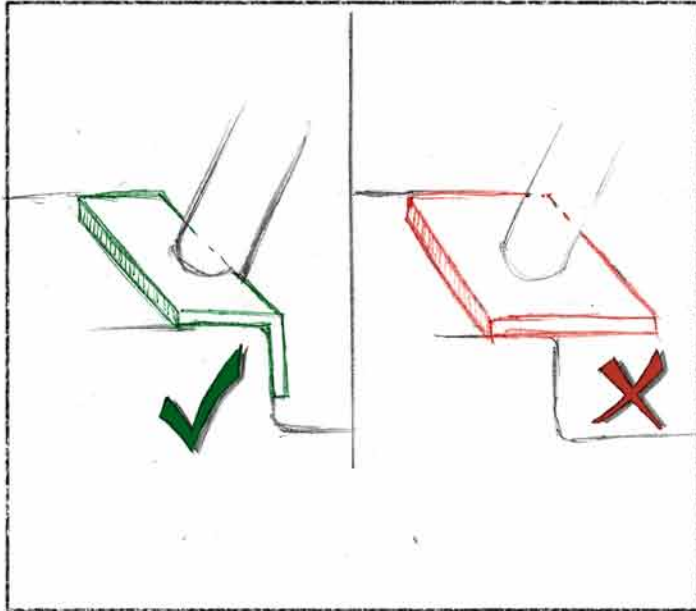

In a crash, downtubes can tear through sheetmetal like paper. Spreader plates (so named for helping to spread out the load) are the solution. Plates should be big (24 square inches minimum is a good rule of thumb); beefy; continuously welded to solid body or frame parts; and shaped to conform to the structure below.

ROLL CAGE - FIG. 8
GOOD BENDS



Good, pro-quality bends come from good, pro-quality tools; those Harbor Freight hand-pump-and-die jobbies are worthless here. Stretched, crimped, or pinched tubes will get you an instant fail.



BACKSTAYS FIG. 1
ANGLES AND STRAIGHTNESS

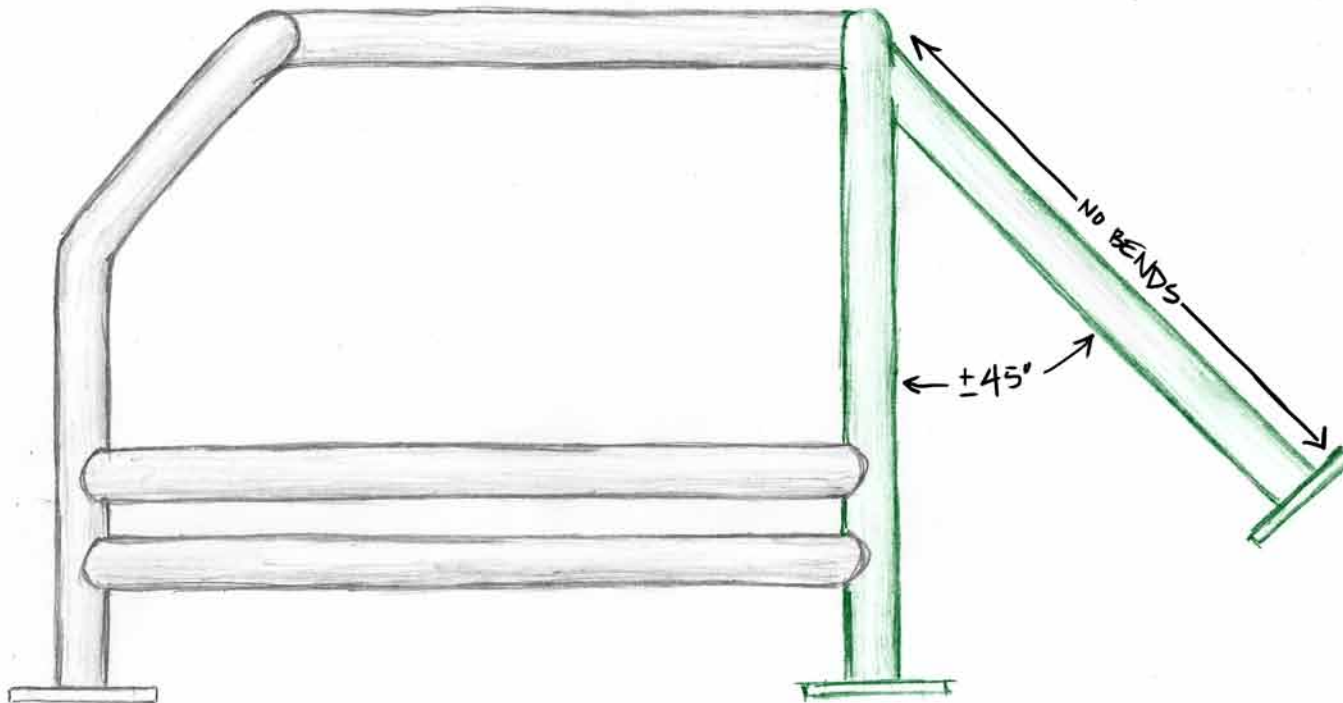

Backstays keep the main hoop from folding over or flattening down from the top. They need to be straight with no bends, securely attached top and bottom, and right around 45 degrees off horizontal.

BACKSTAYS - FIG. 2
 PROPER POSITIONING

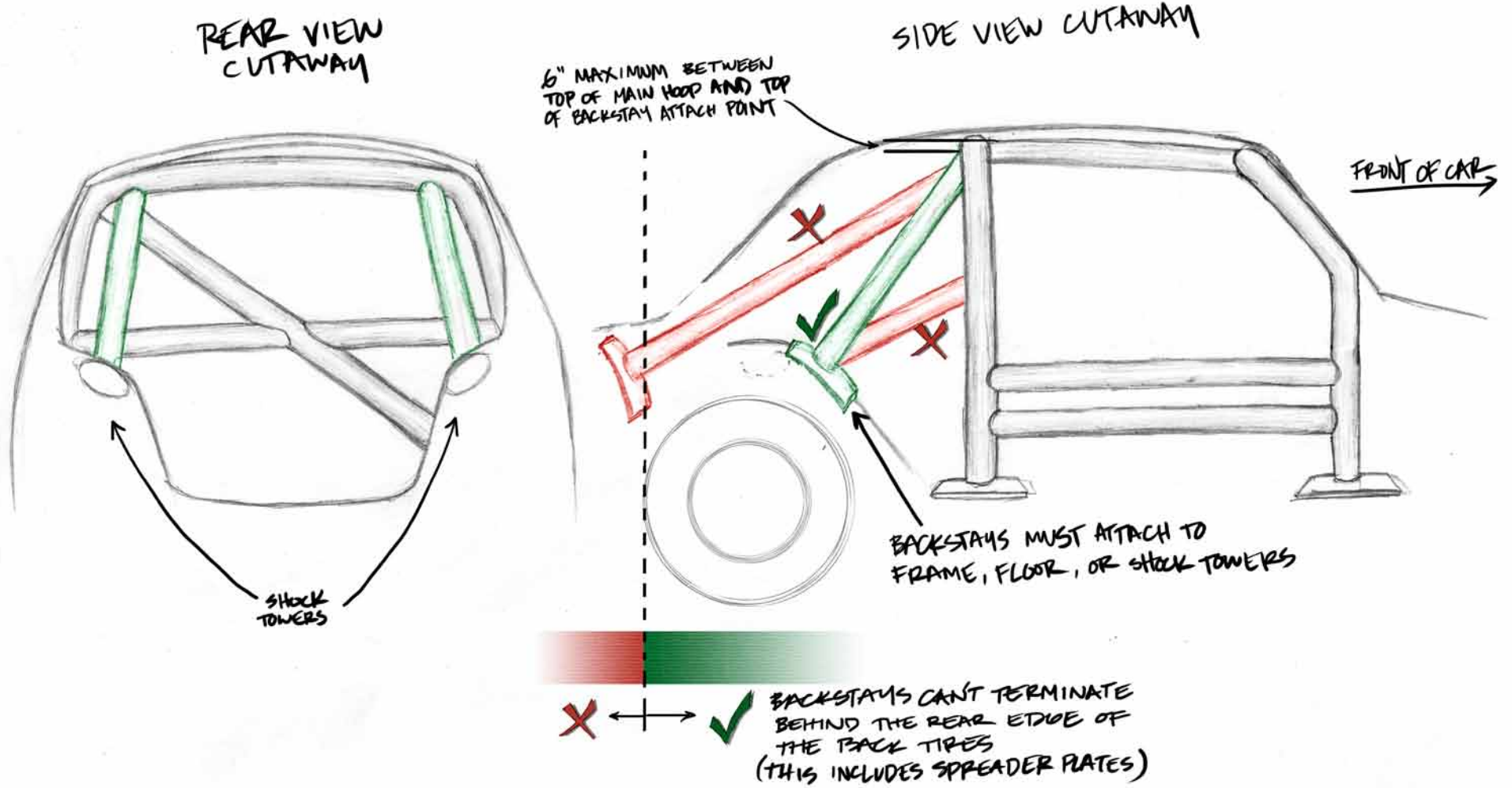

Every car's different, but places like shock towers and rear-seat bases often get reinforced at the factory, which can make them good mounting points. Just make sure the spreader plates are formed to the weird-shaped contours beneath.

BACKSTAYS-FIG. 3
WRONG ANCHOR POSITION

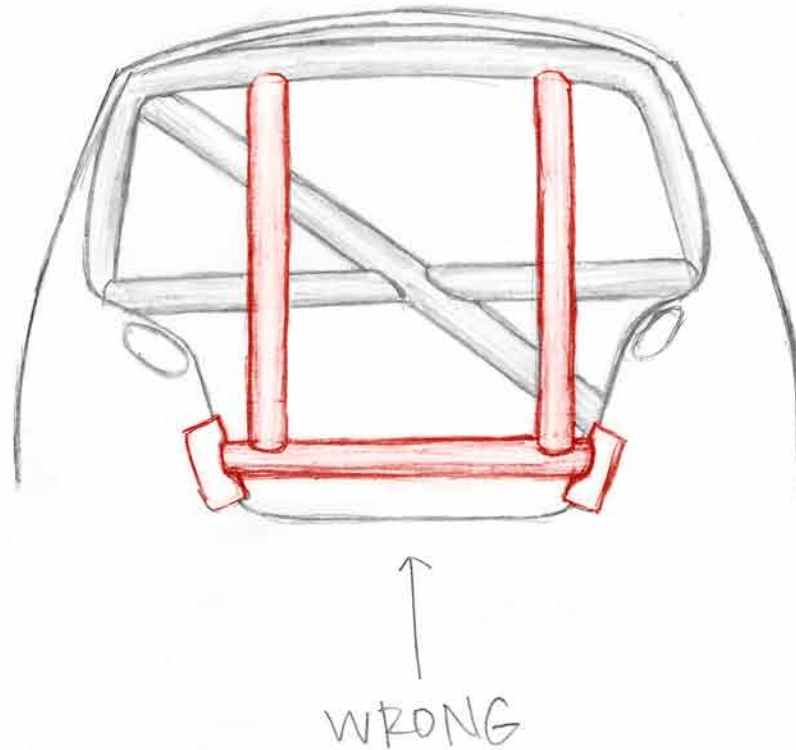

We don't care how they do it down 'ta the local dirt track—don't do this for LEMONS. If you're that desperate to tie your shock towers together, use a separate bar. The backstays need to go all the way down to the car with no bends or interruptions.

SEAT/HARNESSES-FIG.1

MOUNTING REQUIREMENTS

A head-on crash can generate 80g of deceleration—that means your beer-swilling, 220-pound frame suddenly weighs about nine tons. Extremely strong seat mounts and very precise belt angles are needed to keep all that mass from slipping right through the webbing or crushing your internal organs.

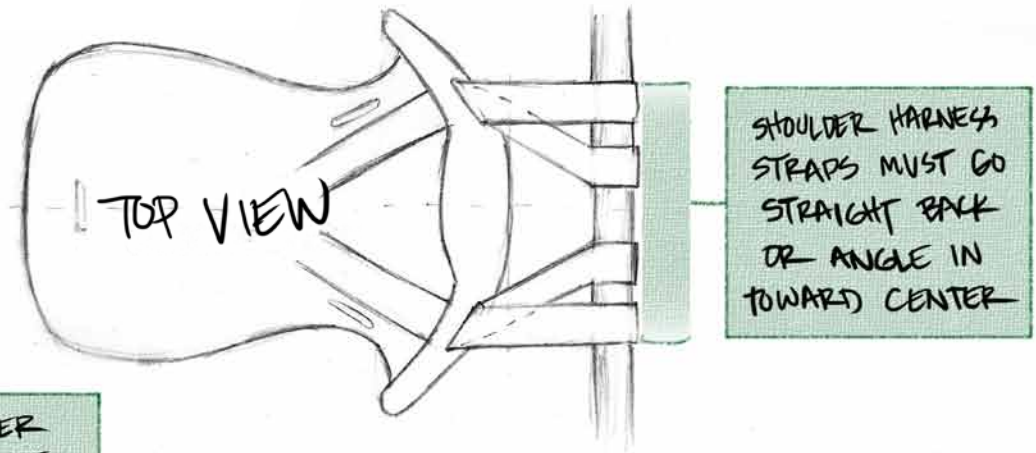

SHOULDER HARNESS STRAPS MUST GO STRAIGHT BACK OR ANGLE IN TOWARD CENTER

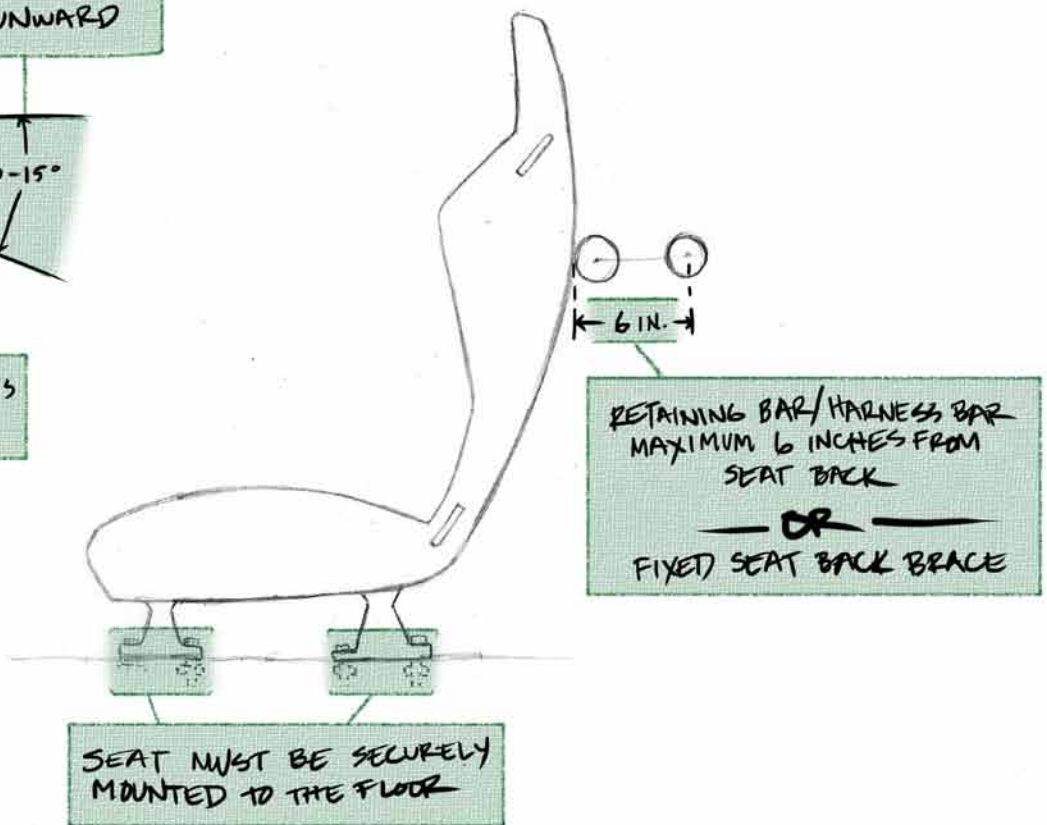
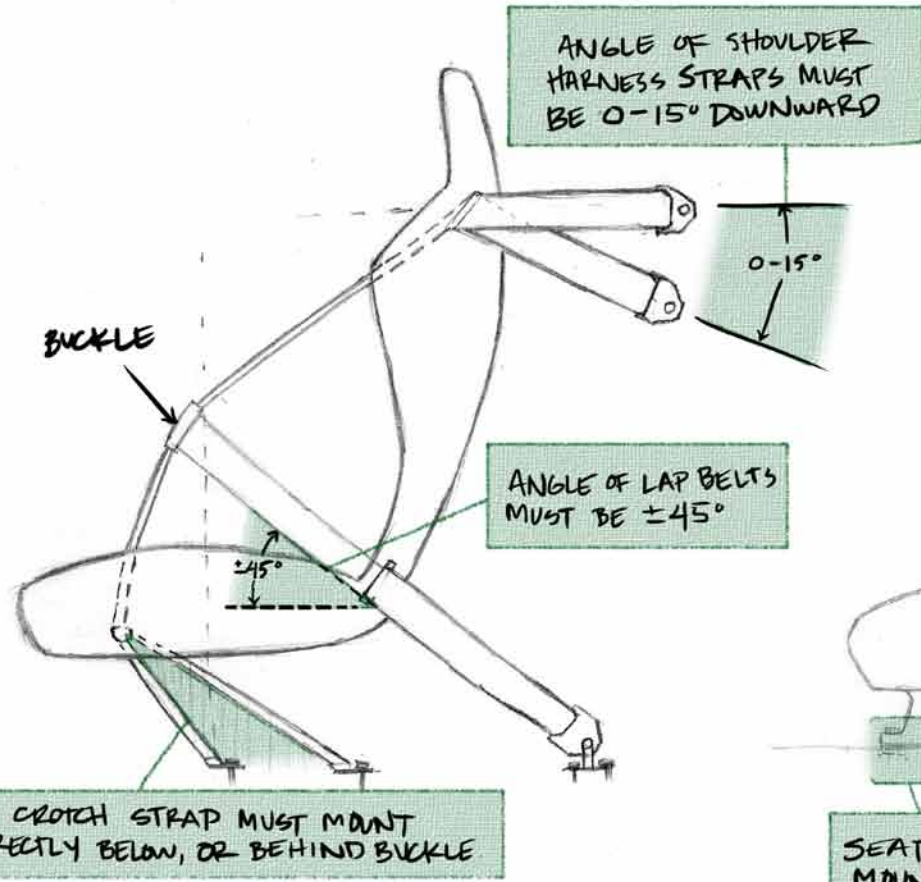

SEAT/HARNESS - FIG. 2
CORRECT LOOPING

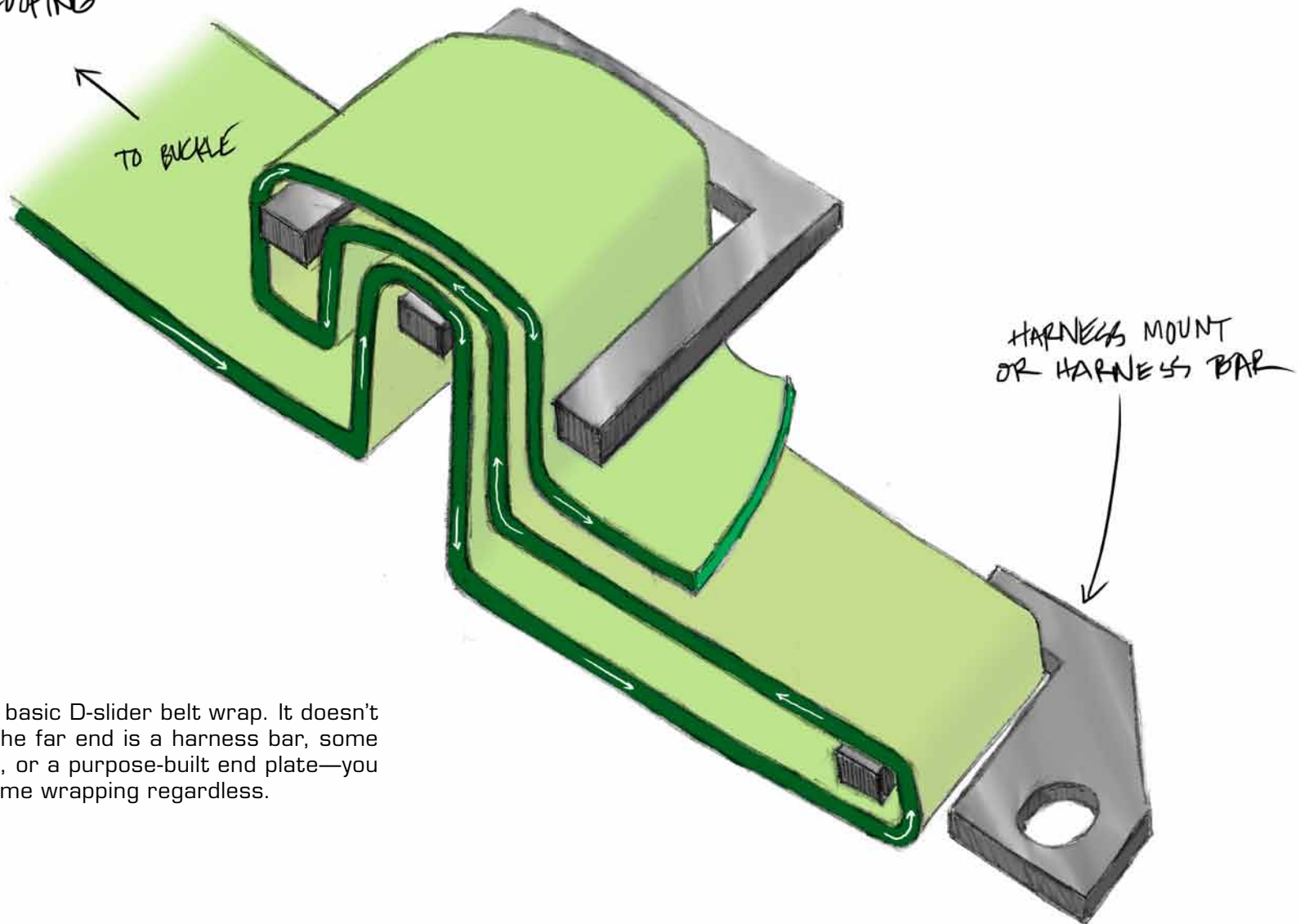

Here's the basic D-slider belt wrap. It doesn't matter if the far end is a harness bar, some other tube, or a purpose-built end plate—you use the same wrapping regardless.

FIREWALL - FIG. 1 PATCHES/PLUGS

NO



HOLES



TAPED OVER
HOLES



CHEWING GUM,
ETC.



IMPROPERLY-SIZED
GROMMETS

YES

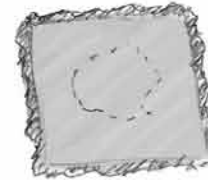

SOLID METAL
PLUGS/PATCHES



PROPERLY-SIZED
GROMMETS

Know why they call it a firewall? *Because it keeps fire away.* No daylight allowed here—good, solid metal or purpose-made rubber grommets required. Duct tape, boogers, bare holes...not so much.

FUEL CELL - FIG. 1 FIA CERTIFICATION

Stock tanks in the stock location are fine. But if you're going to switch to a fuel cell, what most catalogs call "fuel cells" are really just big plastic gas cans with drain holes. A real fuel cell has a separate metal case, an internal deformable fuel vessel, splash- and leak-fighting foam filler, and purpose-built fittings and mounting. Everything else is just another gas tank, and frequently less safe than stock.



THE ONLY FUEL TANK THAT DOES NOT REQUIRE A FULL METAL BULKHEAD BETWEEN IT AND THE DRIVER'S COMPARTMENT IS AN FIA CERTIFIED FUEL CELL.

FUEL CELL - FIG. 2 LOCATION AND BULKHEAD

Always mount any non-OE tank or cell high enough to avoid punctures, low enough to avoid rollovers, and far enough away from the car's edges to avoid typical accidents. It also needs to be very solidly located, correctly vented and plumbed, and (unless it's a current FIA-certified cell) 100% isolated from the cabin by a continuous metal bulkhead. Yes, that includes hatchbacks and wagons.

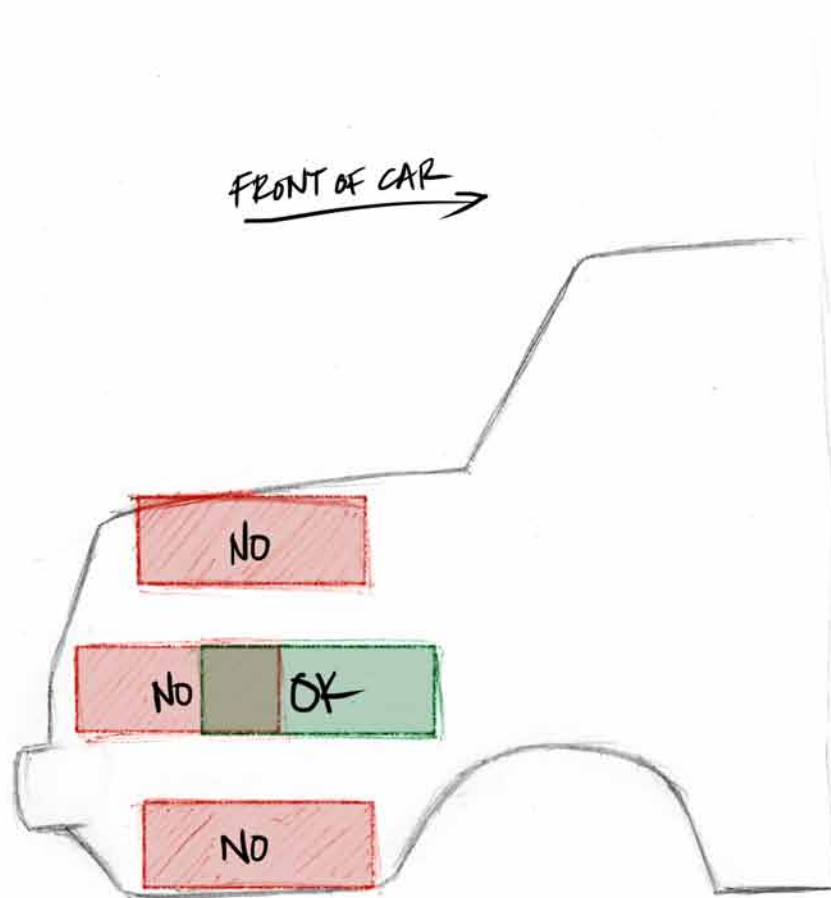

THE FUEL CELL SHOULD BE POSITIONED SO THAT IT IS NOT TOO HIGH, TOO LOW, OR TOO EASY TO CREAM FROM BEHIND

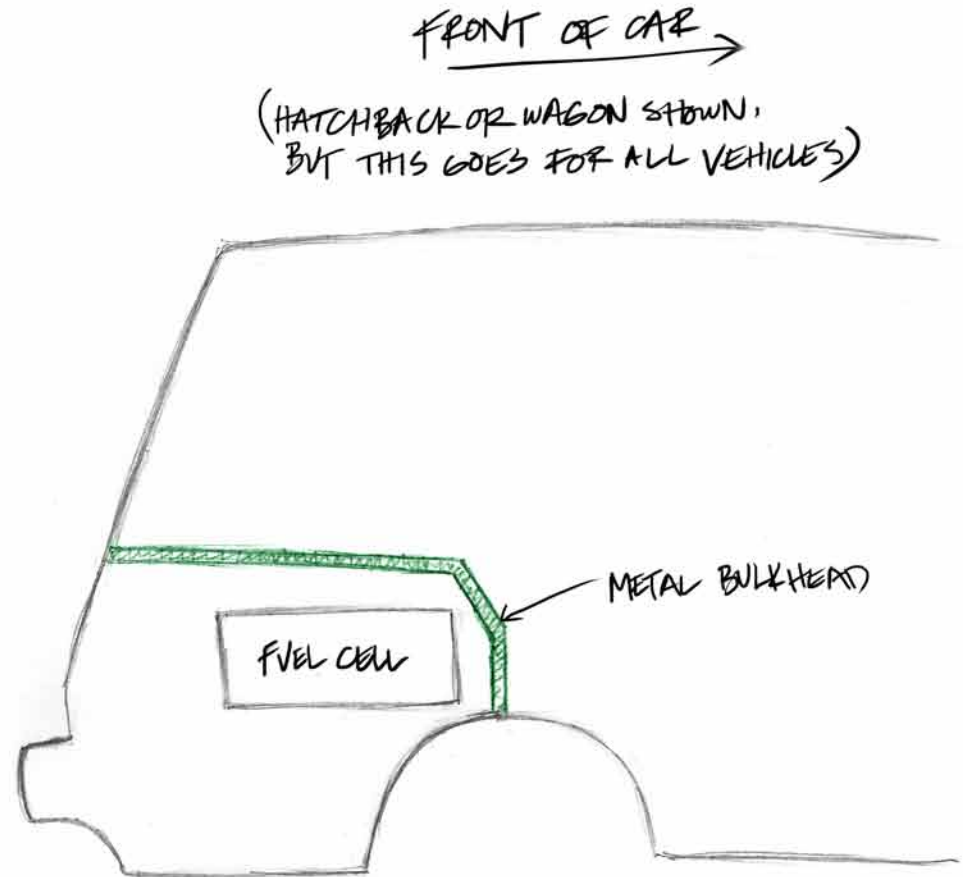

ALL NON-FIA CERTIFIED FUEL CELLS MUST BE PROTECTED FROM THE COCKPIT BY A METAL BULKHEAD.

INTERIOR SANITATION-FIG.1 WIRES AND HOSES

NO

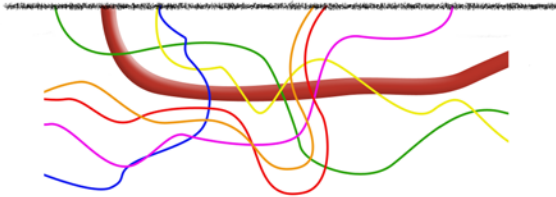

YES

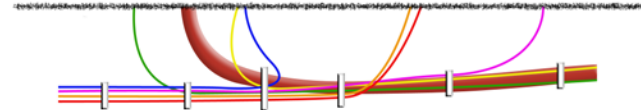

TIDY UP LOOSE OR STRAY WIRES AND HOSES IN THE COCKPIT.
USE A CRAPLOAD OF ZIPTIES. THE FAA REQUIRES ZIPTIES
EVERY 4 INCHES IN AIRCRAFT WIRING, SO THINK THAT WAY.
THINGS NEED TO BE KEPT FROM GETTING IN THE WAY OF THE
DRIVER, OR, IF NEEDED BE, THE RESCUER.

Rat's-nest hoses and wires are, admittedly, entertaining. Alas, they also have a nasty habit of snagging control lines, causing mysterious cutouts, and catching on fire. That's why Al Gore invented the Zip-Tie. Use 'em.

WINDSHIELD FIG. 1 VISION

A few minor cracks or stars? No biggie. But end-to-end cracks, soft areas that compromise strength, or anything obscuring the driver's vision is a no-no. Remember, a small crack can turn into a big one under racing stresses, leading to a black flag—so if you've got any doubt just replace it. Glass doesn't count toward the \$500 limit.

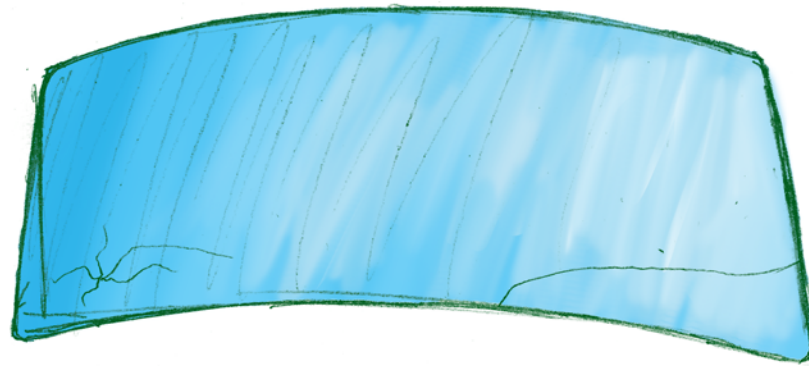

✓ OK

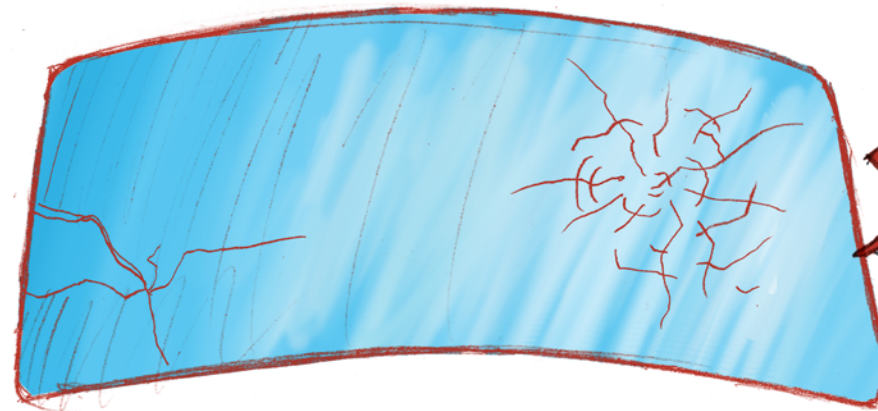

✗ NO

NO CRACKS OBSCURING DRIVER'S VISION. MINOR STARS AND CRACKS OUTSIDE OF DRIVER'S VISION ARE OKAY, BUT NOTHING THAT CAN IMPEDE VISION OR COMPROMISE WINDSHIELD STRENGTH