

PRIMA: Planner-Reasoner Inside a Multi-task Reasoning Agent

Daoming Lyu
Auburn University, Auburn, AL
daoming.lyu@auburn.edu

Bo Liu
Auburn University, Auburn, AL
boliu@auburn.edu

Jianshu Chen
Tencent AI Lab, Bellevue, WA
jianshuchen@tencent.com

Abstract

We consider the problem of multi-task reasoning (MTR), where an agent can solve multiple tasks via (first-order) logic reasoning. This capability is essential for human-like intelligence due to its strong generalizability and simplicity for handling multiple tasks. However, a major challenge in developing effective MTR is the intrinsic conflict between reasoning capability and efficiency. An MTR-capable agent must master a large set of “skills” to tackle diverse tasks, but executing a particular task at the inference stage requires only a small subset of immediately relevant skills. How can we maintain broad reasoning capability and also efficient specific-task performance? To address this problem, we propose a Planner-Reasoner framework capable of state-of-the-art MTR capability and high efficiency. The Reasoner models shareable (first-order) logic deduction rules, from which the Planner selects a subset to compose into efficient reasoning paths. The entire model is trained in an end-to-end manner using deep reinforcement learning, and experimental studies over a variety of domains validate its effectiveness.

1 Introduction

Multi-task learning (MTL) (Zhang and Yang, 2021; Zhou et al., 2011) demonstrates superior sample complexity and generalizability compared with the conventional “one model per task” style to solve multiple tasks. Recent research has additionally leveraged the great success of deep learning (LeCun et al., 2015) to empower learning deep multi-task models (Zhang and Yang, 2021; Crawshaw, 2020). Deep MTL models either learn a common multi-task feature representation by sharing several bottom layers of deep neural networks (Zhang et al., 2014; Liu et al., 2015; Zhang et al., 2015; Mrksic et al., 2015; Li et al., 2015), or learn task-invariant and task-specific neural modules (Shinohara, 2016; Liu et al., 2017) via generative adversarial networks (Goodfellow et al., 2014). Although MTL is successful in many applications, a major challenge is the often impractically large MTL models. Although still smaller than piling up all models across different tasks, existing MTL models are significantly larger than a single model for tackling a specific task. This results from the intrinsic conflict underlying all MTL algorithms: balancing *across-task generalization capability* to perform different tasks with *single-task efficiency* in executing a specific task. On the one hand, good generalization ability requires an MTL agent to be equipped with a large set of skills that can be combined to solve many different tasks. On the other hand, solving one particular task does not require all these skills. Instead, the agent needs to compose only a (small) subset of these skills into an efficient solution for a specific task. This conflict often hobbles existing MTL approaches.

This paper focuses on multi-task reasoning (MTR), a subarea of MTL that uses logic reasoning to solve multiple tasks. MTR is ubiquitous in human reasoning, where humans construct different reasoning paths for multiple tasks from the *same* set of reasoning skills. Conventional deep learning, although capable of strong expressive power, falls short in reasoning capabilities (Bengio, 2019). Considerable research has been

devoted to endowing deep learning with logic reasoning abilities, the results of which include Deep Neural Reasoning (Jaeger, 2016), Neural Logic Reasoning (Besold et al., 2017; Bader et al., 2004; Bader and Hitzler, 2005), Neural Logic Machines (Dong et al., 2019), and other approaches (Besold et al., 2017; Bader et al., 2004; Bader and Hitzler, 2005). However, these approaches consider only single-task reasoning rather than a multi-task setting, and applying existing MTL approaches to learning these neural reasoning models leads to the same conflict between *across-task generalization* and *single-task efficiency*.

To strike a balance between reasoning capability and efficiency in MTR, we develop a *Planner-Reasoner architecture Inside a Multi-task reasoning Agent* (PRIMA) (Section 3), wherein the reasoner defines a set of neural logic operators for modeling reusable reasoning meta-rules (“skills”) across tasks (Section 3.2). When defining the logic operators, we focus on first-order logic because of its simplicity and wide applicability to many reasoning problems, such as automated theorem proving (Fitting, 2012; Gallier, 2015) and knowledge-based systems (Van Harmelen et al., 2008). A separate planner module activates only a small subset of the meta-rules necessary for a given task and composes them into a deduction process (Section 3.3). Thus, our planner-reasoner architecture features the dual capabilities of *composing* and *pruning* a logic deduction process, achieving a graceful capability-efficiency tradeoff in MTR. The model architecture is trained in an end-to-end manner using deep reinforcement learning (Section 4), and experimental results on several benchmarks demonstrate that this framework leads to a state-of-the-art balance between capability and efficiency (Section 5). We discuss related works in Section 6, and conclude our paper in Section 7.

2 Problem Formulation

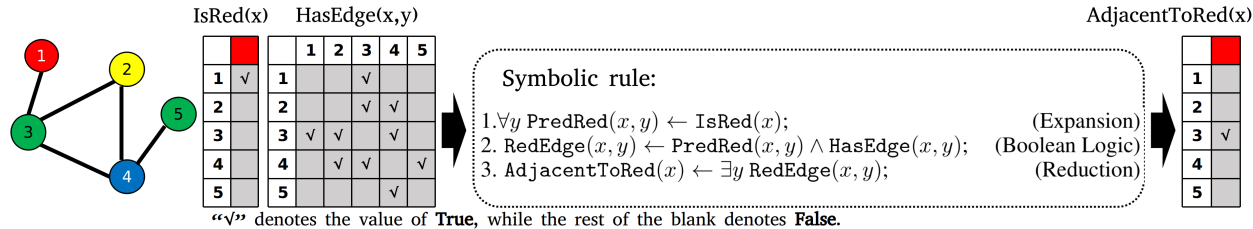

Figure 1: An example from the `AdjacentToRed` task and its formulation as a logical reasoning problem.

Logic reasoning We begin with a brief introduction of the logic reasoning problem. Specifically, we consider a special variant of the First-Order Logic (FOL) system, which only consists of *individual variables*, *constants* and up to r -ary *predicate variables*. That is, we do not consider *functions* that map individual variables/constants into *terms*. An r -ary predicate $p(x_1, \dots, x_r)$ can be considered as a relation between r constants, which takes the value of **True** or **False**. An atom $p(x_1, \dots, x_r)$ is an r -ary predicate with its arguments x_1, \dots, x_r being either variables or constants. A *well-defined formula* in our FOL system is a logical expression that is composed from atoms, logical connectives (e.g., negation \neg , conjunction \wedge , disjunction \vee , implication \leftarrow), and possibly existential \exists and universal \forall quantifiers according to certain formation rules (see Andrews (2002) for the details). In particular, the quantifiers \exists and \forall are only allowed to be applied to individual variables in FOL. In Fig. 1, we give an example from the `AdjacentToRed` task (Graves et al., 2016) and show how it could be formulated as a logical reasoning problem. Specifically, we are given a random graph along with the *properties* (i.e., the color) of the nodes and the *relations* (i.e., connectivity) between nodes. In our context, each node i in the graph is a *constant* and an *individual variable* x takes values in the set of constants $\{1, \dots, 5\}$. The properties of nodes and the relations between nodes are modeled as the unary predicate `IsRed(x)` (5×1 vector) and the binary predicate `HasEdge(x, y)` (5×5 matrix), respectively. The objective of logical reasoning is to deduce the value of the unary predicate `AdjacentToRed(x)` (i.e., whether a node x has a neighbor of red color) from the *base* predicates `IsRed(x)` and `HasEdge(x, y)` (see Fig. 1 for an example of the deduction process).

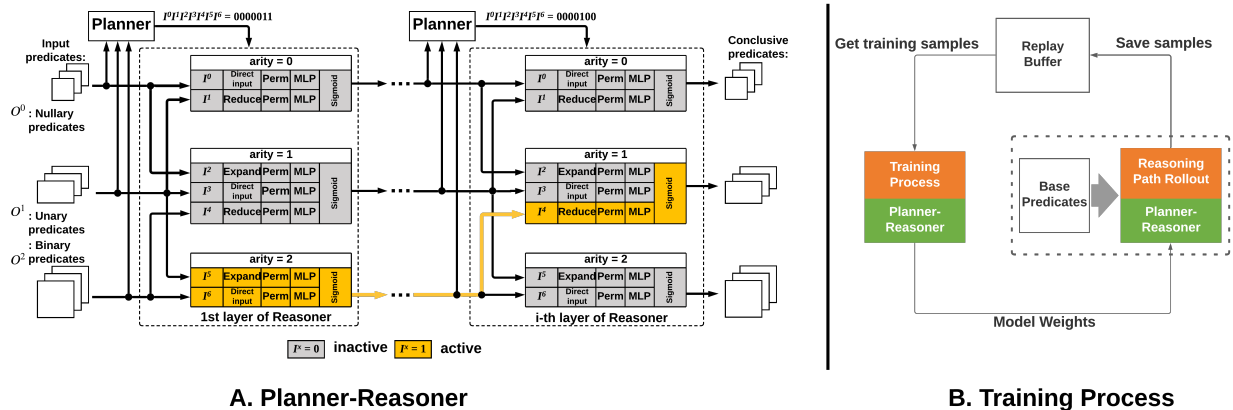

Figure 2: Left (A): The Planner-Reasoner Architecture with an example solution. Right (B): The overall (end-to-end) training process of the model by deep reinforcement learning. “Perm” denotes **Per**mute operator.

Multi-task reasoning Next, we introduce the definition of MTR. With a slight abuse of notations, let $\{p(x_1, \dots, x_r) : r \in [1, n]\}$ be the set of input predicates sampled from any of the k different reasoning tasks, where x_1, \dots, x_r are the individual variables and n is the maximum arity. A multi-task reasoning model takes $p(x_1, \dots, x_r)$ as its input and seeks to predict the corresponding ground-truth output predicates $q(x_1, \dots, x_r)$. The aim is to learn multiple reasoning tasks jointly in a single model so that the reasoning skills in a task can be leveraged by other tasks to improve the general performance of all tasks at hand.

3 PRIMA: Planner-Reasoner for Multi-task Reasoning

In this section, we develop our PRIMA framework, which is a novel neural-logic model architecture for multi-task reasoning. We begin with an introduction to the overall architecture (Section 3.1) along with its key design insights, and then discuss its two modules in Sections 3.2–3.3.

3.1 The Overall Model Architecture of PRIMA

Logic reasoning typically seeks to chain an appropriate sequence of logic operators to reach desirable logical consequences from premises. There are two types of chaining to conduct logic reasoning: (i) forward-chaining and (ii) backward-chaining. The forward-chaining strategy recursively deduces all the possible conclusions based on all the available facts and deduction rules until it reaches the answer. In contrast, backward-chaining starts from the desired conclusion (i.e., the goal) and then works backward recursively to validate conditions through available facts. This paper adopts the forward-chaining strategy since the goal is unavailable here beforehand. Note that, in the MTR setting, it generally requires a large set of “skills” (logic operators) to tackle diverse tasks. Therefore, it is unrealistic to recursively generate all possible conclusions by chaining all the available deduction rules as in the vanilla forward-chaining strategy. Therefore, pruning the forward-chaining process is essential to improve MTR’s reasoning efficiency.

We note that reasoning via pruned forward-chaining could be implemented by: (i) constructing the elementary logic operators and (ii) selecting and chaining a subset of these logic operators together. Accordingly, we develop a novel neural model architecture, named Planner-Reasoner (see Figure 2A), to jointly accomplish these two missions with two interacting neural modules. Specifically, a “Reasoner” defines a set of neural-logic operators (representing learnable Horn clauses (Horn, 1951)). Meanwhile, a “Planner” learns to select and chain a small subset of these logic operators together towards the correct solution (e.g., the orange-colored path in Figure 2A). The inputs to the Planner-Reasoner model are the base predicates $\{p, p(x), p(x, y), \dots\}$ that describe the premises. In particular, in the MTR setting, the nullary predicate p characterizes the

current task to be solved. This design allows the Planner to condition its decisions on the input task type. We feed the outputs (i.e., the conclusion predicates) into multiple output heads, one for each task (just as in standard multitask learning), to generate predictions. The entire model is trained in a complete data-driven end-to-end approach via deep reinforcement learning (Figure 2B and Section 4): it trains the Planner to dynamically prune the forward-chaining process while jointly learning the logic operators in the Reasoner, leading to a state-of-the-art balance between MTR capability and efficiency (Section 5).

3.2 Reasoner: transforming logic rules into neural operators

The Reasoner module conducts logical deduction using a set of neural operators constructed from first-order logic rules (more specifically, a set of “learnable” Horn clauses). Its architecture is inspired by NLM (Dong et al., 2019) (details about the difference can be found in Appendix D). Three logic rules are considered as essential meta-rules: **BooleanLogic**, **Expansion**, and **Reduction**. **BooleanLogic**: $\text{expression}(x_1, x_2, \dots, x_r) \rightarrow \hat{p}(x_1, x_2, \dots, x_r)$, where **expression** is composed of a combination of Boolean operations (**AND**, **OR**, and **NOT**) and \hat{p} is the *output predicate*. For a given r -ary predicate and a given permutation $\psi \in S_n$, we define $p_\psi(x_1, \dots, x_r) = p(x_{\psi(1)}, \dots, x_{\psi(r)})$ where S_n is the set of all possible permutations as the arguments to an input predicate. The corresponding neural implementation of **BooleanLogic** is $\sigma(\text{MLP}(p_\psi(x_1, \dots, x_r)); \theta)$, where σ is the sigmoid activation function, **MLP** refers to a multi-layer perceptron, a **Permute**(\cdot) neural operator transforms input predicates to $p_\psi(x_1, \dots, x_r)$, and θ is the learnable parameter within the model. This is similar to the implicit Horn clause with the universal quantifier (\forall), e.g., $p_1(x) \wedge p_2(x) \rightarrow \hat{p}(x)$ implicitly denoting $\forall x p_1(x) \wedge p_2(x) \rightarrow \hat{p}(x)$. The class of neural operators can be viewed as “learnable” Horn clauses.

Expansion, and **Reduction** are two types of meta-rules for quantification that bridge predicates of different arities with logic quantifiers (\forall and \exists). **Expansion** introduces a new and distinct variable x_{r+1} for a set of r -ary predicates with the universal quantifier (\forall). For this reason, **Expansion** creates a new predicate q from p . **Expansion**: $p(x_1, x_2, \dots, x_r) \rightarrow \forall x_{r+1}, q(x_1, x_2, \dots, x_r, x_{r+1})$, where $x_{r+1} \notin \{x_i\}_{i=1}^r$. The corresponding neural implementation of **Expansion**, denoted by **Expand**(\cdot), expands the r -ary predicates into the $(r + 1)$ -ary predicates by repeating the r -ary predicates and stacking them in a new dimension. Conversely, **Reduction** removes x_{r+1} in a set of $(r + 1)$ -ary predicates via the quantifiers of \forall or \exists . **Reduction**: $\forall x_{r+1} p(x_1, x_2, \dots, x_r, x_{r+1}) \rightarrow q(x_1, x_2, \dots, x_r)$, or $\exists x_{r+1} p(x_1, x_2, \dots, x_r, x_{r+1}) \rightarrow q(x_1, x_2, \dots, x_r)$. The corresponding neural implementation of **Reduction**, denoted by **Reduce**(\cdot), reduces the $(r + 1)$ -ary predicates into the r -ary predicates by taking the minimum (resp. maximum) along the dimension of x_{r+1} for the universal quantifier \forall (resp. existential quantifier \exists).

3.3 Planner: activating and forward-chaining learnable Horn clauses

The Planner is our key module to address the capability-efficiency tradeoff in the MTR problem; it is responsible for activating the neural operators in the Reasoner and chaining them into reasoning paths. Existing learning-to-reason approaches, which are often based on inductive logic programming (ILP) (Cropper et al., 2020; Cropper and Dumancic, 2020; Muggleton and De Raedt, 1994) and the correspondingly neural-ILP methods (Dong et al., 2019; Shi et al., 2020). Conventional ILP methods suffer from several drawbacks, such as heavy reliance on human-crafted templates and sensitivity to noise. On the other hand, neural-ILP methods (Dong et al., 2019; Shi et al., 2020), leveraging the strength of deep learning and ILP, such as the Neural Logic Machine (NLM) (Dong et al., 2019), lack explicitness in the learning process of searching for reasoning paths. Let us take the learning process of NLM for example, which follows an intuitive two-step procedure. It first fully connects all the neural blocks and then searches all possible connections (corresponding to all possible predicate candidates) exhaustively to identify the desired reasoning path (corresponding to the desired predicate).

By using our proposed Planner module, we can strike a better capability-efficiency tradeoff. Rather than conducting an exhaustive search over all possible predicate candidates as in NLM, the Planner prunes all the unnecessary operators and identifies an essential reasoning path with low complexity for a given problem. Consider the following example. As shown in Fig. 1 and Fig. 2A (the highlighted orange-colored blocks), at each reasoning step, the Planner takes the input predicates and determines which neural operators should be

activated. The decision is represented as a binary vector — $[I^0 \dots I^6]$ (termed *operator footprint*) — that corresponds to the neural operators of Expand, Reduce and DirectInput at different arity groups. DirectInput is an identity mapping where its following operations of Permute, MLP and sigmoid nonlinearity can directly approximate the `BooleanLogic`. By chaining these sequential decisions, a sequence of operator footprints is formulated as a reasoning path, as the highlighted orange-colored path in Fig. 2A. Generally, the neural operators defined in the Reasoner can also be viewed as (learnable) Horn Clauses (Horn, 1951; Chandra and Harel, 1985), and the Planner *forward-chains* them into a reasoning path.

4 Learning-to-Reason via Reinforcement Learning

In our problem, the decision variables of the Planner are binary indicators of whether a neural operator module should be activated. Readers familiar with Markov decision processes (MDPs) (Puterman, 2014) might notice that the reasoning path of our model in Fig. 2A resembles a temporal rollout in MDP formulation (Sutton and Barto, 2018). Therefore, we frame learning-to-reason as a sequential decision-making problem and adopt off-the-shelf reinforcement learning (RL) algorithms.

4.1 An MDP formulation of the learning-to-reason problem

An MDP is defined as the tuple $(\mathcal{S}, \mathcal{A}, P_{ss'}^a, R, \gamma)$, where \mathcal{S} and \mathcal{A} are finite sets of states and actions, the transition kernel $P_{ss'}^a$ specifies the probability of transition from state $s \in \mathcal{S}$ to state $s' \in \mathcal{S}$ by taking action $a \in \mathcal{A}$, $R(s, a) : \mathcal{S} \times \mathcal{A} \rightarrow \mathbb{R}$ is the reward function, and $0 \leq \gamma \leq 1$ is a discount factor. A stationary policy $\pi : \mathcal{S} \times \mathcal{A} \rightarrow [0, 1]$ is a probabilistic mapping from states to actions. The primary objective of an RL algorithm

is to identify a near-optimal policy π^* that satisfies $\pi^* := \arg \max_{\pi} \left\{ J(\pi) := \mathbb{E} \left[\sum_{t=0}^{T_{\max}-1} \gamma^t r(s_t, a_t \sim \pi) \right] \right\}$,

where T_{\max} is a positive integer denoting the horizon length — that is, the maximum length of a rollout. The resemblance between Fig. 2 and an MDP formulation is relatively intuitive as summarized in Table 1. At the t -th time step, the state s_t corresponds to the set of predicates, $s_t = [O_t^0, O_t^1, O_t^2]$, with the superscript denoting the corresponding arity. The action $a_t = [I_t^0, I_t^1, \dots, I_t^{K-1}]$ (e.g., $a_0 = [000011]$) is a binary vector that indicates the activated neural operators (i.e., the operator footprint), where K is the number of operators per layer. The reward r_t is defined to be

$$r_t := \begin{cases} -\sum_{i=0}^{K-1} I_t^i, & \text{if } t < T_{\max} \\ \text{Accuracy}, & t = T_{\max} \end{cases}. \quad (1)$$

That is, the terminal reward is set to be the reasoning accuracy at the end of the reasoning path (see Appendix A.2 for its definition), and the intermediate reward at each step is chosen to be the negated number of activated operators (which penalizes the cost of performing the current reasoning step). The transition kernel $P_{ss'}^a$ corresponds to the function modeled by one Reasoner layer; each Reasoner layer will take the state (predicates) $s_{t-1} = [O_{t-1}^0, O_{t-1}^1, O_{t-1}^2]$ and the action (operator footprint) $a_t = [I_t^0, I_t^1, \dots, I_t^{K-1}]$ as its input and then generate the next state (predicates) $s_t = [O_t^0, O_t^1, O_t^2]$. This also implies that the Reasoner layer defines a deterministic transition kernel, i.e., given s_{t-1} and a_t the next state s_t is determined.

Table 1: The identification between the concepts of PRIMA and that of RL at the t -th time step.

RL	State s_t	Action a_t	Reward r_t	Transition Kernel $P_{ss'}^a$	Policy	Rollout
PRIMA	Predicates of different arities: $[O_t^0, O_t^1, O_t^2]_t$	Operator footprint: $[I_t^0 \dots I_t^{K-1}]$	Eq. (1)	One layer of Reasoner	Planner	Reasoning path

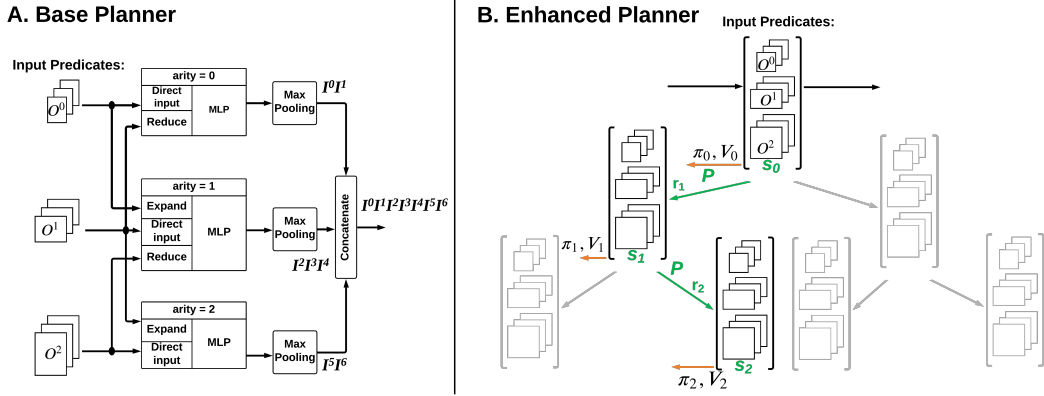

Figure 3: The architecture of the Base Planner and its enhanced version. Left: The Base Planner is based on a one-layer fully-activated Reasoner followed by max-pooling operations to predict an indicator of whether an op should be activated. Right: The Enhanced Planner uses MCTS to further boost the performance.

4.2 Policy network: modeling of planner

The Planner module is embodied in the policy network. As shown in Fig. 3A, the base planner is a separate module that has the same architecture of 1-layer (fully-activated) Reasoner followed by a max-pooling layer. This architecture enables the reduction of input predicates to the specific indicators by reflecting whether the operations at the corresponding position of one layer of Reasoner are active or inactive. Further, we can also leverage Monte-Carlo Tree Search (MCTS) (Browne et al., 2012; Munos, 2014) to boost the performance, which leads to an Enhanced Planner (Fig. 3B). An MCTS algorithm such as the Upper Confidence Bound for Trees (UCT) method (Kocsis et al., 2006), is a model-based RL algorithm that plans the best action at each time step (Browne et al., 2012) by constructing a search tree, with states as nodes and actions as edges. The Enhanced Planner uses MCTS to exploit partial knowledge of the problem structure (i.e., the deterministic transition kernel $P_{ss'}^a$, defined by the Reasoner layer) and construct a search tree to help identify the best actions (which ops to activate). Details of the MCTS algorithms used in the Enhanced Planner can be found in Appendix A.1.

4.3 Overall learning framework

As illustrated in Fig. 3, we introduce concrete data-driven decision-making methods—that is, RL approaches (Sutton and Barto, 2018)—to address the learning-to-reason problem. To illustrate this, we apply the model-free RL method REINFORCE (Williams, 1992) and the model-based method MuZero (Schrittwieser et al., 2019). Compared with model-free reinforcement learning, model-based reinforcement learning (MBRL) more effectively handles large search-space problems, such as the game of Go (Silver et al., 2017b,b,a). MuZero (Schrittwieser et al., 2019), a recently proposed MBRL approach to integrating planning and learning, has achieved great success with a variety of complex tasks. Motivated by the success of MuZero, we propose an MBRL approach for neural-symbolic reasoning. The key insight behind adopting MuZero is that in real applications, we typically have partial structural knowledge of the transition kernel $P_{ss'}^a$ and reward function $r(s, a)$. As a result of the model-based module, testing complexity can be greatly reduced by adopting MCTS, which leads to a better set of predicates. Of course, MuZero is just one option in the model-based family of approaches. We leave it as future research to propose and compare other model-based alternatives.

The pipeline of the training process is illustrated in Fig.2.B (the right subfigure). After loading the model weights, the reasoning path rollouts are executed by the agent (or model instance), according to the current policy network. The performed reasoning path rollout is then stored in the replay buffer. The Planner-Reasoner is trained via rollouts sampled from the replay buffer.

5 Experimental Results and Analysis

In this section, we evaluate the performance of different variants of PRIMA on eight tasks from the family tree and graph benchmarks (Graves et al., 2016), including `1-Outdegree`, `AdjacentToRed`, `HasFather`, `HasSister`, `4-Connectivity`, `IsGrandparent`, `IsUncle`, `IsMGUncle`. These tasks are widely used benchmarks for inductive logic programming (Krötzsch, 2020; Calautti et al., 2015). Detailed descriptions about those tasks can be found in Appendix B.1. We evaluate their testing accuracy and reasoning cost (measured in FLOPs: the number of floating-point operations executed (Clark et al., 2020)) on these tasks and compare them to several baselines. Furthermore, detailed case studies are conducted on the reasoning path, which indicates the operator sharing among different tasks. All the results demonstrate the graceful capability-efficiency tradeoff of PRIMA in MTR.

5.1 Experimental Setups

In the multi-task setting, we first randomly sample a task according to a pre-defined probability distribution (over different tasks), and then generate the data for the selected task using the same methods as in NLM (Dong et al., 2019). In addition, we also augment the generated data with one-hot encoding to indicate the selected task, which will be further converted into nullary (background) input predicates. Also, task-specific output heads are introduced to generate outputs for different tasks. These adaptations apply to DLM-MTR and PRIMA. The reasoning accuracy is used as the reward. In the inference (or testing) stage, the Reasoner is combined with the learned Base Planner to perform the tasks, instead of an enhanced planner (MCTS), to reduce the extra computation. The problem size for training is always 10 for graph tasks and 20 for family tree tasks across all settings, regardless of the sizes of testing problems.

5.2 Overall performance

Single-task reasoning capability Before we proceed to evaluate the MTR capabilities of PRIMA, we first adapt it to the single-task setting by letting the nullary input predicates to be zero, and then train a separate model for each task. We name this single-task version of PRIMA as PRISA (i.e., *Planner-Reasoner Inside a Single Reasoning Agent*), and compare it with existing (single-task) neural-logic reasoning approaches (e.g., NLM (Dong et al., 2019), DLM (Matthieu et al., 2021), and MemNN (Sukhbaatar et al., 2015)). First, we compare the performance of three different variants of PRISA (Section 4.3) for single-task reasoning, which learns their planners based on different reinforcement learning algorithms; PRISA-REINFORCE uses REINFORCE (Williams, 1992), PRISA-PPO uses PPO (Schulman et al., 2017), and PRISA-MuZero uses MuZero (Schrittwieser et al., 2019). We report the test accuracy and the Percentage of Successful Seeds (PSS) in Table 2 to measure the model’s reasoning *capabilities*, where the PSS reaches 100% of success rates (Matthieu et al., 2021). We note that PRISA-MuZero has the same 100% accuracy as NLM (Dong et al., 2019), DLM (Matthieu et al., 2021), and ∂ ILP (Evans and Grefenstette, 2018) across different tasks, and outperforms MemNN (Sukhbaatar et al., 2015) (shown in the single-task part in Table 3). But it also has a higher successful percentage (PSS) compared to other methods. The results show that PRISA-MuZero achieves the best performance on single-task reasoning, which confirms the strength of the MCTS-based Enhanced Planner (Section 4.3) and the MuZero learning strategy. Therefore, we will use the Enhanced Planner and MuZero in PRISA and PRIMA in the rest of our empirical studies.

Multi-task reasoning capability Next, we evaluate the MTR capabilities of PRIMA. To the best of our knowledge, there is no existing approach designed specifically for MTR. Therefore, we adapt DLM into its multi-task versions, named DLM-MTR, respectively. DLM-MTR follow the same input and output modification as what we did to upgrade PRISA to PRIMA (Section 3.1). By this, we can examine the contribution of our proposed *Planner-Reasoner architecture* for MTR. As shown in Table 3, PRIMA (with MuZero as the Base Planner) performs well (perfectly) on different reasoning tasks. On the other hand, DLM-MTR experiences some performance degradation (on `AdjacentToRed`). This result confirms that our Planner-Reasoner architecture is more suitable for MTR. We conjecture that the benefit comes from using a

Table 2: **Testing Accuracy and PSS** of different variants of PRISA on different tasks. PRISA-MuZero achieves the best performance on single-task reasoning, which confirms the strength of the MCTS-based Enhanced Planner and the MuZero learning strategy. “*m*”: the problem size. “PSS”: Percentage of Successful Seeds.

testing accuracy	Single Task	Family Tree	HasFather	HasSister	IsGrandparent	IsUncle	IsMGUncle	Graph	AdjacentToRed	4-Connectivity	1-OutDegree
		PRISA-REINFORCE	m=20 m=100 PSS	62.6 87.8 0	50.7 69.8 0	96.5 2.3 0	97.3 97.7 0	99.8 98.4 0	m=10 m=50 PSS	47.7 71.6 0	33.5 92.8 0
PRISA-PPO	m=20 m=100 PSS	71.5 93.2 0	64.3 78.7 0	97.5 98.2 0	98.1 97.3 0	99.6 99.1 0	m=10 m=50 PSS	62.3 85.5 0	57.8 95.2 0	61.6 96.3 0	
PRISA-MuZero	m=20 m=100 PSS	100 100 100	100 100 100	100 100 100	100 100 100	100 100 100	m=10 m=50 PSS	100 100 90	100 100 100	100 100 100	

Planner to explicitly select the necessary neural operators for each task, avoiding potential conflicts between different tasks during the learning process.

Experiments are also conducted to test the performance of PRIMA with different problem sizes. The problem size in training is 10 for all graph tasks and 20 for all family-tree tasks. In testing, we evaluate the methods on much larger problem sizes (50 for the graph tasks and 100 for the family tree tasks), which the methods have not seen before. Therefore, the Planner must dynamically activate a proper set of neural operators to construct a path to solve the new problem. As reported in Fig. 4 and Tables 2 and 3, PRIMA can achieve the best accuracy and lower flops when the problem sizes for training and testing are different.

Table 3: **Testing Accuracy and PSS** of PRIMA and other baselines on different reasoning tasks. The results of ∂ ILP, NLM, and DLM are merged in one row due to space constraints and are presented in the same order if the results are different. “*m*”: the problem size. “PSS”: Percentage of Successful Seeds. Numbers in red denote < 100%.

testing accuracy	Single Task	Family Tree	HasFather	HasSister	IsGrandparent	IsUncle	IsMGUncle	Graph	AdjacentToRed	4-Connectivity	1-OutDegree
		MemNN	m=20 m=100 PSS	99.9 59.8 0	86.3 59.8 0	96.5 97.7 0	96.3 96 0	99.7 98.4 0	m=10 m=50 PSS	95.2 93.1 0	92.3 81.3 0
∂ ILP/ NLM/ DLM	m=20 m=100 PSS	100 100 100	100 100 100	100 100 100	100 100 100	100 100 100	m=10 m=50 PSS	100 100 100/ 90/ 90	100 100 100	100 100 100	
DLM-MTR	m=20 m=100 PSS	100 100 100	100 100 100	100 100 100	100 100 100	100 100 100	m=10 m=50 PSS	96.7 97.2 0	100 100 100	100 100 100	
PRIMA	m=20 m=100 PSS	100 100 100	100 100 100	100 100 100	100 100 100	100 100 90	m=10 m=50 PSS	100 100 90	100 100 100	100 100 100	

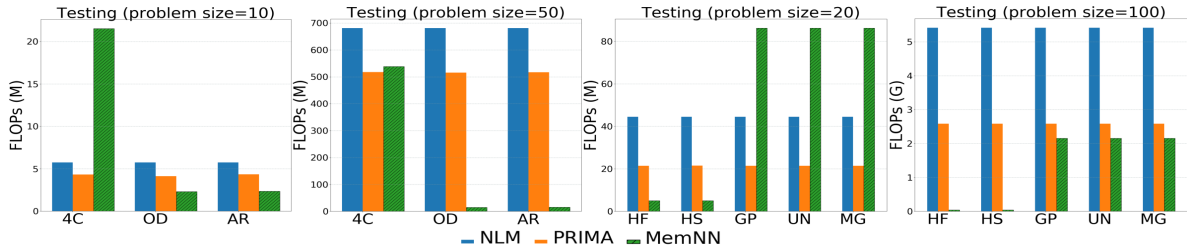

Figure 4: The reasoning costs (in FLOPs) of different models at the inference stage (1 M= 1×10^6 , 1 G= 1×10^9). Compared to NLM family, our PRIMA significantly reduces the reasoning complexity by intelligently selecting ops (short for neural operators) using a planner. Although the FLOPs of MemNN seem low in most cases of testing, its testing accuracy is bad and cannot achieve accurate predictions (see Table 3). “OD” denotes 1-Outdegree, likewise, “AR”:AdjacentToRed, “4C”:4-Connectivity, “HF”:HasFather, “HS”:HasSister, “GP”:IsGrandparent, “UN”:IsUncle, “MG”:IsMGUncle.

Operator/Path sharing in MTR To take a closer look into how PRIMA achieves such a better capability-efficiency tradeoff (in Fig. 4), we examine the reasoning paths on three different graph tasks: **1-Outdegree**, **AdjacentToRed**, and **4-Connectivity**. Specifically, we sample instances from these three tasks and feed them into PRIMA separately to generate their corresponding reasoning paths. The results are plotted in Fig. 5A, where the gray paths denote the ones shared across tasks, and the colored ones are task-specific. It clearly shows that PRIMA learns a large set of neural operators sharable across tasks. Given each input instance from a particular task, PRIMA activates a set of shared paths along with a few task-specific paths to deduce the logical consequences.

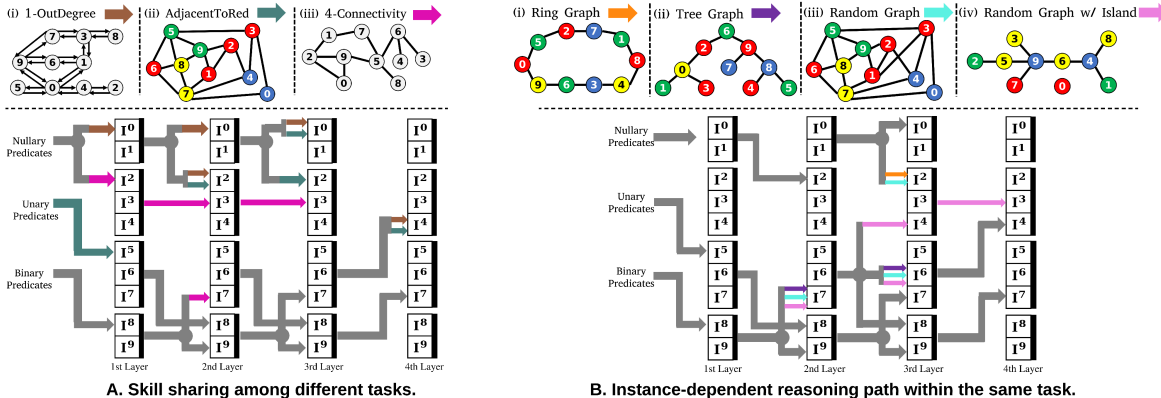

Figure 5: The reasoning paths of PRIMA. The gray arrows denote the “shared path”. The colored arrows in sub-figures (A) and (B) denote task-specific paths and instance-specific paths, respectively. In (A), besides the **AdjacentToRed** task we have introduced earlier, we also consider the **1-Outdegree** task, which reasons about whether the out-degree of a node is exactly equal to 1, and the **4-Connectivity** task, which is to decide whether there are two nodes connected within 4 hops.

Generalizability of the Planner To demonstrate the generalizability of the Planner module in PRIMA, we generate input instances of **AdjacentToRed** with topologies that have not been seen during training. In Fig. 5B, we show the reasoning paths activated by the Planner for these different topologies, which demonstrates that different input instances share a large portion of reasoning paths. This fact is not surprising as solving the same task of **AdjacentToRed** should rely on a common set of skills. More interestingly, we notice that even for solving this same task, the Planner will have to call upon a few *instance-dependent* sub-paths to handle the subtle inherent differences (e.g., the graph topology) that exist between different input instances. For this reason, PRIMA maintains an instance-dependent *dynamic* architecture, which is in sharp contrast to the Neural Architecture Search (NAS) approaches. Although NAS may also use RL algorithms to seek for a smaller architecture (Zoph and Le, 2017), it only searches for a *static* architecture that will be applied to all the input instances.

6 Related Work

Multi-task learning Multi-task Learning (Zhang and Yang, 2021; Zhou et al., 2011; Pan and Yang, 2009) has focused primarily on the supervised learning paradigm, which itself can be divided into several approaches. The first is feature-based MTL, also called multi-task feature learning, (Argyriou et al., 2008), which explores the sharing of features across different tasks using regularization techniques (Shinohara, 2016; Liu et al., 2017). The second approach assumes that tasks are intrinsically related, such as low-rank learning (Ando and Zhang, 2005; Zhang et al., 2005), learning with task clustering (Gu et al., 2011; Zhang et al., 2016), and task-relation learning (such as via task similarity, task correlation, or task covariance) (Goncalves et al., 2016; Zhang, 2013; Ciliberto et al., 2015).

Neural-symbolic reasoning Neural-symbolic AI for reasoning and inference has a long history (Besold et al., 2017; Bader et al., 2004; Garcez et al., 2008), and neural-ILP has developed primarily in two major directions (Cropper et al., 2020). The first direction applies neural operators such as tensor calculus to simulate logic reasoning (Yang et al., 2017; Dong et al., 2019; Shi et al., 2020) and (Manhaeve et al., 2018). The second direction involves relaxed subset selection (Evans and Grefenstette, 2018; Si et al., 2019) with a predefined set of task-specific logic clauses. This approach reduces the task to a subset-selection problem by selecting a subset of clauses from the predefined set and using neural networks to search for a relaxed solution.

Our work is different from the most recent work, such as (Dong et al., 2019; Shi et al., 2020), in several ways. Compared with (Dong et al., 2019), the most notable difference is the improvement in efficiency by introducing learning-to-reason via reinforcement learning. A second major difference is that PRIMA offers more generalizability than NLM by decomposing the logic operators into more finely-grained units. We refer readers for more detailed related work to Appendix D.

7 Conclusion

A long-standing challenge in multi-task reasoning (MTR) is the intrinsic conflict between capability and efficiency. Our main contribution is the development of a novel neural-logic architecture termed PRIMA, which learns to perform efficient multitask reasoning (in first-order logic) by dynamically chaining learnable Horn clauses (represented by the neural logic operators). PRIMA improves inference efficiency by dynamically pruning unnecessary neural logic operators and achieves a state-of-the-art balance between MTR capability and inference efficiency. The model’s training follows a complete data-driven end-to-end approach via deep reinforcement learning, and the performance is validated across a variety of benchmarks. Future work could include extending the framework to high-order logic and investigating scenarios when meta-rules have a hierarchical structure.

References

- Ando, R. K. and Zhang, T. (2005). A framework for learning predictive structures from multiple tasks and unlabeled data. *JMLR*.
- Andreas, J., Klein, D., and Levine, S. (2017). Modular multitask reinforcement learning with policy sketches. In *ICML*.
- Andrews, P. B. (2002). *An introduction to mathematical logic and type theory*, volume 27. Springer Science & Business Media.
- Argyriou, A., Evgeniou, T., and Pontil, M. (2008). Convex multi-task feature learning. *MLJ*.
- Auer, P. (2002). Using confidence bounds for exploitation-exploration trade-offs. *Journal of Machine Learning Research*, 3(Nov):397–422.
- Auer, P., Cesa-Bianchi, N., and Fischer, P. (2002). Finite-time analysis of the multiarmed bandit problem. *Machine learning*, 47(2-3):235–256.
- Bader, S. and Hitzler, P. (2005). Dimensions of neural-symbolic integration-a structured survey. *arXiv preprint cs/0511042*.
- Bader, S., Hitzler, P., and Hölldobler, S. (2004). The integration of connectionism and first-order knowledge representation and reasoning as a challenge for artificial intelligence. *arXiv preprint cs/0408069*.
- Battaglia, P. W., Hamrick, J. B., Bapst, V., Sanchez-Gonzalez, A., Zambaldi, V., Malinowski, M., Tacchetti, A., Raposo, D., Santoro, A., Faulkner, R., et al. (2018). Relational inductive biases, deep learning, and graph networks. *arXiv preprint arXiv:1806.01261*.

- Battaglia, P. W., Pascanu, R., Lai, M., Rezende, D., and Kavukcuoglu, K. (2016). Interaction networks for learning about objects, relations and physics. *arXiv preprint arXiv:1612.00222*.
- Bengio, Y. (2019). From system 1 deep learning to system 2 deep learning. In *Thirty-third Conference on Neural Information Processing Systems*.
- Besold, T. R., Garcez, A. d., Bader, S., Bowman, H., Domingos, P., Hitzler, P., Kühnberger, K.-U., Lamb, L. C., Lowd, D., Lima, P. M. V., et al. (2017). Neural-symbolic learning and reasoning: A survey and interpretation. *arXiv preprint arXiv:1711.03902*.
- Bräm, T., Brunner, G., Richter, O., and Wattenhofer, R. (2019). Attentive multi-task deep reinforcement learning. In *ECML/PKDD*.
- Browne, C. B., Powley, E., Whitehouse, D., Lucas, S. M., Cowling, P. I., Rohlfshagen, P., Tavener, S., Perez, D., Samothrakis, S., and Colton, S. (2012). A survey of monte carlo tree search methods. *IEEE Transactions on Computational Intelligence and AI in games*, 4(1):1–43.
- Bsat, S. E., Bou-Ammar, H., and Taylor, M. E. (2017). Scalable multitask policy gradient reinforcement learning. In *AAAI*.
- Calandriello, D., Lazaric, A., and Restelli, M. (2014). Sparse multi-task reinforcement learning. In *NIPS*.
- Calautti, M., Gottlob, G., and Pieris, A. (2015). Chase termination for guarded existential rules. In *Proceedings of the 34th ACM SIGMOD-SIGACT-SIGAI Symposium on Principles of Database Systems*, pages 91–103.
- Cao, L. (2016). Non-iid recommender systems: A review and framework of recommendation paradigm shifting. *Engineering*, 2(2):212–224.
- Chakrabarti, D. and Faloutsos, C. (2006). Graph mining: Laws, generators, and algorithms. *ACM computing surveys (CSUR)*, 38(1):2–es.
- Chandra, A. K. and Harel, D. (1985). Horn clause queries and generalizations. *The Journal of Logic Programming*, 2(1):1–15.
- Chen, J., Muggleton, S., and Santos, J. (2008). Learning probabilistic logic models from probabilistic examples. *Machine learning*, 73(1):55–85.
- Chen, K., Yang, F., and Chen, X. (2016). Planning with task-oriented knowledge acquisition for a service robot. In *IJCAI*, pages 812–818.
- Chen, X., Li, L.-J., Fei-Fei, L., and Gupta, A. (2018). Iterative visual reasoning beyond convolutions. In *Proceedings of the IEEE Conference on Computer Vision and Pattern Recognition*, pages 7239–7248.
- Ciliberto, C., Mroueh, Y., Poggio, T. A., and Rosasco, L. (2015). Convex learning of multiple tasks and their structure. In *ICML*.
- Clark, K., Luong, M.-T., Le, Q. V., and Manning, C. D. (2020). Electra: Pre-training text encoders as discriminators rather than generators. *arXiv preprint arXiv:2003.10555*.
- Cook, D. J. and Holder, L. B. (2006). *Mining graph data*. John Wiley & Sons.
- Crawshaw, M. (2020). Multi-task learning with deep neural networks: A survey. *arXiv preprint arXiv:2009.09796*.
- Cropper, A. and Dumancic, S. (2020). Inductive logic programming at 30: a new introduction. *arXiv preprint arXiv:2008.07912*.

- Cropper, A., Dumancic, S., and Muggleton, S. H. (2020). Turning 30: New ideas in inductive logic programming. *arXiv preprint arXiv:2002.11002*.
- Deshmukh, A. A., Dogan, Ü., and Scott, C. (2017). Multi-task learning for contextual bandits. In *NIPS*.
- Diuk, C., Cohen, A., and Littman, M. L. (2008). An object-oriented representation for efficient reinforcement learning. In *Proceedings of the 25th international conference on Machine learning*, pages 240–247.
- Dong, H., Mao, J., Lin, T., Wang, C., Li, L., and Zhou, D. (2019). Neural logic machines. *arXiv preprint arXiv:1904.11694*.
- Džeroski, S., De Raedt, L., and Driessens, K. (2001). Relational reinforcement learning. *Machine learning*, 43(1):7–52.
- Espeholt, L., Soyer, H., Munos, R., Simonyan, K., Mnih, V., Ward, T., Doron, Y., Firoiu, V., Harley, T., Dunning, I., Legg, S., and Kavukcuoglu, K. (2018). IMPALA: scalable distributed deep-RL with importance weighted actor-learner architectures. In *ICML*.
- Evans, R. and Grefenstette, E. (2018). Learning explanatory rules from noisy data. *Journal of Artificial Intelligence Research*, 61:1–64.
- Fitting, M. (2012). *First-order logic and automated theorem proving*. Springer Science & Business Media.
- Gallier, J. H. (2015). *Logic for computer science: foundations of automatic theorem proving*. Courier Dover Publications.
- Ganiz, M. C., George, C., and Pottenger, W. M. (2010). Higher order naive bayes: A novel non-iid approach to text classification. *IEEE Transactions on Knowledge and Data Engineering*, 23(7):1022–1034.
- Garcez, A. S., Lamb, L. C., and Gabbay, D. M. (2008). *Neural-symbolic cognitive reasoning*. Springer Science & Business Media.
- Gebser, M., Kaufmann, B., and Schaub, T. (2012). Conflict-driven answer set solving: From theory to practice. *Artificial Intelligence*, 187-188:52–89.
- Gelfond, M. and Lifschitz, V. (1998). Action languages.
- Goncalves, A. R., Zuben, F. J. V., and Banerjee, A. (2016). Multi-task sparse structure learning with Gaussian copula models. *JMLR*.
- Goodfellow, I. J., Pouget-Abadie, J., Mirza, M., Xu, B., Warde-Farley, D., Ozair, S., Courville, A., and Bengio, Y. (2014). Generative adversarial networks. *arXiv preprint arXiv:1406.2661*.
- Graves, A., Wayne, G., Reynolds, M., Harley, T., Danihelka, I., Grabska-Barwińska, A., Colmenarejo, S. G., Grefenstette, E., Ramalho, T., Agapiou, J., et al. (2016). Hybrid computing using a neural network with dynamic external memory. *Nature*, 538(7626):471–476.
- Gu, Q., Li, Z., and Han, J. (2011). Learning a kernel for multi-task clustering. In *AAAI*.
- Guestrin, C., Koller, D., Gearhart, C., and Kanodia, N. (2003). Generalizing plans to new environments in relational mdps. In *Proceedings of the 18th international joint conference on Artificial intelligence*, pages 1003–1010.
- Hanheide, M., Göbelbecker, M., Horn, G. S., Pronobis, A., Sjöö, K., Aydemir, A., Jensfelt, P., Gretton, C., Dearden, R., Janicek, M., et al. (2015). Robot task planning and explanation in open and uncertain worlds. *Artificial Intelligence*.
- Helmert, M. (2006). The fast downward planning system. *Journal of Artificial Intelligence Research*, 26:191–246.

- Horn, A. (1951). On sentences which are true of direct unions of algebras¹. *The Journal of Symbolic Logic*, 16(1):14–21.
- Igl, M., Gambardella, A., Nardelli, N., Siddharth, N., Böhmer, W., and Whiteson, S. (2020). Multitask soft option learning. In *UAI*.
- Jaeger, H. (2016). Deep neural reasoning. *Nature*, 538(7626):467–468.
- Keramati, R., Whang, J., Cho, P., and Brunskill, E. (2018). Strategic object oriented reinforcement learning. In *Exploration in Reinforcement Learning Workshop at the 35th International Conference on Machine Learning*.
- Khandelwal, P., Zhang, S., Sinapov, J., Leonetti, M., Thomason, J., Yang, F., Gori, I., Svetlik, M., Khante, P., Lifschitz, V., and Stone, P. (2017). Bwibots: A platform for bridging the gap between ai and human–robot interaction research. *The International Journal of Robotics Research*, 36(5-7):635–659.
- Kocsis, L., Szepesvári, C., and Willemsen, J. (2006). Improved monte-carlo search. *Univ. Tartu, Estonia, Tech. Rep*, 1.
- Koller, D. (1999). Probabilistic relational models. In *International Conference on Inductive Logic Programming*, pages 3–13. Springer.
- Koller, D., Friedman, N., Džeroski, S., Sutton, C., McCallum, A., Pfeffer, A., Abbeel, P., Wong, M.-F., Heckerman, D., Meek, C., et al. (2007). *Introduction to statistical relational learning*. MIT press.
- Krötzsch, M. (2020). Computing cores for existential rules with the standard chase and asp. In *Proceedings of the International Conference on Principles of Knowledge Representation and Reasoning*, volume 17, pages 603–613.
- Lazaric, A. and Ghavamzadeh, M. (2010). Bayesian multi-task reinforcement learning. In *ICML*.
- LeCun, Y., Bengio, Y., and Hinton, G. (2015). Deep learning. *nature*, 521(7553):436–444.
- Li, H., Liao, X., and Carin, L. (2009). Multi-task reinforcement learning in partially observable stochastic environments. *JMLR*.
- Li, S., Liu, Z., and Chan, A. B. (2015). Heterogeneous multi-task learning for human pose estimation with deep convolutional neural network. *IJCV*.
- Lifschitz, V. (2008). What is answer set programming? In *Proceedings of the AAAI Conference on Artificial Intelligence*, pages 1594–1597. MIT Press.
- Lin, X., Baweja, H. S., Kantor, G., and Held, D. (2019). Adaptive auxiliary task weighting for reinforcement learning. In *NeurIPS*.
- Liu, P., Qiu, X., and Huang, X. (2017). Adversarial multi-task learning for text classification. In *ACL*.
- Liu, W., Mei, T., Zhang, Y., Che, C., and Luo, J. (2015). Multi-task deep visual-semantic embedding for video thumbnail selection. In *CVPR*.
- Manhaeve, R., Dumancic, S., Kimmig, A., Demeester, T., and De Raedt, L. (2018). Deepproblog: Neural probabilistic logic programming. In *Advances in Neural Information Processing Systems*, pages 3749–3759.
- Matthieu, Z., Xuening, F., Claire, G., Zhaohui, J., Jianyi, Z., Paul, W., Hao, J., Li, D., and Liu, W. (2021). Differentiable logic machines. *arXiv preprint arXiv:2102.11529*.
- McDermott, D., Ghallab, M., Howe, A., Knoblock, C., Ram, A., Veloso, M., Weld, D., and Wilkins, D. (1998). Pddl-the planning domain definition language.

- Minton, S. (1990). Quantitative results concerning the utility of explanation-based learning. *Artificial Intelligence*, 42(2-3):363–391.
- Mrksic, N., Séaghdha, D. Ó., Thomson, B., Gasic, M., Su, P., Vandyke, D., Wen, T., and Young, S. J. (2015). Multi-domain dialog state tracking using recurrent neural networks. In *ACL*.
- Muggleton, S. and De Raedt, L. (1994). Inductive logic programming: Theory and methods. *The Journal of Logic Programming*, 19:629–679.
- Munos, R. (2014). From bandits to monte-carlo tree search: The optimistic principle applied to optimization and planning. *Foundations and Trends in Machine Learning*.
- Omidshafiei, S., Pazis, J., Amato, C., How, J. P., and Vian, J. (2017). Deep decentralized multi-task multi-agent reinforcement learning under partial observability. In *ICML*.
- Palm, R. B., Paquet, U., and Winther, O. (2017). Recurrent relational networks. *arXiv preprint arXiv:1711.08028*.
- Pan, S. J. and Yang, Q. (2009). A survey on transfer learning. *IEEE Transactions on knowledge and data engineering*, 22(10):1345–1359.
- Parisotto, E., Ba, J., and Salakhutdinov, R. (2016). Actor-mimic: Deep multitask and transfer reinforcement learning. In *ICLR*.
- Puterman, M. L. (2014). *Markov decision processes: discrete stochastic dynamic programming*. John Wiley & Sons.
- Rosin, C. D. (2011). Multi-armed bandits with episode context. *Annals of Mathematics and Artificial Intelligence*, 61(3):203–230.
- Rusu, A. A., Colmenarejo, S. G., Gülgehre, Ç., Desjardins, G., Kirkpatrick, J., Pascanu, R., Mnih, V., Kavukcuoglu, K., and Hadsell, R. (2016). Policy distillation. In *ICLR*.
- Santoro, A., Raposo, D., Barrett, D. G., Malinowski, M., Pascanu, R., Battaglia, P., and Lillicrap, T. (2017). A simple neural network module for relational reasoning. *arXiv preprint arXiv:1706.01427*.
- Santurkar, S., Tsipras, D., Ilyas, A., and Madry, A. (2018). How does batch normalization help optimization? *arXiv preprint arXiv:1805.11604*.
- Saxe, A. M., Earle, A. C., and Rosman, B. (2017). Hierarchy through composition with multitask LMDPs. In *ICML*.
- Schrittwieser, J., Antonoglou, I., Hubert, T., Simonyan, K., Sifre, L., Schmitt, S., Guez, A., Lockhart, E., Hassabis, D., Graepel, T., et al. (2019). Mastering atari, go, chess and shogi by planning with a learned model. *arXiv preprint arXiv:1911.08265*.
- Schulman, J., Wolski, F., Dhariwal, P., Radford, A., and Klimov, O. (2017). Proximal policy optimization algorithms. *arXiv preprint arXiv:1707.06347*.
- Sharma, S., Jha, A. K., Hegde, P., and Ravindran, B. (2018). Learning to multi-task by active sampling. In *ICLR*.
- Sharma, S. and Ravindran, B. (2017). Online multi-task learning using active sampling. In *ICLR Workshop*.
- Shi, S., Chen, H., Ma, W., Mao, J., Zhang, M., and Zhang, Y. (2020). Neural logic reasoning. In *Proceedings of the 29th ACM International Conference on Information & Knowledge Management*, pages 1365–1374.
- Shinohara, Y. (2016). Adversarial multi-task learning of deep neural networks for robust speech recognition. In *Interspeech*.

- Si, X., Raghothaman, M., Heo, K., and Naik, M. (2019). Synthesizing datalog programs using numerical relaxation. *arXiv preprint arXiv:1906.00163*.
- Silver, D., Hubert, T., Schrittwieser, J., Antonoglou, I., Lai, M., Guez, A., Lanctot, M., Sifre, L., Kumaran, D., Graepel, T., et al. (2017a). Mastering chess and shogi by self-play with a general reinforcement learning algorithm. *arXiv preprint arXiv:1712.01815*.
- Silver, D., Schrittwieser, J., Simonyan, K., Antonoglou, I., Huang, A., Guez, A., Hubert, T., Baker, L., Lai, M., Bolton, A., et al. (2017b). Mastering the game of go without human knowledge. *nature*, 550(7676):354–359.
- Sukhbaatar, S., Szlam, A., Weston, J., and Fergus, R. (2015). End-to-end memory networks. In *Advances in Neural Information Processing Systems*, pages 2440–2448.
- Sutton, R. S. and Barto, A. G. (2018). *Reinforcement learning: An introduction*. MIT press.
- Tadepalli, P., Givan, R., and Driessens, K. (2004). Relational reinforcement learning: An overview. In *Proceedings of the ICML-2004 workshop on relational reinforcement learning*, pages 1–9.
- Teh, Y. W., Bapst, V., Czarnecki, W. M., Quan, J., Kirkpatrick, J., Hadsell, R., Heess, N., and Pascanu, R. (2017). Distal: Robust multitask reinforcement learning. In *NIPS*.
- Tutunov, R., Kim, D., and Bou-Ammar, H. (2018). Distributed multitask reinforcement learning with quadratic convergence. In *NeurIPS*.
- Van Harmelen, F., Lifschitz, V., and Porter, B. (2008). *Handbook of knowledge representation*. Elsevier.
- Vithayathil Varghese, N. and Mahmoud, Q. H. (2020). A survey of multi-task deep reinforcement learning. *Electronics*, 9(9):1363.
- Vuong, T., Nguyen, D. V., Nguyen, T., Bui, C., Kieu, H., Ta, V., Tran, Q., and Le, T. H. (2019). Sharing experience in multitask reinforcement learning. In *IJCAI*.
- Williams, R. J. (1992). Simple statistical gradient-following algorithms for connectionist reinforcement learning. *Machine learning*, 8(3-4):229–256.
- Wilson, A., Fern, A., Ray, S., and Tadepalli, P. (2007). Multi-task reinforcement learning: A hierarchical Bayesian approach. In *ICML*.
- Xia, V., Wang, Z., and Kaelbling, L. P. (2018). Learning sparse relational transition models. *arXiv preprint arXiv:1810.11177*.
- Yang, F., Yang, Z., and Cohen, W. W. (2017). Differentiable learning of logical rules for knowledge base reasoning. In *Advances in Neural Information Processing Systems*, pages 2319–2328.
- Yi, K., Wu, J., Gan, C., Torralba, A., Kohli, P., and Tenenbaum, J. (2018). Neural-symbolic vqa: Disentangling reasoning from vision and language understanding. In *NIPS*, pages 1031–1042.
- Yoshida, N., Nishio, T., Morikura, M., Yamamoto, K., and Yonetani, R. (2020). Hybrid-fl for wireless networks: Cooperative learning mechanism using non-iid data. In *ICC 2020-2020 IEEE International Conference on Communications (ICC)*, pages 1–7. IEEE.
- Zambaldi, V., Raposo, D., Santoro, A., Bapst, V., Li, Y., Babuschkin, I., Tuyls, K., Reichert, D., Lillicrap, T., Lockhart, E., et al. (2018). Relational deep reinforcement learning. *arXiv preprint arXiv:1806.01830*.
- Zhang, J., Ghahramani, Z., and Yang, Y. (2005). Learning multiple related tasks using latent independent component analysis. In *NIPS*.
- Zhang, S., Tong, H., Xu, J., and Maciejewski, R. (2019). Graph convolutional networks: a comprehensive review. *Computational Social Networks*, 6(1):1–23.

- Zhang, W., Li, R., Zeng, T., Sun, Q., Kumar, S., Ye, J., and Ji, S. (2015). Deep model based transfer and multi-task learning for biological image analysis. In *KDD*.
- Zhang, X., Zhang, X., and Liu, H. (2016). Self-adapted multi-task clustering. In *IJCAI*.
- Zhang, Y. (2013). Heterogeneous-neighborhood-based multi-task local learning algorithms. In *NIPS*.
- Zhang, Y. and Yang, Q. (2021). A survey on multi-task learning. *IEEE Transactions on Knowledge and Data Engineering*.
- Zhang, Z., Luo, P., Loy, C. C., and Tang, X. (2014). Facial landmark detection by deep multi-task learning. In *ECCV*.
- Zhou, J., Chen, J., and Ye, J. (2011). Malsar: Multi-task learning via structural regularization. *Arizona State University*, 21.
- Zhou, J., Cui, G., Hu, S., Zhang, Z., Yang, C., Liu, Z., Wang, L., Li, C., and Sun, M. (2020). Graph neural networks: A review of methods and applications. *AI Open*, 1:57–81.
- Zhu, Z., Lin, K., and Zhou, J. (2020). Transfer learning in deep reinforcement learning: A survey. *arXiv preprint arXiv:2009.07888*.
- Zoph, B. and Le, Q. V. (2017). Neural architecture search with reinforcement learning. *ICLR*.

Appendix

A Algorithm Details

A.1 Details of MCTS: four key steps

During each epoch, MCTS repeatedly performs four sequential steps: selection, expansion, simulation, and backpropagation. The selection step traverses the existing search tree until the leaf node (or termination condition) by choosing actions (edges) a_s at each node s according to a tree policy. One widely used tree policy is the UCT (Kocsis et al., 2006) policy, which conducts the node-selection via

$$a_s = \arg \max_{s' \in \mathcal{C}(s)} \left\{ V_{s'} + \beta \sqrt{\frac{2 \log N_s}{N_{s'}}} \right\}, \quad (2)$$

where $\mathcal{C}(s)$ denotes the set of all child nodes for s , the first term $V_{s'}$ is an estimate of the long-term cumulative reward that can be received when starting from the state represented by node s' , and the second term represents the uncertainty (confidence-interval size) of that estimate. The confidence interval is calculated based on the upper confidence bound (UCB) (Auer et al., 2002; Auer, 2002) using N_s and $N_{s'}$, which denote the number of times that nodes s and s' have been visited (respectively). The key idea of UCT policy (Eq. (2)) is to select the best action according to an optimistic estimation (the upper confidence bound) of the expected return, which balances the exploitation (first term) and exploration (second term) with β controlling the trade-off. The second step (node expansion) is conducted according to a prior policy by adding a new child node if the selection process reaches a leaf node of the search tree. Next, the simulation step estimates the value function (cumulative reward) \hat{V}_s by running the environment simulator with a default (simulation) policy. Finally, the *backpropagation* step updates the statistics V_s and N_s from the leaf node s_T to the root node s_0 of the selected path by recursively performing the following update (i.e., from $t = T - 1$ to $t = 0$):

$$N_{s_t} \leftarrow N_{s_t} + 1, \quad \hat{V}_{s_t} \leftarrow r(s_t, a_t) + \gamma \hat{V}_{s_{t+1}}, \quad V_{s_t} \leftarrow ((N_{s_t} - 1)V_{s_t} + \hat{V}_{s_t})/N_{s_t}, \quad (3)$$

where \hat{V}_{s_T} is the simulation return of s_T , and a_t denotes the action selected following Eq. (2) at state s_t . Generally, the expansion step and the simulation step are more time-consuming than the other two steps, as they involve a large number of interactions with the environment.

In our Enhanced Planner, we adopt a recently proposed variant of MCTS that is based on probabilistic upper confidence tree (PUCT) (Rosin, 2011). It conducts node-selection according to a so-called PUCT score with two components $\text{PUCT}(s, a) = Q(s, a) + U(s, a)$. $Q(s, a)$ is the mean state-action value calculated from the averaged game result that takes action a during current simulations, and $U(s, a)$ is the exploration bonus calculated as

$$U(s, a) = \pi(a|s) \frac{\sqrt{\sum_b N(s, b)}}{1 + N(s, a)} \left(c_1 + \log \left(\frac{\sum_b N(s, b) + c_2 + 1}{c_2} \right) \right), \quad (4)$$

where a, b are possible actions, $\pi(a|s)$ is the output of the Base Planner, $N(s, a)$ is the visit count of the (s, a) pair during current simulations, and constants c_1, c_2 are the exploration-controlling hyper-parameters.

An MCTS algorithm is a model-based RL algorithm that plans the best action at each time step (Browne et al., 2012) by constructing a search tree, with states as nodes and actions as edges. It uses the MDP model to identify the best action at each time step until the leaf node (or until other termination conditions are satisfied) by choosing actions (edges) a_s at each node s according to a tree policy. For implementations of Monte-Carlo Tree Search, we refer readers to <https://github.com/werner-duvaud/muzero-general> for details.

A.2 Details of calculating reasoning accuracy

Since the “target” predicates are available for all objects or pairs of objects, the reasoning accuracy refers to the accuracy evaluated on all objects (for properties such as `AdjacentToRed(x)` or `1-OutDegree(x)`) or pairs of objects (for relations such as `4-Connectivity(x, y)`).

B Experimental Details

B.1 Reasoning tasks introduction

Graph For graph tasks, they have the same background knowledge (or background predicate): `HasEdge(x, y)`, i.e., `HasEdge(x, y)` is *True* if there is an undirected edge between node x and node y . However, `AdjacentToRed` has an extra background predicate, `IsRed(x)`. `IsRed(x)` is *True* if the color of node x is red. Specifically, these graph tasks seeks to predict the target concepts (or target predicates) shown as below.

- **1-OutDegree**: `1-OutDegree(x)` is *True* if the out-degree of node x is exactly 1.
- **AdjacentToRed**: `AdjacentToRed(x)` is *True* if the node x has an edge with a red node.
- **4-Connectivity**: `4-Connectivity(x, y)` is *True* if there are within 4 hops between node x and node y .

Family Tree For family tree tasks, they have the same background knowledge (or background predicates): `IsFather(x, y)`, `IsMother(x, y)`, `IsSon(x, y)` and `IsDaughter(x, y)`. For instance, `IsFather(x, y)` is *True* when y is x 's father. Specifically, these family tree tasks seek to predict the target concepts (or target predicates) shown below.

- **HasFather**: `HasFather(x)` is *True* if x has father.
- **HasSister**: `HasSister(x)` is *True* if x has at least one sister.
- **IsGrandparent**: `IsGrandparent(x, y)` is *True* if y is x 's grandparent.
- **IsUncle**: `IsUncle(x, y)` is *True* if y is x 's uncle.
- **IsMGUncle**: `IsMGUncle(x, y)` is *True* if y is x 's maternal great uncle.

B.1.1 Relations among different tasks

We would like to clarify that these different tasks are indeed standard benchmarks for Inductive Logic Programming (ILP) [3,4,5]. They are commonly used in previous ILP works to evaluate different aspects (such as compositional relation prediction or property prediction) of the logic reasoning capability. First, each task includes its own task-dependent knowledge besides carrying common knowledge. Second, although each category of tasks (e.g., graph tasks and family tree tasks) shares a certain amount of common background knowledge, the objectives of the tasks (even in the same category) differ a lot due to each task's individual information and goal (see our example below). For example, `1-OutDegree`, `AdjacentToRed`, and `4-Connectivity` are graph tasks and share the same background knowledge of `HasEdge`, which provides the information on the connectedness between two nodes in a graph. However, the goal of `1-OutDegree` is to predict if the out-degree of a node is exactly 1, while that of `4-Connectivity` is to predict if the number of hops between two nodes is within 4. `AdjacentToRed` has task-specific information on the color of each node (`IsRed`), and its goal is to predict if a node has an edge with a red node.

For convenience, we list an example below that compares between `AdjacentToRed`, `4-Connectivity`, and `1-OutDegree`. We can see that the corresponding logic expressions differ significantly, even if the graph topologies are the same. The logic rule for `AdjacentToRed` is:

$$\forall y \text{PredRed}(x, y) \leftarrow \text{IsRed}(x)$$

Table 4: Hyper-parameter settings for DLM-MTR.

DLM-MTR	
learning rate	0.005
epochs	200
epoch size	2000
batch size (train)	4
breadth	3
depth	9

$$\text{AdjacentToRed}(x) \leftarrow \exists y(\text{HasEdge}(x, y) \wedge \text{PredRed}(x, y)) .$$

The logic rule for 4-Connectivity is:

$$\text{Distance2}(x, y) \leftarrow \exists z(\text{HasEdge}(x, z) \wedge \text{HasEdge}(z, y))$$

$$\text{Distance3}(x, y) \leftarrow \exists z(\text{Distance2}(x, z) \wedge \text{HasEdge}(z, y))$$

$$\text{Distance4}(x, y) \leftarrow \exists z(\text{Distance2}(x, z) \wedge \text{Distance2}(z, y))$$

$$\text{4-Connectivity}(x, y) \leftarrow \text{HasEdge}(x, y) \vee \text{Distance2}(x, y) \vee \text{Distance3}(x, y) \vee \text{Distance4}(x, y) .$$

The logic rule for 1-OutDegree is:

$$\text{1-Outdegree}(x) \leftarrow \exists y \forall z(\text{HasEdge}(x, y) \wedge \neg \text{HasEdge}(x, z)) .$$

B.2 Hyper-parameter Settings

For simplicity, we set discount factor $\gamma = 1$ in all experiments. The T_{\max} depends on the depth of the Reasoner. In single-task setting, we use the same hyper-parameter settings as in the original papers for MemNN (Sukhbaatar et al., 2015), ∂ ILP (Evans and Grefenstette, 2018), NLM (Dong et al., 2019), and DLM (Matthieu et al., 2021). That distribution for DLM-MTR is [0.1, 0.12, 0.12, 0.1, 0.1, 0.13, 0.13, 0.2]. The details of hyper-parameters in DLM-MTR can be found in Table 4. Similarly, the ‘‘Internal Logic’’, initial temperature and scale of the Gumbel distribution, and the dropout probability in DLM-MTR are also kept the same settings as those in DLM. Besides, the probability distribution of sampling a task for PRIMA is [0.1, 0.12, 0.12, 0.1, 0.1, 0.13, 0.13, 0.2]. Regarding the hyper-parameters of PRIMA, details can be found in Table 5. We also show the hyper-parameters of PRISA-REINFORCE, PRISA-PPO, PRISA-MuZero in Table 5.

We note that the problem size for training is always 10 for graph tasks and 20 for family tree tasks in single-task and multi-task settings.

B.3 Computing infrastructure

We conducted our experiments on a CPU server where the CPU is ‘‘Intel(R) Xeon(R) Silver 4114 CPU’’ with 40 cores and 64 GB memory in total.

C Additional Experiments

C.1 Reasoning costs of PRISA

To demonstrate the improved reasoning efficiency in PRISA at the inference stage, three variants of PRISA (e.g., PRISA-REINFORCE, PRISA-PPO, and PRISA-MuZero) are compared with PRIMA in terms of FLOPs. As shown in Fig. 6, three variants of PRISA generally have lower reasoning complexity than PRIMA. The difference in FLOPs between PRIMA and PRISA-MuZero is primarily from the difference between multi-tasking settings and single-task settings.

Table 5: Hyper-parameter settings for PRISA and PRIMA. “lr-reasoner” refers to the learning rate for the reasoner, “lr-policy” denotes the learning rate for the policy network, “lr-value” denotes the learning rate for the value network, “residual” refers to the residual connection in the reasoner, “NumWarmups” refers to the number of warm-ups before starting the training, “NumRollouts” refers to the number of roll-outs in MCTS, “RwdDecay” refers to the constant exponential decay applied on the reward, “ c_1 and c_2 ” refers to the same constants in PUCT formula in Section A.1, “RBSize” refers to the replay buffer size that is used to count the number of stored trajectories, “BatchSize” refers to the batch size for training, “TrainingSteps” refers to the number of training steps. For PRISA-REINFORCE, PRISA-PPO, PRISA-MuZero, the “TrainingSteps” denotes the training steps for each task, while that of PRIMA represents the training steps for all 8 tasks.

	PRISA- REINFORCE	PRISA- PPO	PRISA- MuZero	PRIMA
lr-reasoner	0.005	0.005	0.005	0.004
lr-policy	0.085	0.085	0.075	0.075
lr-value	-	0.15	0.075	0.075
breadth	3	3	3	3
depth	4	4	4	4
residual	<i>False</i>	<i>False</i>	<i>False</i>	<i>False</i>
NumWarmups	-	-	200	200
NumRollouts	-	-	1200	1200
RwdDecay	5	5	5	5
c_1	-	-	30	30
c_2	-	-	19652	19652
RBSize	16	32	400	400
BatchSize	16	16	16	16
TrainingSteps	7×10^4	7×10^4	7×10^4	39×10^4

Table 6: Additional results: The performance of PRIMA w.r.t different numbers of intermediate predicates. “# pred”: the number of intermediate predicates.

testing accuracy	Family Tree	HasFather	HasSister	IsGrandparent	IsUncle	IsMGUncle	Graph	AdjacentToRed	4-Connectivity	1-OutDegree
	# pred = 2	m=20 m=100 PSS	61.78 87.5 0	54.97 31.2 0	96.46 97.7 0	97.19 96.5 0	99.67 98.4 0	m=10 m=50 PSS	42.62 11.1 0	89.28 96.6 0
# pred = 4	m=20 m=100 PSS	100 100 100	100 100 100	100 100 100	97.2 96.6 0	99.7 98.4 0	m=10 m=50 PSS	67.3 91.7 0	93.4 97.8 0	100 100 100
# pred = 6	m=20 m=100 PSS	100 100 100	100 100 100	100 100 100	100 100 100	100 100 90	m=10 m=50 PSS	99.7 100 0	100 100 100	100 100 100
# pred = 8	m=20 m=100 PSS	100 100 100	100 100 100	100 100 100	100 100 100	100 100 90	m=10 m=50 PSS	100 100 90	100 100 100	100 100 100

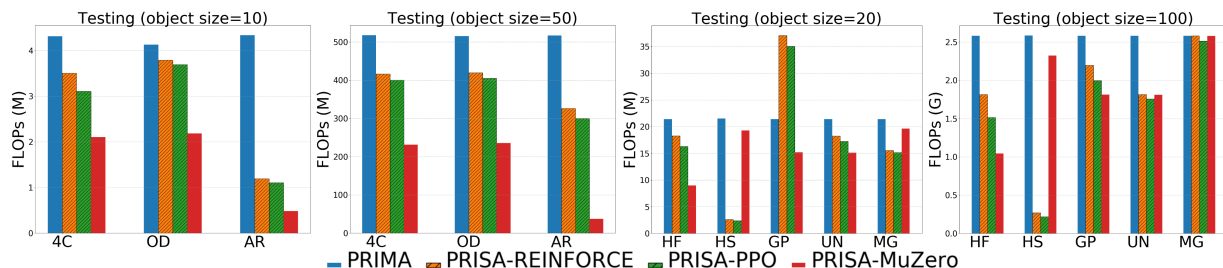

Figure 6: The reasoning costs (in FLOPs) of PRIMA and three variants of PRISA at the inference stage (1 M= 1×10^6 , 1 G= 1×10^9).

C.2 Predicate dimension analysis

Since the Reasoner only realizes a partial set of Horn clauses of FOL, the number of intermediate predicates will greatly determine the expressive power of the model. The performance of PRIMA degrades gracefully when the number of intermediate predicates decreases. This is shown in the additional experiments of examining the limiting performance of our PRIMA, where we examine the limiting performance of our PRIMA when the number of intermediate predicates at each layer decreases. The results in Table 6 show that the performance of PRIMA degrades gracefully when the number of intermediate predicates decreases; for example, it still performs reasonably well on most tasks even when the number of predicates becomes 4.

C.3 Analysis of multi-tasking capabilities

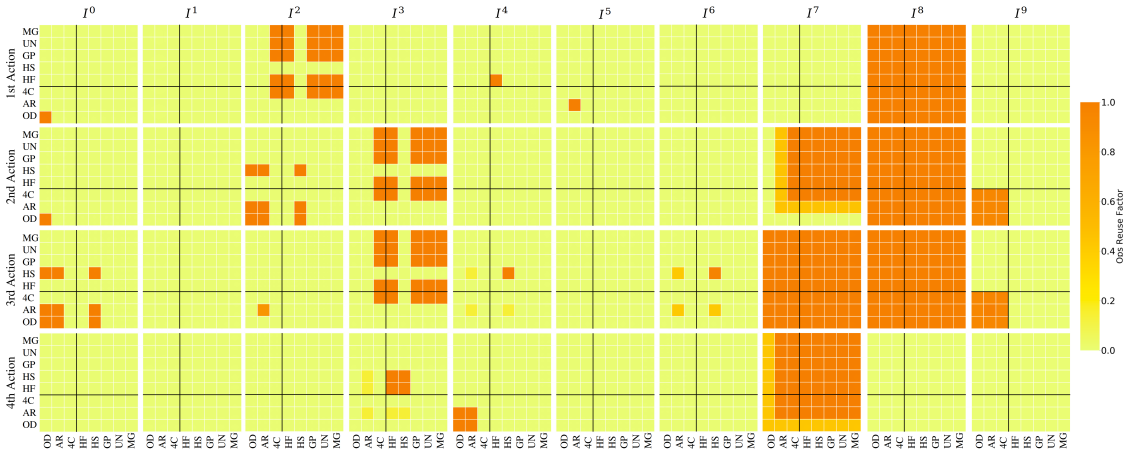

Figure 7: The quantitative evaluation of ops reuse between different Tasks in PRIMA.

Why/how do different tasks share blocks (of ops) as in Fig. 7? To quantitatively measure how different tasks reuses the “skills”, we show in Fig. 7, which is a heat-map showing the probability of overlapping about Ops reuse across different tasks, where red color denotes a high-level of Ops overlapping. Ops reuse factor is defined as $\min(P_a(I^j), P_b(I^j))$ where $P_a(I^j)$ refers to the probability of ops I^j ($j \in \{0, \dots, 9\}$) being active for task a and $P_b(I^j)$ denotes the probability of I^j being active for task b . From Fig. 7, it can be inferred that some tasks share skills more than others. For example, in most of the actions, I^8 is shared across different tasks.

Does the 100% accuracy imply these testbeds are too simple? In fact, these tasks are quite challenging for deep learning (DL) approaches (e.g., the poor performance of MemNN in Table 3). In particular, they are designed to evaluate the model’s out-of-distribution generalization capabilities. For example, in Table 3, when the deep learning model (MemNN) is tested at a problem size ($m=100$ in Family tree tasks) that has never been seen during training (i.e., MemNN is trained on Family tree tasks with $m=20$), its performance will degrade drastically. It shows that DL-based approaches cannot learn the correct logical rules for solving these problems. In contrast, logic reasoning methods (e.g., ILP/ NLM/ DLM) can (and are expected to) reach 100% generalization accuracy on those tasks. In other words, reaching 100% accuracy is a “must-be” criterion for those logic reasoning methods. For this reason, Tables 2& 3 are not used to show our improvement in accuracy but to justify that PRIMA can meet the expectation of perfect generalization (aka, 100% accuracy). Under such a “perfect generalization” constraint, our major objective is to improve the reasoning efficiency (i.e., reducing FLOPs) over other approaches.

C.4 The significance of reducing FLOPs in practice

First, the comparison between PRIMA and the baseline (e.g., NLM) is indeed fair in that the expressiveness of NLM and that of the Reasoner module in PRIMA are similar (i.e., same hidden dimensions and number of layers — see Appendix D of the supplementary material). So NLM is not using more FLOPs for expressive power. Note that the difference lies in the Planner module of PRIMA, which NLM doesn't have. We would also like to highlight that reducing the computational cost (in FLOPs) of reasoning has significant meanings in practice.

- For example, when we deploy a trained model as a cloud API service, the model will receive a massive amount of API calls (e.g., more than 1 million API calls per day for speech/image recognition service), which accounts for a huge number of repeated model inference operations on GPU servers. Although cutting the reasoning time by half may not seem much for one single input sample, repeating it a massive amount of times during inference over months or years will incur a huge cost. (The aggregated inference cost is even significantly higher than the training cost, where training is generally incurred every 6-12 months in such systems.) In the multi-task reasoning setting, we believe this behavior will be even more outstanding as a single model is deployed to handle many different types of services and tasks. When translated into spending cost, if we can reduce the FLOPs by half, we can generally cut the spending cost on cloud GPU servers by half, which would be a significant cut for operating spending to host these cloud API services.
- Another important application where reducing FLOPs is essential is when the trained model is deployed on mobile/edge devices. In this situation, the computation task of the model must be accomplished with limited resource supplies, such as computing time, storage space, battery power, etc.
- In addition, we would also like to point out that improving the inference efficiency of general machine learning models has attracted a significant amount of interest from both academia and industry.

C.5 Training cost for different MTR models

We here report the approximate training costs of different methods below (in total training time) in order to give readers an overall picture of the overhead (running on CPU clusters):

- DLM-MTR = 4~5days
- PRIMA = 13~14 days

In summary, PRIMA tends to have a higher training cost: about 2.6~3.5 times that of DLM-MTR. This is not surprising since multiple rollouts of MCTS would generate additional overheads. Nevertheless, it should be noted that such an overhead is still affordable and could be amortized if the inference efficiency is more important as in the cloud API service.

D Additional Related Work

This section provides complementary contents to Sec. 6.

Model-based symbolic planning Another large body of related work is symbolic planning (SP) (Van Harmelen et al., 2008; Hanheide et al., 2015; Chen et al., 2016; Khandelwal et al., 2017). In SP approaches, a planning agent carries prior symbolic knowledge of objects, properties, and how they are changed by executing actions in the dynamic system, represented in a formal, logic-based language such as PDDL (McDermott et al., 1998) or an action language (Gelfond and Lifschitz, 1998) that relates to logic programming under answer set semantics (answer set programming) (Lifschitz, 2008). The agent utilizes a symbolic planner, such as a PDDL planner FASTDOWNWARD (Helmert, 2006) or an answer set solver CLINGO (Gebser et al., 2012)

to generate a sequence of actions based on its symbolic knowledge, executes the actions to achieve its goal. Compared with RL approaches, an SP agent does not require a large number of trial-and-error to behave reasonably well, yet requires predefined symbolic knowledge as the model prior. It should be noted that it remains questionable if PDDL-based methods can be applied directly to our problem, as there is no explicitly predefined prior knowledge under our problem setting, which is required by PDDL-based approaches. In contrast, we address the learning-to-reason problem via a complete data-driven deep reinforcement approach.

Multi-task RL Multi-task learning can help boost the performance of reinforcement learning, leading to multi-task reinforcement learning (Vithayathil Varghese and Mahmoud, 2020; Zhu et al., 2020). Some research (Wilson et al., 2007; Li et al., 2009; Lazaric and Ghavamzadeh, 2010; Calandriello et al., 2014; Andreas et al., 2017; Deshmukh et al., 2017; Saxe et al., 2017; Bräm et al., 2019; Vuong et al., 2019; Igl et al., 2020) has adapted the ideas behind multi-task learning to RL. For example, in (Bräm et al., 2019), a multi-task deep RL model based on attention can group tasks into sub-networks with state-level granularity. The idea of compression and distillation has been incorporated into multi-task RL as in (Parisotto et al., 2016; Rusu et al., 2016; Omidshafiei et al., 2017; Teh et al., 2017). For example, in (Parisotto et al., 2016), the proposed actor-mimic method combines deep reinforcement learning with model-compression techniques to train a policy network that can learn to act for multiple tasks. Other research in multi-task RL focuses on online and distributed settings (Bsat et al., 2017; Sharma and Ravindran, 2017; Sharma et al., 2018; Espeholt et al., 2018; Tutunov et al., 2018; Lin et al., 2019).

RL for logic reasoning Relational RL integrates RL with statistical relational learning and connects RL with classical AI for knowledge representation and reasoning. Most prominently, Džeroski et al. (2001) originally proposed relational RL, Tadepalli et al. (2004) surveyed relational RL, Guestrin et al. (2003) introduced relational MDPs, and Diuk et al. (2008) introduced objected-oriented MDPs (OO-MDPs). More recently, Battaglia et al. (2018) proposed to incorporate relational inductive bias, Zambaldi et al. (2018) proposed deep relational RL, Keramati et al. (2018) proposed strategic object-oriented RL, and some researchers have also adopted deep learning approaches for dealing with relations and/or reasoning, for example (Battaglia et al., 2016; Chen et al., 2018; Santoro et al., 2017; Santurkar et al., 2018; Palm et al., 2017; Xia et al., 2018; Yi et al., 2018).

Statistical relational reasoning Statistical relational reasoning (SRL) (Koller et al., 2007) often provides a better understanding of domains and predictive accuracy, but with more complex learning and inference processes. Unlike ILP, SRL takes a statistical and probabilistic learning perspective and extends the probabilistic formalism with relational aspects. Examples of SRL include text classification (Ganiz et al., 2010), recommendation systems (Cao, 2016), and wireless networks (Yoshida et al., 2020). SRL can be divided into two research branches: probabilistic relational models (PRMs) (Koller, 1999) and probabilistic logic models (PLMs) (Chen et al., 2008). PRMs start from probabilistic graphical models and then extend to relational aspects, while PLMs start from ILP and extend to probabilistic semantics. A related research area is graph relational reasoning, such as using graph neural networks (Zhou et al., 2020) to conduct reasoning. A discussion of this approach is beyond the scope of this paper, but we refer interested readers to (Chakrabarti and Faloutsos, 2006; Cook and Holder, 2006; Zhang et al., 2019) for a comprehensive review.

Comparisons with NLM The Reasoner shares the same functionality with NLM, in terms of approximating the meta-rules (`BooleanLogic`, `Expansion`, and `Reduction`). However, our Reasoner has major differences from NLM. *First*, the targets are different. Our Reasoner targets the trade-off between capability and efficiency. Compared with NLM, our Reasoner can greatly improve efficiency by using a Planner module. *Second*, our Reasoner has more explicitness in the reasoning path. Let $[O_{i-1}^{r-1}, O_{i-1}^r, O_{i-1}^{r+1}]$ denote the output predicates (in tensor representation) from the previous layer, and $\text{Concat}(\cdot)$ denotes the concatenation operation. NLM performs the intra-group computation as

$$O_i^r = \sigma(\text{MLP}(\text{Permute}(Z_i^r); \theta_i^r)), \quad (5)$$

where O_i^r is the output predicate, $Z_i^r = \text{Concat}(\text{Expand}(O_{i-1}^{r-1}), O_{i-1}^r, \text{Reduce}(O_{i-1}^{r+1}))$, σ is the sigmoid non-linearity and θ_i^r denotes learnable parameters. On the contrary, in the Reasoner module of our PRISA/PRIMA, the implementation is

$$O_i^r = \sigma \left(\text{MLP}(\text{Permute}(\text{Expand}(O_{i-1}^{r-1})); \theta_i^r) + \text{MLP}(\text{Permute}(O_{i-1}^r); \theta_i^r) \right) \quad (6)$$

$$+ \text{MLP}(\text{Permute}(\text{Reduce}(O_{i-1}^{r+1})); \theta_i^r), \quad (7)$$

which allows for the neural implementations of `BooleanLogic`, `Expansion`, and `Reduction` (at the same arity group) to be executed independently to some extent and reduce the unnecessary computations.

Comparisons with chaining in logic reasoning Our main focus is to develop a neural architecture that learns to perform efficient (first-order logic) reasoning. There are two types of chaining to conduct logic reasoning, i.e., forward-chaining and backward-chaining. The forward-chaining strategy deduces all the possible conclusions based on (all) the available facts and deduction rules until it reaches the desired conclusion. (The other strategy is backward-chaining, which starts from the desired conclusion (i.e., the goal) and then works backward recursively to validate the available facts.) This paper adopts the forward-chaining approach (of the learnable Horn clauses) to perform logic reasoning. Note that it is generally unrealistic to generate all the possible conclusions based on all the available deduction rules as in the vanilla forward-chaining strategy. Therefore, our focus in the paper is to learn a neural module (named “planner”) capable of identifying a small subset of paths in the forward-chaining strategy that can lead to the correct solution (as well as learning the Horn clauses in reasoner). If the “planner” module does not chain the correct subset of Horn clauses (logic operators), it will obviously NOT give us the correct solution. Therefore, we need to select a subset of paths that can guarantee the correct answer with low cost, which is reflected in our RL reward design as well (see Eq. (1) in the paper).

Comparisons with Minton (1990) There are several major differences between our work and Minton (1990) regarding motivations, methods, and technical details. We list a few here.

First, both PRIMA and Minton (1990) can learn to improve reasoning regarding the utility issue, while PRIMA uses RL to achieve this goal.

Second, PRIMA differs from Minton (1990) in several perspectives, including input information/problem settings. EBL requires that the input domain knowledge must be formulated via rule-based logic. In contrast, the domain knowledge can be probabilistic transition functions in PRIMA, depending on the concrete MBRL method adopted. EBL follows an explain-generalize-refine procedure (detailed see below). Our PRIMA follows another style: we first learn the neural operators equivalent to (in functionality) the explainable logic operations and then learn the solution paths expanded based on these neural operators. multi-task capability. PRIMA is designed for multi-task reasoning, while it remains unclear in Minton (1990) if EBL can conduct multi-task reasoning and under what scenarios. EBL features the following steps:

1. Explain: explaining the observed target value for this example in terms of the domain theory.
2. Generalize: analyzing this explanation to determine the general conditions under which the explanation holds.
3. Refine: refining its hypothesis to incorporate these general conditions.