









TIMOTHY OULTON'S
NOBLE SOULS
 ARGALI BED
 Assembly Instruction

PARTS INCLUDED

- A [1] Headboard
- B [1] Footboard
- C [1] Side Rail(Right)
- D [1] Side Rail(Left)
- E [1] Slatted Base

TOOLS NEEDED

NO.	Description	Size	QTY.
1	 Bolts	M8*60 mm	12 pcs
2	 Spring wash		12 pcs
3	 Flat Washer		12 pcs
4	 Rubber Washer		12 pcs
5	 Nuts		12 pcs
6	 Wrench		1 pcs
7	 Support leg		6 pcs
8	 Allen Key		1 pcs

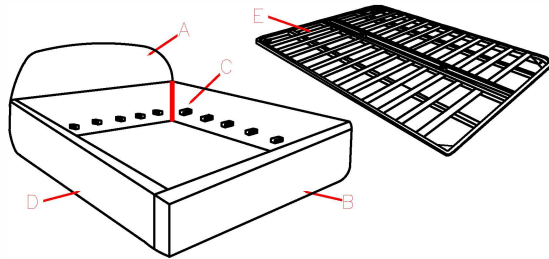

NOTE

- Bed must be assembled by at least two people.
- Please read instructions carefully before assembling bed.
- Use the above parts and fittings list to identify each component.
- Keep all packing materials until assembly is completed to avoid loss of smaller parts.

ASSEMBLY INSTRUCTIONS

STEP 1:

1. Place the headboard (A) on a protective surface to prevent damage.
2. Pull up the zipper between Headboard(A) and Side Rail(Right) (C) (as seen in diagram) .
3. Repeat this step to attach the Side Rail(Right) (C) to Footboard(B).
4. Repeat this step to attach the other side rail(Right) (D) to headboard (A) and Footboard(B).

5. To attach the footboard (B), please repeat the above assembly procedure.

6. Make sure the Headboard , Footboard and Side Rail are height consistently, then tighten the Hex hardware by Allen Key provided.

STEP 2:

1. Turn over the Slatted Base (E) and then Align the holes on the Support leg(7) with the threaded holes on the Slatted Base (E).
2. Attaching Support leg(7) to Slatted Base(E) by inserting the Hex hardware ; then Affix the Hex hardware , Spring wash , Flat Washer , Rubber Washer , nut (5) onto the connection bolt and tighten nut with the wrench (6) as seen in the diagram.

STEP 3:

Place the Slatted Base inside the bed and lock the magic stick(as seen in diagram).

STEP 1

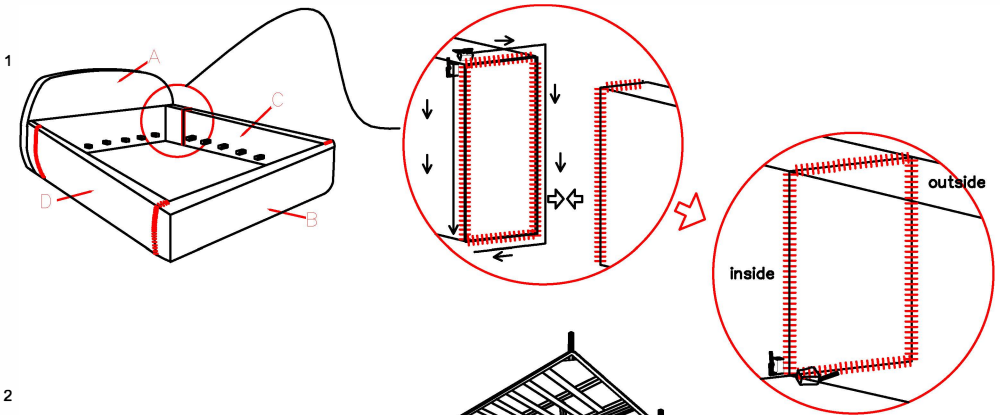

STEP 2

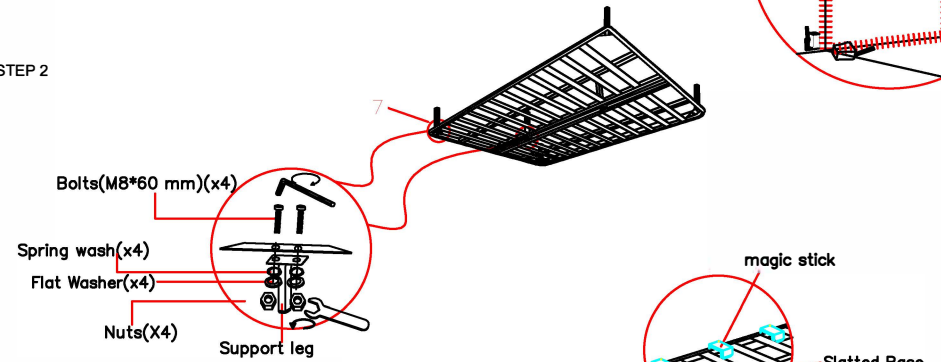

STEP 3

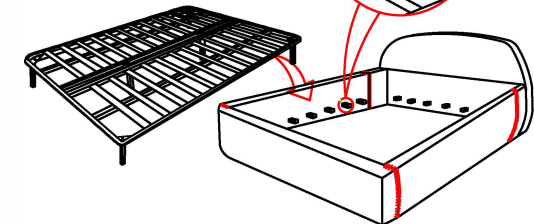

CARE INSTRUCTIONS

Dust or vacuum regularly to help keep fabric looking new. Dab spills immediately with a soft white cloth dampened with distilled water. Do not use tap water or detergents to clean. Professional in-home upholstery cleaning is recommended. Avoid direct sunlight and heat to protect fabric.

IMPORTANT SAFETY INSTRUCTIONS

1. Exercise care and precaution when moving furniture as careless handling may cause injury and damage.
2. Never drag furniture. Always lift it.
3. Periodically check all fixtures to ensure none have come loose.
4. Re-tighten as and when necessary. Incorrect assembly of furniture can be dangerous.
5. Assembly should be carried out by competent personal.
6. No liability will be accepted for damage or injury caused by incorrect assembled furniture.
7. Heavy item warning
8. Take care and seek assistance when lifting heavy furniture to avoid personal injury and or damage to product .

 The bed should be assembled by two people more than 1 hour.