



TIMOTHY OULTON

ASSEMBLY INSTRUCTION

BAROQUE SMALL CHANDELIER 60CM

PARTS ENCLOSED

ITEMS	DIAGRAM	DESCRIPTION	QTY.
(A)		Junction Box (Not included)	1
(B)		Mounting Plate	1
(C)		Mounting Hardware (Not included)	2 Sets
(D1)		Canopy	1
(E1)		Hang Straight	1
(E2)		Collar	1
(E3)		Chain	1
(E4)		Quick Link	1
(F1)		Wire Nuts	3
(F2)		Terminal Box	1
(G)		Candle Sleeves	5
(H)		Bulbs	5
(I)		Body A	1
(J)		Body B	1

IMPORTANT SAFETY INSTRUCTIONS:

1. Use an authorized and certified electrician for consultation and installation.
2. This fixture has been rated for:
 - EU/UK/AUS---5x25-watt maximum E14 standard bulbs or 5x6-watt maximum E14 LED bulbs.
 - US ---5x25-watt maximum E12 standard bulbs or 5x6-watt maximum E12 LED bulbs.
3. To avoid the risk of fire, do not exceed the recommended wattage.
4. The manufacturer and distributor accepts no liability for incorrect installation.
5. For indoor use only.
6. Keep away from children.

WARNINGS:

1. Turn-off electricity supply at main circuit panel before installing. Do not connect electricity supply until your fixture is fully assembled and installed.
2. All wires are connected. Do not remove the fixture from its packaging by pulling on the power cord, as a bad connection may result.
3. To reduce the risk of fire, electrical shock, or personal injury, always turn off the fixture and allow it to cool prior to replacing light source. Do not touch light source when fixture is turned on or look directly at light source. Keep flammable materials away from light source.
4. Deviation from instructions may result in a risk of fire or electric shock.

PRODUCT DESCRIPTION:

General material: Glass & Iron
 Height: 90.0cm (35.4in)
 Diameter: 60.0cm (23.6in)
 Weight: 15.2kg (33.5lbs)
 Grounded / Hardwired

ASSEMBLY INSTRUCTIONS:

1. Carefully remove all parts from the box and remove all plastic covering.
2. Turn OFF power to the junction box where the lighting fixture will be installed.
3. Loosen the bolt (E5) of collar (E2) and remove the hang straight (E1) from the collar (E2) by unscrewing it. Then insert hang straight (E1) into canopy (D1) and re-attach hang straight (E1) to collar (E2). Tighten the bolt (E5) of the collar (E2).
4. Feed main cable through the body A (I). Loosen the bolt (J1), Then fasten body A (I) to body B (J). Tighten the bolts (J1) on body B (J).
5. Unlock the quick link (E4) at the opposite end of the chain (E3) to attach the body A(I).
6. Attach the mounting plate (B) to the junction box (A) with mounting hardware (C).
7. Hang the hang straight (E1) to the mounting plate (B). Loosen bolt (D2), move down the canopy from ceiling. Feed wires through hang straight (E1).
8. Carefully inspect the fixture wires. One is the ground wire (marked with ⊕). The second is the neutral wire (marked with N). The third wire is the live/hot wire (marked with L).
9. For US Market: Connect the fixture ground wire (marked with ⊕) to the power supply ground wire, connect the fixture neutral wire (marked with N) to the power supply neutral wire, and connect the fixture live/hot wire (marked with L) to the power supply live/hot wire with wire nuts (F1).
10. For non-US Market: Connect the fixture ground wire (marked with ⊕) to the power supply ground wire, connect the fixture neutral wire (marked with N) to the power supply neutral wire, and connect the fixture live/hot wire (marked with L) to the power supply live/hot wire with terminal box (F2).
11. Move the canopy (D1) up to the ceiling, then fasten the bolt (D2).
12. Place candle sleeves (G) onto lampholder, then fasten light bulbs (H).
13. Hang the glass drops from bottom to top refer to next page illustration. To ensure safety of lighting fixture during glass drops installation, please hang glass drops in a balanced way on opposite side.
14. Restore power to the junction box and test lighting fixture.

CARE INSTRUCTIONS:

1. Make sure that the power is turned off and light source has cooled before handling.
2. Wipe clean with a dry cloth. Do not use corrosive cleaners.

WEEE STATEMENT:



Disposal of waste equipment by users.

This symbol means do not dispose of your product with your other household waste. Instead, you should protect human health and the environment by handing over your waste equipment to a designated collection point for the recycling of waste electrical and electronic equipment. For more information, please contact your household waste disposal service.

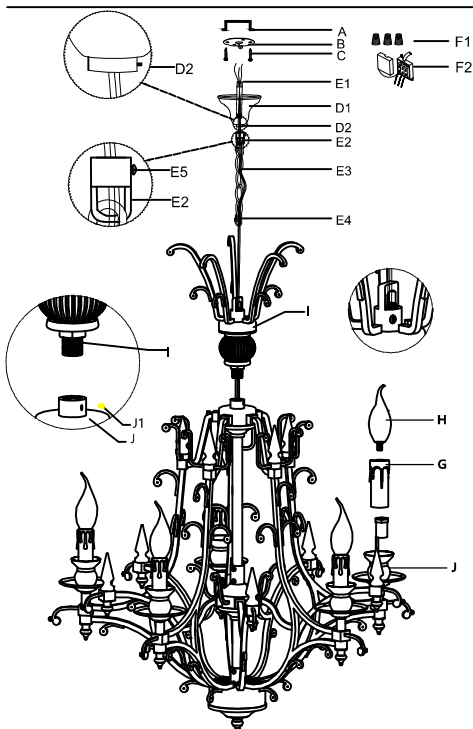







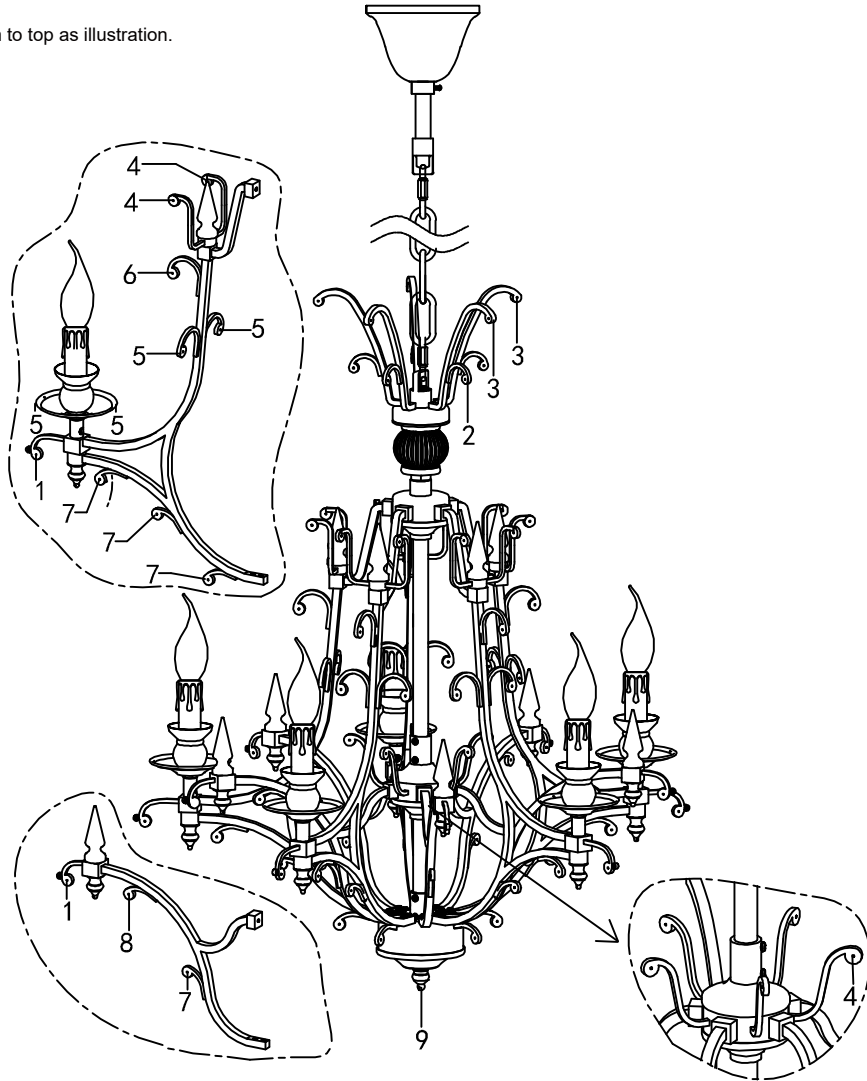

TIMOTHY OULTON ASSEMBLY INSTRUCTION

BAROQUE SMALL CHANDELIER 60CM

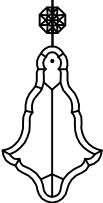
GLASS DROPS INSTALLATION

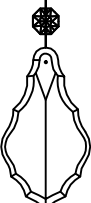
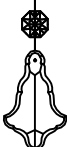
Hang the glass drops from bottom to top as illustration.

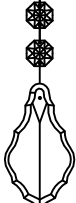
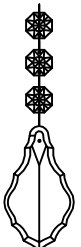

<p>1 20mmx1pc</p>  <p>80x126mm 10pcs</p>	<p>2 20mmx1pc</p>  <p>56x100mm 5pcs</p>	<p>3 20mmx1pc</p>  <p>72x130mm 5pcs</p>	<p>4 20mmx1pc</p>  <p>51x80mm 15pcs</p>	<p>5 20mmx1pc</p>  <p>34x56mm 20pcs</p>	<p>6 20mmx1pc</p>  <p>44x75mm 5pcs</p>	<p>7 20mmx2pcs</p>  <p>56x100mm 20pcs</p>
<p>8 20mmx3pcs</p>  <p>56x100mm 5pcs</p>	<p>9 20mmx3pcs</p>  <p>D40mm 1pc</p>					