

# CARSONITE®

A **valmont**  BRAND

Your Best Source For Quality, Durability, and Innovation



**Marking, Safety, Fencing, Parking, Traffic Control, Noise Abatement and Installation Products for Parks and Recreational Facilities**

---



**CARSONITE**<sup>®</sup>  
A valmont  BRAND



# Marking and Safety Products for Parks and Recreational Applications

## Who we are

With more than 30 years of experience serving highway, utility, and federal recreation markets, Carsonite has developed distinctive products and applications geared to each market. Our posts offer the maximum in durability and flexibility to address vehicle impacts and a variety of soil conditions. Carsonite posts are engineered to enhance visibility, simplify installation, withstand the elements and increase safety.

Our markers and delineators are the industry standard. Many of the marking products in wide use today are based on Carsonite patents. Our trademarked profiles remain the standard by which all other markers are measured, and Carsonite's easily identifiable products are manufactured and assembled in the United States.

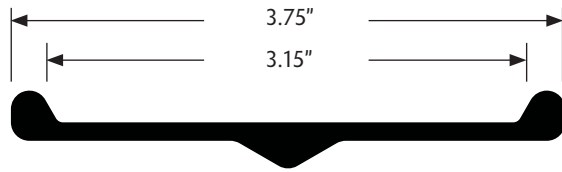
Carsonite is committed to excellence. Our name appears on all of our products, and we are dedicated to customer service. Our sales representatives and a vast distribution network stand ready to serve you with quality products and timely delivery.

## Table of Contents

<b>Posts and Markers</b>	
Carsonite RoadMarker™ (CRM).....	4
Curv-Flex™ Marker (CFR) .....	5
Dual-Sided Marker (CIB) .....	6
Tuff-Flex™ Marker (CTFM) .....	7
Boundary Marker (CBM) .....	8
Carsonite Sign Support Post (CSS) .....	9
Carsonite Support Post (CSP) .....	10
GreenLine™ Single-Curve Marker (CGD) .....	11
High-Impact Survivor™ (CDS) .....	12
Campsite Marker (CCSM) .....	13
The Channelizer™ Surface Mount (SDC) .....	14
SuperDuck™ Surface Mount (SDR3) .....	15
<b>Signs &amp; Decals</b>	
Federal Recreation Universal Symbols .....	16-19
Winter Recreation .....	18
Water Recreation .....	18
Accommodations and Services .....	18
General Recreation .....	19
Land Recreation .....	19
Custom & Stock Signs & Decals .....	20, 21
Traffic Control Signs .....	22
Parking Signs .....	23
Handicap Signs .....	24
Road Closure Signs and Kits .....	25
Die-cut Letters and Numbers .....	26, 27
Reflective Sheeting .....	28
Reflective Sign Support Cover (RSC) .....	29
<b>Safety Fencing</b>	
Carsonite Flexible Fencing Systems .....	30, 31
<b>Sound Barriers</b>	
Carsonite AcoustaShield™ Sound Barrier Systems .....	32-35
<b>Tools &amp; Other Products</b>	
Installation Tools .....	36
Anchor Barb .....	37
Notes .....	38, 39



19845 U.S. Highway 76  
Newberry, South Carolina 29108  
800-648-7916 · [www.carsonite.com](http://www.carsonite.com)



## Withstands highway-speed vehicle impacts

The three-rail design of the Carsonite RoadMarker provides both flexibility and structural integrity. Two ribs on the side protect sheeting from vehicle impacts, while the back rib gives added strength for driving into hard soil.

### How to Order:

**CRM 3**

Product number

**072**

Length (in.)

See chart for availability by color.

Other lengths and colors are available. Contact your representative.

Color (See chart below)

**01**

Post color	Standard Lengths (in.)
01-White	60, 62, 66, 72, 84
02-Yellow	60, 62, 66, 72
03-Brown	72
04-Orange	60, 62, 66, 72
05-Red	60, 62, 66
07-Green	72
08-Blue	66

Material: Fiberglass Composite, high-performance construction

Options and Accessories: Reflective sheeting  
Stock or custom decals  
Direct Graphics  
Visibility Enhancer  
Anchor Barb

Installation tools: Post Driver (PDR, PDRL)  
Post Puller  
Pilot Hole Driver

Carsonite High Performance RoadMarkers are designed to stand up to nature as well as vehicular impacts, controlled ditch burns, and even small arms gunfire.

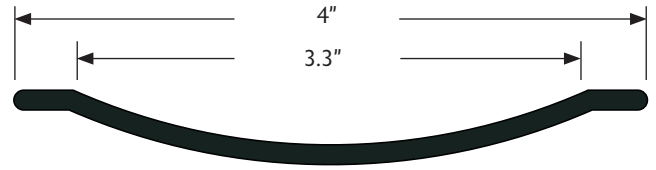


# Curv-Flex™ Marker

# CFR

## Drivable, flexible, impact resistant marker

Our most flexible fiberglass composite marker. The Curv-Flex is recommended for areas where vehicle impacts are likely. With its trademarked curve and flange profile, the Curv-Flex marker withstands direct tire impacts. In dense soil conditions, the Curv-Flex may require a small pilot hole before installation.



### How to Order:

Color (See chart below)

**CFR4**

Product number

**062**

Length (in.)

See chart for availability by color.

**01**

Post color	Standard Lengths (in.)
01-White	27, 60, 62, 66

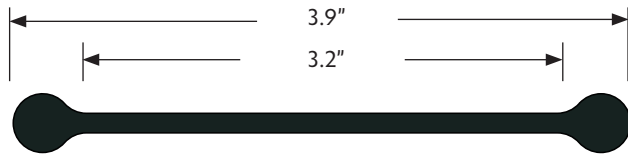
Other lengths and colors are available. Contact your representative.

Material:

Fiberglass Composite

- Options and Accessories: Reflective sheeting  
Stock or custom decals  
Anchor Barb
- Installation tools: Post Driver (PDR, PDRL)  
Post Puller  
Pilot Hole Driver  
Guide Tube





### Durable, attractive two-sided marker

This durable fiberglass composite Carsonite Dual Sided Marker accepts sheeting or decals on both sides. It is ideal for 180-degree messages—for rural route marking or for 9-1-1 identification. The marker rebounds after impacts, and resists vandalism. The raised, reinforced ribs along each side help prevent scratching or removal of the legends if impacted.

#### How to Order:

**CIB3**  
Product number

**066**  
Length (in.)  
See chart for availability by color.

Color (See chart below)

**01**

Post color	Standard Lengths (in.)
01-White	60, 62, 66
03-Brown	60, 62, 66, 72

Other lengths and colors are available. Contact your representative.

Material: Fiberglass Composite

- Options and Accessories:
- Reflective sheeting
  - Stock or custom decals
  - Direct Graphics
  - Visibility Enhancer
  - Anchor Barb

- Installation tools:
- Post Driver (PDR, PDRL)
  - Post Puller
  - Pilot Hole Driver

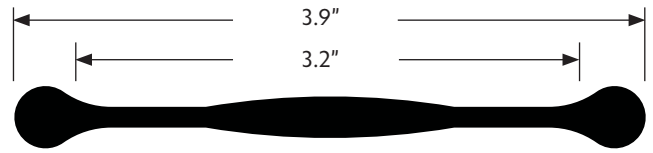


# Tuff-Flex™ Marker

# CTFM

**Designed for two-sided messages and hard soils** This

fiberglass composite marker offers all of the benefits of the Dual Sided Marker, with additional rigidity. With its thickened center rib, it remains drivable in virtually any soil condition. Excellent for 180-degree visibility.



### How to Order:

**CTFM**  
Product number

**060**  
Length (in.)  
See chart for availability by color.

Color (See chart below)

**05**

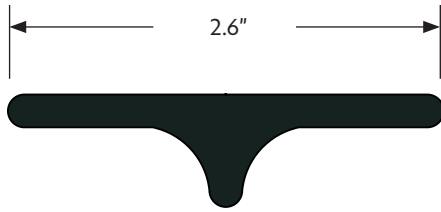
Post color	Standard Lengths (in.)
02–Yellow	60, 62, 66, 72
04–Orange	60, 62, 66, 72
05–Red	60, 62, 66, 72
08–Blue	60, 62, 66, 72

Other lengths and colors are available. Contact your representative.

**Material:** Fiberglass Composite

- Options and Accessories:** Reflective sheeting  
Stock or custom decals  
Visibility Enhancer  
Anchor Barb
- Installation tools:** Post Driver (PDR, PDRL)  
Post Puller  
Pilot Hole Driver





## Excellent for pedestals and enclosures

The Carsonite Boundary Marker post is a rigid composite post that can be driven in virtually any soil conditions. When cost is a concern, this economical marker is an ideal solution.

### How to Order:

**CBM 2**  
Product number

**062**  
Length (in.)  
See chart for availability by color.

Color (See chart below)

**04**

Color	Standard Lengths (in.)
04-Orange	48, 60, 62, 66, 72

Other lengths and colors are available. Contact your representative.

- Material:** Fiberglass Composite
- Options and Accessories:** Stock or custom decals  
Reflective sheeting
- Installation tools:** Post Driver (D250)  
Post Puller  
Pilot Hole Driver

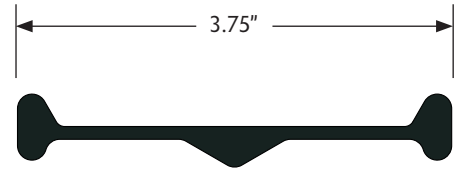




# Sign Support Post

## Great Looks and Maximum Durability

This composite post is specifically designed for use with Carsonite's composite signs up to 12" x 36". When ordered with Carsonite signs, the post can be ordered pre-drilled for ease of installation.



### How to Order:

Color  
(See chart below)

**CSS3**      **072**      **01**

Product number      Length (in.)

See chart for availability by color.

Color	Standard Lengths (in.)
01-White	72, 84, 96
03-Brown	72, 84, 96

Other lengths and colors are available. Contact your representative.

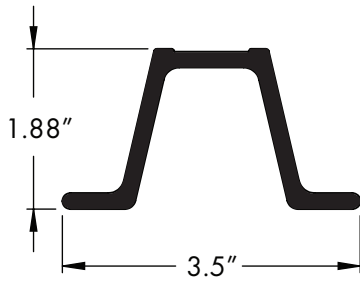
Material: Fiberglass Composite

Options and Accessories: Reflective sheeting  
Stock or custom signs

Installation tools: Post Driver (PDR, PDRL)  
Post Puller  
Pilot Hole Driver



## Support Post

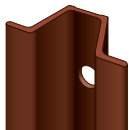


### How to Order:

**CSP**      **72**      **07**  
 Product number      Length (In.)      Color (3 choices)

Length
072-72"
096-96"
120-120"
144-144"

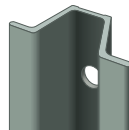
Color
03-Brown
07-Green
09-Gray



03 Brown

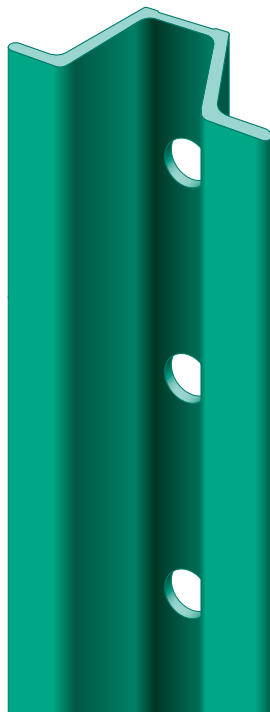


07 Green



09 Gray

Material: Fiberglass Reinforced Composite



### Durable, and easy installation

The Carsonite Support Post (CSP) is a U-channel shaped sign posts meeting the dimensions of a standard 3 lb U-channel. This post is intended for use as an object marker and a sign posts in applications requiring long-term outdoor durability, vandal resistance, and easy installation.

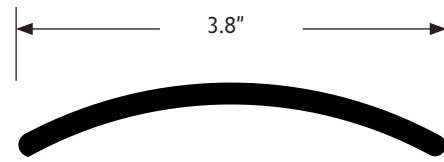


# GreenLine™ Single-Curve Marker

# CGD

## Highly flexible and available in bright colors

The GreenLine Single-Curve Marker is a highly flexible post featuring a simple, curved design that will take direct tire impacts at highway speeds. Available in bright colors, this attractive marker is ideal for 9-1-1 and yard marker applications. Decals or reflective sheeting can be applied to both sides. For hard soils, a convenient metal U-channel anchor may be added.



### How to Order:

**CGD**

Product number

**1**

1=plain  
U=U-channel  
option  
*Note: U-channel posts' overall length are 12" longer*

**060**

Length (in.)  
*See chart for availability by color.*

Color  
(See chart below)

**01**

Color	Standard Lengths (in.)
01-White	60, 66
02-Yellow	60, 66

Add U for optional U-channel

**U**

Other lengths and colors are available. Contact your representative.

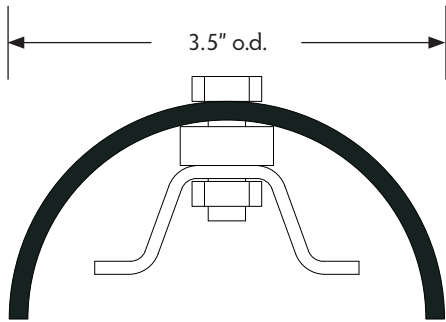
Material:

Polycarbonate

Options and Accessories:

- Reflective sheeting
- Stock or custom decals
- Anchor Barb
- Installation tools: Post Driver (PDR, PDRL)
- Guide Tube
- Post Puller
- Pilot Hole Driver
- U-channel Driver





### High-performance marker for high-impact areas

One of Carsonite's most durable posts. This polymer post with integral metal U-channel is easily driven into all types of soils. For use in areas where impacts are likely, this post has been impact tested at speeds of 65 mph.

#### How to Order:

**CDS3**  
Product number

**066**  
Length (in.)  
See chart for availability by color.

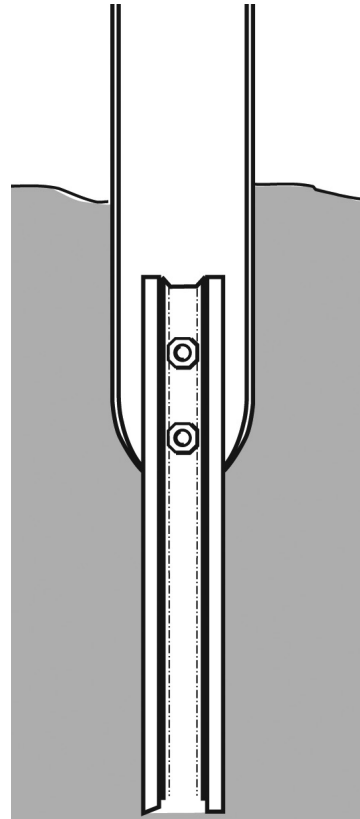
Color (See chart below)

**01**

Color	Standard Lengths (in.)
01-White	66
02-Yellow	66
09-Gray	66

Other lengths and colors are available. Contact your representative.

- Material: Polypropylene
- Options and Accessories: Reflective sheeting  
Stock or custom decals
- Installation tools: U-channel Driver (D300)



# Campsite Marker

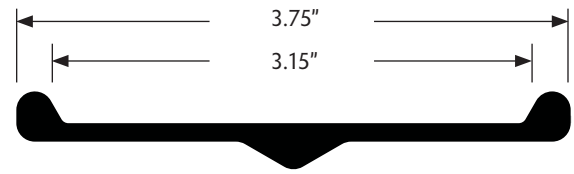
# CCSM

## Low-cost, dual-sided for campsites, picnic areas, etc.

For high visibility and easy identification, the Carsonite Campsite Marker is the perfect choice. This three-rail design combines structural integrity with above-ground flexibility, as well as protection for decals.

The marker is also highly resistant to vandalism. Anchors (sold separately) make it virtually impossible to remove the markers without proper equipment.

The reflective site identification decal is included. Custom decals are available, and can be applied to the metal slider—up to 6" long. Add your logo, name or any message. Carsonite will apply decals at our factory to save you time and money.



### How to Order:

**CCSM 3**

Product number

**066**

Length (in.)

See chart for availability by color.

Color (See chart below)

**01**

Post color	Standard Lengths (in.)
01-White	66, 72
03-Brown	66, 72

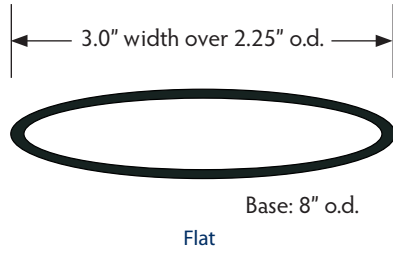
Other lengths and colors are available. Contact your representative.

Material: Fiberglass Composite post  
Metal slide

Options and Accessories: Reflective sheeting  
Stock or custom decals  
Direct Graphics  
Anchor Barb

Installation tools: Post Driver (PDR, PDRL)  
Post Puller  
Pilot Hole Driver





### Surface mounted, impact-resistant delineator

Carsonite's 2.25" Channelizer provides excellent delineation for high-traffic areas. The top of the post may be round for bands of reflective sheeting or flattened to support strips of sheeting up to 3" wide. Great for parking lots.

#### How to Order:

SDC     2     036

Product number     Round-2 / Flattened-F     Length (in.)

*See chart for availability by color.*

Color  
(See chart below)

01

Color	Standard Lengths (in.)
01-White	36, 42
02-Yellow	36, 42
04-Orange	36, 42

Other lengths and colors are available. Contact your representative.

- Material:** Polypropylene
- Options and Accessories:** Reflective sheeting, Stock or custom decals, Mastic Pad

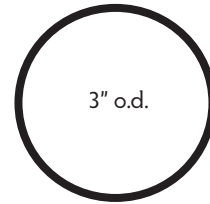


# Super Duck™

# SDR3

## Surface-mounted, Impact-resistant Delineator

This unique 3" channelizer supports up to 6 bands of reflective sheeting. Ideal for construction sites, lane changes, and adding visibility to raised medians.



Base: 8" o.d.



### How to Order:

**SDR3**

Product number

**036**

Length (in.)

Color  
(See chart below)

**01**

Color	Standard Lengths (in.)
01-White	36
02-Yellow	36
04-Orange	36

Material:

Polypropylene

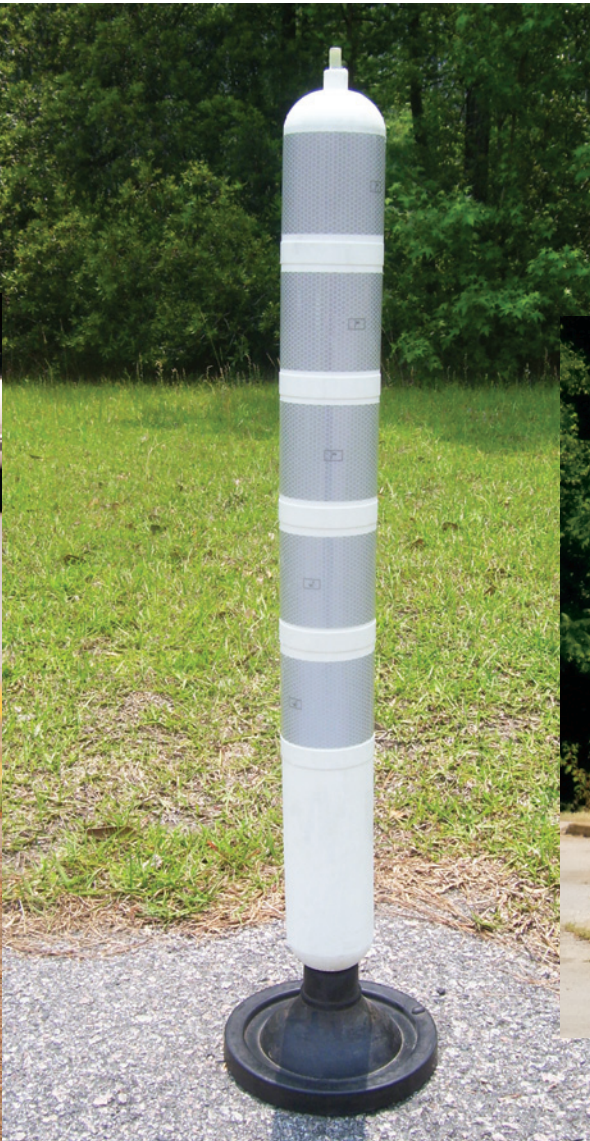
Base: Rubber

Options and Accessories:

Reflective sheeting

Stock or custom decals

Mastic Pad



# Federal Recreation Signing (Universal Symbols)



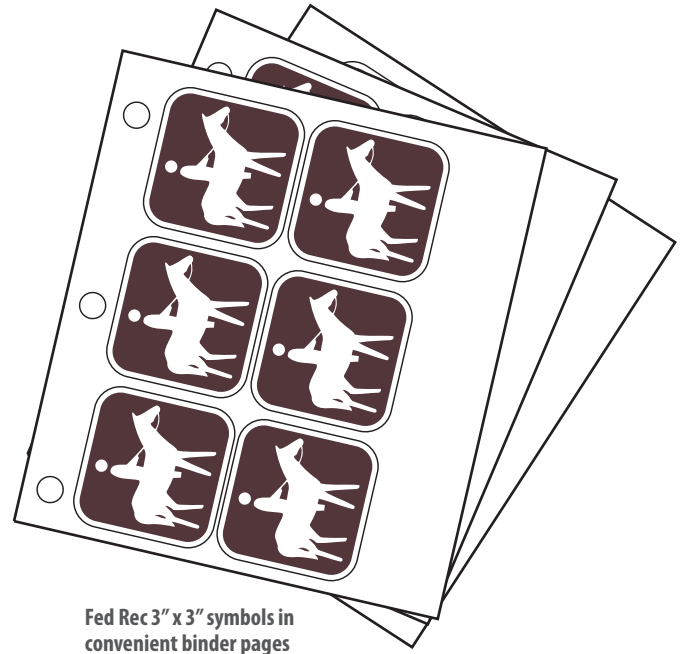


# Stock or Custom Made

Carsonite offers a complete line of outdoor quality signs and decals featuring universally recognized federal symbols for recreation. These signs and decals can be combined with a Carsonite marker to create a highly cost-effective, low-maintenance signing system. All signs and decals can be customized for your needs.

3" x 3" recreational symbols are available in 8½" x 11" pages containing six symbols and three directional arrows. All recreational symbols are printed with a white engineering-grade reflective background with brown copy. Custom colors are available. Add a red slash to any recreational symbol to prohibit the activity.

Recreational symbols can also be ordered as 8" x 8" or 12" x 12" signs. See illustration below.



Fed Rec 3" x 3" symbols in convenient binder pages



Fed Rec 12" X 12" Sign



Fed Rec 8" X 8" Sign



RSS034  
Parking



Add a red slash to any graphic to prohibit the activity.  
Add "SL" to the product number.  
For example: RSS034SL  
NO Parking

ILLUSTRATIONS ARE NOT TO SCALE

### FACILITY SYMBOLS

 RSS034 Parking	 RSS035 Showers	 RSS036 Viewing Area	 RSS037 Sleeping Shelter	 RSS038 Campground	 RSS039 Picnic Shelter
 RSS040 Trailer Sites	 RSS041 Trailer Sanitary Station	 RSS042 Campfires	 RSS043 Trailer Shelter	 RSS044 Picnic Area	 RSS045 Kennel
 RSS085 Laundry	 RSS306 Electrical Hookup	 RSS307 Motorhome	 RSS308 Group Camping	 RSS309 Group Picnicking	

### DIRECTION SYMBOLS























 RSS100 Directional Arrows	 RSS101 Left Arrow	 RSS102 Right Arrow	 RSS103 Arrow Head	 RSS327 Arrow	 RSS340 Directional Arrow
---	---	--	---	--	---

### WINTER RECREATION

 RSS046 Cross-Country Skiing	 RSS047 Downhill Skiing	 RSS048 Ski Jumping	 RSS050 Ice Skating	 RSS051 Ski Bobbing	 RSS052 Snowmobiling
 RSS077 Winter Recreation Area	 RSS078 Snowshoeing	 RSS317 Sledding	 RSS318 Chairlift	 RSS319 Snow Tubing	 RSS320 Snowboarding
 RSS607 Mushing					

ILLUSTRATIONS ARE NOT TO SCALE

### WATER RECREATION

 RSS053 Marina	 RSS054 Launching Ramp	 RSS055 Motorboating	 RSS056 Sailboating	 RSS057 Rowboating	 RSS058 Water Skiing
 RSS059 Surfing	 RSS061 Swimming	 RSS062 Diving	 RSS063 Fishing	 RSS079 Canoeing	 RSS087 Boat Tours
 RSS088 Wading	 RSS107 Whitewater Rafting	 RSS303 Seaplane	 RSS321 Scuba Diving	 RSS322 Fishing Pier	 RSS323 Personal Watercraft
 RSS324 Kayak	 RSS325 Raft	 RSS326 Wind Surf			

### ACCOMMODATIONS/SERVICES

 RSS018 Lodging	 RSS019 Food Service	 RSS020 Grocery Store	 RSS021 Men's Restroom	 RSS022 Restrooms	 RSS023 Women's Restroom
 RSS024 First Aid	 RSS025 Telephone	 RSS026 Post Office	 RSS027 Mechanic	 RSS028 Handicapped	 RSS029 Airport
 RSS031 Bus Stop	 RSS032 Gas Station	 RSS033 Vehicle Ferry	 RSS310 Elevator	 RSS311 Family Restroom	 RSS312 Helicopter

All designs are available as 3" x 3" Decal Pages, 8" x 8" and 12" x 12" Signs

## GENERAL RECREATION



RSS001 Firearms  
RSS002 Smoking  
RSS003 Automobiles  
RSS004 Trucks  
RSS005 Tunnel  
RSS006 Lookout Tower



RSS007 Lighthouse  
RSS008 Falling Rock  
RSS009 Dam  
RSS010 Fish Hatchery  
RSS011 Deer Viewing Area  
RSS012 Bear Viewing Area



RSS013 Drinking Water  
RSS014 Information  
RSS015 Ranger Station  
RSS016 Pedestrian Crossing  
RSS017 Pets On Leash  
RSS076 Environmental Study Area



RSS080 Point Of Interest  
RSS086 Litter Container  
RSS208 Firewood Cutting  
RSS301 Natural Study Area  
RSS302 Pickup Truck  
RSS304 Cultural Interest



RSS305 Alcohol Permitted  
RSS305SL No Alcohol  
RSS331SL No Alcohol 3x3  
RSS330SL No Fireworks 3x3

ILLUSTRATIONS ARE NOT TO SCALE



## LAND RECREATION



RSS064 Horse Trail  
RSS065 Trail Bike Trail  
RSS066 Bicycle Trail  
RSS067 Recreational Vehicle Trail  
RSS068 Hiking Trail  
RSS069 Playground



RSS070 Amphitheater  
RSS071 Tramway  
RSS072 Hunting  
RSS073 Stable  
RSS074 Interpretive Trail  
RSS075 Interpretive Auto Trail



RSS081 Climbing  
RSS082 Technical Rock Climbing  
RSS083 Rock Collecting  
RSS084 Spelunking  
RSS105 Jogging  
RSS108 ATV



RSS200 ONLY  
RSS313 Tramway  
RSS314 Corral  
RSS315 Hang Glider  
RSS109 Archer  
RSS110 Mile



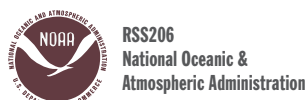
RSS316 Rollerblading  
RSS802 Trail Courtesy  
RSS328 Bicycle Lane  
RSS098 Skateboarding



## AGENCY LOGOS



RSS104 Forest Service Shield  
RSS201 Bureau Of Land Management  
RSS202 National Park Service  
RSS203 Corps of Engineers  
RSS204 Department Of Interior  
RSS205 Fish & Wildlife Service



RSS206 National Oceanic & Atmospheric Administration



RSS207 Bureau Of Indian Affairs

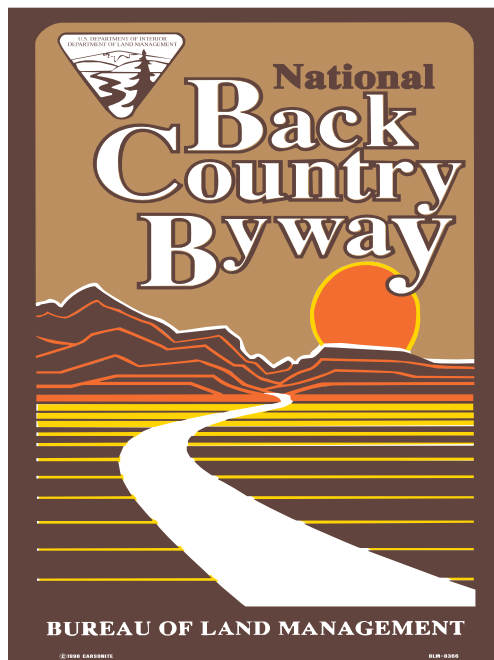
All agency logos are available. Contact your representative.

# Custom Signs and Decals

Recreation Products



ILLUSTRATIONS ARE NOT TO SCALE



# Stock Decals, can be personalized



8621TL  
Closed To Vehicles Wider...  
12x12



808BFC  
Private Property  
2 7/8x10 1/4



499EMR  
Invaluit  
Boundary  
2 3/8x15



283FPB  
Boundary



257FWR  
Survey Marker  
2 3/8x11 1/4



110SM  
Survey Marker  
2 3/8x8 1/2



139PB  
Property  
Boundary  
2 3/8 x 10



378E  
Easiest  
3x4



373MD  
Most Difficult  
3x4



374MD  
More Difficult  
3x4



300NH  
No Hunting  
2 7/8x14 1/2



250R  
Reserved  
2 7/8x12



337DNE  
Do Not Enter  
2 7/8x13 3/4



252V  
Visitors  
2 7/8x12



251HC  
Handicapped  
Only  
2 7/8x20 1/2



321R  
Registration  
2 7/8x16



917LNF  
Trail Exit  
2 7/8x15



916ENF  
Trail Entrance  
2 7/8x15



394TRMR  
(Diamond)  
3x5



394TRIMW  
(Diamond)  
3x5



394TRMBLK  
(Diamond)  
3x5



394TRIMG  
(Diamond)  
3x5



979MPH  
5 Miles Per Hour  
2 7/8x5 1/2



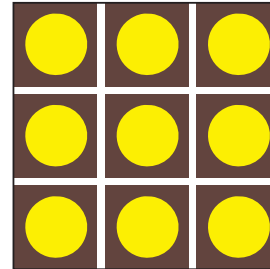
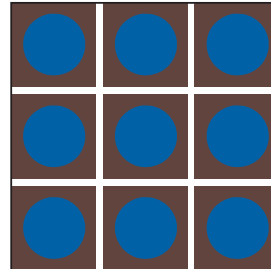
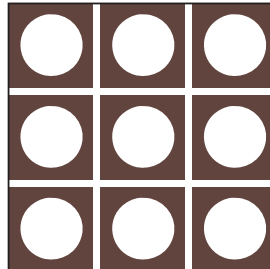
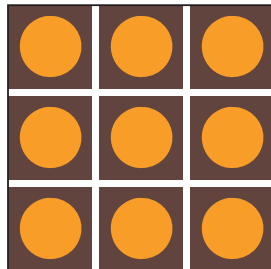
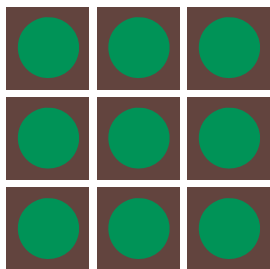
394TRIMY  
Symbol  
3x5



394TRMO  
(Diamond)  
3x5



394TRMBL  
(Diamond)  
3x5



Discs (3x3)  
Sheets of 9 discs per color, white, blue, orange, green or yellow on a brown background

White: 1007DW  
Blue: 1007DB  
Orange: 1007DO  
Green: 1007DG  
Yellow: 1007DY



249FL  
Fire Lane  
2 7/7x12



1215FL Fire  
Lane  
2 7/8x13 1/2



317NP  
No Parking  
2 7/7x13 1/8



600CL  
Closed  
2 7/8x16



535ORV  
Off Road  
Vehicles  
3x9



535SLORV  
No Off Road  
Vehicles  
3x9



798CP  
Customer  
Parking  
2 7/8x13 7/8



601RTR  
Route  
2 7/8x14



602RTB  
Route  
2 7/8x14



832MO  
No Motor  
Vehicles  
2 7/8x12 1/2

ILLUSTRATIONS ARE NOT TO SCALE

# Traffic Control Signs and Decals



9238PS  
Do Not Enter  
18x18



9239PS  
(No Left)  
18x18



9240PS  
(No Right)  
18x18



9242PS  
(No Truck)  
18x18



9243PS  
(Symbol)  
18x18



9244PS  
Slow  
18x18



9245PS  
Bump  
18x18



9246PS  
Caution  
18x18



9247PS  
Exit (Right)  
18x18



9248PS  
Exit (Left)  
18x18



9250PS  
Exit Only...  
12x18



9249PS  
Exit Only  
18x18



9252PS  
Enter Only  
18x18



9258PS  
Enter (Right)  
18x18



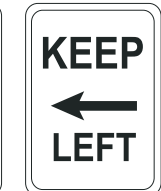
9259PS  
Enter (Left)  
18x18



9253PS  
No Left Turn  
12x18



9260PS  
Keep Right  
12x18



9261PS  
Keep Left  
12x18



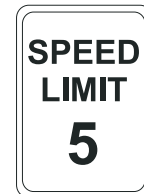
9262PS  
One Way (Right)  
18x18



9263PS  
One Way (Left)  
18x18



9254PS  
No Right Turn  
12x18



9256PS  
Speed Limit 5  
12x18



9255PS  
Speed Limit 20  
12x18



9257PS  
Speed Limit 10  
12x18



8448STOP  
Stop  
18x18



9251PS  
Employee Entrance  
12x18



9264PS  
One Way (Arrow Right)  
18x6



9265PS  
One Way (Arrow Left)  
18x6

ILLUSTRATIONS ARE NOT TO SCALE

# Parking Signs



**NO  
PARKING**

9186PS  
No Parking  
12x18



**NO PARKING  
ANY TIME**

9187PS  
...Any Time  
12x18



**NO PARKING  
FIRE LANE**

9188PS  
...Fire Lane  
12x18



**NO  
PARKING  
FIRE LANE**

9189PS  
...Fire Lane  
12x18



**NO  
PARKING  
BETWEEN  
SIGNS**

9190PS  
...Between Signs  
12x18



**NO  
PARKING  
BETWEEN  
SIGNS**

9191PS  
...Between Signs  
12x18



**NO  
PARKING  
ANY TIME**

9192PS  
...Any Time  
12x18



**NO  
PARKING  
ANY TIME**

9193PS  
...Any Time  
12x18



**NO  
PARKING  
THIS  
SIDE**

9194PS  
...This Side  
12x18



**NO  
PARKING  
FIRE  
LANE**

9195PS  
...Fire Lane  
12x18



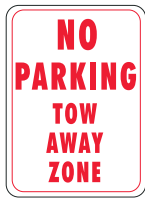
**NO  
PARKING  
LOADING  
ZONE**

9196PS  
...Loading Zone  
12x18



**NO  
TRUCK  
PARKING**

9197PS  
No Truck Parking  
12x18



**NO  
PARKING  
TOW  
AWAY  
ZONE**

9203PS  
...Tow Away Zone  
12x18



**NO  
PARKING  
PRIVATE  
DRIVE**

9204PS  
...Private Drive  
12x18



**2 HR  
PARKING  
VISITOR  
PARKING  
ONLY**

9200PS  
2 Hr Parking Visitor  
12x18



**1 HR  
PARKING  
VISITOR  
PARKING  
ONLY**

9201PS  
1 Hr Parking Visitor  
12x18



**NO  
PARKING  
BEYOND  
THIS  
SIGN**

9202PS  
...Beyond This Sign  
12x18



**1 HR  
PARKING  
CUSTOMERS  
ONLY**

9205PS  
1 Hr / Customers  
12x18



**CUSTOMER  
PARKING  
ONLY**

9209PS  
Customer Only  
12x18



**EMPLOYEE  
PARKING  
ONLY**

9210PS  
Employee Parking  
12x18



**TENANT  
PARKING  
ONLY**

9211PS  
Tenant Parking  
12x18



**VISITOR  
PARKING  
ONLY**

9212PS  
Visitor Parking  
12x18



**VISITOR  
PARKING**

9213PS  
Visitor (Right)  
12x18



**VISITOR  
PARKING**

9214PS  
Visitor (Left)  
12x18



**VISITOR  
PARKING**

9218PS  
Visitor (Arrows)  
12x18



**TOW-AWAY  
ZONE**

9198PS  
Tow-Away Zone  
12x6



**FIRE LANE**

9199PS  
Fire Lane  
12x6

Stock and custom signs are available for any use.



**EMPLOYEE  
PARKING**

9215PS  
Employee Parking  
12x18



**EMPLOYEE  
PARKING**

9216PS  
Employee (Arrows)  
12x18



**CUSTOMER  
PARKING**

9217PS  
Customer (Arrows)  
12x18



**15  
MINUTE  
PARKING**

9219PS  
15 Minute Parking  
12x18



**30  
MINUTE  
PARKING**

9220PS  
30 Minute Parking  
12x18



**ONE  
HOUR  
PARKING**

9221PS  
One Hour Parking  
12x18



9241PS  
(No Parking)  
18x18



8620CR  
(Symbol)  
18x18



**WRONG  
WAY**

9207PS  
Wrong Way  
12x9



**DO NOT  
ENTER**

9208PS  
Do Not Enter...  
12x21



**DO NOT  
ENTER**

9206PS  
Do Not Enter  
12x12



# Handicap access signs

Recreation Products



9222PS  
Handicapped Parking  
12x18



9223PS  
Disabled Parking  
12x18



9224PS  
(Symbol)  
12x18



9225PS  
Reserved Parking  
12x18



9226PS  
Reserved Parking  
(Arrow Left)  
12x18



9227PS  
Reserved Parking  
(Arrow Right)  
12x18



9228PS  
Reserved Parking (Arrows)  
12x18



9229PS  
Parking By Permit Only  
12x18



9230PS  
Reserved Parking  
Permit Required  
12x18



9231PS  
Van Accessible  
12x18



9232PS  
(Symbol)  
12x12



9233PS  
Reserved Parking  
Permit Required  
12x18



9234PS  
Unauthorized Vehicles...  
18x12



9235PS  
Van Accessible  
12x6



9236PS  
Permit Required  
12x6



9237PS  
Violators Will Be Fined  
12x6



# Road Closure Signs and Kits

These durable, highly visible, composite signs attach to gates, fencing, or posts to easily close roads, temporarily or permanently. Posts sold separately. Add Hazard Marker Signs, Object Markers, and Reflective Sheeting around the area as needed for safety.

## Road Closure Kits

Our Standard Road Closure Kit offers a choice of two styles of larger, 15"x30" "Road Closed" signs: with or without a message area that accommodates an explanation decal. The LowVolume Road Closure Kit features a smaller, 10"x20" "Road Closed" sign with a message area. For both, our standard message inserts are listed on Page 28. Custom decals are also available.



**8607RC**  
Road Closure  
(without message area)  
18x30

### Standard Road Closure Kit

**RCSTKIT**

- (2) Type II Object Marker Signs – **8301YS**
- (1) Hazard Sign with Right to Left Stripes 12"x36" – **8311HM**
- (1) Hazard Sign with Left to Right Stripes 12"x36" – **8310HM**
- (1) Road Closed Sign, choice of:

**8607RC** "Road Closed" without message area

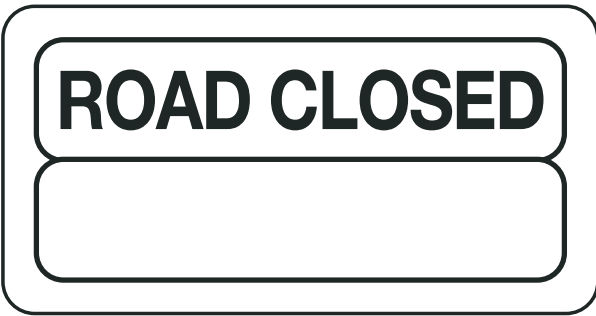
OR

**8608RC** "Road Closed" with message area (message decal sold separately, see page 32)

### Low-Volume Road Closure Kit

**RCLVKIT**

- (2) Type II Object Marker Signs – **8301YS**
- (1) Hazard Sign with Right to Left Stripes 8"x24" – **8302HM**
- (1) Hazard Sign with Left to Right Stripes 8"x24" – **8303HM**
- (1) Road Closed Sign 10"x20" with message area – **8608RC**



**8608RC**  
Road Closure  
(with message area)  
15x30

**RC-8608LV**  
Road Closure  
(with message area)  
10x20



**8728RCA**  
Road Closed Ahead  
12x12



**8706RC**  
Road Closed  
12x12



Colors:

Road Closure Kits: Red/White

# Decals, Letters and Numbers

Carsonite's graphics department manufactures decals to order using a highly specialized, state of the art process that results in tough, UV-resistant decals that stand up to harsh outdoor environments. Our decals start with top quality vinyl or reflective pressure sensitive material. We then use outdoor quality, UV-resistant materials and pigments to put your message on the decal. The process is completed by embedding the graphics under a protective laminate called UV Shield™, which provides resistance to weather, graffiti, vandalism, and fading.

Carsonite offers complete production services to make your message clear, visible, and customized to your needs. Our processes yield unsurpassed weatherability, durability and UV resistance. We are the experts in visibility!



We use state-of-the-art equipment throughout the process to ensure a quality job that meets your specifications and imposes as few limitations as possible to your creativity. Your corporate, park, DOT, or other logos can be faithfully reproduced.

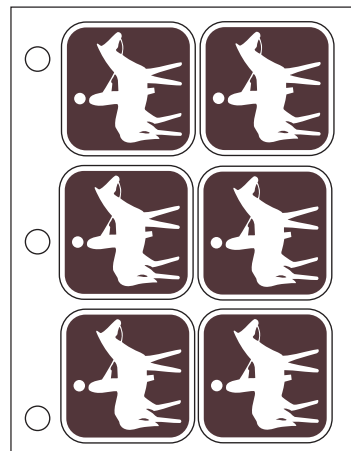
## LETTERS AND NUMERALS

These outdoor-quality, ready-made alphabets and numeral sets meet the Federal Highway Administration's specifications. You can apply them to identify equipment, to enumerate sites, and to specify mileage, route numbers, dates and times on signs and decals. Available non-reflective or reflective in 1" to 4" height, any color and any character, including accented characters.



### Available products:

- Individual Decals: stock or custom
- Die-Cut Decal sheets: 8½"x11" sheets containing 1", 2", 3" or 4" numerals or letters.
- Die-Cut Decal sheets, 8½"x11" sheets containing 2" or 4" arrows
- Die-Cut Decal sheets, 8½"x11" sheets containing 1", 3/8", 1/2" or 5/16" decimals
- Travel Management System Components for easy-to-assemble specialized decals
- Kits of Letters and Numerals



# Decals, Letters and Numbers

## Die-Cut Numerals & Alphabets

Available in a variety of colors to suit any need, Carsonite's die-cut numerals and alphabets come in convenient sheets suitable for storage in standard three-hole binders. They are available in reflective or non-reflective self-adhesive material, and in sheets of 1", 2", 3" or 4" letters or numerals.

Reflective or non-reflective letters and numerals are also supplied in white or any color on a solid color background (specify colors). The sizes are 1", 2", 3" and 4".

Symbols per sheet:

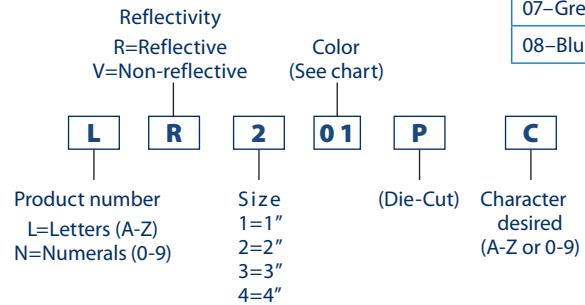
- 1" solid or 1" die-cut: 70
- 2" solid or 2" die-cut: 28
- 3" solid or 3" die-cut: 6
- 4" solid or 4" die-cut: 5

Other sizes and designs, decimal points and arrows, as well as kits of letters and numerals are also available. Custom symbols and logos can also be accommodated. Contact your representative.

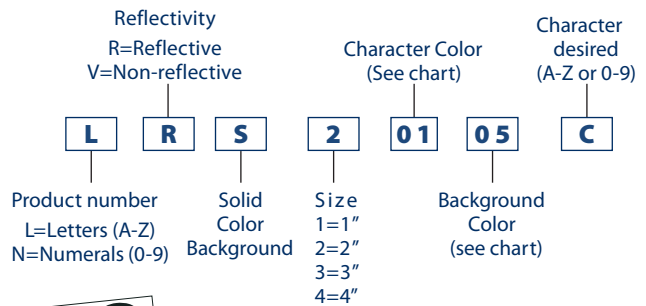
Colors Available
01-White
02-Yellow
03-Brown
04-Orange
05-Red
06-Black
07-Green
08-Blue

### How to Order:

#### Die-Cut Letters or Numerals:



#### Solid-Color Background Letters or Numerals:



# Reflective Sheeting

## How to Order:

### ENGINEER GRADE 3"

**RSE30**

Product number

**12**

Length (in.)

See chart for availability by color.

Other lengths and colors are available. Contact your representative.

Color  
(See chart below)

**04**

Color
01-White
02-Yellow
04-Orange
05-Red
06-Black
08-Blue

### HI-INTENSITY 3"

**RSH30**

Product number

**12**

Length (in.)

See chart for availability by color.

Other lengths and colors are available. Contact your representative.

Color  
(See chart below)

**10**

Color
01-White
02-Yellow
05-Red
07-Green
08-Blue
10-Fluorescent Yellow/Green

### DIAMOND 3"

**RSD30**

Product number

**06**

Length (in.)

See chart for availability by color.

Other lengths and colors are available. Contact your representative.

Color  
(See chart below)

**10**

Color
01-White
02-Yellow
05-Red
07-Green
08-Blue
10-Fluorescent Yellow/Green

Material: Vinyl or Reflective Media

Options and Accessories: Flat or Round Markers  
Visibility Enhancers

Number/Letter Kits also available

## Enhance Visibility

Carsonite offers a full array of reflective media that can be permanently applied to your posts at the factory or shipped separately. Standard widths are 3.0"; but others are available on special order—contact your representative.

Reflective Sheeting is available in three grades:

- Engineer Grade (RSE30) Type I
- Hi Intensity (RSH30) Type III/IV
- Diamond Grade (RSD30) Type VIII

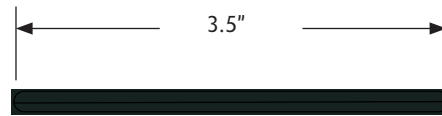


# Reflective Sign Support Cover

# RSC

## Surface mounted, impact-resistant delineator

Carsonite's Reflective Sign Support Cover adds visibility to signs. Available in high-intensity or diamond grade reflectivity, these covers attach easily to metal or wooden posts for heightened day or night visibility—safety you can't miss.



### How to Order:

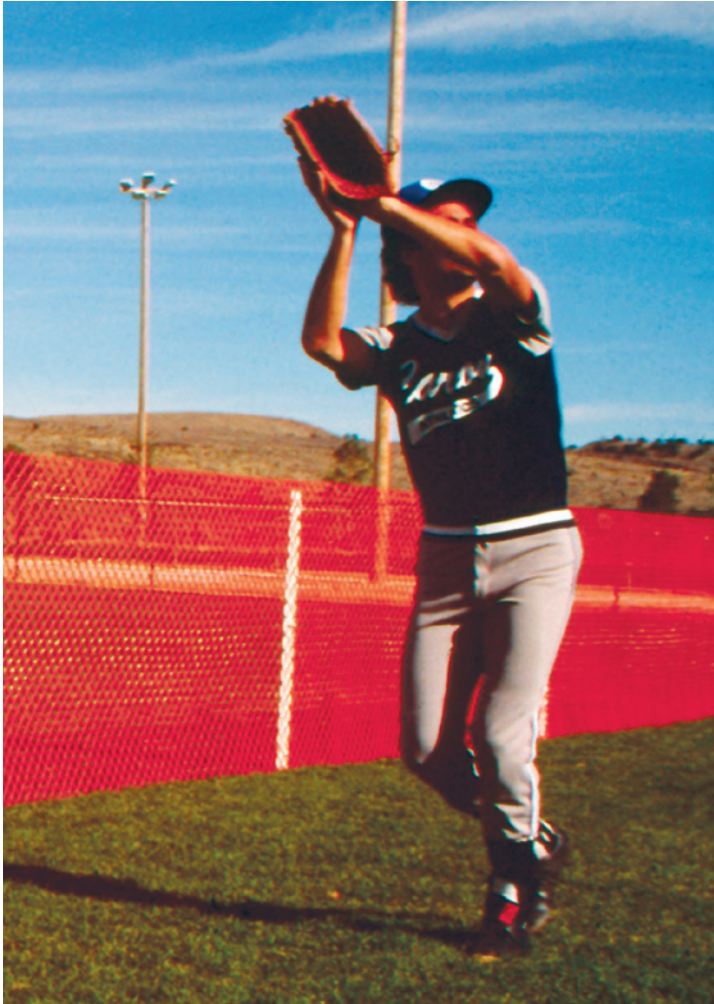
<b>RSC</b>	<b>048</b>	<b>02</b>	<b>RSD</b>	<b>01</b>						
Product number	Length (in.) See chart for availability by color.	Color	Grade Hi-Intensity—RSH Diamond—RSD	Sheeting Color (see 2nd chart below)						
	Other lengths and colors are available. Contact your representative.	<table border="1"> <thead> <tr> <th>Color</th> <th>Standard Lengths (in.)</th> </tr> </thead> <tbody> <tr> <td>01-White</td> <td>48, 60, 72</td> </tr> </tbody> </table>			Color	Standard Lengths (in.)	01-White	48, 60, 72		
Color	Standard Lengths (in.)									
01-White	48, 60, 72									
		<table border="1"> <thead> <tr> <th>Sheeting Color</th> </tr> </thead> <tbody> <tr> <td>01-White</td> </tr> <tr> <td>02-Yellow</td> </tr> <tr> <td>05-Red</td> </tr> <tr> <td>08-Blue</td> </tr> <tr> <td>10-Fluorescent Yellow Green</td> </tr> </tbody> </table>			Sheeting Color	01-White	02-Yellow	05-Red	08-Blue	10-Fluorescent Yellow Green
Sheeting Color										
01-White										
02-Yellow										
05-Red										
08-Blue										
10-Fluorescent Yellow Green										

Material: Polycarbonate  
 Options and Accessories: Stock or custom decals  
Mounting Hardware



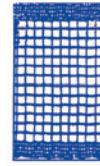
Recreation Products

# Flexible Safety Fencing



### TuffNet Mesh Flexible Fencing

Orange (04), Red (05), Blue (08), Hunter Green (25)  
 4'x50' **FMF048050** \_\_  
 4'x100' **FMF048100** \_\_  
 4'x150' **FMF048150** \_\_



**TuffNet Mesh** is made from tear-resistant, knitted polypropylene in vibrant colors. Suitable for youth or adult sports.

### Carsonite Original Post

White (01). Includes safety cap, tension strap, and drive tip.  
 66" **CRFP06601**

### Flex-Rod Post

White (01). Includes safety cap, and tension strap.  
 66" **1-FR-66**

### Hi-Impact Post

White (01), with gray rubber padding. Includes safety cap, tension strap, and Ground Sleeve.  
 66" **1-IP-66**

### Flat Ground Sleeve

For Carsonite Original Post. Includes removable cap. Enables easy changeover to multiple configurations—soccer, baseball, volleyball, for example. **FGS401804U**

Package of 6 sleeves **FGS401804KIT**  
 Replacement cap **FSC400**

### Ground Sleeve for FlexRod or Hi-Impact Post

Package of 6 sleeves **1-IGS-18KIT**  
 Replacement cap **1-LSC-A**

### Corner Post

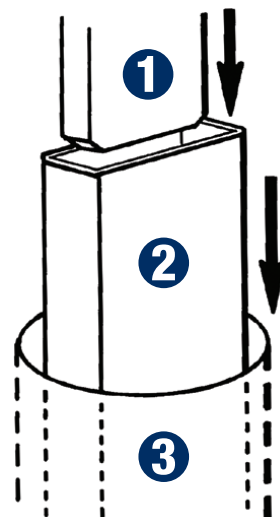
Adds rigidity to Carsonite Original Post Systems. . . . **CSFP06601**

### Tools

Post Driver for Carsonite Original Flat Posts **RMTLPDR1**  
 Post Driver for FlexRod Round Posts **RMTLDFROD**  
 Pilot Hole Driver for rocky or hardpan soils **RMTLDP100**  
 Post Puller for easy removal of any post style **RMTLCP**

### Replacement Parts

Reusable heavy duty fence ties (pack of 100) **FFMRTYPK**  
 Rope clips (pack of 85) **FFMCLPK**  
<sup>3</sup>/<sub>16</sub>" x 170' Poly Rope for TuffNet fence **FFMR**



1. Carsonite Post
2. Ground Sleeve
3. Post Hole



# Flexible safety Fencing

## Fence Packages

### TuffNet Mesh Fence Systems

Includes 4' roll of fencing, Fence Ties, Poly Rope, 6 Posts with safety caps and tension straps for each 50' of fence. Tools and Ground Sleeves, if needed, are available separately. Green, Orange, Red, or Blue.

### With Carsonite Original Posts

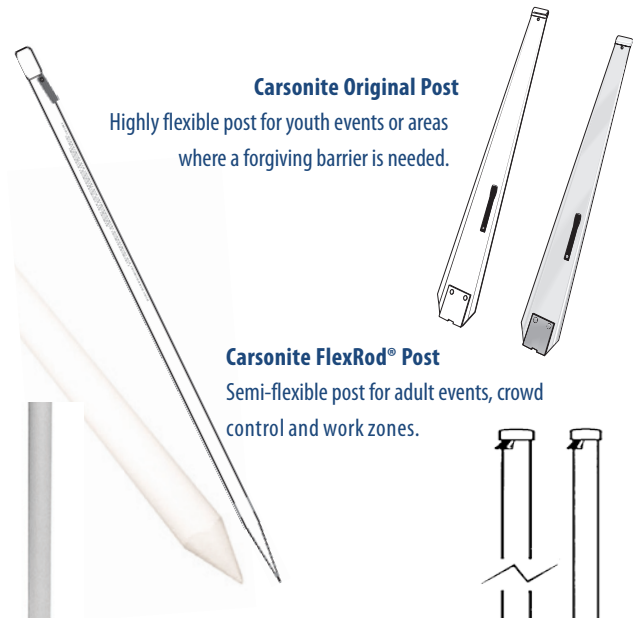
50' Fence Kit	CRFM06601PK
100' Fence Kit	CRFM06601PKX100
150' Fence Kit	CRFM06601PKX150

### With FlexRod Posts

50' Fence Kit	FRFM0106PK
100' Fence Kit	FRFM0112PK
150' Fence Kit	FRFM0118PK

### With Hi-Impact Posts with Magnetic Ground Sleeves

50' Fence Kit	HIFM2906PK
100' Fence Kit	HIFM2912PK
150' Fence Kit	HIFM2918PK



### Carsonite Original Post

Highly flexible post for youth events or areas where a forgiving barrier is needed.

### Carsonite FlexRod® Post

Semi-flexible post for adult events, crowd control and work zones.

### Carsonite Hi-Impact Post

Offers 360-degree flexibility for both youth and adult events. Requires a Magnetic Locking Ground Sleeve for installation.

**Ground Sleeves for FlexRod Posts** remain in the ground and allow easy insertion and removal of fence posts. Ideal for applications where the fence will be taken down and put back up frequently.

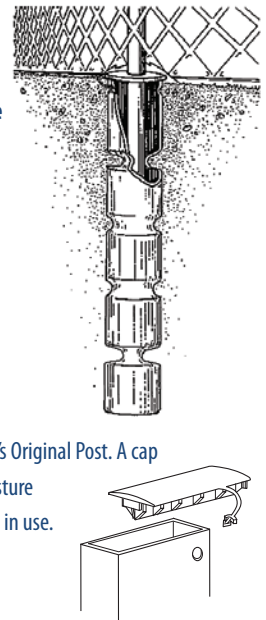
### Magnetic Locking Ground Sleeve

For use with FlexRod® and Hi-Impact Posts.

**Special Locking Pin** locks into the Magnetic Locking Ground Sleeve to reduce vandalism and tampering.

### Rectangular Ground Sleeve

For use with Carsonite's Original Post. A cap excludes dirt and moisture when the sleeve is not in use.



ILLUSTRATIONS ARE NOT TO SCALE

# Carsonite AcoustaShield™ Sound Barriers

## How to Order:

Contact your representative or visit [www.carsonite.com](http://www.carsonite.com) to request more information and an AcoustaShield information packet.

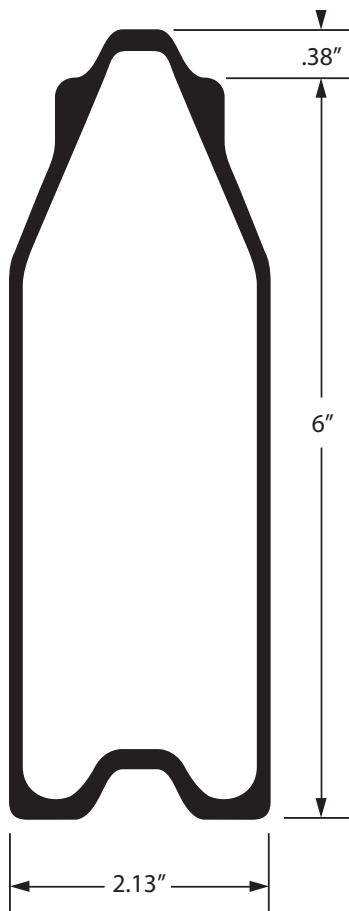
- ▶ Meets AASHTO and DOT sound wall guidelines
- ▶ Low maintenance over life of product
- ▶ Wide variety of colors available
- ▶ Spans up to 18 feet
- ▶ Graffiti resistant
- ▶ Lightweight, easily installed with minimal equipment
- ▶ Non-conductive fiberglass supports and panels

## Effective against noise and light pollution

Carsonite's AcoustaShield Sound Barrier provides noise abatement along transportation corridors, as well as other applications requiring long-term outdoor durability, vandal resistance and ease of construction.

Easily customized, the system lets you design your sound barrier to fit your specific needs. Choose from unfilled, recycled-rubber filled, or absorptive options. These lightweight panels can be installed by a small crew without the use of heavy lifting equipment. The flame retardant panels can be easily cut in the field if on-site adjustments are needed. For applications under 15' in height, inquire about our fiberglass uprights.

Material: Fiberglass composite

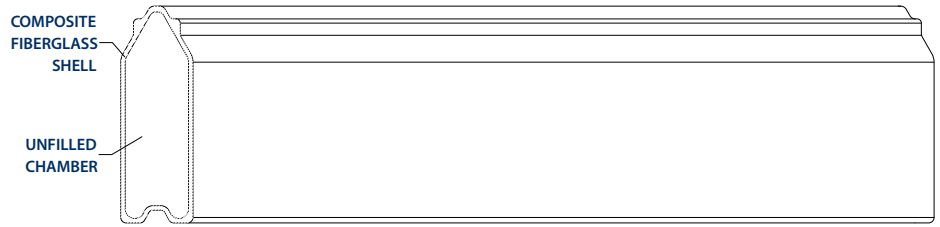


Acoustical Ratings			
	AcoustShield Absorptive	AcoustaShield Filled	AcoustaShield Unfilled
STC Rating	28	37	28
NRC Value	.95	.15	.20

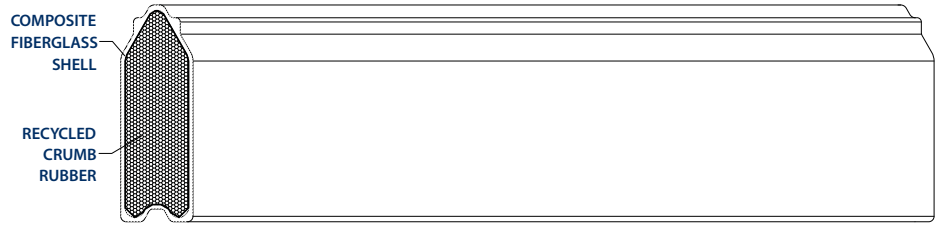


At only 5 to 7 pounds per square foot, AcoustaShield does not add unnecessary weight to bridge structures.

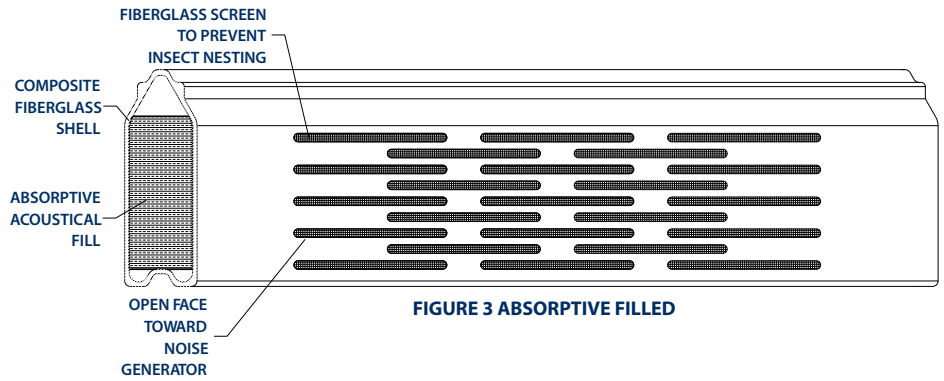




**FIGURE 1 UNFILLED**



**FIGURE 2 RUBBER FILLED**



**FIGURE 3 ABSORPTIVE FILLED**



# Carsonite AcoustaShield™ Sound Barriers



Carsonite sound barrier planks are adjustable and can be cut in the field.

A two-person crew can install 180 square feet in less than five minutes after uprights are set.



# AcoustaShield™

By Carsonite®

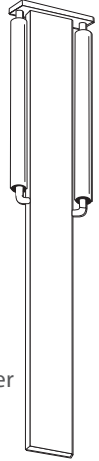
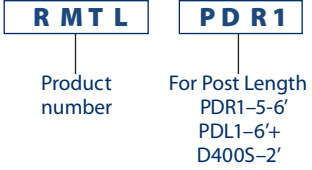


Recreation Products

# Installation Tools

**How to Order:**

Post Driver



**For all soils and applications**

Carsonite's Standard Post Driver (PDR1) is used to install RoadMarker,® Tuff-Flex™, Curv-Flex™, Dual-Sided Marker and GreenLine™ Single Curve Marker. 48" in length, this driver is for posts from 5 to 6 feet long.

Guide Tube



Post Driver



Carsonite's Long Post Driver (PDL1) is used to install RoadMarker, Tuff-Flex, Curv-Flex, Dual-Sided Marker and GreenLine Single Curve Marker. At 56" in length, it is for posts over 6' long.

FlexGuard Socket Driver



FlexGuard Socket Driver

Carsonite's Short Post Driver (D400S) is used to install RoadMarker, Tuff-Flex, Curv-Flex, Dual-Sided Marker and GreenLine Single Curve Marker. At 24" in length, this driver is for posts under 5' long.

The FlexGuard Socket Driver (RMTLSMD10) is for installing FlexGuard post sockets.

Boundary Marker Driver



Boundary Marker Driver

The Guide Tube (RMTLPGT1) gives an added assist in keeping posts vertical during installation. Also useful in preventing posts from flexing when installing into hard or rocky soil. The Guide Tube is useful with RMTLPDR1 or RMTLPDL1 drivers.

Boundary Marker Driver (RMTLD250). This accessory is intended for use with the Boundary Marker (CBM).

Pilot Hole Driver



Pilot Hole Driver

The U-Channel Driver (RMTLSD300) is intended for installing Carsonite's Curv-Flex or other Carsonite markers that utilize the U-Channel option.

U-Channel Driver



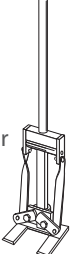
U-Channel Driver

The Pilot Hole Driver (RMTLDP100) is for use in hard or rocky soil when driving posts can be exceedingly difficult. The driver's spaded head leaves a hole to assist in driving the post. For use with all Carsonite markers.

Post Puller



Post Puller



Carsonite's Post Puller (RMTLCPP) is used to remove posts that may need replacing. Use the Post Puller with any of our flat markers.

Material: Welded Steel

Other specialized tools are also available. Contact your representative.

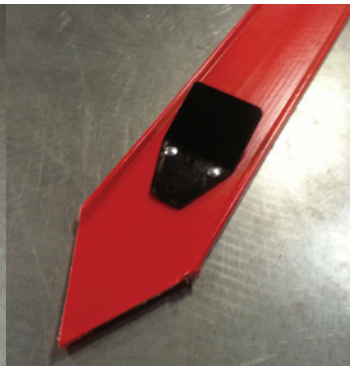




## ANCHOR BARBS

### Protection from theft

Anchor barbs are intended to prevent the post from being pushed out of the ground during freeze/thaw cycles, as well as from attempts to pull them out by would-be vandals. Anchor barbs are available in polycarbonate. Purchase in packs of 10 or have them factory installed when ordering posts.



### How to Order:

Composite Anchor Barb  
(Installed at Factory)

**ANCBARU**

Product  
number

Composite Anchor Barb  
(loose, 10 pcs, including rivets)

**ANCBARPK**

Product  
number

**Notes**



Lined area for notes, consisting of approximately 25 horizontal lines.





<http://carsonite.com/recreation.asp>



19845 U.S. Highway 76  
Newberry, South Carolina 29108  
800-648-7916 · f/803-276-8940 · [www.carsonite.com](http://www.carsonite.com)