

U C B E R K E L E Y
2020 LONG RANGE
DEVELOPMENT PLAN

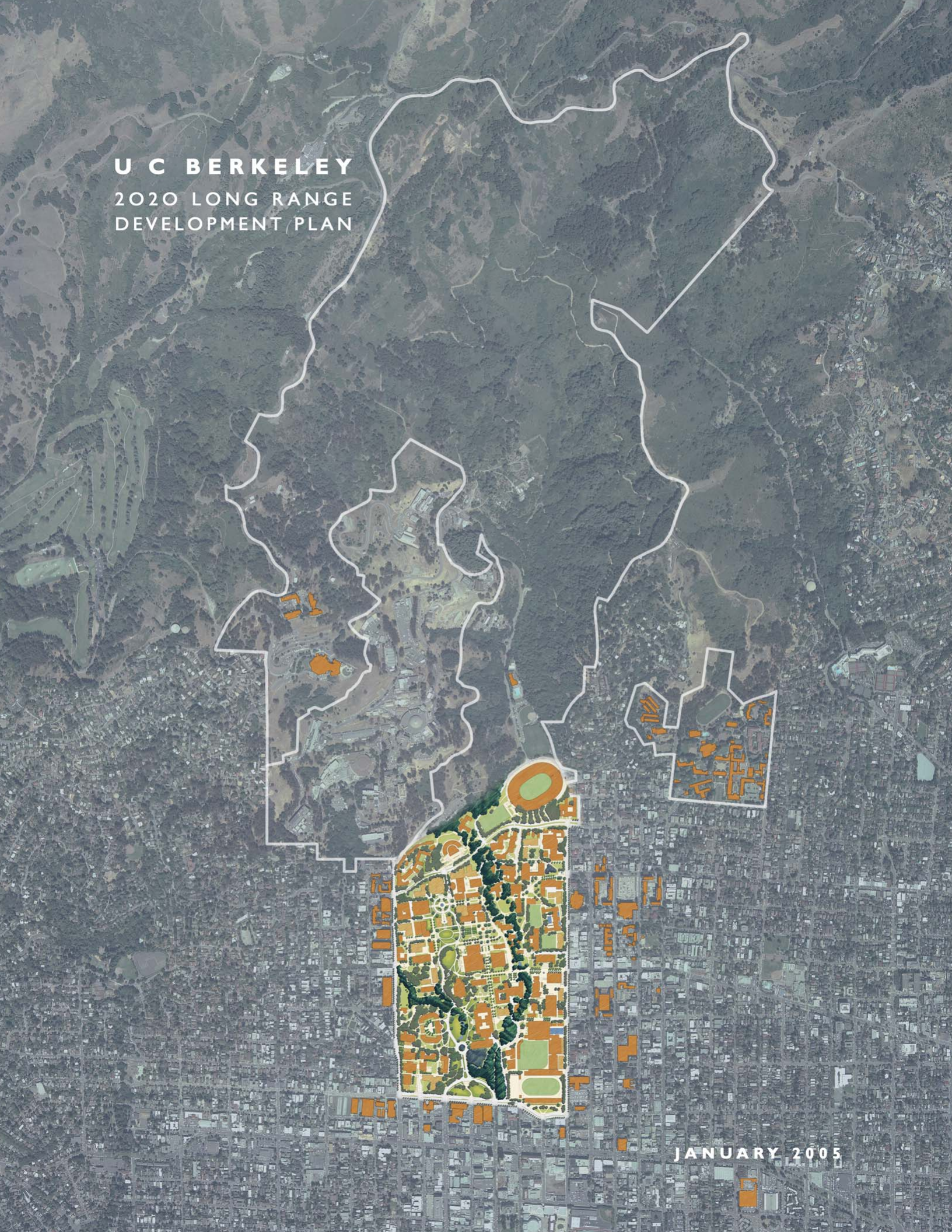

JANUARY 2005

UNIVERSITY OF CALIFORNIA, BERKELEY 2020 LONG RANGE DEVELOPMENT PLAN

INTRODUCTION	I
PURPOSE OF THE 2020 LRDP	3
SCOPE OF THE 2020 LRDP	5
ACADEMIC PRINCIPLES	9
OBJECTIVES OF THE 2020 LRDP	10
DEVELOPMENT PROGRAM	11
CAMPUS POPULATION	13
CAMPUS SPACE & INFRASTRUCTURE	15
CAMPUS LAND USE	19
CAMPUS HOUSING	25
CAMPUS ACCESS	28
CAMPUS OPEN SPACE	31
SUSTAINABLE CAMPUS	33
STRATEGIC INVESTMENT	35
DESIGN FRAMEWORK	37
CAMPUS PARK FRAMEWORK	39
CITY ENVIRONS FRAMEWORK	47
HILL CAMPUS FRAMEWORK	51
PROJECT GUIDELINES	59
LOCATION GUIDELINES	61
CAMPUS PARK DESIGN GUIDELINES	63
CAMPUS PROJECT APPROVAL PROCESS	71
ACKNOWLEDGEMENTS	75



DOE LIBRARY FROM CAMPANILE WAY

INTRODUCTION

PURPOSE OF THE 2020 LRDP

SCOPE OF THE 2020 LRDP

ACADEMIC PRINCIPLES

OBJECTIVES OF THE 2020 LRDP

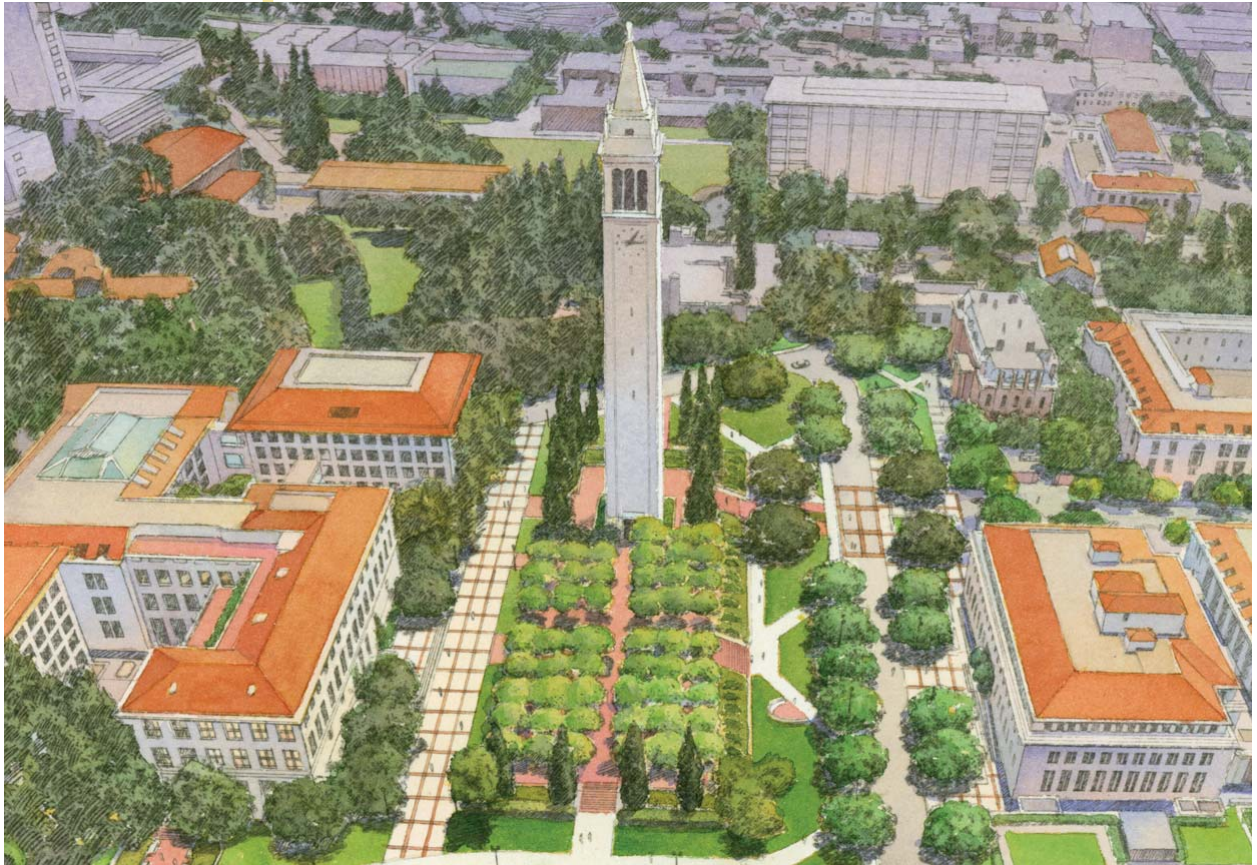

I PURPOSE OF THE 2020 LRDP

Our mission at UC Berkeley is to deliver programs of instruction, research and public service of exceptional quality to the state of California. Over the years, our performance in support of this mission has not only equaled but often outpaced the nation's elite private universities, despite their longer histories and far larger private endowments. The excellence of UC Berkeley is a testament to the vision and public spirit of the people of California, who have sustained us for over a century as a premier research university, while also ensuring a UC Berkeley education remains within reach of the full spectrum of Californians.

Yet, UC Berkeley enters the new century faced with profound challenges:

- to pursue exciting new fields of inquiry and discovery, and achieve excellence in every field we pursue,
- to maintain the unique breadth and variety of our academic programs, and build a strong and vital intellectual community,
- to provide every student with an outstanding education, in which critical inquiry, analysis and discovery are integral to the coursework,
- to strengthen our ability to recruit and retain exceptional individuals, and ensure the campus reflects the full social and cultural spectrum of Californians,
- to provide the space, technology, and infrastructure required to meet the demands of leading edge instruction and research,
- to preserve our extraordinary legacy of landscape and architecture, and become a model of wise and sustainable growth,
- to preserve the character and livability of the city around us, and enhance the economic and cultural synergy of city and university,
- to ensure each capital investment represents the optimal use of public resources, and
- to serve the people of California, and uphold our standard as the best research university in the world.

To enable UC Berkeley to maintain and build upon this standard, the 2020 Long Range Development Plan for UC Berkeley presents a framework for land use and capital investment to meet the academic goals and objectives of the university through the year 2020. It describes both the scope and nature of development anticipated within this timeframe, as well as policies to guide the location, scale and design of individual capital projects.

The 2020 LRDP does not commit the university to any specific project, but rather provides a strategic framework for decisions on those projects. The capital investment program described in the 2020 LRDP does, however, establish a maximum amount of net new growth in the UC Berkeley space inventory during this timeframe, which the campus may not substantially exceed without amending the 2020 LRDP.

ENVIRONMENTAL IMPACT REPORT

The potential environmental impacts of the 2020 LRDP are evaluated in an Environmental Impact Report (EIR), as required by the California Environmental Quality Act (CEQA). The EIR has several purposes:

- to inform university decisionmakers, responsible and interested agencies, and the general public of the environmental implications of the proposed 2020 LRDP,
- to enable the Regents of the University of California to consider the environmental implications of the proposed 2020 LRDP in their consideration of it, and
- to serve as a reference document for the subsequent CEQA review of each individual capital project undertaken to implement the 2020 LRDP.

PROJECT REVIEW

The 2020 LRDP and its EIR provide a framework for the subsequent review of individual projects as they occur at UC Berkeley. Each project with potential to affect the physical environment will be assessed within this framework to determine the appropriate level of CEQA review. Once CEQA review is complete, each individual project must then be approved by the Regents, the President of the University of California, or the Chancellor of UC Berkeley, depending on the scope and nature of the project.

RELATED PLANS

The objectives in the 2020 LRDP support the longterm vision and goals presented in two advisory UC Berkeley documents: the Strategic Academic Plan and the New Century Plan. Both documents were completed in 2002 and published on the campus website. The purpose of both documents is to serve as living, evolving guides for campus decisions, and as such will be revisited and updated at regular intervals as new challenges emerge. The Academic Plan and New Century Plan are advisory: they provide a foundation for the 2020 LRDP, but are not part of the 2020 LRDP. The scope of the 2020 LRDP EIR is represented entirely and exclusively by the contents of the 2020 LRDP.

STRATEGIC ACADEMIC PLAN It is a fundamental principle at UC Berkeley that our capital investment strategy should align with and promote the academic goals of the campus. Toward this end, the Chancellor formed a campus committee in fall 2000 and charged it to prepare a Strategic Academic Plan, which has now been completed. The scope of the Strategic Academic Plan is much broader than the 2020 LRDP, but many of its provisions have significant implications for land use and capital investment, and serve as the foundation for the **Objectives** in the 2020 LRDP.

NEW CENTURY PLAN The New Century Plan presents a design framework of policies, guidelines and initiatives for UC Berkeley based on the principles established in the Strategic Academic Plan. Together, the Strategic Academic Plan and the New Century Plan define a longterm vision for the future of the campus: the 2020 LRDP outlines the scope of capital investment UC Berkeley intends to pursue through 2020, in order to realize this vision.

2 SCOPE OF THE 2020 LRDP

While the campus functions as a single academic enterprise, the areas that comprise it differ significantly in terms of physical capacity and environmental sensitivity. To allow more precise analysis of both, the 2020 LRDP is organized in terms of the land use zones shown in figure 1 and described below.

CAMPUS PARK

The historic 180 acre Campus Park, defined by Hearst on the north, Oxford/Fulton on the west, Bancroft on the south, and Gayley/Piedmont on the east, contains 56% of the UC Berkeley space inventory. Although intensively developed, the Campus Park retains a distinctive parklike environment of natural and formal open spaces, as well as an outstanding ensemble of historic architecture. The Campus Park serves both as the center of campus intellectual life and as a scenic and cultural resource for the entire Bay region.

HILL CAMPUS

The Hill Campus consists of roughly 1,000 acres extending east from Stadium Rimway to Grizzly Peak Boulevard. 200 of these acres are managed under the separate jurisdiction of Lawrence Berkeley National Laboratory, and are not within the scope of the UC Berkeley 2020 LRDP. Berkeley Lab operates under its own LRDP and EIR, approved separately by the UC Regents.

While the 800 acre balance contains several UC Berkeley facilities concentrated along Centennial Drive, including the Lawrence Hall of Science, the Botanical Garden, the Space Sciences Laboratory and the Mathematical Sciences Research Institute, the primary use of the Hill Campus is natural open space, including over 300 acres in the Ecological Study Area. The Hill Campus also includes Strawberry Canyon Recreation Area and the adjacent Witter and Levine-Fricke sport fields. The Hill Campus contains 2% of the UC Berkeley space inventory.

CITY ENVIRONS

The City Environs are defined to include the Adjacent Blocks, the Southside, Other Berkeley Sites, and the Housing Zone in its entirety: in other words, the entire scope of the 2020 LRDP except for the Campus Park and Hill Campus. The areas within the City Environs are similar in consisting mostly of city blocks served by city streets, and include university properties interspersed with non-university properties.

ADJACENT BLOCKS

This zone includes the blocks adjacent to the north, west, south and east of the Campus Park. Those to the north, west, and south are city blocks defined by city streets, but include numerous major campus facilities. The 'blocks' to the east are owned entirely by the university, but are separated from the Campus Park by Gayley Road and Piedmont Ave: Gayley Road north of Memorial Stadium is owned by the university. For the purpose of land use and environmental analysis, the 2020 LRDP subdivides the adjacent blocks into three subzones, below. The adjacent blocks together contain 14% of the UC Berkeley space inventory, and roughly 45% of the land is owned by the university.

ADJACENT BLOCKS SOUTH, the blocks defined by Ellsworth, Durant, College, the Bancroft frontage from College to Piedmont, Bancroft, Stadium Rimway, and the Campus Park. Major campus facilities on these blocks include Memorial Stadium, International House, and the University Art Museum.

FIGURE I
LAND USE ZONES

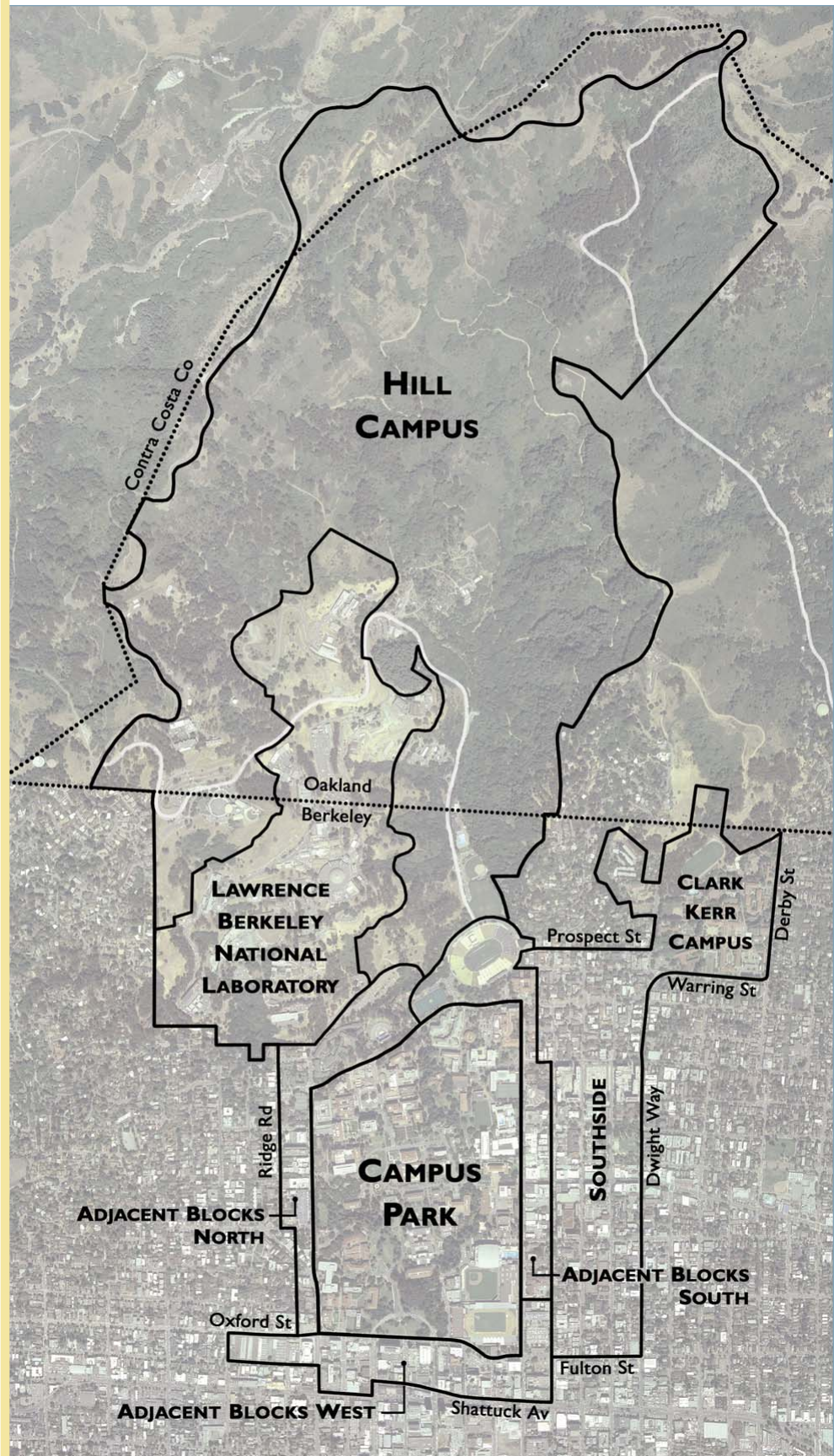

ADJACENT BLOCKS WEST, the blocks defined by Oxford, Virginia, Walnut, Hearst, Shattuck, Durant, Ellsworth, and the Campus Park. Major campus facilities on these blocks include the Tang Health Center, the University Printing Plant, University Hall, 2195 Hearst, and the plant research facilities of the Oxford Tract.

ADJACENT BLOCKS NORTH, the blocks defined by the Hill Campus, Berkeley Lab, Ridge, Scenic, the Hearst frontage from Scenic to Oxford, Oxford, and the Campus Park. Major campus facilities on these blocks include Etcheverry Hall, Soda Hall, Goldman School of Public Policy, the Greek Theater, and the Bowles, Stern and Foothill residence halls.

SOUTHSIDE

As defined in the 2020 LRDP, the Southside includes the blocks defined by the Adjacent Blocks South, Prospect, Dwight, and Fulton, as well as the 50 acre, university owned Clark Kerr Campus and Smyth-Fernwald complex. The Clark Kerr Campus includes student and faculty housing, a recreation center, conference facility, and child care. The university owns roughly 45% of the land in the Southside including the Clark Kerr Campus, primarily student residence halls and apartments. The Southside, including the Clark Kerr Campus, contains 10% of the UC Berkeley space inventory.

As commonly used in Berkeley, the term 'Southside' also includes most of the Adjacent Blocks South. The 2020 LRDP treats these blocks separately, because they differ from the balance of the Southside in terms of both current land use and the nature of future development proposed by the university. However, as described in the City Environs Framework, projects on the Adjacent Blocks within the area of the City of Berkeley Southside Plan would use the Southside Plan as a guide for project location and design.

HOUSING ZONE

The objectives for the 2020 LRDP include a significant program of new undergraduate, graduate, and faculty housing. These objectives include location criteria:

- New lower division student housing should be within a one mile radius of the center of campus, defined as Doe Library.
- Other student housing should be within this one mile radius or within one block of a transit line providing trips to Doe Library in under 20 minutes.

A transit trip is defined as the time on the transit vehicle to the stop nearest to campus, with no transfers, plus the walking time from the stop to Doe Library. The 2020 LRDP Housing Zone includes all sites which meet the above criteria, except for those sites with residential designations of under 40 units per acre in a municipal general plan as of July 2003. The Housing Zone overlays the other land use zones, as shown in figure 5.

OTHER BERKELEY SITES



These include all other campus properties in or partly in the City of Berkeley, including 2000 Carleton and 6701 San Pablo: they comprise 5% of the UC Berkeley space inventory.

OUTSIDE 2020 LRDP SCOPE

As in the 1990-2005 LRDP, the scope of the 2020 LRDP excludes University Village Albany and Richmond Field Station; it also excludes remote field stations and other campus properties lying entirely outside the City of Berkeley. These sites are sufficiently distant and different from the Campus Park and its environs to merit separate environmental review. The properties in Albany, Richmond and elsewhere together comprise 13% of the UC Berkeley space inventory.

FIGURE 2
ILLUSTRATIVE CONCEPT



-  Existing Buildings
-  Potential Campus Buildings



This illustrative concept, from the UC Berkeley **New Century Plan**, depicts one way in which the program described in the 2020 LRDP might be realized on the UC Berkeley campus.

Potential new buildings in this figure are represented as prototypes, based on modular dimensions adaptable to a range of university functions. However, the buildings are configured to respect and enhance campus spatial and architectural relationships, and are meant to inform the design of future projects by depicting building concepts consistent with the **Campus Park Guidelines**.

3 ACADEMIC PRINCIPLES

At its heart, the 2020 LRDP must reflect and further the core values, articulated in the Strategic Academic Plan, that make UC Berkeley both great and unique:

THE INTEGRATION AND SYNERGY OF EDUCATION AND RESEARCH We strive to provide an education in which critical inquiry, analysis, and discovery are integral to the course work. Our students in turn participate in and contribute to research, under the guidance of faculty and staff engaged in the creation of knowledge.

THE BREADTH AND QUALITY OF ACADEMIC PROGRAMS We believe the rich variety of the academic enterprise at Berkeley creates a setting uniquely conducive to creative thought and insight, through the confluence of different perspectives and paradigms.

A COMPREHENSIVE FOUNDATION IN THE LIBERAL ARTS We believe every Berkeley graduate should possess literacy and numeracy across a broad range of disciplines, and that a solid foundation in the liberal arts is as fundamental to leadership as specific knowledge within an individual discipline.

A PASSION FOR INQUIRY AND DISCOVERY Research provides the energy that drives the modern research university. We believe Berkeley must provide a research environment that optimizes creativity and productivity, and supports vibrant, cutting edge research.

THE SYNERGY OF ACADEMIC AND PROFESSIONAL PROGRAMS We believe professional education at Berkeley must be built on a strong foundation in the liberal arts, and that academic and professional disciplines are both significantly enriched by the insights they gain through interaction.

A VITAL AND DIVERSE INTELLECTUAL COMMUNITY We believe social and cultural diversity are essential to the university. They stimulate creative thought and new paths of inquiry, ensure that the research questions we tackle address the whole of society, and enable us to train leaders who encompass the entire spectrum of Californians.

THE VALUE OF CONTIGUITY We believe a vital intellectual community can only thrive when the entire scope of the academic enterprise is located in close proximity, in order to foster the formal and informal interactions that lead to productive collaboration.

A PARTNERSHIP OF STUDENTS, FACULTY AND STAFF We recognize the contributions of each are both essential and inseparable: no group can excel without the support of the others, and each must have adequate resources for the enterprise as a whole to succeed.

INDEPENDENCE OF MIND IN THE PURSUIT OF KNOWLEDGE Notwithstanding the inherently political nature of a public institution, we believe the pursuit of knowledge must not be constrained by temporal economic or political considerations. The research university is by definition a place where perceived truth is under constant challenge.

THE PRIMACY OF PUBLIC SERVICE Notwithstanding the growing pressure to seek private resources, we recognize our core purpose is to serve and benefit the people of California through the creation, dissemination and application of knowledge, including outreach to underserved communities.

EXCELLENCE IN EVERY ENDEAVOR We must ensure each element of the academic enterprise - teaching, research and public service - continues to maintain the Berkeley standard of excellence. This requires us to recruit and retain the best people from the full talent pool, and to provide the resources they need to excel.

4 OBJECTIVES OF THE 2020 LRDP

The purpose of the 2020 LRDP is to set forth a framework for land use and capital investment undertaken in support of the campus' academic principles. The 2020 LRDP is driven by the following broad objectives:

- **PROVIDE THE SPACE, TECHNOLOGY AND INFRASTRUCTURE WE REQUIRE TO EXCEL IN EDUCATION, RESEARCH, AND PUBLIC SERVICE.**
- **PROVIDE THE HOUSING, ACCESS, AND SERVICES WE REQUIRE TO SUPPORT A VITAL INTELLECTUAL COMMUNITY AND PROMOTE FULL ENGAGEMENT IN CAMPUS LIFE.**
- **STABILIZE ENROLLMENT AT A LEVEL COMMENSURATE WITH OUR ACADEMIC STANDARDS AND OUR LAND AND CAPITAL RESOURCES.**
- **BUILD A CAMPUS THAT FOSTERS INTELLECTUAL SYNERGY AND COLLABORATIVE ENDEAVORS BOTH WITHIN AND ACROSS DISCIPLINES.**
- **PLAN EVERY NEW PROJECT TO REPRESENT THE OPTIMAL INVESTMENT OF LAND AND CAPITAL IN THE FUTURE OF THE CAMPUS.**
- **PLAN EVERY NEW PROJECT AS A MODEL OF RESOURCE CONSERVATION AND ENVIRONMENTAL STEWARDSHIP.**
- **MAINTAIN AND ENHANCE THE IMAGE AND EXPERIENCE OF THE CAMPUS, AND PRESERVE OUR HISTORIC LEGACY OF LANDSCAPE AND ARCHITECTURE.**
- **PLAN EVERY NEW PROJECT TO RESPECT AND ENHANCE THE CHARACTER, LIVABILITY, AND CULTURAL VITALITY OF OUR CITY ENVIRONS.**
- **MAINTAIN THE HILL CAMPUS AS A NATURAL RESOURCE FOR RESEARCH, EDUCATION AND RECREATION, WITH FOCUSED DEVELOPMENT ON SUITABLE SITES.**





HAAS SCHOOL OF BUSINESS

DEVELOPMENT PROGRAM

CAMPUS POPULATION

CAMPUS SPACE & INFRASTRUCTURE

CAMPUS LAND USE

CAMPUS HOUSING

CAMPUS ACCESS

CAMPUS OPEN SPACE

SUSTAINABLE CAMPUS

STRATEGIC INVESTMENT



Concept: At Sather Gate, the broad swaths of asphalt north and south of the Creek are reclaimed and transformed into a new riparian glade. The streamcourse widens to enhance habitat value and provide stormwater retention.

5 CAMPUS POPULATION

STABILIZE ENROLLMENT AT A LEVEL COMMENSURATE WITH OUR ACADEMIC STANDARDS AND OUR LAND AND CAPITAL RESOURCES.

The University of California has a clear role in the California Master Plan for Higher Education, which articulates complementary roles for Community Colleges, California State University, and UC. The Master Plan designates UC as the state's primary research institution: UC selects from among the top 12.5% of California high school graduates, as well as the top 4% of graduates of each California high school. Due to the projected growth in the number of college age Californians, by 2010 UC as a whole must increase its enrollment by 63,000 students over the base year 1998 to continue to meet its Master Plan mandate.

As part of this strategy, UC Berkeley has been requested to evaluate the ability to grow by 4,000 full time equivalent students over base year 1998 by 2010. This represents an increase in enrollment of roughly 13%: a significant increase for any campus, but particularly for a mature, urban campus with aging facilities and limited capacity to expand. However, once our current target is reached, at an estimated two-semester average of 33,450 students, enrollment at UC Berkeley should stabilize.

Not only do few undeveloped sites remain on and around the campus, but our capital resources are also very limited. What capital funds the campus does receive from the state are consumed largely by seismic upgrades to existing buildings, and this need will continue for the near future. Moreover, to the extent university land and capital are utilized to accommodate further enrollment growth, they can no longer be utilized for campus renewal. Yet, the renewal of our buildings and infrastructure is crucial to our ability to recruit and retain exceptional individuals, to pursue new paths of inquiry and discovery, and to maintain our historic standard of excellence.

As a result of growth in both education and research, by 2020 we estimate total campus headcount during the regular academic year may increase by up to 12% over what it was in 2001-2002, as shown in table 1. The estimates for academic and nonacademic staff reflect the impacts of both enrollment growth and growth in external research funds through 2020. Research funds are projected to grow at 3.6% per year: the average rate of growth minus inflation during the last decade of the 20th century.

While UC Berkeley can accommodate some of our new students through growth in summer programs and education abroad, to meet our 4,000 student target also requires an increase in on-campus enrollment during the regular academic year. The enrollment figures in table 1 are presented in terms of student headcount: the estimates for the regular academic year represent the two-semester average, while the summer estimates represent the number of individual students enrolled in one or more summer courses.

The actual rate at which campus headcount grows in the future depends on a variety of factors, including future demographic trends, state and university policy, and available resources. In the near term, funds may not be available to support further growth in enrollment. However, the projections in the 2020 LRDP are based on underlying demographic needs through the year 2020, rather than on near-term funding considerations.

TABLE 1 PROJECTED CAMPUS HEADCOUNT

	Actual Headcount 2001-2002	Net Addl Headcount 2020 LRDP	Est Total Headcount 2020
Students			
Regular Terms*	31,800	1,650	33,450
Summer	11,400	5,700	17,100
Employees	12,940	2,870	15,810
Faculty**	1,760	220	1,980
Academic Staff & Visitors**	3,040	1,840	4,880
Nonacademic Staff**	8,140	810	8,950
Other Visitors & Vendors	1,200	800	2,000
Estimated Regular Terms Headcount	45,940	5,320	51,260
Estimated On-Campus Headcount***	44,834		

* Campus population today is counted in two ways: by actual headcounts and by full time equivalents, or FTE. While budgets are calculated in terms of FTE, for the purpose of environmental analysis actual headcount is the better measure, since FTE tends to under-represent peak impacts. For example, two students taking six units each are likely to have a greater impact than one student taking 12 units. The 2020 LRDP therefore uses two-semester average headcount as the measure of campus population.

** All non-student categories exclude student workers to avoid double counting.

*** Excludes off campus programs and other exclusions per April 2002 Population Report to City of Berkeley.

TABLE 2 PROJECTED SPACE DEMAND

	Actual + Approved UC Berkeley Space	Net Addl Space 2020 LRDP	Est Total 2020
Academic & Support (GSF)	12,107,100	2,200,000	14,307,100
Actual 2001-2002*	11,637,900		
Net Addl Complete Mar 2004	116,600		
Net Addl Underway Mar 2004	352,600		
Housing (bed spaces)		8,190	2,600 °
Actual UC Owned 2001-2002	6,960		
City Environs**	6,004		
University Village Albany**	956		
Net Addl Complete Mar 2004	120		
Net Addl Underway Mar 2004	1,110		
Parking (spaces): phase 1		7,690	1,800 °°
phase 2			500 °°
Actual 2001-2002	6,900		
Net Addl Complete Mar 2004	100		
Net Addl CEQA Reviewed	690		

* 2001-2002 A&S space includes all buildings except those primarily housing or parking.

** City Environs includes 74 student family units at Smyth Fernwald and 27 faculty units, counted as one bed space per unit, as well as 585 bed spaces at International House, for consistency with 1990-2005 LRDP. University Village Albany includes 956 student family units counted as one bed space per unit.

° Includes up to 100 family-suitable units for faculty, staff, or visiting scholars within 2020 LRDP scope. Does not include new housing proposed for University Village Albany, which is outside the scope of the 2020 LRDP and the subject of a separate CEQA review.

°° Phase 2 parking would be deferred until after 2020 if the AC Transit Bus Rapid Transit/Telegraph route is approved and the system is under construction by January 2010, as described in Campus Access

6 CAMPUS SPACE & INFRASTRUCTURE

PROVIDE THE SPACE, TECHNOLOGY AND INFRASTRUCTURE WE REQUIRE TO EXCEL IN EDUCATION, RESEARCH, AND PUBLIC SERVICE.

Enrollment is only one of many drivers for growth at UC Berkeley. New academic initiatives and continued growth in research also create demand for more space on and around campus. While some of this demand can be met through renovation of existing buildings, new buildings are also required, particularly for programs that demand high performance infrastructure and other advanced features renovated space can not provide.

The impact of change is most severe in laboratory-based research, where many of our older buildings are unable to meet modern standards for power systems, climate and vibration controls, and safety and environmental protocols. Moreover, the entire university has been transformed by the revolution in information technology: infrastructure to support broadband networks have become a necessity in every discipline.

UC Berkeley is the oldest campus of the university, and nearly two thirds of its space inventory is over forty years old. Both instruction and research have undergone dramatic change in this period, in terms of both the workstyles we employ and the infrastructure we require. Many of our instructors and researchers struggle with spaces and systems compromised not only by time, but also by decades of inadequate reinvestment. The renewal of our physical plant is crucial to our ability to recruit and retain exceptional individuals, and to pursue new topics of research and new models of instruction.

RESEARCH & EDUCATION Research is fundamental to our mission of education. As a research university, UC Berkeley strives to provide our students with a unique experience, one in which critical inquiry, analysis, and discovery are integral to the coursework. Our students expect to play an active role in research, under the guidance of faculty who are themselves engaged in creating, not merely imparting, new knowledge.

While we presently engage our graduate students in research, it is a goal of the Academic Plan to also integrate research-based learning into undergraduate education. In order to do so, we must expand the scope of our research programs to accommodate more direct, mentored participation by undergraduates, and must also provide adequate and suitable space to house those programs.

RESEARCH & SERVICE Research is also fundamental to our mission of public service. The direct public benefits of the research and scholarship undertaken at UC Berkeley range from advances in human and environmental health, to new insights into personal and social behavior, to improved agricultural and industrial productivity. Our limits on space and resources require us to be selective in pursuing new initiatives, but a vital research enterprise is critical to the public service mission of the university.

UC Berkeley has experienced steady growth in research sponsored by external agencies, and this trend is expected to continue. In the last decade of the 20th century, our external research funds increased in real terms by an average of 3.6% per year. Over 95% of those funds came from federal, state, and nonprofit agencies.

More space is also required to accommodate the evolving nature of research. Many of the complex problems explored at UC Berkeley today require a combination of focused, individual work and work in interactive teams, often comprised of several academic disciplines. The campus must provide adequate space for both kinds of work, in buildings that support the high performance technology and infrastructure modern research demands.

NEW ACADEMIC INITIATIVES The state provides the university with incremental operating funds to support future enrollment growth. UC Berkeley intends to use these resources not only to expand the capacity of existing high-demand programs, but also to extend existing programs in promising new directions, and create new interdisciplinary programs to pursue new areas of inquiry.

By 2010, UC Berkeley intends to establish several new interdisciplinary programs that combine education and research. In June 2003 we selected our first set of new interdisciplinary programs: Computational Biology, Nanosciences, Metropolitan Studies, and New Arts Media. While each of these programs will be built on a base of existing core faculty, capital investment will also be required to create or adapt space to house these new endeavors.

SPACE DEMAND

As a result of the overall growth at UC Berkeley under the 2020 LRDP, the space demands of campus academic and support programs may grow by up to 18%, or 2,200,000 GSF, over current and approved space by 2020, as shown in table 2. The figures in table 2 represent net new space, and reflect space lost through demolition.

In the 2020 LRDP, the term ‘academic and support space’ includes the entire UC Berkeley space inventory except for housing and parking, which are tabulated separately given their unique program and environmental characteristics. The academic and support category includes a wide range of space types:

- Classrooms and class labs and studios,
- Offices and research labs and studios for faculty, postdocs, researchers, student instructors, and organized research units,
- Libraries, including study facilities as well as collections and operations,
- Other academic resources, including museums and cultural centers, computer resources, plant and animal research facilities, and other program specific facilities,
- Student services, including health, advising, and counseling programs, athletics and recreation, and student organizations, and
- Campus operations, including campus administration, financial operations, human resources, computer and network services, construction and plant operations.

As described above, UC Berkeley requires more space not only to educate a larger student body, but also to support continued growth in research and the increased synergy of research and education. Expansion of the research enterprise is required not only to meet the increased demand from federal, state and other sponsors for UC Berkeley to pursue new areas of inquiry, but also to enable us to integrate research-based learning into undergraduate as well as graduate programs. Up to 700,000 GSF of the space demands of academic and support programs may consist of research laboratories, including some expansion of animal research facilities.

Our estimates of future space needs are not due entirely to future growth: some new space is required just to compensate for the shortages we have today. The most recent survey of academic space at UC Berkeley, in 2001-2002, revealed a deficit of roughly 450,000 GSF in academic programs alone, based on university-wide guidelines for space utilization.

UC Berkeley also has roughly 450,000 GSF of leased space in various locations in and outside Berkeley. Some of this space is deficient in terms of life safety, functionality, or both. Our estimate of future space needs, therefore, also includes a contingency for the strategic replacement of some leased space with new university-owned space.

The actual rate at which new academic and support program space is built in the future depends on both the actual rate and type of growth in space demand and the resources available.

LIFE SAFETY

A program of seismic evaluations undertaken in 1997-1998 rated 102 UC Berkeley structures as 'poor' or 'very poor', indicating a significant hazard to life in a major seismic event. At the time, seismic upgrades to several campus buildings had already been completed, but the campuswide evaluations greatly increased the scope of the improvements program, and the capital investment it requires.

POLICY: ELIMINATE 'POOR' AND 'VERY POOR' SEISMIC RATINGS IN CAMPUS BUILDINGS THROUGH RENOVATION OR REPLACEMENT.

As of 2003, 46% of campus space requiring seismic upgrades had already been improved, and another 25% of space was under construction or in design. However, the balance remains a substantial obligation: the capital funds UC Berkeley now receives from the state are consumed entirely by seismic upgrades, and this is expected to continue for the near future.

POLICY: CONSIDER ENHANCED LEVELS OF SEISMIC PERFORMANCE FOR CRITICAL BUILDINGS.

While UC Berkeley is already committed to ensuring life safety in every campus building, many of our buildings also house equipment, experiments, and other contents of considerable value. Where relevant, the feasibility analyses for new projects should also consider additional structural enhancements to reduce building downtime after a magnitude 7.0 earthquake to no more than 30 days, both to protect its contents and to enable rapid resumption of university operations.

POLICY: MINIMIZE NONSTRUCTURAL HAZARDS TO IMPROVE LIFE SAFETY AND PROGRAM CONTINUITY.

In many campus buildings, the most significant seismic risk to life safety is not structural failure, but rather damage to its contents. Inadequately secured ceilings, fixtures, shelves and equipment pose a serious threat of injury. They also threaten the sustained operation of the campus and the continuity of research, and pose a substantial economic loss: much of our laboratory equipment is both fragile and very expensive. UC Berkeley should ensure all new buildings are designed to minimize nonstructural hazards and operational downtime, and should also continue our programs to mitigate such hazards in existing buildings.

INFORMATION SYSTEMS

While there is no substitute for face-to-face conversation, today it is only one of the ways scholars communicate. The introduction of e-mail alone has transformed the nature of collaboration: many faculty today communicate more often with colleagues in other parts of the world than they do with those in the next office. The revolution in information technology has furnished researchers with new tools for analyzing and discovering patterns and connections in enormous sets of data, leading in turn to changes in the ways we conceptualize and approach problems.

Because the pace of change will only accelerate in the future, the quality of our networks is just as crucial to academic excellence as the quality of our interior and exterior spaces. Because the potential for creative interaction is everywhere, our first principle for information technology should be to ensure the entire campus has access to state-of-the-art high capacity networks.

POLICY: COMPLETE THE NEW CAMPUS INTERBUILDING INFORMATION INFRASTRUCTURE.

While nearly all campus buildings are connected to the campus information network in some way, many are linked to it through ad hoc pathways such as old utility conduits. Many of these conduits are at capacity, many others are damaged or hazardous: in both cases, such conditions limit or preclude further upgrades in capability. The construction of a common interbuilding 'backbone' to replace these ad hoc pathways, and provide capacity for future growth, began in 1985: to date, 4 of the 7 elements have been completed, and funding is approved for element 5, now in design. The campus should continue to pursue the completion of the interbuilding system as a funding priority.

POLICY: INCLUDE UPGRADES TO INTRABUILDING INFORMATION SYSTEMS IN MAJOR RENOVATIONS.

The interbuilding backbone provides service to each building, but the quality of service also depends on the intrabuilding infrastructure, the quality of which varies enormously across the campus. Many of our intrabuilding systems have been unable to keep up with the tremendous growth in performance demand. In response, UC Berkeley has initiated the 'riser project', a phased investment program to equip each building with a modern fiber-optic infrastructure. The riser project will ultimately provide every campus user with equal access to state-of-the-art network service.

Many campus buildings require seismic improvements. Many also require extensive renovation due to the age and condition of their program spaces and systems. UC Berkeley should ensure the requisite improvements to the information infrastructure, as prescribed in the riser project, are undertaken in conjunction with these projects.

UTILITY SYSTEMS

In general, campus utility systems have adequate capacity for current demands, partly as a result of the major upgrades implemented through the Utility Infrastructure Upgrade Project begun in 1999. However, given the increasing reliance on technology and high-performance infrastructure in many disciplines, and the cost and disruption further upgrades would entail, UC Berkeley should pursue a rigorous program of resource conservation in order to minimize both local and general impacts on utility systems.

POLICY: DESIGN FUTURE PROJECTS TO MINIMIZE ENERGY AND WATER CONSUMPTION AND WASTEWATER PRODUCTION.

Sustainable Campus describes a comprehensive strategy to minimize campus power and water consumption. Substantial savings in water and energy consumption can often be achieved through intelligent design at little or no increase in cost: for example, by the careful selection of landscape materials, and by orienting and configuring building volumes and composing building facades to optimize energy performance. The Campus Park Guidelines include several such provisions, which should inform every future project.

7 CAMPUS LAND USE

BUILD A CAMPUS THAT FOSTERS INTELLECTUAL SYNERGY AND COLLABORATIVE ENDEAVORS BOTH WITHIN AND ACROSS DISCIPLINES.

The breadth and quality of our academic programs are the equal of any university in the world, but UC Berkeley is more than the sum of its parts. A great research university also requires a vital and dynamic intellectual community, one that provides exposure to a wide range of cultures and perspectives, and generates the encounters and interactions that lead to new insight and discovery. For such a community to thrive requires a campus organized and designed to foster those interactions.

Although the academic structure of the campus reflects the traditional disciplines defined over a century ago, those disciplines are no longer insular and self-contained. For example, the health sciences initiative brings researchers from physics, biology and chemistry together to study phenomena at the molecular level, while our programs focused on culture, gender, and ethnicity integrate the humanities and social sciences.

The four new academic initiatives established in 2003 - Nanosciences, Computational Biology, Metropolitan Studies, and New Arts Media - were selected not only because the work to date at UC Berkeley already shows extraordinary promise, but also because the initiatives are broad in scope, are explicitly collaborative, and have significant potential for both undergraduate and graduate student participation. And there are more to come: future anticipated initiatives include the integration of the social, physical, and biological sciences to pursue more holistic investigations of complex environmental problems.

Because the potential for synergy is everywhere at UC Berkeley, our first principle of land use should be to retain and reinforce the contiguity of the academic enterprise, in order to encourage interaction and exchange both within and across disciplines.

POLICY: ACCOMMODATE NEW AND GROWING ACADEMIC PROGRAMS PRIMARILY THROUGH MORE INTENSIVE USE OF UNIVERSITY OWNED LAND ON AND ADJACENT TO THE CAMPUS PARK.

The need for growth, combined with the principle of contiguity, requires an increase in density on and around campus. As shown in figures 3A and 3B, the campus and its environs include a number of sites suitable for more intensive development, including surface parking lots and older academic buildings with both seismic and functional deficiencies. However, because UC Berkeley is an urban campus, each of these sites exists within an established physical context that includes many significant natural and cultural resources.

Our goal should be to ensure each new capital project not only respects but enhances its context, and contributes positively to the image and experience of UC Berkeley as a whole. In order to realize this goal, the **Campus Park Framework**, **City Environs Framework**, and **Hill Campus Framework** establish policies for land use and project design specific to each context.

POLICY: PRIORITIZE CAMPUS PARK SPACE FOR PROGRAMS THAT DIRECTLY ENGAGE STUDENTS IN INSTRUCTION AND RESEARCH.

PRIORITIZE SPACE ON THE ADJACENT BLOCKS FOR OTHER RESEARCH, CULTURAL AND SERVICE PROGRAMS THAT REQUIRE CAMPUS PARK PROXIMITY.

FIGURE 3A
**CANDIDATE BUILDINGS
 FOR REPLACEMENT**



- Existing/Approved Campus Buildings
- Replacement Candidates UC Owned
- Replacement Candidates DHS Site

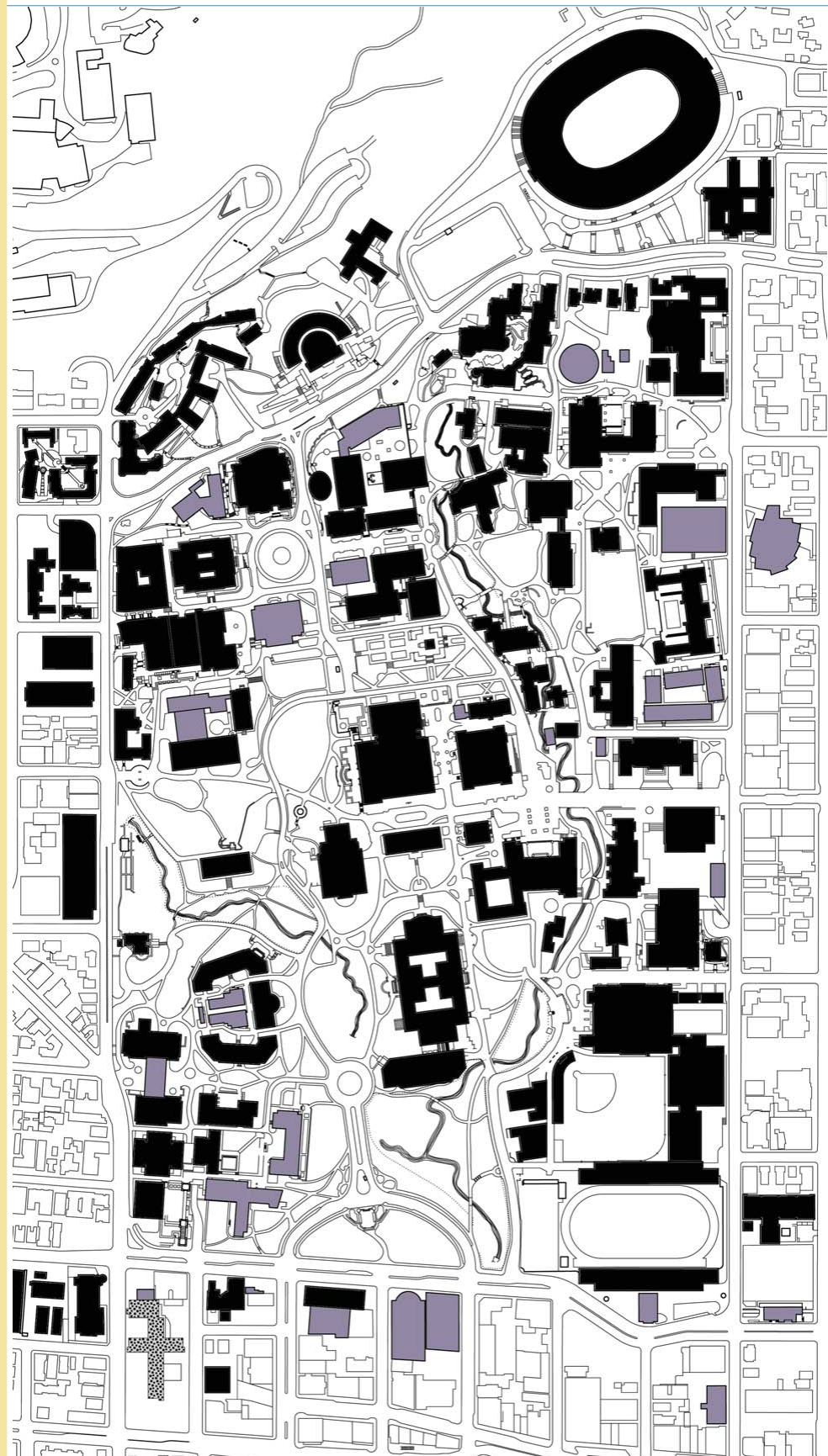

Buildings shown as candidates for replacement include those which have seismic and/or functional deficiencies, or which represent underutilizations of their respective sites.

This figure does not commit the university to replacing these buildings: in some instances renovation may be the better option. As described below in **Strategic Investment**, a full range of alternate solutions will be evaluated for each major capital investment.

The stipple pattern indicates the California Department of Health Services facility. The state is relocating these operations to a new facility in Richmond: the university has an option to acquire the site once it is vacated, and intends to do so.



FIGURE 3B
ILLUSTRATIVE CONCEPT



Existing/Approved
Campus Buildings
Potential Projects

The projects shown in this figure represent one way in which the 2020 LRDP program might be realized on the Campus Park and adjacent blocks, by selectively redeveloping:

- buildings with potential for replacement, as indicated in figure 3A, and
- other underutilized sites such as surface parking lots.

The figure based on the **New Century Plan** is illustrative only, and does not commit the university to pursuing the projects as shown.

Projects other than those shown may also be pursued in the future, either by the university directly or in collaboration with cities and/or the private sector.

Land at UC Berkeley is a scarce and finite resource, and it is neither feasible nor desirable to house every campus function on or adjacent to the Campus Park. For example, some research and operations units are incompatible with the campus' urban environs due to scale, service, or environmental requirements. In order to optimize the use of campus resources, and ensure space on or adjacent to the Campus Park is reserved for programs that require it, future capital investment at UC Berkeley should be informed by the **Location Guidelines** in section 16.

SPACE DISTRIBUTION

The contiguity of academic programs is a core principle of the Academic Plan. We believe a vital intellectual community can only thrive when the entire scope of the academic enterprise is located in close proximity, in order to foster the formal and informal interactions that lead to synergy and discovery.

In support of this principle, 90-100% of the estimated future demand for program space is planned to be accommodated on or adjacent to the Campus Park, as shown in table 3. The figures in table 3 represent net new program space, and include the removal and replacement of existing facilities as well as construction of new facilities. The land use zones are shown in figure 1.

In order to provide the campus some flexibility in locating new projects, the sum of the maxima for the individual land use zones is roughly 10% greater than the 2020 LRDP totals of 2,200,000 net new GSF of program space and 2,300 net new parking spaces. However, the total net new program space and parking within the scope of the LRDP may not substantially exceed 2,200,000 GSF or 2,300 spaces without amending the 2020 LRDP.

TABLE 3 PROJECTED SPACE DISTRIBUTION BY LAND USE ZONE

	Max Net Addl Academic & Support GSF	Max Net Addl Housing Beds	Max Net Addl Parking Spaces
Campus Park	1,000,000		600
Adjacent Blocks			
North	50,000		
West	800,000		1,300
South	400,000		600
Southside	50,000		
Hill Campus	100,000		
Other Berkeley	50,000		
Housing Zone			
Students		2,500	
Faculty/Staff		100 *	
Max Net Addl Space NTE	2,200,000 **	2,600	2,300 ***

* Represents up to 100 family-suitable units for faculty and/or staff

** Does not include projects already approved as of January 2004

*** 500 of these 2,300 spaces would be deferred until after 2020 if the AC Transit Bus Rapid Transit/Telegraph route is approved and the system is under construction by January 2010, as described in Campus Access

Note: In order to provide flexibility in siting individual projects, the sum of the maxima for individual land use zones is greater than the maximum 'not to exceed' (NTE) totals for all the zones combined. However, the university may not substantially exceed the NTE totals without amending the 2020 LRDP.

LAND ACQUISITION

Future growth in both program space and parking is planned to be accommodated primarily through more intensive use of university-owned land. As shown in figures 3A and 3B, the Campus Park and its adjacent blocks include numerous sites where more intensive use is possible, and university-owned land will always be the first option explored for both program space and parking.

Some new university housing can also be accommodated on current university-owned land. However, in order to meet the targets described in **Campus Housing**, some of this new housing would have to be constructed on land within the Housing Zone which is not presently owned by the university.

The university will explore a full range of delivery options for each such project, including partnerships with private sector developers as well as direct acquisition and construction by the university. In those instances where the university does find it necessary to acquire land, preference should be given to sites which are underutilized, which are not on the tax rolls, and/or where displacement of existing tenants can be minimized.

As described in the **City Environs Framework**, project location and design will be informed by municipal land use policies. Moreover, mixed-use projects with ground-floor retail space, such as the Manville Apartments, will be considered where such projects align with municipal policies and are compatible with neighboring land use.

One acquisition the university does expect to complete within the timeframe of the 2020 LRDP is the California Department of Health Services site at Hearst and Shattuck. The state is relocating its operations to a new facility in Richmond; the university has an option to acquire the site once it is vacated, and intends to do so. The DHS site has the capacity to accommodate a substantial amount of new university program space; however, the ground floor frontage along Shattuck is planned to accommodate retail space.



SPROUL PLAZA

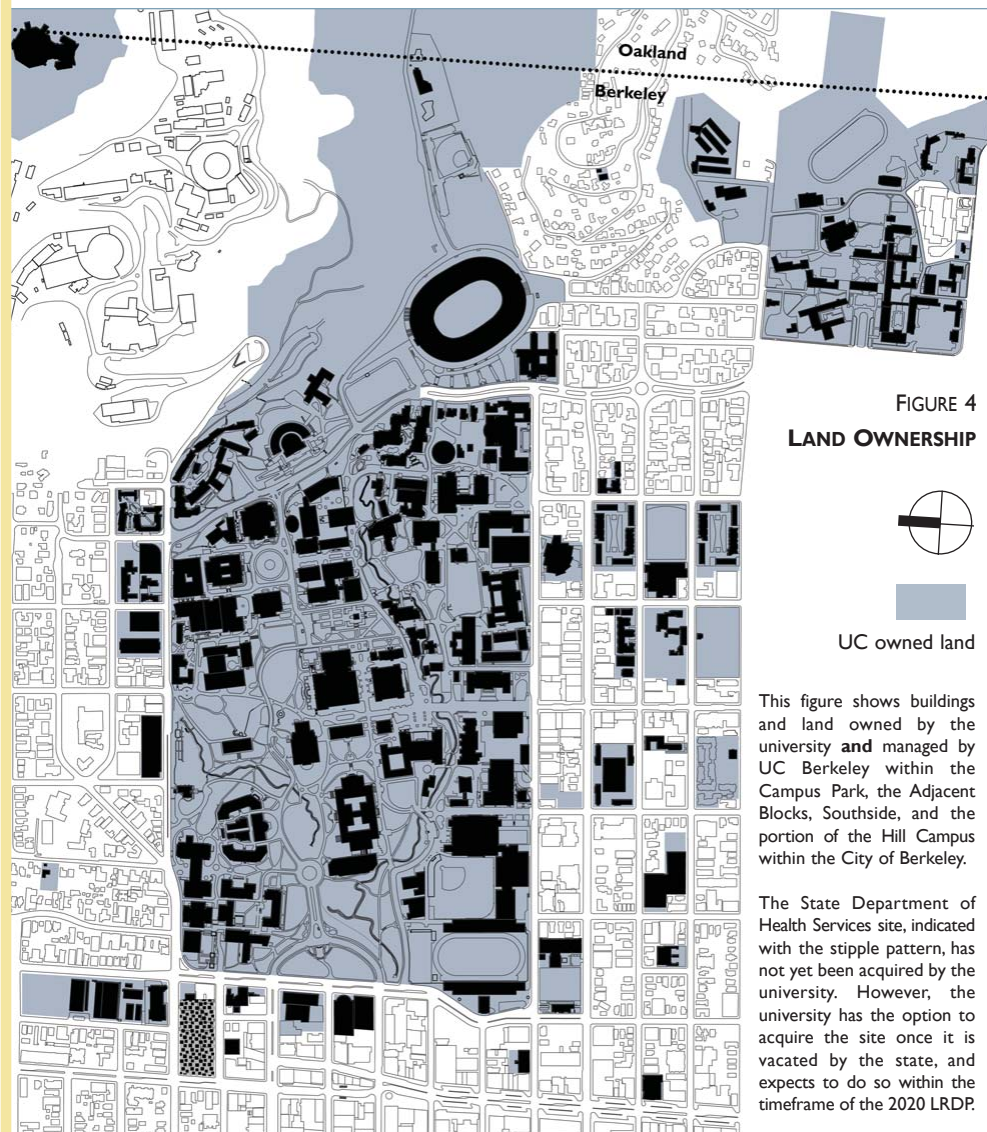

8 CAMPUS HOUSING

PROVIDE THE HOUSING, ACCESS, AND SERVICES WE REQUIRE TO SUPPORT A VITAL INTELLECTUAL COMMUNITY AND PROMOTE FULL ENGAGEMENT IN CAMPUS LIFE.

The ability of UC Berkeley to recruit, retain, and support outstanding individuals is fundamental to academic excellence. Many of our best student and faculty candidates cite the scarcity of good, reasonably priced housing and child care near campus as key factors in their decisions whether or not to come to UC Berkeley. The problem of housing is particularly acute for students: expanding and improving the supply of housing near campus is critical not only to ensure our students are adequately housed, but also to provide the community of peers and mentors, and the access to campus resources, they require to excel.

The Strategic Academic Plan defines our long-term goals for both student and faculty housing at UC Berkeley:

- provide two years of university housing to entering freshmen who desire it,
- provide one year of university housing to entering transfer students who desire it,
- provide one year of university housing to entering graduate students who desire it,
- maintain the number of university housing units suitable for students with children,
- provide up to 3 years of university housing to new untenured ladder faculty who desire it.

The policies described below represent targets for each of these goals which are feasible within the timeframe of the 2020 LRDP. As shown in table 2, by 2020 we propose to increase the supply of university housing within the 2020 LRDP scope by up to 32% over current and approved bed spaces.

Because the state provides no funds for university housing, the entire cost of housing construction, operation, and maintenance must be supported by rent revenues. Our goals to improve the amount and quality of housing must therefore be balanced by the need to keep rents at reasonable levels, and avoid building surplus capacity. The 2020 targets, and the pace at which we achieve them, may be adjusted in the future to reflect changes in market conditions and demand for university housing.

POLICY: INCREASE SINGLE UNDERGRADUATE BED SPACES TO EQUAL 100% OF ENTERING FRESHMEN PLUS 50% OF SOPHOMORES AND ENTERING TRANSFER STUDENTS BY 2020.

For lower division students, new both to independent living and to the intense demands of university coursework, group housing in close proximity to the educational resources of the campus is the best solution. As well as convenience to campus, such housing also provides its residents with a wide range of on-site counseling, mentoring and academic support programs.

POLICY: INCREASE SINGLE GRADUATE STUDENT BED SPACES TO EQUAL 50% OF ENTERING GRADUATE STUDENTS BY 2020.

As they progress, students gravitate toward peer groups based on their major fields of study or other shared interests. They also continue to mature and acquire the social experience required to live as independent adults. By the third year, it is no longer necessary for UC Berkeley to take as direct a role in creating a residence-based intellectual community. However, we must continue to take a proactive role to ensure our students have access to good and reasonably priced housing.

FIGURE 5
2020 LRDP HOUSING ZONE

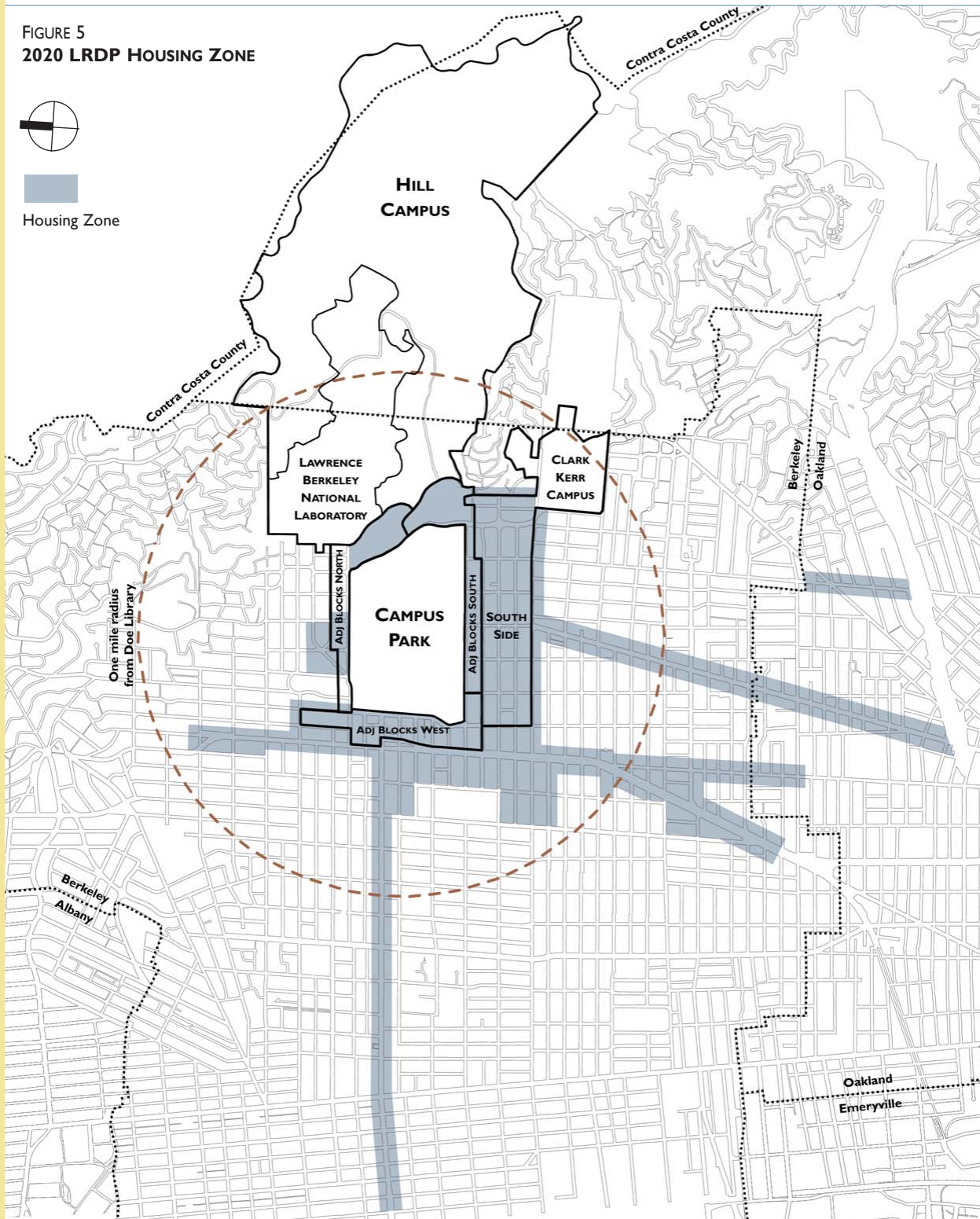

The 2020 LRDP Housing Zone overlays the other Land Use Zones. It includes all areas within a one mile radius of Doe Library, or within a block of a transit line providing trips to Doe Library in under 20 minutes. The Housing Zone excludes those sites with residential designations of under 40 units per acre in a municipal general plan as of July 2003. This figure shows the extent of the Housing Zone based on transit trips via AC Transit routes as of July 2003. Suitable sites within one block of some BART Stations may also qualify for inclusion in the Zone. The depiction of the Housing Zone is generalized in this figure, and may not reflect the precise boundaries of individual parcels or land use designations. The zone boundary may be revised in the future to reflect service changes which affect travel time and/or changes in land use designations due to adoption of the Southside Plan.

Such housing is particularly critical for first-year graduate students. Not only does the cost and scarcity of housing make it harder for all our students to focus on and excel in their academic endeavors: in the case of first year graduate students, it also makes it far harder to recruit them in the first place. For graduate students, apartments are the best solution, not only because older students tend to prefer a less structured environment, but also because conventional apartments offer a broader range of delivery options, including joint ventures with private developers.

POLICY: MAINTAIN AND UPGRADE THE CURRENT SUPPLY OF UNIVERSITY HOUSING SUITABLE FOR STUDENTS WITH CHILDREN.

It is particularly difficult for students with children to find suitable housing in the constrained Berkeley market. While UC Berkeley operates over 850 units suitable for students with children, many are in need of major repair or replacement. As we pursue these improvements, the supply of units must be maintained.

POLICY: PROVIDE UP TO 3 YEARS OF UNIVERSITY RENTAL HOUSING TO NEW UNTENURED LADDER FACULTY WHO DESIRE IT BY 2020.

While the university has begun to address the long-term housing needs of faculty through its down payment and mortgage subsidy programs, such programs do not address the critical need for good rental housing. As with graduate students, our ability to recruit and retain outstanding individuals depends to a great extent on our ability to ensure good and reasonably priced housing for at least their first years at UC Berkeley.

At projected rates of future faculty hires, this policy may result in construction of up to 100 such units within the LRDP Housing Zone. This housing may be separate or co-located with the graduate and /or student family housing described above.

POLICY: LOCATE ALL NEW UNIVERSITY HOUSING WITHIN A MILE OR WITHIN 20 MINUTES OF CAMPUS BY TRANSIT.

To ensure university housing improves access to the academic life and resources of the campus, and supports a vital intellectual community, all new housing built under the 2020 LRDP would be located within the Housing Zone shown in figure 5, namely:

- Within a one mile radius of the center of campus, defined as Doe Library, or
- Within one block of a transit line providing trips to Doe Library in under 20 minutes. A transit trip is defined as the time on the transit vehicle to the stop nearest to campus, with no transfers, plus the walking time from the stop to Doe Library.

POLICY: IMPROVE ACCESS TO QUALITY CHILD CARE FOR STUDENTS, FACULTY AND STAFF.

The need for good and convenient child care is, like housing, a critical factor in our ability to recruit and retain exceptional individuals, and to enable them to participate fully in campus intellectual life. The demand for university child care in spring 2004 was far greater than our capacity of 205 children. Moreover, some of our child care centers are housed in temporary facilities unable to fully support our programmatic goals. Under the 2020 LRDP, UC Berkeley should expand its permanent child care facilities to accommodate both current unmet demand and future campus growth, at locations within easy walking distance of the Campus Park.

9 CAMPUS ACCESS

PROVIDE THE HOUSING, ACCESS, AND SERVICES WE REQUIRE TO SUPPORT A VITAL INTELLECTUAL COMMUNITY AND PROMOTE FULL ENGAGEMENT IN CAMPUS LIFE.

Access to campus is vital to the work and culture of UC Berkeley. Our faculty, students and researchers depend not only on the academic resources of the campus, but also on their interactions with colleagues that lead to new insights, concepts and methods. Many of our senior faculty with long tenures at UC Berkeley enjoy the convenience of a residence near campus, acquired in the days when a Berkeley home was within reach of even moderate income households.

But more recently, due in large part to the shortage of good and reasonably priced housing near campus, our residential patterns have become more and more dispersed. For those who live beyond walking or bicycling distance or good transit service, the time and inconvenience of travel to and from campus, exacerbated by the shortage of parking, has become a significant disincentive to on-campus presence. This trend undermines the goal of a strong and vital intellectual community, and we must strive to reverse it.

POLICY: ENSURE UNIVERSITY HOUSING AND ACCESS STRATEGIES ARE INTEGRATED AND SYNERGETIC.

The 2020 LRDP objectives for housing would significantly increase the supply of student housing within a mile or a within a 20 minute transit trip of campus: our surveys indicate for most students a mile is a reasonable walking distance. These housing initiatives should be linked to the campus access strategy, to ensure the resources we commit to new housing also serve to reduce the demand for drive-alone trips, and to ensure our parking targets are adjusted to reflect any such reductions.

POLICY: INCREASE THE SUPPLY OF PARKING TO ACCOMMODATE EXISTING UNMET DEMAND AND FUTURE CAMPUS GROWTH.

The demand for parking on and around campus is far greater than the current supply, and this demand will grow as a result of future campus growth. Adequate parking is critical to the mission of UC Berkeley, but given our urban setting, the campus should achieve this through a balanced strategy of parking construction and demand management.

By California standards, UC Berkeley has an exemplary record of promoting alternatives to the automobile. The 2001 survey of faculty and staff indicated only 51% of faculty and staff, and only 11% of students, drive alone to campus: these percentages compare to the estimate of 46% for all commuters to campus and downtown Berkeley presented in the 2001 City-UC Berkeley Transportation Demand Management Study, and the 2000 Census estimate of 66% for Alameda County as a whole.

The projected campus growth under the 2020 LRDP could, at target drive-alone rates of 10% for students and 50% for employees, result in a demand by 2020 for up to 2,300 net new parking spaces beyond the current inventory and approved projects. However, while this figure includes substantial current unmet demand as well as future growth, it could be reduced if drive-alone rates could be improved through a combination of transit incentives and transit service improvements, as described below.

As with housing, because the state provides no funds for university parking, the full cost of parking construction, operation and maintenance must be supported by revenues. Our objectives to improve the parking supply must therefore be balanced by the need to maintain reasonable fees for those who must drive to campus, and to avoid building surplus capacity. The 2020 targets may be adjusted in the future to reflect changes in market conditions and parking demand.

POLICY: REDUCE DEMAND FOR PARKING THROUGH INCENTIVES FOR ALTERNATE TRAVEL MODES.**COLLABORATE WITH CITIES AND TRANSIT PROVIDERS TO IMPROVE SERVICE TO CAMPUS.**

UC Berkeley presently offers a wide range of incentives for alternatives to drive-alone auto trips, including price subsidies and pre-tax purchase of transit tickets, discounted parking to alternate mode users who must occasionally drive alone, free parking and reserved parking spaces for carpoolers, free emergency rides home for alternate mode users, and a secure bicycle parking program for bike commuters. Based on the findings of the 2001 City-UC Berkeley Transportation Demand Management Study, UC Berkeley will continue to pursue existing and new incentives for alternative modes of transportation, directly as well as in collaboration with cities and regional transit providers.

While cost and dependent care are often cited as reasons why people drive to work, in our 2001 survey of faculty and staff only 9% and 10%, respectively, selected these reasons. Convenience, at 37%, and travel time, at 30%, were by far the most oft-cited reasons why faculty and staff drive rather than use transit or other alternate modes. The university is working with transit providers to ensure reasonably priced transit options and adequate service. However, if significant numbers of drivers are to be shifted to transit, convenience and travel time must be improved. Although minor further improvements might be achieved through operational measures, significant improvements require major capital investments.

As part of its Bus Rapid Transit (BRT) project, AC Transit is proposing to upgrade transit service to the campus along a Telegraph Avenue alignment. The BRT/Telegraph project would create dedicated bus lanes and station structures along an 18-mile route from San Leandro through Oakland to UC Berkeley and downtown Berkeley. BRT/Telegraph would offer riders a rail-like transit experience that operates more quickly and reliably than regular bus service today, and would thus address the issues of convenience and travel time that now induce commuters to drive.

For example, if BRT/Telegraph and UC Berkeley transit incentives could combine to produce a 10% improvement in current estimated drive-alone rates, the 2020 parking demand at UC Berkeley could be reduced from 2,300 to roughly 1,800 net new spaces. To ensure adequate time to assess the impact of BRT/Telegraph and its own transit incentives on drive-alone rates, UC Berkeley would defer 500 of the 2,300 net new spaces until after 2020 if the following conditions are met:

- the cities of Berkeley and Oakland approve the final route for BRT/Telegraph by January 2010, and
- construction is underway on the BRT/Telegraph system as described above by January 2010.

POLICY: REPLACE AND CONSOLIDATE EXISTING UNIVERSITY PARKING DISPLACED BY NEW PROJECTS.

The previous objectives can not be realized if existing campus parking is displaced without replacement. Our strategy to accommodate future campus growth requires, and in fact depends upon, existing surface lots being replaced by new buildings and open spaces. In order to maintain the campus parking supply, these displaced spaces should be replaced on site or elsewhere, and the scope and budget for each such project should include those replacement spaces. The strategy to replace this parking should also be designed to consolidate it, not only to improve operations but also to reduce congestion caused by multiple-lot searches for available space.

FIGURE 6
**CAMPUS PARK
 LANDSCAPE & OPEN
 SPACE INITIATIVES**



- A South Fork Renewal
- B Eucalyptus Grove
- C Observatory Hill**
- D Founders Rock
- E West Oval Glade**
- F Campanile Glade
- G Faculty Glade**
- H Wheeler Glade**
- J Grinnell Glade
- K Edwards Glade
- L Campanile Environs**
- M Mining Circle**
- N Oppenheimer Way
- O West Circle
- P Campanile Way**
- Q Sather Road**
- R Sproul Plaza**
- S Lower Sproul Plaza
- T Wheeler-Dwinelle Plaza**
- U College Plaza
- V Arts Quad
- W Wellman Courtyard
- X Tolman Plaza
- Y University Walk
- Z West Hearst Field

Priority initiatives in **bold**.

The Landscape Master Plan also designates the entire perimeter of the Campus Park as the Edges and Gateways initiatives: this group includes initiatives for each of the four perimeter roads and the entry points to the Campus Park.

This figure includes the potential future projects shown in the illustrative concept in figure 3B. These potential projects represent only one scenario of how the 2020 LRDP program might be implemented on the Campus Park. However, the potential projects serve as an example of how the **Campus Park Framework** would help guide the location and configuration of future buildings in the Campus Park.

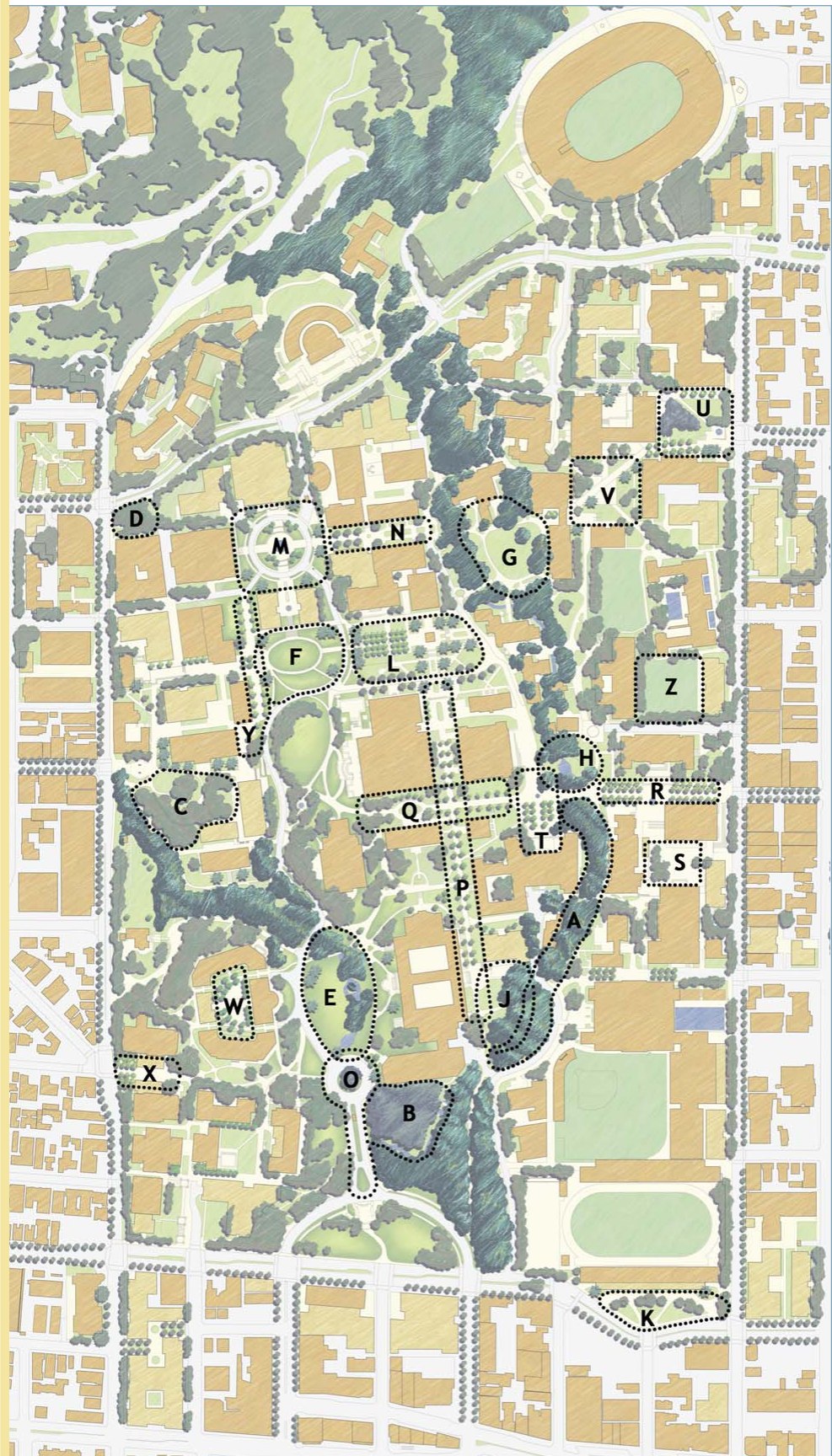

10 CAMPUS OPEN SPACE

MAINTAIN AND ENHANCE THE IMAGE AND EXPERIENCE OF THE CAMPUS, AND PRESERVE OUR HISTORIC LEGACY OF LANDSCAPE AND ARCHITECTURE.

The UC Berkeley campus is a unique synergy of natural and formal elements. The organic forms of the creek and the sloping terrain contrast with the axial geometry of historic places such as Campanile Way and Esplanade. Together, these elements provide the campus with a rich variety of open spaces, and a peaceful counterpoint to our urbanized environs.

Open spaces for both quiet contemplation and active recreation have always been an integral part of the campus. The removal of the wartime-vintage 'T buildings' and the construction of Memorial Glade restored John Galen Howard's original vision of a grand central open space at the heart of campus. Yet, notwithstanding this one outstanding example, capital investment at UC Berkeley in recent years has focused almost entirely on our aging buildings and infrastructure, rather than the landscape.

OPEN SPACE

The campus landscape is not only an extraordinary natural and visual resource, it also serves as an important complement to spaces within buildings, as a venue for relaxation, recreation, and social and cultural interaction.

POLICY: IMPLEMENT AN ONGOING PROGRAM OF INVESTMENT TO RESTORE AND RENEW THE CAMPUS PARK LANDSCAPE.

To the casual observer, the mature campus landscape seems deceptively stable, but a closer look reveals the impacts of age, intensive use and misuse, and lack of investment. The great beauty of the campus, often taken for granted, is in fact increasingly fragile, particularly in light of the intensive construction activity it must continue to endure for at least the near future. The **Campus Park Framework** and **Guidelines** establish preservation zones to protect and maintain the campus' most significant views, natural areas, and open spaces.

But preservation alone is not enough: investment is also required. Many areas of the campus landscape are dominated by plants nearing the end of their natural life cycles: this problem is particularly acute for the many specimen trees and groves that serve as campus landmarks and frame key vistas. The natural riparian areas along the creek forks reveal the cumulative impacts of erosion, unstable banks, and the displacement of native plants by invasive exotics.

POLICY: IMPLEMENT A PROGRAM OF STRATEGIC INVESTMENT IN NEW AND ENHANCED CAMPUS OPEN SPACES.

The lack of past investment is also evident in the campus' formal open spaces. While few would dispute the value of places such as Sproul Plaza or Campanile Way, due to the lack of funds for renewal these and other campus open spaces have fallen into severe disrepair. Our capital investment program should acknowledge the critical role of our landscape and open spaces in the image and experience of the campus, and include proactive measures to reverse their decline.

In order to guide and prioritize future investment in campus open spaces, the UC Berkeley Landscape Master Plan has identified 29 initiatives, as shown in figure 6: 25 place-specific initiatives plus the four urban edges of the Campus Park. Both in formulating the campuswide capital program, and in scoping and budgeting individual capital projects, UC Berkeley should address the need to both renew and enhance the campus landscape within the framework of the Landscape Master Plan.

Moreover, this policy is not limited to the Campus Park. Our objective to respect and enhance the City Environs requires more than just sensitive building design: it also requires that each university project in the City Environs contribute its fair share of improvements to the adjacent public realm, including undergrounding surface utilities and improving paving, planting and lighting within the project frontages.

PLACES OF INTERACTION

Of particular importance to the goal of a vital intellectual community are open spaces designed to encourage informal interactions both within and among disciplines. Several of the open spaces shown in figure 6 have the potential to become true 'places of interaction', because they are located on major pedestrian routes and/or because they are framed by multiple buildings housing a variety of academic programs.

POLICY: CREATE PLACES OF INTERACTION AT KEY NODES OF ACTIVITY.

For such places of interaction, moreover, the program and design of buildings adjacent to these open spaces is as important as the design of the open spaces themselves. Buildings should be programmed and designed so active interior spaces face and observe major pedestrian routes and places of interaction, and help ensure the campus is a safe place to work and study at any hour, as prescribed in the Campus Park Guidelines.

RECREATION

Space for recreation is essential to the health and wellness of the campus community. However, while the campus population continues to grow, recreational facilities have remained constant or, in the case of playfields, considerably declined: Underhill Field was demolished due to seismic hazard, and temporary buildings were constructed on West Hearst Field to provide surge space for seismic retrofit projects. The loss of these two fields, combined with the growth in field space demand for athletics programs, has reduced the amount of recreational field space per student to 40% of what it was in 1990.

POLICY: PRESERVE EXISTING RECREATIONAL FIELDS AND RESTORE THE FIELDS LOST SINCE 1990.

A project to replace Underhill Field has already been planned as part of the 2000 Underhill Area Master Plan. UC Berkeley should also remove the temporary buildings on West Hearst Field and return it to recreational use as soon as possible, preferably as a synthetic turf field over one or more levels of parking. Once restored, these and other campus recreational fields should be protected from future conversion to other uses.

POLICY: PRESERVE AND ENHANCE RECREATIONAL AQUATICS FACILITIES.

Strawberry Canyon Recreation Area is a precious recreational resource for both campus and community, but the 2002 closure of the east pool has significantly increased the pressure on other campus pools to accommodate both athletics and recreational users. UC Berkeley should prepare and implement a plan to improve the pool complex at Strawberry Canyon as part of a comprehensive strategy for campus aquatics facilities.

II SUSTAINABLE CAMPUS

PLAN EVERY NEW PROJECT AS A MODEL OF RESOURCE CONSERVATION AND ENVIRONMENTAL STEWARDSHIP.

As one of the world's great research universities, UC Berkeley has a special obligation to serve as a model of how creative design can both minimize resource consumption and enhance environmental quality. Each new capital investment at UC Berkeley has the potential to advance the state of the art in responsible, sustainable design, and thereby contribute to our mission of public service.

In July 2003 the UC Regents adopted a university-wide Green Building Policy and Clean Energy Standard to reduce the consumption of non-renewable energy, through a combination of energy conservation measures, local renewable power measures for both existing and new facilities, and the purchase of energy derived from renewable sources. In support of this policy, UC Berkeley should develop a strategy for the campus that reflects the specific characteristics of our site, climate, and facility inventory.

The principles of sustainable design are not separate and discrete. On the contrary, they are interdependent, and require a comprehensive approach to design. Therefore, while standard criteria can be very useful as a framework for analysis, sustainable design ultimately depends on the integrated efforts of a multidisciplinary project team. This comprehensive approach is particularly critical during the feasibility phase of a project, where a range of alternate solutions is evaluated and the optimal solution is defined.

POLICY: INCORPORATE SUSTAINABLE DESIGN PRINCIPLES INTO CAPITAL INVESTMENT DECISIONS.

The policies in **Strategic Investment** require UC Berkeley to consider a range of alternate solutions at the feasibility phase of the project approval process. This analysis should include an evaluation of how each option supports the principles of sustainable design, which include:

- preserving and restoring the integrity and biodiversity of natural systems,
- minimizing energy use in travel to and within the campus,
- minimizing building energy use and peak energy demand,
- minimizing water use and maximizing on-site conservation and reuse,
- minimizing the use of nonrenewable energy and material resources,
- minimizing adverse impacts to air and water quality,
- optimizing the use, and adaptive reuse, of existing facilities,
- concentrating growth on sites served by existing infrastructure,
- maximizing the productive life of new facilities through durable, flexible design, and
- creating environments that enhance human health, comfort, and performance.

POLICY: BASE CAPITAL INVESTMENT DECISIONS ON LIFE CYCLE COST, INCLUDING THE COST OF KNOWN FUTURE EXPENDITURES.

Sustainable design also depends on analyses based on true life cycle cost. While the best environmental solutions often have a lower life cycle cost, their first cost is often greater. The policies in **Strategic Investment** require the campus to evaluate alternate design solutions based on their life cycle cost, including the discounted costs of future expenditures: the policy is repeated here because it is essential to an effective strategy for sustainable design.

It is also essential to consider initial capital cost in the context of the building as a whole, since an upgrade in one system can sometimes reduce the capital cost of others. For example, investing in a high-performance window system may reduce the required capacity, and thus the initial capital as well as the future operating cost, of the space conditioning systems.

POLICY: DESIGN NEW PROJECTS TO MINIMIZE ENERGY AND WATER CONSUMPTION AND WASTE-WATER PRODUCTION.

Toward this end, substantial savings in water and energy consumption can often be achieved through architecture and landscape design: for example, by the careful selection of landscape materials, and by orienting and configuring building volumes and composing building facades to optimize energy performance. The **Campus Park Guidelines** include several such provisions, which should inform every future capital project.

POLICY: DESIGN NEW BUILDINGS TO A STANDARD EQUIVALENT TO LEED 2.1 CERTIFICATION. DESIGN NEW LABORATORY BUILDINGS TO A STANDARD EQUIVALENT TO LEED 2.1 CERTIFICATION AND LABS 21 ENVIRONMENTAL PERFORMANCE CRITERIA. DESIGN NEW BUILDINGS TO OUTPERFORM THE REQUIRED PROVISIONS OF TITLE 24 OF THE CALIFORNIA ENERGY CODE BY AT LEAST 20 PERCENT.

Many other institutions have adopted the LEED (Leadership in Energy & Environmental Design) system as their reference standard for sustainable design. The LEED system offers a reference standard that is well established and well supported by the design industry. However, it is also generic: it does not address particular building types or physical environments, nor does it address multi-building campus environments. As a research university, with a wide range of laboratories and other specialized buildings, UC Berkeley would be best served in the long run by performance guidelines more specific to our unique facility inventory and our temperate climate.

However, given the intensive pace of new construction and renovation on the Berkeley campus, it is imperative that we begin now to incorporate the principles of sustainable design into every new project. The LEED system is our best option today, and UC Berkeley should use version 2.1 as an interim reference standard while we investigate a more customized approach. Given the importance of sustainable design in laboratory facilities, UC Berkeley should supplement the LEED criteria with LABS 21 (Laboratories for the 21st Century) environmental performance criteria.

Moreover, the aforementioned objectives should serve only as a minimum standard for design. UC Berkeley should strive for a standard equivalent to LEED Silver wherever program needs, site conditions and budget parameters permit.

POLICY: DEVELOP A CAMPUS STANDARD FOR SUSTAINABLE DESIGN SPECIFIC TO OUR SITE, CLIMATE, AND FACILITY INVENTORY.

In consultation with the UC Office of the President, UC Berkeley should develop an internal evaluation and certification standard based on LEED and LABS 21 criteria as well as other sustainable design measures and guidelines, one which reflects both the unique composition of the UC Berkeley facility inventory and our temperate, semi-arid climate.

12 STRATEGIC INVESTMENT

PLAN EVERY NEW PROJECT TO REPRESENT THE OPTIMAL INVESTMENT OF LAND AND CAPITAL IN THE FUTURE OF THE CAMPUS.

Given the scarcity of both land and capital in relation to the future needs of the university, UC Berkeley must ensure each investment decision represents the best possible use of these limited resources, and the best long-term solution for the campus as a whole.

Capital investment decisions are often strongly influenced by the magnitude of first cost. Seismic retrofits, for example, are often less expensive than new buildings. But seismic retrofits alone do not improve inadequate building systems, dysfunctional layouts, or insensitive design: in fact, they perpetuate and often exacerbate them. Ensuring each decision is based on a full analysis of alternate solutions, and a full recognition of life cycle cost, is critical to the wise use of university resources.

POLICY: EVALUATE A FULL RANGE OF ALTERNATE SOLUTIONS IN CAPITAL INVESTMENT DECISIONS.

As a general rule, the set of options for this analysis should include retrofit, renovation, adaptive reuse, replacement, relocation and, if relevant, noncapital solutions such as reorganization. The options should consider alternate models for project delivery, as described below, and sustainable design features, as described in **Sustainable Campus**.

POLICY: BASE CAPITAL INVESTMENT DECISIONS ON LIFE CYCLE COST, INCLUDING THE COST OF KNOWN FUTURE EXPENDITURES.

For example, an existing building may not only require seismic and other life safety improvements, but may also have one or more building systems past the ends of their useful lives, as well as other systems nearing the same point. In order to make a valid comparison with the replacement option, the retrofit and renovation options should include these known future costs. This comparison should include assessment of the future maintenance requirements for all elements of the building infrastructure in relation to first cost.

POLICY: CONSIDER JOINT VENTURES THAT LEVERAGE UNIVERSITY RESOURCES WITH PRIVATE LAND AND CAPITAL.

While such partnerships have clear advantages in terms of augmenting university resources, advocates also cite their potential to reduce both cost and time to delivery. The advantages a well chosen partner brings to a project include extensive experience with the project type, established relationships with providers of labor, materials, and services, and state-of-the-art management.

However, in considering such models, it is also important to recognize quality has value, given the heavy use and long service expected of campus buildings. The analyses of alternate solutions, particularly for joint ventures, should be based on projects designed to comparable standards of durability and performance.

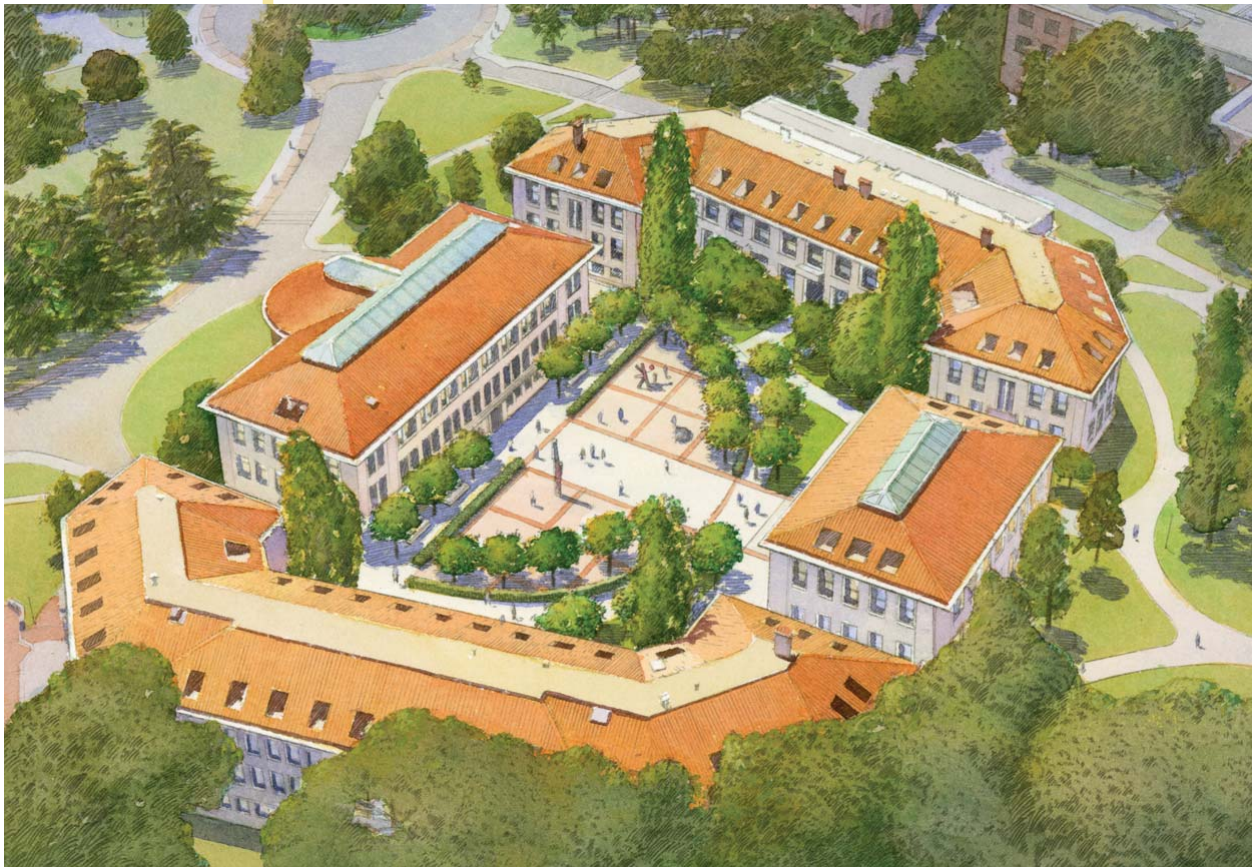

Concept: Wellman Courtyard is transformed into a social place and sculpture garden, framed by a double arc of trees and the magnificent buildings of the Agriculture Complex.



FACULTY GLADE

DESIGN FRAMEWORK

CAMPUS PARK FRAMEWORK

CITY ENVIRONS FRAMEWORK

HILL CAMPUS FRAMEWORK



Concept: Evans Hall is replaced with a pair of new pavilions, restoring the view from the Mining Circle to the Bay. A new green at the base of the pavilions, on axis with the Campanile, completes the east end of Memorial Glade.

13 CAMPUS PARK FRAMEWORK

MAINTAIN AND ENHANCE THE IMAGE AND EXPERIENCE OF THE CAMPUS, AND PRESERVE OUR HISTORIC LEGACY OF LANDSCAPE AND ARCHITECTURE.

The heart of UC Berkeley is often described as a 'university in a park', and it is this park-like character that unifies its disparate buildings and diverse academic functions, and imparts a unique and memorable identity. UC Berkeley was established on an expansive landscape of rolling hills, framed by the north and south forks of Strawberry Creek. Over the years, two complementary design themes have emerged to define the relationship of buildings and landscape in the Campus Park.

The first theme, pursued in the Frederick Law Olmsted plan of 1866, emphasized the complex natural order of the site in its organic landscape forms and informal clusters of buildings. The second theme, pursued in the John Galen Howard Plan of 1908, sought to overlay on this natural landscape a formal composition of classical buildings, oriented along an east-west axis aligned with the Golden Gate. The unique character of the Campus Park results from the synergy of these two themes, the natural and the formal.

Although intensively developed, the Campus Park today retains a magnificent legacy of natural and formal open spaces, as well as numerous historic buildings and ensembles. Preserving this legacy is a fundamental objective of the 2020 LRDP: each future project should be scoped and designed to enhance the image and experience of the campus, and the quality of campus life.

LAND USE

The Campus Park is also our center of intellectual community, and there is a strong preference among academic programs for Campus Park locations. However, because university land is both scarce and finite, our use of land on and around the Campus Park must be strategic. As described in **Campus Land Use**, space in the Campus Park is prioritized for programs that directly engage students and promote student-faculty interaction.

In response to future space demand by academic and other campus programs, capital investment in the Campus Park through 2020 may result in a net increase of up to 1,000,000 GSF and up to 600 parking spaces, as shown in table 3.

New space in the Campus Park would be produced through a combination of renovation and expansion of existing buildings, strategic building replacements, and new buildings on underutilized sites. Many of these renovations, expansions and replacements would be done in conjunction with seismic improvements. To ensure its parklike character is preserved, the **Campus Park Guidelines** define preservation zones to protect the campus' most significant open spaces: no new buildings may intrude into those areas.

LANDSCAPE

The Campus Park landscape provides a wide variety of experiences, from the shady peaceful glens along Strawberry Creek, to the broad open lawns of the Central Glades, to the serene geometry of places such as Campanile Way and Esplanade. Located within the densely urbanized Eastbay, the Campus Park is a precious resource for both the university and the city around us.

**FIGURE 7
CAMPUS PARK
PRESERVATION AREAS**



Natural riparian areas



Rustic campus woodlands



Rustic hill woodlands



View & open space
preservation zones

Key numbers refer to
zone descriptions in the
Campus Park Guidelines

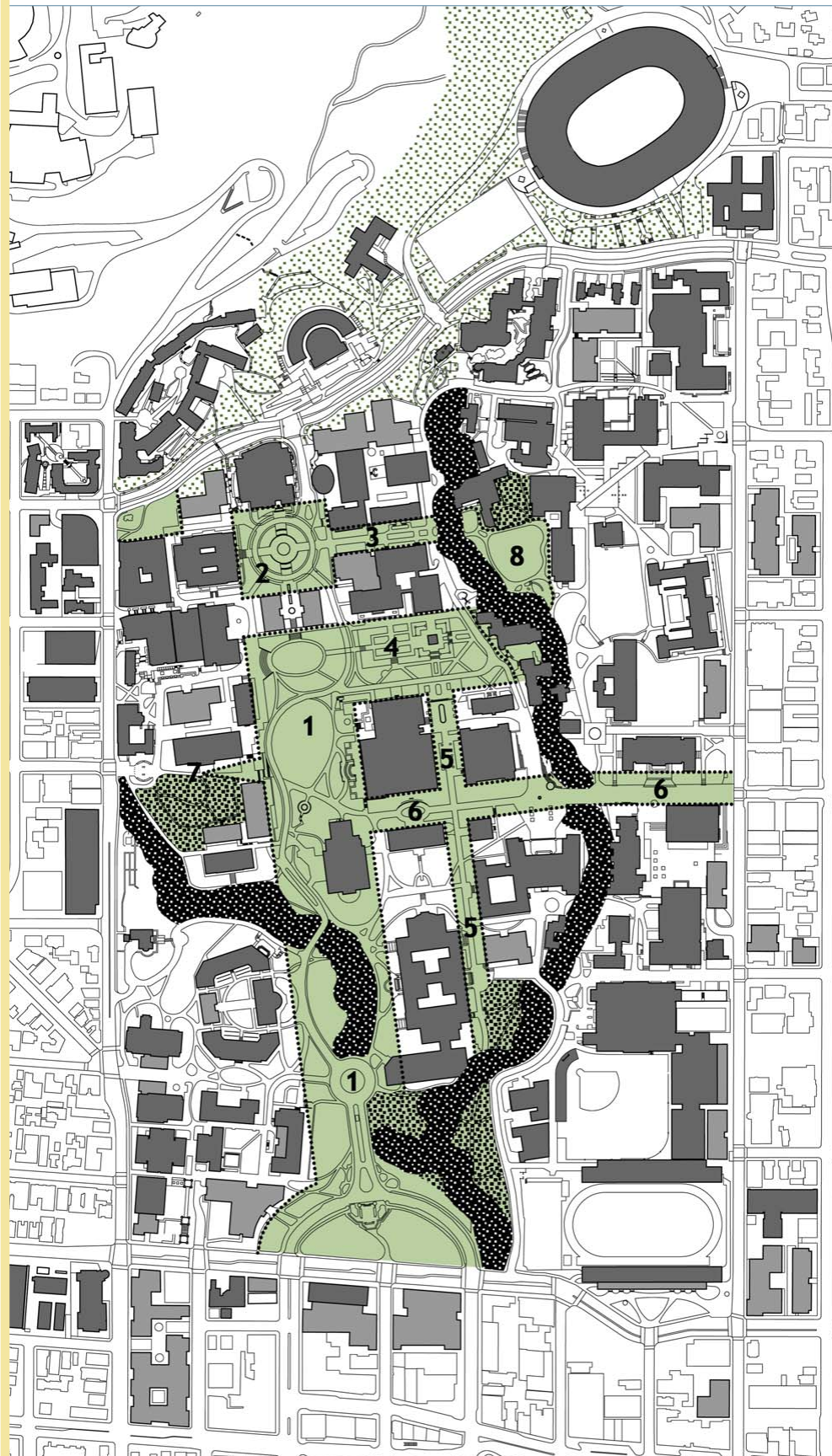

This figure includes the potential future projects shown in the illustrative concept in figure 3B. These potential projects represent only one scenario of how the 2020 LRDP program might be implemented on the Campus Park. However, the potential projects serve as an example of how the **Campus Park Framework** would help guide the location and configuration of future buildings in the Campus Park.

However, over the years the integrity of the landscape has been damaged by insensitively sited and designed projects. Sometimes the damage is obvious, such as the location of Evans and Moffitt within the Central Glades, while other times it is more subtle, such as the gradual and cumulative impacts of ongoing construction.

POLICY: PRESERVE AND MAINTAIN SIGNIFICANT VIEWS, NATURAL AREAS, AND OPEN SPACES IN THE CAMPUS PARK.

The 2020 LRDP takes as axiomatic the principle there should be no further degradation of the Campus Park landscape. The first principle of design for the Campus Park, therefore, is to identify those areas of the landscape into which new buildings should not intrude. These 'preservation areas', shown in figure 7 and described in detail in the **Campus Park Guidelines**, include the campus' most significant natural areas, open spaces, and scenic vistas.

The experience of the Campus Park is created by the synergy of buildings and landscape, and the character of many of our open spaces depends to a great extent on how they are framed and defined by the buildings around them. For this reason, some of the preservation areas described in the **Campus Park Guidelines** include setback and build-to lines, to ensure their character is maintained and reinforced by new buildings.

POLICY: IMPLEMENT AN ONGOING PROGRAM OF INVESTMENT TO RESTORE AND RENEW THE CAMPUS PARK LANDSCAPE.

IMPLEMENT A PROGRAM OF STRATEGIC INVESTMENT IN NEW AND ENHANCED CAMPUS PARK OPEN SPACES.

The section on **Campus Open Space** describes the principles for future investment in the public realm of the Campus Park. The above policies are repeated in this section to emphasize the point that protection alone is essential but not sufficient to achieve this objective: the landscape must be continuously renewed in order to thrive.



STRAWBERRY CREEK WOODLAND

FIGURE 8
**CAMPUS PARK
 ARCHITECTURE &
 CULTURAL RESOURCES**



Classical core



Picturesque ensemble



National Register:
 classical buildings



National Register:
 other buildings

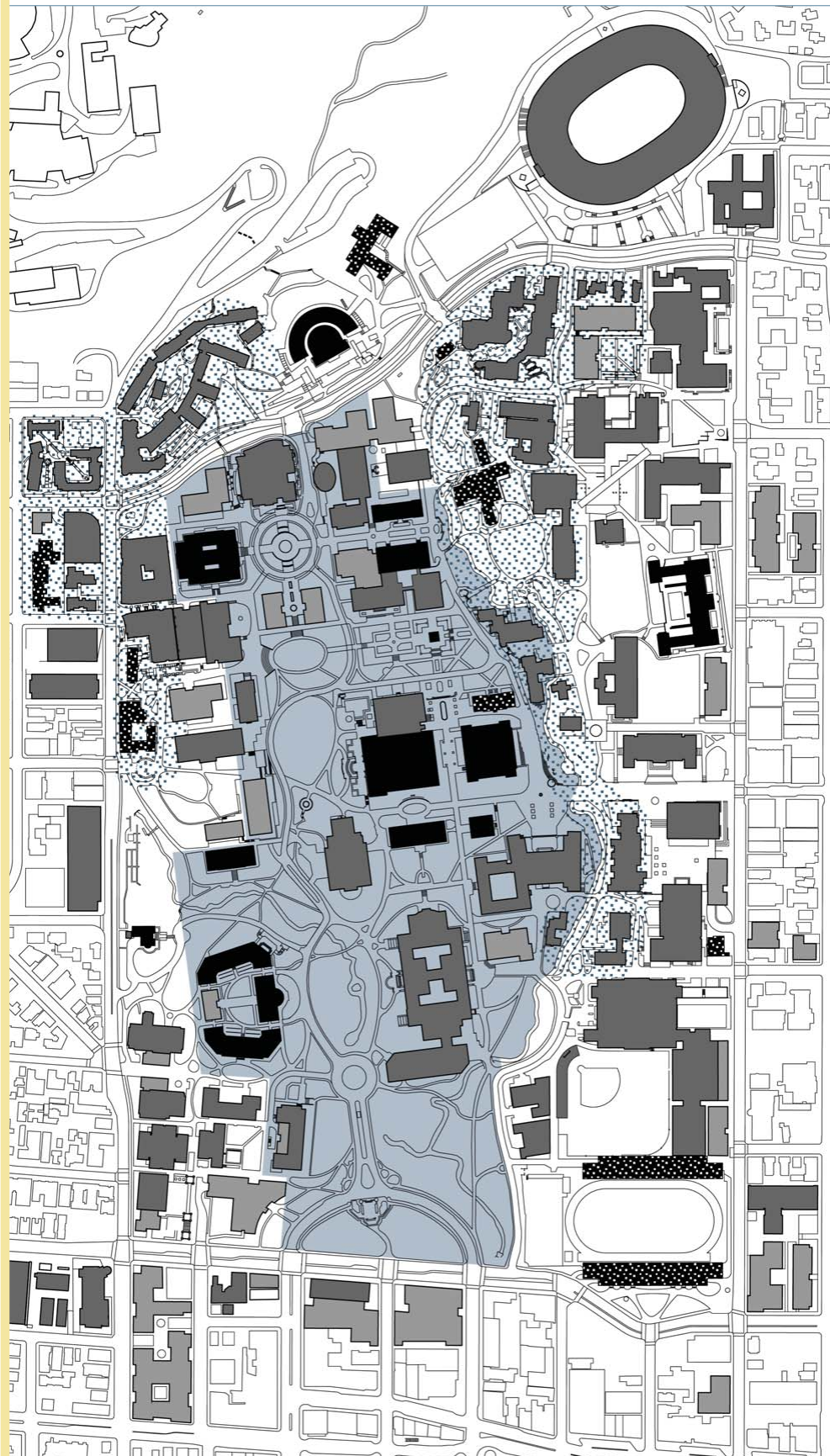

This figure includes the potential future projects shown in the illustrative concept in figure 3B. These potential projects represent only one scenario of how the 2020 LRDP program might be implemented on the Campus Park. However, the potential projects serve as an example of how the **Campus Park Framework** would help guide the location and configuration of future buildings in the Campus Park.

ARCHITECTURE

While the campus does not have a single, coherent architectural vocabulary, it does have many buildings of great distinction, and the best of these comprise the 'classical core': the beaux-arts ensemble designed primarily by John Galen Howard, the first campus architect. The classical symmetry of these buildings, and their common palette of granite facades, tile roofs, and copper trim, impart a sense of unity and dignity to the heart of campus.

UC Berkeley includes 50 sites, structures, and districts on the National Register of Historic Places, and two more are in the process of nomination. As shown in figure 8, 27 are located on the Campus Park and Adjacent Blocks: the majority are neoclassical buildings located primarily within the classical core, with the balance comprised of picturesque buildings located primarily along the historic route of Strawberry Creek.

The classical core represents a unique cultural resource, in terms of both its architectural merit and the open spaces its buildings frame and define. For this reason, new projects within the classical core, as shown in figure 8, should be sited, configured and designed to reinforce and enhance this ensemble, as prescribed in the **Campus Park Guidelines**.

The campus identity is also shaped by another, more subtle ensemble: the variety of picturesque buildings along the creek, which also includes a number of historic structures. In contrast to the formality of the classical core, these picturesque buildings are designed as informal, highly articulated volumes that respond to the natural contours and features of the site. As exemplified by the Haas School of Business, new projects within the areas of picturesque influence should respect and continue these traditions.

POLICY: ENSURE FUTURE CAMPUS PARK PROJECTS CONFORM TO THE CAMPUS PARK GUIDELINES.

PREPARE PROJECT SPECIFIC DESIGN GUIDELINES FOR EACH MAJOR NEW PROJECT.







While the design of each campus building should reflect its own time and place, it should also reflect the enduring values of elegance and quality, and contribute to a memorable identity for the campus as a whole. Toward this goal, major capital projects should be reviewed at each stage of design by the UC Berkeley Design Review Committee: a majority of DRC participants should be external to the campus.

The **Campus Park Guidelines** should guide these reviews to ensure they both reflect a coherent esthetic vision and support the academic goals of the campus. The **Guidelines** prescribe general design principles for the Campus Park as a whole, as well as more prescriptive criteria in selected areas to ensure:

- projects within the classical core enhance the architectural integrity of the ensemble, and complement rather than compete with historic buildings,
- projects at the city interface create a graceful transition from campus to city, and enhance the visual image and pedestrian experience of the campus edge,
- projects facing places of interaction provide enclosure and security, admit sunlight, and have active ground level uses that observe and activate the place.

Moreover, given the variety of site conditions present in the Campus Park, project specific design guidelines should be prepared for each major project, based on the **Campus Park Guidelines**, and should be reviewed by the campus DRC prior to selection of the project design team. The project specific design guidelines should specify the landscape and open space improvements to be incorporated into the project scope and budget.

FIGURE 9
CAMPUS PARK
VEHICULAR ACCESS

- 
-  External vehicular routes
-  Internal vehicular routes
-  Bicycle routes
-  Major campus entrances
-  Gate to internal route

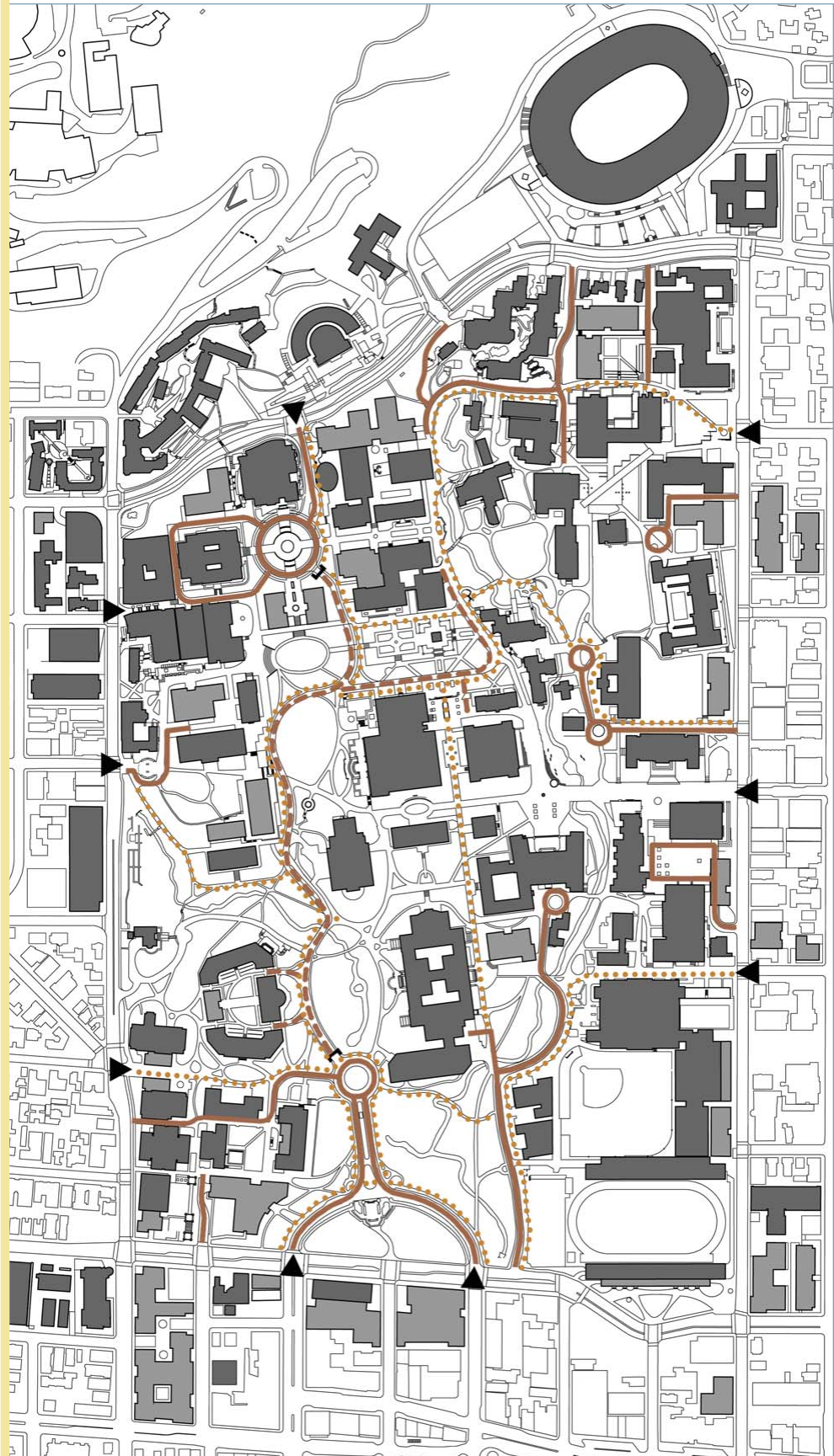

This figure includes the potential future projects shown in the illustrative concept in figure 3B. These potential projects represent only one scenario of how the 2020 LRDP program might be implemented on the Campus Park. However, the potential projects serve as an example of how the **Campus Park Framework** would help guide the location and configuration of future buildings in the Campus Park.

The UC Berkeley Design Review Committee should include at least one architectural historian or other person with equivalent experience and knowledge in historic preservation. As part of project review, the DRC should assess potential adverse impacts on cultural resources and recommend measures to minimize such impacts.

CIRCULATION

A vital intellectual community depends on a safe, pedestrian- and bicycle-friendly environment, accessible to people with both full and limited mobility. The intricate web of internal campus routes should not only have a clear wayfinding system, but their design should reflect a clear hierarchy of purpose and minimize conflicts with vehicles.

The work of the university today also has no defined 'working hours': study and research go on day and night, and the campus should provide a safe and secure environment for those who use the campus after dark. Well-lit routes should link key campus destinations, as well as places of interaction framed and observed by active interior spaces.

POLICY: IMPLEMENT A PROGRAM OF STRATEGIC INVESTMENT IN CAMPUS PARK PEDESTRIAN AND BICYCLE ROUTES.

ENSURE THE CAMPUS PARK PROVIDES FULL ACCESS TO USERS AT ALL LEVELS OF MOBILITY.

The Campus Park is an intensively developed environment, laced with an intricate web of circulation systems that are complex and often confusing in their purpose, hierarchy, and linkages. There is a lack of signage leading to the campus, and a lack of a legible wayfinding system within it. Moreover, some primary routes of travel on campus include segments that are not accessible for those with impaired mobility.

The Campus Park presently has only one well-developed bicycle route: other paths are designated but not well developed for bicycles. As a result, cyclists often use pedestrian routes. Improvements to campus required to limit vehicle traffic should also incorporate investments to separate bicycle, vehicle and pedestrian traffic, and improve paving, lighting and signage on bicycle routes. This investment program should also identify routes that are or may become suitable for mixed traffic.

Many of the improvements required to improve campus routes and wayfinding about potential future building projects, and should be timed to coincide with those projects. As prescribed in **Campus Open Space**, adequate funds for those improvements should be defined at the feasibility stage of each project and incorporated into the project budget, and not diverted later to other project elements.

POLICY: MINIMIZE PRIVATE VEHICLE TRAFFIC IN THE CAMPUS PARK.

LOCATE NEW CAMPUS PARKING AT THE EDGE OR OUTSIDE THE CAMPUS PARK.

While the Campus Park is often described as a 'pedestrian' environment, in fact a wide variety of vehicles enter the campus on a typical workday: not just campus vehicles, but service and maintenance trucks, package service vans, construction vehicles and private cars. Not only do they pose a hazard to pedestrians, particularly on busy routes such as Sather Road and Campanile Way, they also cause paving and landscape damage which the campus has very limited funds to repair. As the campus becomes more and more congested due to both growth and construction activity, the unregulated flow of private vehicles through the Campus Park should be managed more assertively.

Many campus buildings can be served via short access roads directly from city streets: these are shown as 'external routes' in figure 9. In general, these external routes do not cause serious conflicts. Vehicles on internal routes, however, not only interfere with major pedestrian routes and places, but also degrade the serenity and historic quality of the heart of campus. The longterm goal for the campus should be to limit access to internal routes to two points, east and west gate, and by permit only from 8 am to 5 pm, to minimize vehicular movement on campus during peak times of instruction.

Surface parking located within the Campus Park not only encourages vehicle traffic, it is a poor use of scarce and valuable land. In general, campus parking, except for spaces required for service, loading, and disabled parking, should be consolidated in structures at the perimeter or outside the Campus Park, accessed directly from city streets.

CITY INTERFACE

Projects at the edge of the Campus Park should be designed to enhance its visual quality and create a graceful, yet clear and distinctive, transition to the Campus Environs. The **Campus Park Guidelines** prescribe special criteria for the city interface, to create a campus edge more coherent in design and more responsive to its urban context.

POLICY: PARTNER WITH THE CITY AND LBNL ON AN INTEGRATED PROGRAM OF ACCESS AND LANDSCAPE IMPROVEMENTS AT THE CAMPUS PARK EDGE.

The streets that define the Campus Park - Bancroft, Oxford/Fulton, Hearst, and Gayley/Piedmont - should be re-envisioned as 'seams' linking the Campus Park and its adjacent blocks, rather than dividers. UC Berkeley should collaborate with the City of Berkeley and Lawrence Berkeley National Laboratory to define, and jointly seek funds for, an integrated program of capital investments to improve the visual quality, pedestrian safety, functionality, amenity, bicycle access and transit service on these streets.



14 CITY ENVIRONS FRAMEWORK

PLAN EVERY NEW PROJECT TO RESPECT AND ENHANCE THE CHARACTER, LIVABILITY, AND CULTURAL VITALITY OF OUR CITY ENVIRONS.

UC Berkeley is an urban campus, and the City Environs are as much a part of the Berkeley experience as the campus itself. The quality of city life, including its diverse and dynamic mix of students and non-students, is a large part of what makes UC Berkeley a unique and desirable place to learn, work, and live.

LAND USE

As defined in the 2020 LRDP, the City Environs include the Adjacent Blocks, the Southside, Other Berkeley Sites, and the Housing Zone in its entirety: in other words, the entire scope of the 2020 LRDP except for the Campus Park and Hill Campus. The areas within the City Environs consist mostly of city blocks served by city streets, and include university properties interspersed with non-university properties.

It is not possible to accommodate all projected future space demand through 2020 on Campus Park sites. The **Location Guidelines** prioritize Campus Park space for programs that directly engage students and promote student-faculty interaction: at least some of the growth in other programs must be accommodated elsewhere within the City Environs.

ADJACENT BLOCKS

The Adjacent Blocks include several campus facilities intermixed with other properties. They also include the State Department of Health Services (DHS) facility, now being vacated by the state: the university has an option to acquire this site once it is vacated, and expects to do so. The **Location Guidelines** prioritize space on the Adjacent Blocks for programs that require locations near, but not on, the Campus Park.

In response to future space demand by campus programs, capital investment on Adjacent Blocks through 2020 may result in a net increase in program space of up to 1,250,000 GSF, and up to 1,900 net new parking spaces. New space on the Adjacent Blocks would be produced by more intensive redevelopment of existing university owned sites, as well as the DHS site if acquired by the university. New space may also be produced on other sites by the university directly or through joint ventures.

As shown in table 3, the majority of this space would be developed on the Adjacent Blocks West, and these blocks offer enormous potential to enhance the synergy of campus and city. Viewed on a map, the juxtaposition of downtown Berkeley and the grand west entrance to the campus might suggest an elegant, vibrant interface of town and gown: but this potential is largely unrealized. While the downtown BART station and bus lines from the north and west ensure a steady flow of people through the blocks west of campus, the visible university presence on these blocks in 2003 consisted of a parking structure, the printing plant, the bus garage, and administrative offices.

Given both its superior transit access and its established mixed-use character, downtown Berkeley should be the primary focus of future university investment in new research, cultural and service functions that require locations near, but not on, the Campus Park, as described above. However, these future investments should be planned not merely to accommodate the program needs of the university, but also to invigorate the downtown and create an inviting, exciting 'front door' to the UC Berkeley campus. They should also be planned to enable university land and capital to be leveraged through creative partnerships with other public and private sector organizations.

For example: the Berkeley Art Museum, now housed in a building with a poor seismic rating, and the Pacific Film Archive, now in a temporary facility, would both greatly benefit from a move to a downtown site, not only for the improved visibility and transit access, but also for the synergy with other downtown cultural and retail activity, including the thriving arts district along Addison Street. This new complex could also include exhibit spaces for other campus museums, as well as the campus visitor center.

Downtown is also the logical place for a hotel and conference center, a critical and long-standing need of the campus, as well as the city and its many public and private organizations. UC Berkeley should seek to encourage a privately developed and operated conference center: one flexible enough to serve a variety of users and events, but also large enough to meet the demand generated by both the campus and other users.

SOUTHSIDE

In response to future space demand by campus programs, capital investment in the Southside through 2020 may result in a net increase in program space of up to 50,000 GSF. New space in the Southside would be produced by more intensive redevelopment of existing university owned sites. New space may also be produced on other sites by the university directly or through joint ventures.

In 1982 the university executed a Declaration of Covenants and Restrictions with neighboring property owners and a Memorandum of Understanding with the City of Berkeley, both of which commit the university to a site plan and land use program on the Clark Kerr Campus for a period of 50 years. While many of its 26 buildings require extensive repairs and upgrades, including seismic upgrades, no significant change in either the use or physical character of the Clark Kerr Campus is proposed in the 2020 LRDP.

LRDP HOUSING ZONE

The housing objectives for the 2020 LRDP require that all new lower division undergraduate housing be located within a mile of the center of the Campus Park, defined as Doe Library, and all other student housing either within this radius or within one block of a transit line providing trips to Doe Library in under 20 minutes. In the 2020 LRDP, this Housing Zone is defined to exclude those areas with residential designations of under 40 units per acre in a municipal general plan as of July 2003.

In support of the campus' academic goals, capital investment in the Housing Zone through 2020 may result in a net increase of up to 2,600 bed spaces, including up to 100 units suitable for faculty or staff. New student housing in the Housing Zone would be produced by more intensive redevelopment of existing university owned sites, as well as on other sites by the university directly or through joint ventures.

OTHER BERKELEY SITES

The 'Other Berkeley Sites' category includes all land within the 2020 LRDP scope but outside any other defined land use zone. University owned sites within this zone include 2000 Carleton Street and 6701 San Pablo Avenue. In response to future space demand by campus programs, capital investment in this zone through 2020 may result in a net increase in program space of up to 50,000 GSF. New space may be produced by more intensive redevelopment of existing university owned sites, as well as on other sites by the university directly or through joint ventures.

PROJECT DESIGN

UC Berkeley serves the entire state of California, and thus has a mission that can not always be met entirely within the parameters of municipal policy. In the City Environs, however, the objectives of UC Berkeley must be informed by the plans and policies of neighboring cities, to respect and enhance their character and livability through new university investment.

POLICY: USE MUNICIPAL PLANS AND POLICIES TO INFORM THE DESIGN OF FUTURE CAPITAL PROJECTS IN THE CITY ENVIRONS.

USE THE SOUTHSIDE PLAN AS A GUIDE TO THE DESIGN OF FUTURE CAPITAL PROJECTS IN THE SOUTHSIDE.

PREPARE PROJECT SPECIFIC DESIGN GUIDELINES FOR EACH MAJOR NEW PROJECT.

ADJACENT BLOCKS

City of Berkeley land use regulations for the Adjacent Blocks in place as of July 2003, particularly the height and density provisions of the zoning ordinance, reflect a strong preference toward residential and mixed-use projects. However, in order to meet the demands for program space created by enrollment growth and by ongoing growth in research, sites on the Adjacent Blocks must provide adequate capacity to accommodate these demands, in order to maintain UC Berkeley as the compact, interactive campus described in **Campus Land Use**.

Major capital projects would be reviewed at each stage of design by the UC Berkeley Design Review Committee, based on project specific design guidelines informed by the provisions of the Berkeley General Plan and other relevant city plans and policies. The university would make informational presentations of all major projects on the Adjacent Blocks to the City of Berkeley Planning Commission and, if relevant, the City of Berkeley Landmarks Commission for comment prior to schematic design review by the UC Berkeley Design Review Committee.

Projects on the Adjacent Blocks within the area of the Southside Plan would as a general rule use the Southside Plan as a guide to project design, as described below.

SOUTHSIDE

The university owns roughly 45% of the land in the Southside, and students comprise over 80% of Southside residents. For both reasons, the Southside has always been the area of Berkeley where a positive, shared city-campus vision is most urgently required, and the lack of such a vision most acutely felt.

In 1997 the City of Berkeley and UC Berkeley signed a Memorandum of Understanding, which states 'the city and the university will jointly participate in the preparation of a Southside Plan ... the campus will acknowledge the Plan as the guide for campus developments in the Southside area'. The city and university have since collaborated on a draft Southside Plan, which as of March 2004 was being finalized for formal city adoption.

Given the mixed-use character of the Southside and the constant influx of new student residents, it is important to remember the Southside is, first and foremost, a place where people live. While the Southside Plan recognizes there are many areas within the Southside suitable for new non-residential projects, it also recognizes such projects must be planned to enhance the quality of life for all Southside residents.

Assuming no further substantive changes are made by the city prior to adoption, the university should as a general rule use the Southside Plan as its guide for the location and design of future projects in the Southside, as envisioned in the Memorandum of Understanding

Major capital projects would be reviewed at each stage of design by the UC Berkeley Design Review Committee, informed by the provisions of the Southside Plan. The university would make informational presentations of all major projects within the Southside Plan area to the City of Berkeley Planning Commission and, if relevant, the City of Berkeley Landmarks Commission for comment prior to schematic design review by the UC Berkeley Design Review Committee.

OTHER BERKELEY SITES

Major capital projects would be reviewed at each stage of design by the UC Berkeley Design Review Committee, based on project specific design guidelines informed by the provisions of the Berkeley General Plan and other relevant city plans and policies. The university would make informational presentations of all major projects on Other Berkeley Sites to the City of Berkeley Planning Commission and, if relevant, the City of Berkeley Landmarks Commission for comment prior to schematic design review by the UC Berkeley Design Review Committee.

2020 LRDP HOUSING ZONE

The housing objectives for the 2020 LRDP require that all new lower division undergraduate housing be located within a mile of the center of the Campus Park, defined as Doe Library, and all other student housing either within this radius or within one block of a transit line providing trips to Doe Library in under 20 minutes. In the 2020 LRDP, this Housing Zone is defined to exclude those areas with residential designations of under 40 units per acre in a municipal general plan as of July 2003.

The definition of the Housing Zone not only serves the objectives of improving student access to the intellectual and cultural life of the campus and minimizing vehicle trips, it also aligns with our goal to concentrate new housing development along transit routes. While future university housing projects must have adequate density to support reasonable rents, they should also be designed to respect and enhance the character and livability of the cities in which they are located. Therefore, to the extent feasible university housing projects in the Housing Zone should not have a greater number of stories nor have setback dimensions less than could be permitted for a project under the relevant city zoning ordinance as of July 2003.

Major capital projects would be reviewed at each stage of design by the UC Berkeley Design Review Committee, based on project specific design guidelines informed by the provisions of the relevant city general plan and other relevant city plans and policies. The university would make informational presentations of all major projects in the Housing Zone to the relevant city planning commission and landmarks commission for comment prior to schematic design review by the UC Berkeley Design Review Committee.

15 HILL CAMPUS FRAMEWORK

MAINTAIN THE HILL CAMPUS AS A NATURAL RESOURCE FOR RESEARCH, EDUCATION AND RECREATION, WITH FOCUSED DEVELOPMENT ON SUITABLE SITES.

The Hill Campus consists of roughly 1,000 acres extending east from Stadium Rimway to Grizzly Peak Boulevard. 200 of these acres are managed under the separate jurisdiction of Lawrence Berkeley National Laboratory, and are not within the scope of the UC Berkeley 2020 LRDP. Lawrence Berkeley National Laboratory operates under its own LRDP and EIR, approved separately by the UC Regents.

While the 800 acre balance managed by UC Berkeley contains several campus public and research facilities concentrated along Centennial Drive, including the Lawrence Hall of Science, the Botanical Garden, the Space Sciences Laboratory and the Mathematical Sciences Research Institute, the primary use of the Hill Campus is natural open space, including the 300 acre Ecological Study Area.

Roughly 85% of these 800 acres lie within the City of Oakland, while the westernmost 10% lie within the City of Berkeley, and the easternmost 5% within unincorporated Contra Costa County. The western third of the Hill Campus abuts low-density private residential areas to the north and south, while the eastern two-thirds of the site abuts the largely undeveloped lands of the East Bay Regional Park District and the East Bay Municipal Utility District.

From a base elevation of roughly 400 feet at its western edge, the Hill Campus rises to nearly 1800 feet at Chaparral Hill at its eastern edge. Slopes range from moderate to steep, but in general the terrain is rugged: few sites within the Hill Campus are suitable for development without extensive site alterations.

The most dramatic physical feature of the Hill Campus is Strawberry Canyon, a watershed of roughly one square mile drained by the south fork of Strawberry Creek. This water supply helped convince the trustees of the College of California to acquire the ranch lands along the creek in 1868 as the site for their new campus. At the time, the hills above the campus were a mix of grassland, oak savannah and open chaparral. It was not until speculators in the next decade planted eucalyptus, in a failed scheme to grow and harvest them for commercial use, that the hills began to acquire their present, largely forested look.

The Hill Campus landscape today is a mosaic of wet and dry north coastal scrub intermixed with stands of trees: oak-bay woodland and clusters of redwoods as well as pine and eucalyptus plantations. The pattern of vegetation has changed significantly from the original mix of grassland and oak savannah, due not only to the decline of grazing, but also to human introduction of eucalyptus and conifers as well as invasive perennials such as brooms and euphorbia, and to the fact the introduced species often out-compete natives.

LAND USE

While the Hill Campus is over four times the size of the Campus Park, its potential to accommodate new development is limited by several factors. First, the Hill Campus is a scenic and recreational resource for the entire East Bay, and is part of the continuous greenbelt of park and watershed land that extends the length of the East Bay Hills from Richmond to Hayward. A greenbelt of such size and integrity, in such close proximity to densely urbanized areas, is a unique feature of the region and contributes significantly to the quality of East Bay life.

FIGURE 10
HILL CAMPUS LAND USE

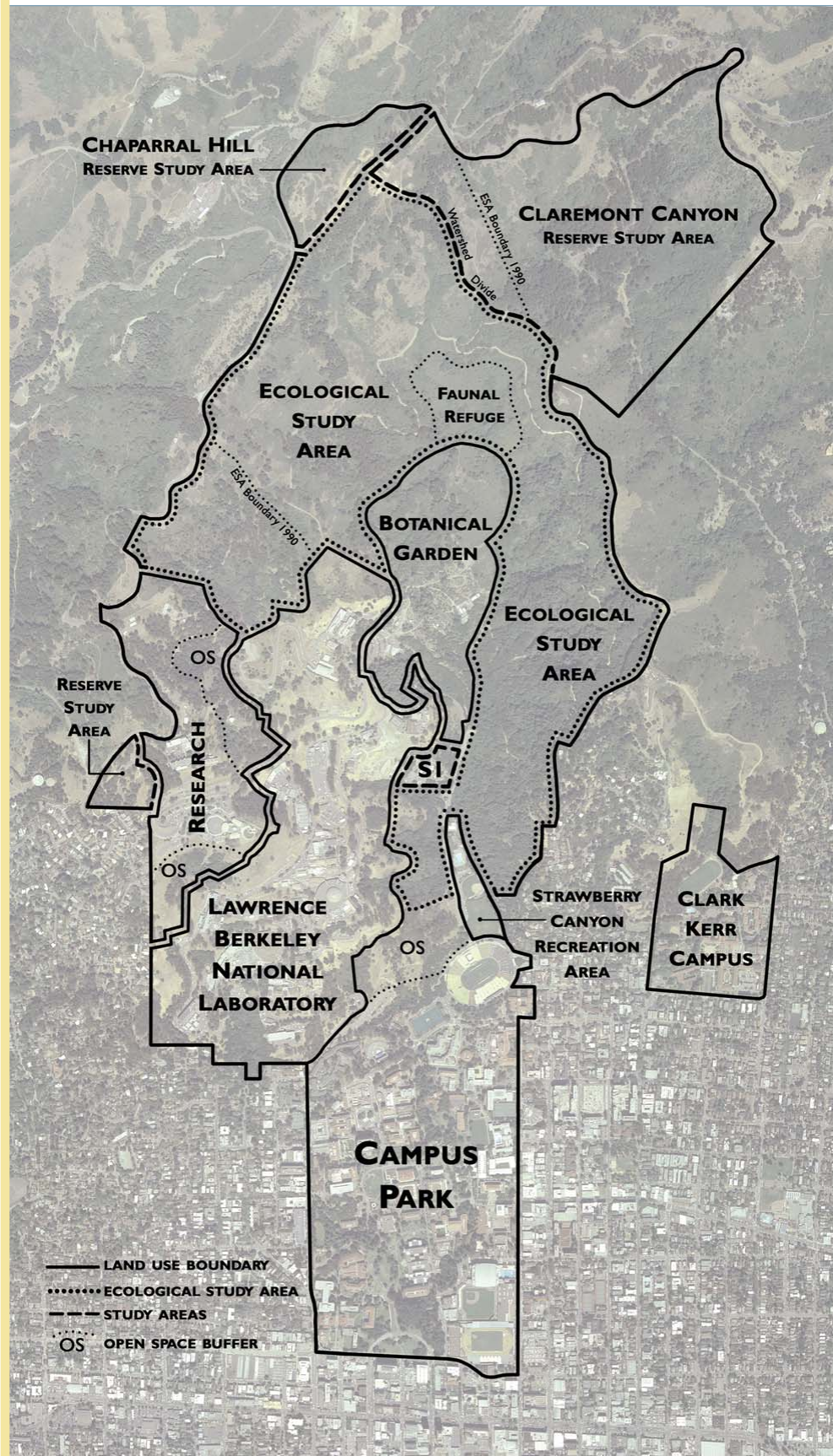

Second, the mix of scrub and conifer and eucalyptus stands makes the East Bay Hills, including the Hill Campus, a regular seasonal fire risk. This risk becomes particularly pronounced during the periodic one- or two-day shifts from the normal northwesterly winds to 'Diablo' winds blowing in from the warm, dry regions to the east. 20th century Diablo wind fires have burned over ten times the acreage of normal wind condition fires, and include the firestorms of 1923 and 1991. The steep terrain and poor access and infrastructure in the Hill Campus present enormous obstacles to fire response, and some areas such as Claremont Canyon may be indefensible in Diablo wind conditions.

Third, the steep terrain and the poor access and infrastructure also make development itself more disruptive and costly. Over 75% of the Hill Campus has a slope over 40%, and over 90% has a slope over 20%. Areas with slopes under 20% are scattered throughout the Hill Campus, often in locations not served by either roads or utilities. With few exceptions, substantial regrading would be required for new projects, and in many areas infrastructure extensions or upgrades would also be required. Lastly, the physical separation of the Hill Campus is itself a serious obstacle to productive working relationships with Campus Park units, due to time lost in travel and the absence of informal interaction.

In response to future space demand by academic and other campus programs, capital investment in the Hill Campus through 2020 may result in a net increase in program space of up to 100,000 GSF. As shown in figure 10, the 2020 LRDP divides the Hill Campus into six land use categories, described below, that reflect their environmental characteristics and their current and planned future use.

ECOLOGICAL STUDY AREA

The use of Strawberry and Claremont Canyons for instruction and research related to the natural environment, and their preservation in a primarily natural state, has been a longstanding policy of the campus. The mix of native and introduced trees established a wide variety of flora and fauna, making the Hill Campus a useful resource for field study, and led to the initial designation of a 'primitive area' in the 1930s.



CLAREMONT CANYON

The Hill Campus was recognized as an 'invaluable asset' to instruction and research by a faculty advisory committee, in their 1958 proposal that 'the guiding principle in the development of Strawberry Canyon and the Hill Campus should be ... maximum use consistent with conservation of native values.' This proposal led ultimately to the designation of a 300 acre Ecological Study Area (ESA) in 1968.

The 1990-2005 LRDP proposed three expansions of the ESA boundary, and also designated a faunal refuge area at the center of the ESA. The 2020 LRDP incorporates these expansions, as well as a further expansion to extend the ESA boundary west to the Field Station for Behavioral Research. The 2020 LRDP also adjusts the eastern boundary of the ESA to align with the watershed divide separating Claremont and Strawberry Canyons.

The purpose of the Ecological Study Area is to preserve the area for education and research. Yet the potential value of the ESA to academic programs is largely unrealized due to inadequate management. Because the campus has no formal mechanism for recording and tracking individual research projects in the hills, those projects are often neither informed of one another nor protected from public intrusion and damage. The trails within the ESA also represent a significant recreational resource to both campus and community, but there is no management entity to balance the needs of recreational users with those of researchers and instructors.

POLICY: ESTABLISH A MANAGEMENT AUTHORITY FOR THE ECOLOGICAL STUDY AREA.

The Ecological Study Area management authority would:

- maintain a registry of all instructional and research projects in the ESA,
- track external funding prospects for new research initiatives,
- implement strategies to improve coexistence of recreation, education, and research,
- implement strategies for protection from invasive plants, animals and humans, and
- collaborate with other campus service units to implement management practices that both reduce fire risk and help restore a mosaic of native vegetation.

BOTANICAL GARDEN

The oldest campus-operated Botanical Garden in the country was established in the Campus Park in 1891, and moved to its present location in 1926. The Garden is located on a 34 acre site, split into north and south sections by Centennial Drive. Strawberry Creek flows through the southern section and is incorporated into the Garden design. Ranging in elevation from 600 to 900 feet, the site provides a unique variety of micro-climates that accommodate over 13,000 plant species and varieties, organized by geographic origin.

Expansion of the Garden grounds to the east has been proposed in several previous campus plans, including the 1984 Task Force Report and the 1990-2005 LRDP, which recommends an expansion of roughly 40 acres. The 2020 LRDP incorporates this expansion, as shown in figure 10, which is consistent with the objective of the Botanical Garden to triple its student, faculty and public visitors by 2020. However, before this expansion occurs, the plans for both its improvement and long-term management must be clearly defined.

POLICY: ENSURE THE FUTURE MANAGEMENT OF, AND INVESTMENTS IN, THE ECOLOGICAL STUDY AREA AND THE BOTANICAL GARDEN ARE INTEGRATED AND SYNERGETIC.

The Botanical Garden requires a new master plan to replace the plan completed in 1981. The new master plan should not only describe the proposed site expansion, but also describe how its interface with the Ecological Study Area, and in particular the Faunal Refuge Area, should be designed and managed. A goal of the master plan, and of the management strategies for both resources, should be to improve the synergy of Botanical Garden and Ecological Study Area programs.

RESEARCH

The Hill Campus is home to several research facilities, including the Silver Space Sciences Laboratory, the Mathematical Sciences Research Institute, and the Field Station for Behavioral Research. The Hill Campus also includes the Lawrence Hall of Science, a museum and resource center for bay area schools and residents, which draws over 300,000 visitors a year. None of these facilities presently anticipates significant physical expansion within the timeframe of the 2020 LRDP. While LHS projects the number of visitors to double by 2020, it expects to accommodate this growth through internal renovation to increase the amount of usable space, not by expansion.

While the 2020 LRDP does include a modest amount of net new capacity in the Hill Campus to accommodate research and other program growth, this growth should be limited to future expansion of existing Hill Campus programs and other programs that may benefit from a setting removed from the busy urban environs of the campus.

In general, new research space at UC Berkeley should be concentrated at sites on and adjacent to the Campus Park, as prescribed in **Campus Land Use**.

RECREATION

The campus corporation yard was removed in 1959 to make way for the Strawberry Canyon Recreation Area, composed of the Haas Clubhouse, Stern Pool, tennis courts and a turf athletic field. The East Pool was subsequently completed in 1967. As proposed in the 1990-2005 LRDP, the tennis courts were removed and the parking lots reconfigured in 1993 to create the present Witter and Levine-Fricke Fields. Strawberry Canyon Recreation Area should remain in its present form, albeit with potential renovation and expansion, or replacement, of the buildings and pools.

The upper, east portion of the Hill Campus includes several heavily used trails that connect with trails in the adjacent East Bay Regional Park District lands. Many points within the Hill Campus offer magnificent views of the Bay and Golden Gate.

STUDY SITE

The upslope area of the former Poultry Husbandry site, shown as S1 in figure 10, is now used by the campus as a materials storage and vehicle parking site. This site was designated in the 1990-2005 LRDP as a reserve site for a future research facility. While the current use may remain as an interim use in the near term, a feasibility study should be conducted to identify a more suitable long term use for this site and a more suitable location for the current use.

RESERVE SITES

The 1990-2005 LRDP designated several 'reserves' for future study. The two largest such sites are Claremont Canyon and Chaparral Hill, and they are similar in several respects: they are remote from the Campus Park, they would require substantial infrastructure investment to support new development, and no clear demand for more intensive campus use of either site has emerged since the 1990-2005 LRDP.

The roughly 40 acre site at Chaparral Hill is defined by the ridgeline of Strawberry Canyon on the west and Grizzly Peak Boulevard on the east. Due to its relatively gentle slopes, it has been designated as a potential development site in numerous past campus studies. More intensive use of this site is severely constrained by the distance to campus: roughly 3.5 miles from Memorial Stadium.

The site lacks utility infrastructure, and protected natural open space surrounds the site: regional parklands on the north, east, and south, and the ESA on the west. Moreover, the south-facing slopes of the site represent a potential colonization habitat for the endangered Alameda Whipsnake. While some very limited future development of the north-facing slopes might be possible, it would be constrained by the need to preserve the integrity of the adjacent habitat.

The roughly 200 university owned acres in Claremont Canyon lie south of the ridge dividing the Claremont and Strawberry Creek watersheds, and is nearly as distant from campus: roughly 2.5 miles from Memorial Stadium. Unlike Chaparral Hill, most of Claremont Canyon consists of steep terrain, much of which is heavily forested.

The only feasible campus uses of Chaparral Hill or Claremont Canyon are those for which physical separation from the Campus Park is not a major disadvantage. Faculty housing is one potential use; a campus retreat center is another. However, as described in the **City Environs Framework**, other more promising near-term options exist for both faculty housing and conference venues, and these options must be fully explored before either reserve site is given serious consideration. Both Chaparral Hill and Claremont Canyon should retain their current designations as reserve sites, pending further study.

The Northwest Promontory, the undeveloped site located southwest of the intersection of Centennial and Grizzly Peak, is also retained as a reserve site, as it was in the 1990-2005 LRDP.

PROJECT DESIGN

While the Hill Campus contains a number of sites suitable for clustered development, future projects should be designed to respect its scenic and recreational value to both UC Berkeley and the larger East Bay community.

POLICY: MAINTAIN THE VISUAL PRIMACY OF THE NATURAL LANDSCAPE IN THE HILL CAMPUS.

New building projects should conform to the contours of the land, and grading should be minimized. Project landscaping should utilize native plant materials and reflect the rustic style of adjacent natural areas, and should incorporate the fire management provisions described below.

Buildings should be clustered to minimize site disturbance, and should utilize articulated volumes to reduce the perception of building mass. Exterior colors and materials should be selected to help the buildings blend into rather than contrast with the landscape. Flamboyant or decorative architectural treatments are strongly discouraged, as are those imitative of historical styles. Rather, architectural design should strive for a simple elegance of form, details and materials that respects and complements rather than competes with the natural setting.

Major capital projects in the Hill Campus would be reviewed at each stage of design by the UC Berkeley Design Review Committee. Project specific design guidelines based on the above principles should be prepared for each major project to guide the DRC reviews.

POLICY: MANAGE THE HILL CAMPUS LANDSCAPE TO REDUCE FIRE AND FLOOD RISK AND RESTORE NATIVE VEGETATION AND HYDROLOGY PATTERNS.

UC Berkeley maintains an ongoing program of fire fuel management in the Hill Campus to reduce fire risk to the campus, LBNL, neighboring residents, and recreational visitors to adjacent park and watershed lands. While the treatment used in a given area must be customized to address its specific conditions, including vegetation type, access, and proximity to roads and structures, in general the treatments are designed to meet one or more of the following goals:

- reducing fuel load by removing dead material, reducing plant density, and favoring species with lower fuel content,
- reducing horizontal spread by reducing fine fuel material and by separating dense clusters of vegetation with areas of lower fuel load, and
- reducing vertical fire spread by increasing separation of understory and crown fuels.

Whenever feasible, future fuel management practices should include the selective replacement of high-hazard introduced species with native species: for example, the restoration of native grassland and oak-bay woodland through the eradication of invasive exotics (broom, acacia, pampas grass) and the replacement of aged Monterey pines and second-growth eucalyptus. Such conversions must be planned with care, however, to avoid significant disruptive impacts to faunal habitats.

New building projects within the Hill Campus should be designed to minimize fire risk to neighbors as well as occupants, but this should be achieved as part of a larger, holistic design strategy. Some older areas of LBNL, for example, include extensive alteration of natural contours and large areas of built and paved surfaces. While this does reduce fire risk, it also increases runoff and degrades habitat and scenic value. Risk mitigation measures, such as low-fuel buffers and fire-resistive materials, should be incorporated into the design of Hill Campus projects in ways that respect the integrity, ecology, and visual quality of the natural landscape.



GRINNELL GLADE

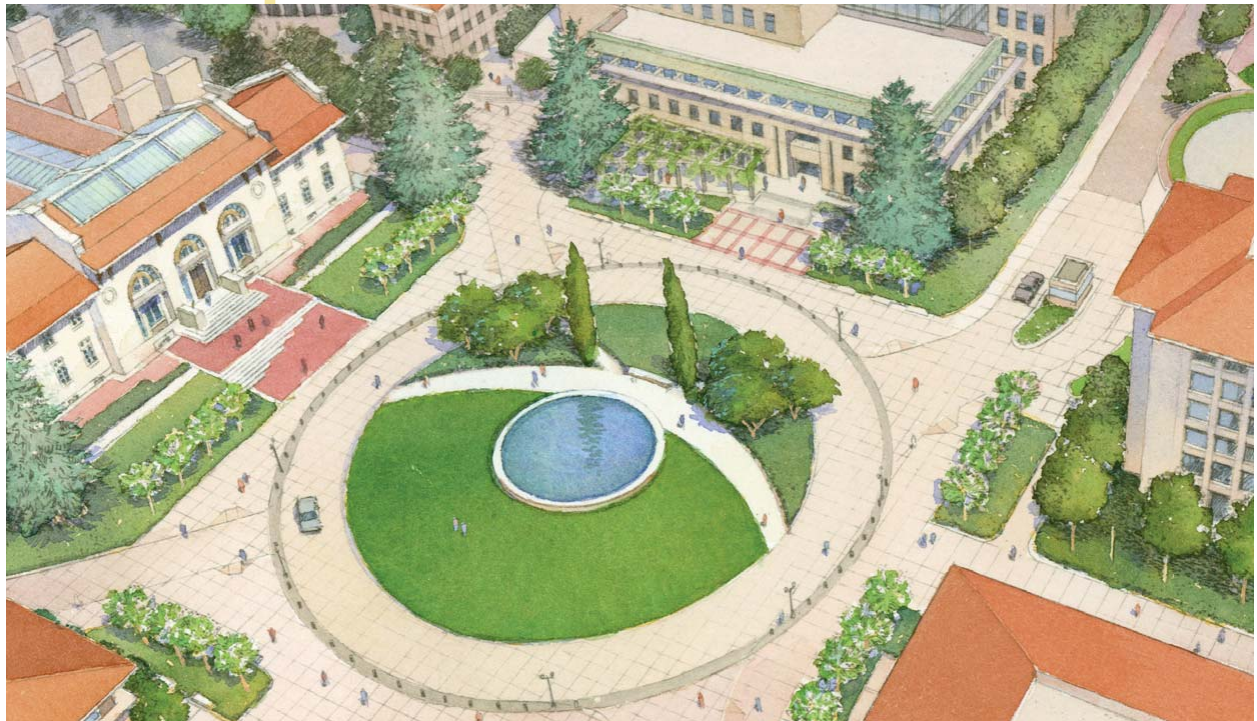

Concept: The Mining Circle returns as the crossroads of the northeast campus and a grand forecourt to the newly restored Hearst Memorial Mining Building.



HEARST MEMORIAL MINING BUILDING

PROJECT GUIDELINES

LOCATION GUIDELINES

CAMPUS PARK DESIGN GUIDELINES

CAMPUS PROJECT APPROVAL PROCESS

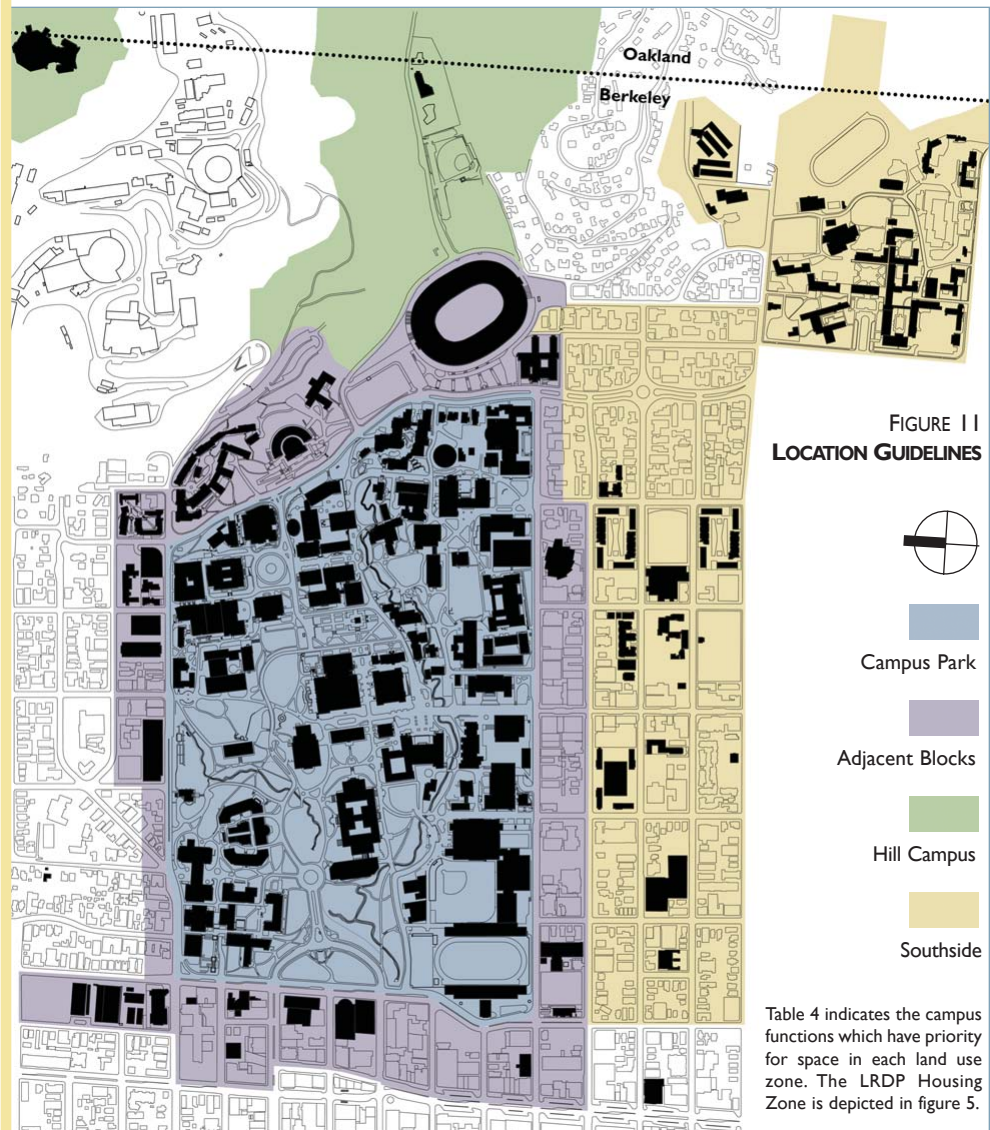

CLARK KERR CAMPUS

16 LOCATION GUIDELINES

Land at UC Berkeley is a scarce and finite resource, and it is neither feasible nor desirable to house every campus function on or adjacent to the Campus Park. In order to optimize the use of campus resources, future capital investment and space utilization at UC Berkeley shall be informed by the **Location Guidelines** shown below. For each new capital project, the policy reviews undertaken at phase 1 and phase 2 of the **Campus Project Approval Process**, described in section 18, shall include a finding that the project conforms to the Location Guidelines, or state why an exception is warranted.

TABLE 4 LOCATION PRIORITY BY LAND USE ZONE

	Location Priority
Academic Programs	
Instructional spaces	Campus Park
Faculty office, research and conference spaces	Campus Park
Academic Support	
Libraries and student workspaces	Campus Park
Academic administration	Campus Park
Museums and performance venues	Adjacent Blocks
Research Programs	
Research activities with substantial student engagement & participation	Campus Park
Research activities without substantial student engagement & participation	Adjacent Blocks or Hill Campus
Research activities incompatible with on- or near-campus locations due to scale, service requirements, or environmental impacts	Urban Eastbay
Institutional Support	
Chancellor and units requiring frequent direct interaction w/Chancellor	Campus Park
Critical on-site plant operations services	Campus Park
Visitor-intensive: frequent visitors from outside campus	Adjacent Blocks
Service-intensive: frequent visits to & from Campus Park units	Adjacent Blocks
Process-intensive: primarily document-based or computer-based functions with limited, infrequent face to face interactions	Urban Eastbay
Computer and telcom centers, industrial production, materials handling and storage, vehicle service and storage, plant operations administration	Urban Eastbay
Student Services	
Service-intensive: frequent face to face interactions	Campus Park
Process-intensive: primarily document-based or computer-based functions with limited, infrequent face to face interactions	Adjacent Blocks
Fitness, recreation, intercollegiate athletics	Campus Park Hill Campus Adjacent Blocks Southside
Public Programs	
University extension	Urban Eastbay
University Housing	
Student housing	Housing Zone
Faculty and staff housing	Housing Zone

Note: Urban Eastbay includes cities of Berkeley, Oakland, Emeryville, Albany, El Cerrito and Richmond



Concept: Campanile Way is refurbished with new paving and lighting, and the historic landscape is restored. Service vehicles are removed to a court on the South Hall Annex site, and Campanile Way is returned to the pedestrian.

17 CAMPUS PARK DESIGN GUIDELINES

This section includes general design and program guidelines for the Campus Park as a whole, as well as for certain place types in the Campus Park with particular design conditions. However, each major project also requires project-specific guidelines, to ensure the unique features of the site and environs are respected.

The provisions of the Guidelines are not meant to entirely preclude alternate design solutions. The best solution for a site should not be rejected just because we could not imagine it in advance. In practice, however, while the project designers may present a concept which departs from the Guidelines, they must also present a concept which conforms entirely to the Guidelines. As a rule, the campus should not depart from the Guidelines except for solutions of extraordinary quality.

DESIGN GUIDELINES

Campus design has always been diverse. John Galen Howard himself broke with the classical vocabulary of his first several campus buildings to design the gothic-inspired Stephens Union; and the classical buildings themselves were departures from the earlier Victorian styles of North and South Halls. However, while the design of each building should reflect its own time and place, it should also reflect the enduring values of elegance, quality and durability, and form a coherent and memorable identity for the campus as a whole. Moreover, there are several specific locations on campus where more prescriptive guidelines are required:

- New construction and renovation within the Classical Core should enhance the integrity of this ensemble, and complement rather than compete with existing historic buildings.
- New buildings facing Places of Interaction should be designed to shape these places, provide enclosure and security, and admit sunlight. Ground level spaces within these buildings should house uses that observe and activate the place.
- Buildings at the City Interface should be designed to create a graceful transition from campus to city, and to enhance the visual and experiential quality of the street.

GUIDELINE G.1 PRESERVATION AREAS

The preservation areas described below and in figure 12 protect the major elements of the campus landscape armature, as well as its most significant historic exterior spaces. No new buildings should intrude into the preservation areas.

NATURAL PRESERVES The natural landscape along the two forks of the creek requires careful ecological management, as well as protection from development and the impacts of adjacent development. The natural preserves are comprised of two subzones: the riparian areas along the streamcourse, and other rustic woodlands adjacent to these riparian areas.

- The riparian areas are dominated by native and naturalized plants forming dense woodlands along the streamcourse. Their width may vary in response to local conditions, but in general should be at least 100', centered on the streamcourse.
- The rustic campus woodlands have a strong complementary relationship to the creek, and may also have a strong visual identity in their own right, such as Eucalyptus Grove or Observatory Hill.

FIGURE 12
**COMPOSITE CAMPUS
 PARK DESIGN
 GUIDELINES**

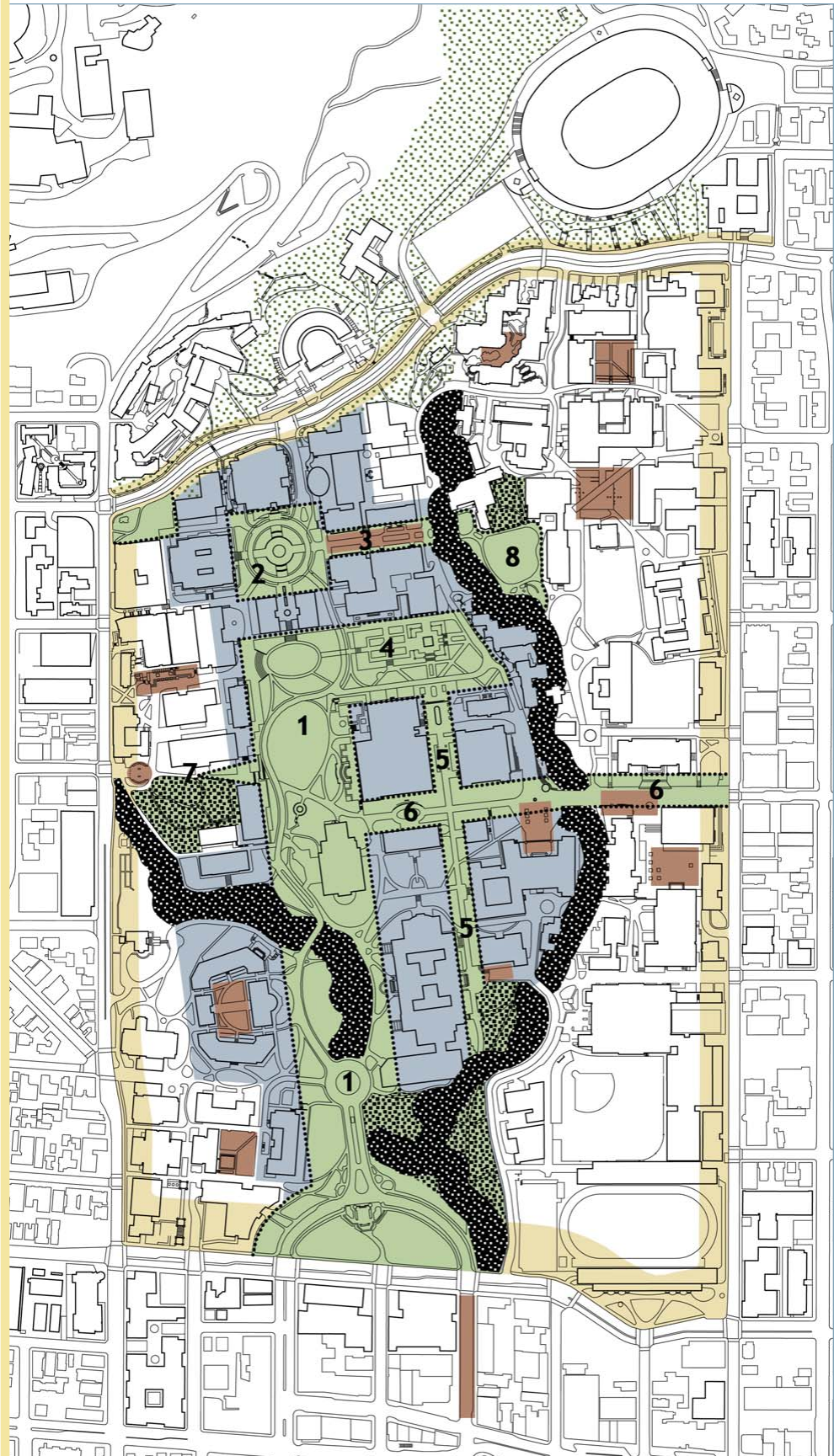
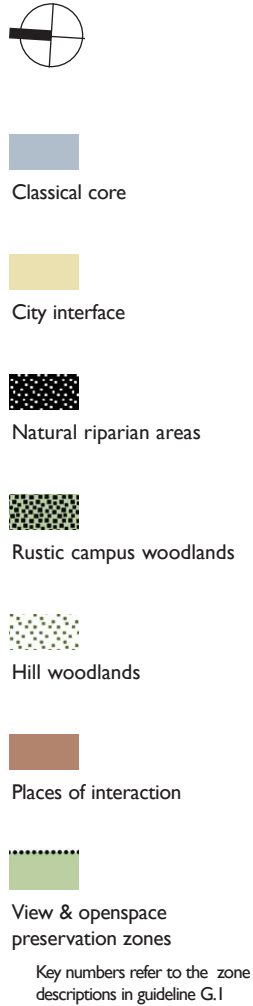

This figure includes the potential future projects shown in the illustrative concept in figure 3B. These potential projects represent only one scenario of how the 2020 LRDP program might be implemented on the Campus Park. However, the potential projects serve as an example of how the **Campus Park Framework** would help guide the location and configuration of future buildings in the Campus Park.

Management of the natural preserves should be based on ecological principles, including replacing invasive exotic plants with native plants suited to this biotic zone, replacing unhealthy plants and plants at the ends of their natural lives, and preserving and enhancing the habitat value of the zone.

HILL WOODLANDS While the woodlands east of Gayley Road are comprised primarily of introduced species, they provide a forested backdrop to the campus, and a graceful transition to the hills. Those woodlands that remain west of LBNL should be maintained as a preservation zone, to retain the unique rustic character they impart to the student residences, the Greek Theatre, and Gayley Road.

CENTRAL GLADES (1) The preservation zone for the Central Glades reflects the axial geometry of the classical ensemble of buildings that frame and define them. No building to the north or south should intrude within 180' of the east-west axis of the Glades: these setbacks coincide with the facades of Doe Library and McLaughlin Hall. The east edge of the preservation zone coincides with the east edge of Campanile Esplanade, below. At the west end of campus, the preservation zone widens to an arc 100' from the curbline of the West Crescent.

MINING CIRCLE (2) The preservation zone is defined as a square 360' by 360' centered on the Circle. In order to reinforce the formal character of the Mining Circle as an outdoor room framed and defined by buildings, at least 75% of any new building facade should lie on the setback line.

OPPENHEIMER WAY (3) The preservation zone is defined as 50' on either side of the north-south axis centered on the Mining Circle and extending to the creek zone. To reinforce the continuity of spatial enclosure, at least 75% of any new building facade should lie on the setback line.

CAMPANILE ESPLANADE (4) The preservation zone for Campanile Esplanade reflects the formal geometry defined by the north-south axis of Sather Tower, and is defined as 100' east and 200' west of this axis: these setbacks coincide with the facades of Birge Hall and Bancroft Library. To reinforce the continuity of spatial enclosure, at least 75% of any new building facade should lie on the setback line.

CAMPANILE WAY (5) The preservation setback is defined as 50' on either side of the east-west axis centered on Sather Tower and extending to the creek zone. To reinforce the continuity of spatial enclosure, at least 75% of any new building facade should lie on the setback line.

SPROUL PLAZA & SATHER ROAD (6) This 120' wide zone preserves the primary north-south route through campus as a gracious, generous space with unobstructed views of Sather Gate. The zone is defined by the facades of Doe Library, Wheeler and Sproul Halls on the east and King Union, Durant and California Halls on the west.

NORTH GATE (7) This zone is defined as a view cone originating at the entry plaza to McCone Hall, with the east and west sides aligned with the corners of the north facade of Doe Library.

FACULTY GLADE (8) The preservation zone for Faculty Glade is defined by the Strawberry Creek natural preserve to the north and west, Morrison Hall to the south, and Hertz Hall and Faculty Club to the east.

Setbacks prescribed in Guidelines G.1 and G.2 apply to all above-grade structures. Below-grade structures may extend into the setbacks, but only if they are invisible at the surface; provide soil depth adequate to support landscaping at grade; and do not compromise the integrity of sensitive landscapes. Any elements that project above grade, such as vents, entry pavilions, or skylights, should be sited outside the setback.

GUIDELINE G.2 CITY INTERFACE

Campus edges and entrances should create a positive first image of both the campus itself and its synergy with the city around it. New buildings at the city interface should be sited and designed to accommodate a more coherent and unifying landscape treatment.

HEARST & BANCROFT FRONTAGES Buildings should be set back at least 20' from the curbline to accommodate a formal, urban, but generous landscape treatment along both frontages. The Landscape Master Plan should define a palette of planting and paving materials and typical details for these setbacks.

OXFORD FRONTAGE The majority of the Oxford frontage is comprised of green open space: the Crescent, the Creek, and the proposed Edwards Green. In order to create a more coherent landscape treatment in the picturesque style along this frontage, new buildings along Oxford should be set back a minimum of 60' from the curbline.

GAYLEY & PIEDMONT FRONTAGES One of the most memorable aspects of the campus is its setting at the base of the East Bay hills, and Gayley Road should be reinforced as the 'seam' linking the campus with the hill landscape. Each building should be set back an average of 40' from the curbline to accommodate an informal landscape treatment along both sides of the roadway. While building edges should be articulated to vary the setback depth, no portion of a building should be closer than 20' to the curbline.

Individual sites at the city interface may have spatial relationships that require wider setbacks: for example, to align facades with neighboring buildings. These should be prescribed in the project-specific guidelines.

GUIDELINE G.3 BUILD-TO LINES

Guideline G.1 prescribes build-to lines for certain historic campus open spaces. While some variation is desirable to allow for entrances and facade articulation, at least 75% of the facade should lie on the build-to line.

GUIDELINE G.4 ORIENTATION & EXPOSURE

Each new building should be oriented and designed to take advantage of solar angles and wind direction to reduce energy consumption. The design should include consideration of shading options on south and west exposures to reduce heat gain in summer but admit natural light in winter. Shading options include landscape elements, such as deciduous trees, as well as architectural elements.

The design should also include consideration of facade treatments that respond to the characteristics of each exposure with respect to heat, light and ventilation. For example: more glass on the north and east exposures, less glass and greater thermal mass on the south and west, and vents and operable windows located and designed to optimize natural airflow.

CLASSICAL CORE Within the classical core the axial, orthogonal relationships of the historic ensemble should take precedence in determining building orientation.

GUIDELINE G.5 ACTIVE FRONTAGES

PLACES OF INTERACTION Ground level spaces in each building facing a place of interaction should house functions with a high frequency of human presence and public activity, such as lounges, libraries, cafes, display spaces, and walk-up services. The main building entrance should be located in the facade facing the place of interaction.

CITY INTERFACE In the city general plan, several sections of blocks adjacent to campus are designated 'commercial': ground level spaces in university buildings within those areas should include retail and/or storefront services. Other university buildings at the campus perimeter or on adjacent blocks should house functions with a high frequency of human presence and activity at ground level.

GUIDELINE G.6 ENTRANCES

Each new building should be sited and designed to create a plaza or terrace at the main entrance, to serve as a casual gathering place for its users. The plaza or terrace should be distinguished as a place by design treatment - paving, lighting, furnishings - and must provide direct access for persons with special mobility needs.

GUIDELINE G.7 SERVICES

All bulk trash containers and building equipment should be concealed within enclosures designed as integral elements of the architecture. Loading docks should be concealed and secured when not in use.

GUIDELINE G.8 HEIGHT

PLACES OF INTERACTION Buildings facing places of interaction should be scaled to admit sunlight to the place and impart a comfortable human scale. As shown in figure 15, buildings to the south and west of the place should be no greater than 65' in height within 75' of the build-to line. Beyond this distance, height may increase 1' for every 1.5' of distance from the build-to line.

Individual sites may present spatial relationships that require lower heights along the build-to line: for example, to align cornice lines in order to create a more formal sense of enclosure. These should be specified in the project-specific guidelines.

CITY INTERFACE Buildings at the campus edge should be designed to create a graceful transition in scale from campus to city. Along the Hearst and Bancroft frontages of the Campus Park, buildings should be no greater than 65' in height within 100' of the curblin. On sloping sites, parts of the building may be greater than 65' but not over 80' in height, but the average height within the 100' wide zone should be no greater than 65'.

Along the Oxford frontage, buildings should be no greater than 95' in height within 200' of the curblin. On sloping sites, parts of the building may be greater than 95' but not over 110' in height, but the average height within the 200' wide zone should be no greater than 95'.

Under guideline G.8, the height of buildings with flat roofs is defined as the vertical distance from grade to the top of the exterior wall plane, including parapet. For buildings with sloped, hip, or gable roofs, height is defined as the vertical distance from grade to the average of the height at the ridge and the height at the exterior wall. Nonhabitable elements of the building such as equipment, vents, and other similar elements may extend above these height limits, but should conform to the enclosure provisions of guideline G.10.

GUIDELINE G.9 COMPOSITION

Large buildings should be designed to reduce their perceived mass and impart a human scale to the campus. Each building with a horizontal dimension greater than 200' should incorporate changes in both facade plane and vertical height to reduce its perceived scale and bulk, as shown in figure 13.

Each building over 3 stories should have both an articulated base and an articulated top, as shown in figure 14. Flamboyant architectural gestures are discouraged: rather, the top should create a simple and graceful terminus for the building.

CLASSICAL CORE Each new building within the classical core should be composed of elements orthogonal in plan and composition, and sited to reinforce the axial relationships of the historic core buildings and the Central Glades.

GUIDELINE G.10 ROOF FORMS

Roof top equipment should be enclosed so the equipment itself is not visible, and the enclosure should be designed as an integral element of the building architecture. In new buildings, the design should include consideration of roof forms that accommodate passive and active solar energy devices and/or green roof structures as elements integral to the building architecture.

CLASSICAL CORE Each new building within the classical core should have a hip or gable roof, with a pitch similar to existing historic core buildings.

GUIDELINE G.11 FACADES

Each building should be a coherent architectural composition, and should employ a single, unifying vocabulary of forms, details and materials on all building facades. Facades should be composed primarily of solid planes with punched windows. While metal and glass wall systems may be employed as special architectural features, in general the pattern of solid and transparent elements should respect the structural grid.

CLASSICAL CORE Each new building within the classical core should be fenestrated exclusively with individual punched windows, having a greater vertical than horizontal dimension. Windows and doors should be inset at least 6" from the exterior wall surface. Windows may be large and paned, but should not span structural elements.

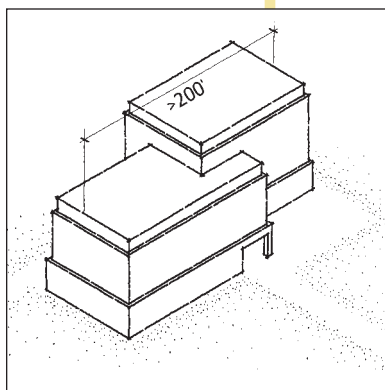

Fig 13 Variations in plane and height in long buildings.

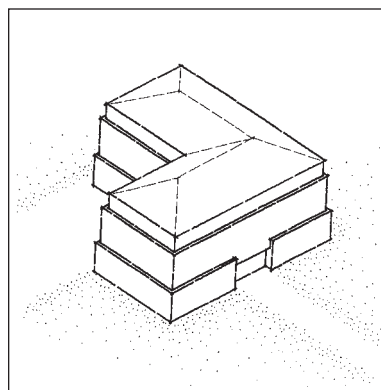

Fig 14 Articulated base and top. (Pitched roof form required only within the classical core.)

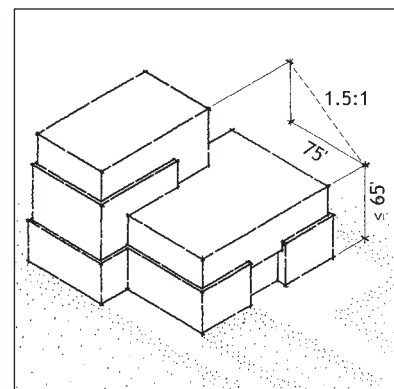

Fig 15 Heights of buildings facing places of interaction on the south and west.

GUIDELINE G.12 ARCHITECTURAL MATERIALS

Exterior materials should be selected to convey an image of quality and durability. Suitable primary exterior materials include granite, concrete and true plaster. Metal and glass wall systems may be used sparingly as special architectural features; however, dark, opaque or reflective glass is prohibited.

Visual interest should be created by the articulation of planes and volumes, not by arbitrary changes in materials. Changes in materials should occur only at the inside corners of changes in surface plane.

CLASSICAL CORE Each new building within the classical core should utilize the following materials palette:

- Roofs: unglazed red clay mission tile.
- Walls: light grey granite or architectural concrete, sand finish.
- Windows: clear or lightly tinted glass, copper or bronze frames.
- Skylights: copper or bronze frames.

GUIDELINE G.13 SITE & LANDSCAPE MATERIALS

The UC Berkeley Landscape Master Plan prescribes more detailed palettes of site and landscape materials for the campus.

PLANT MATERIALS Landscapes within the Natural Preserves should follow the provisions of guideline G.1 for plant selection. Elsewhere, plant materials should be selected to fit the desired structural form and function, while also contributing to a campuswide landscape which is both diverse and well suited to its site, climate, and intensive use.

In general, plants with similar water and maintenance needs should be grouped into zones to optimize both water use and maintenance. High maintenance zones should be limited to building entrances and other heavily used places.

SITE MATERIALS Presently nearly all routes on the central campus are surfaced with asphalt. While this material is suitable for vehicular roads and narrow, secondary pathways, major plazas and pedestrian routes deserve better: not only to improve their visual quality, but also to clarify the hierarchy of routes and the primacy of the pedestrian.

Suitable paving materials for major plazas and primary pedestrian routes include brick, cast and natural stone, and concrete. Paving materials, lighting and furnishings should be selected with care to ensure the identity and continuity of pedestrian routes are clearly discernable.

Paving materials should be selected for durability and safety, and should not pose slip or trip hazards. Paving should also be selected to maximize the amount of pervious surface: materials that allow water infiltration are encouraged, particularly for secondary paths and roads.

PROGRAM GUIDELINES

Campus buildings endure far longer than their initial contents, and should be designed to maximize their flexibility and adaptability. Although the future is unpredictable, a few basic conventions should be followed in the design of all new buildings to ensure these major investments have a long and productive life.

GUIDELINE G.14 GROUND FLOOR SPACES

Guideline G.5 prescribes specific programming for buildings facing Places of Interaction and at the City Interface. However, the program of every new building on campus should seek to optimize its contribution to the quality of campus life. The ground level spaces of each building should be reserved for its most public functions, and those spaces facing public areas should be as transparent as the program allows. Main entry lobbies should be designed as inviting places for waiting and engagement, with features commensurate with the scale and functions of the building.

GUIDELINE G.15 FLOOR HEIGHTS

Each new building in the Campus Park should have a floor-to-floor height of at least 15', in order to accommodate a wide range of instruction and research functions and the infrastructure they require. A greater height on the ground floor may be desirable to accommodate larger public and assembly spaces, such as libraries or lecture halls.

GUIDELINE G.16 FLOOR CONFIGURATION

Each new building should be configured to accommodate a broad range of functions. The need to provide for a specific program in the near term must be balanced against the rapid pace of cultural and technological change, and the long lives of campus buildings. In general, a building width of 75-80' can accommodate a variety of office, lab and classroom layouts.

GUIDELINE G.17 INTERNAL PARTITIONS

Each new building should be designed to consolidate fixed, immovable elements at the core and perimeter, and minimize or eliminate such elements elsewhere. Spaces should be demised with easily reconfigurable partitions.

GUIDELINE G.18 TOP FLOOR SPACES

In tall buildings, particularly those with a view to the west, at least some top floor space with views should be reserved for conference/event rooms available for use by the entire campus. This is an emerging campus tradition, begun in Barrows and continuing through Wurster, Tan and Haas, and should be encouraged as a way to foster intellectual collaboration.

18 CAMPUS PROJECT APPROVAL PROCESS

A strategic plan is only as effective as its means of implementation. The UC Berkeley campus has been the subject of many outstanding analyses over the years, yet decisions on individual projects have often been ad hoc: not because the campus lacks sound decisionmaking principles, but because there has been no clear linkage of those principles to a practical decision sequence.

UC Berkeley has already taken the first steps to change this paradigm, by forming the Executive Campus Planning Committee (ECPC) and by establishing a new, clear approval process for capital projects. This section describes how the policies and guidelines articulated in the 2020 LRDP shall be integrated into the campus approval process, to ensure investment decisions both optimize the use of resources and conform to the vision and policies in the 2020 LRDP.

Because UC Berkeley is a dynamic organization, the names of organizational units and the details of each task sequence in the process may evolve over time, but the overriding concept of a comprehensive, deliberative evaluation of each project at each stage of program and design would continue for the duration of the 2020 LRDP.

PHASE I: CONCEPT REVIEW (PROJECTS OVER \$1 MILLION)

- 1.1 Sponsor submits proposal with VC signature, including funding strategy
- 1.2 Facilities Services meets with Sponsor to explain process
- 1.3 Sponsor prepares abstract of proposal: objectives, justification, alternatives considered, and funding strategy; Facilities Services consults with sponsor on range of alternatives.
- 1.4 Facilities Services reviews abstract for adequacy of information
- 1.5 Facilities Services manages **Policy Review**
 - 1.5a Facilities Services reviews for conformance with 2020 LRDP
 - 1.5b University Relations and Budget & Finance confirm funding strategy
- 1.6 Facilities Services manages **Technical Review**: technical implications and preliminary budget projection
- 1.7 Facilities Services prepares **Concept Analysis** and action recommendation
- 1.8 VC Facilities Services reviews analysis, confirms recommendation
- 1.9 Facilities Services prepares draft ECPC item
- 1.10 Facilities Services reviews draft ECPC item with Sponsor
- 1.11 ECPC recommendation and Chancellor approval
(projects under \$5 million may be delegated to Vice Chancellors' Administrative Council)
- 1.12 Funds allocated to cover phases 2 and 3

PHASE 2: FEASIBILITY ANALYSIS (PROJECTS OVER \$1 MILLION)

- 2.1 Sponsoring VC appoints Preprogram Committee
- 2.2 Facilities Services prepares workplan for phase 2: scope, timeline, staff budget and, if required, consultant budget
- 2.3 If required: Facilities Services prepares scope of consultant services, identifies prospective consultants, obtains and reviews proposals, and recommends selection to Preprogram Committee
- 2.4 Facilities Services or Consultant develops preliminary space program and diagrams
- 2.5 Facilities Services identifies options: range of alternate solutions plus ‘no action’
- 2.6 Facilities Services manages **Policy Review**: conformance with 2020 LRDP
- 2.7 Facilities Services prepares **Options Analysis** and proposed solution
- 2.8 Facilities Services prepares project design guidelines and environmental initial study based on proposed solution
- 2.9 Facilities Services manages **Campus Review**
 - 2.9a University Relations and Community Relations
 - 2.9b Campus Design Review Committee
 - 2.9c Space Assignment & Capital Improvements Committee
 - 2.9d Committee on Academic Planning & Resource Allocation
- 2.10 Academic Effects Study completed prior to start of phase 3
- 2.11 VC Facilities Services confirms proposed solution
- 2.12 Facilities Services prepares draft ECPC item
- 2.13 Facilities Services reviews draft ECPC item with Sponsor
- 2.14 ECPC recommendation and Chancellor approval

PHASE 3: PROGRAM DEVELOPMENT (PROJECTS OVER \$1 MILLION)

- 3.1 EVC/Provost appoints Program Committee
- 3.2 Facilities Services prepares workplan for phase 3: scope, timeline, staff and consultant budget
- 3.3 Facilities Services selects architect for project
- 3.4 Architect and Program Committee prepare program and design concept: space program, conceptual site plan, conceptual floor plans, conceptual massing, proposed budget and schedule
- 3.5 Facilities Services manages **Project Review** of program and design concept
 - 3.5a Facilities Services reviews for conformance with design guidelines
 - 3.5b Facilities Services begins environmental review based on initial study, to be completed prior to start of phase 6
 - 3.5c Facilities Services prepares surge analysis
- 3.6 Facilities Services manages **Campus Review**
 - 3.6a University Relations and Community Relations
 - 3.6b Campus Design Review Committee
 - 3.6c Space Assignments & Capital Improvements Committee
 - 3.6d Committee on Academic Planning & Resource Allocation
- 3.7 University Relations and Community Relations prepare communications plan
- 3.8 Budget & Finance reviews project in relation to capital budget
- 3.9 VC Facilities Services confirms program and design concept, budget, schedule
- 3.10 Facilities Services prepares draft ECPC item
- 3.11 Facilities Services reviews draft ECPC item with Sponsor
- 3.12 ECPC recommendation and Chancellor approval
- 3.13 UCOP/Regents' approval of budget/capital improvement program amendment (*extent of UCOP/Regents' review depends on size of project budget*)
- 3.14 Funds allocated to cover phase 4

PHASE 4: SCHEMATIC DESIGN (PROJECTS OVER \$1 MILLION)

- 4.1 Architect completes schematic design
- 4.2 Facilities Services reviews for conformance with project design guidelines
- 4.3 Facilities Services manages **Campus Review**
 - 4.3a Design Review Committee
 - 4.3b Seismic Review Committee
 - 4.3c Committee on Removal of Architectural Barriers
 - 4.3d Program Committee (*if changes to scope/budget/schedule*)
 - 4.3e Space Assignments & Capital Improvements Committee (*if changes to scope/budget/schedule*)
- 4.4 Facilities Services presents schematic design to ECPC, plus any scope/budget/schedule changes
- 4.5 ECPC recommendation and Chancellor approval
- 4.6 UCOP/Regents' environmental and design approvals to be completed prior to start of phase 6 (*extent of UCOP/Regents' review depends on size of project budget*)
- 4.7 Sources for 85% of project funds must be identified before starting phase 5

PHASE 5: DESIGN DEVELOPMENT (PROJECTS OVER \$1 MILLION)**PHASE 6: WORKING DRAWINGS** (PROJECTS OVER \$1 MILLION)

- 5.1/6.1 Architect completes design development (phase 5) or working drawings (phase 6)
- 5.2/6.2 Facilities Services reviews for conformance with project design guidelines and schematic design
- 5.3/6.3 Facilities Services manages **Campus Review**
 - 5.3a/6.3a Design Review Committee (*if changes to exterior design*)
 - 5.3b/6.3b Seismic Review Committee (*if changes to structural design*)
 - 5.3c/6.3c Program Committee (*if changes to scope/budget/schedule*)
 - 5.3d/6.3d Space Assignments & Capital Improvements Committee (*if changes to scope/budget/schedule*)
- 5.4/6.4 ECPC review (*if changes to design or scope/budget/schedule*) and Chancellor approval
- 6.5 100% of funds must be in place before awarding construction contract

PHASE 7: BID AND CONSTRUCTION (PROJECTS OVER \$1 MILLION)

- 7.1 Budget augmentations require review and recommendation by Vice Chancellors' Administrative Council
- 7.2 Augmentation requests must identify source of additional funds
- 7.3 Chancellor approval

Projects \$1 - 5 million may be delegated to the Vice Chancellors' Administrative Council (VCAC) following Concept Review approval.

Projects Under \$1 million are reviewed by VCAC: they may proceed directly from Concept Review approval to a combined Program and Design phase, and then to Bid and Construction.



CLASS IN THE CENTRAL GLADES

ACKNOWLEDGEMENTS

2020 LRDP STEERING COMMITTEE

Vice Provost William Webster, Chair
 Vice Chancellor Edward Denton
 Professor Ronald Gronsky
 Professor Catherine Koshland
 Assistant Vice Chancellor Thomas Koster
 Vice Provost Christina Maslach
 Dean Mary Ann Mason
 Vice Chancellor Donald McQuade
 Vice Chancellor Horace Mitchell
 Professor Calvin Moore
 Associate Vice Chancellor Robert Price
 Student Representative Anthony Falcone
 Student Representative Andrew Katz
 Student Representative Brandon Simmons

2020 LRDP PROJECT TEAM

Assistant Vice Chancellor Thomas Lollini
 Principal Planner Kerry O'Banion
 Principal Planner Jennifer Lawrence
 Principal Analyst Janet Brewster

