

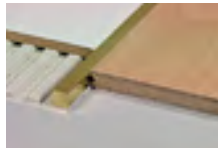

# COMPLEMENTARY PROFILES AND TRIMS

**FINISHES**

Page 1



**PROJOINT**  
Page 21



**CERFIX PRONIVEL M**  
Page 35

**INTRODUCTION**

Page 8



**PROJOINT T**  
Page 22



**PROLEVEL HIGH**  
Page 36-38

**HOW TO ORDER**

Page 11



**PROJOINT R**  
Page 24

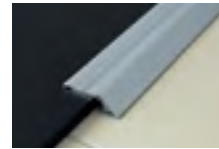

**PROLEVEL MEDIUM**  
Page 38-39

**FLOOR APPLICATIONS**  
PROFILES FOR FLOORS OF EQUAL HEIGHT



**PROJOINT M**  
Page 24



**PROLEVEL THIN**  
Page 39



**CERFIX PROANGLE**  
Page 16



**PROCLASSIC R**  
Page 25-27

**WALL APPLICATIONS**

**EXTERNAL CORNER PROFILES**



**CERFIX PROANGLE B**  
Page 17



**PROCLASSIC F**  
Page 28-29



**CERFIX PROANGLE Q**  
Page 42-49



**CERFIX PROANGLE FLEX**  
Page 18

**PROFILES FOR FLOORS OF DIFFERENT HEIGHTS**



**CERFIX PROANGLE**  
Page 50-54



**CERFIX PRODECOR DJ**  
Page 19



**CERFIX PRONIVEL N**  
Page 32



**CERFIX PROTRIM IP**  
Page 55



**CERFIX PRODECOR DJ FLEX**  
Page 19



**CERFIX PRONIVEL P**  
Page 33



**CERFIX PROTRIM**  
Page 56-64



**CERFIX PRODECOR**  
Page 19



**CERFIX PRONIVEL L**  
Page 34



**CERFIX PROTRIM N**  
Page 61

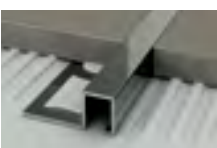

**CERFIX PROSTYLE**  
Page 20



**CERFIX PRONIVEL PB**  
Page 34

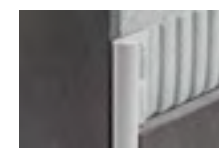

**CERFIX PROTRIM ECO**  
Page 65



**PROJOINT U**  
Page 21



**CERFIX PRONIVEL FLEX**  
Page 35



**CERFIX PROANGLE F**  
Page 66-67





**CERFIX PROANGLE  
AX - M DESIGN**  
Page 68

## SHOWER TILE TRIMS

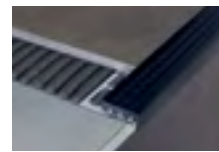

**CERFIX  
PROSTEP SP**  
Page 102



**CERFIX  
PRONIVEL M**  
Page 68

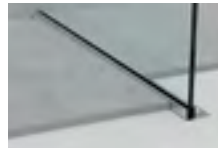

**GLASS  
PROFILE**  
Page 86-93



**CERFIX  
PROSTEP  
SA - SB**  
Page 103



**CERFIX  
PROCORNER M**  
Page 61-71



**SANIBORD**  
Page 94-95



**PROTECT**  
Page 103-111



**CERFIX  
PROCORNER P**  
Page 71

## STAIR APPLICATIONS STAIR-NOSING PROFILES



**PROSTEP  
FLEX**  
Page 105



**CERFIX  
PROCORNER  
PVC LINE**  
Page 72



**PROSTEP  
SGA - SGI - SGN - SGK**  
Page 98



**SAFETY-STEP**  
Page 112-113



**CERFIX  
PROBORD**  
Page 73-74



**PROSTEP  
SMA - SM**  
Page 98



**PROSTAIR**  
Page 114-115



**CERFIX PROTOP**  
Page 75



**PROTRIM IP**  
Page 99

## MOVEMENT JOINTS AND COVE-SHAPED PROFILES INTERNAL CORNER PROFILES

## LISTELLOS AND DECORATIVE PROFILES



**CERFIX  
PROSTEP  
SNG - SN**  
Page 99



**CERFIX  
PROROUND M**  
Page 118-120



**CERFIX  
PROLIST**  
Page 78



**CERFIX  
PROSTEP  
SAR - SIR**  
Page 100



**CERFIX  
PROROUND P**  
Page 121



**METAL LINE  
AF - M DESIGN**  
Page 79



**CERFIX  
PROSTEP SIS**  
Page 101



**CERFIX  
PROROUND M  
GIC/  
Page 122**



**CERFIX  
PROLIST-X DESIGN**  
Page 79

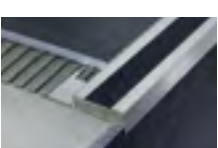

**CERFIX  
PROSTEP SIX**  
Page 101

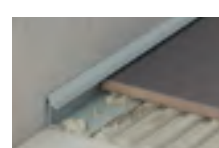

**CERFIX POINT  
PIN/ PIA/ AND PI/  
Page 122-123**



**CERFIX  
PRODECOR-C DESIGN**  
Page 80-81





































**CERFIX  
PROSTEP  
WOOD**  
Page 102



**PROROUND B**  
Page 124-125

**MOVEMENT JOINTS**

			<b>CERFIX PROJJOINT DIL NZS</b> Page 135		<b>PRESTOWOOD</b> Page 154-156
	<b>CERFIX PROJJOINT DIL NE</b> Page 128		<b>CERFIX PROJJOINT DIL PBE</b> Page 136		<b>RC</b> Page 157
	<b>CERFIX PROJJOINT DIL NJ</b> Page 128		<b>CERFIX PROJJOINT DIL PBH</b> Page 137		<b>TERMINAL RC FLEX</b> Page 157
	<b>CERFIX PROJJOINT DIL NL</b> Page 129		<b>CERFIX PROJJOINT DIL PAS</b> Page 137		<b>PROLEVEL HIGH</b> Page 157
	<b>CERFIX PROJJOINT DIL NF</b> Page 129		<b>CERFIX PROJJOINT DIL PHDE</b> Page 138		<b>ALFIX 616</b> Page 158
	<b>CERFIX PROJJOINT DIL NAN</b> Page 130		<b>CERFIX PROJJOINT DIL PFFE</b> Page 138		<b>ALFIX 46</b> Page 159
	<b>CERFIX PROJJOINT DIL NPAN</b> Page 130		<b>CERFIX PROCOVER FLEX</b> Page 139		<b>CERFIX PROJJOINT DIL</b> Page 160
	<b>CERFIX PROJJOINT DIL NIN</b> Page 131		<b>CERFIX PROCOVER FIX</b> Page 139		<b>CERFIX PRONIVEL PB</b> Page 160 - 161
	<b>CERFIX PROJJOINT DIL NIL</b> Page 131		<b>CERFIX PROCOVER</b> Page 140-141		<b>CERFIX PROJJOINT T</b> Page 161
	<b>CERFIX PROJJOINT DIL NTA - NTI - NTO</b> Page 132	<b>RESILIENT, WOOD, CARPET</b> PROFILES FOR RESILIENT FLOORS, WOOD, ENGINEERED WOOD, CARPET AND CARPET TILES			<b>PROSTEP</b> Page 162
	<b>CERFIX PROJJOINT DIL STA - STI</b> Page 133		<b>UNISYSTEM/ UNISYSTEM PLUS</b> Page 144 - 151		<b>PROTECT</b> Page 162
	<b>CERFIX PROJJOINT DIL NZA</b> Page 134		<b>PROFIX THIN</b> Page 152-153		<b>CERFIX PROTRIM</b> Page 163



**CERFIX  
PROANGLE**  
Page 163

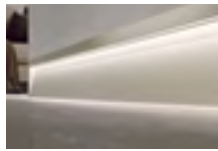

**PROLIGHT METAL  
LINE S SKL/2**  
Page 176



**METAL LINE  
89/613**  
Page 190



**CERFIX  
PROANGLE Q**  
Page 163



**PROLIGHT METAL  
LINE 87/88**  
Page 177



**METAL LINE 105**  
Page 191



**CERFIX  
PROROUND M**  
Page 164

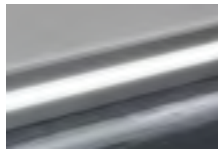

**PROLIGHT METAL  
LINE 89**  
Page 178



**METAL LINE  
87 - 88**  
Page 192



**CERFIX  
PROINT**  
Page 164



**ELECTRICAL  
COMPONENTS**  
Page 179-181



**PROLIGHT METAL  
LINE S SKL/2**  
Page 193

## LED PROFILES

### PROLIGHT



**PROLIGHT  
PROLIST  
LLA - LLB**  
Page 170



**PROLIGHT  
PROLIST  
TLA - CLA**  
Page 171

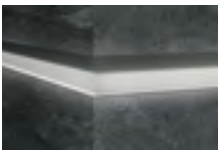

**PROLIGHT  
PROLIST  
Q LQL**  
Page 172



**PROLIGHT  
PROANGLE  
Q ZQAL**  
Page 173

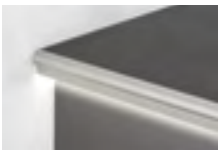

**PROLIGHT  
PROSTEP  
SGA/11L**  
Page 174



**PROLIGHT PROTECT  
G/9/F**  
Page 174



**PROLIGHT PROTECT  
126/L/F**  
Page 175

## SKIRTING BOARDS

### METAL SKIRTING BOARDS



**METAL LINE 90**  
Page 184-185



**METAL LINE 790**  
Page 186



**METAL LINE 92**  
Page 187



**METAL LINE 93**  
Page 187



**METAL LINE 89**  
Page 188



**METAL LINE 89  
I DESIGN**  
Page 189



**PROLIGHT  
METAL LINE 89**  
Page 190



**METAL LINE  
AF - M DESIGN**  
Page 193



**METAL LINE 100**  
Page 194

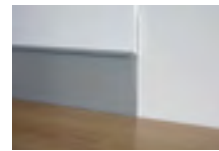

**METAL LINE 101**  
Page 194



**METAL LINE 95**  
Page 195



**METAL LINE 98**  
Page 196



**METAL LINE 97/4**  
Page 197



**METAL LINE 97/7**  
Page 198



**METAL LINE 97/8**  
Page 199

**PVC SKIRTING BOARDS**



**PVC LINE 8605**  
Page 202



**PVC LINE 8606**  
Page 202



**PVC LINE 8608**  
Page 203



**PVC LINE 8615**  
Page 204



**PVC LINE 8616**  
Page 204



**PVC LINE 8613**  
Page 205



**PVC LINE 8612**  
Page 206



**PVC LINE 8614**  
Page 206

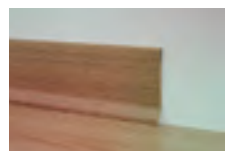

**PVC LINE 8600**  
Page 207



**PVC LINE 8181**  
Page 207

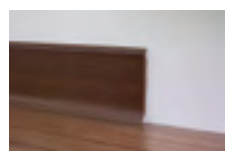

**PVC LINE 8596 - 8598**  
Page 208



**PVC LINE 8602**  
Page 209



**PVC LINE 8603**  
Page 210



**PVC LINE 8607**  
Page 211



**PVC LINE 148 - 172 - 173**  
Page 212



**PVC LINE 170 - 169 - 171**  
Page 213



**CERFIX PROTEC CPQV**  
Page 221



**CERFIX PROTEC CPEV - CPEI**  
Page 222-223



**CERFIX PROTEC CPHA - CPHV**  
Page 224



**CERFIX PROTEC CPLB - CPLV**  
Page 225

**DISPLAY RACK**

**EXTERIOR APPLICATIONS  
PROFILES FOR BALCONIES  
AND TERRACES**



**CERFIX PROTEC CPCV - CPCI**  
Page 216-217

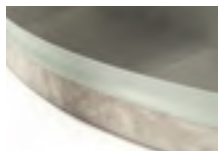

**CERFIX PROTEC CPCVF**  
Page 216-217



**CERFIX PROTEC CPCV/30/**  
Page 218



**CERFIX PROTEC CPNV**  
Page 219



**CERFIX PROTEC CPNVF**  
Page 219



**CERFIX PROTEC CPGV**  
Page 220



**DISPLAY RACK**  
Page 227

**MATERIALS AND CHARACTERISTICS**

**MATERIALS AND CHARACTERISTICS**  
Page 228-229



**STAINLESS STEEL**



**SS**  
Polished stainless steel AISI 304



**SS3**  
Polished stainless steel AISI 316



**SSO**  
Polished stainless steel AISI 430



**SSP**  
Superpolished stainless steel AISI 304



**SSS**  
Satin stainless steel AISI 304



**SSB**  
Sandblasted stainless steel AISI 304



**SSS**  
Satin stainless steel AISI 430

**BRASS**



**BN**  
Natural



**BP**  
Polished

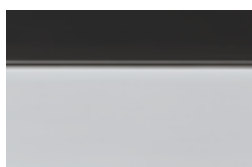

**BCP**  
Chromium-plated



**BCG**  
24-kt gold-plated

**ALUMINUM**



**AN**  
Natural

**ANODIZED ALUMINUM**

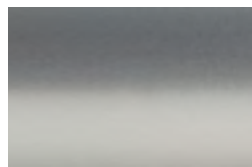

**AS**  
Silver



**AG**  
Gold



**ASG**  
Sand gold



**AT**  
Titanium



**AB**  
Bronze

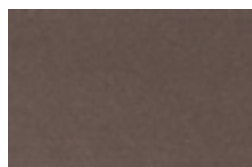

**ABE**  
Bronze elox

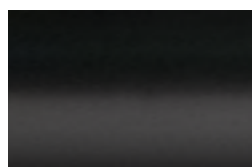

**ABL**  
Black



Platinum



Titanium



Brown



Dark brown



Carbon

**BRIGHT POLISHED ALUMINUM**



**ABPS**  
Silver



**ABPG**  
Gold



**ABPT**  
Titanium



**ABPC**  
Copper

**BRIGHT SATIN ALUMINUM**

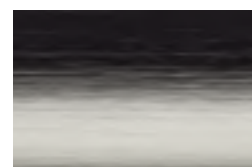

**ABSS**  
Silver



**ABSG**  
Gold



**ABST**  
Titanium



**ABSG**  
Copper

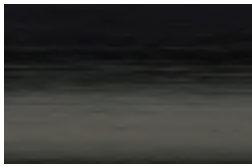

**ABSB**  
Black

**BRIGHT SCRATCHED ALUMINUM**

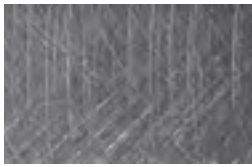

**ABBS**  
Silver

**COLOR-COATED ALUMINUM  
TREND COLOR STONE**



**AC**  
Ancient gray

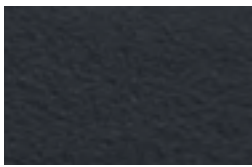

**AC**  
Anthracite gray



**AC**  
Beige



**AC**  
Black stone



**AC**  
Bronze



**AC**  
Dark brown

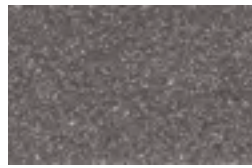

**AC**  
Gray



**AC**  
Greige



**AC**  
Rust



**AC**  
Sand



**AC**  
Stone

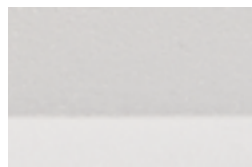

**AC**  
White stone

**COLOR-COATED ALUMINUM  
TREND COLOR CONCRETE**



**AC**  
Concrete graphite



**AC**  
Concrete mud



**AC**  
Concrete graphite



**AC**  
Concrete sand



**AC**  
Concrete smoke



**AC**  
Concrete white



**AC**  
Solid white

**COLOR-COATED ALUMINUM  
TREND COLOR METAL**



**AC**  
Metal dark



**AC**  
Metal light

**COLOR-COATED ALUMINUM**



**AC**  
Aluminum gray,  
RAL 9007



**AC**  
Ash gray,  
RAL 7038



**AC**  
Ash gray  
embossed,  
RAL 7038



**AC**  
Dark brown,  
RAL 8019



**AC**  
Matte white,  
RAL 9003



**AC**  
Matte white,  
RAL 9010



13



36



**AC**  
Metal gray,  
RAL 9006



14



37

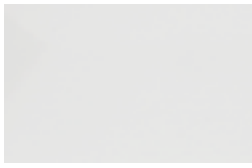

**AC**  
Polished white,  
RAL 9010



18



38



**AC**  
White,  
RAL 9003

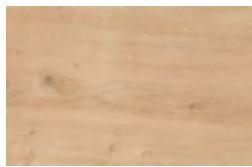

19



39

**DURABLE-FILM DECORS**



02



20



40



05



25



41

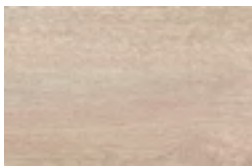

08



26



42



10



31



43



11



32



44



12



34



47



35

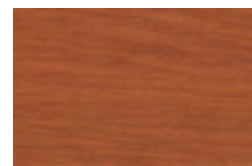

65



71

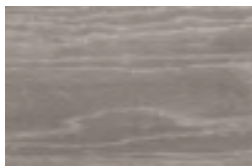

91



590



72



92



665



73



93

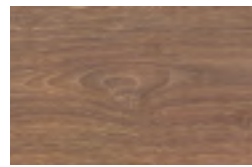

670



74



94

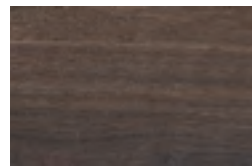

951

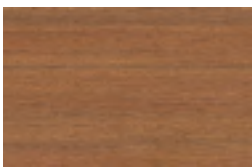

76

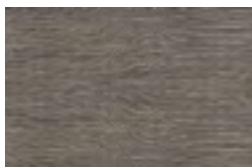

95

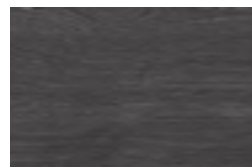

975



77



351



1003



78



363



1006



79



372



1009



80



490



1012



81



560



1021



89



580



1024





1030



1069



1202



1033



1081



1203



1036



1084



1204



1042



1090



1205



1045



1093



1206



1051



1096



1207



1054



1099



1208



1057

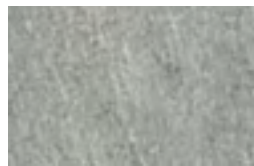

1102

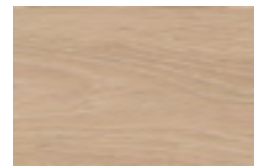

1209



1060

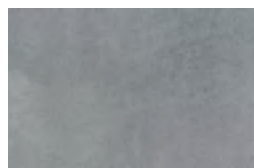

1105



1210



1063



1108



1211



1066



1111



1212



1213



1214



1215



1216



1217



96  
Embossed white,  
RAL 9010



97  
Embossed black,  
RAL 9005



99  
Satin silver

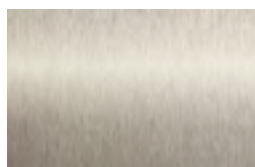

100  
Satin steel

**SOLID WOOD**



Natural oak

**PVC**

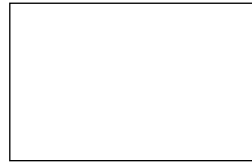

**CODE 400**  
Snow white



**CODE 402**  
White

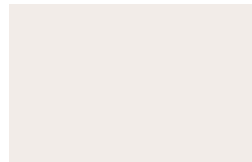

**CODE 404**  
Cream white,  
RAL 9001



**CODE 406**  
Ivory, RAL 1015



**CODE 408**  
Beige gray,  
RAL 1019



**CODE 410**  
Stone gray,  
RAL 7030



**CODE 412**  
Ash gray,  
RAL 7038



**CODE 414**  
Light gray,  
RAL 7035



**CODE 416**  
Anthracite



**CODE 418**  
Blue



**CODE 420**  
Pastel blue



**CODE 422**  
Light green



**CODE 424**  
Red,  
RAL 3002



**CODE 426**  
Black,  
RAL 9005



**CODE 428**  
Yellow,  
RAL 1023



**CODE 430**  
Pastel pink



**CODE 432**  
Beige bahama



**CODE 434**  
Peach



**CODE 436**  
Caramel



**CODE 438**  
Brown



**CODE 440**  
Dark brown



**CODE 442**  
Coral red



**CODE 444**  
Raw sienna



**CODE 446**  
Terracotta

**FOAM PVC**



**DECOR 518**

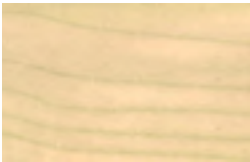

**DECOR 520**



**DECOR 524**



**DECOR 525**



**DECOR 528**



**DECOR 530**



**DECOR 531**



**DECOR 532**



**DECOR 533**



**DECOR 534**



**DECOR 536**

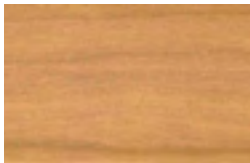

**DECOR 540**

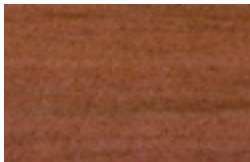

**DECOR 542**



**DECOR 544**

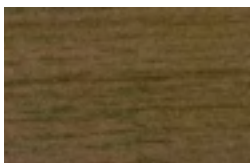

**DECOR 545**

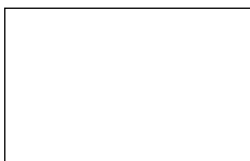

**DECOR 555**  
White

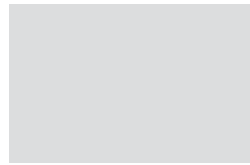

**DECOR 556**  
Light gray



**DECOR 557**  
Black



**DECOR 558**  
Anthracite



**DECOR 559**  
Gray



**DECOR 561**  
Yellow



**DECOR 562**  
Green



**DECOR 563**  
Light blue



**DECOR 564**  
Red



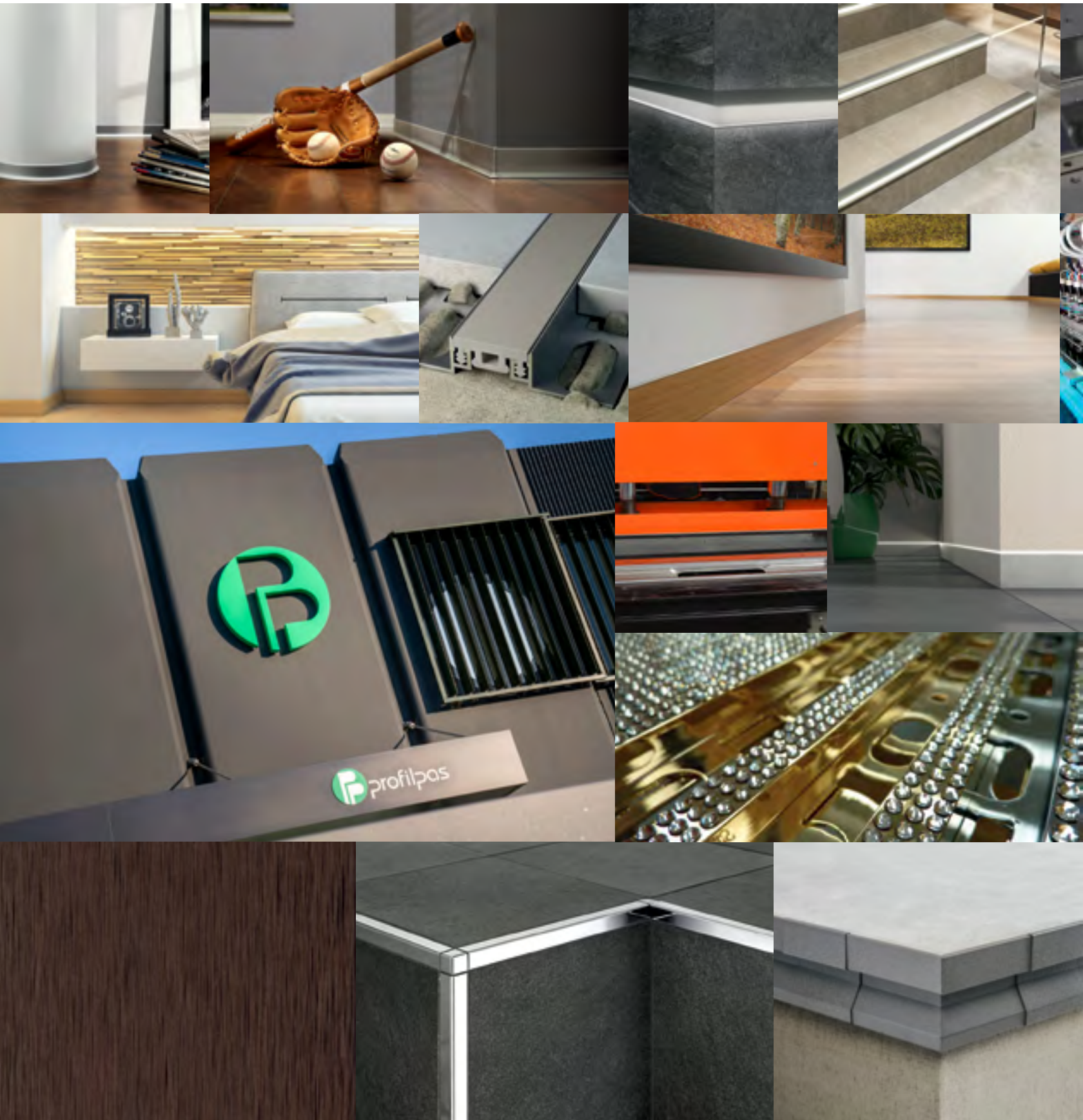





Since 1976, Profilpas has been an industry-leading producer of finishing and edge-protection profiles. With two manufacturing plants and eight subsidiaries, Profilpas has become one of the most well-known and trusted brands among building industry professionals looking for complementary flooring accessories and top-quality solutions. The variety and depth of Profilpas' product catalog range from profiles for wall and floor applications... to transition profiles, baseboards and expansion joints... to profiles for ceramic tiles... to trims for carpets and resilient floors, all designed for both residential and commercial applications. With more than 6,000 SKUs, Profilpas offers one of the most complete and extensive lines in the industry. Thanks to its September 2022 acquisition by MAPEI, one of the world's leading manufacturers of chemical products for the building industry, Profilpas is now part of a global company that has 102 subsidiaries operating in 57 countries and 90 manufacturing plants in 35 nations.



## 16 PRODUCT LINES OF NORTH AMERICA

1

Tile & Stone Installation Systems

2

UltraCare® Stone, Tile, Grout Care and Maintenance Solutions

3

Floor Covering Installation Systems

4

Products for Sports Flooring

5

Products for Wood Flooring

6

Profiles for Floors and Coverings

7

Skirting Boards

8

Raised Floors

9

Concrete Restoration Systems

10

Cementitious and Resin Flooring Systems

11

Products for Structural Strengthening

12

Waterproofing Systems

13

Products for Underground Construction (UTT)

14

Admixtures for Concrete

15

Cement Additives

16

Products for the Marine Industry\*

\*USA & Puerto Rico only

# SUSTAINABILITY

is built into everything we do

MAPEI's processes focus on sustaining the environment for today and tomorrow. We call it "The 3 P's of MAPEI: People, Planet and Products"



PEOPLE



PLANET

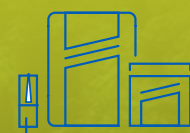

PRODUCTS

MAPEI's corporate vision, including our Code of Ethics, has always included the philosophy of sustainability.

Our operational processes are designed to reduce our carbon footprint and maximize our environmental "handprint."

With many sustainable attributes and certifications, our products can contribute to a variety of green building standards and certification programs.

For more information about our sustainability commitment, visit [www.mapei.com](http://www.mapei.com)

#HealthandtheEnvironment #MAPEIusa









## SUPERIOR PRODUCTS

### A Complete Range of Products

MAPEI produces the most innovative products for the construction market. More than 7,000 products globally (adhesives, sealants, mortars, admixtures, latex, etc.) are manufactured in MAPEI's plants, which produce the world's most complete range of building products. Diversified, high-quality chemical products – from powdered adhesives, to liquid and paste products, to polymers – are created to meet the needs of more than 70,000 customers around the world.

### Quality Control

MAPEI is an ISO 9001-2000 certified company. Its products are produced according to exacting standards, strictly adhering to process and procedural guidelines with documented compliance. This rigid production format is vigilantly followed to ensure that every product is produced uniformly from batch to batch.



## PROFESSIONAL SUPPORT NETWORK

### Knowledgeable Sales Force

MAPEI offers the largest, most highly trained sales force within the industry to serve your needs for product application/installation recommendations. Its sales representatives are focused on supporting you with product knowledge, product demonstrations, product information, marketing support materials and other relevant tools to help you generate sales.

### Technical Expertise

An in-house Technical Services Call Center responds to customers' telephone inquiries with answers to installation challenges in real time. In addition, MAPEI can offer field support for job startups, product training and on-site problem resolution.



### Customer Service Plus

MAPEI's standards for customer service are best-in-class. Our leadership includes such service innovations as:

- Customer-friendly, efficient processes
- One-call resolution
- Employee commitment to effective customer dialog





Profilpas  
Profiles and Trims



### Innovative Research & Development

We have always been highly committed to this sector. Our research scientists work within a global network comprising 32 centers, with our Corporate Research Centre in Milan acting as a hub to coordinate the activities of all the other centers and as a central analysis laboratory. The United States has four centers, and Canada has one. All equipped with cutting-edge equipment, the centers collaborate continuously with universities as well as scientific and industrial research institutes.

The research and development laboratories also provide support for our Technical Services Division to help provide solutions for even the most complex requests from our clients. Working alongside these centers are our quality-control laboratories, which are present in all the MAPEI Group's production facilities.

### Best-Backed<sup>SM</sup> Warranty Program

To bring it all together, MAPEI complements the industry's best products with simple, easy-to-understand requirements for a variety of warranty options.







## Profiles for Floors of Equal Height

This line of profiles allows the combination of different materials with elegance and simplicity, extending the boundaries of creativity in design.

# Cerfix™ Proangle™

Proangle profiles are for finishing, protecting and decorating floors of same level in ceramic, marble, granite, wood and other materials. These profiles are also ideal as separation and decoration joints between floors made of different materials, as finishing and protection element for the edges of steps, platforms and worktops, and as perimeter profiles for the shaping of doormats. Proangle B in natural aluminum is particularly suitable for materials that require deep polishing, such as marble, resin and wood surfaces.



Al/10 stainless steel AISI 304

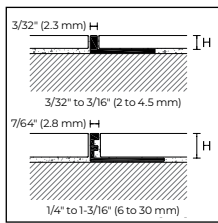

ZG/  
ZA/  
ZN/  
ZK/

PPDesign

### CERFIX PROANGLE

Length = 8'10" or 270 cm  
20-piece package

Item	Finish		H				
			3/32" (2 mm)	7/64" (2.5 mm)	1/8" (3 mm)	3/16" (4.5 mm)	1/4" (6 mm)
<b>ALUMINUM</b>							
ZG/	Natural aluminum		90207	90206	90208	90210	88159
	<b>\$/pc</b>						
ZA/	Silver anodized		90336	90337	90338	90340	88204
	<b>\$/pc</b>						
<b>BRASS</b>							
ZN/	Natural brass		-	-	90078	90080	88024
	<b>\$/pc</b>						
ZK/	Chromium-plated		-	-	-	90081	88114
	<b>\$/pc</b>						

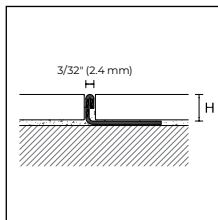

Al/  
AIS/  
AIX/

### CERFIX PROANGLE

Length = 8'10" or 270 cm  
20-piece package

Item	Finish		H			
			1/8" (3 mm)	3/16" (4.5 mm)	1/4" (6 mm)	5/16" (8 mm)
<b>STAINLESS STEEL</b>						
Al/	Stainless steel AISI 304		91636	91638	91642	91644
	<b>\$/pc</b>					
AIS/	Satin stainless steel AISI 304		-	91671	91673	91674
	<b>\$/pc</b>					
AIX/	Stainless steel AISI 316		-	-	91684	91685
	<b>\$/pc</b>					

Profiles PROANGLE sandblasted stainless steel finish see page 52.

To place orders correctly, find the desired model, size and finish. Then place your order by using the letters "PPS" followed by the corresponding 5-digit code.

Items AIX/ in other heights, on demand for minimum 200 pieces for each height



ZG/10 natural aluminum

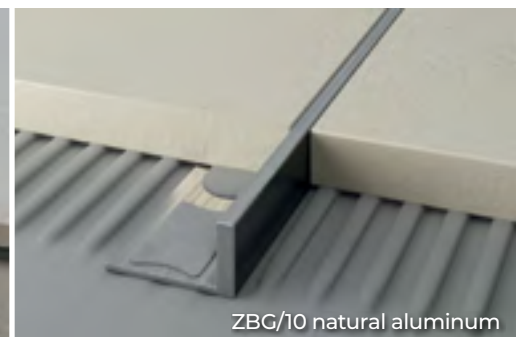

ZBG/10 natural aluminum





ZN/10 natural brass

ZK/10 chromium-plated brass

H												
5/16" (8 mm)	11/32" (9 mm)	3/8" (10 mm)	7/16" (11 mm)	1/2" (12.5 mm)	17/32" (14 mm)	9/16" (15 mm)	11/16" (17.5 mm)	3/4" (20 mm)	7/8" (22.5 mm)	1" (25 mm)	1-1/16" (27.5 mm)	1-3/16" (30 mm)
88160	88155	88161	88156	88162	88157	88163	88164	88165	88166	88167	-	-
88205	88217	88206	88218	88207	-	88208	88209	88210	88211	88212	-	-
88025	-	88026	88038	88027	-	88028	88029	88030	88031	-	-	-
88115	-	88116	88118	88117	-	-	-	-	-	-	-	-

H												
11/32" (9 mm)	3/8" (10 mm)	7/16" (11 mm)	1/2" (12.5 mm)	17/32" (14 mm)	9/16" (15 mm)	11/16" (17.5 mm)	3/4" (20 mm)	7/8" (22.5 mm)	1" (25 mm)	1-1/16" (27.5 mm)	1-3/16" (30 mm)	
91645	91646	91647	91648	91649	91650	91652	91654	91656	91658	91660	91662	
-	91675	91677	91676	-	91678	-	91679	-	-	-	-	
-	91686	91688	91687	-	-	-	-	-	-	-	-	

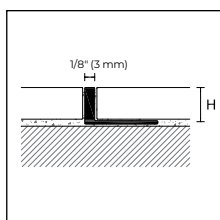

ZBG/



**CERFIX PROANGLE B**

Length = 8'10" or 270 cm  
20-piece package

		H					
Item	Finish	5/16" (8 mm)	3/8" (10 mm)	1/2" (12.5 mm)	9/16" (15 mm)	3/4" (20 mm)	7/8" (22.5 mm)
<b>ALUMINUM</b>							
ZBG/	Natural aluminum	90010	90012	90014	90016	90018	90020
	\$/pc						

Individually packaged

To place orders correctly, find the desired model, size and finish. Then place your order by using the letters "PPS" followed by the corresponding 5-digit code.

# Cerfix™ Proangle™ Flex

Proangle is also available in the Flex version, specially suited for those situations where there is the need to curve the profile. Proangle Flex can be curved by hand or with the Proflex Machine tool.



AIF/10 stainless steel AISI 304



PRO FLEX LINE

## CERFIX PROANGLE FLEX

Length = 8'10" or 270 cm  
20-piece package

Item	Finish	H						
		1/8" (3 mm)	3/16" (4.5 mm)	1/4" (6 mm)	5/16" (8 mm)	3/8" (10 mm)	1/2" (12.5 mm)	9/16" (15 mm)
<b>ALUMINUM</b>								
ZGF/	Natural aluminum	88720	88721	88722	88723	88724	88725	88726
	\$/pc							
<b>BRASS</b>								
ZNF/	Natural brass	88701	-	88703	88704	88705	88706	-
	\$/pc							
Length = 8'10" or 270 cm 10-piece package								
<b>STAINLESS STEEL</b>								
AIF/	Stainless steel AISI 304	-	-	91622	91623	91624	91625	-
	\$/pc							

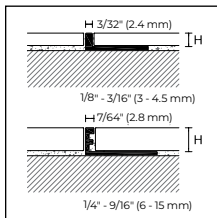

ZGF/  
ZNF/

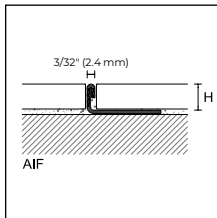

AIF/

PRO FLEX LINE

## CERFIX PROANGLE FLEX

Length = 8'10" or 270 cm  
20-piece package

Item	Finish	H					
		5/16" (8 mm)	3/8" (10 mm)	1/2" (12.5 mm)	9/16" (15 mm)	3/4" (20 mm)	7/8" (22.5 mm)
<b>ALUMINUM</b>							
ZBGF/	Natural aluminum	90011	90013	90015	90017	90019	90021
	\$/pc						

Individually packaged

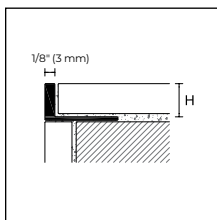

ZBGF/

To place orders correctly, find the desired model, size and finish. Then place your order by using the letters "PPS" followed by the corresponding 5-digit code.

# Cerfix™ Prodecor™

Prodecor and Prodecor DJ profiles are for finishing and protecting floors of same level in ceramic, marble, granite, wood and other materials. These profiles are also ideal as separation and decoration joints between floors made of different materials, as perimeter profiles for the shaping of doormats or as protection and finishing of platforms and ceramic steps. The visible thickness makes for an elegant separation element perfectly integrated into the floor.

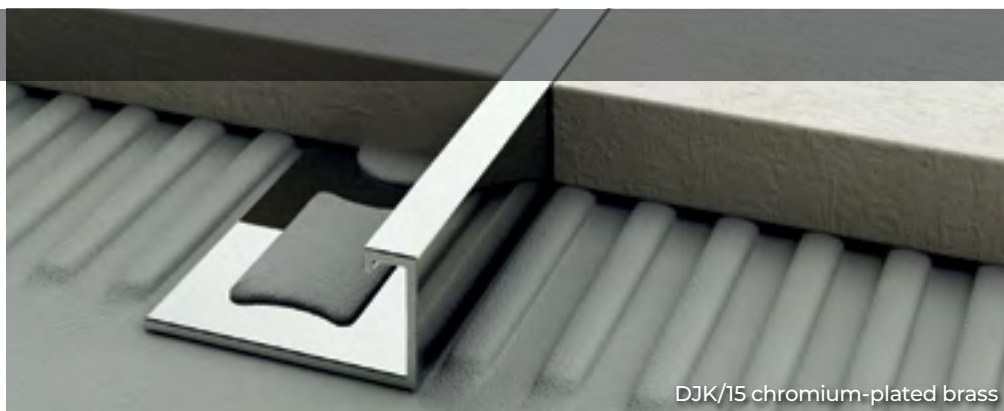

DJK/15 chromium-plated brass

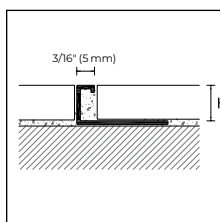

DJG/  
DJA/  
DJN/  
DJK/

PPDESIGN

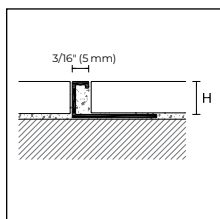
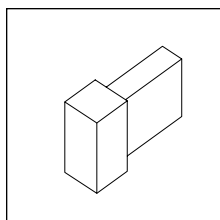

DJAF/  
DJNF/



PRO FLEX LINE

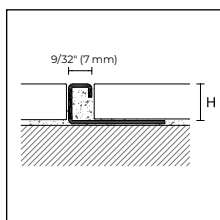

DI/



## CERFIX PRODECOR DJ

Length = 8'10" or 270 cm  
20-piece package

Item	Finish		H				
			5/16" (8 mm)	3/8" (10 mm)	1/2" (12.5 mm)	9/16" (15 mm)	3/4" (20 mm)
<b>ALUMINUM</b>							
DJG/	Natural aluminum		95670	95672	95674	-	-
	<b>\$/pc</b>						
DJA/	Silver anodized		95680	95682	95684	-	-
	<b>\$/pc</b>						
<b>BRASS</b>							
DJN/	Natural brass		95690	95692	95694	95691	95693
	<b>\$/pc</b>						
<b>CHROMIUM-PLATED BRASS</b>							
DJK/	Chromium-plated		95700	95702	95704	95703	95705
	<b>\$/pc</b>						

Individually packaged. Items DJN/20 and DJK/20 come in 10-piece packages

## OUTSIDE AND INSIDE CORNERS

5-piece packages

Item	Finish		H				
			5/16" (8 mm)	3/8" (10 mm)	1/2" (12.5 mm)	9/16" (15 mm)	3/4" (20 mm)
<b>ALUMINUM</b>							
DJG/ /EI	Natural aluminum		95676	95677	95678	-	-
	<b>\$/d</b>						
DJA/ /EI	Silver anodized		95686	95687	95688	-	-
	<b>\$/pc</b>						
<b>BRASS</b>							
DJN/ /EI	Natural brass		95696	95697	95698	95715	95716
	<b>\$/pc</b>						
<b>CHROMIUM-PLATED BRASS</b>							
DJK/ /EI	Chromium-plated		95706	95707	95708	95709	95710
	<b>\$/pc</b>						

No partial packaging

## CERFIX PRODECOR DJ FLEX

Length = 8'10" or 270 cm  
10-piece package

Item	Finish		H				
			5/16" (8 mm)	3/8" (10 mm)	1/2" (12.5 mm)	9/16" (15 mm)	3/4" (20 mm)
<b>ALUMINUM</b>							
DJAF/	Silver anodized		-	95685	95689	-	-
	<b>\$/pc</b>						
<b>BRASS</b>							
DJNF/	Natural brass		-	95695	95699	-	-
	<b>\$/pc</b>						

Individually packaged

## CERFIX PRODECOR

Length = 8'10" or 270 cm  
20-piece package

Item	Finish		H				
			5/16" (8 mm)	3/8" (10 mm)	1/2" (12.5 mm)	9/16" (15 mm)	3/4" (20 mm)
<b>STAINLESS STEEL</b>							
DI/	Polished stainless steel AISI 304		95906	95908	95910	95911	95907
	<b>\$/pc</b>						

Item DI/20 comes in a 10-piece package

To place orders correctly, find the desired model, size and finish. Then place your order by using the letters "PPS" followed by the corresponding 5-digit code.

# Cerfix™ Prostyle

Prostyle multipurpose profiles are for the finishing and decoration of same-level floors of ceramic, marble, granite and other types of materials. They are also ideal as separation and decoration joint between floors of different materials and, in the stainless-steel version, suitable for the protection of ceramic steps and for surfaces that are subject to heavy and frequent loads.

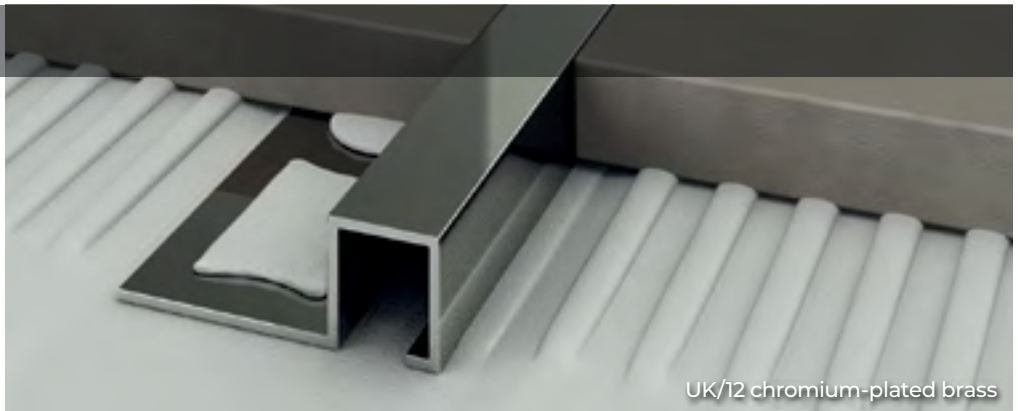

UK/12 chromium-plated brass

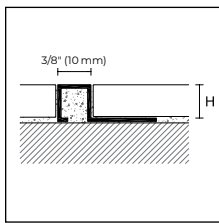

UG/  
UA/  
UN/  
UK/

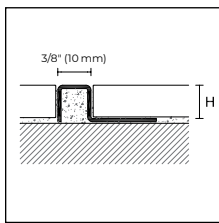

UI/  
UIS/

PPDESIGN

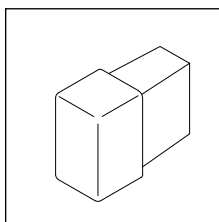

## CERFIX PROSTYLE

Length = 8'10" or 270 cm  
20-piece package

Item	Finish	H						
		5/16" (8 mm)	3/8" (10 mm)	7/16" (11 mm)	1/2" (12.5 mm)	9/16" (15 mm)	3/4" (20 mm)	
<b>ALUMINUM</b>								
UG/	Natural aluminum		93368	93370	-	93372	93377	-
	<b>\$/pc</b>							
UA/	Silver anodized		93378	93380	-	93382	93387	-
	<b>\$/pc</b>							

Length = 8'10" or 270 cm  
10-piece package

<b>STAINLESS STEEL</b>								
UI/	Polished stainless steel AISI 304		93400	93401	-	93402	93403	93404
	<b>\$/pc</b>							
UIS/	Satin stainless steel AISI 304		93348	93350	-	93352	93360	93361
	<b>\$/pc</b>							
<b>BRASS</b>								
UN/	Natural brass		93300	93302	93311	93304	93306	93308
	<b>\$/pc</b>							
UK/	Chromium-plated		93325	93327	93312	93329	93338	93340
	<b>\$/pc</b>							

Individually packaged

## OUTSIDE AND INSIDE CORNERS

5-piece package

Item	Finish	H						
		5/16" (8 mm)	3/8" (10 mm)	7/16" (11 mm)	1/2" (12.5 mm)	9/16" (15 mm)	3/4" (20 mm)	
<b>ALUMINUM</b>								
UG//EI	Natural aluminum		93373	93374	-	93375	93376	-
	<b>\$/pc</b>							
UA//EI	Silver anodized		93383	93384	-	93385	93386	-
	<b>\$/pc</b>							
<b>STAINLESS STEEL</b>								
UI//EI	Polished stainless steel AISI 304		93405	93406	-	93407	93408	93409
	<b>\$/pc</b>							
UIS//EI	Satin stainless steel AISI 304		93353	93354	-	93355	93356	93357
	<b>\$/pc</b>							
<b>BRASS</b>								
UN//EI	Natural brass		93301	93303	93341	93305	93307	93309
	<b>\$/pc</b>							
UK//EI	Chromium-plated		93334	93335	93342	93336	93337	93339
	<b>\$/pc</b>							

No partial packaging

To place orders correctly, find the desired model, size and finish. Then place your order by using the letters "PPS" followed by the corresponding 5-digit code.



# Projoint™

Projoint U and Projoint separation joints come in stainless steel and brass, and are especially suitable for areas subject to high and frequent loads. Version 799/ can be inserted and polished.

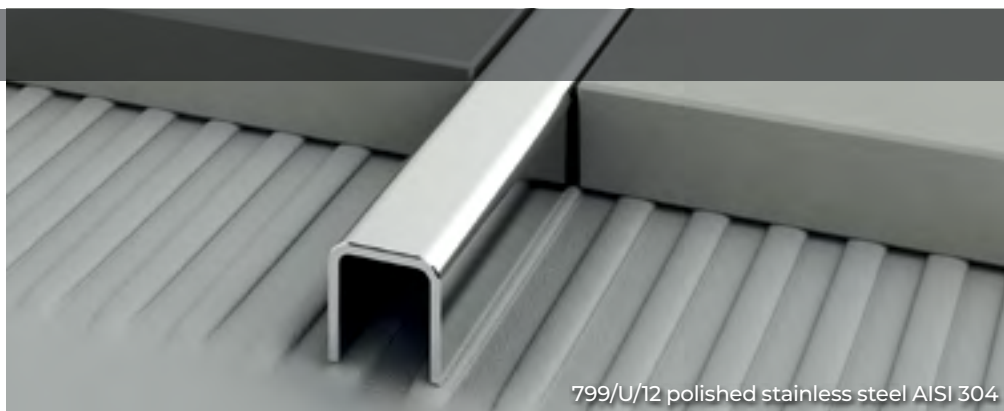

799/U/12 polished stainless steel AISI 304

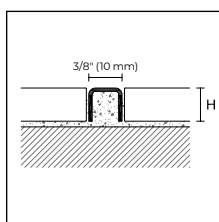

799/U/  
399/U

## PROJOINT U

Length = 8'10" or 270 cm  
20-piece package

		H	
		3/8" (10 mm)	1/2" (12.5 mm)
Item	Finish		
<b>STAINLESS STEEL</b>			
799/U/	Polished stainless steel AISI 304	75078	75072
	\$/pc		
<b>BRASS</b>			
399/U	Polished brass	75077	-
	\$/pc		

Individually packaged

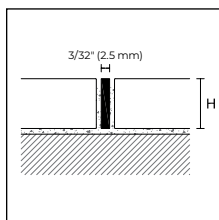

799/

## PROJOINT

Length = 8'10" or 270 cm  
20-piece package

		H	
		3/8" (10 mm)	
Item	Finish		
<b>STAINLESS STEEL</b>			
799/	Stainless steel AISI 304	74966	
	\$/pc		

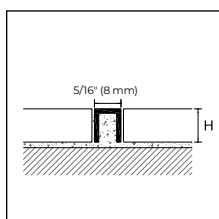

380/8

## PROJOINT

Length = 8'10" or 270 cm  
20-piece package

		L x H	
		5/16" x 3/8" (8 x 10 mm)	
Item	Finish		
<b>BRASS</b>			
380/8	Natural brass	75047	
	\$/pc		

To place orders correctly, find the desired model, size and finish. Then place your order by using the letters "PPS" followed by the corresponding 5-digit code.

# Projoint™

Projoint T profiles are for separating, protecting and decorating same-level floors of ceramic, marble, granite, wood and other materials. They are also ideal for covering any imperfections due to cutting or installing floors made of different materials, and covering slight height differences (from 3/32" to 1/8", or 2 to 3 mm). These profiles are easy to install, thanks to the arrow shape that allows a perfect repair with sealants or adhesives.

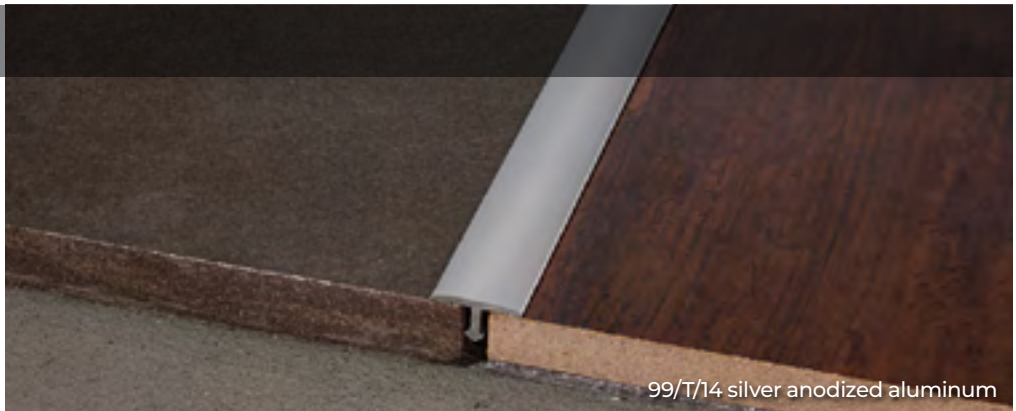

99/T/14 silver anodized aluminum

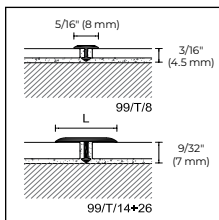

99/T/  
399/T/  
399/TC/

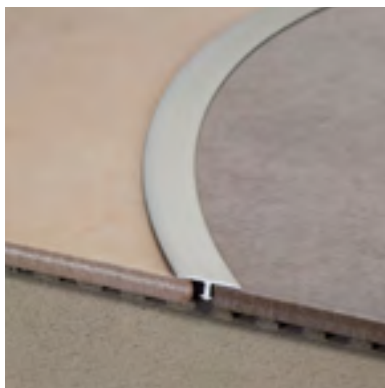

99/T/14 silver anodized aluminum

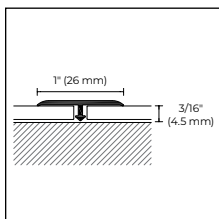

99/TR/26

## PROJOINT T

Length = 8'10" or 270 cm		50 pcs	50 pcs	30 pcs	20 pcs
Pieces per package					
Width		5/16" (8 mm)	17/32" (14 mm)	3/4" (20 mm)	1" (26 mm)
Item	Finish				

### ALUMINUM

99/T/	Silver anodized		75075	75080	63600	75082
	<b>\$/pc</b>					
	Gold anodized		-	75083	75084	75085
	<b>\$/pc</b>					
	Titanium anodized		-	75099	-	-
	<b>\$/pc</b>					
	Color-coated anthracite gray RAL 7016		-	75091	-	-
	<b>\$/pc</b>					

Length = 8'10" or 270 cm		-	10 pcs	-	-
Pieces per package					
Width		-	17/32" (14 mm)	-	-
Item	Finish				

### ALUMINUM DECORS DURABLE FILM

99/T/	97 black		-	75095	-	-
	<b>\$/pc</b>					

Individually packaged

## PROJOINT T

Length = 36" (90 cm)					L
10-piece package / blister					
Width					17/32" (14 mm)
Item	Finish				

### ALUMINUM

499/T	Silver anodized			20008	
	<b>\$/pc</b>				
	Gold anodized			20010	
	<b>\$/pc</b>				

## PROJOINT T

Length = 8'10" or 270 cm					L x H
20-piece package					
Width					1" x 3/16" (26 x 4.5 mm)
Item	Finish				

### ALUMINUM

99/TR/26	Silver anodized			75081	
	<b>\$/pc</b>				

Individually packaged

### PRO FLEX LINE

Projoint T 99/T/ can be bent with Proflex Machine (except 99/T/14 97 black).

To place orders correctly, find the desired model, size and finish. Then place your order by using the letters "PPS" followed by the corresponding 5-digit code.

Packaging in blister. No partial packaging.

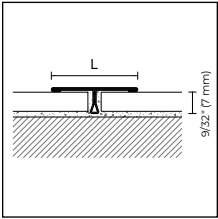

799/T/  
799/TS/

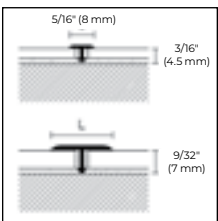

399/T/  
399/TC/

PPDESIGN

### PROJOINT T

Length = 8'10" or 270 cm  
Pieces per package

30 pcs

Width

17/32" (14 mm)

Item Finish

#### STAINLESS STEEL

799/T/	Polished stainless steel AISI 304 \$/pc		75092
799/TS/	Satin stainless steel AISI 304 \$/pc		75093

Individually packaged

### PROJOINT T

Length = 36" (90 cm)  
10-piece package / blister

L

Item Finish 17/32" (14 mm)

4799/T	Polished stainless steel AISI 304 \$/pc		20001
4799/TS	Satin stainless steel AISI 304 \$/pc		20002

### PROJOINT T

Length = 8'10" or 270 cm  
Pieces per package

50 pcs

20 pcs

20 pcs

20 pcs

Width

5/16" (8 mm)

17/32" (14 mm)

3/4" (20 mm)

1" (26 mm)

Item Finish

#### BRASS

399/T/	Polished \$/pc		75070	75087	75090	75088
<b>Package</b>			<b>30 pcs</b>	<b>30 pcs</b>	-	<b>10 pcs</b>
399/TC/	Chromium-plated \$/pc		75071	75086	-	75089

Individually packaged

### PROJOINT T

Length = 36" (90 cm)  
10-piece package / blister

L

Item Finish 17/32" (14 mm)

4399/T	Polished \$/pc		20016
--------	-------------------	--	-------



799/T/26 polished stainless steel AISI 304



399/T/14 polished brass

#### PRO FLEX LINE

Projoint T 399/T/ and 399/TC/ can be bent with Proflex Machine.

To place orders correctly, find the desired model, size and finish. Then place your order by using the letters "PPS" followed by the corresponding 5-digit code.

# Projoint™

Projoint R profiles are for subdividing and/or decorating same-level floors of ceramic, marble, granite, wood and other materials. The thickness of the upper part makes it particularly suitable for the polishing of wood, marble, etc.

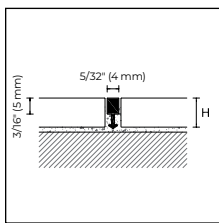
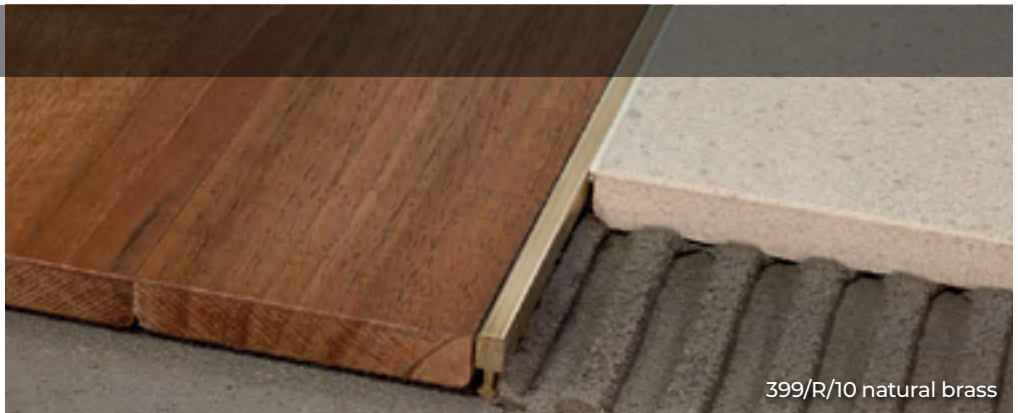

99/R/  
399/R/

## PROJOINT R

Length = 8'10" or 270 cm  
50-piece package

Item	Finish		3/8" (10 mm)	17/32" (14 mm)
------	--------	--	--------------	----------------

### ALUMINUM

99/R/	Natural aluminum		75006	75016
	<b>\$/pc</b>			

Length = 8'10" or 270 cm  
20-piece package

### BRASS

399/R/	Natural brass		75007	75017
	<b>\$/pc</b>			

Length = 36" or 90 cm  
10-piece package

### BRASS

4399/R/10	Natural brass		20006	-
	<b>\$/pc</b>			-

Projoint M is ideal as a separation joint and/or renovating and decorating between same-level floors installed with adhesive or mortar. When used between materials of different thickness or type, it could also be polished, both in its aluminum and brass versions.

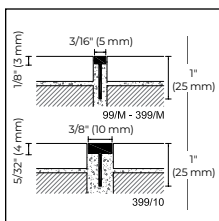

99/M  
399/M  
399/10

## PROJOINT M

Length = 8'10" or 270 cm  
Pieces per package

Dimensions	3/16" x 1/8" x 1" (5 x 3 x 25 mm)	3/8" x 5/32" x 1" (10 x 4 x 25 mm)
------------	-----------------------------------	------------------------------------

Item	Finish		50 pcs	
------	--------	--	--------	--

### ALUMINUM

99/M	Natural aluminum		75005	-
	<b>\$/pc</b>			-
	Pieces per package		20 pcs	10 pcs

### BRASS

399/M	Natural brass		74975	-
	<b>\$/pc</b>			

399/10	Natural brass		-	74906
	<b>\$/pc</b>			

To place orders correctly, find the desired model, size and finish. Then place your order by using the letters "PPS" followed by the corresponding 5-digit code.

Packaging in blister. No partial packaging.



# Proclassic

Proclassic R profiles are specially designed as threshold covers and for hiding junctions and imperfections due to cutting or installing floors made of different materials. The rounded shape covers slight height differences (from 3/32" to 1/8", or 2 to 3 mm) between two different types of flooring. Repairs are particularly easy thanks to the option of using adhesive or screws.

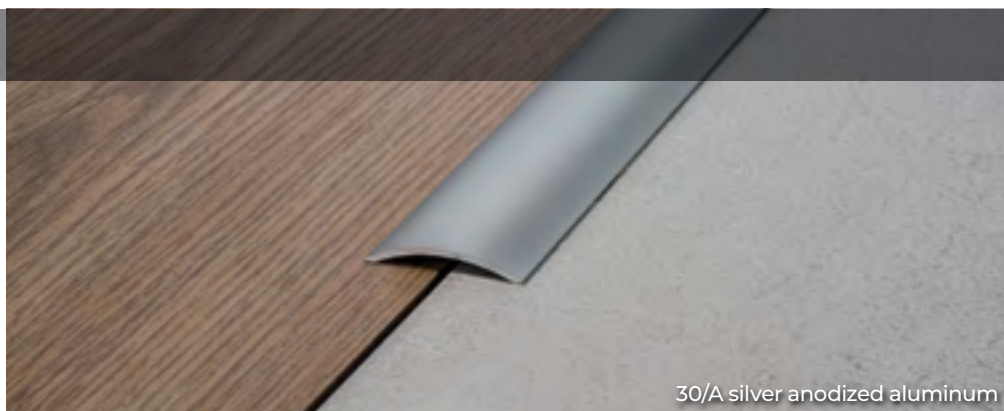

30/A silver anodized aluminum

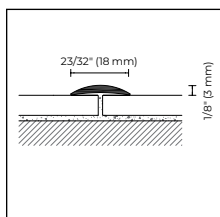

21/

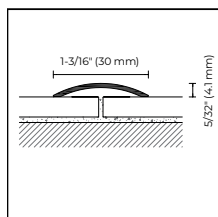

30/



## PROCLASSIC R

Length = 8'10" or 270 cm – 20-piece package

Item	Finish		A
<b>ALUMINUM</b>			
21/	Silver anodized		71037
	Gold anodized		71047

Individually packaged

## PROCLASSIC R

Package	30 pcs		10 pcs / blister								
Length	8'10" (270 cm)		32-11/16" (83 cm)	36-19/32" (93 cm)	40-9/16" (103 cm)	44-1/8" (112 cm)	48-1/8" (122 cm)	52-1/8" (132 cm)	56-1/8" (142 cm)	60-1/8" (152 cm)	
Item	30/		430/								
Finish	F	A	CV	AD	CV	AD	CV	AD	CV	AD	
<b>ALUMINUM</b>											
Silver anodized		71067	71097	20128	20148	20132	20152	-	20156	20140	20160
Gold anodized		71077	71107	-	-	20133	20153	-	20157	-	20161
<b>\$/pc</b>											
Titanium anodized		-	71098	-	-	-	-	-	-	-	-
<b>\$/pc</b>											
Bronze anodized		-	71117	-	-	-	20154	-	-	-	-
<b>\$/pc</b>											
Color-coated anthracite gray RAL 7016		-	71101	-	-	-	-	-	-	-	-
<b>\$/pc</b>											

Individually packaged

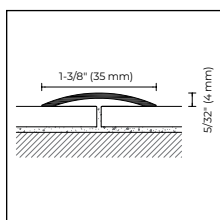

35/

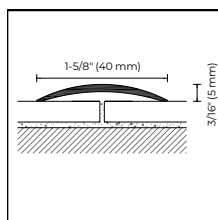

41/

## PROCLASSIC R

Length = 8'10" or 270 cm – 20-piece package

Item	35/		
Finish	F	A	
<b>ALUMINUM</b>			
Silver anodized		71387	71417
<b>\$/pc</b>			

Individually packaged

## PROCLASSIC R

Package	20 pcs		10 pcs / blister	
Length	8'10" (270 cm)		36" (90 cm)	
Item	41/		441/	
Finish	F	A	AD	
<b>ALUMINUM</b>				
Silver anodized		71587	71617	20552
<b>\$/pc</b>				-
Gold anodized		-	71627	20553
Titanium anodized		-	71618	20555
<b>\$/pc</b>				
Bronze anodized		-	71637	-
<b>\$/pc</b>				

Individually packaged

To place orders correctly, find the desired model, size and finish. Then place your order by using the letters "PPS" followed by the corresponding 5-digit code.

Packaging in blister. No partial packaging.

# Proclassic

Proclassic R profiles in stainless steel are particularly suitable for public spaces and for areas subject to frequent and heavy loads. The sparkle of polished stainless steel also matches modern floors and furnishings perfectly. Proclassic R profiles in polished brass are simultaneously classic and modern, and can be easily matched to handles, taps and other furniture accessories of the same material and finish.



720/A polished stainless steel AISI 430

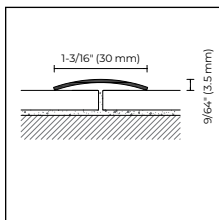

720/  
722/  
020/

## PROCLASSIC R

Package	20 pcs		PRO										
Length	8'10" (270 cm)		28-3/4" (73 cm)		32-11/16" (83 cm)		36-19/32" (93 cm)		40-9/16" (103 cm)		65-5/16" (166 cm)		
Item	720/		720/										
Finish	F	A	F	A	F	A	F	A	F	A	F	A	
<b>STAINLESS STEEL (THICKNESS 10/10)</b>													
Polished stainless steel AISI 430		71287	71297	71280	71290	71281	71291	71282	71292	-	-	-	71294
\$/pc													
			10 pcs / blister										
Item			4720/										
Finish			CV	AD	CV	AD	CV	AD	CV	AD	CV	AD	
Polished stainless steel AISI 430		-	-	20287	20293	20288	20294	20289	20295	20290	20296	20291	20297
\$/pc													
Satin stainless steel AISI 430		-	71298	-	-	-	-	-	-	-	-	-	-
\$/pc													

Individually packaged

## PROCLASSIC R

Package	20 pcs		10 pcs / blister										
Length	8'10" (270 cm)		28-3/4" (73 cm)		32-11/16" (83 cm)		36-19/32" (93 cm)		40-9/16" (103 cm)		65-5/16" (166 cm)		
Item	722/		4722/										
Finish	-	A	CV	AD	CV	AD	CV	AD	CV	AD	CV	AD	
<b>STAINLESS STEEL (THICKNESS 10/10)</b>													
Satin stainless steel AISI 304		-	71268	-	-	-	-	-	20300	-	-	-	-
\$/pc													

Individually packaged

## PROCLASSIC R

Package	20 pcs		10 pcs / blister										
Length	8'10" (270 cm)		28-3/4" (73 cm)		32-11/16" (83 cm)		36-19/32" (93 cm)		40-9/16" (103 cm)		65-5/16" (166 cm)		
Item	020/		4020/										
Finish	F	A	CV	AD	CV	AD	CV	AD	CV	AD	CV	AD	
<b>BRASS (THICKNESS 10/10)</b>													
Polished		71187	71207	20207	20213	20208	20214	20209	20215	20210	20216	20211	20217
\$/pc													

Individually packaged



020/A polished brass

To place orders correctly, find the desired model, size and finish. Then place your order by using the letters "PPS" followed by the corresponding 5-digit code.

Packaging in blister. No partial packaging.

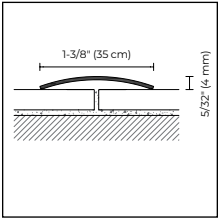

726/

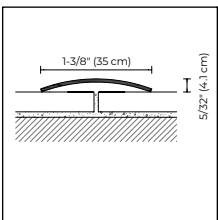

026/

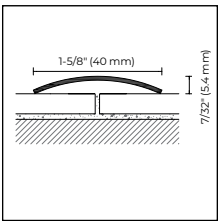

729/

**PROCLASSIC R**

Package	20 pcs		PRO			
Length	8'10" (270 cm)		32-11/16" (83 cm)	36-19/32" (93 cm)	65-5/16" (166 cm)	
Item	726/		726/			
Finish	F	A	F	A	F	A

**STAINLESS STEEL (THICKNESS 10/10)**

Polished stainless steel AISI 430		71507	71517	-	-	71502	71512	-	-
<b>\$/pc</b>									

	10 pcs / blister			
Item	4726/			

Finish		CV	AD	CV	AD	CV	AD		
Polished stainless steel AISI 430		-	-	-	26016	26010	26017	-	26019
<b>\$/pc</b>									

Satin stainless steel AISI 430		-	71518	-	-	-	-	-	-
<b>\$/pc</b>									

Individually packaged

**PROCLASSIC R**

Package	20 pcs		10 pcs / blister	
Length	8'10" (270 cm)		36-19/32" (93 cm)	
Item	026/		4026/	
Finish	F	A	CV	AD

**BRASS (THICKNESS 10/10)**

Polished		71447	71457	20409	20415
<b>\$/pc</b>					

Individually packaged

**PROCLASSIC R**

Package	20 pcs		5 pcs / blister	
Length	8'10" (270 cm)		36-19/32" (93 cm)	
Item	729/		4729/	
Finish	F	A	CV	AD

**STAINLESS STEEL (THICKNESS 12/10)**

Polished stainless steel AISI 430		71667	71677	-	40220
<b>\$/pc</b>					

Satin stainless steel AISI 430		-	71678	-	-
<b>\$/pc</b>					

Individually packaged

To place orders correctly, find the desired model, size and finish. Then place your order by using the letters "PPS" followed by the corresponding 5-digit code.

Packaging in blister. No partial packaging.

722/A satin stainless steel AISI 304





# Proclassic

Proclassic F threshold cover profiles have a thickness that allows application under doors. The 19/ and 25/ versions include a useful non-slip knurled surface. Installation of the profiles is particularly simple, thanks to the option of using adhesive or screws.



25/A silver anodized aluminum

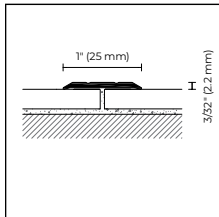

19/



### PROCLASSIC F

Package	30 pcs		10 pcs / blister		
Length	8'10" (270 cm)		36-19/32" (93 cm)		
Item	19/		419/		
Finish	F	A	CV	AD	
<b>ALUMINUM</b>					
Silver anodized		71867	71897	27074	27092
<b>\$/pc</b>					
Gold anodized		-	71907	-	27099
<b>\$/pc</b>					

Individually packaged

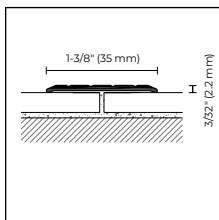

25/

### PROCLASSIC F

Package	20 pcs		10 pcs / blister			
Length	8'10" (270 cm)		36-19/32" (93 cm)			
Item	25/		425/			
Finish	F	D	A	CV	AD	
<b>ALUMINUM</b>						
Silver anodized		71947	71948	71977	22533	22553
<b>\$/pc</b>						
Gold anodized		71957	-	71987	22534	22554
<b>\$/pc</b>						
Bronze anodized		-	-	71997	-	22555
<b>\$/pc</b>						

Individually packaged

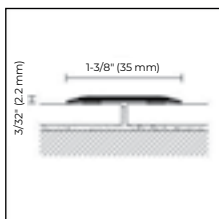

22/A  
422/AD

### PROCLASSIC F

Package	10 pcs		10 pcs / blister	
Length	8'10" (270 cm)		36" (90 cm)	
Item	22/A		422/AD	
Finish				
<b>ALUMINUM</b>				
Silver		44000		43790
<b>\$/pc</b>				
Titanium		44001		43791
<b>\$/pc</b>				
<b>ALUMINUM - DECORS DURABLE FILM</b>				
Black 97		43996		-
<b>\$/pc</b>				

Wood-effect decors available on page 154 and 155

To place orders correctly, find the desired model, size and finish. Then place your order by using the letters "PPS" followed by the corresponding 5-digit code.

Packaging in blister. No partial packaging.

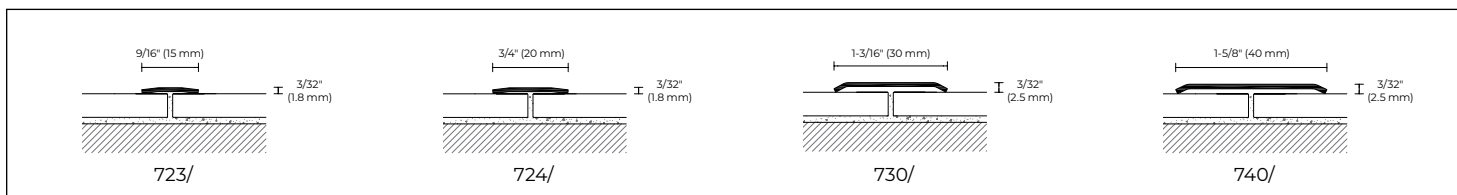

**PROCLASSIC F**

Package	20 pcs			10 pcs / blister	10 pcs
Length	8'10" (270 cm)			36" (90 cm)	8'10" (270 cm)
Dimensions	9/16" x 1/16" (15 x 1.8 mm)	3/4" x 1/16" (20 x 1.8 mm)	1-3/16" x 3/32" (30 x 2.5 mm)	1-3/16" x 3/32" (30 x 2.5 mm)	1-9/16" x 3/32" (40 x 2.5 mm) thickness 10/10
Item	723/A	724/A	730/A	4730/AD	740/A
<b>STAINLESS STEEL</b>					
Polished stainless steel	71717	71777	72117	20692	72377
AISI 430					
\$/pc					

Item 723/ not individually packaged. Items 730/ and 740/ individually packaged.

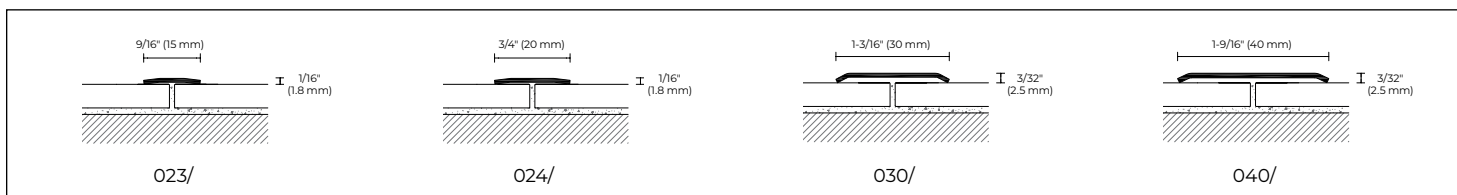

**PROCLASSIC F**

Package	20 pcs			10 pcs / blister	10 pcs
Thickness 10/10 - Length	8'10" (270 cm)			36" (90 cm)	8'10" (270 cm)
Dimensions	9/16" x 1/16" (15 x 1.8 mm)	3/4" x 1/16" (20 x 1.8 mm)	1-3/16" x 3/32" (30 x 2.5 mm)	1-3/16" x 3/32" (30 x 2.5 mm)	1-9/16" x 3/32" (40 x 2.5 mm)
Item	023/A	024/A	030/A	4030/AD	040/A
<b>BRASS</b>					
Polished	71697	71757	72057	20612	72317
\$/pc					

Items 030/ and 040/ individually packaged. Items 023/ and 024/ not individually packaged.



To place orders correctly, find the desired model, size and finish. Then place your order by using the letters "PPS" followed by the corresponding 5-digit code.

Packaging in blister. No partial packaging.

22/A aluminum covered with durable film black 97







## Profiles for Floors of Different Heights

Ramp profiles for floors of different heights feature a sloping section that connects floors with varying thicknesses. These profiles are made from stainless steel, brass and aluminum, allowing different options for the target environment.



# Cerfix™ Pronivel™

Pronivel NZS/ is a line of ramp profiles composed of an L shape that works as the shoulder and a ramp that is available in 2 widths. Together, these two components eliminate the step between floors of different thickness. The articulated connector enables many combinations as well as the installation of new flooring alongside the connector, even after the application of NZS/.

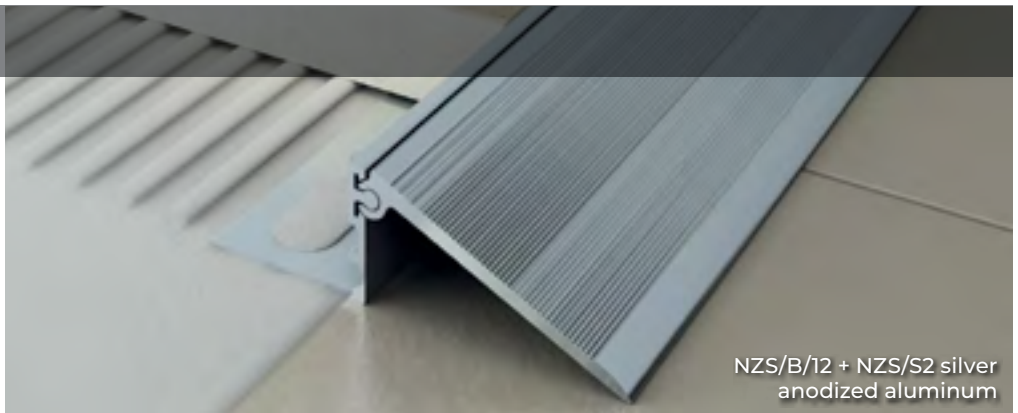

NZS/B/12 + NZS/S2 silver anodized aluminum



## CERFIX PRONIVEL N

Length = 8'10" or 270 cm (10-piece package)

		H			
Item	Finish	3/8" (10 mm)	1/2" (12.5 mm)	9/16" (15 mm)	3/4" (20 mm)
<b>ALUMINUM</b>					
NZS/B/	Silver anodized	99905	99906	99907	99908
	\$/p c				
		L			
Item	Finish	1-1/2" (38 mm)	2" 50 mm)		
NZS/S1	Connection silver anodized	99900	-		
	\$/pc				
NZS/S2	Connection silver anodized	-	99901		
	\$/pc				

Individually packaged

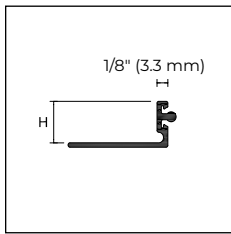

NZS/B/

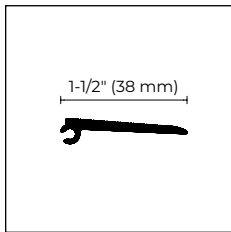

NZS/S1

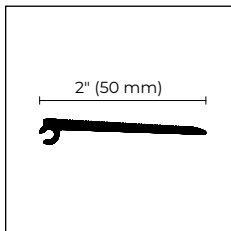

NZS/S2

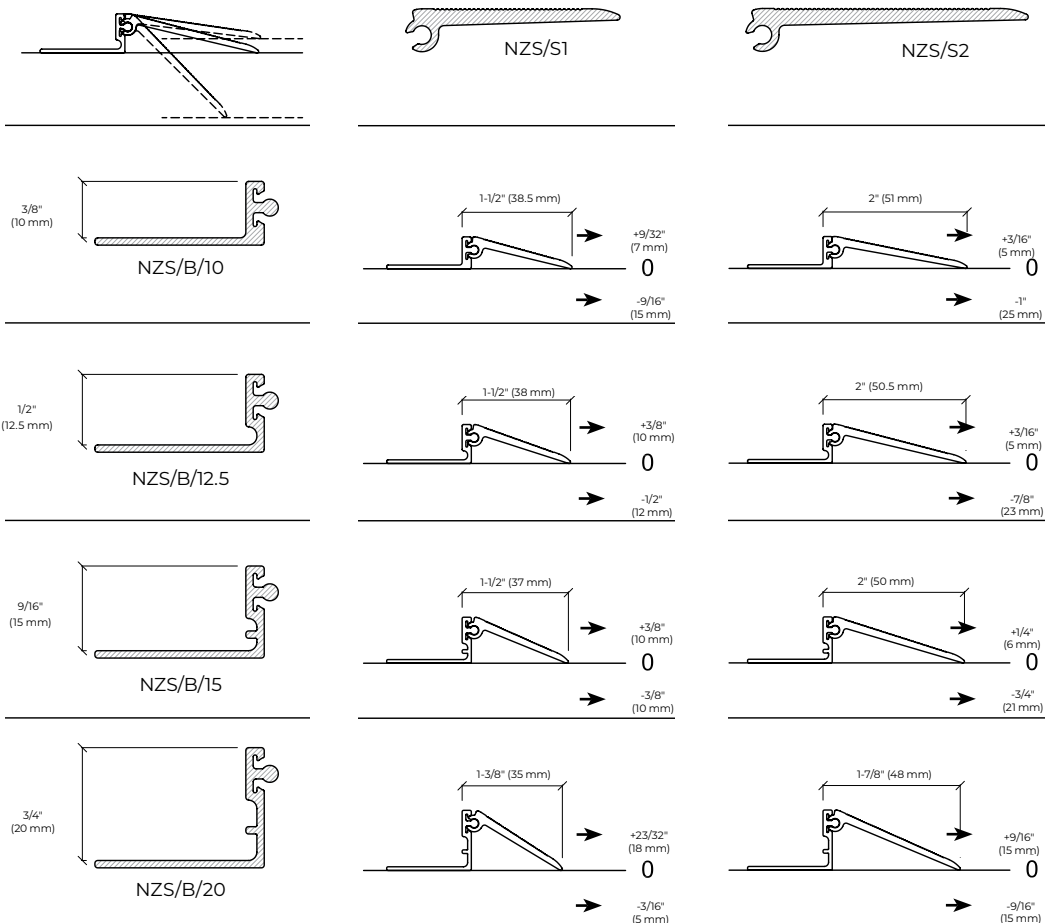

To place orders correctly, find the desired model, size and finish. Then place your order by using the letters "PPS" followed by the corresponding 5-digit code.

Pronivel P profiles are designed to be applied during the installation of ceramic or marble flooring and connect differing thicknesses of flooring. Both versions, stainless steel and brass, can withstand heavy stress.

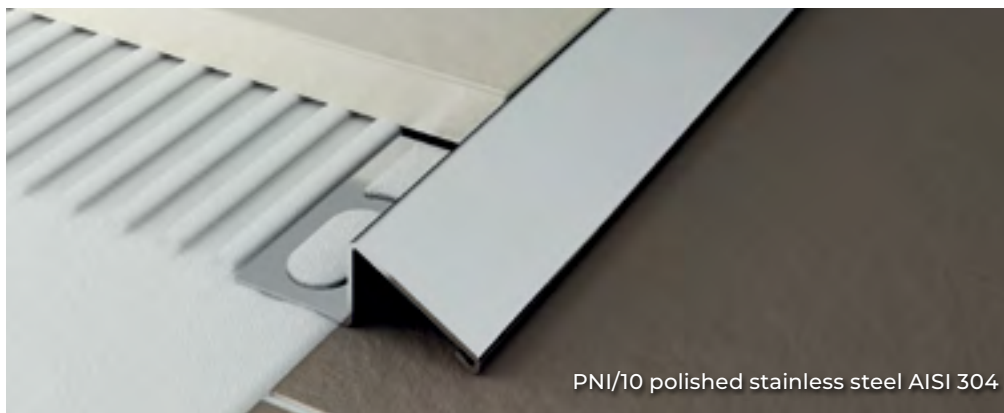

PNI/10 polished stainless steel AISI 304



### CERFIX PRONIVEL P

Length = 8'10" or 270 cm  
(10-piece package)

Item	Finish	H								
		3/16" (4.5 mm)	5/16" (8 mm)	3/8" (10 mm)	7/16" (11 mm)	1/2" (12.5 mm)	17/32" (14 mm)	9/16" (15 mm)	3/4" (20 mm)	
<b>ALUMINUM</b>										
PA/	Silver anodized		93175	93181	93182	93185	93183	93184	-	-
	\$/pc									
<b>STAINLESS STEEL</b>										
PNI/	Polished stainless steel AISI 304		-	93092	93094	93090	93096	-	93098	93100
	\$/pc									
PNIS/	Satin stainless steel AISI 304		-	93093	93095	93091	93097	-	93099	93101
	\$/pc									
<b>BRASS</b>										
PN/	Natural brass		-	-	93122	-	93123	-	-	-
	\$/pc									

Individually packaged

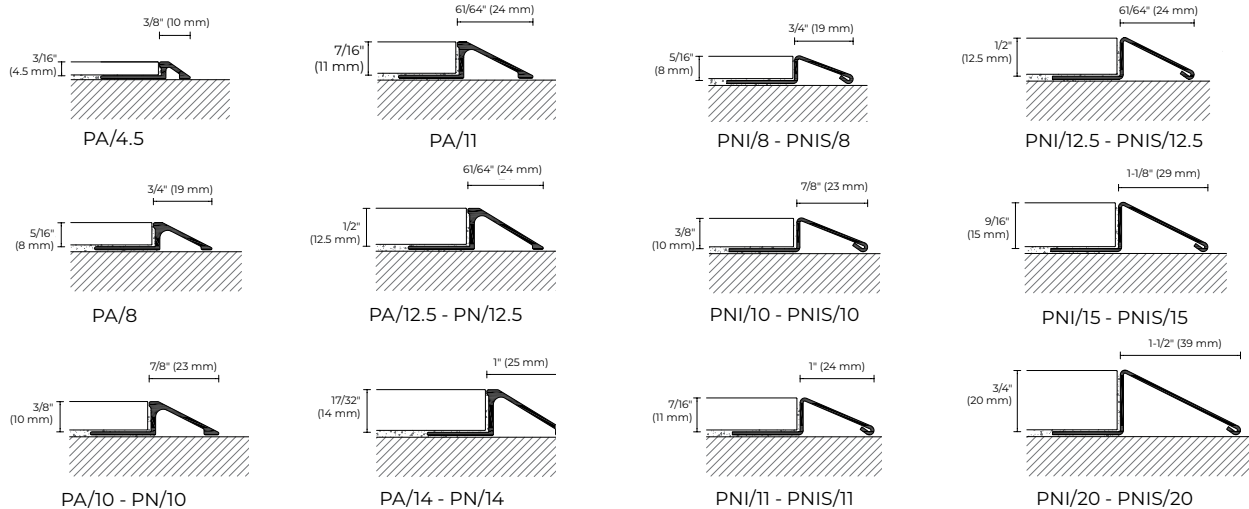

To place orders correctly, find the desired model, size and finish. Then place your order by using the letters "PPS" followed by the corresponding 5-digit code.

## Cerfix™ Pronivel™

Pronivel L profile is designed to connect already installed floors of different heights and is adfixed to the floors with adhesive.



45/SF silver anodized aluminum

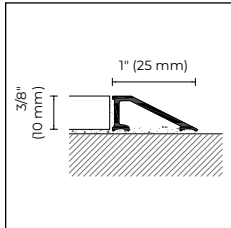

45/

### CERFIX PRONIVEL L

Length = 8'10" or 270 cm - 20-piece package

Item	Finish	H	
		3/8" (10 mm)	A
ALUMINUM		SF	A
45/	Silver anodized	73550	73552
	\$/pc		

Individually packaged

Pronivel PB profile is designed to provide a transition between two different-level floors that are subject to stress. The slight slope makes the transition easier for wheeled carts and wheelchairs.



PBA/10 silver anodized aluminum

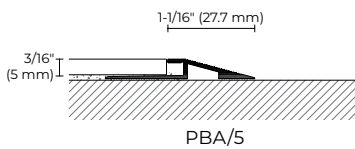

PBA/5

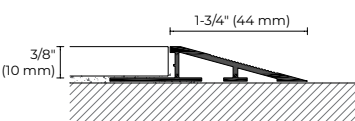

PBA/10

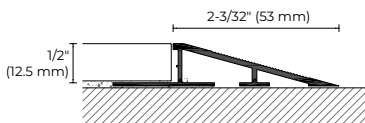

PBA/12.5

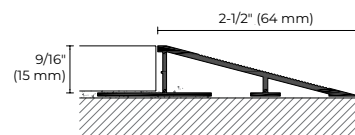

PBA/15

### CERFIX PRONIVEL PB

Length = 8'10" or 270 cm - 10-piece package

Item	Finish	H			
		3/16" (5 mm)	3/8" (10 mm)	1/2" (12.5 mm)	9/16" (15 mm)
ALUMINUM					
PBA/	Silver anodized	93204	93206	93208	93210
	\$/pc				

Individually packaged

To place orders correctly, find the desired model, size and finish. Then place your order by using the letters "PPS" followed by the corresponding 5-digit code.

Pronivel Flex is a line of bendable profiles for connecting different-level floors. These profiles can be curved through our bending machine and the specific wheels kit.



PLAF/10 silver anodized aluminum

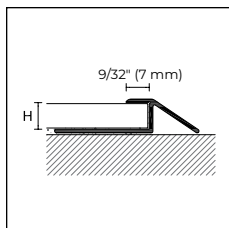

PLAF/

**CERFIX PRONIVEL FLEX**

Length = 8'10" or 270 cm - 10-piece package

Item	Finish	H		
		5/16" (8 mm)	3/8" (10 mm)	
<b>ALUMINUM</b>				
PLAF/	Silver anodized	93190	93192	
	<b>\$/pc</b>			

Individually packaged

Pronivel M profiles connect floors of different heights that are being installed. The special section of the profiles is effective when connecting with carpet or LVT.



MIN/10 polished stainless steel AISI 304

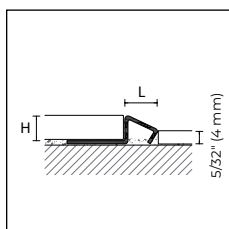

MIN/

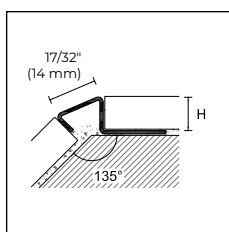

MIN/

**CERFIX PRONIVEL M**

Length = 8'10" or 270 cm - 10-piece package

Item	Finish	H		
		5/16" (8 mm)	3/8" (10 mm)	1/2" (12.5 mm)
<b>STAINLESS STEEL</b>				
MIN/	Polished stainless steel AISI 304	93023	93024	-
	<b>\$/pc</b>			

Individually packaged

To place orders correctly, find the desired model, size and finish. Then place your order by using the letters "PPS" followed by the corresponding 5-digit code.



# Prolevel™

Prolevel 61/ is a line of profiles, designed to be applied after the flooring installation, that can compensate for height differences from 1/4" to 1/2" (6.5 and 13 mm).

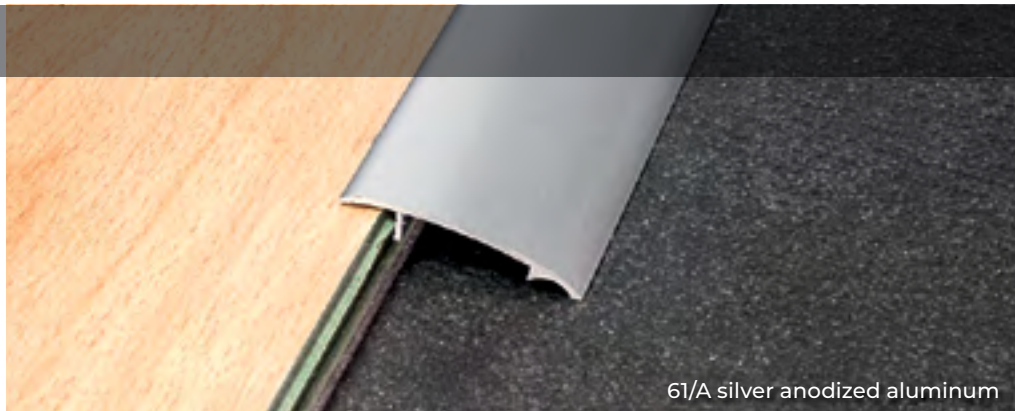

61/A silver anodized aluminum

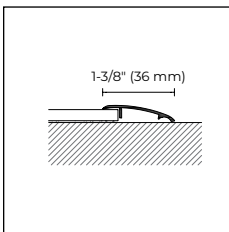

61/

## PROLEVEL HIGH

Package	20 pcs	10 pcs / blister
Length	8'10" (270 cm)	36" (90 cm)
Item	61/	461/
Finish	A	AD
<b>ALUMINUM</b>		
Silver anodized \$/pc	73437	21200

Item 61/ individually packaged

Prolevel High 55/ and 57/ are two aluminum profiles that eliminate the small step between two floors with a height difference of 5/16" to 31/64" (8 to 12 mm). Available also in blister packs and with adhesive, these profiles can be easily used in DIY installations.



57/A silver anodized aluminum

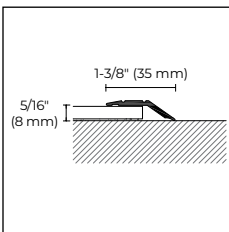

55/

## PROLEVEL HIGH

Package	20 pcs	10 pcs / blister
Length	8'10" (270 cm)	36" (90 cm)
Item	55/	455/
Finish	F A	CV AD
<b>ALUMINUM</b>		
Silver anodized	73907 73937	42312 42330
Gold anodized	- 73947	- 42336
\$/pc		

Item 55/ individually packaged

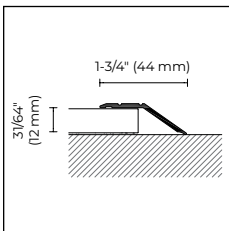

57/

## PROLEVEL HIGH

Package	20 pcs	10 pcs / blister
Length	8'10" (270 cm)	36" (90 cm)
Item	57/	457/
Finish	F A	CV AD
<b>ALUMINUM</b>		
Silver anodized	73967 73997	42352 42370
Gold anodized	- 74007	- 42376
\$/pc		

Item 57/ individually packaged

packaging in blister, no partial packaging

Prolevel 711/ and 311/ are a line of self-adhesive stainless steel and polished brass profiles that eliminate the height differences between floors, with a slope measuring 9/32" or 31/64" (7 mm or 12 mm). Also available in blister packs and with self-adhesive, these profiles are easily applicable for DIY installers.

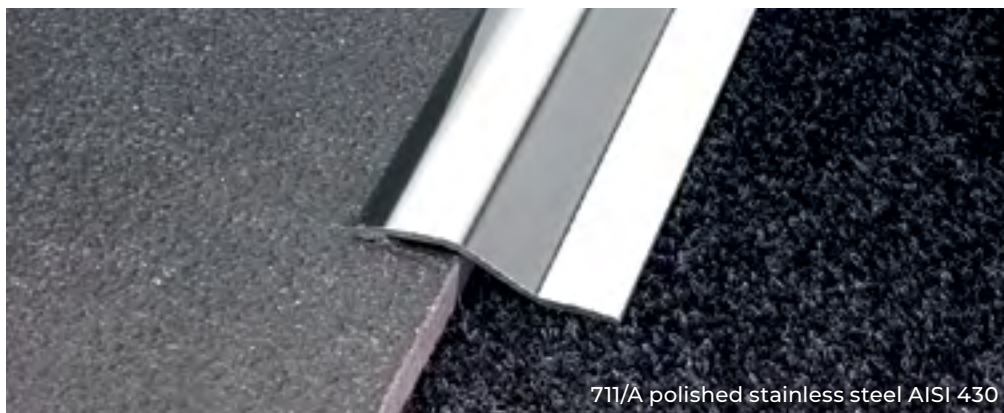

711/A polished stainless steel AISI 430

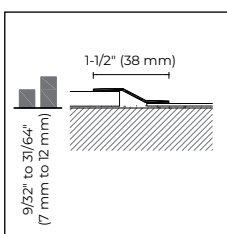

711/  
311/

**PROLEVEL HIGH**

Package	20 pcs	10 pcs / blister	
	8'10" (270 cm)	32-11/16" (83 cm)	36-19/32" (93 cm)
Length			
Item	711/	4711/	
Finish	A	AD	AD
<b>STAINLESS STEEL</b>			
Polished stainless steel AISI 430	73627	40431	40432
\$/pc			
Satin stainless steel AISI 430	73628	-	-
\$/pc			
Item	311/	4311/	
Finish	A	AD	AD
<b>BRASS</b>			
Polished	73607	-	22656
\$/pc			

Items 711/ and 311/ individually packaged

Prolevel 712/ and 312/ are a line of self-adhesive stainless steel and polished brass profiles that eliminate the height differences between floors, with a slope measuring 31/64" or 5/8" (12 or 16 mm). Available also in blister pack and with self-adhesive, these profiles are easily applicable for DIY installers.



312/A polished brass

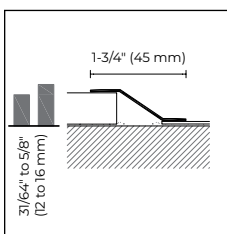

712/  
312/

**PROLEVEL HIGH**

Package	10 pcs	5 pcs / blister
	8'10" (270 cm)	36" (90 cm)
Length		
Item	712/	4712/
Finish	A	AD
<b>STAINLESS STEEL</b>		
Polished stainless steel AISI 430	73637	40898
\$/pc		
Item	312/	4312/
Finish	A	AD
<b>BRASS</b>		
Polished	73617	40868
\$/pc		

Items 712/ and 312/ individually packaged

To place orders correctly, find the desired model, size and finish. Then place your order by using the letters "PPS" followed by the corresponding 5-digit code.

 packaging in blister, no partial packaging

## Prolevel™

Prolevel High 732/ is a line of profiles for the protection of the perimeter border of floors. Available in stainless steel, it can be also used as stair nosing.



732/SF/10 polished stainless steel AISI 430

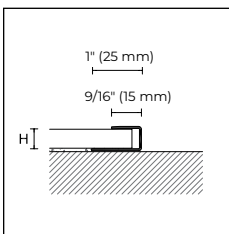

732/SF/

### PROLEVEL HIGH

Length = 8'10" or 270 cm - 15-piece package

Item	Finish	H		
		3/8" (10 mm)	1/2" (12.5 mm)	9/16" (15 mm)
<b>STAINLESS STEEL</b>				
732/SF/	Polished stainless steel AISI 430	74217	74227	74237
<b>\$/pc</b>				

Individually packaged

Prolevel 700/, 300/ and 10/ profiles provide transitions for already installed resilient floors. Available in different widths and also in blister packs, with self-adhesive and with screws, they are easily applicable for DIY installers.



700/A polished stainless steel AISI 430

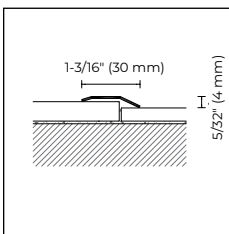

700/  
300/

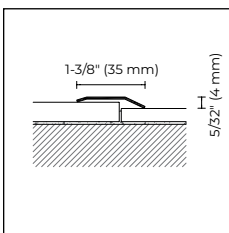

701/

### PROLEVEL MEDIUM

Package	20 pcs		10 pcs / blister
	8'10" (270 cm)	8'10" (270 cm)	36-19/32" (93 cm)
Length	8'10" (270 cm)	8'10" (270 cm)	36-19/32" (93 cm)
Item	700/	701/	4701/
Finish	A	F	A
<b>STAINLESS STEEL</b>			
Polished stainless steel AISI 430	72877	-	72957
<b>\$/pc</b>			
Items 700/ and 701/ individually packaged			

### PROLEVEL MEDIUM

Package	20 pcs	10 pcs / blister
	8'10" (270 cm)	36-19/32" (93 cm)
Length	8'10" (270 cm)	36-19/32" (93 cm)
Item	300/	4300/
Finish	A	AD
<b>BRASS</b>		
Polished	72857	21035
<b>\$/pc</b>		
Items 300/ individually packaged		

To place orders correctly, find the desired model, size and finish. Then place your order by using the letters "PPS" followed by the corresponding 5-digit code.

Prolevel 6/ aluminum profiles provide transitions for already installed resilient floors. Available also in blister pack, with self-adhesive and with screws, they are easily applicable for DIY installers.



6/A silver anodized aluminum

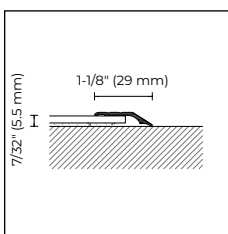

6/

**PROLEVEL MEDIUM**

Package	30 pcs		10 pcs / blister			
	8'10" (270 cm)		36-19/32" (93 cm)		65-5/16" (166 cm)	
Item	6/		46/			
Finish	F	A	CV	AD	CV	AD
<b>ALUMINUM</b>						
Silver anodized		72727 72757	20932	20952	20940	20960
Gold anodized		72737 72767	20933	20953	-	-
Bronze anodized		- 72777	-	-	-	-
<b>\$/pc</b>						

Item 6/Individually packaged

Prolevel Medium 10/ and Prolevel Thin 54/ are profiles for connecting PVC floors. They can be installed on already installed floors and also protect floor edges.



54/A gold anodized aluminum

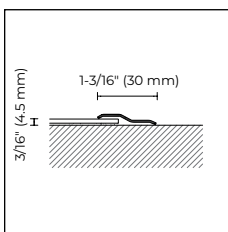

10/

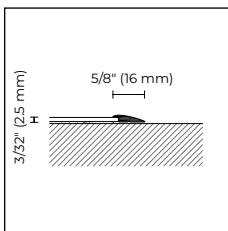

54/

**PROLEVEL MEDIUM**

Package	20 pcs	
Length	8'10" (270 cm)	
Item	10/	
Finish	A	
<b>ALUMINUM</b>		
Silver anodized		72527
<b>\$/pc</b>		

Individually packaged

**PROLEVEL THIN**

Length = 8'10" or 270 cm - 20-piece package			
Item	Finish	SF	A
<b>ALUMINUM</b>			
54/	Silver anodized		72587 72617
	Gold anodized		- 72627
<b>\$/pc</b>			

Individually packaged



To place orders correctly, find the desired model, size and finish. Then place your order by using the letters "PPS" followed by the corresponding 5-digit code.







## External Corner Profiles

Wall profiles are used to protect and decorate. We offer a variety of finishes and materials to suit different environments and needs.



# Cerfix™ Proangle™ Q

Proangle Q in aluminum is a line of universal square-shaped profiles specially designed to edge and protect the external corners of ceramic coverings. The profiles can be also used for finishing worktops and platforms. ZQVNH/ boasts the certified antibacterial technology (according to the internationally recognized laboratory test JIS Z 2801:2000) that reduces the presence of the most dangerous bacteria up to 99%, thus ensuring the best hygiene over time.

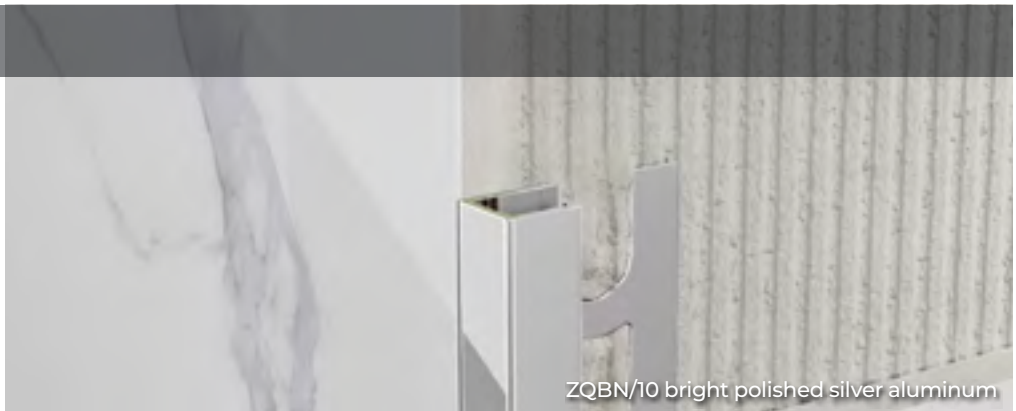

ZQBN/10 bright polished silver aluminum

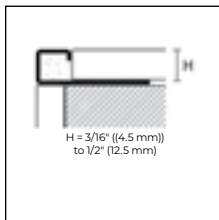
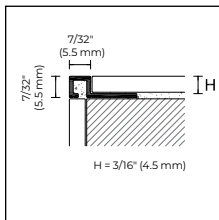

ZQAN/10 black anodized aluminum

## CERFIX PROANGLE Q

Length = 8'10" or 2.7 m  
(20 pieces per package)

Item	Finish	H							
		3/16" (4.5 mm)	1/4" (6 mm)	5/16" (8 mm)	11/32" (9 mm)	3/8" (10 mm)	7/16" (11 mm)	1/2" (12.5 mm)	
<b>ALUMINUM</b>									
ZQAN/	Silver anodized \$/pc		88772	88875	88876	88877	88878	88879	88880
ZQAN/	Titanium anodized \$/pc		88902	88903	88904	88905	88906	88907	88908
ZQAN/	Black anodized \$/pc		-	-	89205	-	89206	89207	89208
ZQAN/	Bright polished silver \$/pc		88816	88919	88920	88921	88922	88923	88924
ZQBN/	Bright polished gold		88933	-	88935	-	88937	-	88939
ZQTN/	Bright polished titanium		88949	88950	88951	88952	88953	88954	88955
ZQBRN/	Bright polished copper \$/pc		-	-	-	-	88969	-	88971
ZQBSN/	Bright satin silver		88981	88982	88983	-	88985	88986	88987
	Bright satin gold		88997	-	88999	-	89001	-	89003
ZQTMN/	Bright satin titanium		89013	89014	89015	-	89017	-	89019
ZQBRSN/	Bright satin copper \$/pc		-	-	89031	-	89033	-	89035
ZQBSN/	Bright satin black \$/pc		-	-	-	-	89209	89210	89211
ZQAGN/	Bright scratched silver \$/pc		89061	-	89063	-	89065	-	89067
<b>COLOR-COATED ALUMINUM</b>									
ZQVN/	Color-coated matte white RAL 9003		-	-	89200	-	89202	89203	89204
	Color-coated white RAL 9003 \$/pc		89077	89076	89079	-	89081	89078	89083
<b>ANTIBACTERIAL COLOR-COATED ALUMINUM</b>									
ZQVNH/	Color-coated white RAL 9003 \$/pc		-	-	89080	-	89082	-	89084

To place orders correctly, find the desired model, size and finish. Then place your order by using the letters "PPS" followed by the corresponding 5-digit code.

Items ZQVN available in different colors on demand. Minimum quantity 200 pieces for color. Minimum order quantity: 1 box



ZQAN/ /EI  
silver anodized  
aluminum

### CERFIX PROANGLE Q – OUTSIDE/INSIDE CORNERS AND END CAPS

5 pieces per package

Item	Finish	H							
		3/16" (4.5 mm)	1/4" (6 mm)	5/16" (8 mm)	11/32" (9 mm)	3/8" (10 mm)	7/16" (11 mm)	1/2" (12.5 mm)	
<b>ALUMINUM</b>									
ZQAN/ /EI	Silver anodized		88809	88882	88883	88884	88885	88886	88887
	Titanium anodized		88910	88911	88912	88913	88914	88915	88916
<b>\$/pc</b>									
ZQAN/ /EI	Black anodized		-	-	89223	-	89224	89225	89226
<b>\$/pc</b>									
ZQBN/ /EI	Bright polished silver		88829	88926	88927	88928	88929	88930	88931
	Bright polished gold		88941	-	88943	-	88945	-	88947
ZQVN/ /EI	Color-coated matte white RAL 9003		-	-	89192	-	89194	89195	89196
	Color-coated white RAL 9003		89085	89086	89087	-	89089	89088	89091
<b>\$/pc</b>									
ZQTN/ /EI	Bright polished titanium		88957	88958	88959	88960	88961	88962	88963
ZQBRN/ /EI	Bright polished copper		-	-	-	-	88977	-	88979
ZQBSN/ /EI	Bright satin silver		88989	88990	88991	-	88993	88994	88995
	Bright satin gold		89005	-	89007	-	89009	-	89011
ZQTMN/ /EI	Bright satin titanium		89021	89022	89023	-	89025	-	89027
ZQBRSN/ /EI	Bright satin copper		-	-	89039	-	89041	-	89043
ZQBSN/ /EI	Bright satin black		-	-	-	-	89227	89228	89229
<b>\$/pc</b>									
ZQAGN/ /EI	Bright scratched silver		89069	-	89071	-	89073	-	89075
<b>\$/pc</b>									

No partial packaging

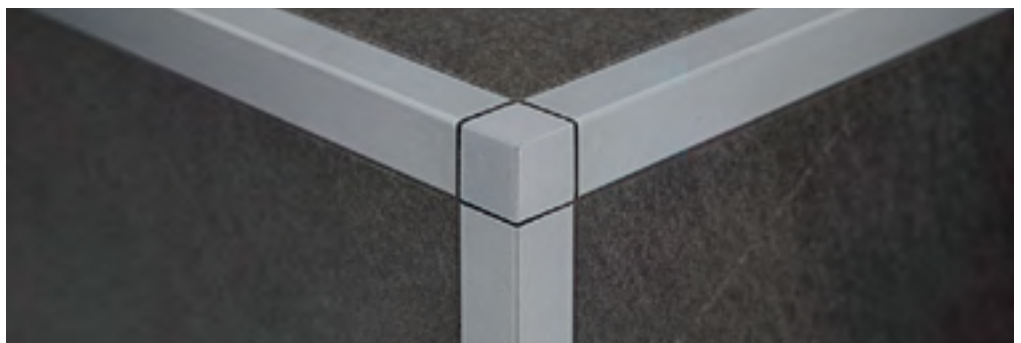

ZQAN/10 + ZQAN/10/EI silver anodized aluminum

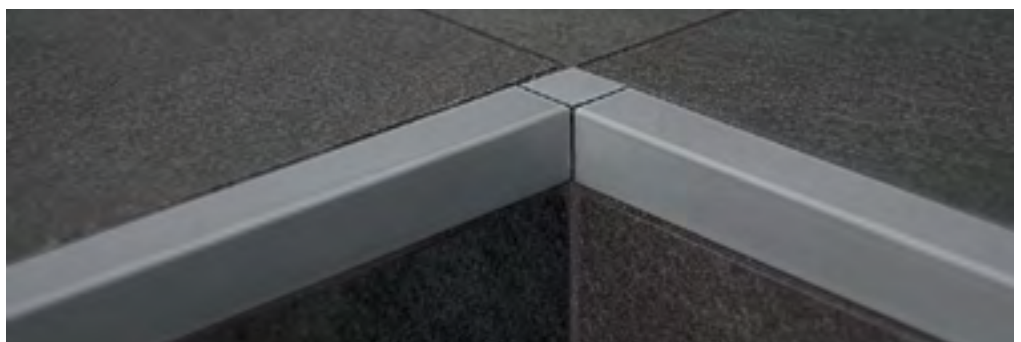

ZQAN/10 + ZQAN/10/EI silver anodized aluminum

To place orders correctly, find the desired model, size and finish. Then place your order by using the letters "PPS" followed by the corresponding 5-digit code.



# Cerfix™ Proangle™ Q

Embossed color-coated aluminum Trend Color Stone: Modern finishes with neutral but warm and soft shades that imitate the heterogeneity of stone thanks to a rough texture.

Color-coated aluminum Trend Color Concrete: Six original cement-effect finishes that emulate typical metropolis colors in a refined way.

Color-coated aluminum Trend Color Metal: Two special metal tonalities that reproduce the iridescent nature of metals.



ZQVN/10 stone color-coated aluminum

## CERFIX PROANGLE Q – TREND COLOR

Length = 8'10" or 2.7 m  
(20 pieces per package)

H

Item	Finish	5/16" (8 mm)	3/8" (10 mm)	7/16" (11 mm)	1/2" (12.5 mm)
------	--------	--------------	--------------	---------------	----------------

### COLOR-COATED ALUMINUM

#### TREND COLOR STONE

Dark brown		89360	89310	89311	89312
Anthracite gray		89093	89095	89106	89097
Ancient gray		89362	89220	89221	89222
Gray		89363	89290	89291	89292
Rust		89094	89096	89107	89098
Bronze		89365	89300	89301	89302
Stone		89366	89280	89281	89282
Greige		89367	89270	89271	89272
Sand		89368	89260	89261	89262
Beige		89369	89250	89251	89252
White stone		89370	89320	89321	89322
Black stone		89371	89330	89331	89332

#### TREND COLOR CONCRETE

Concrete white		-	89131	89161	89181
Concrete graphite		-	89132	89162	89182
Concrete smoke		89372	89133	89163	89183
Concrete mud		-	89134	89164	89184
Concrete sand		-	89135	89165	89185
Solid white		-	89138	89168	89188

#### TREND COLOR METAL

Metal dark		89373	89136	89166	89186
Metal light		-	89137	89167	89187

\$/pc



TREND  
COLOR

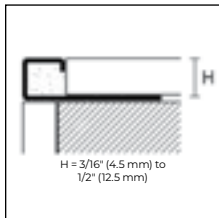

ZQVN/

ZQVN/

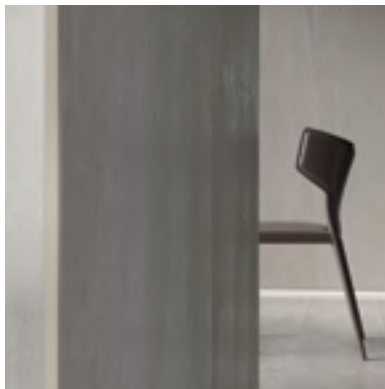

ZQVN/10 concrete white color-coated aluminum

To place orders correctly, find the desired model, size and finish. Then place your order by using the letters "PPS" followed by the corresponding 5-digit code.



Zqvn/ /EI  
sand color-coated  
aluminum



LED-light profiles and skirting boards with  
Trend Color finishes on page 172 and 176

### CERFIX PROANGLE Q – TREND COLOR – OUTSIDE/INSIDE CORNERS AND END CAPS

5 pieces per package		H			
Item	Finish	5/16" (8 mm)	3/8" (10 mm)	7/16" (11 mm)	1/2" (12.5 mm)
<b>COLOR-COATED ALUMINUM</b>					
<b>TREND COLOR STONE</b>					
	Dark brown	89380	89303	89304	89305
	Anthracite gray	89100	89102	89108	89104
	Ancient gray	89382	89213	89214	89215
	Gray	89383	89283	89284	89285
	Rust	89101	89103	89109	89105
	Bronze	89385	89293	89294	89295
	Stone	89386	89273	89274	89275
	Greige	89387	89263	89264	89265
	Sand	89388	89253	89254	89255
	Beige	89389	89243	89244	89245
ZQVN/ /EI	White stone	89390	89340	89341	89342
	Black stone	89391	89350	89351	89352
<b>TREND COLOR CONCRETE</b>					
	Concrete white	-	89392	89402	89410
	Concrete graphite	-	89394	89403	89411
	Concrete smoke	89418	89395	89404	89412
	Concrete mud	-	89396	89405	89413
	Concrete sand	-	89397	89406	89414
	Solid white	-	89400	89409	89417
<b>TREND COLOR METAL</b>					
	Metal dark	89419	89398	89407	89415
	Metal light	-	89399	89408	89416
	<b>\$/pc</b>				

No partial packaging

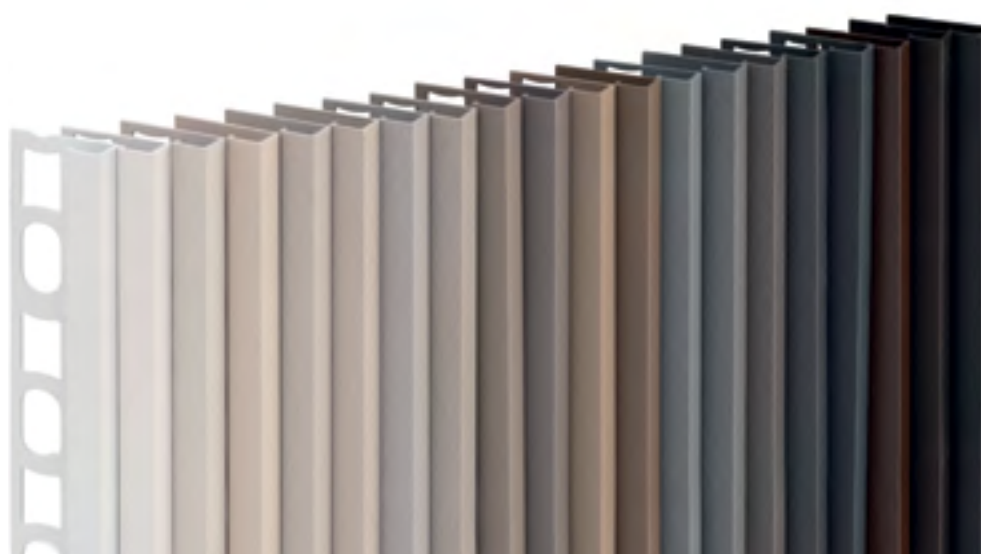

ZQVN/10 Trend Color finishes

To place orders correctly, find the desired model, size and finish. Then place your order by using the letters "PPS" followed by the corresponding 5-digit code.

# Cerfix™ Proangle™ Q

In anodized aluminum, X Design is characterized by a special scratched finish and original colors that allow different chromatic combinations. These are created for interior designers and architects according to the latest trends in modern design.



ZQAND/10 brown anodized aluminum



### CERFIX PROANGLE Q – X DESIGN

Length = 8'10" or 2.7 m  
(20 pieces per package)

		H			
Item	Finish	5/16" (8 mm)	3/8" (10 mm)	1/2" (12.5 mm)	
<b>ANODIZED ALUMINUM</b>					
ZQAND/	Platinum		31110	31112	31114
	Titanium		31120	31122	31124
	Brown		31130	31132	31134
	Dark brown		31140	31142	31144
	Carbon		31150	31152	31154
		<b>\$/pc</b>			

Individually packaged

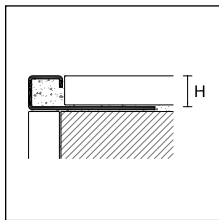

ZQAND/

### CERFIX PROANGLE Q – X DESIGN – OUTSIDE / INSIDE CORNERS / END CAPS

5 pieces per package

		H			
Item	Finish	5/16" (8 mm)	3/8" (10 mm)	1/2" (12.5 mm)	
<b>ANODIZED ALUMINUM</b>					
ZQAND/ /EI	Platinum		31160	31162	31164
	Titanium		31170	31172	31174
	Brown		31180	31182	31184
	Dark brown		31190	31192	31194
	Carbon		31200	31202	31204
		<b>\$/pc</b>			

No partial packaging



ZQAND/ /EI  
brown anodized  
aluminum



To place orders correctly, find the desired model, size and finish. Then place your order by using the letters "PPS" followed by the corresponding 5-digit code.

# Cerfix™ Proangle™ Q

Proangle Q in stainless steel is a line of universal square-shaped profiles. Stainless steel makes these profiles particularly resistant to chemical and atmospheric agents. The AISI 316 quality offers superior resistance to corrosion and is therefore recommended for applications in areas subject to greater chemical stress, such as in swimming pools, food industries and coastal areas.



ZQINP/10 sandblasted stainless steel AISI 304

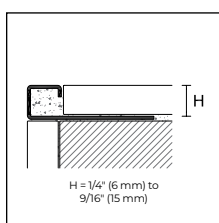

ZQIN/ EI stainless steel AISI 304

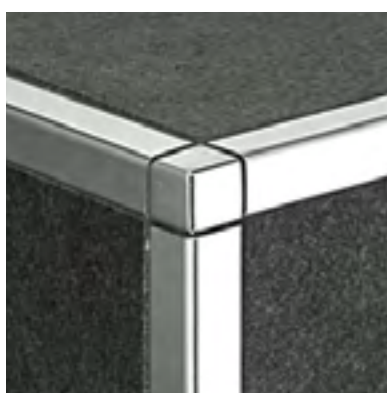

ZQIN/10/EI stainless steel AISI 304

## CERFIX PROANGLE Q

Length = 8'10" or 2.7 m  
(20 pieces per package)

Item	Finish		1/4" (6 mm)	5/16" (8 mm)	11/32" (9 mm)	3/8" (10 mm)	7/16" (11 mm)	1/2" (12.5 mm)	9/16" (15 mm)
<b>STAINLESS STEEL</b>									
ZQIN/	Stainless steel AISI 304		90049	90050	90051	90052	90053	90054	90055
	<b>\$/pc</b>								
ZQINS/	Satin stainless steel AISI 304		90100	90101	90102	90103	90104	90105	90106
ZQINP/	Sandblasted stainless steel AISI 304		90130	90131	90132	90133	90134	90135	90136
	<b>\$/pc</b>								
ZQINX/	Stainless steel AISI 316		-	90107	-	90109	-	90111	-
	<b>\$/pc</b>								

Individually packaged – ZQIN/15, ZQINS/15 and ZQINP/15 packaging of 10 pcs

## CERFIX PROANGLE Q – OUTSIDE/INSIDE CORNERS AND END CAPS

5 pieces per package

Item	Finish		1/4" (6 mm)	5/16" (8 mm)	11/32" (9 mm)	3/8" (10 mm)	7/16" (11 mm)	1/2" (12.5 mm)	9/16" (15 mm)
<b>STAINLESS STEEL</b>									
ZQIN/ EI	Stainless steel AISI 304		90064	90065	90066	90067	90068	90069	90070
	<b>\$/pc</b>								
ZQINS/ EI	Satin stainless steel AISI 304		90112	90113	90114	90115	90116	90117	90118
ZQINP/ EI	Sandblasted stainless steel AISI 304		90137	90138	90139	90140	90141	90142	90143
	<b>\$/pc</b>								
ZQINX/ EI	Stainless steel AISI 316		-	90119	-	90121	-	90123	-
	<b>\$/pc</b>								
<b>METAL</b>									
ZQIM/ EI	Polished stainless steel		-	90092	90093	90094	90095	90096	-
	<b>\$/pc</b>								
ZQIMS/ EI	Satin steel		-	90152	90153	90154	90155	90156	-
	<b>\$/pc</b>								
ZQIMP/ EI	Sandblasted steel		-	90162	90163	90164	90165	90166	-
	<b>\$/pc</b>								

No partial packaging for ZQIM/ EI, ZQIMS/ EI and ZQIMP/ EI

To place orders correctly, find the desired model, size and finish. Then place your order by using the letters "PPS" followed by the corresponding 5-digit code.



# Cerfix™ Proangle™ Q

Proangle Q in polished brass is both classic and modern at the same time and can be easily combined with handles, taps and other furniture accessories of the same material and finish. The chromium-plated version stands out for its brilliance and is perfect as a decorative element in spaces characterized by elegance and attention to detail.



ZQKN/10 chromium-plated brass

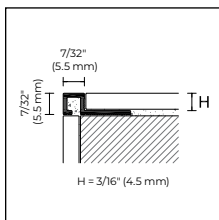

PPDESIGN

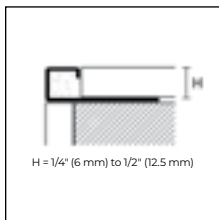

ZQKN /EI chromium-plated brass

## CERFIX PROANGLE Q

Length = 8'10" or 2.7 m  
(20 pieces per package)

Item	Finish		H				
			3/16" (4.5 mm)	5/16" (8 mm)	3/8" (10 mm)	7/16" (11 mm)	1/2" (12.5 mm)
<b>POLISHED BRASS</b>							
ZQLN/	Polished		90022	90056	90057	90063	90058
	\$/pc						
<b>CHROMIUM-PLATED BRASS</b>							
ZQKN/	Chromium-plated		88870	90059	90060	90074	90061
	\$/pc						

Individually packaged – ZQKN/12,5 packaging of 10 pcs

## CERFIX PROANGLE Q – OUTSIDE/INSIDE CORNERS AND END CAPS

Length = 8'10" or 2.7 m  
(5 pieces per package)

Item	Finish		H				
			3/16" (4.5 mm)	5/16" (8 mm)	3/8" (10 mm)	7/16" (11 mm)	1/2" (12.5 mm)
<b>BRASS</b>							
ZQLN/ /EI	Polished		90062	90071	90072	90075	90073
	\$/pc						
ZQKN/ /EI	Chromium-plated		88872	90077	90083	90085	90087
	\$/pc						



ZQLN/10 polished brass

To place orders correctly, find the desired model, size and finish. Then place your order by using the letters "PPS" followed by the corresponding 5-digit code.

# Cerfix™ Proangle™ Q

Proangle Q in coextruded PVC is a line of universal square-shaped profiles specially designed to edge and protect the external corners of ceramic coverings. Thanks to the special section with soft PVC inserts, these profiles absorb the micro-movements and tension of the wall coverings.



ZQP/8 white PVC

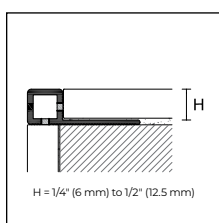

ZQP/



ZQP/8 beige bahama PVC



ZQP/ EI  
white  
polypropylene

## CERFIX PROANGLE Q

Length = 8'10" or 2.7 m

Item	Finish	H				
		1/4" (6 mm)	5/16" (8 mm)	3/8" (10 mm)	1/2" (12.5 mm)	
<b>CO-EXTRUDED PVC</b>						
ZQP/	White		80800	80801	80802	80803
	Cream white RAL 9001		80804	80805	80806	80807
	Ivory RAL 1015		80808	80809	80810	80811
	Beige gray RAL 1019		80812	80813	80814	80815
	Stone gray RAL 7030		80816	80817	80818	80819
	Light gray RAL 7035		80820	80821	80822	80823
	Anthracite		80824	80825	80826	80827
	Beige bahama		80832	80833	80834	80835
	Brown		80836	80837	80838	80839

20 pieces per package

**\$/pc**

No partial packaging

## CERFIX PROANGLE Q – OUTSIDE/INSIDE CORNERS AND END CAPS

12 pieces per package

Item	Finish	H				
		1/4" (6 mm)	5/16" (8 mm)	3/8" (10 mm)	1/2" (12.5 mm)	
<b>POLYPROPYLENE</b>						
ZQP/ EI	White		80850	80851	80852	80853
	Cream white RAL 9001		80854	80855	80856	80857
	Ivory RAL 1015		80858	80859	80860	80861
	Beige gray RAL 1019		80862	80863	80864	80865
	Stone gray RAL 7030		80866	80867	80868	80869
	Light gray RAL 7035		80870	80871	80872	80873
	Anthracite		80874	80875	80876	80877
	Beige bahama		80882	80883	80884	80885
	Brown		80886	80887	80888	80889
	<b>\$/pc</b>					

To place orders correctly, find the desired model, size and finish. Then place your order by using the letters "PPS" followed by the corresponding 5-digit code.

Colors available on demand – minimum quantity 1,000 pieces

# Cerfix™ Proangle™

Proangle in aluminum is a line of profiles for edging and protecting the external corners of ceramic coverings. Its L shape clearly outlines atile coverings, such as rectified porcelain stoneware. Available in different colors and finishes, Proangle can also be used as decorative element, creating refined and pleasant combination/contrast effects with a wide variety of coverings. ZQVNH/ boasts the certified antibacterial technology (according to the internationally recognized laboratory test JIS Z 2801:2000) that reduces the presence of the most dangerous bacteria up to 99%, thus ensuring the best hygiene over time.

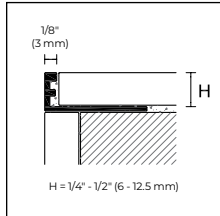
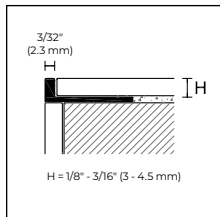

## CERFIX PROANGLE

Length = 8'10" or 2.7 m  
(20 pieces per package)

Item	Finish	H								
		1/8" (3 mm)	3/16" (4.5 mm)	1/4" (6 mm)	5/16" (8 mm)	11/32" (9 mm)	3/8" (10 mm)	7/16" (11 mm)	1/2" (12.5 mm)	
<b>ALUMINUM</b>										
ZA/	Silver anodized		90338	90340	88204	88205	88217	88206	88218	88207
	Gold anodized		-	-	-	-	-	88251	-	88252
	Titanium anodized		-	-	88253	88254	-	88255	88257	88256
ZA/	Black anodized		-	-	-	88265	-	88266	88267	88268
ZB/	Bright polished silver		-	88260	88294	88295	-	88296	88220	88297
ZB/	Bright polished gold		-	88261	88339	88340	-	88341	-	88342
	Bright polished titanium		-	90341	88344	88345	-	88346	88348	88347
	Bright polished black		-	-	-	88223	-	88224	-	88225
ZBS/	Bright satin silver		-	-	88349	88350	-	88356	88357	88358
ZTM/	Bright satin titanium		-	-	-	88351	-	88359	88360	88361
ZBS/	Bright satin black		-	-	-	-	-	88353	88354	88355
<b>COLOR-COATED ALUMINUM</b>										
ZV/	Color-coated matte white RAL 9003		-	-	-	88395	-	88396	88435	88397
	Color-coated white RAL 9003		-	-	88384	88385	-	88386	88436	88387
<b>ANTIBACTERIAL COLOR-COATED ALUMINUM</b>										
ZVH/	Color-coated white RAL 9003		-	-	-	88390	-	88392	-	88394

Individually packaged

To place orders correctly, find the desired model, size and finish. Then place your order by using the letters "PPS" followed by the corresponding 5-digit code.

Proangle: for different heights up to 1" (2.5 cm) please see page 16-17

Items ZA-AI bendable version: See page 163



ZA/10 black anodized aluminum



ZA/10 titanium anodized aluminum

# Cerfix™ Proangle™

Color-coated aluminum Trend Color Stone: Modern finishes with neutral but warm and soft shades that imitate the heterogeneity of stone thanks to a rough texture.

Color-coated aluminum Trend Color Concrete: Six original cement-effect finishes that emulate typical metropolis colors in a refined way.

Color-coated aluminum Trend Color Metal: Two special metal tonalities that reproduce the iridescent nature of metals.



ZV/10 beige color-coated aluminum



TREND  
COLOR

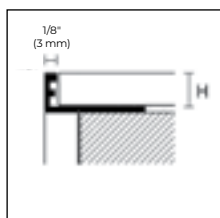

ZV/



ZV/10 white stone color-coated aluminum

## CERFIX PROANGLE – TREND COLOR

Length = 8'10" or 2.7 m  
(20 pieces per package)

Item	Finish	H			
		5/16" (8 mm)	3/8" (10 mm)	7/16" (11 mm)	1/2" (12.5 mm)
<b>COLOR-COATED ALUMINUM</b>					
<b>TREND COLOR STONE</b>					
	Dark brown	88446	88407	88417	88481
	Anthracite gray	88447	88398	88408	88482
	Ancient gray	88448	88400	88410	88483
	Gray	88449	88405	88415	88484
	Rust	88450	88399	88409	88485
	Bronze	88451	88406	88416	88486
	Stone	88452	88404	88414	88491
	Greige	88453	88403	88413	88492
	Sand	88454	88402	88412	88493
	Beige	88455	88401	88411	88494
ZV/	White stone	88456	88428	88433	88495
	Black stone	88457	88429	88434	88496
<b>TREND COLOR CONCRETE</b>					
	Concrete white	88469	88437	88461	88497
	Concrete graphite	88470	88438	88462	88498
	Concrete smoke	88471	88439	88463	88499
	Concrete mud	88472	88440	88464	88500
	Concrete sand	88473	88441	88465	88501
	Solid white	88478	88460	88468	88502
<b>TREND COLOR METAL</b>					
	Metal dark	88479	88458	88466	88503
	Metal light	88480	88459	88467	88504
<b>\$/pc</b>					

Individually packaged

LED-light profiles and skirting boards with Trend Color finishes on page 172 and 176.

To place orders correctly, find the desired model, size and finish. Then place your order by using the letters "PPS" followed by the corresponding 5-digit code.



# Cerfix™ Proangle™

Proangle in stainless steel is a line of profiles for edging and protecting the external corners of ceramic coverings. Its L shape clearly outlines tile coverings, such as as rectified porcelain stoneware.

Stainless steel makes these profiles particularly resistant to chemical and atmospheric agents. The AISI 316 quality offers superior resistance to corrosion and is therefore recommended for applications in areas subject to greater chemical stress, such as in swimming pools, food industries and coastal areas.



AI/10 stainless steel AISI 304

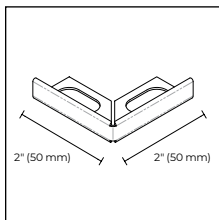
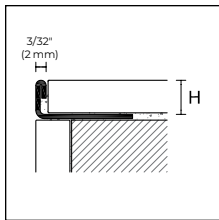

AI//E  
AIS//E



AI//E stainless steel AISI 304

## CERFIX PROANGLE

Length = 8'10" or 2.7 m  
(20 pieces per package)

Item	Finish	H								
		1/8" (3 mm)	3/16" (4.5 mm)	1/4" (6 mm)	5/16" (8 mm)	11/32" (9 mm)	3/8" (10 mm)	7/16" (11 mm)	1/2" (12.5 mm)	
<b>STAINLESS STEEL</b>										
AI/	Stainless steel AISI 304		91636	91638	91642	91644	91645	91646	91647	91648
	<b>\$/pc</b>									
AIL/	Superpolished stainless steel AISI 304		-	91690	-	91694	-	91696	-	91698
	<b>\$/pc</b>									
AIS/	Satin stainless steel AISI 304		-	91671	91673	91674	-	91675	91677	91676
	<b>\$/pc</b>									
AIP/	Sandblasted stainless steel AISI 304		-	-	91700	91702	-	91704	91705	91706
	<b>\$/pc</b>									
AIX/	Stainless steel AISI 316		-	-	91684	91685	-	91686	91688	91687
	<b>\$/pc</b>									

Individually packaged

## CERFIX PROANGLE – OUTSIDE CORNER

5 pieces per package

Item	Finish	H								
		1/8" (3 mm)	3/16" (4.5 mm)	1/4" (6 mm)	5/16" (8 mm)	11/32" (9 mm)	3/8" (10 mm)	7/16" (11 mm)	1/2" (12.5 mm)	
<b>STAINLESS STEEL</b>										
AI//E	Stainless steel AISI 304		-	-	-	-	-	91663	91664	91665
	<b>\$/pc</b>									
AIS//E	Satin stainless steel AISI 304		-	-	-	-	-	91680	91681	91682
	<b>\$/pc</b>									

To place orders correctly, find the desired model, size and finish. Then place your order by using the letters "PPS" followed by the corresponding 5-digit code.

# Cerfix™ Proangle™

Proangle ZK and Prodecor DJK are two L-shaped profiles in chromium-plated brass, with different sections, designed for edging and protecting the external corners of ceramic coverings. The chromium-plated version stands out for its brilliance and is perfect as a decorative element in spaces characterized by elegance and attention to detail.



Proangle ZK/ chromium-plated brass



PPDESIGN

## CERFIX PROANGLE

Length = 8'10" or 2.7 m  
(20 pieces per package)

Item	Finish	3/16" (4.5 mm)	1/4" (6 mm)	5/16" (8 mm)	11/32" (9 mm)	3/8" (10 mm)	7/16" (11 mm)	1/2" (12.5 mm)
------	--------	-------------------	----------------	-----------------	------------------	-----------------	------------------	-------------------

### CHROMIUM-PLATED BRASS

ZK/	Chromium-plated	90081	88114	88115	-	88116	88118	88117
	<b>\$/pc</b>							

Individually packaged

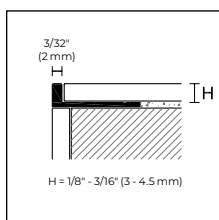

ZK/

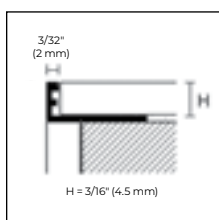

ZK/



PPDESIGN

## CERFIX PRODECOR DJ

Length = 8'10" or 2.7 m  
(20 pieces per package)

Item	Finish	5/16" (8 mm)	3/8" (10 mm)	1/2" (12.5 mm)	9/16" (15 mm)	3/4" (20 mm)
------	--------	-----------------	-----------------	-------------------	------------------	-----------------

### CHROMIUM-PLATED BRASS

DJK/	Chromium-plated	95700	95702	95704	95703	95705
	<b>\$/pc</b>					

Individually packaged. Item DJK/20 pack 10 pcs

### CERFIX PRODECOR DJ – OUTSIDE AND INSIDE CORNERS

5 pieces per package

Item	Finish	5/16" (8 mm)	3/8" (10 mm)	1/2" (12.5 mm)	9/16" (15 mm)	3/4" (20 mm)
------	--------	-----------------	-----------------	-------------------	------------------	-----------------

### CHROMIUM-PLATED BRASS

DJK/ /EI	Chromium-plated	95706	95707	95708	95709	95710
	<b>\$/pc</b>					

No partial packaging

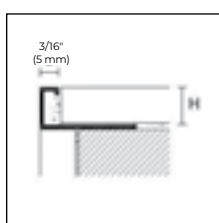

DJK/



DJK/ /EI



Prodecor DJK/ chromium-plated brass

To place orders correctly, find the desired model, size and finish. Then place your order by using the letters "PPS" followed by the corresponding 5-digit code.



# Cerfix™ Protrim IP

Protrim IP are minimalist profiles in aluminum or stainless steel, suitable for the edging of external corners that need the 45 degrees cut. Protrim IP profiles protect the edge of mitered tiles from chipping.

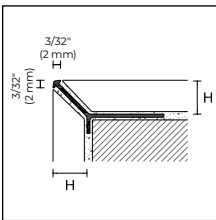

IPA/  
IPB/  
IPV/

TREND  
COLOR



IPV/11 beige color-coated aluminum

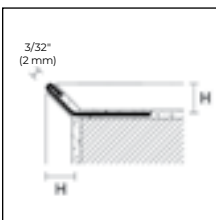

IPI/

## CERFIX PROTRIM IP

Length = 8'10" or 2.7 m  
(20 pieces per package)

Item	Finish		3/16" (4.5 mm)	5/16" (8 mm)	7/16" (11 mm)	9/16" (15 mm)
<b>ALUMINUM</b>						
IPA/	Silver anodized		95006	95178	95181	95185
	<b>\$/pc</b>					
IPB/	Bright polished silver		95008	-	-	-
	<b>\$/pc</b>					

Individually packaged

## CERFIX PROTRIM IP – TREND COLOR STONE

Length = 8'10" or 2.7 m  
(20 pieces per package)

Item	Finish		7/16" (11 mm)
<b>COLOR-COATED ALUMINUM</b>			
<b>TREND COLOR STONE</b>			
IPV/	Dark brown		95182
	Anthracite gray		95183
	Ancient gray		95184
	Grey		95186
	Rust		95187
	Bronze		95188
	Stone		95189
	Creige		95190
	Sand		95191
	Beige		95192
	White stone		95193
	Black stone		95194
	<b>\$/pc</b>		

## CERFIX PROTRIM IP

Length = 8'10" or 2.7 m  
(20 pieces per package)

Item	Finish		9/32" (7 mm)	5/16" (8 mm)	7/16" (11 mm)	1/2" (12.5 mm)
<b>STAINLESS STEEL</b>						
IPI/	Stainless steel AISI 304		95169	95170	95173	95174
	<b>\$/pc</b>					

Individually packaged

To place orders correctly, find the desired model, size and finish. Then place your order by using the letters "PPS" followed by the corresponding 5-digit code.



# Cerfix™ Protrim

Protrim in aluminum is a line of profiles with rounded shape, specially designed to edge and protect the external corners of ceramic coverings. Their shape also acts as symmetric finishing and helps to prevent accidents. RVH/ boasts the certified antibacterial technology (according to the internationally recognized laboratory test JIS Z 2801:2000) that reduces the presence of the most dangerous bacteria up to 99%, thus ensuring the best hygiene over time.



RA/10 silver anodized aluminum

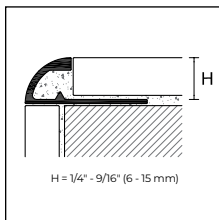
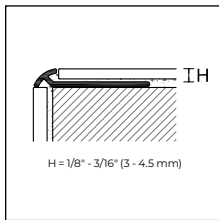

## CERFIX PROTRIM

Length = 8'10" or 2.7 m  
(20 pieces per package)

Item	Finish	H								
		1/8" (3 mm)	3/16" (4.5 mm)	1/4" (6 mm)	5/16" (8 mm)	3/8" (10 mm)	7/16" (11 mm)	1/2" (12.5 mm)	9/16" (15 mm)	
<b>ALUMINUM</b>										
RA/	Silver anodized	92055	92056	92070	92072	92074	92060	92076	92078	
	Gold anodized	92025	92026	92040	92042	92044	-	92046	-	
	Titanium anodized	92085	92086	92087	92090	92094	-	92096	-	
RB/	Bright polished silver	92315	92316	92310	92312	92314	92061	92318	-	
RB/	Bright polished gold	92325	92326	92340	92342	92344	-	92348	-	
RT/	Bright polished titanium	92015	92016	92018	92020	92022	-	92023	-	
RAS/	Bright satin silver	92050	92051	92071	92073	92075	92062	92077	-	
	Bright satin gold	-	-	92041	92043	92045	-	92047	-	
RTM/	Bright satin titanium	92053	92057	92064	92066	92068	-	92079	-	
<b>COLOR-COATED ALUMINUM</b>										
RV/	Matte white RAL 9003	-	-	-	92107	92108	92109	92110	-	
	White RAL 9003	-	-	92100	92102	92104	92111	92106	-	
<b>ANTIBACTERIAL COLOR-COATED ALUMINUM</b>										
RVH/	White RAL 9003	-	-	-	92112	92114	-	92116	-	

Individually packaged



RAS/10 bright satin silver aluminum

To place orders correctly, find the desired model, size and finish. Then place your order by using the letters "PPS" followed by the corresponding 5-digit code.

Items PV/ available in different colors on demand - minimum quantity 200 pcs for color



TA/ silver anodized aluminum

**CERFIX PROTRIM – OUTSIDE CORNER**

		5 pieces per package					
Item	Finish	H					
		1/4" (6 mm)	5/16" (8 mm)	3/8" (10 mm)	7/16" (11 mm)	1/2" (12.5 mm)	
<b>ALUMINUM</b>							
TA/	Silver anodized		92606	92608	92610	92600	92612
	Gold anodized		92614	92616	92618	-	92619
	Titanium anodized		92564	92566	92568	-	92569
<b>\$/pc</b>							
TB/	Bright polished silver		92690	92692	92694	92601	92696
	Bright polished gold		92700	92702	92704	-	92706
TAT/	Bright polished titanium		92724	92726	92728	-	92729
<b>\$/pc</b>							
TAS/	Bright satin silver		92710	92711	92712	92602	92713
	Bright satin gold		92720	92721	92722	-	92723
TATM/	Bright satin titanium		92714	92716	92718	-	92773
<b>\$/pc</b>							
<b>COLOR-COATED ALUMINUM</b>							
TV/	Matte white RAL 9003		-	92636	92637	92638	92639
	White RAL 9003		92620	92622	92624	92628	92626
<b>\$/pc</b>							

No partial packaging



TIA/ silver anodized aluminum

**CERFIX PROTRIM – INSIDE CORNER**

		5 pieces per package					
Item	Finish	H					
		1/4" (6 mm)	5/16" (8 mm)	3/8" (10 mm)	7/16" (11 mm)	1/2" (12.5 mm)	
<b>ALUMINUM</b>							
TIA/	Silver anodized		92570	92571	92572	92603	92573
	Gold anodized		92575	92576	92577	-	92578
	Titanium anodized		92554	92555	92556	-	92558
<b>\$/pc</b>							
TIB/	Bright polished silver		92580	92581	92582	92604	92583
	Bright polished gold		92585	92586	92587	-	92588
TIAT/	Bright polished titanium		92730	92732	92734	-	92736
<b>\$/pc</b>							
TIAS/	Bright satin silver		92550	92551	92552	92605	92553
	Bright satin gold		92560	92561	92562	-	92563
<b>\$/pc</b>							
<b>COLOR-COATED ALUMINUM</b>							
TIV/	Matte white RAL 9003		-	92646	92647	92648	92649
	White RAL 9003		92621	92623	92625	92629	92627
<b>\$/pc</b>							

No partial packaging



RA/10+TA/10+TIA/10 silver anodized aluminum

To place orders correctly, find the desired model, size and finish. Then place your order by using the letters "PPS" followed by the corresponding 5-digit code.

# Cerfix™ Protrim

Protrim line is dedicated to the protection of corners where ceramic tiles have been installed. Using Protrim is the perfect alternative to the fragile mitered corner installation.



RV color-coated aluminum

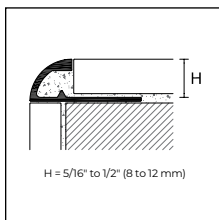











TV/



TIV/

### CERFIX PROTRIM











Length = 8'10" or 2.7 m  
(20 pieces per package)

		H			
Item	Finish	5/16" (8 mm)	3/8" (10 mm)	1/2" (12.5 mm)	
<b>ALUMINUM</b>					
RA/	Black anodized		92059	92063	92083
	<b>\$/pc</b>				
<b>TREND COLOR STONE</b>					
	Dark brown		92135	92255	92369
	Ancient gray		92136	92256	92370
	Gray		92137	92257	92371
RV/	Bronze		92138	92258	92372
	Stone		92139	92259	92373
	Griege		92195	92364	92374
	Beige		92196	92365	92375
	Black stone		92197	92366	92376
	<b>\$/pc</b>				
<b>TREND COLOR CONCRETE</b>					
RV/	Concrete smoke		92198	92367	92377
	<b>\$/pc</b>				
<b>TREND COLOR METAL</b>					
RV/	Metal dark		92199	92368	92378
	<b>\$/pc</b>				

Individually packaged

### CERFIX PROTRIM – EXTERNAL CORNERS











5 pieces per package

		H			
Item	Finish	5/16" (8 mm)	3/8" (10 mm)	1/2" (12.5 mm)	
<b>ALUMINUM</b>					
RA/	Black anodized		92613	92656	92657
	<b>\$/pc</b>				
<b>TREND COLOR STONE</b>					
	Dark brown		92676	92699	92780
	Ancient gray		92677	92737	92781
	Gray		92678	92738	92782
RV/	Bronze		92679	92739	92783
	Stone		92686	92774	92784
	Griege		92687	92775	92785
	Beige		92688	92776	92786
	Black stone		92689	92777	92787
	<b>\$/pc</b>				
<b>TREND COLOR CONCRETE</b>					
RV/	Concrete smoke		92697	92778	92788
	<b>\$/pc</b>				
<b>TREND COLOR METAL</b>					
RV/	Metal dark		92698	92779	92789
	<b>\$/pc</b>				

No partial packaging

To place orders correctly, find the desired model, size and finish. Then place your order by using the letters "PPS" followed by the corresponding 5-digit code.

**CERFIX PROTRIM – INTERNAL CORNERS**

5 pieces per package		H			
Item	Finish	5/16" (8 mm)	3/8" (10 mm)	1/2" (12.5 mm)	
<b>ALUMINUM</b>					
RA/	Black anodized		92579	92589	92591
	\$/pc				
<b>TREND COLOR STONE</b>					
	Dark brown		92806	92845	92860
	Ancient gray		92807	92846	92861
	Gray		92808	92847	92862
RV/	Bronze		92809	92848	92863
	Stone		92839	92849	92864
	Griege		92840	92855	92865
	Beige		92841	92856	92866
	Black stone		92842	92857	92867
	\$/pc				
<b>TREND COLOR CONCRETE</b>					
RV/	Concrete smoke		92843	92858	92868
	\$/pc				
<b>TREND COLOR METAL</b>					
RV/	Metal dark		92844	92859	92869
	\$/pc				

No partial packaging

To place orders correctly, find the desired model, size and finish. Then place your order by using the letters "PPS" followed by the corresponding 5-digit code.



# Cerfix™ Protrim

Protrim in stainless steel is a line of rounded-shape profiles specially designed to edge and protect the external corners of ceramic coverings and also recommended for floors, steps and countertops. The AISI 304 versions are recommended for food industries, kitchens, hospitals and outdoor spaces, while the AISI 316 versions are suggested for such difficult applications as swimming pools, spas and sites exposed to salt.



RI/10 stainless steel AISI 304

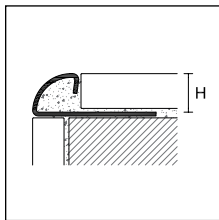

RIL/10 + TIEL/10 superpolished stainless steel



RIL/10 + TIIL/10 superpolished stainless steel

### CERFIX PROTRIM

Length = 8'10" or 2.7 m  
(20 pieces per package)

Item	Finish	H							
		3/16" (4.5 mm)	1/4" (6 mm)	5/16" (8 mm)	11/32" (9 mm)	3/8" (10 mm)	7/16" (11 mm)	1/2" (12.5 mm)	9/16" (15 mm)
<b>STAINLESS STEEL</b>									
RI/	Stainless steel AISI 304 \$/pc	92413	92420	92422	92423	92424	92425	92426	92428
RIL/	Superpolished stainless steel AISI 304 \$/pc	92415	92416	92417	-	92418	-	92419	-
RIS/	Satin stainless steel AISI 304 \$/pc	-	92430	92431	92438	92432	92439	92433	92434
RIP/	Sandblasted stainless steel AISI 304 \$/pc	-	92450	92451	92452	92453	92454	92455	-
RIX/	Stainless steel AISI 316 \$/pc	92405	92406	92407	92410	92408	92411	92409	-

Individually packaged - art. RI/15 pack 10 pcs

### CERFIX PROTRIM – OUTSIDE CORNER – 5 pieces per package

TIE/	Stainless steel AISI 304 \$/pc	92750	92480	92481	92751	92482	92752	92483	92484
TIEL/	Superpolished stainless steel AISI 304 \$/pc	92790	92792	92794	-	92798	-	92802	-
TIES/	Satin stainless steel AISI 304 \$/pc	-	92485	92486	92753	92487	92754	92488	92489
TIEP/	Sandblasted stainless steel AISI 304 \$/pc	-	92510	92511	92512	92513	92514	92515	-
TIEX/	Stainless steel AISI 316 \$/pc	92500	92501	92502	92755	92503	92756	92504	-

### CERFIX PROTRIM – INSIDE CORNER – 5 pieces per package

TII/	Stainless steel AISI 304 \$/pc	92759	92490	92491	92757	92492	92758	92493	92494
TIIL/	Stainless steel superpolished AISI 304 \$/pc	92791	92793	92795	-	92799	-	92803	-
TIIS/	Satin stainless steel AISI 304 \$/pc	-	92495	92496	92760	92497	92761	92498	92499
TIIP/	Sandblasted stainless steel AISI 304 \$/pc	-	92516	92517	92518	92519	92520	92521	-
TIIX/	Stainless steel AISI 316 \$/pc	92505	92506	92507	92762	92508	92763	92509	-

To place orders correctly, find the desired model, size and finish. Then place your order by using the letters "PPS" followed by the corresponding 5-digit code.

METAL		5/16" (8 mm)	3/8" (10 mm)	7/16" (11 mm)
<b>OUTSIDE CORNER – 5 pieces per package</b>				
TIME/ \$/pc	Polished stainless steel	92960	92964	92966
<b>INSIDE CORNER – 5 pieces per package</b>				
TIMI/ \$/pc	Polished stainless steel	92970	92974	92976

No partial packaging



RIN/10 stainless steel AISI 304

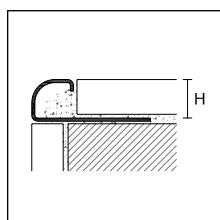

RIN/  
RINS/  
RINX/



TIEN/ stainless  
steel AISI 304



TIIN/ stainless steel  
AISI 304

**CERFIX PROTRIM N**

Length = 8"10" or 2.7 m  
(20 pieces per package)

		H		
Item	Finish	5/16" (8 mm)	3/8" (10 mm)	1/2" (12.5 mm)
<b>STAINLESS STEEL</b>				
RIN/	Stainless steel AISI 304 \$/pc	92353	92356	92359
RINS/	Satin stainless steel AISI 304 \$/pc	92354	92357	92360
RINX/	Stainless steel AISI 316 \$/pc	92355	92358	92361

Individually packaged

**CERFIX PROTRIM N – OUTSIDE CORNER – 5 pieces per package**

TIEN/	Stainless steel AISI 304 \$/pc	92813	92816	92819
TIENS/	Satin stainless steel AISI 304 \$/pc	92814	92817	92820
TIENX/	Stainless steel AISI 316 \$/pc	92815	92818	92821

**CERFIX PROTRIM N – INSIDE CORNER – 5 pieces per package**

TIIN/	Stainless steel AISI 304 \$/pc	92828	92831	92834
TIINS/	Satin stainless steel AISI 304 \$/pc	92829	92832	92835
TIINX/	Stainless steel AISI 316 \$/pc	92830	92833	92836

To place orders correctly, find the desired model, size and finish. Then place your order by using the letters "PPS" followed by the corresponding 5-digit code.

# Cerfix™ Protrim

Protrim in polished brass is both classic and modern at the same time and can be easily combined with handles, taps and other furniture accessories of the same material and finish. The chromium-plated version stands out for its brilliance and is perfect as a decorative element in spaces characterized by elegance and attention to detail.



RKN/10 chromium-plated brass



PPDESIGN

### CERFIX PROTRIM

Length = 8"10" or 2.7 m  
(20 pieces per package)

		H				
Item	Finish	1/4" (6 mm)	5/16" (8 mm)	3/8" (10 mm)	1/2" (12.5 mm)	
<b>POLISHED BRASS</b>						
RLN/	Polished		92465	92466	92467	92468
	\$/pc					
<b>CHROMIUM-PLATED BRASS</b>						
RKN/	Chromium plated		92469	92470	92471	92472
	\$/pc					

Individually packaged. Items RLN/10, RLN/12,5, RKN/10, RKN/12,5 packaging of 10 pcs

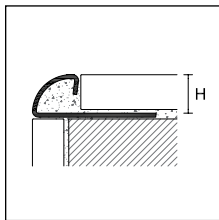

RLN/  
RKN/



TIEL/



TIIL/

### CERFIX PROTRIM – OUTSIDE/INSIDE CORNERS

5 pieces per package

		H				
Item	Finish	1/4" (6 mm)	5/16" (8 mm)	3/8" (10 mm)	1/2" (12.5 mm)	
<b>OUTSIDE CORNERS FOR RLN/ ARTICLES</b>						
<b>ALUMINUM</b>						
TB/	Bright polished gold		92700	92702	92704	92706
	\$/pc					
<b>INSIDE CORNERS FOR RLN/ ARTICLES</b>						
<b>ALUMINUM</b>						
TIB/	Bright polished gold		92585	92586	92587	92588
	\$/pc					

No partial packaging

5 pieces per package

OUTSIDE CORNERS IN SUPERPOLISHED STAINLESS STEEL FOR RKN/ ITEMS

<b>STAINLESS STEEL</b>						
TIEL/	Superpolished stainless steel AISI 304		92792	92794	92798	92802
	\$/pc					

INSIDE CORNERS IN SUPERPOLISHED STAINLESS STEEL FOR RKN/ ITEMS

<b>STAINLESS STEEL</b>						
TIIL/	Superpolished stainless steel AISI 304		92793	92795	92799	92803
	\$/pc					

To place orders correctly, find the desired model, size and finish. Then place your order by using the letters "PPS" followed by the corresponding 5-digit code.

## Cerfix™ Protrim

Protrim in coextruded PVC is a line of round-shaped profiles specially designed to edge and protect the external corners of ceramic coverings. Their shape also acts as symmetric finishing and helps to prevent accidents. Thanks to the special section with soft PVC inserts, these profiles absorb the micro-movements and tension of the wall coverings. Mass-dye colored and available in many colors, these profiles can be used in the most varied spaces.

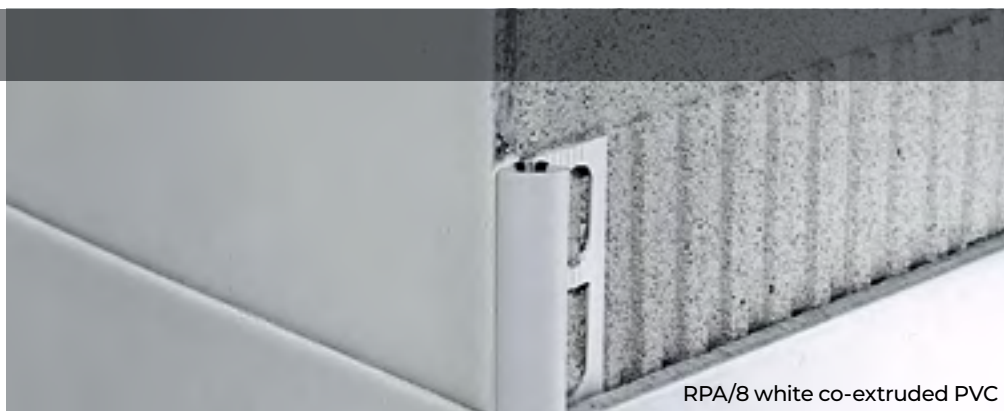

RPA/8 white co-extruded PVC

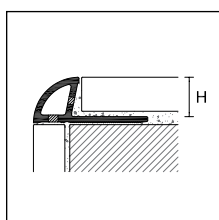

RPA/

### CERFIX PROTRIM

Length = 8'10" or 2.7 m  
(20 pieces per package)

		H		
		CO-EXTRUDED PVC		
Item	Finish	1/4" (6 mm)	5/16" (8 mm)	3/8" (10 mm)
RPA/	Snow white	80640	80641	80642
	White	80644	80645	80646
	Cream white RAL 9001	80648	80649	80650
	Ivory RAL 1015	80652	80653	80654
	Beige gray RAL 1019	80656	80657	80658
	Stone gray RAL 7030	80660	80661	80662
	Ash gray RAL 7038	80664	80665	80666
	Light gray RAL 7035	80668	80669	80670
	Beige bahama	80680	80681	80682
	Brown	80692	80693	80694

\$/pc

No partial packaging

### CERFIX PROTRIM

12 pieces per package

		H					
		TPAE/			TPAI/		
		POLYPROPYLENE					
		OUTSIDE CORNER			INSIDE CORNER		
Finish		1/4" (6 mm)	5/16" (8 mm)	3/8" (10 mm)	1/4" (6 mm)	5/16" (8 mm)	3/8" (10 mm)
Snow white	80700	80701	80702	80702	80753	80751	80752
White	80703	80704	80705	80705	80750	80754	80755
Cream white RAL 9001	80706	80707	80708	80708	80756	80757	80758
Ivory RAL 1015	80709	80710	80711	80711	80759	80760	80761
Beige gray RAL 1019	80712	80713	80714	80714	80762	80763	80764
Stone gray RAL 7030	80715	80716	80717	80717	80765	80766	80767
Ash gray RAL 7038	80718	80719	80720	80720	80768	80769	80770
Light gray RAL 7035	80721	80722	80723	80723	80771	80772	80773
Beige bahama	80730	80731	80732	80732	80780	80781	80782
Brown	80739	80740	80741	80741	80789	80790	80791

\$/pc

To place orders correctly, find the desired model, size and finish. Then place your order by using the letters "PPS" followed by the corresponding 5-digit code.



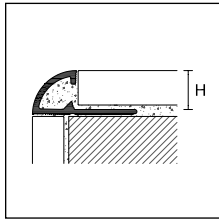

RE/



RE/8 PVC red RAL 3002

To place orders correctly, find the desired model, size and finish. Then place your order by using the letters "PPS" followed by the corresponding 5-digit code.

**CERFIX PROTRIM**

Length = 8'10" or 2.7 m  
(20 pieces per package)

		H			
		PVC			
Item	Finish	1/4" (6 mm)	5/16" (8 mm)	3/8" (10 mm)	1/2" (12.5 mm)
	Snow white	79996	79997	79998	79999
	White	80100	80101	80102	80103
	Cream white RAL 9001	80104	80105	80106	80107
	Ivory RAL 1015	80108	80109	80110	-
	Beige gray RAL 1019	80112	80113	80114	-
	Stone gray RAL 7030	80116	80117	80118	-
	Ash gray RAL 7038	80120	80121	80122	-
	Light gray RAL 7035	80124	80125	80126	80127
	Anthracite	80175	80176	80177	-
	Blue	80160	80161	80162	-
	Pastel blue	80140	80141	80142	-
	Light green	80179	80180	80181	-
RE/	Red RAL 3002	80128	80129	80130	-
	Black RAL 9005	80132	80133	80134	-
	Yellow RAL 1023	80136	80137	80138	-
	Pastel pink	80144	80145	80146	-
	Beige bahama	80150	80151	80152	-
	Peach	80154	80155	80156	-
	Caramel	80164	80165	80166	-
	Brown	80168	80169	80170	-
	Dark brown	80172	80173	80174	-
	Coral red	80187	80188	80189	-
	Raw sienna	80191	80192	80193	-
	Terracotta	80195	80362	80194	-
<b>\$/pc</b>					

**CERFIX PROTRIM**

12 pieces per package

		H				H			
		TE/				TEI/			
Finish		POLYPROPYLENE							
		OUTSIDE CORNER				INSIDE CORNER			
		1/4" (6 mm)	5/16" (8 mm)	3/8" (10 mm)	1/2" (12.5 mm)	1/4" (6 mm)	5/16" (8 mm)	3/8" (10 mm)	1/2" (12.5 mm)
	Snow white	80396	80397	80398	80399	79800	79801	79802	79803
	White	80400	80401	80402	80403	79804	79805	79806	79807
	Cream white RAL 9001	80404	80405	80406	80407	79808	79809	79810	79811
	Ivory RAL 1015	80408	80409	80410	-	79812	79813	79814	-
	Beige gray RAL 1019	80412	80413	80414	-	79816	79817	79818	-
	Stone gray RAL 7030	80416	80417	80418	-	79820	79821	79822	-
	Ash gray RAL 7038	80420	80421	80422	-	79824	79825	79826	-
	Light gray RAL 7035	80424	80425	80426	80427	79828	79829	79830	79831
	Anthracite	80479	80480	80481	-	79875	79876	79877	-
	Blue	80470	80471	80472	-	79848	79849	79850	-
	Pastel blue	80440	80441	80442	-	79844	79845	79846	-
	Light green	80475	80476	80477	-	79879	79880	79881	-
	Red RAL 3002	80428	80429	80430	-	79832	79833	79834	-
	Black RAL 9005	80432	80433	80434	-	79836	79837	79838	-
	Yellow RAL 1023	80436	80437	80438	-	79840	79841	79842	-
	Pastel pink	80444	80445	80446	-	79852	79853	79854	-
	Beige bahama	80448	80449	80450	-	79856	79857	79858	-
	Peach	80452	80453	80454	-	79860	79861	79862	-
	Caramel	80458	80459	80460	-	79864	79865	79866	-
	Brown	80462	80463	80464	-	79868	79869	79870	-
	Dark brown	80466	80467	80468	-	79872	79873	79874	-
	Coral red	80483	80484	80485	-	79887	79888	79889	-
	Raw sienna	80487	80488	80489	-	79891	79892	79893	-
	Terracotta	80491	80492	80493	-	79895	79896	79897	-
<b>\$/pc</b>									

No partial packaging

To place orders correctly, find the desired model, size and finish. Then place your order by using the letters "PPS" followed by the corresponding 5-digit code.

# Cerfix™ Protrim Eco

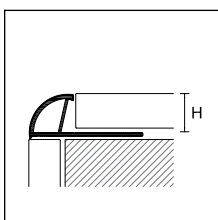







RECO/

## PROTRIM ECO

Length = 8'6" or 2.6 m  
(80 pieces per package)

H

Item	Finish	1/4" (6 mm)	5/16" (8 mm)	3/8" (10 mm)	
	Snow white		79400	79401	79402
	White		79403	79404	79405
	Cream white RAL 9001		79406	79407	79408
	Ivory RAL 1015		79409	79410	79411
RECO/ /80	Ash gray RAL 7038		79412	79413	79414
	Light gray RAL 7035		79415	79416	79417
	Beige bahama		79418	79419	79420
	<b>\$/pc</b>				

No partial packaging

Other colors upon request for a minimum 1,000 pieces per color

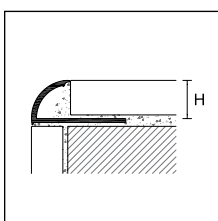









REC/

## PROTRIM ECO

Width = 8'6" or 2.6 m  
(100 pieces per package)

ECOLINE PVC

Item	Finish	5/16" (8 mm)	3/8" (10 mm)	
	Snow white		79601/100	79602/100
	Cream white RAL 9001		79605/100	79606/100
	Ivory RAL 1015		-	79610/100
	Beige gray RAL 1019		-	79614/100
REC/ /100	Stone gray RAL 7030		-	79618/100
	Ash gray RAL 7038		-	79622/100
	Light gray RAL 7035		-	79626/100
	Beige bahama		-	79642/100
	<b>\$/pc</b>			

No partial packaging

Other colors upon request for a minimum 1,000 pieces per color



REC/10 white PVC ecoline

To place orders correctly, find the desired model, size and finish. Then place your order by using the letters "PPS" followed by the corresponding 5-digit code.

# Cerfix™ Proangle F

Proangle F is a triangular profile designed as a decorative element and for closing the outside corners of tiles.

The stainless-steel version with reduced base is suitable for the protection and finishing of the interior angles of ceramic coverings.



FMB/10 + FMBE/10 bright polished silver aluminum

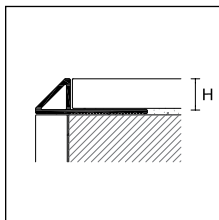

FMA/  
FMB/

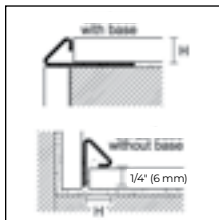

FMI/  
FMIS/

### CERFIX PROANGLE F

Length = 8'10" or 2.7 m  
(20 pieces per package)

		H		
Item	Finish	5/16" (8 mm)	3/8" (10 mm)	1/2" (12.5 mm)
<b>ALUMINUM</b>				
FMA/	Silver anodized	93025	93026	93027
	<b>\$/pc</b>			
FMB/	Bright polished silver	93028	93029	93030
	<b>\$/pc</b>			

Individually packaged













### CERFIX PROANGLE F

Length = 8'10" or 2.7 m  
(20 pieces per package)

		H			
Item	Finish	5/16" (8 mm)		3/8" (10 mm)	
		with base	without base	with base	without base
<b>STAINLESS STEEL</b>					
FMI/	Stainless steel AISI 304	93050	93051	93052	93053
	<b>\$/pc</b>				
FMIS/	Satin stainless steel AISI 304	93054	93055	93056	93057
	<b>\$/pc</b>				

Individually packaged

To place orders correctly, find the desired model, size and finish. Then place your order by using the letters "PPS" followed by the corresponding 5-digit code.

OUTSIDE CORNER						OUTSIDE CORNER				
5 pieces per package						5 pieces per package				
		H						H		
Item	Finish	5/16" (8 mm)	3/8" (10 mm)	1/2" (12.5 mm)		Item	Finish	5/16" (8 mm)	3/8" (10 mm)	
<b>ALUMINUM</b>						<b>STAINLESS STEEL</b>				
FMAE/	Silver anodized		93031	93032	93033	FMIE/	Stainless steel AISI 304		93058	93059
	<b>\$/pc</b>						<b>\$/pc</b>			
FMBE/	Bright polished silver		93040	93041	93042	FMIES/	Satin stainless steel AISI 304		93064	93065
	<b>\$/pc</b>						<b>\$/pc</b>			
<b>INSIDE CORNER</b>						<b>INSIDE CORNER</b>				
5 pieces per package						5 pieces per package				
		H						H		
Item	Finish	5/16" (8 mm)	3/8" (10 mm)	1/2" (12.5 mm)		Item	Finish	5/16" (8 mm)	3/8" (10 mm)	
<b>ALUMINUM</b>						<b>STAINLESS STEEL</b>				
FMAI/	Silver anodized		93034	93035	93036	FMII/	Stainless steel AISI 304		93060	93061
	<b>\$/pc</b>						<b>\$/pc</b>			
FMBI/	Bright polished silver		93043	93044	93045	FMIS/	Satin stainless steel AISI 304		93066	93067
	<b>\$/pc</b>						<b>\$/pc</b>			
<b>END CAP</b>						<b>END CAP</b>				
5 pieces per package						5 pieces per package				
		H						H		
Item	Finish	5/16" (8 mm)	3/8" (10 mm)	1/2" (12.5 mm)		Item	Finish	5/16" (8 mm)	3/8" (10 mm)	
<b>ALUMINUM</b>						<b>STAINLESS STEEL</b>				
FMAC/	Silver anodized		93037	93038	93039	FMIC/	Stainless steel AISI 304		93062	93063
	<b>\$/pc</b>						<b>\$/pc</b>			
FMBC/	Bright polished silver		93046	93047	93048	FMICS/	Satin stainless steel AISI 304		93068	93069
	<b>\$/pc</b>						<b>\$/pc</b>			

No partial packaging for aluminum accessories

To place orders correctly, find the desired model, size and finish. Then place your order by using the letters "PPS" followed by the corresponding 5-digit code.



## Cerfix™ Proangle AX – Pronivel M

Proangle AX M Design profiles in anodized or color-coated aluminum finish the vertical edge of the coverings, accentuating the discontinuity between the wall in an elegant way.



AX/2/ silver anodized aluminum

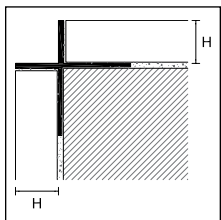

AX/2/

### CERFIX PROANGLE AX – M DESIGN

Length = 8'10" or 2.7 m  
(10 pieces per package)

		H		
Item	Finish	1/4" (6 mm)	3/8" (10 mm)	1/2" (12.5 mm)
<b>ALUMINUM</b>				
AX/2/	Silver anodized	13208	13209	13210
	<b>\$/pc</b>			
	Titanium anodized	13211	13213	13212
	Color-coated polished white RAL 9010	13215	13216	13214
	<b>\$/pc</b>			

Individually packaged

Pronivel M is a line of profiles designed to connect floors of different heights during the installation. Thanks to its shape, MIN/ can be also used as edging profile for the protection of 135-degree external corners of tile coverings.



MIN/10 polished stainless steel AISI 304

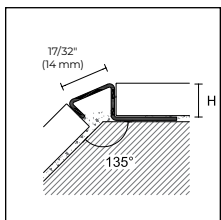

MIN/10

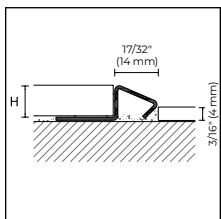

MIN/10 application for floors of different height

### CERFIX PRONIVEL M

Length = 8'10" or 2.7 m  
(10 pieces per package)

		H	
Item	Finish	5/16" (8 mm)	3/8" (10 mm)
MIN/	Polished stainless steel AISI 304	93023	93024
	<b>\$/pc</b>		

Individually packaged

To place orders correctly, find the desired model, size and finish. Then place your order by using the letters "PPS" followed by the corresponding 5-digit code.

# Cerfix™ Procorner M

Procorner M is a line of protection profiles of the outside corners of wall to be applied on the surfaces of the tiles already installed. Procorner M profiles are also available in a self-adhesive version for a quick and easy installation.

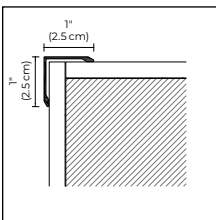

210/  
210H/A

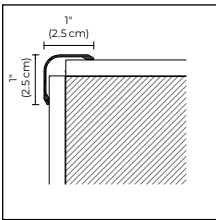

220/

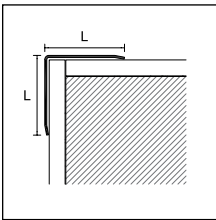

277/

## CERFIX PROCORNER M

Length = 9'10" or 3 m  
(30 pieces per package)

		L x L	
		1" x 1" (2.5 x 2.5 cm)	
Item	Finish	/SF	/A
<b>ALUMINUM</b>			
210/	Silver anodized	76068	76098
	Gold anodized	-	76108
	<b>\$/pc</b>		
	Color-coated white RAL 9003	76128	76208
	<b>\$/pc</b>		

SF = not drilled A = adhesive  
Individually packaged

## CERFIX PROCORNER M

Length = 9'10" or 3 m  
(30 pieces per package)

		L x L	
		1" x 1" (2.5 x 2.5 cm)	
Item	Finish	/SF	/A
<b>ANTIBACTERIAL COLOR-COATED ALUMINUM</b>			
210H/A	Color-coated antibacterial white RAL 9003	76209	
	<b>\$/pc</b>		

A = adhesive  
Individually packaged

## CERFIX PROCORNER M

Length = 9'10" or 3 m  
(30 pieces per package)

		L x L	
		1" x 1" (2.5 x 2.5 cm)	
Item	Finish	/SF	/A
<b>ALUMINUM</b>			
220/	Silver anodized	77888	77894
	<b>\$/pc</b>		
	Color-coated white RAL 9003	77900	-
	<b>\$/pc</b>		

SF = not drilled A = adhesive  
Individually packaged

## CERFIX PROCORNER M

### SILVER ANODIZED ALUMINUM

Length = 9'10" or 3 m  
(30 pieces per package)

Item	measure L x L	code	\$/pc
277/SF/	3/4" x 3/4" (20 x 20 mm)	76308	
277/A/ adhesive	3/4" x 3/4" (20 x 20 mm)	76309	
277/SF/	1" x 1" (2.5 x 2.5 cm)	76318	
277/A/ adhesive	1" x 1" (2.5 x 2.5 cm)	76319	
277/SF/	1-3/16" x 1-3/16" (3 x 3 cm)	76328	
277/A/ adhesive	1-3/16" x 1-3/16" (3 x 3 cm)	76329	

Individually packaged

To place orders correctly, find the desired model, size and finish. Then place your order by using the letters "PPS" followed by the corresponding 5-digit code.

# Cerfix™ Procorner M



775/A/40 polished stainless steel AISI 304

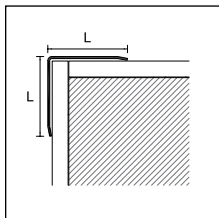

777/  
776/

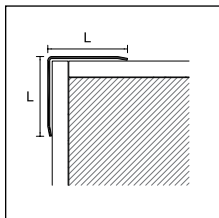

775/

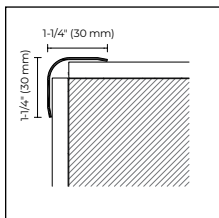

774/

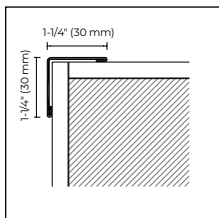

779/SF

## CERFIX PROCORNER M

### POLISHED STAINLESS STEEL AISI 430

Length = 9'10" or 3 cm / thickness = 1/32" (0.6 mm)

Item	L x L	code	\$/pc	pieces per package
777/SF/	9/16" x 9/16 (15 x 15 mm)	76888		30
777/A/ adhesive	9/16" x 9/16 (15 x 15 mm)	76938		30
777/SF/	3/4" x 3/4" (20 x 20 mm)	76898		30
777/A/ adhesive	3/4" x 3/4" (20 x 20 mm)	76948		30
777/SF/	1" x 1" (2.5 x 2.5 cm)	76908		15
777/A/ adhesive	1" x 1" (2.5 x 2.5 cm)	76958		15
777/SF/	1-3/16" x 1-3/16" (3 x 3 cm)	76918		20
777/A/ adhesive	1-3/16" x 1-3/16" (3 x 3 cm)	76968		20

Length = 6' 6-3/4" or 2 m / thickness = 1/16" (1 mm)

Item	L x L	code	\$/pc	pieces per package
776/SF/	1-3/16" x 1-3/16" (3 x 3 cm)	77004		20
776/A/ adhesive	1-3/16" x 1-3/16" (3 x 3 cm)	77044		20
776/SF/	1-5/8" x 1-5/8" (4 x 4 cm)	77014		10
776/A/ adhesive	1-5/8" x 1-5/8" (4 x 4 cm)	77054		10
776/SF/	2" x 2" (5 x 5 cm)	77024		10
776/A/ adhesive	2" x 2" (5 x 5 cm)	77064		10

Length = 8'10" or 2.7 m / thickness = 1/16" (1 mm)

Item	L x L	code	\$/pc	pieces per package
776/SF/	1-3/16" x 1-3/16" (3 x 3 cm)	77008		10
776/A/ adhesive	1-3/16" x 1-3/16" (3 x 3 cm)	77048		10
776/SF/	1-5/8" x 1-5/8" (4 x 4 cm)	77018		10
776/A/ adhesive	1-5/8" x 1-5/8" (4 x 4 cm)	77058		10
776/SF/	2" x 2" (5 x 5 cm)	77028		5
776/A/ adhesive	2" x 2" (5 x 5 cm)	77068		5

### POLISHED STAINLESS STEEL AISI 304

Length = 8'10" or 2.7 m / thickness = 1/16" (1 mm)

Item	L x L	code	\$/pc	pieces per package
775/SF/	1-3/16" x 1-3/16" (3 x 3 cm)	77108		10
775/A/ adhesive	1-3/16" x 1-3/16" (3 x 3 cm)	77148		10
775/SF/	1-5/8" x 1-5/8" (4 x 4 cm)	77118		10
775/SF/	2" x 2" (5 x 5 cm)	77128		5
775/A/ adhesive	2" x 2" (5 x 5 cm)	77168		5

### SATIN STAINLESS STEEL AISI 304

Length = 8'10" or 2.7 m / thickness = 1/16" (1 mm)

Item	L x L	code	\$/pc	pieces per package
775/SF/	1-3/16" x 1-3/16" (3 x 3 cm)	77110		10
775/SF/	2" x 2" (5 x 5 cm)	77130		5

### POLISHED STAINLESS STEEL AISI 304

Length = 8'10" or 2.7 m / thickness = 1/16" (1 mm)

Item	L x L	code	\$/pc	pieces per package
774/SF	1-3/16" x 1-3/16" (3 x 3 cm)	77954		10

### SATIN STAINLESS STEEL AISI 304

Length = 8'10" or 2.7 m / thickness = 1/16" (1 mm)

Item	L x L	code	\$/pc	pieces per package
779/SF	1-3/16" x 1-3/16" (3 x 3 cm)	77106		10

SF = not drilled A = adhesive

To place orders correctly, find the desired model, size and finish. Then place your order by using the letters "PPS" followed by the corresponding 5-digit code.

## Cerfix™ Procorner M – Procorner P

Procorner M profiles are designed to protect the external corners of coverings. Recommended for such places as schools, offices, kindergartens and public spaces, they are available in polished brass to highlight the covering corners.

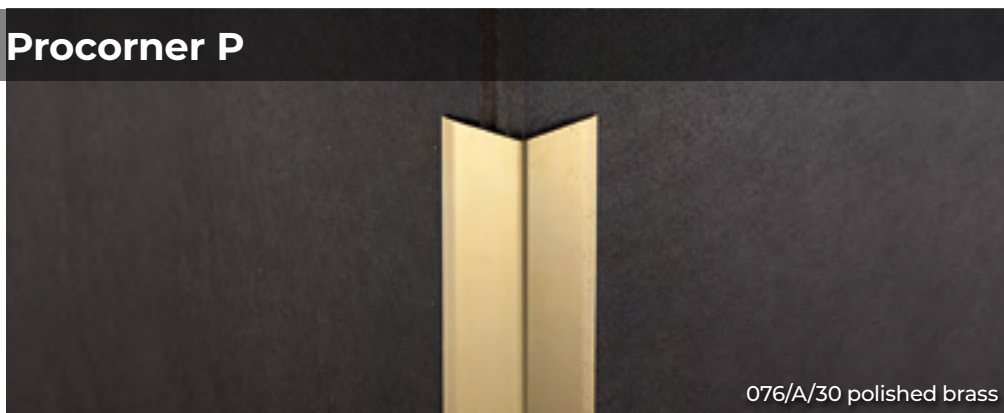

076/A/30 polished brass

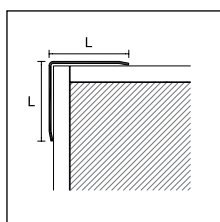

076/SF/  
076/A/

### CERFIX PROCORNER M

#### POLISHED BRASS

Length = 8'10" or 2.7 m / thickness = 1/16" (1 mm)

Item	L x L	code	\$/pc	pieces per package
076/SF/	9/16" x 9/16" (15 x 15 mm)	76800		30
076/A/ adhesive	9/16" x 9/16" (15 x 15 mm)	76840		15
076/SF/	3/4" x 3/4" (20 x 20 mm)	76802		15
076/A/ adhesive	3/4" x 3/4" (20 x 20 mm)	76842		15
076/SF/	1" x 1" (2.5 x 2.5 cm)	76806		15
076/A/ adhesive	1" x 1" (2.5 x 2.5 cm)	76846		10
076/SF/	1-3/16" x 1-3/16" (3 x 3 cm)	76808		10
076/A/ adhesive	1-3/16" x 1-3/16" (3 x 3 cm)	76848		10

SF = not drilled A = adhesive

Procorner P edge profiles protect in many ways. Recommended for such environments as schools, offices, kindergartens and public spaces, they are made from soft PVC and in bright colors to visually highlight the edges of walls.

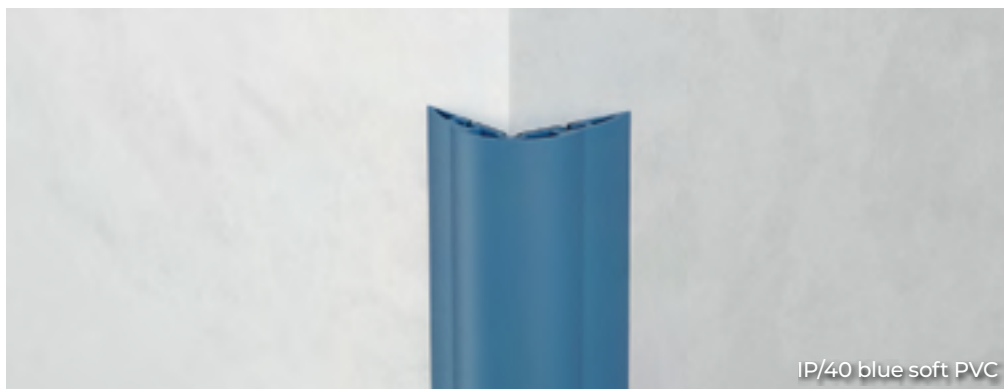

IP/40 blue soft PVC

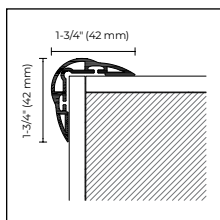

IP/40

### CERFIX PROCORNER P

Length = 8'10" or 2.7 m  
(20 pieces per package)

Item	Finish	L x L	
		1-3/4" x 1-3/4" (42 x 42 mm)	
<b>SOFT PVC</b>			
	White		95010
	Yellow		95011
IP/40	Red		95012
	Blue		95013
	\$/pc		

To place orders correctly, find the desired model, size and finish. Then place your order by using the letters "PPS" followed by the corresponding 5-digit code.

Item IP/40 in PVC should be stored horizontally.



# Cerfix™ Procorner PVC Line

Cerfix Procorner PVC Line 8610 and 8611 are lines of edging profiles in foam PVC that are impact-resistant. Quick and easy to install, they are particularly suitable for DIY installations. Available in vivid colors, they are suitable for sites such as schools, kindergartens and public spaces in general.



8610 white decor 555

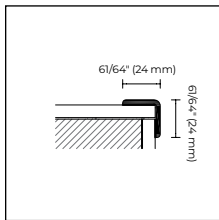

8610

## CERFIX PROCORNER PVC LINE

Length = 9'10" or 3 m  
(20 pieces per package)

FOAM PVC

Item	Decors		Decors		Decors	
8610		518 29810		536 29830		Yellow 561 29848
		520 29812		540 29832		Green 562 29850
		524 29814		542 29834		Light blue 563 29847
		525 29816		544 29836		Red 564 29849
		528 29818		545 29838		
		530 29820		White 555 29840		
		531 29822		Light gray 556 29842		
		532 29824		Black 557 29844		
		534 29828		Anthracite 558 29846		

\$/pc

No partial packaging

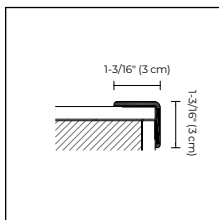

8611

## CERFIX PROCORNER PVC LINE

Length = 9'10" or 3 m  
(20 pieces per package)

FOAM PVC

Item	Decors		Decors		Decors		Decors	
8611		518 29910		White 555 29940		Yellow 561 29946		Silver dec. 559 29949
		532 29924		Light gray 556 29942		Green 562 29948		
		542 29934		Black 557 29944		Light blue 563 29945		
		545 29938				Red 564 29947		

\$/pc

No partial packaging

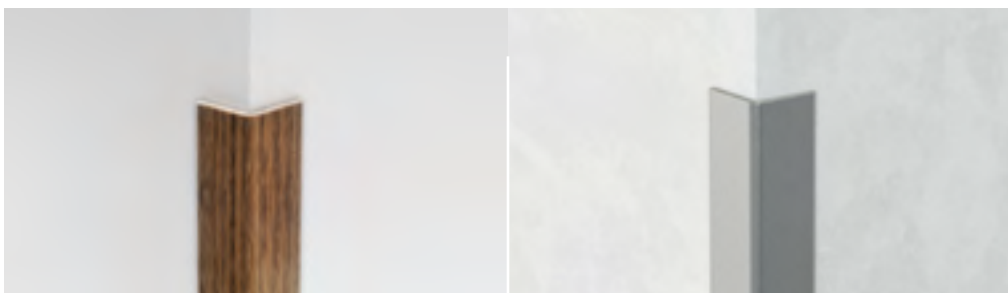

8610 decor 532

8611 silver decor 559

To place orders correctly, find the desired model, size and finish. Then place your order by using the letters "PPS" followed by the corresponding 5-digit code.

## Cerfix™ Probord

Stainless-steel Probord ILN are security profiles for the outside corners of wall tiles and can be combined with the Proround M profiles. They are recommended for the prevention of accidents and in environments where high hygienic safety is also required, such as kitchens, the food industry and schools. The version in AISI 316 stainless steel is suitable for swimming pools, spas and environments exposed to salt.



ILN/10 polished stainless steel AISI 304

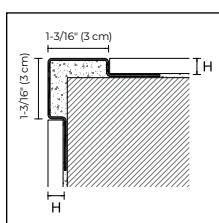

ILN/  
ILNS/  
ILNX/

### CERFIX PROBORD

Length = 8'10" or 2.7 m  
(5 pieces per package)

Item	Finish	H		
		5/16" (8 mm)	3/8" (10 mm)	1/2" (12.5 mm)
<b>STAINLESS STEEL</b>				
ILN/	Polished stainless steel AISI 304 \$/pc	94997	94998	94999
ILNS/	Satin stainless steel AISI 304 \$/pc	94984	94985	94986
ILNX/	Stainless steel AISI 316 \$/pc	94987	94988	94989

Individually packaged

To place orders correctly, find the desired model, size and finish. Then place your order by using the letters "PPS" followed by the corresponding 5-digit code.

# Cerfix™ Probord

Probord IL, ILE and ILES have a rounded angle (compared with the model ILN). The fixing system with a single flange favors the correct alignment of the profile even in the presence of corners and uneven surfaces.

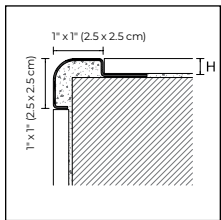

IL/

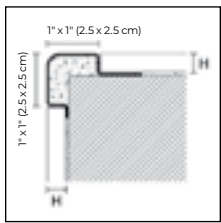

ILE/  
ILES/

### CERFIX PROBORD

Length = 8'10" or 2.7 m  
(10 pieces per package)

		H		
Item	Finish	5/16" (8 mm)	3/8" (10 mm)	1/2" (12.5 mm)
<b>STAINLESS STEEL</b>				
IL/	Stainless steel AISI 304	94994	94995	94996
		<b>\$/pc</b>		

Individually packaged

### CERFIX PROBORD

Length = 8'10" or 2.7 m  
(5 pieces per package)

		H
Item	Finish	3/8" (10 mm)
<b>STAINLESS STEEL</b>		
ILE/10	Polished stainless steel AISI 304	95002
		<b>\$/pc</b>
ILES/10	Satin stainless steel AISI 304	95003
		<b>\$/pc</b>

Individually packaged

To place orders correctly, find the desired model, size and finish. Then place your order by using the letters "PPS" followed by the corresponding 5-digit code.

# Cerfix™ Protop

Cerfix Protop is a profile for the protection and finishing of external corners of countertops and ceramic-tiled kitchens.



TOP/A/10 silver anodized aluminum

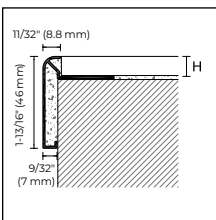

TOP/A/  
TOP/TM/

## CERFIX PROTOP

Length = 8'10" or 2.7 m  
(10 pieces per package)

Item	Finish	H	
		3/8" (10 mm)	1/2" (12.5 mm)
<b>ALUMINUM</b>			
TOP/A/	Silver anodized	86050	86060
	<b>\$/pc</b>		
TOP/TM/	Titanium anodized	86052	86062
	<b>\$/pc</b>		
TOP/TM/	Bright satin titanium	86051	86061
	<b>\$/pc</b>		

Individually packaged

OUTSIDE CORNER – 2 pieces per package

Item	Finish	90°		135°	
		90°	135°	90°	135°
<b>ALUMINUM</b>					
TOP//E	Silver anodized	86074	86072	86074	86072
	<b>\$/pc</b>				
TOP//ETM	Titanium anodized	86080	86082	86080	86082
	<b>\$/pc</b>				
TOP//ETM	Bright satin titanium	86075	86073	86075	86073
	<b>\$/pc</b>				

INSIDE CORNER – 2 pieces per package

Item	Finish	90°		135°	
		90°	135°	90°	135°
<b>ALUMINUM</b>					
TOP//I	Silver anodized	86078	86076	86078	86076
	<b>\$/pc</b>				
TOP//ITM	Titanium anodized	86081	86083	86081	86083
	<b>\$/pc</b>				
TOP//ITM	Bright satin titanium	86079	86077	86079	86077
	<b>\$/pc</b>				

No partial packaging

To place orders correctly, find the desired model, size and finish. Then place your order by using the letters "PPS" followed by the corresponding 5-digit code.



TOP/A/10 + TOP/90/E + TOP/135/I silver anodized aluminum







## Listello Tile Trims and Decorative Profiles

The line of decorative profiles provides a wide variety of finishes, suitable for endless combinations and multiple aesthetic architectural tastes, from classic to contemporary. They are applicable to all environments with ceramic tiles from kitchen to bathroom, from living rooms to large commercial spaces.



# Cerfix™ Prolist

Prolist is a range of decorative listellos designed to create stylish and eye-catching aesthetic effects of wall tiles. They are available in a variety of materials and colors, and can be coordinated with the Protrim and Proangle profiles to obtain elegant and sophisticated combinations.



LDB/20 bright polished silver aluminum

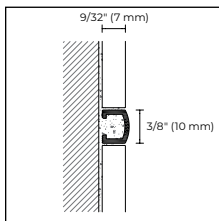
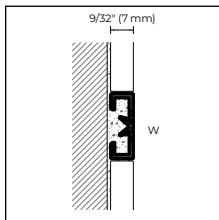

LB/B/10

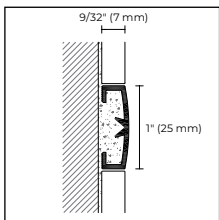

LB/A  
LB/B/25

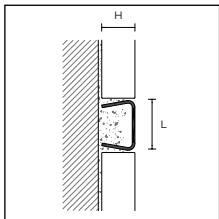

LA//  
LA/IS/

### CERFIX PROLIST

Length = 8'10" or 2.7 m  
(20 pieces per package)

Item	Finish	W x H				
		3/8" x 9/32" (10 x 7 mm)	9/16" x 9/32" (15 x 7 mm)	3/4" x 9/32" (20 x 7 mm)	1" x 9/32" (25 x 7 mm)	
<b>ALUMINUM</b>						
LDA/	Silver anodized		93255	93215	93220	93256
	<b>\$/pc</b>					
LDB/	Bright polished silver		93258	93219	93224	93259
LDT/	Bright polished titanium		93257	93218	93223	93268
	<b>\$/pc</b>					
LDS/	Bright satin silver		93240	93216	93221	93244
	Bright satin gold		93241	93217	93222	93245
LDTM/	Bright satin titanium		93266	93211	93225	93246
LDRS/	Bright satin copper		93242	93267	93229	93269
	<b>\$/pc</b>					
LDAG/	Bright scratched silver		93263	93214	93228	93243
	<b>\$/pc</b>					
<b>COLOR-COATED ALUMINUM</b>						
LDV/	White stone		-	-	93207	-
	Black stone		-	-	93209	-
	<b>\$/pc</b>					

Individually packaged

### CERFIX PROLIST

Length = 8'10" or 2.7 m  
(20 pieces per package)

Item	Finish	W x H		
		3/8" x 9/32" (10 x 7 mm)	1" x 9/32" (25 x 7 mm)	
<b>ALUMINUM</b>				
LB/A	Silver anodized		-	93270
	<b>\$/pc</b>			
LB/B/	Bright polished silver		93252	93272
	Bright polished gold		93253	93273
	<b>\$/pc</b>			

Individually packaged

### CERFIX PROLIST

Length = 8'10" or 2.7 m  
(20 pieces per package)

Item	Finish	W x H			
		3/8" x 3/8" (10 x 10 mm)	9/16" x 3/8" (15 x 10 mm)	1" x 3/8" (2.5 cm x 10 mm)	
<b>STAINLESS STEEL</b>					
LA//	Polished stainless steel AISI 304		93283	93284	93285
	<b>\$/pc</b>				
LA/IS/	Satin stainless steel AISI 304		93296	93297	93298
	<b>\$/pc</b>				

Individually packaged

To place orders correctly, find the desired model, size and finish. Then place your order by using the letters "PPS" followed by the corresponding 5-digit code.

## Metal Line AF – M Design

Metal Line AF - M Design is a decorative listello in aluminum characterized by modern and minimalist lines that, thanks to its special shape, creates an elegant shadow.



AF/1/10 silver anodized aluminum

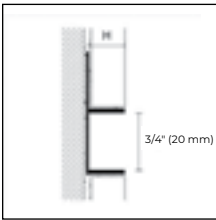

AF/1/

### METAL LINE AF – M DESIGN

Length = 8'10" or 2.7 m  
(10 pieces per package)

Item	Finish	W x H			
		3/4" x 1/4" (20 x 6 mm)	3/4" x 3/8" (20 x 10 mm)	3/4" x 1/2" (20 x 12.5 mm)	
<b>ALUMINUM</b>					
AF/1/	Silver anodized		13198	13199	13200
	<b>\$/pc</b>				
	Titanium anodized		13201	13203	13202
	Color-coated polished white RAL 9010		13196	13197	13204
	<b>\$/pc</b>				

Individually packaged

## Cerfix™ Prolist – X Design

Prolist is available in five original X Design finishes. In anodized aluminum, X Design is characterized by a special scratched finish and original colors that allow different chromatic combinations, created for interior designers and architects by following the latest trends of modern design.

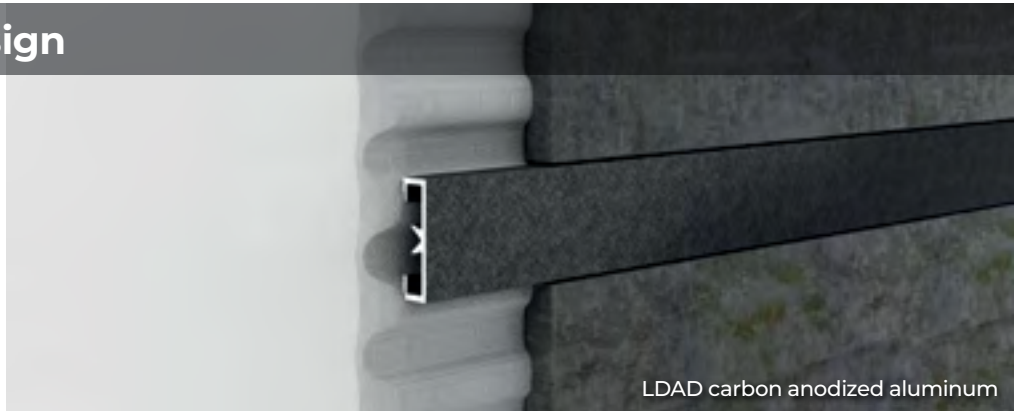

LDAD carbon anodized aluminum

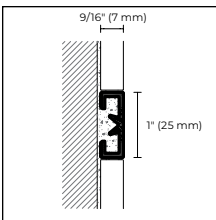

LDAD

### CERFIX PROLIST – X DESIGN

Length = 8'10" or 2.7 m  
(10 pieces per package)

Item	Finish	W x H
		1" x 9/16" (25 x 7 mm)
<b>ANODIZED ALUMINUM</b>		
LDAD	Platinum	31320
	Titanium	31322
	Brown	31324
	Dark brown	31326
	Carbon	31328
	<b>\$/pc</b>	

Individually packaged



LED-light decorative listellos on Page 172

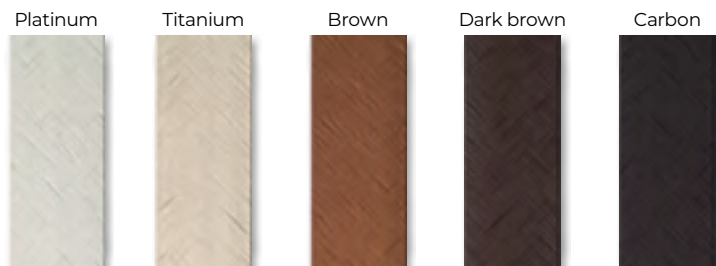

To place orders correctly, find the desired model, size and finish. Then place your order by using the letters "PPS" followed by the corresponding 5-digit code.



## Cerfix™ – C Design

C Design is a line of profiles embellished with crystals from Swarovski. The combination of the chromium-plated or gold-plated profile and the crystal enhances the brightness of the lines and makes any space elegant.

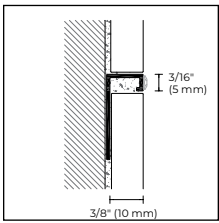

DJKC/10

### CERFIX PRODECOR – C DESIGN

Length = 8'10" or 2.7 m  
(5 pieces per package)

W x H

Item Finish **3/16" x 3/8" (5 x 10 mm)**

#### CHROMIUM-PLATED BRASS

	Chromium-plated + crystals from Swarovski		13300
	<b>\$/pc</b>		
<b>DJKC/10</b>	Chromium-plated + crystals from Swarovski		13302
	<b>\$/pc</b>		

Individually packaged



DJKC/10 chromium-plated brass with crystals from Swarovski (cod. 13300)



DJKC/10 chromium-plated brass with crystals from Swarovski (cod. 13302)

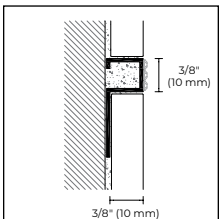

UKC/10

### CERFIX PROSTYLE – C DESIGN

Length = 8'10" or 2.7 m  
(5 pieces per package)

W x H

Item Finish **3/8" x 3/8" (10 x 10 mm)**

#### CHROMIUM-PLATED BRASS

	Chromium-plated + crystals from Swarovski		13310
	<b>\$/pc</b>		

Individually packaged



UKC/10 chromium-plated brass with crystals from Swarovski

To place orders correctly, find the desired model, size and finish. Then place your order by using the letters "PPS" followed by the corresponding 5-digit code.

# Cerfix™ – C Design

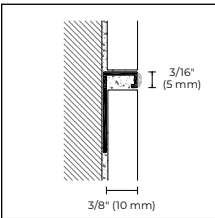

DJKGC/10

## CERFIX PRODECOR – C DESIGN

Length = 8'10" or 2.7 m  
(5 pieces per package)

W x H

Item Finish **3/16" x 3/8" (5 x 10 mm)**

### BRASS

DJK- 24-kt gold-plated + crystals  13402  
GC/10 \$/pc

Individually packaged



DJKGC/10 24-kt gold-plated brass + crystals

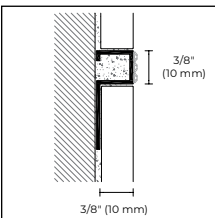

UKGC/10

## CERFIX PRODECOR – C DESIGN

Length = 8'10" or 2.7 m  
(5 pieces per package)

W x H

Item Finish **3/8" x 3/8" (10 x 10 mm)**

### BRASS

UKGC/10 24-kt gold-plated + crystals  13410  
\$/pc

Individually packaged



UKGC/10 24-kt gold-plated brass + crystals

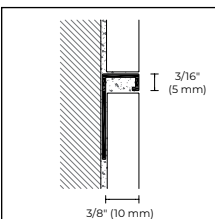

DJKG/10

## CERFIX PRODECOR – C DESIGN

Length = 8'10" or 2.7 m  
(5 pieces per package)

W x H

Item Finish **3/8" x 3/8" (10 x 10 mm)**

### BRASS

DJKG/10 24-kt gold-plated  12902  
\$/pc

Individually packaged

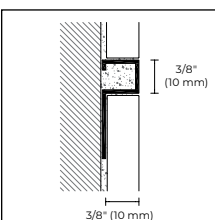

UKG/10

## CERFIX PROSTYLE – C DESIGN

Length = 8'10" or 2.7 m  
(5 pieces per package)

W x H

Item Finish **3/8" x 3/8" (10 x 10 mm)**

### BRASS

UKG/10 24-kt gold-plated  12910  
\$/pc

Individually packaged

To place orders correctly, find the desired model, size and finish. Then place your order by using the letters "PPS" followed by the corresponding 5-digit code.







## Shower Tile Trims

This extensive line of profiles is for glass-wall partitions and flooring installation in the shower area.





We offer an extensive line of profiles for glass shower walls. In this section, you will also find pre-sloped profiles designed to avoid undesirable oblique cuts on wall tiles in the shower area.

## Glass Profile

Glass Profile is a line of stainless steel profiles designed to cover the difference in height of the surface with a 2% slope and create a flat surface with a modern and linear design. Two finishes are offered: Satin stainless steel and matte black color-coated stainless steel.

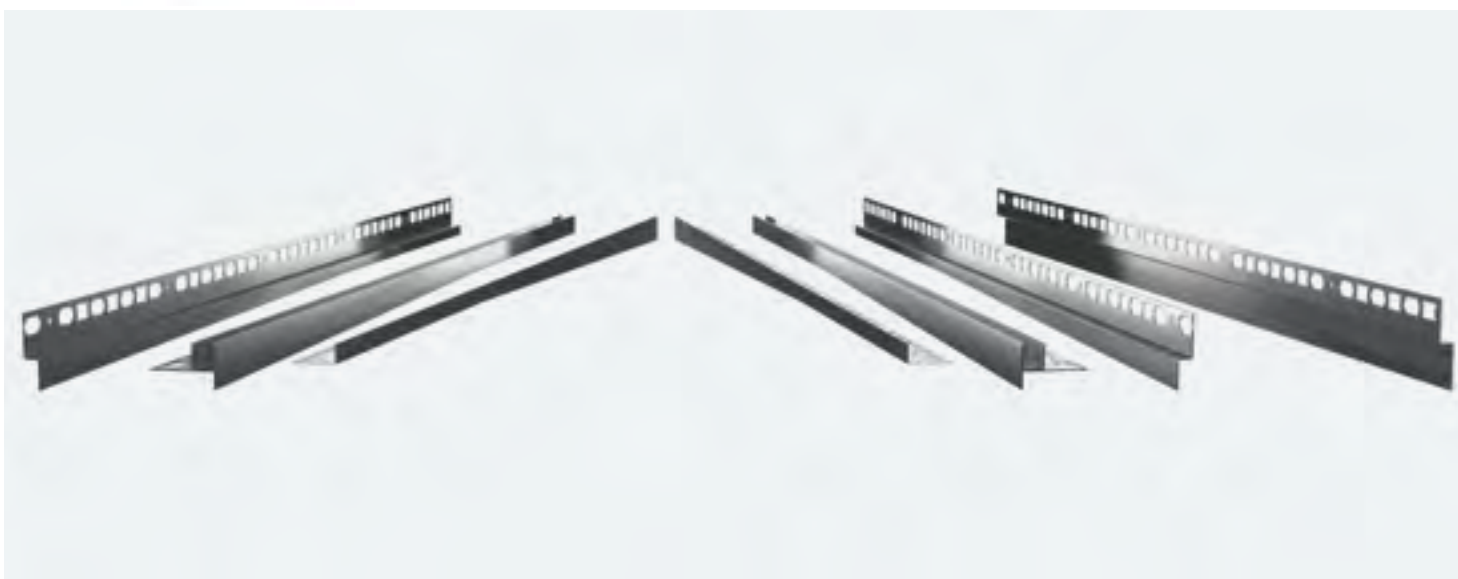
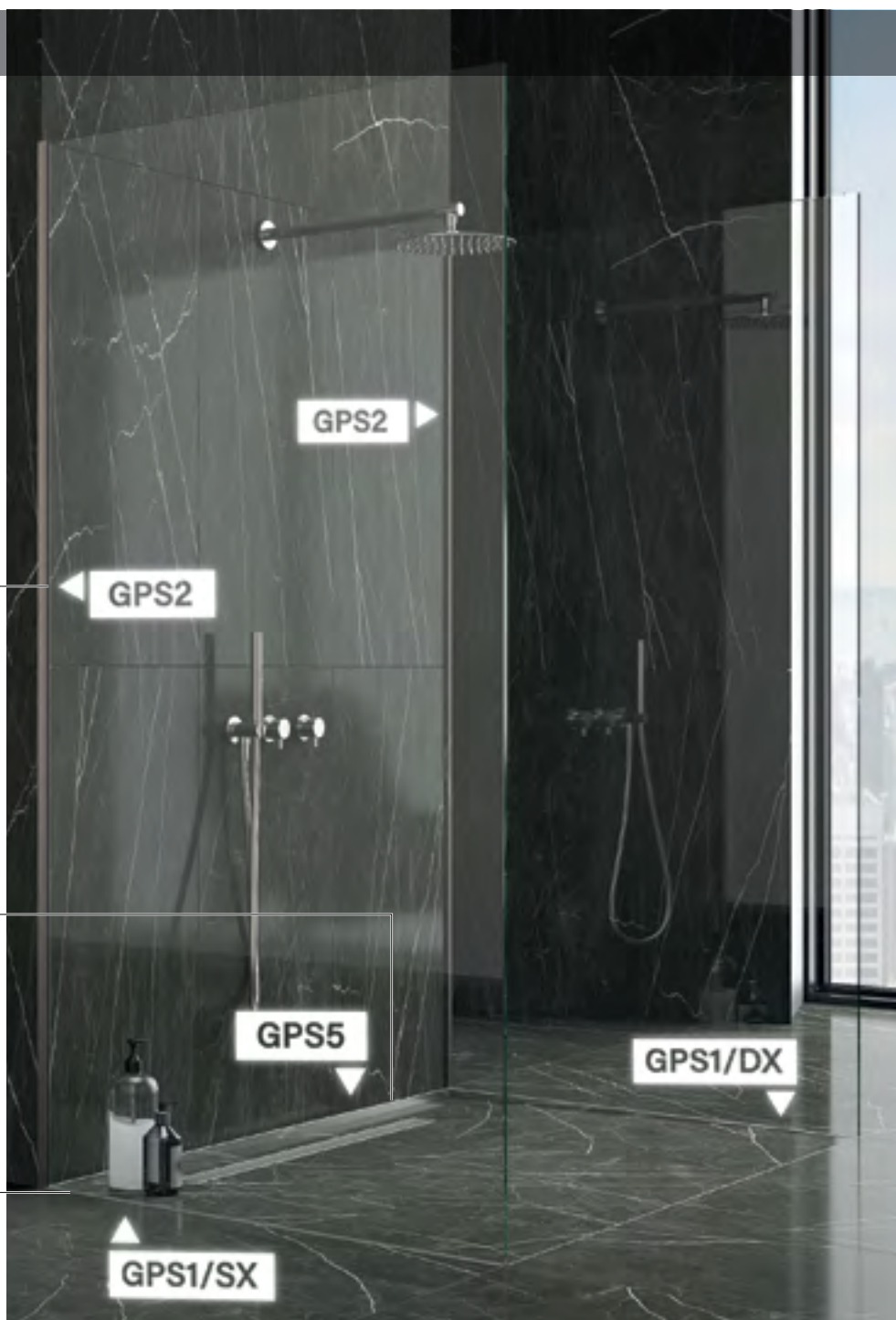

## Glass Profile

Glass Profile GPS1/ is a stainless steel profile for the insertion of glass walls of floor-level showers. GPS1/ features a 2% slope on the shower's inner side, for a perfect aesthetic solution for the sloped surface.

Completing the profile's installation is GPS/6, the end cap for hiding the section of the glass wall.

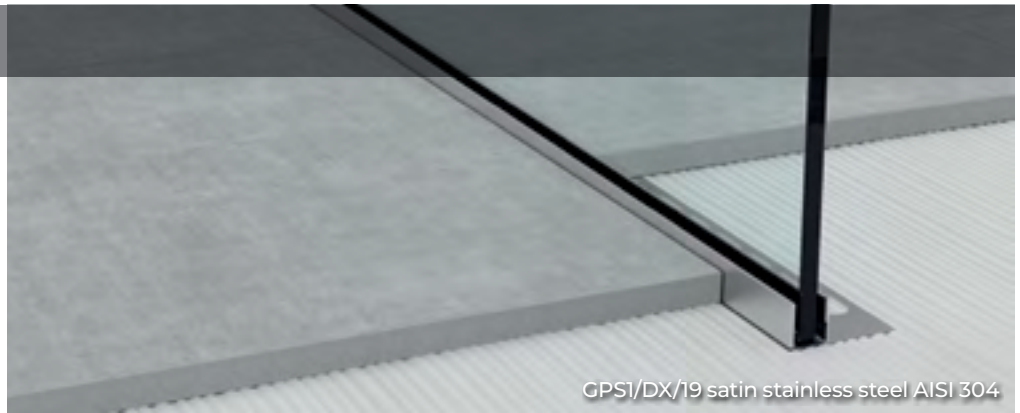

GPS1/DX/19 satin stainless steel AISI 304

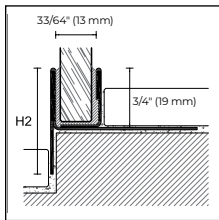

GPS1/DX/19

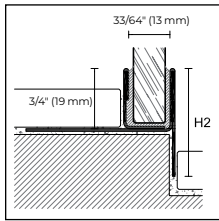

GPS1/SX/19

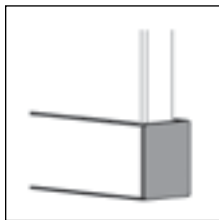

GPS/6



Transparent silicone strips

### GLASS PROFILE

5-piece package

Item	GPS1/ /19							
	DX	SX	DX	SX	DX	SX	DX	SX
Length	3'2" (98 cm)		4' (120 cm)		4'10" (148 cm)		6'6" (200 cm)	
H2	1-3/8" (34 mm)		1-1/2" (37 mm)		1-5/8" (42 mm)		2-1/4" (60 mm)	

#### STAINLESS STEEL

Satin stainless steel AISI 304		31505	31507	31515	31517	31525	31527	31535	31537
--------------------------------	---	-------	-------	-------	-------	-------	-------	-------	-------

\$/pc

#### MATTE BLACK COLOR-COATED STAINLESS STEEL

Matte black RAL 9005 color-coated stainless steel AISI 304		31506	31508	31516	31518	31526	31528	-	-
--	---	-------	-------	-------	-------	-------	-------	---	---

\$/pc

Individually packaged

### GLASS PROFILE - END CAP FOR GPS1/ /19

5-piece package

Item	GPS/6
------	-------

#### STAINLESS STEEL

Satin stainless steel AISI 304		31564
--------------------------------	---	-------

\$/pc

#### MATTE BLACK COLOR-COATED STAINLESS STEEL

Matte black RAL 9005 color-coated stainless steel AISI 304		31566
--	---	-------

\$/pc

No partial packaging

### TRANSPARENT SILICONE STRIPS

Length = 16.4' or 500 cm (5-piece package)

Item	Thickness	
GG/2	3/32" (2 mm)	31590
	\$/package	
GG/3	1/8" (3 mm)	31592
	\$/package	
GG/4	5/32" (4 mm)	31594
	\$/package	

No partial packaging

To place orders correctly, find the desired model, size and finish. Then place your order by using the letters "PPS" followed by the corresponding 5-digit code.

## Glass Profile

Glass Profile GPS2/ and GPS14/12 are stainless steel profiles for inserting glass walls on wall coverings. GPS2/ is simple to install, is suitable for tiles of any thickness and does not require drilling. GPS/6 is the end cap to complete the profile, to hide the visible section of the glass wall. GPS14/12 can be affixed directly onto the already installed wall covering.



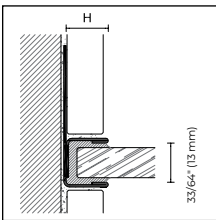

GPS2/19 satin stainless steel AISI 304



GPS2/

### GLASS PROFILE

Length = 6'10" or 210 cm (5-piece package)

Item	Finish	H			
		3/8" (10 mm)	1/2" (12.5 mm)	3/4" (19 mm)	
<b>STAINLESS STEEL</b>					
GPS2/	Satin stainless steel AISI 304		31541	31542	31543
	<b>\$/pc</b>				
<b>MATTE BLACK COLOR-COATED STAINLESS STEEL</b>					
GPS2/	Matte black RAL 9005 color-coated stainless steel AISI 304		31546	31547	31545
	<b>\$/pc</b>				

Individually packaged

### GLASS PROFILE



Length = 8' 2-1/2" or 250 cm (5-piece package)

Item	Finish	H			
		3/8" (10 mm)	1/2" (12.5 mm)	3/4" (19 mm)	
<b>STAINLESS STEEL</b>					
GPS2/	Satin stainless steel AISI 304		31548	31549	31544
	<b>\$/pc</b>				

Individually packaged

### GLASS PROFILE – END CAP FOR GPS2/19

5-piece package

Item	GPS/6		
<b>STAINLESS STEEL</b>			
Satin stainless steel AISI 304			31564
	<b>\$/pc</b>		
<b>MATTE BLACK COLOR-COATED STAINLESS STEEL</b>			
Matte black RAL 9005 color-coated stainless steel AISI 304			31566
	<b>\$/pc</b>		

No partial packaging

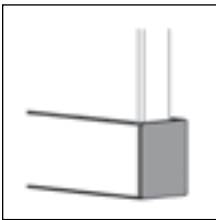

GPS/6

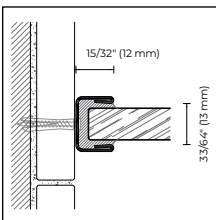

GPS14/12

### GLASS PROFILE

5-piece package

Item	GPS14/12		
<b>STAINLESS STEEL</b>			
Length	6'10" (210 cm)	8' 2-1/2" (250 cm)	
Satin stainless steel AISI 304		32000	32001
	<b>\$/pc</b>		

Individually packaged

To place orders correctly, find the desired model, size and finish. Then place your order by using the letters "PPS" followed by the corresponding 5-digit code.



# Glass Profile

Glass Profile GPS3/ is a stainless steel profile featuring a 2% slope on the shower's inner side for a perfect aesthetic solution for the sides of the sloped surface.

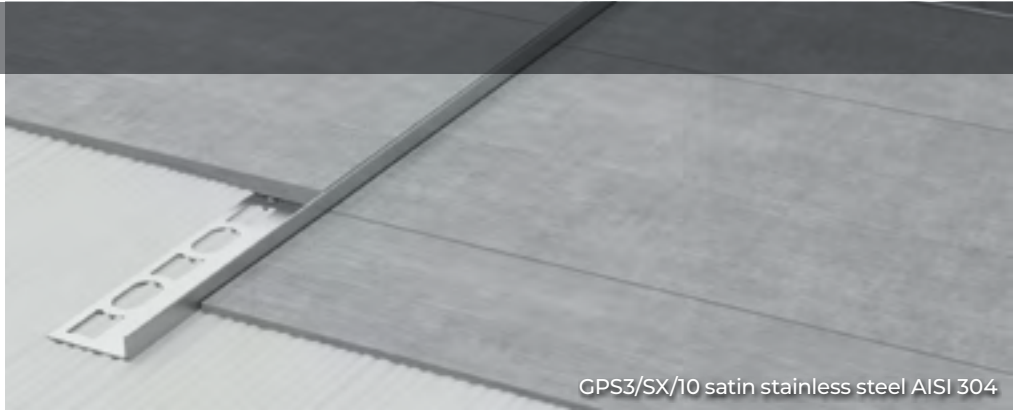

GPS3/SX/10 satin stainless steel AISI 304

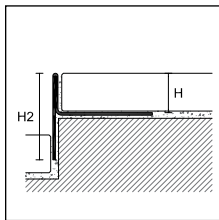

GPS3/DX/

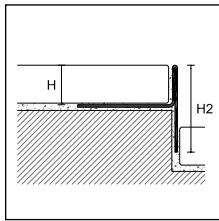

GPS3/SX/

## GLASS PROFILE

Length = 39-1/4" or 98 cm (5-piece package)

Item	Finish	H	H2	DX	SX
<b>STAINLESS STEEL</b>					
GPS3/ /10	Satin stainless steel AISI 304 \$/pc	3/8" (10 mm)	1" (25 mm)	31615	31617
GPS3/ /11	Satin stainless steel AISI 304 \$/pc	7/16" (11 mm)	1-1/32" (26 mm)	31619	31620
GPS3/ /12	Satin stainless steel AISI 304 \$/pc	1/2" (12.5 mm)	1-1/16" (27.5 mm)	31625	31627
<b>MATTE BLACK COLOR-COATED STAINLESS STEEL</b>					
GPS3/ /10	Matte black RAL 9005 color-coated stainless steel AISI 304 \$/pc	3/8" (10 mm)	1" (25 mm)	31616	31618
GPS3/ /11	Matte black RAL 9005 color-coated stainless steel AISI 304 \$/pc	7/16" (11 mm)	1-1/32" (26 mm)	31629	31630
GPS3/ /12	Matte black RAL 9005 color-coated stainless steel AISI 304 \$/pc	1/2" (12.5 mm)	1-1/16" (27.5 mm)	31626	31628

Individually packaged

## GLASS PROFILE

Length = 4' or 120 cm (5-piece package)







Item	Finish	H	H2	DX	SX
<b>STAINLESS STEEL</b>					
GPS3/ /10	Satin stainless steel AISI 304 \$/pc	3/8" (10 mm)	1-1/18" (28 mm)	31645	31647
GPS3/ /11	Satin stainless steel AISI 304 \$/pc	7/16" (11 mm)	1-5/32" (29 mm)	31649	31650
GPS3/ /12	Satin stainless steel AISI 304 \$/pc	1/2" (12.5 mm)	1-3/16" (30.5 mm)	31655	31657
<b>MATTE BLACK COLOR-COATED STAINLESS STEEL</b>					
GPS3/ /10	Matte black RAL 9005 color-coated stainless steel AISI 304 \$/pc	3/8" (10 mm)	1-1/18" (28 mm)	31646	31648
GPS3/ /11	Matte black RAL 9005 color-coated stainless steel AISI 304 \$/pc	7/16" (11 mm)	1-5/32" (29 mm)	31652	31654
GPS3/ /12	Matte black RAL 9005 color-coated stainless steel AISI 304 \$/pc	1/2" (12.5 mm)	1-3/16" (30.5 mm)	31656	31658

Individually packaged

To place orders correctly, find the desired model, size and finish. Then place your order by using the letters "PPS" followed by the corresponding 5-digit code.

**GLASS PROFILE**



Length = 4'10" or 148 cm (5-piece package)

Item	Finish		H	H2	DX	SX
<b>STAINLESS STEEL</b>						
GPS3/ /10	Satin stainless steel AISI 304		3/8" (10 mm)	1-5/16" (33 mm)	31675	31677
	<b>\$/pc</b>					
GPS3/ /11	Satin stainless steel AISI 304		7/16" (11 mm)	1-3/8" (34 mm)	31679	31680
	<b>\$/pc</b>					
GPS3/ /12	Satin stainless steel AISI 304		1/2" (12.5 mm)	1-3/8" (35.5 mm)	31685	31687
	<b>\$/pc</b>					
<b>MATTE BLACK COLOR-COATED STAINLESS STEEL</b>						
GPS3/ /10	Matte black RAL 9005 color-coated stainless steel AISI 304		3/8" (10 mm)	1-5/16" (33 mm)	31676	31678
	<b>\$/pc</b>					
GPS3/ /11	Matte black RAL 9005 color-coated stainless steel AISI 304		7/16" (11 mm)	1-3/8" (34 mm)	31682	31684
	<b>\$/pc</b>					
GPS3/ /12	Matte black RAL 9005 color-coated stainless steel AISI 304		1/2" (12.5 mm)	1-3/8" (35.5 mm)	31686	31688
	<b>\$/pc</b>					

Individually packaged

**GLASS PROFILE**

Length = 6' 6-3/4" or 200 cm (5-piece package)

Item	Finish		H	H2	DX	SX
<b>STAINLESS STEEL</b>						
GPS3/ /10	Satin stainless steel AISI 304		3/8" (10 mm)	2" (51 mm)	31694	31695
	<b>\$/pc</b>					
GPS3/ /12	Satin stainless steel AISI 304		1/2" (12.5 mm)	2-1/8" (53.5 mm)	31698	31699
	<b>\$/pc</b>					

Individually packaged



GPS3/DX/10 matte black RAL 9005 color-coated stainless steel AISI 304

To place orders correctly, find the desired model, size and finish. Then place your order by using the letters "PPS" followed by the corresponding 5-digit code.

## Glass Profile

Glass Profile GPS4/ is a stainless steel profile featuring a 2% slope on the shower's inner side. It connects the sloped floor and the wall covering perfectly, thus avoiding the oblique cut of the tiles.



GPS4/DX/10 matte black RAL 9005 color-coated stainless steel AISI 304

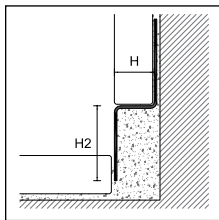

GPS4/DX/

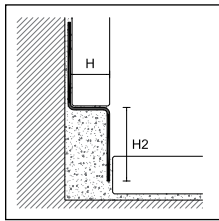

GPS4/SX/

### GLASS PROFILE

Length = 39-1/4" or 98 cm (5-piece package)

Item	Finish		H	H2	DX	SX
<b>STAINLESS STEEL</b>						
GPS4/ /10	Satin stainless steel AISI 304 \$/pc		3/8" (10 mm)	7/8" (23 mm)	31715	31717
GPS4/ /11	Satin stainless steel AISI 304 \$/pc		7/16" (11 mm)	7/8" (23 mm)	31716	31718
GPS4/ /12	Satin stainless steel AISI 304 \$/pc		1/2" (12.5 mm)	7/8" (23 mm)	31725	31727
<b>MATTE BLACK COLOR-COATED STAINLESS STEEL</b>						
GPS4/ /10	Matte black RAL 9005 color-coated stainless steel AISI 304 \$/pc		3/8" (10 mm)	7/8" (23 mm)	31719	31720
GPS4/ /11	Matte black RAL 9005 color-coated stainless steel AISI 304 \$/pc		7/16" (11 mm)	7/8" (23 mm)	31722	31724
GPS4/ /12	Matte black RAL 9005 color-coated stainless steel AISI 304 \$/pc		1/2" (12.5 mm)	7/8" (23 mm)	31726	31728



Individually packaged

### GLASS PROFILE

Length = 4' or 120 cm (5-piece package)

Item	Finish		H	H2	DX	SX
<b>STAINLESS STEEL</b>						
GPS4/ /10	Satin stainless steel AISI 304 \$/pc		3/8" (10 mm)	1-1/32" (26 mm)	31745	31747
GPS4/ /11	Satin stainless steel AISI 304 \$/pc		7/16" (11 mm)	1-1/32" (26 mm)	31746	31748
GPS4/ /12	Satin stainless steel AISI 304 \$/pc		1/2" (12.5 mm)	1-1/32" (26 mm)	31755	31757



To place orders correctly, find the desired model, size and finish. Then place your order by using the letters "PPS" followed by the corresponding 5-digit code.

MATTE BLACK COLOR-COATED STAINLESS STEEL						
GPS4/ /10	Matte black RAL 9005 color-coated stainless steel AISI 304 \$/pc		3/8" (10 mm)	1-1/32" (26 mm)	31749	31750
GPS4/ /11	Matte black RAL 9005 color-coated stainless steel AISI 304 \$/pc		7/16" (11 mm)	1-1/32" (26 mm)	31752	31754
GPS4/ /12	Matte black RAL 9005 color-coated stainless steel AISI 304 \$/pc		1/2" (12.5 mm)	1-1/32" (26 mm)	31756	31758



Individually packaged

#### GLASS PROFILE

Length = 4'10" or 148 cm (5-piece package)

Item	Finish		H	H2	DX	SX
STAINLESS STEEL						
GPS4/ /10	Satin stainless steel AISI 304 \$/pc		3/8" (10 mm)	1-1/4" (31 mm)	31775	31777
GPS4/ /11	Satin stainless steel AISI 304 \$/pc		7/16" (11 mm)	1-1/4" (31 mm)	31776	31778
GPS4/ /12	Satin stainless steel AISI 304 \$/pc		1/2" (12.5 mm)	1-1/4" (31 mm)	31785	31787



#### MATTE BLACK COLOR-COATED STAINLESS STEEL

GPS4/ /10	Matte black RAL 9005 color-coated stainless steel AISI 304 \$/pc		3/8" (10 mm)	1-1/4" (31 mm)	31779	31780
GPS4/ /11	Matte black RAL 9005 color-coated stainless steel AISI 304 \$/pc		7/16" (11 mm)	1-1/4" (31 mm)	31782	31784
GPS4/ /12	Matte black RAL 9005 color-coated stainless steel AISI 304 \$/pc		1/2" (12.5 mm)	1-1/4" (31 mm)	31786	31800

Individually packaged

#### GLASS PROFILE

Length = 6' 6-15/32" or 200 cm (5-piece package)

Item	Finish		H	H2	DX	SX
STAINLESS STEEL						
GPS4/ /10	Satin stainless steel AISI 304 \$/pc		3/8" (10 mm)	1-7/8" (49 mm)	31794	31795
GPS4/ /12	Satin stainless steel AISI 304 \$/pc		1/2" (12.5 mm)	1-7/8" (49 mm)	31798	31799

Individually packaged

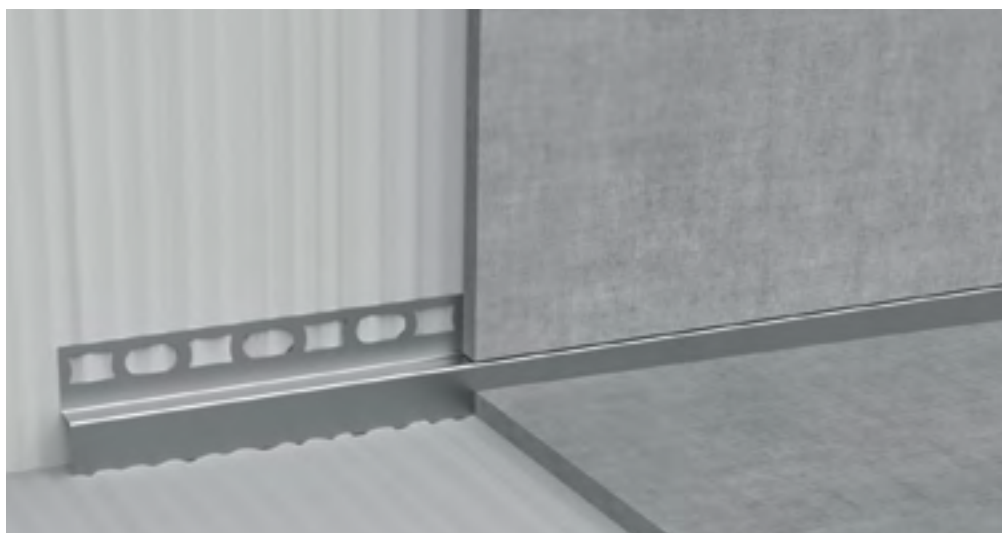

GPS4/SX/10 satin stainless steel AISI 304

To place orders correctly, find the desired model, size and finish. Then place your order by using the letters "PPS" followed by the corresponding 5-digit code.



## Glass Profile

Glass Profile GPS5/ is a stainless steel profile to be installed on the wall covering, above the shower drain with a sloped surface, in order to hide the cut of the tiles.



GPS5/ satin stainless steel AISI 304

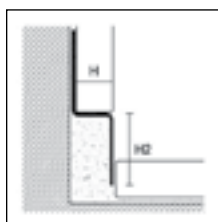

GPS5/

### GLASS PROFILE

Length = 4'2" or 125 cm (5-piece package)

Item	Finish	H	H2		
			7/8" (23 mm)	1-5/16" (33 mm)	1-3/4" (45 mm)
<b>STAINLESS STEEL</b>					
<b>GPS5/10/</b>	Satin stainless steel AISI 304 \$/pc	3/8" (10 mm)	31551	31553	31559
<b>GPS5/11/</b>	Satin stainless steel AISI 304 \$/pc	7/16" (11 mm)	31563	31572	-
<b>GPS5/12/</b>	Satin stainless steel AISI 304 \$/pc	1/2" (12.5 mm)	31555	31557	31561
<b>MATTE BLACK COLOR-COATED STAINLESS STEEL</b>					
<b>GPS5/10/</b>	Matte black RAL 9005 color-coated stainless steel AISI 304 \$/pc	3/8" (10 mm)	31567	31568	-
<b>GPS5/11/</b>	Matte black RAL 9005 color-coated stainless steel AISI 304 \$/pc	7/16" (11 mm)	31570	31571	-
<b>GPS5/12/</b>	Matte black RAL 9005 color-coated stainless steel AISI 304 \$/pc	1/2" (12.5 mm)	31573	31574	-

Individually packaged



GPS5/ matte black RAL 9005 color-coated stainless steel AISI 304

To place orders correctly, find the desired model, size and finish. Then place your order by using the letters "PPS" followed by the corresponding 5-digit code.

# Glass Profile

GU/ and TGU/ are anodized aluminum profiles designed for the insertion of glass walls on the floor and on the wall of floor-level showers.



GU/40/12 + TGU/12 silver anodized aluminum

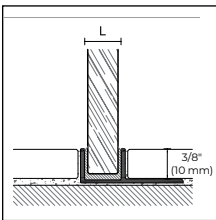

TGU/

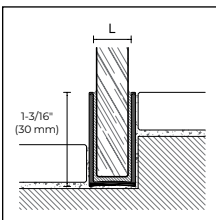

GU/30/

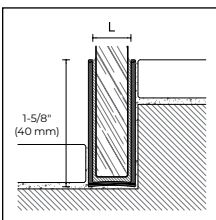

GU/40/

### GLASS PROFILE

Length = 8'10" or 270 cm /  
10-piece package

L

Item	Finish	31/64" (12 mm)	17/32" (14 mm)
<b>ALUMINUM</b>			
TGU/	Silver anodized	67760	67762
	<b>\$/pc</b>		

Individually packaged

### GLASS PROFILE

Length = 8'10" or 270 cm /  
10-piece package

L

Item	Finish	31/64" (12 mm)	17/32" (14 mm)
<b>ALUMINUM</b>			
GU/30/	Silver anodized	67770	67772
	<b>\$/pc</b>		
GU/40/	Silver anodized	67780	67782
	<b>\$/pc</b>		

Individually packaged

To place orders correctly, find the desired model, size and finish. Then place your order by using the letters "PPS" followed by the corresponding 5-digit code.

# Sanibord

Sanibord BP/22 and BP/25 are technical profiles made of coextruded PVC and designed to be inserted between the wall covering and the bathtub or shower tray during installation. These profiles avoid the use of silicone and, besides the aesthetic advantages, guarantee a high hygienic level over time.

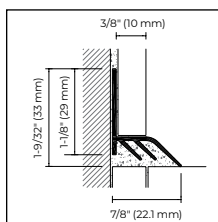

BP/22

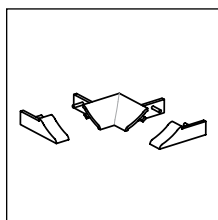

BPT/22

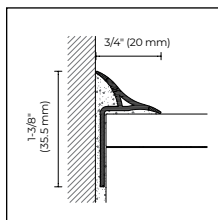

BP/25

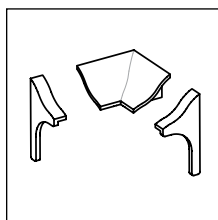

BPT/25

## SANIBORD

Length = 8'10" or 270 cm / 20-piece package

Item	Finish		
<b>CO-EXTRUDED PVC</b>			
BP/22	Anti-mold white	<input type="checkbox"/>	95520
	<b>\$/pc</b>		

No partial packaging

### INSIDE CORNER AND RIGHT/LEFT END CAPS FOR BP/22

6-blister package

Item	Finish		
<b>POLYPROPYLENE</b>			
BPT/22	White	<input type="checkbox"/>	95530
	<b>\$/blister</b>		

No partial packaging

## SANIBORD

Length = 8'10" or 270 cm / 20-piece package

Item	Finish		
<b>CO-EXTRUDED PVC</b>			
BP/25	Anti-mold white	<input type="checkbox"/>	95540
	<b>\$/pc</b>		

No partial packaging

### INSIDE CORNER AND RIGHT/LEFT END CAPS FOR BP/25

6-blister package

Item	Finish		
<b>POLYPROPYLENE</b>			
BPT/25	White	<input type="checkbox"/>	95545
	<b>\$/blister</b>		

No partial packaging

To place orders correctly, find the desired model, size and finish. Then place your order by using the letters "PPS" followed by the corresponding 5-digit code.

# Sanibord

Sanibord BH/20 and BP/20 are technical profiles made of color-coated aluminum and coextruded PVC and designed to be installed between the wall covering and the bathtub or the shower tray.

These profiles avoid the use of silicone and, besides the aesthetic advantages, guarantee a high hygienic level over time.

BH/20 is manufactured with certified antibacterial technology (according to the internationally recognized laboratory test JIS Z 2801:2000), which allows up to 99% reduction in the presence of the most harmful bacteria.



BP/20 anti-mold white co-extruded PVC

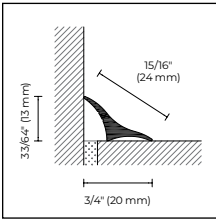

BH/20

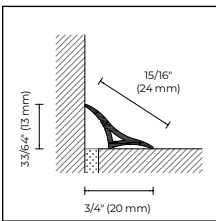

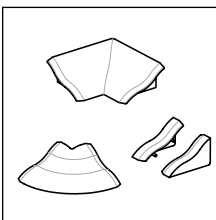

BP/20



BPT/20



## SANIBORD

Length = 8'10" or 270 cm / 20-piece package

Item	Finish		
<b>ANTIBACTERIAL COLOR-COATED ALUMINUM</b>			
BH/20	Color-coated white antibacterial RAL 9003		95459
	<b>\$/pc</b>		
BH/20/A adhesive	Color-coated white antibacterial RAL 9003		95460
	<b>\$/pc</b>		

## SANIBORD

Length = 8'10" or 270 cm / 20-piece package

Item	Finish		
<b>CO-EXTRUDED PVC</b>			
BP/20	Anti-mold white		95490
	<b>\$/pc</b>		
BP/20/A adhesive	Anti-mold white		95470
	<b>\$/pc</b>		

No partial packaging

To place orders correctly, find the desired model, size and finish. Then place your order by using the letters "PPS" followed by the corresponding 5-digit code.







## Stair-Nosing Profiles

Protect and Prostep are two lines of stair-nosing profiles that offer protection, finishing and safety for commercial and residential applications.

# Prostep™

Prostep SGA, SGI, SGN and SGK profiles are designed for the realization and protection of ceramic, marble and stone steps. Thanks to the rounded section, they give elegance to the steps. The versions made of chromium-plated brass and anodized aluminum are not recommended in case of intense foot traffic, whereas those made of stainless steel are particularly suitable for heavy foot traffic.



SGI/11 polished stainless steel AISI 304

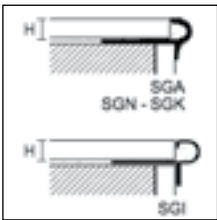

PPDESIGN

### PROSTEP

Length = 8'10" or 270 cm  
(10 pieces per package)

Item	Finish		H			
			9/32" (7 mm)	11/32" (9 mm)	7/16" (11 mm)	1/2" (13 mm)
<b>ALUMINUM</b>						
SGA/	Silver anodized		94965	94966	94967	94968
	\$/pc					
<b>STAINLESS STEEL</b>						
SGI/	Polished stainless steel AISI 304		-	94922	94924	-
	\$/pc					
<b>BRASS</b>						
SGN/	Natural brass		94970	94971	94972	-
	\$/pc					
<b>CHROMIUM-PLATED BRASS</b>						
SGK/	Chromium-plated brass		94980	94981	94982	-
	\$/pc					

Individually packaged. Items SGK/9 and SGK/11 come in 5-piece packages.

Prostep SMA and SM are aluminum and brass profiles for creation and protection of ceramic, marble and stone steps. The grooved top provides a non-slip surface.



SMA/4.5 natural aluminum

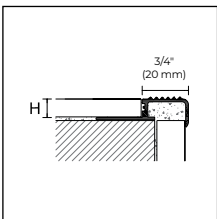

SMA/  
SM/

### PROSTEP

Length = 8'10" or 270 cm  
(10 pieces per package)

Item	Finish		H				
			3/16" (4.5 mm)	5/16" (8 mm)	3/8" (10 mm)	7/16" (11 mm)	1/2" (12.5 mm)
<b>ALUMINUM</b>							
SMA/	Natural aluminum		93967	93969	93970	93979	93971
	\$/pc						
SMA/	Silver anodized		93975	93976	93977	93980	93978
	\$/pc						
<b>BRASS</b>							
SM/	Natural brass		-	-	93972	-	93973
	\$/pc						

Individually packaged

To place orders correctly, find the desired model, size and finish. Then place your order by using the letters "PPS" followed by the corresponding 5-digit code.



# Prostep™ / Protrim

Protrim IPI/ is a minimal profile made of aluminum or stainless steel that can be used with mitred tiles.



IPA/11 silver anodized aluminum

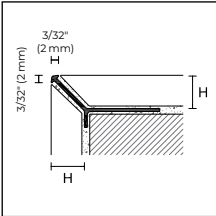

IPA/  
IPB/

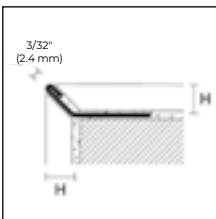

IPI/

Prostep SNG and SN are aluminum and brass profiles designed for the creation and protection of ceramic, marble and stone steps.

## PROTRIM IP

Length = 8'10" or 270 cm  
(20 pieces per package)

		H			
Item	Finish	3/16" (4.5 mm)	5/16" (8 mm)	7/16" (11 mm)	9/16" (15 mm)
<b>ALUMINUM</b>					
IPA/	Silver anodized	95006	95178	95181	95185
	<b>\$/pc</b>				
IPB/	Bright polished silver	95008	-	-	-
	<b>\$/pc</b>				

Individually packaged

## PROTRIM IP

Length = 8'10" or 270 cm  
(20 pieces per package)

		H			
Item	Finish	9/32"(7 mm)	5/16" (8 mm)	7/16" (11 mm)	1/2" (12.5 mm)
<b>STAINLESS STEEL</b>					
IPI/	Stainless steel AISI 304	95169	95170	95173	95174
	<b>\$/pc</b>				

Individually packaged



SNG/10 silver anodized aluminum

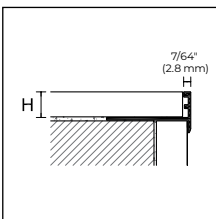

SNG/  
SN/

## CERFIX PROSTEP

Length = 8'10" or 270 cm  
(20 pieces per package)

		H			
Item	Finish	5/16" (8 mm)	3/8" (10 mm)	1/2" (12.5 mm)	9/16" (15 mm)
<b>ALUMINUM</b>					
	Natural aluminum	90040	90042	90044	90046
	<b>\$/pc</b>				
SNG/	Silver anodized	90041	90043	90045	90047
	<b>\$/pc</b>				
SN/	Natural brass	93991	93992	93993	-
	<b>\$/pc</b>				

Individually packaged. Item SN/ comes in a 10-piece package.

To place orders correctly, find the desired model, size and finish. Then place your order by using the letters "PPS" followed by the corresponding 5-digit code.



# Cerfix™ Prostep™

Prostep SAR and SIR are stair-nosing profiles made of aluminum and stainless steel, suitable for protecting steps and pavements.

Thanks to the reversible shapes, these two versions can be used for tiles of different thicknesses.



SAR/10/12 silver anodized aluminum



SIR/10/12 stainless steel AISI 304

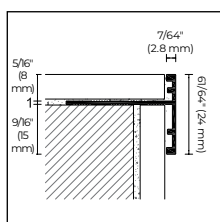

SAR/8

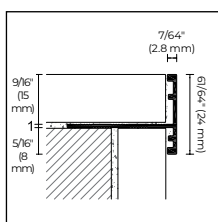

SAR/15

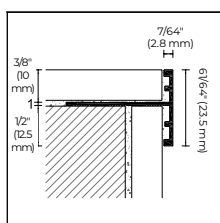

SAR/10

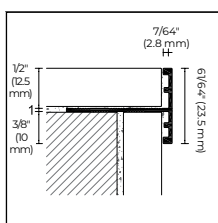

SAR/12

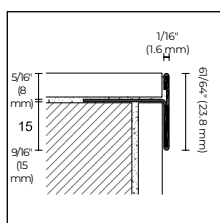

SIR/8  
SIRS/8

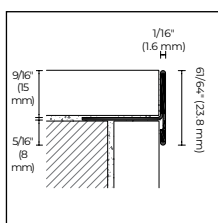

SIR/15  
SIRS/15

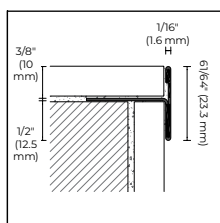

SIR/10  
SIRS/10

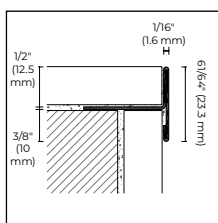

SIR/12  
SIRS/12

## CERFIX PROSTEP

Length = 8'10" or 270 cm – (10 pieces per package)

Item	Finish		
<b>ALUMINUM</b>			
SAR/8/15	Silver anodized		93956
	<b>\$/pc</b>		
SAR/10/12	Silver anodized		93958
	<b>\$/pc</b>		

Individually packaged

## CERFIX PROSTEP

Length = 8'10" or 270 cm – (10 pieces per package)

Item	Finish		
<b>STAINLESS STEEL</b>			
SIR/8/15	Polished stainless steel AISI 304		93952
	<b>\$/pc</b>		
SIR/10/12	Polished stainless steel AISI 304		93954
	<b>\$/pc</b>		
SIRS/8/15	Satin stainless steel AISI 304		93953
	<b>\$/pc</b>		
SIRS/10/12	Satin stainless steel AISI 304		93955
	<b>\$/pc</b>		

Individually packaged

To place orders correctly, find the desired model, size and finish. Then place your order by using the letters "PPS" followed by the corresponding 5-digit code.

Prostep SIS is a stainless steel profile for the creation and protection of ceramic, marble and stone steps. This profile is designed with a grooved non-slip surface.

Prostep SIS is particularly suitable for the protection of steps subject to heavy pedestrian traffic.



SIS/10 satin stainless steel AISI 304

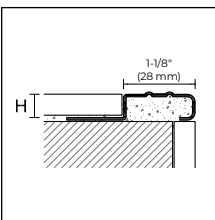

SIS/

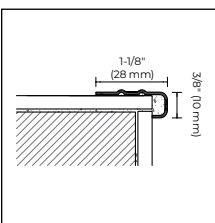

SIS/10/SF

Prostep SIX is a stainless-steel profile for the creation and protection of ceramic, marble and stone steps, featuring a black 1" (25 mm) non-slip Safety-Step strip. It is particularly suitable for protecting stairs with heavy pedestrian traffic.

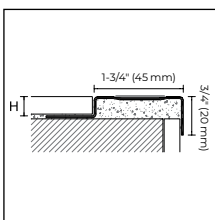

SIX/

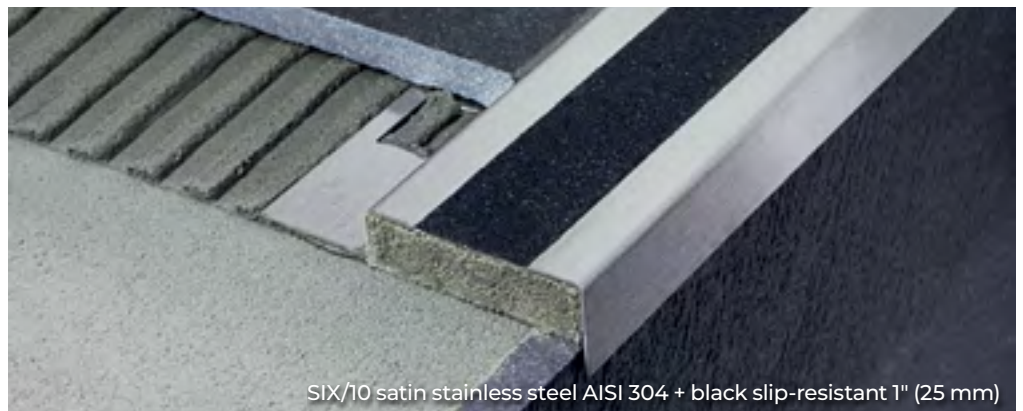

SIX/10 satin stainless steel AISI 304 + black slip-resistant 1" (25 mm)

### CERFIX PROSTEP

Length = 8'10" or 270 cm  
(10 pieces per package)

		H		
Item	Finish	3/8" (10 mm)	7/16" (11 mm)	1/2" (12.5 mm)
<b>STAINLESS STEEL</b>				
SIS/	Satin stainless steel AISI 304 \$/pc	93987	93989	93988
SIS/10/SF	Satin stainless steel AISI 304 \$/pc	93997	-	-

Individually packaged

### CERFIX PROSTEP

Length = 8'10" or 270 cm  
(10 pieces per package)

		H		
Item	Finish	5/16" (8 mm)	3/8" (10 mm)	1/2" (12.5 mm)
<b>STAINLESS STEEL</b>				
SIX/	Satin stainless steel AISI 304 + black slip-resistant 25 mm \$/pc	93981	93982	93983

Individually packaged

To place orders correctly, find the desired model, size and finish. Then place your order by using the letters "PPS" followed by the corresponding 5-digit code.

## Cerfix™ Prostep™

Prostep Wood is a line of solid-wood profiles with an aluminum base for the creation and protection of ceramic, wood and cotto tile steps. Available in different heights, it can be painted immediately after installation for the best finishing and durability results.



SWA/10 oak

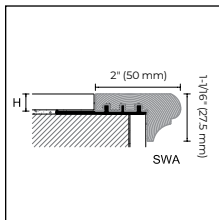

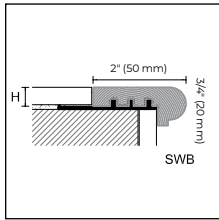

SWA/



SWB/

### CERFIX PROSTEP WOOD

Length = 8'10" or 270 cm  
(5 pieces per package)

Item	Finish	H			
		3/8" (10 mm)	1/2" (12.5 mm)	9/16" (15 mm)	
SWA/	Oak		90480	90484	90488
	\$/pc				
SWB/	Oak		90512	90516	-
	\$/pc				

Prostep SP is a line of PVC profiles with an aluminum base for the creation and protection of ceramic, stone and brick floors. The grooved PVC insert provides a non-slip surface.



SP/10 aluminum + Black PVC

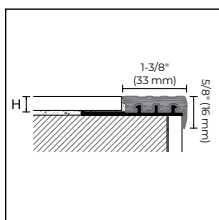

SP/

### CERFIX PROSTEP

Length = 8'10" or 270 cm  
(10 pieces per package)

Item	Finish	H			
		5/16" (8 mm)	3/8" (10 mm)	1/2" (12.5 mm)	
SP/	Aluminum + black PVC		95200	95210	95220
	\$/pc				

To place orders correctly, find the desired model, size and finish. Then place your order by using the letters "PPS" followed by the corresponding 5-digit code.

Prostep SA and SB is a line of PVC profiles with an aluminum base for the creation and protection of ceramic, stone and brick floors. The grooved PVC insert provides a non-slip surface.



SB/10 aluminum + dark gray PVC

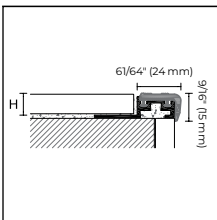

SA/

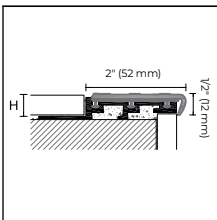

SB/

**CERFIX PROSTEP**

Length = 8'10" or 270 cm (10 pieces per package) H

Item	Finish	5/16" (8 mm)	3/8" (10 mm)	1/2" (12.5 mm)	9/16" (15 mm)
SA/	Aluminum + dark gray PVC	94041	94101	94161	-
	\$/pc				

**SPARE PVC – 10-piece package**

SA/G	Dark gray PVC			94913	
	\$/pc				

Length = 8'10" or 270 cm (10 pieces per package) H

Item	Finish	5/16" (8 mm)	3/8" (10 mm)	1/2" (12.5 mm)	9/16" (15 mm)
SB/	Aluminum + dark gray PVC	94441	94501	94561	94621
	\$/pc				

**SPARE PVC – 10-piece package**

SB/G	Dark gray PVC			94963	
	\$/pc				

No partial packaging with SA/G and SB/G.

Prostep 111 and 75 are anodized aluminum profiles for the creation and protection of stairs where resilient floors are installed.



111/4/F silver anodized aluminum



75/F silver anodized aluminum

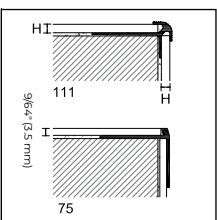

**PROTECT**

Length = 8'10" or 270 cm (20 pieces per package) H

Item	Finish	3/32" (2.5 mm)	3/16" (4.5 mm)	13/64" (5 mm)	1/4" (6 mm)
111/ /F	Silver anodized	75782	75784	75785	75786
	\$/pc				

**CERFIX PROTECT**

Length = 8'10" or 270 cm (20 pieces per package) H

Item	Finish	9/64" (3.5 mm)
75/F	Silver anodized	75388
	\$/pc	

To place orders correctly, find the desired model, size and finish. Then place your order by using the letters "PPS" followed by the corresponding 5-digit code.



# Protect

Protect 73, 74 and 58 are profiles for protection of step edges where flooring material has already been installed. Protect 87, 370 and 373 have a non-slip surface. The profiles are available in versions with drilled holes as well as with self-adhesive.

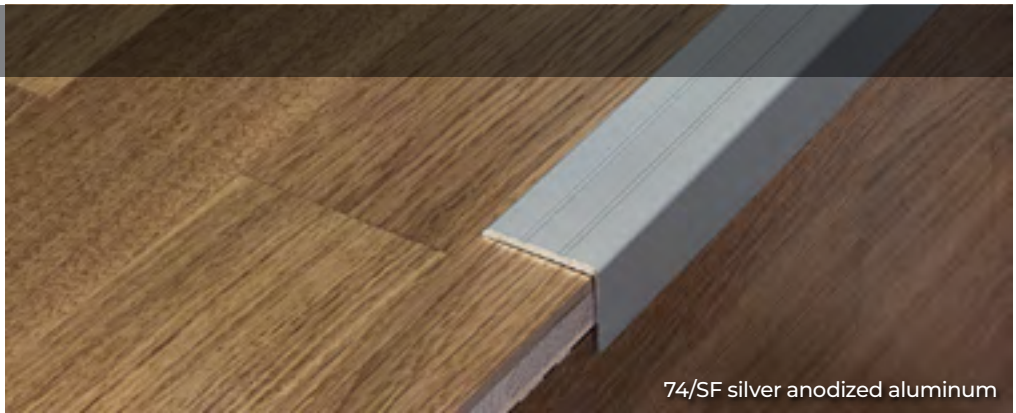

74/SF silver anodized aluminum

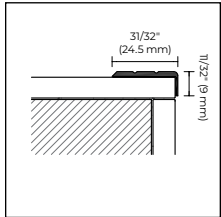

73/

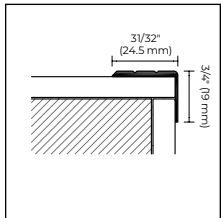

74/

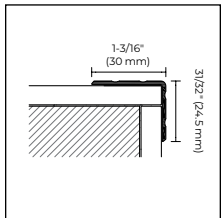

58/

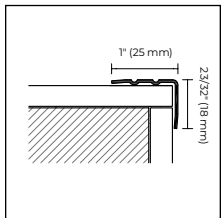

74/1F

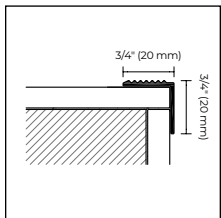

87/  
370/

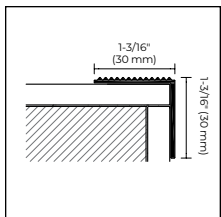

373/

## PROTECT

<b>Package</b>	30 pcs			10 pcs / blister				
<b>Length</b>	8'10" (270 cm)			36" (90 cm)	39-3/8" (100 cm)		-	
<b>Item</b>	73/			473/			-	
<b>Finish</b>	F	SF	A	CV	AD	CV	-	
<b>ALUMINUM</b>								
Silver anodized		75208	75209	75238	21422	21434	00337	-
Gold anodized		75218	-	75248	21423	21435	00338	-
Bronze anodized		-	-	75258	-	-	-	-
<b>\$/pc</b>								

<b>Package</b>	20 pcs.	30 pcs		10 pcs / blister			20 pcs		
<b>Item</b>	58/	74/		474/			74/l		
<b>Finish</b>	A	F	SF	A	CV	AD	CV	F	
<b>ALUMINUM</b>									
Silver anodized		75900	75268	75269	75298	21512	21524	00390	-
Gold anodized		-	75278	-	75308	21513	21525	00392	-
Bronze anodized		-	-	-	75318	-	-	-	-
<b>\$/pc</b>									
Titanium anodized		-	-	75299	-	-	-	-	-
<b>Length</b>									8'10" (270 cm)
<b>STAINLESS STEEL</b>									
Satin stainless steel AISI 304		-	-	-	-	-	-	-	75275
<b>\$/pc</b>									

## PROTECT

<b>Package</b>	30 pcs			10 pcs / blister		
<b>Length</b>	11' 1-3/4" (340 cm)			44-1/2" (113 cm)		
<b>Item</b>	87/			487/		
<b>Finish</b>	F	SF	A	CV	AD	
<b>ALUMINUM</b>						
Silver anodized		75108	75109	75138	22615	22641
<b>\$/pc</b>						
<b>Package</b>	10 pcs			5 pcs		
<b>Length</b>	8'10" (270 cm)			8'10" (270 cm)		
<b>Item</b>	370/			373/		
<b>Finish</b>	F	SF	A	F	A	
<b>BRASS</b>						
Polished		75169	75178	75188	75198	
<b>\$/pc</b>						

Items 87/ and 370/ individually packaged.

To place orders correctly, find the desired model, size and finish. Then place your order by using the letters "PPS" followed by the corresponding 5-digit code.

Packaging in blister. No partial packaging.

# Cerfix™ Prostep Flex / Protect

Prostep Flex is a line of bendable profiles for the protection of steps or platforms. These profiles can be curved through our Proflex Machine.

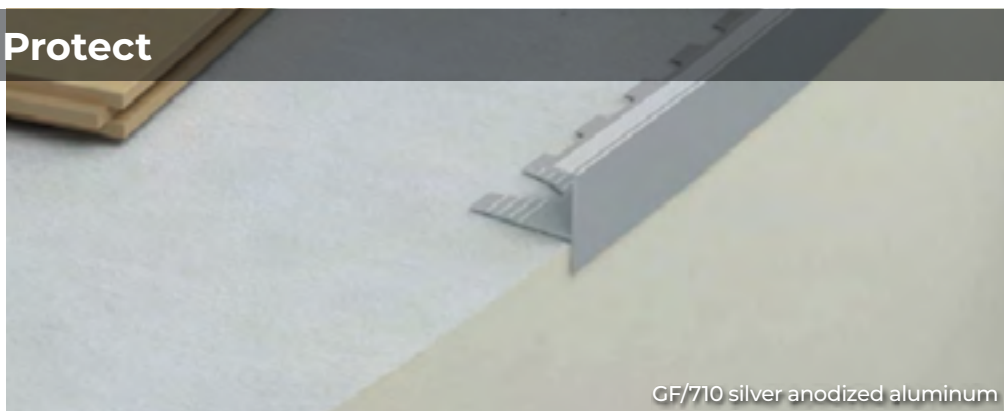

GF/710 silver anodized aluminum

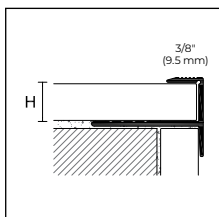

GF/

## PRO FLEX LINE

### CERFIX PROSTEP FLEX

Length = 8'10" or 270 cm – (10 pieces per package)		H	
Item	Finish	3/8" (10 mm)	9/16" (15 mm)
<b>ALUMINUM</b>			
GF/	Silver anodized	710	715
	<b>\$/pc</b>	67569	67350

Individually packaged

Protect 70, 71 and 130 are profiles for protection of step edges where flooring has been installed. The grooved top provides a non-slip surface. They are available in the version with drilled holes and with self-adhesive, and they are particularly suitable for public environments.



71/SF silver anodized aluminum

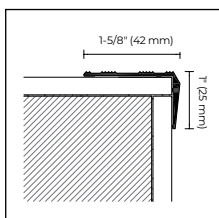

70/

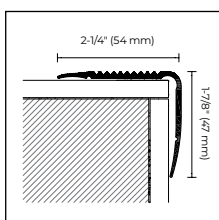

71/

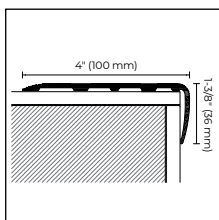

130/

### PROTECT

Package	20			10 pcs / blister	
Length	11' 1-3/4" (340 cm)			44-1/2" (113 cm)	65-3/8" (166 cm)
Item	70/			470/	
Finish	F	SF	A	CV	CV
<b>ALUMINUM</b>					
Silver anodized	75328	75329	75358	21560	21564
Gold anodized	75338	-	75368	-	-
<b>\$/pc</b>					

### PROTECT

Package	10 pcs		8 pcs	
Length	11' 1-3/4" (340 cm)		8'10" (270 cm)	
Item	71/		130/	
Finish	F	SF	F	SF
<b>ALUMINUM</b>				
Silver anodized	64067	64066	75804	75805
<b>\$/pc</b>				

To place orders correctly, find the desired model, size and finish. Then place your order by using the letters "PPS" followed by the corresponding 5-digit code.

Packaging in blister. No partial packaging.

# Protect

Protect 76, 124, 110, 80 and 126 are anodized aluminum profiles with non-slip Safety-Step inserts or rubber for the protection of already installed ceramic, wood and carpet steps. They are available in a version with drilled holes and are particularly suitable for public spaces.

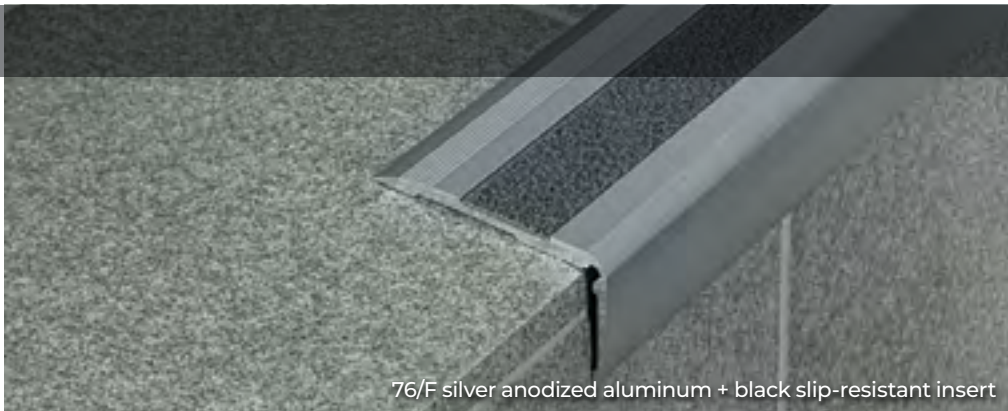

76/F silver anodized aluminum + black slip-resistant insert

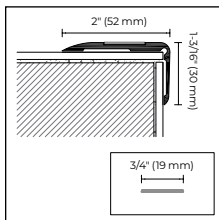

76/

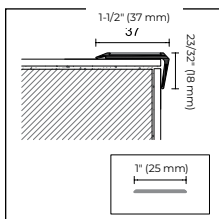

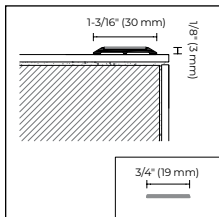

124/





110/



### PROTECT

<b>Package</b>	10 pcs	5 pcs / blister 	
<b>Length</b>	11' 1-3/4" (340 cm)	44-1/2" (113 cm)	
<b>Item</b>	76/	476/	
<b>Finish</b>	F	CV	AD
<b>ALUMINUM</b>			
Silver anodized 	75448	21680	21696
<b>\$/pc</b>			
<b>SLIP-RESISTANT ROLL</b>			
Length = 59' 8-1/2" (18.2 m) – (4 rolls per package)		Width = 3/4" (19 mm)	
Black 		23002	
<b>\$/pc</b>			

### PROTECT

Length = 8'10" or 270 cm (24 pieces per package)			
<b>Item</b>	124/		
<b>Finish</b>	F		
<b>ALUMINUM</b>			
Silver anodized 	75794		
<b>\$/pc</b>			
<b>SLIP-RESISTANT ROLL</b>			
Length = 59' 8-1/2" (18.2 m) – (4 rolls per package)		Width = 1" (25 mm)	
Black 		23004	
<b>\$/pc</b>			

### PROTECT

Length = 8'10" or 270 cm (24 pieces per package)			
<b>Item</b>	110/		
<b>Finish</b>	F		
<b>ALUMINUM</b>			
Silver anodized 	75780		
<b>\$/pc</b>			
<b>SLIP-RESISTANT ROLL</b>			
Length = 59' 8-1/2" (18.2 m) – (4 rolls per package)		Width = 3/4" (19 mm)	
Black 		23002	
<b>\$/pc</b>			

The price per meter of 76/, 124/ and 110/ does not include the non-slip insert that must be ordered separately.

To place orders correctly, find the desired model, size and finish. Then place your order by using the letters "PPS" followed by the corresponding 5-digit code.

 Packaging in blister. No partial packaging.



124/F silver anodized aluminum + black slip-resistant insert

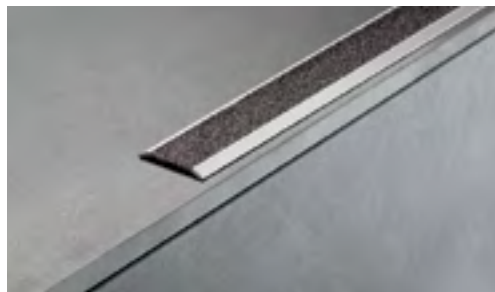

110/F silver anodized aluminum + black slip-resistant insert

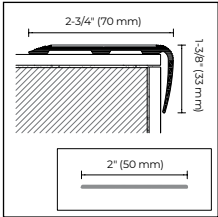

80/

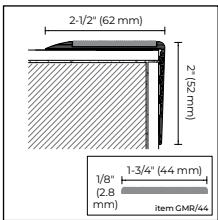

126/

**PROTECT**

Length = 11' 1-3/4" (340 cm) – (10 pieces per package)	
<b>Item</b>	<b>80/</b>
<b>Finish</b>	<b>F</b>
<b>ALUMINUM</b>	
Silver anodized	64077
<b>\$/pc</b>	
<b>SLIP-RESISTANT ROLL</b>	
Length = 59' 8-1/2" (18.2 m) – (2 rolls per package)	Width = 2" (50 mm)
Black	23006
<b>\$/pc</b>	

**PROTECT**

Length = 8'10" or 270 cm (6 pieces per package)	
<b>Item</b>	<b>126/</b>
<b>Finish</b>	<b>F</b>
<b>ALUMINUM</b>	
Silver anodized	75798
<b>\$/pc</b>	
<b>GROOVED RUBBER</b>	
Length = 56' or 17 m (1 roll per package)	
<b>Item</b>	<b>GMR/44</b>
Black	75706
<b>\$/pc</b>	



80/F silver anodized aluminum

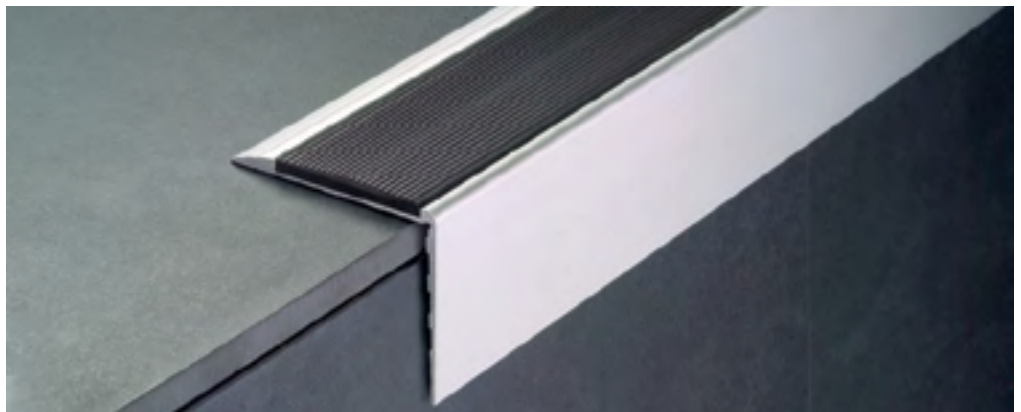

126/F silver anodized aluminum

The price per meter of 80/ does not include the non-slip insert that must be ordered separately.

The price per meter of 126/ does not include the grooved rubber that must be ordered separately.

To place orders correctly, find the desired model, size and finish. Then place your order by using the letters "PPS" followed by the corresponding 5-digit code.



# Protect

Protect 72, 79, 125 and 78 are non-slip anodized aluminum profiles with rubber insert replaceable for the protection of step edges in already installed ceramic, wood, marble and carpet flooring. They are available in a version with drilled holes and are particularly suitable for public environments.



72/F silver anodized aluminum + GM/72 black

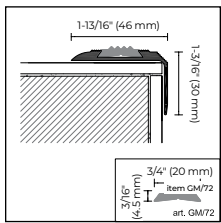

72/

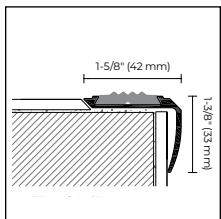

79/F + GM/R

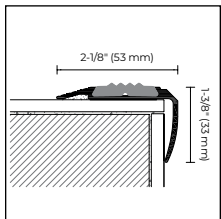

125/F + GM/R

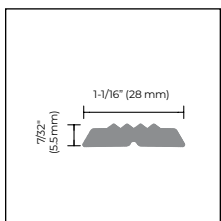

GM/R

The price per meter of 78/ does not include the grooved rubber that must be ordered separately.

To place orders correctly, find the desired model, size and finish. Then place your order by using the letters "PPS" followed by the corresponding 5-digit code.

## PROTECT

Length = 11' 1-3/4" or 340 cm (10 pieces per package)

<b>Item</b>	<b>72/</b>	
<b>Finish</b>	<b>F</b>	
<b>ALUMINUM</b>		
Silver anodized		75508
Gold anodized		75518
<b>\$/pc</b>		

## GROOVED RUBBER

Length = 111'6" or 34 m (2 rolls per package)

<b>Item</b>	<b>GM/72</b>	
Black		75565
<b>\$/pc</b>		

## PROTECT

<b>Package</b>	<b>10</b>	<b>10</b>
<b>Length</b>	<b>11' 1-3/4" (340 cm)</b>	<b>8'10" (270 cm)</b>
<b>Item</b>	<b>79/</b>	<b>125/</b>
<b>Finish</b>	<b>F</b>	<b>F</b>
<b>ALUMINUM</b>		
Silver anodized		75728
<b>\$/pc</b>		

## GROOVED RUBBER

Length = 111'6" or 34 m (2 rolls per package)

<b>Item</b>	<b>GM/R</b>	
Black		75705
<b>\$/pc</b>		

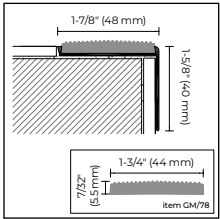

78/

**PROTECT**

Length = 11' 1-3/4" or 340 cm (20 pieces per package)

<b>Item</b>	<b>78/</b>
<b>Finish</b>	<b>F</b>

**ALUMINUM**

Silver anodized		75578
<b>\$/pc</b>		

**GROOVED RUBBER**

Length = 56' or 17 m (2 rolls per package)

<b>Item</b>	<b>GM/78</b>	
Black		75635
<b>\$/pc</b>		

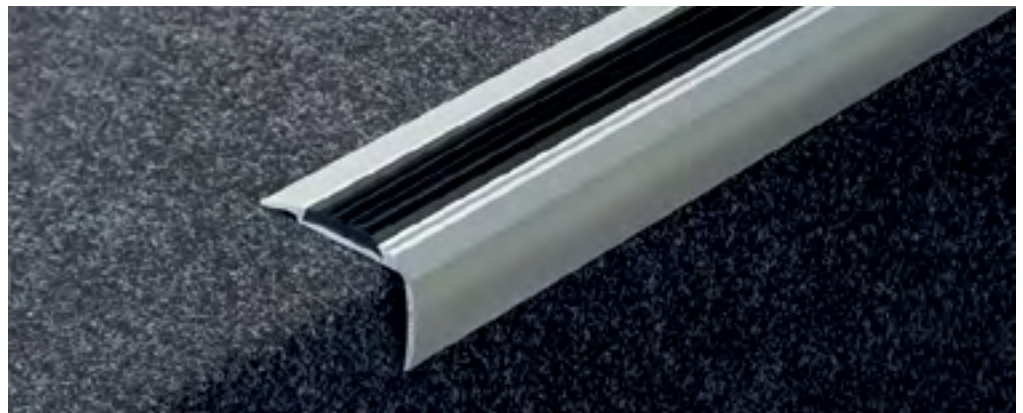

125/F silver anodized aluminum + GM/R black

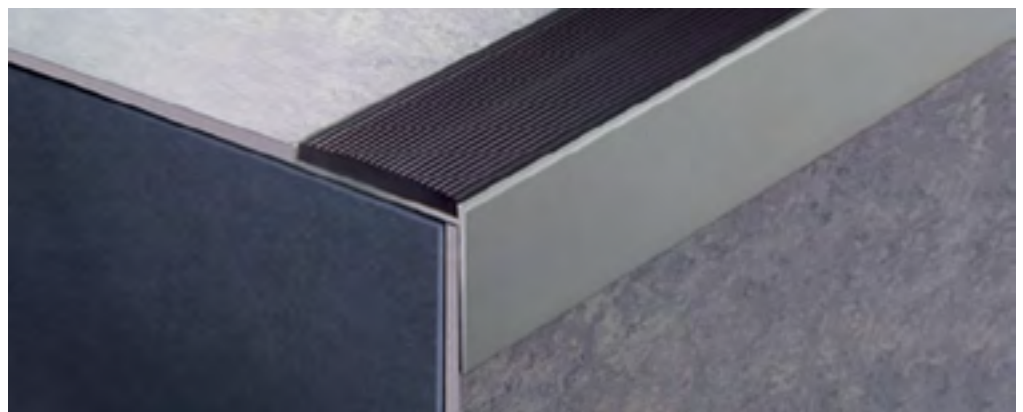

78/F silver anodized aluminum

The price per meter of 78/ does not include the grooved rubber that must be ordered separately.

To place orders correctly, find the desired model, size and finish. Then place your order by using the letters "PPS" followed by the corresponding 5-digit code.

# Protect

Protect 150, 151, 152, 154, 155 and 156 are PVC profiles for the protection of the step edges in already installed ceramic, marble, wood, PVC, linoleum, carpet and LVT flooring.

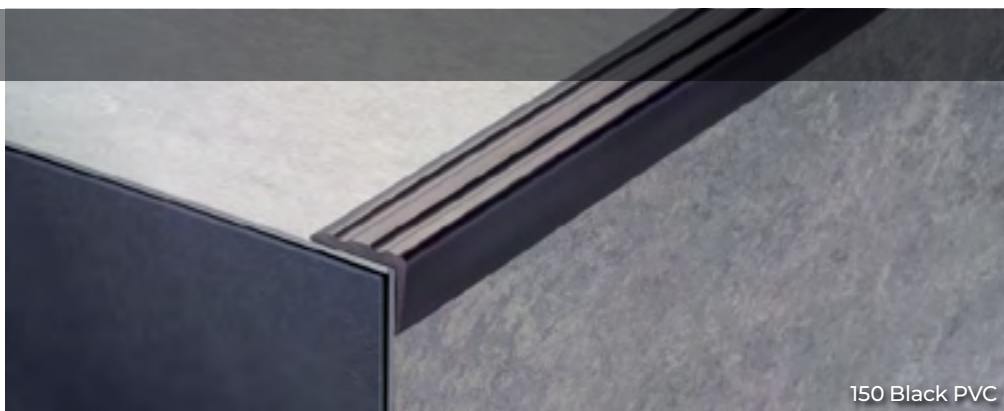

150 Black PVC

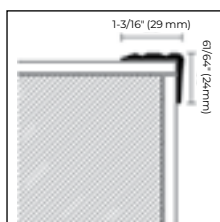

150

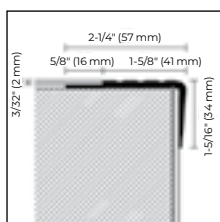

151

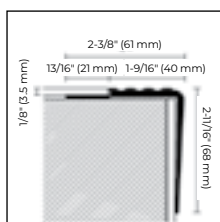

152

### PROTECT

Length = 9'10" or 300 cm (15-piece package)

Item Finish

PVC

150	Black		19100
	Gray		19101
	Brown		19102
	<b>\$/pc</b>		

No partial packaging

### PROTECT

Length = 9'10" or 300 cm (15-piece package)

Item Finish

PVC

151	Black		19110
	Gray		19111
	Brown		19112
	<b>\$/pc</b>		

No partial packaging

### PROTECT

Length = 9'10" or 300 cm (15-piece package)

Item Finish

PVC

152	Black		19120
	Gray		19121
	<b>\$/pc</b>		

No partial packaging

To place orders correctly, find the desired model, size and finish. Then place your order by using the letters "PPS" followed by the corresponding 5-digit code.

All Protect PVC items should be stored horizontally.

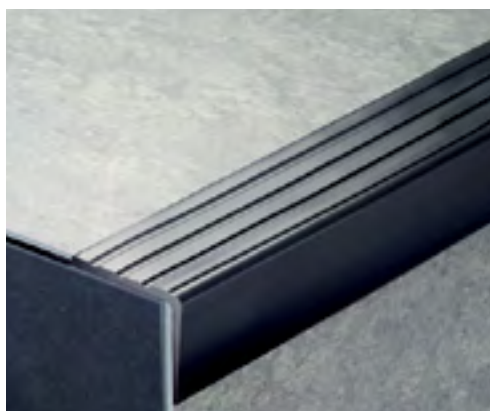

151 Black PVC



152 Black PVC

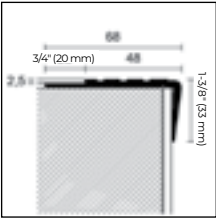

154

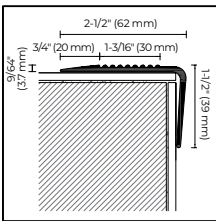

155

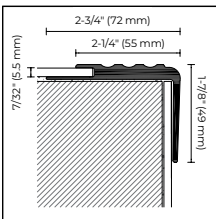

156

### PROTECT

Length = 9'10" or 300 cm (15-piece package)

Item Finish

PVC

154	Black		19140
	Gray		19141
<b>\$/pc</b>			

No partial packaging

### PROTECT

Length = 9'10" or 300 cm (15-piece package)

Item Finish

PVC

155	Black		19150
	Gray		19151
	Brown		19152
<b>\$/pc</b>			

No partial packaging

### PROTECT

Length = 9'10" or 300 cm (15-piece package)

Item Finish

PVC

156	Black		19160
	Gray		19161
	Brown		19162
<b>\$/pc</b>			

No partial packaging

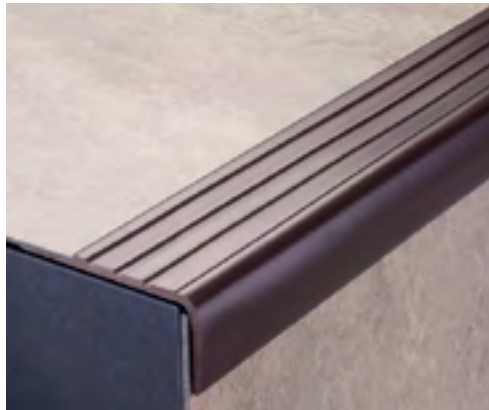

154 Brown PVC



155 Black PVC

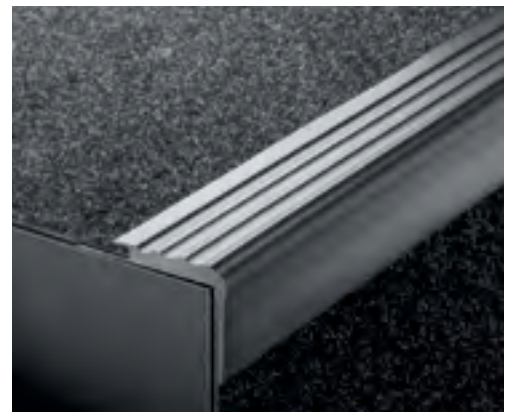

156 Gray PVC

To place orders correctly, find the desired model, size and finish. Then place your order by using the letters "PPS" followed by the corresponding 5-digit code.

All Protect PVC items should be stored horizontally.



## Safety-Step



Safety-Step slip-resistant adhesive strips consist of abrasive particles aggregated by synthetic resins. They are suitable for all surfaces subjected to heavy traffic, both pedestrian and vehicular, such as stairs, hallways of office and apartment buildings, ramps, walkways, elevators and emergency exits.



Safety-Step – slip-resistant strip



### SAFETY-STEP – SLIP-RESISTANT STRIP

Color	Width	Length	Code	\$/pc	Package
Black	3/4" (19 mm)	2' (61 cm)	23000		50
Black	1" (25 mm)	2' (61 cm)	23001		50
Black	3/4" (19 mm)	2' (61 cm)	23100		10 pcs / blister 
Black	1" (25 mm)	2' (61 cm)	23101		10 pcs / blister 
Transparent	3/4" (19 mm)	2' (61 cm)	23016		50

No partial packaging. One blister contains 4 strips.



Safety-Step – slip-resistant strip

To place orders correctly, find the desired model, size and finish. Then place your order by using the letters "PPS" followed by the corresponding 5-digit code.

 Packaging in blister. No partial packaging.



Safety-Step slip-resistant adhesive strips consist of abrasive particles aggregated by synthetic resins. They are suitable for all surfaces subjected to heavy traffic, both pedestrian and vehicular, such as stairs, hallways of office and apartment buildings, ramps, walkways, elevators and emergency exits. The gray versions (Resilient Medium / Fine) consist of a rubber surface and are perfect for areas that receive bare foot traffic, such as showers, locker rooms, saunas, boats and sports equipment.



Safety-Step – slip-resistant strip



#### SAFETY-STEP – SLIP-RESISTANT ROLL

Color	Width	Length	Code	\$/pc	Package
Black	3/4" (19 mm)	59.71' (18.2 m)	23002		4
Black	1" (25 mm)	59.71' (18.2 m)	23004		4
Black	2" (50 mm)	59.71' (18.2 m)	23006		2
Black	3/4" (19 mm)	11.81' (360 cm)	23103		10 pcs / blister 
Black	1" (25 mm)	11.81' (360 cm)	23105		10 pcs / blister 
Transparent	3/4" (19 mm)	59.71' (18.2 m)	23018		4
Transparent	1" (25 mm)	59.71' (18.2 m)	23020		4
Transparent	2" (50 mm)	59.71' (18.2 m)	23022		2
Gray	1" (25 mm)	59.71' (18.2 m)	23044		4
Gray	2" (50 mm)	59.71' (18.2 m)	23046		2



Safety-Step – slip-resistant strip

To place orders correctly, find the desired model, size and finish. Then place your order by using the letters "PPS" followed by the corresponding 5-digit code.

 Packaging in blister. No partial packaging.

# Prostair

Prostair is a system composed of a profile and its relative accessories for the anchorage of stair rods on steps. The fixing accessories permit a quick removal of the stair rods for cleaning or replacement.

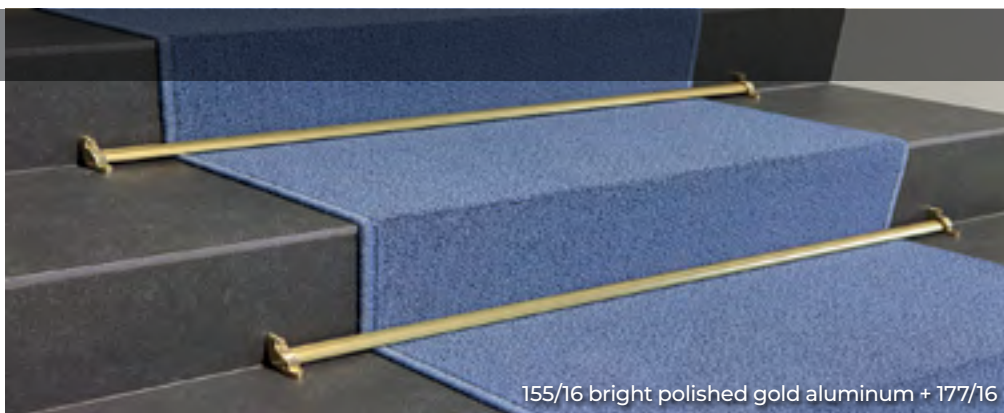

155/16 bright polished gold aluminum + 177/16

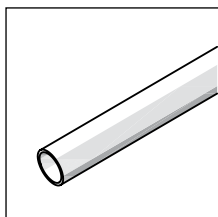

151/11

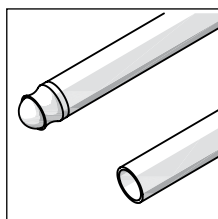

150/

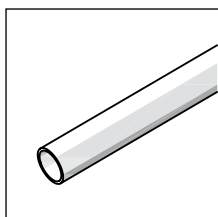

163/

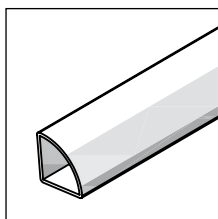

155/16

Item 163/ available in different lengths on request.

To place orders correctly, find the desired model, size and finish. Then place your order by using the letters "PPS" followed by the corresponding 5-digit code.

## PROSTAIR

Length = 12' 5-1/2" or 380 cm – Diameter = 3/8" or 11 mm (20-piece package)

Item	Finish		
<b>ALUMINUM</b>			
151/11	Bright polished silver		78430
	\$/pc		

## PROSTAIR

20-piece package

Length		31-1/2" (80 cm)	36" (90 cm)	39-3/8" (100 cm)	47-1/4" (120 cm)	12' 5-1/2" (380 cm)		
<b>Item Finish</b>		<b>Diameter</b>						
<b>ALUMINUM</b>		<b>3/8" (11 mm)</b>						
		78311	78312	78313	78314	78319		
		<b>\$/pc</b>						
150/	Bright polished gold			78323	-	78329		
		<b>33/64" (13 mm)</b>						
		78321	-	78323	-	78329		
		<b>\$/pc</b>						
		<b>41/64" (16 mm)</b>						
		-	-	-	-	78339		
		<b>\$/pc</b>						
<b>Package 10 pcs / blister</b>								
4150/11/S	Bright polished gold		<b>3/8" (11 mm)</b>	21810	21811	21812	-	-
			<b>\$/pc</b>					

## PROSTAIR

Package		10 pcs	10 pcs	10 pcs	
Length = 12' 5-1/2" or 380 cm					
<b>Finish</b>					
<b>BRASS</b>		<b>Diameter</b>			
163/	Polished		<b>3/8" (11 mm)</b>	<b>33/64" (13 mm)</b>	<b>41/64" (16 mm)</b>
			78801	78802	78803
			<b>\$/pc</b>		

## OTHER PROFILES

Length = 9'10" or 300 cm (20-piece package)

Item	Finish		
<b>ALUMINUM</b>			
155/16	Bright polished gold		78379
			<b>\$/pc</b>

Prostair is a system composed of a profile and its relative accessories for the anchorage of stair rods on steps. The fixing accessories permit a quick removal of the stair rods for cleaning or replacement.

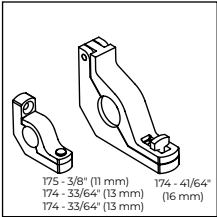
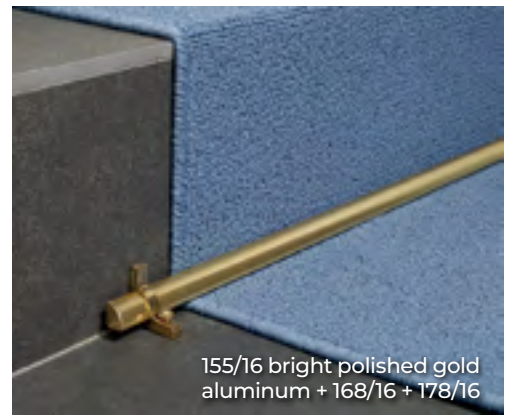

175/11 + 174/16

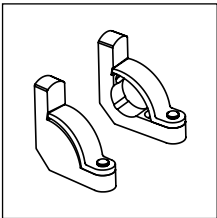

177/16

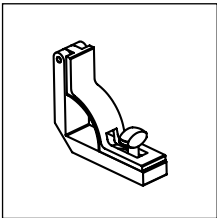

178/16

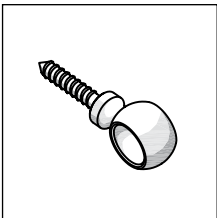

171/170

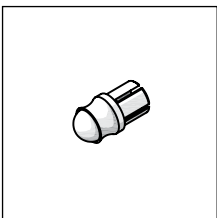

161/11 + 169/16

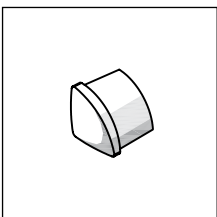

168/16

### ACCESSORIES - BRACKETS

20-piece package		Diameter		
Item	Finish	3/8" (11 mm)	33/64" (13 mm)	41/64" (16 mm)
<b>BRASS</b>				
175/11	Chromium-plated \$/pc	78445	-	-
20-piece package				
174/16	Polished \$/pc	78410	-	78412
Package 10 couples 2 pcs dx/sx				
177/16	Polished \$/pc	-	-	78415
20-piece package				
41/64" x 41/64" (16 x 16 mm)				
178/16	Polished \$/pc	78420		

### ACCESSORIES - RINGS

20-piece package		Diameter		
Item	Finish	3/8" (11 mm)	33/64" (13 mm)	41/64" (16 mm)
<b>BRASS</b>				
171/11	Chromium-plated \$/pc	78440	-	-
20-piece package				
170/16	Polished \$/pc	78400	78401	78402
10 blister packs/ 4 pcs/blister				
4170/15	Polished \$/pc	21852	-	-
No partial packaging				

### ACCESSORIES - KNOBS

20-piece package		Diameter		
Item	Finish	3/8" (11 mm)	33/64" (13 mm)	41/64" (16 mm)
<b>BRASS</b>				
161/11	Chromium-plated \$/pc	78435	-	-
20-piece package				
169/16	Brass (for aluminum and brass profiles) \$/pc	78395	78396	78397
20-piece package				
41/64" x 41/64" (16 x 16 mm)				
168/16	Polished \$/pc	78418		
No partial packaging				

To place orders correctly, find the desired model, size and finish. Then place your order by using the letters "PPS" followed by the corresponding 5-digit code.







## Internal Corner Profiles

These profiles fit the perimeter junction between floors and walls. These products ensure high hygienic efficiency in private and public environments such as hospitals, food industries, spas, swimming pools and industrial kitchens.

# Cerfix™ Proround™

Proround M in aluminum is a connection profile between floors and walls. This curved profile eliminates 90-degree angles to avoid the collection of dirt and possible sources of bacteria, which also facilitates cleaning.

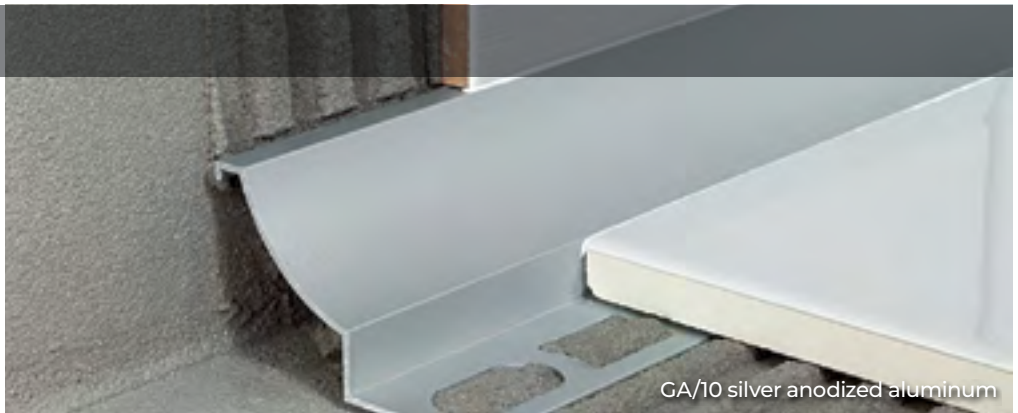

GA/10 silver anodized aluminum

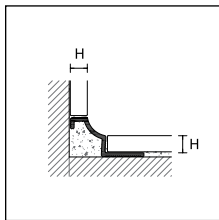

GA/4

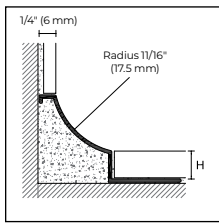

GA/8-10-12  
GV/

### CERFIX PROROUND M

Length = 8'10" or 2.7 m  
(10 pieces per package)

		H			
Item	Finish	3/16" (4.5 mm)	5/16" (8 mm)	3/8" (10 mm)	1/2" (12.5 mm)
<b>ALUMINUM</b>					
GA/	Silver anodized \$/pc	95730	95031	95032	95033
GV/	Color-coated white RAL 9003 \$/pc	-	95071	95072	95073

Individually packaged – GA/4 packaging 20 pcs

### OUTSIDE CORNER

		H		
5-piece package		3/16" (4.5 mm)	5/16", 3/8" and 1/2" (8, 10 and 12.5 mm)	
<b>ALUMINUM</b>				
GTA/E	Silver anodized \$/pc	-	95075	
GTV/E	Color-coated white RAL 9003 \$/pc	-	95083	

### INSIDE CORNER

		H	
5-piece package		3/16" (4.5 mm)	5/16", 3/8" and 1/2" (8, 10 and 12.5 mm)
<b>ALUMINUM</b>			
GTA/I	Silver anodized \$/pc	-	95077
GTV/I	Color-coated white RAL 9003 \$/pc	-	95085

No partial packaging

To place orders correctly, find the desired model, size and finish. Then place your order by using the letters "PPS" followed by the corresponding 5-digit code.

Items GV available in different colors on demand – minimum quantity 200 pieces per color.



GTA/E silver anodized aluminum



GTA/I silver anodized aluminum



GA/4 silver anodized aluminum



# Cerfix™ Proround™

Proround M GAN/ is a profile in aluminum for the connection between floors and walls, characterized by a 11/16" (17.5 mm) radius. GVNH/ boasts the certified antibacterial technology (according to the internationally recognized laboratory test JIS Z 2801:2000) that reduces the presence of the most dangerous bacteria up to 99%, thus ensuring the best hygiene over time.

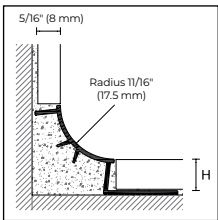

GAN/  
GVNH/

## CERFIX PROROUND M

Length = 8'10" or 2.7 m  
(10 pieces per package)

Item	Finish		H		
			5/16" (8 mm)	3/8" (10 mm)	1/2" (12.5 mm)
<b>ALUMINUM</b>					
GAN/	Silver anodized		95034	95035	95036
	<b>\$/pc</b>				
GVNH/	Color-coated white RAL 9003 antibacterial		95037	95038	95039
	<b>\$/pc</b>				

Individually packaged

## OUTSIDE/INSIDE/TRIAXIAL CORNER/END CAP

12-piece package

Item	Finish		for all H			
			GTP/E	GTP/I	GTP/T	GTP/C
<b>POLYPROPYLENE</b>						
	Color-coated silver		95121	95122	95123	95124
	<b>\$/pc</b>					
	Color-coated white RAL 9003		95125	95126	95127	95128
	<b>\$/pc</b>					

No partial packaging

To place orders correctly, find the desired model, size and finish. Then place your order by using the letters "PPS" followed by the corresponding 5-digit code.

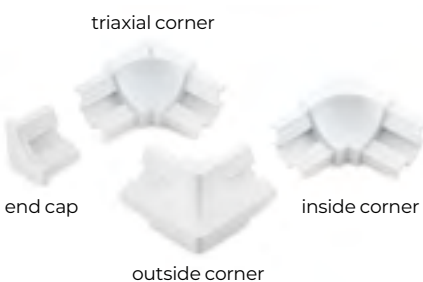



# Cerfix™ Proround™

Stainless steel Proround M is a connection profile to be used in areas requiring heightened levels of sanitary protection (such as restaurants, swimming pools, spas, industrial kitchens and hospitals). Specifically, this product offers superior resistance to corrosion, making it ideal for areas subjected to higher chemical attacks and close to sea water.



GIN/10 + ILN/10 polished stainless steel AISI 304

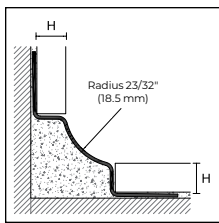

GIN 8/10/11

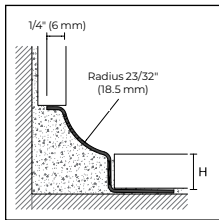

GIN/SA

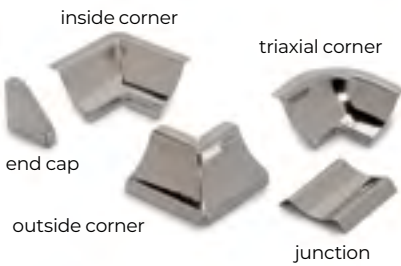

## CERFIX PROROUND M

Length = 8'10" or 2.7 m  
(10 pieces per package)

Item	Finish		H				
			5/16" (8 mm)	3/8" (10 mm)	7/16" (11 mm)	1/2" (12.5 mm)	9/16" (15 mm)
<b>STAINLESS STEEL</b>							
GIN/	Polished stainless steel AISI 304		95046	95047	95045	-	-
	<b>\$/pc</b>						
GIN5/	Satin stainless steel AISI 304		95050	95051	95057	-	-
	<b>\$/pc</b>						
GINX/	Stainless steel AISI 316		95054	95055	-	-	-
	<b>\$/pc</b>						

Individually packaged

## CERFIX PROROUND M

Length = 8'10" or 2.7 m  
(10 pieces per package)

Item	Finish		H				
			5/16" (8 mm)	3/8" (10 mm)	7/16" (11 mm)	1/2" (12.5 mm)	9/16" (15 mm)
<b>STAINLESS STEEL</b>							
GIN/SA	Polished stainless steel AISI 304		-	95044	-	95048	95049
	<b>\$/pc</b>						
GIN5/SA	Satin stainless steel AISI 304		-	-	-	95052	-
	<b>\$/pc</b>						
GINX/SA	Stainless steel AISI 316		-	-	-	95056	-
	<b>\$/pc</b>						

Individually packaged

		OUTSIDE CORNER-E		INSIDE CORNER-I			
5-piece package		for all H		5-piece package for all H			
Item	Finish			Item			
<b>STAINLESS STEEL</b>							
GTIN/E	Polished stainless steel AISI 304		95059	GTIN/I	95058		
	<b>\$/pc</b>						
GTINS/E	Satin stainless steel AISI 304		95063	GTINS/I	95062		
	<b>\$/pc</b>						
GTINX/E	Stainless steel AISI 316		95067	GTINX/I	95066		
	<b>\$/pc</b>						
5-piece package		TRIAXIAL CORNER-T		JUNCTION-G		END CAPS	
for all H		for all H		5-piece package for all H		for all H	
Item	Finish			Item		Item	
GTIN/T	Polished stainless steel AISI 304		95060	GTIN/G	95061	GTIN/C	95040
	<b>\$/pc</b>						
GTINS/T	Satin stainless steel AISI 304		95064	GTINS/G	95065	GTINS/C	95041
	<b>\$/pc</b>						
GTINX/T	Stainless steel AISI 316		95068	GTINX/G	95069	GTINX/C	95042
	<b>\$/pc</b>						

No partial packaging

To place orders correctly, find the desired model, size and finish. Then place your order by using the letters "PPS" followed by the corresponding 5-digit code.

# Cerfix™ Proround™

Proround P is a non-toxic PVC and impact-resistant connection profile between floors and walls. Per North American standards for sanitary maintenance, this curved profile eliminates 90-degree angles to avoid the collection of dirt and possible sources of bacteria, which also facilitates cleaning. Models with a single anchor flange can be used to connect floors and walls with different thicknesses.



GP/10 white co-extruded PVC

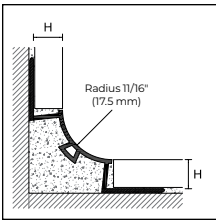

GP/

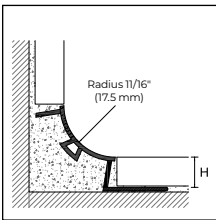

GPU/

## CERFIX PROROUND P

Length = 8'10" or 2.7 m  
(20 pieces per package)

Item	H		H	
	GP/		GPU/	
Finish	5/16" (8 mm)	3/8" (10 mm)	3/8" (10 mm)	1/2" (12.5 mm)
<b>CO-EXTRUDED PVC</b>				
White	95800	95801	95804	95803
Light gray RAL 7035	95805	95806	-	-
Stone gray RAL 7030	95810	95811	-	-
Beige gray RAL 1019	95815	95816	-	-
<b>\$/pc</b>				

## INSIDE/OUTSIDE/TRIAXIAL CORNERS AND END CAPS

12-piece package

Item	for all H			
	GTP/E	GTP/I	GTP/T	GTP/C
<b>POLYPROPYLENE</b>				
White	95852	95851	95850	95853
Light gray RAL 7035	95862	95861	95860	95863
Stone gray RAL 7030	95872	95871	95870	95873
Beige gray RAL 1019	95882	95881	95880	95883
<b>\$/pc</b>				

No partial packaging

To place orders correctly, find the desired model, size and finish. Then place your order by using the letters "PPS" followed by the corresponding 5-digit code.

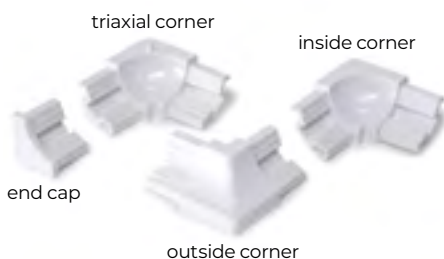

GTP/E RAL 7035 light gray polypropylene



GTP/T RAL 7035 light gray polypropylene

# Cerfix™ Proround™

Proround M GIC/ and Proint PIN/ are two stainless steel profiles with rounded shapes for connecting floors and walls, to be used in areas where special hygiene protection is required. The shape of GIC/ is particularly versatile thanks to its internal fixing flange.



GIC/8 polished stainless steel AISI 304

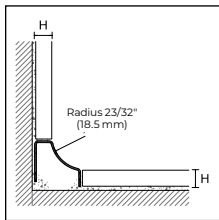

GIC/

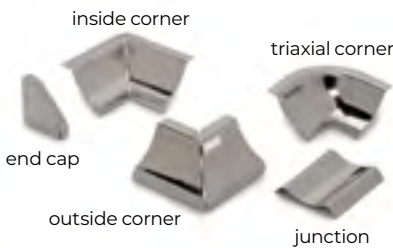

## CERFIX PROROUND M

Length = 8'10" or 2.7 m  
(5 pieces per package)

		H	
Item	Finish	5/16" (8 mm)	
<b>STAINLESS STEEL</b>			
GIC/	Polished stainless steel AISI 304		95140
	<b>\$/pc</b>		

		OUTSIDE CORNER-E for all H		INSIDE CORNER-I for all H	
5-piece package	Item	Finish		5-piece package	Item
<b>STAINLESS STEEL</b>					
GTIN/E	Polished stainless steel AISI 304		95059	GTIN/I	95058
	<b>\$/pc</b>				

No partial packaging

		TRIAXIAL CORNER-T for all H		JUNCTION-G for all H		END CAP for all H	
5-piece package	Item	Finish		5-piece package	Item	5-piece package	Item
<b>STAINLESS STEEL</b>							
GTIN/T	Polished stainless steel AISI 304		95060	GTIN/G	95061	GTIN/C	95040
	<b>\$/pc</b>						

No partial packaging

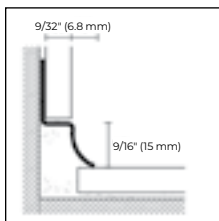

PIN/

## CERFIX PROINT

Length = 8'10" or 2.7 m  
(10 pieces per package)

		H	
Item	Finish	3/8" (10 mm)	1/2" (12.5 mm)
<b>STAINLESS STEEL</b>			
PIN/	Polished stainless steel AISI 304		85392
	<b>\$/pc</b>		85394

Individually packaged



PIN/10 polished stainless steel AISI 304

To place orders correctly, find the desired model, size and finish. Then place your order by using the letters "PPS" followed by the corresponding 5-digit code.

# Cerfix™ Proint

Proint PIA/ and PI/ are two line of profiles in aluminum and PVC, suitable as perimetral connection during the installation of the wall covering and the floor.

The use of Proint PIA/ and PI/ allows to avoid the use of silicone for sealing and, in addition to the aesthetic advantage, it guarantees a high hygiene over time.

The special sections of Proint facilitate the corner connection between the wall covering and the floor.



PIA/9 silver anodized aluminum

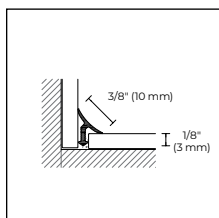

PIA/3

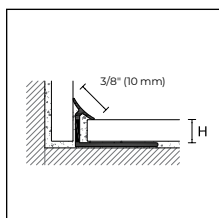

PIA/  
PI/

## CERFIX PROINT

Length = 8'10" or 2.7 m  
(20 pieces per package)

Item	Finish	H			
		1/8" (3 mm)	9/32" (7 mm)	11/32" (9 mm)	31/64" (12 mm)
<b>ALUMINUM</b>					
PIA/	Silver anodized	95431	95430	95432	95429
\$/pc					

Individually packaged

## CERFIX PROINT

Length = 8'10" or 2.7 m  
(20 pieces per package)

Item	Finish	H	
		9/32" (7 mm)	11/32" (9 mm)
<b>CO-EXTRUDED PVC</b>			
	Snow white	95396	95398
	White	95400	95402
	Cream white RAL 9001	-	95406
	Ivory RAL 1015	-	95418
PI/	Beige gray RAL 1019	-	95410
	Stone gray RAL 7030	-	95422
	Ash gray RAL 7038	-	95433
	Light gray RAL 7035	-	95414

20-piece package

\$/pc

No partial packaging – to order the pack of 100 pieces, mark /100 after article code

To place orders correctly, find the desired model, size and finish. Then place your order by using the letters "PPS" followed by the corresponding 5-digit code.

Items PI/ available in different colors on demand – minimum quantity 1,000 pieces per color



PI/9 white co-extruded PVC



PIA/3 silver anodized aluminum



# Cerfix™ Proround™

Proround B in aluminum or PVC is a line of perimeter connection profiles to be used between floors and walls, specially designed for application on already laid surfaces. These profiles are the best solution for renovations and for compliance with hygienic regulations. BLAH/ boasts the certified antibacterial technology (according to the internationally recognized laboratory test JIS Z 2801:2000) that reduces the presence of the most dangerous bacteria up to 99%, thus ensuring the best hygiene over time.

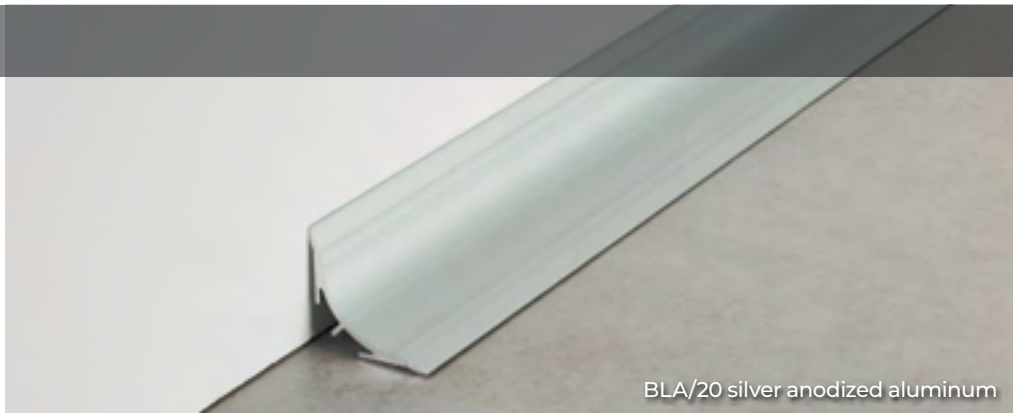

BLA/20 silver anodized aluminum

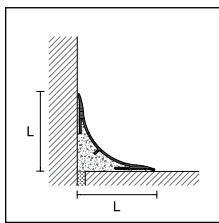

BLA/  
BLAH/

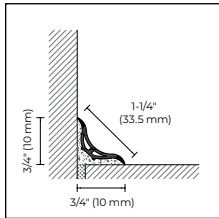

BL/20

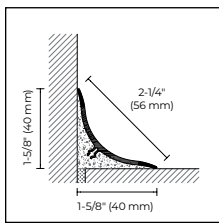

BL/40

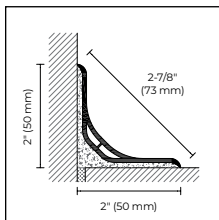

BL/50

### CERFIX PROROUND B

Length = 8'10" or 2.7 m  
(20 pieces per package)

Item	Finish	L x L		
		3/4" x 3/4" (20 x 20 mm)	1-5/8" x 1-5/8" (40 x 40 mm)	2" x 2" (50 x 50 mm)
<b>ALUMINUM</b>				
BLA/	Silver anodized \$/pc	95570	95580	-
<b>ANTIBACTERIAL COLOR-COATED ALUMINUM</b>				
BLAH/	Color-coated white RAL 9003 antibacterial \$/pc	95572	95582	-

Individually packaged

### CERFIX PROROUND B

Length = 8'10" or 2.7 m  
(20 pieces per package)

Item	Finish	L x L		
		3/4" x 3/4" (20 x 20 mm)	1-5/8" x 1-5/8" (40 x 40 mm)	2" x 2" (50 x 50 mm)
<b>PVC</b>				
BL/	White \$/pc	95550	95500	95551

### POLYPROPYLENE ACCESSORIES PACKAGE

		8 pcs	4 pcs	4 pcs
<b>OUTSIDE CORNER IN POLYPROPYLENE</b>				
GBL/ /E	Silver	95574	95584	-
	White	95556	95510	95552
<b>INSIDE CORNER IN POLYPROPYLENE</b>				
GBL/ /I	Silver	95576	95586	-
	White	95557	95512	95553
<b>TRIAXIAL CORNER IN POLYPROPYLENE</b>				
GBL/ /T	Silver	-	95588	-
	White	-	95511	95554
<b>RIGHT-LEFT END CAPS IN POLYPROPYLENE</b>				
GBL/ /C	Silver	95578	95590	-
	White	95558	95513	95555

No partial packaging – article GBL/ /C package of 16 pieces (3/4" x 3/4" or 20 x 20 mm) and 8 pieces (1-5/8" x 1-5/8" or 40 x 40 mm, and 2" x 2" or 50 x 50 mm)

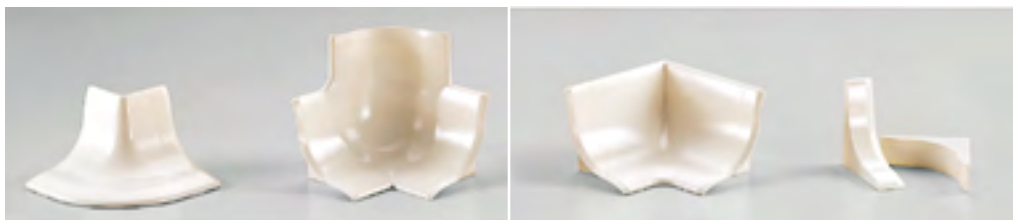

polypropylene accessories

To place orders correctly, find the desired model, size and finish. Then place your order by using the letters "PPS" followed by the corresponding 5-digit code.

# Cerfix™ Proround™

Proround B in stainless steel are perimetral connection profiles to be used between floors and walls, specially designed for the application on already-laid surfaces. These profiles are the best solution for renovations and to be compliant with hygienic regulations.

Stainless steel is particularly resistant to the attack of organic and inorganic agents and, therefore, it is suitable in spaces such as hospitals, food and chemical industries.

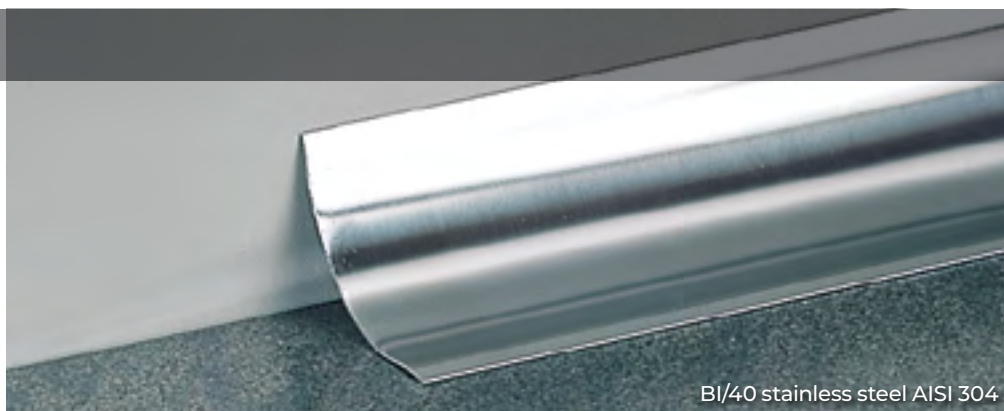

BI/40 stainless steel AISI 304

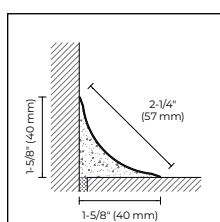

BI/40  
BI/40/A

## CERFIX PROROUND B

Length = 8'10" or 2.7 m  
(20 pieces per package)

L x L

Item Finish 1-5/8" x 1-5/8" (40 x 40 mm)

### STAINLESS STEEL

<b>BI/40</b>	Stainless steel AISI 304 \$/pc		94992
<b>BI/40/A adhesive</b>	Stainless steel AISI 304 \$/pc		94993

### POLYPROPYLENE MATCHING CHROMIUM FINISH PACKAGE OF 4 PIECES

#### OUTSIDE CORNER IN POLYPROPYLENE

<b>GTL/E</b>	Polypropylene chromium effect \$/pc		95515
--------------	---	--	-------

#### INSIDE CORNER IN POLYPROPYLENE

<b>GTL/I</b>	Polypropylene chromium effect \$/pc		95517
--------------	---	--	-------

#### TRIAxIAL CORNER IN POLYPROPYLENE

<b>GTL/T</b>	Polypropylene chromium effect \$/pc		95516
--------------	---	--	-------

#### RIGHT-LEFT END CAPS IN POLYPROPYLENE

<b>GTL/C</b>	Polypropylene chromium effect \$/pc		95518
--------------	---	--	-------

No partial packaging

To place orders correctly, find the desired model, size and finish. Then place your order by using the letters "PPS" followed by the corresponding 5-digit code.



outside corner

triaxial corner

inside corner

rh-lh end cap









## Movement Joints

The line is designed to allow expansion and contraction. Different finishes are available.



## Cerfix™ Projoint™

Projoint DIL NE is an expansion joint in co-extruded PVC. Available in three colors and four heights, it is suitable for large areas with pedestrian traffic, allowing the stresses of compression and expansion to be absorbed.

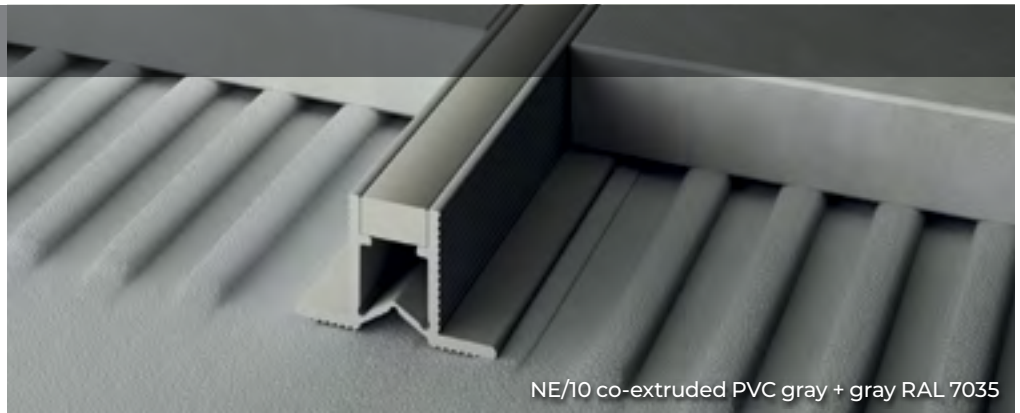

NE/10 co-extruded PVC gray + gray RAL 7035

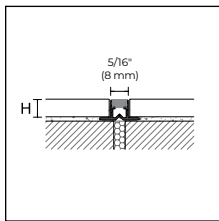

NE/

### CERFIX PROJJOINT DIL

Length = 8' 10" or 2.7 m

Item	Finish		H			
			5/16" (8 mm)	3/8" (10 mm)	1/2" (12.5 mm)	9/16" (15 mm)
<b>CO-EXTRUDED PVC</b>						
NE/	Gray + gray RAL 7035		99650	99660	99670	99680
	<b>\$/pc</b>					
NE/	Stone gray + stone gray RAL 7030		99653	99663	99673	99683
	<b>\$/pc</b>					
NE/	Cream white + cream white RAL 9001		99652	99662	-	-
	<b>\$/pc</b>					

**\$/20-piece package**

No partial packaging

Projoint DIL NJ/ is an expansion joint in co-extruded PVC with perforated side flanges. It can absorb tensile and compression stresses thanks to its central elastic component. Non-toxic, anti-shock and UV-resistant, this joint can be used indoors and outdoors.



NJ/10 co-extruded PVC light gray RAL 7035

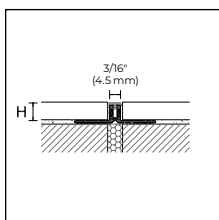

NJ/

### CERFIX PROJJOINT DIL

Length = 8' 10" or 2.7 m

Item	Finish		H				
			3/16" (4.5 mm)	5/16" (8 mm)	3/8" (10 mm)	1/2" (12.5 mm)	9/16" (15 mm)
<b>CO-EXTRUDED PVC</b>							
NJ/	Light gray RAL 7035		99757	99750	99760	99770	99780
	<b>\$/pc</b>						
NJ/	Stone gray RAL 7030		99758	99752	99762	99772	99782
	<b>\$/pc</b>						

No partial packaging

To place orders correctly, find the desired model, size and finish. Then place your order by using the letters "PPS" followed by the corresponding 5-digit code.

Projoint DIL NL/ is an expansion joint in co-extruded PVC with perforated side flanges. Suitable for floors or marble, it can absorb tensile and compression stresses thanks to its central elastic component. It is suitable for both pedestrian traffic and light driveway traffic (cars and transpallets). Non-toxic, anti-shock and UV-resistant, this joint can be used indoors and outdoors.

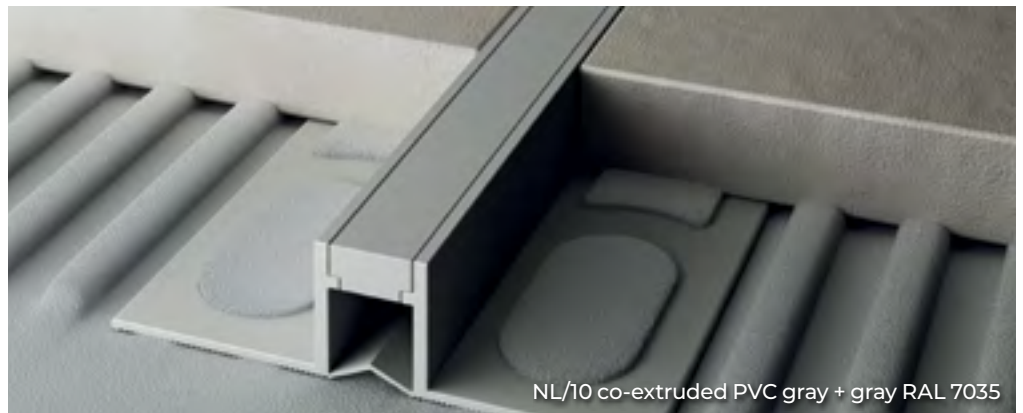

NL/10 co-extruded PVC gray + gray RAL 7035

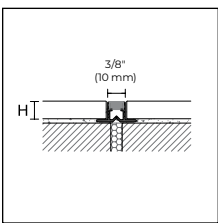

NL/

### CERFIX PROJINT DIL

Length = 8' 10" or 2.7 m

Item	Finish		H				
			5/16" (8 mm)	3/8" (10 mm)	1/2" (12.5 mm)	9/16" (15 mm)	3/4" (20 mm)
<b>CO-EXTRUDED PVC</b>							
NL/	Gray + gray RAL 7035 \$/pc		99700	99710	99720	-	-
NL/	Stone gray + stone gray RAL 7030 \$/pc		99704	99714	99724	99734	99744
NL/	Black + black RAL 9005 \$/pc		99703	99713	99723	-	-

No partial packaging

Projoint DIL NF is a fraction joint in co-extruded PVC for application with mortar. Available in three colors and three heights, it is suitable to divide large areas that are subject to pedestrian traffic. This joint allows compressive and expansion stresses to be absorbed.



NF/45 co-extruded PVC gray + gray RAL 7035

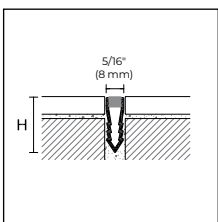

NF/

### CERFIX PROJINT DIL

Length = 8' 10" or 2.7 m

Item	Finish		H		
			1" (25 mm)	1-3/8" (35 mm)	1-3/4" (45 mm)
<b>CO-EXTRUDED PVC</b>					
NF/	Gray + gray RAL 7035 \$/pc		99800	99810	99820
NF/	Stone gray + stone gray RAL 7030 \$/pc		99803	99813	99823
NF/	Cream white + cream white RAL 9001 \$/pc		99802	99812	-

\$/20-piece package

To place orders correctly, find the desired model, size and finish. Then place your order by using the letters "PPS" followed by the corresponding 5-digit code.

## Cerfix™ Projoint™

Projoint DIL NAN is an aluminum expansion joint with an interchangeable insert made of elastic vinyl resin and characterized by a visible section measuring 9/16" (15 mm). This joint protects the edges of tiles and can withstand high traffic, both pedestrian and vehicular.

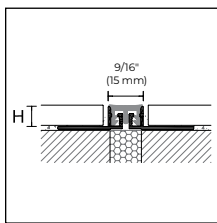

NAN/

### CERFIX PROJOINT DIL

Length = 8' 10" or 2.7 m

Item	Finish	H		
		3/8" (10 mm)	1/2" (12.5 mm)	9/16" (15 mm)
<b>ALUMINUM</b>				
NAN/	Natural aluminum + gray RAL 7035 rubber \$/pc	99974	99975	99976
NAN/	Natural aluminum + stone gray RAL 7030 rubber \$/pc	99977	99978	99979

Individually packed – NAN/ available with black rubber upon request, minimum order 100 pcs

### SPARE INSERT FOR NAN

Length = 8' 10" or 2.7 m (20 pieces per package)

Item	Finish	1/2"
		(12.5 mm)
GM/I	Gray RAL 7035 \$/pc	99993
GM/I	Stone gray RAL 7030 \$/pc	99989

Projoint DIL NPAN/ is an aluminum expansion joint with an interchangeable insert in elastic vinyl resin, characterized by a visible section measuring 3/4" (21 mm). This joint protects the edges of tiles and can withstand high traffic, both pedestrian and vehicular.

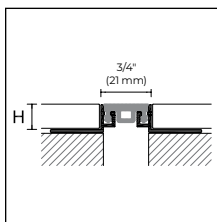

NPAN/

### CERFIX PROJOINT DIL

Length = 8' 10" or 2.7 m (10 pieces per package)

Item	Finish	H		
		3/8" (10 mm)	1/2" (12.5 mm)	9/16" (15 mm)
<b>ALUMINUM</b>				
NPAN/	Natural aluminum + stone gray RAL 7030 rubber \$/pc	99984	99985	99986

Individually packed - NPAN/ available with black rubber upon request, minimum order 100 pcs

### SPARE INSERT FOR NPAN

Length = 8' 10" or 2.7 m (20 pieces per package)

Item	Finish	1/2"
		(12.5 mm)
GMP/I	Stone gray RAL 7030 \$/pc	99988

To place orders correctly, find the desired model, size and finish. Then place your order by using the letters "PPS" followed by the corresponding 5-digit code.

Projoint DIL NIN/ is a stainless-steel expansion joint with an interchangeable insert in elastic vinyl resin, characterized by a reduced section measuring 9/16" (15 mm). This joint protects the edges of tiles and can withstand heavy traffic, both pedestrian and vehicular (forklifts, transpallets and cars).



NIN/10 stainless steel + stone gray rubber

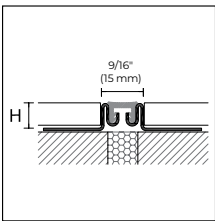

NIN/

#### CERFIX PROJONT DIL

Length = 8' 10" or 2.7 m (5 pieces per package)

Item	Finish	H			
		3/8" (10 mm)	1/2" (12.5 mm)	9/16" (15 mm)	3/4" (20 mm)
<b>STAINLESS STEEL</b>					
NIN/	Stainless steel AISI 304 + gray RAL 7035 rubber	99915	99916	99917	99918
	\$/pc				
NIN/	Stainless steel AISI 304 + stone gray RAL 7030 rubber	99925	99926	99927	99928
	\$/pc				

#### SPARE INSERT FOR NIN

Length = 8' 10" or 2.7 m (20 pieces per package)

Item	Finish	1/2"
		(12.5 mm)
GM/10	Gray RAL 7035	99998
	\$/pc	
GM/10	Stone gray RAL 7030	99999
	\$/pc	

Projoint DIL NIL/ is a perimeter expansion joint in stainless steel, with an interchangeable insert in elastic vinyl resin, characterized by a visible section of 17/32" (14 mm). The structure of the joint allows to connect the floor to the wall and is able to withstand heavy traffic, both pedestrian and vehicular (forklifts, transpallets and cars).



NIL/10 stainless steel + stone gray rubber

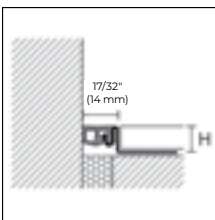

NIL/

#### CERFIX PROJONT DIL

Length = 8' 10" or 2.7 m (5 pieces per package)

Item	Finish	H			
		3/8" (10 mm)	1/2" (12.5 mm)	9/16" (15 mm)	3/4" (20 mm)
<b>STAINLESS STEEL</b>					
NIL/	Stainless steel AISI 304 + stone gray RAL 7030 rubber	99896	99897	99898	99899
	\$/pc				

Individually packed – NIL/ available with black rubber upon request, minimum order 100 pcs

#### SPARE INSERT FOR NIL/

Length = 8' 10" or 2.7 m (20 pieces per package)

Item	Finish	1/2"
		(12.5 mm)
GM12/L	Stone gray RAL 7030	99987
	\$/pc	

To place orders correctly, find the desired model, size and finish. Then place your order by using the letters "PPS" followed by the corresponding 5-digit code.



# Cerfix™ Projoint™

Projoint NTA/, NTI/ and NTO/ are expansion joints with inner sections made from vulcanized EPDM. Their metal structure easily stands up to recurring pedestrian and vehicular traffic (forklift trucks, transpallets and cars).

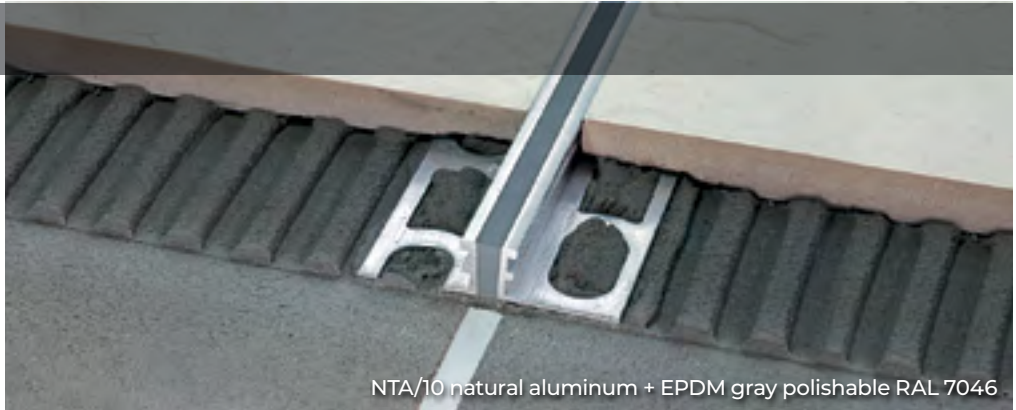

NTA/10 natural aluminum + EPDM gray polishable RAL 7046

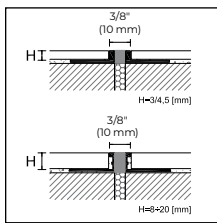

NTA/  
NTO/

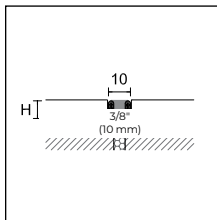

NTI/

### CERFIX PROJJOINT DIL

Length = 8' 10" or 2.7 m  
(10 pieces per package)

Item	Finish	H						
		1/8" (3 mm)	3/16" (4.5 mm)	5/16" (8 mm)	3/8" (10 mm)	1/2" (12.5 mm)	9/16" (15 mm)	3/4" (20 mm)
<b>ALUMINUM</b>								
	Natural aluminum + EPDM gray polishable RAL 7046	99421	99425	99441	99445	99449	99453	99457
	Natural aluminum + EPDM black polishable RAL 9005	99422	99426	99442	99444	99450	99454	99458
	<b>\$/pc</b>							
<b>NTA/</b>	Natural aluminum + EPDM bahama polishable RAL 10070	99427	99428	-	-	-	-	-
	Natural aluminum + EPDM brown polishable RAL 10071	99429	99430	-	-	-	-	-
	<b>\$/pc</b>							
<b>STAINLESS STEEL</b>								
	Stainless steel AISI 304 + EPDM gray RAL 7046	99471	99475	99481	99485	99489	99493	99497
	Stainless steel AISI 304 + EPDM black RAL 9005	99472	99474	99482	99486	99490	-	-
	<b>\$/pc</b>							
<b>NTI/</b>	Stainless steel AISI 304 + EPDM bahama RAL 10070	99431	99432	-	-	-	-	-
	Stainless steel AISI 304 + EPDM brown RAL 10071	99433	99434	-	-	-	-	-
	<b>\$/pc</b>							
<b>STAINLESS STEEL</b>								
<b>NTO/</b>	Brass natural + EPDM gray polishable RAL 7046	-	-	99401	99405	99409	99413	99417
	<b>\$/pc</b>							

Items NTO/15 and NTO/20 in 5-piece packages

To place orders correctly, find the desired model, size and finish. Then place your order by using the letters "PPS" followed by the corresponding 5-digit code.

Projoint STA/ and STI/ are fraction and expansion joints to allow movement at screen level, with inner sections made from vulcanized EPDM. Their metal structure easily withstands recurring pedestrian and vehicular traffic (forklift trucks, transpallets and cars), making them particularly suitable for shopping malls and frequent passage of loads. We suggest the use of the stainless-steel hooks ST/7 for the installation.



STI/40 stainless steel AISI 304 + EPDM  
gray polishable RAL 7046

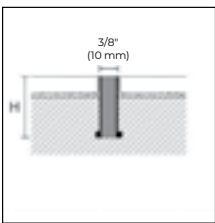

STA/  
STI/

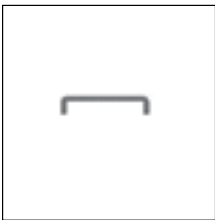

ST/7

### CERFIX PROJOINT DIL

Length = 8' 10" or 2.7 m (10 pieces per package)

Item	Finish		H		
			1-3/16" (30 mm)	1-5/8" (40 mm)	2" (50 mm)
<b>ALUMINUM</b>					
STA/	Natural aluminum + EPDM gray polishable RAL 7046 \$/pc		99581	99585	99589
<b>STAINLESS STEEL</b>					
STI/	Stainless steel AISI 304 + EPDM gray polishable RAL 7046 \$/pc		99621	99625	99629

### ACCESSORIES

100-piece package

Item	Finish		H		
			1-3/16" (30 mm)	1-5/8" (40 mm)	2" (50 mm)
<b>STAINLESS STEEL</b>					
ST/7	Steel hook for STA/ and STI/ profiles \$/pc		-	99640	-

No partial packaging

To place orders correctly, find the desired model, size and finish. Then place your order by using the letters "PPS" followed by the corresponding 5-digit code.

## Cerfix™ Projoint™

Projoint NZA is an aluminum expansion joint consisting of two interlocking and sliding profiles. Suitable for ceramic floors subjected to intense traffic, it ensures a high resistance to loads and high traffic, both pedestrian and vehicular (forklifts, transpallet and cars).



NZA/10 natural aluminum

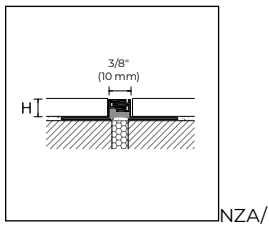

### CERFIX PROJOINT DIL

Length = 8' 10" or 2.7 m  
(20 pieces per package)

Item	Finish	H					
		1/8" (3 mm)	3/16" (5 mm)	5/16" (8 mm)	3/8" (10 mm)	1/2" (12.5 mm)	
<b>ALUMINUM</b>							
	Natural aluminum	■	-	-	99910	99912	99914
	<b>\$/pc</b>						
<b>NZA/</b>	Silver anodized	■	99300	99320	-	-	-
	<b>\$/pc</b>						

Individually packed

To place orders correctly, find the desired model, size and finish. Then place your order by using the letters "PPS" followed by the corresponding 5-digit code.

Projoint NZS is an aluminum expansion joint with high absorption. Thanks to its two interlocking parts, the joint can absorb movements of +/- 3/16" (5 mm) with articulated fins that permit tridimensional movements. This joint protects the edges of tiles and withstands pedestrian and vehicular traffic. NZS is also available as a joint cover when tiles are already installed (NZS/A), or as a side joint for industrial buildings (NZS/L).

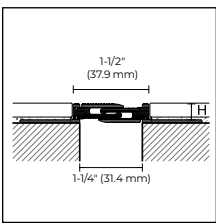

NZS/

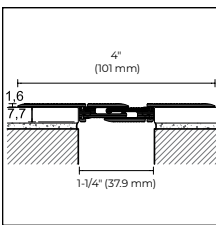

NZS/A/40

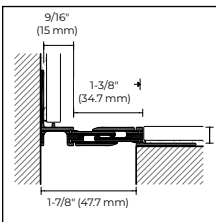

NZS/L

**CERFIX PROJONT DIL**

Length = 8' 10" or 2.7 m (5 pieces per package)

Item	Finish	H			
		3/8" (10 mm)	1/2" (12.5 mm)	9/16" (15 mm)	3/4" (20 mm)
<b>ALUMINUM</b>					
NZS/	Silver anodized \$/pc	99880	99881	99882	99883

**CERFIX PROJONT DIL**

Length = 8' 10" or 2.7 m (5 pieces per package)

Item	Finish	H
		5/16" (8 mm)
<b>ALUMINUM</b>		
NZS/A/40	Silver anodized \$/pc	99885

**CERFIX PROJONT DIL**

Length = 8' 10" or 2.7 m (5 pieces per package)

Item	Finish	H			
		3/8" (10 mm)	1/2" (12.5 mm)	9/16" (15 mm)	3/4" (20 mm)
<b>ALUMINUM</b>					
NZS/L	Silver anodized \$/pc	99890	99891	99892	99893

To place orders correctly, find the desired model, size and finish. Then place your order by using the letters "PPS" followed by the corresponding 5-digit code.



# Cerfix™ Projoint™

Projoint DIL PBE is a structural joint composed of two L-shaped profiles of natural aluminum and an expanding interchangeable part of plasticized PVC, available in black or gray. The two L-shaped profiles have drilled bases to allow them to be screwed to the underlying structure.



PBE/30 natural aluminum + ridged black rubber

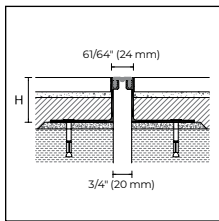

PBE/20 smooth rubber

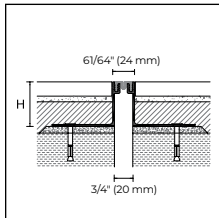

PBE/20 ridged rubber

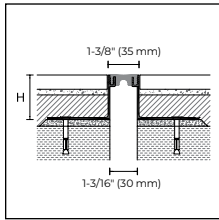

PBE/30 smooth rubber

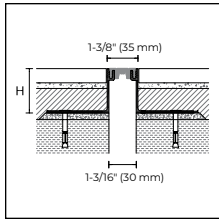

PBE/30 ridged rubber

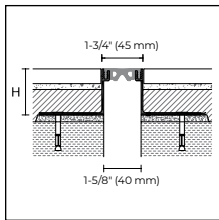

PBE/40 smooth rubber

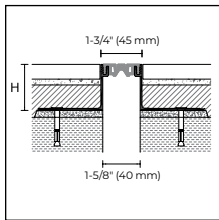

PBE/40 ridged rubber

### CERFIX PROJOINT DIL

Length = 9' 10" or 3 m (5 pieces per package)

Item	Finish	H					
		9/16" (15 mm)	61/64" (24 mm)	1-5/8" (42 mm)	2" (50 mm)	3-1/4" (82 mm)	
<b>ALUMINUM</b>							
PBE/20	Natural aluminum + smooth gray rubber		99321	99322	99323	99324	99325
	Natural aluminum + smooth black rubber		99326	99327	99328	99329	99330
	<b>\$/pc</b>						
	Natural aluminum + ridged gray rubber		99331	99332	99333	99334	99335
PBE/20	Natural aluminum + ridged black rubber		99336	99337	99338	99339	99340
	<b>\$/pc</b>						

No partial packaging – profiles are provided with accessories for mechanical fixing

### CERFIX PROJOINT DIL

Length = 9' 10" or 3 m (5 pieces per package)

Item	Finish	H					
		9/16" (15 mm)	61/64" (24 mm)	1-5/8" (42 mm)	2" (50 mm)	3-1/4" (82 mm)	
<b>ALUMINUM</b>							
PBE/30	Natural aluminum + smooth gray rubber		99341	99342	99343	99344	99345
	Natural aluminum + smooth black rubber		99346	99347	99348	99349	99350
	<b>\$/pc</b>						
	Natural aluminum + ridged gray rubber		99351	99352	99353	99354	99355
PBE/30	Natural aluminum + ridged black rubber		99356	99357	99358	99359	99360
	<b>\$/pc</b>						

No partial packaging – profiles are provided with accessories for mechanical fixing

### CERFIX PROJOINT DIL

Length = 9' 10" or 3 m (5 pieces per package)

Item	Finish	H					
		9/16" (15 mm)	61/64" (24 mm)	1-5/8" (42 mm)	2" (50 mm)	3-1/4" (82 mm)	
<b>ALUMINUM</b>							
PBE/40	Natural aluminum + smooth gray rubber		99361	99362	99363	99364	99365
	Natural aluminum + smooth black rubber		99366	99367	99368	99369	99370
	<b>\$/pc</b>						
	Natural aluminum + ridged gray rubber		99371	99372	99373	99374	99375
PBE/40	Natural aluminum + ridged black rubber		99376	99377	99378	99379	99380
	<b>\$/pc</b>						

No partial packaging – profiles are provided with accessories for mechanical fixing

Projoint DIL PBH and PAS are two structural joints composed of two L-shaped profiles made of natural aluminum and an expanding part of interchangeable EPDM, available in black or gray. Projoint DIL PHDE is a structural joint composed of two interlocking and sliding profiles made of natural aluminum. All profiles have drilled bases to allow them to be screwed to the underlying structure and are designed to withstand the structural movements of large buildings.



PBH/65/ natural aluminum + black EPDM insert

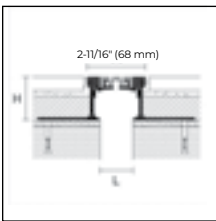

PBH/65

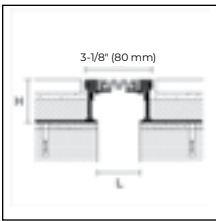

PBH/75

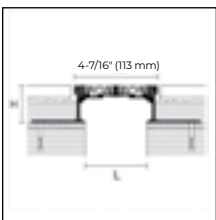

PAS/105

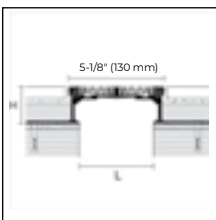

PAS/125

### CERFIX PROJOINT DIL

Length = 9' 10" or 3 m (2 pieces per package)

Item	Finish	H			
		23/32" (18 mm)	1-3/8" (35 mm)	2" (50 mm)	3-1/4" (80 mm)
ALUMINUM		L = 2" (50 mm)	L = 1-5/8" (40 mm)	L = 1-5/8" (40 mm)	L = 1-5/8" (40 mm)
PBH/65	Natural aluminum + gray EPDM insert	99500	99501	99502	99503
	Natural aluminum + black EPDM insert	99504	99505	99506	99507
		<b>\$/pc</b>			

No partial packaging – profiles are provided with accessories for mechanical fixing

### CERFIX PROJOINT DIL

Length = 9' 10" or 3 m (2 pieces per package)

Item	Finish	H			
		23/32" (18 mm)	1-3/8" (35 mm)	2" (50 mm)	3-1/4" (80 mm)
ALUMINUM		L = 2-23/64" (60 mm)	L = 2" (50 mm)	L = 2" (50 mm)	L = 2" (50 mm)
PBH/75	Natural aluminum + gray EPDM insert	99508	99509	99510	99511
	Natural aluminum + black EPDM insert	99512	99513	99514	99515
		<b>\$/pc</b>			

No partial packaging – profiles are provided with accessories for mechanical fixing

### CERFIX PROJOINT DIL

Length = 9' 10" or 3 m (2 pieces per package)

Item	Finish	H			
		23/32" (18 mm)	1-3/8" (35 mm)	2" (50 mm)	3-1/4" (80 mm)
ALUMINUM		L = 3-3/4" (95 mm)	L = 3-11/32" (85 mm)	L = 3-11/32" (85 mm)	L = 3-11/32" (85 mm)
PAS/105	Natural aluminum + gray EPDM insert	99516	99517	99518	99519
	Natural aluminum + black EPDM insert	99520	99521	99522	99523
		<b>\$/pc</b>			

No partial packaging – profiles are provided with accessories for mechanical fixing

### CERFIX PROJOINT DIL

Length = 9' 10" or 3 m (2 pieces per package)

Item	Finish	H			
		23/32" (18 mm)	1-3/8" (35 mm)	2" (50 mm)	3-1/4" (80 mm)
ALUMINUM		L = 4-3/8" (111 mm)	L = 4" (100 mm)	L = 4" (100 mm)	L = 4" (100 mm)
PAS/125	Natural aluminum + gray EPDM insert	99524	99525	99526	99527
	Natural aluminum + black EPDM insert	99528	99529	99530	99531
		<b>\$/pc</b>			

No partial packaging – profiles are provided with accessories for mechanical fixing

To place orders correctly, find the desired model, size and finish. Then place your order by using the letters "PPS" followed by the corresponding 5-digit code.

# Cerfix™ Projoint™

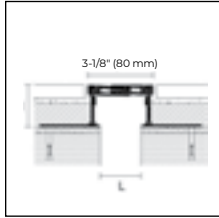

PHDE/80

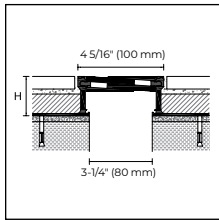

PHDE/110

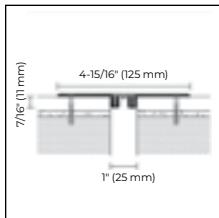

smooth rubber  
ridged rubber  
PFFE/20

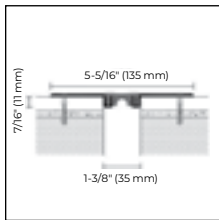

smooth rubber  
ridged rubber  
PFFE/30

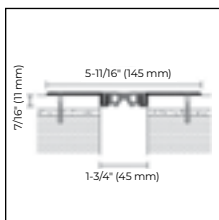

smooth rubber  
ridged rubber  
PFFE/40

Subject to confirmation

### CERFIX PROJOINT DIL

Length = 9' 10" or 3 m (2 pieces per package)

		H			
Item	Finish	23/32" (18 mm)	1-3/8" (35 mm)	2" (50 mm)	3-1/4" (82 mm)
<b>ALUMINUM</b>					
		L = 2-23/64" (60 mm)	L = 2" (50 mm)	L = 2" (50 mm)	L = 2" (50 mm)
PHDE/80	Natural aluminum	99590	99591	99592	99593
	<b>\$/pc</b>				

No partial packaging – profiles are provided with accessories for mechanical fixing

### CERFIX PROJOINT DIL

Length = 9' 10" or 3 m (2 pieces per package)

		H	
Item	Finish	2" (50 mm)	3-1/4" (80 mm)
<b>ALUMINUM</b>			
PHDE/110	Natural aluminum	99594	99595
	<b>\$/pc</b>		

No partial packaging – profiles are provided with accessories for mechanical fixing

### CERFIX PROJOINT DIL

Length = 9' 10" or 3 m (5 pieces per package)

Item	Finish		
<b>ALUMINUM</b>			
	Natural aluminum + smooth gray rubber		99596
	Natural aluminum + smooth black rubber		99597
	<b>\$/pc</b>		
PFFE/20	Natural aluminum + ridged gray rubber		99598
	Natural aluminum + ridged black rubber		99599
	<b>\$/pc</b>		

No partial packaging – profiles are provided with accessories for mechanical fixing

### CERFIX PROJOINT DIL

Length = 9' 10" or 3 m (5 pieces per package)

Item	Finish		
<b>ALUMINUM</b>			
	Natural aluminum + smooth gray rubber		99600
	Natural aluminum + smooth black rubber		99601
	<b>\$/pc</b>		
PFFE/30	Natural aluminum + ridged gray rubber		99602
	Natural aluminum + ridged black rubber		99603
	<b>\$/pc</b>		

No partial packaging – profiles are provided with accessories for mechanical fixing

### CERFIX PROJOINT DIL

Length = 9' 10" or 3 m (5 pieces per package)

Item	Finish		
<b>ALUMINUM</b>			
	Natural aluminum + smooth gray rubber		99604
	Natural aluminum + smooth black rubber		99605
	<b>\$/pc</b>		
PFFE/40	Natural aluminum + ridged gray rubber		99606
	Natural aluminum + ridged black rubber		99607
	<b>\$/pc</b>		

No partial packaging – profiles are provided with accessories for mechanical fixing

# Cerfix™ Procover

Procover Flex is a line of structural aluminum joint covers designed to withstand traction and compression. They withstand both pedestrian and vehicular traffic with rubber wheels (cars). Procover Fix is a line of flat joint cover profiles in aluminum for coplanar floors (GJA/) and perimeter joint cover profiles for the connection of floors and walls (GWA/), suitable to cover structural movements of expansion or compression of two different structures.

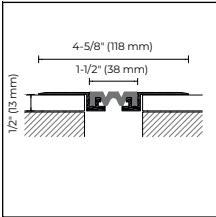

GJF/40



## CERFIX PROCOVER FLEX

Length = 13'1-3/8" or 4 m (5 pieces per package) L

Item	Finish	1-5/8" (40 mm)	2" (50 mm)
<b>ALUMINUM</b>			
GJF/	Natural aluminum + EPDM black insert RAL 9005	74490	74492
	\$/pc		

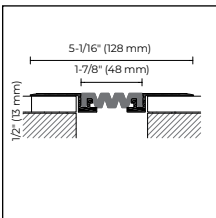

GJF/50

## SPARE INSERT FOR GJF

Length = 13'1-3/8" or 4 m L

Item	Finish	1-5/8" (40 mm)	2" (50 mm)
<b>ALUMINUM</b>			
GM/	EPDM black RAL 9005	74491	74493
	\$/pc		

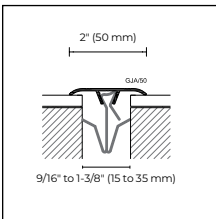

GJA/50



## CERFIX PROCOVER FIX

Length = 9'10" or 3 m (10 pieces per package) L

Item	Finish	2" (50 mm)	2-3/4" (70 mm)
<b>ALUMINUM</b>			
GJA/	Silver anodized	74550	74610
	\$/pc		
GWA/	Silver anodized	-	74552
	\$/pc		

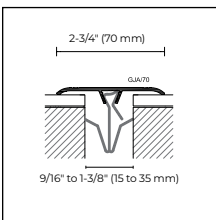

GJA/70

## SPRING CLIP

From 9/16" or 15 mm to 1-3/8" or 35 mm (50 pieces per package) L

Item	Finish	2" (50 mm)
<b>STAINLESS STEEL</b>		
GJS/10	Harmonic stainless steel	74730
	\$/pc	

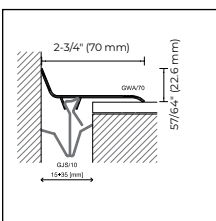

GWA/70

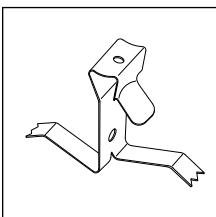

GJS/10



# Cerfix™ Procover

Procover G joint-covering profile made of anodized aluminum is suitable for creating continuity on structures with continuous bays. This joint covering is supplied with adhesive or can be secured with screws and dowels. In the illustration it is perforated laterally and adfixed only to one structure, allowing free sliding over the other.



G/80/A silver anodized aluminum

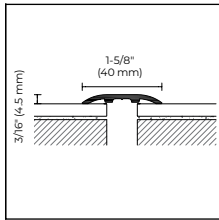

G/40/

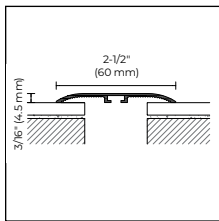

G/60/

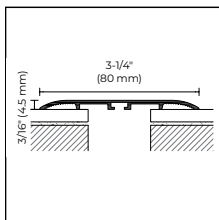

G/80/

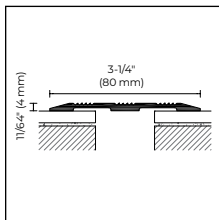

GR/80/SF

### CERFIX PROCOVER

Packaging	20 pcs	20 pcs	6 pcs / blister	20 pcs
Length	9'10" (300 cm)	9'10" (300 cm)	39-25/64" (100 cm)	9'10" (300 cm)
Item	G/40/	G/60/	G/460/	G/80/
Finish	A	SF A	AD	SF A

#### ALUMINUM

Silver anodized	74528	74558	74588	21982	74618	74648
<b>\$/pc</b>						

Items G/40, G/60 and G/80 are individually packaged

### CERFIX PROCOVER

Length = 8'10" or 2.7 m (10 pieces per package)	L
Width	3-1/4" (80 mm)
Item	GR/80/
Finish	SF

#### ALUMINUM

Silver anodized	71855
<b>\$/pc</b>	

Individually packaged

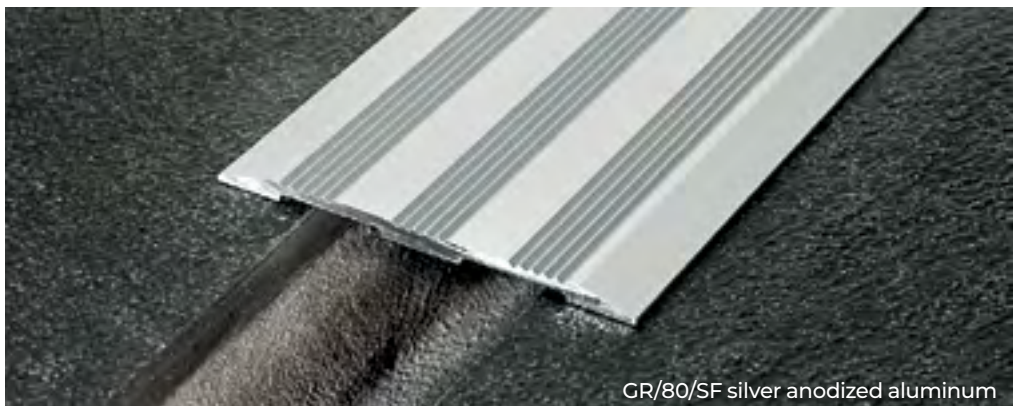

GR/80/SF silver anodized aluminum

To place orders correctly, find the desired model, size and finish. Then place your order by using the letters "PPS" followed by the corresponding 5-digit code.

Procover G joint-covering profiles in stainless steel and polished brass are suitable for creating continuity on structures with continuous bays. These joint coverings are supplied with adhesive or can be secured with screws and dowels. In these illustrations they are perforated laterally and adfixed only to one structure, allowing free sliding over the other. In these versions, they are suitable even to vehicular traffic.

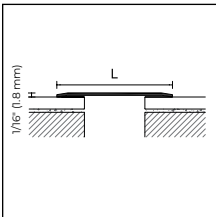
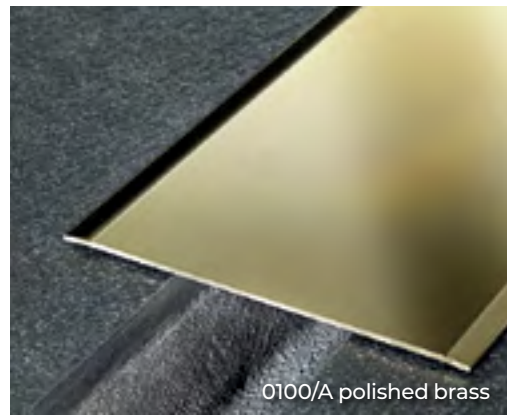
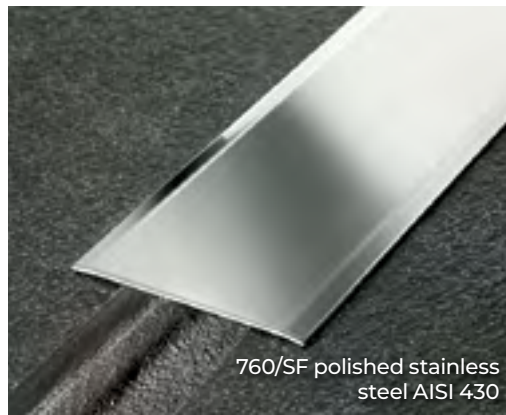

### CERFIX PROCOVER

Packaging	10 pcs	6 pcs / blister	10 pcs	6 pcs / blister	5 pcs	3 pcs / blister	5 pcs
Length	9'10" (300 cm)	39-25/64" (100 cm)	9'10" (300 cm)	39-25/64" (100 cm)	9'10" (300 cm)	39-25/64" (100 cm)	9'10" (300 cm)
Width	2" (50 mm)	2" (50 mm)	2-1/2" (60 mm)	2-1/2" (60 mm)	3-1/4" (80 mm)	3-1/4" (80 mm)	4" (100 mm)
Thickness	12/10						
Item	750/	4750/	760/	4760/	780/	4780/	7100/
Finish	SF A	AD	SF A	AD	SF A	AD	SF A
<b>STAINLESS STEEL</b>							
Polished stainless steel AISI 430	74818 74828	22090	74838 74848	40531	74858 74868	40553	74878 74888
\$/pc							

Items 750/, 760/, 780/ and 7100/ are individually packaged.

### CERFIX PROCOVER

Packaging	10 pcs	6 pcs / blister	5 pcs	6 pcs / blister	5 pcs	3 pcs / blister	5 pcs
Length	9'10" (300 cm)	39-25/64" (100 cm)	9'10" (300 cm)	39-25/64" (100 cm)	9'10" (300 cm)	39-25/64" (100 cm)	9'10" (300 cm)
Width	2" (50 mm)	2" (50 mm)	2-1/2" (60 mm)	2-1/2" (60 mm)	3-1/4" (80 mm)	3-1/4" (80 mm)	4" (100 mm)
Thickness	12/10						
Item	050/	4050/	060/	4060/	080/	4080/	0100/
Finish	SF A	AD	SF A	AD	SF A	AD	SF A
<b>STAINLESS STEEL</b>							
Polished	74738 74748	22050	74758 74768	40504	- 74788	40512	74798 74808
\$/pc							

Items 050/, 060/, 080/ and 0100/ are individually packaged.

To place orders correctly, find the desired model, size and finish. Then place your order by using the letters "PPS" followed by the corresponding 5-digit code.









## Profiles for Resilient Floors, Wood, Engineered Wood, Carpet and Carpet Tiles

Enjoy a full range of profile options for wood, laminate and LVT flooring. Several systems and professional solutions are available in various colors of anodized aluminum and in the exclusive durable film finishes, with the possibility of further customization thanks to Profilpas Digital System (PDS) technology.



## Unisystem™ Plus

Unisystem Plus is a system for the installation of resilient flooring and carpet tiles from 1/4" to 7/8" (6.5 to 22.6 mm) in thickness. Composed of transition profiles for floors with the same or different heights, perimeter profiles and stair-nosing profiles, Unisystem Plus is easy to install and simple to remove. The system is composed of a top profile, an aluminum base and a fixing clip. After inserting the fixing clip in the top profile, just push the top profile to clip it to the aluminum base.

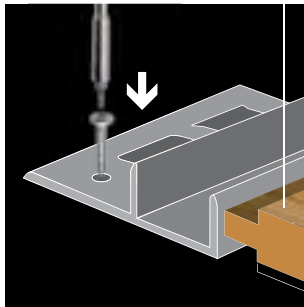

Adfix the aluminum base to the subfloor with screws or glue

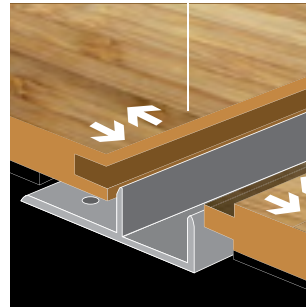

Adjust the flooring to fit

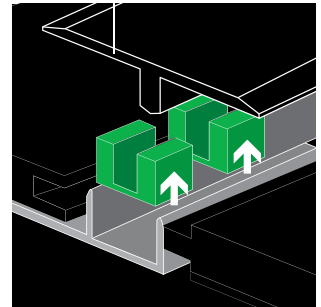

Insert the clips in the top profile

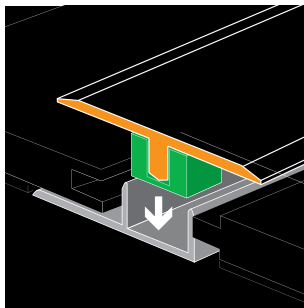

Insert the top profile into the base

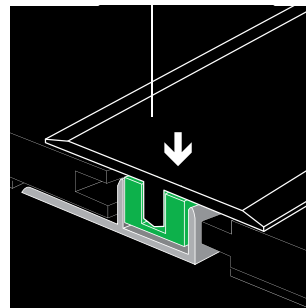

Adjust and level the cover by pushing it down

To place orders correctly, find the desired model, size and finish. Then place your order by using the letters "PPS" followed by the corresponding 5-digit code.

## Unisystem™ Plus line



Transition profiles for floors of the same height



Transition profiles for floors of different heights



Perimeter profiles

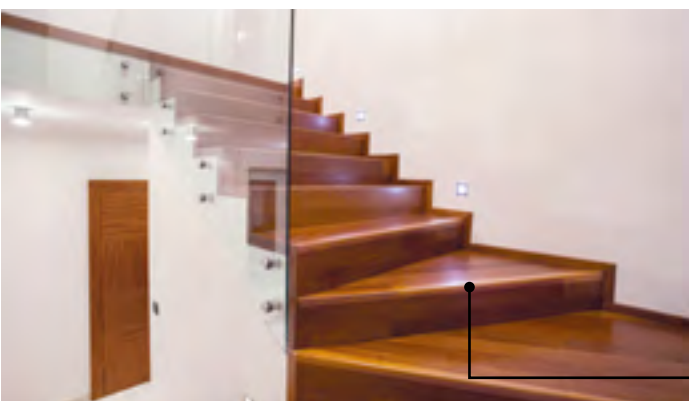

Stair-nosing profiles



# Unisystem™ – Unisystem™ Plus

Unisystem Plus is a system for the installation of resilient flooring and carpet tiles from 1/4" to 7/8" (6.5 to 22.6 mm) in thickness. Composed of transition profiles for floors with the same or different heights, perimeter profiles and stair-nosing profiles, Unisystem Plus is easy to install and simple to remove. The system is composed of a top profile, an aluminum base and a fixing clip. After inserting the fixing clip in the top profile, just push the top profile to clip it to the aluminum base. floor perfectly.



Unisystem Plus S/9/SF, Z/1/SF and C/7/SF

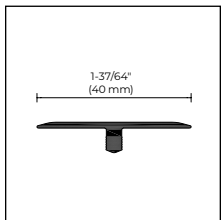

Z/1/SF

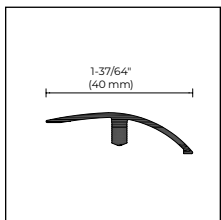

C/7/SF

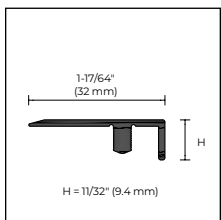

S/9/SF

## UNISYSTEM/ UNISYSTEM PLUS

Length = 8' 10" or 270 cm / 10-piece package

Item	Finish	Z/1/SF	C/7/SF	S/9/SF
<b>Floor thickness range</b>		1/4" - 7/8" (6.5 - 22.6 mm)	1/4" - 3/8" (6.5 - 10 mm)	1/4" - 7/8" (6.5 - 22.6 mm)
<b>ALUMINUM covered with durable film</b>				
02		66301	66001	65701
05		66306	66006	65706
08		66304	66004	65704
10		66307	66007	65707
11		66308	66008	65708
12		66309	66009	65709
13		66310	66010	65710
14		66311	66011	65711
18		66316	66016	65716
19		66318	66018	65718
20		66317	66017	65717
26		66321	66021	65721
31		66328	66028	65728
32		66329	66029	65729
34		66331	66031	65731
35		66332	66032	65732
36		66333	66033	65733
37		66334	66034	65734
38		66335	66035	65735
39		66336	66036	65736
40		66337	66037	65737
41		66338	66038	65738
42		66339	66039	65739
43		66340	66040	65740
44		66341	66041	65741
47		66344	66044	65744
65		66365	66065	65765
71		66368	66068	65768
72		66369	66069	65769
73		66370	66070	65770
74		66371	66071	65771
76		66374	66074	65774
77		66372	66072	65772
78		66376	66076	65776
79		66373	66073	65773
80		66377	66077	65777
81		66378	66078	65778
89		66386	66086	65784

\$/pc

Individually packaged

## UNISYSTEM/ UNISYSTEM PLUS

Length = 8' 10" or 270 cm / 10-piece package

Item	Finish	Z/1/SF	C/7/SF	S/9/SF
<b>Floor thickness range</b>		1/4" - 7/8" (6.5 - 22.6 mm)	1/4" - 3/8" (6.5 - 10 mm)	1/4" - 7/8" (6.5 - 22.6 mm)
<b>ALUMINUM covered with durable film</b>				
91		66388	66088	65786
92		66389	66089	65789
93		66390	66090	65790
94		66391	66091	65791
95		66392	66092	65792
351		66393	66093	-
363		66394	66094	-
372		66395	66095	-
490		66397	66097	-
560		66398	66098	-
580		66399	66099	65793
590		66400	66100	-
665		66401	66101	65794
670		66402	66102	65795
951		66408	66108	65797
975		66409	66109	65798
1024		66410	66110	65799
1033		66411	66111	65800
1042		66412	66112	65801
1090		66414	66114	65803
1202		66416	66116	65805
1203		66417	66117	65806
1204		66418	66118	65807
1205		66419	66119	65808
1206		66420	66120	65809
1207		66421	66121	65810
1208		66422	66122	65811
1209		66423	66123	65812
1210		66424	66124	65813
1211		66425	66125	65814
1212		66426	66126	65815
1213		66427	66127	65816
1214		66428	66128	65817
1215		66429	66129	65818
1216		66430	66130	65819
1217		66431	66131	65820
100		66432	66132	-
Black 97		66433	66133	65821

\$/pc

Individually packaged

Profiles of 270 cm length; please order the base separately.

Customized PDS decors on request, see page 166-167

To place orders correctly, find the desired model, size and finish. Then place your order by using the letters "PPS" followed by the corresponding 5-digit code.

# Unisystem™ – Unisystem™ Plus



## UNISYSTEM/ UNISYSTEM PLUS

Length = 8' 10" or 270 cm / 20-piece package

Item	Finish	Z/1/SF	C/7/SF	S/9/SF
Floor thickness range		1/4" - 7/8" (6.5 - 22.6 mm)	1/4" - 3/8" (6.5 - 10 mm)	1/4" - 7/8" (6.5 - 22.6 mm)

### ANODIZED ALUMINUM

Silver		67217	67007	65680
Titanium		67238	67000	65691
Gold		67227	67017	65685
Gold sand		67234	67024	65688
Bronze		67237	67027	65690

### \$/pc

Other models for thicker floors available on page 148  
Individually packaged

## UNISYSTEM PLUS – BASES

Floor thickness range	1/4" - 3/8" (6.5 - 10 mm)	3/8" - 1/2" (9.6 - 12.5 mm)	1/2" - 9/16" (12.6 - 15.5 mm)	9/16" - 3/4" (15 - 19 mm)	3/4" - 7/8" (19.6 - 22.6 mm)
Length = 8' 10" or 270 cm / 20-piece package (15 TU/6 clips included)	H				
Item	1/4" (6 mm)	3/8" (10 mm)	1/2" (13 mm)	9/16" (15 mm)	7/8" (22 mm)

Length = 8' 10" or 270 cm / 20-piece package (15 TU/6 clips included)

Item	Finish						
ALUMINUM							
TPU/	Natural aluminum		67437	67447	67457	67460	67467

### ALUMINUM

TPU/	Natural aluminum		67437	67447	67457	67460	67467
	\$/pc						

Individually packaged (Item TPU/22 pack 10 pcs)

## SPARE CLIPS

150-piece package

	H				
TU/6	1/4" (6 mm)				
\$/pc	68812/150				

### \$/pc

No partial packaging

## UNISYSTEM – BASES

Floor thickness range	1/4" - 3/8" (6.5 - 10 mm)	3/8" - 1/2" (10 - 12 mm)	1/4" - 3/8" (6.5 - 10 mm)	1/2" - 9/16" (13 - 15 mm)	3/8" - 9/16" (11 - 15 mm)
Length = 8' 10" or 270 cm / 20-piece package	H				
Item	1/4" (7 mm)	3/8" (10 mm)	7/16" (11 mm)	1/2" (13 mm)	9/16" (15 mm)

Length = 8' 10" or 270 cm / 20-piece package

Item	Finish						
ALUMINUM							
T/	Natural aluminum		67287	67297	67317	67307	67327

### ALUMINUM

T/	Natural aluminum		67287	67297	67317	67307	67327
	\$/pc						

### \$/pc

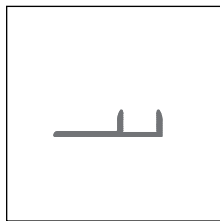

TPU/

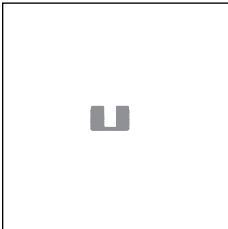

TU/6

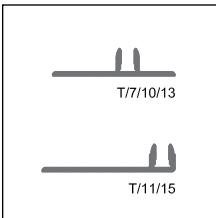

T/

To place orders correctly, find the desired model, size and finish. Then place your order by using the letters "PPS" followed by the corresponding 5-digit code.



Z/1/SF aluminum covered with durable film



C/7/SF aluminum covered with durable film



S/9/SF aluminum covered with durable film



# Unisystem™ – Unisystem™ Plus

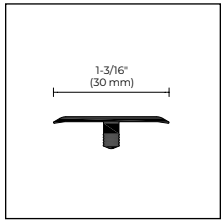

Z3/30/SF



## UNISYSTEM – CERFIX UNISYSTEM PLUS

Length = 8' 10" or 270 cm /  
Package quantities: 20 pieces 20 pieces 10 pieces 10 pieces 10 pieces

Item	Finish	Z3/30/SF	C/10/SF	C/13/SF	C/22/SF	S/15/SF
<b>Floor thickness range</b>		1/4" - 7/8" (6.5 - 22.6 mm)	3/8" - 1/2" (9.6 - 12.5 mm)	1/2" - 9/16" (12.6 - 15.5 mm)	9/16" - 7/8" (15 - 22.6 mm)	3/8" - 7/8" (9.6 - 22.6 mm)

### ANODIZED ALUMINUM

Silver		63700	67077	67147	66907	65480
--------	--	-------	-------	-------	-------	-------

\$/pc

Gold		63702	67087	67157	-	-
------	--	-------	-------	-------	---	---

Gold sand		63704	-	-	-	65488
-----------	--	-------	---	---	---	-------

\$/pc

Individually packaged

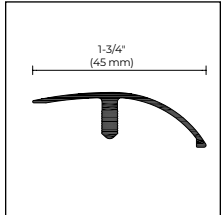

C/10/SF



## UNISYSTEM PLUS – BASES

Floor thickness range	1/4" - 3/8" (6.5 - 10 mm)	3/8" - 1/2" (9.6 - 12.5 mm)	1/2" - 9/16" (12.6 - 15.5 mm)	9/16" - 3/4" (15 - 19 mm)	3/4" - 7/8" (19.6 - 22.6 mm)
Length = 8' 10" or 270 cm / 20-piece package (15 TU/6 clips included)	<b>H</b>				

Item	Finish	1/4" (6 mm)	3/8" (10 mm)	1/2" (13 mm)	9/16" (15 mm)	7/8" (22 mm)	
<b>ALUMINUM</b>							
TPU/	Natural aluminum		67437	67447	67457	67460	67467

\$/pc

Individually packaged (Item TPU/22 pack 10 pcs)

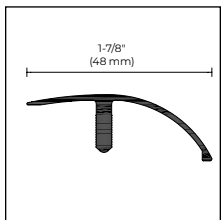

C/13/SF

## SPARE CLIPS

150-piece package

	H
	1/4" (6 mm)

TU/6	68812/150
------	-----------

\$/pc

No partial packaging

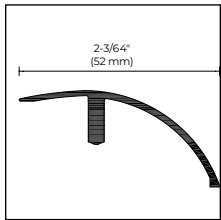

C/22/SF

## UNISYSTEM – BASES

Floor thickness range	1/4" - 3/8" (6.5 - 10 mm)	3/8" - 1/2" (10 - 12 mm)	1/4" - 3/8" (6.5 - 10 mm)	1/2" - 9/16" (13 - 15 mm)	3/8" - 9/16" (11 - 15 mm)
Length = 8' 10" or 270 cm / 20-piece package	<b>H</b>				

Item	Finish	1/4" (7 mm)	3/8" (10 mm)	7/16" (11 mm)	1/2" (13 mm)	9/16" (15 mm)	
<b>ALUMINUM</b>							
T/	Natural aluminum		67287	67297	67317	67307	67327

\$/pc

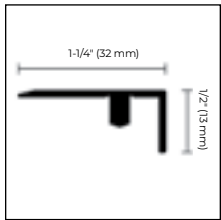

S/15/SF

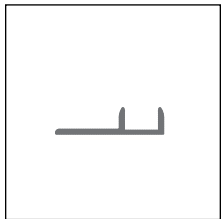

TPU/

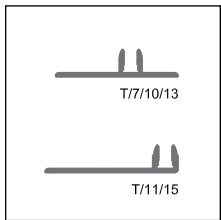

T/



Z3/30/SF silver anodized aluminum

Customized PDS decors on request, see page 166-167

To place orders correctly, find the desired model, size and finish. Then place your order by using the letters "PPS" followed by the corresponding 5-digit code.

# Unisystem™ – Unisystem™ Plus

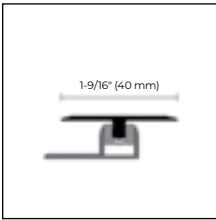

TPZ/



## UNISYSTEM PLUS

Length = 36" or 90 cm / 10-piece blister package / for floor thicknesses 1/4" to 3/8" (6.5 to 10 mm)

Item	Finish	ALUMINUM covered with durable film		
TPZ/47/CV	05	43005	77 43011	1208 43027
	10	43020	78 43066	1209 43029
	14	43006	80 43068	1210 43030
	19	43007	89 43012	1211 43031
	20	43028	91 43013	1212 43033
	26	43008	580 43014	1213 43035
	31	43009	1202 43016	1214 43037
	38	43034	1203 43017	1215 43039
	39	43010	1204 43018	1216 43041
	40	43036	1205 43019	1217 43043
	42	43038	1206 43025	
	65	43056	1207 43026	

\$/pc

Individually packaged



TPZ/47/CV silver anodized aluminum and aluminum covered with durable film

## UNISYSTEM PLUS

Length = 36" or 90 cm / 10-piece blister package

Item	Finish	TPZ/47/CV	TPZ/410/CV	TPZ/413/CV
<b>Floor thickness range</b>				
		1/4" - 3/8" (6.5 - 10 mm)	3/8" - 1/2" (9.6 - 12.5 mm)	1/2" - 9/16" (12.6 - 15.5 mm)
<b>ANODIZED ALUMINUM</b>				
Silver		43000	43072	43144
Gold		43004	43076	43148

\$/pc

Individually packaged

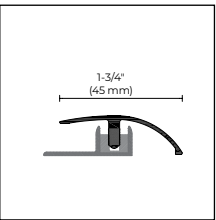

TPC/

## CERFIX UNISYSTEM PLUS

Length = 36" or 90 cm / 10-piece blister package / for floor thicknesses 1/4" to 3/8" (6.5 to 10 mm)

Item	Finish	ALUMINUM covered with durable film		
TPC/47/CV	05	43219	77 43225	1208 43239
	10	43234	78 43280	1209 43240
	14	43220	80 43282	1210 43241
	19	43221	89 43226	1211 43243
	20	43242	91 43227	1212 43244
	26	43222	580 43228	1213 43245
	31	43223	1202 43231	1214 43247
	38	43248	1203 43232	1215 43249
	39	43224	1204 43233	1216 43251
	40	43250	1205 43235	1217 43253
	42	43252	1206 43236	
	65	43270	1207 43237	

\$/pc

Individually packaged

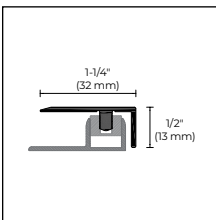

TPS/

## UNISYSTEM PLUS

Length = 36" or 90 cm / 10-piece blister package

Item	Finish	TPC/47/CV	TPC/410/CV	TPC/413/CV
<b>Floor thickness range</b>				
		1/4" - 3/8" (6.5 - 10 mm)	3/8" - 1/2" (9.6 - 12.5 mm)	1/2" - 9/16" (12.6 - 15.5 mm)
<b>ANODIZED ALUMINUM</b>				
Silver		43214	43286	43358
Gold		43218	43290	43362

\$/pc

Individually packaged

## UNISYSTEM PLUS

Length = 36" or 90 cm / 10-piece blister package

Item	Finish	TPS/47/CV	TPS/410/CV	TPS/413/CV
<b>Floor thickness range</b>				
		1/4" - 3/8" (6.5 - 10 mm)	3/8" - 1/2" (9.6 - 12.5 mm)	1/2" - 9/16" (12.6 - 15.5 mm)
<b>ANODIZED ALUMINUM</b>				
Silver		43430	43502	43574

\$/pc

Individually packaged

The blister packaged contains base, clips and profile. To place orders correctly, find the desired model, size and finish. Then place your order by using the letters "PPS" followed by the corresponding 5-digit code.



# Unisystem™ Plus

G/4/SF is a stair-nosing profile of the Unisystem Plus line. Composed of a base and a top profile, it is suitable for the installation of resilient flooring with thicknesses ranging from 1/4" to 9/16" (6.5 to 15.5 mm).

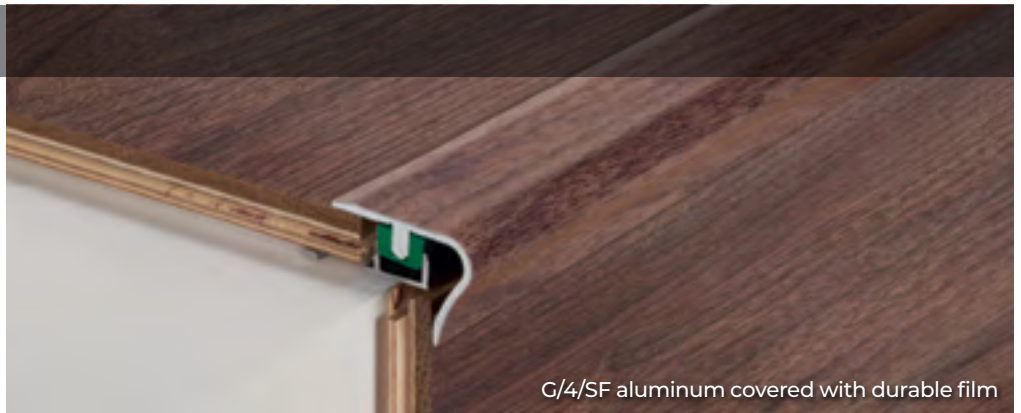

G/4/SF aluminum covered with durable film

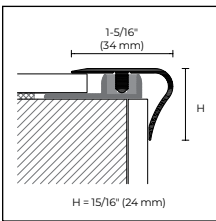

G/4/SF + TPU/

## UNISYSTEM PLUS

Length = 8' 10" or 270 cm / 10-piece package – for floor thicknesses from 1/4" to 9/16" (6.5 to 15.5 mm)

Item	Finish			
<b>ALUMINUM covered with durable film</b>				
G/4/SF	02	63905	37 63943	76 63956
	08	63907	38 63919	77 63937
	10	63910	40 63920	78 63934
	11	63911	41 63926	79 63938
	12	63913	42 63921	80 63935
	13	63916	43 63927	81 63939
	18	63914	44 63929	92 63941
	20	63915	65 63931	93 63944
	32	63917	71 63951	94 63945
	34	63923	72 63952	95 63946
	35	63924	73 63953	
	36	63942	74 63954	
	<b>\$/pc</b>			

Individually packaged

## UNISYSTEM PLUS

Length = 8' 10" or 270 cm / 10-piece package – for floor thicknesses from 1/4" to 9/16" (6.5 to 15.5 mm)

Item	Finish	
<b>ANODIZED ALUMINUM</b>		
G/4/SF	Silver	63900
	Gold sand	63904
<b>\$/pc</b>		

Individually packaged – Sand gold anodized extra \$/pc + 0,63

## UNISYSTEM PLUS – BASES

Floor thickness range		1/4" - 3/8" (6.5 - 10 mm)	3/8" - 1/2" (9.6 - 12.5 mm)	1/2" - 9/16" (12.6 - 15.5 mm)
Length = 8' 10" or 270 cm / 20-piece package (15 TU/6 clips included)		<b>H</b>		
Item	Finish	1/4" (6 mm)	3/8" (10 mm)	1/2" (13 mm)
<b>ALUMINUM</b>				
TPU/	Natural aluminum	67437	67447	67457
<b>\$/pc</b>				

Individually packaged

## SPARE CLIPS

150-piece package	<b>H</b>
	<b>1/4" (6 mm)</b>
TU/6	68812/150
<b>\$/pc</b>	

No partial packaging

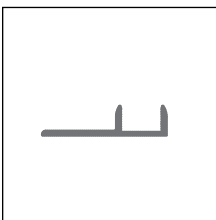

TPU/

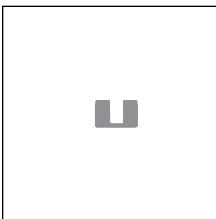

TU/6

Customized PDS decors on request, see page 166-167

Profiles of 8' 10" (270 cm) length: please order the base separately.

To place orders correctly, find the desired model, size and finish. Then place your order by using the letters "PPS" followed by the corresponding 5-digit code.



# Profix Thin

Profix Thin is a system for the installation of thin resilient flooring 5/32" to 5/16" (4 to 8 mm) in thickness, made up of junction profiles for same-level floors (Z/4), connection profiles for different-level floors (C/4) and perimeter profiles (S/4). The system is composed of a PVC base and a top profile available in different finishes of anodized aluminum or covered with a durable wood-, stone- or concrete-effect film for matching floors perfectly.

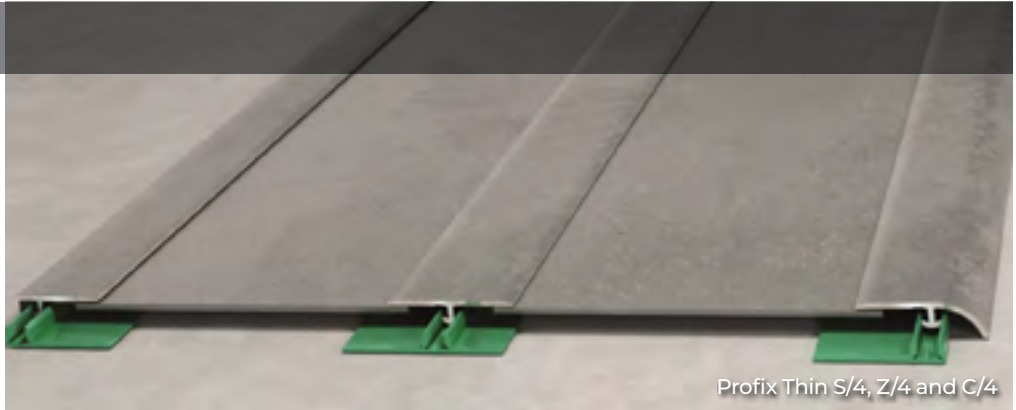

Profix Thin S/4, Z/4 and C/4

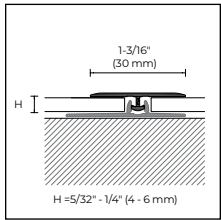

Z/4 + PT/4

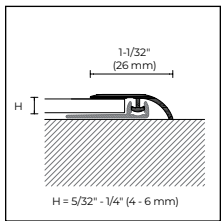

C/4 + PT/4/SA

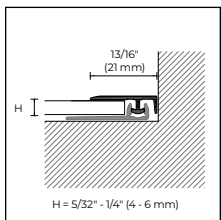

S/4 + PT/4/SA

## PROFIX THIN

Length = 8' 10" or 270 cm / 20-piece package / for floor thicknesses 5/32" to 5/16" (4 to 8 mm)

### ALUMINUM covered with durable film





	Z/4	C/4	S/4
1003	85101	85201	85301
1006	85102	85202	85302
1009	85103	85203	85303
1012	85104	85204	85304
1021	85107	85207	85307
1024	85108	85208	85308
1030	85110	85210	85310
1033	85111	85211	85311
1036	85112	85212	85312
1042	85114	85214	85314
1045	85115	85215	85315
1051	85117	85217	85317
1054	85118	85218	85318
1057	85119	85219	85319
1060	85120	85220	85320
1063	85121	85221	85321
1066	85122	85222	85322
1069	85123	85223	85323
1081	85127	85227	85327
1084	85128	85228	85328
1090	85130	85230	85330
1105	85135	85235	85335
1108	85136	85236	85336
1111	85137	85237	85337

\$/pc

Individually packaged

## PROFIX THIN

Length = 8' 10" or 270 cm / 20-piece package / for floor thicknesses 5/32" to 5/16" (4 to 8 mm)

Item	Z/4	C/4	S/4
<b>Finish</b>			
<b>ANODIZED ALUMINUM</b>			
Silver	 85050	85060	85070
\$/pc			
Gold sand	 85052	85062	85072
Titanium	 85054	85064	85074
\$/pc			
Bronze elox	 85056	85066	85076
\$/pc			

Customized PDS decors on request, see page 166-167

To place orders correctly, find the desired model, size and finish. Then place your order by using the letters "PPS" followed by the corresponding 5-digit code.

# Profix Thin

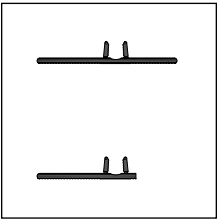

PT/4  
PT/4/SA



## PROFIX THIN - BASES

Length = 8' 10" or 270 cm / 20-piece package / for floor thicknesses 5/32" to 1/4" (4 to 6 mm)

Item	PT/4	PT/4/SA
Finish		
PVC		
Green		85081
\$/pc		85083

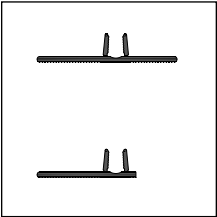

PT/6  
PT/6/SA

## PROFIX THIN - BASES

Length = 8' 10" or 270 cm / 20-piece package / for floor thicknesses 1/4" to 5/16" (6 to 8 mm)

Item	PT/6	PT/6/SA
Finish		
PVC		
Green		85086
\$/pc		85088

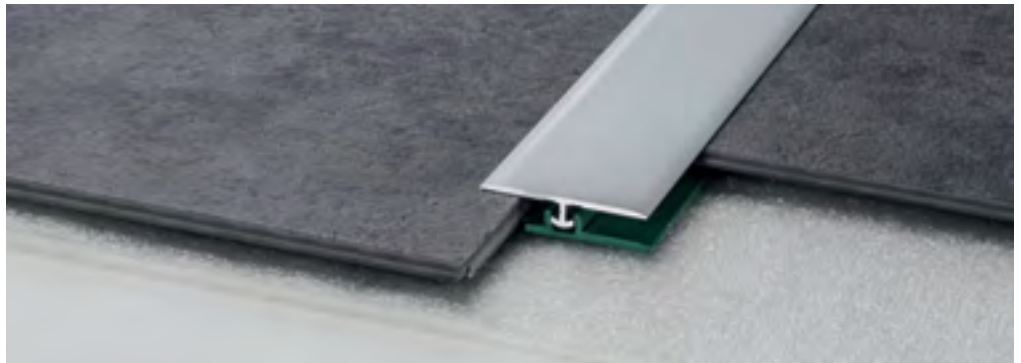

Z/4 + PT/4

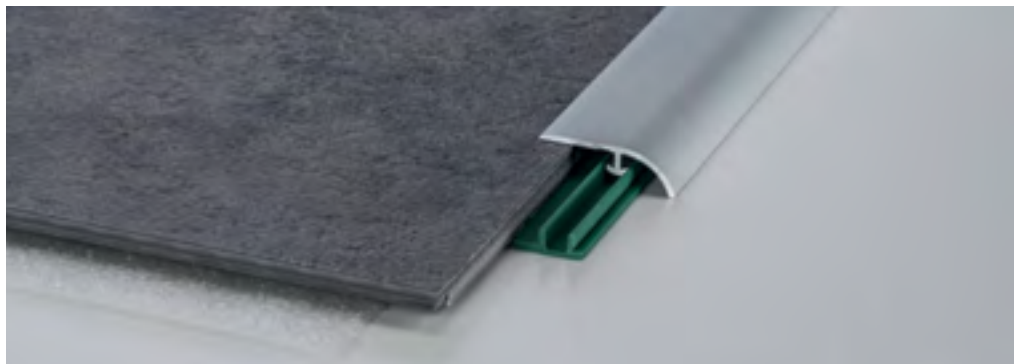

C/4 + PT/4/SA

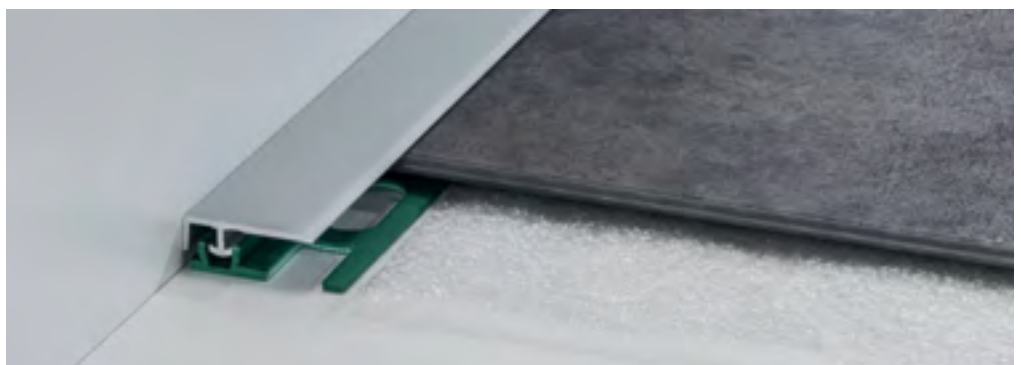

S/4 + PT/4/SA

To place orders correctly, find the desired model, size and finish. Then place your order by using the letters "PPS" followed by the corresponding 5-digit code.

# Prestowood

Prestowood 22/A, 50/A and 63/A are adhesive profiles for same-level and different-level wood floors as well as stairs that have been already installed. Available in anodized aluminum or with a durable film covering, they are particularly easy and quick to install, especially suited to DIY installations.



## PRESTOWOOD

Package	10 pcs / blister	10 pcs	10 pcs / blister	10 pcs	10 pcs
Length	36" (90 mm)	8' 10" (270 mm)	36" (90 mm)	8' 10" (270 mm)	8' 10" (270 mm)
Item	422/AD	22/A	450/AD	50/A	63/A
<b>ALUMINUM covered with durable film</b>					
05	43700	43932	44949	45031	45140
08	43701	43933	44950	45032	45141
12	43702	43934	44951	45033	45142
13	43703	43935	44952	45034	45143
14	43704	43936	44953	45035	45144
19	43705	43937	44954	45036	45145
26	43706	43938	44955	45037	45146
31	43707	43939	44956	45038	-
32	43708	43940	44957	45039	45147
34	43709	43941	44958	45040	-
36	43710	43942	44959	45041	45148
39	43711	43943	44960	45042	45149
40	43712	43944	44961	45043	45150
41	43713	43945	44962	45044	45151
73	43714	43946	44963	45045	-
74	43715	43947	44964	45046	-
77	43716	43948	44965	45047	45152
79	43717	43949	44966	45048	-
81	43718	43950	44967	45049	-
89	43719	43951	44968	45050	45153
91	43720	43952	44969	45051	45154
92	43721	43953	44970	45052	-
93	43762	43995	45013	45094	45155
94	43722	43954	44971	45053	-
351	43723	43955	44972	45054	-
363	43724	43956	44973	45055	-
372	43725	43957	44974	45056	-
490	43727	43959	44976	45058	-
560	43728	43960	44977	45059	-
580	43729	43961	44978	45060	45156
590	43730	43962	44979	45061	-
665	43731	43963	44980	45062	-
670	43732	43964	44981	45063	-
951	43738	43970	44987	45069	-
975	43739	43971	44988	45070	-
1024	43740	43972	44989	45071	-
1033	43741	43973	44990	45072	-
1042	43742	43974	44991	45073	-
1090	43744	43976	44993	45075	-

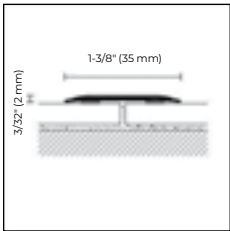

422/AD  
22/A

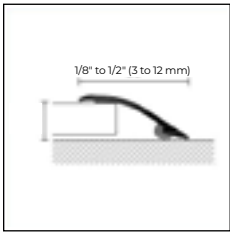

450/AD  
50/A

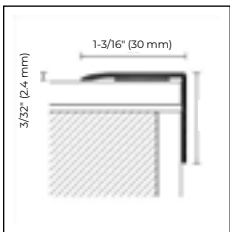

63/A

 Packaging in blister. No partial packaging.

Customized PDS decors on request, see page 166-167

To place orders correctly, find the desired model, size and finish. Then place your order by using the letters "PPS" followed by the corresponding 5-digit code.



Package	10 pcs / blister	10 pcs	10 pcs / blister	10 pcs	10 pcs
Length	36" (90 mm)	8' 10" (270 mm)	36" (90 mm)	8' 10" (270 mm)	8' 10" (270 mm)
Item	422/AD	22/A	450/AD	50/A	63/A
<b>ALUMINUM covered with durable film</b>					
1202	43746	43978	44995	45077	45158
1203	43747	43979	44996	45078	45159
1204	43748	43980	44997	45079	45160
1205	43749	43981	44998	45080	45161
1206	43750	43982	44999	45081	45162
1207	43751	43983	45000	45082	45163
1208	43752	43984	45001	45083	45164
1209	43753	43985	45002	45084	45165
1210	43754	43986	45003	45085	45166
1211	43755	43987	45004	45086	45167
1212	43756	43988	45005	45087	45168
1213	43757	43989	45007	45088	45169
1214	43758	43990	45008	45089	45170
1215	43759	43991	45009	45090	45171
1216	43760	43992	45010	45091	45172
1217	43761	43993	45011	45092	45173
100	-	43994	-	45093	-
Black 97	-	43996	-	45095	45175
<b>\$/pc</b>					

Individually packaged

### PROCLASSIC F / PROLEVEL HIGH / PROTECT

Package	10 pcs / blister	10 pcs	10 pcs / blister	10 pcs	10 pcs
Length	36" (90 mm)	8' 10" (270 mm)	36" (90 mm)	8' 10" (270 mm)	8' 10" (270 mm)
Item	422/AD	22/A	450/AD	50/A	63/A
<b>ANODIZED ALUMINUM</b>					
Silver	43790	44000	45019	45100	45190
<b>\$/pc</b>					
Titanium	43791	44001	45020	45101	45191
<b>\$/pc</b>					

Individually packaged

Packaging in blister. No partial packaging.

Customized PDS decors on request,  
see page 166-167

To place orders correctly, find the desired model,  
size and finish. Then place your order by using  
the letters "PPS" followed by the corresponding  
5-digit code.



50/A titanium anodized aluminum



63/A silver anodized aluminum



# Prestowood

Prestowood 74/A is a line of stair-nosing profiles covered with a wood-effect durable film, for installed wood step edges. Affixed with a specialized adhesive, they are particularly recommended for DIY installations. 74/ is also available in different finishes of anodized aluminum as the stair-nosing profiles 73/ and 58/.

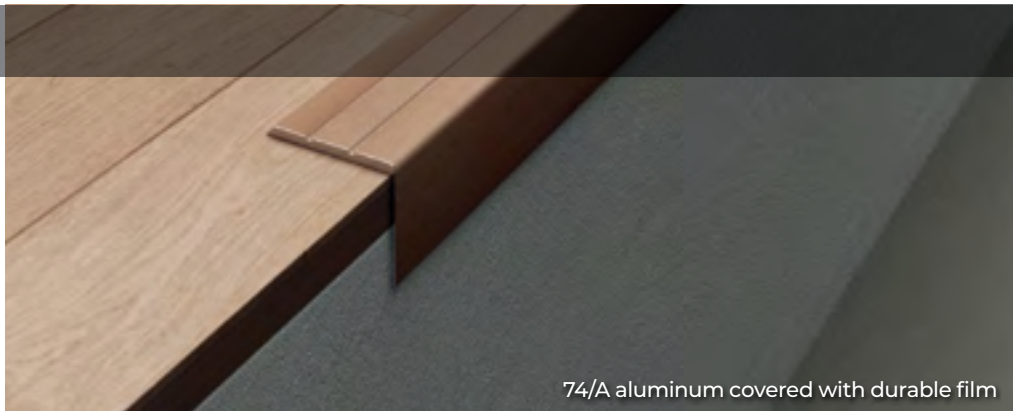

74/A aluminum covered with durable film

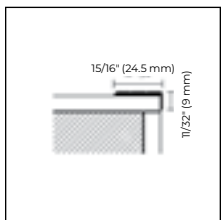

73/

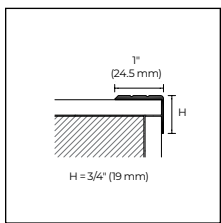

74/

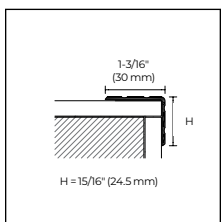

58/A

## PRESTOWOOD

<b>Package</b>	10 pcs	
<b>Length</b>	8' 10" (270 cm)	
<b>Item</b>	74/A	
<b>Finish</b>		
<b>ALUMINUM covered with durable film</b>		
10		75319
12		75297
13		75301
20		75320
32		75303
36		75304
37		75305
38		75306
40		75322
47		75307
65		75294
71		75309
76		75334
78		75311
80		75326
92		75312
94		75313
95		75314
<b>\$/pc</b>		

Individually packaged

## PROTECT

<b>Package</b>	30 pcs						20 pcs	
<b>Length</b>	8' 10" (270 cm)							
<b>Item</b>	73/			74/			58/	
<b>Finish</b>	F	SF	A	F	SF	A	A	
<b>ALUMINUM</b>								
Silver anodized	75208	75209	75238	75268	75269	75298	75900	
Gold anodized	75218	-	75248	75278	-	75308	-	
Bronze anodized	-	-	75258	-	-	75318	-	
<b>\$/pc</b>								
Titanium anodized						75299		
<b>\$/pc</b>								

Customized PDS decors on request, see page 166-167

To place orders correctly, find the desired model, size and finish. Then place your order by using the letters "PPS" followed by the corresponding 5-digit code.

# RC

RC is a line of edge profiles for the installation of wood and resilient flooring, available in different finishes of anodized aluminum or with a wood-effect durable film covering. These profiles are also available in the bendable RCF version that can be curved with the Proflex Machine.

Prolevel High 732/ is a line of profiles that protect the perimeter border of wood and resilient floors.



RC/9/F silver anodized aluminum

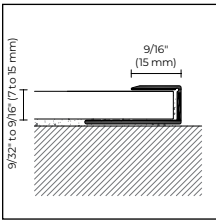

RC/ F  
RCF/



RCF/ silver anodized aluminum

## TERMINAL RC

Length = 8' 10" or 270 cm / 20-piece package

Item	Finish	9/32" (7 mm)	11/32" (9 mm)	7/16" (11 mm)	1/2" (13 mm)	9/16" (15 mm)
<b>ALUMINUM</b>						
RC/ F	Silver anodized	67407	67477	67547	67617	67687
	Gold anodized	-	67487	-	-	-
	Bronze anodized	-	67497	-	-	-
<b>\$/pc</b>						

Length = 8' 10" or 270 cm /  
10-piece package

Item	Finish	9/32" (7 mm)	11/32" (9 mm)	7/16" (11 mm)	1/2" (13 mm)	9/16" (15 mm)
<b>ALUMINUM covered with durable film</b>						
RC/ F	10	-	66731	-	-	-
	20	-	66734	-	-	-
	38	-	66739	-	-	-
	40	-	66740	-	-	-
	42	-	66758	-	-	-
	65	-	66747	-	-	-
	78	-	66751	-	-	-
	80	-	66752	-	-	-
<b>\$/pc</b>						

## TERMINAL RC

Length = 36" or 90 cm / 10-piece blister package

Item	Finish	9/32" (7 mm)	11/32" (9 mm)	7/16" (11 mm)	9/16" (15 mm)
		RC/47/CV	RC/49/CV	RC/411/CV	RC/415/CV
<b>ALUMINUM</b>					
	Silver anodized	42782	41832	41877	42822
	Gold anodized	-	41839	-	-
<b>\$/pc</b>					

## PRO FLEX LINE



## TERMINAL RC FLEX

Length = 8' 10" or 270 cm / 10-piece package

Item	Finish	11/32" (9 mm)	7/16" (11 mm)
RCF/	Silver anodized	67712	67714
<b>\$/pc</b>			

Individually packaged

Customized PDS decors on request, see page 166-167

To place orders correctly, find the desired model, size and finish. Then place your order by using the letters "PPS" followed by the corresponding 5-digit code.

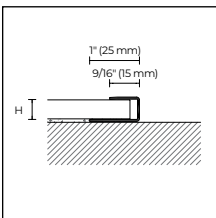

732/SF/



## PROLEVEL HIGH

Length = 8' 10" or 270 cm /  
15-piece package

Item	Finish	3/8" (10 mm)	1/2" (12.5 mm)	9/16" (15 mm)
732/SF/	Polished stainless steel	74217	74227	74237
	AISI 430			
<b>\$/pc</b>				

Individually packaged

# Alfix 616

Alfix 616 is a professional system for the installation of wood and resilient floors 1/4" to 5/8" (6 to 16 mm) in thickness. The system is composed of a top profile in anodized aluminum adfixed with screws on a natural aluminum base. The screws, included in the packaging, perfectly match the color of the top profile.



FIX/L/55 silver anodized aluminum

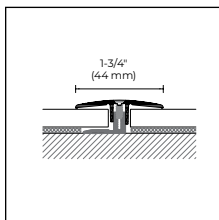

FIX/J/44

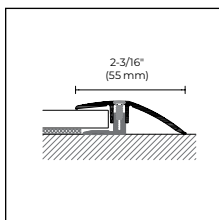

FIX/L/55

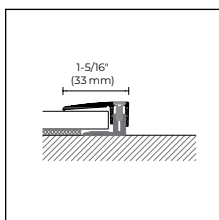

FIX/T/33

### ALFIX 616

Package	10 pcs	10 pcs / blister	
<b>Length</b>	<b>8' 10" (270 cm)</b>	<b>36" (90 cm)</b>	<b>39-3/8" (100 cm)</b>
<b>Item</b>	<b>FIX/J/44</b>		
For floor thicknesses 1/4" to 5/8" (6 to 16 mm)			
<b>Finish</b>			
<b>ALUMINUM</b>			
Silver anodized	37010	37012	37014
Sand gold anodized	37210	37212	-
<b>\$/pc</b>			
Titanium anodized	37410	-	37414
Elox bronze anodized	37310	37312	37314
<b>\$/pc</b>			
Individually packaged			

### ALFIX 616

Package	10 pcs	10 pcs / blister	
<b>Length</b>	<b>8' 10" (270 cm)</b>	<b>36" (90 cm)</b>	<b>39-3/8" (100 cm)</b>
<b>Item</b>	<b>FIX/L/55</b>		
For floor thicknesses 1/4" to 5/8" (6 to 16 mm)			
<b>Finish</b>			
<b>ALUMINUM</b>			
Silver anodized	37040	37042	37044
Sand gold anodized	37240	37242	37244
<b>\$/pc</b>			
Titanium anodized	37440	37442	37444
Elox bronze anodized	37340	-	-
<b>\$/pc</b>			
Individually packaged			

### ALFIX 616

Package	10 pcs	10 pcs / blister	
<b>Length</b>	<b>8' 10" (270 cm)</b>	<b>36" (90 cm)</b>	<b>39-3/8" (100 cm)</b>
<b>Item</b>	<b>FIX/T/33</b>		
For floor thicknesses 1/4" to 5/8" (6 to 16 mm)			
<b>Finish</b>			
<b>ALUMINUM</b>			
Silver anodized	37070	-	37074
Sand gold anodized	37270	37272	-
<b>\$/pc</b>			
Titanium anodized	37470	-	37474
Elox bronze anodized	-	-	37374
<b>\$/pc</b>			
Individually packaged			

Packaging in blister. No partial packaging.

To place orders correctly, find the desired model, size and finish. Then place your order by using the letters "PPS" followed by the corresponding 5-digit code.

## Alfix 46

Alfix 46 is a professional system for the installation of LVT floors  $5/32"$  to  $1/4"$  (4 to 6 mm) in thickness. This system is characterized by top profiles in anodized aluminum, adfixed with a screw system on a natural aluminum base. Screws, included in the package, match the anodization in color and, once adfixed, integrate with the top profile.

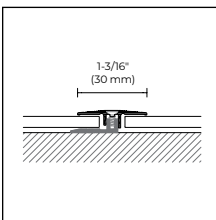

FIX/J/30

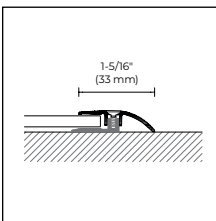

FIX/L/32

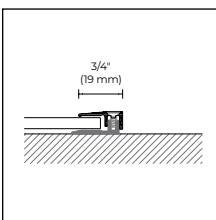

FIX/T/19

### ALFIX 46

Package	10 pcs
<b>Length</b>	<b>8' 10" (270 cm)</b>
<b>Item</b>	<b>FIX/J/30</b>
For floor thicknesses $5/32"$ to $1/4"$ (4 to 6 mm)	
<b>Finish</b>	
<b>ALUMINUM</b>	
Silver anodized	35500
<b>\$/pc</b>	
Individually packaged	

### ALFIX 46

Package	10 pcs
<b>Length</b>	<b>8' 10" (270 cm)</b>
<b>Item</b>	<b>FIX/L/32</b>
For floor thicknesses $5/32"$ to $1/4"$ (4 to 6 mm)	
<b>Finish</b>	
<b>ALUMINUM</b>	
Silver anodized	35510
<b>\$/pc</b>	
Individually packaged	

### ALFIX 46

Package	10 pcs
<b>Length</b>	<b>8' 10" (270 cm)</b>
<b>Item</b>	<b>FIX/T/19</b>
For floor thicknesses $5/32"$ to $1/4"$ (4 to 6 mm)	
<b>Finish</b>	
<b>ALUMINUM</b>	
Silver anodized	35520
<b>\$/pc</b>	
Individually packaged	

To place orders correctly, find the desired model, size and finish. Then place your order by using the letters "PPS" followed by the corresponding 5-digit code.



# Cerfix™ Projoint™ – Pronivel™

NZA is a movement joint in aluminum composed by two interlocking and sliding profiles. It is suitable for resilient floors and available in two thicknesses 1/8" and 3/16". The 3/16" thickness comes with a peel and stick adhesive.

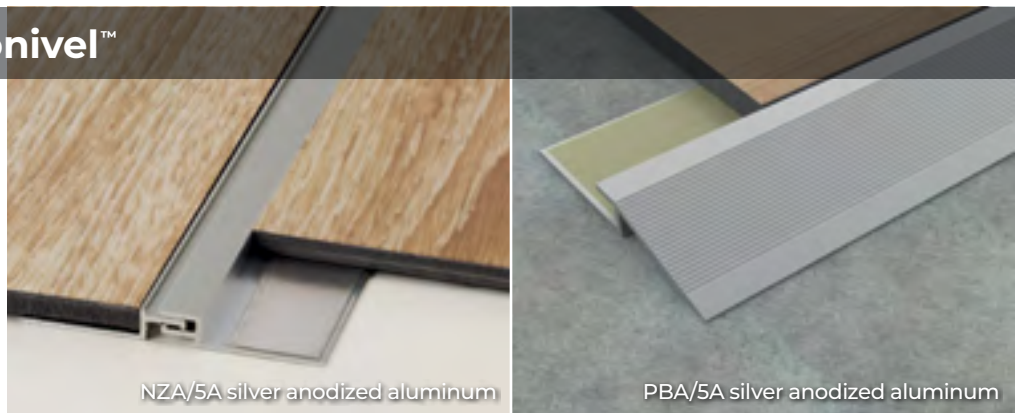

NZA/5A silver anodized aluminum

PBA/5A silver anodized aluminum

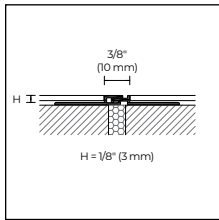

NZA/3

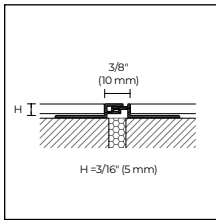

NZA/5

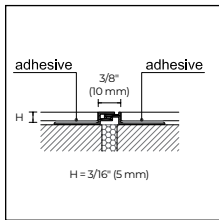

NZA/5A

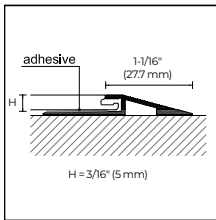

PBA/5/A



### CERFIX PROJOINT DIL

Length = 8' 10" or 270 cm / 20-piece package

		H		
Item	Finish	1/8" (3 mm)	3/16" (5 mm)	3/16" (5 mm)†
<b>ALUMINUM</b>				
NZA/	Silver anodized	99300	99320	99310
	Titanium anodized	-	-	99314
	Elox bronze anodized	-	-	99316
		<b>\$/pc</b>		

Individually packaged



### CERFIX PRONIVEL PB

Length = 8' 10" or 270 cm / 10-piece package

		H
Item	Finish	3/16" (5 mm)
<b>ALUMINUM</b>		
PBA/5/A	Silver anodized	93205
		<b>\$/pc</b>

Individually packaged

†Adhesive version

NTA/ and NTI/ are expansion joints that are also ideal for glued LVT floors and that should be installed in line with the substrate joints.



NTA/3 natural aluminum + EPDM gray

NTI/3 stainless steel + EPDM gray

### CERFIX PROJOINT DIL

Length = 8' 10" or 270 cm / 10-piece package

		H
Item	Finish	1/8" (3 mm)
<b>ALUMINUM</b>		
NTA/	Natural aluminum + EPDM gray polishable RAL 7046	99421
	Natural aluminum + EPDM black polishable RAL 9005	99422
	Natural aluminum + EPDM bahama polishable RAL 10070	99427
	Natural aluminum + EPDM brown polishable RAL 10071	99429
		<b>\$/pc</b>

### CERFIX PROJOINT DIL

Length = 8' 10" or 270 cm / 10-piece package

		H
Item	Finish	1/8" (3 mm)
<b>STAINLESS STEEL</b>		
NTI/	Stainless steel AISI 304 + EPDM gray RAL 7046	99471
	Stainless steel AISI 304 + EPDM black RAL 9005	99472
	Stainless steel AISI 304 + EPDM bahama RAL 10070	99431
	Stainless steel AISI 304 + EPDM brown RAL 10071	99433
		<b>\$/pc</b>

To place orders correctly, find the desired model, size and finish. Then place your order by using the letters "PPS" followed by the corresponding 5-digit code.

# Cerfix™ Projoint™ – Pronivel™

H/5/F, PBAS/5/F, RC/5/F and 99/TR/26 are connection profiles in anodized aluminum for thin flooring. They are suitable as profiles for same-height and different-height floors as well as for borders.

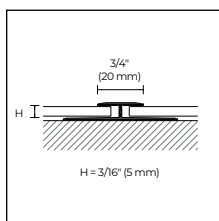
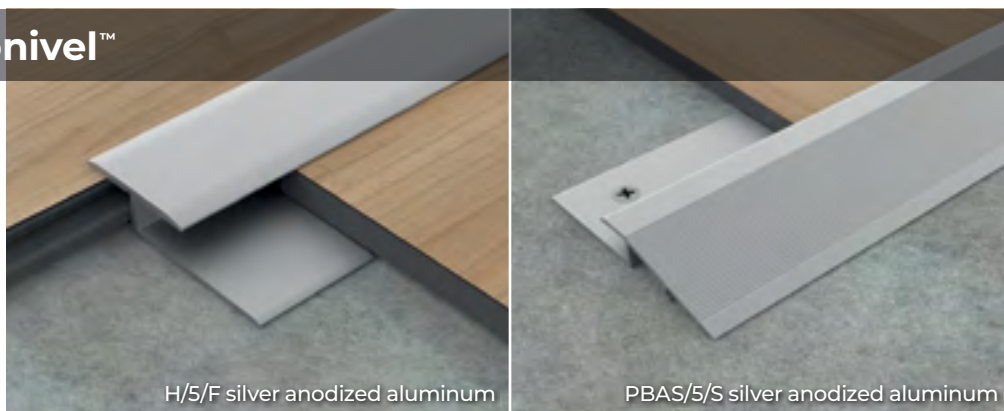

H/5/F

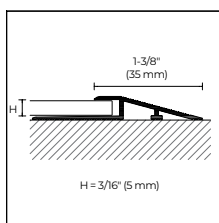

PBAS/5/F

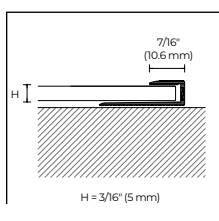

RC/5/F

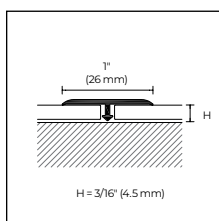

99/TR/26

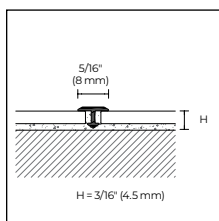

99/T/8

## PROJOINT T

Length = 8' 10" or 270 cm / 20-piece package		H
Item	Finish	3/16" (5 mm)
<b>ALUMINUM</b>		
H/5/F drilled	Silver anodized	75000
	<b>\$/pc</b>	
Individually packaged		

## CERFIX PRONIVEL PB

Length = 8' 10" or 270 cm / 20-piece package		H
Item	Finish	3/16" (5 mm)
<b>ALUMINUM</b>		
PBAS/5/F drilled	Silver anodized	95203
	<b>\$/pc</b>	
Individually packaged		

## TERMINAL RC

Length = 8' 10" or 270 cm / 20-piece package		H
Item	Finish	3/16" (5 mm)
<b>ALUMINUM</b>		
	Silver anodized	67475
	<b>\$/pc</b>	
RC/5/F drilled	Bright satin titanium	67476
	<b>\$/pc</b>	
Individually packaged		

## PROJOINT T

Length = 8' 10" or 270 cm / 20-piece package		L x H
Item	Finish	1" x 3/16" (26 x 4.5 mm)
<b>ALUMINUM</b>		
99/TR/26	Silver anodized	75081
	<b>\$/pc</b>	
Individually packaged		

## PROJOINT T – SEPARATION JOINTS

Length = 8' 10" or 270 cm / 50-piece package		W
Item	Finish	5/16" (8 mm)
<b>ALUMINUM</b>		
99/T/	Silver anodized	75075
	<b>\$/pc</b>	
Length = 8' 10" or 270 cm / 50-piece package		
<b>BRASS</b>		
399/T/	Polished	75070
	<b>\$/pc</b>	
Length = 8' 10" or 270 cm / 30-piece package		
399/TC/	Chromium-plated	75071
	<b>\$/pc</b>	
Individually packaged		

To place orders correctly, find the desired model, size and finish. Then place your order by using the letters "PPS" followed by the corresponding 5-digit code.

# Prostep™ – Protect

SMA/, 75/F, 111/ /F and G/705/F are profiles in anodized aluminum suitable for stairs covered with thin flooring. ZGF/ is a bendable aluminum profile.



SMA/4 silver anodized aluminum

75/F silver anodized aluminum

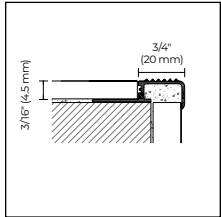

SMA/4



### PROSTEP

Length = 8' 10" or 270 cm / 10-piece package		<b>H</b>	
<b>Item</b>	<b>Finish</b>	<b>3/16" (4.5 mm)</b>	
<b>ALUMINUM</b>			
SMA/	Natural aluminum		93967
	<b>\$/pc</b>		
SMA/	Silver anodized		93975
	<b>\$/pc</b>		

Individually packaged

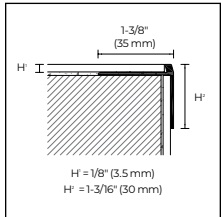

75/F



### PROTECT

Length = 11' 1-3/4" or 340 cm / 20-piece package		<b>H</b>	
<b>Item</b>	<b>Finish</b>	<b>1/8" (3.5 mm)</b>	
<b>ALUMINUM</b>			
75/F drilled	Silver anodized		75388
	<b>\$/pc</b>		

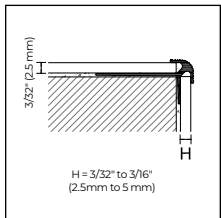

111/

### PROTECT

Length = 8' 10" or 270 cm / 20-piece package		<b>H</b>		
<b>Item</b>	<b>Finish</b>	<b>3/32" (2.5 mm)</b>	<b>3/16" (4.5 mm)</b>	<b>13/64" (5 mm)</b>
<b>ALUMINUM</b>				
111/ /F	Silver anodized		75782	75784
	<b>\$/pc</b>			75785

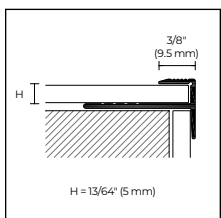

G/705/F

### PROSTEP

Length = 8' 10" or 270 cm / 10-piece package		<b>H</b>	
<b>Item</b>	<b>Finish</b>	<b>13/64" (5 mm)</b>	
<b>ALUMINUM</b>			
G/705/F	Silver anodized		67580
	<b>\$/pc</b>		

Individually packaged

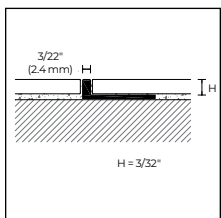

ZGF/

PRO FLEX LINE



### CERFIX PROANGLE FLEX

Length = 8' 10" or 270 cm / 10-piece package		<b>H</b>	
<b>Item</b>	<b>Finish</b>	<b>3/16" (4.5 mm)</b>	
<b>ALUMINUM</b>			
ZGF/	Natural aluminum		88721
	<b>\$/pc</b>		

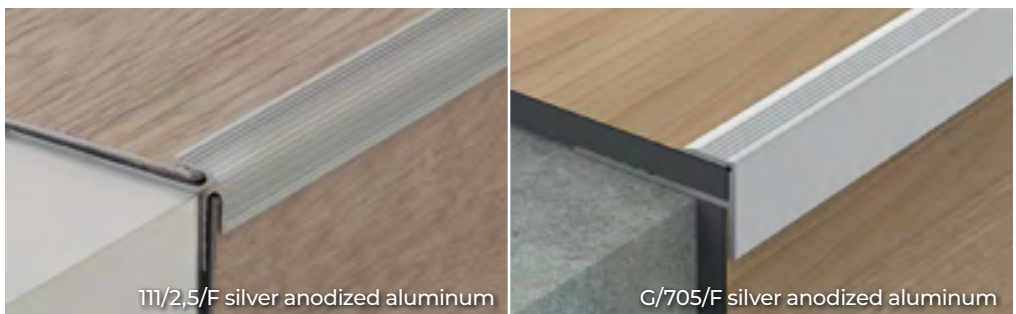

111/2,5/F silver anodized aluminum

G/705/F silver anodized aluminum

To place orders correctly, find the desired model, size and finish. Then place your order by using the letters "PPS" followed by the corresponding 5-digit code.

# Cerfix™ Protrim – Proangle™

RA/ and RI/ are profiles that are ideal for thin flooring.



RI/4 stainless steel AISI 304

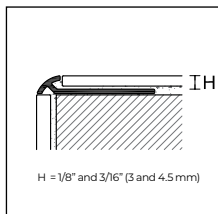

RA/

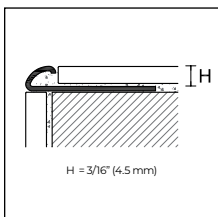

RI/



## CERFIX PROTRIM

Length = 8' 10" or 270 cm / 20-piece package

		H	
Item	Finish	1/8" (3 mm)	3/16" (4.5 mm)
<b>ALUMINUM</b>			
RA/	Silver anodized	92055	92056
	Gold anodized	92025	92026
	Titanium anodized	92085	92086

Individually packaged

## CERFIX PROTRIM

Length = 8' 10" or 270 cm / 20-piece package

		H
Item	Finish	3/16" (4.5 mm)
<b>STAINLESS STEEL</b>		
RI/	Stainless steel AISI 304	92413

Individually packaged

ZA/, AI/, ZQAN/, ZQKN/ and ZK/ are profiles suitable for thin flooring and are recommended as transition and perimeter profiles.

To place orders correctly, find the desired model, size and finish. Then place your order by using the letters "PPS" followed by the corresponding 5-digit code.

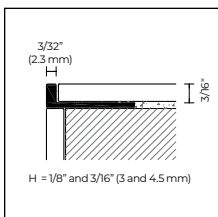

ZA/

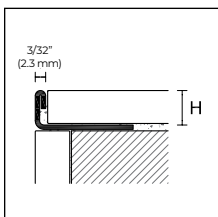

AI/

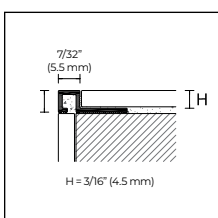

ZQAN/  
ZQKN/



## CERFIX PROANGLE

Length = 8' 10" or 270 cm / 20-piece package

		H		
Item	Finish	3/32" (2.5 mm)	1/8" (3 mm)	3/16" (4.5 mm)
<b>ALUMINUM</b>				
ZA/	Silver anodized	90337	90338	90340
<b>STAINLESS STEEL</b>				
AI/	Stainless steel AISI 304	-	91636	91638

Individually packaged – version chromium – plated brass article ZK/3 and ZK/4,5 see page 29



## CERFIX PROANGLE Q

Length = 8' 10" or 270 cm / 20-piece package

		H
Item	Finish	3/16" (4.5 mm)
<b>ALUMINUM</b>		
ZQAN/	Silver anodized	88772
ZQKN/	Titanium anodized	88902
	Chromium-plated	88870

Individually packaged



ZA/4 silver anodized aluminum

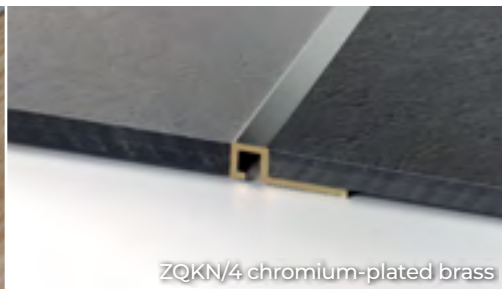

ZQKN/4 chromium-plated brass



# Proround™

GA/, JGA/ and PIA/ are connection profiles for stairs covered with thin flooring. Easy to install, they prevent the accumulation of dirt and simplify cleaning.



GA/4 silver anodized aluminum

JGA/4 silver anodized aluminum

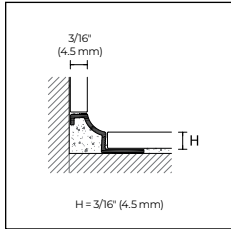

GA/



### CERFIX PROROUND M

Length = 8' 10" or 270 cm / 20-piece package

Item	Finish	H
<b>ALUMINUM</b>		
GA/	Silver anodized	3/16" (4.5 mm)
	<b>\$/pc</b>	95730

Individually packaged

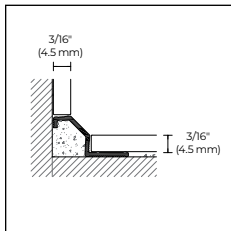

JGA/

### CERFIX PROROUND M

Length = 8' 10" or 270 cm / 20-piece package

Item	Finish	H
<b>ALUMINUM</b>		
JGA/	Silver anodized	3/16" (4.5 mm)
	<b>\$/pc</b>	95732

Individually packaged

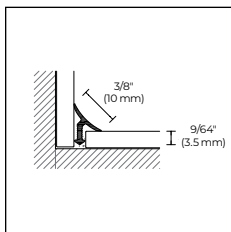

PIA/



### CERFIX PROINT

Length = 8' 10" or 270 cm / 20-piece package

Item	Finish	H
<b>ALUMINUM</b>		
PIA/	Silver anodized	1/8" (3.5 mm)
	<b>\$/pc</b>	95431

Individually packaged



PIA/3 silver anodized aluminum

To place orders correctly, find the desired model, size and finish. Then place your order by using the letters "PPS" followed by the corresponding 5-digit code.

## PVC Line baseboards

for wood, engineered wood and LVT



PVC Line 8605 covered with durable film: See page 202



PVC Line 8608 covered with durable film: See page 203



PVC Line 8615 covered with durable film: See page 204



PVC Line 8613 covered with durable film: See page 205



PVC Line 8612 covered with durable film: See page 206



PVC Line 8614 covered with durable film: See page 206

## Profilpas Digital System no limits to imagination



You can choose from more than 400 standard durable decors to perfectly combine a profile or baseboard with the floor. We offer a wide selection for wood, stone and concrete decors, to meet every need. Just consult our PDS chain set to choose the best color that matches your needs.

But that's not all. Customization is literally limitless with Profilpas. Just provide us with a sample for creating any further decor, even a fantasy one!

This is possible thanks to Profilpas Digital System (PDS), the innovative digital printing technology of Profilpas to reproduce any decor on durable film, eliminating any limits on your imagination. The whole production process takes place in our factory, from the scanning to the printing to the applying of the film. Contact our customer service to learn more.

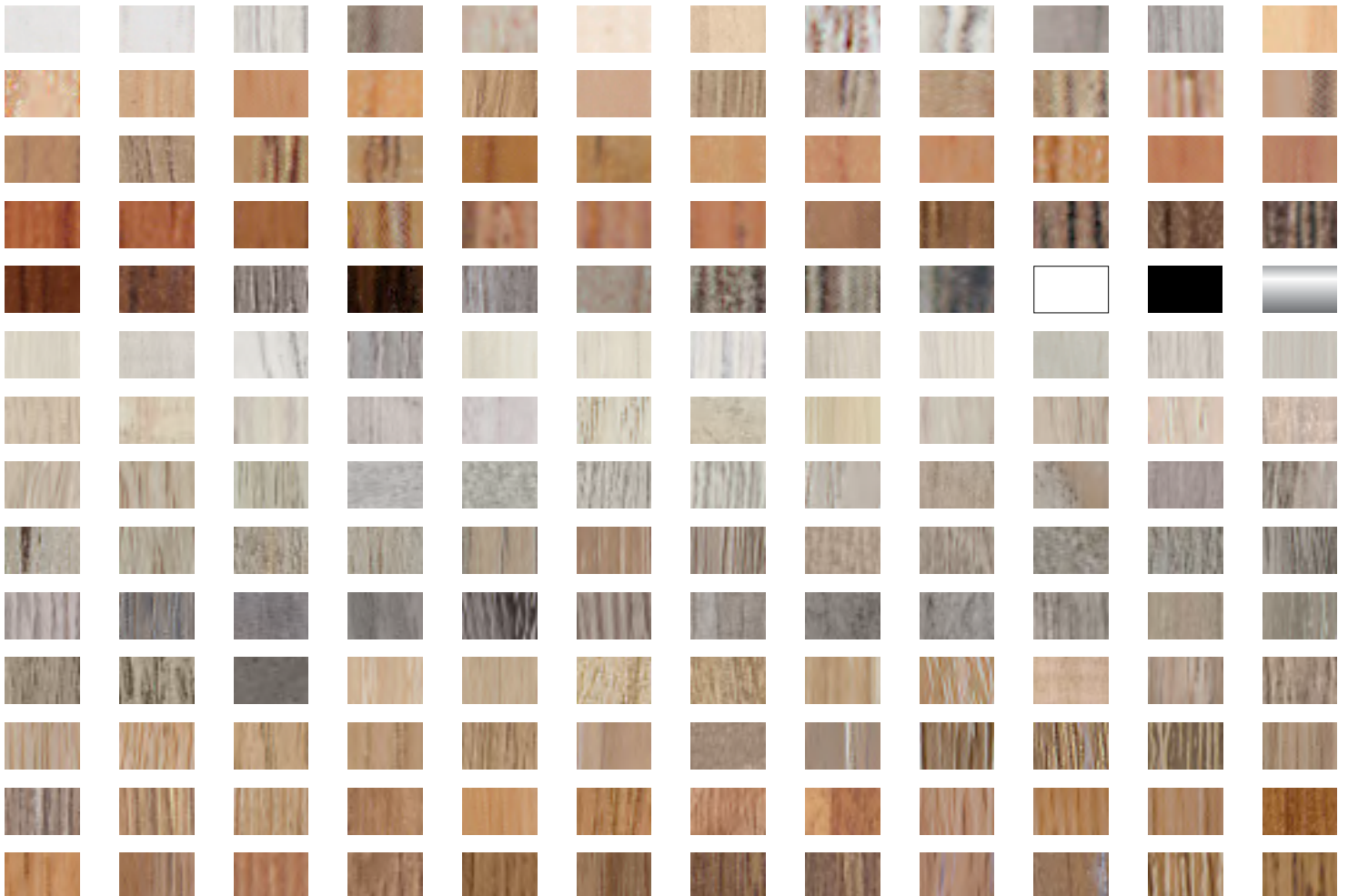









## Prolight

Prolight is a line of profiles designed to be used with LED strips. The LED strips are available in warm, neutral or RGB light and come with a dimmer switch. Prolight is easy to install and suitable for both residential and commercial applications.



# Prolist™

Prolight Prolist LLA and LLB are two aluminum decorative listellos with direct LED light. Suitable for framing mirrors and walls as well as illuminating recessed niches and shelves, these profiles add beauty and interest to bathrooms, kitchens and private spaces in general. Prolight Prolist LLA/20/10, in particular, is perfect for recessed niches in showers.



LLA/20/10 silver anodized aluminum

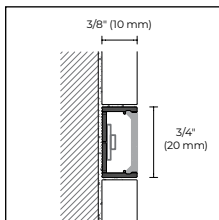

LLA/20

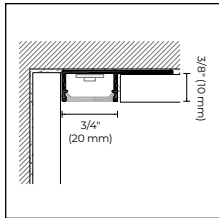

LLA/20/10

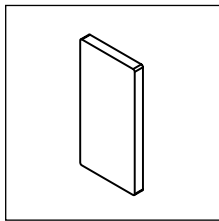

LLA/20P

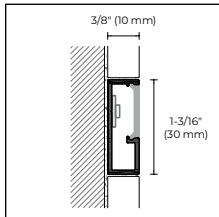

LLA/30  
LLB/30

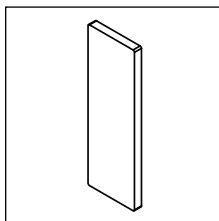

LLA/30P  
LLB/30P

Spare insert in opaline ABS for Item LLA/20, LLA/20/10, LLA/30 and LLB/30 code 84069 L 8'10" cm – 20-piece package \$/pc

For the best aesthetic result and the validity of the warranty, we suggest the exclusive use of our electrical components. See page 179-181

We recommend the use of NT LED strip with continuous light, see page 180-181

### PROLIGHT PROLIST

Length = 8'10" or 270 cm – 10-piece package		<b>L x H</b>
<b>Item</b>	<b>Finish</b>	<b>3/4" x 3/8" (20 x 10 mm)</b>
<b>ALUMINUM</b>		
LLA/20	Silver anodized	84070
	<b>\$/pc</b>	

Individually packaged

### PROLIGHT PROLIST

Length = 8'10" or 270 cm – 10-piece package		<b>H</b>
<b>Item</b>	<b>Finish</b>	<b>3/8" (10 mm)</b>
<b>ALUMINUM</b>		
LLA/20/10	Silver anodized	84076
	<b>\$/pc</b>	

Individually packaged

### END CAPS FOR LLA/20 AND LLA/20/10

5-piece package		
<b>Item</b>	<b>Finish</b>	
<b>ALUMINUM</b>		
LLA/20P	Silver anodized	84072
	<b>\$/pc</b>	

No partial packaging

### PROLIGHT PROLIST

Length = 8'10" or 270 cm – 10-piece package		<b>L x H</b>
<b>Item</b>	<b>Finish</b>	<b>1-3/16" x 3/8" (30 x 10 mm)</b>
<b>ALUMINUM</b>		
LLA/30	Silver anodized	84080
	<b>\$/pc</b>	
LLB/30	Bright polished silver	84081
	<b>\$/pc</b>	

Individually packaged

### END CAPS FOR LLA/30 AND LLB/30

5-piece package		
<b>Item</b>	<b>Finish</b>	
<b>ALUMINUM</b>		
LLA/30P	Silver anodized	84082
	<b>\$/pc</b>	
LLB/30P	Bright polished silver	84083
	<b>\$/pc</b>	

No partial packaging

Prolight Prolist TLA is an aluminum listello with a slot for inserting an LED strip that displays indirect light.

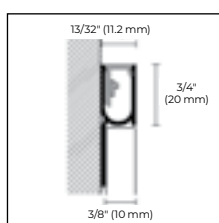
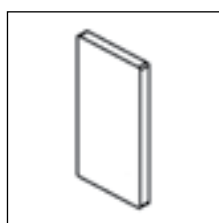
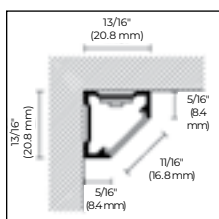
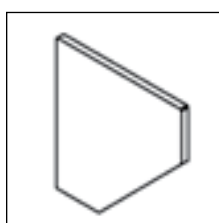

TLA/10/C1 silver anodized aluminum

TLA/10/C1  
TLB/10/C1TLA/10P/C1  
TLB/10P/C1CLA/8  
CLA/8A

CLA/8P

Spare insert in opaline ABS for Item CLA/8 and CLA/8A code 84069 8'10" - 20-piece package \$/pc.

For the best aesthetic result and the validity of the warranty, we suggest the exclusive use of our electrical components. See page 179-181

We recommend the use of NT LED strip with continuous light, see page 180-181

### PROLIGHT PROLIST

Length = 8'10" or 270 cm - 10-piece package

L x H

Item Finish 3/4" x 3/8" (20 x 10 mm)

#### ALUMINUM

TLA/10/C1	Silver anodized	84090
	\$/pc	
TLB/10/C1	Bright polished silver	84091
	\$/pc	

Individually packaged

### END CAPS FOR TLA/10/C1

5-piece package

Item Finish

#### ALUMINUM

TLA/10P/C1	Silver anodized	84092
	\$/pc	
TLB/10P/C1	Bright polished silver	84093
	\$/pc	

No partial packaging

### PROLIGHT PROLIST

Length = 8'10" or 270 cm - 10-piece package

H

Item Finish 5/16" (8 mm)

#### ALUMINUM

CLA/8	Silver anodized	84221
	\$/pc	
CLA/8A adesivo	Silver anodized	84222
	\$/pc	

Individually packaged

### END CAPS FOR CLA/8

5-piece package

H

Item Finish 5/16" (8 mm)

#### ALUMINUM

CLA/8P	Silver anodized	84223
	\$/pc	

No partial packaging



# Prolist Q

Prolight Prolist Q LQL/2 is an aluminum decorative listello that can be used in combination with LED strips. The profile is available in different colors.



LQL/2 metal light color-coated aluminum

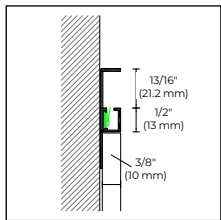

LQL/2

TREND  
COLOR

### PROLIGHT PROLIST Q

Length = 8'10" or 270 cm – 5-piece package

Item	Finish	H
<b>COLOR-COATED ALUMINUM</b>		
	White stone	84020
	Concrete white	84021
	Concrete graphite	84022
	Concrete smoke	84023
LQL/2	Concrete mud	84024
	Concrete sand	84025
	Metal dark	84026
	Metal light	84027
	Solid white	84028

**\$/pc**  
Individually packaged

### ELECTRICAL COMPONENTS AND ACCESSORIES FOR LIGHTING

Item	Description	
L5/NW/65 L	Spool 16.40' (5 m) LED strips, lateral light, neutral color 4000°K, 9.6W/3.28' IP65	84136

**\$/pack**

For the best aesthetic result and the validity of the warranty, we suggest the exclusive use of our electrical components. See page 179-181

For other electrical components page 180

## Proangle™ Q

Prolight Proangle Q ZQAL is an aluminum profile for external corners equipped with LED strips.

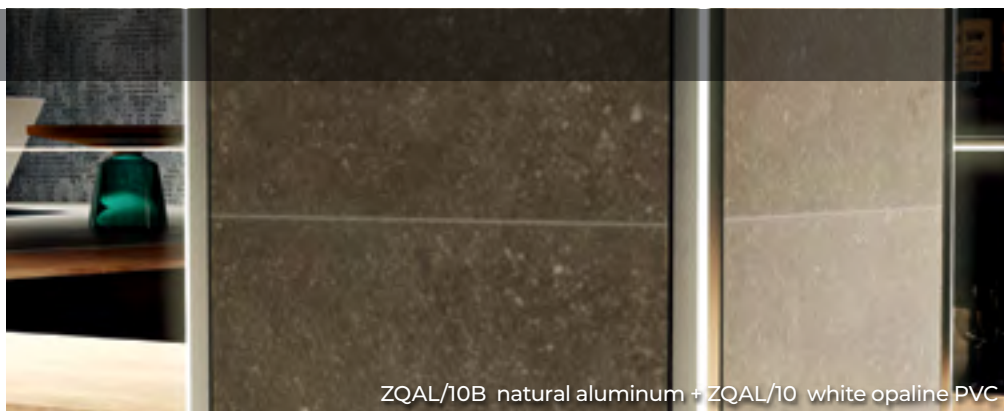

ZQAL/10B natural aluminum + ZQAL/10 white opaline PVC

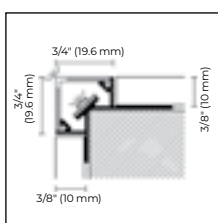

ZQAL/...  
B+ZQAL/10

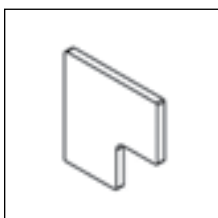







ZQAL/...P

### PROLIGHT PROANGLE Q

Length = 8'10" or 270 cm – 10-piece package



H

Item	Finish	3/8" (10 mm)	1/2" (13 mm)
<b>ALUMINUM</b>			
ZQAL/10B	Natural aluminum base	 87226	
		\$/pc	
ZQAL/13B	Natural aluminum base	 87227	
		\$/pc	
<b>OPALINE PVC</b>			
ZQAL/10	White	 87230	
	Gray	 87231	
	Red	 87232	
	Yellow	 87233	
		\$/pc	

### END CAPS FOR ZQAL

5-piece package

H

Item	Finish	3/8" (10 mm)	1/2" (13 mm)
<b>ALUMINUM</b>			
ZQAL/10P	Natural aluminum	 87229	
		\$/pc	
ZQAL/13P	Natural aluminum	 87228	
		\$/pc	

No partial packaging

For the best aesthetic result and the validity of the warranty, we suggest the exclusive use of our electrical components. See page 179-181

We recommend the use of NT LED strip with continuous light, see page 180-181

# Prostep™ / Protect

Prolight Prostep SGA is an aluminum profile with indirect LED light for the protection and finishing of steps.

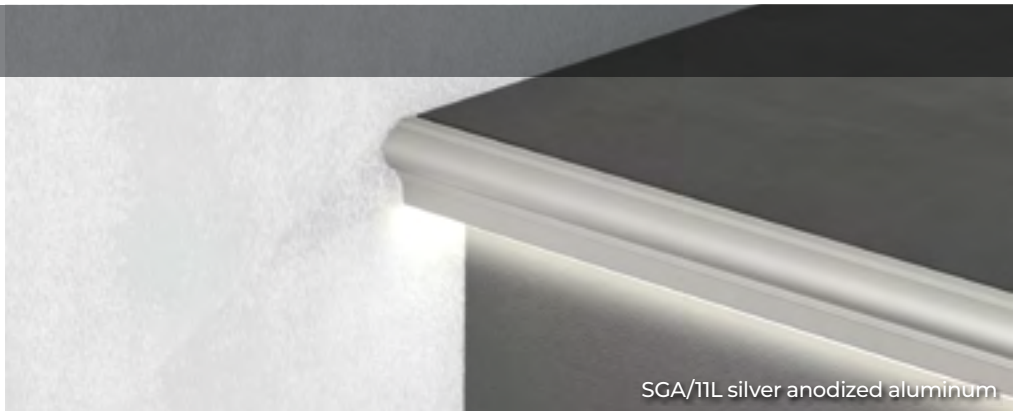

SGA/T1L silver anodized aluminum

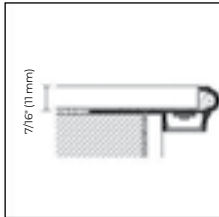

SGA/T1L

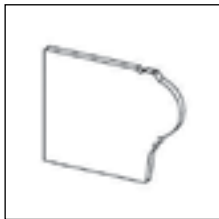

SGA/T1P

### PROLIGHT PROSTEP

Length = 8'10" or 270 cm – 10-piece package		<b>H</b>
<b>Item</b>	<b>Finish</b>	<b>7/16" (11 mm)</b>
<b>ALUMINUM</b>		
<b>SGA/T1L</b>	Silver anodized	94969
	<b>\$/pc</b>	

Individually packaged

### END CAPS FOR PROFILE SGA/T1L

5-piece package		<b>H</b>
<b>Item</b>	<b>Finish</b>	<b>7/16" (11 mm)</b>
<b>ALUMINUM</b>		
<b>SGA/T1P</b>	Silver anodized	94964
	<b>\$/pc</b>	

No partial packaging

Prolight Protect G/9 is an aluminum stair nosing profile equipped with direct LED light as well as a non-slip surface.



G/9/SF silver anodized aluminum

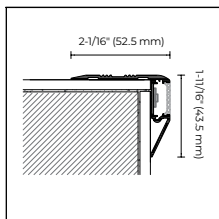

G/9/F

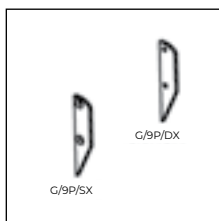

G/9P/

### PROLIGHT PROTECT

Length = 8'10" or 270 cm – 10-piece package		
<b>Item</b>	<b>Finish</b>	
<b>ALUMINUM</b>		
<b>G/9/F</b>	Silver anodized	84050
	<b>\$/pc</b>	

Individually packaged

### END CAPS FOR PROFILE G/9/F

5-piece package		
<b>Item</b>	<b>Finish</b>	
<b>ALUMINUM</b>		
<b>G/9P/DX</b>	Silver anodized	84052
	<b>\$/pc</b>	
<b>G/9P/SX</b>	Silver anodized	84053
	<b>\$/pc</b>	

No partial packaging

Spare insert in opaline ABS for Item SGA/T1L and G/9/F code 84069 – 20-piece package \$/pc

For the best aesthetic result and the validity of the warranty, we suggest the exclusive use of our electrical components. See page 179-181

We recommend the use of NT LED strip with continuous light, see page 180-181

## Protect

Prolight Protect 126/L/F is an aluminum stair nosing profile equipped with direct light as well as a non-slip replaceable rubber insert on top.



126/L/F silver anodized aluminum + GMR/44 black striped rubber

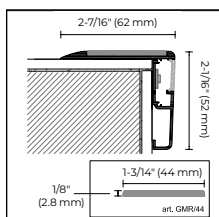

126/L/F

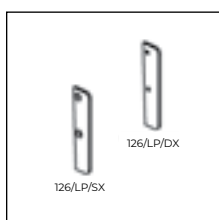

126/LP

### PROLIGHT PROTECT

Length = 8'10" or 270 cm – 6-piece package

Item	Finish
<b>ALUMINUM</b>	
126/L/F	Silver anodized
	<b>\$/pc</b>

84060

Individually packaged

### GROOVED RUBBER

Length = 55.77' or 1700 cm – 1-roll package

Item	Finish
<b>GMR/44</b>	
GMR/44	Black
	<b>\$/pc</b>

75706

### END CAPS FOR 126/L/F

5-piece package

Item	Finish
<b>ALUMINUM</b>	
126/LP/DX	Silver anodized
	<b>\$/pc</b>
126/LP/SX	Silver anodized
	<b>\$/pc</b>

84062

84063

No partial packaging

Spare insert in opaline ABS for Item 126/L/F code 84069 8'10" – 20-piece package \$/pc

For the best aesthetic result and the validity of the warranty, we suggest the exclusive use of our electrical components. See page 179-181

We recommend the use of NT LED strip with continuous light, see page 180-181

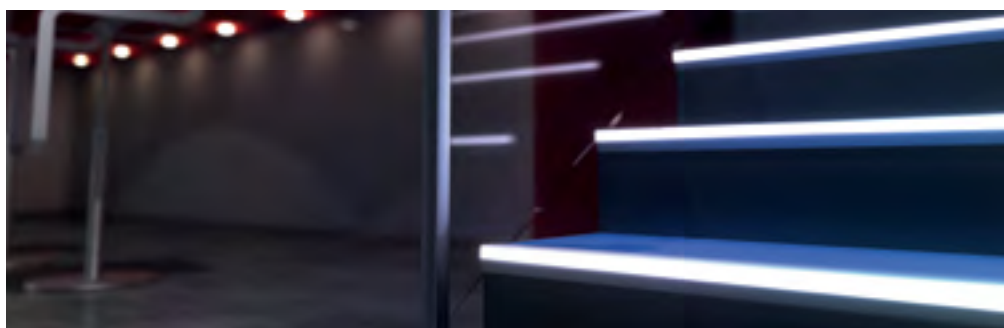



## Metal Line S

Prolight Metal Line SKL/2 is an aluminum baseboard with indirect LED light. The model is available in different finishes.

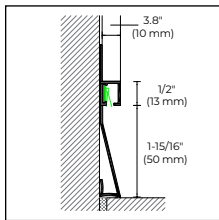

SKL/2

TREND  
COLOR

### PROLIGHT METAL LINE S

Length = 8'10" or 270 cm – 5-piece package

Item	Finish	H
<b>ALUMINUM</b>		
SKL/2	Silver anodized	78579
	<b>\$/pc</b>	
<b>COLOR-COATED ALUMINUM</b>		
	White stone	78591
	Concrete white	78592
	Concrete graphite	78593
	Concrete smoke	78594
SKL/2	Concrete mud	78595
	Concrete sand	78596
	Metal dark	78597
	Metal light	78598
	Solid white	78599
	<b>\$/pc</b>	

Individually packaged

### ELECTRICAL COMPONENTS AND ACCESSORIES FOR LIGHTING

Item	Description	
L5/NW/65 L	Spool 16.40' (5 m) LED strips, lateral light, neutral color 4000°K, 9.6W/3.28ft IP65	84136
	<b>\$/pack</b>	

For the best aesthetic result and the validity of the warranty, we suggest the exclusive use of our electrical components. See page 179-181

## Metal Line

Prolight Metal Line 88/16L/A is a baseboard with integrated LED light that can be installed flush to the wall. This model offers the option to add a dimmer switch.



88/16L/A silver anodized aluminum

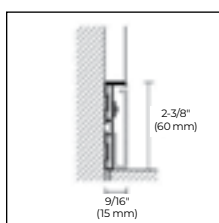

87/6 + 88/16L

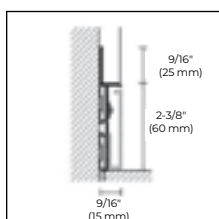

88/6 + 88/16L



88/6E

### PROLIGHT METAL LINE 87 – 88

Length = 6' 6-15/32" or 200 cm – 20-piece package

		H
Item	Finish	2.4" (6 cm)
<b>ALUMINUM</b>		
87/6	Natural aluminum (drilled)	78338
	<b>\$/pc</b>	
88/6	Natural aluminum (drilled)	78310
	<b>\$/pc</b>	

Individually packaged

### ALUMINUM INSERT FOR LED LIGHT

Length = 6' 6-15/32" or 200 cm – 20-piece package

		H
Item	Finish	2.4" (6 cm)
	Silver anodized	78559
88/16L/A	Color-coated matte white RAL 9010	78560
	<b>\$/pc</b>	

Adesivo – Individually packaged

### OUTSIDE CORNER IN METAL

4-piece package

		H
Item	Finish	2.4" (6 cm)
	Silver	78561
88/6E	Color-coated matte white RAL 9010	78562
	<b>\$/pc</b>	

No partial packaging

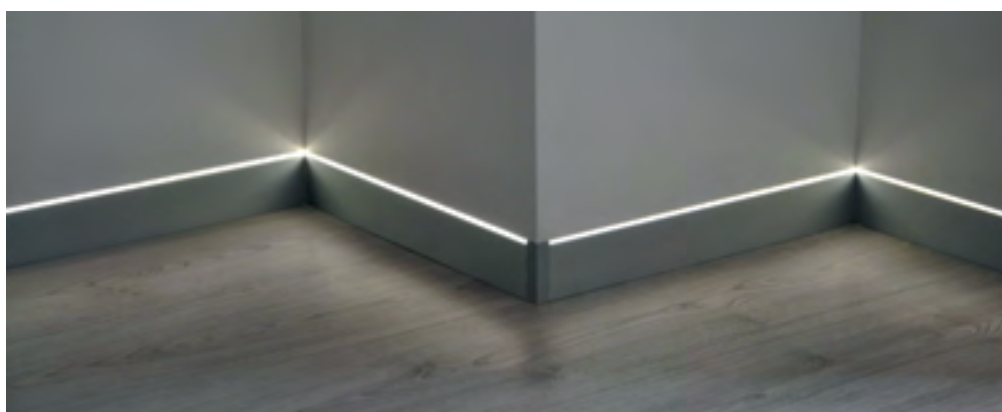

88/6 + 88/16L/A silver anodized aluminum

For the best aesthetic result and the validity of the warranty, we suggest the exclusive use of our electrical components. See page 179-181

## Metal Line

Prolight Metal Line 89 is an aluminum baseboard with LED integrated light. A dimmer switch is available and can be ordered separately.

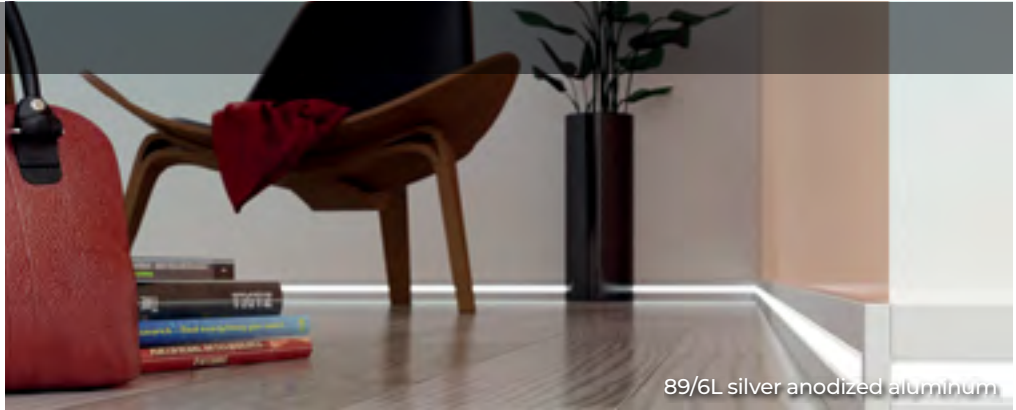

89/6L silver anodized aluminum

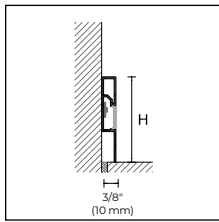

89/6L



89/6EI

### PROLIGHT METAL LINE 89

Length = 6'6-15/32" or 200 cm – 25-piece package		<b>H cm</b>
<b>Item</b>	<b>Finish</b>	<b>2.4" (6 cm)</b>
<b>ALUMINUM</b>		
<b>89/6L</b>	Silver Anodized	86000
	<b>\$/pc</b>	

Individually packaged

### INSIDE/OUTSIDE CORNER – RIGHT/LEFT END CAP

4-piece package		<b>H cm</b>
<b>Item</b>	<b>Finish</b>	<b>2.4" (6 cm)</b>
<b>ALUMINUM</b>		
<b>89/6EI</b>	Silver anodized	78506
	<b>\$/pc</b>	

No partial packaging

Spare insert in opaline ABS for Item 89/6L code 84069 L= 8'10" or 270 cm – 20-piece package \$/pc  
 For the best aesthetic result and the validity of the warranty, we suggest the exclusive use of our electrical components. See page 179-181  
 We recommend the use of NT LED strip with continuous light, see page 180-181

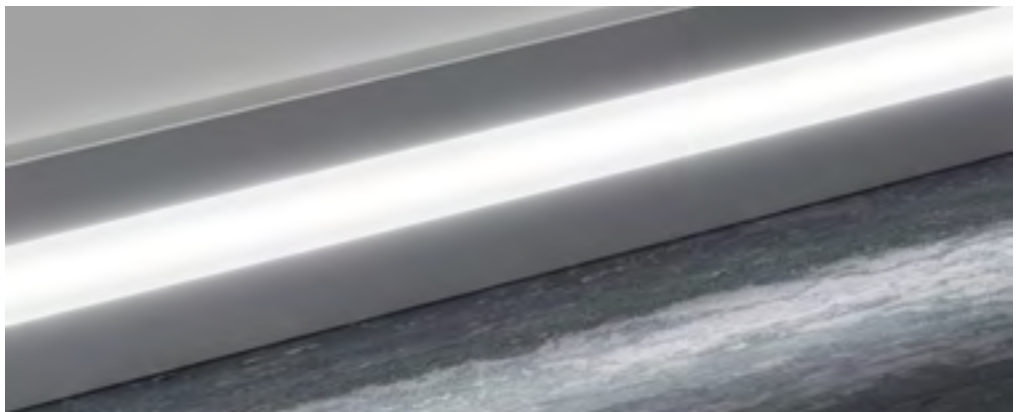

89/6L silver anodized aluminum

# Prolight

## HOW TO ORDER THE ELECTRICAL COMPONENTS

### LED (white light)

Measure how many feet/meters of LED strip must be installed on our profiles. A spool is 16.4' or 5 m long. Spools have 120 LED every 3.28' or 1 m. The voltage is 24 volts. The energy usage is 2.92 watts every foot, or 9.6 watts every 1 m. To determine the energy usage, multiply the length in feet by 2.92, or in meters by 9.6.

*Examples: 10' x 2.92 watts = 29.2 total watts, 7.4 m x 9.6 watts = 71 total watts*

Choose the color of the light. LED strips are available in neutral white light (4000°K) or warm white light (3000°K).

Choose the degree of protection: IP33 for inside and dry spaces, IP67 for outside or moist spaces.

### POWER SUPPLIES

Choose the suitable power supply on the basis of the total watts, being careful not to exceed 90% of the maximum power.

*Example: For 71W, a power supply of 79W capacity is required (71 = 90% of 79), so use the 90W power supply.*

		Item	
1-15/16" to 18.04' (5 cm to 5.5 m)	60W	AL/60/24	84150
18' to 27.5' (5.6 m to 8.4 m)	90W	AL/90/24	84152
27.5' to 36.5' (8.5 m to 11.2 m)	120W	AL/120/24	84154
36.5' to 46' (11.3 m to 14 m)	150W	AL/150/24	84156

We recommend powering the LED strips every 10' or 3 m in order to avoid differences in brightness and the overheating of the LED in the initial part of them. A cable with 3/64<sup>1/2</sup> or 1 mm<sup>2</sup> section has a maximum range of about 4 amps and a voltage drop of 1 volt every 32' or 10 m. For specialized installations, contact our Technical Services Department.

### DIMMER (optional)

The dimmer/fader/driver adjusts the intensity of LED light. It supports a maximum of 10 amps to a maximum length of 82' or 25 m of our LED strip. It must be placed between the power supply and the LED strip, and must be connected to a switch (not supplied) and/or to the receiver of the remote control (optional).

In the case of more lines being turned on simultaneously, the first dimmer is connected in sync mode and it will switch on the consecutive dimmers.

*Example: To connect 3 lines that will be turned on simultaneously, use 3 dimmers.*

### REMOTE CONTROL + RECEIVER (optional)

The remote control emits a radio frequency and can control up to 4 channels. Used with the master control unit, it is used to turn on/off the LEDs.

The receiver must be installed between the power supply and the LED strip, or connected to the dimmer if present.

If there is a dimmer, the remote control can adjust the LED light intensity.

### ELECTRICAL CABLES

The cables are necessary to connect the power supply to the LED strips where needed.

A cable with 3/64<sup>1/2</sup> or 1 mm<sup>2</sup> section has a maximum range of about 4 amps and a voltage drop of 1 volt every 32' or 10 m.

### CONNECTORS

Item IR/C01 connects the LED strips to the line of the power supply.  
Item IR/W3 connects a maximum of 3 cables.

We recommend assigning the assembly of the electrical components to qualified staff.

### LED RGB (colored light)

Measure how many feet/meters of LED strip must be installed on our profiles. A spool is 16.4' or 5 m long. Spools can be cut every 3-15/16" or 10 cm. The voltage is 24 volts. The energy usage is 4.39 watts every foot, or 14.4 watts every meter. To determine the energy usage, multiply the length in feet by 4.39, or in meters by 14.4.

*Examples: 10' x 4.39 watts = 43.9 total watts,  
7.4 m x 14.4 watts = 106.6 total watts*

RGB LED strips are available in degree of protection IP67, are covered with silicone sheath and are provided with adhesive for the fastening in inside or outside spaces.

### POWER SUPPLIES

Choose the suitable power supply on the basis of the total watts, being careful not to exceed 90% of the maximum power.

*For 106.6W, a power supply of 118W capacity is required (106.6 = 90% of 118), so use the 120W power supply.*

		Item	
3-15/16" to 12' (10 cm to 3.7 m)	60W	AL/60/24	84150
12' to 18' (3.8 m to 5.5 m)	90W	AL/90/24	84152
18' to 24.5' (5.6 m to 7.5 m)	120W	AL/120/24	84154
24.5' to 30.5' (7.6 m to 9.3 m)	150W	AL/150/24	84156

We recommend powering the LED strips every 10' or 3 m in order to avoid differences in brightness and the overheating of the LED in the initial part of them. A cable with 3/64<sup>1/2</sup> or 1 mm<sup>2</sup> section has a maximum range of about 4 amps and a voltage drop of 1 volt every 32' or 10 m. For lengths over 30.5' or 9.3 m, see the "Slave Control Unit" section below. For specialized installations, contact our Technical Services Department.

### REMOTE CONTROL

The remote control emits a radio frequency and can control up to 4 channels. Used with the master control unit, it is used to turn on/off the LEDs, adjust light intensity and choose the color/sequence of the LEDs.

### MASTER CONTROL UNIT

Connected with the remote control, the master control unit is used to turn on/off the LEDs, adjust light intensity and choose the color/sequence of the LEDs.

It must be connected between the power supply and the LED strip.

### SLAVE CONTROL UNIT

Every time that the system needs more lines controlled by just one unit, 1 slave switch must be added for every additional line.

*Example: To connect 3 lines with simultaneous lighting, use 1 master control unit and 2 slave switch control units.*

The slave control unit must be connected to the master control unit with RJ11 6-poles cable (not supplied).

### ELECTRICAL CABLES

The cable has 4 poles, 3 of them have a 1/64<sup>1/2</sup> or 0.5 mm<sup>2</sup> section (for the three colors), one of them has a 3/64<sup>1/2</sup> or 1 mm<sup>2</sup> section (for the negative pole).

### CONNECTORS

Item IR/C02 connects the LED strips with coloured light to the line of power supply, with a length of 5-7/8" or 15 cm.  
Item IR/C03 connects LED strips to LED strips with colored light, with a length of 5-7/8" or 15 cm.



# Prolight

When selecting electrical components and accessories for Prolight profiles, each element must be chosen based on the established length of the light profiles. The energy usage in watts per feet/meter must be calculated in order to choose one or more power supplies to be combined with the dimmer and the controller.



Spool 16.40' or 5 m NT LED strip



L5/.../33



L5/.../67



AL/.../24

DIMM/02



TEL/04



TEL/RGB/04



RIC/01

## ELECTRICAL COMPONENTS AND ACCESSORIES FOR LIGHTING

Item	Description	
L5/NW/33	Spool 16.4' (5 m) LED strip color neutral white 4000°K – 9.6 W/3.2' (9.6 W/m) – IP33	84105
	\$/pc	
L5/WW/33	Spool 16.4' (5 m) LED strip color warm white 3000°K – 9.6 W/3.2' (9.6 W/m) – IP33	84115
	\$/pc	
L5/NW/67	Spool 16.4' (5 m) LED strip color neutral white 4000°K – 9.6 W/3.2' (9.6 W/m) – IP67	84125
	\$/pc	
L5/WW/67	Spool 16.4' (5 m) LED strip color warm white 3000°K – 9.6 W/3.2' (9.6 W/m) – IP67	84135
	\$/pc	
L5/RGB/67	Spool 16.4' (5 m) RGB LED strip – 14.4 W/3.2' (14.4 W/m) – IP67	84140
	\$/pc	
L5/NW/65NT	Spool 16.4' (5 m) NT LED strip neutral white color 4000°K – 10 W/3.2' (10 W/m) – IP65	84118
	\$/pc	
L5/NW/67NT	Spool 16.4' (5 m) NT LED strip neutral white color 4000°K – 10 W/3.2' (10 W/m) – IP67	84122
	\$/pc	
AL/60/24	Power supply IP67 – PFC active – 24Vdc/60W	84150
	\$/pc	
AL/90/24	Power supply IP67 – PFC active – 24Vdc/90W	84152
	\$/pc	
AL/120/24	Power supply IP67 – PFC active – 24Vdc/120W	84154
	\$/pc	
AL/150/24	Power supply IP67 – PFC active – 24Vdc/150W	84156
	\$/pc	
DIMM/02	Dimmer/driver 24V/10 Amp – for white LED light	84187
	\$/pc	
TEL/04	4 channel radio frequency remote control	84182
	\$/pc	
RIC/01	4-channel radio frequency remote control receiver	84184
	\$/pc	
TEL/RGB/04	4-channel radio-frequency remote control 433.92 MHz for RGB LED diam. 80x13 h	84183
	\$/pc	



RIC/RGB/...

<b>RIC/RGB/M</b>	Master control unit with dimmer function / wireless for RGB LED \$/pc	84185
------------------	--	-------

<b>RIC/RGB/S</b>	Slave control unit white dimmer function for RGB LED (maximum 4 slave for each master) \$/pc	84186
------------------	--	-------

<b>CE/5/20</b>	Electrical cable sect. 0.5 mm <sup>2</sup> – 65.6' or 20 m (linear) package \$/pc	84420
----------------	--	-------

<b>CE/10/20</b>	Electrical cable sect. 1 mm <sup>2</sup> – 65.6' or 20 m (linear) package \$/pc	84422
-----------------	--	-------

<b>CE/10/100</b>	Electrical cable sect. 1 mm <sup>2</sup> – 328' or 100 m (linear) package \$/pc	84424
------------------	--	-------

<b>CE/RGB/20</b>	Electrical cable for RGB LED section 1.8" x 1/64" + 1 x 1 mm <sup>2</sup> -- 65.6' or 20 m (linear) package \$/pc	84426
------------------	---	-------

<b>IR/C01</b>	Rapid fit connector for strip LED white light – 10-piece package \$/pc	84411
---------------	---	-------

<b>IR/W3</b>	Rapid fit connector 3 cables – 10-piece package \$/pc	84410
--------------	--	-------

<b>IR/C02</b>	Rapid fit connector RGB LED strip – 10-piece package \$/pc	84415
---------------	---	-------

<b>IR/C03</b>	Rapid fit double connector RGB LED strip – 10-piece package \$/pc	84416
---------------	--	-------

<b>IR/C01NT</b>	Rapid fit connector for NT LED strip white light – 10-piece package \$/pc	84413
-----------------	--	-------

CE/5/20  
CE/10/...

CE/RGB/20

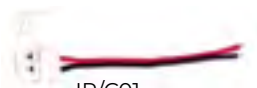

IR/C01



IR/W3

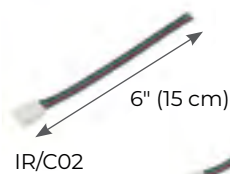

IR/C02

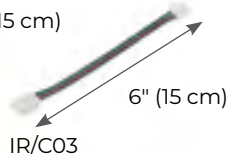

IR/C03



IR/C01NT



IR/C01NT







## Metal Skirting Boards

Metal Line profiles, made of stainless steel and aluminum, come in wide variety of trendy styles and colors for residential and commercial environments.



## Metal Line

Metal Line 90 is an aluminum baseboard, available in different finishes, that creates an elegant junction between the wall and the floor. The terminal is curved to adapt perfectly to the floor. Metal Line 90 is also available in white and black Trend Color Stone, two matte colors that perfectly match the most modern tile floorings. The baseboards can be curved using a standard bending machine.

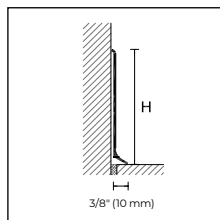
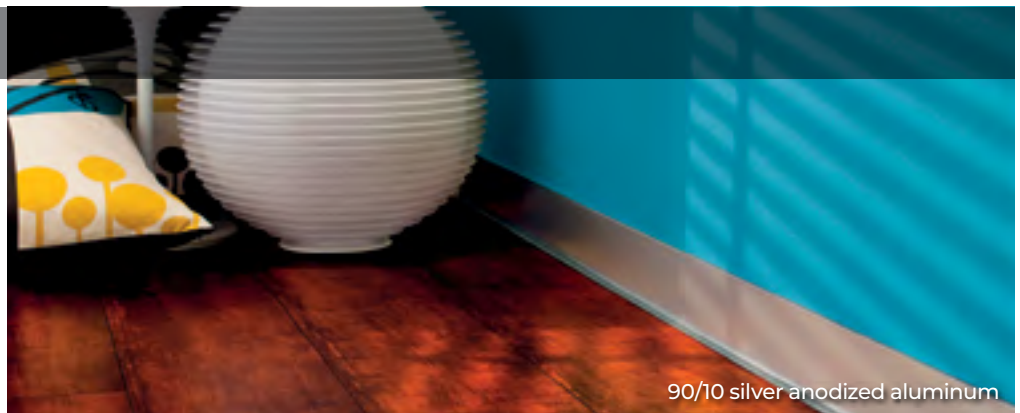

Metal Line 90 white stone color-coated aluminum



Metal Line 90/6 silver anodized aluminum

**PRO FLEX LINE** **TREND COLOR**

Metal Line 90 can be curved by using a standard bending machine.

The self-adhesive version in height 4, 5, 7, and 10 is available on request, with a minimum order of 100 pcs.

RAL 9003, RAL 7038, RAL 8019, RAL 9006, RAL 9007 color-coated aluminum skirting boards are available on request, with a minimum order of 150 pcs. For other colors, please contact our sales department.

To place orders correctly, find the desired model, size and finish. Then place your order by using the letters "PPS" followed by the corresponding 5-digit code.

### METAL LINE 90

Length = 6'6-15/32" or 200 cm / 25-piece package

Item	Finish	H					
		1-9/16" (4 cm)	1-15/16" (5 cm)	2-3/8" (6 cm)	2-3/4" (7 cm)	3-1/8" (8 cm)	3-15/16" (10 cm)
<b>ALUMINUM</b>							
90/ SF	Silver anodized	78080	78084	78100	78138	78130	78137
	Color-coated polished white RAL 9010	-	-	78112	-	-	-
	Color-coated matte white RAL 9010	-	-	78110	-	-	-
	<b>\$/pc</b>						
	Titanium anodized	-	-	78103	-	-	-
	<b>\$/pc</b>						
	Color-coated anthracite gray	-	-	78118	-	-	-
	Color-coated ancient gray	-	-	78119	-	-	-
	<b>\$/pc</b>						
	90/ A	Self-adhesive silver anodized	-	-	78106	-	78136
<b>\$/pc</b>							
90/ TSF	Bright polished titanium	-	78087	78111	-	78141	-
90/ SSF	Bright satin silver	78082	-	78105	-	78133	-
	Bright satin gold	-	-	78107	-	78135	-
<b>\$/pc</b>							
90/ TMSF	Bright satin titanium	78088	-	78102	-	78134	-
<b>\$/pc</b>							
<b>TREND COLOR STONE</b>							
90/ SF	Color-coated white stone	-	-	78094	-	-	-
	Color-coated black stone	-	-	78099	-	-	-
<b>\$/pc</b>							
<b>ANTIBACTERIAL COLOR-COATED ALUMINUM</b>							
90H/ SF	Color-coated white RAL 9003 antibacterial	-	-	78104	-	-	-
<b>\$/pc</b>							

Individually packaged



inside corner, outside corner, junction and right-left end caps

### INSIDE CORNER

4-piece package		H					
Item	Finish	1-9/16" (4 cm)	1-15/16" (5 cm)	2-3/8" (6 cm)	2-3/4" (7 cm)	3-1/8" (8 cm)	3-15/16" (10 cm)
<b>METAL</b>							
	Silver	78630	78640	78650	78660	78670	78680
	<b>\$/pc</b>						
	Titanium	-	-	78654	-	-	-
	Polished white RAL 9010	-	-	78664	-	-	-
	Matte white RAL 9010	-	-	78674	-	-	-
90/ MI	Anthracite gray	-	-	78684	-	-	-
	Ancient gray	-	-	78694	-	-	-
	Polished titanium	-	78644	78704	-	78708	-
	Satin silver	78718	-	78720	-	78722	-
	Satin gold	-	-	78724	-	78744	-
	Satin titanium	78714	-	78734	-	78754	-
	<b>\$/pc</b>						
90/ MI	White stone	-	-	78172	-	-	-
	Black stone	-	-	78173	-	-	-
	<b>\$/pc</b>						
90H/ MI	White RAL 9003 antibacterial	-	-	78690	-	-	-
	<b>\$/pc</b>						

### POLYPROPYLENE

90/ I	Silver anodized	78236	78231	78190	78370	78195	78091
	<b>\$/pc</b>						
No partial packaging							

### JUNCTION

4-piece package		H					
Item	Finish	1-9/16" (4 cm)	1-15/16" (5 cm)	2-3/8" (6 cm)	2-3/4" (7 cm)	3-1/8" (8 cm)	3-15/16" (10 cm)
<b>METAL</b>							
	Silver	78632	78642	78652	78662	78672	78682
	<b>\$/pc</b>						
	Titanium	-	-	78656	-	-	-
	Polished white RAL 9010	-	-	78666	-	-	-
	Matte white RAL 9010	-	-	78676	-	-	-
90/ MG	Anthracite gray	-	-	78686	-	-	-
	Ancient gray	-	-	78696	-	-	-
	Polished titanium	-	78646	78706	-	78710	-
	Satin silver	78738	-	78740	-	78742	-
	Satin gold	-	-	78726	-	78746	-
	Satin titanium	78716	-	78736	-	78756	-
	<b>\$/pc</b>						
90/ MG	White stone	-	-	78187	-	-	-
	Black stone	-	-	78188	-	-	-
	<b>\$/pc</b>						
90H/ MG	White RAL 9003 antibacterial	-	-	78692	-	-	-
	<b>\$/pc</b>						

### POLYPROPYLENE

90/ G	Silver anodized	78237	78232	78192	78372	78197	78092
	<b>\$/pc</b>						
No partial packaging							

### OUTSIDE CORNER

4-piece package		H					
Item	Finish	1-9/16" (4 cm)	1-15/16" (5 cm)	2-3/8" (6 cm)	2-3/4" (7 cm)	3-1/8" (8 cm)	3-15/16" (10 cm)
<b>METAL</b>							
	Silver	78631	78641	78651	78661	78671	78681
	<b>\$/pc</b>						
	Titanium	-	-	78655	-	-	-
	Polished white RAL 9010	-	-	78665	-	-	-
	Matte white RAL 9010	-	-	78675	-	-	-
90/ ME	Anthracite gray	-	-	78685	-	-	-
	Ancient gray	-	-	78695	-	-	-
	Polished titanium	-	78645	78705	-	78709	-
	Satin silver	78728	-	78730	-	78732	-
	Satin gold	-	-	78725	-	78745	-
	Satin titanium	78715	-	78735	-	78755	-
	<b>\$/pc</b>						
90/ ME	White stone	-	-	78174	-	-	-
	Black stone	-	-	78178	-	-	-
	<b>\$/pc</b>						
90H/ ME	White RAL 9003 antibacterial	-	-	78691	-	-	-
	<b>\$/pc</b>						

### POLYPROPYLENE

90/ E	Silver anodized	78235	78230	78191	78371	78196	78090
	<b>\$/pc</b>						
No partial packaging							

### RIGHT/LEFT END CAPS

4-couples package		H					
Item	Finish	1-9/16" (4 cm)	1-15/16" (5 cm)	2-3/8" (6 cm)	2-3/4" (7 cm)	3-1/8" (8 cm)	3-15/16" (10 cm)
<b>METAL</b>							
	Silver	78633	78643	78653	78663	78673	78683
	<b>\$/pc</b>						
	Titanium	-	-	78657	-	-	-
	Polished white RAL 9010	-	-	78667	-	-	-
	Matte white RAL 9010	-	-	78677	-	-	-
90/ MP	Anthracite gray	-	-	78687	-	-	-
	Ancient gray	-	-	78697	-	-	-
	Polished titanium	-	78647	78707	-	78711	-
	Satin silver	78748	-	78750	-	78752	-
	Satin gold	-	-	78727	-	78747	-
	Satin titanium	78717	-	78737	-	78757	-
	<b>\$/pc</b>						
90/ MP	White stone	-	-	78189	-	-	-
	Black stone	-	-	78199	-	-	-
	<b>\$/couple</b>						
90H/ MP	White RAL 9003 antibacterial	-	-	78693	-	-	-
	<b>\$/couple</b>						

### POLYPROPYLENE

90/ P	Silver anodized	78238	78233	78193	78373	78198	78093
	<b>\$/couple</b>						
No partial packaging							

To place orders correctly, find the desired model, size and finish. Then place your order by using the letters "PPS" followed by the corresponding 5-digit code.

# Metal Line

Metal Line 790 is a baseboard in polished or satin stainless steel, available in different heights, that follows the minimalist trends of modern design. Thanks to the curved section, this baseboard perfectly hides the perimeter expansion gap of a floating floor.



790/6 polished stainless steel AISI 304

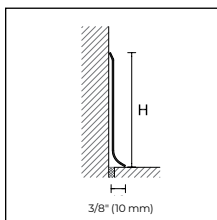

## METAL LINE 790

Length = 8'10" or 270 cm / 10-piece package

Item	Finish	H				
		1-9/16" (4 cm)	2" (5 cm)	2-3/8" (6 cm)	3-1/8" (8 cm)	3-15/16" (10 cm)
<b>STAINLESS STEEL</b>						
790/ SF	Polished stainless steel AISI 304	78120	78108	78129	78132	78139
	\$/pc					
790/ SF	Satin stainless steel AISI 304	78128	78109	78126	78127	78140
	\$/pc					

Individually packaged - Item 790/10 SF pack 5 pcs

## INSIDE CORNER IN METAL

4-piece package

Item	Finish	H				
		1-9/16" (4 cm)	2" (5 cm)	2-3/8" (6 cm)	3-1/8" (8 cm)	3-15/16" (10 cm)
790/ MI	Finish polished	78760	78761	78762	78763	78764
	\$/pc					
790/ MIS	Finish satin	78780	78781	78782	78783	78784
	\$/pc					

No partial packaging

## OUTSIDE CORNER IN METAL

4-piece package

Item	Finish	H				
		1-9/16" (4 cm)	2" (5 cm)	2-3/8" (6 cm)	3-1/8" (8 cm)	3-15/16" (10 cm)
790/ ME	Finish polished	78765	78766	78767	78768	78769
	\$/pc					
790/ MES	Finish satin	78785	78786	78787	78788	78789
	\$/pc					

No partial packaging

## JUNCTION IN METAL

4-piece package

Item	Finish	H				
		1-9/16" (4 cm)	2" (5 cm)	2-3/8" (6 cm)	3-1/8" (8 cm)	3-15/16" (10 cm)
790/ MG	Finish polished	78770	78771	78772	78773	78774
	\$/pc					
790/ MGS	Finish satin	78790	78791	78792	78793	78794
	\$/pc					

No partial packaging

## RIGHT/LEFT END CAPS IN METAL

4-couples package

Item	Finish	H				
		1-9/16" (4 cm)	2" (5 cm)	2-3/8" (6 cm)	3-1/8" (8 cm)	3-15/16" (10 cm)
790/ MP	Finish polished	78775	78776	78777	78778	78779
	\$/couple					
790/ MPS	Finish satin	78795	78796	78797	78798	78799
	\$/couple					

No partial packaging



790/MI  
790/MIS



790/ME  
790/MES



790/MG  
790/MGS



790/MP  
790/MPS

To place orders correctly, find the desired model, size and finish. Then place your order by using the letters "PPS" followed by the corresponding 5-digit code.

Metal Line 92 and 93 are two aluminum baseboards characterized by a simple design and a slightly rounded shape, creating a perfect junction between floors and walls. These two elements are easy to install thanks to the interlocking system with supports, in natural aluminum or PVC, to be affixed to the wall with screws and dowels.

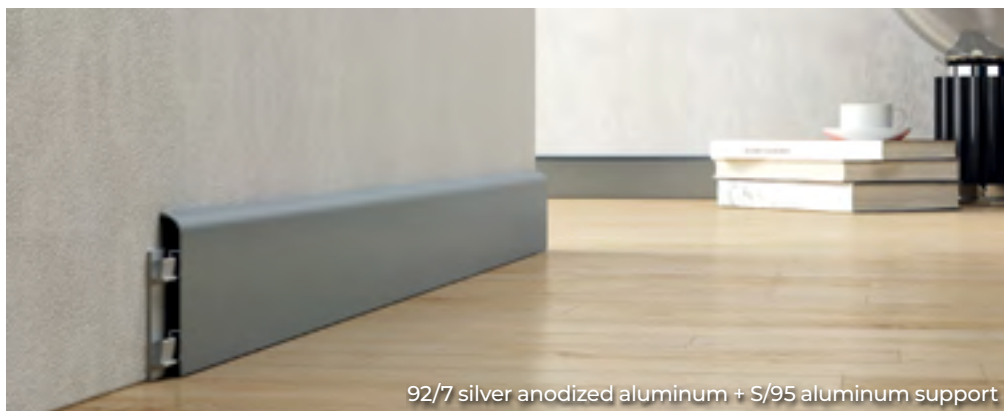

92/7 silver anodized aluminum + S/95 aluminum support

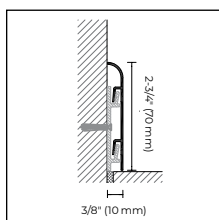

92/7

#### METAL LINE 92

Length = 6'6-15/32" or 200 cm / 20-piece package		H
Item	Finish	2-3/4" (7 cm)
<b>ALUMINUM</b>		
92/7	Silver anodized	78490
	<b>\$/pc</b>	
Individually packaged		
<b>ALUMINUM SUPPORT</b>		
100-piece package		
S/95		78295
	<b>\$/pc</b>	

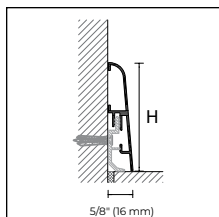

93/

#### METAL LINE 93

Length = 200 cm + 5 supports – 25-piece package		H	
Item	Finish	2-3/4" (7 cm)	3-9/16" (9 cm)
<b>ALUMINUM</b>			
93/	Silver anodized	78495	78496
	<b>\$/pc</b>		
Individually packaged			
<b>FIXING CLIPS</b>			
100-piece package			
8608/C		29751	
	<b>\$/pack</b>		



93/7 silver anodized aluminum + 8608/C fixing clips

Ancient gray, RAL 9003, RAL 7038, RAL 8019, RAL 9006, RAL 9007 color-coated aluminum skirting boards are available on request, with a minimum order of 150 pcs.

For other colors, please contact our sales department.



# Metal Line

Metal Line 89 is an aluminum baseboard characterized by minimalist lines. Available in different finishes and heights, it outlines the space with simplicity and elegance. Affixed on the wall with a specialized adhesive, it perfectly hides the perimeter expansion gap of a floating floor, as well as having a decorative role. Metal Line 89 is also available in white and black Trend Color Stone, two matte colors that perfectly combine with the most modern flooring.

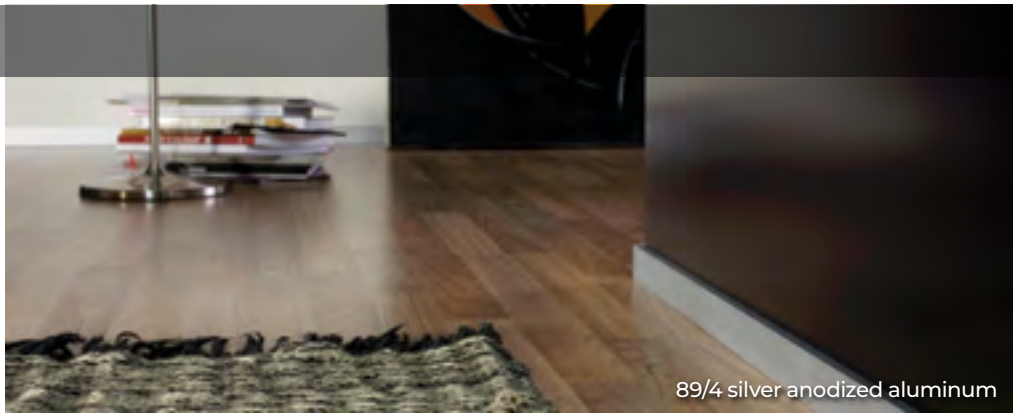

89/4 silver anodized aluminum

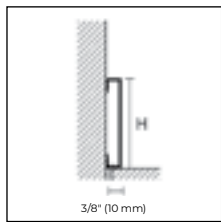

89/  
89/ TM  
89H/



89/ EI

TREND  
COLOR

## METAL LINE 89

Length = 6'6-15/32" or 200 cm /  
25-piece package

		H		
Item	Finish	1-9/16" (4 cm)	2-3/8" (6 cm)	3-1/8" (8 cm)
<b>ALUMINUM</b>				
	Silver anodized	78378	78478	78487
	<b>\$/pc</b>			
	Titanium anodized	78521	78522	-
	<b>\$/pc</b>			
89/	Color-coated matte white RAL 9010	78517	78518	-
	<b>\$/pc</b>			
	Color-coated ancient gray	78515	78485	-
	Color-coated rust	78516	-	-
	<b>\$/pc</b>			
89/ TM	Bright satin titanium	78388	78480	-
	<b>\$/pc</b>			
<b>TREND COLOR STONE</b>				
89/	Color-coated white stone	78481	-	-
	Color-coated black stone	78482	-	-
	<b>\$/pc</b>			
<b>COLOR-COATED ALUMINUM ANTIBACTERIAL</b>				
89H/	Color-coated white RAL 9003 antibacterial	-	78531	-
	<b>\$/pc</b>			

Individually packaged

Ancient gray, RAL 9003, RAL 7038, RAL 8019, RAL 9006, RAL 9007 color-coated aluminum skirting boards are available on request, with a minimum order of 150 pcs. For other colors, please contact our sales department.

## INSIDE/OUTSIDE CORNER - RIGHT/LEFT END CAP

4-piece package

		H		
Item	Finish	1-9/16" (4 cm)	2-3/8" (6 cm)	3-1/8" (8 cm)
<b>ALUMINUM</b>				
	Silver anodized	78505	78506	78527
	<b>\$/pc</b>			
	Titanium anodized	78523	78524	-
	<b>\$/pc</b>			
89/ EI	Color-coated matte white RAL 9010	78519	78520	-
	<b>\$/pc</b>			
	Color-coated ancient gray	78512	78513	-
	Color-coated rust	78514	-	-
	<b>\$/pc</b>			
89/ TMEI	Bright satin titanium	78509	78510	-
	<b>\$/pc</b>			
89/ EI	Color-coated white stone	78507	-	-
	Color-coated black stone	78508	-	-
	<b>\$/pc</b>			
89H/ EI	Color-coated white RAL 9003 antibacterial	-	78533	-
	<b>\$/pc</b>			

No partial packaging



Metal Line 89 bright satin titanium

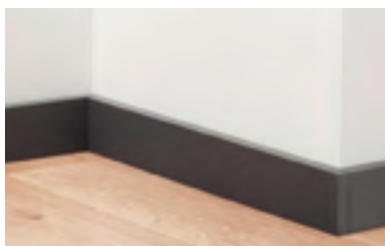

89/4 ancient gray color-coated aluminum  
+ 89/4EI

To place orders correctly, find the desired model, size and finish. Then place your order by using the letters "PPS" followed by the corresponding 5-digit code.

Metal Line 89 I Design is an anodized aluminum baseboard characterized by a special scratched finish and original colors that allow various chromatic combinations, created for interior designers and architects by following the latest trends in design.

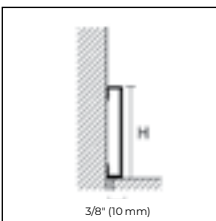
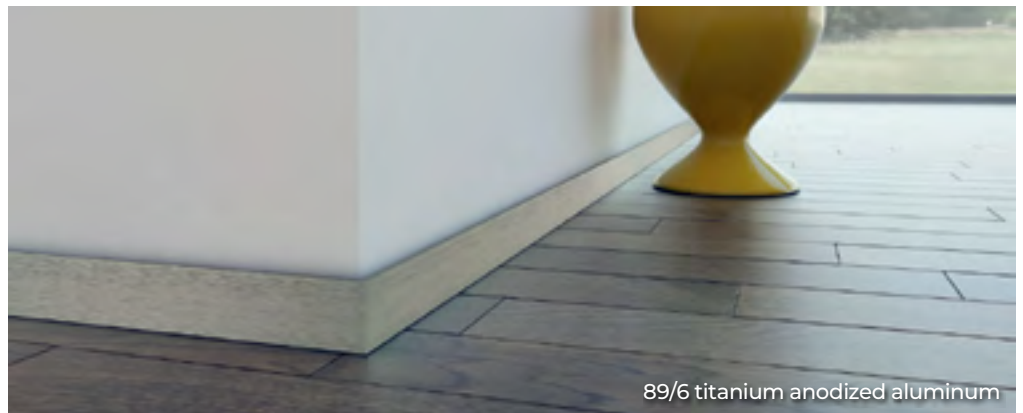

89/



89/ EI

**METAL LINE - I DESIGN**

Length = 6'6-15/32" or 200 cm /  
25-piece package

		H	
Item	Finish	1-9/16" (4 cm)	2-3/8" (6 cm)
<b>ANODIZED ALUMINUM</b>			
89/	Platinum	31400	31402
	Titanium	31410	31412
	Brown	31420	31422
	Dark brown	31430	31432
	Carbon	31440	31442
		<b>\$/pc</b>	

Individually packaged

**INSIDE/OUTSIDE CORNER - RIGHT/LEFT END CAP**

2-piece package

		H	
Item	Finish	1-9/16" (4 cm)	2-3/8" (6 cm)
<b>ANODIZED ALUMINUM</b>			
89/ EI	Platinum	31450	31452
	Titanium	31460	31462
	Brown	31470	31472
	Dark brown	31480	31482
	Carbon	31490	31492
		<b>\$/pc</b>	

No partial packaging

To place orders correctly, find the desired model, size and finish. Then place your order by using the letters "PPS" followed by the corresponding 5-digit code.

## Metal Line

Metal Line 89/613 is an aluminum baseboard and characterized by minimalist lines. With a thickness of 1/2" (13 mm), it perfectly hides the perimeter expansion gap of a floating floor.

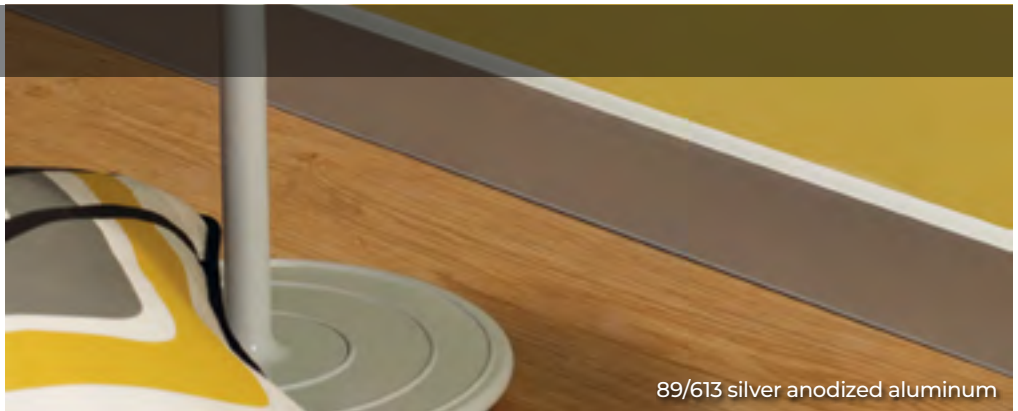

89/613 silver anodized aluminum

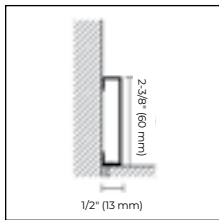

89/613



89/613 EI

### METAL LINE 89/613

Length = 6'-15/32" or 200 cm / 25-piece package

Item	Finish	H
<b>ALUMINUM</b>		
	Silver anodized	78486
	<b>\$/pc</b>	
<b>89/613</b>	Color-coated matte white RAL 9010	78488
	<b>\$/pc</b>	

Individually packaged

### INSIDE/OUTSIDE CORNER – RIGHT/LEFT END CAP

4-piece package

Item	Finish	H
<b>ALUMINUM</b>		
	Silver anodized	78525
	<b>\$/pc</b>	
<b>89/613 EI</b>	Color-coated matte white RAL 9010	78526
	<b>\$/pc</b>	

No partial packaging

Metal Line 105 is an aluminum baseboard characterized by minimalist lines. This model stands out for a simple and quick interlocking installation system with a coextruded PVC base, to be affixed to the wall with screws and dowels.

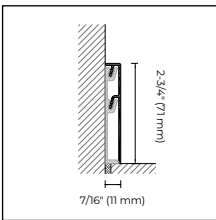

105/7  
105/CB

### METAL LINE

10-piece package			H
Item	Finish	Length	2-3/4" (7 cm)
<b>ALUMINUM</b>			
105/7	Silver anodized	6' 6-15/32" (200 cm)	78900
	Silver anodized	13' 1-7/16" (400 cm)	78910
<b>\$/pc</b>			

Individually packaged

### FIXING BASE

10-piece package			H
Item	Finish	Length	2-3/4" (7 cm)
<b>CO-EXTRUDED PVC</b>			
105/CB	White	6' 6-15/32" (200 cm)	78920
<b>\$/pc</b>			

No partial packaging

### INSIDE CORNER

4-piece package			H
Item	Finish	Length	2-3/4" (7 cm)
<b>METAL</b>			
105/7I	Silver		78932
<b>\$/pc</b>			

No partial packaging

### OUTSIDE CORNER

4-piece package			H
Item	Finish	Length	2-3/4" (7 cm)
<b>METAL</b>			
105/7E	Silver		78934
<b>\$/pc</b>			

No partial packaging

### JUNCTION

4-piece package			H
Item	Finish	Length	2-3/4" (7 cm)
<b>METAL</b>			
105/7G	Silver		78936
<b>\$/pc</b>			

No partial packaging

### RIGHT/LEFT END CAP

4-couples package			H
Item	Finish	Length	2-3/4" (7 cm)
<b>METAL</b>			
105/7P	Silver		78938
<b>\$/pc</b>			

No partial packaging





## Metal Line

Metal Line 87/6 and 88/6 are two flush, recessed baseboards for plaster, plasterboards and other types of wallboards. Both are composed of two separate elements: A base in natural aluminum and an insert in silver anodized or matte white color-coated aluminum. Once installed, the baseboard integrates perfectly into the wall surface, outlining the perimeter of the space without limiting it. There are two phases of installation: The base element must be installed before finishing the walls, while the chosen insert must be placed after the flooring installation.



87/6 and 88/6 natural aluminum + 88/16L/A aluminum insert for LED light

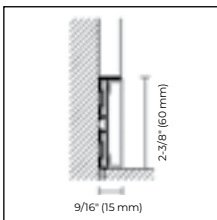

87/6 + 88/16SF aluminum insert

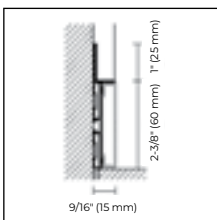

88/6 + 88/16SF aluminum insert

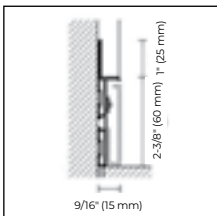

88/6 + 88/16L/A aluminum insert for LED light



88/6E

### METAL LINE 87 - 88

Length = 6'6-15/32" or 200 cm /  
20-piece package

		H
Item	Finish	2-3/8" (6 cm)
<b>ALUMINUM</b>		
87/6	Natural aluminum (drilled)	78338
	<b>\$/pc</b>	
88/6	Natural aluminum (drilled)	78310
	<b>\$/pc</b>	

Individually packaged

### ALUMINUM INSERT

Length = 6'6-15/32" or 200 cm /  
20-piece package

		H
Item	Finish	2-3/8" (6 cm)
88/16SF	Silver anodized	78563
	Matte white RAL 9010 color-coated	78558
	<b>\$/pc</b>	

Individually packaged

### METAL OUTSIDE CORNER

4-piece package

		H
Item	Finish	2-3/8" (6 cm)
88/6E	Silver	78561
	Matte white RAL 9010 color-coated	78562
	<b>\$/pc</b>	

No partial packaging



88/6 natural aluminum + 88/16SF matte white aluminum insert

For the best aesthetic result and the validity of the warranty, we suggest the exclusive use of our electrical components. Page 179-181

Prolight Metal Line SKL/2 is a skirting board in aluminum with indirect LED light. Its special section allows to create an original play of light along the wall, thus adding value to the whole surface. In addition to the silver anodized and the white stone versions, SKL/2 is available in a wide range of colors including five original cement effects, two special metal tonalities and a white characterized by an extremely solid and full color.

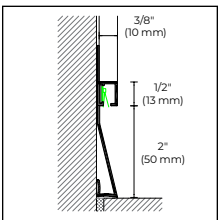

TREND  
COLOR

SKL/2



SKL/2 concrete white color-coated aluminum

### PROLIGHT METAL LINE S

Length = 8'10" or 270 cm /  
10-piece package

		H		
		3/8" (10 cm)		
Item	Finish			
<b>ALUMINUM</b>				
SKL/2	Silver anodized			78579
				\$/pc
<b>COLOR-COATED ALUMINUM</b>				
SKL/2	White stone			78591
	Concrete white			78592
	Concrete graphite			78593
	Concrete smoke			78594
	Concrete mud			78595
	Concrete sand			78596
	Metal dark			78597
	Metal light			78598
	Solid white			78599

Individually packaged

### ELECTRICAL COMPONENTS AND ACCESSORIES FOR LIGHTING

Item	Description	
L5/NW/65 L	Spool 16 ft. (5 m) LED strips, lateral light, neutral color 4000 °K, 2.92W/ft IP65	84136
		\$/pc

For other electrical components. Page 180

Metal Line AF M Design is an aluminum baseboard with modern and minimalist lines. The particular recessed design creates an elegant shadow that highlights the two surfaces distinctly.

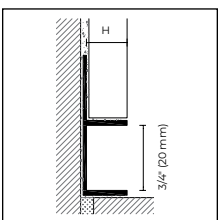

AF/1/



AF/1/ silver anodized aluminum

### METAL LINE AF – M DESIGN

Length = 270 cm – 10-piece package

		H		
		2-3/8" (6 cm)	3/8" (10 cm)	1/2" (12.5 mm)
Item	Finish			
<b>ALUMINUM</b>				
AF/1/	Silver anodized		13198	13199
				13200
				\$/pc
AF/1/	Titanium anodized		13201	13203
	Color-coated polished white RAL 9010		13196	13197
				13204
				\$/pc

Individually packaged

## Metal Line

Metal Line 100 is an anodized aluminum baseboard available in two heights and suitable for direct application onto plasterboard walls. The profile is easy to apply through the use of specialized adhesives.

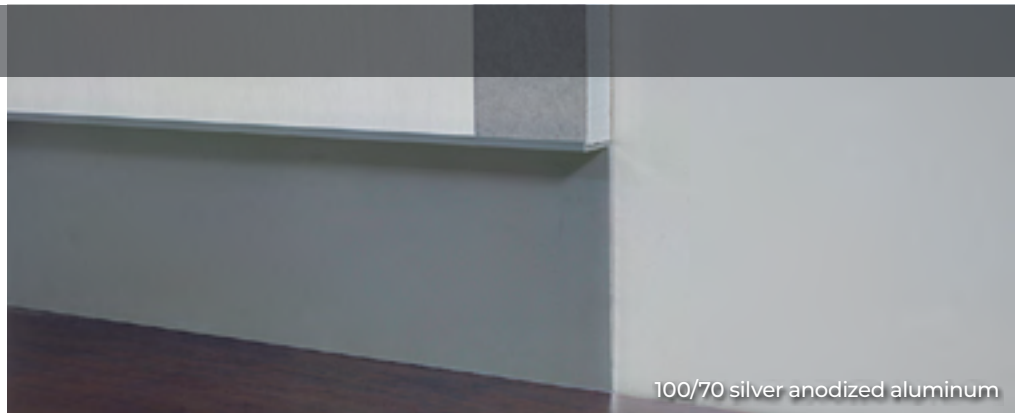

100/70 silver anodized aluminum

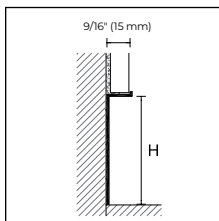

100/

### METAL LINE 100

Length = 6' 6-15/32" or 200 cm –  
20-piece package

		H	
Item	Finish	1-9/16" (40 mm)	2-3/4" (70 mm)
<b>ALUMINUM</b>			
100/	Silver anodized	78277	78279
		<b>\$/pc</b>	

Individually packaged

Metal Line 101, ideal for plaster and made from anodized aluminum, is suitable for application directly on the unfinished wall. This baseboard is applied using a specialized adhesive before the wall is plastered.



101/74 silver anodized aluminum

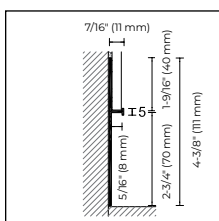

101/74

### METAL LINE 101

Length = 6' 6-15/32" or 200 cm –  
20-piece package

		H
Item	Finish	2-3/4" (70 mm)
<b>ALUMINUM</b>		
101/74	Silver anodized	78281
		<b>\$/pc</b>

Individually packaged

Ancient gray, RAL 9003, RAL 7038, RAL 8019, RAL 9006, RAL 9007 color-coated aluminum skirting boards are available on request, with a minimum order of 150 pcs.

For other colors, please contact our sales department.

Metal Line 95 is an aluminum baseboard, available in two heights, that can hide service cables (for phones, computers, TVs, etc.). Its simple and quick interlocking installation system with natural aluminum supports, once affixed to walls with screws and dowels, allows easy access to the cables for their maintenance.

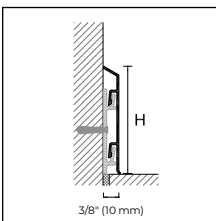
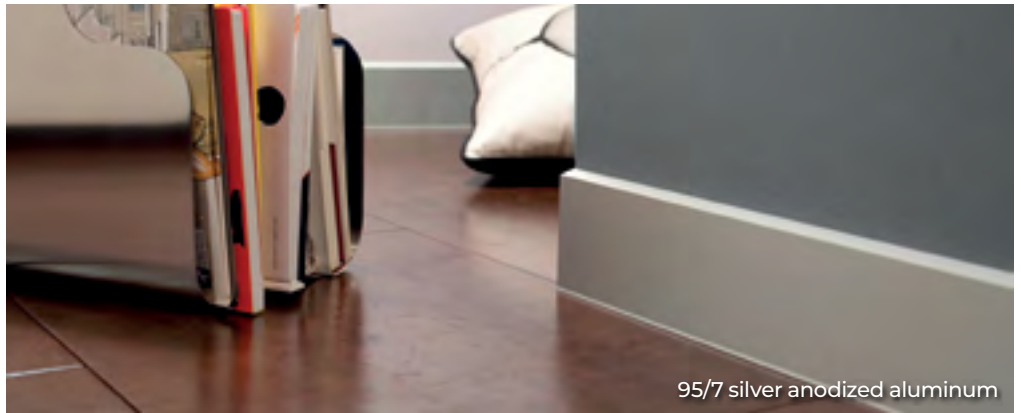

95/

### METAL LINE 95

25-piece package		Length	H	
Item	Finish		2-3/4" (7 cm)	3-15/16" (10 cm)
<b>ALUMINUM</b>				
95/ SF	Silver anodized	6' 6-15/32" (200 cm) + 3 supports	78160	78175
		13' 1-7/16" (400 cm) + 6 supports	78161	78176
		<b>\$/pc</b>		

Individually packaged – Length 13' 1-7/16" or 400 cm - 10-piece package

### ALUMINUM SUPPORT

100-piece package			
S/95			78295
		<b>\$/pc</b>	

No partial packaging

### INSIDE CORNER IN POLYPROPYLENE

4-piece package			H
Item	Finish	2-3/4" (7 cm)	3-15/16" (10 cm)
95/ I	Silver anodized	78201	78206
		<b>\$/pc</b>	

No partial packaging

### OUTSIDE CORNER IN POLYPROPYLENE

4-piece package			H
Item	Finish	2-3/4" (7 cm)	3-15/16" (10 cm)
95/ E	Silver anodized	78200	78205
		<b>\$/pc</b>	

No partial packaging

### JUNCTION IN POLYPROPYLENE

4-piece package			H
Item	Finish	2-3/4" (7 cm)	3-15/16" (10 cm)
95/ G	Silver anodized	78202	78207
		<b>\$/pc</b>	

No partial packaging

### RIGHT/LEFT END CAPS IN POLYPROPYLENE

4-couples package			H
Item	Finish	2-3/4" (7 cm)	3-15/16" (10 cm)
95/ P	Silver anodized	78203	78208
		<b>\$/pc</b>	

No partial packaging



95/7 silver anodized aluminum + S/95 aluminum support

Ancient gray, RAL 9003, RAL 7038, RAL 8019, RAL 9006, RAL 9007 color-coated aluminum skirting boards are available on request, with a minimum order of 150 pcs.

For other colors, please contact our sales department.

To place orders correctly, find the desired model, size and finish. Then place your order by using the letters "PPS" followed by the corresponding 5-digit code.



## Metal Line

Metal Line 98 is an aluminum baseboard featuring a rounded design and a thickness that allows the housing of service cables (for phones, computers, TVs, etc.). A simple and functional interlocking installation system with natural aluminum supports, once affixed to walls, allows easy access to the cables for their maintenance.

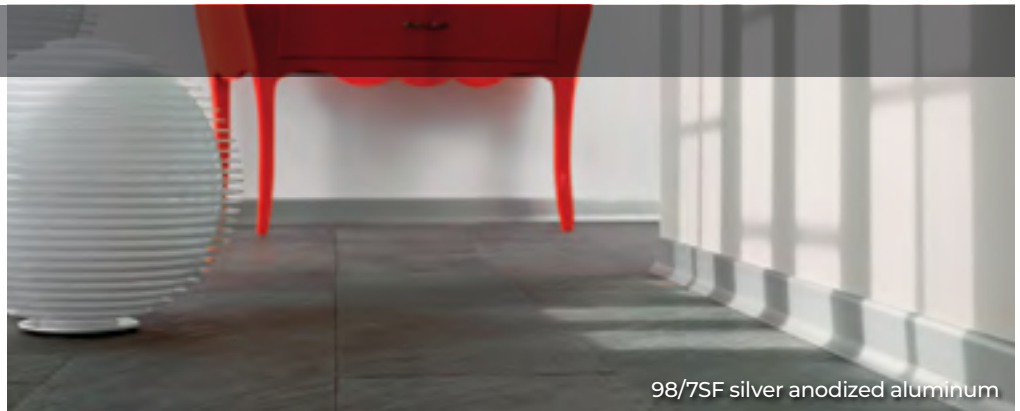

98/7SF silver anodized aluminum

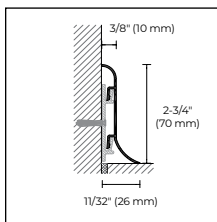

98/7SF

### METAL LINE 98

25-piece package

Item	Finish	Length	H
			<b>2-3/4" (7 cm)</b>
<b>ALUMINUM</b>			
98/7SF	Silver anodized	6' 6-15/32" (200 cm) + 3 supports	78040
		13' 1-7/16" (400 cm) + 6 supports	78041
<b>\$/pc</b>			

Individually packaged – Length 13' 1-7/16" (400 cm) 10-piece package

### ALUMINUM SUPPORT

100-piece package

S/95			78295
<b>\$/pc</b>			

No partial packaging

### INSIDE CORNER IN POLYPROPYLENE

4-piece package

Item	Finish	H	
			<b>2-3/4" (7 cm)</b>
98/7I	Silver anodized	78221	
<b>\$/pc</b>			

No partial packaging

### OUTSIDE CORNER IN POLYPROPYLENE

4-piece package

Item	Finish	H	
			<b>2-3/4" (7 cm)</b>
98/7E	Silver anodized	78220	
<b>\$/pc</b>			

No partial packaging

### JUNCTION IN POLYPROPYLENE

4-piece package

Item	Finish	H	
			<b>2-3/4" (7 cm)</b>
98/7G	Silver anodized	78222	
<b>\$/pc</b>			

No partial packaging

### RIGHT/LEFT END CAPS IN POLYPROPYLENE

4-couples package

Item	Finish	H	
			<b>2-3/4" (7 cm)</b>
98/7P	Silver anodized	78223	
<b>\$/pc</b>			

No partial packaging



98/7SF silver anodized aluminum + S/95 aluminum support

Ancient gray, RAL 9003, RAL 7038, RAL 8019, RAL 9006, RAL 9007 color-coated aluminum skirting boards are available on request, with a minimum order of 150 pieces.

For other colors, please contact our sales department.

Metal Line 97/4 is an aluminum baseboard that measures 1-9/16" (4 cm) high and can house service cables (for phones, computers, TVs, etc.). Thanks to its simple interlocking installation system with stainless-steel clips to be affixed to walls with screws and dowels, it combines ease and speed of installation with easy access to the cables for their maintenance.

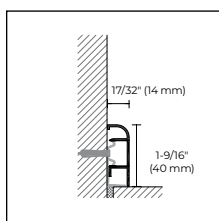
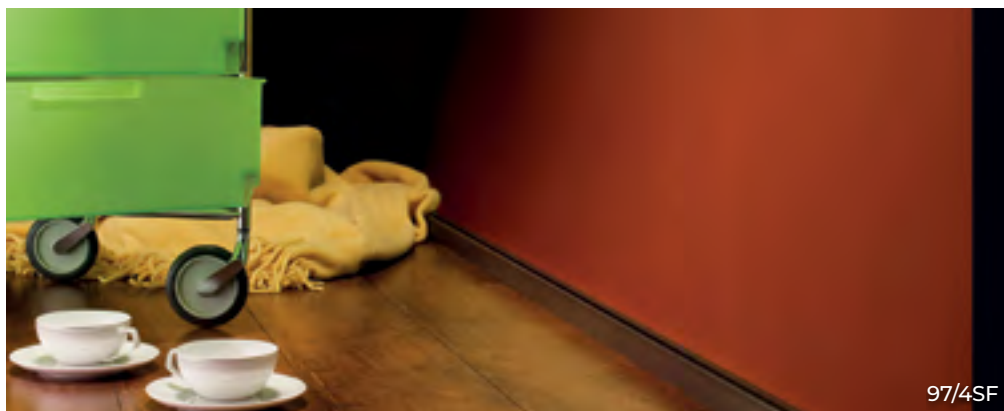

97/

### METAL LINE 97

Length = 6' 6-15/32" or 200 cm –  
25-piece package

Item	Finish		H
			1-9/16" (4 cm)
<b>ALUMINUM</b>			
97/4SF + 5 clips	Silver anodized		78000
		\$/pc	

Individually packaged

### FIXING CLIPS

10 blister packs / 20 pcs/blister

8602/C			29750
		\$/pc	

No partial packaging

### INSIDE CORNER IN POLYPROPYLENE

4-piece package

Item	Finish		H
			1-9/16" (4 cm)
97/4I	Silver anodized		78002
		\$/pc	

No partial packaging

### OUTSIDE CORNER IN POLYPROPYLENE

4-piece package

Item	Finish		H
			1-9/16" (4 cm)
97/4E	Silver anodized		78001
		\$/pc	

No partial packaging

### JUNCTION IN POLYPROPYLENE

4-piece package

Item	Finish		H
			1-9/16" (4 cm)
97/4G	Silver anodized		78003
		\$/pc	

No partial packaging

### RIGHT/LEFT END CAPS IN POLYPROPYLENE

4-couples package

Item	Finish		H
			1-9/16" (4 cm)
97/4P	Silver anodized		78004
		\$/pc	

No partial packaging



97/4SF silver anodized aluminum + 8602/C fixing clip

Ancient gray, RAL 9003, RAL 7038, RAL 8019, RAL 9006, RAL 9007 color-coated aluminum skirting boards are available on request, with a minimum order of 150 pieces.

For other colors, please contact our sales department.

## Metal Line

Metal Line 97/7 is an aluminum skirting board that measures 2-3/4" (7 cm) high with a simple and linear design. Easy and quick to install thanks to its interlocking installation system with natural aluminum supports to be affixed to walls with screws and dowels, it allows easy access to the cables for their maintenance.

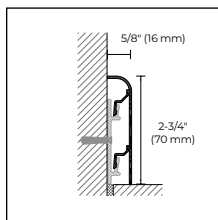
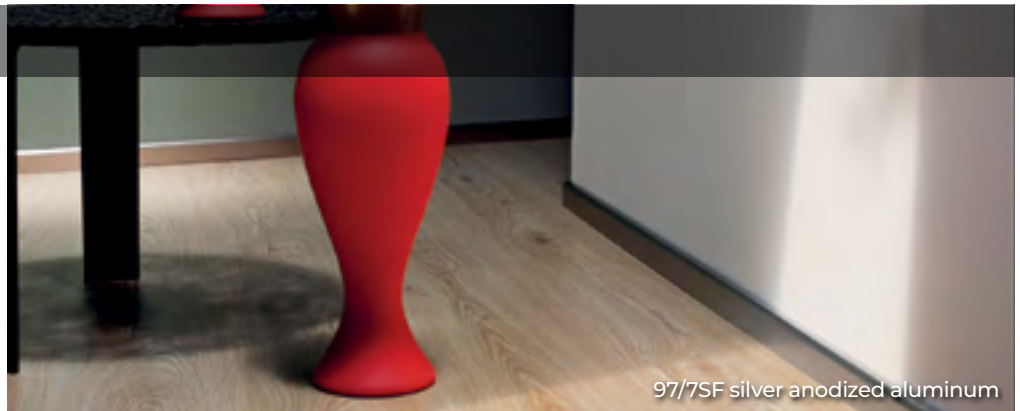

97/7SF

### METAL LINE 97

Length = 6' 6-15/32" or 200 cm -  
20-piece package

Item	Finish	H
		<b>2-3/4" (7 cm)</b>

#### ALUMINUM

<b>97/7SF + 3 supports</b>	Silver anodized		78005
			<b>\$/pc</b>

Individually packaged

### ALUMINUM SUPPORT

100-piece package

<b>S/95</b>			78295
			<b>\$/pc</b>

No partial packaging

### INSIDE CORNER IN POLYPROPYLENE

4-piece package

Item	Finish	H
		<b>2-3/4" (7 cm)</b>

<b>97/7I</b>	Silver anodized		78157
			<b>\$/pc</b>

No partial packaging

### OUTSIDE CORNER IN POLYPROPYLENE

4-piece package

Item	Finish	H
		<b>2-3/4" (7 cm)</b>

<b>97/7E</b>	Silver anodized		78156
			<b>\$/pc</b>

No partial packaging

### JUNCTION IN POLYPROPYLENE

4-piece package

Item	Finish	H
		<b>2-3/4" (7 cm)</b>

<b>97/7G</b>	Silver anodized		78158
			<b>\$/pc</b>

No partial packaging

### RIGHT/LEFT END CAPS IN POLYPROPYLENE

4-couples package

Item	Finish	H
		<b>2-3/4" (7 cm)</b>

<b>97/7P</b>	Silver anodized		78159
			<b>\$/pc</b>

No partial packaging



97/7SF silver anodized aluminum + S/95 aluminum support

Ancient gray, RAL 9003, RAL 7038, RAL 8019, RAL 9006, RAL 9007 color-coated aluminum skirting boards are available on request, with a minimum order of 150 pcs.

For other colors, please contact our sales department.

Metal Line 97/8 is an aluminum baseboard that measures 3-1/8" (8 cm) high and is specially designed for housing service cables. Its specific PVC-cable trunking, once affixed to walls with screws and dowels, also acts as a support for the baseboard. It is particularly suitable for renovations, as it avoids making new tracks for the running of cables. It is also simple and quick to install, using natural aluminum supports that allow easy access to the cables for maintenance.

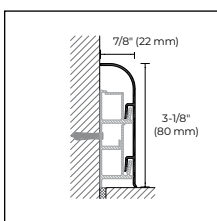

97/8SF



97/8SF silver anodized aluminum + 97/8CB white PVC trunking



97/8SF silver anodized aluminum

### METAL LINE 97

20-piece package

Item	Finish	Length	H 3-1/8" (8 cm)
<b>ALUMINUM</b>			
97/8SF	Silver anodized	6' 6-15/32" (200 cm) + 3 supports	78010
		13' 1-7/16" (400 cm) + 6 supports	78011
\$/pc			

Individually packaged - Length 13' 1-7/16" or 400 cm - 10-piece package

### WHITE PVC TRUNKING

Length = 6' 6-15/32" or 200 cm - 20-piece package

97/8CB			78290
\$/pc			

No partial packaging

### ALUMINUM SUPPORT

100-piece package

S/97			78299
\$/pc			

No partial packaging

### INSIDE CORNER IN POLYPROPYLENE

4-piece package

Item	Finish	H 3-1/8" (8 cm)
97/8I	Silver anodized	78211
\$/pc		

No partial packaging

### OUTSIDE CORNER IN POLYPROPYLENE

4-piece package

Item	Finish	H 3-1/8" (8 cm)
97/8E	Silver anodized	78210
\$/pc		

No partial packaging

### JUNCTION IN POLYPROPYLENE

4-piece package

Item	Finish	H 3-1/8" (8 cm)
97/8G	Silver anodized	78212
\$/pc		

No partial packaging

### RIGHT/LEFT END CAPS IN POLYPROPYLENE

4-couples package

Item	Finish	H 3-1/8" (8 cm)
97/8P	Silver anodized	78213
\$/pc		

No partial packaging

Ancient gray, RAL 9003, RAL 7038, RAL 8019, RAL 9006, RAL 9007 color-coated aluminum skirting boards are available on request, with a minimum order of 150 pcs.

For other colors, please contact our sales department.









## PVC Skirting Boards

Our range of PVC baseboards are designed to meet every technical and aesthetic need, suitable for both professional and DIY use. Some baseboards can be customized using the digital printing technology Profilpas Digital System.

# PVC Line

PVC Line 8605 and 8606 are two skirting boards in co-extruded PVC, characterized by a rounded shape and a height of 2-3/4" or 70 mm. Both are composed of a core in foam PVC and a visible surface in colored rigid PVC to guarantee the best aesthetic result and color uniformity. 8605 can also be covered with durable film and can be further customized thanks to the digital printing technology Profilpas Digital System. 8505 and 8606 can be fixed to the wall with adhesive (PP/96) or nails. Moreover, they do not absorb water and are resistant to impact, wear and tear, UV rays and the products normally used for cleaning floors and wall coverings.

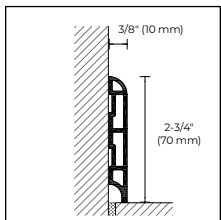

8605

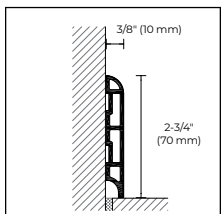

8605 covered with durable film

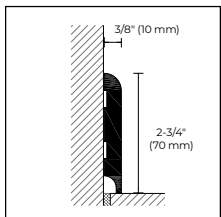

8606

## PVC LINE

Length = 8'2-1/2" or 250 cm / 20-piece package / H = 2-3/4" or 70 mm

Item	Decors Finish		
<b>CO-EXTRUDED PVC (FOAM PVC + RIGID PVC)</b>			

8605	White RAL 9003		29175
	White RAL 9010		29177
	Black RAL 9005		29176
	<b>\$/pc</b>		
	Silver		29178
	<b>\$/pc</b>		

<b>CO-EXTRUDED PVC (FOAM PVC + RIGID PVC) COVERED WITH DURABLE FILM</b>			
---	--	--	--

Item	Decors Finish		
8605	96 white RAL 9010 embossed		29030
	97 black RAL 9005 embossed		29031
	<b>\$/pc</b>		
	99 satin silver		29035
	100 satin steel		29036
	<b>\$/pc</b>		

<b>CO-EXTRUDED PVC (FOAM PVC + RIGID PVC)</b>			
---	--	--	--

8606	White RAL 9003		29227
	White RAL 9010		29229
	Black RAL 9004		29228
	<b>\$/pc</b>		
	Silver		29230
	<b>\$/pc</b>		

No partial packaging

## PVC LINE

Length = 8'2-1/2" or 250 cm / 20-piece package / H = 2-3/4" or 70 mm

<b>CO-EXTRUDED PVC (FOAM PVC + RIGID PVC) COVERED WITH DURABLE FILM</b>										
---	--	--	--	--	--	--	--	--	--	--

Item	Decors Finish		Decors Finish		Decors Finish		Decors Finish					
8605	02		29000	44		29013	1009		29103	1063		29121
	08		29001	47		29033	1012		29104	1066		29122
	10		29003	48		29015	1021		29107	1069		29123
	11		29004	65		29018	1024		29108	1081		29127
	12		29005	76		29020	1030		29110	1084		29128
	20		29006	77		29021	1033		29111	1087		29129
	25		29032	78		29022	1036		29112	1090		29130
	32		29007	80		29023	1042		29114	1105		29135
	34		29008	81		29024	1045		29115	1108		29136
	35		29009	92		29026	1051		29117	1111		29137
	36		29010	95		29029	1054		29118			
	40		29011	1003		29101	1057		29119			
	41		29012	1006		29102	1060		29120			
			<b>\$/pc</b>									

No partial packaging - 8605 can be covered with customized durable film on request, for an additional cost. Contact our Customer Service for details.

To place orders correctly, find the desired model, size and finish. Then place your order by using the letters "PPS" followed by the corresponding 5-digit code.

# PVC Line

PVC Line 8608 is a baseboard in PVC foam, characterized by a round shape and covered with durable film. Available in several finishes, it can be further customized thanks to the digital printing technology Profilpas Digital System. 8608 can be affixed to the wall with adhesive (PP/96 or similar), nails or special fixing clips. PVC does not absorb water; does not contain formaldehyde; and is resistant to shocks, wear, UV rays and the most common cleaning products for floors and wall coverings.



8608 foam PVC covered with durable film + 8608/C

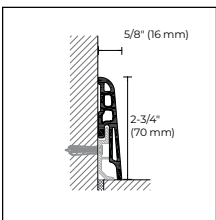

8608

## PVC LINE

Length = 8'-2-1/2" or 250 cm / 20-piece package / H = 2-3/4" (70 mm)

### FOAM PVC COVERED WITH DURABLE FILM

Item	Decors Finish		Decors Finish		Decors Finish		
	Color	Code	Color	Code	Color	Code	
8608	02	29040	32	29047	77	29061	
	05	29075	34	29048	78	29062	
	08	29041	35	29049	80	29063	
	10	29043	36	29050	81	29064	
	11	29044	39	29080	89	29081	
	12	29045	40	29051	91	29082	
	14	29076	41	29052	92	29066	
	19	29077	44	29053	95	29069	
	20	29046	47	29073	96 white embossed	29070	
	26	29078	65	29058	97 black embossed	29071	
	31	29079	76	29060			
	<b>\$/pc</b>						

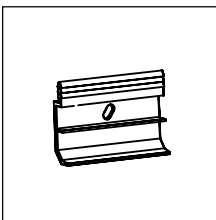

8608/C

## FIXING CLIPS FOR ITEM 8608

100-piece package

8608/C

89751

\$/pc

Use MAPEI polymer-based adhesive for baseboards.

Customized PDS decors on request for 8608 with a minimum order of 200 pieces.



08 foam PVC covered with durable film plus 99 satin silver

To place orders correctly, find the desired model, size and finish. Then place your order by using the letters "PPS" followed by the corresponding 5-digit code.



## PVC Line

PVC Line 8615 and 8616 are two baseboards in co-extruded PVC, characterized by a square shape and a height of 2-3/4" or 70 mm. Both are composed of a core in foam PVC and a visible surface in colored rigid PVC to guarantee the best aesthetic result and color uniformity. They can also be covered with durable film and can be further customized thanks to the digital printing technology Profilpas Digital System. 8615 and 8616 can be fixed to the wall with adhesive (PP/96) or nails. Moreover, they do not absorb water and are resistant to impact, wear and tear, UV rays and the products normally used for cleaning floors and wall coverings.



8615 silver co-extruded PVC

### PVC LINE

Length = 8'2-1/2" or 250 cm / 20-piece package / H = 2-3/4" or 70 mm

#### Item Decors Finish

#### CO-EXTRUDED PVC (FOAM PVC + RIGID PVC)

	White RAL 9003	<input type="checkbox"/>	29353
	White RAL 9010	<input type="checkbox"/>	29355
<b>8615</b>	Black RAL 9004	<input checked="" type="checkbox"/>	29354
	<b>\$/pc</b>		
	Silver	<input checked="" type="checkbox"/>	29356
	<b>\$/pc</b>		

No partial packaging

### PVC LINE

Length = 8'2-1/2" or 250 cm / 20-piece package / H = 2-3/4" or 70 mm

#### Item Decors Finish

#### CO-EXTRUDED PVC (FOAM PVC + RIGID PVC) COVERED WITH DURABLE FILM

	96 white RAL 9010 embossed	<input type="checkbox"/>	29357
<b>8615</b>	97 black RAL 9005 embossed	<input checked="" type="checkbox"/>	29358
	<b>\$/pc</b>		

No partial packaging. 8615 can be covered with customized durable film on request, for an additional cost. Contact our Customer Service for details.

### PVC LINE

Length = 8'2-1/2" or 250 cm / 20-piece package / H = 2-3/4" or 70 mm

#### Item Decors Finish

#### CO-EXTRUDED PVC (FOAM PVC + RIGID PVC)

	White RAL 9003	<input type="checkbox"/>	29495
	Black RAL 9004	<input checked="" type="checkbox"/>	29496
<b>8616</b>	<b>\$/pc</b>		
	Silver	<input checked="" type="checkbox"/>	29498
	<b>\$/pc</b>		

No partial packaging. 8616 can be covered with customized durable film on request, for an additional cost. Contact our Customer Service for details.

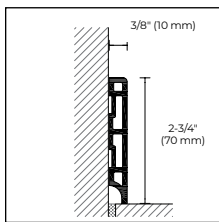

8615

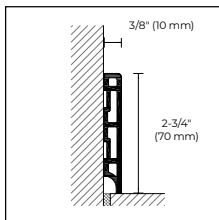

8615 decors with durable film

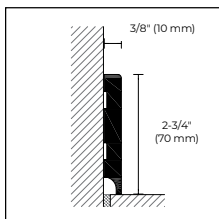

8616

Use MAPEI polymer-based adhesive for baseboards.

To place orders correctly, find the desired model, size and finish. Then place your order by using the letters "PPS" followed by the corresponding 5-digit code.



8616 black RAL 9004 co-extruded PVC

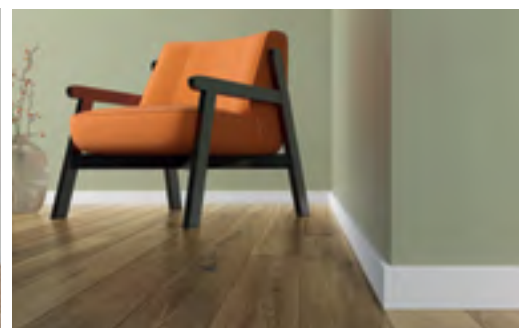

8615 white RAL 9003 co-extruded PVC

## PVC Line

PVC Line 8613 is a foam PVC baseboard covered with durable film, suitable for wooden floors. It can be affixed to the wall with adhesive (PP/96) or the fixing clip 8608/C.



8613 foam PVC covered with durable film - decor 96

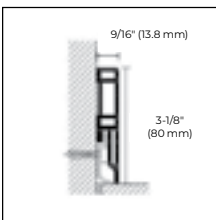

8613

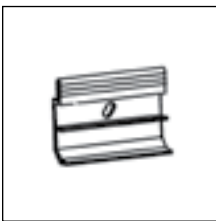

8608/C



8613 covered with durable film - decor 100 satin steel

### PVC LINE

Length = 8'2-1/2" or 250 cm / 20-piece package/ H = 3-1/8" or 80 mm

#### FOAM PVC COVERED WITH DURABLE FILM

Item	Decors Finish	Decors Finish	Decors Finish
05		30060	580
08		30061	1202
12		30062	1203
13		30063	1204
14		30064	1205
19		30065	1206
26		30066	1207
31		30094	1208
32		30067	1209
36		30068	1210
39		30069	1211
40		30070	1212
41		30071	1213
77		30072	1214
89		30073	1215
91		30074	1216
93		30075	1217
96 white RAL 9010 embossed		29971	
<b>\$/pc</b>			
99 satin silver		29974	
100 satin steel		29977	
<b>\$/pc</b>			

8613

No partial packaging

### FIXING CLIPS FOR ITEM 8608

100-piece package

8608/C

89751

**\$/pc**

No partial packaging

Customized PDS decors on request for 8613 with a minimum order of 200 pieces.

To place orders correctly, find the desired model, size and finish. Then place your order by using the letters "PPS" followed by the corresponding 5-digit code.

## PVC Line

PVC Line 8612 is a foam PVC baseboard covered with durable film, suitable for both ceramic and LVT floors. It can be affixed to the wall with adhesive (PP/96).



8612/10 foam PVC covered with durable film - decor 96

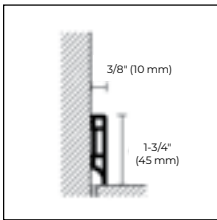

8612/10

### PVC LINE

Length = 8'2-1/2" or 250 cm / 20-piece package / H = 1-3/4" or 45 mm

Item	Decors Finish		
<b>FOAM PVC COVERED WITH DURABLE FILM</b>			
<b>8612/10</b>	96 white RAL 9010 embossed		29970
	<b>\$/pc</b>		
	99 satin silver		29968
	100 satin steel		29967
	<b>\$/pc</b>		

No partial packaging

PVC Line 8614 is a foam PVC baseboard covered with white durable film, suitable for refurbishing/covering over old baseboards that are still affixed to walls. It can be affixed to the old baseboard with adhesive (PP/96).



8614 foam PVC covered with durable film - decor 96

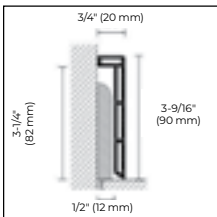

8614

### PVC LINE

Length = 8'2-1/2" or 250 cm / 20-piece package / H = 3-9/16" or 90 mm

Item	Decors Finish		
<b>FOAM PVC COVERED WITH DURABLE FILM</b>			
<b>8614</b>	96 white RAL 9010 embossed		29972
	<b>\$/pc</b>		

No partial packaging

8612 and 8614 can be covered with customized durable film on request, with a minimum order of 200 pieces.

To place orders correctly, find the desired model, size and finish. Then place your order by using the letters "PPS" followed by the corresponding 5-digit code.

## PVC Line

PVC Line 8600 is a foam PVC baseboard, particularly suitable for DIY installations thanks to its quick and easy application. It is available in different colors and can be affixed with adhesive (PP/96).



8600 foam PVC decor 532

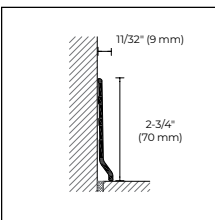

8600

To place orders correctly, find the desired model, size and finish. Then place your order by using the letters "PPS" followed by the corresponding 5-digit code.

### PVC LINE

Length = 6'-15/32" or 200 cm / 20-piece package and 100-piece / H = 2-3/4" (70 mm)

#### FOAM PVC

Item	Decors Finish	Decors Finish	Decors Finish	Decors Finish				
8600	518	29762	536	29782	561 yellow	29802	559 silver	29800
	520	29764	540	29784	562 green	29804		
	524	29766	542	29786	563 light blue	29801		
	525	29768	544	29788	564 red	29803		
	528	29770	545	29790				
	530	29772	555 white	29792				
	531	29774	556 light gray	29794				
	532	29776	557 black	29796				
	533	29778	558 anthracite	29798				
	534	29780						

\$/pc

\$/20-piece package

\$/100-piece package

No partial packaging - external corner profiles available in the same decors.

PVC Line 8181 is a baseboard in plastic-coated PVC that measures 2-3/4" or 70 mm in height, characterized by a special shape that makes it suitable for installation on curved walls. 8181 is particularly suitable for DIY installation, thanks to its quick and easy application. Available in different colors, it must be affixed to the wall with adhesive.



8181 white PVC

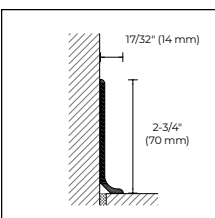

8181

Item 8181 should be stored horizontally.

### PVC LINE

Length = 8'-2-1/2" or 250 cm / 12-piece package / H = 2-3/4" or 70 mm

#### Item Decors Finish

#### PLASTIC-COATED PVC

8181	White	19216
	Gray	19217
	Black	19218

\$/pc

No partial packaging



## PVC Line

PVC Line 8596 and 8598 are two varieties of impact-resistant baseboards in foam PVC. The upper part that rests on the wall and the lower part that rests on the floor are composed of soft material. These baseboards allow for perfect adhesion even to surfaces that are not perfectly flat, for speed and simplicity of application. They are available in different colors and can be affixed with adhesive (PP/96).

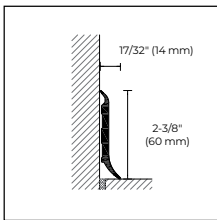

8596

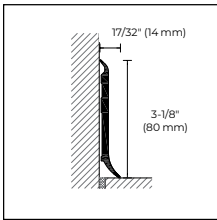

8598

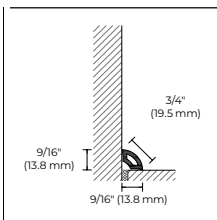

8580

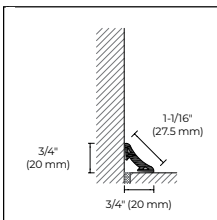

8582

### PVC LINE

Length = 8'2-1/2" or 250 cm / 40-piece package/ H = 2-3/8" or 60 mm

#### FOAM PVC

Item	Decors Finish		Decors Finish		Decors Finish	
8596	518	30800	531	30812	542	30824
	524	30804	532	30814	545	30828
	525	30806	533	30816	555 white	30830
	528	30808	536	30820	556 light gray	30832
	530	30810	540	30822	557 black	30834
<b>\$/pc</b>						

No partial packaging

### PVC LINE

Length = 8'2-1/2" or 250 cm / 40-piece package/ H = 3-1/8" or 80 mm

#### FOAM PVC

Item	Decors Finish	
8598	555 white	30880
	556 light gray	30882
	557 black	30884
<b>\$/pc</b>		

No partial packaging

### PVC LINE

Length = 8'2-1/2" or 250 cm / 80-piece package

#### FOAM PVC

Item	Decors Finish		Decors Finish	
8580	532	30764	555 white	30780
	542	30774	556 light gray	30782
	545	30778	557 black	30784
<b>\$/pc</b>				

No partial packaging

### PVC LINE

Length = 8'2-1/2" or 250 cm / 60-piece package

#### FOAM PVC

Item	Decors Finish		Decors Finish	
8582	532	30714	555 white	30730
	542	30724	556 light gray	30732
	545	30728	557 black	30734
<b>\$/pc</b>				

No partial packaging

To place orders correctly, find the desired model, size and finish. Then place your order by using the letters "PPS" followed by the corresponding 5-digit code.

## PVC Line

PVC Line 8602 is an impact-resistant baseboard in foam PVC measuring 1-7/8" or 48 mm high. It is particularly suitable for DIY installation, thanks to its speed and ease of application. Available in different colors, it is installed with a simple interlocking system featuring flexible stainless-steel clips. In addition to its decorative function, it can hide the expansion gap perimeter of floating wood and laminate floors.



8602 Foam PVC

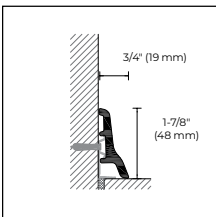

8602

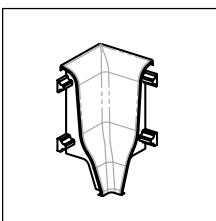

8602/I

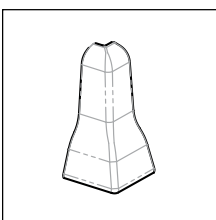

8602/E

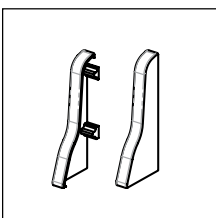

8602/P



8602/C fixing clips

### PVC LINE

Length = 8'2-1/2" or 250 cm / 40-piece package / H = 1-7/8" or 48 mm

#### FOAM PVC

Item	Decors Finish		
8602	555 white		29530
	556 light gray		29532
	557 black		29534
	<b>\$/pc</b>		

No partial packaging

### INSIDE CORNER

10-piece package / H = 1-7/8" or 48 mm

#### POLYPROPYLENE

Item	Decors Finish		
8602/I	555 white		29578
	556 light gray		29580
	557 black		29582
	<b>\$/pc</b>		

No partial packaging

### OUTSIDE CORNER

10-piece package / H = 1-7/8" or 48 mm

#### POLYPROPYLENE

Item	Decors Finish		
8602/E	555 white		29628
	556 light gray		29630
	557 black		29632
	<b>\$/pc</b>		

No partial packaging

### RIGHT/LEFT END CAPS

10-piece package / H = 1-7/8" or 48 mm

#### POLYPROPYLENE

Item	Decors Finish		
8602/P dx/sx	555 white		29728
	556 light gray		29730
	557 black		29732
	<b>\$/pc</b>		

No partial packaging

### FIXING CLIPS

10 blister packs / 20 pieces per blister

Item		
8602/C		29750
	<b>\$/pc</b>	

# PVC Line

PVC Line 8603 is an impact-resistant baseboard in foam PVC measuring 2-3/4" or 70 mm high. It is particularly suitable for DIY installation, thanks to its speed and easiness of application. Available in different colors, it can be installed with a simple interlocking system featuring flexible stainless-steel clips. In addition to its decorative function, it can hide the expansion gap perimeter of floating wood and laminate floors.



8603 Foam PVC decor 555

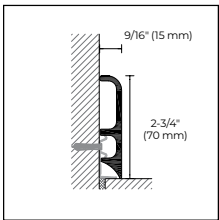

8603

## PVC LINE

Length = 8'2-1/2" or 250 cm / 40-piece package/ H = 2-3/4" or 70 mm

### FOAM PVC

Item	Decors Finish		
8603	532		30144
	542		30154
	545		30158
	555 white		30160
	556 light gray		30162
	557 black		30164
		<b>\$/pc</b>	

No partial packaging

## INSIDE CORNER

10-piece package/ H = 2-3/4" or 70 mm

### POLYPROPYLENE

Item	Decors Finish		
8603/I	532		30194
	542		30204
	545		30208
	555 white		30210
	556 light gray		30212
	557 black		30214
	<b>\$/pc</b>		

No partial packaging

## OUTSIDE CORNER

10-piece package/ H = 2-3/4" or 70 mm

### POLYPROPYLENE

Item	Decors Finish		
8603/E	532		30244
	542		30254
	545		30258
	555 white		30260
	556 light gray		30262
	557 black		30264
	<b>\$/pc</b>		

No partial packaging

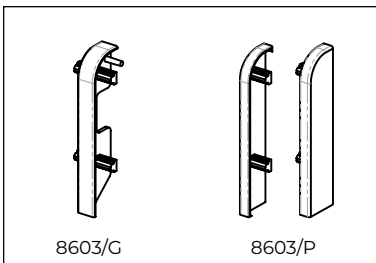
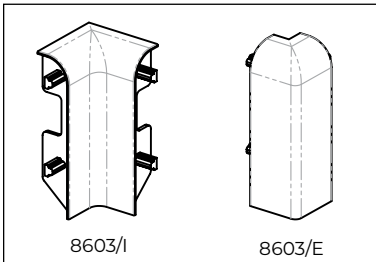

## JUNCTION

10-piece package/ H = 2-3/4" or 70 mm

### POLYPROPYLENE

Item	Decors Finish		
8603/G	532		30294
	542		30304
	545		30308
	555 white		30310
	556 light gray		30312
	557 black		30314
	<b>\$/pc</b>		

No partial packaging

## RIGHT/LEFT END CAPS

10-piece package/ H = 2-3/4" or 70 mm

### POLYPROPYLENE

Item	Decors Finish		
8603/P dx/sx	532		30344
	542		30354
	545		30358
	555 white		30360
	556 light gray		30362
	557 black		30364
	<b>\$/pc</b>		

No partial packaging



8602/C fixing clips

## FIXING CLIPS

10 blister packs / 20 pieces per blister

Item	
8602/C	29750
<b>\$/pc</b>	

# PVC Line

PVC Line 8607 is an impact-resistant baseboard in foam PVC measuring 2-3/4" or 70 mm high. It is particularly suitable for DIY installation, thanks to its speed and ease of application. Available in different colors, it can be installed with a simple interlocking system featuring flexible stainless-steel clips. In addition to its decorative use, it can hide the expansion gap perimeter of floating wood and laminate floors.

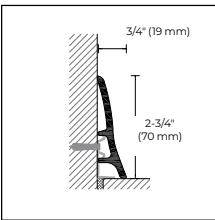

8607

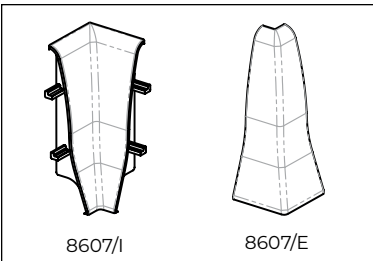

8607/I

8607/E

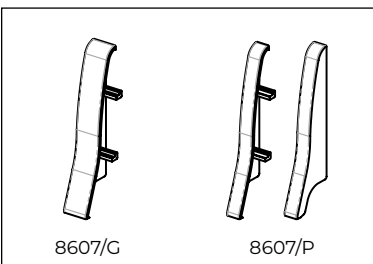

8607/G

8607/P



8602/C fixing clips

## PVC LINE

Length = 8'2-1/2" or 250 cm / 40-piece package/ H = 2-3/4" or 70 mm

### FOAM PVC

Item	Decors Finish		
8607	532		30414
	542		30424
	545		30428
	555 white		30430
	556 light gray		30432
	557 black		30434
		<b>\$/pc</b>	

No partial packaging

## INSIDE CORNER

10-piece package/ H = 2-3/4" or 70 mm

### POLYPROPYLENE

Item	Decors Finish		
8607/I	532		30464
	542		30474
	545		30478
	555 white		30480
	556 light gray		30482
	557 black		30484
		<b>\$/pc</b>	

No partial packaging

## JUNCTION

10-piece package/ H = 2-3/4" or 70 mm

### POLYPROPYLENE

Item	Decors Finish		
8607/G	532		30564
	542		30574
	545		30578
	555 white		30580
	556 light gray		30582
	557 black		30584
		<b>\$/pc</b>	

No partial packaging

## FIXING CLIPS

10 blister packs / 20 pieces per blister

Item	
8602/C	29750
<b>\$/pc</b>	

## OUTSIDE CORNER

10-piece package/ H = 2-3/4" or 70 mm

### POLYPROPYLENE

Item	Decors Finish		
8607/E	532		30514
	542		30524
	545		30528
	555 white		30530
	556 light gray		30532
	557 black		30534
		<b>\$/pc</b>	

No partial packaging

## RIGHT/LEFT END CAPS

10-PIECE PACKAGE/ H = 2-3/4" OR 70 MM

### POLYPROPYLENE

Item	Decors Finish		
8607/P dx/sx	532		30614
	542		30624
	545		30628
	555 white		30630
	556 light gray		30632
	557 black		30634
		<b>\$/pc</b>	

No partial packaging



## PVC Line

PVC Line 148 is a baseboard for carpet and PVC flooring that is composed of a base in rigid PVC and a clip in soft PVC. Used as internal corner connection profile, it creates a curvature on the corner once the flooring has been installed. It also allows finishing and covering the extremities of the carpet or the PVC flooring, thus hiding any cutting inaccuracies. This profile is recommended for public spaces such as hospitals and schools.



172 PVC white

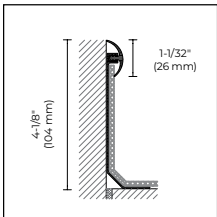

148/B +  
148/C

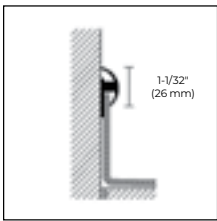

148/BR +  
148/C

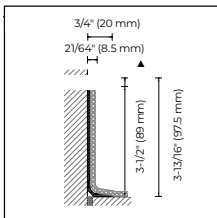

172

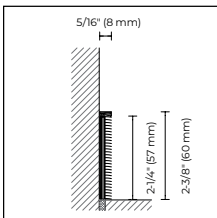

173

### PVC LINE - BASE

Length = 9'10" or 300 cm / 30-piece package

#### WHITE RIGID PVC

Item	Finish		
148/B	PVC white	<input type="checkbox"/>	19095
	<b>\$/pc</b>		
148/BR	PVC white	<input type="checkbox"/>	19094
	<b>\$/pc</b>		

No partial packaging

### PVC LINE - CLIP

Length = 9'12" or 305 cm / 30-piece package

#### PVC MORBIDO

Item	Finish		
148/C	PVC white	<input type="checkbox"/>	19096
	PVC ash gray	<input type="checkbox"/>	19097
	PVC sand	<input type="checkbox"/>	19098
	<b>\$/pc</b>		

No partial packaging

### PVC LINE

Length = 9'10" or 300 cm / 20-piece package

Item	Finish		H
172	PVC white	<input type="checkbox"/>	3-15/16" (100 mm)
	<b>\$/pc</b>		

No partial packaging

### PVC LINE

Length = 9'10" or 300 cm / 20-piece package

Item	Finish		H
173	Silver anodized drilled	<input type="checkbox"/>	2-3/8" (60 mm)
	<b>\$/pc</b>		

No partial packaging

148/C is available in different colors on request.

To place orders correctly, find the desired model, size and finish. Then place your order by using the letters "PPS" followed by the corresponding 5-digit code.

# PVC Line

PVC Line 170, 169 and 171 are cove-shaped connection profiles in plastic-coated PVC. They are recommended for easy installations on resilient flooring and carpet.



171 black PVC

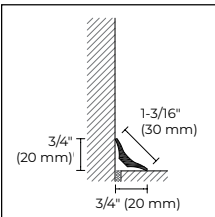

170

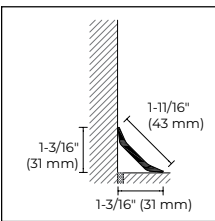

169

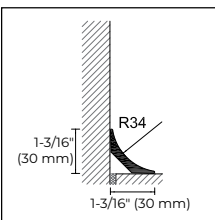

171

## PVC LINE - COVE-SHAPED

Length = 6'6-15/32" or 200 cm / 50-piece package

PVC

Item	Finish		
170	Black		19200
	<b>\$/pc</b>		

No partial packaging

## PVC LINE - COVE-SHAPED

Length = 6'6-15/32" or 200 cm / 50-piece package

PVC

Item	Finish		
169	Black		19195
	<b>\$/pc</b>		

No partial packaging

## PVC LINE - COVE-SHAPED

Length = 6'6-15/32" or 200 cm / 50-piece package

PVC

Item	Finish		
171	Black		19205
	<b>\$/pc</b>		

No partial packaging

All PVC line cove-shaped items should be stored horizontally.

To place orders correctly, find the desired model, size and finish. Then place your order by using the letters "PPS" followed by the corresponding 5-digit code.







## Profiles for Balconies and Terraces

Protec is a functional and stylish line of profiles for the protection of terraces and balconies.



# Cerfix™ Protec

Protec CPCV and CPCI are a series of edge profiles for protecting and finishing the outside edges of terraces and balconies. Available in color-coated aluminum and stainless steel, they have been designed with a protruding section and can be used with tile thicknesses up to 3/4" or 21 mm. They also guarantee the outflow of water from the floor, avoiding contact with the wall. In addition, Protec CPCV is available in the bendable version CPCVF, provided with a special cutout that allows the profile to be bent with a radius up to 3.28' or 1 m.

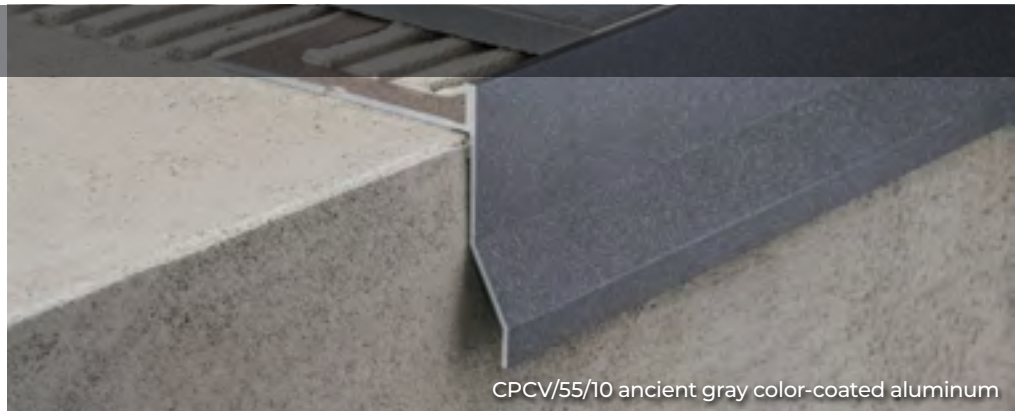

CPCV/55/10 ancient gray color-coated aluminum

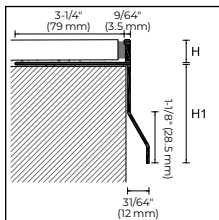

CPCV/

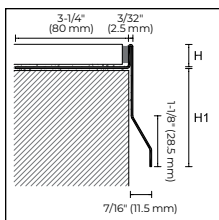

CPCI/

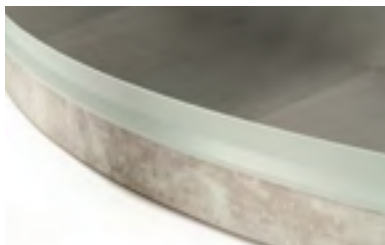

CPCVF/55/10 ash gray RAL 7038 embossed color-coated aluminum

## CERFIX PROTEC

Length = 8'10" or 270 cm – 10-piece package

Item	H								
	3/8" (10 mm)	1/2" (12.5 mm)	3/4" (21 mm)	3/8" (10 mm)	1/2" (12.5 mm)	3/4" (21 mm)	3/8" (10 mm)	1/2" (12.5 mm)	3/4" (21 mm)
<b>Finish</b>	CPCV/55/			CPCV/75/			CPCV/95/		
<b>COLOR-COATED ALUMINUM</b>									
White RAL 9003	87677	87678	-	87687	87688	-	87697	87698	-
Ash gray RAL 7038	87681	87682	87660	87691	87692	87661	87701	87702	87662
Ash gray RAL 7038 embossed	87713	87714	-	87715	87716	-	87717	87718	-
Dark brown RAL 8019	87683	87684	-	87693	87694	-	87703	87704	-
Rust	87616	87617	-	87618	87619	-	-	-	-
Metal gray RAL 9006	87720	87721	-	87723	87724	-	87726	87727	-
Aluminum gray RAL 9007	87750	87751	-	87753	87754	-	87756	87757	-
Ancient gray	87707	87708	-	87709	87710	-	87711	87712	-
<b>\$/pc</b>									

For colors on request please contact our sales department

## CERFIX PROTEC

Length = 8'10" or 270 cm – 10-piece package

Item	H					
	3/8" (10 mm)	1/2" (12.5 mm)	3/8" (10 mm)	1/2" (12.5 mm)	3/8" (10 mm)	1/2" (12.5 mm)
<b>Finish</b>	CPCI/55/		CPCI/75/		CPCI/95/	
<b>STAINLESS STEEL</b>						
Polished stainless steel AISI 304	87671	87672	87673	87674	87675	87676
<b>\$/pc</b>						

## CERFIX PROTEC FLEX PRO FLEX LINE

Length = 8'10" or 270 cm – 10-piece package

Item	Finish	H	
		3/8" (10 mm)	1/2" (12.5 mm)
<b>CPCVF/55/</b>			
<b>COLOR-COATED ALUMINUM</b>			
Ash gray RAL 7038		87790	-
Ash gray RAL 7038 embossed		87791	87793
Ancient gray		87792	87794
<b>\$/pc</b>			

No partial packaging  
For colors on request and other heights please contact our sales department

To place orders correctly, find the desired model, size and finish. Then place your order by using the letters "PPS" followed by the corresponding 5-digit code.

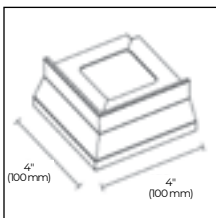

CPCV//E  
CPCI//E

### 90° OUTSIDE CORNER

5-piece package		H								
		3/8"	1/2"	3/4"	3/8"	1/2"	3/4"	3/8"	1/2"	3/4"
		(10 mm)	(12.5mm)	(21mm)	(10 mm)	(12.5mm)	(21 mm)	(10 mm)	(12.5mm)	(21 mm)
Item	Finish	CPCV/55/ /E			CPCV/75/ /E			CPCV/95/ /E		
<b>COLOR-COATED ALUMINUM</b>										
White RAL 9003		87817	87818	-	87827	87828	-	87837	87838	-
Ash gray RAL 7038		87821	87822	87663	87831	87832	87664	87841	87842	87665
Ash gray RAL 7038 embossed		87894	87895	-	87896	87897	-	87898	87899	-
Dark brown RAL 8019		87825	87826	-	87835	87836	-	87845	87846	-
Rust		87620	87621	-	87622	87623	-	-	-	-
Metal gray RAL 9006		87730	87731	-	87733	87734	-	87736	87737	-
Aluminum gray RAL 9007		87760	87761	-	87763	87764	-	87766	87767	-
Ancient gray		87877	87878	-	87879	87880	-	87881	87882	-
<b>\$/pc</b>										

### 90° OUTSIDE CORNER

5-piece package		H					
		3/8"	1/2"	3/8"	1/2"	3/8"	1/2"
		(10 mm)	(12.5mm)	(10 mm)	(12.5mm)	(10 mm)	(12.5mm)
Item	Finish	CPCI/55/ /E		CPCI/75/ /E		CPCI/95/ /E	
<b>STAINLESS STEEL</b>							
Polished stainless steel AISI 304		87801	87802	87803	87804	87805	87806
<b>\$/pc</b>							

### 90° INSIDE CORNER

5-piece package		H			
		3/8"	1/2"		
		(10mm)	(12.5mm)		
Item	Finish	CPCV/55/ /I			
<b>COLOR-COATED ALUMINUM</b>					
Ash gray RAL 7038		87890	87891		
Ash gray RAL 7038 embossed		87807	87808		
Ancient gray		87892	87893		
<b>\$/pc</b>					

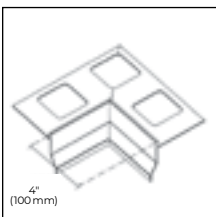

CPCV/55/ /I

### JUNCTION

Width = 2-3/4" or 70 mm – 5-piece package		H								
		3/8"	1/2"	3/4"	3/8"	1/2"	3/4"	3/8"	1/2"	3/4"
		(10 mm)	(12.5mm)	(21 mm)	(10 mm)	(12.5mm)	(21 mm)	(10 mm)	(12.5mm)	(21 mm)
Item	Finish	CPCV/55/ /G			CPCV/75/ /G			CPCV/95/ /G		
<b>COLOR-COATED ALUMINUM</b>										
White RAL 9003		87847	87848	-	87857	87858	-	87867	87868	--
Ash gray RAL 7038		87851	87852	87666	87861	87862	87667	87871	87872	87668
Ash gray RAL 7038 embossed		87748	87749	-	87758	87759	-	87768	87769	-
Dark brown RAL 8019		87853	87854	-	87863	87864	-	87873	87874	-
Rust		87624	87625	-	87626	87627	-	-	-	-
Metal gray RAL 9006		87740	87741	-	87743	87744	-	87746	87747	-
Aluminum gray RAL 9007		87770	87771	-	87773	87774	-	87776	87777	-
Ancient gray		87883	87884	-	87885	87886	-	87887	87888	-
<b>\$/pc</b>										

No partial packaging

### JUNCTION

Width = 2-3/4" or 70 mm – 5-piece package		H					
		3/8"	1/2"	3/8"	1/2"	3/8"	1/2"
		(10 mm)	(12.5 mm)	(10 mm)	(12.5 mm)	(10 mm)	(12.5 mm)
Item	Finish	CPCI/55/ /G		CPCI/75/ /G		CPCI/95/ /G	
<b>STAINLESS STEEL</b>							
Polished Stainless Steel AISI 304		87811	87812	87813	87814	87815	87816
<b>\$/pc</b>							

No partial packaging

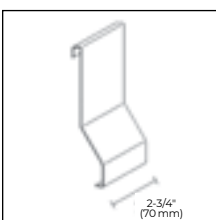

CPCV//G  
CPCI//G



CPCV/55/E + CPCV/55/G ancient gray color-coated aluminum

To place orders correctly, find the desired model, size and finish. Then place your order by using the letters "PPS" followed by the corresponding 5-digit code.

# Cerfix™ Protec

Protec CPCV/30/ is a perimeter profile available in 3/8" and 1/2" (10 and 12.5 mm) sizes and functions to protect walls from rain.



CPCV/30/ ancient gray color-coated aluminum

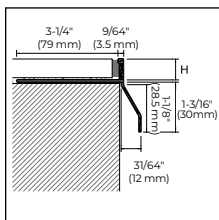

CPCV/30/

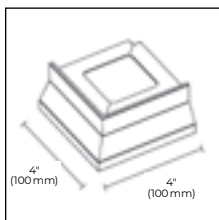

CPCV/30/ / E

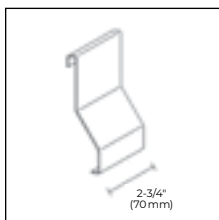

CPCV/30/ / G

## CERFIX PROTEC

Length = 8"10" or 270 cm – 10-piece package

	H	
	3/8" (10 mm)	1/2" (12.5 mm)
Item	CPCV/30/10	CPCV/30/12
<b>Finish</b>		
<b>COLOR-COATED ALUMINUM</b>		
Ash gray RAL 7038	87651	87652
Ash gray RAL 7038 embossed	87655	87656
Ancient gray	87653	87654
<b>\$/pc</b>		

## 90° OUTSIDE CORNER

5-piece package

	H		
	3/8" (10 mm)	1/2" (12.5 mm)	
Item	Finish	CPCV/30/10/E	CPCV/30/12/E
<b>COLOR-COATED ALUMINUM</b>			
Ash gray RAL 7038		87780	87781
Ash gray RAL 7038 embossed		87784	87785
Ancient gray		87782	87783
<b>\$/pc</b>			

## JUNCTION

Width = 2-3/4" or 70 mm – 5-piece package

	H		
	3/8" (10 mm)	1/2" (12.5 mm)	
Item	Finish	CPCV/30/10/G	CPCV/30/12/G
<b>COLOR-COATED ALUMINUM</b>			
Ash gray RAL 7038		87631	87632
Ash gray RAL 7038 embossed		87635	87636
Ancient gray		87633	87634
<b>\$/pc</b>			
No partial packaging			



CPCV/30/ / E ancient gray color-coated aluminum

To place orders correctly, find the desired model, size and finish. Then place your order by using the letters "PPS" followed by the corresponding 5-digit code.

Protec CPNV is a series of edge profiles for protecting and finishing the outside edges of terraces and balconies. Available in color-coated aluminum, these profiles are well suited for protecting the borders of steps or sidewalks, because they hide the junctions between treads and risers. In addition, Protec CPNV is available in the bendable version CPNVF, provided with a special cutout that allows the profile to be bent with a radius up to 15-3/4" or 40 cm.



CPNV/45/ ash gray RAL 7038 embossed color-coated aluminum

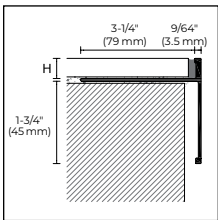

CPNV/45/

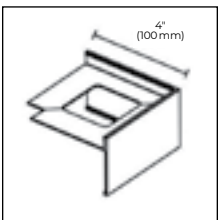

CPNV/45/ E

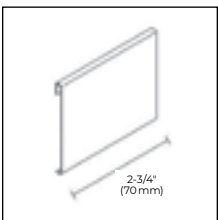

CPNV/45/ G



CPNVF/45/10 ancient gray color-coated aluminum

### CERFIX PROTEC

Length = 8"10" or 270 cm – 10-piece package

Item	Finish	H		
		3/8" (10 mm)	7/16" (11 mm)	1/2" (12.5 mm)
<b>COLOR-COATED ALUMINUM</b>				
CPNV/45/	Ash gray			
	RAL 7038 embossed	87270	87271	87272
	Ancient gray	87273	87274	87275
<b>\$/pc</b>				

For colors on request please contact our sales department.

### 90° OUTSIDE CORNER

5-piece package

Item	Finish	H		
		3/8" (10 mm)	7/16" (11 mm)	1/2" (12.5 mm)
<b>COLOR-COATED ALUMINUM</b>				
CPNV/45/ E	Ash gray			
	RAL 7038 embossed	87276	87277	87278
	Ancient gray	87279	87280	87281
<b>\$/pc</b>				

### JUNCTION

Width = 2-3/4" or 70 mm – 5-piece package

Item	Finish	H		
		3/8" (10 mm)	7/16" (11 mm)	1/2" (12.5 mm)
<b>COLOR-COATED ALUMINUM</b>				
CPNV/45/ G	Ash gray			
	RAL 7038 embossed	87282	87283	87284
	Ancient gray	87285	87286	87287
<b>\$/pc</b>				

No partial packaging

### CERFIX PROTEC FLEX PRO FLEX LINE

Width = 2-3/4" or 70 mm – 2-piece package

Item	Finish	H	
		3/8" (10 mm)	1/2" (12.5 mm)
<b>COLOR-COATED ALUMINUM</b>			
CPNVF/45/	Ash gray RAL 7038 embossed	87288	87290
	Ancient gray	87289	87291
<b>\$/pc</b>			

No partial packaging

For colors on request and other heights please contact our sales department.

To place orders correctly, find the desired model, size and finish. Then place your order by using the letters "PPS" followed by the corresponding 5-digit code.



# Cerfix™ Protec

Protec CPGV is a perimeter profile for protecting and finishing the outside edges of terraces and balconies. This profile is composed of a vertical part that facilitates the outflow of rainwater from the tiled surface and protects the border of the floor, and a sloping part equipped with holes for a further discharge of the water. This technical solution and the consequent drainage reduce the problems of freezing and thawing as well as unsightly efflorescence on tile grout. The profile can be used with tile thicknesses up to 1/2" or 12.5 mm.



CPGV/55/10 ancient gray color-coated aluminum

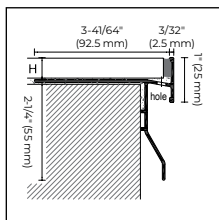

CPGV/55/

## CERFIX PROTEC

Length = 8'10" or 270 cm – 10-piece package

		H	
		3/8" (10 mm)	1/2" (12.5 mm)
Item	Finish	CPGV/55/10	CPGV/55/12
<b>COLOR-COATED ALUMINUM</b>			
Ash gray RAL 7038		87580	87581
Ash gray RAL 7038 embossed		87578	87579
Metal gray RAL 9006		87590	87591
Ancient gray		87582	87583
White stone		87547	87548
<b>\$/pc</b>			

White RAL 9003, dark brown RAL 8019 and aluminum gray RAL 9007 with a minimum of 100 pieces, on request, without surcharge. For colors on request please contact our sales department.

## 90° OUTSIDE CORNER

5-piece package

		H	
		3/8" (10 mm)	1/2" (12.5 mm)
Item	Finish	CPGV/55/10/E	CPGV/55/12/E
<b>COLOR-COATED ALUMINUM</b>			
Ash gray RAL 7038		87584	87585
Ash gray RAL 7038 embossed		87595	87596
Metal gray RAL 9006		87592	87593
Ancient gray		87586	87587
White stone		87536	87537
<b>\$/pc</b>			

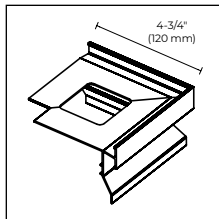

CPGV/55/ /E

## 90° INSIDE CORNER

5-piece package

		H	
		3/8" (10 mm)	1/2" (12.5 mm)
Item	Finish	CPGV/55/10/I	CPGV/55/12/I
<b>COLOR-COATED ALUMINUM</b>			
Ancient gray		87566	87567
White stone		87538	87539
<b>\$/pc</b>			

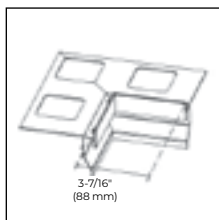

CPGV/55/ /I

## JUNCTION

Width = 2-3/4" or 70 mm – 5-piece package

		H	
		3/8" (10 mm)	1/2" (12.5 mm)
Item	Finish	CPGV/55/10/G	CPGV/55/12/G
<b>COLOR-COATED ALUMINUM</b>			
Ash gray RAL 7038		87610	87610
Ash gray RAL 7038 embossed		87612	87612
Metal gray RAL 9006		87594	87594
Ancient gray		87611	87611
White stone		87528	87528
<b>\$/pc</b>			

No partial packaging

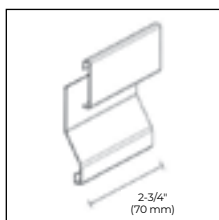

CPGV/55/ /G

To place orders correctly, find the desired model, size and finish. Then place your order by using the letters "PPS" followed by the corresponding 5-digit code.

Protec CPQV is a perimeter profile for protecting and finishing the outside edges of terraces and balconies. This profile is composed of a vertical part that covers the border of the floor and facilitates the outflow of rainwater from the tiled surface, and a sloping part equipped with holes for a further discharge of the water. This technical solution and the consequent drainage reduce the problems of freezing and thawing as well as unsightly efflorescence on tiles grout. The profile can be used with tile thicknesses up to 1/2" or 12.5 mm.



CPQV/50/10 ash gray RAL 7038 embossed color-coated aluminum

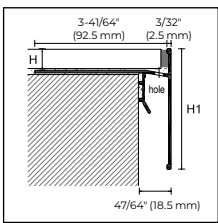

CPQV

### CERFIX PROTEC

Length = 8'10" or 270 cm – 10-piece package

Item	Finish	H			
		3/8" (10 mm)	1/2" (12.5 mm)	3/8" (10 mm)	1/2" (12.5 mm)
		CPQV/50/ (H1=50)		CPQV/70/ (H1=70)	
<b>COLOR-COATED ALUMINUM</b>					
Ash gray RAL 7038		86960	86961	86962	86963
Ash gray RAL 7038 embossed		86964	86965	86966	86967
Metal gray RAL 9006		86968	86969	86970	86971
Ancient gray		86972	86973	86974	86975
White stone		86976	86977	86978	86979
<b>\$/pc</b>					

White RAL 9003, dark brown RAL 8019 and aluminum gray RAL 9007 with a minimum of 100 pieces, on request, without surcharge. For colors on request please contact our sales department.

### 90° OUTSIDE CORNER

5-piece package

Item	Finish	H			
		3/8" (10 mm)	1/2" (12.5 mm)	3/8" (10 mm)	1/2" (12.5 mm)
		CPQV/50/ /E		CPQV/70/ /E	
<b>COLOR-COATED ALUMINUM</b>					
Ash gray RAL 7038		86980	86981	86982	86983
Ash gray RAL 7038 embossed		86984	86985	86986	86987
Metal gray RAL 9006		86988	86989	86990	86991
Ancient gray		86992	86993	86994	86995
White stone		86996	86997	86998	86999
<b>\$/pc</b>					

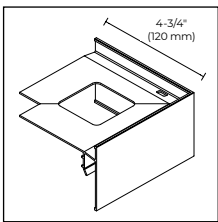

CPQV//E

### JUNCTION

Width = 2-3/4" or 70 mm – 5-piece package

Item	Finish	H	
		CPQV/50/G	CPQV/70/G
<b>COLOR-COATED ALUMINUM</b>			
Ash gray RAL 7038		87000	87001
Ash gray RAL 7038 embossed		87002	87003
Metal gray RAL 9006		87004	87005
Ancient gray		87006	87007
White stone		87008	87009
<b>\$/pc</b>			

No partial packaging

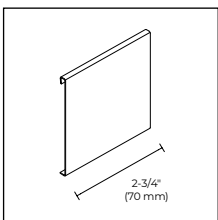

CPQV//G



CPQV ash gray RAL 7038

To place orders correctly, find the desired model, size and finish. Then place your order by using the letters "PPS" followed by the corresponding 5-digit code.

# Cerfix™ Protec

Protec CPEV and CPEI edge-reversible profiles are designed for protecting and finishing the outside edges of terraces and balconies. Available in stainless steel and color-coated aluminum, these profiles can be installed flush with the border or detached from it. They can be used with tile or marble at thicknesses of 3/8" to 1-1/4" (11 to 32 mm). The particular design is recommended to protect the stair nosing and sidewalk edge, hiding the connection between treads and risers.

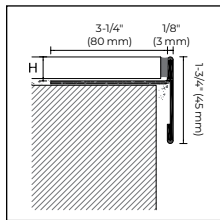

CPEV/45/

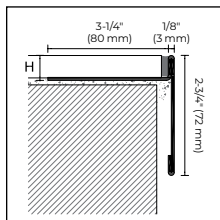

CPEV/72/

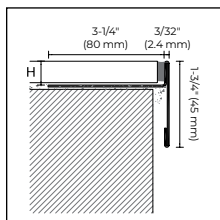

CPEI/

## CERFIX PROTEC

Length = 8'10" or 270 cm – 10-piece package

Item	H				
	7/16" (11 mm)	1/2" (12.5 mm)	9/16" (15 mm)	3/4" (20 mm)	1/2" (12.5 mm)
Finish	CPEV/45/				CPEV/72/
<b>COLOR-COATED ALUMINUM</b>					
Ash gray RAL 7038	87530	87550	87551	87552	87252
Metal gray RAL 9006	87531	87540	87541	87542	–
Ancient gray	87532	87553	87554	87555	–
<b>\$/pc</b>					

For CPEV/72 white RAL 9003, dark brown RAL 8019, metal gray RAL 9006, aluminum gray RAL 9007, ancient gray, ash gray RAL 7038 embossed and rust with minimum 100 pieces, on request, without surcharge. For different colors, please contact our Sales Department. For CPEV/45 white RAL 9003, dark brown RAL 8019, aluminum gray RAL 9007, ash gray RAL 7038 embossed and rust with minimum 100 pieces, on request, without surcharge. For colors on request please contact our sales department.

## CERFIX PROTEC

Length = 8'10" or 270 cm – 10-piece package

Item	H		
	1/2" (12.5 mm)	9/16" (15 mm)	3/4" (20 mm)
Finish	CPEI/45/		
<b>STAINLESS STEEL</b>			
Polished stainless steel AISI 304	87570	87571	87572
<b>\$/pc</b>			

To place orders correctly, find the desired model, size and finish. Then place your order by using the letters "PPS" followed by the corresponding 5-digit code.

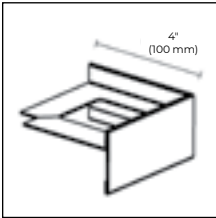

CPEV//E  
CPEI//E

### 90° OUTSIDE CORNER

5-piece package		H					
		7/16" (11 mm)	1/2" (12.5 mm)	9/16" (15 mm)	3/4" (20 mm)	1/2" (12.5 mm)	
<b>Item</b>		CPEV/45/ E					CPEV/72/ E
<b>Finish</b>							
<b>COLOR-COATED ALUMINUM</b>							
Ash gray RAL 7038		87533	87556	87557	87558	87255	
Metal gray RAL 9006		87534	87543	87544	87545	-	
Ancient gray		87535	87559	87560	87561	-	
<b>\$/pc</b>							

### 90° OUTSIDE CORNER

5-piece package		H		
		1/2" (12.5 mm)	9/16" (15 mm)	3/4" (20 mm)
<b>Item</b>		CPEI/45/ E		
<b>STAINLESS STEEL</b>				
Polished Stainless Steel AISI 304		87573	87574	87575
<b>\$/pc</b>				

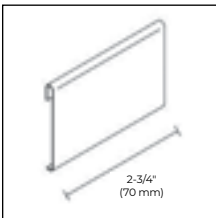

CPEV//G  
CPEI//G

### JUNCTION

Width = 2-3/4" or 70 mm – 5-piece package		H					
		7/16" (11 mm)	1/2" (12.5 mm)	9/16" (15 mm)	3/4" (20 mm)	1/2" (12.5 mm)	
<b>Item</b>		CPEV/45/ G					CPEV/72/ G
<b>Finish</b>							
<b>COLOR-COATED ALUMINUM</b>							
Ash gray RAL 7038		87562	87562	87562	87562	87258	
Metal gray RAL 9006		87546	87546	87546	87546	-	
Ancient gray		87563	87563	87563	87563	-	
<b>\$/pc</b>							

No partial packaging

### JUNCTION

Width = 2-3/4" or 70 mm – 5-piece package		H		
		1/2" (12.5 mm)	9/16" (15 mm)	3/4" (20 mm)
<b>Item</b>		CPEI/45/ G		
<b>STAINLESS STEEL</b>				
Polished stainless steel AISI 304		87576	87576	87576
<b>\$/pc</b>				

No partial packaging



CPEV/45/12/E + CPEI/45/12/G ancient gray color-coated aluminum

To place orders correctly, find the desired model, size and finish. Then place your order by using the letters "PPS" followed by the corresponding 5-digit code.



## Cerfix™ Protec

Protec CPHA and CPHV are edge profiles in anodized and color-coated aluminum for terraces, balconies and sidewalks. The shape allows the outflow of water, avoiding direct contact with the screed. Installed along the perimeter, these profiles can outline ceramic tiles and protect the border in many fields of use. They can be used with tile thicknesses up to 3/4" or 21 mm.



CPHA/10 silver anodized aluminum

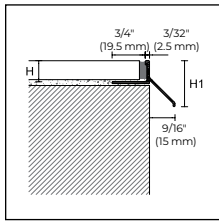

CPHA/  
CPHV/

### CERFIX PROTEC

Length = 8'10" or 270 cm – 10-piece package

Item	Finish	H (H1)			
		5/16" (8 mm)	3/8" (10 mm)	1/2" (12.5 mm)	13/16" (21 mm)
<b>ALUMINUM</b>					
CPHA/	Silver anodized	87599	87600	87601	87602
		<b>\$/pc</b>			
<b>COLOR-COATED ALUMINUM</b>					
	Ash gray RAL 7038	–	87606	87607	87608
CPHV/	Ash gray RAL 7038 embossed	–	87637	87638	–
	Ancient gray	–	87639	87640	–
		<b>\$/pc</b>			

White RAL 9003, dark brown RAL 8019, metal gray RAL 9006, aluminum gray RAL 9007 and ancient gray with a minimum of 100 pieces, on request, without surcharge. For colors on request please contact our sales department.

### 90° OUTSIDE CORNER

Dimensions = 4-3/4" x 4-3/4" (12 x 12 cm) – 5-piece package

Item	Finish	H (H1)			
		5/16" (8 mm)	3/8" (10 mm)	1/2" (12.5 mm)	3/4" (20 mm)
<b>ALUMINUM</b>					
CPHA/ /E	Silver anodized	87564	87565	87597	87598
		<b>\$/pc</b>			
<b>COLOR-COATED ALUMINUM</b>					
	Ash gray RAL 7038	–	87603	87604	87609
CPHV/ /E	Ash gray RAL 7038 embossed	–	87641	87642	–
	Ancient gray	–	87643	87644	–
		<b>\$/pc</b>			

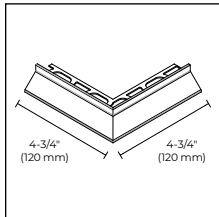

CPHA/ /E  
CPHV/ /E



CPHA/ /E silver anodized aluminum

To place orders correctly, find the desired model, size and finish. Then place your order by using the letters "PPS" followed by the corresponding 5-digit code.

Protec CPLV is a line of perimeter profiles in color-coated aluminum for protecting and finishing the borders of outdoor raised floors, terraces and balconies. These profiles are composed of a drilled base CPLB to be screwed to the supports, or, as an alternative, a cut base CPLB/2 for installed tiles, and a visible profile to be fixed with adhesive, available in 3 different heights according to the floor thickness. There are also special accessories for the creation of external corners and junctions.



CPLB + CPLV/60 ash gray RAL 7038 color-coated aluminum

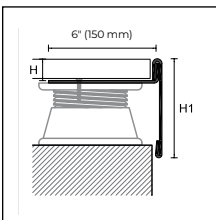

CPLB  
base for raised  
floors

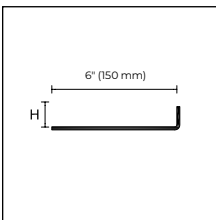

CPLB/2  
punched base  
for tiled floors

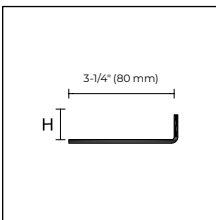

CPLB/2  
punched base  
for tiled floors

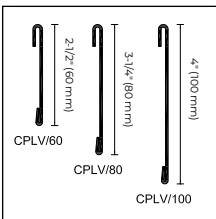

CPLV/

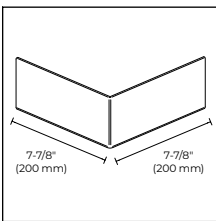

CPLV/ /E

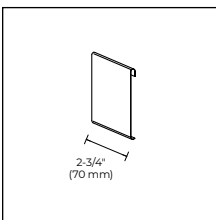

CPLV/ /G

**CERFIX PROTEC**

Length = 8'10" or 270 cm – 10-piece package **H**

BASE			
Item	Finish	3/4" (20 mm)	
<b>ALUMINUM</b>			
CPLB	Natural aluminum		86900
		\$/pc	
CPLB/2	Natural aluminum		86901
		\$/pc	

CPLB with draining holes available on request. CPLB and CPLB/2 in heights of 9/16" (15 mm) and 1" (25 mm) available on request.

**CERFIX PROTEC**

Length = 8'10" or 270 cm – 10-piece package **H1**

FRONT				
Item	Finish	2-1/2" (60 mm)	3-1/4" (80 mm)	4" (100 mm)
<b>COLOR-COATED ALUMINUM</b>				
CPLV/	Ash gray RAL 7038	86902	86904	86906
	Ancient gray	86903	86905	86907
	Stone	86908	86909	86910
	Greige	86911	86912	86913
	Sand	86914	86915	86916
	Beige	86917	86918	86919
			\$/pc	

**90° OUTSIDE CORNER**

5-piece package **H1**

Item	Finish	2-1/2" (60 mm)	3-1/4" (80 mm)	4" (100 mm)
<b>COLOR-COATED ALUMINUM</b>				
CPLV/ /E	Ash gray RAL 7038	86920	86922	86924
	Ancient gray	86921	86923	86925
	Stone	86926	86927	86928
	Greige	86929	86931	86933
	Sand	86935	86936	86937
	Beige	86938	86939	86940
			\$/pc	

**JUNCTION**

Width = 2-3/4" or 70 mm – 5-piece package **H1**

Item	Finish	2-1/2" (60 mm)	3-1/4" (80 mm)	4" (100 mm)
<b>COLOR-COATED ALUMINUM</b>				
CPLV/ /G	Ash gray RAL 7038	86930	86932	86934
	Ancient gray	86941	86942	86943
	Stone	86944	86945	86946
	Greige	86947	86948	86949
	Sand	86950	86951	86952
	Beige	86953	86954	86955
			\$/pc	

No partial packaging





# PROFILES and TRIMS



Display Racks,  
Materials and  
Characteristics

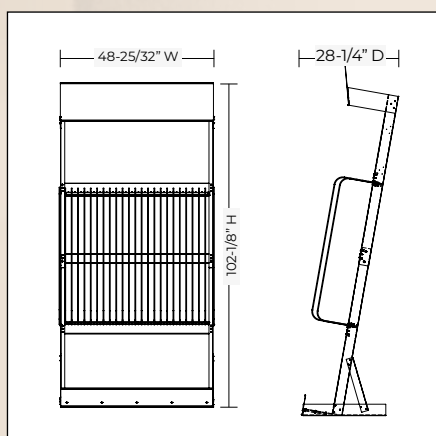

48" Divider Rack,  
With 24 dividers  
MKUSA00004



## Materials and Characteristics

### MATERIALS AND CHARACTERISTICS

The following information summarizes the main characteristics of the materials. Further information is available upon request of the product specifications.

#### NATURAL BRASS

**Alloy CW624N UNI EN 12167:** The profiles are produced by extrusion. They have a good resistance to chemical agents and mechanical stresses. On the visible parts the brass naturally oxidizes to create a superficial glaze. The brass, when exposed to corrosive agents or high humidity, is subject to phenomena of high oxidation and can present superficial spots. Where necessary, it can be restored to its original state by using abrasives or specific polishing products.

#### POLISHED BRASS

**Alloy CW624N UNI EN 12167:** The profiles are produced by extrusion and then mechanically polished. The visible surface must be protected from scratches and frictions. The resistance to chemical agents and mechanical stresses is good. On the visible parts the brass naturally oxidizes to create a superficial glaze. The brass, when exposed to corrosive agents or high humidity, is subject to phenomena of high oxidation and can present superficial spots. Where necessary, it can be restored to its original state by using abrasives or specific polishing products.

#### CHROMIUM-PLATED BRASS

**Alloy CW624N UNI EN 12167:** The profiles are produced by extrusion and then chromed. They are resistant to ultraviolet rays, weathering and chemical agents. They are not suitable for applications in floors with intense mechanical stresses.

#### NATURAL ALUMINUM

**Alloy of Al-Mg-Si thermally treated in conditions T6 (6060 T6):** The profiles are produced by extrusion and guarantee a fair resistance to atmospheric and chemical agents. The cement and its derivatives produce, if wet, alkaline substances that, acting on the surface, can corrode the metal (formation of hydroxide of aluminum). For that reason, the visible surface of the profile must be immediately cleaned from cement, glue and other materials used for joints.

#### ANODIZED ALUMINUM

**Alloy of Al-Mg-Si thermally treated in conditions T6 (6060 T6):** The profiles are produced by extrusion and then anodized. They have a good resistance to atmospheric and chemical agents. The cement and its derivatives produce, if wet, alkaline substances that, acting on the surface, can corrode the metal (formation of hydroxide of aluminum). For that reason, the visible surface of the profile must be immediately and gently cleaned from cement, glue and other materials used for joints. Wear and pedestrian traffic could damage the surface (in cases of profiles laid on the floor) and remove the original anodized finish.

#### POLISHED ALUMINUM

**Alloy of Al-Mg-Si thermally treated in conditions T6 (6463 T6):** The profiles are produced by extrusion and then mechanically treated and processed. They guarantee a fair resistance to atmospheric and chemical agents. The cement and its derivatives produce, if wet, alkaline substances that, acting on the surface, can corrode the metal (formation of hydroxide of aluminum). For that reason, the visible surface of the profile must be immediately and gently cleaned from cement, glue and other materials used for joints. Polished aluminum profiles are not suitable for floor applications.

#### COLOR-COATED ALUMINUM

**Alloy of Al-Mg-Si thermally treated in conditions T6 (6060 T6):** The profiles are made by extrusion and then coated with a thickness of  $\geq 80 \mu\text{m}$ . They have a fair resistance to atmospheric and chemical agents while they do not have a good resistance to mechanical

stresses that would damage the surface enamel; therefore they are not recommended for floor applications. For that reason, the visible surface of the profile must be immediately and gently cleaned from cement, glue and other materials used for joints.

#### FOILED ALUMINUM

**Alloy of Al-Mg-Si thermally treated in conditions T6 (6060 T6):** The profiles are produced by extrusion in natural alloy. The wood decoration is obtained by foiling the aluminum profiles with a special film, resistant to wear, perfectly reproducing grains and colors of wood.

#### STAINLESS STEEL - AISI 430

This kind of stainless steel has a moderate resistance to corrosive agents. It is recommended exclusively for indoor use.

#### STAINLESS STEEL - AISI 304

This is extremely resistant to most chemical and atmospheric agents, lime, mortar, tile glue and common cleaning products. It is recommended for outdoor use, food processing plants, hospitals, etc.

#### STAINLESS STEEL - AISI 316

This is extremely resistant to most chemical and atmospheric agents, lime, mortar, tile glue and common cleaning products. Moreover it has a good resistance to chlorine and salt, and is particularly recommended for extreme conditions of use.

#### INSTALLATION WARNING

Even stainless steel can be damaged if not treated with proper precautions during the installation. In particular, pay attention to: keeping the profiles protected inside their individual packaging up until the installation. (This precaution allows to avoid the contamination with other ferrous materials during the transport.) Avoiding the direct contact with cleaning products for cotto tiles and marble, decalcifying agents and cleaners containing chlorine and its compounds. Be cautious about the gases of hydrochloric acid during the cleaning of special floors. After installation, proceed immediately with an accurate cleaning of the surface with plenty of water and the consequent drying.

#### MAINTENANCE WARNING

Frequent cleaning is essential to preserve the beauty of stainless-steel profile surfaces. Pay close attention to the treatment of the profiles' surface during the installation. Immediately after installation, clean by rinsing the surfaces accurately. Avoid the use of abrasive products that may scratch the profiles. Do not use cleaners containing chlorine or its compounds, such as bleach, muriatic acid and decalcifying agents. Do not use abrasive sponges or wire wools that may scratch the surface or leave rust stains.

#### CHROMIUM-PLATED STAINLESS STEEL - AISI 304 - (Profilpas design)

Offering a refined aesthetic value, this is suitable for wall coverings but not for floors: Cleaning maintenance should be done with sponges or soft and non-abrasive cloths as well as neutral detergents.

#### Rigid PVC

Vinyl compound of rigid PVC. Unleaded, anti-shock and nonflammable. Eco-friendly mixture with Ca-Zn salts.

#### Plasticized PVC

Vinyl compound of plasticized PVC. Unleaded and nonflammable. Eco-friendly mixture with Ca-Zn salts.

#### Foam PVC

Vinyl compound of foam PVC. Unleaded and nonflammable. Eco-friendly mixture with Ca-Zn salts.

### Co-Extruded PVC - Rigid/Rigid

Vinyl compound of rigid PVC. Unleaded, anti-shock and nonflammable. Eco-friendly mixture with Ca-Zn salts.

### Co-Extruded PVC - Plasticized/Plasticized

Vinyl compound of plasticized PVC. Unleaded and nonflammable. Eco-friendly mixture with Ca-Zn salts.

### Co-Extruded PVC - Rigid/Plasticized

Vinyl compound of rigid PVC: Unleaded, anti-shock and nonflammable. Eco-friendly mixture with Ca-Zn salts. Vinyl compound of plasticized PVC: Unleaded and nonflammable. Eco-friendly mixture with Ca-Zn salts.

### Co-Extruded PVC - Rigid/Plasticized Anti-Mold

Vinyl compound of rigid PVC: Unleaded, anti-shock and nonflammable. Eco-friendly mixture with Ca-Zn salts. Vinyl compound of plasticized PVC: Unleaded, nonflammable and injected with biocide. Eco-friendly mixture with Ca-Zn salts.

### Co-Extruded PVC - Foam/Plasticized

Vinyl compound of foam PVC: Unleaded and nonflammable. Eco-friendly mixture with Ca-Zn salts. Vinyl compound of plasticized PVC: Unleaded and nonflammable. Eco-friendly mixture with Ca-Zn salts.

## CLEANING AND MAINTENANCE TIPS

MATERIAL	FINISHING	CLEANING AFTER INSTALLATION	MAINTENANCE
Aluminum	Anodized	Use of acid-based cleaners and not alkaline	Exclusive use of neutral cleaning products
Aluminum	Bril. polished	Use of acid-based cleaners and not alkaline	Exclusive use of neutral cleaning products
Aluminum	Bright polished copper	Use of acid-based cleaners and not alkaline	Exclusive use of neutral cleaning products
Aluminum	Bright polished titanium	Use of acid-based cleaners and not alkaline	Exclusive use of neutral cleaning products
Aluminum	Bright polished gold	Use of acid-based cleaners and not alkaline	Exclusive use of neutral cleaning products
Aluminum	Color-coated	Use of acid-based cleaners	Use neutral or alkaline detergents
Aluminum	Bright satin	Use of acid-based cleaners and not alkaline	Exclusive use of neutral cleaning products
Stainless steel	Polished	Use of acid-based cleaners without chlorine	Use neutral or alkaline detergents
Stainless steel	Inox AISI 316	Use of acid-based cleaners	Exclusive use of neutral cleaning products
Stainless steel	Sandblast	Use of acid-based cleaners only neutral	Use neutral or alkaline detergents
Stainless steel	Satin	Use of acid-based cleaners without chlorine	Use neutral or alkaline detergents
Brass	Natural	Use of acid-based cleaners only neutral	Exclusive use of neutral cleaning products
Brass	Polished	Use of acid-based cleaners only neutral	Exclusive use of neutral cleaning products
Brass	Chromium-plated	Use of acid-based cleaners	Use neutral or alkaline detergents
PVC		Use of acid-based cleaners and not alkaline	Exclusive use of neutral cleaning products

## PROFILES' CHARACTERISTICS AND PACKAGING

### SELF-ADHESIVE PROFILES

Self-adhesive profiles are made of nontoxic, nonflammable and solvent-free hot-melt glues. Although these products are nonflammable, they should not be exposed to open flames. Product preservation is guaranteed when storage takes place in "normal" climatic conditions.

Glue deteriorates at temperatures over 194°F (90°C) and crystallizes at temperatures below 5°F (-15°C). During the application, the temperature of self-adhesive profiles and the ambient temperature where profiles have to be installed should not be below 50°F (10°C).

Important: Self-adhesive profiles cannot be installed on friable supports, as a junction between two carpeted floors, or between PVC floors and wall coverings.

### DRILLED PROFILES

Some of the profiles can be fastened using flat-head or round-head screws. Acceptable screw sizes are 1/8" and 9/64" (3 and 3.5 mm).

### PACKAGING

The  means blister packaging.

"Individually packaged" means that the packaging is made for the single profile with a protective shrink-wrap film.

### DIRECTIONS

Do not use aggressive chemicals, as they could stain the metals. In particular lime, mortar or tile glue cause scratches on the visible surface of profiles. Therefore it is necessary to clean these parts immediately after installing of the profiles. Please note that in the current catalog, due to printing limitations, the color shades can be slightly different from the actual colors.









MAPEI USA  
MAPEI Caribe  
MAPEI Canada

**MAPEI Headquarters of North America**

1144 East Newport Center Drive  
Deerfield Beach, Florida 33442  
1-888-US-MAPEI (1-888-876-2734) /  
(954) 246-8888

**Technical Services**

1-800-992-6273 (U.S. and Puerto Rico)  
1-800-361-9309 (Canada)

**Customer Service**

1-800-42-MAPEI (1-800-426-2734)

Copyright ©2024 by MAPEI Corporation ("MAPEI") and all rights are reserved. All intellectual property rights and other information contained in this document are the exclusive property of MAPEI (or its parent or related companies), unless otherwise noted. No part of this document may be reproduced or transmitted in any form without the prior written consent of MAPEI.

Printed in the USA.

