



TOSCA Simple Profile in YAML Version 1.3

Committee Specification 01

18 September 2019

This version:

<https://docs.oasis-open.org/tosca/TOSCA-Simple-Profile-YAML/v1.3/cs01/TOSCA-Simple-Profile-YAML-v1.3-cs01.pdf> (Authoritative)

<https://docs.oasis-open.org/tosca/TOSCA-Simple-Profile-YAML/v1.3/cs01/TOSCA-Simple-Profile-YAML-v1.3-cs01.html>

<https://docs.oasis-open.org/tosca/TOSCA-Simple-Profile-YAML/v1.3/cs01/TOSCA-Simple-Profile-YAML-v1.3-cs01.docx>

Previous version:

<https://docs.oasis-open.org/tosca/TOSCA-Simple-Profile-YAML/v1.3/csprd01/TOSCA-Simple-Profile-YAML-v1.3-csprd01.pdf> (Authoritative)

<https://docs.oasis-open.org/tosca/TOSCA-Simple-Profile-YAML/v1.3/csprd01/TOSCA-Simple-Profile-YAML-v1.3-csprd01.html>

<https://docs.oasis-open.org/tosca/TOSCA-Simple-Profile-YAML/v1.3/csprd01/TOSCA-Simple-Profile-YAML-v1.3-csprd01.docx>

Latest version:

<https://docs.oasis-open.org/tosca/TOSCA-Simple-Profile-YAML/v1.3/TOSCA-Simple-Profile-YAML-v1.3.pdf> (Authoritative)

<https://docs.oasis-open.org/tosca/TOSCA-Simple-Profile-YAML/v1.3/TOSCA-Simple-Profile-YAML-v1.3.html>

<https://docs.oasis-open.org/tosca/TOSCA-Simple-Profile-YAML/v1.3/TOSCA-Simple-Profile-YAML-v1.3.docx>

Technical Committee:

OASIS Topology and Orchestration Specification for Cloud Applications (TOSCA) TC

Chairs:

Paul Lipton (paul.lipton@live.com), Individual Member

Chris Lauwers (lauwers@ubicity.com), Individual Member

Editors:

Matt Rutkowski (mrutkows@us.ibm.com), IBM

Chris Lauwers (lauwers@ubicity.com), Individual Member

Claude Noshpitz (claude.noshpitz@att.com), AT&T

Calin Curescu (calin.curescu@ericsson.com), Ericsson

Related work:

This specification replaces or supersedes:

- *TOSCA Simple Profile in YAML Version 1.2*. Edited by Matt Rutkowski, Luc Boutier, and Chris Lauwers. OASIS Standard. Latest version: <https://docs.oasis-open.org/tosca/TOSCA-Simple-Profile-YAML/v1.2/TOSCA-Simple-Profile-YAML-v1.2.html>.

This specification is related to:

- *Topology and Orchestration Specification for Cloud Applications Version 1.0*. Edited by Derek Palma and Thomas Spatzier. OASIS Standard. Latest version: <http://docs.oasis-open.org/tosca/TOSCA/v1.0/TOSCA-v1.0.html>.

Declared XML namespaces:

- <http://docs.oasis-open.org/tosca/ns/simple/yaml/1.3>

Abstract:

This document defines a simplified profile of the TOSCA version 1.0 specification in a YAML rendering which is intended to simplify the authoring of TOSCA service templates. This profile defines a less verbose and more human-readable YAML rendering, reduced level of indirection between different modeling artifacts as well as the assumption of a base type system.

Status:

This document was last revised or approved by the membership of OASIS on the above date. The level of approval is also listed above. Check the “Latest version” location noted above for possible later revisions of this document. Any other numbered Versions and other technical work produced by the Technical Committee (TC) are listed at https://www.oasis-open.org/committees/tc_home.php?wg_abbrev=tosca#technical.

TC members should send comments on this specification to the TC’s email list. Others should send comments to the TC’s public comment list, after subscribing to it by following the instructions at the “[Send A Comment](#)” button on the TC’s web page at <https://www.oasis-open.org/committees/tosca/>.

This specification is provided under the [RF on Limited Terms](#) Mode of the [OASIS IPR Policy](#), the mode chosen when the Technical Committee was established. For information on whether any patents have been disclosed that may be essential to implementing this specification, and any offers of patent licensing terms, please refer to the Intellectual Property Rights section of the TC’s web page (<https://www.oasis-open.org/committees/tosca/ipr.php>).

Note that any machine-readable content ([Computer Language Definitions](#)) declared Normative for this Work Product is provided in separate plain text files. In the event of a discrepancy between any such plain text file and display content in the Work Product’s prose narrative document(s), the content in the separate plain text file prevails.

Citation format:

When referencing this specification the following citation format should be used:

[TOSCA-Simple-Profile-YAML-v1.3]

TOSCA Simple Profile in YAML Version 1.3. Edited by Matt Rutkowski, Chris Lauwers, Claude Noshpitz, and Calin Curescu. 18 September 2019. OASIS Committee Specification 01. <https://docs.oasis-open.org/tosca/TOSCA-Simple-Profile-YAML/v1.3/cs01/TOSCA-Simple-Profile-YAML-v1.3-cs01.html>. Latest version: <https://docs.oasis-open.org/tosca/TOSCA-Simple-Profile-YAML/v1.3/TOSCA-Simple-Profile-YAML-v1.3.html>.

Notices

Copyright © OASIS Open 2019. All Rights Reserved.

All capitalized terms in the following text have the meanings assigned to them in the OASIS Intellectual Property Rights Policy (the "OASIS IPR Policy"). The full [Policy](#) may be found at the OASIS website.

This document and translations of it may be copied and furnished to others, and derivative works that comment on or otherwise explain it or assist in its implementation may be prepared, copied, published, and distributed, in whole or in part, without restriction of any kind, provided that the above copyright notice and this section are included on all such copies and derivative works. However, this document itself may not be modified in any way, including by removing the copyright notice or references to OASIS, except as needed for the purpose of developing any document or deliverable produced by an OASIS Technical Committee (in which case the rules applicable to copyrights, as set forth in the OASIS IPR Policy, must be followed) or as required to translate it into languages other than English.

The limited permissions granted above are perpetual and will not be revoked by OASIS or its successors or assigns.

This document and the information contained herein is provided on an "AS IS" basis and OASIS DISCLAIMS ALL WARRANTIES, EXPRESS OR IMPLIED, INCLUDING BUT NOT LIMITED TO ANY WARRANTY THAT THE USE OF THE INFORMATION HEREIN WILL NOT INFRINGE ANY OWNERSHIP RIGHTS OR ANY IMPLIED WARRANTIES OF MERCHANTABILITY OR FITNESS FOR A PARTICULAR PURPOSE.

OASIS requests that any OASIS Party or any other party that believes it has patent claims that would necessarily be infringed by implementations of this OASIS Committee Specification or OASIS Standard, to notify OASIS TC Administrator and provide an indication of its willingness to grant patent licenses to such patent claims in a manner consistent with the IPR Mode of the OASIS Technical Committee that produced this specification.

OASIS invites any party to contact the OASIS TC Administrator if it is aware of a claim of ownership of any patent claims that would necessarily be infringed by implementations of this specification by a patent holder that is not willing to provide a license to such patent claims in a manner consistent with the IPR Mode of the OASIS Technical Committee that produced this specification. OASIS may include such claims on its website, but disclaims any obligation to do so.

OASIS takes no position regarding the validity or scope of any intellectual property or other rights that might be claimed to pertain to the implementation or use of the technology described in this document or the extent to which any license under such rights might or might not be available; neither does it represent that it has made any effort to identify any such rights. Information on OASIS' procedures with respect to rights in any document or deliverable produced by an OASIS Technical Committee can be found on the OASIS website. Copies of claims of rights made available for publication and any assurances of licenses to be made available, or the result of an attempt made to obtain a general license or permission for the use of such proprietary rights by implementers or users of this OASIS Committee Specification or OASIS Standard, can be obtained from the OASIS TC Administrator. OASIS makes no representation that any information or list of intellectual property rights will at any time be complete, or that any claims in such list are, in fact, Essential Claims.

The name "OASIS" is a trademark of [OASIS](#), the owner and developer of this specification, and should be used only to refer to the organization and its official outputs. OASIS welcomes reference to, and implementation and use of, specifications, while reserving the right to enforce its marks against misleading uses. Please see <https://www.oasis-open.org/policies-guidelines/trademark> for above guidance.

Table of Contents

Table of Examples	7
Table of Figures	8
1 Introduction	9
1.1 IPR Policy	9
1.2 Objective	9
1.3 Summary of key TOSCA concepts	9
1.4 Implementations	10
1.5 Terminology	10
1.6 Notational Conventions	10
1.7 Normative References	11
1.8 Non-Normative References	11
1.9 Glossary	12
2 TOSCA by example	14
2.1 A “hello world” template for TOSCA Simple Profile in YAML	14
2.2 TOSCA template for a simple software installation	17
2.3 Overriding behavior of predefined node types	18
2.4 TOSCA template for database content deployment	19
2.5 TOSCA template for a two-tier application	22
2.6 Using a custom script to establish a relationship in a template	24
2.7 Using custom relationship types in a TOSCA template	26
2.8 Defining generic dependencies between nodes in a template	27
2.9 Describing abstract requirements for nodes and capabilities in a TOSCA template	28
2.10 Using node template substitution for model composition	33
2.11 Using node template substitution for chaining subsystems	37
2.12 Using node template substitution to provide product choice	43
2.13 Grouping node templates	47
2.14 Using YAML Macros to simplify templates	49
2.15 Passing information as inputs to Interfaces and Operations	50
2.16 Returning output values from operations	51
2.17 Receiving asynchronous notifications	52
2.18 Topology Template Model versus Instance Model	53
2.19 Using attributes implicitly reflected from properties	53
2.20 Creating Multiple Node Instances from the Same Node Template	55
3 TOSCA Simple Profile definitions in YAML	59
3.1 TOSCA Namespace URI and alias	59
3.2 Using Namespaces	60
3.3 Parameter and property types	64
3.4 Normative values	74
3.5 TOSCA Metamodel	76
3.6 Reusable modeling definitions	76
3.7 Type-specific definitions	119
3.8 Template-specific definitions	138
3.9 Topology Template definition	157
3.10 Service Template definition	165

4	TOSCA functions	178
4.1	Reserved Function Keywords	178
4.2	Environment Variable Conventions	178
4.3	Intrinsic functions	181
4.4	Property functions	183
4.5	Attribute functions	187
4.6	Operation functions	188
4.7	Navigation functions	188
4.8	Artifact functions	189
4.9	Context-based Entity names (global)	192
5	TOSCA normative type definitions	193
5.1	Assumptions	193
5.2	TOSCA normative type names	193
5.3	Data Types	193
5.4	Artifact Types	205
5.5	Capabilities Types	208
5.6	Requirement Types	219
5.7	Relationship Types	219
5.8	Interface Types	222
5.9	Node Types	229
5.10	Group Types	243
5.11	Policy Types	244
6	TOSCA Cloud Service Archive (CSAR) format	246
6.1	Overall Structure of a CSAR	246
6.2	TOSCA Meta File	246
6.3	Archive without TOSCA-Metadata	247
7	TOSCA workflows	249
7.1	Normative workflows	249
7.2	Declarative workflows	249
7.3	Imperative workflows	253
8	TOSCA networking	269
8.1	Networking and Service Template Portability	269
8.2	Connectivity semantics	269
8.3	Expressing connectivity semantics	270
8.4	Network provisioning	272
8.5	Network Types	276
8.6	Network modeling approaches	282
9	Non-normative type definitions	287
9.1	Artifact Types	287
9.2	Capability Types	289
9.3	Node Types	290
10	Component Modeling Use Cases	294
11	Application Modeling Use Cases	301
11.1	Use cases	301
12	TOSCA Policies	350
12.1	A declarative approach	350

12.2	Consideration of Event, Condition and Action	350
12.3	Types of policies	350
12.4	Policy relationship considerations	351
12.5	Use Cases	352
13	Artifact Processing and creating Portable Service Templates	355
13.1	CSAR Onboarding	355
13.2	Artifacts Processing	356
13.3	Dynamic Artifacts	360
13.4	Discussion of Examples.....	360
13.5	Artifact Types and Metadata.....	367
14	Conformance	368
14.1	Conformance Targets	368
14.2	Conformance Clause 1: TOSCA YAML service template	368
14.3	Conformance Clause 2: TOSCA processor.....	368
14.4	Conformance Clause 3: TOSCA orchestrator	368
14.5	Conformance Clause 4: TOSCA generator	369
14.6	Conformance Clause 5: TOSCA archive.....	369
Appendix A.	Known Extensions to TOSCA v1.0.....	370
A.1	Model Changes	370
A.2	Normative Types	370
Appendix B.	Acknowledgments	372
Appendix C.	Revision History.....	374

Table of Examples

Example 1 - TOSCA Simple "Hello World"	14
Example 2 - Template with input and output parameter sections	15
Example 3 - Simple (MySQL) software installation on a TOSCA Compute node	17
Example 4 - Node Template overriding its Node Type's "configure" interface	19
Example 5 - Template for deploying database content on-top of MySQL DBMS middleware	20
Example 6 - Basic two-tier application (web application and database server tiers).....	22
Example 7 - Providing a custom relationship script to establish a connection	24
Example 8 - A web application Node Template requiring a custom database connection type	26
Example 9 - Defining a custom relationship type	27
Example 10 - Simple dependency relationship between two nodes.....	27
Example 11 - An abstract "host" requirement using a node filter	29
Example 12 - An abstract Compute node template with a node filter	30
Example 13 - An abstract database requirement using a node filter	31
Example 14 - An abstract database node template	32
Example 15 - Referencing an abstract database node template	34
Example 16 - Using substitution mappings to export a database implementation	36
Example 17 - Declaring a transaction subsystem as a chain of substitutable node templates	38
Example 18 - Defining a TransactionSubsystem node type	40
Example 19 - Implementation of a TransactionSubsystem node type using substitution mappings.....	41
Example 20 - Grouping Node Templates for possible policy application	47
Example 21 - Grouping nodes for anti-colocation policy application	48
Example 22 - Using YAML anchors in TOSCA templates	49
Example 23 - Properties reflected as attributes	54
Example 24 – TOSCA SD-WAN Service Template	56
Example 25 – TOSCA SD-WAN Service Template	57
Example 26 – TOSCA SD-WAN Service Template	58

Table of Figures

Figure 1: Using template substitution to implement a database tier	34
Figure 2: Substitution mappings	36
Figure 3: Chaining of subsystems in a service template	38
Figure 4: Defining subsystem details in a service template	41
Figure-5: Typical 3-Tier Network.....	273
Figure-6: Generic Service Template	282
Figure-7: Service template with network template A	283
Figure-8: Service template with network template B	283

1 Introduction

1.1 IPR Policy

This specification is provided under the [RF on Limited Terms](#) Mode of the [OASIS IPR Policy](#), the mode chosen when the Technical Committee was established. For information on whether any patents have been disclosed that may be essential to implementing this specification, and any offers of patent licensing terms, please refer to the Intellectual Property Rights section of the TC's web page (<https://www.oasis-open.org/committees/tosca/ipr.php>).

1.2 Objective

The TOSCA Simple Profile in YAML specifies a rendering of TOSCA which aims to provide a more accessible syntax as well as a more concise and incremental expressiveness of the TOSCA DSL in order to minimize the learning curve and speed the adoption of the use of TOSCA to portably describe cloud applications.

This proposal describes a YAML rendering for TOSCA. YAML is a human friendly data serialization standard (<http://yaml.org/>) with a syntax much easier to read and edit than XML. As there are a number of DSLs encoded in YAML, a YAML encoding of the TOSCA DSL makes TOSCA more accessible by these communities.

This proposal prescribes an isomorphic rendering in YAML of a subset of the TOSCA v1.0 XML specification ensuring that TOSCA semantics are preserved and can be transformed from XML to YAML or from YAML to XML. Additionally, in order to streamline the expression of TOSCA semantics, the YAML rendering is sought to be more concise and compact through the use of the YAML syntax.

1.3 Summary of key TOSCA concepts

The TOSCA metamodel uses the concept of service templates that describe cloud workloads as a topology template, which is a graph of node templates modeling the components a workload is made up of and of relationship templates modeling the relations between those components. TOSCA further provides a type system of node types to describe the possible building blocks for constructing a service template, as well as relationship types to describe possible kinds of relations. Both node and relationship types may define lifecycle operations to implement the behavior an orchestration engine can invoke when instantiating a service template. For example, a node type for some software product might provide a 'create' operation to handle the creation of an instance of a component at runtime, or a 'start' or 'stop' operation to handle a start or stop event triggered by an orchestration engine. Those lifecycle operations are backed by implementation artifacts such as scripts or Chef recipes that implement the actual behavior.

An orchestration engine processing a TOSCA service template uses the mentioned lifecycle operations to instantiate single components at runtime, and it uses the relationship between components to derive the order of component instantiation. For example, during the instantiation of a two-tier application that includes a web application that depends on a database, an orchestration engine would first invoke the 'create' operation on the database component to install and configure the database, and it would then invoke the 'create' operation of the web application to install and configure the application (which includes configuration of the database connection).

The TOSCA simple profile assumes a number of base types (node types and relationship types) to be supported by each compliant environment such as a 'Compute' node type, a 'Network' node type or a generic 'Database' node type. Furthermore, it is envisioned that a large number of additional types for use in service templates will be defined by a community over time. Therefore, template authors in many cases will not have to define types themselves but can simply start writing service templates that use existing

types. In addition, the simple profile will provide means for easily customizing and extending existing types, for example by providing a customized 'create' script for some software.

1.4 Implementations

Different kinds of processors and artifacts qualify as implementations of the TOSCA simple profile. Those that this specification is explicitly mentioning or referring to fall into the following categories:

- TOSCA YAML service template (or "service template"): A YAML document artifact containing a (TOSCA) topology template (see sections 3.9 "Service template definition") that represents a Cloud application. (see sections 3.8 "Topology template definition")
- TOSCA processor (or "processor"): An engine or tool that is capable of parsing and interpreting a TOSCA service template for a particular purpose. For example, the purpose could be validation, translation or visual rendering.
- TOSCA orchestrator (also called orchestration engine): A TOSCA processor that interprets a TOSCA service template or a TOSCA CSAR in order to instantiate, deploy, and manage the described application in a Cloud.
- TOSCA generator: A tool that generates a TOSCA service template. An example of generator is a modeling tool capable of generating or editing a TOSCA service template (often such a tool would also be a TOSCA processor).
- TOSCA archive (or TOSCA Cloud Service Archive, or "CSAR"): a package artifact that contains a TOSCA service template and other artifacts usable by a TOSCA orchestrator to deploy an application.

The above list is not exclusive. The above definitions should be understood as referring to and implementing the TOSCA simple profile as described in this document (abbreviated here as "TOSCA" for simplicity).

1.5 Terminology

The TOSCA language introduces a YAML grammar for describing service templates by means of Topology Templates and towards enablement of interaction with a TOSCA instance model perhaps by external APIs or plans. The primary focus currently is on design time aspects, i.e. the description of services to ensure their exchange between Cloud providers, TOSCA Orchestrators and tooling.

The language provides an extension mechanism that can be used to extend the definitions with additional vendor-specific or domain-specific information.

1.6 Notational Conventions

The key words "MUST", "MUST NOT", "REQUIRED", "SHALL", "SHALL NOT", "SHOULD", "SHOULD NOT", "RECOMMENDED", "MAY", and "OPTIONAL" in this document are to be interpreted as described in [RFC2119].

1.6.1 Notes

- Sections that are titled "Example" throughout this document are considered non-normative.
- A feature marked as *deprecated* in a particular version will be removed in the subsequent version of the specification.

1.7 Normative References

Reference Tag	Description
[RFC2119]	S. Bradner, <i>Key words for use in RFCs to Indicate Requirement Levels</i> , http://www.ietf.org/rfc/rfc2119.txt , IETF RFC 2119, March 1997.
[TOSCA-1.0]	Topology and Orchestration Specification for Cloud Applications (TOSCA) Version 1.0, an OASIS Standard, 25 November 2013, http://docs.oasis-open.org/tosca/TOSCA/v1.0/os/TOSCA-v1.0-os.pdf
[YAML-1.2]	YAML, Version 1.2, 3rd Edition, Patched at 2009-10-01, Oren Ben-Kiki, Clark Evans, Ingy döt Net http://www.yaml.org/spec/1.2/spec.html
[YAML-TS-1.1]	Timestamp Language-Independent Type for YAML Version 1.1, Working Draft 2005-01-18, http://yaml.org/type/timestamp.html

1.8 Non-Normative References

Reference Tag	Description
[Apache]	Apache Server, https://httpd.apache.org/
[Chef]	Chef, https://chef.io
[NodeJS]	Node.js, https://nodejs.org/
[Puppet]	Puppet, http://puppetlabs.com/
[WordPress]	WordPress, https://wordpress.org/
[Maven-Version]	Apache Maven version policy draft: https://wiki.apache.org/confluence/display/MAVEN/Version+number+policy
[JSON-Spec]	The JSON Data Interchange Format (ECMA and IETF versions): <ul style="list-style-type: none">• http://www.ecma-international.org/publications/files/ECMA-ST/ECMA-404.pdf• https://tools.ietf.org/html/rfc7158
[JSON-Schema]	JSON Schema specification: <ul style="list-style-type: none">• http://json-schema.org/documentation.html
[XMLSpec]	XML Specification, W3C Recommendation, February 1998, http://www.w3.org/TR/1998/REC-xml-19980210
[XML Schema Part 1]	XML Schema Part 1: Structures, W3C Recommendation, October 2004, http://www.w3.org/TR/xmlschema-1/
[XML Schema Part 2]	XML Schema Part 2: Datatypes, W3C Recommendation, October 2004, http://www.w3.org/TR/xmlschema-2/
[IANA register for Hash Function Textual]	https://www.iana.org/assignments/hash-function-text-names/hash-function-text-names.xhtml

	Nam es]
[Jinja2]	Jinja2, jinja.pocoo.org/
[Twig]	Twig, https://twig.symfony.com

1.9 Glossary

The following terms are used throughout this specification and have the following definitions when used in context of this document.

Term	Definition
Instance Model	A deployed service is a running instance of a Service Template. More precisely, the instance is derived by instantiating the Topology Template of its Service Template, most often by running a declarative workflow that is automatically generated based on the node templates and relationship templates defined in the Topology Template.
Node Template	A <i>Node Template</i> specifies the occurrence of a component node as part of a Topology Template. Each Node Template refers to a Node Type that defines the semantics of the node (e.g., properties, attributes, requirements, capabilities, interfaces). Node Types are defined separately for reuse purposes.
Relationship Template	A <i>Relationship Template</i> specifies the occurrence of a relationship between nodes in a Topology Template. Each Relationship Template refers to a Relationship Type that defines the semantics relationship (e.g., properties, attributes, interfaces, etc.). Relationship Types are defined separately for reuse purposes.
Service Template	<p>A <i>Service Template</i> is typically used to specify the “topology” (or structure) and “orchestration” (or invocation of management behavior) of IT services so that they can be provisioned and managed in accordance with constraints and policies.</p> <p>Specifically, TOSCA Service Templates optionally allow definitions of a TOSCA Topology Template, TOSCA types (e.g., Node, Relationship, Capability, Artifact, etc.), groupings, policies and constraints along with any input or output declarations.</p>
Topology Model	The term Topology Model is often used synonymously with the term Topology Template with the use of “model” being prevalent when considering a Service Template’s topology definition as an abstract representation of an application or service to facilitate understanding of its functional components and by eliminating unnecessary details.
Topology Template	A Topology Template defines the structure of a service in the context of a Service Template. A Topology Template consists of a set of Node Template and Relationship Template definitions that together define the topology model of a service as a (not necessarily connected) directed

graph. The term Topology Template is often used synonymously with the term [Topology Model](#). The distinction is that a topology template can be used to instantiate and orchestrate the model as a **reusable pattern** and includes all details necessary to accomplish it.

Abstract Node Template	An abstract node template is a node template that doesn't define any implementations for the TOSCA lifecycle management operations. Service designers explicitly mark node templates as abstract using the <code>substitute</code> directive. TOSCA orchestrators provide implementations for abstract node templates by finding substituting templates for those node templates.
-------------------------------	---

No-Op Node Template	A No-Op node template is a node template that does not specify implementations for any of its operations, but is not marked as abstract. No-op templates only act as placeholders for information to be used by other node templates and do not need to be orchestrated.
----------------------------	--

2 TOSCA by example

This **non-normative** section contains several sections that show how to model applications with TOSCA Simple Profile using YAML by example starting with a “Hello World” template up through examples that show complex composition modeling.

2.1 A “hello world” template for TOSCA Simple Profile in YAML

As mentioned before, the TOSCA simple profile assumes the existence of a small set of pre-defined, normative set of node types (e.g., a ‘Compute’ node) along with other types, which will be introduced through the course of this document, for creating TOSCA Service Templates. It is envisioned that many additional node types for building service templates will be created by communities. Some may be published as profiles that build upon the TOSCA Simple Profile specification. Using the normative TOSCA Compute node type, a very basic “Hello World” TOSCA template for deploying just a single server would look as follows:

Example 1 - TOSCA Simple “Hello World”

```
tosca_definitions_version: tosca_simple_yaml_1_3tosca_simple_yaml_1_3

description: Template for deploying a single server with predefined properties.

topology_template:
  node_templates:
    db_server:
      type: tosca.nodes.Compute
      capabilities:
        # Host container properties
        host:
          properties:
            num_cpus: 1
            disk_size: 10 GB
            mem_size: 4096 MB
        # Guest Operating System properties
        os:
          properties:
            # host Operating System image properties
            architecture: x86_64
            type: linux
            distribution: rhel
            version: 6.5
```

The template above contains a very simple topology template” with only a single ‘Compute’ node template named “**db_server**” that declares some basic values for properties within two of the several capabilities that are built into the Compute node type definition. All TOSCA Orchestrators are expected to know how to instantiate a Compute node since it is normative and expected to represent a well-known function that is portable across TOSCA implementations. This expectation is true for all normative TOSCA Node and Relationship types that are defined in the Simple Profile specification. This means, with

TOSCA's approach, that the application developer does not need to provide any deployment or implementation artifacts that contain code or logic to orchestrate these common software components. TOSCA orchestrators simply select or allocate the correct node (resource) type that fulfills the application topologies requirements using the properties declared in the node and its capabilities.

In the above example, the “**host**” capability contains properties that allow application developers to optionally supply the number of CPUs, memory size and disk size they believe they need when the Compute node is instantiated in order to run their applications. Similarly, the “**os**” capability is used to provide values to indicate what host operating system the Compute node should have when it is instantiated.

The logical diagram of the “hello world” Compute node would look as follows:

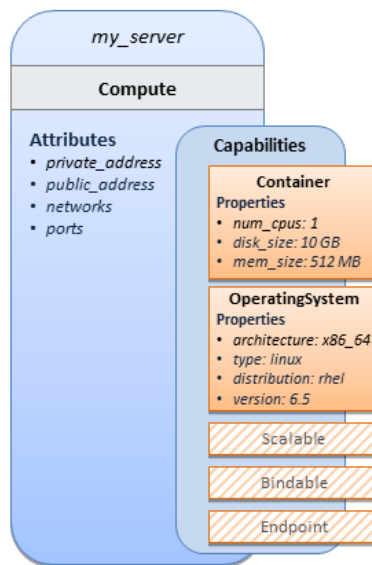

As you can see, the **Compute** node also has attributes and other built-in capabilities, such as **Bindable** and **Endpoint**, each with additional properties that will be discussed in other examples later in this document. Although the Compute node has no direct properties apart from those in its capabilities, other TOSCA node type definitions may have properties that are part of the node type itself in addition to having Capabilities. TOSCA orchestration engines are expected to validate all property values provided in a node template against the property definitions in their respective node type definitions referenced in the service template. The **tosca_definitions_version** keyname in the TOSCA service template identifies the versioned set of normative TOSCA type definitions to use for validating those types defined in the TOSCA Simple Profile including the Compute node type. Specifically, the value **tosca_simple_yaml_1_3** indicates Simple Profile v1.3.0 definitions would be used for validation. Other type definitions may be imported from other service templates using the **import** keyword discussed later.

2.1.1 Requesting input parameters and providing output

Typically, one would want to allow users to customize deployments by providing input parameters instead of using hardcoded values inside a template. In addition, output values are provided to pass information that perhaps describes the state of the deployed template to the user who deployed it (such as the private IP address of the deployed server). A refined service template with corresponding **inputs** and **outputs** sections is shown below.

Example 2 - Template with input and output parameter sections

```
tosca_definitions_version: toscasimple_yaml_1_3
```

```

description: Template for deploying a single server with predefined properties.

topology_template:
  inputs:
    db_server_num_cpus:
      type: integer
      description: Number of CPUs for the server.
      constraints:
        - valid_values: [ 1, 2, 4, 8 ]

  node_templates:
    db_server:
      type: tosca.nodes.Compute
      capabilities:
        # Host container properties
        host:
          properties:
            # Compute properties
            num_cpus: { get_input: db_server_num_cpus }
            mem_size: 2048 MB
            disk_size: 10 GB
            mem_size: 4096 MB
        # Guest Operating System properties
        os:
          # omitted for brevity

  outputs:
    server_ip:
      description: The private IP address of the provisioned server.
      value: { get_attribute: [ db_server, private_address ] }

```

The **inputs** and **outputs** sections are contained in the **topology_template** element of the TOSCA template, meaning that they are scoped to node templates within the topology template. Input parameters defined in the inputs section can be assigned to properties of node template within the containing topology template; output parameters can be obtained from attributes of node templates within the containing topology template.

Note that the **inputs** section of a TOSCA template allows for defining optional constraints on each input parameter to restrict possible user input. Further note that TOSCA provides for a set of intrinsic functions like **get_input**, **get_property** or **get_attribute** to reference elements within the template or to retrieve runtime values.

2.2 TOSCA template for a simple software installation

Software installations can be modeled in TOSCA as node templates that get related to the node template for a server on which the software would be installed. With a number of existing software node types (e.g. either created by the TOSCA work group or a community) template authors can just use those node types for writing service templates as shown below.

Example 3 - Simple (MySQL) software installation on a TOSCA Compute node

```
tosca_definitions_version: tosca_simple_yaml_1_3

description: Template for deploying a single server with MySQL software on top.

topology_template:
  inputs:
    mysql_rootpw:
      type: string
    mysql_port:
      type: integer
    # rest omitted here for brevity

  node_templates:
    db_server:
      type: tosca.nodes.Compute
      # rest omitted here for brevity

    mysql:
      type: tosca.nodes.DBMS.MySQL
      properties:
        root_password: { get_input: mysql_rootpw }
        port: { get_input: mysql_port }
      requirements:
        - host: db_server

  outputs:
    # omitted here for brevity
```

The example above makes use of a node type `tosca.nodes.DBMS.MySQL` for the `mysql` node template to install MySQL on a server. This node type allows for setting a property `root_password` to adapt the password of the MySQL root user at deployment. The set of properties and their schema has been defined in the node type definition. By means of the `get_input` function, a value provided by the user at deployment time is used as the value for the `root_password` property. The same is true for the `port` property.

The `mysql` node template is related to the `db_server` node template (of type `tosca.nodes.Compute`) via the `requirements` section to indicate where MySQL is to be installed. In the TOSCA metamodel, nodes get related to each other when one node has a requirement against some capability provided by another node. What kinds of requirements exist is defined by the respective node type. In case of MySQL, which

is software that needs to be installed or hosted on a compute resource, the underlying node type named **tosca.nodes.SoftwareComponent** has a predefined requirement called **host**, which needs to be fulfilled by pointing to a node template of type **tosca.nodes.Compute**.

The logical relationship between the **mysql** node and its host **db_server** node would appear as follows:

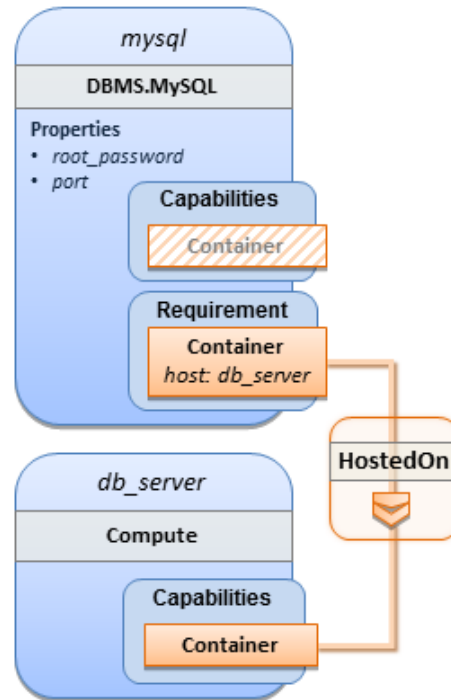

Within the list of **requirements**, each list entry is a map that contains a single key/value pair where the symbolic name of a requirement definition is the *key* and the identifier of the fulfilling node is the *value*. The value is essentially the symbolic name of the other node template; specifically, or the example above, the **host** requirement is fulfilled by referencing the **db_server** node template. The underlying TOSCA **DBMS** node type already has a complete requirement definition for the **host** requirement of type **Compute** and assures that a **HostedOn** TOSCA relationship will automatically be created and will only allow a valid target host node is of type **Compute**. This approach allows the template author to simply provide the name of a valid **Compute** node (i.e., **db_server**) as the value for the **mysql** node's **host** requirement and not worry about defining anything more complex if they do not want to.

2.3 Overriding behavior of predefined node types

Node types in TOSCA have associated implementations that provide the automation (e.g. in the form of scripts such as Bash, Chef or Python) for the normative lifecycle operations of a node. For example, the node type implementation for a MySQL database would associate scripts to TOSCA node operations like **configure**, **start**, or **stop** to manage the state of MySQL at runtime.

Many node types may already come with a set of operational scripts that contain basic commands that can manage the state of that specific node. If it is desired, template authors can provide a custom script for one or more of the operations defined by a node type in their node template which will override the default implementation in the type. The following example shows a **mysql** node template where the template author provides their own configure script:

Example 4 - Node Template overriding its Node Type's "configure" interface

```
tosca_definitions_version: toska_simple_yaml_1_3

description: Template for deploying a single server with MySQL software on top.

topology_template:
  inputs:
    # omitted here for brevity

  node_templates:
    db_server:
      type: toska.nodes.Compute
      # rest omitted here for brevity

    mysql:
      type: toska.nodes.DBMS.MySQL
      properties:
        root_password: { get_input: mysql_rootpw }
        port: { get_input: mysql_port }
      requirements:
        - host: db_server
      interfaces:
        Standard:
          configure: scripts/my_own_configure.sh

  outputs:
    # omitted here for brevity
```

In the example above, the `my_own_configure.sh` script is provided for the `configure` operation of the MySQL node type's `Standard` lifecycle interface. The path given in the example above (i.e., 'scripts/') is interpreted relative to the template file, but it would also be possible to provide an absolute URI to the location of the script.

In other words, operations defined by node types can be thought of as "hooks" into which automation can be injected. Typically, node type implementations provide the automation for those "hooks". However, within a template, custom automation can be injected to run in a hook in the context of the one, specific node template (i.e. without changing the node type).

2.4 TOSCA template for database content deployment

In the Example 4, shown above, the deployment of the MySQL middleware only, i.e. without actual database content was shown. The following example shows how such a template can be extended to also contain the definition of custom database content on-top of the MySQL DBMS software.

Example 5 - Template for deploying database content on-top of MySQL DBMS middleware

```
tosca_definitions_version: toska_simple_yaml_1_3

description: Template for deploying a single server with predefined properties.

topology_template:
  inputs:
    wordpress_db_name:
      type: string
    wordpress_db_user:
      type: string
    wordpress_db_password:
      type: string
    # rest omitted here for brevity

  node_templates:
    db_server:
      type: toska.nodes.Compute
      # rest omitted here for brevity

  mysql:
    type: toska.nodes.DBMS.MySQL
    # rest omitted here for brevity

  wordpress_db:
    type: toska.nodes.Database.MySQL
    properties:
      name: { get_input: wordpress_db_name }
      user: { get_input: wordpress_db_user }
      password: { get_input: wordpress_db_password }
    artifacts:
      db_content:
        file: files/wordpress_db_content.txt
        type: toska.artifacts.File
    requirements:
      - host: mysql
    interfaces:
      Standard:
        create:
          implementation: db_create.sh
        inputs:
```

```

# Copy DB file artifact to server's staging area
db_data: { get_artifact: [ SELF, db_content ] }

outputs:
  # omitted here for brevity

```

In the example above, the `wordpress_db` node template of type `tosca.nodes.Database.MySQL` represents an actual MySQL database instance managed by a MySQL DBMS installation. The `requirements` section of the `wordpress_db` node template expresses that the database it represents is to be hosted on a MySQL DBMS node template named `mysql` which is also declared in this template.

In the `artifacts` section of the `wordpress_db` the node template, there is an artifact definition named `db_content` which represents a text file `wordpress_db_content.txt` which in turn will be used to add content to the SQL database as part of the `create` operation.

As you can see above, a script is associated with the create operation with the name `db_create.sh`. The TOSCA Orchestrator sees that this is not a named artifact declared in the node's artifact section, but instead a filename for a normative TOSCA implementation artifact script type (i.e., `tosca.artifacts.Implementation.Bash`). Since this is an implementation type for TOSCA, the orchestrator will execute the script automatically to create the node on `db_server`, but first it will prepare the local environment with the declared inputs for the operation. In this case, the orchestrator would see that the `db_data` input is using the `get_artifact` function to retrieve the file (`wordpress_db_content.txt`) which is associated with the `db_content` artifact name prior to executing the `db_create.sh` script.

The logical diagram for this example would appear as follows:

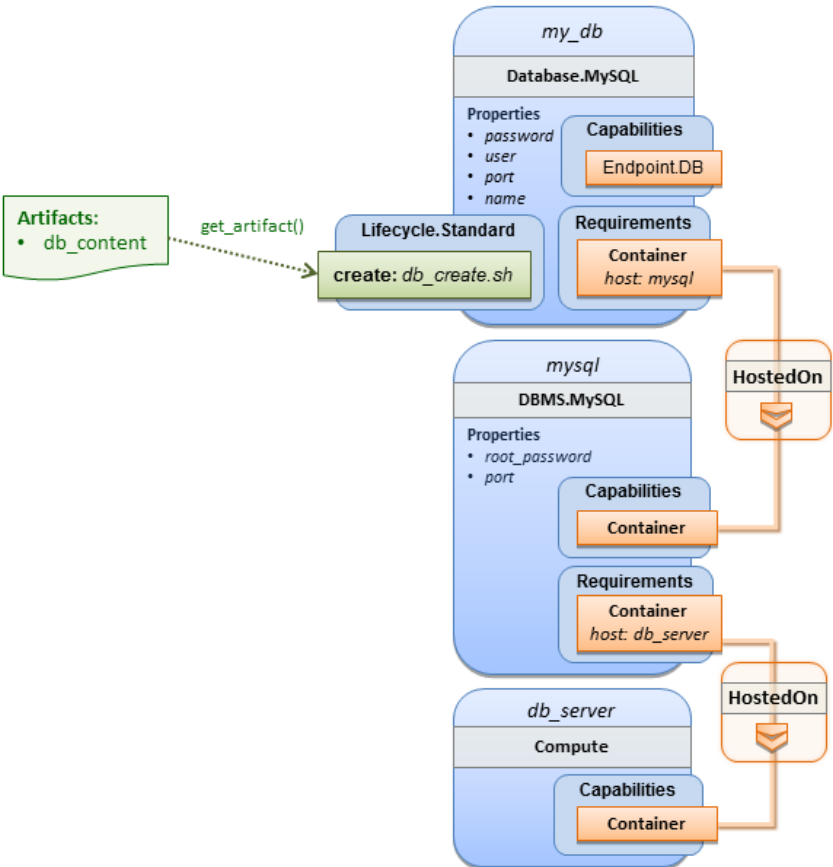

Note that while it would be possible to define one node type and corresponding node templates that represent both the DBMS middleware and actual database content as one entity, TOSCA normative node types distinguish between middleware (container) and application (containee) node types. This allows on one hand to have better re-use of generic middleware node types without binding them to content running on top of them, and on the other hand this allows for better substitutability of, for example, middleware components like a DBMS during the deployment of TOSCA models.

2.5 TOSCA template for a two-tier application

The definition of multi-tier applications in TOSCA is quite similar to the example shown in section 2.2, with the only difference that multiple software node stacks (i.e., node templates for middleware and application layer components), typically hosted on different servers, are defined and related to each other. The example below defines a web application stack hosted on the **web_server** “compute” resource, and a database software stack similar to the one shown earlier in section 6 hosted on the **db_server** compute resource.

Example 6 - Basic two-tier application (web application and database server tiers)

```
tosca_definitions_version: tosca_simple_yaml_1_3

description: Template for deploying a two-tier application servers on 2 servers.

topology_template:
  inputs:
    # Admin user name and password to use with the WordPress application
    wp_admin_username:
      type: string
    wp_admin_password:
      type: string
    mysql_root_password:
      type: string
    context_root:
      type: string
    # rest omitted here for brevity

  node_templates:
    db_server:
      type: tosca.nodes.Compute
      # rest omitted here for brevity

    mysql:
      type: tosca.nodes.DBMS.MySQL
      # rest omitted here for brevity

    wordpress_db:
```

```

type: tosca.nodes.Database.MySQL
# rest omitted here for brevity

web_server:
  type: tosca.nodes.Compute
  # rest omitted here for brevity

apache:
  type: tosca.nodes.WebServer.Apache
  requirements:
    - host: web_server
  # rest omitted here for brevity

wordpress:
  type: tosca.nodes.WebApplication.WordPress
  properties:
    context_root: { get_input: context_root }
    admin_user: { get_input: wp_admin_username }
    admin_password: { get_input: wp_admin_password }
    db_host: { get_attribute: [ db_server, private_address ] }
  requirements:
    - host: apache
    - database_endpoint: wordpress_db
  interfaces:
    Standard:
      inputs:
        db_host: { get_attribute: [ db_server, private_address ] }
        db_port: { get_property: [ mysql, port ] }
        db_name: { get_property: [ wordpress_db, name ] }
        db_user: { get_property: [ wordpress_db, user ] }
        db_password: { get_property: [ wordpress_db, password ] }

  outputs:
    # omitted here for brevity

```

The web application stack consists of the **wordpress** [WordPress], the **apache** [Apache] and the **web_server** node templates. The **wordpress** node template represents a custom web application of type **tosca.nodes.WebApplication.WordPress** which is hosted on an Apache web server represented by the **apache** node template. This hosting relationship is expressed via the **host** entry in the **requirements** section of the **wordpress** node template. The **apache** node template, finally, is hosted on the **web_server** compute node.

The database stack consists of the **wordpress_db**, the **mysql** and the **db_server** node templates. The **wordpress_db** node represents a custom database of type **tosca.nodes.Database.MySQL** which is

hosted on a MySQL DBMS represented by the **mysql** node template. This node, in turn, is hosted on the **db_server** compute node.

The **wordpress** node requires a connection to the **wordpress_db** node, since the WordPress application needs a database to store its data in. This relationship is established through the **database_endpoint** entry in the **requirements** section of the **wordpress** node template's declared node type. For configuring the WordPress web application, information about the database to connect to is required as input to the **configure** operation. Therefore, the input parameters are defined and values for them are retrieved from the properties and attributes of the **wordpress_db** node via the **get_property** and **get_attribute** functions. In the above example, these inputs are defined at the interface-level and would be available to all operations of the **Standard** interface (i.e., the **tosca.interfaces.node.lifecycle.Standard** interface) within the **wordpress** node template and not just the **configure** operation.

2.6 Using a custom script to establish a relationship in a template

In previous examples, the template author did not have to think about explicit relationship types to be used to link a requirement of a node to another node of a model, nor did the template author have to think about special logic to establish those links. For example, the **host** requirement in previous examples just pointed to another node template and based on metadata in the corresponding node type definition the relationship type to be established is implicitly given.

In some cases, it might be necessary to provide special processing logic to be executed when establishing relationships between nodes at runtime. For example, when connecting the WordPress application from previous examples to the MySQL database, it might be desired to apply custom configuration logic in addition to that already implemented in the application node type. In such a case, it is possible for the template author to provide a custom script as implementation for an operation to be executed at runtime as shown in the following example.

Example 7 - Providing a custom relationship script to establish a connection

```
tosca_definitions_version: tosca_simple_yaml_1_3

description: Template for deploying a two-tier application on two servers.

topology_template:
  inputs:
    # omitted here for brevity

  node_templates:
    db_server:
      type: tosca.nodes.Compute
      # rest omitted here for brevity

    mysql:
      type: tosca.nodes.DBMS.MySQL
      # rest omitted here for brevity

    wordpress_db:
      type: tosca.nodes.Database.MySQL
      # rest omitted here for brevity
```



```

web_server:
  type: toska.nodes.Compute
  # rest omitted here for brevity

apache:
  type: toska.nodes.WebServer.Apache
  requirements:
    - host: web_server
  # rest omitted here for brevity

wordpress:
  type: toska.nodes.WebApplication.WordPress
  properties:
    # omitted here for brevity
  requirements:
    - host: apache
    - database_endpoint:
        node: wordpress_db
        relationship: wp_db_connection
  # rest omitted here for brevity

wordpress_db:
  type: toska.nodes.Database.MySQL
  properties:
    # omitted here for the brevity
  requirements:
    - host: mysql

relationship_templates:
  wp_db_connection:
    type: ConnectsTo
    interfaces:
      Configure:
        pre_configure_source: scripts/wp_db_configure.sh

outputs:
  # omitted here for brevity

```

The node type definition for the **wordpress** node template is **WordPress** which declares the complete **database_endpoint** requirement definition. This **database_endpoint** declaration indicates it must be fulfilled by any node template that provides an **Endpoint.Database** Capability Type using a **ConnectsTo** relationship. The **wordpress_db** node template's underlying **MySQL** type definition indeed provides the

Endpoint.Database Capability type. In this example however, no explicit relationship template is declared; therefore, TOSCA orchestrators would automatically create a **ConnectsTo** relationship to establish the link between the **wordpress** node and the **wordpress_db** node at runtime.

The **ConnectsTo** relationship (see 5.7.4) also provides a default **Configure** interface with operations that optionally get executed when the orchestrator establishes the relationship. In the above example, the author has provided the custom script **wp_db_configure.sh** to be executed for the operation called **pre_configure_source**. The script file is assumed to be located relative to the referencing service template such as a relative directory within the TOSCA Cloud Service Archive (CSAR) packaging format. This approach allows for conveniently hooking in custom behavior without having to define a completely new derived relationship type.

2.7 Using custom relationship types in a TOSCA template

In the previous section it was shown how custom behavior can be injected by specifying scripts inline in the requirements section of node templates. When the same custom behavior is required in many templates, it does make sense to define a new relationship type that encapsulates the custom behavior in a re-usable way instead of repeating the same reference to a script (or even references to multiple scripts) in many places.

Such a custom relationship type can then be used in templates as shown in the following example.

Example 8 - A web application Node Template requiring a custom database connection type

```
tosca_definitions_version: tosca_simple_yaml_1_3

description: Template for deploying a two-tier application on two servers.

topology_template:
  inputs:
    # omitted here for brevity

  node_templates:
    wordpress:
      type: tosca.nodes.WebApplication.WordPress
      properties:
        # omitted here for brevity
      requirements:
        - host: apache
        - database_endpoint:
            node: wordpress_db
            relationship: my.types.WordpressDbConnection

    wordpress_db:
      type: tosca.nodes.Database.MySQL
      properties:
        # omitted here for the brevity
      requirements:
```

```
- host: mysql

# other resources not shown here ...
```

In the example above, a special relationship type `my.types.WordpressDbConnection` is specified for establishing the link between the `wordpress` node and the `wordpress_db` node through the use of the `relationship` keyword in the `database` reference. It is assumed, that this special relationship type provides some extra behavior (e.g., an operation with a script) in addition to what a generic “connects to” relationship would provide. The definition of this custom relationship type is shown in the following section.

2.7.1 Definition of a custom relationship type

The following YAML snippet shows the definition of the custom relationship type used in the previous section. This type derives from the base “ConnectsTo” and overrides one operation defined by that base relationship type. For the `pre_configure_source` operation defined in the `Configure` interface of the `ConnectsTo` relationship type, a script implementation is provided. It is again assumed that the custom configure script is located at a location relative to the referencing service template, perhaps provided in some application packaging format (e.g., the TOSCA Cloud Service Archive (CSAR) format).

Example 9 - Defining a custom relationship type

```
tosca_definitions_version: tosca_simple_yaml_1_3

description: Definition of custom WordpressDbConnection relationship type

relationship_types:
  my.types.WordpressDbConnection:
    derived_from: tosca.relationships.ConnectsTo
    interfaces:
      Configure:
        pre_configure_source: scripts/wp_db_configure.sh
```

2.8 Defining generic dependencies between nodes in a template

In some cases, it can be necessary to define a generic dependency between two nodes in a template to influence orchestration behavior, i.e. to first have one node processed before another dependent node gets processed. This can be done by using the generic `dependency` requirement which is defined by the [TOSCA Root Node Type](#) and thus gets inherited by all other node types in TOSCA (see section 5.9.1).

Example 10 - Simple dependency relationship between two nodes

```
tosca_definitions_version: tosca_simple_yaml_1_3

description: Template with a generic dependency between two nodes.

topology_template:
  inputs:
    # omitted here for brevity
```

```

node_templates:
  my_app:
    type: my.types.MyApplication
    properties:
      # omitted here for brevity
    requirements:
      - dependency: some_service

some_service:
  type: some.nodetype.SomeService
  properties:
    # omitted here for brevity

```

As in previous examples, the relation that one node depends on another node is expressed in the **requirements** section using the built-in requirement named **dependency** that exists for all node types in TOSCA. Even if the creator of the **MyApplication** node type did not define a specific requirement for **SomeService** (similar to the **database** requirement in the example in section 2.6), the template author who knows that there is a timing dependency and can use the generic **dependency** requirement to express that constraint using the very same syntax as used for all other references.

2.9 Describing abstract requirements for nodes and capabilities in a TOSCA template

In TOSCA templates, nodes are either:

- **Concrete:** meaning that they have a deployment and/or one or more implementation artifacts that are declared on the “create” operation of the node’s Standard lifecycle interface, or they are
- **Abstract:** where the template describes only the node type along with its required capabilities and properties that must be satisfied.

TOSCA Orchestrators, by default, when finding an abstract node in TOSCA Service Template during deployment will attempt to “select” a concrete implementation for the abstract node type that best matches and fulfills the requirements and property constraints the template author provided for that abstract node. The concrete implementation of the node could be provided by another TOSCA Service Template (perhaps located in a catalog or repository known to the TOSCA Orchestrator) or by an existing resource or service available within the target Cloud Provider’s platform that the TOSCA Orchestrator already has knowledge of.

TOSCA supports two methods for template authors to express requirements for an abstract node within a TOSCA service template.

1. **Using a target node filter:** where a node template can describe a requirement (relationship) for another node without including it in the topology. Instead, the node provides a `node_filter` to describe the target node type along with its capabilities and property constraints
2. **Using an abstract node template:** that describes the abstract node’s type along with its property constraints and any requirements and capabilities it also exports. This first method you have

already seen in examples from previous chapters where the Compute node is abstract and selectable by the TOSCA Orchestrator using the supplied Container and [OperatingSystem](#) capabilities property constraints.

These approaches allow architects and developers to create TOSCA service templates that are composable and can be reused by allowing flexible matching of one template's requirements to another's capabilities. Examples of both these approaches are shown below.

The following section describe how a user can define a requirement for an orchestrator to select an implementation and replace a node. For more details on how an orchestrator may perform matching and select a node from it's catalog(s) you may look at section 14 of the specification.

2.9.1 Using a `node_filter` to define hosting infrastructure requirements for a software

Using TOSCA, it is possible to define only the software components of an application in a template and just express constrained requirements against the hosting infrastructure. At deployment time, the provider can then do a late binding and dynamically allocate or assign the required hosting infrastructure and place software components on top.

This example shows how a single software component (i.e., the mysql node template) can define its **host** requirements that the TOSCA Orchestrator and provider will use to select or allocate an appropriate host **Compute** node by using matching criteria provided on a **node_filter**.

Example 11 - An abstract "host" requirement using a node filter

```
tosca_definitions_version: tosca_simple_yaml_1_3

description: Template with requirements against hosting infrastructure.

topology_template:
  inputs:
    # omitted here for brevity

  node_templates:
    mysql:
      type: tosca.nodes.DBMS.MySQL
      properties:
        # omitted here for brevity
      requirements:
        - host:
            node_filter:
              capabilities:
                # Constraints for selecting "host" (Container Capability)
                - host:
                    properties:
                      - num_cpus: { in_range: [ 1, 4 ] }
```

```

        - mem_size: { greater_or_equal: 2 GB }
# Constraints for selecting "os" (OperatingSystem Capability)
- os:
  properties:
    - architecture: { equal: x86_64 }
    - type: linux
    - distribution: ubuntu

```

In the example above, the `mysql` component contains a `host` requirement for a node of type `Compute` which it inherits from its parent DBMS node type definition; however, there is no declaration or reference to any node template of type `Compute`. Instead, the `mysql` node template augments the abstract `host` requirement with a `node_filter` which contains additional selection criteria (in the form of property constraints that the provider must use when selecting or allocating a host `Compute` node).

Some of the constraints shown above narrow down the boundaries of allowed values for certain properties such as `mem_size` or `num_cpus` for the `host` capability by means of qualifier functions such as `greater_or_equal`. Other constraints, express specific values such as for the `architecture` or `distribution` properties of the `os` capability which will require the provider to find a precise match.

Note that when no qualifier function is provided for a property (filter), such as for the `distribution` property, it is interpreted to mean the `equal` operator as shown on the `architecture` property.

2.9.2 Using an abstract node template to define infrastructure requirements for software

This previous approach works well if no other component (i.e., another node template) other than `mysql` node template wants to reference the same `Compute` node the orchestrator would instantiate. However, perhaps another component wants to also be deployed on the same host, yet still allow the flexible matching achieved using a node-filter. The alternative to the above approach is to create an abstract node template that represents the `Compute` node in the topology as follows:

Example 12 - An abstract Compute node template with a node filter

```

tosca_definitions_version: tosca_simple_yaml_1_3

description: Template with requirements against hosting infrastructure.

topology_template:
  inputs:
    # omitted here for brevity

  node_templates:
    mysql:
      type: tosca.nodes.DBMS.MySQL
      properties:
        # omitted here for brevity
      requirements:
        - host: mysql_compute

# Abstract node template (placeholder) to be selected by provider
mysql_compute:
  type: Compute
  directives: [ select ]
  node_filter:

```

```

capabilities:
  - host:
      properties:
        num_cpus: { equal: 2 }
        mem_size: { greater_or_equal: 2 GB }
  - os:
      properties:
        architecture: { equal: x86_64 }
        type: linux
        distribution: ubuntu

```

In this node template, the `mysql_compute` node template is marked as abstract using the `select` directive. As you can see the resulting `mysql_compute` node template looks very much like the “hello world” template as shown in [Chapter 2.1](#) but this one also allows the TOSCA orchestrator more flexibility when “selecting” a host `Compute` node by providing flexible constraints for properties like `mem_size`.

As we proceed, you will see that TOSCA provides many normative node types like `Compute` for commonly found services (e.g., `BlockStorage`, `WebServer`, `Network`, etc.). When these TOSCA normative node types are used in your application’s topology they are always assumed to be “implementable” by TOSCA Orchestrators which work with target infrastructure providers to find or allocate the best match for them based upon your application’s requirements and constraints.

2.9.3 Using a `node_filter` to define requirements on a database for an application

In the same way requirements can be defined on the hosting infrastructure (as shown above) for an application, it is possible to express requirements against application or middleware components such as a database that is not defined in the same template. The provider may then allocate a database by any means, (e.g. using a database-as-a-service solution).

Example 13 - An abstract database requirement using a node filter

```

tosca_definitions_version: tosca_simple_yaml_1_3

description: Template with a TOSCA Orchestrator selectable database requirement
using a node_filter.

topology_template:
  inputs:
    # omitted here for brevity

  node_templates:
    my_app:
      type: my.types.MyApplication
      properties:
        admin_user: { get_input: admin_username }
        admin_password: { get_input: admin_password }
        db_endpoint_url: { get_property: [SELF, database_endpoint, url_path ] }
      requirements:
        - database_endpoint:

```

```

node: my.types.nodes.MyDatabase
node_filter:
  properties:
    - db_version: { greater_or_equal: 5.5 }

```

In the example above, the application `my_app` requires a database node of type `MyDatabase` which has a `db_version` property value of `greater_or_equal` to the value 5.5.

This example also shows how the `get_property` intrinsic function can be used to retrieve the `url_path` property from the database node that will be selected by the provider and connected to `my_app` at runtime due to fulfillment of the `database_endpoint` requirement. To locate the property, the `get_property`'s first argument is set to the keyword `SELF` which indicates the property is being referenced from something in the node itself. The second parameter is the name of the requirement named `database_endpoint` which contains the property we are looking for. The last argument is the name of the property itself (i.e., `url_path`) which contains the value we want to retrieve and assign to `db_endpoint_url`.

The alternative representation, which includes a node template in the topology for database that is still selectable by the TOSCA orchestrator for the above example, is as follows:

Example 14 - An abstract database node template

```

tosca_definitions_version: tosca_simple_yaml_1_3

description: Template with a TOSCA Orchestrator selectable database using node
template.

topology_template:
  inputs:
    # omitted here for brevity

  node_templates:
    my_app:
      type: my.types.MyApplication
      properties:
        admin_user: { get_input: admin_username }
        admin_password: { get_input: admin_password }
        db_endpoint_url: { get_property: [SELF, database_endpoint, url_path ] }
      requirements:
        - database_endpoint: my_abstract_database

    my_abstract_database:
      type: my.types.nodes.MyDatabase
      properties:
        - db_version: { greater_or_equal: 5.5 }

```

2.10 Using node template substitution for model composition

From an application perspective, it is often not necessary or desired to dive into platform details, but the platform/runtime for an application is abstracted. In such cases, the template for an application can use generic representations of platform components. The details for such platform components, such as the underlying hosting infrastructure and its configuration, can then be defined in separate template files that can be used for substituting the more abstract representations in the application level template file. Service designers use the **substitute** directive to declare node templates as abstract. At deployment time, TOSCA orchestrators are expected to *substitute* abstract node templates in a service template before service orchestration can be performed.

2.10.1 Understanding node template instantiation through a TOSCA Orchestrator

When a topology template is instantiated by a TOSCA Orchestrator, the orchestrator has to first look for abstract node templates in the topology template. Abstract node templates are node templates that include the **substitute** directive. These abstract node templates must then be realized using *substituting service templates* that are compatible with the node types specified for each abstract node template. Such realizations can either be node types that include the appropriate implementation artifacts and deployment artifacts that can be used by the orchestrator to bring to life the real-world resource modeled by a node template. Alternatively, separate topology templates may be annotated as being suitable for realizing a node template in the top-level topology template.

In the latter case, a TOSCA Orchestrator will use additional substitution mapping information provided as part of the substituting topology templates to derive how the substituted part gets “wired” into the overall deployment, for example, how capabilities of a node template in the top-level topology template get bound to capabilities of node templates in the substituting topology template.

Thus, in cases where no “normal” node type implementation is available, or the node type corresponds to a whole subsystem that cannot be implemented as a single node, additional topology templates can be used for filling in more abstract placeholders in top level application templates.

2.10.2 Definition of the top-level service template

The following sample defines a web application **web_app** connected to a database **db**. In this example, the complete hosting stack for the application is defined within the same topology template: the web application is hosted on a web server **web_server**, which in turn is installed (hosted) on a compute node **server**.

The hosting stack for the database **db**, in contrast, is not defined within the same file but only the database is represented as a node template of type **tosca.nodes.Database**. The underlying hosting stack for the database is defined in a separate template file, which is shown later in this section. Within the current template, only a number of properties (**user**, **password**, **name**) are assigned to the database using hardcoded values in this simple example.

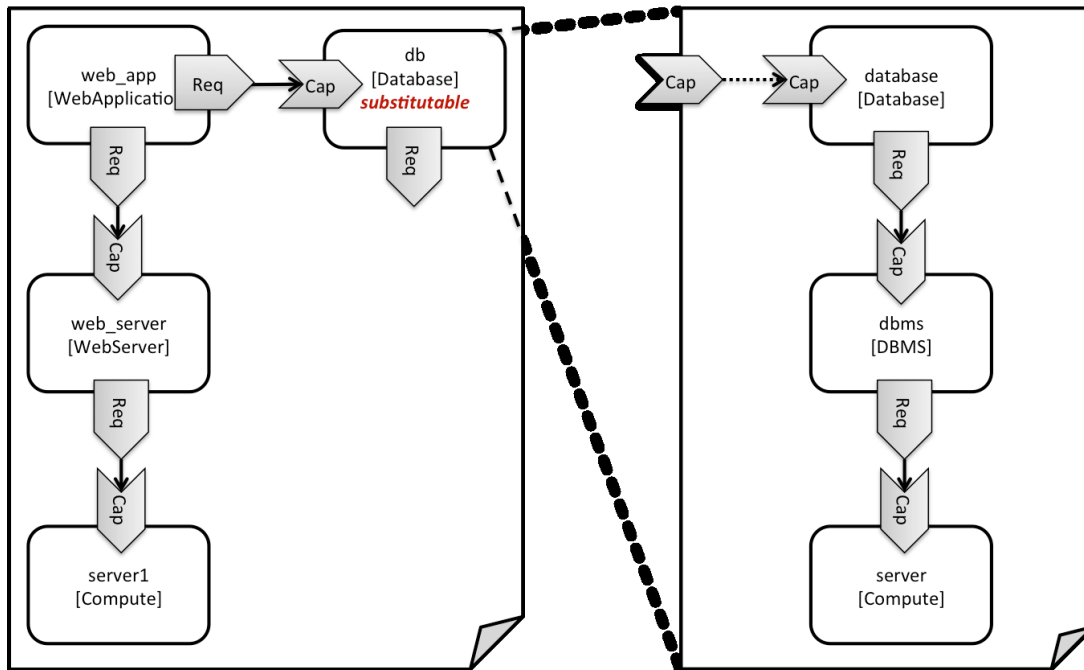

Figure 1: Using template substitution to implement a database tier

When a node template is to be substituted by another service template, this has to be indicated to an orchestrator by marking the node template as abstract using the **substitute** directive. Orchestrators can only instantiate abstract node templates by substituting them with a service template that consists entirely of concrete nodes. Note that abstract node template substitution may need to happen recursively before a service template is obtained that consists only of concrete nodes.

Note that in contrast to the use case described in section 2.9.2 (where a database was abstractly referred to in the **requirements** section of a node and the database itself was not represented as a node template), the approach shown here allows for some additional modeling capabilities in cases where this is required.

For example, if multiple components need to use the same database (or any other sub-system of the overall service), this can be expressed by means of normal relations between node templates, whereas such modeling would not be possible in **requirements** sections of disjoint node templates.

Example 15 - Referencing an abstract database node template

```
tosca_definitions_version: tosca_simple_yaml_1_3

topology_template:
  description: Template of an application connecting to a database.

  node_templates:
    web_app:
      type: tosca.nodes.WebApplication.MyWebApp
      requirements:
        - host: web_server
        - database_endpoint: db
```

```

web_server:
  type: toska.nodes.WebServer
  requirements:
    - host: server

server:
  type: toska.nodes.Compute
  # details omitted for brevity

db:
  # This node is abstract as specified by the substitute directive
  # and must be substituted with a topology provided by another template
  # that exports a Database type's capabilities.
  type: toska.nodes.Database
  directives:
    - substitute
  properties:
    user: my_db_user
    password: secret
    name: my_db_name

```

2.10.3 Definition of the database stack in a service template

The following sample defines a template for a database including its complete hosting stack, i.e. the template includes a **database** node template, a template for the database management system (**dbms**) hosting the database, as well as a computer node **server** on which the DBMS is installed.

This service template can be used standalone for deploying just a database and its hosting stack. In the context of the current use case, though, this template can also substitute the database node template in the previous snippet and thus fill in the details of how to deploy the database.

In order to enable such a substitution, an additional metadata section **substitution_mappings** is added to the topology template to tell a TOSCA Orchestrator how exactly the topology template will fit into the context where it gets used. For example, requirements or capabilities of the node that gets substituted by the topology template have to be mapped to requirements or capabilities of internal node templates for allow for a proper wiring of the resulting overall graph of node templates.

In short, the **substitution_mappings** section provides the following information:

1. It defines what node templates, i.e. node templates of which type, can be substituted by the topology template.
2. It defines how capabilities of the substituted node (or the capabilities defined by the node type of the substituted node template, respectively) are bound to capabilities of node templates defined in the topology template.
3. It defines how requirements of the substituted node (or the requirements defined by the node type of the substituted node template, respectively) are bound to requirements of node templates defined in the topology template.

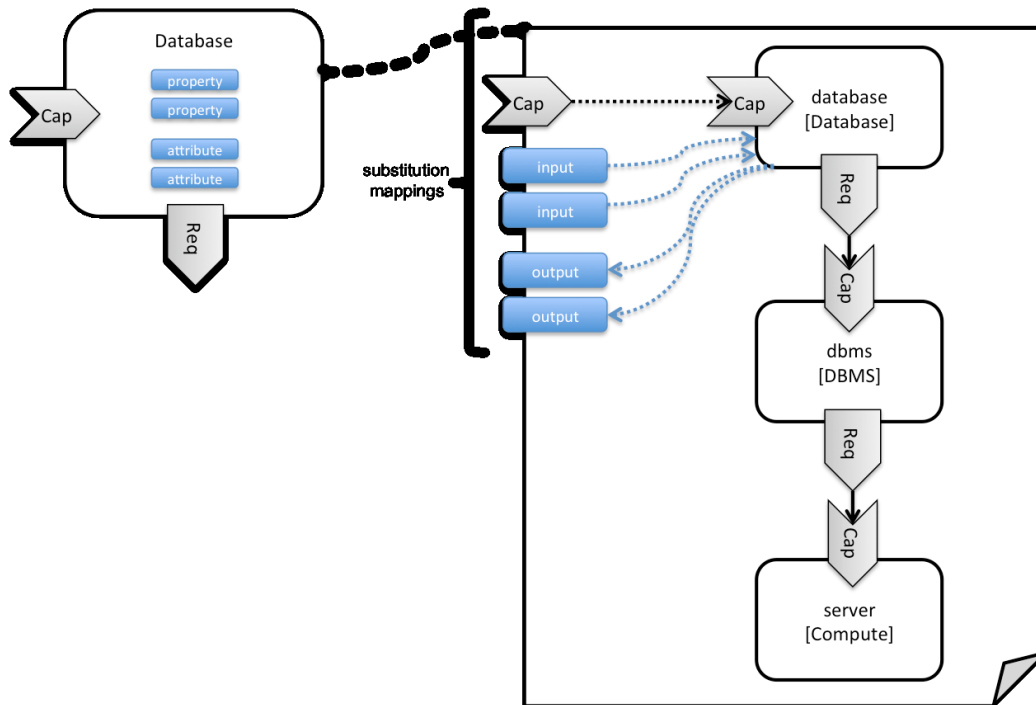

Figure 2: Substitution mappings

The **substitution_mappings** section in the sample below denotes that this topology template can be used for substituting node templates of type **tosca.nodes.Database**. It further denotes that the **database_endpoint** capability of the substituted node gets fulfilled by the **database_endpoint** capability of the **database** node contained in the topology template.

Example 16 - Using substitution mappings to export a database implementation

```

tosca_definitions_version: tosca_simple_yaml_1_3

topology_template:
  description: Template of a database including its hosting stack.

  inputs:
    db_user:
      type: string
    db_password:
      type: string
    # other inputs omitted for brevity

  substitution_mappings:
    node_type: tosca.nodes.Database
    capabilities:
      database_endpoint: [ database, database_endpoint ]

  node_templates:

```

```

database:
  type: toska.nodes.Database
  properties:
    user: { get_input: db_user }
    # other properties omitted for brevity
  requirements:
    - host: dbms

dbms:
  type: toska.nodes.DBMS
  # details omitted for brevity

server:
  type: toska.nodes.Compute
  # details omitted for brevity

```

Note that the **substitution_mappings** section does not define any mappings for requirements of the Database node type, since all requirements are fulfilled by other nodes templates in the current topology template. In cases where a requirement of a substituted node is bound in the top-level service template as well as in the substituting topology template, a TOSCA Orchestrator should raise a validation error.

Further note that no mappings for properties or attributes of the substituted node are defined. Instead, the inputs and outputs defined by the topology template are mapped to the appropriate properties and attributes of the substituted node. If there are more inputs than the substituted node has properties, default values must be defined for those inputs, since no values can be assigned through properties in a substitution case.

2.11 Using node template substitution for chaining subsystems

A common use case when providing an end-to-end service is to define a chain of several subsystems that together implement the overall service. Those subsystems are typically defined as separate service templates to (1) keep the complexity of the end-to-end service template at a manageable level and to (2) allow for the re-use of the respective subsystem templates in many different contexts. The type of subsystems may be specific to the targeted workload, application domain, or custom use case. For example, a company or a certain industry might define a subsystem type for company- or industry specific data processing and then use that subsystem type for various end-user services. In addition, there might be generic subsystem types like a database subsystem that are applicable to a wide range of use cases.

2.11.1 Defining the overall subsystem chain

Figure 3 shows the chaining of three subsystem types – a message queuing subsystem, a transaction processing subsystem, and a databank subsystem – that support, for example, an online booking application. On the front end, this chain provides a capability of receiving messages for handling in the message queuing subsystem. The message queuing subsystem in turn requires a number of receivers, which in the current example are two transaction processing subsystems. The two instances of the transaction processing subsystem might be deployed on two different hosting infrastructures or datacenters for high-availability reasons. The transaction processing subsystems finally require a database subsystem for accessing and storing application specific data. The database subsystem in the backend does not require any further component and is therefore the end of the chain in this example.

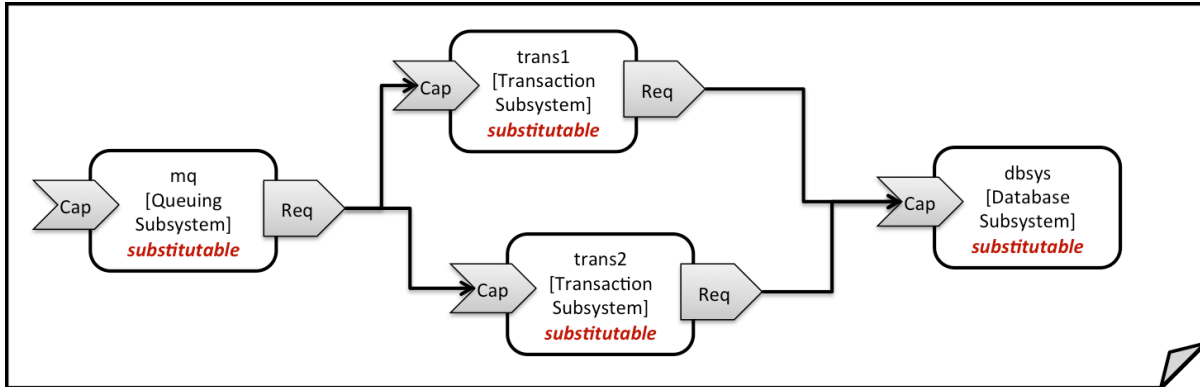

Figure 3: Chaining of subsystems in a service template

All of the node templates in the service template shown above are abstract and considered substitutable where each can be treated as their own subsystem; therefore, when instantiating the overall service, the orchestrator would realize each substitutable node template using other TOSCA service templates. These service templates would include more nodes and relationships that include the details for each subsystem. A simplified version of a TOSCA service template for the overall service is given in the following listing.

Example 17 - Declaring a transaction subsystem as a chain of substitutable node templates

```

tosca_definitions_version: tosca_simple_yaml_1_3

topology_template:
  description: Template of online transaction processing service.

  node_templates:
    mq:
      type: example.QueuingSubsystem
      directives:
        - substitute
      properties:
        # properties omitted for brevity
      capabilities:
        message_queue_endpoint:
          # details omitted for brevity
      requirements:
        - receiver: trans1
        - receiver: trans2

    trans1:
      type: example.TransactionSubsystem
      directives:
        - substitute
  
```

```

properties:
  mq_service_ip: { get_attribute: [ mq, service_ip ] }
  receiver_port: 8080
capabilities:
  message_receiver:
    # details omitted for brevity
requirements:
  - database_endpoint: dbsys

trans2:
  type: example.TransactionSubsystem
  directives:
    - substitute
  properties:
    mq_service_ip: { get_attribute: [ mq, service_ip ] }
    receiver_port: 8080
  capabilities:
    message_receiver:
      # details omitted for brevity
  requirements:
    - database_endpoint: dbsys

dbsys:
  type: example.DatabaseSubsystem
  directives:
    - substitute
  properties:
    # properties omitted for brevity
  capabilities:
    database_endpoint:
      # details omitted for brevity

```

As can be seen in the example above, the subsystems are chained to each other by binding requirements of one subsystem node template to other subsystem node templates that provide the respective capabilities. For example, the **receiver** requirement of the message queuing subsystem node template **mq** is bound to transaction processing subsystem node templates **trans1** and **trans2**.

Subsystems can be parameterized by providing properties. In the listing above, for example, the IP address of the message queuing server is provided as property **mq_service_ip** to the transaction processing subsystems and the desired port for receiving messages is specified by means of the **receiver_port** property.

If attributes of the instantiated subsystems need to be obtained, this would be possible by using the **get_attribute** intrinsic function on the respective subsystem node templates.

2.11.2 Defining a subsystem (node) type

The types of subsystems that are required for a certain end-to-end service are defined as TOSCA node types as shown in the following example. Node templates of those node types can then be used in the end-to-end service template to define subsystems to be instantiated and chained for establishing the end-to-end service.

The realization of the defined node type will be given in the form of a whole separate service template as outlined in the following section.

Example 18 - Defining a TransactionSubsystem node type

```
tosca_definitions_version: tosca_simple_yaml_1_3

node_types:
  example.TransactionSubsystem:
    properties:
      mq_service_ip:
        type: string
      receiver_port:
        type: integer
    attributes:
      receiver_ip:
        type: string
      receiver_port:
        type: integer
    capabilities:
      message_receiver: tosca.capabilities.Endpoint
    requirements:
      - database_endpoint: tosca.capabilities.Endpoint.Database
```

Configuration parameters that would be allowed for customizing the instantiation of any subsystem are defined as properties of the node type. In the current example, those are the properties **mq_service_ip** and **receiver_port** that had been used in the end-to-end service template in section 2.11.1.

Observable attributes of the resulting subsystem instances are defined as attributes of the node type. In the current case, those are the IP address of the message receiver as well as the actually allocated port of the message receiver endpoint.

2.11.3 Defining the details of a subsystem

The details of a subsystem, i.e. the software components and their hosting infrastructure, are defined as node templates and relationships in a service template. By means of substitution mappings that have been introduced in section 2.10.2, the service template is annotated to indicate to an orchestrator that it can be used as realization of a node template of a certain type, as well as how characteristics of the node type are mapped to internal elements of the service template.

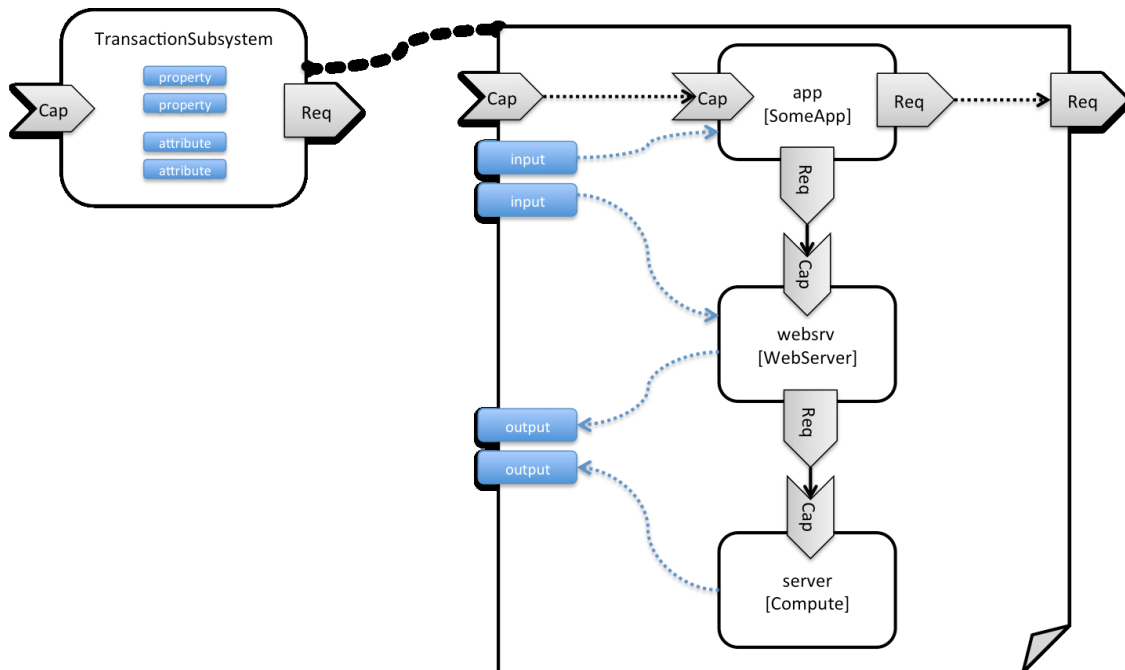

Figure 4: Defining subsystem details in a service template

Figure 1 illustrates how a transaction processing subsystem as outlined in the previous section could be defined in a service template. In this example, it simply consists of a custom application **app** of type **SomeApp** that is hosted on a web server **websrv**, which in turn is running on a compute node.

The application named **app** provides a capability to receive messages, which is bound to the **message_receiver** capability of the substitutable node type. It further requires access to a database, so the application's **database_endpoint** requirement is mapped to the **database_endpoint** requirement of the **TransactionSubsystem** node type.

Properties of the **TransactionSubsystem** node type are used to customize the instantiation of a subsystem. Those properties can be mapped to any node template for which the author of the subsystem service template wants to expose configurability. In the current example, the application **app** and the web server middleware **websrv** get configured through properties of the **TransactionSubsystem** node type. All properties of that node type are defined as **inputs** of the service template. The input parameters in turn get mapped to node templates by means of **get_input** function calls in the respective sections of the service template.

Similarly, attributes of the whole subsystem can be obtained from attributes of particular node templates. In the current example, attributes of the web server and the hosting compute node will be exposed as subsystem attributes. All exposed attributes that are defined as attributes of the substitutable **TransactionSubsystem** node type are defined as outputs of the subsystem service template.

An outline of the subsystem service template is shown in the listing below. Note that this service template could be used for stand-alone deployment of a transaction processing system as well, i.e. it is not restricted just for use in substitution scenarios. Only the presence of the **substitution_mappings** metadata section in the **topology_template** enables the service template for substitution use cases.

Example 19 - Implementation of a *TransactionSubsystem* node type using substitution mappings

```
tosca_definitions_version: toska_simple_yaml_1_3
```

```
topology_template:
```

```

description: Template of a database including its hosting stack.

inputs:
  mq_service_ip:
    type: string
    description: IP address of the message queuing server to receive messages
from
  receiver_port:
    type: string
    description: Port to be used for receiving messages
  # other inputs omitted for brevity

substitution_mappings:
  node_type: example.TransactionSubsystem
  capabilities:
    message_receiver: [ app, message_receiver ]
  requirements:
    database_endpoint: [ app, database ]

node_templates:
  app:
    type: example.SomeApp
    properties:
      # properties omitted for brevity
    capabilities:
      message_receiver:
        properties:
          service_ip: { get_input: mq_service_ip }
          # other properties omitted for brevity
    requirements:
      - database:
          # details omitted for brevity
      - host: webserv

  webserv:
    type: toska.nodes.WebServer
    properties:
      # properties omitted for brevity
    capabilities:
      data_endpoint:
        properties:

```

```

        port_name: { get_input: receiver_port }
        # other properties omitted for brevity
requirements:
  - host: server

server:
  type: tosca.nodes.Compute
  # details omitted for brevity

outputs:
  receiver_ip:
    description: private IP address of the message receiver application
    value: { get_attribute: [ server, private_address ] }
  receiver_port:
    description: Port of the message receiver endpoint
    value: { get_attribute: [ app, app_endpoint, port ] }

```

2.12 Using node template substitution to provide product choice

Some service templates might include abstract node templates that model specific functionality without fully specifying the exact product or technology that provides that functionality. The objective of such service templates is to allow the end-user of the service to decide *at service deployment time* which specific product component to use.

2.12.1 Defining a service template with vendor-independent component

For example, let's assume an abstract security service that includes a firewall component where the choice of firewall product is left to the end-user at service deployment time. The following template shows an example of such a service: it includes an abstract firewall node template that has a *vendor* property that represents the firewall vendor. The value of this property is obtained from a topology input variable that allows end-users to specify the desired firewall vendor at deployment time.

Defining a security service with a vendor-independent firewall component

```

tosca_definitions_version: tosca_simple_yaml_1_3

description: Service template for an abstract security service

topology_template:

  inputs:
    vendorInput:
      type: string
    rulesInput:
      type: list
      entry_schema: FirewallRules

  node_templates:
    firewall:
      type: abstract.Firewall
      directives:
        - substitute

```

```
properties:
  vendor: { get_input: vendorInput }
  rules: { get_input: rulesInput }
```

The abstract firewall node type is defined in the following code snippet. The abstract firewall node type defines a *rules* property to hold the configured firewall rules. In addition, it also defines a property for capturing the name of the vendor of the firewall.

Node type defining an abstract firewall component

```
tosca_definitions_version: tosca_simple_yaml_1_3

description: Template defining an abstract firewall component

node_types:
  abstract.Firewall:
    derived_from: tosca.nodes.Root
    properties:
      vendor:
        type: string
      rules:
        type: list
        entry_schema: FirewallRules
```

2.12.2 Defining vendor-specific component options

In the above example, the firewall node template is abstract, which means that it needs to be substituted with a substituting firewall template. Let's assume we have two firewall vendors—ACME Firewalls and Simple Firewalls—who each provide implementations for the abstract firewall component. Their respective implementations are defined in vendor-specific service templates. ACME Firewall's service template might look as follows:

Service template for an ACME firewall

```
tosca_definitions_version: tosca_simple_yaml_1_3

description: Service template for an ACME firewall

topology_template:

  inputs:
    rulesInput:
      type: list
      entry_schema: FirewallRules

  substitution_mappings:
    node_type: abstract.Firewall
    properties:
      rules: [ rulesInput ]

  node_templates:
    acme:
      type: ACMEFirewall
      properties:
        rules: { get_input: rulesInput }
        acmeConfig: # any ACME-specific properties go here.
```

In this example the node type ACMEFirewall is an ACME-specific node type that models the internals of the ACME firewall product. The ACMEFirewall node type definition is omitted here for brevity since it is not relevant for the example.

Similarly, Simple Firewall's service template looks as follows:

Service template for a Simple Firewall

```
tosca_definitions_version: tosca_simple_yaml_1_3

description: Service template for a Simple Corp. firewall

topology_template:

  inputs:
    rulesInput:
      type: list
      entry_schema: FirewallRules

  substitution_mappings:
    node_type: abstract.Firewall
    properties:
      rules: [ rulesInput ]

  node_templates:
    acme:
      type: SimpleFirewall
      properties:
        rules: { get_input: rulesInput }
```

As the substitution mappings section in the service templates show, either firewall service template can be used to implement the abstract firewall component defined above.

2.12.3 Substitution matching using substitution filters

Since both the ACME Firewall and the Simple Firewall can substitute for abstract node templates of type `abstract.Firewall`, either firewall is a valid candidate to substitute the abstract firewall node template. When multiple matching templates are available, the orchestrator must provide mechanisms to allow the end-user to drive the decision about which matching template must be selected.

TOSCA uses a **substitution_filter** in the substitution mappings section of a service template to further constrain the abstract nodes for which a service template can be a valid substitution. Using substitution filters, a service template is a valid candidate to substitute an abstract node template if the following two conditions are met:

1. The **type** advertised in the `substitution_mappings` section of the service template matches the type of the abstract node template.
2. The property values of the abstract node template satisfy the constraints defined in the **substitution_filter** of the substituting service template.

In the security service example used in this section, the value of the `vendor` property of the abstract firewall node template is provide by the end-user using a topology input parameter. Substituting templates use a `substitution_filter` to match the appropriate vendor-specific service templates with the abstract firewall node template based on the value of the `vendor` property.

The following code snippet shows an updated version of the ACME Firewall service template. This version includes a `substitution_filter` that specifies that this service template only matches abstract firewall nodes with a `vendor` property equal to 'ACME'.

Service template for an ACME firewall with a substitution filter

```
tosca_definitions_version: tosca_simple_yaml_1_3

description: Service template for an ACME firewall
```

```

topology_template:

  inputs:
    rulesInput:
      type: list
      entry_schema: FirewallRules

  substitution_mappings:
    node_type: abstract.Firewall
    substitution_filter:
      properties:

---

- vendor: { equal: ACME }

---

  properties:
    rules: [ rulesInput ]

  node_templates:
    acme:
      type: ACMEFirewall
      properties:
        rules: { get_input: rulesInput }
        acmeConfig: # any ACME-specific properties go here.

---



```

Similarly, an updated service template for Simple Corp's firewall looks as follows:

Service template for a Simple firewall with a substitution filter

```



---

tosca_definitions_version: tosca_simple_yaml_1_3
description: Service template for a Simple Corp. firewall

topology_template:

  inputs:
    rulesInput:
      type: list
      entry_schema: FirewallRules

  substitution_mappings:
    node_type: abstract.Firewall
    substitution_filter:
      properties:

---

- vendor: { equal: Simple }

---

  properties:
    rules: [ rulesInput ]

  node_templates:
    acme:
      type: SimpleFirewall
      properties:
        rules: { get_input: rulesInput }

---



```

As specified in this example, only abstract firewall node templates that have the *vendor* property set to 'Simple' can be substituted by this service template.

2.13 Grouping node templates

In designing applications composed of several interdependent software components (or nodes) it is often desirable to manage these components as a named group. This can provide an effective way of associating policies (e.g., scaling, placement, security or other) that orchestration tools can apply to all the components of group during deployment or during other lifecycle stages.

In many realistic scenarios it is desirable to include scaling capabilities into an application to be able to react on load variations at runtime. The example below shows the definition of a scaling web server stack, where a variable number of servers with apache installed on them can exist, depending on the load on the servers.

Example 20 - Grouping Node Templates for possible policy application

```
tosca_definitions_version: tosca_simple_yaml_1_3

description: Template for a scaling web server.

topology_template:
  inputs:
    # omitted here for brevity

  node_templates:
    apache:
      type: tosca.nodes.WebServer.Apache
      properties:
        # Details omitted for brevity
      requirements:
        - host: server

    server:
      type: tosca.nodes.Compute
      # details omitted for brevity

  groups:
    webservers_group:
      type: tosca.groups.Root
      members: [ apache, server ]
```

The example first of all uses the concept of grouping to express which components (node templates) need to be scaled as a unit – i.e. the compute nodes and the software on-top of each compute node. This is done by defining the **webservers_group** in the **groups** section of the template and by adding both the **apache** node template and the **server** node template as a member to the group.

Furthermore, a scaling policy is defined for the group to express that the group as a whole (i.e. pairs of **server** node and the **apache** component installed on top) should scale up or down under certain conditions.

In cases where no explicit binding between software components and their hosting compute resources is defined in a template, but only requirements are defined as has been shown in section 2.9, a provider

could decide to place software components on the same host if their hosting requirements match, or to place them onto different hosts.

It is often desired, though, to influence placement at deployment time to make sure components get collocation or anti-collocated. This can be expressed via grouping and policies as shown in the example below.

Example 21 - Grouping nodes for anti-collocation policy application

```
tosca_definitions_version: tosca_simple_yaml_1_3

description: Template hosting requirements and placement policy.

topology_template:
  inputs:
    # omitted here for brevity

  node_templates:
    wordpress_server:
      type: tosca.nodes.WebServer
      properties:
        # omitted here for brevity
      requirements:
        - host:
            # Find a Compute node that fulfills these additional filter reqs.
            node_filter:
              capabilities:
                - host:
                    properties:
                      - mem_size: { greater_or_equal: 512 MB }
                      - disk_size: { greater_or_equal: 2 GB }
                - os:
                    properties:
                      - architecture: x86_64
                      - type: linux

    mysql:
      type: tosca.nodes.DBMS.MySQL
      properties:
        # omitted here for brevity
      requirements:
        - host:
            node: tosca.nodes.Compute
            node_filter:
```



```

capabilities:
  - host:
      properties:
        - disk_size: { greater_or_equal: 1 GB }
  - os:
      properties:
        - architecture: x86_64
        - type: linux

groups:
  my_co_location_group:
    type: toska.groups.Root
    members: [ wordpress_server, mysql ]

policies:
  - my_anti_collocation_policy:
    type: my.policies.anticollocateion
    targets: [ my_co_location_group ]
    # For this example, specific policy definitions are considered
    # domain specific and are not included here

```

In the example above, both software components **wordpress_server** and **mysql** have similar hosting requirements. Therefore, a provider could decide to put both on the same server as long as both their respective requirements can be fulfilled. By defining a group of the two components and attaching an anti-collocation policy to the group it can be made sure, though, that both components are put onto different hosts at deployment time.

2.14 Using YAML Macros to simplify templates

The YAML 1.2 specification allows for defining of [aliases](#), which allow for authoring a block of YAML (or node) once and indicating it is an “anchor” and then referencing it elsewhere in the same document as an “alias”. Effectively, YAML parsers treat this as a “macro” and copy the anchor block’s code to wherever it is referenced. Use of this feature is especially helpful when authoring TOSCA Service Templates where similar definitions and property settings may be repeated multiple times when describing a multi-tier application.

For example, an application that has a web server and database (i.e., a two-tier application) may be described using two **Compute** nodes (one to host the web server and another to host the database). The author may want both **Compute** nodes to be instantiated with similar properties such as operating system, distribution, version, etc.

To accomplish this, the author would describe the reusable properties using a named anchor in the “**dsl_definitions**” section of the TOSCA Service Template and reference the anchor name as an alias in any **Compute** node templates where these properties may need to be reused. For example:

Example 22 - Using YAML anchors in TOSCA templates

```

tosca_definitions_version: toska_simple_yaml_1_3

```

```

description: >
  TOSCA simple profile that just defines a YAML macro for commonly reused Compute
  properties.

dsl_definitions:
  my_compute_node_props: &my_compute_node_props
    disk_size: 10 GB
    num_cpus: 1
    mem_size: 2 GB

topology_template:
  node_templates:
    my_server:
      type: Compute
      capabilities:
        host:
          properties: *my_compute_node_props

    my_database:
      type: Compute
      capabilities:
        host:
          properties: *my_compute_node_props

```

2.15 Passing information as inputs to Interfaces and Operations

It is possible for type and template authors to declare input variables within an **inputs** block on interfaces to nodes or relationships in order to pass along information needed by their operations (scripts). These declarations can be scoped such as to make these variable values available to all operations on a node or relationships interfaces or to individual operations. TOSCA orchestrators will make these values available using the appropriate mechanisms depending on the type of implementation artifact used for each operation. For example, when using script artifacts, input values are passed as environment variables within the execution environments in which the scripts associated with lifecycle operations are run.

2.15.1 Example: declaring input variables for all operations on a single interface

```

node_templates:
  wordpress:
    type: tosca.nodes.WebApplication.WordPress
    requirements:
      ...

```

```

- database_endpoint: mysql_database
interfaces:
  Standard:
    inputs:
      wp_db_port: { get_property: [ SELF, database_endpoint, port ] }

```

2.15.2 Example: declaring input variables for a single operation

```

node_templates:
  wordpress:
    type: tosca.nodes.WebApplication.WordPress
    requirements:
      ...
      - database_endpoint: mysql_database
    interfaces:
      Standard:
        create: wordpress_install.sh
        configure:
          implementation: wordpress_configure.sh
        inputs:
          wp_db_port: { get_property: [ SELF, database_endpoint, port ] }

```

In the case where an input variable name is defined at more than one scope within the same interfaces section of a node or template definition, the lowest (or innermost) scoped declaration would override those declared at higher (or more outer) levels of the definition.

2.16 Returning output values from operations

Service template designers have the ability to define operation outputs that specify named output values that are expected to be returned by interface operations as well as the attributes on nodes or relationships into which these output values must be stored.

2.16.1 Example: setting output values to a node attribute

The service template below shows an example service template that is used to create a compute node. The config operation of the Standard lifecycle returns both the private and the public IP addresses of the config node. The *attribute mappings grammar* is used to reflect these addresses into the appropriate Compute node attributes:

```

tosca_definitions_version: tosca_simple_yaml_1_3

description: Template for creating compute node

topology_template:

```

```

node_templates:

  node:
    type: toska.nodes.Compute
    interfaces:
      Standard:
        configure:
          outputs:
            ip1: [ SELF, private_address ]
            ip2: [ SELF, public_address ]

```

2.16.2 Example: setting output values to a capability attribute

Some operation outputs may need to be reflected into attributes of capabilities of nodes, rather than in attributes of the nodes themselves. The following example shows how an IP address returned by a config operation is stored in the *ip_address* attribute of the *endpoint* capability of a *Compute* node:

```

tosca_definitions_version: toska_simple_yaml_1_2_0

description: Template for creating compute node

topology_template:

  node_templates:

    compute:
      type: toska.nodes.Compute
      interfaces:
        Standard:
          config:
            outputs:
              ip1: [ SELF, endpoint, ip_address ]

```

2.17 Receiving asynchronous notifications

As shown in the previous section, TOSCA allows service template designers to reflect the results of executing interface operations into node or relationship artifacts using output mappings. However, there are many situations where components modeled by a node can change independently as a result of external events (e.g. load changes, failures, mode changes, etc.) rather than as a result of executing lifecycle management operations. To support those situations, TOSCA includes support for **notifications** that allow service template designers to specify how to asynchronously receive external events and how those events should result in node or relationship attribute changes.

Just like operations, notifications are specified as part of interface definitions. The major difference between notifications and operations is that the former are called from the outside world to on the orchestrator, and not the other way around. As a result, notifications do not have inputs defined (since they are called asynchronously from the outside). Information carried in notifications is pushed to the orchestrator via notification outputs (similar to operation outputs).

The following example shows how a health monitoring interface is used to allow the orchestrator to monitor the health of a database node by listening for heartbeats as well as by waiting for asynchronous failure alerts:

```
tosca_definitions_version: toska_simple_yaml_1_3

description: Template showing a health monitoring interface

topology_template:
  node_templates:
    db_1:
      type: org.ego.nodes.Database
      interfaces:
        HealthMonitor:
          notifications:
            heartbeat:
              outputs:
                tick: [ SELF, still_alive ]
          failure_report:
            outputs:
              level: [SELF, failure_level]
              time: [SELF, failure_time]
              environment: [SELF, failure_context]
```

2.18 Topology Template Model versus Instance Model

A TOSCA service template contains a **topology template**, which models the components of an application, their relationships and dependencies (a.k.a., a topology model) that get interpreted and instantiated by TOSCA Orchestrators. The actual node and relationship instances that are created represent a set of resources distinct from the template itself, called a **topology instance (model)**. The direction of this specification is to provide access to the instances of these resources for management and operational control by external administrators. This model can also be accessed by an orchestration engine during deployment – i.e. during the actual process of instantiating the template in an incremental fashion. That is, the orchestrator can choose the order of resources to instantiate (i.e., establishing a partial set of node and relationship instances) and have the ability, as they are being created, to access them in order to facilitate instantiating the remaining resources of the complete topology template.

2.19 Using attributes implicitly reflected from properties

Most entity types in TOSCA (e.g., Node, Relationship, Capability Types, etc.) have [property definitions](#), which allow template authors to set the values for as inputs when these entities are instantiated by an orchestrator. These property values are considered to reflect the desired state of the entity by the author. Once instantiated, the actual values for these properties on the realized (instantiated) entity are obtainable via attributes on the entity with the same name as the corresponding property.

In other words, TOSCA orchestrators will automatically reflect (i.e., make available) any property defined on an entity as an attribute of the entity with the same name as the property.

Use of this feature is shown in the example below where a source node named **my_client**, of type **ClientNode**, requires a connection to another node named **my_server** of type **ServerNode**. As you can see, the **ServerNode** type defines a property named **notification_port** which defines a dedicated port number which instances of **my_client** may use to post asynchronous notifications to it during runtime. In this case, the TOSCA Simple Profile assures that the **notification_port** property is implicitly reflected as an attribute in the **my_server** node (also with the name **notification_port**) when its node template is instantiated.

Example 23 - Properties reflected as attributes

```
tosca_definitions_version: toska_simple_yaml_1_3

description: >
  TOSCA simple profile that shows how the (notification_port) property is
  reflected as an attribute and can be referenced elsewhere.

node_types:
  ServerNode:
    derived_from: SoftwareComponent
    properties:
      notification_port:
        type: integer
    capabilities:
      # omitted here for brevity

  ClientNode:
    derived_from: SoftwareComponent
    properties:
      # omitted here for brevity
    requirements:
      - server:
          capability: Endpoint
          node: ServerNode
          relationship: ConnectsTo

topology_template:
  node_templates:

    my_server:
      type: ServerNode
      properties:
        notification_port: 8000
```

```

my_client:
  type: ClientNode
  requirements:
    - server:
        node: my_server
        relationship: my_connection

relationship_templates:
  my_connection:
    type: ConnectsTo
    interfaces:
      Configure:
        inputs:
          targ_notify_port: { get_attribute: [ TARGET, notification_port ] }
          # other operation definitions omitted here for brevity

```

Specifically, the above example shows that the **ClientNode** type needs the **notification_port** value anytime a node of **ServerType** is connected to it using the **ConnectsTo** relationship in order to make it available to its **Configure** operations (scripts). It does this by using the **get_attribute** function to retrieve the **notification_port** attribute from the **TARGET** node of the **ConnectsTo** relationship (which is a node of type **ServerNode**) and assigning it to an environment variable named **targ_notify_port**.

It should be noted that the actual port value of the **notification_port** attribute may or may not be the value **8000** as requested on the property; therefore, any node that is dependent on knowing its actual “runtime” value would use the **get_attribute** function instead of the **get_property** function.

2.20 Creating Multiple Node Instances from the Same Node Template

TOSCA service templates specify a set of nodes that need to be instantiated at service deployment time. Some service templates may include multiple nodes that perform the same role. For example, a template that models an SD-WAN service might contain multiple VPN Site nodes, one for each location that accesses the SD-WAN. Rather than having to create a separate service template for each possible number of VPN sites, it would be preferable to have a single service template that allows the number of VPN sites to be specified as an input to the template at deployment time. This section introduces **experimental** TOSCA language extensions in support of this functionality. It is expected that these extensions will be formally standardized in a future version of this specifications.

The discussion in this section uses an example SD-WAN deployment to three sites as shown in the following figure:

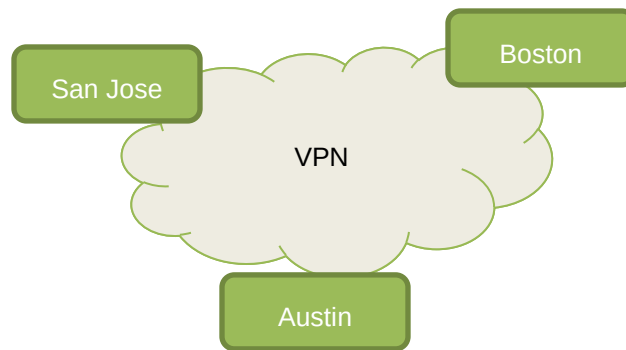

Example SD-WAN Service Deployment

The following code snippet shows a TOSCA service template from which this service could have been deployed:

Example 24 – TOSCA SD-WAN Service Template

```
tosca_definitions_version: tosca_simple_yaml_1_3

description: Template for deploying SD-WAN with three sites.

-----
topology_template:
  inputs:
    location1:
      type: Location
    location2:
      type: Location
    location3:
      type: Location
  node_templates:
    sdwan:
      type: VPN
    site1:
      type: VPNSite
      properties:
        location: { get_input: location1 }
      requirements:
        - vpn: sdwan
    site2:
      type: VPNSite
      properties:
        location: { get_input: location2 }
      requirements:
        - vpn: sdwan
    site3:
      type: VPNSite
      properties:
        location: { get_input: location3 }
      requirements:
        - vpn: sdwan
-----
```

Unfortunately, this template can only be used to deploy an SD-WAN with three sites. To deploy a different number of sites, additional service templates would have to be created, one for each number of possible SD-WAN sites. This leads to template proliferation, which is undesirable. The next section explores alternatives.

2.20.1 Specifying Number of Occurrences

To avoid the need for multiple service templates, TOSCA must provide a mechanism that allows all VPN Site nodes to be created from the same Site node template in the topology, and allow the number of sites to be specified at deployment time. Specifically, this functionality must:

- Allow service template designers to specify that multiple node instances can be created from a single node template
- Allow service template designers to constrain how many node instances can be created from a single node template
- Allow users to specify at deployment time the exact number of instances that need to be created from the single node template.

To provide this functionality, the TOSCA node template definition grammar is extended with an **occurrences** keyword that specifies the minimum and maximum number of instances that can be created from this node template. If occurrences is not specified, only one single instance can be created. In addition, an **instance_count** keyword is used to specify the requested number of runtime instances of this node template. It is expected that the value of the instance_count is provided as an input to the topology template. These extensions enable the creation of a simplified SD-WAN service template that contains only one single VPN Site node as shown in the following code snippet:

Example 25 – TOSCA SD-WAN Service Template

```
tosca_definitions_version: tosca_simple_yaml_1_3

description: Template for deploying SD-WAN with a variable number of sites.

topology_template:
  inputs:
    numberOfSites:
      type: integer

  node_templates:
    sdwan:
      type: VPN
    site:
      type: VPNSite
      occurrences: [1, UNBOUNDED]
      instance_count: { get_input: numberOfSites }
      requirements:
        - vpn: sdwan
```

2.20.2 Specifying Inputs

The service template in the previous section conveniently ignores the location property of the Site node. As shown earlier, the location property is expected to be provided as an input value. If Site node templates can be instantiated multiple times, then it follows that multiple input values are required to initialize the location property for each of the Site node instances.

To allow specific input values to be matched with specific node template instances, a new reserved keyword called INDEX is introduced. A TOSCA orchestrator will interpret this keyword as the runtime index in the list of node instances created from a single node template.

The following service template shows how the INDEX keyword is used to retrieve specific values from a list of input values in a service template:

Example 26 – TOSCA SD-WAN Service Template

```
tosca_definitions_version: tosca_simple_yaml_1_3

-----

description: Template for deploying SD-WAN with a variable number of sites.

topology_template:
  inputs:
    numberOfSites:
      type: integer
    locations:
      type: list
      entry_schema: Location

  node_templates:
    sdwan:
      type: VPN
    site:
      type: VPNSite
      occurrences: [1, UNBOUNDED]
      instance_count: { get_input: numberOfSites }
      properties:
        location: { get_input: [ locations, INDEX ] }
      requirements:
        - vpn: sdwan

-----
```

3 TOSCA Simple Profile definitions in YAML

Except for the examples, this section is **normative** and describes all of the YAML grammar, definitions and block structure for all keys and mappings that are defined for the TOSCA Version 1.3 Simple Profile specification that are needed to describe a TOSCA Service Template (in YAML).

3.1 TOSCA Namespace URI and alias

The following TOSCA Namespace URI alias and TOSCA Namespace Alias are reserved values which SHALL be used when identifying the TOSCA Simple Profile version 1.3 specification.

Namespace Alias	Namespace URI	Specification Description
tosca_simple_yaml_1_3	http://docs.oasis-open.org/tosca/ns/simple/yaml/1.3	The TOSCA Simple Profile v1.3 (YAML) target namespace and namespace alias.

3.1.1 TOSCA Namespace prefix

The following TOSCA Namespace prefix is a reserved value and SHALL be used to reference the default TOSCA Namespace URI as declared in TOSCA Service Templates.

Namespace Prefix	Specification Description
tosca	The reserved TOSCA Simple Profile Specification prefix that can be associated with the default TOSCA Namespace URI

3.1.2 TOSCA Namespacing in TOSCA Service Templates

In the TOSCA Simple Profile, TOSCA Service Templates MUST always have, as the first line of YAML, the keyword “**tosca_definitions_version**” with an associated TOSCA Namespace Alias value. This single line accomplishes the following:

1. Establishes the TOSCA Simple Profile Specification version whose grammar MUST be used to parse and interpret the contents for the remainder of the TOSCA Service Template.
2. Establishes the default TOSCA Namespace URI and Namespace Prefix for all types found in the document that are not explicitly namespaced.
3. Automatically imports (without the use of an explicit import statement) the normative type definitions (e.g., Node, Relationship, Capability, Artifact, etc.) that are associated with the TOSCA Simple Profile Specification the TOSCA Namespace Alias value identifies.
4. Associates the TOSCA Namespace URI and Namespace Prefix to the automatically imported TOSCA type definitions.

3.1.3 Rules to avoid namespace collisions

TOSCA Simple Profiles allows template authors to declare their own types and templates and assign them simple names with no apparent namespaces. Since TOSCA Service Templates can import other service templates to introduce new types and topologies of templates that can be used to provide concrete implementations (or substitute) for abstract nodes. Rules are needed so that TOSCA Orchestrators know how to avoid collisions and apply their own namespaces when import and nesting occur.

3.1.3.1 Additional Requirements

- The URI value “<http://docs.oasis-open.org/tosca>”, as well as all (path) extensions to it, SHALL be reserved for TOSCA approved specifications and work. That means Service Templates that do

not originate from a TOSCA approved work product MUST NOT use it, in any form, when declaring a (default) Namespace.

- Since TOSCA Service Templates can import (or substitute in) other Service Templates, TOSCA Orchestrators and tooling will encounter the “**tosca_definitions_version**” statement for each imported template. In these cases, the following additional requirements apply:
 - Imported type definitions with the same Namespace URI, local name and version SHALL be equivalent.
 - If different values of the “**tosca_definitions_version**” are encountered, their corresponding type definitions MUST be uniquely identifiable using their corresponding Namespace URI using a different Namespace prefix.
- Duplicate local names (i.e., within the same Service Template SHALL be considered an error. These include, but are not limited to duplicate names found for the following definitions:
 - Repositories (repositories)
 - Data Types (data_types)
 - Node Types (node_types)
 - Relationship Types (relationship_types)
 - Capability Types (capability_types)
 - Artifact Types (artifact_types)
 - Interface Types (interface_types)
- Duplicate Template names within a Service Template’s Topology Template SHALL be considered an error. These include, but are not limited to duplicate names found for the following template types:
 - Node Templates (node_templates)
 - Relationship Templates (relationship_templates)
 - Inputs (inputs)
 - Outputs (outputs)
- Duplicate names for the following keynames within Types or Templates SHALL be considered an error. These include, but are not limited to duplicate names found for the following keynames:
 - Properties (properties)
 - Attributes (attributes)
 - Artifacts (artifacts)
 - Requirements (requirements)
 - Capabilities (capabilities)
 - Interfaces (interfaces)
 - Policies (policies)
 - Groups (groups)

3.2 Using Namespaces

As of TOSCA version 1.2, Service template authors may declare a namespace within a Service Template that would be used as the default namespace for any types (e.g., Node Type, Relationship Type, Data Type, etc.) defined within the same Service template.

Specifically, a Service Template’s namespace declaration’s URI would be used to form a unique, fully qualified Type name when combined with the locally defined, unqualified name of any Type in the same Service Template. The resultant, fully qualified Type name would be used by TOSCA Orchestrators, Processors and tooling when that Service Template was imported into another Service Template to avoid Type name collision.

If a default namespace for the Service Template is declared, then it should be declared immediately after the “`tosca_definitions_version`” declaration, to ensure that the namespace is clearly visible.

3.2.1 Example – Importing a Service Template and Namespaces

For example, let say we have two Service Templates, A and B, both of which define Types and a Namespace. Service Template B contains a Node Type definition for “MyNode” and declares its (default) Namespace to be “`http://companyB.com/service/namespace/`”:

Service Template B

```
tosca_definitions_version: toska_simple_yaml_1_2
description: Service Template B
namespace: http://companyB.com/service/namespace/

node_types:
  MyNode:
    derived_from: SoftwareComponent
    properties:
      # omitted here for brevity
    capabilities:
      # omitted here for brevity
```

Service Template A has its own, completely different, Node Type definition also named “MyNode”.

Service Template A

```
tosca_definitions_version: toska_simple_yaml_1_2
description: Service Template A
namespace: http://companyA.com/product/ns/

imports:
  - file: csar/templates/ServiceTemplateB.yaml
    namespace_prefix: templateB

node_types:
  MyNode:
    derived_from: Root
    properties:
      # omitted here for brevity
    capabilities:
```

```
# omitted here for brevity
```

As you can see, Service Template A also “imports” Service Template B (i.e., “ServiceTemplateB.yaml”) bringing in its Type definitions to the global namespace using the Namespace URI declared in Service Template B to fully qualify all of its imported types.

In addition, the import includes a “namespace_prefix” value (i.e., “templateB”), that can be used to qualify and disambiguate any Type reference from from Service Template B within Service Template A. This prefix is effectively the local alias for the corresponding Namespace URI declared within Service Template B (i.e., “http://companyB.com/service/namespace/”).

To illustrate conceptually what a TOSCA Orchestrator, for example, would track for their global namespace upon processing Service Template A (and by import Service Template B) would be a list of global Namespace URIs and their associated Namespace prefixes, as well as a list of fully qualified Type names that comprises the overall global namespace.

3.2.1.1 Conceptual Global Namespace URI and Namespace Prefix tracking

Entry#	Namespace URI	Namespace Prefix	Added by Key (Source file)
1	http://open.org/tosca/ns/simple/yaml/1.3/	tosca	• <code>tosca_definitions_version:</code> - <i>from Service Template A</i>
2	http://companyA.com/product/ns/	<None>	• <code>namespace:</code> - <i>from Service Template A</i>
3	http://companyB.com/service/namespace/	templateB	• <code>namespace:</code> - <i>from Service Template B</i> • <code>namespace_prefix:</code> - <i>from Service Template A, during import</i>

In the above table,

- **Entry 1:** is an entry for the default TOSCA namespace, which is required to exist for it to be a valid Service template. It is established by the “`tosca_definitions_version`” key’s value. By default, it also gets assigned the “`tosca`” Namespace prefix.
- **Entry 2:** is the entry for the local default namespace for Service Template A as declared by the “`namespace`” key.
 - *Note that no Namespace prefix is needed; any locally defined types that are not qualified (i.e., not a full URI or using a Namespace Prefix) will default to this namespace if not found first in the TOSCA namespace.*
- **Entry 3:** is the entry for default Namespace URI for any type imported from Service Template B. The author of Service Template A has assigned the local Namespace Prefix “`templateB`” that can be used to qualify reference to any Type from Service Template B.

As per TOSCA specification, any Type, that is not qualified with the 'tosca' prefix or full URI name, should be first resolved by its unqualified name within the TOSCA namespace. If it not found there, then it may be resolved within the local Service Template's default namespace.

3.2.1.2 Conceptual Global Namespace and Type tracking

Entry#	Namespace URI	Unqualified Full Name	Unqualified Short Name	Type Classification
1	http://open.org/tosca/ns/simple/yaml/1.3/	tosca.nodes.Compute	Compute	node
2	http://open.org/tosca/ns/simple/yaml/1.3/	tosca.nodes.SoftwareComponent	SoftwareComponent	
3	http://open.org/tosca/ns/simple/yaml/1.3/	tosca.relationships.ConnectsTo	ConnectsTo	relationship
...	...			
100	http://companyA.com/product/ns/	N/A	MyNode	node
...	...			
200	http://companyB.com/service/namespace/	N/A	MyNode	node
...	...			

In the above table,

- **Entry 1:** is an example of one of the TOSCA standard Node Types (i.e., "Compute") that is brought into the global namespace via the "tosca_definitions_version" key.
 - It also has two forms, full and short that are unique to TOSCA types for historical reasons. Reference to a TOSCA type by either its unqualified short or full names is viewed as equivalent as a reference to the same fully qualified Type name (i.e., its full URI).
 - In this example, use of either "tosca.nodes.Compute" or "Compute" (i.e., an unqualified full and short name Type) in a Service Template would be treated as its fully qualified URI equivalent of:
 - "http://docs.oasis-open.org/tosca/ns/simple/yaml/1.3/tosca.nodes.Compute".
- **Entry 2:** is an example of a standard TOSCA Relationship Type
- **Entry 100:** contains the unique Type identifier for the Node Type "MyNode" from Service Template A.
- **Entry 200:** contains the unique Type identifier for the Node Type "MyNode" from Service Template B.

As you can see, although both templates defined a NodeType with an unqualified name of "MyNode", the TOSCA Orchestrator, processor or tool tracks them by their unique fully qualified Type Name (URI).

The classification column is included as an example on how to logically differentiate a "Compute" Node Type and "Compute" capability type if the table would be used to "search" for a match based upon context in a Service Template.

For example, if the short name “Compute” were used in a template on a Requirements clause, then the matching type would not be the Compute Node Type, but instead the Compute Capability Type based upon the Requirement clause being the context for Type reference.

3.3 Parameter and property types

This clause describes the primitive types that are used for declaring normative properties, parameters and grammar elements throughout this specification.

3.3.1 Referenced YAML Types

Many of the types we use in this profile are built-in types from the [YAML 1.2 specification](#) (i.e., those identified by the “tag:yaml.org,2002” version tag) [YAML-1.2].

The following table declares the valid YAML type URIs and aliases that SHALL be used when possible when defining parameters or properties within TOSCA Service Templates using this specification:

Valid aliases	Type URI
string	tag:yaml.org,2002:str (default)
integer	tag:yaml.org,2002:int
float	tag:yaml.org,2002:float
boolean	tag:yaml.org,2002:bool (i.e., a value either ‘true’ or ‘false’)
timestamp	tag:yaml.org,2002:timestamp [YAML-TS-1.1]
null	tag:yaml.org,2002:null

3.3.1.1 Notes

- The “string” type is the default type when not specified on a parameter or property declaration.
- While YAML supports further type aliases, such as “str” for “string”, the TOSCA Simple Profile specification promotes the fully expressed alias name for clarity.

3.3.2 TOSCA version

TOSCA supports the concept of “reuse” of type definitions, as well as template definitions which could be version and change over time. It is important to provide a reliable, normative means to represent a version string which enables the comparison and management of types and templates over time. Therefore, the TOSCA TC intends to provide a normative version type (string) for this purpose in future Working Drafts of this specification.

Shorthand Name	version
Type Qualified Name	tosca:version

3.3.2.1 Grammar

TOSCA version strings have the following grammar:

```
<major_version>.<minor_version>[.<fix_version>[.<qualifier>[-<build_version>] ] ]
```

In the above grammar, the pseudo values that appear in angle brackets have the following meaning:

- **major_version**: is a required integer value greater than or equal to 0 (zero)
- **minor_version**: is a required integer value greater than or equal to 0 (zero).

- **fix_version**: is an optional integer value greater than or equal to 0 (zero).
- **qualifier**: is an optional string that indicates a named, pre-release version of the associated code that has been derived from the version of the code identified by the combination **major_version**, **minor_version** and **fix_version** numbers.
- **build_version**: is an optional integer value greater than or equal to 0 (zero) that can be used to further qualify different build versions of the code that has the same **qualifier_string**.

3.3.2.2 Version Comparison

- When comparing TOSCA versions, all component versions (i.e., *major*, *minor* and *fix*) are compared in sequence from left to right.
- TOSCA versions that include the optional qualifier are considered older than those without a qualifier.
- TOSCA versions with the same major, minor, and fix versions and have the same qualifier string, but with different build versions can be compared based upon the build version.
- Qualifier strings are considered domain-specific. Therefore, this specification makes no recommendation on how to compare TOSCA versions with the same major, minor and fix versions, but with different qualifiers strings and simply considers them different named branches derived from the same code.

3.3.2.3 Examples

Examples of valid TOSCA version strings:

```
# basic version strings
6.1
2.0.1

# version string with optional qualifier
3.1.0.beta

# version string with optional qualifier and build version
1.0.0.alpha-10
```

3.3.2.4 Notes

- [\[Maven-Version\]](#) The TOSCA version type is compatible with the Apache Maven versioning policy.

3.3.2.5 Additional Requirements

- A version value of zero (i.e., '0', '0.0', or '0.0.0') SHALL indicate there no version provided.
- A version value of zero used with any qualifiers SHALL NOT be valid.

3.3.3 TOSCA range type

The range type can be used to define numeric ranges with a lower and upper boundary. For example, this allows for specifying a range of ports to be opened in a firewall.

Shorthand Name	range
Type Qualified Name	tosca:range

3.3.3.1 Grammar

TOSCA range values have the following grammar:

```
[<lower_bound>, <upper_bound>]
```

In the above grammar, the pseudo values that appear in angle brackets have the following meaning:

- **lower_bound**: is a required integer value that denotes the lower boundary of the range.
- **upper_bound**: is a required integer value that denotes the upper boundary of the range. This value **MUST** be greater than or equal to **lower_bound**.

3.3.3.2 Keywords

The following Keywords may be used in the TOSCA range type:

Keyword	Applicable Types	Description
UNBOUNDED	scalar	Used to represent an unbounded upper bounds (positive) value in a set for a scalar type.

3.3.3.3 Examples

Example of a node template property with a range value:

```
# numeric range between 1 and 100
a_range_property: [ 1, 100 ]

# a property that has allows any number 0 or greater
num_connections: [ 0, UNBOUNDED ]
```

3.3.4 TOSCA list type

The list type allows for specifying multiple values for a parameter of property. For example, if an application allows for being configured to listen on multiple ports, a list of ports could be configured using the list data type.

Note that entries in a list for one property or parameter must be of the same type. The type (for simple entries) or schema (for complex entries) is defined by the **entry_schema** attribute of the respective [property definition](#), [attribute definitions](#), or input or output [parameter definitions](#).

Shorthand Name	list
Type Qualified Name	tosca:list

3.3.4.1 Grammar

TOSCA lists are essentially normal YAML lists with the following grammars:

3.3.4.1.1 Square bracket notation

```
[ <list_entry_1>, <list_entry_2>, ... ]
```

3.3.4.1.2 Bulleted list notation

```
- <list_entry_1>  
- ...  
- <list_entry_n>
```

In the above grammars, the pseudo values that appear in angle brackets have the following meaning:

- **<list_entry_*>**: represents one entry of the list.

3.3.4.2 Declaration Examples

3.3.4.2.1 List declaration using a simple type

The following example shows a list declaration with an entry schema based upon a simple integer type (which has additional constraints):

```
<some_entity>:  
  ...  
  properties:  
    listen_ports:  
      type: list  
      entry_schema:  
        description: listen port entry (simple integer type)  
        type: integer  
        constraints:  
          - max_length: 128
```

3.3.4.2.2 List declaration using a complex type

The following example shows a list declaration with an entry schema based upon a complex type:

```
<some_entity>:  
  ...  
  properties:  
    products:  
      type: list  
      entry_schema:  
        description: Product information entry (complex type) defined elsewhere  
        type: ProductInfo
```

3.3.4.3 Definition Examples

These examples show two notation options for defining lists:

- A single-line option which is useful for only short lists with simple entries.
- A multi-line option where each list entry is on a separate line; this option is typically useful or more readable if there is a large number of entries, or if the entries are complex.

3.3.4.3.1 Square bracket notation

```
listen_ports: [ 80, 8080 ]
```

3.3.4.3.2 Bulleted list notation

```
listen_ports:
- 80
- 8080
```

3.3.5 TOSCA map type

The map type allows for specifying multiple values for a parameter or property as a map. In contrast to the list type, where each entry can only be addressed by its index in the list, entries in a map are named elements that can be addressed by their keys.

Note that entries in a map for one property or parameter must be of the same type. The type (for simple entries) or schema (for complex entries) is defined by the **entry_schema** attribute of the respective [property definition](#), [attribute definition](#), or input or output [parameter definition](#). In addition, the keys that identify entries in a map must be of the same type as well. The type of these keys is defined by the **key_schema** attribute of the respective [property_definition](#), [attribute_definition](#), or input or output [parameter_definition](#). If the **key_schema** is not specified, keys are assumed to be of type string.

Shorthand Name	map
Type Qualified Name	tosca:map

3.3.5.1 Grammar

TOSCA maps are normal YAML dictionaries with following grammar:

3.3.5.1.1 Single-line grammar

```
{ <entry_key_1>: <entry_value_1>, ..., <entry_key_n>: <entry_value_n> }
```

3.3.5.1.2 Multi-line grammar

```
<entry_key_1>: <entry_value_1>
...
<entry_key_n>: <entry_value_n>
```

In the above grammars, the pseudo values that appear in angle brackets have the following meaning:

- **entry_key_***: is the required key for an entry in the map
- **entry_value_***: is the value of the respective entry in the map

3.3.5.2 Declaration Examples

3.3.5.2.1 Map declaration using a simple type

The following example shows a map with an entry schema definition based upon an existing string type (which has additional constraints):

```
<some_entity>:
  ...
  properties:
    emails:
      type: map
      entry_schema:
        description: basic email address
        type: string
        constraints:
          - max_length: 128
```

3.3.5.2.2 Map declaration using a complex type

The following example shows a map with an entry schema definition for contact information:

```
<some_entity>:
  ...
  properties:
    contacts:
      type: map
      entry_schema:
        description: simple contact information
        type: ContactInfo
```

3.3.5.3 Definition Examples

These examples show two notation options for defining maps:

- A single-line option which is useful for only short maps with simple entries.
- A multi-line option where each map entry is on a separate line; this option is typically useful or more readable if there is a large number of entries, or if the entries are complex.

3.3.5.3.1 Single-line notation

```
# notation option for shorter maps
user_name_to_id_map: { user1: 1001, user2: 1002 }
```

3.3.5.3.2 Multi-line notation

```
# notation for longer maps
user_name_to_id_map:
```

```
user1: 1001
user2: 1002
```

3.3.6 TOSCA scalar-unit type

The scalar-unit type can be used to define scalar values along with a unit from the list of recognized units provided below.

3.3.6.1 Grammar

TOSCA scalar-unit typed values have the following grammar:

```
<scalar> <unit>
```

In the above grammar, the pseudo values that appear in angle brackets have the following meaning:

- **scalar**: is a required scalar value.
- **unit**: is a required unit value. The unit value **MUST** be type-compatible with the scalar.

3.3.6.2 Additional requirements

- **Whitespace**: any number of spaces (including zero or none) **SHALL** be allowed between the **scalar** value and the **unit** value.
- It **SHALL** be considered an error if either the scalar or unit portion is missing on a property or attribute declaration derived from any scalar-unit type.
- When performing constraint clause evaluation on values of the scalar-unit type, both the scalar value portion and unit value portion **SHALL** be compared together (i.e., both are treated as a single value). For example, if we have a property called **storage_size**, which is of type scalar-unit, a valid range constraint would appear as follows:
 - `storage_size: in_range [4 GB, 20 GB]`

where **storage_size**'s range would be evaluated using both the numeric and unit values (combined together), in this case '4 GB' and '20 GB'.

3.3.6.3 Concrete Types

Shorthand Names	scalar-unit.size, scalar-unit.time, scalar-unit.frequency, scalar-unit.bitrate
Type Qualified Names	tosca:scalar-unit.size, toska:scalar-unit.time

The scalar-unit type grammar is abstract and has four recognized concrete types in TOSCA:

- **scalar-unit.size** – used to define properties that have scalar values measured in size units.
- **scalar-unit.time** – used to define properties that have scalar values measured in size units.
- **scalar-unit.frequency** – used to define properties that have scalar values measured in units per second.
- **scalar-unit.bitrate** – used to define properties that have scalar values measured in bits or bytes per second

These types and their allowed unit values are defined below.

3.3.6.4 scalar-unit.size

3.3.6.4.1 Recognized Units

Unit	Usage	Description
B	size	byte
kB	size	kilobyte (1000 bytes)
KiB	size	kibibytes (1024 bytes)
MB	size	megabyte (1000000 bytes)
MiB	size	mebibyte (1048576 bytes)
GB	size	gigabyte (1000000000 bytes)
GiB	size	gibibytes (1073741824 bytes)
TB	size	terabyte (1000000000000 bytes)
TiB	size	tebibyte (1099511627776 bytes)

3.3.6.4.2 Examples

```
# Storage size in Gigabytes
properties:
  storage_size: 10 GB
```

3.3.6.4.3 Notes

- The unit values recognized by TOSCA Simple Profile for size-type units are based upon a subset of those defined by GNU at http://www.gnu.org/software/parted/manual/html_node/unit.html, which is a non-normative reference to this specification.
- TOSCA treats these unit values as case-insensitive (e.g., a value of 'kB', 'KB' or 'kb' would be equivalent), but it is considered best practice to use the case of these units as prescribed by GNU.
- Some Cloud providers may not support byte-level granularity for storage size allocations. In those cases, these values could be treated as desired sizes and actual allocations would be based upon individual provider capabilities.

3.3.6.5 scalar-unit.time

3.3.6.5.1 Recognized Units

Unit	Usage	Description
d	time	days
h	time	hours

Unit	Usage	Description
m	time	minutes
s	time	seconds
ms	time	milliseconds
us	time	microseconds
ns	time	nanoseconds

3.3.6.5.2 Examples

```
# Response time in milliseconds
properties:
  response_time: 10 ms
```

3.3.6.5.3 Notes

- The unit values recognized by TOSCA Simple Profile for time-type units are based upon a subset of those defined by International System of Units whose recognized abbreviations are defined within the following reference:
 - <http://www.ewh.ieee.org/soc/ias/pub-dept/abbreviation.pdf>
 - This document is a non-normative reference to this specification and intended for publications or grammars enabled for Latin characters which are not accessible in typical programming languages

3.3.6.6 scalar-unit.frequency

3.3.6.6.1 Recognized Units

Unit	Usage	Description
Hz	frequency	Hertz, or Hz. equals one cycle per second.
kHz	frequency	Kilohertz, or kHz, equals to 1,000 Hertz
MHz	frequency	Megahertz, or MHz, equals to 1,000,000 Hertz or 1,000 kHz
GHz	frequency	Gigahertz, or GHz, equals to 1,000,000,000 Hertz, or 1,000,000 kHz, or 1,000 MHz.

3.3.6.6.2 Examples

```
# Processor raw clock rate
properties:
  clock_rate: 2.4 GHz
```

3.3.6.6.3 Notes

- The value for Hertz (Hz) is the International Standard Unit (ISU) as described by the Bureau International des Poids et Mesures (BIPM) in the “*SI Brochure: The International System of Units (SI) [8th edition, 2006; updated in 2014]*”, <http://www.bipm.org/en/publications/si-brochure/>

3.3.6.7 scalar-unit.bitrate

3.3.6.7.1 Recognized Units

Unit	Usage	Description
bps	bitrate	bit per second
Kbps	bitrate	kilobit (1000 bits) per second
Kibps	bitrate	kibibits (1024 bits) per second
Mbps	bitrate	megabit (1000000 bits) per second
Mibps	bitrate	mebibit (1048576 bits) per second
Gbps	bitrate	gigabit (1000000000 bits) per second
Gibps	bitrate	gibibits (1073741824 bits) per second
Tbps	bitrate	terabit (1000000000000 bits) per second
Tibps	bitrate	tebibits (1099511627776 bits) per second
Bps	bitrate	byte per second
KBps	bitrate	kilobyte (1000 bytes) per second
KiBps	bitrate	kibibytes (1024 bytes) per second
MBps	bitrate	megabyte (1000000 bytes) per second
MiBps	bitrate	mebibyte (1048576 bytes) per second
GBps	bitrate	gigabyte (1000000000 bytes) per second
GiBps	bitrate	gibibytes (1073741824 bytes) per second
TBps	bitrate	terabytes (1000000000000 bytes) per second
TiBps	bitrate	tebibytes (1099511627776 bytes) per second

3.3.6.7.2 Examples

```
#### Somewhere in a node template definition
requirements:
  - link:
      node_filter:
        capabilities:
          - myLinkable
        properties:
          bitrate:
            - greater_or_equal: 10 Kbps # 10 * 1000 bits per second at
least
```

3.3.6.7.3 Notes

- Unlike with the scalar-unit.size type, TOSCA treats scalar-unit.bitrate values as case-sensitive (e.g., a value of 'KBs' means kilobyte per second, whereas 'Kb' means kilobit per second).
- For comparison purposes, 1 byte is the same as 8 bits.

3.4 Normative values

3.4.1 Node States

As components (i.e., nodes) of TOSCA applications are deployed, instantiated and orchestrated over their lifecycle using normative lifecycle operations (see section 5.8 for normative lifecycle definitions) it is important define normative values for communicating the states of these components normatively between orchestration and workflow engines and any managers of these applications.

The following table provides the list of recognized node states for TOSCA Simple Profile that would be set by the orchestrator to describe a node instance's state:

Node State		
Value	Transitional	Description
initial	no	Node is not yet created. Node only exists as a template definition.
creating	yes	Node is transitioning from initial state to created state.
created	no	Node software has been installed.
configuring	yes	Node is transitioning from created state to configured state.
configured	no	Node has been configured prior to being started.
starting	yes	Node is transitioning from configured state to started state.
started	no	Node is started.
stopping	yes	Node is transitioning from its current state to a configured state.
deleting	yes	Node is transitioning from its current state to one where it is deleted and its state is no longer tracked by the instance model.
error	no	Node is in an error state.

3.4.2 Relationship States

Similar to the Node States described in the previous section, Relationships have state relative to their (normative) lifecycle operations.

The following table provides the list of recognized relationship states for TOSCA Simple Profile that would be set by the orchestrator to describe a node instance's state:

Node State		
Value	Transitional	Description
initial	no	Relationship is not yet created. Relationship only exists as a template definition.

3.4.2.1 Notes

- Additional states may be defined in future versions of the TOSCA Simple Profile in YAML specification.

3.4.3 Directives

The following directive values are defined for this version of the TOSCA Simple Profile:

Directive	Description
substitute	Marks a node template as abstract and instructs the TOSCA Orchestrator to substitute this node template with an appropriate substituting template.
substitutable	This deprecated directive is synonymous to the substitute directive.
select	Marks a node template as abstract and instructs the TOSCA Orchestrator to select a node of this type from its inventory (based on constraints specified in the optional <code>node_filter</code> in the node template)
selectable	This deprecated directive is synonymous to the select directive.

3.4.4 Network Name aliases

The following are recognized values that may be used as aliases to reference types of networks within an application model without knowing their actual name (or identifier) which may be assigned by the underlying Cloud platform at runtime.

Alias value	Description
PRIVATE	<p>An alias used to reference the first private network within a property or attribute of a Node or Capability which would be assigned to them by the underlying platform at runtime.</p> <p>A private network contains IP addresses and ports typically used to listen for incoming traffic to an application or service from the Intranet and not accessible to the public internet.</p>
PUBLIC	<p>An alias used to reference the first public network within a property or attribute of a Node or Capability which would be assigned to them by the underlying platform at runtime.</p> <p>A public network contains IP addresses and ports typically used to listen for incoming traffic to an application or service from the Internet.</p>

3.4.4.1 Usage

These aliases would be used in the **tosca.capabilities.Endpoint** Capability type (and types derived from it) within the **network_name** field for template authors to use to indicate the type of network the Endpoint is supposed to be assigned an IP address from.

3.5 TOSCA Metamodel

This section defines all modelable entities that comprise the TOSCA Version 1.0 Simple Profile specification along with their keynames, grammar and requirements.

3.5.1 Required Keynames

The TOSCA metamodel includes complex types (e.g., Node Types, Relationship Types, Capability Types, Data Types, etc.) each of which include their own list of reserved keynames that are sometimes marked as **required**. These types may be used to derive other types. These derived types (e.g., child types) do not have to provide required keynames as long as they have been specified in the type they have been derived from (i.e., their parent type).

3.6 Reusable modeling definitions

3.6.1 Description definition

This optional element provides a means include single or multiline descriptions within a TOSCA Simple Profile template as a scalar string value.

3.6.1.1 Keyname

The following keyname is used to provide a description within the TOSCA Simple Profile specification:

```
description
```

3.6.1.2 Grammar

Description definitions have the following grammar:

```
description: <string>
```

3.6.1.3 Examples

Simple descriptions are treated as a single literal that includes the entire contents of the line that immediately follows the **description** key:

```
description: This is an example of a single line description (no folding).
```

The YAML “folded” style may also be used for multi-line descriptions which “folds” line breaks as space characters.

```
description: >  
  This is an example of a multi-line description using YAML. It permits for line  
  breaks for easier readability...  
  
  if needed. However, (multiple) line breaks are folded into a single space  
  character when processed into a single string value.
```

3.6.1.4 Notes

- Use of “folded” style is discouraged for the YAML string type apart from when used with the **description** keyname.

3.6.2 Metadata

This optional element provides a means to include optional metadata as a map of strings.

3.6.2.1 Keyname

The following keyname is used to provide metadata within the TOSCA Simple Profile specification:

```
metadata
```

3.6.2.2 Grammar

Metadata definitions have the following grammar:

```
metadata:  
  map of <string>
```

3.6.2.3 Examples

```
metadata:  
  foo1: bar1  
  foo2: bar2  
  ...
```

3.6.2.4 Notes

- Data provided within metadata, wherever it appears, MAY be ignored by TOSCA Orchestrators and SHOULD NOT affect runtime behavior.

3.6.3 Constraint clause

A constraint clause defines an operation along with one or more compatible values that can be used to define a constraint on a property or parameter's allowed values when it is defined in a TOSCA Service Template or one of its entities.

3.6.3.1 Operator keynames

The following is the list of recognized operators (keynames) when defining constraint clauses:

Operator	Type	Value Type	Description
equal	scalar	any	Constrains a property or parameter to a value equal to ('=') the value declared.
greater_than	scalar	comparable	Constrains a property or parameter to a value greater than ('>') the value declared.
greater_or_equal	scalar	comparable	Constrains a property or parameter to a value greater than or equal to ('>=') the value declared.
less_than	scalar	comparable	Constrains a property or parameter to a value less than ('<') the value declared.
less_or_equal	scalar	comparable	Constrains a property or parameter to a value less than or equal to ('<=') the value declared.

Operator	Type	Value Type	Description
in_range	dual scalar	comparable, range	Constrains a property or parameter to a value in range of (inclusive) the two values declared. Note: subclasses or templates of types that declare a property with the in_range constraint MAY only further restrict the range specified by the parent type.
valid_values	list	any	Constrains a property or parameter to a value that is in the list of declared values.
length	scalar	string , list , map	Constrains the property or parameter to a value of a given length.
min_length	scalar	string , list , map	Constrains the property or parameter to a value to a minimum length.
max_length	scalar	string , list , map	Constrains the property or parameter to a value to a maximum length.
pattern	regex	string	Constrains the property or parameter to a value that is allowed by the provided regular expression. Note: Future drafts of this specification will detail the use of regular expressions and reference an appropriate standardized grammar.
schema	string	string	Constrains the property or parameter to a value that is allowed by the referenced schema.

3.6.3.1.1 Comparable value types

In the Value Type column above, an entry of “comparable” includes [integer](#), [float](#), [timestamp](#), [string](#), [version](#), and [scalar-unit](#) types while an entry of “any” refers to any type allowed in the TOSCA simple profile in YAML.

3.6.3.2 Schema Constraint purpose

TOSCA recognizes that there are external data-interchange formats that are widely used within Cloud service APIs and messaging (e.g., JSON, XML, etc.).

The ‘schema’ Constraint was added so that, when TOSCA types utilize types from these externally defined data (interchange) formats on Properties or Parameters, their corresponding Property definitions’ values can be optionally validated by TOSCA Orchestrators using the schema string provided on this operator.

3.6.3.3 Additional Requirements

- If no operator is present for a simple scalar-value on a constraint clause, it **SHALL** be interpreted as being equivalent to having the “**equal**” operator provided; however, the “**equal**” operator may be used for clarity when expressing a constraint clause.
- The “**length**” operator **SHALL** be interpreted mean “size” for set types (i.e., list, map, etc.).
- Values provided by the operands (i.e., values and scalar values) **SHALL** be type-compatible with their associated operations.
- Future drafts of this specification will detail the use of regular expressions and reference an appropriate standardized grammar.
- The value for the keyname ‘schema’ **SHOULD** be a string that contains a valid external schema definition that matches the corresponding Property definitions type.
 - When a valid ‘schema’ value is provided on a Property definition, a TOSCA Orchestrator **MAY** choose use the contained schema definition for validation.

3.6.3.4 Grammar

Constraint clauses have one of the following grammars:

```
# Scalar grammar
<operator>: <scalar_value>

# Dual scalar grammar
<operator>: [ <scalar_value_1>, <scalar_value_2> ]

# List grammar
<operator>: [ <value_1>, <value_2>, ..., <value_n> ]

# Regular expression (regex) grammar
pattern: <regular_expression_value>

# Schema grammar
schema: <schema_definition>
```

In the above grammar, the pseudo values that appear in angle brackets have the following meaning:

- **operator**: represents a required operator from the specified list shown above (see section 3.6.3.1 “Operator keynames”).
- **scalar_value**, **scalar_value_***: represents a required scalar (or atomic quantity) that can hold only one value at a time. This will be a value of a primitive type, such as an integer or string that is allowed by this specification.
- **value_***: represents a required value of the operator that is not limited to scalars.
- **regular_expression_value**: represents a regular expression (string) value.
- **schema_definition**: represents a schema definition as a string.

3.6.3.5 Examples

Constraint clauses used on parameter or property definitions:

```
# equal
equal: 2

# greater_than
greater_than: 1

# greater_or_equal
greater_or_equal: 2

# less_than
less_than: 5

# less_or_equal
```

```

less_or_equal: 4

# in_range
in_range: [ 1, 4 ]

# valid_values
valid_values: [ 1, 2, 4 ]
# specific length (in characters)
length: 32

# min_length (in characters)
min_length: 8

# max_length (in characters)
max_length: 64

# schema
schema: <
  {
    # Some schema syntax that matches corresponding property or parameter.
  }

```

3.6.4 Property Filter definition

A property filter definition defines criteria, using constraint clauses, for selection of a TOSCA entity based upon its property values.

3.6.4.1 Grammar

Property filter definitions have one of the following grammars:

3.6.4.1.1 Short notation:

The following single-line grammar may be used when only a single constraint is needed on a property:

```
<property_name>: <property constraint clause>
```

3.6.4.1.2 Extended notation:

The following multi-line grammar may be used when multiple constraints are needed on a property:

```

<property_name>:
- <property constraint clause 1>
- ...
- <property constraint clause n>

```

In the above grammars, the pseudo values that appear in angle brackets have the following meaning:

- **property_name**: represents the name of property that would be used to select a property definition with the same name (**property_name**) on a TOSCA entity (e.g., a Node Type, Node Template, Capability Type, etc.).
- **property_constraint_clause_***: represents constraint clause(s) that would be used to filter entities based upon the named property's value(s).

3.6.4.2 Additional Requirements

- Property constraint clauses must be type compatible with the property definitions (of the same name) as defined on the target TOSCA entity that the clause would be applied against.

3.6.5 Node Filter definition

A node filter definition defines criteria for selection of a TOSCA Node Template based upon the template's property values, capabilities and capability properties.

3.6.5.1 Keynames

The following is the list of recognized keynames for a TOSCA node filter definition:

Keyname	Required	Type	Description
properties	no	list of property filter definition	An optional list of property filters that would be used to select (filter) matching TOSCA entities (e.g., Node Template, Node Type, Capability Types, etc.) based upon their property definitions' values.
capabilities	no	list of capability names or capability type names	An optional list of capability names or types that would be used to select (filter) matching TOSCA entities based upon their existence.

3.6.5.2 Additional filtering on named Capability properties

Capabilities used as filters often have their own sets of properties which also can be used to construct a filter.

Keyname	Required	Type	Description
<capability name_or_type> name>: properties	no	list of property filter definitions	An optional list of property filters that would be used to select (filter) matching TOSCA entities (e.g., Node Template, Node Type, Capability Types, etc.) based upon their capabilities' property definitions' values.

3.6.5.3 Grammar

Node filter definitions have following grammar:

```
node_filter:
  properties:
    - <property filter def 1>
    - ...
    - <property filter def n>
  capabilities:
```

```

- <capability_name_or_type_1>:
  properties:
    - <cap_1_property_filter_def_1>
    - ...
    - <cap_m_property_filter_def_n>
- ...
- <capability_name_or_type_n>:
  properties:
    - <cap_1_property_filter_def_1>
    - ...
    - <cap_m_property_filter_def_n>

```

In the above grammar, the pseudo values that appear in angle brackets have the following meaning:

- **property_filter_def_***: represents a property filter definition that would be used to select (filter) matching TOSCA entities (e.g., Node Template, Node Type, Capability Types, etc.) based upon their property definitions' values.
- **capability_name_or_type_***: represents the type or name of a capability that would be used to select (filter) matching TOSCA entities based upon their existence.
- **cap_*_property_def_***: represents a property filter definition that would be used to select (filter) matching TOSCA entities (e.g., Node Template, Node Type, Capability Types, etc.) based upon their capabilities' property definitions' values.

3.6.5.4 Additional requirements

- TOSCA orchestrators **SHALL** search for matching capabilities listed on a target filter by assuming the capability name is first a symbolic name and secondly it is a type name (in order to avoid namespace collisions).

3.6.5.5 Example

The following example is a filter that would be used to select a TOSCA [Compute](#) node based upon the values of its defined capabilities. Specifically, this filter would select Compute nodes that supported a specific range of CPUs (i.e., **num_cpus** value between 1 and 4) and memory size (i.e., **mem_size** of 2 or greater) from its declared "host" capability.

```

my_node_template:
  # other details omitted for brevity
  requirements:
    - host:
      node_filter:
        capabilities:
          # My "host" Compute node needs these properties:
          - host:
              properties:
                - num_cpus: { in_range: [ 1, 4 ] }
                - mem_size: { greater_or_equal: 512 MB }

```

3.6.6 Repository definition

A repository definition defines a named external repository which contains deployment and implementation artifacts that are referenced within the TOSCA Service Template.

3.6.6.1 Keynames

The following is the list of recognized keynames for a TOSCA repository definition:

Keyname	Required	Type	Constraints	Description
description	no	description	None	The optional description for the repository.
url	yes	string	None	The required URL or network address used to access the repository.
credential	no	Credential	None	The optional Credential used to authorize access to the repository.

3.6.6.2 Grammar

Repository definitions have one the following grammars:

3.6.6.2.1 Single-line grammar (no credential):

```
<repository\_name>: <repository_address>
```

3.6.6.2.2 Multi-line grammar

```
<repository\_name>:  
  description: <repository\_description>  
  url: <repository\_address>  
  credential: <authorization\_credential>
```

In the above grammar, the pseudo values that appear in angle brackets have the following meaning:

- **repository_name**: represents the required symbolic name of the repository as a [string](#).
- **repository_description**: contains an optional description of the repository.
- **repository_address**: represents the required URL of the repository as a string.
- **authorization_credential**: represents the optional credentials (e.g., user ID and password) used to authorize access to the repository.

3.6.6.3 Example

The following represents a repository definition:

```
repositories:  
  my_code_repo:  
    description: My project's code repository in GitHub  
    url: https://github.com/my-project/
```

3.6.7 Artifact definition

An artifact definition defines a named, typed file that can be associated with Node Type or Node Template and used by orchestration engine to facilitate deployment and implementation of interface operations.

3.6.7.1 Keynames

The following is the list of recognized keynames for a TOSCA artifact definition when using the extended notation:

Keyname	Required	Type	Description
type	yes	string	The required artifact type for the artifact definition.
file	yes	string	The required URI string (relative or absolute) which can be used to locate the artifact's file.
repository	no	string	The optional name of the repository definition which contains the location of the external repository that contains the artifact. The artifact is expected to be referenceable by its file URI within the repository.
description	no	description	The optional description for the artifact definition.
deploy_path	no	string	The file path the associated file would be deployed into within the target node's container.
artifact_version	no	string	The version of this artifact. One use of this artifact_version is to declare the particular version of this artifact type, in addition to its mime_type (that is declared in the artifact type definition). Together with the mime_type it may be used to select a particular artifact processor for this artifact. For example a python interpreter that can interpret python version 2.7.0
checksum	no	string	The checksum used to validate the integrity of the artifact.
checksum_algorithm	no	string	Algorithm used to calculate the artifact checksum (e.g. MD5, SHA [Ref]). Shall be specified if checksum is specified for an artifact.
properties	no	map of property assignments	The optional map of property assignments associated with the artifact.

3.6.7.2 Grammar

Artifact definitions have one of the following grammars:

3.6.7.2.1 Short notation

The following single-line grammar may be used when the artifact's type and mime type can be inferred from the file URI:

```
<artifact name>: <artifact file URI>
```

3.6.7.2.2 Extended notation:

The following multi-line grammar may be used when the artifact's definition's type and mime type need to be explicitly declared:

```
<artifact_name>:  
  description: <artifact_description>  
  type: <artifact_type_name>  
  file: <artifact_file_URI>  
  repository: <artifact_repository_name>  
  deploy_path: <file_deployment_path>  
  version: <artifact_version>  
  checksum: <artifact_checksum>  
  checksum_algorithm: <artifact_checksum_algorithm>  
  properties: <property assignments>
```

In the above grammars, the pseudo values that appear in angle brackets have the following meaning:

- **artifact_name**: represents the required symbolic name of the artifact as a [string](#).
- **artifact_description**: represents the optional [description](#) for the artifact.
- **artifact_type_name**: represents the required [artifact type](#) the artifact definition is based upon.
- **artifact_file_URI**: represents the required [URI string \(relative or absolute\) which can be used to locate the artifact's file](#).
- **artifact_repository_name**: represents the optional name of the [repository definition](#) to use to retrieve the associated artifact (file) from.
- **file_deployment_path**: represents the optional path the **artifact_file_URI** would be copied into within the target node's container.
- **artifact_version**: represents the version of artifact
- **artifact_checksum**: represents the checksum of the Artifact
- **artifact_checksum_algorithm**: represents the algorithm for verifying the checksum. Shall be specified if checksum is specified
- **properties**: represents an optional map of property assignments associated with the artifact

3.6.7.3 Examples

The following represents an artifact definition:

```
my_file_artifact: ../my_apps_files/operation_artifact.txt
```

The following example represents an artifact definition with property assignments:

```
artifacts:  
  sw_image:  
    description: Image for virtual machine  
    type: toska.artifacts.Deployment.Image.VM  
    file: http://10.10.86.141/images/Juniper_vSRX_15.1x49_D80_preconfigured.qcow2  
    checksum: ba411cafee2f0f702572369da0b765e2  
    version: 3.2  
    checksum_algorithm: MD5
```

```

properties:
  name: vSRX
  container_format: BARE
  disk_format: QCOW2
  min_disk: 1 GB
  size: 649 MB

```

3.6.8 Import definition

An import definition is used within a TOSCA Service Template to locate and uniquely name another TOSCA Service Template file which has type and template definitions to be imported (included) and referenced within another Service Template.

3.6.8.1 Keynames

The following is the list of recognized keynames for a TOSCA import definition:

Keyname	Required	Type	Constraints	Description
file	yes	string	None	The required symbolic name for the imported file.
repository	no	string	None	The optional symbolic name of the repository definition where the imported file can be found as a string.
namespace_prefix	no	string	None	The optional namespace prefix (alias) that will be used to indicate the namespace_uri when forming a qualified name (i.e., QName) when referencing type definitions from the imported file.
namespace_uri	no	string	Deprecated	The optional, deprecated namespace URI to that will be applied to type definitions found within the imported file as a string.

3.6.8.2 Grammar

Import definitions have one the following grammars:

3.6.8.2.1 Single-line grammar:

```

imports:
  - <URI_1>
  - <URI_2>

```

3.6.8.2.2 Multi-line grammar

```

imports:
  - file: <file_URI>
    repository: <repository_name>
    namespace_uri: <definition_namespace_uri> # deprecated
    namespace_prefix: <definition_namespace_prefix>

```

In the above grammar, the pseudo values that appear in angle brackets have the following meaning:

- **file_uri**: contains the required name (i.e., URI) of the file to be imported as a [string](#).

- **repository_name**: represents the optional symbolic name of the repository definition where the imported file can be found as a [string](#).
- **namespace_uri**: represents the optional namespace URI to that will be applied to type definitions found within the imported file as a [string](#).
- **namespace_prefix**: represents the optional namespace prefix (alias) that will be used to indicate the default namespace as declared in the imported Service Template when forming a qualified name (i.e., QName) when referencing type definitions from the imported file as a [string](#).

3.6.8.2.3 Requirements

- The “file” keyname’s value MAY be an approved TOSCA Namespace alias.
- The namespace prefix “tosca” is reserved and SHALL NOT be used to as a value for “namespace_prefix” on import.
- The imports key “namespace_uri” is now deprecated. It was intended to be able to define a default namespace for any types that were defined within the Service Template being imported; however, with version 1.2, Service Templates MAY now declare their own default Namespace which SHALL be used in place of this key’s value.
 - Please note that TOSCA Orchestrators and Processors MAY still use the “namespace_uri” value if provided, if the imported Service Template has no declared default Namespace value. Regardless it is up to the TOSCA Orchestrator or Processor to resolve Namespace collisions caused by imports as they see fit, for example, they may treat it as an error or dynamically generate a unique namespace themselves on import.

3.6.8.2.4 Import URI processing requirements

TOSCA Orchestrators, Processors and tooling SHOULD treat the <file_URI> of an import as follows:

- **URI**: If the <file_URI> is a known namespace URI (identifier), such as a well-known URI defined by a TOSCA specification, then it SHOULD cause the corresponding Type definitions to be imported.
 - This implies that there may or may not be an actual Service Template, perhaps it is a known set Types identified by the well-known URI.
 - This also implies that internet access is NOT needed to import.
- **Alias** – If the <file_URI> is a reserved TOSCA Namespace alias, then it SHOULD cause the corresponding Type definitions to be imported, using the associated full, Namespace URI to uniquely identify the imported types.
- **URL** - If the <file_URI> is a valid URL (i.e., network accessible as a remote resource) and the location contains a valid TOSCA Service Template, then it SHOULD cause the remote Service Template to be imported.
- **Relative path** - If the <file_URI> is a relative path URL, perhaps pointing to a Service Template located in the same CSAR file, then it SHOULD cause the locally accessible Service Template to be imported.
 - If the “repository” key is supplied, this could also mean relative to the repository’s URL in a remote file system;
 - If the importing file located in a CSAR file, it should be treated as relative to the current document’s location within a CSAR file’s directory structure.
- Otherwise, the import SHOULD be considered a failure.

3.6.8.3 Example

The following represents how import definitions would be used for the imports keyname within a TOSCA Service Template:

```

imports:
  - path1/path2/some_defs.yaml
  - file: path1/path2/file2.yaml
  repository: my_service_catalog
  namespace_uri: http://mycompany.com/tosca/1.0/platform
  namespace_prefix: mycompany

```

3.6.9 Schema Definition

All entries in a map or list for one property or parameter must be of the same type. Similarly, all keys for map entries for one property or parameter must be of the same type as well. A TOSCA schema definition specifies the type (for simple entries) or schema (for complex entries) for keys and entries in TOSCA set types such as the TOSCA list or map.

3.6.9.1 Keynames

The following is the list of recognized keynames for a TOSCA schema definition:

Keyname	Required	Type	Constraints	Description
type	yes	string	None	The required data type for the key or entry.
description	no	description	None	The optional description for the schema.
constraints	no	list of constraint clauses	None	The optional list of sequenced constraint clauses for the property.
key_schema	no	schema_definition	None	When the schema itself is of type map, the optional schema definition that is used to specify the type of they keys of that map's entries.
entry_schema	no	schema_definition	None	When the schema itself is of type map or list, the optional schema definition that is used to specify the type of the entries in that map or list

3.6.9.2 Grammar

Schema definitions have the following grammar:

```

<schema definition>:
  type: <schema type>
  description: <schema description>
  constraints:
    - <schema constraints>
  key_schema : <key_schema_definition>
  entry_schema: <entry_schema_definition>

```

In the above grammar, the pseudo values that appear in angle brackets have the following meaning:

- **schema_description**: represents the optional [description](#) of the schema definition
- **schema_type**: represents the required type name for entries of the specified schema.
- **schema_constraints**: represents the optional list of one or more [constraint clauses](#) on on entries of the specified schema.

- **key_schema_definition**: if the schema_type is map, represents the optional schema definition for they keys of that map's entries.
- **entry_schema_definition**: if the schema_type is map or list, represents the optional schema definition for the entries in that map or list.

3.6.10 Property definition

A property definition defines a named, typed value and related data that can be associated with an entity defined in this specification (e.g., Node Types, Relationship Types, Capability Types, etc.). Properties are used by template authors to provide input values to TOSCA entities which indicate their “desired state” when they are instantiated. The value of a property can be retrieved using the **get_property** function within TOSCA Service Templates.

3.6.10.1 Attribute and Property reflection

The actual state of the entity, at any point in its lifecycle once instantiated, is reflected by **Attribute definitions**. TOSCA orchestrators automatically create an attribute for every declared property (with the same symbolic name) to allow introspection of both the desired state (property) and actual state (attribute).

3.6.10.2 Keynames

The following is the list of recognized keynames for a TOSCA property definition:

Keyname	Required	Type	Constraints	Description
type	yes	string	None	The required data type for the property.
description	no	description	None	The optional description for the property.
required	no	boolean	default: true	An optional key that declares a property as required (true) or not (false).
default	no	<any>	None	An optional key that may provide a value to be used as a default if not provided by another means.
status	no	string	default: supported	The optional status of the property relative to the specification or implementation. See table below for valid values.
constraints	no	list of constraint clauses	None	The optional list of sequenced constraint clauses for the property.
key_schema	no	schema_definition	None	The optional schema definition for the keys used to identify entries in properties of type TOSCA map.
entry_schema	no	schema_definition	None	The optional schema definition for the entries in properties of TOSCA set types such as list or map.
external-schema	no	string	None	The optional key that contains a schema definition that TOSCA Orchestrators MAY use for validation when the “type” key’s value indicates an External schema (e.g., “json”) <p>See section “External schema” below for further explanation and usage.</p>
metadata	no	map of string	N/A	Defines a section used to declare additional metadata information.

3.6.10.3 Status values

The following property status values are supported:

Value	Description
supported	Indicates the property is supported. This is the default value for all property definitions.
unsupported	Indicates the property is not supported.
experimental	Indicates the property is experimental and has no official standing.
deprecated	Indicates the property has been deprecated by a new specification version.

3.6.10.4 Grammar

Named property definitions have the following grammar:

```
<property_name>:  
  type: <property_type>  
  description: <property_description>  
  required: <property_required>  
  default: <default_value>  
  status: <status_value>  
  constraints:  
    - <property_constraints>  
  key_schema : <key_schema_definition>  
  entry_schema: <entry_schema_definition>  
  metadata:  
    <metadata_map>
```

In the above grammar, the pseudo values that appear in angle brackets have the following meaning:

- **property_name**: represents the required symbolic name of the property as a **string**.
- **property_description**: represents the optional **description** of the property.
- **property_type**: represents the required data type of the property.
- **property_required**: represents an optional **boolean** value (true or false) indicating whether or not the property is required. If this keyname is not present on a property definition, then the property SHALL be considered **required** (i.e., true) by **default**.
- **default_value**: contains a type-compatible value that may be used as a default if not provided by another means.
- **status_value**: a **string** that contains a keyword that indicates the status of the property relative to the specification or implementation.
- **property_constraints**: represents the optional list of one or more sequenced **constraint clauses** on the property definition.
- **key_schema_definition**: if the **property_type** is map, represents the optional schema definition for they keys used to identify entries in that map.
- **entry_schema_definition**: if the **property_type** is map or list, represents the optional schema definition for the entries in that map or list.
- **metadata_map**: represents the optional map of string.

3.6.10.5 Additional Requirements

- Implementations of the TOSCA Simple Profile **SHALL** automatically reflect (i.e., make available) any property defined on an entity as an attribute of the entity with the same name as the property.
- A property **SHALL** be considered required by default (i.e., as if the **required** keyname on the definition is set to **true**) unless the definition's **required** keyname is explicitly set to **false**.
- The value provided on a property definition's **default** keyname SHALL be type compatible with the type declared on the definition's **type** keyname.
- Constraints of a property definition **SHALL** be type-compatible with the type defined for that definition.
- If a 'schema' keyname is provided, its value (string) **MUST** represent a valid schema definition that matches the recognized external type provided as the value for the 'type' keyname as described by its corresponding schema specification.
- TOSCA Orchestrators **MAY** choose to validate the value of the 'schema' keyname in accordance with the corresponding schema specification for any recognized external types.

3.6.10.6 Refining Property Definitions

TOSCA allows derived types to **refine** properties defined in base types. A property definition in a derived type is considered a refinement when a property with the same name is already defined in one of the base types for that type.

Property definition refinements use **parameter definition** grammar rather than **property definition grammar**. Specifically, this means the following:

- The **type** keyname is optional. If no type is specified, the property refinement reuses the type of the property it refines. If a type is specified, the type must be the same as the type of the refined property or it must derive from the type of the refined property.
- Property definition refinements support the **value** keyname that specifies a fixed type-compatible value to assign to the property. These value assignments are considered final, meaning that it is not valid to change the property value later (e.g. using further refinements)..

Property refinement definitions can refine properties defined in one of base types by doing one or more of the following:

- Assigning a new (compatible) type as per the rules outlined above.
- Assigning a (final) fixed value
- Adding a default value
- Changing a default value
- Adding constraints.
- Turning an optional property into a required property.

No other refinements are allowed.

3.6.10.7 Notes

- This element directly maps to the **PropertiesDefinition** element defined as part of the schema for most type and entities defined in the [TOSCA v1.0 specification](#).
- In the [TOSCA v1.0 specification](#) constraints are expressed in the XML Schema definitions of Node Type properties referenced in the **PropertiesDefinition** element of **NodeType** definitions.

3.6.10.8 Examples

The following represents an example of a property definition with constraints:

```
properties:
  num_cpus:
    type: integer
    description: Number of CPUs requested for a software node instance.
    default: 1
    required: true
    constraints:
      - valid_values: [ 1, 2, 4, 8 ]
```

The following shows an example of a property refinement. Consider the definition of an Endpoint capability type:

```
tosca.capabilities.Endpoint:
  derived_from: tosca.capabilities.Root
  properties:
    protocol:
      type: string
      required: true
      default: tcp
    port:
      type: PortDef
      required: false
    secure:
      type: boolean
      required: false
      default: false
  # Other property definitions omitted for brevity
```

The Endpoint.Admin capability type refines the *secure* property of the Endpoint capability type from which it derives by forcing its value to always be true:

```
tosca.capabilities.Endpoint.Admin:
  derived_from: tosca.capabilities.Endpoint
  # Change Endpoint secure indicator to true from its default of false
  properties:
    secure: true
```

3.6.11 Property assignment

This section defines the grammar for assigning values to named properties within TOSCA Node and Relationship templates that are defined in their corresponding named types.

3.6.11.1 Keynames

The TOSCA property assignment has no keynames.

3.6.11.2 Grammar

Property assignments have the following grammar:

3.6.11.2.1 Short notation:

The following single-line grammar may be used when a simple value assignment is needed:

```
<property_name>: <property_value> | { <property_value_expression> }
```

In the above grammars, the pseudo values that appear in angle brackets have the following meaning:

- **property_name:** represents the name of a property that would be used to select a property definition with the same name within on a TOSCA entity (e.g., Node Template, Relationship Template, etc.) which is declared in its declared type (e.g., a Node Type, Node Template, Capability Type, etc.).
- **property_value, property_value_expression:** represent the type-compatible value to assign to the named property. Property values may be provided as the result from the evaluation of an expression or a function.

3.6.12 Attribute definition

An attribute definition defines a named, typed value that can be associated with an entity defined in this specification (e.g., a Node, Relationship or Capability Type). Specifically, it is used to expose the “actual state” of some property of a TOSCA entity after it has been deployed and instantiated (as set by the TOSCA orchestrator). Attribute values can be retrieved via the **get_attribute** function from the instance model and used as values to other entities within TOSCA Service Templates.

3.6.12.1 Attribute and Property reflection

TOSCA orchestrators automatically create [Attribute definitions](#) for any [Property definitions](#) declared on the same TOSCA entity (e.g., nodes, node capabilities and relationships) in order to make accessible the actual (i.e., the current state) value from the running instance of the entity.

3.6.12.2 Keynames

The following is the list of recognized keynames for a TOSCA attribute definition:

Keyname	Required	Type	Constraints	Description
type	yes	string	None	The required data type for the attribute.
description	no	description	None	The optional description for the attribute.
default	no	<any>	None	An optional key that may provide a value to be used as a default if not provided by another means. This value SHALL be type compatible with the type declared by the property definition’s type keyname.
status	no	string	default: supported	The optional status of the attribute relative to the specification or implementation. See supported status values defined under the Property definition section.

Keyname	Required	Type	Constraints	Description
key_schema	No	schema_definition	None	The optional schema definition for the keys used to identify entries in attributes of type TOSCA map.
entry_schema	no	schema_definition	None	The optional schema definition for the entries in attributes of TOSCA set types such as list or map.

3.6.12.3 Grammar

Attribute definitions have the following grammar:

```

attributes:
  <attribute_name>:
    type: <attribute_type>
    description: <attribute_description>
    default: <default_value>
    status: <status_value>
    key_schema : <key_schema_definition>
    entry_schema: <entry_schema_definition>

```

In the above grammar, the pseudo values that appear in angle brackets have the following meaning:

- **attribute_name**: represents the required symbolic name of the attribute as a [string](#).
- **attribute_type**: represents the required data type of the attribute.
- **attribute_description**: represents the optional [description](#) of the attribute.
- **default_value**: contains a type-compatible value that may be used as a default if not provided by another means.
- **status_value**: contains a value indicating the attribute's status relative to the specification version (e.g., supported, deprecated, etc.). Supported [status values](#) for this keyname are defined under [Property definition](#).
- **key_schema_definition**: if the attribute_type is map, represents the optional schema definition for they keys used to identify entries in that map.
- **entry_schema_definition**: if the attribute_type is map or list, represents the optional schema definition for the entries in that map or list.

3.6.12.4 Additional Requirements

- In addition to any explicitly defined attributes on a TOSCA entity (e.g., Node Type, RelationshipType, etc.), implementations of the TOSCA Simple Profile **MUST** automatically reflect (i.e., make available) any property defined on an entity as an attribute of the entity with the same name as the property.
- Values for the default keyname **MUST** be derived or calculated from other attribute or operation output values (that reflect the actual state of the instance of the corresponding resource) and not hard-coded or derived from a property settings or inputs (i.e., desired state).

3.6.12.5 Notes

- Attribute definitions are very similar to [Property definitions](#); however, properties of entities reflect an input that carries the template author's requested or desired value (i.e., desired state) which

the orchestrator (attempts to) use when instantiating the entity whereas attributes reflect the actual value (i.e., actual state) that provides the actual instantiated value.

- For example, a property can be used to request the IP address of a node using a property (setting); however, the actual IP address after the node is instantiated may be different and made available by an attribute.

3.6.12.6 Example

The following represents a required attribute definition:

```
actual_cpus:  
  type: integer  
  description: Actual number of CPUs allocated to the node instance.
```

3.6.13 Attribute assignment

This section defines the grammar for assigning values to named attributes within TOSCA Node and Relationship templates which are defined in their corresponding named types.

3.6.13.1 Keynames

The TOSCA attribute assignment has no keynames.

3.6.13.2 Grammar

Attribute assignments have the following grammar:

3.6.13.2.1 Short notation:

The following single-line grammar may be used when a simple value assignment is needed:

```
<attribute_name>: <attribute_value> | { <attribute_value_expression> }
```

3.6.13.2.2 Extended notation:

The following multi-line grammar may be used when a value assignment requires keys in addition to a simple value assignment:

```
<attribute_name>:  
  description: <attribute_description>  
  value: <attribute_value> | { <attribute_value_expression> }
```

In the above grammars, the pseudo values that appear in angle brackets have the following meaning:

- **attribute_name**: represents the name of an attribute that would be used to select an attribute definition with the same name within on a TOSCA entity (e.g., Node Template, Relationship Template, etc.) which is declared (or reflected from a Property definition) in its declared type (e.g., a Node Type, Node Template, Capability Type, etc.).
- **attribute_value**, **attribute_value_expression**: represent the type-compatible value to assign to the named attribute. Attribute values may be provided as the result from the evaluation of an expression or a function.
- **attribute_description**: represents the optional [description](#) of the attribute.

3.6.13.3 Additional requirements

- Attribute values **MAY** be provided by the underlying implementation at runtime when requested by the `get_attribute` function or it **MAY** be provided through the evaluation of expressions and/or functions that derive the values from other TOSCA attributes (also at runtime).

3.6.14 Parameter definition

A parameter definition is essentially a TOSCA property definition; however, it also allows a value to be assigned to it (as for a TOSCA property assignment). In addition, in the case of output parameters, it can optionally inherit the data type of the value assigned to it rather than have an explicit data type defined for it.

3.6.14.1 Keynames

The TOSCA parameter definition has all the keynames of a TOSCA Property definition, but in addition includes the following additional or changed keynames:

Keyname	Required	Type	Constraints	Description
type	no	string	None	The required data type for the parameter. Note: This keyname is required for a TOSCA Property definition, but is not for a TOSCA Parameter definition.
value	no	<any>	N/A	The type-compatible value to assign to the named parameter. Parameter values may be provided as the result from the evaluation of an expression or a function.

3.6.14.2 Grammar

Named parameter definitions have the following grammar:

```
<parameter_name>:  
  type: <parameter_type>  
  description: <parameter_description>  
  value: <parameter_value> | { <parameter_value_expression> }  
  required: <parameter_required>  
  default: <parameter_default_value>  
  status: <status_value>  
  constraints:  
    - <parameter_constraints>  
  key_schema : <key_schema_definition>  
  entry_schema: <entry_schema_definition>
```

In addition, the following single-line grammar is supported when only a fixed value needs to be provided:

```
<parameter_name>: <parameter_value> | { <parameter_value_expression> }
```

This single-line grammar is equivalent to the following:

```
<parameter_name>:  
value : <parameter_value> | { <parameter_value_expression> }
```

In the above grammar, the pseudo values that appear in angle brackets have the following meaning:

- **parameter_name**: represents the required symbolic name of the parameter as a [string](#).
- **parameter_description**: represents the optional [description](#) of the parameter.
- **parameter_type**: represents the optional data type of the parameter. Note, this keyname is required for a TOSCA Property definition, but is not for a TOSCA Parameter definition.
- **parameter_value**, **parameter_value_expresssion**: represent the type-compatible value to assign to the named parameter. Parameter values may be provided as the result from the evaluation of an expression or a function.
- **parameter_required**: represents an optional [boolean](#) value (true or false) indicating whether or not the parameter is required. If this keyname is not present on a parameter definition, then the property SHALL be considered **required** (i.e., true) by **default**.
- **default_value**: contains a type-compatible value that may be used as a default if not provided by another means.
- **status_value**: a [string](#) that contains a keyword that indicates the status of the parameter relative to the specification or implementation.
- **parameter_constraints**: represents the optional list of one or more sequenced [constraint clauses](#) on the parameter definition.
- **key_schema_definition**: if the parameter_type is map, represents the optional schema definition for they keys used to identify entries in that map.
- **entry_schema_definition**: if the parameter_type is map or list, represents the optional schema definition for the entries in that map or list.

3.6.14.3 Additional Requirements

- A parameter **SHALL** be considered required by default (i.e., as if the **required** keyname on the definition is set to **true**) unless the definition's **required** keyname is explicitly set to **false**.
- The value provided on a parameter definition's **default** keyname **SHALL** be type compatible with the type declared on the definition's **type** keyname.
- Constraints of a parameter definition **SHALL** be type-compatible with the type defined for that definition.

3.6.14.4 Example

The following represents an example of an input parameter definition with constraints:

```
inputs:  
  cpus:  
    type: integer  
    description: Number of CPUs for the server.  
    constraints:  
      - valid_values: [ 1, 2, 4, 8 ]
```

The following represents an example of an (untyped) output parameter definition:

```
outputs:  
  server_ip:  
    description: The private IP address of the provisioned server.
```

```
value: { get_attribute: [ my_server, private_address ] }
```

3.6.15 Attribute Mapping definition

An attribute mapping defines a named output value that is expected to be returned by an operation implementations and a mapping that specifies the node or relationship attribute into which the returned output value must be stored.

3.6.15.1 Grammar

Attribute mappings have the following grammar :

```
output_name: [ <SELF | SOURCE | TARGET >, <optional_capability_name>,  
<attribute_name>, <nested_attribute_name_or_index_1>, ...,  
<nested_attribute_name_or_index_or_key_n> ]
```

The various entities in this grammar are defined as follows:

Parameter	Required	Type	Description
SELF SOURCE TARGET	yes	string	For operation outputs in interfaces on node templates, the only allowed keyname is SELF: output values must always be stored into attributes that belong to the node template that has the interface for which the output values are returned. For operation outputs in interfaces on relationship templates, allowable keynames are SELF, SOURCE, or TARGET.
<optional_capability_name>	no	string	The optional name of the capability within the specified node template that contains the named attribute into which the output value must be stored.
<attribute_name>	yes	string	The name of the attribute into which the output value must be stored.
<nested_attribute_name_or_index_or_key_*>	no	string integer	Some TOSCA attributes are complex (i.e., composed as nested structures). These parameters are used to dereference into the names of these nested structures when needed. Some attributes represent <i>list</i> or <i>map</i> types. In these cases, an index or key may be provided to reference a specific entry in the list or map (as named in the previous parameter) to return.

Note that it is possible for multiple operations to define outputs that map onto the same attribute value. For example, a *create* operation could include an output value that sets an attribute to an initial value, and the subsequent *configure* operation could then update that same attribute to a new value.

It is also possible that a node template assigns a value to an attribute that has an operation output mapped to it (including a value that is the result of calling an intrinsic function). Orchestrators could use the assigned value for the attribute as its initial value. After the operation runs that maps an output value

onto that attribute, the orchestrator must then use the updated value, and the value specified in the node template will no longer be used.

3.6.16 Operation implementation definition

An operation implementation definition specifies one or more artifacts (e.g. scripts) to be used as the implementation for an operation in an interface.

3.6.16.1 Keynames

The following is the list of recognized keynames for a TOSCA operation implementation definition:

Keyname	Required	Type	Description
primary	no	Artifact definition	The optional implementation artifact (i.e., the primary script file within a TOSCA CSAR file).
dependencies	no	list of Artifact definition	The optional list of one or more dependent or secondary implementation artifacts which are referenced by the primary implementation artifact (e.g., a library the script installs or a secondary script).
timeout	No	integer	Timeout value in seconds
operation_host	no	string	<p>The node on which operations should be executed (for TOSCA call_operation activities).</p> <p>If the operation is associated with an interface on a node type or a relationship template, valid_values are SELF or HOST – referring to the node itself or to the node that is the target of the HostedOn relationship for that node.</p> <p>If the operation is associated with a relationship type or a relationship template, valid_values are SOURCE or TARGET – referring to the relationship source or target node.</p> <p>In both cases, the value can also be set to ORCHESTRATOR to indicated that the operation must be executed in the orchestrator environment rather than within the context of the service being orchestrated.</p>

3.6.16.2 Grammar

Operation implementation definitions have the following grammars:

3.6.16.2.1 Short notation for use with single artifact

The following single-line grammar may be used when only a primary implementation artifact name is needed:

```
implementation: <primary_artifact_name>
```

This notation can be used when the primary artifact name uniquely identifies the artifact, either because it refers to a named artifact specified in the artifacts section of a type or template, or because it represents the name of a script in the CSAR file that contains the definition.

3.6.16.2.2 Short notation for use with multiple artifact

The following multi-line short-hand grammar may be used when multiple artifacts are needed, but each of the artifacts can be uniquely identified by name as before:

```
implementation:
  primary: <primary_artifact_name>
  dependencies:
    - <list_of_dependent_artifact_names>
  operation_host : SELF
  timeout : 60
```

3.6.16.2.3 Extended notation for use with single artifact

The following multi-line grammar may be used in Node or Relationship Type or Template definitions when only a single artifact is used but additional information about the primary artifact is needed (e.g. to specify the repository from which to obtain the artifact, or to specify the artifact type when it cannot be derived from the artifact file extension):

```
implementation:
  primary:
    <primary_artifact_definition>
  operation_host : HOST
  timeout : 100
```

3.6.16.2.4 Extended notation for use with multiple artifacts

The following multi-line grammar may be used in Node or Relationship Type or Template definitions when there are multiple artifacts that may be needed for the operation to be implemented and additional information about each of the artifacts is required:

```
implementation:
  primary:
    <primary_artifact_definition>
  dependencies:
    - <list_of_dependent_artifact_definitions>
  operation_host: HOST
  timeout: 120
```

In the above grammars, the pseudo values that appear in angle brackets have the following meaning:

- **primary_artifact_name**: represents the optional name (**string**) of an implementation artifact definition (defined elsewhere), or the direct name of an implementation artifact's relative filename (e.g., a service template-relative, path-inclusive filename or absolute file location using a URL).
- **primary_artifact_definition**: represents a full inline definition of an implementation artifact.
- **list_of_dependent_artifact_names**: represents the optional ordered list of one or more dependent or secondary implementation artifact names (as strings) which are referenced by the primary implementation artifact. TOSCA orchestrators will copy these files to the same location as the primary artifact on the target node so as to make them accessible to the primary implementation artifact when it is executed.

- **list_of_dependent_artifact_definitions**: represents the ordered list of one or more inline definitions of dependent or secondary implementation artifacts. TOSCA orchestrators will copy these artifacts to the same location as the primary artifact on the target node so as to make them accessible to the primary implementation artifact when it is executed.

3.6.17 Operation definition

An operation definition defines a named function or procedure that can be bound to an operation implementation.

3.6.17.1 Keynames

The following is the list of recognized keynames for a TOSCA operation definition:

Keyname	Required	Type	Description
description	no	description	The optional description string for the associated named operation.
implementation	no	Operation implementation definition	The optional definition of the operation implementation
inputs	no	map of parameter definitions	The optional map of input properties definitions (i.e., parameter definitions) for operation definitions that are within TOSCA Node or Relationship Type definitions. This includes when operation definitions are included as part of a Requirement definition in a Node Type.
	no	map of property assignments	The optional map of input property assignments (i.e., parameters assignments) for operation definitions that are within TOSCA Node or Relationship Template definitions. This includes when operation definitions are included as part of a Requirement assignment in a Node Template.
outputs	no	map of attribute mappings	The optional map of attribute mappings that specify named operation output values and their mappings onto attributes of the node_type or relationship that contains the interface within which the operation is defined.

3.6.17.2 Grammar

Operation definitions have the following grammars:

3.6.17.2.1 Short notation

The following single-line grammar may be used when the operation's implementation definition is the only keyname that is needed, and when the operation implementation definition itself can be specified using a single line grammar

```
<operation_name>: <implementation_artifact_name>
```

3.6.17.2.2 Extended notation for use in Type definitions

The following multi-line grammar may be used in Node or Relationship Type definitions when additional information about the operation is needed:

```
<operation_name>:
```

```
description: <operation description>
implementation: <Operation implementation definition>
inputs:
  <property definitions>
outputs:
  <attribute mappings>
```

3.6.17.2.3 Extended notation for use in Template definitions

The following multi-line grammar may be used in Node or Relationship Template definitions when additional information about the operation is needed:

```
<operation name>:
  description: <operation description>
  implementation: <Operation implementation definition>
  inputs:
    <property assignments>
```

In the above grammars, the pseudo values that appear in angle brackets have the following meaning:

- **operation_name**: represents the required symbolic name of the operation as a [string](#).
- **operation_description**: represents the optional [description](#) string for the corresponding **operation_name**.
- **operation_implementation_definition**: represents the optional specification of the operation's implementation).
- **property_definitions**: represents the optional map of [property definitions](#) which the TOSCA orchestrator would make available (i.e., or pass) to the corresponding implementation artifact during its execution.
- **property_assignments**: represents the optional map of property assignments for passing parameters to Node or Relationship Template operations providing values for properties defined in their respective type definitions.
- **attribute_mappings**: represents the optional map of of **attribute_mappings** that consists of named output values returned by operation implementations (i.e. artifacts) and associated mappings that specify the attribute into which this output value must be stored.

3.6.17.3 Additional requirements

- The default sub-classing behavior for implementations of operations SHALL be override. That is, implementation artifacts assigned in subclasses override any defined in its parent class.
- Template authors MAY provide property assignments on operation inputs on templates that do not necessarily have a property definition defined in its corresponding type.
- Implementation artifact file names (e.g., script filenames) may include file directory path names that are relative to the TOSCA service template file itself when packaged within a TOSCA Cloud Service ARchive (CSAR) file.

3.6.17.4 Examples

3.6.17.4.1 Single-line example

```
interfaces:  
  Standard:  
    start: scripts/start_server.sh
```

3.6.17.4.2 Multi-line example with shorthand implementation definitions

```
interfaces:  
  Configure:  
    pre_configure_source:  
      implementation:  
        primary: scripts/pre_configure_source.sh  
      dependencies:  
        - scripts/setup.sh  
        - binaries/library.rpm  
        - scripts/register.py
```

3.6.17.4.3 Multi-line example with extended implementation definitions

```
interfaces:  
  Configure:  
    pre_configure_source:  
      implementation:  
        primary:  
          file: scripts/pre_configure_source.sh  
          type: tosca.artifacts.Implementation.Bash  
          repository: my_service_catalog  
      dependencies:          - file : scripts/setup.sh  
                             type : tosca.artifacts.Implementation.Bash  
                             Repository : my_service_catalog
```

3.6.18 Notification implementation definition

A notification implementation definition specifies one or more artifacts to be used by the orchestrator to subscribe to that particular notification. We use the *primary* and *dependencies* keynames as in the operation implementation definition.

3.6.18.1 Keynames

The following is the list of recognized keynames for a TOSCA notification implementation definition:

Keyname	Required	Type	Description
primary	no	Artifact definition	The optional implementation artifact (i.e., the primary script file within a TOSCA CSAR file).
dependencies	no	list of Artifact definition	The optional list of one or more dependent or secondary implementation artifacts which are referenced by the primary implementation artifact (e.g., a library the script installs or a secondary script).

3.6.18.2 Grammar

Notification implementation definitions have the following grammars:

3.6.18.2.1 Short notation for use with single artifact

The following single-line grammar may be used when only a primary implementation artifact name is needed:

```
implementation: <primary_artifact_name>
```

This notation can be used when the primary artifact name uniquely identifies the artifact, either because it refers to a named artifact specified in the artifacts section of a type or template, or because it represents the name of a script in the CSAR file that contains the definition.

3.6.18.2.2 Short notation for use with multiple artifact

The following multi-line short-hand grammar may be used when multiple artifacts are needed, but each of the artifacts can be uniquely identified by name as before:

```
implementation:
  primary: <primary_artifact_name>
  dependencies:
    - <list_of_dependent_artifact_names>
```

3.6.19 Notification definition

A notification definition defines a named notification that can be associated with an interface. The notification is a way for an external event to be transmitted to the TOSCA orchestrator. Parameter values can be sent together with a notification and we can map them to node/relationship attributes imilarly to the way operation outputs are mapped to attributes. The artifact that the orchestrator is registering with in order to receive the notification is specified using the “implementation” keyname in a similar way to operations.

When the notification is received an event is generated within the orchestrator that can be associated to triggers in policies to call other internal operations and workflows. The notification name (the unqualified full name) itself identifies the event type that is generated and can be textually used when defining the associated triggers.

3.6.19.1 Keynames

The following is the list of recognized keynames for a TOSCA notification definition:

Keyname	Required	Type	Description
description	no	description	The optional description string for the associated named notification.
implementation	no	notification implementation definition	The optional definition of the notification implementation.
outputs	no	map of attribute mappings	The optional map of property mappings that specify named notification output values and their mappings onto attributes of the node or relationship that contains the interface within which the notification is defined.

3.6.19.2 Grammar

The following multi-line grammar may be used in Node or Relationship Template or Type definitions:

```
<notification_name>:
  description: <notification_description>
  implementation: <notification_implementation_definition>
  outputs:
    <attribute_mappings>
```

In the above grammar, the pseudo values that appear in angle brackets have the following meaning:

- **notification_name**: represents the required symbolic name of the notification as a string.
- **notification_description**: represents the optional description string for the corresponding notification_name.
- **notification_implementation_definition**: represents the optional specification of the notification implementation (i.e. the external artifact that is may send notifications)
- **attribute_mappings**: represents the optional map of attribute assignments for mapping the outputs values to the respective attributes of the node or relationship.

3.6.20 Interface definition

An interface definition defines a named interface that can be associated with a Node or Relationship Type

3.6.20.1 Keynames

The following is the list of recognized keynames for a TOSCA interface definition:

Keyname	Required	Type	Description
inputs	no	map of property definitions	The optional map of input property definitions available to all defined operations for interface definitions that are within TOSCA Node or Relationship Type definitions. This includes when interface definitions are included as part of a Requirement definition in a Node Type.
	no	map of property assignments	The optional map of input property assignments (i.e., parameters assignments) for interface definitions that are within TOSCA Node or Relationship Template definitions. This includes when interface definitions are referenced as part of a Requirement assignment in a Node Template.

Keyname	Required	Type	Description
operations	no	map of operation definitions	The optional map of operations defined for this interface.
notifications	no	map of notification definitions	The optional map of notifications defined for this interface.

3.6.20.2 Grammar

Interface definitions have the following grammar:

3.6.20.2.1 Extended notation for use in Type definitions

The following multi-line grammar may be used in Node or Relationship Type definitions:

```
<interface definition name>:
  type: <interface type name>
  inputs:
    <property definitions>
  operations:
    <operation definitions>
  notifications:
    <notification definitions>
```

3.6.20.2.2 Extended notation for use in Template definitions

The following multi-line grammar may be used in Node or Relationship Template definitions:

```
<interface definition name>:
  inputs:
    <property assignments>
  operations:
    <operation definitions>
  notifications:
    <notification definitions>
```

In the above grammars, the pseudo values that appear in angle brackets have the following meaning:

- **interface_definition_name**: represents the required symbolic name of the interface as a [string](#).
- **interface_type_name**: represents the required name of the Interface Type for the interface definition.
- **property_definitions**: represents the optional map of [property definitions](#) (i.e., parameters) which the TOSCA orchestrator would make available (i.e., or pass) to all defined operations.
 - *This means these properties and their values would be accessible to the implementation artifacts (e.g., scripts) associated to each operation during their execution.*
- **property_assignments**: represents the optional map of [property assignments](#) for passing parameters to Node or Relationship Template operations providing values for properties defined in their respective type definitions.
- **operation_definitions**: represents the required name of one or more [operation definitions](#).

- **notification_definitions**: represents the required name of one or more notification definitions.

3.6.20.3 Notes

Starting with Version 1.3 of this specification, interface definition grammar was changed to support notifications as well as operations. As a result, operations must now be specified under the newly-introduced **operations** keyname and the notifications under the new **notifications** keyname. For backward compatibility if neither the operations or notifications are specified then we assume the symbolic names in the interface definition to mean operations, but this use is deprecated. Operations and notifications names should not overlap.

3.6.21 Event Filter definition

An event filter definition defines criteria for selection of an attribute, for the purpose of monitoring it, within a TOSCA entity, or one its capabilities.

3.6.21.1 Keynames

The following is the list of recognized keynames for a TOSCA event filter definition:

Keyname	Required	Type	Description
node	yes	string	The required name of the node type or template that contains either the attribute to be monitored or contains the requirement that references the node that contains the attribute to be monitored.
requirement	no	string	The optional name of the requirement within the filter's node that can be used to locate a referenced node that contains an attribute to monitor.
capability	no	string	The optional name of a capability within the filter's node or within the node referenced by its requirement that contains the attribute to monitor.

3.6.21.2 Grammar

Event filter definitions have following grammar:

```
node: <node_type_name> | <node_template_name>
requirement: <requirement_name>
capability: <capability_name>
```

In the above grammar, the pseudo values that appear in angle brackets have the following meaning:

- **node_type_name**: represents the required name of the node type that would be used to select (filter) the node that contains the attribute to monitor or contains the requirement that references another node that contains the attribute to monitor.
- **node_template_name**: represents the required name of the node template that would be used to select (filter) the node that contains the attribute to monitor or contains the requirement that references another node that contains the attribute to monitor.
- **requirement_name**: represents the optional name of the requirement that would be used to select (filter) a referenced node that contains the attribute to monitor.

- **capability_name:** represents the optional name of a capability that would be used to select (filter) the attribute to monitor. If a requirement_name is specified, then the capability_name refers to a capability of the node that is targeted by the requirement.

3.6.22 Trigger definition

A trigger definition defines the event, condition and action that is used to “trigger” a policy it is associated with.

3.6.22.1 Keynames

The following is the list of recognized keynames for a TOSCA trigger definition:

Keyname	Required	Type	Description
description	no	description	The optional description string for the named trigger.
event	yes	string	The required name of the event that activates the trigger’s action. A deprecated form of this keyname is “event_type”.
schedule	no	TimeInterval	The optional time interval during which the trigger is valid (i.e., during which the declared actions will be processed).
target_filter	no	event filter	The optional filter used to locate the attribute to monitor for the trigger’s defined condition. This filter helps locate the TOSCA entity (i.e., node or relationship) or further a specific capability of that entity that contains the attribute to monitor.
condition	no	condition clause definition	The optional condition which contains a condition clause definition specifying one or multiple attribute constraint that can be monitored. Note: this is optional since sometimes the event occurrence itself is enough to trigger the action.
action	yes	list of activity definition	The list of sequential activities to be performed when the event is triggered and the condition is met (i.e. evaluates to true).

3.6.22.2 Additional keynames for the extended condition notation

Keyname	Required	Type	Description
constraint	no	condition clause definition	The optional condition which contains a condition clause definition specifying one or multiple attribute constraint that can be monitored. Note: this is optional since sometimes the event occurrence itself is enough to trigger the action.
period	no	scalar-unit.time	The optional period to use to evaluate for the condition.
evaluations	no	integer	The optional number of evaluations that must be performed over the period to assert the condition exists.
method	no	string	The optional statistical method name to use to perform the evaluation of the condition.

3.6.22.3 Grammar

Trigger definitions have the following grammars:

3.6.22.3.1 Short notation

```
<trigger\_name>:
```

```

description: <trigger_description>
event: <event_name>
schedule: <time_interval_for_trigger>
target_filter:
  <event_filter_definition>
condition:
  <condition_clause_definition>
action:
  - <list_of_activity_definition>

```

3.6.22.3.2 Extended notation:

```

<trigger_name>:
  description: <trigger_description>
  event: <event_name>
  schedule: <time_interval_for_trigger>
  target_filter:
    <event_filter_definition>
  condition:
    constraint: <condition_clause_definition>
    period: <scalar-unit.time> # e.g., 60 sec
    evaluations: <integer> # e.g., 1
    method: <string> # e.g., average
  action:
    - <list_of_activity_definition>

```

In the above grammars, the pseudo values that appear in angle brackets have the following meaning:

- **trigger_name**: represents the required symbolic name of the trigger as a [string](#).
- **trigger_description**: represents the optional [description](#) string for the corresponding **trigger_name**.
- **event_name**: represents the required name of an event associated with an interface notification on the identified resource (node).
- **time_interval_for_trigger**: **represents the optional time interval that the trigger is valid for.**
- **event_filter_definition**: represents the optional filter to use to locate the resource (node) or capability attribute to monitor.
- **condition_clause_definition**: represents one or multiple attribute constraint that can be monitored and that would be used to test for a specific condition on the monitored resource.
- **list_of_activity_definition**: represents the list of activities that are performed if the event and (optionally) condition are met. The activity definitions are the same as the ones used in a workflow step. One could regard these activities as an anonymous workflow that is invoked by this trigger and is applied to the target(s) of this trigger's policy.

3.6.23 Activity definitions

An activity defines an operation to be performed in a TOSCA workflow step or in an action body of a policy trigger.

Activity definitions can be of the following types:

- [Delegate workflow activity definition](#)
 - Defines the name of the delegate workflow and optional input assignments. This activity requires the target to be provided by the orchestrator (no-op node or relationship).
- [Set state activity definition](#)
 - Sets the state of a node.
- [Call operation activity definition](#)
 - Calls an operation defined on a TOSCA interface of a node, relationship or group. The operation name uses the <interface_name>.<operation_name> notation. Optionally, assignments for the operation inputs can also be provided. If provided, they will override for this operation call the operation inputs assignment in the node template.
- [Inline workflow activity definition](#)

Inline another workflow defined in the topology (to allow reusability). The definition includes the name of a workflow to be inlined and optional workflow input assignments.

3.6.23.1 Delegate workflow activity definition

3.6.23.1.1 Keynames

The following is a list of recognized keynames for a delegate activity definition.

Keyname	Required	Type	Description
delegate	yes	string or empty (see grammar below)	Defines the name of the delegate workflow and optional input assignments. This activity requires the target to be provided by the orchestrator (no-op node or relationship).
workflow	no	string	The name of the delegate workflow. Required in the extended notation.
inputs	no	map of parameter assignments	The optional map of input parameter assignments for the delegate workflow.

3.6.23.1.2 Grammar

A delegate activity definition has the following grammar. The short notation can be used if no input assignments are provided.

3.6.23.1.2.1 Short notation

```
- delegate: <delegate_workflow_name>
```

3.6.23.1.2.2 Extended notation

```
- delegate:  
  workflow: <delegate_workflow_name>  
  inputs:  
    <parameter_assignments>
```

In the above grammar, the pseudo values that appear in angle brackets have the following meaning:

- **delegate_workflow_name**: represents the name of the workflow of the node provided by the TOSCA orchestrator
- **parameter_assignments**: represents the optional map of property assignments for passing parameters as inputs to this workflow delegation.

3.6.23.2 Set state activity definition

Sets the state of the target node.

3.6.23.2.1 Keynames

The following is a list of recognized keynames for a set state activity definition.

Keyname	Required	Type	Description
set_state	yes	string	Value of the node state.

3.6.23.2.2 Grammar

A set state activity definition has the following grammar.

```
- set_state: <new_node_state>
```

In the above grammar, the pseudo values that appear in angle brackets have the following meaning:

- **new_node_state**: represents the state that will be affected to the node once the activity is performed.

3.6.23.3 Call operation activity definition

This activity is used to call an operation on the target node. Operation input assignments can be optionally provided.

3.6.23.3.1 Keynames

The following is a list of recognized keynames for a call operation activity definition.

Keyname	Required	Type	Description
call_operation	yes	string or empty (see grammar below)	Defines the operation call. The operation name uses the <interface_name>.<operation_name> notation. Optionally, assignments for the operation inputs can also be provided. If provided, they will override for this operation call the operation inputs assignment in the node template.
operation	no	string	The name of the operation to call, using the <interface_name>.<operation_name> notation. Required in the extended notation.
inputs	no	map of parameter assignments	The optional map of input parameter assignments for the called operation. Any provided input assignments will override the operation input assignment in the target node template for this operation call.

3.6.23.3.2 Grammar

A call operation activity definition has the following grammar. The short notation can be used if no input assignments are provided.

3.6.23.3.2.1 Short notation

```
- call_operation: <operation_name>
```

3.6.23.3.2.2 Extended notation

```
- call_operation:
  operation: <operation name>
  inputs:
    <parameter assignments>
```

In the above grammar, the pseudo values that appear in angle brackets have the following meaning:

- **operation_name**: represents the name of the operation that will be called during the workflow execution. The notation used is <interface_sub_name>.<operation_sub_name>, where interface_sub_name is the interface name and the operation_sub_name is the name of the operation within this interface.
- **parameter_assignments**: represents the optional map of property assignments for passing parameters as inputs to this workflow delegation.

3.6.23.4 Inline workflow activity definition

This activity is used to inline a workflow in the activities sequence. The definition includes the name of the inlined workflow and optional input assignments.

3.6.23.4.1 Keynames

The following is a list of recognized keynames for an inline workflow activity definition.

Keyname	Required	Type	Description
inline	yes	string or empty (see grammar below)	The definition includes the name of a workflow to be inlined and optional workflow input assignments.
workflow	no	string	The name of the inlined workflow. Required in the extended notation.
inputs	no	map of parameter assignments	The optional map of input parameter assignments for the inlined workflow.

3.6.23.4.2 Grammar

An inline workflow activity definition has the following grammar. The short notation can be used if no input assignments are provided.

3.6.23.4.2.1 Short notation

```
- inline: <inlined_workflow_name>
```

3.6.23.4.2.2 Extended notation

```
- inline:
  workflow: <inlined workflow name>
  inputs:
    <parameter assignments>
```

In the above grammar, the pseudo values that appear in angle brackets have the following meaning:

- **inlined_workflow_name**: represents the name of the workflow to inline.
- **parameter_assignments**: represents the optional map of property assignments for passing parameters as inputs to this workflow delegation.

3.6.23.5 Example

The following represents a list of activity definitions (using the short notation):

```
- delegate: deploy
- set_state: started
- call_operation: toska.interfaces.node.lifecycle.Standard.start
- inline: my_workflow
```

3.6.24 Assertion definition

A workflow assertion is used to specify a single condition on a workflow filter definition. The assertion allows to assert the value of an attribute based on TOSCA constraints.

3.6.24.1 Keynames

The TOSCA workflow assertion definition has no keynames.

3.6.24.2 Grammar

Workflow assertion definitions have the following grammar:

```
<attribute_name>: <list_of_constraint_clauses>
```

In the above grammars, the pseudo values that appear in angle brackets have the following meaning:

- **attribute_name**: represents the name of an attribute defined on the assertion context entity (node instance, relationship instance, group instance) and from which value will be evaluated against the defined constraint clauses.
- **list_of_constraint_clauses**: represents the list of constraint clauses that will be used to validate the attribute assertion.

3.6.24.3 Example

Following represents a workflow assertion with a single equals constraint:

```
my_attribute: [{equal : my_value}]
```

Following represents a workflow assertion with multiple constraints:

```
my_attribute:  
- min_length: 8  
- max_length : 10
```

3.6.25 Condition clause definition

A workflow condition clause definition is used to specify a condition that can be used within a workflow precondition or workflow filter.

3.6.25.1 Keynames

The following is the list of recognized keynames for a TOSCA workflow condition definition:

Keyname	Required	Type	Description
and	no	list of condition clause definition	An and clause allows to define sub-filter clause definitions that must all be evaluated truly so the and clause is considered as true.
or	no	list of condition clause definition	An or clause allows to define sub-filter clause definitions where one of them must all be evaluated truly so the or clause is considered as true.
not	no	list of condition clause definition	A not clause allows to define sub-filter clause definitions where one or more of them must be evaluated as false.
assert	no	deprecated list of assertion definition	An assert clause defines a list of filter assertions that must be evaluated on entity attributes. Assert acts as an and clause, i.e. every defined filter assertion must be true so the assertion is considered as true. Because assert and and are logically identical, the assert keyname has been deprecated.

Note : It is allowed to add direct assertion definitions directly to the condition clause definition without using any of the supported keynames. . In that case, an *and* clause is performed for all direct assertion definition.

3.6.25.2 Grammar

Condition clause definitions have the following grammars:

3.6.25.2.1 And clause

```
and: <list_of_condition_clause_definition>
```

In the above grammars, the pseudo values that appear in angle brackets have the following meaning:

- **list_of_condition_clause_definition:** represents the list of condition clauses. All condition clauses MUST be asserted to true so that the and clause is asserted to true.

3.6.25.2.2 Or clause

```
or: <list_of_condition_clause_definition>
```

In the above grammars, the pseudo values that appear in angle brackets have the following meaning:

- **list_of_condition_clause_definition:** represents the list of condition clauses. One of the condition clause have to be asserted to true so that the or clause is asserted to true.

3.6.25.2.3 Not clause

```
not: <list_of_condition_clause_definition>
```

In the above grammars, the pseudo values that appear in angle brackets have the following meaning:

- **list_of_condition_clause_definition:** represents the list of condition clauses. One of the condition clause have to be asserted to false so that the not clause is asserted to true.

3.6.25.3 Direct assertion definition

```
<attribute_name>: <list_of_constraint_clauses>
```

In the above grammars, the pseudo values that appear in angle brackets have the following meaning:

- **attribute_name:** represents the name of an attribute defined on the assertion context entity (node instance, relationship instance, group instance) and from which value will be evaluated against the defined constraint clauses.
- **list_of_constraint_clauses:** represents the list of constraint clauses that will be used to validate the attribute assertion.

3.6.25.4 Additional Requirement

- Keynames are mutually exclusive, i.e. a filter definition can define only one of *and*, *or*, or *not* keyname.

3.6.25.5 Notes

- The TOSCA processor SHOULD perform assertion in the order of the list for every defined condition clause or direct assertion definition.

3.6.25.6 Example

Following represents a workflow condition clause with a single direct assertion definition:

```
condition:
  - my_attribute: [{equal: my_value}]
```

Following represents a workflow condition clause with single equals constraints on two different attributes.

```
condition:
  - my_attribute: [{equal: my_value}]
  - my_other_attribute: [{equal: my_other_value}]
```

Note that these two direct assertion constraints are logically *and*-ed. This means that the following is logically identical to the previous example:

```
condition:
  - and:
    - my_attribute: [{equal: my_value}]
    - my_other_attribute: [{equal: my_other_value}]
```

Following represents a workflow condition clause with a or constraint on two different assertions:

```
condition:
  - or:
    - my_attribute: [{equal: my_value}]
    - my_other_attribute: [{equal: my_other_value}]
```

The following shows an example of the *not* operator. The condition yields TRUE when the attribute `my_attribute1` takes any value other than `value1`:

```
condition:
  - not:
    - my_attribute1: [{equal: value1}]
```

The following condition yields TRUE when none of the attributes `my_attribute1` and `my_attribute2` is equal to `value1`.

```
condition:
  - not:
    - and:
      - my_attribute1: [{equal: value1}]
      - my_attribute2: [{equal: value1}]
```

The following condition is a functional equivalent of the previous example:

```
condition:
  - or:
```

```

- not:
  - my_attribute1: [{equal: value1}]
- not:
  - my_attribute2: [{equal: value1}]

```

Following represents multiple levels of condition clauses with direct assertion definitions to build the following logic: use http on port 80 or https on port 431:

```

condition:
- or:
  - and:
    - protocol: { equal: http }
    - port: { equal: 80 }
  - and:
    - protocol: { equal: https }
    - port: { equal: 431 }

```

3.6.26 Workflow precondition definition

A workflow condition can be used as a filter or precondition to check if a workflow can be processed or not based on the state of the instances of a TOSCA topology deployment. When not met, the workflow will not be triggered.

3.6.26.1 Keynames

The following is the list of recognized keynames for a TOSCA workflow condition definition:

Keyname	Required	Type	Description
target	yes	string	The target of the precondition (this can be a node template name, a group name)
target_relationship	no	string	The optional name of a requirement of the target in case the precondition has to be processed on a relationship rather than a node or group. Note that this is applicable only if the target is a node.
condition	no	list of condition clause definitions	A list of workflow condition clause definitions. Assertion between elements of the condition are evaluated as an AND condition.

3.6.26.2 Grammar

Workflow precondition definitions have the following grammars:

```

- target: <target_name>
  target_relationship: <target_requirement_name>
  condition:
    <list_of_condition_clause_definition>

```

In the above grammar, the pseudo values that appear in angle brackets have the following meaning:

- **target_name:** represents the name of a node template or group in the topology.

- **target_requirement_name**: represents the name of a requirement of the node template (in case target_name refers to a node template).
- **list_of_condition_clause_definition**: represents the list of condition clauses to be evaluated. The value of the resulting condition is evaluated as an AND clause between the different elements.

3.6.27 Workflow step definition

A workflow step allows to define one or multiple sequenced activities in a workflow and how they are connected to other steps in the workflow. They are the building blocks of a declarative workflow.

3.6.27.1 Keynames

The following is the list of recognized keynames for a TOSCA workflow step definition:

Keyname	Required	Type	Description
target	yes	string	The target of the step (this can be a node template name, a group name)
target_relationship	no	string	The optional name of a requirement of the target in case the step refers to a relationship rather than a node or group. Note that this is applicable only if the target is a node.
operation_host	no	string	The node on which operations should be executed (for TOSCA call_operation activities). This element is required only for relationships and groups target. If target is a relationships operation_host is required and valid_values are SOURCE or TARGET – referring to the relationship source or target node. If target is a group operation_host is optional. If not specified the operation will be triggered on every node of the group. If specified the valid_value is a node_type or the name of a node template.
filter	no	list of constraint clauses	Filter is a map of attribute name, list of constraint clause that allows to provide a filtering logic.
activities	yes	list of activity definition	The list of sequential activities to be performed in this step.
on_success	no	list of string	The optional list of step names to be performed after this one has been completed with success (all activities has been correctly processed).
on_failure	no	list of string	The optional list of step names to be called after this one in case one of the step activity failed.

3.6.27.2 Grammar

Workflow step definitions have the following grammars:

```
steps:
  <step_name>
    target: <target_name>
```

```

target_relationship: <target_requirement_name>
operation_host: <operation_host_name>
filter:
  - <list_of_condition_clause_definition>
activities:
  - <list_of_activity_definition>
on_success:
  - <target_step_name>
on_failure:
  - <target_step_name>

```

In the above grammar, the pseudo values that appear in angle brackets have the following meaning:

- **target_name**: represents the name of a node template or group in the topology.
- **target_requirement_name**: represents the name of a requirement of the node template (in case target_name refers to a node template).
- **operation_host**: the node on which the operation should be executed
- **list_of_condition_clause_definition**: represents a list of condition clause definition.
- **list_of_activity_definition**: represents a list of activity definition
- **target_step_name**: represents the name of another step of the workflow.

3.7 Type-specific definitions

3.7.1 Entity Type Schema

An Entity Type is the common, base, polymorphic schema type which is extended by TOSCA base entity type schemas (e.g., Node Type, Relationship Type, Artifact Type, etc.) and serves to define once all the commonly shared keynames and their types. This is a “meta” type which is abstract and not directly instantiatable.

3.7.1.1 Keynames

The following is the list of recognized keynames for a TOSCA Entity Type definition:

Keyname	Required	Type	Constraints	Description
derived_from	no	string	‘None’ is the only allowed value	An optional parent Entity Type name the Entity Type derives from.
version	no	version	N/A	An optional version for the Entity Type definition.
metadata	no	map of string	N/A	Defines a section used to declare additional metadata information.
description	no	description	N/A	An optional description for the Entity Type.

3.7.1.2 Grammar

Entity Types have following grammar:

```

<entity_keyname>:
  # The only allowed value is ‘None’

```

```

derived_from: None
version: <version_number>
metadata:
  <metadata_map>
description: <interface\_description>

```

In the above grammar, the pseudo values that appear in angle brackets have the following meaning:

- **version_number**: represents the optional TOSCA [version](#) number for the entity.
- **entity_description**: represents the optional [description](#) string for the entity.
- **metadata_map**: represents the optional map of string.

3.7.1.3 Additional Requirements

- The TOSCA Entity Type SHALL be the common base type used to derive all other top-level base TOSCA Types.
- The TOSCA Entity Type SHALL NOT be used to derive or create new base types apart from those defined in this specification or a profile of this specification.

3.7.2 Capability definition

A capability definition defines a named, typed set of data that can be associated with Node Type or Node Template to describe a transparent capability or feature of the software component the node describes.

3.7.2.1 Keynames

The following is the list of recognized keynames for a TOSCA capability definition:

Keyname	Required	Type	Constraints	Description
type	yes	string	N/A	The required name of the Capability Type the capability definition is based upon.
description	no	description	N/A	The optional description of the Capability definition.
properties	no	map of property definitions	N/A	An optional map of property definitions for the Capability definition.
attributes	no	map of attribute definitions	N/A	An optional map of attribute definitions for the Capability definition.
valid_source_types	no	string []	N/A	An optional list of one or more valid names of Node Types that are supported as valid sources of any relationship established to the declared Capability Type.
occurrences	no	range of integer	implied default of [1,UNBOUNDED]	The optional minimum and maximum occurrences for the capability. By default, an exported Capability should allow at least one relationship to be formed with it with a maximum of UNBOUNDED relationships. Note: the keyword UNBOUNDED is also supported to represent any positive integer.

3.7.2.2 Grammar

Capability definitions have one of the following grammars:

3.7.2.2.1 Short notation

The following single-line grammar may be used when only the capability definition name needs to be declared, without further refinement of the capability type definitions:

```
<capability_definition_name>: <capability_type>
```

3.7.2.2.2 Extended notation

The following multi-line grammar may be used when additional information on the capability definition is needed:

```
<capability_definition_name>:  
  type: <capability_type>  
  description: <capability_description>  
  properties:  
    <property_definitions>  
  attributes:  
    <attribute_definitions>  
  valid_source_types: [ <node_type_names> ]  
  occurrences : <range_of_occurrences>
```

In the above grammars, the pseudo values that appear in angle brackets have the following meaning:

- **capability_definition_name**: represents the symbolic name of the capability as a [string](#).
- **capability_type**: represents the required name of a [capability type](#) the capability definition is based upon.
- **capability_description**: represents the optional [description](#) of the capability definition.
- **property_definitions**: represents the optional map of [property definitions](#) for the capability definition.
- **attribute_definitions**: represents the optional map of [attribute definitions](#) for the capability definition.
- **node_type_names**: represents the optional list of one or more names of [Node Types](#) that the Capability definition supports as valid sources for a successful relationship to be established to itself.
- **Range_of_occurrences**: represents the optional minimum and maximum occurrences for the capability.

3.7.2.3 Examples

The following examples show capability definitions in both simple and full forms:

3.7.2.3.1 Simple notation example

```
# Simple notation, no properties defined or augmented  
some_capability: mytypes.mycapabilities.MyCapabilityTypeName
```

3.7.2.3.2 Full notation example

```
# Full notation, augmenting properties of the referenced capability type
some_capability:
  type: mytypes.mycapabilities.MyCapabilityTypeName
  properties:
    limit:
      type: integer
      default: 100
```

3.7.2.4 Additional requirements

- Any Node Type (names) provides as values for the **valid_source_types** keyname SHALL be type-compatible (i.e., derived from the same parent Node Type) with any Node Types defined using the same keyname in the parent Capability Type.
- Capability symbolic names SHALL be unique; it is an error if a capability name is found to occur more than once.

3.7.2.5 Notes

- The Capability Type, in this example **MyCapabilityTypeName**, would be defined elsewhere and have an integer property named **limit**.
- This definition directly maps to the **CapabilitiesDefinition** of the Node Type entity as defined in the [TOSCA v1.0 specification](#).

3.7.3 Requirement definition

The Requirement definition describes a named requirement (dependencies) of a TOSCA Node Type or Node template which needs to be fulfilled by a matching Capability definition declared by another TOSCA modelable entity. The requirement definition may itself include the specific name of the fulfilling entity (explicitly) or provide an abstract type, along with additional filtering characteristics, that a TOSCA orchestrator can use to fulfill the capability at runtime (implicitly).

3.7.3.1 Keynames

The following is the list of recognized keynames for a TOSCA requirement definition:

Keyname	Required	Type	Constraints	Description
capability	yes	string	N/A	The required reserved keyname used that can be used to provide the name of a valid Capability Type that can fulfill the requirement.
node	no	string	N/A	The optional reserved keyname used to provide the name of a valid Node Type that contains the capability definition that can be used to fulfill the requirement.
relationship	no	string	N/A	The optional reserved keyname used to provide the name of a valid Relationship Type to construct when fulfilling the requirement.
occurrences	no	range of integer	implied default of [1,1]	The optional minimum and maximum occurrences for the requirement. Note: the keyword UNBOUNDED is also supported to represent any positive integer.

3.7.3.1.1 Additional Keynames for multi-line relationship grammar

The Requirement definition contains the Relationship Type information needed by TOSCA Orchestrators to construct relationships to other TOSCA nodes with matching capabilities; however, it is sometimes recognized that additional properties may need to be passed to the relationship (perhaps for configuration). In these cases, additional grammar is provided so that the Node Type may declare additional Property definitions to be used as inputs to the Relationship Type's declared interfaces (or specific operations of those interfaces).

Keyname	Required	Type	Constraints	Description
type	yes	string	N/A	The optional reserved keyname used to provide the name of the Relationship Type for the requirement definition's relationship keyname.
interfaces	no	map of interface definitions	N/A	The optional reserved keyname used to reference declared (named) interface definitions of the corresponding Relationship Type in order to declare additional Property definitions for these interfaces or operations of these interfaces.

3.7.3.2 Grammar

Requirement definitions have one of the following grammars:

3.7.3.2.1 Simple grammar (Capability Type only)

```
<requirement_definition_name>: <capability_type_name>
```

3.7.3.2.2 Extended grammar (with Node and Relationship Types)

```
<requirement_definition_name>:  
  capability: <capability_type_name>  
  node: <node_type_name>  
  relationship: <relationship_type_name>  
  occurrences: [ <min_occurrences>, <max_occurrences> ]
```

3.7.3.2.3 Extended grammar for declaring Property Definitions on the relationship's Interfaces

The following additional multi-line grammar is provided for the relationship keyname in order to declare new Property definitions for inputs of known Interface definitions of the declared Relationship Type.

```
<requirement_definition_name>:  
  # Other keynames omitted for brevity  
  relationship:  
    type: <relationship_type_name>  
    interfaces:  
      <interface_definitions>
```

In the above grammars, the pseudo values that appear in angle brackets have the following meaning:

- **requirement_definition_name**: represents the required symbolic name of the requirement definition as a [string](#).
- **capability_type_name**: represents the required name of a Capability type that can be used to fulfill the requirement.
- **node_type_name**: represents the optional name of a TOSCA Node Type that contains the Capability Type definition the requirement can be fulfilled by.
- **relationship_type_name**: represents the optional name of a [Relationship Type](#) to be used to construct a relationship between this requirement definition (i.e., in the source node) to a matching capability definition (in a target node).
- **min_occurrences**, **max_occurrences**: represents the optional minimum and maximum occurrences of the requirement (i.e., its cardinality).
- **interface_definitions**: represents one or more already declared interface definitions in the Relationship Type (as declared on the **type** keyname) allowing for the declaration of new Property definition for these interfaces or for specific Operation definitions of these interfaces.

3.7.3.3 Additional Requirements

- Requirement symbolic names SHALL be unique; it is an error if a requirement name is found to occur more than once.
- If the **occurrences** keyname is not present, then the occurrence of the requirement **SHALL** be one and only one; that is a default declaration as follows would be assumed:
 - occurrences: [1,1]

3.7.3.4 Notes

- This element directly maps to the **RequirementsDefinition** of the Node Type entity as defined in the [TOSCA v1.0 specification](#).
- The requirement symbolic name is used for identification of the requirement definition only and not relied upon for establishing any relationships in the topology.

3.7.3.5 Requirement Type definition is a tuple

A requirement definition allows type designers to govern which types are allowed (valid) for fulfillment using three levels of specificity with only the Capability Type being required.

1. Node Type (optional)
2. Relationship Type (optional)
3. Capability Type (required)

The first level allows selection, as shown in both the simple or complex grammar, simply providing the node's type using the **node** keyname. The second level allows specification of the relationship type to use when connecting the requirement to the capability using the **relationship** keyname. Finally, the specific named capability type on the target node is provided using the **capability** keyname.

3.7.3.5.1 Property filter

In addition to the node, relationship and capability types, a filter, with the keyname **node_filter**, may be provided to constrain the allowed set of potential target nodes based upon their properties and their capabilities' properties. This allows TOSCA orchestrators to help find the "best fit" when selecting among multiple potential target nodes for the expressed requirements.

3.7.4 Artifact Type

An Artifact Type is a reusable entity that defines the type of one or more files that are used to define implementation or deployment artifacts that are referenced by nodes or relationships on their operations.

3.7.4.1 Keynames

The Artifact Type is a TOSCA Entity and has the common keynames listed in section 3.7.1 TOSCA Entity Schema.

In addition, the Artifact Type has the following recognized keynames:

Keyname	Required	Type	Constraints	Description
mime_type	no	string	None	The required mime type property for the Artifact Type.
file_ext	no	string[]	None	The required file extension property for the Artifact Type.
properties	no	map of property definitions	No	An optional map of property definitions for the Artifact Type.

3.7.4.2 Grammar

Artifact Types have following grammar:

```
<artifact_type_name>:  
  derived_from: <parent_artifact_type_name>  
  version: <version_number>  
  metadata:  
    <map of string>  
  description: <artifact_description>  
  mime_type: <mime_type_string>  
  file_ext: [ <file_extensions> ]  
  properties:  
    <property_definitions>
```

In the above grammar, the pseudo values that appear in angle brackets have the following meaning:

- **artifact_type_name**: represents the name of the Artifact Type being declared as a **string**.
- **parent_artifact_type_name**: represents the **name** of the **Artifact Type** this Artifact Type definition derives from (i.e., its “parent” type).
- **version_number**: represents the optional TOSCA **version** number for the Artifact Type.
- **artifact_description**: represents the optional **description** string for the Artifact Type.
- **mime_type_string**: represents the optional Multipurpose Internet Mail Extensions (MIME) standard string value that describes the file contents for this type of Artifact Type as a **string**.
- **file_extensions**: represents the optional list of one or more recognized file extensions for this type of artifact type as **strings**.
- **property_definitions**: represents the optional map of **property definitions** for the artifact type.

3.7.4.3 Examples

```
my_artifact_type:
```

```

description: Java Archive artifact type
derived_from: tosca.artifact.Root
mime_type: application/java-archive
file_ext: [ jar ]
properties:
  id:
    description: Identifier of the jar
    type: string
    required: true
  creator:
    description: Vendor of the java implementation on which the jar is based
    type: string
    required: false

```

3.7.4.4 Additional Requirements

- The 'mime_type' keyname is meant to have values that are Apache mime types such as those defined here: <http://svn.apache.org/repos/asf/httpd/httpd/trunk/docs/conf/mime.types>

3.7.4.5 Notes

Information about artifacts can be broadly classified in two categories that serve different purposes :

1. Selection of artifact processor – This category includes informational elements such as artifact version, checksum, checksum algorithm etc. and is used by TOSCA Orchestrator to select the correct artifact processor for the artifact. These informational elements are captured in TOSCA as keywords for the artifact.
 2. Properties processed by artifact processor - Some properties are not processed by the Orchestrator, but passed on to the artifact processor to assist with proper processing of the artifact. These informational elements are described through artifact properties.
- .

3.7.5 Interface Type

An Interface Type is a reusable entity that describes a set of operations that can be used to interact with or manage a node or relationship in a TOSCA topology.

3.7.5.1 Keynames

The Interface Type is a TOSCA Entity and has the common keynames listed in section 3.7.1 TOSCA Entity Schema.

In addition, the Interface Type has the following recognized keynames:

Keyname	Required	Type	Description
inputs	no	map of property definitions	The optional map of input parameter definitions.

Keyname	Required	Type	Description
operations	no	map of operation definitions	The optional map of operations defined for this interface.
notifications	no	map of notification definitions	The optional map of notifications defined for this interface.

3.7.5.2 Grammar

Interface Types have following grammar:

```

<interface type name>:
  derived_from: <parent interface type name>
  version: <version_number>
  metadata:
    <map of string>
  description: <interface description>
  inputs:
    <property definitions>
  operations:
    <operation definitions>
  notifications:
    <notification definitions>

```

In the above grammar, the pseudo values that appear in angle brackets have the following meaning:

- **interface_type_name**: represents the required name of the interface as a [string](#).
- **parent_interface_type_name**: represents the name of the [Interface Type](#) this Interface Type definition derives from (i.e., its “parent” type).
- **version_number**: represents the optional TOSCA [version](#) number for the Interface Type.
- **interface_description**: represents the optional [description](#) string for the Interface Type.
- **property_definitions**: represents the optional map of [property definitions](#) (i.e., parameters) which the TOSCA orchestrator would make available (i.e., or pass) to all implementation artifacts for operations declared on the interface during their execution.
- **operation_definitions**: represents the required map of one or more [operation definitions](#).
- **notification_definitions**: represents the required name of one or more notification definitions.

3.7.5.3 Example

The following example shows a custom interface used to define multiple configure operations.

```

mycompany.mytypes.myinterfaces.MyConfigure:
  derived_from: tosca.interfaces.relationship.Root
  description: My custom configure Interface Type
  inputs:
    mode:

```

```

type: string
operations:
  pre_configure_service:
    description: pre-configure operation for my service
  post_configure_service:
    description: post-configure operation for my service

```

3.7.5.4 Additional Requirements

- Interface Types **MUST NOT** include any implementations for defined operations or notifications; that is, the implementation keyname is invalid in this context.
- The **inputs** keyname is reserved and **SHALL NOT** be used for an operation name.

3.7.5.5 Notes

Starting with Version 1.3 of this specification, interface type definition grammar was changed to support notifications as well as operations. As a result, operations must now be specified under the newly-introduced **operations** keyname and the notifications under the new **notifications** keyname. For backward compatibility if neither the operations or notifications are specified then we assume the symbolic names in the interface definition to mean operations, but this use is deprecated. Operations and notifications names should not overlap.

3.7.6 Data Type

A Data Type definition defines the schema for new named datatypes in TOSCA.

3.7.6.1 Keynames

The Data Type is a TOSCA Entity and has the common keynames listed in section 3.7.1 TOSCA Entity Schema.

In addition, the Data Type has the following recognized keynames:

Keyname	Required	Type	Description
constraints	no	list of constraint clauses	The optional list of <i>sequenced</i> constraint clauses for the Data Type.
properties	no	map of property definitions	The optional map property definitions that comprise the schema for a complex Data Type in TOSCA.
key_schema	no	schema_definition	For data types that derive from the TOSCA map data type, the optional schema definition for the keys used to identify entries in properties of this data type.
entry_schema	no	schema_definition	For data types that derive from the TOSCA map or list data types, the optional schema definition for the entries in properties of this data type.

3.7.6.2 Grammar

Data Types have the following grammar:

```
<data\_type\_name>:
```



```

derived_from: <existing\_type\_name>
version: <version\_number>
metadata:
  <map of string>
description: <datatype\_description>
constraints:
  - <type\_constraints>
properties:
  <property\_definitions>
key_schema : <key_schema_definition>
entry_schema: <entry_schema_definition>

```

In the above grammar, the pseudo values that appear in angle brackets have the following meaning:

- **data_type_name**: represents the required symbolic name of the Data Type as a [string](#).
- **version_number**: represents the optional TOSCA [version](#) number for the Data Type.
- **datatype_description**: represents the optional [description](#) for the Data Type.
- **existing_type_name**: represents the optional name of a valid TOSCA type this new Data Type would derive from.
- **type_constraints**: represents the optional list of one or more type-compatible [constraint clauses](#) that restrict the Data Type.
- **property_definitions**: represents the optional map of one or more [property definitions](#) that provide the schema for the Data Type.
- **key_schema_definition**: if the data_type derives from the TOSCA map type (i.e. existing_type_name is a map or derives from a map), represents the optional schema definition for they keys used to identify entries properties of this type..
- **entry_schema_definition**: if the data_type derives from the TOSCA map or list types (i.e. existing_type name is a map or list or derives from a map or list), represents the optional schema definition for the entries in properties of this type.

3.7.6.3 Additional Requirements

- A valid datatype definition **MUST** have either a valid **derived_from** declaration or at least one valid property definition.
- Any **constraint** clauses **SHALL** be type-compatible with the type declared by the **derived_from** keyname.
- If a **properties** keyname is provided, it **SHALL** contain one or more valid property definitions.

3.7.6.4 Examples

The following example represents a Data Type definition based upon an existing string type:

3.7.6.4.1 Defining a complex datatype

```

# define a new complex datatype
mytypes.phonenumber:
  description: my phone number datatype
  properties:
    countrycode:
      type: integer

```

```

areacode:
  type: integer
number:
  type: integer

```

3.7.6.4.2 Defining a datatype derived from an existing datatype

```

# define a new datatype that derives from existing type and extends it
mytypes.phonenumber.extended:
  derived_from: mytypes.phonenumber
  description: custom phone number type that extends the basic phonenumber type
  properties:
    phone_description:
      type: string
    constraints:
      - max_length: 128

```

3.7.7 Capability Type

A Capability Type is a reusable entity that describes a kind of capability that a Node Type can declare to expose. Requirements (implicit or explicit) that are declared as part of one node can be matched to (i.e., fulfilled by) the Capabilities declared by another node.

3.7.7.1 Keynames

The Capability Type is a TOSCA Entity and has the common keynames listed in section 3.7.1 TOSCA Entity Schema.

In addition, the Capability Type has the following recognized keynames:

Keyname	Required	Type	Description
properties	no	map of property definitions	An optional map of property definitions for the Capability Type.
attributes	no	map of attribute definitions	An optional map of attribute definitions for the Capability Type.
valid_source_types	no	string []	An optional list of one or more valid names of Node Types that are supported as valid sources of any relationship established to the declared Capability Type.

3.7.7.2 Grammar

Capability Types have following grammar:

```

<capability type name>:
  derived_from: <parent capability type name>
  version: <version number>
  description: <capability description>

```

```
properties:
  <property_definitions>
attributes:
  <attribute_definitions>
valid_source_types: [ <node_type_names> ]
```

In the above grammar, the pseudo values that appear in angle brackets have the following meaning:

- **capability_type_name**: represents the required name of the Capability Type being declared as a *string*.
- **parent_capability_type_name**: represents the name of the *Capability Type* this Capability Type definition derives from (i.e., its “parent” type).
- **version_number**: represents the optional TOSCA *version* number for the Capability Type.
- **capability_description**: represents the optional *description* string for the corresponding **capability_type_name**.
- **property_definitions**: represents an optional map of *property definitions* that the Capability type exports.
- **attribute_definitions**: represents the optional map of *attribute definitions* for the Capability Type.
- **node_type_names**: represents the optional list of one or more names of *Node Types* that the Capability Type supports as valid sources for a successful relationship to be established to itself.

3.7.7.3 Example

```
mycompany.mytypes.myapplication.MyFeature:
  derived_from: toska.capabilities.Root
  description: a custom feature of my company's application
  properties:
    my_feature_setting:
      type: string
    my_feature_value:
      type: integer
```

3.7.8 Requirement Type

A Requirement Type is a reusable entity that describes a kind of requirement that a Node Type can declare to expose. The TOSCA Simple Profile seeks to simplify the need for declaring specific Requirement Types from nodes and instead rely upon nodes declaring their features sets using TOSCA Capability Types along with a named Feature notation.

Currently, there are no use cases in this TOSCA Simple Profile in YAML specification that utilize an independently defined Requirement Type. This is a desired effect as part of the simplification of the TOSCA v1.0 specification.

3.7.9 Node Type

A Node Type is a reusable entity that defines the type of one or more Node Templates. As such, a Node Type defines the structure of observable properties via a *Properties Definition, the Requirements and Capabilities of the node as well as its supported interfaces*.

3.7.9.1 Keynames

The Node Type is a TOSCA Entity and has the common keynames listed in section 3.7.1 TOSCA Entity Schema.

In addition, the Node Type has the following recognized keynames:

Keyname	Required	Type	Description
attributes	no	map of attribute definitions	An optional map of attribute definitions for the Node Type.
properties	no	map of property definitions	An optional map of property definitions for the Node Type.
requirements	no	list of requirement definitions	An optional list of requirement definitions for the Node Type.
capabilities	no	map of capability definitions	An optional map of capability definitions for the Node Type.
interfaces	no	map of interface definitions	An optional map of interface definitions supported by the Node Type.
artifacts	no	map of artifact definitions	An optional map of named artifact definitions for the Node Type.

3.7.9.2 Grammar

Node Types have following grammar:

```
<node_type_name>:  
  derived_from: <parent node type name>  
  version: <version number>  
  metadata:  
    <map of string>  
  description: <node type description>  
  attributes:  
    <attribute definitions>  
  properties:  
    <property definitions>  
  requirements:  
    - <requirement definitions>  
  capabilities:  
    <capability definitions>  
  interfaces:  
    <interface definitions>  
  artifacts:  
    <artifact definitions>
```

In the above grammar, the pseudo values that appear in angle brackets have the following meaning:

- **node_type_name**: represents the required symbolic name of the Node Type being declared.

- **parent_node_type_name**: represents the name ([string](#)) of the [Node Type](#) this Node Type definition derives from (i.e., its “parent” type).
- **version_number**: represents the optional TOSCA [version](#) number for the Node Type.
- **node_type_description**: represents the optional [description](#) string for the corresponding **node_type_name**.
- **property_definitions**: represents the optional map of [property definitions](#) for the Node Type.
- **attribute_definitions**: represents the optional map of [attribute definitions](#) for the Node Type.
- **requirement_definitions**: represents the optional list of [requirement definitions](#) for the Node Type.
- **capability_definitions**: represents the optional map of [capability definitions](#) for the Node Type.
- **interface_definitions**: represents the optional map of one or more [interface definitions](#) supported by the Node Type.
- **artifact_definitions**: represents the optional map of [artifact definitions](#) for the Node Type.

3.7.9.3 Additional Requirements

- Requirements are intentionally expressed as a list of TOSCA [Requirement definitions](#) which **SHOULD** be resolved (processed) in sequence order by TOSCA Orchestrators.

3.7.9.4 Best Practices

- It is recommended that all Node Types **SHOULD** derive directly (as a parent) or indirectly (as an ancestor) of the TOSCA Root Node Type (i.e., **tosca.nodes.Root**) to promote compatibility and portability. However, it is permitted to author Node Types that do not do so.
- TOSCA Orchestrators, having a full view of the complete application topology template and its resultant dependency graph of nodes and relationships, **MAY** prioritize how they instantiate the nodes and relationships for the application (perhaps in parallel where possible) to achieve the greatest efficiency

3.7.9.5 Example

```
my_company.my_types.my_app_node_type:
  derived_from: toska.nodes.SoftwareComponent
  description: My company's custom applicaton
  properties:
    my_app_password:
      type: string
      description: application password
      constraints:
        - min_length: 6
        - max_length: 10
  attributes:
    my_app_port:
      type: integer
      description: application port number
  requirements:
```

```

- some_database:
  capability: EndPoint.Database
  node: Database
  relationship: ConnectsTo

```

3.7.10 Relationship Type

A Relationship Type is a reusable entity that defines the type of one or more relationships between Node Types or Node Templates.

3.7.10.1 Keynames

The Relationship Type is a TOSCA Entity and has the common keynames listed in section 3.7.1 TOSCA Entity Schema.

In addition, the Relationship Type has the following recognized keynames:

Keyname	Required	Definition/Type	Description
properties	no	map of property definitions	An optional map of property definitions for the Relationship Type.
attributes	no	map of attribute definitions	An optional map of attribute definitions for the Relationship Type.
interfaces	no	map of interface definitions	An optional map of interface definitions interfaces supported by the Relationship Type.
valid_target_types	no	string []	An optional list of one or more names of Capability Types that are valid targets for this relationship.

3.7.10.2 Grammar

Relationship Types have following grammar:

```

<relationship type name>:
  derived_from: <parent relationship type name>
  version: <version number>
  metadata:
    <map of string>
  description: <relationship description>
  properties:
    <property definitions>
  attributes:
    <attribute definitions>
  interfaces:
    <interface definitions>
  valid_target_types: [ <capability type names> ]

```

In the above grammar, the pseudo values that appear in angle brackets have the following meaning:

- **relationship_type_name**: represents the required symbolic name of the Relationship Type being declared as a [string](#).
- **parent_relationship_type_name**: represents the name ([string](#)) of the [Relationship Type](#) this Relationship Type definition derives from (i.e., its “parent” type).
- **relationship_description**: represents the optional [description](#) string for the corresponding **relationship_type_name**.
- **version_number**: represents the optional TOSCA [version](#) number for the Relationship Type.
- **property_definitions**: represents the optional map of [property definitions](#) for the Relationship Type.
- **attribute_definitions**: represents the optional map of [attribute definitions](#) for the Relationship Type.
- **interface_definitions**: represents the optional map of one or more names of valid [interface definitions](#) supported by the Relationship Type.
- **capability_type_names**: represents one or more names of valid target types for the relationship (i.e., [Capability Types](#)).

3.7.10.3 Best Practices

- For TOSCA application portability, it is recommended that designers use the normative Relationship types defined in this specification where possible and derive from them for customization purposes.
- The TOSCA Root Relationship Type (**tosca.relationships.Root**) SHOULD be used to derive new types where possible when defining new relationships types. This assures that its normative configuration interface (**tosca.interfaces.relationship.Configure**) can be used in a deterministic way by TOSCA orchestrators.

3.7.10.4 Examples

```
mycompanytypes.myrelationships.AppDependency:
  derived_from: tosca.relationships.DependsOn
  valid_target_types: [ mycompanytypes.mycapabilities.SomeAppCapability ]
```

3.7.11 Group Type

A Group Type defines logical grouping types for nodes, typically for different management purposes. Conceptually, group definitions allow the creation of logical “membership” relationships to nodes in a service template that are not a part of the application’s explicit requirement dependencies in the topology template (i.e. those required to actually get the application deployed and running). Instead, such logical membership allows for the introduction of things such as group management and uniform application of policies (i.e., requirements that are also not bound to the application itself) to the group’s members.

3.7.11.1 Keynames

The Group Type is a TOSCA Entity and has the common keynames listed in section 3.7.1 TOSCA Entity Schema.

In addition, the Group Type has the following recognized keynames:

Keyname	Required	Type	Description
attributes	no	map of attribute definitions	An optional map of attribute definitions for the Group Type.

Keyname	Required	Type	Description
properties	no	map of property definitions	An optional map of property definitions for the Group Type.
members	no	string []	An optional list of one or more names of Node Types that are valid (allowed) as members of the Group Type. Note: This can be viewed by TOSCA Orchestrators as an implied relationship from the listed members nodes to the group, but one that does not have operational lifecycle considerations. For example, if we were to name this as an explicit Relationship Type we might call this "MemberOf" (group).

3.7.11.2 Grammar

Group Types have one the following grammars:

```

<group_type_name>:
  derived_from: <parent_group_type_name>
  version: <version_number>
  metadata:
    <map of string>
  description: <group_description>
  attributes :
    <attribute_definitions>
  properties:
    <property_definitions>
  members: [ <list_of_valid_member_types> ]

```

In the above grammar, the pseudo values that appear in angle brackets have the following meaning:

- **group_type_name**: represents the required symbolic name of the Group Type being declared as a [string](#).
- **parent_group_type_name**: represents the name ([string](#)) of the [Group Type](#) this Group Type definition derives from (i.e., its "parent" type).
- **version_number**: represents the optional TOSCA [version](#) number for the Group Type.
- **group_description**: represents the optional description string for the corresponding [group_type_name](#).
- **attribute_definitions**: represents the optional map of [attribute_definitions](#) for the Group Type.
- **property_definitions**: represents the optional map of [property_definitions](#) for the Group Type.
- **list_of_valid_member_types**: represents the optional list of TOSCA types (e.g.,, Node, Capability or even other Group Types) that are valid member types for being added to (i.e., members of) the Group Type.

3.7.11.3 Notes

Note that earlier versions of this specification support interface definitions, capability definitions, and requirement definitions in group types. These definitions have been deprecated in this version based on the realization that groups in TOSCA only exist for purposes of uniform application of policies to

collections of nodes. Consequently, groups do not have a lifecycle of their own that is independent of the lifecycle of their members.

3.7.11.4 Additional Requirements

- Group definitions **SHOULD NOT** be used to define or redefine relationships (dependencies) between nodes that can be expressed using normative TOSCA Relationships (e.g., HostedOn, ConnectsTo, etc.) within a TOSCA topology template.
- The list of values associated with the “members” keyname **MUST** only contain types that are homogenous (i.e., derive from the same type hierarchy).

3.7.11.5 Example

The following represents a Group Type definition:

```
group_types:
  mycompany.mytypes.groups.placement:
    description: My company's group type for placing nodes of type Compute
    members: [ tosca.nodes.Compute ]
```

3.7.12 Policy Type

A Policy Type defines a type of requirement that affects or governs an application or service's topology at some stage of its lifecycle, but is not explicitly part of the topology itself (i.e., it does not prevent the application or service from being deployed or run if it did not exist).

3.7.12.1 Keynames

The Policy Type is a TOSCA Entity and has the common keynames listed in section 3.7.1 TOSCA Entity Schema.

In addition, the Policy Type has the following recognized keynames:

Keyname	Required	Type	Description
properties	no	map of property definitions	An optional map of property definitions for the Policy Type.
targets	no	string[]	An optional list of valid Node Types or Group Types the Policy Type can be applied to. Note: This can be viewed by TOSCA Orchestrators as an implied relationship to the target nodes, but one that does not have operational lifecycle considerations. For example, if we were to name this as an explicit Relationship Type we might call this “AppliesTo” (node or group).
triggers	no	map of trigger definitions	An optional map of policy triggers for the Policy Type.

3.7.12.2 Grammar

Policy Types have the following grammar:

```
<policy type name>:
```

```

derived_from: <parent\_policy\_type\_name>
version: <version\_number>
metadata:
  <map of string>
description: <policy\_description>
properties:
  <property\_definitions>
targets: [ <list\_of\_valid\_target\_types> ]
triggers:
  <trigger\_definitions>

```

In the above grammar, the pseudo values that appear in angle brackets have the following meaning:

- **policy_type_name**: represents the required symbolic name of the Policy Type being declared as a [string](#).
- **parent_policy_type_name**: represents the name ([string](#)) of the Policy Type this Policy Type definition derives from (i.e., its “parent” type).
- **version_number**: represents the optional TOSCA [version](#) number for the Policy Type.
- **policy_description**: represents the optional description string for the corresponding **policy_type_name**.
- **property_definitions**: represents the optional map of [property definitions](#) for the Policy Type.
- **list_of_valid_target_types**: represents the optional list of TOSCA types (i.e., Group or Node Types) that are valid targets for this Policy Type.
- **trigger_definitions**: represents the optional map of [trigger definitions](#) for the policy.

3.7.12.3 Example

The following represents a Policy Type definition:

```

policy_types:
  mycompany.mytypes.policies.placement.Container.Linux:
    description: My company's placement policy for linux
    derived_from: tosca.policies.Root

```

3.8 Template-specific definitions

The definitions in this section provide reusable modeling element grammars that are specific to the Node or Relationship templates.

3.8.1 Capability assignment

A capability assignment allows node template authors to assign values to properties and attributes for a named capability definition that is part of a Node Template’s type definition.

3.8.1.1 Keynames

The following is the list of recognized keynames for a TOSCA capability assignment:

Keyname	Required	Type	Description
properties	no	map of property assignments	An optional map of property definitions for the Capability definition.
attributes	no	map of attribute assignments	An optional map of attribute definitions for the Capability definition.
occurrences	no	range of integer	An optional range that further refines the minimum and maximum occurrences specified in the corresponding capability definition. If no range is specified, the range from the corresponding capability definition is used.

3.8.1.2 Grammar

Capability assignments have one of the following grammars:

```
<capability_definition_name>:
  properties:
    <property_assignments>
  attributes:
    <attribute_assignments>
  occurrences: [ min_occurrences, max_occurrences ]
```

In the above grammars, the pseudo values that appear in angle brackets have the following meaning:

- **capability_definition_name**: represents the symbolic name of the capability as a [string](#).
- **property_assignments**: represents the optional map of [property assignments](#) for the capability definition.
- **attribute_assignments**: represents the optional map of [attribute assignments](#) for the capability definition.
- **min_occurrences, max_occurrences**: lower and upper bounds of the range that further refines the minimum and maximum occurrences for this capability specified in the corresponding capability definition. The range specified here must fall completely within the occurrences range specified in the corresponding capability definition

3.8.1.3 Example

The following example shows a capability assignment:

3.8.1.3.1 Notation example

```
node_templates:
  some_node_template:
    capabilities:
      some_capability:
        properties:
          limit: 100
```

3.8.2 Requirement assignment

A Requirement assignment allows template authors to provide either concrete names of TOSCA templates or provide abstract selection criteria for providers to use to find matching TOSCA templates that are used to fulfill a named requirement's declared TOSCA Node Type.

3.8.2.1 Keynames

The following is the list of recognized keynames for a TOSCA requirement assignment:

Keyname	Required	Type	Description
capability	no	string	The optional reserved keyname used to provide the name of either a: <ul style="list-style-type: none">• Capability definition within a <i>target</i> node template that can fulfill the requirement.• Capability Type that the provider will use to select a type-compatible <i>target</i> node template to fulfill the requirement at runtime.
node	no	string	The optional reserved keyname used to identify the target node of a relationship. specifically, it is used to provide either a: <ul style="list-style-type: none">• Node Template name that can fulfill the target node requirement.• Node Type name that the provider will use to select a type-compatible node template to fulfill the requirement at runtime.
relationship	no	string	The optional reserved keyname used to provide the name of either a: <ul style="list-style-type: none">• Relationship Template to use to relate the <i>source</i> node to the (capability in the) <i>target</i> node when fulfilling the requirement.• Relationship Type that the provider will use to select a type-compatible relationship template to relate the <i>source</i> node to the <i>target</i> node at runtime.
node_filter	no	node filter	The optional filter definition that TOSCA orchestrators or providers would use to select a type-compatible <i>target</i> node that can fulfill the associated abstract requirement at runtime.
occurrences	no	range of integer	An optional range that further refines the optional minimum and maximum occurrences for this requirement. If no range is specified, the range from the corresponding requirement definition is used.

The following is the list of recognized keynames for a TOSCA requirement assignment's **relationship** keyname which is used when property assignments or inputs of declared interfaces (or their operations) need to be provided:

Keyname	Required	Type	Description
type	no	string	The optional reserved keyname used to provide the name of the Relationship Type for the requirement assignment's relationship keyname.
properties	no	map of property assignments	An optional map of property assignments for the relationship.
interfaces	no	map of interface definitions	The optional reserved keyname used to reference declared (named) interface definitions of the corresponding Relationship Type in order to provide Property assignments for these interfaces or operations of these interfaces.

3.8.2.2 Grammar

Named requirement assignments have one of the following grammars:

3.8.2.2.1 Short notation:

The following single-line grammar may be used if only a concrete Node Template for the target node needs to be declared in the requirement:

```
<requirement_name>: <node_template_name>
```

This notation is only valid if the corresponding Requirement definition in the Node Template's parent Node Type declares (at a minimum) a valid Capability Type which can be found in the declared target Node Template. A valid capability definition always needs to be provided in the requirement declaration of the *source* node to identify a specific capability definition in the *target* node the requirement will form a TOSCA relationship with.

3.8.2.2.2 Extended notation:

The following grammar would be used if the requirement assignment needs to provide more information than just the Node Template name:

```
<requirement_name>:  
  node: <node_template_name> | <node_type_name>  
  relationship: <relationship_template_name> | <relationship_type_name>  
  capability: <capability_symbolic_name> | <capability_type_name>  
  node_filter:  
    <node_filter_definition>  
  occurrences: [ min_occurrences, max_occurrences ]
```

3.8.2.2.3 Extended grammar with Property Assignments for the relationship's Interfaces

The following additional multi-line grammar is provided for the relationship keyname in order to provide new Property assignments for inputs of known Interface definitions of the declared Relationship Type.

```
<requirement_name>:  
  # Other keynames omitted for brevity  
  relationship:  
    type: <relationship_template_name> | <relationship_type_name>  
    properties:  
      <property_assignments>  
    interfaces:  
      <interface_assignments>
```

Examples of uses for the extended requirement assignment grammar include:

- The need to allow runtime selection of the target node based upon an abstract Node Type rather than a concrete Node Template. This may include use of the `node_filter` keyname to provide node and capability filtering information to find the "best match" of a concrete Node Template at runtime.
- The need to further clarify the concrete Relationship Template or abstract Relationship Type to use when relating the source node's requirement to the target node's capability.

- The need to further clarify the concrete capability (symbolic) name or abstract Capability Type in the target node to form a relationship between.
- The need to (further) constrain the occurrences of the requirement in the instance model.

In the above grammars, the pseudo values that appear in angle brackets have the following meaning:

- **requirement_name**: represents the symbolic name of a requirement assignment as a [string](#).
- **node_template_name**: represents the optional name of a Node Template that contains the capability this requirement will be fulfilled by.
- **relationship_template_name**: represents the optional name of a Relationship Template to be used when relating the requirement appears to the capability in the target node.
- **capability_symbolic_name**: represents the required named capability definition within the target Node Type or Template.
- **node_type_name**: represents the optional name of a TOSCA Node Type the associated named requirement can be fulfilled by. This must be a type that is compatible with the Node Type declared on the matching requirement (same symbolic name) the requirement's Node Template is based upon.
- **relationship_type_name**: represents the optional name of a [Relationship Type](#) that is compatible with the Capability Type in the target node.
- **property_assignments**: represents the optional map of property value assignments for the declared relationship.
- **interface_assignments**: represents the optional map of interface definitions for the declared relationship used to provide property assignments on inputs of interfaces and operations.
- **capability_type_name**: represents the optional name of a Capability Type definition within the target Node Type this requirement needs to form a relationship with.
- **node_filter_definition**: represents the optional [node filter](#) TOSCA orchestrators would use to fulfill the requirement for selecting a target node. Note that this SHALL only be valid if the **node** keyname's value is a Node Type and is invalid if it is a Node Template.

3.8.2.3 `min_occurrences`, `max_occurrences`: lower and upper bounds of the range that further refines the minimum and maximum occurrences for this requirement specified in the corresponding requirement definition. The range specified here must fall completely within the occurrences range specified in the corresponding requirement definition Examples

3.8.2.3.1 Example 1 – Abstract hosting requirement on a Node Type

A web application node template named 'my_application_node_template' of type `WebApplication` declares a requirement named 'host' that needs to be fulfilled by any node that derives from the node type `WebServer`.

```
# Example of a requirement fulfilled by a specific web server node template
node_templates:
  my_application_node_template:
    type: tosca.nodes.WebApplication
    ...
    requirements:
      - host:
          node: tosca.nodes.WebServer
```

In this case, the node template's type is **WebApplication** which already declares the Relationship Type **HostedOn** to use to relate to the target node and the Capability Type of **Container** to be the specific target of the requirement in the target node.

3.8.2.3.2 Example 2 - Requirement with Node Template and a custom Relationship Type

This example is similar to the previous example; however, the requirement named 'database' describes a requirement for a connection to a database endpoint (**Endpoint.Database**) Capability Type in a named node template (**my_database**). However, the connection requires a custom Relationship Type (**my.types.CustomDbConnection**) declared on the keyname 'relationship'.

```
# Example of a (database) requirement that is fulfilled by a node template named
# "my_database", but also requires a custom database connection relationship
my_application_node_template:
  requirements:
    - database:
        node: my_database
        capability: Endpoint.Database
        relationship: my.types.CustomDbConnection
```

3.8.2.3.3 Example 3 - Requirement for a Compute node with additional selection criteria (filter)

This example shows how to extend an abstract 'host' requirement for a **Compute** node with a filter definition that further constrains TOSCA orchestrators to include additional properties and capabilities on the target node when fulfilling the requirement.

```
node_templates:
  mysql:
    type: tosca.nodes.DBMS.MySQL
    properties:
      # omitted here for brevity
    requirements:
      - host:
          node: tosca.nodes.Compute
          node_filter:
            capabilities:
              - host:
                  properties:
                    - num_cpus: { in_range: [ 1, 4 ] }
                    - mem_size: { greater_or_equal: 512 MB }
              - os:
                  properties:
                    - architecture: { equal: x86_64 }
                    - type: { equal: linux }
                    - distribution: { equal: ubuntu }
              - mytypes.capabilities.compute.encryption:
                  properties:
                    - algorithm: { equal: aes }
                    - keylength: { valid_values: [ 128, 256 ] }
```

3.8.3 Node Template

A Node Template specifies the occurrence of a manageable software component as part of an application's topology model which is defined in a TOSCA Service Template. A Node template is an instance of a specified Node Type and can provide customized properties, constraints or operations which override the defaults provided by its Node Type and its implementations.

3.8.3.1 Keynames

The following is the list of recognized keynames for a TOSCA Node Template definition:

Keyname	Required	Type	Description
type	yes	string	The required name of the Node Type the Node Template is based upon.
description	no	description	An optional description for the Node Template.
metadata	no	map of string	Defines a section used to declare additional metadata information.
directives	no	string[]	An optional list of directive values to provide processing instructions to orchestrators and tooling.
properties	no	map of property assignments	An optional map of property value assignments for the Node Template.
attributes	no	map of attribute assignments	An optional map of attribute value assignments for the Node Template.
requirements	no	list of requirement assignments	An optional list of requirement assignments for the Node Template.
capabilities	no	map of capability assignments	An optional map of capability assignments for the Node Template.
interfaces	no	map of interface definitions	An optional map of named interface definitions for the Node Template.
artifacts	no	map of artifact definitions	An optional map of named artifact definitions for the Node Template.
node_filter	no	node filter	The optional filter definition that TOSCA orchestrators would use to select the correct target node.
copy	no	string	The optional (symbolic) name of another node template to copy into (all keynames and values) and use as a basis for this node template.

3.8.3.2 Grammar

```
<node template name>:  
  type: <node type name>  
  description: <node template description>  
  directives: [<directives>]  
  metadata:  
    <map of string>
```



```

properties:
  <property_assignments>
attributes:
  <attribute_assignments>
requirements:
  - <requirement_assignments>
capabilities:
  <capability_assignments>
interfaces:
  <interface_definitions>
artifacts:
  <artifact_definitions>
node_filter:
  <node_filter_definition>
copy: <source_node_template_name>

```

In the above grammar, the pseudo values that appear in angle brackets have the following meaning:

- **node_template_name**: represents the required symbolic name of the Node Template being declared.
- **node_type_name**: represents the name of the Node Type the Node Template is based upon.
- **node_template_description**: represents the optional [description](#) string for Node Template.
- **directives**: represents the optional list of processing instruction keywords (as strings) for use by tooling and orchestrators.
- **property_assignments**: represents the optional map of [property assignments](#) for the Node Template that provide values for properties defined in its declared Node Type.
- **attribute_assignments**: represents the optional map of [attribute assignments](#) for the Node Template that provide values for attributes defined in its declared Node Type.
- **requirement_assignments**: represents the optional list of [requirement assignments](#) for the Node Template that allow assignment of type-compatible capabilities, target nodes, relationships and target (node filters) for use when fulfilling the requirement at runtime.
- **capability_assignments**: represents the optional map of [capability assignments](#) for the Node Template that augment those provided by its declared Node Type.
- **interface_definitions**: represents the optional map of [interface definitions](#) for the Node Template that [augment](#) those provided by its declared Node Type.
- **artifact_definitions**: represents the optional map of [artifact definitions](#) for the Node Template that augment those provided by its declared Node Type.
- **node_filter_definition**: represents the optional [node filter](#) TOSCA orchestrators would use for selecting a matching node template.
- **source_node_template_name**: represents the optional (symbolic) name of another node template to copy into (all keynames and values) and use as a basis for this node template.

3.8.3.3 Additional requirements

- The source node template provided as a value on the **copy** keyname **MUST NOT** itself use the **copy** keyname (i.e., it must itself be a complete node template description and not copied from another node template).

3.8.3.4 Example

```
node_templates:
  mysql:
    type: tosca.nodes.DBMS.MySQL
    properties:
      root_password: { get_input: my_mysql_rootpw }
      port: { get_input: my_mysql_port }
    requirements:
      - host: db_server
    interfaces:
      Standard:
        configure: scripts/my_own_configure.sh
```

3.8.4 Relationship Template

A Relationship Template specifies the occurrence of a manageable relationship between node templates as part of an application's topology model that is defined in a TOSCA Service Template. A Relationship template is an instance of a specified Relationship Type and can provide customized properties, constraints or operations which override the defaults provided by its Relationship Type and its implementations.

3.8.4.1 Keynames

The following is the list of recognized keynames for a TOSCA Relationship Template definition:

Keyname	Required	Type	Description
type	yes	string	The required name of the Relationship Type the Relationship Template is based upon.
description	no	description	An optional description for the Relationship Template.
metadata	no	map of string	Defines a section used to declare additional metadata information.
properties	no	map of property assignments	An optional map of property assignments for the Relationship Template.
attributes	no	map of attribute assignments	An optional map of attribute assignments for the Relationship Template.
interfaces	no	map of interface definitions	An optional map of named interface definitions for the Node Template.
copy	no	string	The optional (symbolic) name of another relationship template to copy into (all keynames and values) and use as a basis for this relationship template.

3.8.4.2 Grammar

```
<relationship_template_name>:
  type: <relationship type name>
  description: <relationship type description>
```

```

metadata:
  <map of string>
properties:
  <property assignments>
attributes:
  <attribute assignments>
interfaces:
  <interface definitions>
copy:
  <source relationship template name>

```

In the above grammar, the pseudo values that appear in angle brackets have the following meaning:

- **relationship_template_name**: represents the required symbolic name of the Relationship Template being declared.
- **relationship_type_name**: represents the name of the Relationship Type the Relationship Template is based upon.
- **relationship_template_description**: represents the optional [description](#) string for the Relationship Template.
- **property_assignments**: represents the optional map of [property assignments](#) for the Relationship Template that provide values for properties defined in its declared Relationship Type.
- **attribute_assignments**: represents the optional map of [attribute assignments](#) for the Relationship Template that provide values for attributes defined in its declared Relationship Type.
- **interface_definitions**: represents the optional map of [interface definitions](#) for the Relationship Template that augment those provided by its declared Relationship Type.
- **source_relationship_template_name**: represents the optional (symbolic) name of another relationship template to copy into (all keynames and values) and use as a basis for this relationship template.

3.8.4.3 Additional requirements

- The source relationship template provided as a value on the **copy** keyname MUST NOT itself use the **copy** keyname (i.e., it must itself be a complete relationship template description and not copied from another relationship template).

3.8.4.4 Example

```

relationship_templates:
  storage_attachment:
    type: AttachesTo
    properties:
      location: /my_mount_point

```

3.8.5 Group definition

A group definition defines a logical grouping of node templates, typically for management purposes, but is separate from the application's topology template.

3.8.5.1 Keynames

The following is the list of recognized keynames for a TOSCA group definition:

Keyname	Required	Type	Description
type	yes	string	The required name of the group type the group definition is based upon.
description	no	description	The optional description for the group definition.
metadata	no	map of string	Defines a section used to declare additional metadata information.
properties	no	map of property assignments	An optional map of property value assignments for the group definition.
members	no	list of string	The optional list of one or more node template names that are members of this group definition.

3.8.5.2 Grammar

Group definitions have one the following grammars:

```
<group_name>:  
  type: <group_type_name>  
  description: <group_description>  
  metadata:  
    <map of string>  
  attributes :  
    <attribute_assignments>  
  properties:  
    <property_assignments>  
  members: [ <list_of_node_templates> ]
```

In the above grammar, the pseudo values that appear in angle brackets have the following meaning:

- **group_name**: represents the required symbolic name of the group as a [string](#).
- **group_type_name**: represents the name of the Group Type the definition is based upon.
- **group_description**: contains an optional description of the group.
- **attribute_assignments**: represents the optional map of [attribute_assignments](#) for the group definition that provide values for attributes defined in its declared Group Type.
- **property_assignments**: represents the optional map of [property_assignments](#) for the group definition that provide values for properties defined in its declared Group Type.
- **list_of_node_templates**: contains the required list of one or more node template names (within the same topology template) that are members of this logical group.

3.8.5.3 Notes

Note that earlier versions of this specification support interface definitions in group definitions. These definitions have been deprecated in this version based on the realization that groups in TOSCA only exist for purposes of uniform application of policies to collections of nodes. Consequently, groups do not have a lifecycle of their own that is independent of the lifecycle of their members.

3.8.5.4 Additional Requirements

- Group definitions **SHOULD NOT** be used to define or redefine relationships (dependencies) for an application that can be expressed using normative TOSCA Relationships within a TOSCA topology template.

3.8.5.5 Example

The following represents a group definition:

```
groups:
  my_app_placement_group:
    type: toasca.groups.Root
    description: My application's logical component grouping for placement
    members: [ my_web_server, my_sql_database ]
```

3.8.6 Policy definition

A policy definition defines a policy that can be associated with a TOSCA topology or top-level entity definition (e.g., group definition, node template, etc.).

3.8.6.1 Keynames

The following is the list of recognized keynames for a TOSCA policy definition:

Keyname	Required	Type	Description
type	yes	string	The required name of the policy type the policy definition is based upon.
description	no	description	The optional description for the policy definition.
metadata	no	map of string	Defines a section used to declare additional metadata information.
properties	no	map of property assignments	An optional map of property value assignments for the policy definition.
targets	no	string[]	An optional list of valid Node Templates or Groups the Policy can be applied to.
triggers	no	map of trigger definitions	An optional map of trigger definitions to invoke when the policy is applied by an orchestrator against the associated TOSCA entity.

3.8.6.2 Grammar

Policy definitions have one the following grammars:

```
<policy name>:
  type: <policy type name>
  description: <policy description>
  metadata:
    <map of string>
  properties:
```

```

<property_assignments>
targets: [<list_of_policy_targets>]
triggers:
  <trigger_definitions>

```

In the above grammar, the pseudo values that appear in angle brackets have the following meaning:

- **policy_name**: represents the required symbolic name of the policy as a [string](#).
- **policy_type_name**: represents the name of the policy the definition is based upon.
- **policy_description**: contains an optional description of the policy.
- **property_assignments**: represents the optional map of [property assignments](#) for the policy definition that provide values for properties defined in its declared Policy Type.
- **list_of_policy_targets**: represents the optional list of names of node templates or groups that the policy is to applied to.
- **trigger_definitions**: represents the optional map of [trigger definitions](#) for the policy.

3.8.6.3 Example

The following represents a policy definition:

```

policies:
- my_compute_placement_policy:
  type: toasca.policies.placement
  description: Apply my placement policy to my application's servers
  targets: [ my_server_1, my_server_2 ]
  # remainder of policy definition left off for brevity

```

3.8.7 Imperative Workflow definition

A workflow definition defines an imperative workflow that is associated with a TOSCA topology. A workflow definition can either include the steps that make up the workflow, or it can refer to an artifact that expresses the workflow using an external workflow language.

3.8.7.1 Keynames

The following is the list of recognized keynames for a TOSCA workflow definition:

Keyname	Required	Type	Description
description	no	description	The optional description for the workflow definition.
metadata	no	map of string	Defines a section used to declare additional metadata information.
inputs	no	map of property definitions	The optional map of input parameter definitions.
preconditions	no	list of precondition definitions	List of preconditions to be validated before the workflow can be processed.
steps	no	map of step definitions	An optional map of valid imperative workflow step definitions.

Keyname	Required	Type	Description
implementation	no	operation implementation definition	The optional definition of an external workflow definition. This keyname is mutually exclusive with the steps keyname above.
outputs	no	map of attribute mappings	The optional map of attribute mappings that specify named workflow output values and their mappings onto attributes of a node or relationship defined in the topology

3.8.7.2 Grammar

Imperative workflow definitions have the following grammar:

```

<workflow_name>:
  description: <workflow_description>
  metadata:
    <map of string>
  inputs:
    <property_definitions>
  preconditions:
    - <workflow_precondition_definition>
  steps:
    <workflow_steps>
  implementation:
    <operation_implementation_definitions>
  outputs:
    <attribute_mappings>

```

In the above grammar, the pseudo values that appear in angle brackets have the following meaning:

- **workflow_name:**
- **workflow_description:**
- **property_definitions:**
- **workflow_precondition_definition:**
- **workflow_steps:**
- **operation_implementation_definition:** represents a full inline definition of an implementation artifact
- **attribute_mappings:** represents the optional map of of attribute_mappings that consists of named output values returned by operation implementations (i.e. artifacts) and associated mappings that specify the attribute into which this output value must be stored.

3.8.8 Property mapping

A property mapping allows to map the property of a substituted node type an input of the topology template.

3.8.8.1 Keynames

The following is the list of recognized keynames for a TOSCA property mapping:

Keyname	Required	Type	Description
mapping	no	list of strings	An array with 1 string element that references an input of the topology..
value	no	matching the type of this property	This deprecated keyname allows to explicitly assign a value to this property. This field is mutually exclusive with the mapping keyname.

3.8.8.2 Grammar

The single-line grammar of a **property_mapping** is as follows:

```
<property_name>: <property_value> # This use is deprecated
<property_name>: [ <input_name> ]
```

The multi-line grammar is as follows :

```
<property_name>:
  mapping: [ < input_name > ]
<property_name>:
  value: <property_value> # This use is deprecated
```

3.8.8.3 Notes

- Single line grammar for a property value assignment is not allowed for properties of `property_value` type in order to avoid collision with the mapping single line grammar.
- The **property_value** mapping grammar has been deprecated. The original intent of the *property-to-constant-value* mapping was not to provide a *mapping*, but rather to present a *matching* mechanism to drive selection of the appropriate substituting template when more than one template was available as a substitution for the abstract node. In that case, a topology template was only a valid candidate for substitution if the property value in the abstract node template matched the constant value specified in the **property_value** mapping for that property. With the introduction of substitution filter syntax to drive matching, there is no longer a need for the property-to-constant-value mapping functionality.
- The previous version of the specification allowed direct mappings from properties of the abstract node template to properties of node templates in the substituting topology template. Support for these mappings has been deprecated since they would have resulted in unpredictable behavior, for the following reason. If the substituting template is a valid TOSCA template, then all the (required) properties of all its node templates must have valid property assignments already defined. If the substitution mappings of the substituting template include direct property-to-property mappings, the the substituting template ends up with two conflicting property assignments: one defined in the substituting template itself, and one defined by the substitution mappings. These conflicting assignments lead to unpredictable behavior.

3.8.8.4 Additional constraints

- When Input mapping it may be referenced by multiple nodes in the topologies with resulting attributes values that may differ later on in the various nodes. In any situation, the attribute reflecting the property of the substituted type will remain a constant value set to the one of the input at deployment time.

3.8.9 Attribute mapping

An attribute mapping allows to map the attribute of a substituted node type an output of the topology template.

3.8.9.1 Keynames

The following is the list of recognized keynames for a TOSCA attribute mapping:

Keyname	Required	Type	Description
mapping	no	list of strings	An array with 1 string element that references an output of the topology..

3.8.9.2 Grammar

The single-line grammar of an **attribute_mapping** is as follows:

```
<attribute_name>: [ <output_name> ]
```

3.8.10 Capability mapping

A capability mapping allows to map the capability of one of the node of the topology template to the capability of the node type the service template offers an implementation for.

3.8.10.1 Keynames

The following is the list of recognized keynames for a TOSCA capability mapping:

Keyname	Required	Type	Description
mapping	no	list of strings (with 2 members)	A list of strings with 2 members, the first one being the name of a node template, the second the name of a capability of the specified node template.
properties	no	map of property assignments	This field is mutually exclusive with the mapping keyname and allows to provide a capability assignment for the template and specify it's related properties.
attributes	no	map of attributes assignments	This field is mutually exclusive with the mapping keyname and allows to provide a capability assignment for the template and specify it's related attributes.

3.8.10.2 Grammar

The single-line grammar of a **capability_mapping** is as follows:

```
<capability_name>: [ <node_template_name>, <node_template_capability_name> ]
```

The multi-line grammar is as follows :

```
<capability_name>:  
  mapping: [ <node_template_name>, <node_template_capability_name> ]  
  properties:  
    <property_name>: <property_value>  
  attributes:  
    <attribute_name>: <attribute_value>
```

In the above grammar, the pseudo values that appear in angle brackets have the following meaning:

- **capability_name**: represents the name of the capability as it appears in the Node Type definition for the Node Type (name) that is declared as the value for on the substitution_mappings' "node_type" key.
- **node_template_name**: represents a valid name of a Node Template definition (within the same topology_template declaration as the substitution_mapping is declared).
- **node_template_capability_name**: represents a valid name of a [capability definition](#) within the <node_template_name> declared in this mapping.
- **property_name**: represents the name of a property of the capability.
- **property_value**: represents the value to assign to a property of the capability.
- **attribute_name**: represents the name a an attribute of the capability.
- **attribute_value**: represents the value to assign to an attribute of the capability.

3.8.10.3 Additional requirements

- Definition of capability assignment in a capability mapping (through properties and attribute keynames) SHOULD be prohibited for connectivity capabilities as `tosca.capabilities.Endpoint`.

3.8.11 Requirement mapping

A requirement mapping allows to map the requirement of one of the node of the topology template to the requirement of the node type the service template offers an implementation for.

3.8.11.1 Keynames

The following is the list of recognized keynames for a TOSCA requirement mapping:

Keyname	Required	Type	Description
mapping	no	list of strings (2 members)	A list of strings with 2 elements, the first one being the name of a node template, the second the name of a requirement of the specified node template.
properties	no	List of property assignment	This field is mutually exclusive with the mapping keyname and allow to provide a requirement for the template and specify it's related properties.

Keyname	Required	Type	Description
attributes	no	List of attributes assignment	This field is mutually exclusive with the mapping keyname and allow to provide a requirement for the template and specify it's related attributes.

3.8.11.2 Grammar

The single-line grammar of a **requirement_mapping** is as follows:

```
<requirement_name>: [ <node_template_name>, <node_template_requirement_name> ]
```

The multi-line grammar is as follows :

```
<requirement_name>:
  mapping: [ <node_template_name>, <node_template_requirement_name> ]
  properties:
    <property_name>: <property_value>
  attributes:
    <attribute_name>: <attribute_value>
```

In the above grammar, the pseudo values that appear in angle brackets have the following meaning:

- **requirement_name**: represents the name of the requirement as it appears in the Node Type definition for the Node Type (name) that is declared as the value for on the substitution_mappings' "node_type" key.
- **node_template_name**: represents a valid name of a Node Template definition (within the same topology_template declaration as the substitution_mapping is declared).
- **node_template_requirement_name**: represents a valid name of a requirement definition within the <node_template_name> declared in this mapping.
- **property_name**: represents the name of a property of the requirement.
- **property_value**: represents the value to assign to a property of the requirement.
- **attribute_name**: represents the name a an attribute of the requirement.
- **attribute_value**: represents the value to assign to an attribute of the requirement.

3.8.11.3 Additional requirements

- Definition of capability assignment in a capability mapping (through properties and attribute keynames) SHOULD be prohibited for connectivity capabilities as toscacapabilities.Endpoint.

3.8.12 Interface mapping

An interface mapping allows to map a workflow of the topology template to an operation of the node type the service template offers an implementation for.

3.8.12.1 Grammar

The grammar of an **interface_mapping** is as follows:

```
<interface_name>:
  <operation_name>: <workflow_name>
```

In the above grammar, the pseudo values that appear in angle brackets have the following meaning:

- **interface_name**: represents the name of the interface as it appears in the Node Type definition for the Node Type (name) that is declared as the value for on the substitution_mappings' "node_type" key. Or the name of a new management interface to add to the generated type.
- **operation_name**: represents the name of the operation as it appears in the interface type definition.
- **workflow_name**: represents the name of a workflow of the template to map to the specified operation.

3.8.12.2 Notes

- Declarative workflow generation will be applied by the TOSCA orchestrator after the topology template have been substituted. Unless one of the normative operation of the standard interface is mapped through an interface mapping. In that case the declarative workflow generation will consider the substitution node as any other node calling the create, configure and start mapped workflows as if they where single operations.
- Operation implementation being TOSCA workflows the TOSCA orchestrator replace the usual operation_call activity by an inline activity using the specified workflow.

3.8.13 Substitution mapping

A substitution mapping allows a given topology template to be used as an implementation of abstract node templates of a specific node type. This allows the consumption of complex systems using a simplified vision.

3.8.13.1 Keynames

Keyname	Required	Type	Description
node_type	yes	string	The required name of the Node Type the Topology Template is providing an implementation for.
substitution_filter	no	node filter	The optional filter that further constrains the abstract node templates for which this topology template can provide an implementation.
properties	no	map of property mappings	The optional map of properties mapping allowing to map properties of the node_type to inputs of the topology template.
attributes	no	map of attribute mappings	The optional map of attribute mappings allowing to map outputs from the topology template to attributes of the node_type.
capabilities	no	map of capability mappings	The optional map of capabilities mapping.
requirements	no	map of requirement mappings	The optional map of requirements mapping.
interfaces	no	map of interfaces mappings	The optional map of interface mapping allows to map an interface and operations of the node type to implementations that could be either workflows or node template interfaces/operations.

3.8.13.2 Grammar

The grammar of the **substitution_mapping** section is as follows:

```
node_type: <node_type_name>
substitution_filter : <node_filter>
properties:
  <property_mappings>
capabilities:
  <capability_mappings>
requirements:
  <requirement_mappings>
attributes:
  <attribute_mappings>
interfaces:
  <interface_mappings>
```

In the above grammar, the pseudo values that appear in angle brackets have the following meaning:

- **node_type_name**: represents the required Node Type name that the Service Template's topology is offering an implementation for.
- **node_filter**: represents the optional node filter that reduces the set of abstract node templates for which this topology template is an implementation by only substituting for those node templates whose properties and capabilities satisfy the constraints specified in the node filter.
- **properties**: represents the <optional> map of properties mappings.
- **capability_mappings**: represents the <optional> map of capability mappings.
- **requirement_mappings**: represents the <optional> map of requirement mappings.
- **attributes**: represents the <optional> map of attributes mappings.
- **interfaces**: represents the <optional> map of interfaces mappings.

3.8.13.3 Examples

3.8.13.4 Additional requirements

- The substitution mapping **MUST** provide mapping for every property, capability and requirement defined in the specified <node_type>

3.8.13.5 Notes

- The node_type specified in the substitution mapping **SHOULD** be abstract (does not provide implementation for normative operations).

3.9 Topology Template definition

This section defines the topology template of a cloud application. The main ingredients of the topology template are node templates representing components of the application and relationship templates representing links between the components. These elements are defined in the nested **node_templates**

section and the nested **relationship_templates** sections, respectively. Furthermore, a topology template allows for defining input parameters, output parameters as well as grouping of node templates.

3.9.1 Keynames

The following is the list of recognized keynames for a TOSCA Topology Template:

Keyname	Required	Type	Description
description	no	description	The optional description for the Topology Template.
inputs	no	map of parameter definitions	An optional map of input parameters (i.e., as parameter definitions) for the Topology Template.
node_templates	no	map of node templates	An optional map of node template definitions for the Topology Template.
relationship_templates	no	map of relationship templates	An optional map of relationship templates for the Topology Template.
groups	no	map of group definitions	An optional map of Group definitions whose members are node templates defined within this same Topology Template.
policies	no	list of policy definitions	An optional list of Policy definitions for the Topology Template.
outputs	no	map of parameter definitions	An optional map of output parameters (i.e., as parameter definitions) for the Topology Template.
substitution_mappings	no	substitution_mapping	An optional declaration that exports the topology template as an implementation of a Node type. This also includes the mappings between the external Node Types named capabilities and requirements to existing implementations of those capabilities and requirements on Node templates declared within the topology template.
workflows	no	map of imperative workflow definitions	An optional map of imperative workflow definition for the Topology Template.

3.9.2 Grammar

The overall grammar of the **topology_template** section is shown below.—Detailed grammar definitions of the each sub-sections are provided in subsequent subsections.

```

topology_template:
  description: <template description>
  inputs: <input_parameters>
  outputs: <output_parameters>

```

```

node_templates: <node_templates>
relationship_templates: <relationship_templates>
groups: <group_definitions>
policies:
  - <policy_definition_list>
workflows: <workflows>
# Optional declaration that exports the Topology Template
# as an implementation of a Node Type.
substitution_mappings:
  <substitution_mappings>

```

In the above grammar, the pseudo values that appear in angle brackets have the following meaning:

- **template_description**: represents the optional [description](#) string for Topology Template.
- **input_parameters**: represents the optional map of input parameters (i.e., as property definitions) for the Topology Template.
- **output_parameters**: represents the optional map of output parameters (i.e., as property definitions) for the Topology Template.
- **group_definitions**: represents the optional map of [group definitions](#) whose members are node templates that also are defined within this Topology Template.
- **policy_definition_list**: represents the optional list of sequenced policy definitions for the Topology Template.
- **workflows**: represents the optional map of imperative workflow definitions for the Topology Template.
- **node_templates**: represents the optional map of [node template](#) definitions for the Topology Template.
- **relationship_templates**: represents the optional map of [relationship templates](#) for the Topology Template.
- **node_type_name**: represents the optional name of a [Node Type](#) that the Topology Template implements as part of the **substitution_mappings**.
- **map_of_capability_mappings_to_expose**: represents the mappings that expose internal capabilities from node templates (within the topology template) as capabilities of the Node Type definition that is declared as part of the **substitution_mappings**.
- **map_of_requirement_mappings_to_expose**: represents the mappings of link requirements of the Node Type definition that is declared as part of the **substitution_mappings** to internal requirements implementations within node templates (declared within the topology template).

More detailed explanations for each of the Topology Template grammar's keynames appears in the sections below.

3.9.2.1 inputs

The **inputs** section provides a means to define parameters using TOSCA parameter definitions, their allowed values via constraints and default values within a TOSCA Simple Profile template. Input parameters defined in the **inputs** section of a topology template can be mapped to properties of node templates or relationship templates within the same topology template and can thus be used for parameterizing the instantiation of the topology template.

This section defines topology template-level input parameter section.

- Inputs here would ideally be mapped to BoundaryDefinitions in TOSCA v1.0.
- Treat input parameters as fixed global variables (not settable within template)
- If not in input take default (nodes use default)

3.9.2.1.1 Grammar

The grammar of the **inputs** section is as follows:

```
inputs:  
  <parameter_definitions>
```

3.9.2.1.2 Examples

This section provides a set of examples for the single elements of a topology template.

Simple **inputs** example without any constraints:

```
inputs:  
  fooName:  
    type: string  
    description: Simple string typed property definition with no constraints.  
    default: bar
```

Example of **inputs** with constraints:

```
inputs:  
  SiteName:  
    type: string  
    description: string typed property definition with constraints  
    default: My Site  
    constraints:  
      - min_length: 9
```

3.9.2.2 node_templates

The **node_templates** section lists the Node Templates that describe the (software) components that are used to compose cloud applications.

3.9.2.2.1 grammar

The grammar of the **node_templates** section is as follows:

```
node_templates:  
  <node_template_defn 1>  
  ...  
  <node_template_defn n>
```

3.9.2.2.2 Example

Example of `node_templates` section:

```
node_templates:
  my_webapp_node_template:
    type: WebApplication

  my_database_node_template:
    type: Database
```

3.9.2.3 relationship_templates

The `relationship_templates` section lists the Relationship Templates that describe the relations between components that are used to compose cloud applications.

Note that in the TOSCA Simple Profile, the explicit definition of relationship templates as it was required in TOSCA v1.0 is optional, since relationships between nodes get implicitly defined by referencing other node templates in the requirements sections of node templates.

3.9.2.3.1 Grammar

The grammar of the `relationship_templates` section is as follows:

```
relationship_templates:
  <relationship_template defn 1>
  ...
  <relationship_template defn n>
```

3.9.2.3.2 Example

Example of `relationship_templates` section:

```
relationship_templates:
  my_connectsto_relationship:
    type: toska.relationships.ConnectsTo
    interfaces:
      Configure:
        inputs:
          speed: { get_attribute: [ SOURCE, connect_speed ] }
```

3.9.2.4 outputs

The `outputs` section provides a means to define the output parameters that are available from a TOSCA Simple Profile service template. It allows for exposing attributes of node templates or relationship templates within the containing `topology_template` to users of a service.

3.9.2.4.1 Grammar

The grammar of the `outputs` section is as follows:

```
outputs:
  <parameter_definitions>
```

3.9.2.4.2 Example

Example of the **outputs** section:

```
outputs:
  server_address:
    description: The first private IP address for the provisioned server.
    value: { get_attribute: [ HOST, networks, private, addresses, 0 ] }
```

3.9.2.5 groups

The **groups** section allows for grouping one or more node templates within a TOSCA Service Template and for assigning special attributes like policies to the group.

3.9.2.5.1 Grammar

The grammar of the **groups** section is as follows:

```
groups:
  <group_defn 1>
  ...
  <group_defn n>
```

3.9.2.5.2 Example

The following example shows the definition of three Compute nodes in the **node_templates** section of a **topology_template** as well as the grouping of two of the Compute nodes in a group **server_group_1**.

```
node_templates:
  server1:
    type: toasca.nodes.Compute
    # more details ...

  server2:
    type: toasca.nodes.Compute
    # more details ...

  server3:
    type: toasca.nodes.Compute
    # more details ...

groups:
  # server2 and server3 are part of the same group
```

```
server_group_1:
  type: toasca.groups.Root
  members: [ server2, server3 ]
```

3.9.2.6 policies

The **policies** section allows for declaring policies that can be applied to entities in the topology template.

3.9.2.6.1 Grammar

The grammar of the **policies** section is as follows:

```
policies:
- <policy_defn_1>
- ...
- <policy_defn_n>
```

3.9.2.6.2 Example

The following example shows the definition of a placement policy.

```
policies:
- my_placement_policy:
  type: mycompany.mytypes.policy.placement
```

3.9.2.7 substitution_mapping

3.9.2.7.1 requirement_mapping

The grammar of a **requirement_mapping** is as follows:

```
<requirement_name>: [ <node_template_name>, <node_template_requirement_name> ]
```

The multi-line grammar is as follows :

```
<requirement_name>:
  mapping: [ <node_template_name>, <node_template_capability_name> ]
  properties:
    <property_name>: <property_value>
```

- **requirement_name**: represents the name of the requirement as it appears in the Node Type definition for the Node Type (name) that is declared as the value for on the substitution_mappings' "node_type" key.
- **node_template_name**: represents a valid name of a Node Template definition (within the same topology_template declaration as the substitution_mapping is declared).
- **node_template_requirement_name**: represents a valid name of a [requirement definition](#) within the <node_template_name> declared in this mapping.

3.9.2.7.2 Example

The following example shows the definition of a placement policy.

```
topology_template:

inputs:
  cpus:
    type: integer
    constraints:
      less_than: 2 # OR use "defaults" key

substitution_mappings:
  node_type: MyService
  properties: # Do not care if running or matching (e.g., Compute node)
    # get from outside? Get from constraint?
    num_cpus: cpus # Implied "PUSH"
    # get from some node in the topology...
    num_cpus: [ <node>, <cap>, <property> ]
    # 1) Running
    architecture:
      # a) Explicit
      value: { get_property: [some_service, architecture] }
      # b) implicit
      value: [ some_service, <req | cap name>, <property name> architecture ]
      default: "amd"
      # c) INPUT mapping?
      ???
    # 2) Catalog (Matching)
    architecture:
      constraints: equals: "x86"

  capabilities:
    bar: [ some_service, bar ]
  requirements:
    foo: [ some_service, foo ]

node_templates:
  some_service:
    type: MyService
    properties:
      rate: 100
```

```

capabilities:
  bar:
    ...
requirements:
  - foo:
    ...

```

3.9.2.8 Notes

- The parameters (properties) that are part of the **inputs** block can be mapped to **PropertyMappings** provided as part of **BoundaryDefinitions** as described by the TOSCA v1.0 specification.
- The node templates that are part of the **node_templates** block can be mapped to the **NodeTemplate** definitions provided as part of **TopologyTemplate** of a **ServiceTemplate** as described by the TOSCA v1.0 specification.
- The relationship templates that are part of the **relationship_templates** block can be mapped to the **RelationshipTemplate** definitions provided as part of **TopologyTemplate** of a **ServiceTemplate** as described by the TOSCA v1.0 specification.
- The output parameters that are part of the **outputs** section of a topology template can be mapped to **PropertyMappings** provided as part of **BoundaryDefinitions** as described by the TOSCA v1.0 specification.
 - Note, however, that TOSCA v1.0 does not define a direction (input vs. output) for those mappings, i.e. TOSCA v1.0 **PropertyMappings** are underspecified in that respect and TOSCA Simple Profile's **inputs** and **outputs** provide a more concrete definition of input and output parameters.

3.10 Service Template definition

A TOSCA Service Template (YAML) document contains element definitions of building blocks for cloud application, or complete models of cloud applications. This section describes the top-level structural elements (TOSCA keynames) along with their grammars, which are allowed to appear in a TOSCA Service Template document.

3.10.1 Keynames

The following is the list of recognized keynames for a TOSCA Service Template definition:

Keyname	Required	Type	Description
tosca_definitions_version	yes	string	Defines the version of the TOSCA Simple Profile specification the template (grammar) complies with.
namespace	no	URI	The default (target) namespace for all unqualified Types defined within the Service Template.
metadata	no	map of string	Defines a section used to declare additional metadata information. Domain-specific TOSCA profile specifications may define keynames that are required for their implementations.

Keyname	Required	Type	Description
description	no	description	Declares a description for this Service Template and its contents.
dsl_definitions	no	N/A	Declares optional DSL-specific definitions and conventions. For example, in YAML, this allows defining reusable YAML macros (i.e., YAML alias anchors) for use throughout the TOSCA Service Template.
repositories	no	map of Repository definitions	Declares the map of external repositories which contain artifacts that are referenced in the service template along with their addresses and necessary credential information used to connect to them in order to retrieve the artifacts.
imports	no	list of Import Definitions	Declares a list import statements pointing to external TOSCA Definitions documents. For example, these may be file location or URIs relative to the service template file within the same TOSCA CSAR file.
artifact_types	no	map of Artifact Types	This section contains an optional map of artifact type definitions for use in the service template
data_types	no	map of Data Types	Declares a map of optional TOSCA Data Type definitions.
capability_types	no	map of Capability Types	This section contains an optional map of capability type definitions for use in the service template.
interface_types	no	map of Interface Types	This section contains an optional map of interface type definitions for use in the service template.
relationship_types	no	map of Relationship Types	This section contains a map of relationship type definitions for use in the service template.
node_types	no	map of Node Types	This section contains a map of node type definitions for use in the service template.
group_types	no	map of Group Types	This section contains a map of group type definitions for use in the service template.
policy_types	no	list of Policy Types	This section contains a list of policy type definitions for use in the service template.
topology_template	no	Topology Template definition	Defines the topology template of an application or service, consisting of node templates that represent the application's or service's components, as well as relationship templates representing relations between the components.

3.10.1.1 Metadata keynames

The following is the list of recognized metadata keynames for a TOSCA Service Template definition:

Keyname	Required	Type	Description
template_name	no	string	Declares a descriptive name for the template.
template_author	no	string	Declares the author(s) or owner of the template.
template_version	no	string	Declares the version string for the template.

3.10.2 Grammar

The overall structure of a TOSCA Service Template and its top-level key collations using the TOSCA Simple Profile is shown below:

```
# Required TOSCA Definitions version string
tosca_definitions_version: <value> # Required, see section 3.1 for usage
namespace: <URI> # Optional, see section 3.2 for usage

# Optional metadata keyname: value pairs
metadata:
  template_name: <value> # Optional, name of this service template
  template_author: <value> # Optional, author of this service template
  template_version: <value> # Optional, version of this service template
  # More optional entries of domain or profile specific metadata keynames

# Optional description of the definitions inside the file.
description: <template type description>

dsl_definitions:
  # map of YAML alias anchors (or macros)

repositories:
  # map of external repository definitions which host TOSCA artifacts

imports:
  # ordered list of import definitions

artifact_types:
  # map of artifact type definitions

data_types:
  # map of datatype definitions

capability_types:
  # map of capability type definitions

interface_types
  # map of interface type definitions

relationship_types:
  # map of relationship type definitions
```

```
node_types:
  # map of node type definitions

group_types:
  # map of group type definitions

policy_types:
  # map of policy type definitions

topology_template:
  # topology template definition of the cloud application or service
```

3.10.2.1 Requirements

- The URI value “<http://docs.oasis-open.org/tosca>”, as well as all (path) extensions to it, SHALL be reserved for TOSCA approved specifications and work. That means Service Templates that do not originate from a TOSCA approved work product MUST NOT use it, in any form, when declaring a (default) Namespace.
- The key “`tosca_definitions_version`” SHOULD be the first line of each Service Template.

3.10.2.2 Notes

- TOSCA Service Templates do not have to contain a `topology_template` and MAY contain simply type definitions (e.g., Artifact, Interface, Capability, Node, Relationship Types, etc.) and be imported for use as type definitions in other TOSCA Service Templates.

3.10.3 Top-level keyname definitions

3.10.3.1 `tosca_definitions_version`

This required element provides a means to include a reference to the TOSCA Simple Profile specification within the TOSCA Definitions YAML file. It is an indicator for the version of the TOSCA grammar that should be used to parse the remainder of the document.

3.10.3.1.1 Keyname

```
tosca_definitions_version
```

3.10.3.1.2 Grammar

Single-line form:

```
tosca_definitions_version: <tosca_simple_profile_version>
```

3.10.3.1.3 Examples:

TOSCA Simple Profile version 1.3 specification using the defined namespace alias (see Section 3.1):

```
tosca_definitions_version: toska_simple_yaml_1_3
```

TOSCA Simple Profile version 1.3 specification using the fully defined (target) namespace (see Section 3.1):

```
tosca_definitions_version: http://docs.oasis-open.org/tosca/ns/simple/yaml/1.3
```

3.10.3.2 metadata

This keyname is used to associate domain-specific metadata with the Service Template. The metadata keyname allows a declaration of a map of keynames with string values.

3.10.3.2.1 Keyname

```
metadata
```

3.10.3.2.2 Grammar

```
metadata:  
  <map_of_string_values>
```

3.10.3.2.3 Example

```
metadata:  
  creation_date: 2015-04-14  
  date_updated: 2015-05-01  
  status: developmental
```

3.10.3.3 template_name

This optional metadata keyname can be used to declare the name of service template as a single-line string value.

3.10.3.3.1 Keyname

```
template_name
```

3.10.3.3.2 Grammar

```
template_name: <name string>
```

3.10.3.3.3 Example

```
template_name: My service template
```

3.10.3.3.4 Notes

- Some service templates are designed to be referenced and reused by other service templates. Therefore, in these cases, the **template_name** value SHOULD be designed to be used as a unique identifier through the use of namespacing techniques.

3.10.3.4 template_author

This optional metadata keyname can be used to declare the author(s) of the service template as a single-line string value.

3.10.3.4.1 Keyname

```
template_author
```

3.10.3.4.2 Grammar

```
template_author: <author string>
```

3.10.3.4.3 Example

```
template_author: My service template
```

3.10.3.5 template_version

This optional metadata keyname can be used to declare a domain specific version of the service template as a single-line string value.

3.10.3.5.1 Keyname

```
template_version
```

3.10.3.5.2 Grammar

```
template_version: <version>
```

3.10.3.5.3 Example

```
template_version: 2.0.17
```

3.10.3.5.4 Notes:

- Some service templates are designed to be referenced and reused by other service templates and have a lifecycle of their own. Therefore, in these cases, a **template_version** value SHOULD be included and used in conjunction with a unique **template_name** value to enable lifecycle management of the service template and its contents.

3.10.3.6 description

This optional keyname provides a means to include single or multiline descriptions within a TOSCA Simple Profile template as a scalar string value.

3.10.3.6.1 Keyname

```
description
```

3.10.3.7 dsl_definitions

This optional keyname provides a section to define macros (e.g., YAML-style macros when using the TOSCA Simple Profile in YAML specification).

3.10.3.7.1 Keyname

```
dsl_definitions
```

3.10.3.7.2 Grammar

```
dsl_definitions:  
  <dsl_definition_1>  
  ...  
  <dsl_definition_n>
```

3.10.3.7.3 Example

```
dsl_definitions:  
  ubuntu_image_props: &ubuntu_image_props  
    architecture: x86_64  
    type: linux  
    distribution: ubuntu  
    os_version: 14.04  
  
  redhat_image_props: &redhat_image_props  
    architecture: x86_64  
    type: linux  
    distribution: rhel  
    os_version: 6.6
```

3.10.3.8 repositories

This optional keyname provides a section to define external repositories which may contain artifacts or other TOSCA Service Templates which might be referenced or imported by the TOSCA Service Template definition.

3.10.3.8.1 Keyname

```
repositories
```

3.10.3.8.2 Grammar

```
repositories:  
  <repository_definition_1>  
  ...  
  <repository_definition_n>
```

3.10.3.8.3 Example

```
repositories:  
  my_project_artifact_repo:  
    description: development repository for TAR archives and Bash scripts  
    url: http://mycompany.com/repository/myproject/
```

3.10.3.9 imports

This optional keyname provides a way to import a *block sequence* of one or more TOSCA Definitions documents. TOSCA Definitions documents can contain reusable TOSCA type definitions (e.g., Node Types, Relationship Types, Artifact Types, etc.) defined by other authors. This mechanism provides an effective way for companies and organizations to define normative types and/or describe their software applications for reuse in other TOSCA Service Templates.

3.10.3.9.1 Keyname

```
imports
```

3.10.3.9.2 Grammar

```
imports:  
  - <import_definition_1>  
  - ...  
  - <import_definition_n>
```

3.10.3.9.3 Example

```
# An example import of definitions files from a location relative to the  
# file location of the service template declaring the import.  
imports:  
  - some_definitions: relative_path/my_defns/my_typesdefs_1.yaml  
  - file: my_defns/my_typesdefs_n.yaml  
    repository: my_company_repo  
    namespace_prefix: mycompany
```

3.10.3.10 artifact_types

This optional keyname lists the Artifact Types that are defined by this Service Template.

3.10.3.10.1 Keyname

```
artifact_types
```

3.10.3.10.2 Grammar

```
artifact_types:  
  <artifact type defn 1>  
  ...  
  <artifact type defn n>
```

3.10.3.10.3 Example

```
artifact_types:  
  mycompany.artifacttypes.myFileType:  
    derived_from: toscartifacts.File
```

3.10.3.11 data_types

This optional keyname provides a section to define new data types in TOSCA.

3.10.3.11.1 Keyname

```
data_types
```

3.10.3.11.2 Grammar

```
data_types:  
  <tosca datatype def 1>  
  ...  
  <tosca datatype def n>
```

3.10.3.11.3 Example

```
data_types:  
  # A complex datatype definition  
  simple_contactinfo_type:  
    properties:  
      name:  
        type: string  
      email:  
        type: string  
      phone:  
        type: string
```

```

# datatype definition derived from an existing type
full_contact_info:
  derived_from: simple_contact_info
  properties:
    street_address:
      type: string
    city:
      type: string
    state:
      type: string
    postalcode:
      type: string

```

3.10.3.12 capability_types

This optional keyname lists the Capability Types that provide the reusable type definitions that can be used to describe features Node Templates or Node Types can declare they support.

3.10.3.12.1 Keyname

```
capability_types
```

3.10.3.12.2 Grammar

```

capability_types:
  <capability_type_defn 1>
  ...
  <capability_type_defn n>

```

3.10.3.12.3 Example

```

capability_types:
  mycompany.mytypes.myCustomEndpoint:
    derived_from: toska.capabilities.Endpoint
    properties:
      # more details ...

  mycompany.mytypes.myCustomFeature:
    derived_from: toska.capabilities.Feature
    properties:
      # more details ...

```

3.10.3.13 interface_types

This optional keyname lists the Interface Types that provide the reusable type definitions that can be used to describe operations for on TOSCA entities such as Relationship Types and Node Types.

3.10.3.13.1 Keyname

```
interface_types
```

3.10.3.13.2 Grammar

```
interface_types:  
  <interface type defn 1>  
  ...  
  <interface type defn n>
```

3.10.3.13.3 Example

```
interface_types:  
  mycompany.interfaces.service.Signal:  
    signal_begin_receive:  
      description: Operation to signal start of some message processing.  
    signal_end_receive:  
      description: Operation to signal end of some message processed.
```

3.10.3.14 relationship_types

This optional keyname lists the Relationship Types that provide the reusable type definitions that can be used to describe dependent relationships between Node Templates or Node Types.

3.10.3.14.1 Keyname

```
relationship_types
```

3.10.3.14.2 Grammar

```
relationship_types:  
  <relationship type defn 1>  
  ...  
  <relationship type defn n>
```

3.10.3.14.3 Example

```
relationship_types:  
  mycompany.mytypes.myCustomClientServerType:  
    derived_from: toscarelationships.HostedOn  
    properties:
```

```
# more details ...

mycompany.mytypes.myCustomConnectionType:
  derived_from: tosca.relationships.ConnectsTo
  properties:
    # more details ...
```

3.10.3.15 node_types

This optional keyname lists the Node Types that provide the reusable type definitions for software components that Node Templates can be based upon.

3.10.3.15.1 Keyname

```
node_types
```

3.10.3.15.2 Grammar

```
node_types:
  <node\_type\_defn\_1>
  ...
  <node\_type\_defn\_n>
```

3.10.3.15.3 Example

```
node_types:
  my_webapp_node_type:
    derived_from: WebApplication
    properties:
      my_port:
        type: integer

  my_database_node_type:
    derived_from: Database
    capabilities:
      mytypes.myfeatures.transactSQL
```

3.10.3.15.4 Notes

- The node types that are part of the **node_types** block can be mapped to the **NodeType** definitions as described by the TOSCA v1.0 specification.

3.10.3.16 group_types

This optional keyname lists the Group Types that are defined by this Service Template.

3.10.3.16.1 Keyname

```
group_types
```

3.10.3.16.2 Grammar

```
group_types:  
  <group_type_defn 1>  
  ...  
  <group_type_defn n>
```

3.10.3.16.3 Example

```
group_types:  
  mycompany.mytypes.myScalingGroup:  
    derived_from: toscagroups.Root
```

3.10.3.17 policy_types

This optional keyname lists the Policy Types that are defined by this Service Template.

3.10.3.17.1 Keyname

```
policy_types
```

3.10.3.17.2 Grammar

```
policy_types:  
  <policy_type_defn 1>  
  ...  
  <policy_type_defn n>
```

3.10.3.17.3 Example

```
policy_types:  
  mycompany.mytypes.myScalingPolicy:  
    derived_from: toscapolicies.Scaling
```

4 TOSCA functions

Except for the examples, this section is **normative** and includes functions that are supported for use within a TOSCA Service Template.

4.1 Reserved Function Keywords

The following keywords MAY be used in some TOSCA function in place of a TOSCA Node or Relationship Template name. A TOSCA orchestrator will interpret them at the time the function would be evaluated at runtime as described in the table below. Note that some keywords are only valid in the context of a certain TOSCA entity as also denoted in the table.

Keyword	Valid Contexts	Description
SELF	Node Template or Relationship Template	A TOSCA orchestrator will interpret this keyword as the Node or Relationship Template instance that contains the function at the time the function is evaluated.
SOURCE	Relationship Template only.	A TOSCA orchestrator will interpret this keyword as the Node Template instance that is at the source end of the relationship that contains the referencing function.
TARGET	Relationship Template only.	A TOSCA orchestrator will interpret this keyword as the Node Template instance that is at the target end of the relationship that contains the referencing function.
HOST	Node Template only	<p>A TOSCA orchestrator will interpret this keyword to refer to the all nodes that “host” the node using this reference (i.e., as identified by its HostedOn relationship).</p> <p>Specifically, TOSCA orchestrators that encounter this keyword when evaluating the get_attribute or get_property functions SHALL search each node along the “HostedOn” relationship chain starting at the immediate node that hosts the node where the function was evaluated (and then that node’s host node, and so forth) until a match is found or the “HostedOn” relationship chain ends.</p>

4.2 Environment Variable Conventions

4.2.1 Reserved Environment Variable Names and Usage

TOSCA orchestrators utilize certain reserved keywords in the execution environments that implementation artifacts for Node or Relationship Templates operations are executed in. They are used to provide information to these implementation artifacts such as the results of TOSCA function evaluation or information about the instance model of the TOSCA application

The following keywords are reserved environment variable names in any TOSCA supported execution environment:

Keyword	Valid Contexts	Description
TARGETS	Relationship Template only.	<ul style="list-style-type: none"> For an implementation artifact that is executed in the context of a relationship, this keyword, if present, is used to supply a list of Node Template instances in a TOSCA application's instance model that are currently target of the context relationship. The value of this environment variable will be a comma-separated list of identifiers of the single target node instances (i.e., the tosca_id attribute of the node).
TARGET	Relationship Template only.	<ul style="list-style-type: none"> For an implementation artifact that is executed in the context of a relationship, this keyword, if present, identifies a Node Template instance in a TOSCA application's instance model that is a target of the context relationship, and which is being acted upon in the current operation. The value of this environment variable will be the identifier of the single target node instance (i.e., the tosca_id attribute of the node).
SOURCES	Relationship Template only.	<ul style="list-style-type: none"> For an implementation artifact that is executed in the context of a relationship, this keyword, if present, is used to supply a list of Node Template instances in a TOSCA application's instance model that are currently source of the context relationship. The value of this environment variable will be a comma-separated list of identifiers of the single source node instances (i.e., the tosca_id attribute of the node).
SOURCE	Relationship Template only.	<ul style="list-style-type: none"> For an implementation artifact that is executed in the context of a relationship, this keyword, if present, identifies a Node Template instance in a TOSCA application's instance model that is a source of the context relationship, and which is being acted upon in the current operation. The value of this environment variable will be the identifier of the single source node instance (i.e., the tosca_id attribute of the node).

For scripts (or implementation artifacts in general) that run in the context of relationship operations, select properties and attributes of both the relationship itself as well as select properties and attributes of the source and target node(s) of the relationship can be provided to the environment by declaring respective operation inputs.

Declared inputs from mapped properties or attributes of the source or target node (selected via the **SOURCE** or **TARGET** keyword) will be provided to the environment as variables having the exact same name as the inputs. In addition, the same values will be provided for the complete set of source or target nodes, however prefixed with the ID if the respective nodes. By means of the **SOURCES** or **TARGETS** variables holding the complete set of source or target node IDs, scripts will be able to iterate over corresponding inputs for each provided ID prefix.

The following example snippet shows an imaginary relationship definition from a load-balancer node to worker nodes. A script is defined for the **add_target** operation of the Configure interface of the relationship, and the **ip_address** attribute of the target is specified as input to the script:

```
node_templates:
  load_balancer:
    type: some.vendor.LoadBalancer
```

```

requirements:
  - member:
      relationship: some.vendor.LoadBalancerToMember
      interfaces:
        Configure:
          add_target:
            inputs:
              member_ip: { get_attribute: [ TARGET, ip_address ] }
            implementation: scripts/configure_members.py

```

The `add_target` operation will be invoked, whenever a new target member is being added to the load-balancer. With the above inputs declaration, a `member_ip` environment variable that will hold the IP address of the target being added will be provided to the `configure_members.py` script. In addition, the IP addresses of all current load-balancer members will be provided as environment variables with a naming scheme of `<target node ID>_member_ip`. This will allow, for example, scripts that always just write the complete list of load-balancer members into a configuration file to do so instead of updating existing list, which might be more complicated.

Assuming that the TOSCA application instance includes five load-balancer members, `node1` through `node5`, where `node5` is the current target being added, the following environment variables (plus potentially more variables) would be provided to the script:

```

# the ID of the current target and the IDs of all targets
TARGET=node5
TARGETS=node1,node2,node3,node4,node5

# the input for the current target and the inputs of all targets
member_ip=10.0.0.5
node1_member_ip=10.0.0.1
node2_member_ip=10.0.0.2
node3_member_ip=10.0.0.3
node4_member_ip=10.0.0.4
node5_member_ip=10.0.0.5

```

With code like shown in the snippet below, scripts could then iterate of all provided `member_ip` inputs:

```

#!/usr/bin/python
import os

targets = os.environ['TARGETS'].split(',')

for t in targets:
    target_ip = os.environ.get('%s_member_ip' % t)
    # do something with target_ip ...

```

4.2.2 Prefixed vs. Unprefixed TARGET names

The list target node types assigned to the TARGETS key in an execution environment would have names prefixed by unique IDs that distinguish different instances of a node in a running model. Future drafts of this specification will show examples of how these names/IDs will be expressed.

4.2.2.1 Notes

- Target of interest is always un-prefixed. Prefix is the target opaque ID. The IDs can be used to find the environment var. for the corresponding target. Need an example here.
- If you have one node that contains multiple targets this would also be used (add or remove target operations would also use this you would get set of all current targets).

4.3 Intrinsic functions

These functions are supported within the TOSCA template for manipulation of template data.

4.3.1 concat

The **concat** function is used to concatenate two or more string values within a TOSCA service template.

4.3.1.1 Grammar

```
concat: [<string_value_expressions_*> ]
```

4.3.1.2 Parameters

Parameter	Required	Type	Description
<string_value_expressions_*>	yes	list of string or string value expressions	A list of one or more strings (or expressions that result in a string value) which can be concatenated together into a single string.

4.3.1.3 Examples

```
outputs:  
  description: Concatenate the URL for a server from other template values  
  server_url:  
    value: { concat: [ 'http://',  
                      get_attribute: [ server, public_address ],  
                      ':',  
                      get_attribute: [ server, port ] ] }
```

4.3.2 join

The **join** function is used to join an array of strings into a single string with optional delimiter.

4.3.2.1 Grammar

```
join: [<list of string_value_expressions_*> [ <delimiter> ] ]
```

4.3.2.2 Parameters

Parameter	Required	Type	Description
<list of string_value_expressions_*>	yes	list of string or string value expressions	A list of one or more strings (or expressions that result in a list of string values) which can be joined together into a single string.
<delimiter>	no	string	An optional delimiter used to join the string in the provided list.

4.3.2.3 Examples

```
outputs:
  example1:
    # Result: prefix_1111_suffix
    value: { join: [ ["prefix", 1111, "suffix" ], "_" ] }
  example2:
    # Result: 9.12.1.10,9.12.1.20
    value: { join: [ { get_input: my_IPs }, "," ] }
```

4.3.3 token

The **token** function is used within a TOSCA service template on a string to parse out (tokenize) substrings separated by one or more token characters within a larger string.

4.3.3.1 Grammar

```
token: [ <string_with_tokens>, <string_of_token_chars>, <substring_index> ]
```

4.3.3.2 Parameters

Parameter	Required	Type	Description
string_with_tokens	yes	string	The composite string that contains one or more substrings separated by token characters.
string_of_token_chars	yes	string	The string that contains one or more token characters that separate substrings within the composite string.
substring_index	yes	integer	The integer indicates the index of the substring to return from the composite string. Note that the first substring is denoted by using the '0' (zero) integer value.

4.3.3.3 Examples

```
outputs:
  webserver_port:
    description: the port provided at the end of my server's endpoint's IP address
    value: { token: [ get_attribute: [ my_server, data_endpoint, ip_address ],
                    ':' }
```

4.4 Property functions

These functions are used within a service template to obtain property values from property definitions declared elsewhere in the same service template. These property definitions can appear either directly in the service template itself (e.g., in the `inputs` section) or on entities (e.g., node or relationship templates) that have been modeled within the template.

Note that the `get_input` and `get_property` functions may only retrieve the static values of property definitions of a TOSCA application as defined in the TOSCA Service Template. The `get_attribute` function should be used to retrieve values for attribute definitions (or property definitions reflected as attribute definitions) from the runtime instance model of the TOSCA application (as realized by the TOSCA orchestrator).

4.4.1 get_input

The `get_input` function is used to retrieve the values of properties declared within the `inputs` section of a TOSCA Service Template.

4.4.1.1 Grammar

```
get_input: <input_property_name>
```

or

```
get_input: [ <input_property_name>, <nested_input_property_name_or_index_1>, ...,
<nested_input_property_name_or_index_n> ]
```

4.4.1.2 Parameters

Parameter	Required	Type	Description
<code><input_property_name></code>	yes	string	The name of the property as defined in the <code>inputs</code> section of the service template.
<code><nested_input_property_name_or_index_*></code>	no	string integer	Some TOSCA input properties are complex (i.e., composed as nested structures). These parameters are used to dereference into the names of these nested structures when needed. Some properties represent list types. In these cases, an index may be provided to reference a specific entry in the list (as named in the previous parameter) to return.

4.4.1.3 Examples

The following snippet shows an example of the simple `get_input` grammar:

```
inputs:
  cpus:
    type: integer
```

```

node_templates:
  my_server:
    type: toska.nodes.Compute
    capabilities:
      host:
        properties:
          num_cpus: { get_input: cpus }

```

The following template shows an example of the nested `get_input` grammar. The template expects two input values, each of which has a complex data type. The `get_input` function is used to retrieve individual fields from the complex input data.

```

data_types:
  NetworkInfo:
    derived_from: toska.Data.Root
    properties:
      name:
        type: string
      gateway:
        type: string

  RouterInfo:
    derived_from: toska.Data.Root
    properties:
      ip:
        type: string
      external:
        type: string

topology_template:
  inputs:
    management_network:
      type: NetworkInfo
    router:
      type: RouterInfo

  node_templates:
    Bono_Main:
      type: vRouter.Cisco
      directives: [ substitutable ]
      properties:

```



```

mgmt_net_name: { get_input: [management_network, name]}
mgmt_cp_v4_fixed_ip: { get_input: [router, ip]}
mgmt_cp_gateway_ip: { get_input: [management_network, gateway]}
mgmt_cp_external_ip: { get_input: [router, external]}
requirements:
  - lan_port:
      node: host_with_net
      capability: virtualBind
  - mgmt_net: mgmt_net

```

4.4.2 get_property

The `get_property` function is used to retrieve property values between modelable entities defined in the same service template.

4.4.2.1 Grammar

```

get_property: [ <modelable_entity_name>, <optional_req_or_cap_name>,
<property_name>, <nested_property_name_or_index_1>, ...,
<nested_property_name_or_index_n> ]

```

4.4.2.2 Parameters

Parameter	Required	Type	Description
<modelable_entity_name> SELF SOURCE TARGET HOST	yes	string	The required name of a modelable entity (e.g., Node Template or Relationship Template name) as declared in the service template that contains the named property definition the function will return the value from. See section B.1 for valid keywords.
<optional_req_or_cap_name>	no	string	The optional name of the requirement or capability name within the modelable entity (i.e., the <modelable_entity_name> which contains the named property definition the function will return the value from. Note: If the property definition is located in the modelable entity directly, then this parameter MAY be omitted.
<property_name>	yes	string	The name of the property definition the function will return the value from.
<nested_property_name_or_index_*>	no	string integer	Some TOSCA properties are complex (i.e., composed as nested structures). These parameters are used to dereference into the names of these nested structures when needed. Some properties represent list types. In these cases, an index may be provided to reference a specific entry in the list (as named in the previous parameter) to return.

4.4.2.3 Examples

The following example shows how to use the `get_property` function with an actual Node Template name:

```

node_templates:

  mysql_database:
    type: toska.nodes.Database
    properties:
      name: sql_database1

  wordpress:
    type: toska.nodes.WebApplication.WordPress
    ...
    interfaces:
      Standard:
        configure:
          inputs:
            wp_db_name: { get_property: [ mysql_database, name ] }

```

The following example shows how to use the `get_property` function using the `SELF` keyword:

```

node_templates:

  mysql_database:
    type: toska.nodes.Database
    ...
    capabilities:
      database_endpoint:
        properties:
          port: 3306

  wordpress:
    type: toska.nodes.WebApplication.WordPress
    requirements:
      ...
      - database_endpoint: mysql_database
    interfaces:
      Standard:
        create: wordpress_install.sh
        configure:
          implementation: wordpress_configure.sh
          inputs:
            ...
            wp_db_port: { get_property: [ SELF, database_endpoint, port ] }

```

The following example shows how to use the `get_property` function using the `TARGET` keyword:

```

relationship_templates:
  my_connection:
    type: ConnectsTo
    interfaces:
      Configure:
        inputs:
          targets_value: { get_property: [ TARGET, value ] }

```

4.5 Attribute functions

These functions (attribute functions) are used within an instance model to obtain attribute values from instances of nodes and relationships that have been created from an application model described in a service template. The instances of nodes or relationships can be referenced by their name as assigned in the service template or relative to the context where they are being invoked.

4.5.1 get_attribute

The `get_attribute` function is used to retrieve the values of named attributes declared by the referenced node or relationship template name.

4.5.1.1 Grammar

```

get_attribute: [ <modelable_entity_name>, <optional_req_or_cap_name>,
<attribute_name>, <nested_attribute_name_or_index_1>, ...,
<nested_attribute_name_or_index_n> ]

```

4.5.1.2 Parameters

Parameter	Required	Type	Description
<modelable entity name> SELF SOURCE TARGET HOST	yes	string	The required name of a modelable entity (e.g., Node Template or Relationship Template name) as declared in the service template that contains the named attribute definition the function will return the value from. See section B.1 for valid keywords.
<optional_req_or_cap_name>	no	string	The optional name of the requirement or capability name within the modelable entity (i.e., the <modelable_entity_name> which contains the named attribute definition the function will return the value from. Note: If the attribute definition is located in the modelable entity directly, then this parameter MAY be omitted.
<attribute_name>	yes	string	The name of the attribute definition the function will return the value from.
<nested_attribute_name_or_index_*>	no	string integer	Some TOSCA attributes are complex (i.e., composed as nested structures). These parameters are used to dereference into the names of these nested structures when needed. Some attributes represent list types. In these cases, an index may be provided to reference a specific entry in the list (as named in the previous parameter) to return.

4.5.1.3 Examples:

The attribute functions are used in the same way as the equivalent Property functions described above. Please see their examples and replace “get_property” with “get_attribute” function name.

4.5.1.4 Notes

These functions are used to obtain attributes from instances of node or relationship templates by the names they were given within the service template that described the application model (pattern).

- These functions only work when the orchestrator can resolve to a single node or relationship instance for the named node or relationship. This essentially means this is acknowledged to work only when the node or relationship template being referenced from the service template has a cardinality of 1 (i.e., there can only be one instance of it running).

4.6 Operation functions

These functions are used within an instance model to obtain values from interface operations. These can be used in order to set an attribute of a node instance at runtime or to pass values from one operation to another.

4.6.1 get_operation_output

The **get_operation_output** function is used to retrieve the values of variables exposed / exported from an interface operation.

4.6.1.1 Grammar

```
get_operation_output: <modelable_entity_name>, <interface_name>,  
<operation_name>, <output_variable_name>
```

4.6.1.2 Parameters

Parameter	Required	Type	Description
<modelable_entity_name> SELF SOURCE TARGET	yes	string	The required name of a modelable entity (e.g., Node Template or Relationship Template name) as declared in the service template that implements the named interface and operation.
<interface_name>	Yes	string	The required name of the interface which defines the operation.
<operation_name>	yes	string	The required name of the operation whose value we would like to retrieve.
<output_variable_name>	Yes	string	The required name of the variable that is exposed / exported by the operation.

4.6.1.3 Notes

- If operation failed, then ignore its outputs. Orchestrators should allow orchestrators to continue running when possible past deployment in the lifecycle. For example, if an update fails, the application should be allowed to continue running and some other method would be used to alert administrators of the failure.

4.7 Navigation functions

- This version of the TOSCA Simple Profile does not define any model navigation functions.

4.7.1 get_nodes_of_type

The `get_nodes_of_type` function can be used to retrieve a list of all known instances of nodes of the declared Node Type.

4.7.1.1 Grammar

```
get_nodes_of_type: <node_type_name>
```

4.7.1.2 Parameters

Parameter	Required	Type	Description
<node_type_name>	yes	string	The required name of a Node Type that a TOSCA orchestrator would use to search a running application instance in order to return all unique, named node instances of that type.

4.7.1.3 Returns

Return Key	Type	Description
TARGETS	<see above>	The list of node instances from the current application instance that match the <code>node_type_name</code> supplied as an input parameter of this function.

4.8 Artifact functions

4.8.1 get_artifact

The `get_artifact` function is used to retrieve artifact location between modelable entities defined in the same service template.

4.8.1.1 Grammar

```
get_artifact: [ <modelable_entity_name>, <artifact_name>, <location>, <remove> ]
```

4.8.1.2 Parameters

Parameter	Required	Type	Description
<modelable entity name> SELF SOURCE TARGET HOST	yes	string	The required name of a modelable entity (e.g., Node Template or Relationship Template name) as declared in the service template that contains the named property definition the function will return the value from. See section B.1 for valid keywords.
<artifact_name>	yes	string	The name of the artifact definition the function will return the value from.

Parameter	Required	Type	Description
<location> LOCAL_FILE	no	string	<p>Location value must be either a valid path e.g. '/etc/var/my_file' or 'LOCAL_FILE'.</p> <p>If the value is LOCAL_FILE the orchestrator is responsible for providing a path as the result of the get_artifact call where the artifact file can be accessed. The orchestrator will also remove the artifact from this location at the end of the operation.</p> <p>If the location is a path specified by the user the orchestrator is responsible to copy the artifact to the specified location. The orchestrator will return the path as the value of the get_artifact function and leave the file here after the execution of the operation.</p>
remove	no	boolean	<p>Boolean flag to override the orchestrator default behavior so it will remove or not the artifact at the end of the operation execution.</p> <p>If not specified the removal will depends of the location e.g. removes it in case of 'LOCAL_FILE' and keeps it in case of a path.</p> <p>If true the artifact will be removed by the orchestrator at the end of the operation execution, if false it will not be removed.</p>

4.8.1.3 Examples

The following example uses a snippet of a WordPress [WordPress] web application to show how to use the **get_artifact** function with an actual Node Template name:

4.8.1.3.1 Example: Retrieving artifact without specified location

```
node_templates:

wordpress:
  type: tosca.nodes.WebApplication.WordPress
  ...
  interfaces:
    Standard:
      configure:
        create:
          implementation: wordpress_install.sh
          inputs
            wp_zip: { get_artifact: [ SELF, zip ] }
  artifacts:
    zip: /data/wordpress.zip
```

In such implementation the TOSCA orchestrator may provide the **wordpress.zip** archive as

- a local URL (example: file:///home/user/wordpress.zip) or

- a remote one (example: `http://cloudrepo:80/files/wordpress.zip`) where some orchestrator may indeed provide some global artifact repository management features.

4.8.1.3.2 Example: Retrieving artifact as a local path

The following example explains how to force the orchestrator to copy the file locally before calling the operation's implementation script:

```
node_templates:

  wordpress:
    type: toska.nodes.WebApplication.WordPress
    ...
    interfaces:
      Standard:
        configure:
          create:
            implementation: wordpress_install.sh
            inputs
              wp_zip: { get_artifact: [ SELF, zip, LOCAL_FILE ] }
    artifacts:
      zip: /data/wordpress.zip
```

In such implementation the TOSCA orchestrator must provide the `wordpress.zip` archive as a local path (example: `/tmp/wordpress.zip`) and **will remove it** after the operation is completed.

4.8.1.3.3 Example: Retrieving artifact in a specified location

The following example explains how to force the orchestrator to copy the file locally to a specific location before calling the operation's implementation script :

```
node_templates:

  wordpress:
    type: toska.nodes.WebApplication.WordPress
    ...
    interfaces:
      Standard:
        configure:
          create:
            implementation: wordpress_install.sh
            inputs
              wp_zip: { get_artifact: [ SELF, zip, C:/wpdata/wp.zip ] }
    artifacts:
      zip: /data/wordpress.zip
```

In such implementation the TOSCA orchestrator must provide the wordpress.zip archive as a local path (example: C:/wpdata/wp.zip) and **will let it** after the operation is completed.

4.9 Context-based Entity names (global)

Future versions of this specification will address methods to access entity names based upon the context in which they are declared or defined.

4.9.1.1 Goals

- Using the full paths of modelable entity names to qualify context with the future goal of a more robust `get_attribute` function: e.g., `get_attribute(<context-based-entity-name>, <attribute name>)`

5 TOSCA normative type definitions

Except for the examples, this section is **normative** and contains normative type definitions which must be supported for conformance to this specification.

The declarative approach is heavily dependent of the definition of basic types that a declarative container must understand. The definition of these types must be very clear such that the operational semantics can be precisely followed by a declarative container to achieve the effects intended by the modeler of a topology in an interoperable manner.

5.1 Assumptions

- Assumes alignment with/dependence on XML normative types proposal for TOSCA v1.1
- Assumes that the normative types will be versioned and the TOSCA TC will preserve backwards compatibility.
- Assumes that security and access control will be addressed in future revisions or versions of this specification.

5.2 TOSCA normative type names

Every normative type has three names declared:

1. **Type URI** – This is the unique identifying name for the type.
 - a. These are reserved names within the TOSCA namespace.
2. **Shorthand Name** – This is the shorter (simpler) name that can be used in place of its corresponding, full **Type URI** name.
 - a. These are reserved names within TOSCA namespace that MAY be used in place of the full Type URI.
 - b. Profiles of the OASIS TOSCA Simple Profile specification SHALL assure non-collision of names for new types when they are introduced.
 - c. TOSCA type designers SHOULD NOT create new types with names that would collide with any TOSCA normative type Shorthand Name.
3. **Type Qualified Name** – This is a modified **Shorthand Name** that includes the “**tosca:**” namespace prefix which clearly qualifies it as being part of the TOSCA namespace.
 - a. This name MAY be used to assure there is no collision when types are imported from other (non) TOSCA approved sources.

5.2.1 Additional requirements

- **Case sensitivity** - TOSCA Type URI, Shorthand and Type Qualified names SHALL be treated as case sensitive.
 - The case of each type name has been carefully selected by the TOSCA working group and TOSCA orchestrators and processors SHALL strictly recognize the name casing as specified in this specification or any of its approved profiles.

5.3 Data Types

5.3.1 `tosca.datatypes.Root`

This is the default (root) TOSCA Root Type definition that all complex TOSCA Data Types derive from.

5.3.1.1 Definition

The TOSCA Root type is defined as follows:

```
tosca.datatypes.Root:  
  description: The TOSCA root Data Type all other TOSCA base Data Types derive  
  from
```

5.3.2 tosca.datatypes.json

The json type is a TOSCA data Type used to define a string that contains data in the JavaScript Object Notation (JSON) format.

Shorthand Name	json
Type Qualified Name	tosca:json
Type URI	tosca.datatypes.json

5.3.2.1 Definition

The json type is defined as follows:

```
tosca.datatypes.json:  
  derived_from: string
```

5.3.2.2 Examples

5.3.2.2.1 Type declaration example

Simple declaration of an 'event_object' property declared to be a 'json' data type with its associated JSON Schema:

```
properties:  
  event_object:  
    type: json  
    constraints:  
      schema: >  
        {  
          "$schema": "http://json-schema.org/draft-04/schema#",  
          "title": "Event",  
          "description": "Example Event type schema",  
          "type": "object",  
          "properties": {  
            "uuid": {  
              "description": "The unique ID for the event.",  
              "type": "string"  
            },  
            "code": {
```

```

        "type": "integer"
      },
      "message": {
        "type": "string"
      }
    },
    "required": ["uuid", "code"]
  }

```

5.3.2.2.2 Template definition example

This example shows a valid JSON datatype value for the 'event_object' schema declare in the previous example.

```

# properties snippet from a TOSCA template definition.
properties:
  event_object: <
    {
      "uuid": "cadf:1234-56-0000-abcd",
      "code": 9876
    }

```

5.3.3 Additional Requirements

- The json datatype SHOULD only be assigned string values that contain valid JSON syntax as defined by the "The JSON Data Interchange Format Standard" (see reference [\[JSON-Spec\]](#)).

5.3.4 toasca.datatypes.xml

The xml type is a TOSCA data Type used to define a string that containst data in the Extensible Markup Language (XML) format.

Shorthand Name	xml
Type Qualified Name	tosca:xml
Type URI	tosca.datatypes.xml

5.3.4.1 Definition

The xml type is defined as follows:

```

tosca.datatypes.xml:
  derived_from: string

```

5.3.4.2 Examples

5.3.4.2.1 Type declaration example

Simple declaration of an 'event_object' property declared to be an 'xml' data type with its associated XML Schema:

```
properties:
  event_object:
    type: xml
    constraints:
      schema: >
        <xs:schema xmlns:xs="http://www.w3.org/2001/XMLSchema"
          targetNamespace="http://cloudplatform.org/events.xsd"
          xmlns="http://tempuri.org/po.xsd" elementFormDefault="qualified">
          <xs:annotation>
            <xs:documentation xml:lang="en">
              Event object.
            </xs:documentation>
          </xs:annotation>
          <xs:element name="eventObject">
            <xs:complexType>
              <xs:sequence>
                <xs:element name="uuid" type="xs:string"/>
                <xs:element name="code" type="xs:integer"/>
                <xs:element name="message" type="xs:string" minOccurs="0"/>
              </xs:sequence>
            </xs:complexType>
          </xs:element>
        </xs:schema>
```

5.3.4.2.2 Template definition example

This example shows a valid XML datatype value for the 'event_object' schema declare in the previous example.

```
# properties snippet from a TOSCA template definition.
properties:
  event_object: <
    <eventObject>
      <uuid>cadf:1234-56-0000-abcd</uuid>
      <code>9876</code>
    </eventObject>
```

5.3.5 Additional Requirements

The xml datatype SHOULD only be assigned string values that contain valid XML syntax as defined by the “Extensible Markup Language (XML)” specification” (see reference [XMLSpec]).

5.3.6 tosca.datatypes.Credential

The Credential type is a complex TOSCA data Type used when describing authorization credentials used to access network accessible resources.

Shorthand Name	Credential
Type Qualified Name	tosca:Credential
Type URI	tosca.datatypes.Credential

5.3.6.1 Properties

Name	Required	Type	Constraints	Description
protocol	no	string	None	The optional protocol name.
token_type	yes	string	default: password	The required token type.
token	yes	string	None	The required token used as a credential for authorization or access to a networked resource.
keys	no	map of string	None	The optional map of protocol-specific keys or assertions.
user	no	string	None	The optional user (name or ID) used for non-token based credentials.

5.3.6.2 Definition

The TOSCA Credential type is defined as follows:

```
tosca.datatypes.Credential:  
  derived_from: tosca.datatypes.Root  
  properties:  
    protocol:  
      type: string  
      required: false  
    token_type:  
      type: string  
      default: password  
    token:  
      type: string  
    keys:  
      type: map  
      required: false  
  entry_schema:
```

```
    type: string
  user:
    type: string
    required: false
```

5.3.6.3 Additional requirements

- TOSCA Orchestrators SHALL interpret and validate the value of the **token** property based upon the value of the **token_type** property.

5.3.6.4 Notes

- Specific token types and encoding them using network protocols are not defined or covered in this specification.
- The use of transparent user names (IDs) or passwords are not considered best practice.

5.3.6.5 Examples

5.3.6.5.1 Provide a simple user name and password without a protocol or standardized token format

```
<some_tosca_entity>:
  properties:
    my_credential:
      type: Credential
      properties:
        user: myusername
        token: mypassword
```

5.3.6.5.2 HTTP Basic access authentication credential

```
<some_tosca_entity>:
  properties:
    my_credential: # type: Credential
      protocol: http
      token_type: basic_auth
      # Username and password are combined into a string
      # Note: this would be base64 encoded before transmission by any impl.
      token: myusername:mypassword
```

5.3.6.5.3 X-Auth-Token credential

```
<some_tosca_entity>:
  properties:
    my_credential: # type: Credential
      protocol: xauth
```

```

token_type: X-Auth-Token
# token encoded in Base64
token: 604bbe45ac7143a79e14f3158df67091

```

5.3.6.5.4 OAuth bearer token credential

```

<some_tosca_entity>:
  properties:
    my_credential: # type: Credential
    protocol: oauth2
    token_type: bearer
    # token encoded in Base64
    token: 8ao9nE2DEjr1zCsicWmpBC

```

5.3.6.6 OpenStack SSH Keypair

```

<some_tosca_entity>:
  properties:
    my_ssh_keypair: # type: Credential
    protocol: ssh
    token_type: identifier
    # token is a reference (ID) to an existing keypair (already installed)
    token: <keypair_id>

```

5.3.7 tosca.datatypes.TimeInterval

The TimeInterval type is a complex TOSCA data Type used when describing a period of time using the YAML ISO 8601 format to declare the start and end times.

Shorthand Name	TimeInterval
Type Qualified Name	tosca:TimeInterval
Type URI	tosca.datatypes.TimeInterval

5.3.7.1 Properties

Name	Required	Type	Constraints	Description
start_time	yes	timestamp	None	The inclusive start time for the time interval.
end_time	yes	timestamp	None	The inclusive end time for the time interval.

5.3.7.2 Definition

The TOSCA TimeInterval type is defined as follows:

```

tosca.datatypes.TimeInterval:

```

```

derived_from: toska.datatypes.Root
properties:
  start_time:
    type: timestamp
    required: true
  end_time:
    type: timestamp
    required: true

```

5.3.7.3 Examples

5.3.7.3.1 Multi-day evaluation time period

```

properties:
  description:
    evaluation_period: Evaluate a service for a 5-day period across time zones
    type: TimeInterval
    start_time: 2016-04-04-15T00:00:00Z
    end_time: 2016-04-08T21:59:43.10-06:00

```

5.3.8 toska.datatypes.network.NetworkInfo

The Network type is a complex TOSCA data type used to describe logical network information.

Shorthand Name	NetworkInfo
Type Qualified Name	tosca:NetworkInfo
Type URI	tosca.datatypes.network.NetworkInfo

5.3.8.1 Properties

Name	Type	Constraints	Description
network_name	string	None	The name of the logical network. e.g., "public", "private", "admin". etc.
network_id	string	None	The unique ID of for the network generated by the network provider.
addresses	string []	None	The list of IP addresses assigned from the underlying network.

5.3.8.2 Definition

The TOSCA NetworkInfo data type is defined as follows:

```

tosca.datatypes.network.NetworkInfo:
  derived_from: toska.datatypes.Root
  properties:
    network_name:

```



```

type: string
network_id:
  type: string
addresses:
  type: list
entry_schema:
  type: string

```

5.3.8.3 Examples

Example usage of the NetworkInfo data type:

```

<some_tosca_entity>:
  properties:
    private_network:
      network_name: private
      network_id: 3e54214f-5c09-1bc9-9999-44100326da1b
      addresses: [ 10.111.128.10 ]

```

5.3.8.4 Additional Requirements

- It is expected that TOSCA orchestrators **MUST** be able to map the **network_name** from the TOSCA model to underlying network model of the provider.
- The properties (or attributes) of NetworkInfo may or may not be required depending on usage context.

5.3.9 tosca.datatypes.network.PortInfo

The PortInfo type is a complex TOSCA data type used to describe network port information.

Shorthand Name	PortInfo
Type Qualified Name	tosca:PortInfo
Type URI	tosca.datatypes.network.PortInfo

5.3.9.1 Properties

Name	Type	Constraints	Description
port_name	string	None	The logical network port name.
port_id	string	None	The unique ID for the network port generated by the network provider.
network_id	string	None	The unique ID for the network.
mac_address	string	None	The unique media access control address (MAC address) assigned to the port.
addresses	string []	None	The list of IP address(es) assigned to the port.

5.3.9.2 Definition

The TOSCA PortInfo type is defined as follows:

```
tosca.datatypes.network.PortInfo:
  derived_from: tosca.datatypes.Root
  properties:
    port_name:
      type: string
    port_id:
      type: string
    network_id:
      type: string
    mac_address:
      type: string
    addresses:
      type: list
      entry_schema:
        type: string
```

5.3.9.3 Examples

Example usage of the PortInfo data type:

```
<some_tosca_entity>:
  properties:
    ethernet_port:
      port_name: port1
      port_id: 2c0c7a37-691a-23a6-7709-2d10ad041467
      network_id: 3e54214f-5c09-1bc9-9999-44100326da1b
      mac_address: f1:18:3b:41:92:1e
      addresses: [ 172.24.9.102 ]
```

5.3.9.4 Additional Requirements

- It is expected that TOSCA orchestrators **MUST** be able to map the **port_name** from the TOSCA model to underlying network model of the provider.
- The properties (or attributes) of PortInfo may or may not be required depending on usage context.

5.3.10 `tosca.datatypes.network.PortDef`

The PortDef type is a TOSCA data Type used to define a network port.

Shorthand Name	PortDef
Type Qualified Name	tosca:PortDef
Type URI	tosca.datatypes.network.PortDef

5.3.10.1 Definition

The TOSCA PortDef type is defined as follows:

```
tosca.datatypes.network.PortDef:
  derived_from: integer
  constraints:
    - in_range: [ 1, 65535 ]
```

5.3.10.2 Examples

Simple usage of a PortDef property type:

```
properties:
  listen_port: 9090
```

Example declaration of a property for a custom type based upon PortDef:

```
properties:
  listen_port:
    type: PortDef
    default: 9000
    constraints:
      - in_range: [ 9000, 9090 ]
```

5.3.11 tosca.datatypes.network.PortSpec

The PortSpec type is a complex TOSCA data Type used when describing port specifications for a network connection.

Shorthand Name	PortSpec
Type Qualified Name	tosca:PortSpec
Type URI	tosca.datatypes.network.PortSpec

5.3.11.1 Properties

Name	Required	Type	Constraints	Description
protocol	yes	string	default: tcp	The required protocol used on the port.
source	no	PortDef	See PortDef	The optional source port.
source_range	no	range	in_range: [1, 65536]	The optional range for source port.
target	no	PortDef	See PortDef	The optional target port.

Name	Required	Type	Constraints	Description
target_range	no	range	in_range: [1, 65536]	The optional range for target port.

5.3.11.2 Definition

The TOSCA PortSpec type is defined as follows:

```
tosca.datatypes.network.PortSpec:
  derived_from: toska.datatypes.Root
  properties:
    protocol:
      type: string
      required: true
      default: tcp
      constraints:
        - valid_values: [ udp, tcp, igmp ]
    target:
      type: PortDef
      required: false
    target_range:
      type: range
      required: false
      constraints:
        - in_range: [ 1, 65535 ]
    source:
      type: PortDef
      required: false
    source_range:
      type: range
      required: false
      constraints:
        - in_range: [ 1, 65535 ]
```

5.3.11.3 Additional requirements

- A valid PortSpec MUST have at least one of the following properties: **target**, **target_range**, **source** or **source_range**.
- A valid PortSpec MUST have a value for the **source** property that is within the numeric range specified by the property **source_range** when **source_range** is specified.
- A valid PortSpec MUST have a value for the **target** property that is within the numeric range specified by the property **target_range** when **target_range** is specified.

5.3.11.4 Examples

Example usage of the PortSpec data type:

```
# example properties in a node template
some_endpoint:
  properties:
    ports:
      user_port:
        protocol: tcp
        target: 50000
        target_range: [ 20000, 60000 ]
        source: 9000
        source_range: [ 1000, 10000 ]
```

5.4 Artifact Types

TOSCA Artifacts Types represent the types of packages and files used by the orchestrator when deploying TOSCA Node or Relationship Types or invoking their interfaces. Currently, artifacts are logically divided into three categories:

- **Deployment Types:** includes those artifacts that are used during deployment (e.g., referenced on create and install operations) and include packaging files such as RPMs, ZIPs, or TAR files.
- **Implementation Types:** includes those artifacts that represent imperative logic and are used to implement TOSCA Interface operations. These typically include scripting languages such as Bash (.sh), Chef [Chef] and Puppet [Puppet].
- **Runtime Types:** includes those artifacts that are used during runtime by a service or component of the application. This could include a library or language runtime that is needed by an application such as a PHP or Java library.
- **Template Types:** includes those artifacts that are executed by template engines which play the role of artifact processors. Typically, template artifact types are static files. At runtime, the template engine processes the artifact by replacing variables in a template file with actual values. Some examples of template files are Twig [Twig] and Jinja2 [Jinja2].

Note: Additional TOSCA Artifact Types will be developed in future drafts of this specification.

5.4.1 `tosca.artifacts.Root`

This is the default (root) TOSCA [Artifact Type](#) definition that all other TOSCA base Artifact Types derive from.

5.4.1.1 Definition

```
tosca.artifacts.Root:
  description: The TOSCA Artifact Type all other TOSCA Artifact Types derive from
```

5.4.2 `tosca.artifacts.File`

This artifact type is used when an artifact definition needs to have its associated file simply treated as a file and no special handling/handlers are invoked (i.e., it is not treated as either an implementation or deployment artifact type).

Shorthand Name	File
Type Qualified Name	tosca:File
Type URI	tosca.artifacts.File

5.4.2.1 Definition

```
tosca.artifacts.File:
  derived_from: tosca.artifacts.Root
```

5.4.3 Deployment Types

5.4.3.1 `tosca.artifacts.Deployment`

This artifact type represents the parent type for all deployment artifacts in TOSCA. This class of artifacts typically represents a binary packaging of an application or service that is used to install/create or deploy it as part of a node's lifecycle.

5.4.3.1.1 Definition

```
tosca.artifacts.Deployment:
  derived_from: tosca.artifacts.Root
  description: TOSCA base type for deployment artifacts
```

5.4.3.2 Additional Requirements

- TOSCA Orchestrators MAY throw an error if it encounters a non-normative deployment artifact type that it is not able to process.

5.4.3.3 `tosca.artifacts.Deployment.Image`

This artifact type represents a parent type for any "image" which is an opaque packaging of a TOSCA Node's deployment (whether real or virtual) whose contents are typically already installed and pre-configured (i.e., "stateful") and prepared to be run on a known target container.

Shorthand Name	Deployment.Image
Type Qualified Name	tosca:Deployment.Image
Type URI	tosca.artifacts.Deployment.Image

5.4.3.3.1 Definition

```
tosca.artifacts.Deployment.Image:
  derived_from: tosca.artifacts.Deployment
```

5.4.3.4 `tosca.artifacts.Deployment.Image.VM`

This artifact represents the parent type for all Virtual Machine (VM) image and container formatted deployment artifacts. These images contain a stateful capture of a machine (e.g., server) including

operating system and installed software along with any configurations and can be run on another machine using a hypervisor which virtualizes typical server (i.e., hardware) resources.

5.4.3.4.1 Definition

```
tosca.artifacts.Deployment.Image.VM:  
  derived_from: tosca.artifacts.Deployment.Image  
  description: Virtual Machine (VM) Image
```

5.4.3.4.2 Notes

- Future drafts of this specification may include popular standard VM disk image (e.g., ISO, VMI, VMDX, QCOW2, etc.) and container (e.g., OVF, bare, etc.) formats. These would include consideration of disk formats such as:

5.4.4 Implementation Types

5.4.4.1 [tosca.artifacts.Implementation](#)

This artifact type represents the parent type for all implementation artifacts in TOSCA. These artifacts are used to implement operations of TOSCA interfaces either directly (e.g., scripts) or indirectly (e.g., config. files).

5.4.4.1.1 Definition

```
tosca.artifacts.Implementation:  
  derived_from: tosca.artifacts.Root  
  description: TOSCA base type for implementation artifacts
```

5.4.4.2 Additional Requirements

- TOSCA Orchestrators **MAY** throw an error if it encounters a non-normative implementation artifact type that it is not able to process.

5.4.4.3 [tosca.artifacts.Implementation.Bash](#)

This artifact type represents a Bash script type that contains Bash commands that can be executed on the Unix Bash shell.

Shorthand Name	Bash
Type Qualified Name	tosca:Bash
Type URI	tosca.artifacts.Implementation.Bash

5.4.4.3.1 Definition

```
tosca.artifacts.Implementation.Bash:  
  derived_from: tosca.artifacts.Implementation  
  description: Script artifact for the Unix Bash shell  
  mime_type: application/x-sh
```

```
file_ext: [ sh ]
```

5.4.4.4 `tosca.artifacts.Implementation.Python`

This artifact type represents a Python file that contains Python language constructs that can be executed within a Python interpreter.

Shorthand Name	Python
Type Qualified Name	tosca:Python
Type URI	tosca.artifacts.Implementation.Python

5.4.4.4.1 Definition

```
tosca.artifacts.Implementation.Python:  
  derived_from: tosca.artifacts.Implementation  
  description: Artifact for the interpreted Python language  
  mime_type: application/x-python  
  file_ext: [ py ]
```

5.4.5 Template Types

5.4.5.1 `tosca.artifacts.template`

This artifact type represents the parent type for all template type artifacts in TOSCA. This class of artifacts typically represent template files that are dependent artifacts for implementation of an interface or deployment of a node.

Like the case of other dependent artifacts, the TOSCA orchestrator copies the dependent artifacts to the same location as the primary artifact for its access during execution. However, the template artifact processor need not be deployed in the environment where the primary artifact executes. At run time, the Orchestrator can invoke the artifact processor (i.e. template engine) to fill in run time values and provide the “filled template” to the primary artifact processor for further processing.

This reduces the requirements on the primary artifact target environment and the processing time of template artifacts.

5.4.5.1.1 Definition

```
tosca.artifacts.template:  
  derived_from: tosca.artifacts.Root  
  description: TOSCA base type for template type artifacts
```

5.5 Capabilities Types

5.5.1 `tosca.capabilities.Root`

This is the default (root) TOSCA Capability Type definition that all other TOSCA Capability Types derive from.

5.5.1.1 Definition

tosca.capabilities.Root:

description: The TOSCA root Capability Type all other TOSCA Capability Types derive from

5.5.2 tosca.capabilities.Node

The Node capability indicates the base capabilities of a TOSCA Node Type.

Shorthand Name	Node
Type Qualified Name	tosca:Node
Type URI	tosca.capabilities.Node

5.5.2.1 Definition

tosca.capabilities.Node:

derived_from: [tosca.capabilities.Root](#)

5.5.3 tosca.capabilities.Compute

The Compute capability, when included on a Node Type or Template definition, indicates that the node can provide hosting on a named compute resource.

Shorthand Name	Compute
Type Qualified Name	tosca:Compute
Type URI	tosca.capabilities.Compute

5.5.3.1 Properties

Name	Required	Type	Constraints	Description
name	no	string	None	The optional name (or identifier) of a specific compute resource for hosting.
num_cpus	no	integer	greater_or_equal: 1	Number of (actual or virtual) CPUs associated with the Compute node.
cpu_frequency	no	scalar-unit.frequency	greater_or_equal: 0.1 GHz	Specifies the operating frequency of CPU's core. This property expresses the expected frequency of one (1) CPU as provided by the property " num_cpus ".
disk_size	no	scalar-unit.size	greater_or_equal: 0 MB	Size of the local disk available to applications running on the Compute node (default unit is MB).
mem_size	no	scalar-unit.size	greater_or_equal: 0 MB	Size of memory available to applications running on the Compute node (default unit is MB).

5.5.3.2 Definition

```
tosca.capabilities.Compute:
  derived_from: toska.capabilities.Container
  properties:
    name:
      type: string
      required: false
    num_cpus:
      type: integer
      required: false
      constraints:
        - greater_or_equal: 1
    cpu_frequency:
      type: scalar-unit.frequency
      required: false
      constraints:
        - greater_or_equal: 0.1 GHz
    disk_size:
      type: scalar-unit.size
      required: false
      constraints:
        - greater_or_equal: 0 MB
    mem_size:
      type: scalar-unit.size
      required: false
      constraints:
        - greater_or_equal: 0 MB
```

5.5.4 toska.capabilities.Network

The Storage capability, when included on a Node Type or Template definition, indicates that the node can provide addressibility for the resource a named network with the specified ports.

Shorthand Name	Network
Type Qualified Name	tosca:Network
Type URI	tosca.capabilities.Network

5.5.4.1 Properties

Name	Required	Type	Constraints	Description
name	no	string	None	The otional name (or identifier) of a specific network resource.

5.5.4.2 Definition

```
tosca.capabilities.Network:  
  derived_from: tosca.capabilities.Root  
  properties:  
    name:  
      type: string  
      required: false
```

5.5.5 tosca.capabilities.Storage

The Storage capability, when included on a Node Type or Template definition, indicates that the node can provide a named storage location with specified size range.

Shorthand Name	Storage
Type Qualified Name	tosca:Storage
Type URI	tosca.capabilities.Storage

5.5.5.1 Properties

Name	Required	Type	Constraints	Description
name	no	string	None	The optional name (or identifier) of a specific storage resource.

5.5.5.2 Definition

```
tosca.capabilities.Storage:  
  derived_from: tosca.capabilities.Root  
  properties:  
    name:  
      type: string  
      required: false
```

5.5.6 tosca.capabilities.Container

The Container capability, when included on a Node Type or Template definition, indicates that the node can act as a container for (or a host for) one or more other declared Node Types.

Shorthand Name	Container
Type Qualified Name	tosca:Container
Type URI	tosca.capabilities.Container

5.5.6.1 Properties

Name	Required	Type	Constraints	Description
N/A	N/A	N/A	N/A	N/A

5.5.6.2 Definition

```
tosca.capabilities.Container:
  derived_from: tosca.capabilities.Root
```

5.5.7 tosca.capabilities.Endpoint

This is the default TOSCA type that should be used or extended to define a network endpoint capability. This includes the information to express a basic endpoint with a single port or a complex endpoint with multiple ports. By default the Endpoint is assumed to represent an address on a private network unless otherwise specified.

Shorthand Name	Endpoint
Type Qualified Name	tosca:Endpoint
Type URI	tosca.capabilities.Endpoint

5.5.7.1 Properties

Name	Required	Type	Constraints	Description
protocol	yes	string	default: tcp	The name of the protocol (i.e., the protocol prefix) that the endpoint accepts (any OSI Layer 4-7 protocols) Examples: http, https, ftp, tcp, udp, etc.
port	no	PortDef	greater_or_equal: 1 less_or_equal: 65535	The optional port of the endpoint.
secure	no	boolean	default: false	Requests for the endpoint to be secure and use credentials supplied on the ConnectsTo relationship.
url_path	no	string	None	The optional URL path of the endpoint's address if applicable for the protocol.
port_name	no	string	None	The optional name (or ID) of the network port this endpoint should be bound to.
network_name	no	string	default: PRIVATE	The optional name (or ID) of the network this endpoint should be bound to. network_name: PRIVATE PUBLIC <network_name> <network_id>
initiator	no	string	one of: <ul style="list-style-type: none"> source target peer default: source	The optional indicator of the direction of the connection.
ports	no	map of PortSpec	None	The optional map of ports the Endpoint supports (if more than one)

5.5.7.2 Attributes

Name	Required	Type	Constraints	Description
ip_address	yes	string	None	Note: This is the IP address as propagated up by the associated node's host (Compute) container.

5.5.7.3 Definition

```
tosca.capabilities.Endpoint:
  derived_from: toska.capabilities.Root
  properties:
    protocol:
      type: string
      required: true
      default: tcp
    port:
      type: PortDef
      required: false
    secure:
      type: boolean
      required: false
      default: false
    url_path:
      type: string
      required: false
    port_name:
      type: string
      required: false
    network_name:
      type: string
      required: false
      default: PRIVATE
    initiator:
      type: string
      required: false
      default: source
      constraints:
        - valid_values: [ source, target, peer ]
    ports:
      type: map
      required: false
      constraints:
        - min_length: 1
```

```

entry_schema:
  type: PortSpec
attributes:
  ip_address:
    type: string

```

5.5.7.4 Additional requirements

- Although both the port and ports properties are not required, one of port or ports must be provided in a valid [Endpoint](#).

5.5.8 [tosca.capabilities.Endpoint.Public](#)

This capability represents a public endpoint which is accessible to the general internet (and its public IP address ranges).

This public endpoint capability also can be used to create a floating (IP) address that the underlying network assigns from a pool allocated from the application's underlying public network. This floating address is managed by the underlying network such that can be routed an application's private address and remains reliable to internet clients.

Shorthand Name	Endpoint.Public
Type Qualified Name	tosca:Endpoint.Public
Type URI	tosca.capabilities.Endpoint.Public

5.5.8.1 Definition

```

tosca.capabilities.Endpoint.Public:
  derived_from: tosca.capabilities.Endpoint
  properties:
    # Change the default network_name to use the first public network found
    network_name:
      type: string
      default: PUBLIC
      constraints:
        - equal: PUBLIC
    floating:
      description: >
        indicates that the public address should be allocated from a pool of
        floating IPs that are associated with the network.
      type: boolean
      default: false
      status: experimental
    dns_name:
      description: The optional name to register with DNS
      type: string

```

```
required: false
status: experimental
```

5.5.8.2 Additional requirements

- If the `network_name` is set to the reserved value **PRIVATE** or if the value is set to the name of network (or subnetwork) that is not public (i.e., has non-public IP address ranges assigned to it) then TOSCA Orchestrators **SHALL** treat this as an error.
- If a `dns_name` is set, TOSCA Orchestrators SHALL attempt to register the name in the (local) DNS registry for the Cloud provider.

5.5.9 `tosca.capabilities.Endpoint.Admin`

This is the default TOSCA type that should be used or extended to define a specialized administrator endpoint capability.

Shorthand Name	Endpoint.Admin
Type Qualified Name	tosca:Endpoint.Admin
Type URI	tosca.capabilities.Endpoint.Admin

5.5.9.1 Properties

Name	Required	Type	Constraints	Description
None	N/A	N/A	N/A	N/A

5.5.9.2 Definition

```
tosca.capabilities.Endpoint.Admin:
  derived_from: tosca.capabilities.Endpoint
  # Change Endpoint secure indicator to true from its default of false
  properties:
    secure:
      type: boolean
      default: true
      constraints:
        - equal: true
```

5.5.9.3 Additional requirements

- TOSCA Orchestrator implementations of Endpoint.Admin (and connections to it) **SHALL** assure that network-level security is enforced if possible.

5.5.10 `tosca.capabilities.Endpoint.Database`

This is the default TOSCA type that should be used or extended to define a specialized database endpoint capability.

Shorthand Name	Endpoint.Database
Type Qualified Name	tosca:Endpoint.Database
Type URI	tosca.capabilities.Endpoint.Database

5.5.10.1 Properties

Name	Required	Type	Constraints	Description
None	N/A	N/A	N/A	N/A

5.5.10.2 Definition

```
tosca.capabilities.Endpoint.Database:
  derived_from: tosca.capabilities.Endpoint
```

5.5.11 tosca.capabilities.Attachment

This is the default TOSCA type that should be used or extended to define an attachment capability of a (logical) infrastructure device node (e.g., [BlockStorage](#) node).

Shorthand Name	Attachment
Type Qualified Name	tosca:Attachment
Type URI	tosca.capabilities.Attachment

5.5.11.1 Properties

Name	Required	Type	Constraints	Description
N/A	N/A	N/A	N/A	N/A

5.5.11.2 Definition

```
tosca.capabilities.Attachment:
  derived_from: tosca.capabilities.Root
```

5.5.12 tosca.capabilities.OperatingSystem

This is the default TOSCA type that should be used to express an Operating System capability for a node.

Shorthand Name	OperatingSystem
Type Qualified Name	tosca:OperatingSystem
Type URI	tosca.capabilities.OperatingSystem

5.5.12.1 Properties

Name	Required	Type	Constraints	Description
architecture	no	string	None	The Operating System (OS) architecture. Examples of valid values include: x86_32, x86_64, etc.
type	no	string	None	The Operating System (OS) type. Examples of valid values include: linux, aix, mac, windows, etc.
distribution	no	string	None	The Operating System (OS) distribution. Examples of valid values for an “type” of “Linux” would include: debian, fedora, rhel and ubuntu.
version	no	version	None	The Operating System version.

5.5.12.2 Definition

```
tosca.capabilities.OperatingSystem:
  derived_from: tosca.capabilities.Root
  properties:
    architecture:
      type: string
      required: false
    type:
      type: string
      required: false
    distribution:
      type: string
      required: false
    version:
      type: version
      required: false
```

5.5.12.3 Additional Requirements

- Please note that the string values for the properties **architecture**, **type** and **distribution** SHALL be normalized to lowercase by processors of the service template for matching purposes. For example, if a “**type**” value is set to either “Linux”, “LINUX” or “linux” in a service template, the processor would normalize all three values to “linux” for matching purposes.

5.5.13 `tosca.capabilities.Scalable`

This is the default TOSCA type that should be used to express a scalability capability for a node.

Shorthand Name	Scalable
Type Qualified Name	tosca:Scalable
Type URI	tosca.capabilities.Scalable

5.5.13.1 Properties

Name	Required	Type	Constraints	Description
min_instances	yes	integer	default: 1	This property is used to indicate the minimum number of instances that should be created for the associated TOSCA Node Template by a TOSCA orchestrator.
max_instances	yes	integer	default: 1	This property is used to indicate the maximum number of instances that should be created for the associated TOSCA Node Template by a TOSCA orchestrator.
default_instances	no	integer	N/A	An optional property that indicates the requested default number of instances that should be the starting number of instances a TOSCA orchestrator should attempt to allocate. Note: The value for this property MUST be in the range between the values set for 'min_instances' and 'max_instances' properties.

5.5.13.2 Definition

```
tosca.capabilities.Scalable:  
  derived_from: tosca.capabilities.Root  
  properties:  
    min_instances:  
      type: integer  
      default: 1  
    max_instances:  
      type: integer  
      default: 1  
    default_instances:  
      type: integer
```

5.5.13.3 Notes

- The actual number of instances for a node may be governed by a separate scaling policy which conceptually would be associated to either a scaling-capable node or a group of nodes in which it is defined to be a part of. This is a planned future feature of the TOSCA Simple Profile and not currently described.

5.5.14 tosca.capabilities.network.Bindable

A node type that includes the Bindable capability indicates that it can be bound to a logical network association via a network port.

Shorthand Name	network.Bindable
Type Qualified Name	tosca:network.Bindable
Type URI	tosca.capabilities.network.Bindable

5.5.14.1 Properties

Name	Required	Type	Constraints	Description
N/A	N/A	N/A	N/A	N/A

5.5.14.2 Definition

```
tosca.capabilities.network.Bindable:  
  derived_from: tosca.capabilities.Node
```

5.6 Requirement Types

There are no normative Requirement Types currently defined in this working draft. Typically, Requirements are described against a known Capability Type

5.7 Relationship Types

5.7.1 tosca.relationships.Root

This is the default (root) TOSCA Relationship Type definition that all other TOSCA Relationship Types derive from.

5.7.1.1 Attributes

Name	Required	Type	Constraints	Description
tosca_id	yes	string	None	A unique identifier of the realized instance of a Relationship Template that derives from any TOSCA normative type.
tosca_name	yes	string	None	This attribute reflects the name of the Relationship Template as defined in the TOSCA service template. This name is not unique to the realized instance model of corresponding deployed application as each template in the model can result in one or more instances (e.g., scaled) when orchestrated to a provider environment.
state	yes	string	default: initial	The state of the relationship instance. See section "Relationship States" for allowed values.

5.7.1.2 Definition

```
tosca.relationships.Root:
```

```

description: The TOSCA root Relationship Type all other TOSCA base Relationship
Types derive from
attributes:
  tosca_id:
    type: string
  tosca_name:
    type: string
interfaces:
  Configure:
    type: tosca.interfaces.relationship.Configure

```

5.7.2 [tosca.relationships.DependsOn](#)

This type represents a general dependency relationship between two nodes.

Shorthand Name	DependsOn
Type Qualified Name	tosca:DependsOn
Type URI	tosca.relationships.DependsOn

5.7.2.1 Definition

```

tosca.relationships.DependsOn:
  derived_from: tosca.relationships.Root
  valid_target_types: [ tosca.capabilities.Node ]

```

5.7.3 [tosca.relationships.HostedOn](#)

This type represents a hosting relationship between two nodes.

Shorthand Name	HostedOn
Type Qualified Name	tosca:HostedOn
Type URI	tosca.relationships.HostedOn

5.7.3.1 Definition

```

tosca.relationships.HostedOn:
  derived_from: tosca.relationships.Root
  valid_target_types: [ tosca.capabilities.Container ]

```

5.7.4 [tosca.relationships.ConnectsTo](#)

This type represents a network connection relationship between two nodes.

Shorthand Name	ConnectsTo
Type Qualified Name	tosca:ConnectsTo
Type URI	tosca.relationships.ConnectsTo

5.7.4.1 Definition

```
tosca.relationships.ConnectsTo:  
  derived_from: tosca.relationships.Root  
  valid_target_types: [ tosca.capabilities.Endpoint ]  
  properties:  
    credential:  
      type: tosca.datatypes.Credential  
      required: false
```

5.7.4.2 Properties

Name	Required	Type	Constraints	Description
credential	no	Credential	None	The security credential to use to present to the target endpoint to for either authentication or authorization purposes.

5.7.5 [tosca.relationships.AttachesTo](#)

This type represents an attachment relationship between two nodes. For example, an AttachesTo relationship type would be used for attaching a storage node to a Compute node.

Shorthand Name	AttachesTo
Type Qualified Name	tosca:AttachesTo
Type URI	tosca.relationships.AttachesTo

5.7.5.1 Properties

Name	Required	Type	Constraints	Description
location	yes	string	min_length: 1	The relative location (e.g., path on the file system), which provides the root location to address an attached node. e.g., a mount point / path such as '/usr/data' Note: The user must provide it and it cannot be "root".
device	no	string	None	The logical device name which for the attached device (which is represented by the target node in the model). e.g., '/dev/hda1'

5.7.5.2 Attributes

Name	Required	Type	Constraints	Description
device	no	string	None	The logical name of the device as exposed to the instance. Note: A runtime property that gets set when the model gets instantiated by the orchestrator.

5.7.5.3 Definition

```
tosca.relationships.AttachesTo:  
  derived_from: tosca.relationships.Root  
  valid_target_types: [ tosca.capabilities.Attachment ]  
  properties:  
    location:  
      type: string  
      constraints:  
        - min_length: 1  
    device:  
      type: string  
      required: false
```

5.7.6 tosca.relationships.RoutesTo

This type represents an intentional network routing between two Endpoints in different networks.

Shorthand Name	RoutesTo
Type Qualified Name	tosca:RoutesTo
Type URI	tosca.relationships.RoutesTo

5.7.6.1 Definition

```
tosca.relationships.RoutesTo:  
  derived_from: tosca.relationships.ConnectsTo  
  valid_target_types: [ tosca.capabilities.Endpoint ]
```

5.8 Interface Types

Interfaces are reusable entities that define a set of operations that that can be included as part of a Node type or Relationship Type definition. Each named operations may have code or scripts associated with them that orchestrators can execute for when transitioning an application to a given state.

5.8.1 Additional Requirements

- Designers of Node or Relationship types are not required to actually provide/associate code or scripts with every operation for a given interface it supports. In these cases, orchestrators SHALL consider that a “No Operation” or “no-op”.

- The default behavior when providing scripts for an operation in a sub-type (sub-class) or a template of an existing type which already has a script provided for that operation SHALL be override. Meaning that the subclasses' script is used in place of the parent type's script.

5.8.2 Best Practices

- When TOSCA Orchestrators substitute an implementation for an abstract node in a deployed service template it SHOULD be able to present a confirmation to the submitter to confirm the implementation chosen would be acceptable.

5.8.3 `tosca.interfaces.Root`

This is the default (root) TOSCA Interface Type definition that all other TOSCA Interface Types derive from.

5.8.3.1 Definition

```
tosca.interfaces.Root:
  derived_from: toska.entity.Root
  description: The TOSCA root Interface Type all other TOSCA Interface Types
  derive from
```

5.8.4 `tosca.interfaces.node.lifecycle.Standard`

This lifecycle interface defines the essential, normative operations that TOSCA nodes may support.

Shorthand Name	Standard
Type Qualified Name	tosca:Standard
Type URI	tosca.interfaces.node.lifecycle.Standard

5.8.4.1 Definition

```
tosca.interfaces.node.lifecycle.Standard:
  derived_from: tosca.interfaces.Root
  create:
    description: Standard lifecycle create operation.
  configure:
    description: Standard lifecycle configure operation.
  start:
    description: Standard lifecycle start operation.
  stop:
    description: Standard lifecycle stop operation.
  delete:
    description: Standard lifecycle delete operation.
```

5.8.4.2 Create operation

The create operation is generally used to create the resource or service the node represents in the topology. TOSCA orchestrators expect node templates to provide either a deployment artifact or an implementation artifact of a defined artifact type that it is able to process. This specification defines normative deployment and implementation artifact types all TOSCA Orchestrators are expected to be able to process to support application portability.

5.8.4.3 TOSCA Orchestrator processing of Deployment artifacts

TOSCA Orchestrators, when encountering a deployment artifact on the create operation; will automatically attempt to deploy the artifact based upon its artifact type. This means that no implementation artifacts (e.g., scripts) are needed on the create operation to provide commands that deploy or install the software.

For example, if a TOSCA Orchestrator is processing an application with a node of type `SoftwareComponent` and finds that the node's template has a create operation that provides a filename (or references to an artifact which describes a file) of a known TOSCA deployment artifact type such as an Open Virtualization Format (OVF) image it will automatically deploy that image into the `SoftwareComponent`'s host `Compute` node.

5.8.4.4 Operation sequencing and node state

The following diagrams show how TOSCA orchestrators sequence the operations of the Standard lifecycle in normal node startup and shutdown procedures.

The following key should be used to interpret the diagrams:

Operation Invocation	●-----<operation>()----->
Node State	○<state>
Transition State	○<state>

5.8.4.4.1 Normal node startup sequence diagram

The following diagram shows how the TOSCA orchestrator would invoke operations on the Standard lifecycle to startup a node.

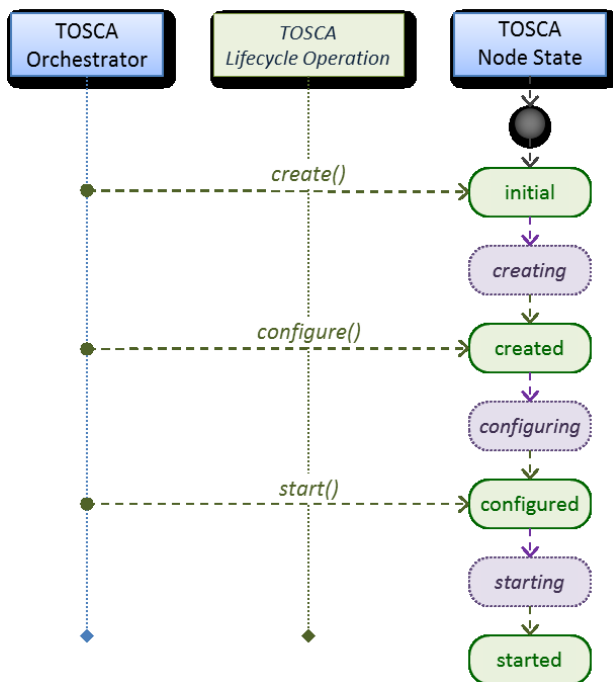

5.8.4.4.2 Normal node shutdown sequence diagram

The following diagram shows how the TOSCA orchestrator would invoke operations on the Standard lifecycle to shut down a node.

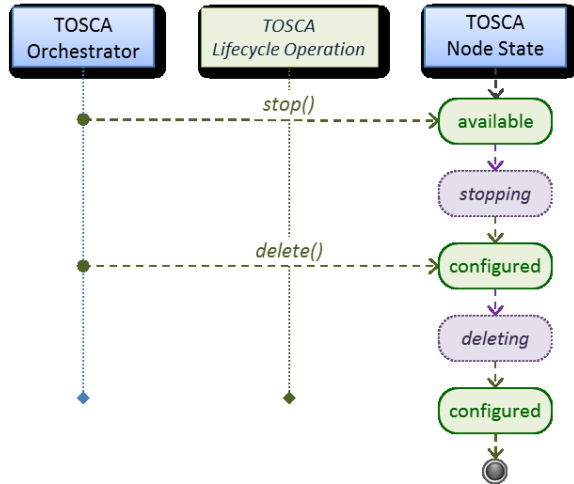

5.8.5 `tosca.interfaces.relationship.Configure`

The lifecycle interfaces define the essential, normative operations that each TOSCA Relationship Types may support.

Shorthand Name	Configure
Type Qualified Name	tosca:Configure
Type URI	tosca.interfaces.relationship.Configure

5.8.5.1 Definition

```

tosca.interfaces.relationship.Configure:
  derived_from: tosca.interfaces.Root
  pre_configure_source:
    description: Operation to pre-configure the source endpoint.
  pre_configure_target:
    description: Operation to pre-configure the target endpoint.
  post_configure_source:
    description: Operation to post-configure the source endpoint.
  post_configure_target:
    description: Operation to post-configure the target endpoint.
  add_target:
    description: Operation to notify the source node of a target node being added
    via a relationship.
  add_source:
    description: Operation to notify the target node of a source node which is
    now available via a relationship.
  target_changed:
    description: Operation to notify source some property or attribute of the
    target changed
  remove_target:
  
```

description: Operation to remove a target node.

5.8.5.2 Invocation Conventions

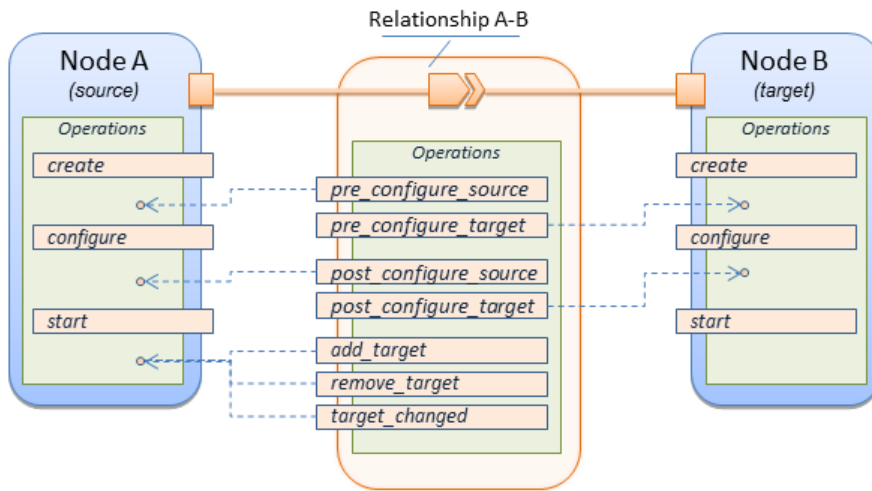

TOSCA relationships are directional connecting a source node to a target node. When TOSCA Orchestrator connects a source and target node together using a relationship that supports the Configure interface it will “interleave” the operations invocations of the Configure interface with those of the node’s own Standard lifecycle interface. This concept is illustrated below:

5.8.5.3 Normal node start sequence with Configure relationship operations

The following diagram shows how the TOSCA orchestrator would invoke Configure lifecycle operations in conjunction with Standard lifecycle operations during a typical startup sequence on a node.

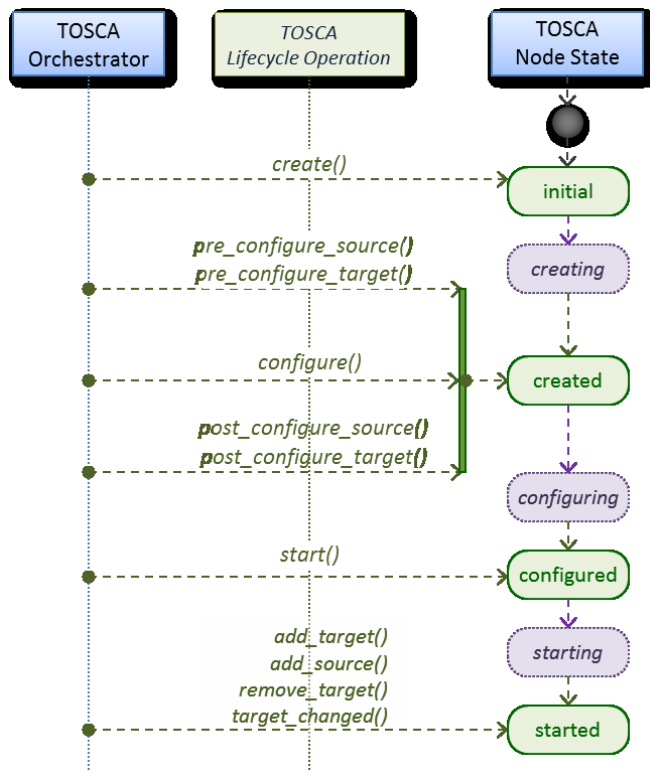

5.8.5.4 Node-Relationship configuration sequence

Depending on which side (i.e., source or target) of a relationship a node is on, the orchestrator will:

- Invoke either the **pre_configure_source** or **pre_configure_target** operation as supplied by the relationship on the node.
- Invoke the node's **configure** operation.
- Invoke either the **post_configure_source** or **post_configure_target** as supplied by the relationship on the node.

Note that the **pre_configure_xxx** and **post_configure_xxx** are invoked only once per node instance.

5.8.5.4.1 Node-Relationship add, remove and changed sequence

Since a topology template contains nodes that can dynamically be added (and scaled), removed or changed as part of an application instance, the Configure lifecycle includes operations that are invoked on node instances that to notify and address these dynamic changes.

For example, a source node, of a relationship that uses the Configure lifecycle, will have the relationship operations **add_target**, or **remove_target** invoked on it whenever a target node instance is added or removed to the running application instance. In addition, whenever the node state of its target node changes, the **target_changed** operation is invoked on it to address this change. Conversely, the **add_source** and **remove_source** operations are invoked on the source node of the relationship.

5.8.5.5 Notes

- The target (provider) **MUST** be active and running (i.e., all its dependency stack **MUST** be fulfilled) prior to invoking **add_target**
 - In other words, all Requirements **MUST** be satisfied before it advertises its capabilities (i.e., the attributes of the matched Capabilities are available).
 - In other words, it cannot be “consumed” by any dependent node.
 - Conversely, since the source (consumer) needs information (attributes) about any targets (and their attributes) being removed before it actually goes away.
- The **remove_target** operation should only be executed if the target has had **add_target** executed. **BUT** in truth we're first informed about a target in **pre_configure_source**, so if we execute that the source node should see **remove_target** called to cleanup.
- **Error handling:** If any node operation of the topology fails processing should stop on that node template and the failing operation (script) should return an error (failure) code when possible.

5.9 Node Types

5.9.1 `tosca.nodes.Root`

The TOSCA **Root** Node Type is the default type that all other TOSCA base Node Types derive from. This allows for all TOSCA nodes to have a consistent set of features for modeling and management (e.g., consistent definitions for requirements, capabilities and lifecycle interfaces).

Shorthand Name	Root
Type Qualified Name	tosca:Root
Type URI	tosca.nodes.Root

5.9.1.1 Properties

Name	Required	Type	Constraints	Description
N/A	N/A	N/A	N/A	The TOSCA Root Node type has no specified properties.

5.9.1.2 Attributes

Name	Required	Type	Constraints	Description
tosca_id	yes	string	None	A unique identifier of the realized instance of a Node Template that derives from any TOSCA normative type.
tosca_name	yes	string	None	This attribute reflects the name of the Node Template as defined in the TOSCA service template. This name is not unique to the realized instance model of corresponding deployed application as each template in the model can result in one or more instances (e.g., scaled) when orchestrated to a provider environment.
state	yes	string	default: initial	The state of the node instance. See section “ Node States ” for allowed values.

5.9.1.3 Definition

```

tosca.nodes.Root:
  derived_from: toasca.entity.Root
  description: The TOSCA Node Type all other TOSCA base Node Types derive from
  attributes:
    toasca_id:
      type: string
    toasca_name:
      type: string
    state:
      type: string
  capabilities:
    feature:
      type: tosca.capabilities.Node
  requirements:
    - dependency:
      capability: tosca.capabilities.Node
      node: tosca.nodes.Root
      relationship: tosca.relationships.DependsOn
      occurrences: [ 0, UNBOUNDED ]

```

```
interfaces:
  Standard:
    type: tosca.interfaces.node.lifecycle.Standard
```

5.9.1.4 Additional Requirements

- All Node Type definitions that wish to adhere to the TOSCA Simple Profile **SHOULD** extend from the TOSCA Root Node Type to be assured of compatibility and portability across implementations.

5.9.2 [tosca.nodes.Abstract.Compute](#)

The TOSCA **Abstract.Compute** node represents an abstract compute resource without any requirements on storage or network resources.

Shorthand Name	Abstract.Compute
Type Qualified Name	tosca:Abstract.Compute
Type URI	tosca.nodes.Abstract.Compute

5.9.2.1 Properties

Name	Required	Type	Constraints	Description
N/A	N/A	N/A	N/A	N/A

5.9.2.2 Attributes

Name	Required	Type	Constraints	Description
N/A	N/A	N/A	N/A	N/A

5.9.2.3 Definition

```
tosca.nodes.Abstract.Compute:
  derived_from: tosca.nodes.Root
  capabilities:
    host:
      type: tosca.capabilities.Compute
  valid_source_types: []
```

5.9.3 [tosca.nodes.Compute](#)

The TOSCA **Compute** node represents one or more real or virtual processors of software applications or services along with other essential local resources. Collectively, the resources the compute node represents can logically be viewed as a (real or virtual) “server”.

Shorthand Name	Compute
Type Qualified Name	tosca:Compute
Type URI	tosca.nodes.Compute

5.9.3.1 Properties

Name	Required	Type	Constraints	Description
N/A	N/A	N/A	N/A	N/A

5.9.3.2 Attributes

Name	Required	Type	Constraints	Description
private_address	no	string	None	The primary private IP address assigned by the cloud provider that applications may use to access the Compute node.
public_address	no	string	None	The primary public IP address assigned by the cloud provider that applications may use to access the Compute node.
networks	no	map of NetworkInfo	None	The map of logical networks assigned to the compute host instance and information about them.
ports	no	map of PortInfo	None	The map of logical ports assigned to the compute host instance and information about them.

5.9.3.3 Definition

```

tosca.nodes.Compute:
  derived_from: tosca.nodes.Abstract.Compute
  attributes:
    private_address:
      type: string
    public_address:
      type: string
    networks:
      type: map
      entry_schema:
        type: tosca.datatypes.network.NetworkInfo
    ports:
      type: map
      entry_schema:
        type: tosca.datatypes.network.PortInfo
  requirements:
    - local_storage:
        capability: tosca.capabilities.Attachment

```



```

node: tosca.nodes.Storage.BlockStorage
relationship: tosca.relationships.AttachesTo
occurrences: [0, UNBOUNDED]
capabilities:
  host:
    type: tosca.capabilities.Compute
    valid_source_types: [tosca.nodes.SoftwareComponent]
  endpoint:
    type: tosca.capabilities.Endpoint.Admin
  os:
    type: tosca.capabilities.OperatingSystem
  scalable:
    type: tosca.capabilities.Scalable
  binding:
    type: tosca.capabilities.network.Bindable

```

5.9.3.4 Additional Requirements

- The underlying implementation of the Compute node SHOULD have the ability to instantiate guest operating systems (either actual or virtualized) based upon the OperatingSystem capability properties if they are supplied in the a node template derived from the Compute node type.

5.9.4 [tosca.nodes.SoftwareComponent](#)

The TOSCA **SoftwareComponent** node represents a generic software component that can be managed and run by a TOSCA **Compute** Node Type.

Shorthand Name	SoftwareComponent
Type Qualified Name	tosca:SoftwareComponent
Type URI	tosca.nodes.SoftwareComponent

5.9.4.1 Properties

Name	Required	Type	Constraints	Description
component_version	no	version	None	The optional software component's version.
admin_credential	no	Credential	None	The optional credential that can be used to authenticate to the software component.

5.9.4.2 Attributes

Name	Required	Type	Constraints	Description
N/A	N/A	N/A	N/A	N/A

5.9.4.3 Definition

```
tosca.nodes.SoftwareComponent:
  derived_from: tosca.nodes.Root
  properties:
    # domain-specific software component version
    component_version:
      type: version
      required: false
    admin_credential:
      type: tosca.datatypes.Credential
      required: false
  requirements:
    - host:
      capability: tosca.capabilities.Compute
      node: tosca.nodes.Compute
      relationship: tosca.relationships.HostedOn
```

5.9.4.4 Additional Requirements

- Nodes that can directly be managed and run by a TOSCA **Compute** Node Type **SHOULD** extend from this type.

5.9.5 tosca.nodes.WebServer

This TOSA **WebServer** Node Type represents an abstract software component or service that is capable of hosting and providing management operations for one or more **WebApplication** nodes.

Shorthand Name	WebServer
Type Qualified Name	tosca:WebServer
Type URI	tosca.nodes.WebServer

5.9.5.1 Properties

Name	Required	Type	Constraints	Description
None	N/A	N/A	N/A	N/A

5.9.5.2 Definition

```
tosca.nodes.WebServer:
  derived_from: tosca.nodes.SoftwareComponent
  capabilities:
    # Private, layer 4 endpoints
    data_endpoint: tosca.capabilities.Endpoint
    admin_endpoint: tosca.capabilities.Endpoint.Admin
  host:
    type: tosca.capabilities.Compute
    valid_source_types: [ tosca.nodes.WebApplication ]
```

5.9.5.3 Additional Requirements

- This node **SHALL** export both a secure endpoint capability (i.e., **admin_endpoint**), typically for administration, as well as a regular endpoint (i.e., **data_endpoint**) for serving data.

5.9.6 [tosca.nodes.WebApplication](#)

The TOSCA **WebApplication** node represents a software application that can be managed and run by a TOSCA **WebServer** node. Specific types of web applications such as Java, etc. could be derived from this type.

Shorthand Name	WebApplication
Type Qualified Name	tosca: WebApplication
Type URI	tosca.nodes.WebApplication

5.9.6.1 Properties

Name	Required	Type	Constraints	Description
context_root	no	string	None	The web application's context root which designates the application's URL path within the web server it is hosted on.

5.9.6.2 Definition

```
tosca.nodes.WebApplication:
  derived_from: tosca.nodes.Root
  properties:
    context_root:
      type: string
  capabilities:
    app_endpoint:
      type: tosca.capabilities.Endpoint
  requirements:
```

```
- host:
  capability: tosca.capabilities.Compute
  node: tosca.nodes.WebServer
  relationship: tosca.relationships.HostedOn
```

5.9.7 tosca.nodes.DBMS

The TOSCA **DBMS** node represents a typical relational, SQL Database Management System software component or service.

5.9.7.1 Properties

Name	Required	Type	Constraints	Description
root_password	no	string	None	The optional root password for the DBMS server.
port	no	integer	None	The DBMS server's port.

5.9.7.2 Definition

```
tosca.nodes.DBMS:
  derived_from: tosca.nodes.SoftwareComponent
  properties:
    root_password:
      type: string
      required: false
      description: the optional root password for the DBMS service
    port:
      type: integer
      required: false
      description: the port the DBMS service will listen to for data and requests
  capabilities:
    host:
      type: tosca.capabilities.Compute
      valid_source_types: [ tosca.nodes.Database ]
```

5.9.8 tosca.nodes.Database

The TOSCA **Database** node represents a logical database that can be managed and hosted by a TOSCA **DBMS** node.

Shorthand Name	Database
Type Qualified Name	tosca:Database
Type URI	tosca.nodes.Database

5.9.8.1 Properties

Name	Required	Type	Constraints	Description
name	yes	string	None	The logical database Name
port	no	integer	None	The port the database service will use to listen for incoming data and requests.
user	no	string	None	The special user account used for database administration.
password	no	string	None	The password associated with the user account provided in the 'user' property.

5.9.8.2 Definition

```

tosca.nodes.Database:
  derived_from: tosca.nodes.Root
  properties:
    name:
      type: string
      description: the logical name of the database
    port:
      type: integer
      description: the port the underlying database service will listen to for
data
    user:
      type: string
      description: the optional user account name for DB administration
      required: false
    password:
      type: string
      description: the optional password for the DB user account
      required: false
  requirements:
    - host:
      capability: tosca.capabilities.Compute
      node: tosca.nodes.DBMS
      relationship: tosca.relationships.HostedOn
  capabilities:
    database_endpoint:
      type: tosca.capabilities.Endpoint.Database

```

5.9.9 tosca.nodes.Abstract.Storage

The TOSCA **Abstract.Storage** node represents an abstract storage resource without any requirements on compute or network resources.

Shorthand Name	AbstractStorage
Type Qualified Name	tosca:Abstract.Storage
Type URI	tosca.nodes.Abstract.Storage

5.9.9.1 Properties

Name	Required	Type	Constraints	Description
name	yes	string	None	The logical name (or ID) of the storage resource.
size	no	scalar-unit.size	greater_or_equal 1: 0 MB	The requested initial storage size (default unit is in Gigabytes).

5.9.9.2 Definition

```
tosca.nodes.Abstract.Storage:
  derived_from: tosca.nodes.Root
  properties:
    name:
      type: string
    size:
      type: scalar-unit.size
      default: 0 MB
      constraints:
        - greater_or_equal: 0 MB
  capabilities:
    # TBD
```

5.9.10 tosca.nodes.Storage.ObjectStorage

The TOSCA **ObjectStorage** node represents storage that provides the ability to store data as objects (or BLOBs of data) without consideration for the underlying filesystem or devices.

Shorthand Name	ObjectStorage
Type Qualified Name	tosca:ObjectStorage
Type URI	tosca.nodes.Storage.ObjectStorage

5.9.10.1 Properties

Name	Required	Type	Constraints	Description
maxsize	no	scalar-unit.size	greater_or_equal: 1: 1 GB	The requested maximum storage size (default unit is in Gigabytes).

5.9.10.2 Definition

```
tosca.nodes.Storage.ObjectStorage:
  derived_from: tosca.nodes.Abstract.Storage
  properties:
    maxsize:
      type: scalar-unit.size
      constraints:
        - greater_or_equal: 0 GB
  capabilities:
    storage_endpoint:
      type: tosca.capabilities.Endpoint
```

5.9.10.3 Notes:

- Subclasses of the `tosca.nodes.Storage.ObjectStorage` node type may impose further constraints on properties. For example, a subclass may constrain the (minimum or maximum) length of the 'name' property or include a regular expression to constrain allowed characters used in the 'name' property.

5.9.11 `tosca.nodes.Storage.BlockStorage`

The TOSCA **BlockStorage** node currently represents a server-local block storage device (i.e., not shared) offering evenly sized blocks of data from which raw storage volumes can be created.

Note: In this draft of the TOSCA Simple Profile, distributed or Network Attached Storage (NAS) are not yet considered (nor are clustered file systems), but the TC plans to do so in future drafts.

Shorthand Name	BlockStorage
Type Qualified Name	tosca:BlockStorage
Type URI	tosca.nodes.Storage.BlockStorage

5.9.11.1 Properties

Name	Required	Type	Constraints	Description
size	yes *	scalar-unit.size	greater_or_equal: 1 MB	The requested storage size (default unit is MB). * Note: <ul style="list-style-type: none">Required when an existing volume (i.e., <code>volume_id</code>) is not available.If volume_id is provided, size is ignored. Resize of existing volumes is not considered at this time.
volume_id	no	string	None	ID of an existing volume (that is in the accessible scope of the requesting application).
snapshot_id	no	string	None	Some identifier that represents an existing snapshot that should be used when creating the block storage (volume).

5.9.11.2 Attributes

Name	Required	Type	Constraints	Description
N/A	N/A	N/A	N/A	N/A

5.9.11.3 Definition

```
tosca.nodes.Storage.BlockStorage:
  derived_from: tosca.nodes.Abstract.Storage
  properties:
    volume_id:
      type: string
      required: false
    snapshot_id:
      type: string
      required: false
  capabilities:
    attachment:
      type: tosca.capabilities.Attachment
```

5.9.11.4 Additional Requirements

- The **size** property is required when an existing volume (i.e., **volume_id**) is not available. However, if the property **volume_id** is provided, the **size** property is ignored.

5.9.11.5 Notes

- Resize of existing volumes is not considered at this time.
- It is assumed that the volume contains a single filesystem that the operating system (that is hosting an associate application) can recognize and mount without additional information (i.e., it is operating system independent).
- Currently, this version of the Simple Profile does not consider regions (or availability zones) when modeling storage.

5.9.12 [tosca.nodes.Container.Runtime](#)

The TOSCA **Container** Runtime node represents operating system-level virtualization technology used to run multiple application services on a single Compute host.

Shorthand Name	Container.Runtime
Type Qualified Name	tosca:Container.Runtime
Type URI	tosca.nodes.Container.Runtime

5.9.12.1 Definition

```
tosca.nodes.Container.Runtime:
  derived_from: tosca.nodes.SoftwareComponent
  capabilities:
    host:
      type: tosca.capabilities.Compute
      valid_source_types: [tosca.nodes.Container.Application]
```

```
scalable:
  type: tosca.capabilities.Scalable
```

5.9.13 [tosca.nodes.Container.Application](#)

The TOSCA **Container** Application node represents an application that requires **Container**-level virtualization technology.

Shorthand Name	Container.Application
Type Qualified Name	tosca:Container.Application
Type URI	tosca.nodes.Container.Application

5.9.13.1 Definition

```
tosca.nodes.Container.Application:
  derived_from: tosca.nodes.Root
  requirements:
    - host:
      capability: tosca.capabilities.Compute
      node: tosca.nodes.Container.Runtime
      relationship: tosca.relationships.HostedOn
    - storage:
      capability: tosca.capabilities.Storage
    - network:
      capability: tosca.capabilities.Endpoint
```

5.9.14 [tosca.nodes.LoadBalancer](#)

The TOSCA **Load Balancer** node represents logical function that be used in conjunction with a Floating Address to distribute an application's traffic (load) across a number of instances of the application (e.g., for a clustered or scaled application).

Shorthand Name	LoadBalancer
Type Qualified Name	tosca:LoadBalancer
Type URI	tosca.nodes.LoadBalancer

5.9.14.1 Definition

```
tosca.nodes.LoadBalancer:
  derived_from: tosca.nodes.Root
  properties:
    algorithm:
      type: string
      required: false
```

```

    status: experimental
  capabilities:
    client:
      type: tosca.capabilities.Endpoint.Public
      occurrences: [0, UNBOUNDED]
      description: the Floating (IP) client's on the public network can connect
to
    requirements:
      - application:
          capability: tosca.capabilities.Endpoint
          relationship: tosca.relationships.RoutesTo
          occurrences: [0, UNBOUNDED]
          description: Connection to one or more load balanced applications

```

5.9.14.2 Notes:

- A **LoadBalancer** node can still be instantiated and managed independently of any applications it would serve; therefore, the load balancer's **application** requirement allows for zero occurrences.

5.10 Group Types

TOSCA Group Types represent logical groupings of TOSCA nodes that have an implied membership relationship and may need to be orchestrated or managed together to achieve some result. Some use cases being developed by the TOSCA TC use groups to apply TOSCA policies for software placement and scaling while other use cases show groups can be used to describe cluster relationships.

Note: Additional normative TOSCA Group Types and use cases for them will be developed in future drafts of this specification.

5.10.1 [tosca.groups.Root](#)

This is the default (root) TOSCA [Group Type](#) definition that all other TOSCA base Group Types derive from.

5.10.1.1 Definition

```

tosca.groups.Root:
  description: The TOSCA Group Type all other TOSCA Group Types derive from
  interfaces:
    Standard:
      type: tosca.interfaces.node.lifecycle.Standard

```

5.10.1.2 Notes:

- Group operations are not necessarily tied directly to member nodes that are part of a group.
- Future versions of this specification will create sub types of the **tosca.groups.Root** type that will describe how Group Type operations are to be orchestrated.

5.11 Policy Types

TOSCA Policy Types represent logical grouping of TOSCA nodes that have an implied relationship and need to be orchestrated or managed together to achieve some result. Some use cases being developed by the TOSCA TC use groups to apply TOSCA policies for software placement and scaling while other use cases show groups can be used to describe cluster relationships.

5.11.1 `tosca.policies.Root`

This is the default (root) TOSCA Policy Type definition that all other TOSCA base Policy Types derive from.

5.11.1.1 Definition

```
tosca.policies.Root:  
  description: The TOSCA Policy Type all other TOSCA Policy Types derive from
```

5.11.2 `tosca.policies.Placement`

This is the default (root) TOSCA Policy Type definition that is used to govern placement of TOSCA nodes or groups of nodes.

5.11.2.1 Definition

```
tosca.policies.Placement:  
  derived_from: tosca.policies.Root  
  description: The TOSCA Policy Type definition that is used to govern placement  
of TOSCA nodes or groups of nodes.
```

5.11.3 `tosca.policies.Scaling`

This is the default (root) TOSCA Policy Type definition that is used to govern scaling of TOSCA nodes or groups of nodes.

5.11.3.1 Definition

```
tosca.policies.Scaling:  
  derived_from: tosca.policies.Root  
  description: The TOSCA Policy Type definition that is used to govern scaling of  
TOSCA nodes or groups of nodes.
```

5.11.4 `tosca.policies.Update`

This is the default (root) TOSCA Policy Type definition that is used to govern update of TOSCA nodes or groups of nodes.

5.11.4.1 Definition

```
tosca.policies.Update:  
  derived_from: tosca.policies.Root
```

description: The TOSCA Policy Type definition that is used to govern update of TOSCA nodes or groups of nodes.

5.11.5 `tosca.policies.Performance`

This is the default (root) TOSCA Policy Type definition that is used to declare performance requirements for TOSCA nodes or groups of nodes.

5.11.5.1 Definition

`tosca.policies.Performance`:

derived_from: [tosca.policies.Root](#)

description: The TOSCA Policy Type definition that is used to declare performance requirements for TOSCA nodes or groups of nodes.

6 TOSCA Cloud Service Archive (CSAR) format

Except for the examples, this section is **normative** and defines changes to the TOSCA archive format relative to the TOSCA v1.0 XML specification.

TOSCA Simple Profile definitions along with all accompanying artifacts (e.g. scripts, binaries, configuration files) can be packaged together in a CSAR file as already defined in the TOSCA version 1.0 specification [**TOSCA-1.0**]. In contrast to the TOSCA 1.0 CSAR file specification (see chapter 16 in [**TOSCA-1.0**]), this simple profile makes a few simplifications both in terms of overall CSAR file structure as well as meta-file content as described below.

6.1 Overall Structure of a CSAR

A CSAR zip file is required to contain one of the following:

- a **TOSCA-Metadata** directory, which in turn contains the **TOSCA.meta** metadata file that provides entry information for a TOSCA orchestrator processing the CSAR file.
- a yaml (.yaml or .yml) file at the root of the archive. The yaml file being a valid tosca definition template that **MUST** define a metadata section where `template_name` and `template_version` are required.

The CSAR file may contain other directories with arbitrary names and contents. Note that in contrast to the TOSCA 1.0 specification, it is not required to put TOSCA definitions files into a special “Definitions” directory, but definitions YAML files can be placed into any directory within the CSAR file.

6.2 TOSCA Meta File

The **TOSCA.meta** file structure follows the exact same syntax as defined in the TOSCA 1.0 specification. However, it is only required to include `block_0` (see section 16.2 in [**TOSCA-1.0**]) with the **Entry-Definitions** keyword pointing to a valid TOSCA definitions YAML file that a TOSCA orchestrator should use as entry for parsing the contents of the overall CSAR file.

Note that it is not required to explicitly list TOSCA definitions files in subsequent blocks of the **TOSCA.meta** file, but any TOSCA definitions files besides the one denoted by the **Entry-Definitions** keyword can be found by a TOSCA orchestrator by processing respective **imports** statements in the entry definitions file (or in recursively imported files).

Note also that any additional artifact files (e.g. scripts, binaries, configuration files) do not have to be declared explicitly through blocks in the **TOSCA.meta** file. Instead, such artifacts will be fully described and pointed to by relative path names through artifact definitions in one of the TOSCA definitions files contained in the CSAR.

Due to the simplified structure of the CSAR file and **TOSCA.meta** file compared to TOSCA 1.0, the **CSAR-Version** keyword listed in `block_0` of the meta-file is required to denote version **1.1**.

The **Other-Definitions** key in `block_0` is used to declare an unambiguous set of files containing substitution templates that can be used to implement nodes defined in the main template (i.e. the file declared in **Entry-Definitions**). Thus, all the topology templates defined in files listed under the **Other-Definitions** key are to be used only as substitution templates, and not as standalone services. If such a topology template cannot act as a substitution template, it will be ignored by the orchestrator.

The value of the **Other-Definitions** key is a list of filenames relative to the root of the CSAR archive delimited by a blank space. If the filenames contain spaces, the filename should be enclosed by double quotation marks (“”). Note that according to the TOSCA.meta structure definition, a value can extend in a new line as long as the new line starts with a blank space.

Due to the changes to the TOSCA.meta file compared to TOSCA 1.2 the **TOSCA-Meta-File-Version** keyword listed in *block_0* of the the meta-file is required to denote version 1.1.

6.2.1 Custom keynames in the TOSCA.meta file

Besides using the normative keynames in *block_0* (i.e. TOSCA-Meta-File-Version, CSAR-Version, Created-By, Entry-Definitions, Other-Definitions) users can populate further blocks in the **TOSCA.meta** file with custom key-value pairs that follow the entry syntax of the **TOSCA.meta** file, but which are outside the scope of the TOSCA specifications.

Nevertheless, future versions of the TOSCA specification may add definitions of new keynames to be used in the **TOSCA.meta** file. In case of a keyname collision (with a custom keyname) the TOSCA specification definitions take precedence.

To minimize such keyname collisions the specification reserves the use of keynames starting with "TOSCA" and "tosca" (the strings within, but not including, the double quotation marks). It is recommended as a good practice to use a specific prefix (e.g. identifying the organization, scope, etc.) when using custom keynames.

6.2.2 Example

The following listing represents a valid **TOSCA.meta** file according to this TOSCA Simple Profile specification.

```
TOSCA-Meta-File-Version: 1.1
CSAR-Version: 1.1
Created-By: OASIS TOSCA TC
Entry-Definitions: definitions/tosca_elk.yaml
Other-Definitions: definitions/tosca_moose.yaml definitions/tosca_deer.yaml
```

This **TOSCA.meta** file indicates its simplified TOSCA Simple Profile structure by means of the **CSAR-Version** keyword with value **1.1**. The **Entry-Definitions** keyword points to a TOSCA definitions YAML file with the name **tosca_elk.yaml** which is contained in a directory called **definitions** within the root of the CSAR file. Additionally, it specifies that substitution templates can be found in the files **tosca_moose.yaml** and **tosca_deer.yaml** also found in the directory called **definitions** in the root of the CSAR file.

6.3 Archive without TOSCA-Metadata

In case the archive doesn't contains a TOSCA-Metadata directory the archive is required to contains a single YAML file at the root of the archive (other templates may exists in sub-directories).

This file must be a valid TOSCA definitions YAML file with the additional restriction that the metadata section (as defined in 3.9.3.2) is required and `template_name` and `template_version` metadata are also required.

TOSCA processors should recognized this file as being the CSAR Entry-Definitions file. The CSAR-Version is defined by the `template_version` metadata section. The Created-By value is defined by the `template_author` metadata.

Note that in an archive without TOSCA-metadata it is not possible to unambiguously include definitions for substitution templates as we can have only one topology template defined in a yaml file.

6.3.1 Example

The following represents a valid TOSCA template file acting as the CSAR Entry-Definitions file in an archive without TOSCA-Metadata directory.

```
tosca_definitions_version: tosca_simple_yaml_1_3

metadata:
  template_name: my_template
  template_author: OASIS TOSCA TC
  template_version: 1.0
```

7 TOSCA workflows

TOSCA defines two different kinds of workflows that can be used to deploy (instantiate and start), manage at runtime or undeploy (stop and delete) a TOSCA topology: declarative workflows and imperative workflows. Declarative workflows are automatically generated by the TOSCA orchestrator based on the nodes, relationships, and groups defined in the topology. Imperative workflows are manually specified by the author of the topology and allows the specification of any use-case that has not been planned in the definition of node and relationships types or for advanced use-case (including reuse of existing scripts and workflows).

Workflows can be triggered on deployment of a topology (deploy workflow) on undeployment (undeploy workflow) or during runtime, manually, or automatically based on policies defined for the topology.

Note: The TOSCA orchestrators will execute a single workflow at a time on a topology to guarantee that the defined workflow can be consistent and behave as expected.

7.1 Normative workflows

TOSCA defines several normative workflows that are used to operate a Topology. That is, reserved names of workflows that should be preserved by TOSCA orchestrators and that, if specified in the topology will override the workflow generated by the orchestrator :

- **deploy**: is the workflow used to instantiate and perform the initial deployment of the topology.
- **undeploy**: is the workflow used to remove all instances of a topology.

7.1.1 Notes

Future versions of the specification will describe the normative naming and declarative generation of additional workflows used to operate the topology at runtime.

- **scaling workflows**: defined for every scalable nodes or based on scaling policies
- **auto-healing workflows**: defined in order to restart nodes that may have failed

7.2 Declarative workflows

Declarative workflows are the result of the weaving of topology's node, relationships, and groups workflows.

The weaving process generates the workflow of every single node in the topology, insert operations from the relationships and groups and finally add ordering consideration. The weaving process will also take care of the specific lifecycle of some nodes and the TOSCA orchestrator is responsible to trigger errors or warnings in case the weaving cannot be processed or lead to cycles for example.

This section aims to describe and explain how a TOSCA orchestrator will generate a workflow based on the topology entities (nodes, relationships and groups).

7.2.1 Notes

This section details specific constraints and considerations that applies during the weaving process.

7.2.1.1 Orchestrator provided nodes lifecycle and weaving

When a node is abstract the orchestrator is responsible for providing a valid matching resources for the node in order to deploy the topology. This consideration is also valid for dangling requirements (as they represents a quick way to define an actual node).

The lifecycle of such nodes is the responsibility of the orchestrator and they may not answer to the normative TOSCA lifecycle. Their workflow is considered as "delegate" and acts as a black-box between the initial and started state in the install workflow and the started to deleted states in the uninstall workflow.

If a relationship to some of this node defines operations or lifecycle dependency constraint that relies on intermediate states, the weaving SHOULD fail and the orchestrator SHOULD raise an error.

7.2.2 Relationship impacts on topology weaving

This section explains how relationships impacts the workflow generation to enable the composition of complex topologies.

7.2.2.1 `tosca.relationships.DependsOn`

The depends on relationship is used to establish a dependency from a node to another. A source node that depends on a target node will be created only after the other entity has been started.

7.2.2.2 Note

`DependsOn` relationship SHOULD not be implemented. Even if the `Configure` interface can be implemented this is not considered as a best-practice. If you need specific implementation, please have a look at the `ConnectsTo` relationship.

7.2.2.2.1 Example `DependsOn`

This example show the usage of a generic `DependsOn` relationship between two custom software components.

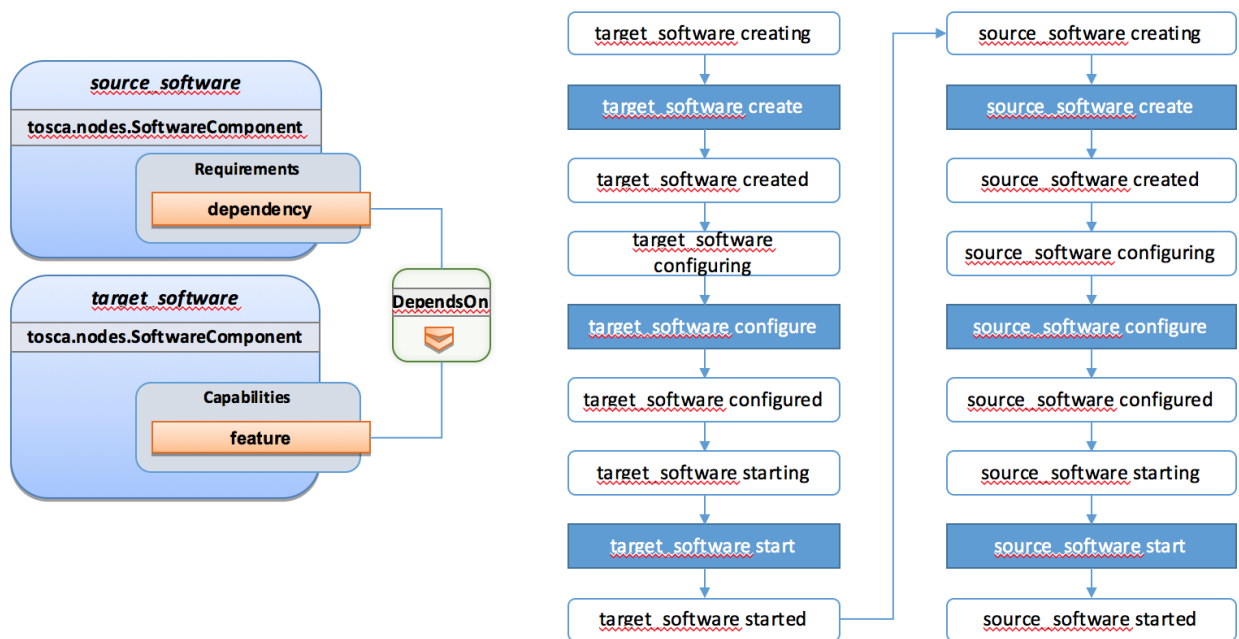

In this example the relationship configure interface doesn't define operations so they don't appear in the generated lifecycle.

7.2.2.3 *tosca.relationships.ConnectsTo*

The connects to relationship is similar to the DependsOn relationship except that it is intended to provide an implementation. The difference is more theoretical than practical but helps users to make an actual distinction from a meaning perspective.

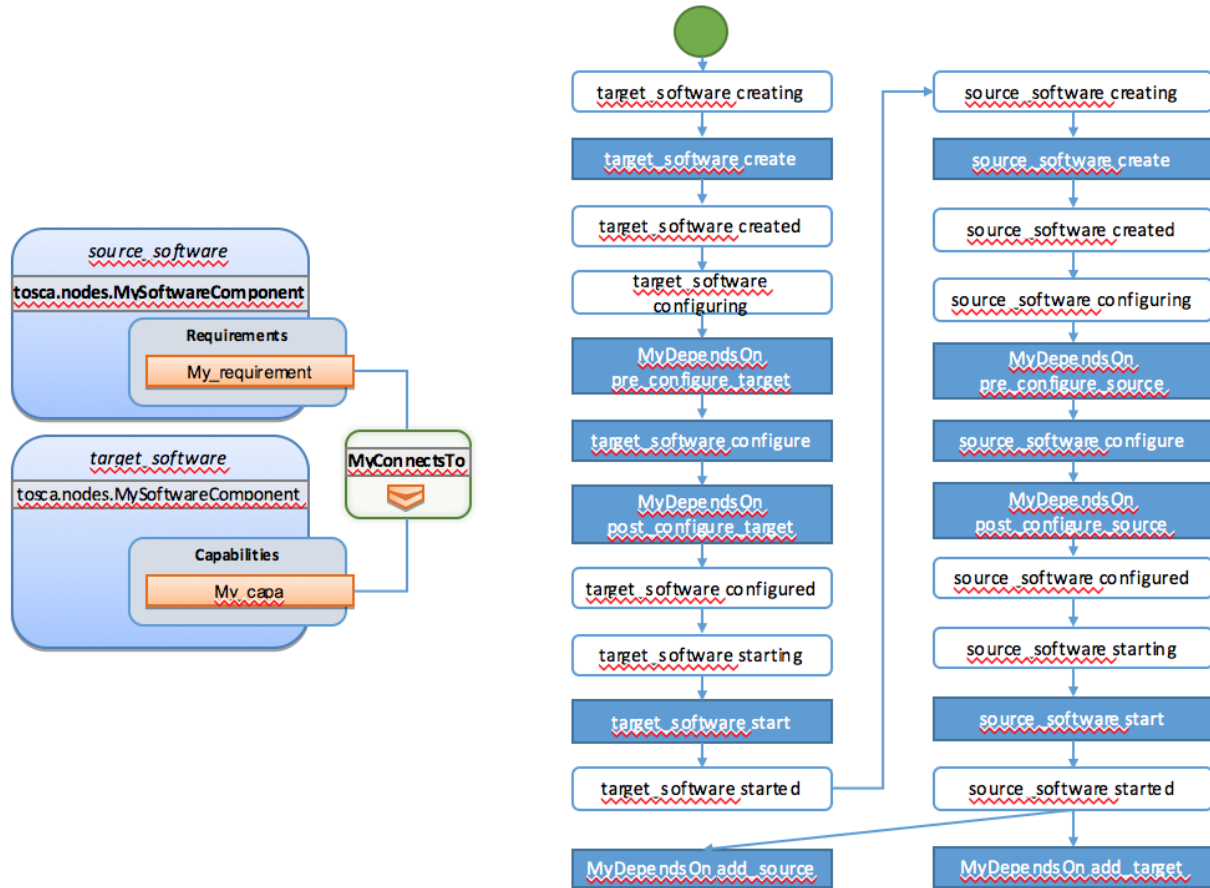

7.2.2.4 *tosca.relationships.HostedOn*

The hosted_on dependency relationship allows to define a hosting relationship between an entity and another. The hosting relationship has multiple impacts on the workflow and execution:

- The implementation artifacts of the source node is executed on the same host as the one of the target node.
- The create operation of the source node is executed only once the target node reach the started state.
- When multiple nodes are hosted on the same host node, the defined operations will not be executed concurrently even if the theoretical workflow could allow it (actual generated workflow will avoid concurrency).

7.2.2.4.1 Example Software Component HostedOn Compute

This example explain the TOSCA weaving operation of a custom SoftwareComponent on a *tosca.nodes.Compute* instance. The compute node is an orchestrator provided node meaning that it's lifecycle is delegated to the orchestrator. This is a black-box and we just expect a started compute node to be provided by the orchestrator.

The software node lifecycle operations will be executed on the Compute node (host) instance.

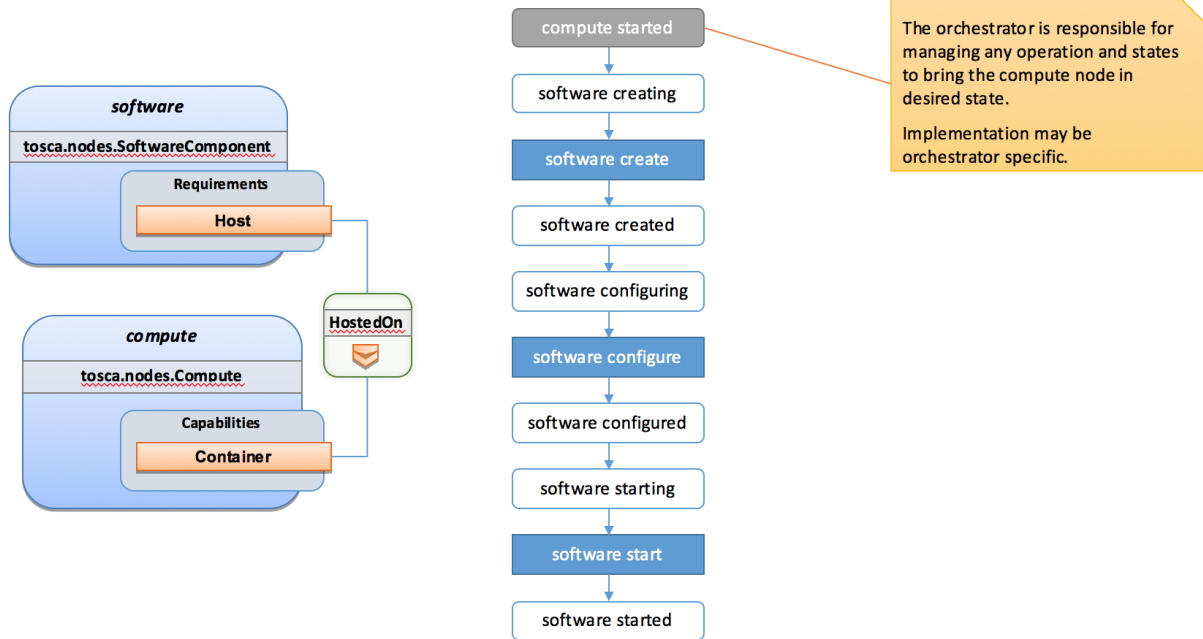

7.2.2.4.2 Example Software Component HostedOn Software Component

Tosca allows some more complex hosting scenarios where a software component could be hosted on another software component.

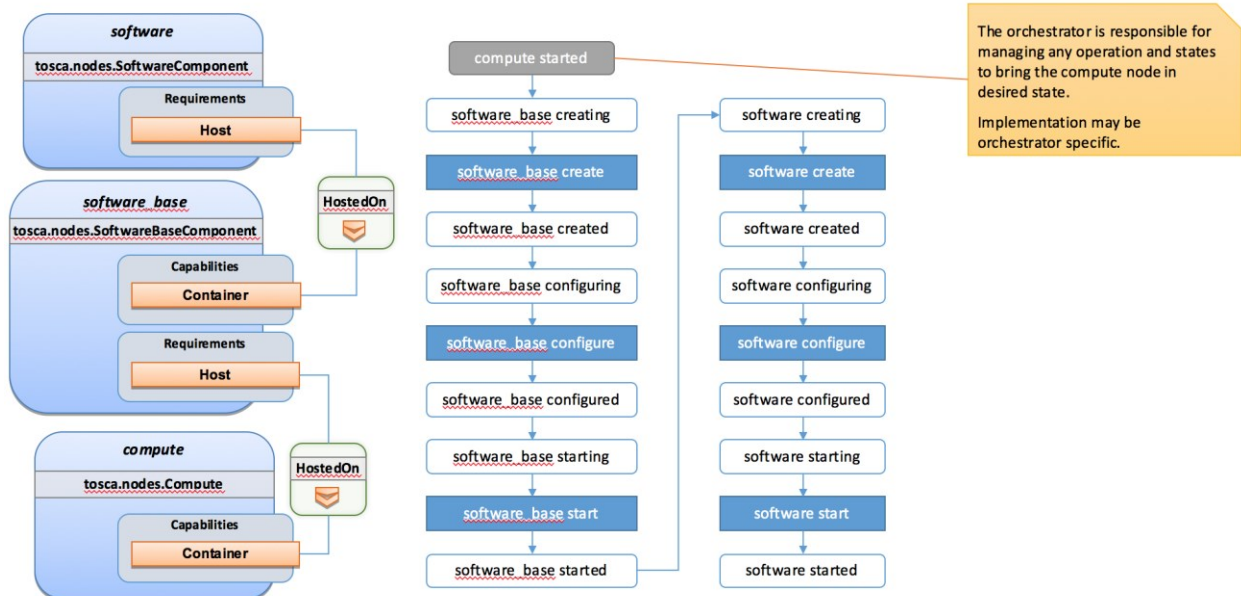

In such scenarios the software create operation is triggered only once the software_base node has reached the started state.

7.2.2.4.3 Example 2 Software Components HostedOn Compute

This example illustrate concurrency constraint introduced by the management of multiple nodes on a single compute.

7.2.3 Limitations

7.2.3.1 Hosted nodes concurrency

TOSCA implementation currently does not allow concurrent executions of scripts implementation artifacts (shell, python, ansible, puppet, chef etc.) on a given host. This limitation is not applied on multiple hosts. This limitation is expressed through the HostedOn relationship limitation expressing that when multiple components are hosted on a given host node then their operations will not be performed concurrently (generated workflow will ensure that operations are not concurrent).

7.2.3.2 Dependent nodes concurrency

When a node depends on another node no operations will be processed concurrently. In some situations, especially when the two nodes lies on different hosts we could expect the create operation to be executed concurrently for performance optimization purpose. The current version of the specification will allow to use imperative workflows to solve this use-case. However, this scenario is one of the scenario that we want to improve and handle in the future through declarative workflows.

7.2.3.3 Target operations and get_attribute on source

The current ConnectsTo workflow implies that the target node is started before the source node is even created. This means that pre_configure_target and post_configure_target operations cannot use any input based on source attribute. It is however possible to refer to get_property inputs based on source properties. For advanced configurations the add_source operation should be used.

Note also that future plans on declarative workflows improvements aims to solve this kind of issues while it is currently possible to use imperative workflows.

7.3 Imperative workflows

Imperative workflows are user defined and can define any really specific constraints and ordering of activities. They are really flexible and powerful and can be used for any complex use-case that cannot be solved in declarative workflows. However, they provide less reusability as they are defined for a specific topology rather than being dynamically generated based on the topology content.

7.3.1 Defining sequence of operations in an imperative workflow

Imperative workflow grammar defines two ways to define the sequence of operations in an imperative workflow:

- Leverage the **on_success** definition to define the next steps that will be executed in parallel.
- Leverage a sequence of activity in a step.

7.3.1.1 Using on_success to define steps ordering

The graph of workflow steps is build based on the values of **on_success** elements of the various defined steps. The graph is built based on the following rules:

- All steps that defines an **on_success** operation must be executed before the next step can be executed. So if A and C defines an **on_success** operation to B, then B will be executed only when both A and C have been successfully executed.
- The multiple nodes defined by an **on_success** construct can be executed in parallel.

- Every step that doesn't have any predecessor is considered as an initial step and can run in parallel.
- Every step that doesn't define any successor is considered as final. When all the final nodes executions are completed then the workflow is considered as completed.

7.3.1.1.1 Example

The following example defines multiple steps and the **on_success** relationship between them.

```
topology_template:
  workflows:
    deploy:
      description: Workflow to deploy the application
      steps:
        A:
          on_success:
            - B
            - C
        B:
          on_success:
            - D
        C:
          on_success:
            - D
        D:
        E:
          on_success:
            - C
            - F
        F:
```

The following schema is the visualization of the above definition in term of sequencing of the steps.

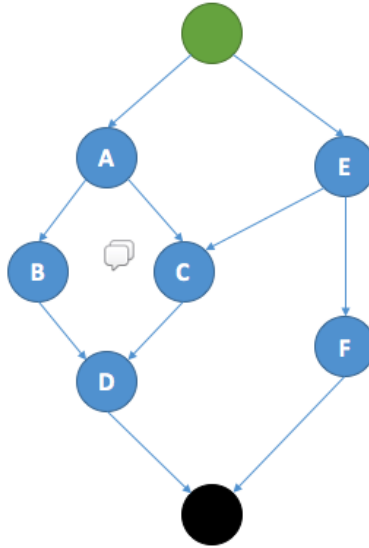

7.3.1.2 Define a sequence of activity on the same element

The step definition of a TOSCA imperative workflow allows multiple activities to be defined :

```

workflows:
  my_workflow:
    steps:
      create_my_node:
        target: my_node
        activities:
          - set_state: creating
          - call_operation: tosca.interfaces.node.lifecycle.Standard.create
          - set_state: created
  
```

The sequence defined here defines three different activities that will be performed in a sequential way. This is just equivalent to writing multiple steps chained by an `on_success` together :

```

workflows:
  my_workflow:
    steps:
      creating_my_node:
        target: my_node
        activities:
          - set_state: creating
        on_success: create_my_node
      create_my_node:
        target: my_node
  
```

```

activities:
  - call_operation: tosca.interfaces.node.lifecycle.Standard.create
  on_success: created_my_node
created_my_node:
  target: my_node
  activities:
    - set_state: created

```

In both situations the resulting workflow is a sequence of activities:

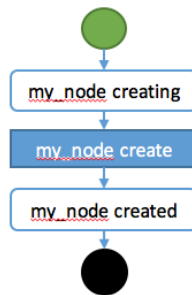

7.3.2 Definition of a simple workflow

Imperative workflow allow user to define custom workflows allowing them to add operations that are not normative, or for example, to execute some operations in parallel when TOSCA would have performed sequential execution.

As Imperative workflows are related to a topology, adding a workflow is as simple as adding a workflows section to your topology template and specifying the workflow and the steps that compose it.

7.3.2.1 Example: Adding a non-normative custom workflow

This sample topology add a very simple custom workflow to trigger the mysql backup operation.

```

topology_template:
  node_templates:
    my_server:
      type: tosca.nodes.Compute
    mysql:
      type: tosca.nodes.DBMS.MySQL
      requirements:
        - host: my_server
      interfaces:
        tosca.interfaces.nodes.custom.Backup:
          operations:
            backup: backup.sh
  workflows:

```



```

backup:
  description: Performs a snapshot of the MySQL data.
  steps:
    my_step:
      target: mysql
      activities:
        - call_operation: tosca.interfaces.nodes.custom.Backup.backup

```

In such topology the TOSCA container will still use declarative workflow to generate the deploy and undeploy workflows as they are not specified and a backup workflow will be available for user to trigger.

7.3.2.2 Example: Creating two nodes hosted on the same compute in parallel

TOSCA declarative workflow generation constraint the workflow so that no operations are called in parallel on the same host. Looking at the following topology this means that the mysql and tomcat nodes will not be created in parallel but sequentially. This is fine in most of the situations as packet managers like apt or yum doesn't not support concurrency, however if both create operations performs a download of zip package from a server most of people will hope to do that in parallel in order to optimize throughput.

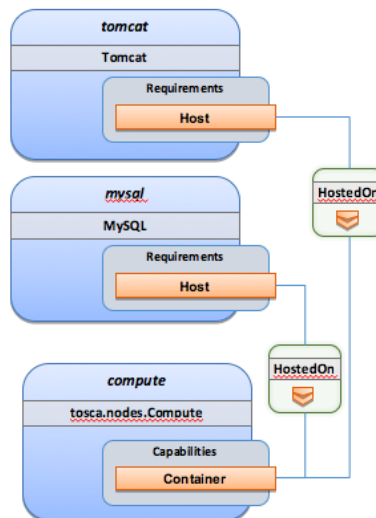

Imperative workflows can help to solve this issue. Based on the above topology we will design a workflow that will create tomcat and mysql in parallel but we will also ensure that tomcat is started after mysql is started even if no relationship is defined between the components:

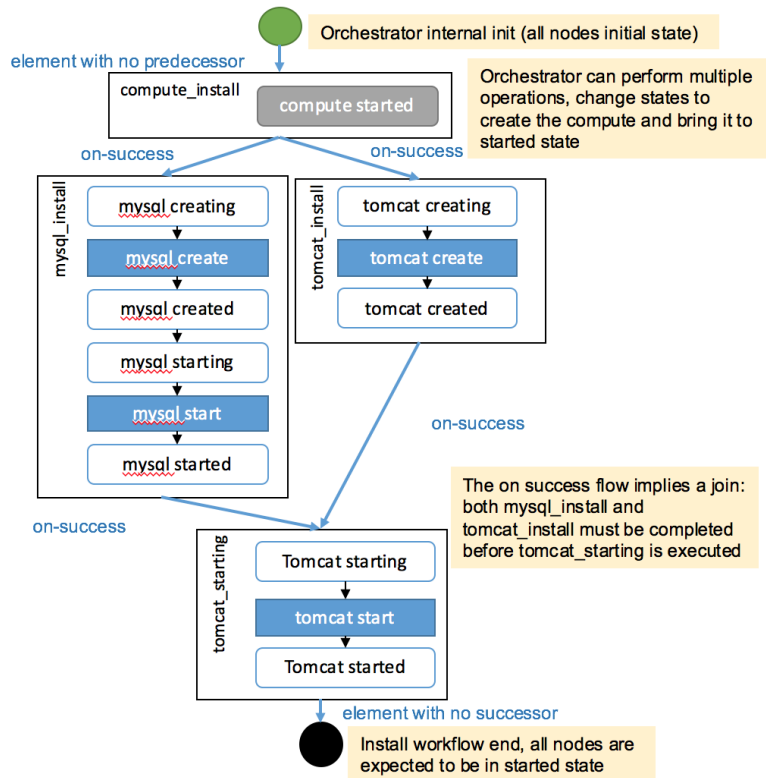

To achieve such workflow, the following topology will be defined:

```

topology_template:
  node_templates:
    my_server:
      type: tosca.nodes.Compute
    mysql:
      type: tosca.nodes.DBMS.MySQL
      requirements:
        - host: my_server
    tomcat:
      type: tosca.nodes.WebServer.Tomcat
      requirements:
        - host: my_server
  workflows:
    deploy:
      description: Override the TOSCA declarative workflow with the following.
      steps:
        compute_install
        target: my_server

```

```

activities:
  - delegate: deploy
on_success:
  - mysql_install
  - tomcat_install
tomcat_install:
  target: tomcat
  activities:
    - set_state: creating
    - call_operation: tosca.interfaces.node.lifecycle.Standard.create
    - set_state: created
  on_success:
    - tomcat_starting
mysql_install:
  target: mysql
  activities:
    - set_state: creating
    - call_operation: tosca.interfaces.node.lifecycle.Standard.create
    - set_state: created
    - set_state: starting
    - call_operation: tosca.interfaces.node.lifecycle.Standard.start
    - set_state: started
  on_success:
    - tomcat_starting
tomcat_starting:
  target: tomcat
  activities:
    - set_state: starting
    - call_operation: tosca.interfaces.node.lifecycle.Standard.start
    - set_state: started

```

7.3.3 Specifying preconditions to a workflow

Pre conditions allows the TOSCA orchestrator to determine if a workflow can be executed based on the states and attribute values of the topology's node. Preconditions must be added to the initial workflow.

7.3.3.1 Example : adding precondition to custom backup workflow

In this example we will use precondition so that we make sure that the mysql node is in the correct state for a backup.

```

topology_template:
  node_templates:
    my_server:
      type: toska.nodes.Compute
    mysql:
      type: toska.nodes.DBMS.MySQL
      requirements:
        - host: my_server
      interfaces:
        toska.interfaces.nodes.custom.Backup:
          operations:
            backup: backup.sh
  workflows:
    backup:
      description: Performs a snapshot of the MySQL data.
      preconditions:
        - target: my_server
          condition:
            - assert:
                - state: [{equal: available}]
        - target: mysql
          condition:
            - assert:
                - state: [{valid_values: [started, available]}]
                - my_attribute: [{equal: ready }]
      steps:
        my_step:
          target: mysql
          activities:
            - call_operation: toska.interfaces.nodes.custom.Backup.backup

```

When the backup workflow will be triggered (by user or policy) the TOSCA engine will first check that preconditions are fulfilled. In this situation the engine will check that *my_server* node is in *available* state AND that *mysql* node is in *started* OR *available* states AND that *mysql my_attribute* value is equal to *ready*.

7.3.4 Workflow reusability

TOSCA allows the reusability of a workflow in other workflows. Such concepts can be achieved thanks to the inline activity.

7.3.4.1 Reusing a workflow to build multiple workflows

The following example show how a workflow can inline an existing workflow and reuse it.

```

topology_template:
  node_templates:
    my_server:
      type: toska.nodes.Compute
    mysql:
      type: toska.nodes.DBMS.MySQL
      requirements:
        - host: my_server
      interfaces:
        toska.interfaces.nodes.custom.Backup:
          operations:
            backup: backup.sh
  workflows:
    start_mysql:
      steps:
        start_mysql:
          target: mysql
          activities :
            - set_state: starting
            - call_operation: toska.interfaces.node.lifecycle.Standard.start
            - set_state: started
    stop_mysql:
      steps:
        stop_mysql:
          target: mysql
          activities:
            - set_state: stopping
            - call_operation: toska.interfaces.node.lifecycle.Standard.stop
            - set_state: stopped

  backup:
    description: Performs a snapshot of the MySQL data.
    preconditions:
      - target: my_server
        condition:
          - assert:
              - state: [{equal: available}]
      - target: mysql
        condition:
          - assert:
              - state: [{valid_values: [started, available]}]

```

```

    - my_attribute: [{equal: ready }]
  steps:
    backup_step:
      activities:
        - inline: stop
        - call_operation: toska.interfaces.nodes.custom.Backup.backup
        - inline: start
  restart:
    steps:
      backup_step:
        activities:
          - inline: stop
          - inline: start

```

The example above defines three workflows and show how the start_mysql and stop_mysql workflows are reused in the backup and restart workflows.

Inlined workflows are inlined sequentially in the existing workflow for example the backup workflow would look like this:

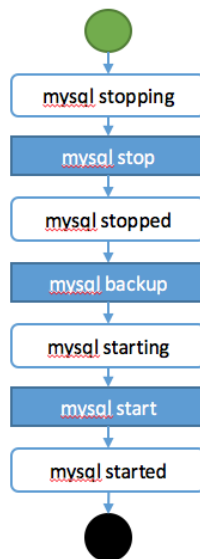

7.3.4.2 Inlining a complex workflow

It is possible of course to inline more complex workflows. The following example defines an inlined workflows with multiple steps including concurrent steps:

```

topology_template:
  workflows:
    inlined_wf:
      steps:

```

```
A:
  target: node_a
  activities:
    - call_operation: a
  on_success:
    - B
    - C
B:
  target: node_a
  activities:
    - call_operation: b
  on_success:
    - D
C:
  target: node_a
  activities:
    - call_operation: c
  on_success:
    - D
D:
  target: node_a
  activities:
    - call_operation: d
E:
  target: node_a
  activities:
    - call_operation: e
  on_success:
    - C
    - F
F:
  target: node_a
  activities:
    - call_operation: f
main_workflow:
  steps:
    G:
      target: node_a
      activities:
        - set_state: initial
        - inline: inlined_wf
```

```
- set_state: available
```

To describe the following workflow:

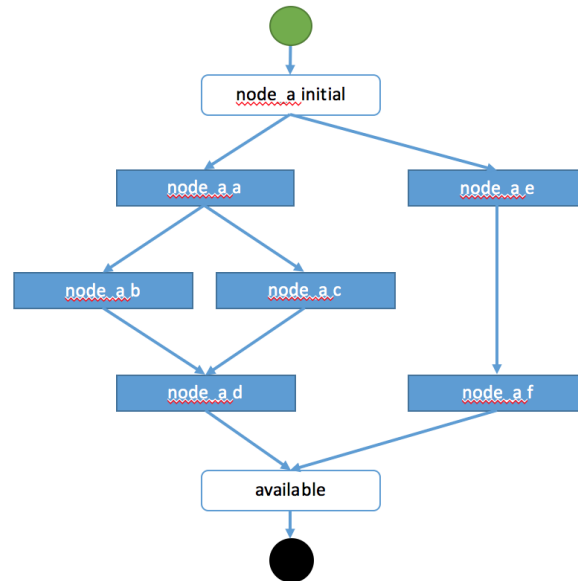

7.3.5 Defining conditional logic on some part of the workflow

Preconditions are used to validate if the workflow should be executed only for the initial workflow. If a workflow that is inlined defines some preconditions these preconditions will be used at the instance level to define if the operations should be executed or not on the defined instance.

This construct can be used to filter some steps on a specific instance or under some specific circumstances or topology state.

```
topology_template:
  node_templates:
    my_server:
      type: tosca.nodes.Compute
    cluster:
      type: tosca.nodes.DBMS.Cluster
      requirements:
        - host: my_server
      interfaces:
        tosca.interfaces.nodes.custom.Backup:
          operations:
            backup: backup.sh
```



```

workflows:
  backup:
    description: Performs a snapshot of the MySQL data.
    preconditions:
      - target: my_server
        condition:
          - assert:
              - state: [{equal: available}]
      - target: mysql
        condition:
          - assert:
              - state: [{valid_values: [started, available]}]
              - my_attribute: [{equal: ready }]
    steps:
      backup_step:
        target: cluster
        filter: # filter is a list of clauses. Matching between clauses is and.
          - or: # only one of sub-clauses must be true.
              - assert:
                  - foo: [{equals: true}]
              - assert:
                  - bar: [{greater_than: 2}, {less_than: 20}]
        activities:
          - call_operation: toska.interfaces.nodes.custom.Backup.backup

```

7.3.6 Define inputs for a workflow

Inputs can be defined in a workflow and will be provided in the execution context of the workflow. If an operation defines a `get_input` function on one of its parameter the input will be retrieved from the workflow input, and if not found from the topology inputs.

7.3.6.1 Example

```

topology_template:
  node_templates:
    my_server:
      type: toska.nodes.Compute
    mysql:
      type: toska.nodes.DBMS.MySQL
  requirements:
    - host: my_server

```

```

interfaces:
  toska.interfaces.nodes.custom.Backup:
    operations:
      backup:
        implementation: backup.sh
        inputs:
          storage_url: { get_input: storage_url }
workflows:
  backup:
    description: Performs a snapshot of the MySQL data.
    preconditions:
      - target: my_server
        valid_states: [available]
      - target: mysql
        valid_states: [started, available]
    attributes:
      my_attribute: [ready]
    inputs:
      storage_url:
        type: string
    steps:
      my_step:
        target: mysql
        activities:
          - call_operation: toska.interfaces.nodes.custom.Backup.backup

```

To trigger such a workflow, the TOSCA engine must allow user to provide inputs that match the given definitions.

7.3.7 Handle operation failure

By default, failure of any activity of the workflow will result in the failure of the workflow and will results in stopping the steps to be executed.

Exception: uninstall workflow operation failure SHOULD not prevent the other operations of the workflow to run (a failure in an uninstall script SHOULD not prevent from releasing resources from the cloud).

For any workflow other than install and uninstall failures may leave the topology in an unknown state. In such situation the TOSCA engine may not be able to orchestrate the deployment. Implementation of **on_failure** construct allows to execute rollback operations and reset the state of the affected entities back to an orchestrator known state.

7.3.7.1 Example

```
topology_template:
  node_templates:
    my_server:
      type: tosca.nodes.Compute
    mysql:
      type: tosca.nodes.DBMS.MySQL
      requirements:
        - host: my_server
      interfaces:
        tosca.interfaces.nodes.custom.Backup:
          operations:
            backup:
              implementation: backup.sh
              inputs:
                storage_url: { get_input: storage_url }
  workflows:
    backup:
      steps:
        backup_step:
          target: mysql
          activities:
            - set_state: backing_up # this state is not a TOSCA known state
            - call_operation: tosca.interfaces.nodes.custom.Backup.backup
            - set_state: available # this state is known by TOSCA orchestrator
          on_failure:
            - rollback_step
        rollback_step:
          target: mysql
          activities:
            - call_operation: tosca.interfaces.nodes.custom.Backup.backup
            - set_state: available # this state is known by TOSCA orchestrator
```

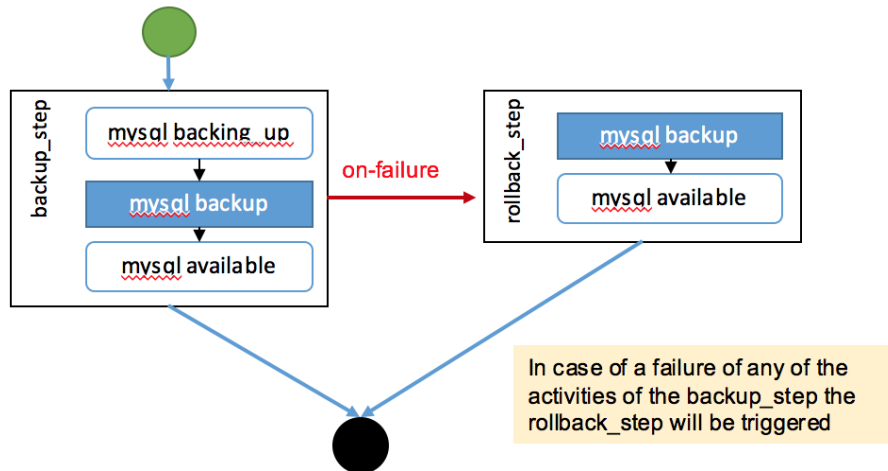

7.3.8 Use a custom workflow language

TOSCA orchestrators may support additional workflow languages beyond the one which has been described in this specification.

7.3.8.1 Example

```

topology_template:
  workflows:
    my_workflow:
      implementation: my_workflow.bpmn.xml
  
```

The **implementation** refers to the artifact **my_workflow.bpmn.xml** containing the workflow definition written in BPMN (Business Process Modeling Notation).

7.3.8.2 Example

```

topology_template:
  workflows:
    my_workflow:
      implementation:
        description: workflow implemented in Mistral
        type: mycompany.artifacts.Implementation.Mistral
        file: my_workflow.workbook.mistral.yaml
  
```

The **implementation** refers to the artifact **my_workflow_script** which is in fact a Mistral workbook written in the Mistral workflow definition language.

8 TOSCA networking

Except for the examples, this section is **normative** and describes how to express and control the application centric network semantics available in TOSCA.

8.1 Networking and Service Template Portability

TOSCA Service Templates are application centric in the sense that they focus on describing application components in terms of their requirements and interrelationships. In order to provide cloud portability, it is important that a TOSCA Service Template avoid cloud specific requirements and details. However, at the same time, TOSCA must provide the expressiveness to control the mapping of software component connectivity to the network constructs of the hosting cloud.

TOSCA Networking takes the following approach.

1. The application component connectivity semantics and expressed in terms of Requirements and Capabilities and the relationships between these. Service Template authors are able to express the interconnectivity requirements of their software components in an abstract, declarative, and thus highly portable manner.
2. The information provided in TOSCA is complete enough for a TOSCA implementation to fulfill the application component network requirements declaratively (i.e., it contains information such as communication initiation and layer 4 port specifications) so that the required network semantics can be realized on arbitrary network infrastructures.
3. TOSCA Networking provides full control of the mapping of software component interconnectivity to the networking constructs of the hosting cloud network independently of the Service Template, providing the required separation between application and network semantics to preserve Service Template portability.
4. Service Template authors have the choice of specifying application component networking requirements in the Service Template or completely separating the application component to network mapping into a separate document. This allows application components with explicit network requirements to express them while allowing users to control the complete mapping for all software components which may not have specific requirements. Usage of these two approaches is possible simultaneously and required to avoid having to re-write components network semantics as arbitrary sets of components are assembled into Service Templates.
5. Defining a set of network semantics which are expressive enough to address the most common application connectivity requirements while avoiding dependencies on specific network technologies and constructs. Service Template authors and cloud providers are able to express unique/non-portable semantics by defining their own specialized network Requirements and Capabilities.

8.2 Connectivity semantics

TOSCA's application centric approach includes the modeling of network connectivity semantics from an application component connectivity perspective. The basic premise is that applications contain components which need to communicate with other components using one or more endpoints over a network stack such as TCP/IP, where connectivity between two components is expressed as a <source component, source address, source port, target component, target address, target port> tuple. Note that source and target components are added to the traditional 4 tuple to provide the application centric information, mapping the network to the source or target component involved in the connectivity.

Software components are expressed as Node Types in TOSCA which can express virtually any kind of concept in a TOSCA model. Node Types offering network based functions can model their connectivity using a special Endpoint Capability, [tosca.capabilities.Endpoint](#), designed for this purpose. Node Types

which require an Endpoint can specify this as a TOSCA requirement. A special Relationship Type, `tosca.relationships.ConnectsTo`, is used to implicitly or explicitly relate the source Node Type's endpoint to the required endpoint in the target node type. Since `tosca.capabilities.Endpoint` and `tosca.relationships.ConnectsTo` are TOSCA types, they can be used in templates and extended by subclassing in the usual ways, thus allowing the expression of additional semantics as needed.

The following diagram shows how the TOSCA node, capability and relationship types enable modeling the application layer decoupled from the network model intersecting at the Compute node using the [Bindable](#) capability type.

As you can see, the Port node type effectively acts a broker node between the Network node description

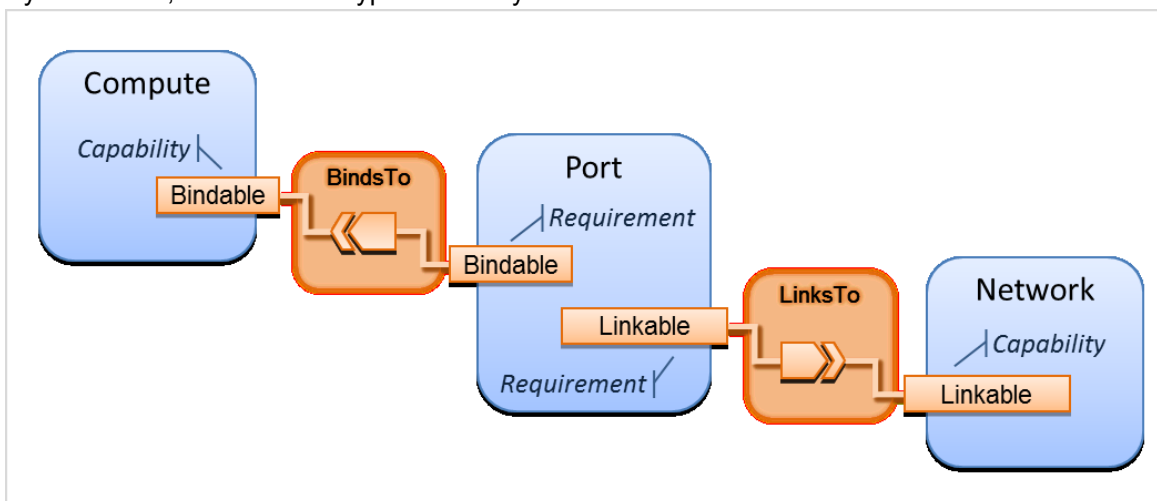

and a host Compute node of an application.

8.3 Expressing connectivity semantics

This section describes how TOSCA supports the typical client/server and group communication semantics found in application architectures.

8.3.1 Connection initiation semantics

The `tosca.relationships.ConnectsTo` expresses that requirement that a source application component needs to be able to communicate with a target software component to consume the services of the target. `ConnectTo` is a component interdependency semantic in the most general sense and does not try imply how the communication between the source and target components is physically realized.

Application component intercommunication typically has conventions regarding which component(s) initiate the communication. Connection initiation semantics are specified in [tosca.capabilities.Endpoint](#). Endpoints at each end of the [tosca.relationships.ConnectsTo](#) must indicate identical connection initiation semantics.

The following sections describe the normative connection initiation semantics for the `tosca.relationships.ConnectsTo` Relationship Type.

8.3.1.1 Source to Target

The Source to Target communication initiation semantic is the most common case where the source component initiates communication with the target component in order to fulfill an instance of the `tosca.relationships.ConnectsTo` relationship. The typical case is a "client" component connecting to a "server" component where the client initiates a stream oriented connection to a pre-defined transport specific port or set of ports.

It is the responsibility of the TOSCA implementation to ensure the source component has a suitable network path to the target component and that the ports specified in the respective [tosca.capabilities.Endpoint](#) are not blocked. The TOSCA implementation may only represent state of the `tosca.relationships.ConnectsTo` relationship as fulfilled after the actual network communication is enabled and the source and target components are in their operational states.

Note that the connection initiation semantic only impacts the fulfillment of the actual connectivity and does not impact the node traversal order implied by the `tosca.relationships.ConnectsTo` Relationship Type.

8.3.1.2 Target to Source

The Target to Source communication initiation semantic is a less common case where the target component initiates communication with the source component in order to fulfill an instance of the `tosca.relationships.ConnectsTo` relationship. This “reverse” connection initiation direction is typically required due to some technical requirements of the components or protocols involved, such as the requirement that SSH must only be initiated from target component in order to fulfill the services required by the source component.

It is the responsibility of the TOSCA implementation to ensure the source component has a suitable network path to the target component and that the ports specified in the respective `tosca.capabilities.Endpoint` are not blocked. The TOSCA implementation may only represent state of the `tosca.relationships.ConnectsTo` relationship as fulfilled after the actual network communication is enabled and the source and target components are in their operational states.

Note that the connection initiation semantic only impacts the fulfillment of the actual connectivity and does not impact the node traversal order implied by the `tosca.relationships.ConnectsTo` Relationship Type.

8.3.1.3 Peer-to-Peer

The Peer-to-Peer communication initiation semantic allows any member of a group to initiate communication with any other member of the same group at any time. This semantic typically appears in clustering and distributed services where there is redundancy of components or services.

It is the responsibility of the TOSCA implementation to ensure the source component has a suitable network path between all the member component instances and that the ports specified in the respective `tosca.capabilities.Endpoint` are not blocked, and the appropriate multicast communication, if necessary, enabled. The TOSCA implementation may only represent state of the `tosca.relationships.ConnectsTo` relationship as fulfilled after the actual network communication is enabled such that at least one-member component of the group may reach any other member component of the group.

Endpoints specifying the Peer-to-Peer initiation semantic need not be related with a `tosca.relationships.ConnectsTo` relationship for the common case where the same set of component instances must communicate with each other.

Note that the connection initiation semantic only impacts the fulfillment of the actual connectivity and does not impact the node traversal order implied by the `tosca.relationships.ConnectsTo` Relationship Type.

8.3.2 Specifying layer 4 ports

TOSCA Service Templates must express enough details about application component intercommunication to enable TOSCA implementations to fulfill these communication semantics in the network infrastructure. TOSCA currently focuses on TCP/IP as this is the most pervasive in today's cloud

infrastructures. The layer 4 ports required for application component intercommunication are specified in `tosca.capabilities.Endpoint`. The union of the port specifications of both the source and target `tosca.capabilities.Endpoint` which are part of the `tosca.relationships.ConnectsTo` Relationship Template are interpreted as the effective set of ports which must be allowed in the network communication.

The meaning of Source and Target port(s) corresponds to the direction of the respective `tosca.relationships.ConnectsTo`.

8.4 Network provisioning

8.4.1 Declarative network provisioning

TOSCA orchestrators are responsible for the provisioning of the network connectivity for declarative TOSCA Service Templates (Declarative TOSCA Service Templates don't contain explicit plans). This means that the TOSCA orchestrator must be able to infer a suitable logical connectivity model from the Service Template and then decide how to provision the logical connectivity, referred to as "fulfillment", on the available underlying infrastructure. In order to enable fulfillment, sufficient technical details still must be specified, such as the required protocols, ports and QOS information. TOSCA connectivity types, such as `tosca.capabilities.Endpoint`, provide well defined means to express these details.

8.4.2 Implicit network fulfillment

TOSCA Service Templates are by default network agnostic. TOSCA's application centric approach only requires that a TOSCA Service Template contain enough information for a TOSCA orchestrator to infer suitable network connectivity to meet the needs of the application components. Thus Service Template designers are not required to be aware of or provide specific requirements for underlying networks. This approach yields the most portable Service Templates, allowing them to be deployed into any infrastructure which can provide the necessary component interconnectivity.

8.4.3 Controlling network fulfillment

TOSCA provides mechanisms for providing control over network fulfillment.

This mechanism allows the application network designer to express in service template or network template how the networks should be provisioned.

For the use cases described below let's assume we have a typical 3-tier application which is consisting of FE (frontend), BE (backend) and DB (database) tiers. The simple application topology diagram can be shown below:

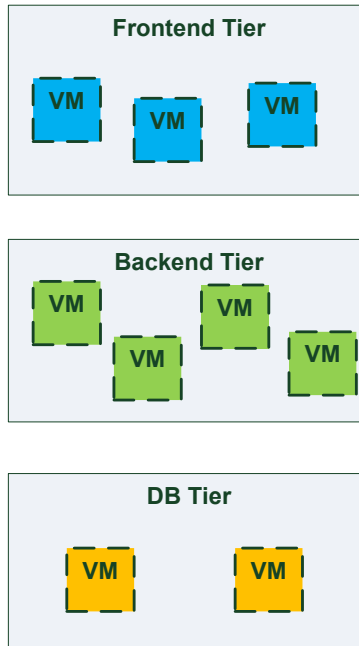

Figure-5: Typical 3-Tier Network

8.4.3.1 Use case: OAM Network

When deploying an application in service provider's on-premise cloud, it's very common that one or more of the application's services should be accessible from an ad-hoc OAM (Operations, Administration and Management) network which exists in the service provider backbone.

As an application network designer, I'd like to express in my TOSCA network template (which corresponds to my TOSCA service template) the network CIDR block, start ip, end ip and segmentation ID (e.g. VLAN id).

The diagram below depicts a typical 3-tiers application with specific networking requirements for its FE tier server cluster:

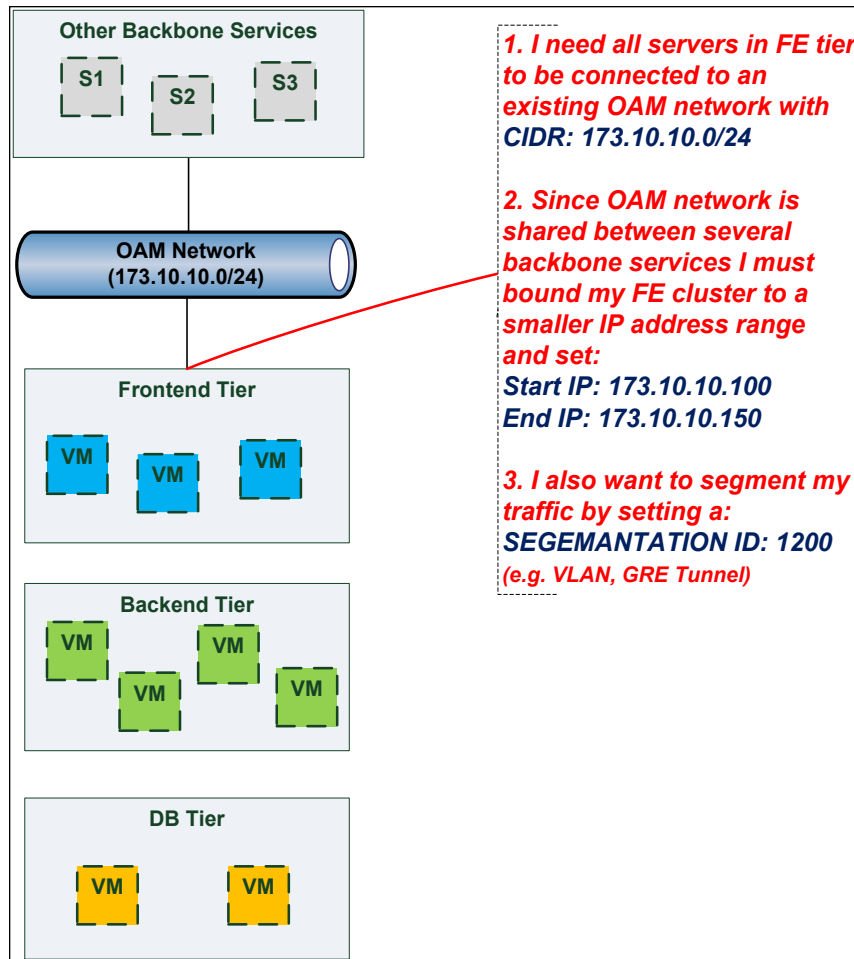

8.4.3.2 Use case: Data Traffic network

The diagram below defines a set of networking requirements for the backend and DB tiers of the 3-tier app mentioned above.

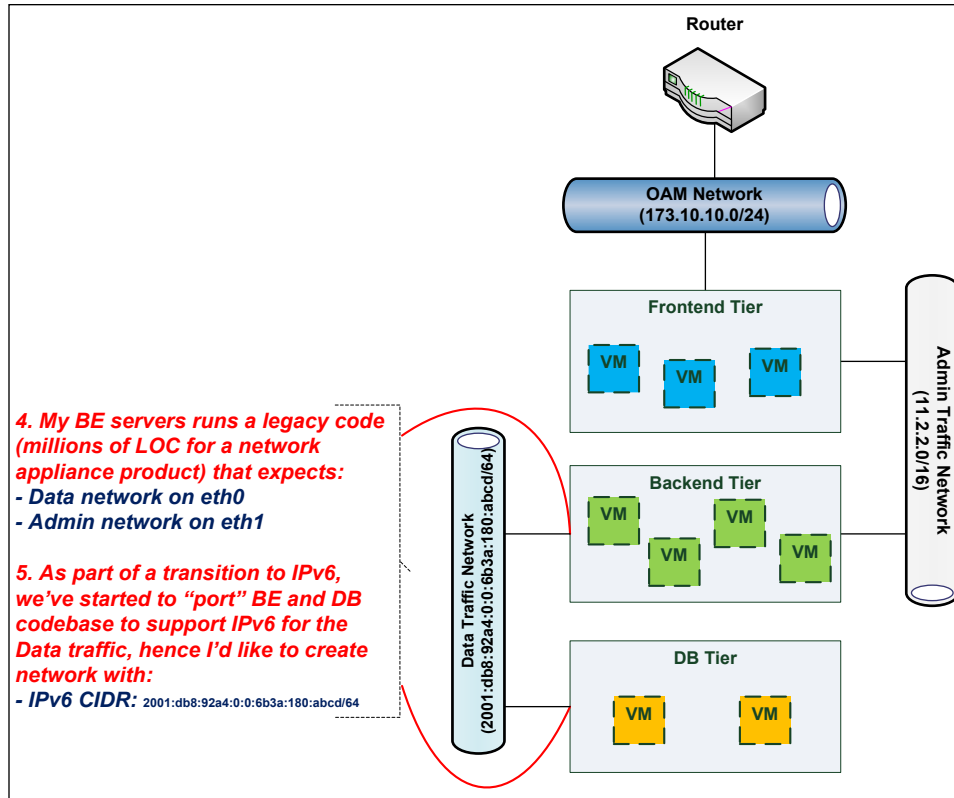

8.4.3.3 Use case: Bring my own DHCP

The same 3-tier app requires for its admin traffic network to manage the IP allocation by its own DHCP which runs autonomously as part of application domain.

For this purpose, the app network designer would like to express in TOSCA that the underlying provisioned network will be set with DHCP_ENABLED=false. See this illustrated in the figure below:

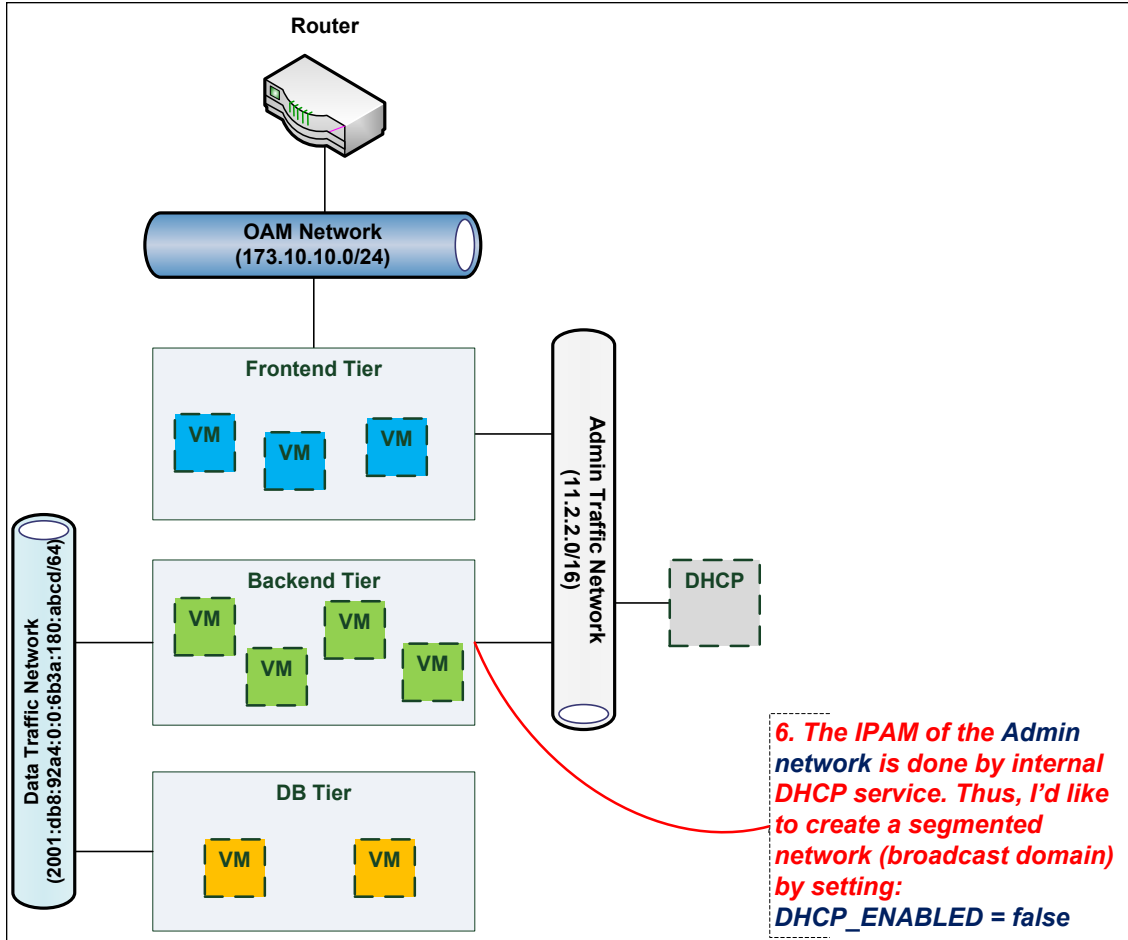

8.5 Network Types

8.5.1 `tosca.nodes.network.Network`

The TOSCA `Network` node represents a simple, logical network service.

Shorthand Name	Network
Type Qualified Name	<code>tosca:Network</code>
Type URI	<code>tosca.nodes.network.Network</code>

8.5.1.1 Properties

Name	Required	Type	Constraints	Description
<code>ip_version</code>	no	<code>integer</code>	<code>valid_values:</code> [4, 6] <code>default:</code> 4	The IP version of the requested network
<code>cidr</code>	no	<code>string</code>	None	The cidr block of the requested network
<code>start_ip</code>	no	<code>string</code>	None	The IP address to be used as the 1 st one in a pool of addresses derived from the cidr block full IP range

Name	Required	Type	Constraints	Description
end_ip	no	string	None	The IP address to be used as the last one in a pool of addresses derived from the cidr block full IP range
gateway_ip	no	string	None	The gateway IP address.
network_name	no	string	None	An Identifier that represents an existing Network instance in the underlying cloud infrastructure – OR – be used as the name of the new created network. <ul style="list-style-type: none"> • If network_name is provided along with network_id they will be used to uniquely identify an existing network and not creating a new one, means all other possible properties are not allowed. • network_name should be more convenient for using. But in case that network name uniqueness is not guaranteed then one should provide a network_id as well.
network_id	no	string	None	An Identifier that represents an existing Network instance in the underlying cloud infrastructure. This property is mutually exclusive with all other properties except network_name. <ul style="list-style-type: none"> • Appearance of network_id in network template instructs the Tosca container to use an existing network instead of creating a new one. • network_name should be more convenient for using. But in case that network name uniqueness is not guaranteed then one should add a network_id as well. • network_name and network_id can be still used together to achieve both uniqueness and convenient.
segmentation_id	no	string	None	A segmentation identifier in the underlying cloud infrastructure (e.g., VLAN id, GRE tunnel id). If the segmentation_id is specified, the network_type or physical_network properties should be provided as well.
network_type	no	string	None	Optionally, specifies the nature of the physical network in the underlying cloud infrastructure. Examples are flat, vlan, gre or vxlan. For flat and vlan types, physical_network should be provided too.
physical_network	no	string	None	Optionally, identifies the physical network on top of which the network is implemented, e.g. physnet1. This property is required if network_type is flat or vlan.
dhcp_enabled	no	boolean	default: true	Indicates the TOSCA container to create a virtual network instance with or without a DHCP service.

8.5.1.2 Attributes

Name	Required	Type	Constraints	Description
segmentation_id	no	string	None	The actual <i>segmentation_id</i> that is been assigned to the network by the underlying cloud infrastructure.

8.5.1.3 Definition

```
tosca.nodes.network.Network:
  derived_from: tosca.nodes.Root
  properties:
    ip_version:
      type: integer
      required: false
      default: 4
      constraints:
        - valid_values: [ 4, 6 ]
    cidr:
      type: string
      required: false
    start_ip:
      type: string
      required: false
    end_ip:
      type: string
      required: false
    gateway_ip:
      type: string
      required: false
    network_name:
      type: string
      required: false
    network_id:
      type: string
      required: false
    segmentation_id:
      type: string
      required: false
    network_type:
      type: string
      required: false
    physical_network:
      type: string
      required: false
  capabilities:
    link:
      type: tosca.capabilities.network.Linkable
```

8.5.2 tosca.nodes.network.Port

The TOSCA **Port** node represents a logical entity that associates between Compute and Network normative types.

The Port node type effectively represents a single virtual NIC on the Compute node instance.

Shorthand Name	Port
Type Qualified Name	tosca:Port
Type URI	tosca.nodes.network.Port

8.5.2.1 Properties

Name	Required	Type	Constraints	Description
ip_address	no	string	None	Allow the user to set a fixed IP address. Note that this address is a request to the provider which they will attempt to fulfill but may not be able to dependent on the network the port is associated with.
order	no	integer	greater_or_equal: 0 default: 0	The order of the NIC on the compute instance (e.g. eth2). Note: when binding more than one port to a single compute (aka multi vNICs) and ordering is desired, it is <i>*mandatory*</i> that all ports will be set with an order value and. The <i>order</i> values must represent a positive, arithmetic progression that starts with 0 (e.g. 0, 1, 2, ..., n).
is_default	no	boolean	default: false	Set is_default =true to apply a default gateway route on the running compute instance to the associated network gateway. Only one port that is associated to single compute node can set as default=true.
ip_range_start	no	string	None	Defines the starting IP of a range to be allocated for the compute instances that are associated by this Port. Without setting this property the IP allocation is done from the entire CIDR block of the network.
ip_range_end	no	string	None	Defines the ending IP of a range to be allocated for the compute instances that are associated by this Port. Without setting this property the IP allocation is done from the entire CIDR block of the network.

8.5.2.2 Attributes

Name	Required	Type	Constraints	Description
ip_address	no	string	None	The IP address would be assigned to the associated compute instance.

8.5.2.3 Definition

```
tosca.nodes.network.Port:
  derived_from: tosca.nodes.Root
  properties:
    ip_address:
      type: string
      required: false
    order:
      type: integer
      required: true
      default: 0
      constraints:
        - greater_or_equal: 0
    is_default:
      type: boolean
      required: false
      default: false
    ip_range_start:
      type: string
      required: false
    ip_range_end:
      type: string
      required: false
  requirements:
    - link:
        capability: tosca.capabilities.network.Linkable
        relationship: tosca.relationships.network.LinkTo
    - binding:
        capability: tosca.capabilities.network.Bindable
        relationship: tosca.relationships.network.BindsTo
```

8.5.3 tosca.capabilities.network.Linkable

A node type that includes the Linkable capability indicates that it can be pointed to by a [tosca.relationships.network.LinkTo](#) relationship type.

Shorthand Name	Linkable
Type Qualified Name	tosca::Linkable
Type URI	tosca.capabilities.network.Linkable

8.5.3.1 Properties

Name	Required	Type	Constraints	Description
N/A	N/A	N/A	N/A	N/A

8.5.3.2 Definition

```
tosca.capabilities.network.Linkable:
  derived_from: tosca.capabilities.Node
```

8.5.4 tosca.relationships.network.LinksTo

This relationship type represents an association relationship between Port and Network node types.

Shorthand Name	LinksTo
Type Qualified Name	tosca:LinksTo
Type URI	tosca.relationships.network.LinksTo

8.5.4.1 Definition

```
tosca.relationships.network.LinksTo:
  derived_from: tosca.relationships.DependsOn
  valid_target_types: [ tosca.capabilities.network.Linkable ]
```

8.5.5 tosca.relationships.network.BindsTo

This type represents a network association relationship between Port and Compute node types.

Shorthand Name	network.BindsTo
Type Qualified Name	tosca:BindsTo
Type URI	tosca.relationships.network.BindsTo

8.5.5.1 Definition

```
tosca.relationships.network.BindsTo:
  derived_from: tosca.relationships.DependsOn
  valid_target_types: [ tosca.capabilities.network.Bindable ]
```

8.6 Network modeling approaches

8.6.1 Option 1: Specifying a network outside the application's Service Template

This approach allows someone who understands the application's networking requirements, mapping the details of the underlying network to the appropriate node templates in the application.

The motivation for this approach is providing the application network designer a fine-grained control on how networks are provisioned and stitched to its application by the TOSCA orchestrator and underlying cloud infrastructure while still preserving the portability of his service template. Preserving the portability means here not doing any modification in service template but just "plug-in" the desired network modeling. The network modeling can reside in the same service template file but the best practice should be placing it in a separated self-contained network template file.

This "pluggable" network template approach introduces a new normative node type called Port, capability called [tosca.capabilities.network.Linkable](#) and relationship type called [tosca.relationships.network.LinksTo](#).

The idea of the Port is to elegantly associate the desired compute nodes with the desired network nodes while not "touching" the compute itself.

The following diagram series demonstrate the plug-ability strength of this approach.

Let's assume an application designer has modeled a service template as shown in Figure 1 that describes the application topology nodes (compute, storage, software components, etc.) with their relationships. The designer ideally wants to preserve this service template and use it in any cloud provider environment without any change.

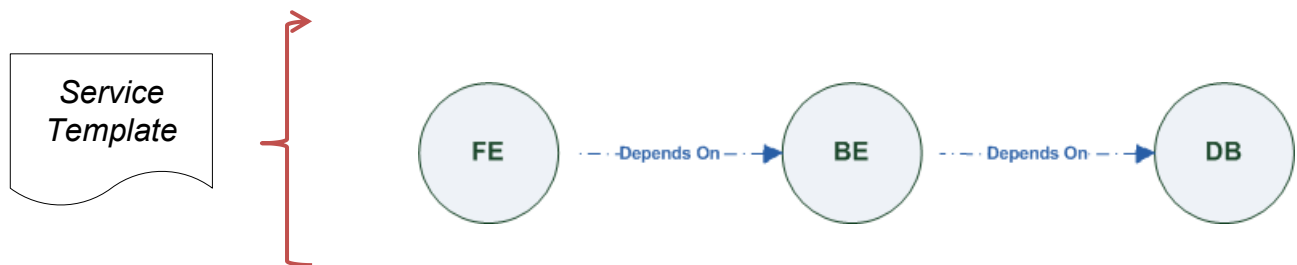

Figure-6: Generic Service Template

When the application designer comes to consider its application networking requirement they typically call the network architect/designer from their company (who has the correct expertise).

The network designer, after understanding the application connectivity requirements and optionally the target cloud provider environment, is able to model the network template and plug it to the service template as shown in Figure 2:

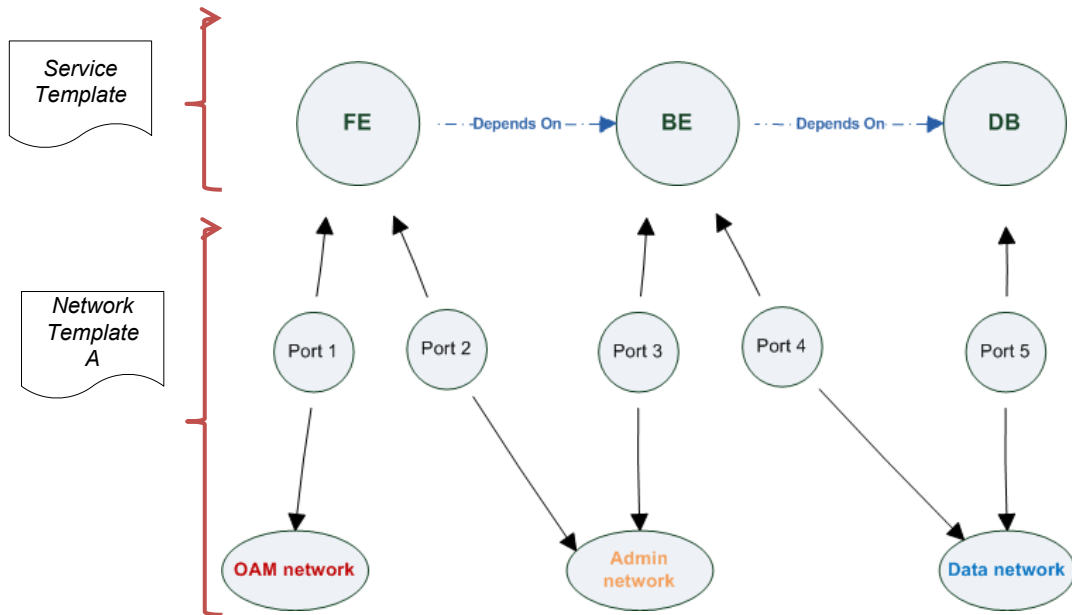

Figure-7: Service template with network template A

When there's a new target cloud environment to run the application on, the network designer is simply creates a new network template B that corresponds to the new environmental conditions and provide it to the application designer which packs it into the application CSAR.

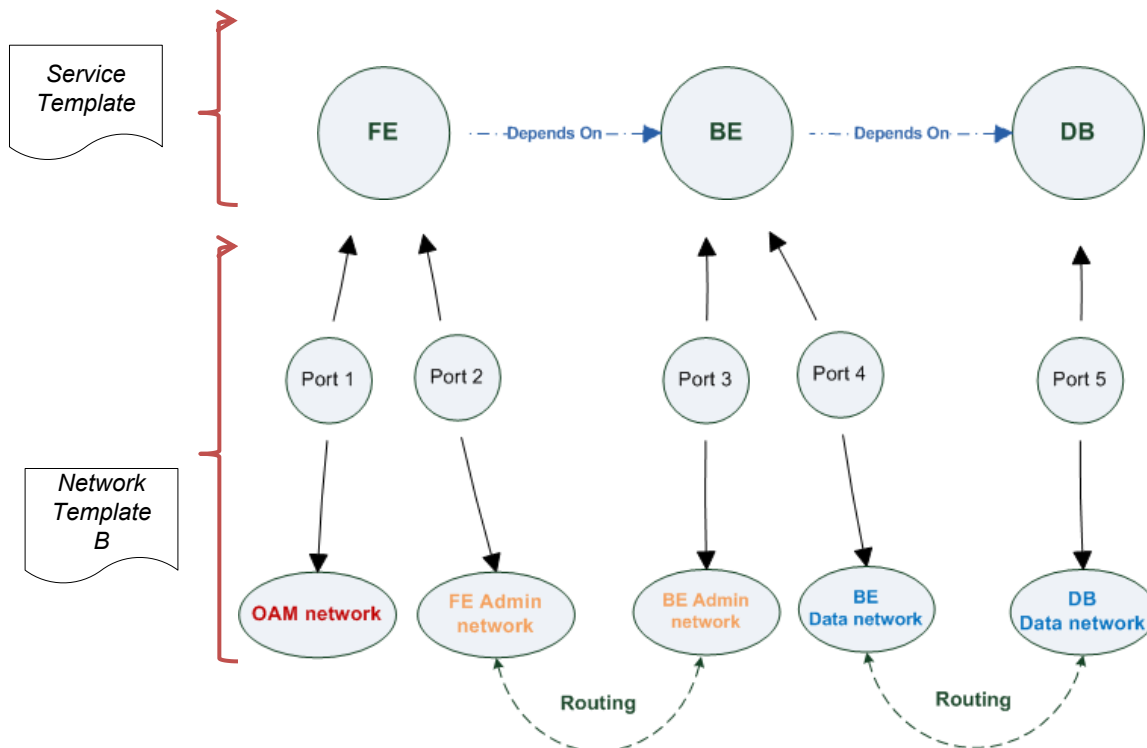

Figure-8: Service template with network template B

The node templates for these three networks would be defined as follows:

```
node_templates:
  frontend:
```

```

type: toska.nodes.Compute
properties: # omitted for brevity

backend:
  type: toska.nodes.Compute
  properties: # omitted for brevity

database:
  type: toska.nodes.Compute
  properties: # omitted for brevity

oam_network:
  type: toska.nodes.network.Network
  properties: # omitted for brevity

admin_network:
  type: toska.nodes.network.Network
  properties: # omitted for brevity

data_network:
  type: toska.nodes.network.Network
  properties: # omitted for brevity

# ports definition
fe_oam_net_port:
  type: toska.nodes.network.Port
  properties:
    is_default: true
    ip_range_start: { get_input: fe_oam_net_ip_range_start }
    ip_range_end: { get_input: fe_oam_net_ip_range_end }
  requirements:
    - link: oam_network
    - binding: frontend

fe_admin_net_port:
  type: toska.nodes.network.Port
  requirements:
    - link: admin_network
    - binding: frontend

be_admin_net_port:

```

```

type: toska.nodes.network.Port
properties:
  order: 0
requirements:
  - link: admin_network
  - binding: backend

be_data_net_port:
type: toska.nodes.network.Port
properties:
  order: 1
requirements:
  - link: data_network
  - binding: backend

db_data_net_port:
type: toska.nodes.network.Port
requirements:
  - link: data_network
  - binding: database

```

8.6.2 Option 2: Specifying network requirements within the application's Service Template

This approach allows the Service Template designer to map an endpoint to a logical network.

The use case shown below examines a way to express in the TOSCA YAML service template a typical 3-tier application with their required networking modeling:

```

node_templates:
  frontend:
    type: toska.nodes.Compute
    properties: # omitted for brevity
    requirements:
      - network_oam: oam_network
      - network_admin: admin_network
  backend:
    type: toska.nodes.Compute
    properties: # omitted for brevity
    requirements:
      - network_admin: admin_network
      - network_data: data_network

```

```
database:
  type: toska.nodes.Compute
  properties: # omitted for brevity
  requirements:
    - network_data: data_network

oam_network:
  type: toska.nodes.network.Network
  properties:
    ip_version: { get_input: oam_network_ip_version }
    cidr: { get_input: oam_network_cidr }
    start_ip: { get_input: oam_network_start_ip }
    end_ip: { get_input: oam_network_end_ip }

admin_network:
  type: toska.nodes.network.Network
  properties:
    ip_version: { get_input: admin_network_ip_version }
    dhcp_enabled: { get_input: admin_network_dhcp_enabled }

data_network:
  type: toska.nodes.network.Network
  properties:
    ip_version: { get_input: data_network_ip_version }
    cidr: { get_input: data_network_cidr }
```

9 Non-normative type definitions

This section defines **non-normative** types which are used only in examples and use cases in this specification and are included only for completeness for the reader. Implementations of this specification are not required to support these types for conformance.

9.1 Artifact Types

This section contains are non-normative Artifact Types used in use cases and examples.

9.1.1 `tosca.artifacts.Deployment.Image.Container.Docker`

This artifact represents a Docker “image” (a TOSCA deployment artifact type) which is a binary comprised of one or more (a union of read-only and read-write) layers created from snapshots within the underlying Docker **Union File System**.

9.1.1.1 Definition

```
tosca.artifacts.Deployment.Image.Container.Docker:  
  derived_from: tosca.artifacts.Deployment.Image  
  description: Docker Container Image
```

9.1.2 `tosca.artifacts.Deployment.Image.VM.ISO`

A Virtual Machine (VM) formatted as an ISO standard disk image.

9.1.2.1 Definition

```
tosca.artifacts.Deployment.Image.VM.ISO:  
  derived_from: tosca.artifacts.Deployment.Image.VM  
  description: Virtual Machine (VM) image in ISO disk format  
  mime_type: application/octet-stream  
  file_ext: [ iso ]
```

9.1.3 `tosca.artifacts.Deployment.Image.VM.QCOW2`

A Virtual Machine (VM) formatted as a QEMU emulator version 2 standard disk image.

9.1.3.1 Definition

```
tosca.artifacts.Deployment.Image.VM.QCOW2:  
  derived_from: tosca.artifacts.Deployment.Image.VM  
  description: Virtual Machine (VM) image in QCOW v2 standard disk format  
  mime_type: application/octet-stream  
  file_ext: [ qcow2 ]
```

9.1.4 `tosca.artifacts.template.Jinja2`

This artifact type represents a template file written in Jinja2 templating language [Jinja2].

Shorthand Name	Template.Jinja2
Type Qualified Name	tosca:template.jinja2
Type URI	tosca.artifacts.template.Jinja2

9.1.4.1 Definition

```
tosca.artifacts.template.Jinja2:
  derived_from: tosca.artifacts.template
  description: Jinja2 template file
```

9.1.4.2 Example

```
dbServer:
  type: toasca.nodes.Compute
  properties:
    name:
    description:
  artifacts:
    configuration:
      type: toasca.artifacts.Implementation.Ansible
      file: implementation/configuration/Ansible/configuration.yml
    template_configuration:
      type: toasca.artifacts.template.Jinja2
      file: implementation/configuration/templates/template_configuration.jinja2
  interfaces:
    Standard:
      configure:
        inputs:
          input1: . . .
        implementation:
          primary: configuration
          dependencies: [ template_configuration ]
```

9.1.5 toasca.artifacts.template.Twig

This artifact type represents a template file written in Twig templating language [Twig].

Shorthand Name	Template.Twig
Type Qualified Name	tosca:template.Twig
Type URI	tosca.artifacts.template.Twig

9.1.5.1 Definition

```
tosca.artifacts.template.Twig:
  derived_from: tosca.artifacts.template
  description: Twig template file
```

9.2 Capability Types

This section contains are non-normative Capability Types used in use cases and examples.

9.2.1 tosca.capabilities.Container.Docker

The type indicates capabilities of a Docker runtime environment (client).

Shorthand Name	Container.Docker
Type Qualified Name	tosca:Container.Docker
Type URI	tosca.capabilities.Container.Docker

9.2.1.1 Properties

Name	Required	Type	Constraints	Description
version	no	version[]	None	The Docker version capability (i.e., the versions supported by the capability).
publish_all	no	boolean	default: false	Indicates that all ports (ranges) listed in the <i>dockerfile</i> using the EXPOSE keyword be published.
publish_ports	no	list of PortSpec	None	List of ports mappings from source (Docker container) to target (host) ports to publish.
expose_ports	no	list of PortSpec	None	List of ports mappings from source (Docker container) to expose to other Docker containers (not accessible outside host).
volumes	no	list of string	None	The <i>dockerfile</i> VOLUME command which is used to enable access from the Docker container to a directory on the host machine.
host_id	no	string	None	The optional identifier of an existing host resource that should be used to run this container on.
volume_id	no	string	None	The optional identifier of an existing storage volume (resource) that should be used to create the container's mount point(s) on.

9.2.1.2 Definition

```
tosca.capabilities.Container.Docker:
```

```

derived_from: tosca.capabilities.Container
properties:
  version:
    type: list
    required: false
    entry_schema: version
  publish_all:
    type: boolean
    default: false
    required: false
  publish_ports:
    type: list
    entry_schema: PortSpec
    required: false
  expose_ports:
    type: list
    entry_schema: PortSpec
    required: false
  volumes:
    type: list
    entry_schema: string
    required: false

```

9.2.1.3 Notes

- When the **expose_ports** property is used, only the **source** and **source_range** properties of [PortSpec](#) would be valid for supplying port numbers or ranges, the **target** and **target_range** properties would be ignored.

9.3 Node Types

This section contains non-normative node types referenced in use cases and examples. All additional Attributes, Properties, Requirements and Capabilities shown in their definitions (and are not inherited from ancestor normative types) are also considered to be non-normative.

9.3.1 [tosca.nodes.Database.MySQL](#)

9.3.1.1 Properties

Name	Required	Type	Constraints	Description
N/A	N/A	N/A	N/A	N/A

9.3.1.2 Definition

```
tosca.nodes.Database.MySQL:
```

```
derived_from: tosca.nodes.Database
requirements:
  - host:
      node: tosca.nodes.DBMS.MySQL
```

9.3.2 [tosca.nodes.DBMS.MySQL](#)

9.3.2.1 Properties

Name	Required	Type	Constraints	Description
N/A	N/A	N/A	N/A	N/A

9.3.2.2 Definition

```
tosca.nodes.DBMS.MySQL:
  derived_from: tosca.nodes.DBMS
  properties:
    port:
      description: reflect the default MySQL server port
      default: 3306
    root_password:
      # MySQL requires a root_password for configuration
      # Override parent DBMS definition to make this property required
      required: true
  capabilities:
    # Further constrain the 'host' capability to only allow MySQL databases
    host:
      valid_source_types: [ tosca.nodes.Database.MySQL ]
```

9.3.3 [tosca.nodes.WebServer.Apache](#)

9.3.3.1 Properties

Name	Required	Type	Constraints	Description
N/A	N/A	N/A	N/A	N/A

9.3.3.2 Definition

```
tosca.nodes.WebServer.Apache:
  derived_from: tosca.nodes.WebServer
```

9.3.4 [tosca.nodes.WebApplication.WordPress](#)

This section defines a non-normative Node type for the WordPress [[WordPress](#)] application.

9.3.4.1 Properties

Name	Required	Type	Constraints	Description
N/A	N/A	N/A	N/A	N/A

9.3.4.2 Definition

```
tosca.nodes.WebApplication.WordPress:
  derived_from: tosca.nodes.WebApplication
  properties:
    admin_user:
      type: string
    admin_password:
      type: string
    db_host:
      type: string
  requirements:
    - database_endpoint:
        capability: tosca.capabilities.Endpoint.Database
        node: tosca.nodes.Database
        relationship: tosca.relationships.ConnectsTo
```

9.3.5 tosca.nodes.WebServer.Nodejs

This non-normative node type represents a Node.js [[NodeJS](#)] web application server.

9.3.5.1 Properties

Name	Required	Type	Constraints	Description
N/A	N/A	N/A	N/A	N/A

9.3.5.2 Definition

```
tosca.nodes.WebServer.Nodejs:
  derived_from: tosca.nodes.WebServer
  properties:
    # Property to supply the desired implementation in the Github repository
    github_url:
      required: no
      type: string
      description: location of the application on the github.
      default: https://github.com/mmm/testnode.git
  interfaces:
    Standard:
```

```
inputs:
  github_url:
    type: string
```

9.3.6 `tosca.nodes.Container.Application.Docker`

9.3.6.1 Properties

Name	Required	Type	Constraints	Description
N/A	N/A	N/A	N/A	N/A

9.3.6.2 Definition

```
tosca.nodes.Container.Application.Docker:
  derived_from: tosca.nodes.Container.Application
  requirements:
    - host:
        capability: tosca.capabilities.Container.Docker
```

10 Component Modeling Use Cases

This section is **non-normative** and includes use cases that explore how to model components and their relationships using TOSCA Simple Profile in YAML.

10.1.1 Use Case: Exploring the HostedOn relationship using WebApplication and WebServer

This use case examines the ways TOSCA YAML can be used to express a simple hosting relationship (i.e., **HostedOn**) using the normative TOSCA **WebServer** and **WebApplication** node types defined in this specification.

10.1.1.1 WebServer declares its “host” capability

For convenience, relevant parts of the normative TOSCA Node Type for **WebServer** are shown below:

```
tosca.nodes.WebServer
  derived_from: SoftwareComponent
  capabilities:
    ...
  host:
    type: tosca.capabilities.Container
    valid_source_types: [ tosca.nodes.WebApplication ]
```

As can be seen, the **WebServer** Node Type declares its capability to “contain” (i.e., host) other nodes using the symbolic name “**host**” and providing the Capability Type **tosca.capabilities.Container**. It should be noted that the symbolic name of “**host**” is not a reserved word, but one assigned by the type designer that implies at or betokens the associated capability. The **Container** capability definition also includes a required list of valid Node Types that can be contained by this, the **WebServer**, Node Type. This list is declared using the keyname of **valid_source_types** and in this case it includes only allowed type **WebApplication**.

10.1.1.2 WebApplication declares its “host” requirement

The **WebApplication** node type needs to be able to describe the type of capability a target node would have to provide in order to “host” it. The normative TOSCA capability type **tosca.capabilities.Container** is used to describe all normative TOSCA hosting (i.e., container-containee pattern) relationships. As can be seen below, the **WebApplication** accomplishes this by declaring a requirement with the symbolic name “**host**” with the **capability** keyname set to **tosca.capabilities.Container**.

Again, for convenience, the relevant parts of the normative **WebApplication** Node Type are shown below:

```
tosca.nodes.WebApplication:
  derived_from: tosca.nodes.Root
  requirements:
    - host:
      capability: tosca.capabilities.Container
      node: tosca.nodes.WebServer
      relationship: tosca.relationships.HostedOn
```

10.1.1.2.1 Notes

- The symbolic name “host” is not a keyword and was selected for consistent use in TOSCA normative node types to give the reader an indication of the type of requirement being referenced. A valid HostedOn relationship could still be established between WebApplicaton and WebServer in a TOSCA Service Template regardless of the symbolic name assigned to either the requirement or capability declaration.

10.1.2 Use Case: Establishing a ConnectsTo relationship to WebServer

This use case examines the ways TOSCA YAML can be used to express a simple connection relationship (i.e., [ConnectsTo](#)) between some service derived from the [SoftwareComponent](#) Node Type, to the normative [WebServer](#) node type defined in this specification.

The service template that would establish a [ConnectsTo](#) relationship as follows:

```
node_types:
  MyServiceType:
    derived_from: SoftwareComponent
    requirements:
      # This type of service requires a connection to a WebServer's data_endpoint
      - connection1:
          node: WebServer
          relationship: ConnectsTo
          capability: Endpoint

topology_template:
  node_templates:
    my_web_service:
      type: MyServiceType
      ...
      requirements:
        - connection1:
            node: my_web_server

    my_web_server:
      # Note, the normative WebServer node type declares the "data_endpoint"
      # capability of type tosca.capabilities.Endpoint.
      type: WebServer
```

Since the normative [WebServer](#) Node Type only declares one capability of type [tosca.capabilities.Endpoint](#) (or [Endpoint](#), its shortname alias in TOSCA) using the symbolic name [data_endpoint](#), the [my_web_service](#) node template does not need to declare that symbolic name on its requirement declaration. If however, the [my_web_server](#) node was based upon some other node type that declared more than one capability of type [Endpoint](#), then the [capability](#) keyname could be used to supply the desired symbolic name if necessary.

10.1.2.1 Best practice

It should be noted that the best practice for designing Node Types in TOSCA should not export two capabilities of the same type if they truly offer different functionality (i.e., different capabilities) which should be distinguished using different Capability Type definitions.

10.1.3 Use Case: Attaching (local) BlockStorage to a Compute node

This use case examines the ways TOSCA YAML can be used to express a simple AttachesTo relationship between a Compute node and a locally attached BlockStorage node.

The service template that would establish an [AttachesTo](#) relationship follows:

```
node_templates:
  my_server:
    type: Compute
    ...
    requirements:
      # contextually this can only be a relationship type
      - local_storage:
          # capability is provided by Compute Node Type
          node: my_block_storage
          relationship:
            type: AttachesTo
            properties:
              location: /path1/path2
          # This maps the local requirement name 'local_storage' to the
          # target node's capability name 'attachment'

  my_block_storage:
    type: BlockStorage
    properties:
      size: 10 GB
```

10.1.4 Use Case: Reusing a BlockStorage Relationship using Relationship Type or Relationship Template

This builds upon the previous use case (10.1.3) to examine how a template author could attach multiple Compute nodes (templates) to the same BlockStorage node (template), but with slightly different property values for the AttachesTo relationship.

Specifically, several notation options are shown (in this use case) that achieve the same desired result.

10.1.4.1 Simple Profile Rationale

Referencing an explicitly declared Relationship Template is a convenience of the Simple Profile that allows template authors an entity to set, constrain or override the properties and operations as defined in its declared (Relationship) Type much as allowed now for Node Templates. It is especially useful when a complex Relationship Type (with many configurable properties or operations) has several logical

occurrences in the same Service (Topology) Template; allowing the author to avoid configuring these same properties and operations in multiple Node Templates.

10.1.4.2 Notation Style #1: Augment AttachesTo Relationship Type directly in each Node Template

This notation extends the methodology used for establishing a HostedOn relationship, but allowing template author to supply (dynamic) configuration and/or override of properties and operations.

Note: This option will remain valid for Simple Profile regardless of other notation (copy or aliasing) options being discussed or adopted for future versions.

```
node_templates:

  my_block_storage:
    type: BlockStorage
    properties:
      size: 10

  my_web_app_tier_1:
    type: Compute
    requirements:
      - local_storage:
          node: my_block_storage
          relationship: MyAttachesTo
          # use default property settings in the Relationship Type definition

  my_web_app_tier_2:
    type: Compute
    requirements:
      - local_storage:
          node: my_block_storage
          relationship:
            type: MyAttachesTo
            # Override default property setting for just the 'location' property
            properties:
              location: /some_other_data_location

relationship_types:

  MyAttachesTo:
    derived_from: AttachesTo
    properties:
```

```
location: /default_location
interfaces:
  Configure:
    post_configure_target:
      implementation: default_script.sh
```

10.1.4.3 Notation Style #2: Use the 'template' keyword on the Node Templates to specify which named Relationship Template to use

This option shows how to explicitly declare different named Relationship Templates within the Service Template as part of a **relationship_templates** section (which have different property values) and can be referenced by different Compute typed Node Templates.

```
node_templates:

  my_block_storage:
    type: BlockStorage
    properties:
      size: 10

  my_web_app_tier_1:
    derived_from: Compute
    requirements:
      - local_storage:
          node: my_block_storage
          relationship: storage_attachesto_1

  my_web_app_tier_2:
    derived_from: Compute
    requirements:
      - local_storage:
          node: my_block_storage
          relationship: storage_attachesto_2

relationship_templates:
  storage_attachesto_1:
    type: MyAttachesTo
    properties:
      location: /my_data_location

  storage_attachesto_2:
```

```

type: MyAttachesTo
properties:
  location: /some_other_data_location

relationship_types:

MyAttachesTo:
  derived_from: AttachesTo
  interfaces:
    some_interface_name:
      some_operation:
        implementation: default_script.sh

```

10.1.4.4 Notation Style #3: Using the “copy” keyname to define a similar Relationship Template

How does TOSCA make it easier to create a new relationship template that is mostly the same as one that exists without manually copying all the same information? TOSCA provides the **copy** keyname as a convenient way to copy an existing template definition into a new template definition as a starting point or basis for describing a new definition and avoid manual copy. The end results are cleaner TOSCA Service Templates that allows the description of only the changes (or deltas) between similar templates.

The example below shows that the Relationship Template named **storage_attachesto_1** provides some overrides (conceptually a large set of overrides) on its Type which the Relationship Template named **storage_attachesto_2** wants to “copy” before perhaps providing a smaller number of overrides.

```

node_templates:

my_block_storage:
  type: BlockStorage
  properties:
    size: 10

my_web_app_tier_1:
  derived_from: Compute
  requirements:
    - attachment:
        node: my_block_storage
        relationship: storage_attachesto_1

my_web_app_tier_2:
  derived_from: Compute
  requirements:
    - attachment:

```

```

        node: my_block_storage
        relationship: storage_attachesto_2

relationship_templates:
  storage_attachesto_1:
    type: MyAttachesTo
    properties:
      location: /my_data_location
    interfaces:
      some_interface_name:
        some_operation_name_1: my_script_1.sh
        some_operation_name_2: my_script_2.sh
        some_operation_name_3: my_script_3.sh

  storage_attachesto_2:
    # Copy the contents of the "storage_attachesto_1" template into this new one
    copy: storage_attachesto_1
    # Then change just the value of the location property
    properties:
      location: /some_other_data_location

relationship_types:

MyAttachesTo:
  derived_from: AttachesTo
  interfaces:
    some_interface_name:
      some_operation:
        implementation: default_script.sh

```

11 Application Modeling Use Cases

This section is **non-normative** and includes use cases that show how to model Infrastructure-as-a-Service (IaaS), Platform-as-a-Service (PaaS) and complete application uses cases using TOSCA Simple Profile in YAML.

11.1 Use cases

Many of the use cases listed below can be found under the following link:

<https://github.com/openstack/heat-translator/tree/master/translator/tests/data>

11.1.1 Overview

Name	Description
Compute: Create a single Compute instance with a host Operating System	Introduces a TOSCA Compute node type which is used to stand up a single compute instance with a host Operating System Virtual Machine (VM) image selected by the platform provider using the Compute node's properties.
Software Component 1: Automatic deployment of a Virtual Machine (VM) image artifact	Introduces the SoftwareComponent node type which declares software that is hosted on a Compute instance. In this case, the SoftwareComponent declares a VM image as a deployment artifact which includes its own pre-packaged operating system and software. The TOSCA Orchestrator detects this known deployment artifact type on the SoftwareComponent node template and automatically deploys it to the Compute node.
BlockStorage-1: Attaching Block Storage to a single Compute instance	Demonstrates how to attach a TOSCA BlockStorage node to a Compute node using the normative AttachesTo relationship.
BlockStorage-2: Attaching Block Storage using a custom Relationship Type	Demonstrates how to attach a TOSCA BlockStorage node to a Compute node using a custom RelationshipType that derives from the normative AttachesTo relationship.
BlockStorage-3: Using a Relationship Template of type AttachesTo	Demonstrates how to attach a TOSCA BlockStorage node to a Compute node using a TOSCA Relationship Template that is based upon the normative AttachesTo Relationship Type.
BlockStorage-4: Single Block Storage shared by 2-Tier Application with custom AttachesTo Type and implied relationships	This use case shows 2 Compute instances (2 tiers) with one BlockStorage node, and also uses a custom AttachesTo Relationship that provides a default mount point (i.e., location) which the 1 st tier uses, but the 2 nd tier provides a different mount point.
BlockStorage-5: Single Block Storage shared by 2-Tier Application with custom AttachesTo Type and explicit Relationship Templates	This use case is like the previous BlockStorage-4 use case, but also creates two relationship templates (one for each tier) each of which provide a different mount point (i.e., location) which overrides the default location defined in the custom Relationship Type.
BlockStorage-6: Multiple Block Storage attached to different Servers	This use case demonstrates how two different TOSCA BlockStorage nodes can be attached to two different Compute nodes (i.e., servers) each using the normative AttachesTo relationship.
Object Storage 1: Creating an Object Storage service	Introduces the TOSCA ObjectStorage node type and shows how it can be instantiated.
Network-1: Server bound to a new network	Introduces the TOSCA Network and Port nodes used for modeling logical networks using the LinksTo and BindsTo Relationship Types. In this use case, the template is invoked without an existing network_name as an input property so a new network is created using the properties declared in the Network node.

Network-2: Server bound to an existing network	Shows how to use a network_name as an input parameter to the template to allow a server to be associated with (i.e. bound to) an existing Network .
Network-3: Two servers bound to a single network	This use case shows how two servers (Compute nodes) can be associated with the same Network node using two logical network Ports .
Network-4: Server bound to three networks	This use case shows how three logical networks (Network nodes), each with its own IP address range, can be associated with the same server (Compute node).
WebServer-DBMS-1: WordPress [WordPress] + MySQL, single instance	Shows how to host a TOSCA WebServer with a TOSCA WebApplication , DBMS and Database Node Types along with their dependent HostedOn and ConnectsTo relationships.
WebServer-DBMS-2: Nodejs with PayPal Sample App and MongoDB on separate instances	Instantiates a 2-tier application with Nodejs and its (PayPal sample) WebApplication on one tier which connects a MongoDB database (which stores its application data) using a ConnectsTo relationship.
Multi-Tier-1: Elasticsearch, Logstash, Kibana (ELK)	<p>Shows Elasticsearch, Logstash and Kibana (ELK) being used in a typical manner to collect, search and monitor/visualize data from a running application.</p> <p>This use case builds upon the previous Nodejs/MongoDB 2-tier application as the one being monitored. The collectd and rsyslog components are added to both the WebServer and Database tiers which work to collect data for Logstash.</p> <p>In addition to the application tiers, a 3rd tier is introduced with Logstash to collect data from the application tiers. Finally a 4th tier is added to search the Logstash data with Elasticsearch and visualize it using Kibana.</p> <p>Note: This use case also shows the convenience of using a single YAML macro (declared in the dsl_definitions section of the TOSCA Service Template) on multiple Compute nodes.</p>
Container-1: Containers using Docker single Compute instance (Containers only)	<p>Minimalist TOSCA Service Template description of 2 Docker containers linked to each other. Specifically, one container runs wordpress and connects to second mysql database container both on a single server (i.e., Compute instance). The use case also demonstrates how TOSCA declares and references Docker images from the Docker Hub repository.</p> <p>Variation 1: Docker Container nodes (only) providing their Docker Requirements allowing platform (orchestrator) to select/provide the underlying Docker implementation (Capability).</p>
Artifacts: Compute Node with multiple artifacts	Illustrates how multiple artifacts for different lifecycle operations (create, terminate, configure, etc.) can be associated with a node.

11.1.2 Compute: Create a single Compute instance with a host Operating System

11.1.2.1 Description

This use case demonstrates how the TOSCA Simple Profile specification can be used to stand up a single **Compute** instance with a guest Operating System using a normative TOSCA **Compute** node. The TOSCA **Compute** node is declarative in that the service template describes both the processor and host operating system platform characteristics (i.e., properties declared on the capability named “**os**” sometimes called a “flavor”) that are desired by the template author. The cloud provider would attempt to fulfill these properties (to the best of its abilities) during orchestration.

11.1.2.2 Features

This use case introduces the following TOSCA Simple Profile features:

- A node template that uses the normative TOSCA **Compute** Node Type along with showing an exemplary set of its properties being configured.
- Use of the TOSCA Service Template **inputs** section to declare a configurable value the template user may supply at runtime. In this case, the “**host**” property named “**num_cpus**” (of type integer) is declared.
 - Use of a property constraint to limit the allowed integer values for the “**num_cpus**” property to a specific list supplied in the property declaration.
- Use of the TOSCA Service Template **outputs** section to declare a value the template user may request at runtime. In this case, the property named “**instance_ip**” is declared
 - The “**instance_ip**” output property is programmatically retrieved from the **Compute** node’s “**public_address**” attribute using the TOSCA Service Template-level **get_attribute** function.

11.1.2.3 Logical Diagram

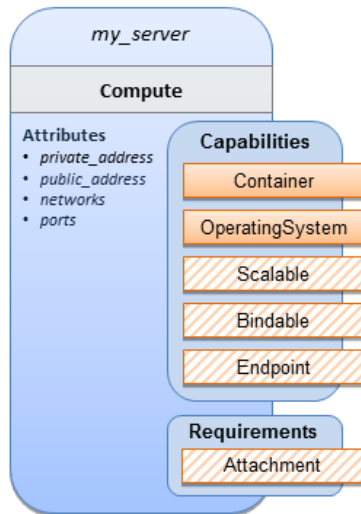

11.1.2.4 Sample YAML

```
tosca_definitions_version: tosca_simple_yaml_1_3

description: >
  TOSCA simple profile that just defines a single compute instance and selects a
  (guest) host Operating System from the Compute node’s properties. Note, this
  example does not include default values on inputs properties.

topology_template:
  inputs:
    cpus:
      type: integer
      description: Number of CPUs for the server.
      constraints:
        - valid_values: [ 1, 2, 4, 8 ]
```

```

node_templates:
  my_server:
    type: Compute
    capabilities:
      host:
        properties:
          disk_size: 10 GB
          num_cpus: { get_input: cpus }
          mem_size: 1 GB
    os:
      properties:
        architecture: x86_64
        type: Linux
        distribution: ubuntu
        version: 12.04
    outputs:
      private_ip:
        description: The private IP address of the deployed server instance.
        value: { get_attribute: [my_server, private_address] }

```

11.1.2.5 Notes

- This use case uses a versioned, Linux Ubuntu distribution on the Compute node.

11.1.3 Software Component 1: Automatic deployment of a Virtual Machine (VM) image artifact

11.1.3.1 Description

This use case demonstrates how the TOSCA SoftwareComponent node type can be used to declare software that is packaged in a standard Virtual Machine (VM) image file format (i.e., in this case QCOW2) and is hosted on a TOSCA Compute node (instance). In this variation, the SoftwareComponent declares a VM image as a deployment artifact that includes its own pre-packaged operating system and software. The TOSCA Orchestrator detects this known deployment artifact type on the SoftwareComponent node template and automatically deploys it to the Compute node.

11.1.3.2 Features

This use case introduces the following TOSCA Simple Profile features:

- A node template that uses the normative TOSCA **SoftwareComponent** Node Type along with showing an exemplary set of its properties being configured.
- Use of the TOSCA Service Template **artifacts** section to declare a Virtual Machine (VM) image artifact type which is referenced by the **SoftwareComponent** node template.
- The VM file format, in this case QCOW2, includes its own guest Operating System (OS) and therefore does **not** “require” a TOSCA **OperatingSystem** capability from the TOSCA Compute node.

11.1.3.3 Assumptions

This use case assumes the following:

- That the TOSCA Orchestrator (working with the Cloud provider’s underlying management services) is able to instantiate a Compute node that has a hypervisor that supports the Virtual Machine (VM) image format, in this case QCOW2, which should be compatible with many standard hypervisors such as XEN and KVM.
- This is not a “bare metal” use case and assumes the existence of a hypervisor on the machine that is allocated to “host” the Compute instance supports (e.g. has drivers, etc.) the VM image format in this example.

11.1.3.4 Logical Diagram

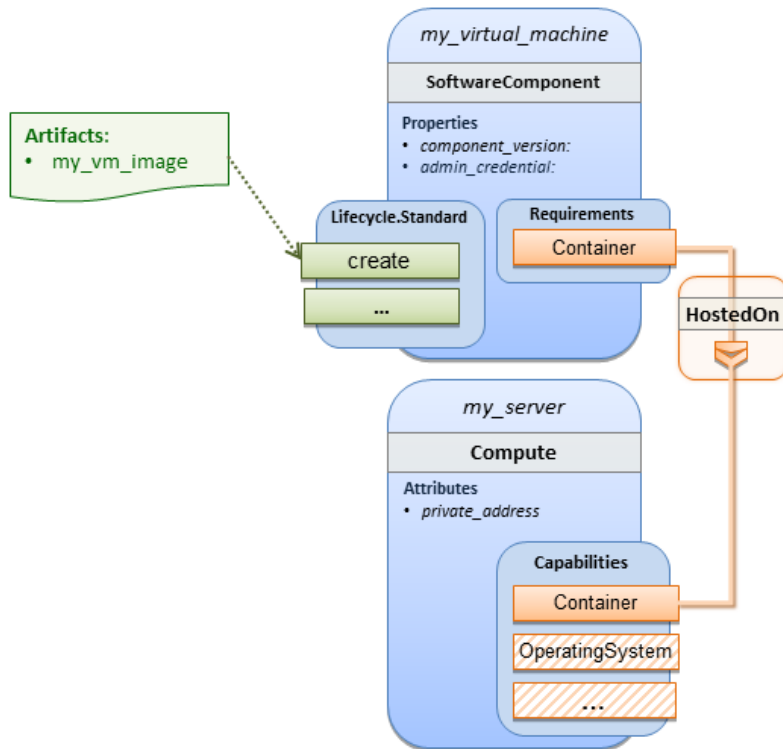

11.1.3.5 Sample YAML

```
tosca_definitions_version: tosca_simple_yaml_1_3

description: >
  TOSCA Simple Profile with a SoftwareComponent node with a declared Virtual
  machine (VM) deployment artifact that automatically deploys to its host Compute
  node.

topology_template:

  node_templates:
    my_virtual_machine:
```

```

type: SoftwareComponent
artifacts:
  my_vm_image:
    file: images/fedora-18-x86_64.qcow2
    type: toska.artifacts.Deployment.Image.VM.QCOW2
    topology: my_VMs_topology.yaml
requirements:
  - host: my_server
# Automatically deploy the VM image referenced on the create operation
interfaces:
  Standard:
    create: my_vm_image

# Compute instance with no Operating System guest host
my_server:
  type: Compute
  capabilities:
    # Note: no guest OperatingSystem requirements as these are in the image.
  host:
    properties:
      disk_size: 10 GB
      num_cpus: { get_input: cpus }
      mem_size: 4 GB

outputs:
  private_ip:
    description: The private IP address of the deployed server instance.
    value: { get_attribute: [my_server, private_address] }

```

11.1.3.6 Notes

- The use of the **type** keyname on the **artifact** definition (within the **my_virtual_machine** node template) to declare the ISO image deployment artifact type (i.e., **toska.artifacts.Deployment.Image.VM.ISO**) is redundant since the file extension is “.iso” which associated with this known, declared artifact type.
- This use case references a filename on the **my_vm_image** artifact, which indicates a Linux, Fedora 18, x86 VM image, only as one possible example.

11.1.4 Block Storage 1: Using the normative AttachesTo Relationship Type

11.1.4.1 Description

This use case demonstrates how to attach a TOSCA **BlockStorage** node to a **Compute** node using the normative **AttachesTo** relationship.

11.1.4.2 Logical Diagram

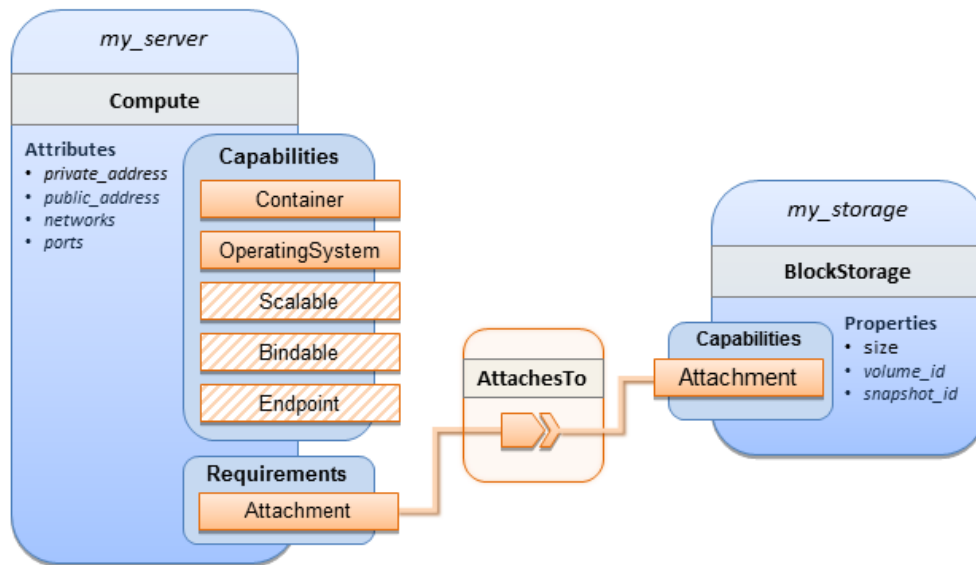

11.1.4.3 Sample YAML

```
tosca_definitions_version: toska_simple_yaml_1_3

description: >
  TOSCA simple profile with server and attached block storage using the normative
  AttachesTo Relationship Type.

topology_template:

  inputs:
    cpus:
      type: integer
      description: Number of CPUs for the server.
      constraints:
        - valid_values: [ 1, 2, 4, 8 ]
    storage_size:
      type: scalar-unit.size
      description: Size of the storage to be created.
      default: 1 GB
    storage_snapshot_id:
      type: string
      description: >
        Optional identifier for an existing snapshot to use when creating
        storage.
    storage_location:
```

```

    type: string
    description: Block storage mount point (filesystem path).

node_templates:
  my_server:
    type: Compute
    capabilities:
      host:
        properties:
          disk_size: 10 GB
          num_cpus: { get_input: cpus }
          mem_size: 1 GB
        os:
          properties:
            architecture: x86_64
            type: linux
            distribution: fedora
            version: 18.0
      requirements:
        - local_storage:
            node: my_storage
            relationship:
              type: AttachesTo
              properties:
                location: { get_input: storage_location }

    my_storage:
      type: BlockStorage
      properties:
        size: { get_input: storage_size }
        snapshot_id: { get_input: storage_snapshot_id }

    outputs:
      private_ip:
        description: The private IP address of the newly created compute instance.
        value: { get_attribute: [my_server, private_address] }
      volume_id:
        description: The volume id of the block storage instance.
        value: { get_attribute: [my_storage, volume_id] }

```

11.1.5 Block Storage 2: Using a custom AttachesTo Relationship Type

11.1.5.1 Description

This use case demonstrates how to attach a TOSCA **BlockStorage** node to a **Compute** node using a custom RelationshipType that derives from the normative **AttachesTo** relationship.

11.1.5.2 Logical Diagram

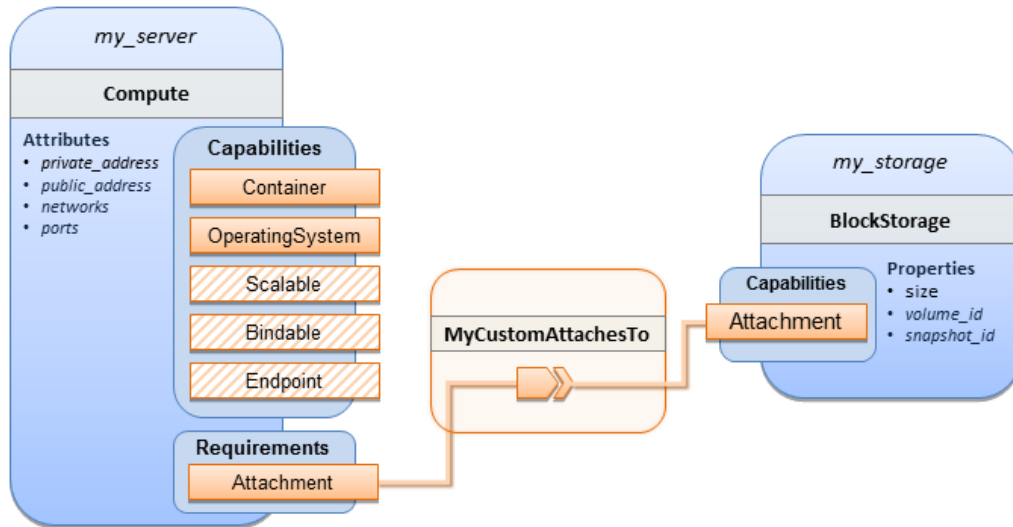

11.1.5.3 Sample YAML

```
tosca_definitions_version: tosca_simple_yaml_1_3

description: >
  TOSCA simple profile with server and attached block storage using a custom
  AttachesTo Relationship Type.

relationship_types:
  MyCustomAttachesTo:
    derived_from: AttachesTo

topology_template:
  inputs:
    cpus:
      type: integer
      description: Number of CPUs for the server.
      constraints:
        - valid_values: [ 1, 2, 4, 8 ]
    storage_size:
```

```

    type: scalar-unit.size
    description: Size of the storage to be created.
    default: 1 GB
  storage_snapshot_id:
    type: string
    description: >
      Optional identifier for an existing snapshot to use when creating
      storage.
  storage_location:
    type: string
    description: Block storage mount point (filesystem path).

node_templates:
  my_server:
    type: Compute
    capabilities:
      host:
        properties:
          disk_size: 10 GB
          num_cpus: { get_input: cpus }
          mem_size: 4 GB
      os:
        properties:
          architecture: x86_64
          type: Linux
          distribution: Fedora
          version: 18.0
    requirements:
      - local_storage:
          node: my_storage
          # Declare custom AttachesTo type using the 'relationship' keyword
          relationship:
            type: MyCustomAttachesTo
            properties:
              location: { get_input: storage_location }
  my_storage:
    type: BlockStorage
    properties:
      size: { get_input: storage_size }
      snapshot_id: { get_input: storage_snapshot_id }

```

```

outputs:
  private_ip:
    description: The private IP address of the newly created compute instance.
    value: { get_attribute: [my_server, private_address] }
  volume_id:
    description: The volume id of the block storage instance.
    value: { get_attribute: [my_storage, volume_id] }

```

11.1.6 Block Storage 3: Using a Relationship Template of type AttachesTo

11.1.6.1 Description

This use case demonstrates how to attach a TOSCA **BlockStorage** node to a **Compute** node using a TOSCA Relationship Template that is based upon the normative **AttachesTo** Relationship Type.

11.1.6.2 Logical Diagram

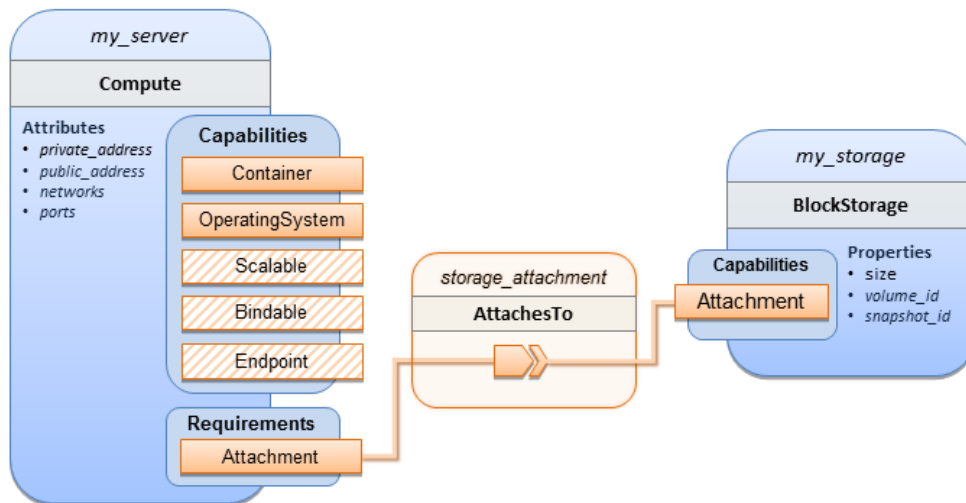

11.1.6.3 Sample YAML

```

tosca_definitions_version: tosca_simple_yaml_1_3

description: >
  TOSCA simple profile with server and attached block storage using a named
  Relationship Template for the storage attachment.

topology_template:
  inputs:
    cpus:
      type: integer

```

```

description: Number of CPUs for the server.
constraints:
  - valid_values: [ 1, 2, 4, 8 ]
storage_size:
  type: scalar-unit.size
  description: Size of the storage to be created.
  default: 1 GB
storage_location:
  type: string
  description: Block storage mount point (filesystem path).

node_templates:
  my_server:
    type: Compute
    capabilities:
      host:
        properties:
          disk_size: 10 GB
          num_cpus: { get_input: cpus }
          mem_size: 4 GB
    os:
      properties:
        architecture: x86_64
        type: Linux
        distribution: Fedora
        version: 18.0
    requirements:
      - local_storage:
          node: my_storage
          # Declare template to use with 'relationship' keyword
          relationship: storage_attachment

  my_storage:
    type: BlockStorage
    properties:
      size: { get_input: storage_size }

relationship_templates:
  storage_attachment:
    type: AttachesTo
    properties:

```



```

location: { get_input: storage_location }

outputs:
  private_ip:
    description: The private IP address of the newly created compute instance.
    value: { get_attribute: [my_server, private_address] }
  volume_id:
    description: The volume id of the block storage instance.
    value: { get_attribute: [my_storage, volume_id] }

```

11.1.7 Block Storage 4: Single Block Storage shared by 2-Tier Application with custom AttachesTo Type and implied relationships

11.1.7.1 Description

This use case shows 2 compute instances (2 tiers) with one BlockStorage node, and also uses a custom **AttachesTo** Relationship that provides a default mount point (i.e., **location**) which the 1st tier uses, but the 2nd tier provides a different mount point.

Please note that this use case assumes both Compute nodes are accessing different directories within the shared, block storage node to avoid collisions.

11.1.7.2 Logical Diagram

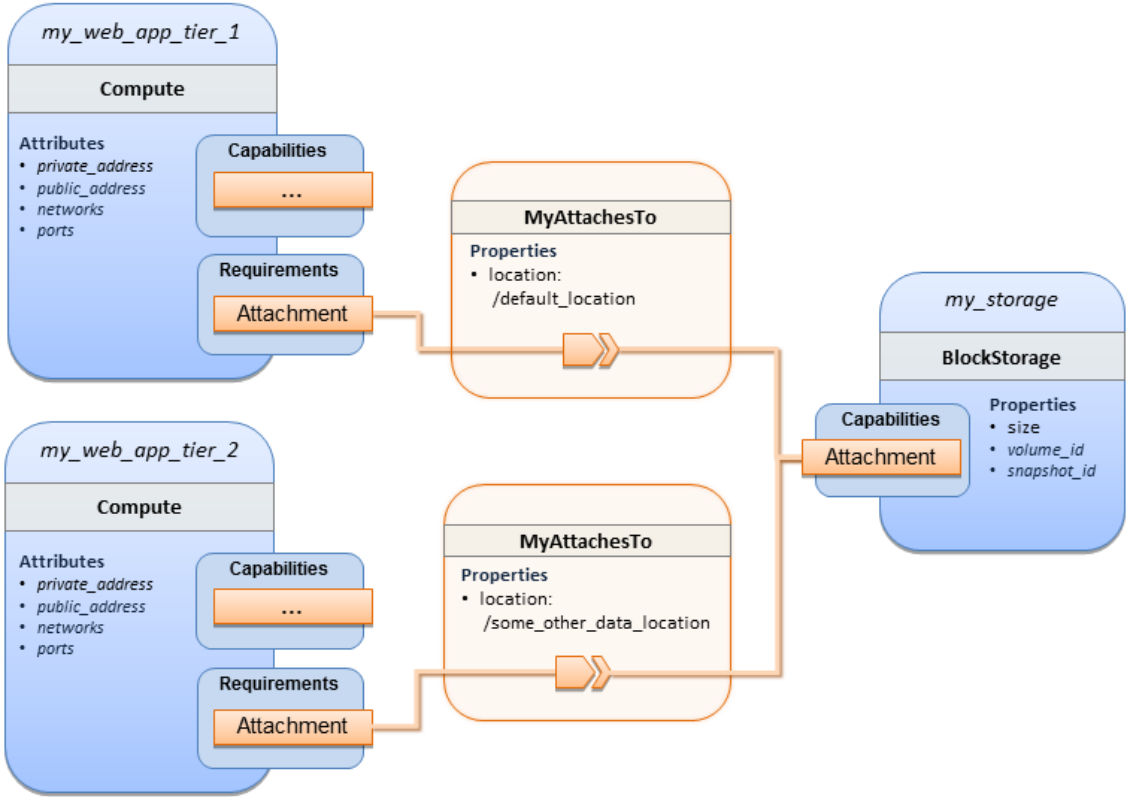

11.1.7.3 Sample YAML

```
tosca_definitions_version: tosca_simple_yaml_1_3

description: >
  TOSCA simple profile with a Single Block Storage node shared by 2-Tier Application with
  custom AttachesTo Type and implied relationships.

relationship_types:
  MyAttachesTo:
    derived_from: tosca.relationships.AttachesTo
    properties:
      location:
        type: string
        default: /default_location

topology_template:
  inputs:
    cpus:
      type: integer
      description: Number of CPUs for the server.
      constraints:
        - valid_values: [ 1, 2, 4, 8 ]
    storage_size:
      type: scalar-unit.size
      default: 1 GB
      description: Size of the storage to be created.
    storage_snapshot_id:
      type: string
      description: >
        Optional identifier for an existing snapshot to use when creating
        storage.

  node_templates:
    my_web_app_tier_1:
      type: tosca.nodes.Compute
      capabilities:
        host:
          properties:
            disk_size: 10 GB
            num_cpus: { get_input: cpus }
            mem_size: 4096 MB
```

```

    os:
      properties:
        architecture: x86_64
        type: Linux
        distribution: Fedora
        version: 18.0
      requirements:
        - local_storage:
            node: my_storage
            relationship: MyAttachesTo

my_web_app_tier_2:
  type: tosca.nodes.Compute
  capabilities:
    host:
      properties:
        disk_size: 10 GB
        num_cpus: { get_input: cpus }
        mem_size: 4096 MB
      os:
        properties:
          architecture: x86_64
          type: Linux
          distribution: Fedora
          version: 18.0
        requirements:
          - local_storage:
              node: my_storage
              relationship:
                type: MyAttachesTo
                properties:
                  location: /some_other_data_location

my_storage:
  type: tosca.nodes.Storage.BlockStorage
  properties:
    size: { get_input: storage_size }
    snapshot_id: { get_input: storage_snapshot_id }

outputs:
  private_ip_1:

```

```

description: The private IP address of the application's first tier.
value: { get_attribute: [my_web_app_tier_1, private_address] }
private_ip_2:
description: The private IP address of the application's second tier.
value: { get_attribute: [my_web_app_tier_2, private_address] }
volume_id:
description: The volume id of the block storage instance.
value: { get_attribute: [my_storage, volume_id] }

```

11.1.8 Block Storage 5: Single Block Storage shared by 2-Tier Application with custom AttachesTo type and explicit Relationship Templates

11.1.8.1 Description

This use case is like the Notation1 use case, but also creates two relationship templates (one for each tier) each of which provide a different mount point (i.e., **location**) which overrides the default location defined in the custom Relationship Type.

Please note that this use case assumes both Compute nodes are accessing different directories within the shared, block storage node to avoid collisions.

11.1.8.2 Logical Diagram

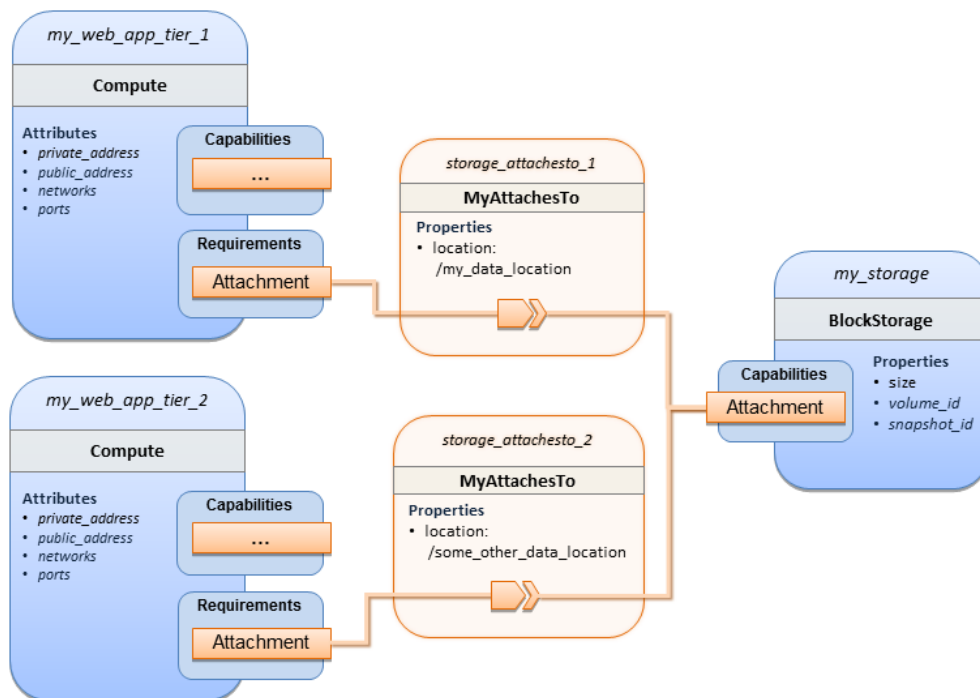

11.1.8.3 Sample YAML

```
tosca_definitions_version: tosca_simple_yaml_1_3
```

```

description: >
  TOSCA simple profile with a single Block Storage node shared by 2-Tier Application with
  custom AttachesTo Type and explicit Relationship Templates.

relationship_types:
  MyAttachesTo:
    derived_from: tosca.relationships.AttachesTo
    properties:
      location:
        type: string
        default: /default_location

topology_template:
  inputs:
    cpus:
      type: integer
      description: Number of CPUs for the server.
      constraints:
        - valid_values: [ 1, 2, 4, 8 ]
    storage_size:
      type: scalar-unit.size
      default: 1 GB
      description: Size of the storage to be created.
    storage_snapshot_id:
      type: string
      description: >
        Optional identifier for an existing snapshot to use when creating
        storage.
    storage_location:
      type: string
      description: >
        Block storage mount point (filesystem path).

  node_templates:

    my_web_app_tier_1:
      type: tosca.nodes.Compute
      capabilities:
        host:
          properties:
            disk_size: 10 GB

```

```

    num_cpus: { get_input: cpus }
    mem_size: 4096 MB
  os:
    properties:
      architecture: x86_64
      type: Linux
      distribution: Fedora
      version: 18.0
  requirements:
    - local_storage:
        node: my_storage
        relationship: storage_attachesto_1

my_web_app_tier_2:
  type: toska.nodes.Compute
  capabilities:
    host:
      properties:
        disk_size: 10 GB
        num_cpus: { get_input: cpus }
        mem_size: 4096 MB
    os:
      properties:
        architecture: x86_64
        type: Linux
        distribution: Fedora
        version: 18.0
  requirements:
    - local_storage:
        node: my_storage
        relationship: storage_attachesto_2

my_storage:
  type: toska.nodes.Storage.BlockStorage
  properties:
    size: { get_input: storage_size }
    snapshot_id: { get_input: storage_snapshot_id }

relationship_templates:
  storage_attachesto_1:
    type: MyAttachesTo

```

```

properties:
  location: /my_data_location

storage_attachesto_2:
  type: MyAttachesTo
  properties:
    location: /some_other_data_location
outputs:
  private_ip_1:
    description: The private IP address of the application's first tier.
    value: { get_attribute: [my_web_app_tier_1, private_address] }
  private_ip_2:
    description: The private IP address of the application's second tier.
    value: { get_attribute: [my_web_app_tier_2, private_address] }
  volume_id:
    description: The volume id of the block storage instance.
    value: { get_attribute: [my_storage, volume_id] }

```

11.1.9 Block Storage 6: Multiple Block Storage attached to different Servers

11.1.9.1 Description

This use case demonstrates how two different TOSCA **BlockStorage** nodes can be attached to two different **Compute** nodes (i.e., servers) each using the normative **AttachesTo** relationship.

11.1.9.2 Logical Diagram

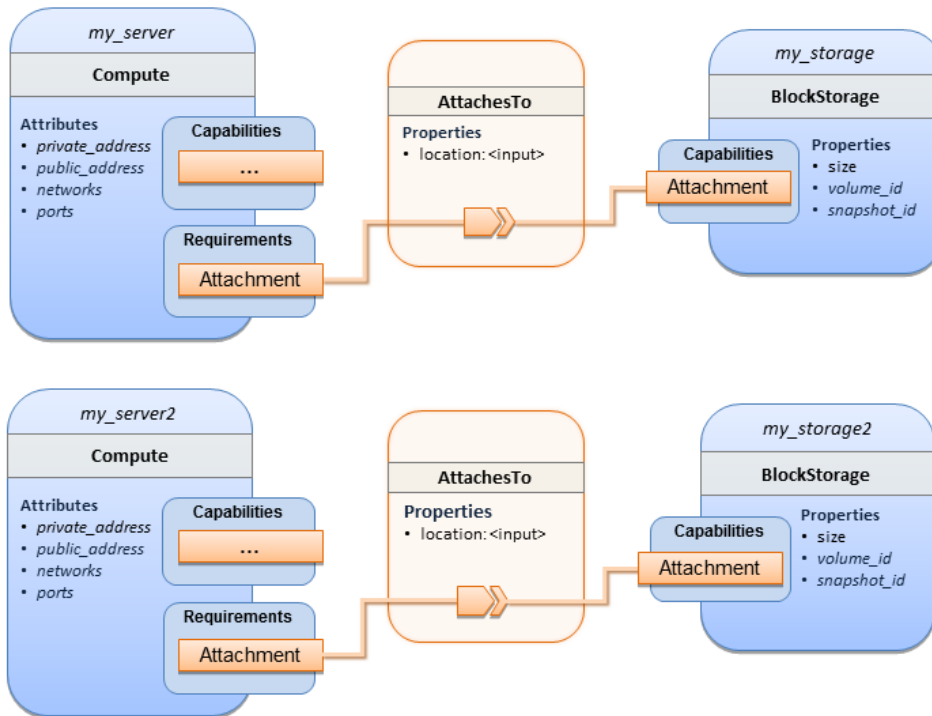

11.1.9.3 Sample YAML

```
tosca_definitions_version: toska_simple_yaml_1_3

description: >
  TOSCA simple profile with 2 servers each with different attached block storage.

topology_template:
  inputs:
    cpus:
      type: integer
      description: Number of CPUs for the server.
      constraints:
        - valid_values: [ 1, 2, 4, 8 ]
    storage_size:
      type: scalar-unit.size
      default: 1 GB
      description: Size of the storage to be created.
    storage_snapshot_id:
      type: string
      description: >
```

Optional identifier for an existing snapshot to use when creating storage.

storage_location:

type: string

description: >

Block storage mount point (filesystem path).

node_templates:

my_server:

type: toska.nodes.Compute

capabilities:

host:

properties:

disk_size: 10 GB

num_cpus: { get_input: cpus }

mem_size: 4096 MB

os:

properties:

architecture: x86_64

type: Linux

distribution: Fedora

version: 18.0

requirements:

- local_storage:

node: my_storage

relationship:

type: AttachesTo

properties:

location: { get_input: storage_location }

my_storage:

type: toska.nodes.Storage.BlockStorage

properties:

size: { get_input: storage_size }

snapshot_id: { get_input: storage_snapshot_id }

my_server2:

type: toska.nodes.Compute

capabilities:

host:

properties:

disk_size: 10 GB

```

    num_cpus: { get_input: cpus }
    mem_size: 4096 MB
  os:
    properties:
      architecture: x86_64
      type: Linux
      distribution: Fedora
      version: 18.0
  requirements:
    - local_storage:
      node: my_storage2
      relationship:
        type: AttachesTo
        properties:
          location: { get_input: storage_location }
  my_storage2:
    type: toska.nodes.Storage.BlockStorage
    properties:
      size: { get_input: storage_size }
      snapshot_id: { get_input: storage_snapshot_id }

  outputs:
    server_ip_1:
      description: The private IP address of the application's first server.
      value: { get_attribute: [my_server, private_address] }
    server_ip_2:
      description: The private IP address of the application's second server.
      value: { get_attribute: [my_server2, private_address] }
    volume_id_1:
      description: The volume id of the first block storage instance.
      value: { get_attribute: [my_storage, volume_id] }
    volume_id_2:
      description: The volume id of the second block storage instance.
      value: { get_attribute: [my_storage2, volume_id] }

```

11.1.10 Object Storage 1: Creating an Object Storage service

11.1.10.1 Description

11.1.10.2 Logical Diagram

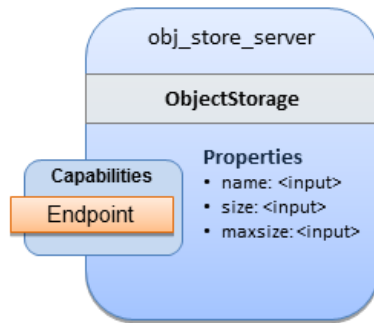

11.1.10.3 Sample YAML

```
tosca_definitions_version: tosca_simple_yaml_1_3

description: >
  Tosca template for creating an object storage service.

topology_template:
  inputs:
    objectstore_name:
      type: string

  node_templates:
    obj_store_server:
      type: tosca.nodes.Storage.ObjectStorage
      properties:
        name: { get_input: objectstore_name }
        size: 4096 MB
        maxsize: 20 GB
```

11.1.11 Network 1: Server bound to a new network

11.1.11.1 Description

Introduces the TOSCA **Network** and **Port** nodes used for modeling logical networks using the **LinksTo** and **BindsTo** Relationship Types. In this use case, the template is invoked without an existing `network_name` as an input property so a new network is created using the properties declared in the Network node.

11.1.11.2 Logical Diagram

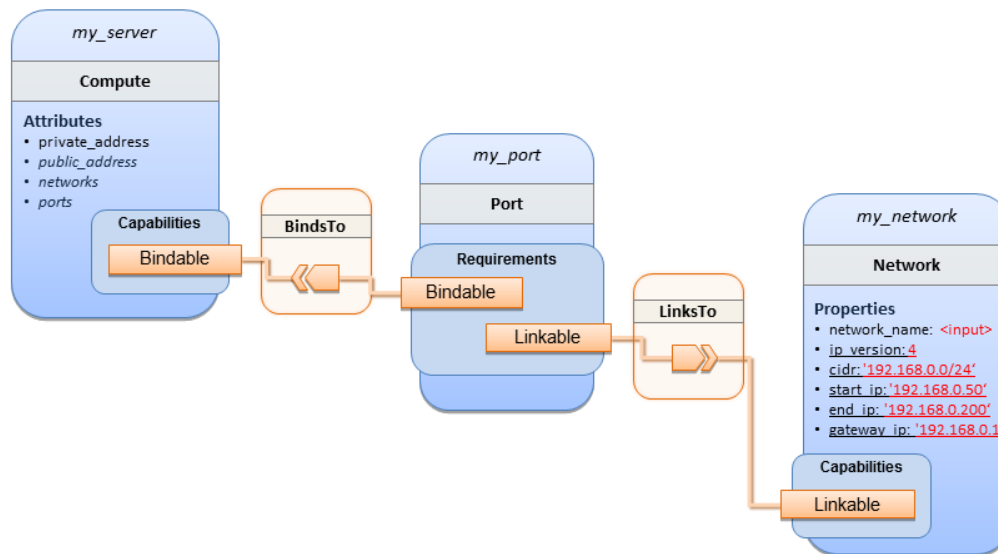

11.1.11.3 Sample YAML

```
tosca_definitions_version: tosca_simple_yaml_1_3

description: >
  TOSCA simple profile with 1 server bound to a new network

topology_template:

  inputs:
    network_name:
      type: string
      description: Network name

  node_templates:
    my_server:
      type: tosca.nodes.Compute
      capabilities:
        host:
          properties:
            disk_size: 10 GB
            num_cpus: 1
            mem_size: 4096 MB
        os:
          properties:
            architecture: x86_64
```

```
type: Linux
distribution: CirrOS
version: 0.3.2
```

```
my_network:
  type: toska.nodes.network.Network
  properties:
    network_name: { get_input: network_name }
    ip_version: 4
    cidr: '192.168.0.0/24'
    start_ip: '192.168.0.50'
    end_ip: '192.168.0.200'
    gateway_ip: '192.168.0.1'
```

```
my_port:
  type: toska.nodes.network.Port
  requirements:
    - binding: my_server
    - link: my_network
```

11.1.12 Network 2: Server bound to an existing network

11.1.12.1 Description

This use case shows how to use a `network_name` as an input parameter to the template to allow a server to be associated with an existing network.

11.1.12.2 Logical Diagram

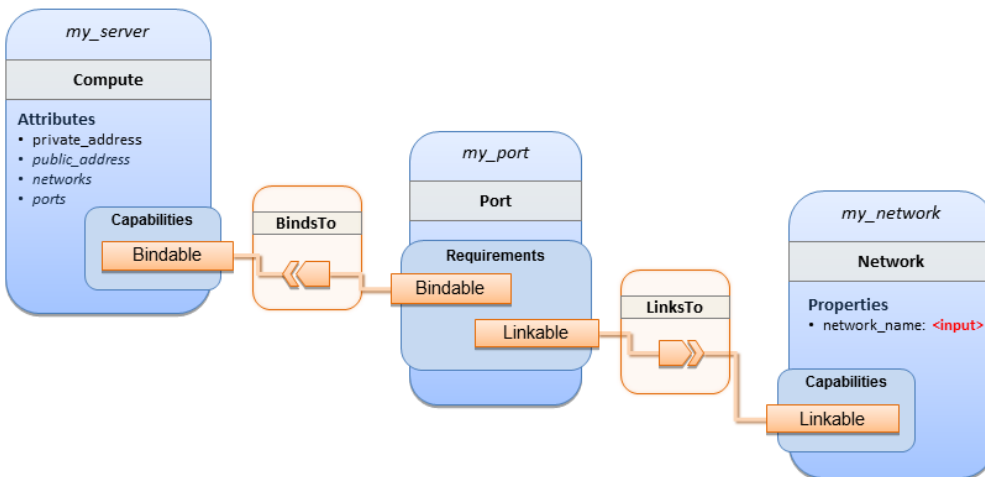

11.1.12.3 Sample YAML

```
tosca_definitions_version: tosca_simple_yaml_1_3

description: >
  TOSCA simple profile with 1 server bound to an existing network

topology_template:
  inputs:
    network_name:
      type: string
      description: Network name

  node_templates:
    my_server:
      type: tosca.nodes.Compute
      capabilities:
        host:
          properties:
            disk_size: 10 GB
            num_cpus: 1
            mem_size: 4096 MB
        os:
          properties:
            architecture: x86_64
            type: Linux
            distribution: CirrOS
            version: 0.3.2

    my_network:
      type: tosca.nodes.network.Network
      properties:
        network_name: { get_input: network_name }

    my_port:
      type: tosca.nodes.network.Port
      requirements:
        - binding:
            node: my_server
        - link:
            node: my_network
```

11.1.13 Network 3: Two servers bound to a single network

11.1.13.1 Description

This use case shows how two servers (**Compute** nodes) can be bound to the same **Network** (node) using two logical network **Ports**.

11.1.13.2 Logical Diagram

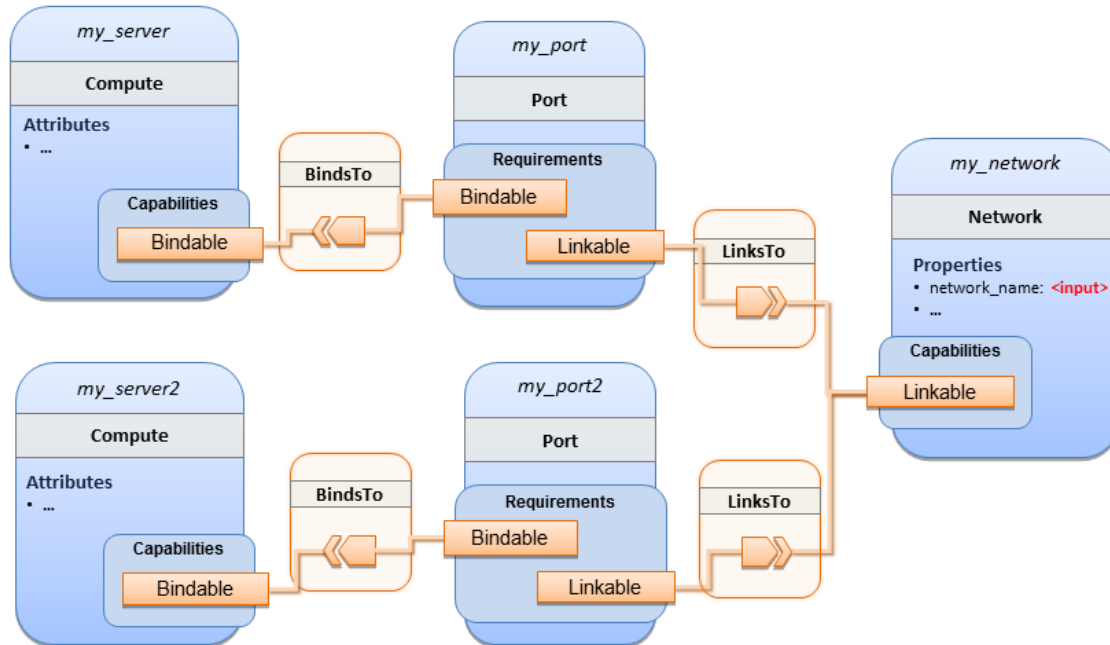

11.1.13.3 Sample YAML

```
tosca_definitions_version: tosca_simple_yaml_1_3

description: >
  TOSCA simple profile with 2 servers bound to the 1 network

topology_template:

  inputs:
    network_name:
      type: string
      description: Network name
    network_cidr:
      type: string
      default: 10.0.0.0/24
      description: CIDR for the network
    network_start_ip:
```

```
    type: string
    default: 10.0.0.100
    description: Start IP for the allocation pool
network_end_ip:
  type: string
  default: 10.0.0.150
  description: End IP for the allocation pool

node_templates:
  my_server:
    type: tosca.nodes.Compute
    capabilities:
      host:
        properties:
          disk_size: 10 GB
          num_cpus: 1
          mem_size: 4096 MB
        os:
          properties:
            architecture: x86_64
            type: Linux
            distribution: CirrOS
            version: 0.3.2

  my_server2:
    type: tosca.nodes.Compute
    capabilities:
      host:
        properties:
          disk_size: 10 GB
          num_cpus: 1
          mem_size: 4096 MB
        os:
          properties:
            architecture: x86_64
            type: Linux
            distribution: CirrOS
            version: 0.3.2

  my_network:
    type: tosca.nodes.network.Network
```



```
properties:
  ip_version: 4
  cidr: { get_input: network_cidr }
  network_name: { get_input: network_name }
  start_ip: { get_input: network_start_ip }
  end_ip: { get_input: network_end_ip }

my_port:
  type: tosca.nodes.network.Port
  requirements:
    - binding: my_server
    - link: my_network

my_port2:
  type: tosca.nodes.network.Port
  requirements:
    - binding: my_server2
    - link: my_network
```

11.1.14 Network 4: Server bound to three networks

11.1.14.1 Description

This use case shows how three logical networks (Network), each with its own IP address range, can be bound to with the same server (Compute node).

11.1.14.2 Logical Diagram

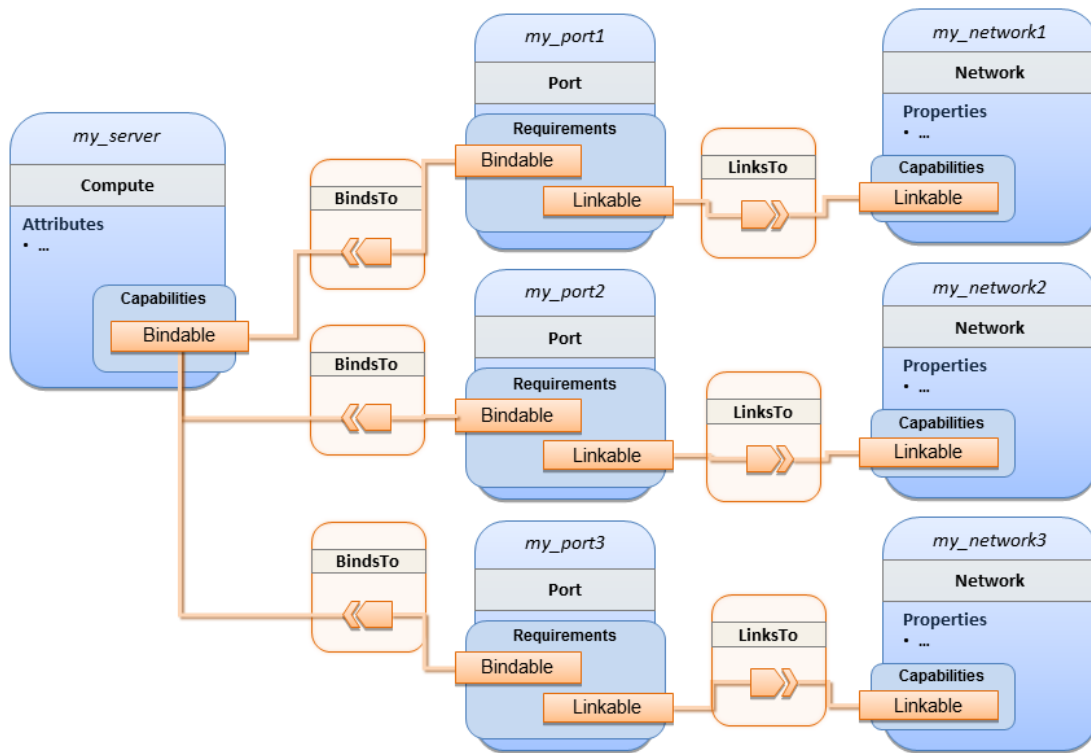

11.1.14.3 Sample YAML

```

tosca_definitions_version: toska_simple_yaml_1_3

description: >
  TOSCA simple profile with 1 server bound to 3 networks

topology_template:

  node_templates:
    my_server:
      type: toska.nodes.Compute
      capabilities:
        host:
          properties:
            disk_size: 10 GB
            num_cpus: 1
            mem_size: 4096 MB
        os:
          properties:
            architecture: x86_64
  
```

```
    type: Linux
    distribution: CirrOS
    version: 0.3.2

my_network1:
  type: tosca.nodes.network.Network
  properties:
    cidr: '192.168.1.0/24'
    network_name: net1

my_network2:
  type: tosca.nodes.network.Network
  properties:
    cidr: '192.168.2.0/24'
    network_name: net2

my_network3:
  type: tosca.nodes.network.Network
  properties:
    cidr: '192.168.3.0/24'
    network_name: net3

my_port1:
  type: tosca.nodes.network.Port
  properties:
    order: 0
  requirements:
    - binding: my_server
    - link: my_network1

my_port2:
  type: tosca.nodes.network.Port
  properties:
    order: 1
  requirements:
    - binding: my_server
    - link: my_network2

my_port3:
  type: tosca.nodes.network.Port
  properties:
```

```

order: 2
requirements:
  - binding: my_server
  - link: my_network3

```

11.1.15 WebServer-DBMS 1: WordPress + MySQL, single instance

11.1.15.1 Description

TOSCA simple profile service showing the WordPress web application with a MySQL database hosted on a single server (instance).

11.1.15.2 Logical Diagram

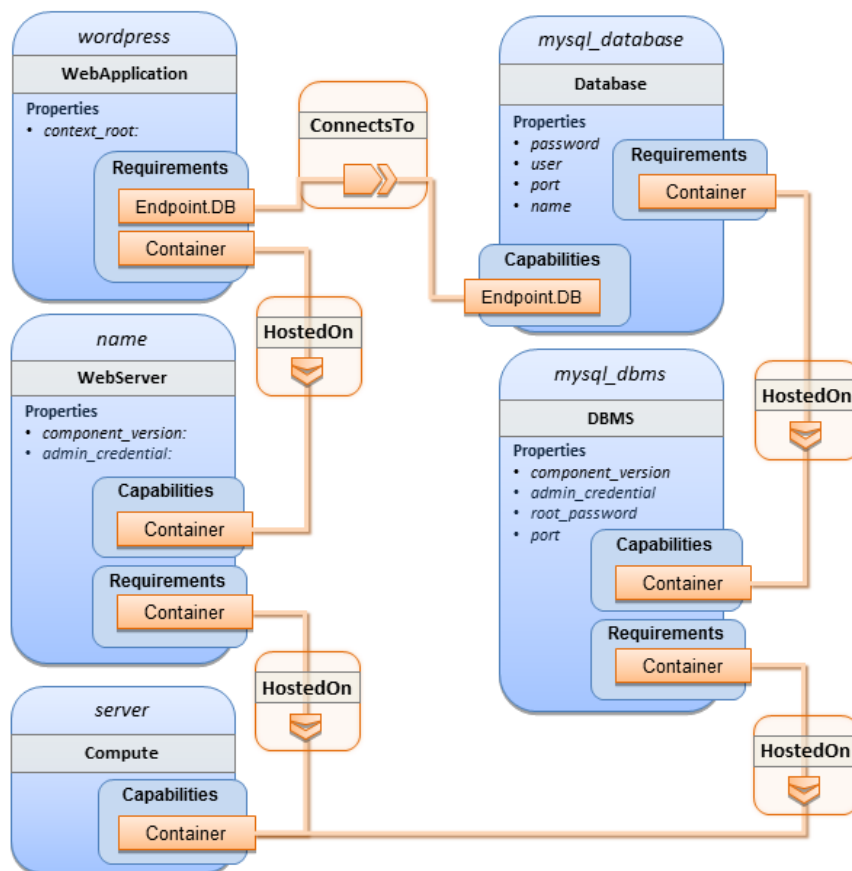

11.1.15.3 Sample YAML

```
tosca_definitions_version: tosca_simple_yaml_1_3
```

```
description: >
```

```
TOSCA simple profile with WordPress, a web server, a MySQL DBMS hosting the
application's database content on the same server. Does not have input defaults
or constraints.
```

```

topology_template:
  inputs:
    cpus:
      type: integer
      description: Number of CPUs for the server.
    db_name:
      type: string
      description: The name of the database.
    db_user:
      type: string
      description: The username of the DB user.
    db_pwd:
      type: string
      description: The WordPress database admin account password.
    db_root_pwd:
      type: string
      description: Root password for MySQL.
    db_port:
      type: PortDef
      description: Port for the MySQL database

  node_templates:
    wordpress:
      type: toasca.nodes.WebApplication.WordPress
      properties:
        context_root: { get_input: context_root }
      requirements:
        - host: webservers
        - database_endpoint: mysql_database
      interfaces:
        Standard:
          create: wordpress\_install.sh
          configure:
            implementation: wordpress\_configure.sh
            inputs:
              wp_db_name: { get_property: [ mysql_database, name ] }
              wp_db_user: { get_property: [ mysql_database, user ] }
              wp_db_password: { get_property: [ mysql_database, password ] }
              # In my own template, find requirement/capability, find port
property

```

```

        wp_db_port: { get_property: [ SELF, database_endpoint, port ] }

mysql_database:
  type: Database
  properties:
    name: { get_input: db_name }
    user: { get_input: db_user }
    password: { get_input: db_pwd }
    port: { get_input: db_port }
  capabilities:
    database_endpoint:
      properties:
        port: { get_input: db_port }
  requirements:
    - host: mysql_dbms
  interfaces:
    Standard:
      configure: mysql_database_configure.sh

mysql_dbms:
  type: DBMS
  properties:
    root_password: { get_input: db_root_pwd }
    port: { get_input: db_port }
  requirements:
    - host: server
  interfaces:
    Standard:
      inputs:
        db_root_password: { get_property: [ mysql_dbms, root_password ] }
      create: mysql_dbms_install.sh
      start: mysql_dbms_start.sh
      configure: mysql_dbms_configure.sh

webservice:
  type: WebServer
  requirements:
    - host: server
  interfaces:
    Standard:
      create: webservice_install.sh

```

```

    start: webservers\_start.sh

server:
  type: Compute
  capabilities:
    host:
      properties:
        disk_size: 10 GB
        num_cpus: { get_input: cpus }
        mem_size: 4096 MB
    os:
      properties:
        architecture: x86_64
        type: linux
        distribution: fedora
        version: 17.0

outputs:
  website_url:
    description: URL for Wordpress wiki.
    value: { get_attribute: [server, public_address] }

```

11.1.15.4 Sample scripts

Where the referenced implementation scripts in the example above would have the following contents

11.1.15.4.1 [wordpress_install.sh](#)

```
yum -y install wordpress
```

11.1.15.4.2 [wordpress_configure.sh](#)

```

sed -i "/Deny from All/d" /etc/httpd/conf.d/wordpress.conf
sed -i "s/Require local/Require all granted/" /etc/httpd/conf.d/wordpress.conf
sed -i s/database_name_here/name/ /etc/wordpress/wp-config.php
sed -i s/username_here/user/ /etc/wordpress/wp-config.php
sed -i s/password_here/password/ /etc/wordpress/wp-config.php
systemctl restart httpd.service

```

11.1.15.4.3 [mysql_database_configure.sh](#)

```

# Setup MySQL root password and create user
cat << EOF | mysql -u root --password=db_root_password

```

```
CREATE DATABASE name;
GRANT ALL PRIVILEGES ON name.* TO "user"@"localhost"
IDENTIFIED BY "password";
FLUSH PRIVILEGES;
EXIT
EOF
```

11.1.15.4.4 mysql_dbms_install.sh

```
yum -y install mysql mysql-server
# Use systemd to start MySQL server at system boot time
systemctl enable mysqld.service
```

11.1.15.4.5 mysql_dbms_start.sh

```
# Start the MySQL service (NOTE: may already be started at image boot time)
systemctl start mysqld.service
```

11.1.15.4.6 mysql_dbms_configure

```
# Set the MySQL server root password
mysqladmin -u root password db_root_password
```

11.1.15.4.7 webserver_install.sh

```
yum -y install httpd
systemctl enable httpd.service
```

11.1.15.4.8 webserver_start.sh

```
# Start the httpd service (NOTE: may already be started at image boot time)
systemctl start httpd.service
```

11.1.16 WebServer-DBMS 2: Nodejs with PayPal Sample App and MongoDB on separate instances

11.1.16.1 Description

This use case Instantiates a 2-tier application with Nodejs and its (PayPal sample) WebApplication on one tier which connects a MongoDB database (which stores its application data) using a ConnectsTo relationship.

11.1.16.2 Logical Diagram

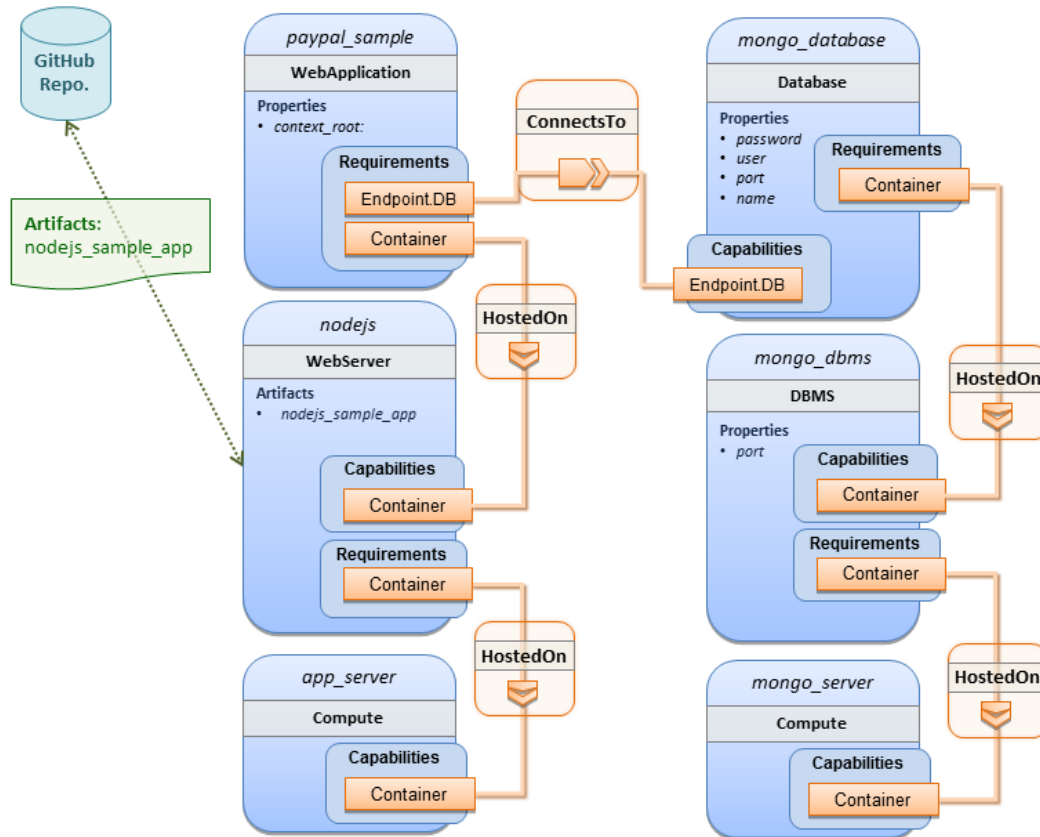

11.1.16.3 Sample YAML

```

tosca_definitions_version: tosca_simple_yaml_1_3

description: >
  TOSCA simple profile with a nodejs web server hosting a PayPal sample
  application which connects to a mongodb database.

imports:
  - custom_types/paypalpizzastore_nodejs_app.yaml

dsl_definitions:
  ubuntu_node: &ubuntu_node
    disk_size: 10 GB
    num_cpus: { get_input: my_cpus }
    mem_size: 4096 MB
  os_capabilities: &os_capabilities
    architecture: x86_64
    type: Linux

```

```

distribution: Ubuntu
version: 14.04

topology_template:
  inputs:
    my_cpus:
      type: integer
      description: Number of CPUs for the server.
      constraints:
        - valid_values: [ 1, 2, 4, 8 ]
      default: 1
    github_url:
      type: string
      description: The URL to download nodejs.
      default: https://github.com/sample.git

  node_templates:

    paypal_pizzastore:
      type: tosca.nodes.WebApplication.PayPalPizzaStore
      properties:
        github_url: { get_input: github_url }
      requirements:
        - host:nodejs
        - database_connection: mongo_db
      interfaces:
        Standard:
          configure:
            implementation: scripts/nodejs/configure.sh
            inputs:
              github_url: { get_property: [ SELF, github_url ] }
              mongoddb_ip: { get_attribute: [ mongo_server, private_address ] }
          start: scriptsscripts/nodejs/start.sh

    nodejs:
      type: tosca.nodes.WebServer.Nodejs
      requirements:
        - host: app_server
      interfaces:
        Standard:
          create: scripts/nodejs/create.sh

```

```

mongo_db:
  type: toska.nodes.Database
  requirements:
    - host: mongo_dbms
  interfaces:
    Standard:
      create: create_database.sh

mongo_dbms:
  type: toska.nodes.DBMS
  requirements:
    - host: mongo_server
  properties:
    port: 27017
  interfaces:
    toska.interfaces.node.lifecycle.Standard:
      create: mongoddb/create.sh
      configure:
        implementation: mongoddb/config.sh
      inputs:
        mongoddb_ip: { get_attribute: [mongo_server, private_address] }
      start: mongoddb/start.sh

mongo_server:
  type: toska.nodes.Compute
  capabilities:
    os:
      properties: *os_capabilities
    host:
      properties: *ubuntu_node

app_server:
  type: toska.nodes.Compute
  capabilities:
    os:
      properties: *os_capabilities
    host:
      properties: *ubuntu_node

outputs:

```

```

nodejs_url:
  description: URL for the nodejs server, http://<IP>:3000
  value: { get_attribute: [app_server, private_address] }
mongodb_url:
  description: URL for the mongodb server.
  value: { get_attribute: [ mongo_server, private_address ] }

```

11.1.16.4 Notes:

- Scripts referenced in this example are assumed to be placed by the TOSCA orchestrator in the relative directory declared in TOSCA.meta of the TOSCA CSAR file.

11.1.17 Multi-Tier-1: Elasticsearch, Logstash, Kibana (ELK) use case with multiple instances

11.1.17.1 Description

TOSCA simple profile service showing the Nodejs, MongoDB, Elasticsearch, Logstash, Kibana, rsyslog and collectd installed on a different server (instance).

This use case also demonstrates:

- Use of TOSCA macros or dsl_definitions
- Multiple **SoftwareComponents** hosted on same Compute node
- Multiple tiers communicating to each other over ConnectsTo using Configure interface.

11.1.17.2 Logical Diagram

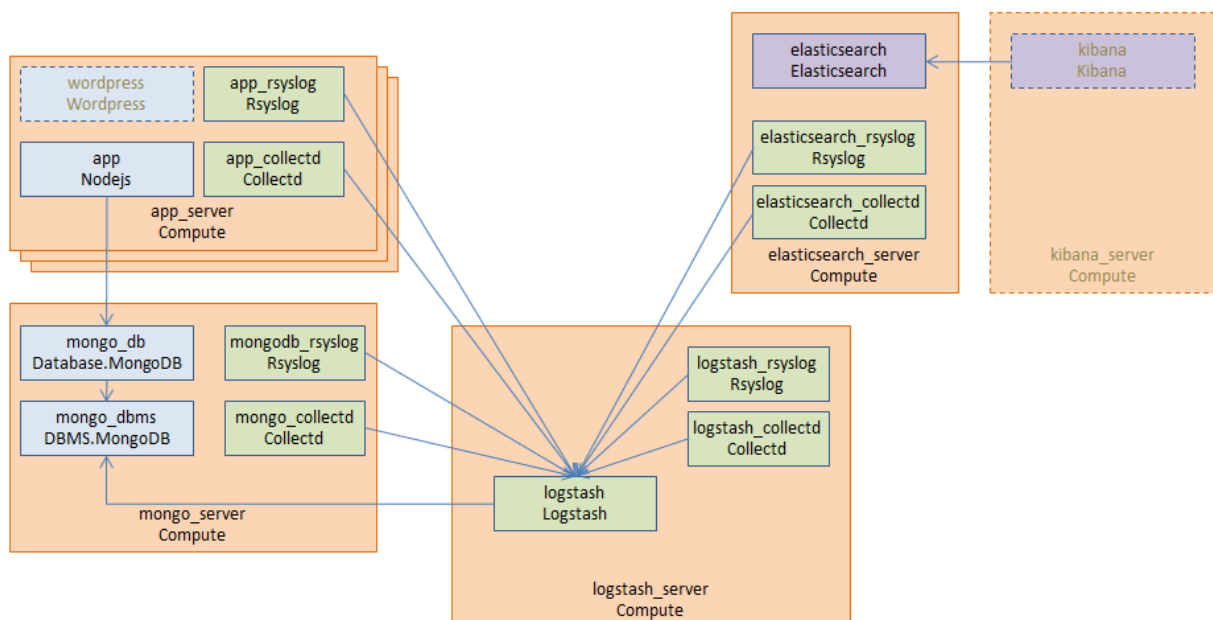

11.1.17.3 Sample YAML

11.1.17.3.1 Master Service Template application (Entry-Definitions)

The following YAML is the primary template (i.e., the Entry-Definition) for the overall use case. The imported YAML for the various subcomponents are not shown here for brevity.

```
tosca_definitions_version: toska_simple_yaml_1_3

description: >
  This TOSCA simple profile deploys nodejs, mongodb, elasticsearch, logstash and kibana each on a separate server with monitoring enabled for nodejs server where a sample nodejs application is running. The syslog and collectd are installed on a nodejs server.

imports:
  - paypalpizzastore_nodejs_app.yaml
  - elasticsearch.yaml
  - logstash.yaml
  - kibana.yaml
  - collectd.yaml
  - rsyslog.yaml

dsl_definitions:
  host_capabilities: &host_capabilities
    # container properties (flavor)
    disk_size: 10 GB
    num_cpus: { get_input: my_cpus }
    mem_size: 4096 MB
  os_capabilities: &os_capabilities
    architecture: x86_64
    type: Linux
    distribution: Ubuntu
    version: 14.04

topology_template:
  inputs:
    my_cpus:
      type: integer
      description: Number of CPUs for the server.
      constraints:
        - valid_values: [ 1, 2, 4, 8 ]
  github_url:
```

```

    type: string
    description: The URL to download nodejs.
    default: https://github.com/sample.git

node_templates:
  paypal_pizzastore:
    type: tosca.nodes.WebApplication.PayPalPizzaStore
    properties:
      github_url: { get_input: github_url }
    requirements:
      - host: nodejs
      - database_connection: mongo_db
    interfaces:
      Standard:
        configure:
          implementation: scripts/nodejs/configure.sh
        inputs:
          github_url: { get_property: [ SELF, github_url ] }
          mongoddb_ip: { get_attribute: [ mongo_server, private_address ] }
        start: scripts/nodejs/start.sh

nodejs:
  type: tosca.nodes.WebServer.Nodejs
  requirements:
    - host: app_server
  interfaces:
    Standard:
      create: scripts/nodejs/create.sh

mongo_db:
  type: tosca.nodes.Database
  requirements:
    - host: mongo_dbms
  interfaces:
    Standard:
      create: create_database.sh

mongo_dbms:
  type: tosca.nodes.DBMS
  requirements:
    - host: mongo_server

```

```

interfaces:
  toska.interfaces.node.lifecycle.Standard:
    create: scripts/mongodb/create.sh
    configure:
      implementation: scripts/mongodb/config.sh
    inputs:
      mongodb_ip: { get_attribute: [mongo_server, ip_address] }
    start: scripts/mongodb/start.sh

elasticsearch:
  type: toska.nodes.SoftwareComponent.Elasticsearch
  requirements:
    - host: elasticsearch_server
  interfaces:
    toska.interfaces.node.lifecycle.Standard:
      create: scripts/elasticsearch/create.sh
      start: scripts/elasticsearch/start.sh
logstash:
  type: toska.nodes.SoftwareComponent.Logstash
  requirements:
    - host: logstash_server
    - search_endpoint: elasticsearch
  interfaces:
    toska.interfaces.relationship.Configure:
      pre_configure_source:
        implementation: python/logstash/configure_elasticsearch.py
      input:
        elasticsearch_ip: { get_attribute: [elasticsearch_server,
ip_address] }
    toska.interfaces.node.lifecycle.Standard:
      create: scripts/logstash/create.sh
      configure: scripts/logstash/config.sh
      start: scripts/logstash/start.sh

kibana:
  type: toska.nodes.SoftwareComponent.Kibana
  requirements:
    - host: kibana_server
    - search_endpoint: elasticsearch
  interfaces:

```

```

tosca.interfaces.node.lifecycle.Standard:
  create: scripts/kibana/create.sh
  configure:
    implementation: scripts/kibana/config.sh
    input:
      elasticsearch_ip: { get_attribute: [elasticsearch_server,
ip_address] }
      kibana_ip: { get_attribute: [kibana_server, ip_address] }
    start: scripts/kibana/start.sh

app_collectd:
  type: tosca.nodes.SoftwareComponent.Collectd
  requirements:
    - host: app_server
    - collectd_endpoint: logstash
  interfaces:
    tosca.interfaces.relationship.Configure:
      pre_configure_target:
        implementation: python/logstash/configure_collectd.py
  interfaces:
    tosca.interfaces.node.lifecycle.Standard:
      create: scripts/collectd/create.sh
      configure:
        implementation: python/collectd/config.py
        input:
          logstash_ip: { get_attribute: [logstash_server, ip_address] }
      start: scripts/collectd/start.sh

app_rsyslog:
  type: tosca.nodes.SoftwareComponent.Rsyslog
  requirements:
    - host: app_server
    - rsyslog_endpoint: logstash
  interfaces:
    tosca.interfaces.relationship.Configure:
      pre_configure_target:
        implementation: python/logstash/configure_rsyslog.py
  interfaces:
    tosca.interfaces.node.lifecycle.Standard:
      create: scripts/rsyslog/create.sh
      configure:

```



```

    implementation: scripts/rsyslog/config.sh
    input:
      logstash_ip: { get_attribute: [logstash_server, ip_address] }
    start: scripts/rsyslog/start.sh

app_server:
  type: toska.nodes.Compute
  capabilities:
    host:
      properties: *host_capabilities
    os:
      properties: *os_capabilities

mongo_server:
  type: toska.nodes.Compute
  capabilities:
    host:
      properties: *host_capabilities
    os:
      properties: *os_capabilities

elasticsearch_server:
  type: toska.nodes.Compute
  capabilities:
    host:
      properties: *host_capabilities
    os:
      properties: *os_capabilities

logstash_server:
  type: toska.nodes.Compute
  capabilities:
    host:
      properties: *host_capabilities
    os:
      properties: *os_capabilities

kibana_server:
  type: toska.nodes.Compute
  capabilities:
    host:

```

```

    properties: *host_capabilities
  os:
    properties: *os_capabilities

outputs:
  nodejs_url:
    description: URL for the nodejs server.
    value: { get_attribute: [ app_server, private_address ] }
  mongodb_url:
    description: URL for the mongodb server.
    value: { get_attribute: [ mongo_server, private_address ] }
  elasticsearch_url:
    description: URL for the elasticsearch server.
    value: { get_attribute: [ elasticsearch_server, private_address ] }
  logstash_url:
    description: URL for the logstash server.
    value: { get_attribute: [ logstash_server, private_address ] }
  kibana_url:
    description: URL for the kibana server.
    value: { get_attribute: [ kibana_server, private_address ] }

```

11.1.17.4 Sample scripts

Where the referenced implementation scripts in the example above would have the following contents

11.1.18 Container-1: Containers using Docker single Compute instance (Containers only)

11.1.18.1 Description

This use case shows a minimal description of two Container nodes (only) providing their Docker Requirements allowing platform (orchestrator) to select/provide the underlying Docker implementation (Capability). Specifically, wordpress and mysql Docker images are referenced from Docker Hub.

This use case also demonstrates:

- Abstract description of Requirements (i.e., Container and Docker) allowing platform to dynamically select the appropriate runtime Capabilities that match.
- Use of external repository (Docker Hub) to reference image artifact.

11.1.18.2 Logical Diagram

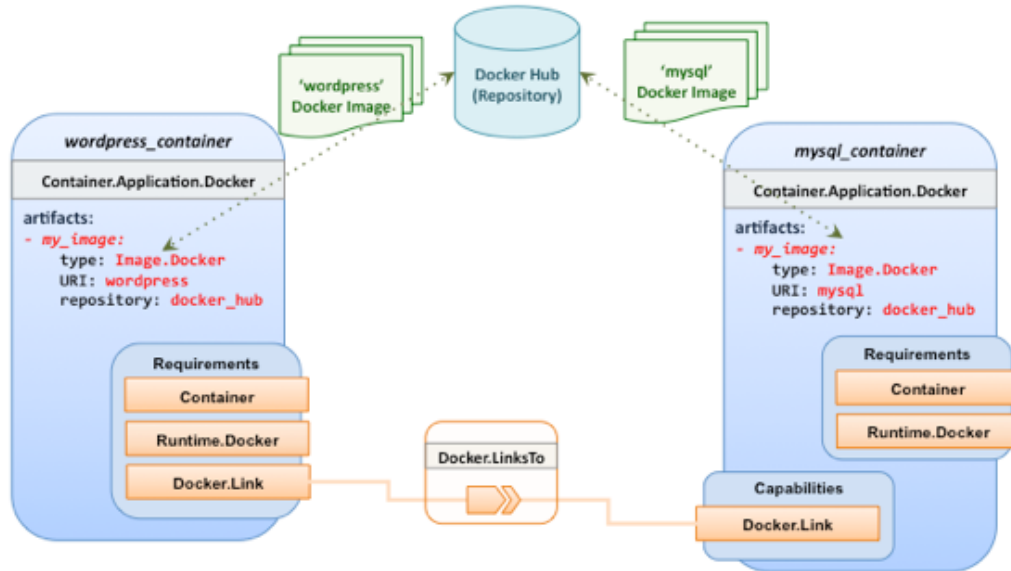

11.1.18.3 Sample YAML

11.1.18.3.1 Two Docker “Container” nodes (Only) with Docker Requirements

```
tosca_definitions_version: tosca_simple_yaml_1_3

description: >
  TOSCA simple profile with wordpress, web server and mysql on the same server.

# Repositories to retrieve code artifacts from
repositories:
  docker_hub: https://registry.hub.docker.com/

topology_template:

  inputs:
    wp_host_port:
      type: integer
      description: The host port that maps to port 80 of the WordPress container.
    db_root_pwd:
      type: string
      description: Root password for MySQL.

  node_templates:
    # The MYSQL container based on official MySQL image in Docker hub
```

```

mysql_container:
  type: tosca.nodes.Container.Application.Docker
  capabilities:
    # This is a capability that would mimic the Docker -link feature
    database_link: tosca.capabilities.Docker.Link
  artifacts:
    my_image:
      file: mysql
      type: tosca.artifacts.Deployment.Image.Container.Docker
      repository: docker_hub
  interfaces:
    Standard:
      create:
        implementation: my_image
      inputs:
        db_root_password: { get_input: db_root_pwd }

# The WordPress container based on official WordPress image in Docker hub
wordpress_container:
  type: tosca.nodes.Container.Application.Docker
  requirements:
    - database_link: mysql_container
  artifacts:
    my_image:
      file: wordpress
      type: tosca.artifacts.Deployment.Image.Container.Docker
      repository: docker_hub
      <metadata-link> : <topology_artifact_name> # defined outside and linked
to from here
  interfaces:
    Standard:
      create:
        implementation: my_image
      inputs:
        host_port: { get_input: wp_host_port }

```

11.1.19 Artifacts: Compute Node with Multiple Artifacts

11.1.19.1 Description

This use case illustrates how multiple artifacts can be associated with a node for different lifecycle operations of a node (create, terminate, configure, etc.)

11.1.19.2 Sample YAML

```
tosca_definitions_version: tosca_simple_yaml_1_3
description: Sample tosca archive to illustrate use of a node with multiple
artifacts for different life cycle operations of the node

topology_template :

  node_templates :
    dbServer:
      type: tosca.nodes.Compute
      properties:
        name: dbServer
        description:
        artifacts:
          - sw_image:
              type: tosca.artifacts.Deployment.SwImage
              file: http://1.1.1.1/images/ubuntu-14.04.qcow2
              name: ubuntu-14.04
              version: 14.04
              checksum: e5c1e205f62f3

          - configuration:
              type: tosca.artifacts.Implementation.Ansible
              file: implementation/configuration/Ansible/configure.yml
              version: 2.0

          - terminate:
              type: tosca.artifacts.Implementation.scripts
              file: implementation/configuration/scripts/terminate.sh
              version: 6.2
```

12 TOSCA Policies

This section is **non-normative** and describes the approach TOSCA Simple Profile plans to take for policy description with TOSCA Service Templates. In addition, it explores how existing TOSCA Policy Types and definitions might be applied in the future to express operational policy use cases.

12.1 A declarative approach

TOSCA Policies are a type of requirement that govern use or access to resources which can be expressed independently from specific applications (or their resources) and whose fulfillment is not discretely expressed in the application's topology (i.e., via TOSCA Capabilities).

TOSCA deems it not desirable for a declarative model to encourage external intervention for resolving policy issues (i.e., via imperative mechanisms external to the Cloud). Instead, the Cloud provider is deemed to be in the best position to detect when policy conditions are triggered, analyze the affected resources and enforce the policy against the allowable actions declared within the policy itself.

12.1.1 Declarative considerations

- Natural language rules are not realistic, too much to represent in our specification; however, regular expressions can be used that include simple operations and operands that include symbolic names for TOSCA metamodel entities, properties and attributes.
- Complex rules can actually be directed to an external policy engine (to check for violation) returns true/false then policy says what to do (trigger or action).
- Actions/Triggers could be:
 - Autonomic/Platform corrects against user-supplied criteria
 - External monitoring service could be utilized to monitor policy rules/conditions against metrics, the monitoring service could coordinate corrective actions with external services (perhaps Workflow engines that can analyze the application and interact with the TOSCA instance model).

12.2 Consideration of Event, Condition and Action

12.3 Types of policies

Policies typically address two major areas of concern for customer workloads:

- **Access Control** – assures user and service access to controlled resources are governed by rules which determine general access permission (i.e., allow or deny) and conditional access dependent on other considerations (e.g., organization role, time of day, geographic location, etc.).
- **Placement** – assures affinity (or anti-affinity) of deployed applications and their resources; that is, what is allowed to be placed where within a Cloud provider's infrastructure.
- **Quality-of-Service** (and continuity) - assures performance of software components (perhaps captured as quantifiable, measure components within an SLA) along with consideration for scaling and failover.

12.3.1 Access control policies

Although TOSCA Policy definitions could be used to express and convey access control policies, definitions of policies in this area are out of scope for this specification. At this time, TOSCA encourages organizations that already have standards that express policy for access control to provide their own guidance on how to use their standard with TOSCA.

12.3.2 Placement policies

There must be control mechanisms in place that can be part of these patterns that accept governance policies that allow control expressions of what is allowed when placing, scaling and managing the applications that are enforceable and verifiable in Cloud.

These policies need to consider the following:

- Regulated industries need applications to control placement (deployment) of applications to different countries or regions (i.e., different logical geographical boundaries).

12.3.2.1 Placement for governance concerns

In general, companies and individuals have security concerns along with general “loss of control” issues when considering deploying and hosting their highly valued application and data to the Cloud. They want to control placement perhaps to ensure their applications are only placed in datacenter they trust or assure that their applications and data are not placed on shared resources (i.e., not co-tenanted).

In addition, companies that are related to highly regulated industries where compliance with government, industry and corporate policies is paramount. In these cases, having the ability to control placement of applications is an especially significant consideration and a prerequisite for automated orchestration.

12.3.2.2 Placement for failover

Companies realize that their day-to-day business must continue on through unforeseen disasters that might disable instances of the applications and data at or on specific data centers, networks or servers. They need to be able to convey placement policies for their software applications and data that mitigate risk of disaster by assuring these cloud assets are deployed strategically in different physical locations. Such policies need to consider placement across geographic locations as wide as countries, regions, datacenters, as well as granular placement on a network, server or device within the same physical datacenter. Cloud providers must be able to not only enforce these policies but provide robust and seamless failover such that a disaster’s impact is never perceived by the end user.

12.3.3 Quality-of-Service (QoS) policies

Quality-of-Service (apart from failover placement considerations) typically assures that software applications and data are available and performant to the end users. This is usually something that is measurable in terms of end-user responsiveness (or response time) and often qualified in SLAs established between the Cloud provider and customer. These QoS aspects can be taken from SLAs and legal agreements and further encoded as performance policies associated with the actual applications and data when they are deployed. It is assumed that Cloud provider is able to detect high utilization (or usage load) on these applications and data that deviate from these performance policies and is able to bring them back into compliance.

12.4 Policy relationship considerations

- Performance policies can be related to scalability policies. Scalability policies tell the Cloud provider exactly **how** to scale applications and data when they detect an application’s performance policy is (or about to be) violated (or triggered).
- Scalability policies in turn are related to placement policies which govern **where** the application and data can be scaled to.
- There are general “tenant” considerations that restrict what resources are available to applications and data based upon the contract a customer has with the Cloud provider. This includes other

constraints imposed by legal agreements or SLAs that are not encoded programmatically or associated directly with actual application or data..

12.5 Use Cases

This section includes some initial operation policy use cases that we wish to describe using the TOSCA metamodel. More policy work will be done in future versions of the TOSCA Simple Profile in YAML specification.

12.5.1 Placement

12.5.1.1 Use Case 1: Simple placement for failover

12.5.1.1.1 Description

This use case shows a failover policy to keep at least 3 copies running in separate containers. In this simple case, the specific containers to use (or name is not important; the Cloud provider must assure placement separation (anti-affinity) in three physically separate containers.

12.5.1.1.2 Features

This use case introduces the following policy features:

- Simple separation on different “compute” nodes (up to discretion of provider).
- Simple separation by region (a logical container type) using an allowed list of region names relative to the provider.
 - Also, shows that set of allowed “regions” (containers) can be greater than the number of containers requested.

12.5.1.1.3 Logical Diagram

Sample YAML: Compute separation

```
failover_policy_1:
  type: tosca.policy.placement.Antilocate
  description: My placement policy for Compute node separation
  properties:
    # 3 diff target containers
    container_type: Compute
    container_number: 3
```

12.5.1.1.4 Notes

- There may be availability (constraints) considerations especially if these policies are applied to “clusters”.
- There may be future considerations for controlling max # of instances per container.

12.5.1.2 Use Case 2: Controlled placement by region

12.5.1.2.1 Description

This use case demonstrates the use of named “containers” which could represent the following:

- Datacenter regions

- Geographic regions (e.g., cities, municipalities, states, countries, etc.)
- Commercial regions (e.g., North America, Eastern Europe, Asia Pacific, etc.)

12.5.1.2.2 Features

This use case introduces the following policy features:

- Separation of resources (i.e., TOSCA nodes) by logical regions, or zones.

12.5.1.2.3 Sample YAML: Region separation amongst named set of regions

```
failover_policy_2:
  type: toska.policy.placement
  description: My failover policy with allowed target regions (logical
containers)
  properties:
    container_type: region
    container_number: 3
    # If "containers" keyname is provided, they represent the allowed set
    # of target containers to use for placement for .
    containers: [ region1, region2, region3, region4 ]
```

12.5.1.3 Use Case 3: Co-locate based upon Compute affinity

12.5.1.3.1 Description

Nodes that need to be co-located to achieve optimal performance based upon access to similar Infrastructure (IaaS) resource types (i.e., Compute, Network and/or Storage).

This use case demonstrates the co-location based upon Compute resource affinity; however, the same approach could be taken for Network as or Storage affinity as well. :

12.5.1.3.2 Features

This use case introduces the following policy features:

- Node placement based upon Compute resource affinity.

12.5.1.4 Notes

- The concept of placement based upon IaaS resource utilization is not future-thinking, as Cloud should guarantee equivalent performance of application performance regardless of placement. That is, all network access between application nodes and underlying Compute or Storage should have equivalent performance (e.g., network bandwidth, network or storage access time, CPU speed, etc.).

12.5.1.4.1 Sample YAML: Region separation amongst named set of regions

```
keep_together_policy:
  type: toska.policy.placement.Colocate
  description: Keep associated nodes (groups of nodes) based upon Compute
  properties:
    affinity: Compute
```

12.5.2 Scaling

12.5.2.1 Use Case 1: Simple node autoscale

12.5.2.1.1 Description

Start with X nodes and scale up to Y nodes, capability to do this from a dashboard for example.

12.5.2.1.2 Features

This use case introduces the following policy features:

- Basic autoscaling policy

12.5.2.1.3 Sample YAML

```
my_scaling_policy_1:
  type: toska.policy.scaling
  description: Simple node autoscaling
  properties:
    min_instances: <integer>
    max_instances: <integer>
    default_instances: <integer>
    increment: <integer>
```

12.5.2.1.4 Notes

- Assume horizontal scaling for this use case
 - Horizontal scaling, implies “stack-level” control using Compute nodes to define a “stack” (i.e., The Compute node’s entire HostedOn relationship dependency graph is considered part of its “stack”)
- Assume Compute node has a SoftwareComponent that represents a VM application.
- Availability Zones (and Regions if not same) need to be considered in further use cases.
- If metrics are introduced, there is a control-loop (that monitors). Autoscaling is a special concept that includes these considerations.
- Mixed placement and scaling use cases need to be considered:
 - *Example:* Compute1 and Compute2 are 2 node templates. Compute1 has 10 instances, 5 in one region 5 in other region.

13 Artifact Processing and creating Portable Service Templates

TOSCA's declarative modelling includes features that allow service designers to model abstract components without having to specify concrete implementations for these components. Declarative modeling is made possible through the use of standardized TOSCA types. Any TOSCA-compliant orchestrator is expected to know how to deploy these standard types. Declarative modeling ensures optimal portability of service templates, since any cloud-specific or technology specific implementation logic is provided by the TOSCA orchestrator, not by the service template.

The examples in the previous chapter also demonstrate how TOSCA allows service designers to extend built-in orchestrator behavior in a number of ways:

- Service designers can override or extend behavior of built-in types by supplying service-specific implementations of lifecycle interface operations in their node templates.
- Service designers can create entirely new types that define custom implementations of standard lifecycle interfaces.

Implementations of Interface operations are provided through artifacts. The examples in the previous chapter showed shell script artifacts, but many other types of artifacts can be used as well. The use of artifacts in TOSCA service templates breaks pure declarative behavior since artifacts effectively contain "imperative logic" that is opaque to the orchestrator. This introduces the risk of non-portable templates. Since some artifacts may have dependencies on specific technologies or infrastructure component, the use of artifacts could result in service templates that cannot be used on all cloud infrastructures.

The goal of this **non-normative** chapter is to ensure portable and interoperable use of artifacts by providing a detailed description of how TOSCA orchestrators process artifacts, by illustrating how a number of standard TOSCA artifact types are expected to be processed, and by describing TOSCA language features that allow artifact to provide metadata containing artifact-specific processing instructions. These metadata around the artifact allow the orchestrator to make descisions on the correct Artifact Processor and runtime(s) needed to execute. The sole purpose of this chapter is to show TOSCA template designers how to best leverage built-in TOSCA capabilities. It is not intended to recommend specific orchestrator implementations.

13.1 CSAR Onboarding

This section is **non-normative** and outlines various options to distribute artifacts to artifact processors as a part of CSAR on-boarding.

CSAR On-boarding refers to the process of

- Creating a CSAR and its contents
- Submitting the CSAR to the Orchestrator to be included in the catalogue
- Uploading CSAR to Orchestrator
- Processing of CSAR by the Orchestrator

13.1.1 How is on-boarding done

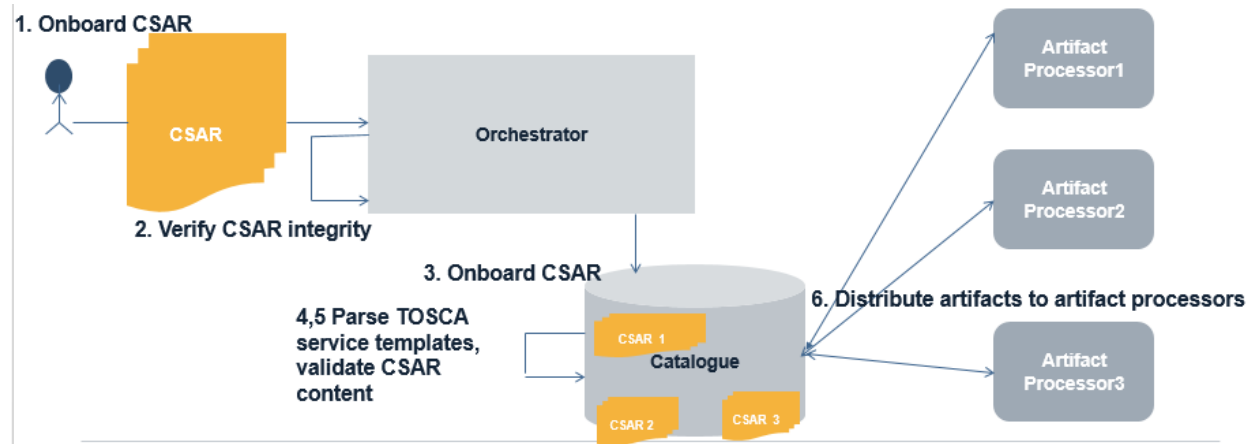

CSAR on-boarding is achieved through the following steps:

1. Request for uploading a CSAR is received by the Orchestrator
2. Orchestrator verifies integrity of package
3. Orchestrator re-directs request with CSAR to Catalogue
4. Catalogue receives CSAR and reads the Package content
5. Catalogue validates the CSAR

The orchestrator distributes artifacts to artifact processors from Catalogue

13.1.2 Artifact Distribution

Artifacts can be distributed to artifact processors through the following mechanisms:

1. *Synchronous on-boarding:* During onboarding, Orchestrator forcefully pushes artifacts to artifacts processor and waits for success response, marks onboarding operation as successful only after a success response is received from artifact processor.
2. *Asynchronous on-boarding:* Orchestrator notifies artifact processors and lets artifact processors pull artifacts
3. Do not distribute artifacts during onboarding, let artifact processors pull them from CSAR catalogue when they are called to execute the artifact

Note: Disabling artifact validation during onboarding opens up possibilities of failures during deployment of CSAR in to the cloud

13.1.3 Why is on-boarding needed

On-boarding eases deployment and reduces the first time instantiation of cloud applications. It helps validation and detection of errors early, prior to deployment.

13.2 Artifacts Processing

Artifacts represent the content needed to realize a deployment or implement a specific management action.

Artifacts can be of many different types. Artifacts could be executables (such as scripts or executable program files) or pieces of data required by those executables (e.g. configuration files, software libraries, license keys, etc). Implementations for some operations may require the use of multiple artifacts.

Different types of artifacts may require different mechanisms for processing the artifact. However, the sequence of steps taken by an orchestrator to process an artifact is generally the same for all types of artifacts:

13.2.1 Identify Artifact Processor

The first step is to identify an appropriate processor for the specified artifact. A processor is any executable that knows how to process the artifact in order to achieve the intended management operation. This processor could be an interpreter for executable shell scripts or scripts written in Python. It could be a tool such as Ansible, Puppet, or Chef for playbook, manifest, or recipe artifacts, or it could be a container management or cloud management system for image artifacts such as container images or virtual machine images.

TOSCA includes a number of standard artifact types. Standard-compliant TOSCA orchestrators are expected to include processors for each of these types. For each type, there is a correspondent Artifact Processor that is responsible for processing artifacts of that type.

Note that aside from selecting the proper artifact processor, it may also be important to use the proper version of the processor. For example, some python scripts may require Python 2.7 whereas other scripts may require Python 3.4. TOSCA provides metadata to describe service template-specific parameters for the Artifact Processor. In addition to specifying specific versions, those metadata could also identify repositories from which to retrieve the artifact processor.

Some templates may require the use of custom Artifact Processors, for example to process non-standard artifacts or to provide a custom Artifact Processor for standard artifact types. For such cases, TOSCA allows service template designers to define Application Processors in service templates as a top-level entity. Alternatively, service template designers can also provide their own artifact processor by providing wrapper artifacts of a supported type. These wrapper artifacts could be shell scripts, python scripts, or artifacts of any other standard type that know how to process or invoke the custom artifact.

13.2.2 Establish an Execution Environment

The second step is to identify or create a proper execution environment within which to run the artifact processor. There are generally three options for where to run artifact processors :

1. One option is to execute the artifact processor in the topology that is being orchestrated, for example on a Compute node created by the orchestrator.
2. A second option is to process the artifact in the same environment in which the orchestrator is running (although for security reasons, orchestrators may create sandboxes that shield the orchestrator from faulty or malicious artifacts).
3. The third option is to process the script in a management environment that is external to both the orchestrator and the topology being orchestrated. This might be the preferred option for scenarios where the environment already exists, but it is also possible for orchestrators to create external execution environments.

It is often possible for the orchestrator to determine the intended execution environment based on the type of the artifact as well as on the topology context in which the artifact was specified. For example, shell script artifacts associated with software components typically contain the install script that needs to be executed on the software component's host node in order to install that software component.

However, other scripts may not need to be run inside the topology being orchestrated. For example, a script that creates a database on a database management system could run on the compute node that hosts the database management system, or it could run in the orchestrator environment and communicate with the DBMS across a management network connection.

Similarly, there may be multiple options for other types of artifacts as well. For example, puppet artifacts could get processed locally by a puppet agent running on a compute node in the topology, or they could get passed to a puppet master that is external to both the orchestrator and the topology.

Different orchestrators could make different decisions about the execution environments for various combinations of node types and artifact types. However, service template designers must have the ability to specify explicitly where artifacts are intended to be processed in those scenarios where correct operation depends on using a specific execution environment.

Need discussion on how this is done.

13.2.3 Configure Artifact Processor User Account

An artifact processor may need to run using a specific user account in the execution environment to ensure that the processor has the proper permissions to execute the required actions. Depending on the artifact, existing user accounts might get used, or the orchestrator might have to create a new user account specifically for the artifact processor. If new user accounts are needed, the orchestrator may also have to create a home directory for those users.

Depending on the security mechanisms used in the execution environment, it may also be necessary to add user accounts to specific groups, or to assign specific roles to the user account.

13.2.4 Deploy Artifact Processor

Once the orchestrator has identified the artifact processor as well as the execution environment, it must make sure that the artifact processor is deployed in the execution environment:

- If the orchestrator's own environment acts as the execution environment for the artifact processor, orchestrator implementors can make sure that a standard set of artifact processors is pre-installed in that environment, and nothing further may need to be done.
- When a Compute node in the orchestrated topology is selected as the execution environment, typically only the most basic processors (such as bash shells) are pre-installed on that compute node. All other execution processors need to be installed on that compute node by the orchestrator.
- When an external execution environment is specified, the orchestrator must at the very least be able to verify that the proper artifact processor is present in the external execution environment and generate an error if it isn't. Ideally, the orchestrator should be able to install the processor if necessary.

The orchestrator may also take the necessary steps to make sure the processor is run as a specific user in the execution environment.

13.2.5 Deploy Dependencies

The imperative logic contained in artifacts may in turn install or configure software components that are not part of the service topology, and as a result are opaque to the orchestrator. This means that the orchestrator cannot reflect these components in an instance model, which also means they cannot be managed by the orchestrator.

It is best practice to avoid this situation by explicitly modeling any dependent components that are required by an artifact processor. When deploying the artifact processor, the orchestrator can then deploy or configure these dependencies in the execution environment and reflect them in an instance model as appropriate.

For artifacts that require dependencies to be installed, TOSCA provides a generic way in which to describe those dependencies, which will avoid the use of monolithic scripts.

Examples of dependent components include the following :

- Some executables may have dependencies on software libraries. For tools like Python, required libraries might be specified in a requirements.txt file and deployed into a virtual environment.
- Environment variables may need to be set.
- Configuration files may need to be created with proper settings for the artifact processor. For example, configuration settings could include DNS names (or IP addresses) for contacting a Puppet Master or Chef Server.
- Artifact processors may require valid software licenses in order to run.
- Other artifacts specified in the template may need to be deposited into the execution environment.

13.2.6 Identify Target

Orchestrators must pass information to the artifact processor that properly identifies the target for each artifact being processed.

- In many cases, the target is the Compute node that acts as the host for the node being created or configured. If that Compute node also acts as the execution environment for the artifact processor, the target for the artifacts being processed is the Compute node itself. If that scenario, there is no need for the orchestrator to pass additional target information aside from specifying that all actions are intended to be applied locally.
- When artifact processors run externally to the topology being deployed, they must establish a connection across a management network to the target. In TOSCA, such targets are identified using Endpoint capabilities that contain the necessary addressing information. This addressing information must be passed to the artifact processor

Note that in addition to endpoint information about the target, orchestrators may also need to pass information about the protocol that must be used to connect to the target. For example, some networking devices only accept CLI commands across a SSH connection, but others could also accept REST API calls. Different python scripts could be used to configure such devices: one that uses the CLI, and one that executes REST calls. The artifact must include metadata about which connection mechanism is intended to be used, and orchestrators must pass on this information to the artifact processor.

Finally, artifact processor may need proper credentials to connect to target endpoints. Orchestrators must pass those credentials to the artifact processor before the artifact can be processed.

13.2.7 Pass Inputs and Retrieve Results or Errors

Orchestrators must pass any required inputs to the artifact processor. Some processors could take inputs through environment variables, but others may prefer command line arguments. Named or positional command line arguments could be used. TOSCA must be very specific about the mechanism for passing input data to processors for each type of artifact.

Similarly, artifact processors must also pass results from operations back to orchestrators so that results values can be reflected as appropriate in node properties and attributes. If the operation fails, error codes

may need to be returned as well. TOSCA must be very specific about the mechanism for returning results and error codes for each type of artifact.

13.2.8 Cleanup

After the artifact has been processed by the artifact processor, the orchestrator could perform optional cleanup:

- If an artifact processor was deployed within the topology that is being orchestrated, the orchestrator could decide to remove the artifact processor (and all its deployed dependencies) from the topology with the goal of not leaving behind any components that are not explicitly modeled in the service template.
- Alternatively, the orchestrator MAY be able to reflect the additional components/resources associated with the Artifact Processor as part of the instance model (post deployment).

Artifact Processors that do not use the service template topology as their execution environment do not impact the deployed topology. It is up to each orchestrator implementation to decide if these artifact processors need to be removed.

13.3 Dynamic Artifacts

Detailed Artifacts may be generated on-the-fly as orchestration happens. May be propagated to other nodes in the topology. How do we describe those?

13.4 Discussion of Examples

This section shows how orchestrators might execute the steps listed above for a few common artifact types, in particular:

1. Shell scripts
2. Python scripts
3. Package artifacts
4. VM images
5. Container images
6. API artifacts
7. Non-standard artifacts

By illustrating how different types of artifacts are intended to be processed, we identify the information needed by artifact processors to properly process the artifacts, and we will also identify the components in the topology from which this information is intended to be obtained.

13.4.1 Shell Scripts

Many artifacts are simple bash scripts that provide implementations for operations in a Node's Lifecycle Interfaces. Bash scripts are typically intended to be executed on Compute nodes that host the node with which these scripts are associated.

We use the following example to illustrate the steps taken by TOSCA orchestrators to process shell script artifacts.

```
tosca_definitions_version: tosca_simple_yaml_1_3
description: Sample tosca archive to illustrate simple shell script usage.
template_name: tosca-samples-shell
```



```

template_version: 1.0.0-SNAPSHOT
template_author: TOSCA TC

node_types:
  toska.nodes.samples.LogIp:
    derived_from: toska.nodes.SoftwareComponent
    description: Simple linux cross platform create script.
    attributes:
      log_attr: { get_operation_output: [SELF, Standard, create, LOG_OUT] }
    interfaces:
      Standard:
        create:
          inputs:
            SELF_IP: { get_attribute: [HOST, ip_address] }
          implementation: scripts/create.sh

topology_template:
  node_templates:
    log_ip:
      type: toska.nodes.samples.LogIp
      requirements:
        - host:
            node: compute
            capability: toska.capabilities.Container
            relationship: toska.relationships.HostedOn
      # Any linux compute.
      compute:
        type: toska.nodes.Compute
        capabilities:
          os:
            properties:
              type: linux

```

This example uses the following script to install the LogIP software :

```

#!/bin/bash

# This is exported so available to fetch as output using the get_operation_output
function
export LOG_OUT="Create script : $SELF_IP"

```

```
# Just a simple example of create operation, of course software installation is better
echo "$LOG_OUT" >> /tmp/tosca_create.log
```

For this simple example, the artifact processing steps outlined above are as follows:

1. **Identify Artifact Processor:** The artifact processor for bash shell scripts is the “bash” program.
2. **Establish Execution Environment:** The typical execution environment for bash scripts is the Compute node representing the Host of the node containing the artifact.
3. **Configure User Account:** The bash user account is the default user account created when instantiating the Compute node. It is assumed that this account has been configured with sudo privileges.
4. **Deploy Artifact Processor:** TOSCA orchestrators can assume that bash is pre-installed on all Compute nodes they orchestrate, and nothing further needs to be done.
5. **Deploy Dependencies:** Orchestrators should copy all provided artifacts using a directory structure that mimics the directory structure in the original CSAR file containing the artifacts. Since no dependencies are specified in the example above, nothing further needs to be done.
6. **Identify Target:** The target for bash is the Compute node itself.
7. **Pass Inputs and Retrieve Outputs:** Inputs are passed to bash as environment variables. In the example above, there is a single input declared for the create operation called SELF_IP. Before processing the script, the Orchestrator creates a corresponding environment variable in the execution environment. Similarly, the script creates a single output that is passed back to the orchestrator as an environment variable. This environment variable can be accessed elsewhere in the service template using the `get_operation_output` function.

13.4.1.1 Progression of Examples

The following examples show a number of potential use case variations (not exhaustive) :

13.4.1.1.1 Simple install script that can run on all flavors for Unix.

For example, a Bash script called “create.sh” that is used to install some software for a TOSCA Node; that this introduces imperative logic points (all scripts perhaps) which MAY lead to the creation of “opaque software” or topologies within the node

13.4.1.1.1.1 Notes

- Initial examples used would be independent of the specific flavor of Linux.
- The “create” operation, as part of the normative Standard node lifecycle, has special meaning in TOSCA in relation to a corresponding deployment artifact; that is, the node is not longer “abstract” if it either has an impl. Artifact on the create operation or a deployment artifact (provided on the node).

“create.sh” prepares/configures environment/host/container for other software (see below for VM image use case variants).

13.4.1.1.1.2 Variants

1. “create.sh” followed by a “configure.sh” (or “stop.sh”, “start.sh” or a similar variant).
2. in Compute node (i.e., within a widely-used, normative, abstract Node Type).
3. In non-compute node like WebServer (is this the hello world)?
 - Container vs. Containee “hello worlds”; create is “special”; speaks to where (target) the script is run at! i.e., Compute node does not have a host.
 - What is BEST PRACTICE for compute? Should “create.sh” even be allowed?
 - Luc: customer wanted to use an non-AWS cloud, used shell scripts to cloud API.
 - i. Should have specific Node type subclass for Compute for that other Cloud (OR) a capability that represents that specific target Cloud.

13.4.1.1.2 Script that needs to be run as specific user

For example, a Postgres user

13.4.1.1.3 Simple script with dependencies

For example, using example from the meeting where script depends on AWS CLI being installed.

- How do you decide whether to install an RPM or python package for the AWS dependency?
- How do we decide whether to install python packages in virtualenv vs. system-wide?

13.4.1.1.4 Different scripts for different Linux flavors

For example. run apt-get vs. yum

- The same operation can be implemented by different artifacts depending on the flavor of Linux on which the script needs to be run. We need the ability to specify which artifacts to use based on the target.
- How do we extend the “operation” grammar to allow for the selection of one specific artifact out of a number of options?
- How do we annotate the artifacts to indicate that they require a specific flavor and/or version of Linux?

13.4.1.1.4.1 Variants

- A variant would be to use different subclasses of abstract nodes, one for each flavor of Linux on which the node is supposed to be deployed. This would eliminate the need for different artifacts in the same node. Of course, this significantly reduces the amount of “abstraction” in service templates.

13.4.1.1.5 Scripts with environment variables

- Environment variables that may not correspond to input parameters
- For example, OpenStack-specific environment variables
- How do we specify that these environment variables need to be set?

13.4.1.1.6 Scripts that require certain configuration files

For example, containing AWS credentials

- This configuration file may need to be created dynamically (rather than statically inside a CSAR file). How do we specify that these files may need to be created?
- Or does this require template files (e.g. Jinja2)?

13.4.2 Python Scripts

A second important class of artifacts are Python scripts. Unlike Bash script artifacts, Python scripts are more commonly executed within the context of the Orchestrator, but service template designers must also be able to provide Python scripts artifacts that are intended to be executed within the topology being orchestrated,

13.4.2.1 Python Scripts Executed in Orchestrator

Need a simple example of a Python script executed in the Orchestrator context.

13.4.2.2 Python Scripts Executed in Topology

Need a simple example of a Python script executed in the topology being orchestrated.

The following grammar is provided to allow service providers to specify the execution environment within which the artifact is intended to be processed :

Need to decide on grammar. Likely an additional keyword to the “operation” section of lifecycle interface definitions.

13.4.2.3 Specifying Python Version

Some python scripts conform to Python version 2, whereas others may require version 3. Artifact designers use the following grammar to specify the required version of Python:

TODO

13.4.2.3.1.1 Assumptions/Questions

- Need to decide on grammar. Is artifact processor version associated with the processor, with the artifact, the artifact type, or the operation implementation?

13.4.2.4 Deploying Dependencies

Most Python scripts rely on external packages that must be installed in the execution environment. Typically, python packages are installed using the ‘pip’ command. To provide isolation between different environments, it is considered best practice to create virtual environments. A virtual environment is a tool to keep the dependencies required by different python scripts or projects in separate places, by creating virtual Python environments for each of them.

The following example shows a Python script that has dependencies on a number of external packages:

TODO

13.4.2.4.1.1 Assumptions/Questions

- Python scripts often have dependencies on a number of external packages (that are referenced by some package artifact). How would these be handled?
- How do we account for the fact that most python packages are available as Linux packages as well as pip packages?
- Does the template designer need to specify the use of virtual environments, or is this up to the orchestrator implementation? Must names be provided for virtual environments?

13.4.2.4.1.2 Notes

- Typically, dependent artifacts must be processed in a specific order. TOSCA grammar must provide a way to define orders and groups (perhaps by extending groups grammar by allowing indented sub-lists).

13.4.3 Package Artifacts

Most software components are distributed as software packages that include an archive of files and information about the software, such as its name, the specific version and a description. These packages are processed by a package management system (PMS), such as rpm or YUM, that automates the software installation process.

Linux packages are maintained in Software Repositories, databases of available application installation packages and upgrade packages for a number of Linux distributions. Linux installations come pre-configured with a default Repository from which additional software components can be installed.

While it is possible to install software packages using Bash script artifacts that invoke the appropriate package installation commands (e.g. using apt or yum), TOSCA provides improved portability by allowing template designers to specify software package artifacts and leaving it up to the orchestrator to invoke the appropriate package management system.

13.4.3.1 RPM Packages

The following example shows a software component with an RPM package artifact.

Need a simple example

13.4.4 Debian Packages

The following example shows a software component with Debian package artifact.

Need a simple example

13.4.4.1.1.1 Notes

- In this scenario, the host on which the software component is deployed must support RPM packages. This must be reflected in the software component's host requirement for a target container.
- In this scenario, the host on which the software component is deployed must support Debian packages. This must be reflected in the software component's host requirement for a target container.

13.4.4.2 Distro-Independent Service Templates

Some template designers may want to specify a generic application software topology that can be deployed on a variety of Linux distributions. Such templates may include software components that include multiple package artifacts, one for each of the supported types of container platforms. It is up to the orchestrator to pick the appropriate package depending on the type of container chosen at deployment time.

Supporting this use case requires the following:

- Allow multiple artifacts to be expressed for a given lifecycle operation.
- Associate the required target platform for which each of those artifacts was meant.

13.4.4.2.1.1 Assumptions/Questions

How do we specify multiple artifacts for the same operation?

How we we specify which platforms are support for each artifact? In the artifact itself? In the artifact type?

13.4.5 VM Images

13.4.5.1.1.1 Premises

- VM Images is a popular opaque deployment artifact that may deploy an entire topology that is not declared itself within the service template.

13.4.5.1.1.2 Notes

- The “create” operation, as part of the normative Standard node lifecycle, has special meaning in TOSCA in relation to a corresponding deployment artifact; that is, the node is not longer “abstract” if it either has an impl. Artifact on the create operation or a deployment artifact (provided on the node).

13.4.5.1.1.3 Assumptions/Questions

- In the future, the image itself could contain TOSCA topological information either in its metadata or externally as an associated file.
 - Can these embedded or external descriptions be brought into the TOSCA Service Template or be reflected in an instance model for management purposes?
- Consider create.sh in conjunction with a VM image deployment artifact
 - VM image only (see below)
 - Create.sh and VM image, both. (Need to address argument that they belong in different nodes).
 - Configure.sh with a VM image.? (see below)
 - Create.sh only (no VM image)
- Implementation Artifact (on TOSCA Operations):
 - Operations that have an artifact (implementation).
- Deployment Artifacts:
 - Today: it must appear in the node under “artifacts” key (grammar)
 - In the Future, should it:
 - Appear directly in “create” operation, distinguish by “type” (which indicates processor)?
 - <or> by artifact name (by reference) to artifact declared in service template.
 - What happens if on create and in node (same artifact=ok? Different=what happens? Error?)
 - What is best practice? And why? Which way is clearer (to user?)?
 - Processing order (use case variant) if config file and VM image appear on same node?

13.4.5.2 Image Onboarding – Uploading image to image repository

In the case of onboarding of images, the cloud management platform plays the role of artifact processor. Different cloud management platforms have different image characteristics.

For example .:

- **Openstack (Glance)** - disk_format, container_format, min_disk, min_ram etc.

- **Vmware** - vmware_disktype, vmware_ostype etc.
- **OpenshiftContainer** - name, namespace, selfLink ,resourceVersion etc.

These are described as artifact properties. They are not processed by the Orchestrator, but passed on to the cloud management platform for further processing.

13.4.6 Container Images

13.4.7 API Artifacts

Some implementations may need to be implemented by invoking an API on a remote endpoint. While such implementations could be provided by shell or python scripts that invoke API client software or use language-specific bindings for the API, it might be preferred to use generic API artifacts that leave decisions about the tools and/or language bindings to invoke the API to the orchestrator.

To support generic API artifacts, the following is required:

- A format in which to express the target endpoint and the required parameters for the API call
- A mechanism for binding input parameters in the operation to the appropriate parameters in the API call.
- A mechanism for specifying the results and/or errors that will be returned by the API call

Moreover, some operations may need to be implemented by making more than one API call. Flexible API support requires a mechanism for expressing the control logic that runs those API calls.

It should be possible to use a generic interface to describe these various API attributes without being forced into using specific software packages or API tooling. Of course, in order to “invoke” the API an orchestrator must launch an API client (e.g. a python script, a Java program, etc.) that uses the appropriate API language bindings. However, using generic API Artifact types, the decision about which API clients and language bindings to use can be left to the orchestrator. It is up to the API Artifact Processor provided by the Orchestrator to create an execution environment within which to deploy API language bindings and associated API clients based on Orchestrator preferences. The API Artifact Processor then uses these API clients to “process” the API artifact.

13.4.7.1 Examples

- REST
- SOAP
- OpenAPI
- IoT
- Serverless

13.4.8 Non-Standard Artifacts with Execution Wrappers

TODO

13.5 Artifact Types and Metadata

To unambiguously describe how artifacts need to be processed, TOSCA provides:

1. Artifact types that define standard ways to process artifacts.
2. Keywords such as checksum, version etc. that enable identification of suitable artifact processor and transfer of artifact to artifact processor.
3. Artifact Properties that enable the artifact processor to process the artifact
4. Descriptive metadata that provide additional information needed to properly process the artifact.

14 Conformance

14.1 Conformance Targets

The implementations subject to conformance are those introduced in Section 11.3 “Implementations”. They are listed here for convenience:

- TOSCA YAML service template
- TOSCA processor
- TOSCA orchestrator (also called orchestration engine)
- TOSCA generator
- TOSCA archive

14.2 Conformance Clause 1: TOSCA YAML service template

A document conforms to this specification as TOSCA YAML service template if it satisfies all the statements below:

- (a) It is valid according to the grammar, rules and requirements defined in section 3 “TOSCA Simple Profile definitions in YAML”.
- (b) When using functions defined in section 4 “TOSCA functions”, it is valid according to the grammar specified for these functions.
- (c) When using or referring to data types, artifact types, capability types, interface types, node types, relationship types, group types, policy types defined in section 5 “TOSCA normative type definitions”, it is valid according to the definitions given in section 5.

14.3 Conformance Clause 2: TOSCA processor

A processor or program conforms to this specification as TOSCA processor if it satisfies all the statements below:

- (a) It can parse and recognize the elements of any conforming TOSCA YAML service template, and generates errors for those documents that fail to conform as TOSCA YAML service template while clearly intending to.
- (b) It implements the requirements and semantics associated with the definitions and grammar in section 3 “TOSCA Simple Profile definitions in YAML”, including those listed in the “additional requirements” subsections.
- (c) It resolves the imports, either explicit or implicit, as described in section 3 “TOSCA Simple Profile definitions in YAML”.
- (d) It generates errors as required in error cases described in sections 3.1 (TOSCA Namespace URI and alias), 3.2 (Parameter and property type) and 3.6 (Type-specific definitions).
- (e) It normalizes string values as described in section 5.4.9.3 (Additional Requirements)

14.4 Conformance Clause 3: TOSCA orchestrator

A processor or program conforms to this specification as TOSCA orchestrator if it satisfies all the statements below:

- (a) It is conforming as a TOSCA Processor as defined in conformance clause 2: TOSCA Processor.
- (b) It can process all types of artifact described in section 5.3 “Artifact types” according to the rules and grammars in this section.
- (c) It can process TOSCA archives as intended in section 6 “TOSCA Cloud Service Archive (CSAR) format” and other related normative sections.

- (d) It can understand and process the functions defined in section 4 “TOSCA functions” according to their rules and semantics.
- (e) It can understand and process the normative type definitions according to their semantics and requirements as described in section 5 “TOSCA normative type definitions”.
- (f) It can understand and process the networking types and semantics defined in section 7 “TOSCA Networking”.
- (g) It generates errors as required in error cases described in sections 2.10 (Using node template substitution for chaining subsystems), 5.4 (Capabilities Types) and 5.7 (Interface Types).

14.5 Conformance Clause 4: TOSCA generator

A processor or program conforms to this specification as TOSCA generator if it satisfies at least one of the statements below:

- (a) When requested to generate a TOSCA service template, it always produces a conforming TOSCA service template, as defined in Clause 1: TOSCA YAML service template,
- (b) When requested to generate a TOSCA archive, it always produces a conforming TOSCA archive, as defined in Clause 5: TOSCA archive.

14.6 Conformance Clause 5: TOSCA archive

A package artifact conforms to this specification as TOSCA archive if it satisfies all the statements below:

- (a) It is valid according to the structure and rules defined in section 6 “TOSCA Cloud Service Archive (CSAR) format”.

Appendix A. Known Extensions to TOSCA v1.0

The following items will need to be reflected in the TOSCA (XML) specification to allow for isomorphic mapping between the XML and YAML service templates.

A.1 Model Changes

- The “TOSCA Simple ‘Hello World’” example introduces this concept in Section 2. Specifically, a VM image assumed to be accessible by the cloud provider.
- Introduce template Input and Output parameters
- The “Template with input and output parameter” example introduces concept in Section 2.1.1.
 - “Inputs” could be mapped to BoundaryDefinitions in TOSCA v1.0. Maybe needs some usability enhancement and better description.
 - “outputs” are a new feature.
- Grouping of Node Templates
 - This was part of original TOSCA proposal, but removed early on from v1.0. This allows grouping of node templates that have some type of logically managed together as a group (perhaps to apply a scaling or placement policy).
- Lifecycle Operation definition independent/separate from Node Types or Relationship types (allows reuse). For now, we added definitions for “node.lifecycle” and “relationship.lifecycle”.
- Override of Interfaces (operations) in the Node Template.
- Service Template Naming/Versioning
 - Should include TOSCA spec. (or profile) version number (as part of namespace)
- Allow the referencing artifacts using a URL (e.g., as a property value).
- Repository definitions in Service Template.
- Substitution mappings for Topology template.
- Addition of Group Type, Policy Type, Group def., Policy def. along with normative TOSCA base types for policies and groups.
- Addition of Artifact Processors (AP) as first class citizens

A.2 Normative Types

- **Types / Property / Parameters**
 - list, map, range, scalar-unit types
 - Includes YAML intrinsic types
 - NetworkInfo, PortInfo, PortDef, PortSpec, Credential
 - TOSCA Version based on Maven
 - JSON and XML types (with schema constraints)
- **Constraints**
 - constraint clauses, regex
 - External schema support
- **Node**
 - Root, Compute, ObjectStorage, BlockStorage, Network, Port, SoftwareComponent, WebServer, WebApplication, DBMS, Database, Container, and others
- **Relationship**
 - Root, DependsOn, HostedOn, ConnectsTo, AttachesTo, RoutesTo, BindsTo, LinksTo and others
- **Artifact**

- Deployment: Image Types (e.g., VM, Container), ZIP, TAR, etc.
- Implementation : File, Bash, Python, etc.

- **Artifact Processors**
 - New in v1.2 as “first class” citizen
- **Requirements**
 - None
- **Capabilities**
 - Container, Endpoint, Attachment, Scalable, ...
- **Lifecycle**
 - Standard (for Node Types)
 - Configure (for Relationship Types)
- **Functions**
 - get_input, get_attribute, get_property, get_nodes_of_type, get_operation_output and others
 - concat, token
 - get_artifact
 - from (file)
- **Groups**
 - Root
- **Policies**
 - Root, Placement, Scaling, Update, Performance
- **Workflow**
 - Complete declarative task-based workflow grammar.
- **Service Templates**
 - Advanced “import” concepts
 - Repository definitions
- **CSAR**
 - Allow multiple top-level Service Templates in same CSAR (with equivalent functionality)

Appendix B. Acknowledgments

The following individuals have participated in the creation of this specification and are gratefully acknowledged:

Contributors:

Alex Vul (alex.vul@intel.com), Intel
Anatoly Katzman (anatoly.katzman@att.com), AT&T
Arturo Martin De Nicolas (arturo.martin-de-nicolas@ericsson.com), Ericsson
Avi Vachnis (avi.vachnis@alcatel-lucent.com), Alcatel-Lucent
Calin Curescu (calin.curescu@ericsson.com), Ericsson
Chris Lauwers (lauwers@ubicity.com)
Claude Noshpitz (claudio.noshpitz@att.com), AT&T
Derek Palma (dpalma@vnomi.com), Vnomic
Dmytro Gassanov (dmytro.gassanov@netcracker.com), NetCracker
Frank Leymann (Frank.Leymann@informatik.uni-stuttgart.de), Univ. of Stuttgart
Gábor Marton (gabor.marton@nokia.com), Nokia
Gerd Breiter (gbreiter@de.ibm.com), IBM
Hemal Surti (hsurti@cisco.com), Cisco
Ifat Afek (ifat.afek@alcatel-lucent.com), Alcatel-Lucent
Idan Moyal, (idan@gigaspaces.com), Gigaspaces
Jacques Durand (jdurand@us.fujitsu.com), Fujitsu
Jin Qin, (chin.qinjin@huawei.com), Huawei
Jeremy Hess, (jeremy@gigaspaces.com), Gigaspaces
John Crandall, (mailto:jcrandal@brocade.com), Brocade
Juergen Meynert (juergen.meynert@ts.fujitsu.com), Fujitsu
Kapil Thangavelu (kapil.thangavelu@canonical.com), Canonical
Karsten Beins (karsten.beins@ts.fujitsu.com), Fujitsu
Kevin Wilson (kevin.l.wilson@hp.com), HP
Krishna Raman (kraman@redhat.com), Red Hat
Luc Boutier (luc.boutier@fastconnect.fr), FastConnect
Luca Gioppo, (luca.gioppo@csi.it), CSI-Piemonte
Matej Artač, (matej.artac@xlab.si), XLAB
Matt Rutkowski (mrutkows@us.ibm.com), IBM
Moshe Elisha (moshe.elisha@alcatel-lucent.com), Alcatel-Lucent
Nate Finch (nate.finch@canonical.com), Canonical
Nikunj Nemani (nnemani@vmware.com), Wmware
Priya TG (priya.g@netcracker.com) NetCracker
Richard Probst (richard.probst@sap.com), SAP AG
Sahdev Zala (spzala@us.ibm.com), IBM
Shitao li (lishitao@huawei.com), Huawei
Simeon Monov (sdmonov@us.ibm.com), IBM
Sivan Barzily, (sivan@gigaspaces.com), Gigaspaces

Sridhar Ramaswamy (sramasw@brocade.com), Brocade
Stephane Maes (stephane.maes@hp.com), HP
Steve Baillargeon (steve.baillargeon@ericsson.com), Ericsson
Thinh Nguyenphu (thinh.nguyenphu@nokia.com), Nokia
Thomas Spatzier (thomas.spatzier@de.ibm.com), IBM
Ton Ngo (ton@us.ibm.com), IBM
Travis Tripp (travis.tripp@hp.com), HP
Vahid Hashemian (vahidhashemian@us.ibm.com), IBM
Wayne Witzel (wayne.witzel@canonical.com), Canonical
Yaron Parasol (aronpa@gigaspaces.com), Gigaspaces

Appendix C. Revision History

Revision	Date	Editor	Changes Made
WDO1, Rev01	2018-02-06	Matt Rutkowski	<ul style="list-style-type: none"> Initial WDO2, Revision 01 baseline for TOSCA Simple Profile in YAML v1.3
WDO1, Rev02	2018-02-27	Matt Rutkowski	<ul style="list-style-type: none"> Updated Rev. history to WDO1, v1.3 Updated all namespaces to 1.3 (to match version). Updated TC Chairs and Editors. Section 6.2.1- Entry Definitions - Added support for multiple (equivalent) Entry Definitions as unordered list (declarative) of Service Templates. Added sections 6.2.2 Notes and 6.2.3 Use Cases to better inform reader about multiple Entry Definitions usages and processing for/by Orchestrators. Section 3.8.5 – Added artifact definitions to Group definition <ul style="list-style-type: none"> Note: we still have to discuss adding Artifact (Types/Defns._ to Group Type and this may affect Node Type schema and processing.
WDO1, Rev03	2018-03-29	Calin Curescu Dmytro Gassanov, Priya T G, Chris Lauwers	<ul style="list-style-type: none"> Updated definition of <code>get_input</code> to allow structure parsing and dereference into the names of these nested structures when needed similar to what <code>get_property</code> and <code>get_attribute</code> can do. See sections 4.4.1.1 and 4.4.1.2 Section 3.7.4: Deprecate the <code>properties</code> keyname in artifact type definitions Section 3.6.8.3: Fix the “imports” example to be consistent with the grammar. Section 3.8.3.3: Remove obsolete prose discussing the use of a “selectable” directive. Section 2.10.2; Remove obsolete prose discussing the use of a “substitutable” directive
WDO1 Rev03a	2018-04-02	Chris Lauwers	<ul style="list-style-type: none"> Minor fix to <code>get_input</code> grammar Section 3.3.6.7: <code>scalar-unit.bitrate</code>
WDO1 Rev04	2018-06-05	Chris Lauwers	<ul style="list-style-type: none"> Section 3.3.6.3: cleanup to prose that introduces the various scalar unit types Section 3.6.5.3: remove <code>filter_name</code> from <code>node_filter</code> grammar Section 2.15: operation output examples Section 3.6.14: attribute mappings Sections 3.6.16 and 3.6.17: add output definitions to operation and interface definitions.
WDO1 Rev05	2018-07-30	Chris Lauwers	<ul style="list-style-type: none"> Section 3.3.5: add <code>key_schema</code> keyword for property, attribute, and parameter definitions of type <code>map</code>. Section 3.9: add new <code>schema_definition</code> section that defines reusable schema definition grammar. Schema definitions support recursion to support lists of lists, maps of maps, maps of lists, and lists of maps. Section 3.6.10: use new <code>schema_definition</code> grammar in property definitions Section 3.6.12: use new <code>schema_definition</code> grammar in attribute definitions Section 3.6.14: use new schema definition grammar in parameter definitions Section 3.7.6: allow <code>entry_schema</code> and <code>key_schema</code> definitions for data type definitions that derive from TOSCA set types such as <code>list</code> or <code>map</code>.

WD01 Rev06	2018-08-23	Calin Curescu	<ul style="list-style-type: none"> • The word “list” was used to describe what are actually YAML maps throughout the document, e.g. the map of property definitions was described as list of property definitions. This created confusion with the real lists and the usage of TOSCA list datatype. Thus I replaced “list” with “map” where the list actually referred to a TOSCA map in sections: 3.6.17, 3.6.18, 3.7.2, 3.7.3.1.1, 3.7.4, 3.7.5, 3.7.6, 3.7.7, 3.7.9, 3.7.10, 3.7.11, 3.7.12, 3.8.1, 3.8.2, 3.8.3, 3.8.4, 3.8.5, 3.8.6, 3.8.7, 3.8.9, 3.8.12, 3.9, 3.10, 5.3.6.1, 5.9.3.2 • The word sequenced list was used to describe a YAML list. As we changed the improper use of list to map, we don’t need the “sequenced” list qualification, as all lists in YAML are sequenced. So I removed the word “sequenced” when used before a list in sections: 3.6.5, 3.6.9.2, 3.6.10.4, 3.6.16.1, 3.7.6, 3.7.9, 3.8.3, 3.9.2, 3.10 • Changed “array of 2 strings” to “list of strings (w. 2 members)” in sections: 3.8.9.1, 3.8.10.1. • Changed the title of section 3.3.4.1.2 from “Bulleted (sequenced) list notation” to “Bulleted list notation” as all YAML lists are sequenced list and the bulleted list notations is semantically not different from the bracket notation. • Corrected the improper use of a bulleted list usage when defining capabilities in example 22, in section 2.13 “Using YAML macros to simplify templates”.
WD01 Rev07	2018-11-05	Chris Lauwers	<ul style="list-style-type: none"> • Accept all changes in the document and publish the “clean” version as a new baseline. No other changes as compared to Rev06.
WD01 Rev08	2018-11-12	Chris Lauwers	<ul style="list-style-type: none"> • Incorporate Priya’s Artifact Properties contribution <ul style="list-style-type: none"> ○ Reintroduce artifact property definitions in artifact type definitions (these were previously deprecated in Rev03) Section 3.7.4 ○ Introduce artifact property assignments in artifact definitions—Section 3.6.7 ○ Added an application modeling use case that shows an example with multiple artifact definitions in a node template—Section 11.1.9 ○ Expand on the use artifact properties for VM Images—Section 13.3.5 • Various edits to fix typos and grammatical errors—Sections 1 and 2
WD01 Rev09	2018-11-15	Chris Lauwers	<ul style="list-style-type: none"> • Correct PortInfo assignment example in Section 5.3.9.3 (courtesy of Steve B.) • Remove get_operation_output examples (Section 2.14.3 and 2.14.4) in anticipation of get_operation_output getting deprecated. • Add introductory section on notifications based on Calin’s proposal (Section 2.16) • Add notification definition and notification implementation definition grammar (Section 3.16.19 and 3.16.18) • Add notification definitions to interface definition grammar (Section 3.6.20)
WD01 Rev10	2018-11-26	Matej Artač	<ul style="list-style-type: none"> • Cleanup examples in Chapter 2 to improve readability
WD01 Rev11	2018-11-27	Thinh Nguyenphu Gabor Marton	<ul style="list-style-type: none"> • Support for external workflow languages (Section 3.8.7) • Add external workflow example (Section 7.3.8)
WD01 Rev12	2018-12.10	Calin Curescu Thinh Nguyenphu Anatoly Katzman	<ul style="list-style-type: none"> • Minor editorial corrections to notification definitions (Section 2.16 and Section 3.6.19) • Various editorial changes to improve correctness and consistency • Introduce not operator in condition clause definitions (Section 3.6.25)
WD01 Rev13	2018-12-17	Priya TG Chris Lauwers	<ul style="list-style-type: none"> • Minor corrections to the artifact definition section (Section 3.6.7) • Deprecate “assert” keyname in condition clauses (Section 3.6.25) and update the examples accordingly.
WD01 Rev14	2018-12-22	Calin Curescu	<ul style="list-style-type: none"> • To eliminate confusion around events and event_types in condition-event-action policy triggers we have changed the keyname “event_type” to “event” in the trigger definition. They serve the same purpose. The usage of “event_type” is deprecated. (Section 3.6.22 Trigger definition).

			<ul style="list-style-type: none"> • We have consolidated the use of activities (as defined in the workflow step) and action (as defined in the policy trigger). We have unified them so that the “action” defined in the policy trigger refers to a list of activity definitions instead of only one. (Section 3.6.23 Activity definitions and Section 3.6.22 Trigger definition). • To allow conditions in policies to effect operations and workflow calls, and thus ensure a meaningful use of event-condition-actions policies we have defined the possibility to specify input values when calling operations or inlining workflows from within the activity definition. Moreover specifying input values is also needed when inlining external workflows, since they have no access to template node attributes. Syntactically this is consolidated in a short and long form of the activity definition, where the short form does not specify input values and is fully backward compatible and the long form allows the specification of input values. (Section 3.6.23 Activity definitions).
WD01 Rev 15	2019-01-22	Chris Lauwers Arturo Martin De Nicolas Calin Curescu Matej Artač	<ul style="list-style-type: none"> • Minor corrections to condition clause examples (Section 3.6.25) • Fix single line map grammar (Section 3.3.5.1.1) • Remove reference to ‘selectable’ directive in node filter definition in node template • Add missing section number to artifact_types definitions section (become Section 3.10.3.10. All sections below 3.10.3.10 have their section number incremented) • Added the keyname Other-Definitions to the TOSCA.meta file in the CSAR. Its value should point to a list of yaml files that define substitution templates that may be used for nodes defined in the main service template (Section 6. TOSCA Cloud Service Archive (CSAR) format). • Fix broken bookmarks (Section 3.6.19 and 3.6.20)
WD01 Rev 16	2019-02-03	Chris Lauwers	<ul style="list-style-type: none"> • Consistently use <code>tosca_simple_yaml_1_3</code> • Clarify definitions of abstract and no-op nodes (Section 1.8) • (Re)-introduce the ‘substitute’ directive to indicate node templates as abstract (Sections 2.10 and 2.11). • Introduce substitution_filter example (new Section 2.12. all sections below 2.12 have their section number incremented by 1) • Add substitution_filter keyname to the substitution_mappings grammar (Section 3.8.13) • Add attribute_mapping section (new Section 3.8.9. All subsequent subsections have their section number incremented) • Remove property-to-constant-value and property-to-property options from property_mapping syntax. Only property-to-input mappings are allowed (Section 3.8.8). • Document the substitute directive (Section 3.4.3)
WD01 Rev 17	2019-02-06	Chris Lauwers Calin Curescu Priya TG	<ul style="list-style-type: none"> • Eliminate inconsistencies between ‘occurrences’ syntax in Capability Definitions, Capability Assignments, Requirement Definitions, and Requirement Assignments (Sections 3.7.2, 3.7.3, 3.8.1, and 3.8.2) • Explicitly specifying the possibility to add custom keynames in the TOSCA.meta file for extended use of the TOSCA.meta beyond the scope of this TOSCA specification (Section 6.2.1 Custom keynames in the TOSCA.meta file) • Note about deprecation (Section 1.5.1) • Add normative and non-normative template artifact types (Sections 5.4.5, 9.1.4, and 9.1.5) • Introduce discussion about CSAR onboarding in the Artifacts Processing chapter (Section 13.1) • Experimental support for creating multiple node instances from the same node template (Section 2.20) • Single-line grammar for parameter definitions (Section 3.6.14.2) • Property definition refinement grammar (Sections 3.6.10.6 and 3.6.10.8)
WD01 Rev 18	2019-02-12	Chris Lauwers	<ul style="list-style-type: none"> • Use “select” directive in abstract node template example that uses node_filter (Section 2.9.2)

			<ul style="list-style-type: none"> • Document “select” directive in node template grammar (Section 3.4.3) • Deprecate interface definitions, requirement definitions, and capability definitions in group types (Section 3.7.11) • Deprecate interface definitions in group definitions (Section 3.8.5)
WE01 Rev 19	2019-02-19	Chris Lauwers	<ul style="list-style-type: none"> • Initial CSD candidate. • Identical to Rev 18 but with all changes accepted.
WD01 Rev 20	2019-03-28	Chris Lauwers	<ul style="list-style-type: none"> • Remove Chapter 14 • Remove Section 7.4
WD01 Rev 22	2019-04-25	Calin Curescu	<ul style="list-style-type: none"> • Definition of range has been changed so that upper bound can be “greater than or equal to” lower bound (and not just not strictly “greater than”). This solves inconsistencies where such a range is needed (e.g. occurrences: [1, 1]) (Section 3.3.3) • Added the changes we introduced to “interface definition” (i.e. operations, notifications) also to “interface type definitions” (Section 3.7.5) • Reformulated the “activity definitions” for better readability (Section 3.6.23)
WD01 Rev 23	2019-08-12	Chris Lauwers	<ul style="list-style-type: none"> • Incorporate minor editorial fixes.