

The image features a large wind turbine on the left and an oil pumpjack on the right, both in silhouette. They are set against a dramatic sunset sky with a bright sun low on the horizon, casting a warm orange and yellow glow. The overall scene is framed by a blue border.

# Texas Energy Assurance Plan

November 2012

Acknowledgment of work by the Public Utility Commission of Texas, the Railroad Commission of Texas and the State Energy Conservation Office contributing to this effort: This material is based on work supported by the US Department of Energy under award number DE-OE0000092.

**Disclaimer:**

This report was prepared as an account of work sponsored by agencies of the state of Texas. Neither the state nor any agency thereof, nor any of its employees, makes any warranty, express or implied, or assumes any legal liability or responsibility for the accuracy, completeness or usefulness of any information, apparatus, product or process disclosed or represents that its use would not infringe privately owned rights. Reference herein to any specific commercial product, process or service by trade name, trademark, manufacturer or otherwise does not necessarily constitute or imply its endorsement, recommendation or favoring by the state of Texas or any agency thereof. The views and opinions of the authors expressed herein do not necessarily state or reflect those of the state of Texas or any agency thereof.

**Cover photo:** courtesy of the Governor’s office.

**Acknowledgements:**

**Public Utility Commission of Texas**

Donna L. Nelson, Chairman  
Kenneth W. Anderson, Jr., Commissioner  
Rolando Pablos, Commissioner

**Railroad Commission of Texas**

Barry T. Smitherman, Chairman  
David Porter, Commissioner  
Buddy Garcia, Commissioner

**Project Supervisors**

David Featherston

Jerry Trognitz

**Project Leads**

Jennifer Hubbs

David Randle

**Special thanks to other contributors:**

**Public Utility Commission:**

Brian Almon\*  
Julie Black  
Mark Bryant  
Shawnee Claiborn-Pinto  
Brian Davison  
Davida Dwyer  
Regina Erales  
Grace Godines  
Richard Greffe  
Theresa Gross\*  
Diana Leese  
Kevin Mathis

Patrick Peters  
Larry Reed  
Katie Rich  
Alan Rivaldo  
Temujin Roach\*  
Christine Wright

**Railroad Commission:**

Gil Bujano  
Bill Geise  
Nigel Gustorf  
Denise Hudson\*  
Lynne LeMon\*

Pat Maxwell  
John Rissler\*

**State Energy Conservation Office:**

Roger Mulder

**Governor’s Office:**

Josh Havens

---

\*no longer with the agency

# Table of Contents

Table of Contents.....	ii
Table of Figures .....	v
<b>JOINT SECTION .....</b>	<b>1</b>
<b>Executive Summary .....</b>	<b>1</b>
<b>The State of Texas.....</b>	<b>3</b>
<b>General Threats to the State.....</b>	<b>5</b>
Natural Disasters .....	5
Terrorism and Crime .....	7
<b>Texas Strategy .....</b>	<b>10</b>
Texas Homeland Security Strategic Plan .....	10
<b>Emergency Response .....</b>	<b>18</b>
Annex L to the State Emergency Management Plan .....	18
Other Annexes to the State Emergency Management Plan.....	21
<b>Energy Interdependency.....</b>	<b>26</b>
Natural Gas as a Fuel Source for Electricity.....	27
<b>PUBLIC UTILITY COMMISSION SECTION .....</b>	<b>33</b>
<b>Introduction.....</b>	<b>34</b>
Texas Transmission Grids .....	37
Wholesale Market Entities .....	41
Retail Market Entities.....	43
Statistical Description of Energy and Expenditures.....	45
<b>Private Industry .....</b>	<b>46</b>
Mutual Assistance .....	47
Trade Associations.....	49
<b>Emergency Management .....</b>	<b>50</b>
Infrastructure Policy Section of the PUC .....	50
Emergency Response Structure .....	52
Emergency Outage Tracking.....	54
<b>Emergency Response .....</b>	<b>57</b>
ERCOT Emergency Measures .....	57
Industry Emergency Response .....	61
The State .....	63
<b>New Energy Resources.....</b>	<b>66</b>
Renewable Energy Mandate .....	68
Wind Generation .....	69
Distributed Generation .....	75
Storage Technologies .....	78
<b>New Energy Issues .....</b>	<b>85</b>
Smart Grid .....	85
Cyber Security .....	100
Plug-In Hybrid Electric Vehicles.....	126
Energy Efficiency .....	130
Economic Variables .....	136
Resource Adequacy .....	138
Emergency Response Service .....	142



Federal Issues .....	143
<b>RAILROAD COMMISSION SECTION .....</b>	<b>147</b>
<b>Introduction.....</b>	<b>147</b>
<b>State Emergency Coordinators.....</b>	<b>152</b>
Texas Division of Emergency Management .....	152
RRC SOC Team Leader .....	152
RRC SOC Team .....	153
RRC District Offices.....	153
RRC Gas Services Division Director.....	153
RRC Emergency Communications Coordinator .....	154
RRC Media Affairs Representative .....	154
Relationship to other Agencies .....	154
<b>Private Industry .....</b>	<b>156</b>
<b>Trade Associations.....</b>	<b>167</b>
<b>Consumption .....</b>	<b>170</b>
Petroleum Consumption .....	170
<b>Threats, Interdependencies, Vulnerabilities and Consequences .....</b>	<b>175</b>
Characterization of the Industry .....	176
Vulnerabilities .....	182
Consequences .....	186
<b>Mitigation and Prevention.....</b>	<b>187</b>
International.....	187
Domestic.....	188
Prevention and Mitigation, Public and Private Sectors.....	190
<b>Critical Infrastructure Program .....</b>	<b>205</b>
Critical Infrastructure Protection Council.....	205
Critical Infrastructure Scope and Details.....	205
Geospatial Map and Database .....	207
<b>The Monitoring and Assessment of Energy Supplies .....</b>	<b>212</b>
Natural Gas Utilities .....	212
Natural Gas Pipelines .....	212
Refineries.....	215
Gasoline .....	215
<b>Emergency Response .....</b>	<b>218</b>
Severity of Shortage .....	218
Short-Term Emergency Response .....	219
Natural Gas, Long-Term Emergency Response .....	219
Petroleum, Long-Term Emergency Response .....	224
<b>Coal .....</b>	<b>227</b>
History .....	227
Production.....	227
Major Coal Mines in Texas .....	229
Emergency Response .....	229
<b>Uranium .....</b>	<b>230</b>
<b>Post Emergencies.....</b>	<b>230</b>
<b>Protecting Sensitive Data.....</b>	<b>230</b>
<b>REFERENCES .....</b>	<b>232</b>
<b>Authorities.....</b>	<b>232</b>
<b>Acronyms/Abbreviations .....</b>	<b>237</b>



<b>Glossary</b> .....	<b>241</b>
<b>Appendix 1: State Emergency Direction and Control</b> .....	<b>245</b>
<b>Appendix 2: PUC Organizational Chart</b> .....	<b>246</b>
<b>Appendix 3: RRC Organizational Chart</b> .....	<b>247</b>



## Table of Figures

Figure 1: Energy profile of Texas.....	4
Figure 2: Typical summer day’s drought conditions, 2011 .....	6
Figure 3: Number of days over 100 degrees, 2011 .....	6
Figure 4: Councils of government regions .....	14
Figure 5: Texas energy emergency response hierarchy.....	20
Figure 6: Basic interdependencies .....	26
Figure 7: US electric interconnections .....	37
Figure 8: Map of Texas Grids.....	37
Figure 9: Generation in ERCOT.....	40
Figure 10: Nodal configuration .....	41
Figure 11: AEP Texas .....	46
Figure 12: Oncor.....	46
Figure 13: TDUs in ERCOT .....	47
Figure 14: Regional mutual assistance groups in the US .....	48
Figure 15: Oncor crew in New Jersey after Hurricane Sandy .....	48
Figure 16: Outage database reporting—current outages.....	55
Figure 17: Outage database reporting—executive summary.....	55
Figure 18: Outage database—public view .....	56
Figure 19: Existing ties .....	59
Figure 20: Generation breakdown.....	66
Figure 21: National renewable energy potential .....	67
Figure 22: Roscoe wind farm .....	67
Figure 23: Generation deployment.....	68
Figure 24: 25 best wind areas .....	69
Figure 25: Wind capacity installed by year, as of April 2012 .....	70
Figure 26: Wind output, regulation and RRS for Jan. 28, 2010.....	72
Figure 27: CREZ selection .....	73
Figure 28: System ratings.....	80
Figure 29: Presidio battery.....	83
Figure 30: Building housing Presidio battery .....	83
Figure 31: SmartMeterTexas.com portal .....	88
Figure 32: AMI/AMS System .....	89
Figure 33: Oncor smart meter.....	90
Figure 34: > 18 GW of demand response potential in Texas by 2019 .....	96
Figure 35: Organizations and roles for smart grid cybersecurity.....	102
Figure 36: Jurisdictions in the electric grid .....	105
Figure 37: Calculating risk .....	107
Figure 38: Projected number of mobile.....	109
Figure 39: Attack sophistication vs. intruder knowledge over time; current defense .....	113
Figure 40: Types of threats against ICSs and their potential consequences .....	114
Figure 41: Frame of Aurora Experiment video from INL.....	116
Figure 42: Likelihood of success vs. consequences of a successful attack .....	117
Figure 43: Information technology vs. control systems.....	120



Figure 44: Organizations supporting smart grid and cybersecurity.....	123
Figure 45: Stakeholders and security assurance responsibilities throughout a product’s lifecycle .....	125
Figure 46: PEV fuel paradigm.....	126
Figure 47: Charging a Volt.....	128
Figure 48: Reserve margin for capacity through 2022.....	138
Figure 49: Remnants of an early cable tool rig .....	148
Figure 50: Workover rig .....	150
Figure 51: Blowout destroys drilling rig .....	152
Figure 52: RRC district office inspector with toughbook computer .....	153
Figure 53: The GLO coordinates with the Coast Guard on offshore oil spills .....	154
Figure 54: Active Operators with Wells .....	156
Figure 55: Largest oil producers in Texas, January – December 2011.....	157
Figure 56: Largest gas producers in Texas, January – December 2011 .....	158
Figure 57: Crude oil pipeline road crossing marker.....	159
Figure 58: Natural gas pipeline meter and regulator station with pig launcher .....	161
Figure 59: Fire department makes emergency response to an LPG tanker truck .....	162
Figure 60: Cost of gas and diesel September 2012.....	163
Figure 61: Oil refinery .....	163
Figure 62: Types of biomass.....	163
Figure 63: Biomass in Texas .....	164
Figure 64: Biomass consumption .....	164
Figure 65: Alternative fuel potential over the next ten years .....	165
Figure 66: Texas petroleum consumption .....	170
Figure 67: 2010 fuel consumption .....	170
Figure 68: Average producer price of natural gas.....	171
Figure 69: Utility prices .....	172
Figure 70: Natural gas consumption .....	173
Figure 71: Natural gas consumption .....	174
Figure 72: RRC jurisdiction .....	176
Figure 73: Reserves .....	176
Figure 74: Oil well pumping unit with counter balance and electric motor.....	178
Figure 75: Imported vs. domestic oil.....	183
Figure 76: 2010 Importers to PAD 3.....	183
Figure 77: Blowout preventer .....	188
Figure 78: Natural gas pipeline road crossing marker .....	190
Figure 79: Gas well and meter run delivering to intrastate pipeline.....	195
Figure 80: Pump jack on a shallow oil well .....	201
Figure 81: Oil and Gas Division district boundaries .....	207
Figure 82: XMap symbols .....	208
Figure 83: xMap .....	209
Figure 84: XMap pipeline layer sample.....	210
Figure 85: XMap features.....	210
Figure 86: XMap features 2.....	211
Figure 87: XMap features 3.....	211
Figure 88: Drilling roughnecks at work .....	212
Figure 89: Drilling rig floor .....	218
Figure 90: Gas well blowout with remains of drilling rig .....	219
Figure 91: Drilling rig.....	220

Figure 92: Natural gas compressor station ..... 220  
Figure 93: Natural gas wellhead "Christmas tree" ..... 221  
Figure 94: Drilling rig floor with vertically stacked drill pipe ..... 222  
Figure 95: Tanker truck burning out of control..... 224  
Figure 96: Intrastate pipeline..... 224  
Figure 97: Coal mines..... 228





## Executive Summary

---

The state of Texas routinely faces challenges. Its traditional antagonist has been the weather—from powerful hurricanes to paralyzing ice storms to violent tornados and drought-induced wildfires. The state has learned from each experience and incorporated those lessons into its approach to preparing for and responding to the next natural disaster. The threat environment of the state has changed in recent years, however. While nature continues to test the state’s emergency procedures, the human threat element has been of increasing concern. Protecting the state from an impartial force of nature requires a different strategy than defending against malicious intent. Since 9/11, the state has dedicated a great deal of thought and resources toward addressing the new threat reality.

As the nature of the threat has expanded, so has the state’s energy profile. Texas remains a leader in the oil and gas industry. New technologies, particularly massive multi-stage hydraulic fracturing and horizontal drilling technologies, have opened up new horizons in the Barnett, Woodford and Eagle Ford Shale formations. Three-dimensional seismic technology has led to the discovery of additional hydrocarbons in traditional plays. Texas is also a leader in renewable energy and energy efficiency. The state is making great strides in implementing the smart grid and in ensuring the safety and reliability of its energy delivery systems. Novel vulnerabilities, however, come with progress. Texas recognizes the trade-off and is moving forward cautiously.

Under the governor’s direction, the Texas Division of Emergency Management leads the state’s emergency efforts through planning and disaster response. The Texas Division of Emergency Management has designated the Public Utility Commission as the primary agency responsible for energy emergency issues including updating and maintaining the Energy Annex (Annex L) to the State Emergency Management Plan. The Railroad Commission and the State Energy Conservation Office are secondary agencies responsible for Annex L. The three agencies, each expert in different aspects of energy policy and assurance, recently coordinated the 2011 update of Annex L which will remain in effect for five years. Annex L is the foundation for the state’s response to disasters affecting energy delivery. The state has developed a series of other plans that focus on various facets of emergency management. Many of those will be discussed in this Plan.

This Energy Assurance Plan is designed to serve as a compilation of data on energy emergencies, supply disruptions and interdependencies and to provide information on new and existing energy issues. The three Annex L agencies—the Public Utility Commission, the Railroad Commission and the State Energy Conservation Office—collaborated in this endeavor pursuant to a US Department of Energy (DOE) grant authorized by the American Recovery and Reinvestment Act, and the information contained herein follows the DOE framework. The

objectives of the grant are to promote awareness, prevention, mitigation, preparation, emergency response and recovery regarding emergency management and homeland security matters on the state level and to incorporate response actions in view of new energy portfolios.

The purpose of the Energy Assurance Plan is to:

- ✦ Identify threats, vulnerabilities, interdependencies and consequences in the energy sector as they relate to electricity, natural gas and oil;
- ✦ Describe prevention and mitigation strategies applicable to energy emergencies;
- ✦ Document emergency response and recovery processes implemented during short-term and long-term emergencies and
- ✦ Explore new energy issues and their effects on energy assurance.

Texas is a large state with tremendous diversity in geography and demographics. Its diversity is one of the state's greatest assets, but it also creates challenges in energy delivery and the homeland security environment.<sup>1</sup>

Texas is the second largest state both in area and population. Second in size to Alaska, Texas contains 267,277 square miles of land and water and occupies about seven percent of the United States. New England, New York, Pennsylvania, Ohio and Illinois combined would fit inside its borders. Texas has 254 counties. Harris County is the most populated with over four million residents, and the least populated is Loving County in far west Texas with only 82 residents. 2011 Census Bureau data estimated the population of the state to be 25,674,681, second only to California and equaling more than eight percent of the population of the US.<sup>2</sup> From 2000 to 2010, the state's population soared by 20.6%.

Texas has a \$1 trillion gross state product and three of the country's ten most populous cities — Houston, San Antonio and Dallas. It ranks first in the nation in international commerce and sixth in the world. Texas is a leader in energy and petrochemicals production and the export of high technology and is home to several key military installations. The Port of Houston is first in the nation in foreign waterborne tonnage, second in total tonnage and tenth in the world. A state as large and complex as Texas inevitably has a very large number of sites that are vulnerable to the effects of natural disasters, criminal/terrorist attacks and miscellaneous catastrophic events.

Texas shares a 1,254 mile border with Mexico—64% of the entire US-Mexico frontier. The Gulf of Mexico coastline is 367 miles long, containing some of the busiest, most economically important shipping lanes and ports in the US. A major portion of the nation's petroleum refining and petrochemical capacity is located along the coast, and it lies in an area of heavy hurricane activity and boat traffic, susceptible to natural and man-made disasters.

Texas is often called the Energy State, primarily for its production of energy but also for its consumption. Figure 1 depicts the energy profile for the state. Texas leads the nation in crude oil production, and the state's signature crude oil, West Texas Intermediate, remains the major benchmark in the Americas. Texas' 27 petroleum refineries process over 4.7 million barrels of crude oil every day—more than 25% of total US refining capacity. Texas produces 30% of the nation's natural gas, and it also leads the country in wind power with over 2,000 turbines in west Texas alone. Texas produces and consumes more electricity than any other state.<sup>3</sup> Per capita residential energy use is significantly higher than the national average, due to the long

---

<sup>1</sup> Much of this section was taken from the Governor's Competitiveness Council, *Texas State Energy Plan* (2008) and the *State of Texas Hazard Mitigation Plan* (2010-2013).

<sup>2</sup> <http://quickfacts.census.gov/qfd/states/48000.html>.

<sup>3</sup> [http://www.eia.doe.gov/state/state\\_energy\\_profiles.cfm?sid=TX](http://www.eia.doe.gov/state/state_energy_profiles.cfm?sid=TX).

periods of hot weather and widespread use of electric-powered central air conditioning and heating.

Safeguarding the state is a complex, demanding homeland security challenge. The state's vast size, immediate proximity to Mexico and the Gulf of Mexico, ever-growing population and unique role in the nation's economy combine to generate enormous homeland security issues.

Figure 1: Energy profile of Texas

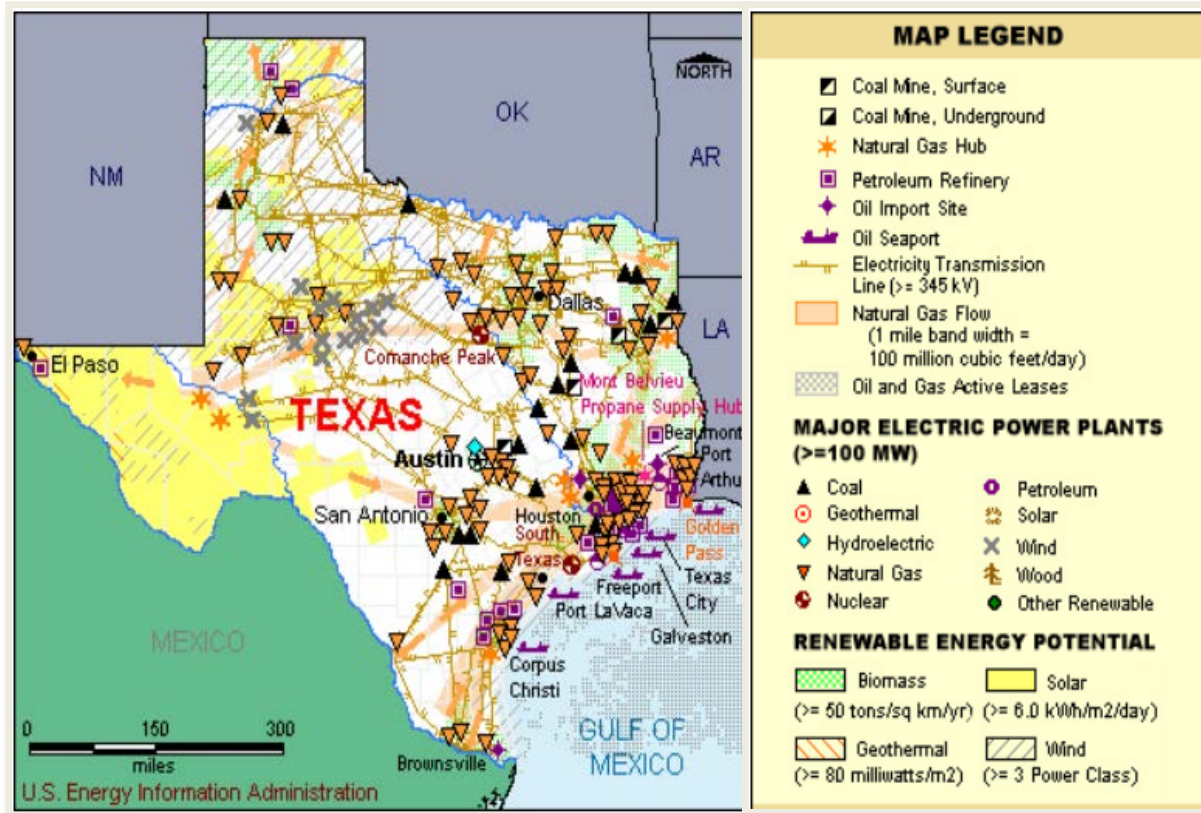

## General Threats to the State

---

Texas will continue to face a broad, complex array of critical infrastructure and homeland security threats. These are comprised of natural hazards—hurricanes, tornados, wildfires, drought, floods, ice storms and lightning—and epidemic diseases in animals, crops and humans as well as the potential for catastrophic industrial accidents associated with petroleum, refinery and petrochemical production. Threats to Texas security include the very real potential for dangerous terrorist attacks and the growing, destructive menace of criminal enterprises. Texas is committed to an all-hazards approach to homeland security, and the state faces an extraordinary threat environment in terms of frequency, severity and potential loss from hazardous events.<sup>4</sup>

### Natural Disasters

The most frequent major disasters in Texas are flooding and tornados. Texas ranks first among the states for frequency of tornados and flash floods. Roughly 125 tornados touch down on Texas soil each year, and the state has more than 10 million acres of floodplain. The Texas Hill Country is one of the three most flash flood prone areas in the world. Hurricanes are, however, the greatest natural threat to the state of Texas. Texas is second only to Florida in the number of hurricane impacts and, nationwide, suffers the greatest economic impact from hurricane losses. Hurricane Ike in 2008, for example, was the third most destructive storm in US history.

In terms of frequency of events (tropical cyclones, tornados, wildfires, droughts, ice storms, heat waves, hail storms, floods, sand storms and petrochemical and other industrial accidents) and amount of losses, Texas ranks as the most hazardous state.<sup>5</sup> Natural hazards impact some portion of the state each year and in comparison to other hazards to date, have caused great loss of life and property.

Drought and wildfires regularly pose serious threats to substantial portions of the state, and 2011 was a particularly bad year for both. By July, the Texas State Climatologist had declared 2011 the most severe one-year drought on record, causing billions of dollars in damages.<sup>6</sup> Figure 2 illustrates the breadth of the 2011 exceptional drought that covered virtually the entire state throughout that summer.<sup>7</sup> For much of the season, 250 of the 254 Texas counties reported burn bans as low humidity and high winds fueled by La Niña conditions set the stage for daily wildfires.

---

<sup>4</sup> Much of this section was taken from the *Texas Homeland Security Strategic Plan* (2010) and the *State of Texas Hazard Mitigation Plan* (2010-2013).

<sup>5</sup> Dennis Mileti, *Disasters by Design* (1999).

<sup>6</sup> <http://tamunews.tamu.edu/2011/08/04/texas-drought-officially-the-worst-ever/>.

<sup>7</sup> <http://droughtmonitor.unl.edu/archive.html>.

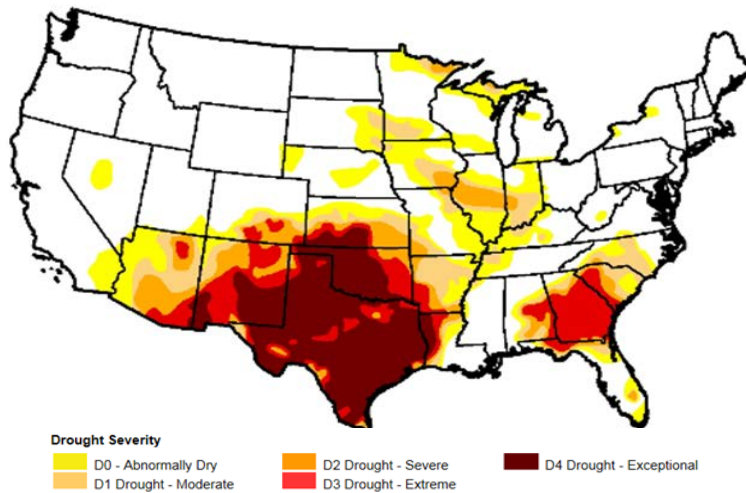

**Figure 2: Typical summer day's drought conditions, 2011**

Texas experiences more wildfires than any other state, recording 30,457 in the 2010-2011 fire season when just less than 4,000,000 acres<sup>8</sup> burned, causing \$750 million in damage.<sup>9</sup> Wildfires are a growing concern given rapid population growth and the steady increase of the wild land-urban interface. The Bastrop County Complex fire that started Labor Day weekend 2011, for example, destroyed 1,554 homes and killed two people just 25 miles from the state capital. Complicating efforts to fight this and other fires, Texas suffered through the hottest summer in the country's history with 90 days topping 100 degrees in Austin, shattering the previous record of 69 days. Figure 3 illustrates how pervasive this phenomenon was throughout the state.<sup>10</sup>

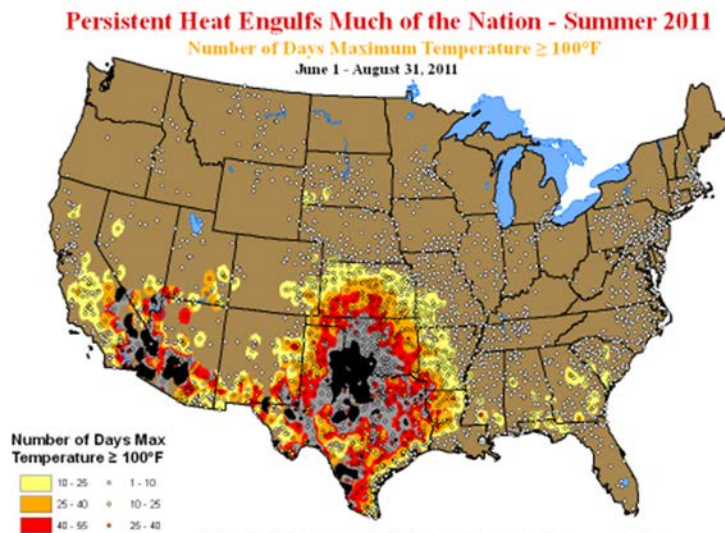

**Figure 3: Number of days over 100 degrees, 2011**

<sup>8</sup> <http://texasforests.tamu.edu/main/article.aspx?id=12888>.

<sup>9</sup> <http://www.noaa.gov/extreme2011/wildfire.html>.

<sup>10</sup> <http://www1.ncdc.noaa.gov/pub/data/cmb/extremes/summer-2011-days-over-100.png>.

In 2011, the electric, oil and gas industries reported damage to infrastructure from wildfires but in most cases had enough forewarning to prepare. Some wildfires, however, may have been started by drought-stricken vegetation falling onto electrical infrastructure.

Weather-related natural disasters threaten energy infrastructure, and damage to this infrastructure can cause extended disruptions of supply to energy users in the state. Nature can also cause energy demand to soar to peak load levels with little lead time. Emergency responders must be prepared for all natural hazards.

## Terrorism and Crime

Terrorism is a threat to Texas, and terrorists with a coordinated plan could cause a major disaster. The economic and/or emotional costs of a single spectacular attack can be enormous. An attack that damages a key petroleum refinery, for example, can impact the entire nation. An attack on a large public gathering such as the Super Bowl could have a lasting effect on the day-to-day interaction of large segments of the population.

Terrorist threats fall into two broad categories: international and domestic. International terrorism remains one of the greatest threats to our national security and the security of Texas. Global trends suggest that the number of international terrorist groups is likely to continue to grow for the foreseeable future. Terrorist groups will continue to become more networked and to increasingly share resources including funds, intelligence, training and logistical support.

Domestic terrorism also poses a threat to Texas. Domestic terrorist groups usually fall into one of two broad categories: left-wing extremists and right-wing extremists. Left-wing groups commit acts of sabotage or violence in order to advance a political agenda, usually related to trade globalization, human and labor rights, animal rights or the environment. Right-wing groups include white supremacist or anti-government groups who target law enforcement, government officials and minority groups.

Terrorists do not always operate within the construct of an organized group but may instead operate as “lone wolf” actors. Lone wolf actors are individuals who draw ideological inspiration from terrorist organizations but operate alone on the fringes of those movements.

Because terrorists and criminals increasingly use similar tactics and operational methods, it has become more challenging to draw a clear distinction between the two. Both groups use drug trafficking, human trafficking and smuggling, document fraud, credit card fraud, kidnapping, extortion and other crimes to generate funds to purchase weapons, pay recruits, underwrite training costs and enable operations overall. Both groups use sophisticated technology to recruit operatives, train members, plan and oversee operations, manage finances, handle logistics and perform other organizational tasks, and both groups represent a threat to the energy sector. The global trend of increasing crime and international terrorism convergence is likely to continue to grow as the lines between the activities of criminal enterprises and terror

organizations become increasingly blurred. Terrorist-criminal alliances complicate efforts to identify and track terrorists operating on foreign soil and in Texas. The state's diverse urban areas, border with Mexico and key critical energy infrastructure further complicate the unique counterterrorism challenges in Texas.

## Weapons

The *National Preparedness Guidelines* issued by the US Department of Homeland Security (DHS) in September 2007 identify scenarios that are useful for illustrating the potential nature and consequence of terrorist attacks. Those that pose "the greatest risk of mass casualties, massive property loss, and immense social disruption" and are most relevant to our discussion are:

- ✚ Nuclear attack with an improvised nuclear device;
- ✚ Radiological attack with a dirty bomb;
- ✚ Chemical attack with toxic industrial chemicals;
- ✚ Tactical use of an improvised explosive device and
- ✚ Cyber attack.

These attacks generally involve the use of weapons of mass effect, explosives and/or cyber attacks. Dealing with these scenarios will require coordinated, multi-jurisdictional/interagency planning, preparation, training and response.

### ***Weapons of Mass Effect***

Weapons of mass effect (WME) include nuclear, biological, chemical, high-yield explosive and radiological weapons. These weapons have a similar purpose: to cause mass casualties and spread panic.

Intelligence reports suggest that several terrorist organizations are aggressively seeking WME capabilities. If obtained, these capabilities would present a serious threat to Texas. WMEs are susceptible to theft and illegal purchase, and complete weapons and their components can be easily concealed and transported. The Texas-Mexico border and our many seaports make the transport of WME an area of grave concern.

### ***Improvised Explosive Devices***

Improvised explosive devices (IED) are homemade explosive devices designed to kill, injure and incite panic, confusion and terror. They are particularly dangerous because they can be assembled using commonly purchased items and transported secretly. IEDs can include a range of explosives, can be packaged in a variety of containers, can employ many different types of delivery methods and can be detonated in combination with toxic chemicals, biological toxins or radiological material. IEDs of particular concern are vehicle-borne IEDs (VBIED) which use vehicles as the delivery mechanism for explosives. VBIEDs can contain hundreds or thousands



of pounds of explosives and cause extraordinary destruction. Examples include the 1993 World Trade Center bombings and the bombing of the Alfred P. Murrah Federal Building in Oklahoma City. Terrorists in Iraq, Afghanistan, Spain and India continually demonstrate that no nation is immune to IEDs, and Texas must be cognizant of the risks that they present.

### ***Cyber Attacks***

Cyber attacks have become a weapon of choice for many terrorist organizations. Cyber attacks can be launched from any location in the world that has Internet access. They are often untraceable and have the potential to wreak havoc on financial and economic systems, defense networks, transportation systems, power infrastructure and other essential capabilities.

Although not widely publicized, cyber attacks occur routinely. Within the state of Texas, a major computer security incident with significant financial and operational impact is a regular event for most organizations, including state government entities. In fact, during fiscal year 2009, state entities reported an average of almost 575 security incidents per day. This includes malicious code execution, unauthorized access to data and service disruptions. Most of these attacks are blocked, prevented or result in only minor disruptions.

Between January 2005 and August 2009, Texas-based organizations reported 105 incidents involving an attack on or invasion of privacy data. Forty-three of these incidents were government-related (universities, cities, counties and state agencies). These 105 incidents exposed over 3,000,000 records with the cost estimated at an all-time high of \$202 per record exposed, totaling \$606 million to recover from the attacks.

## **Illegal Entry**

The volume of people illegally entering Texas from Mexico poses a major homeland security challenge. While many cross the border searching for employment, a large number cross with the intent of introducing drugs, enforcing cartel and gang discipline, conducting kidnappings or murders and committing other crimes. The sheer volume of aliens crossing the border into the US facilitates entry of criminals, gang members, terrorists and others whose purpose is criminal and/or terrorist activities. Trends continue to show that the Mexican border is an avenue of choice for introducing aliens from countries of special interest such as Yemen, Iraq, Saudi Arabia and Pakistan.

### Texas Homeland Security Strategic Plan

Section 421 of the Government Code authorizes the governor to direct homeland security activities and to develop a strategic plan. It also establishes a Homeland Security Council (with representatives from the PUC and RRC), a Private Sector Advisory Council and the Texas Fusion Center. These groups advise the governor and work on planning, coordination, communication and implementation of the Strategic Plan.

The *Texas Homeland Security Strategic Plan 2010-2015* (Strategic Plan) identifies three goals for dealing with the threat environment:

1. **Prevent:** Prevent terrorist attacks in Texas and prevent criminal enterprises from operating successfully in Texas.
2. **Protect:** Reduce vulnerability to natural disasters, criminal and terrorist attacks and catastrophic events.
3. **Prepare to respond and recover:** Prepare to minimize damage through rapid, decisive response and quickly recover from terrorist attacks and other disasters.

These goals align with and encompass the national preparedness priorities and policies established by DHS and consider the unabated threats posed by international and domestic terrorists, the increasing convergence of terrorism and crime, the growing security threat posed by criminal enterprises and the steady increase in the frequency and consequence of natural disasters. The Strategic Plan is tailored to meet the unique homeland security needs of Texas, and it accounts for the state's size, location, lengthy land and sea borders, geographic features, demographics and economic diversity. Some of the most relevant objectives toward achieving these goals in the area of energy assurance are discussed below.<sup>11</sup>

#### Goal One: Prevent

The best way to protect the citizens of Texas from the consequences of a terrorist or criminal attack is to keep such an attack from occurring. Prevention encompasses all efforts to detect terrorists and violent criminals, to deter their activities, to deny access to support structures and to stop assaults and attacks before they are launched. The focus of our prevention efforts is a robust, integrated investigative and intelligence capability. The state's objectives are to:

- ✚ Ensure, expand and enhance a robust investigative capability that reduces the threat of terrorism and criminal enterprises;

---

<sup>11</sup> To read the *Texas Homeland Security Strategic Plan* in full, please see [http://governor.state.tx.us/files/homeland/HmLndSecurity\\_StratPlan2015.pdf](http://governor.state.tx.us/files/homeland/HmLndSecurity_StratPlan2015.pdf).

- ✚ Prevent terrorists and criminal enterprises from exploiting Texas' international borders, including land, air and sea and
- ✚ Increase public awareness and reporting of suspicious activities related to criminal activity and terrorism, with emphasis on drug and human trafficking, smuggling and WME- and IED-related activities.

The first objective of DPS is to prevent terrorist attacks. The Texas Infrastructure Protection Communications Center (TIPCC) is the state's primary entity for planning, coordinating and integrating government communications capabilities to support homeland security prevention, preparedness and response activities. The TIPCC includes two elements:

1. The State Operations Center (SOC) operates around the clock to monitor and analyze the impact of threats and ongoing emergency situations statewide, to notify local, state and federal agencies and officials of such threats and to coordinate state readiness activities and emergency response operations.
2. The Texas Security Alert and Analysis Center, staffed by DPS Special Crimes personnel, analyzes suspicious incidents relating to homeland security that are reported by law enforcement agencies and shares the information developed with local governments, other states and the federal government.

## Goal Two: Protect

Reducing vulnerability results from steps taken to prevent attacks and unintended disastrous events, thereby protecting soft and hard targets from their effects. Prevention encompasses all efforts to reduce vulnerabilities by keeping an event from occurring. Protection efforts might include disrupting an attempted attack, clearing thick brush from populated areas susceptible to wildfires or implementing zoning regulations that discourage building new structures in floodplains. Protection efforts mainly include strategies to monitor, guard and secure physical sites and people with an eye toward mitigating the consequences of any events that may transpire. The state's objectives in achieving this goal are to reduce the vulnerability of critical infrastructure and key resources in Texas and to use mitigation programs to reduce the threats that natural disasters pose to people and property.

### ***Reduce Vulnerability of Critical Infrastructure and Key Resources***

Most critical infrastructure/key resources (CI/KR) sites in the state are privately owned and operated, and many have their own security forces. To secure these sites, the power of public-private partnerships must be maximized to ensure that individual citizens, private security forces, commercial security measures and governmental assets cooperate in every aspect of safeguarding CI/KR. This includes sharing critical information to the maximum extent possible, joint public-private planning, training and exercising, joint funding and communications interoperability.

The first step in securing critical infrastructure and key resources is to identify, update and continually validate CI/KR data in Texas. This occurs through a systematic process that leverages public-private partnerships. Texas employs the Vulnerability Identification Self-Assessment Tool (ViSAT) provided by DHS. ViSAT allows owners and operators of CI/KR across the state in all sectors to perform a multi-dimensional analysis of threats, vulnerabilities and consequences and feed the data into a secure database at the Texas Fusion Center. The Fusion Center administers a database that includes all pertinent CI/KR information. Compiling that information in one location is essential for identifying interdependencies among locations and sectors, prioritizing vulnerabilities across all sectors and appropriately reducing vulnerabilities.

The Texas Fusion Center maintains the centralized CI/KR database of threat, vulnerability and consequence information in order to prioritize vulnerability reduction efforts across the pool of CI/KR and to provide a layer of data for DPS' geospatial technology platform. DHS plays an important role in reducing vulnerabilities at CI/KR facilities in the state using the expertise of the DHS Protective Security Advisors assigned to Texas. Texas also works with DHS to deliver targeted funding to local jurisdictions for the purchase of equipment that will extend the zone of protection beyond the gates of CI/KR facilities through the Buffer Zone Protection Program. The Buffer Zone Protection Program provides both funding and coordination to bring all levels of government, law enforcement and the private sector together to create plans to reduce vulnerabilities in areas surrounding prioritized CI/KR.

The protection of cyber infrastructure in Texas is also a homeland security responsibility. The Texas Department of Information Resources (DIR) is responsible for developing, updating and maintaining a statewide cyber security plan for state agencies that will ensure cyber protection, detection and response capabilities. The current plan is available on the DIR website.<sup>12</sup>

Other priority actions toward achieving this goal are to:

- ✚ Maintain and update the Texas CI/KR information database and improve its accessibility by local, state and federal law enforcement agencies;
- ✚ Expand and upgrade the integrated program used to assess and prioritize the vulnerabilities of each CI/KR site in Texas;
- ✚ Ensure that CI/KR managers, workers and nearby citizens—public and private—are provided training on recognizing and reporting incidents that may indicate terrorist activity;
- ✚ Ensure CI/KR operators throughout the state receive appropriate threat information;
- ✚ Ensure that all suspicious activities and threats related to CI/KR are reported through the statewide intelligence structure and are appropriately addressed;
- ✚ Expand and enhance the statewide cyber security program that tests and protects local and state IT systems from penetration and attack and
- ✚ Develop and rehearse contingency plans to mitigate the effects and consequences of a natural disaster, criminal or terrorist attack or other catastrophic event.

---

<sup>12</sup> <http://www2.dir.state.tx.us/security/policy/Pages/StateEnterpriseSecurityPlan.aspx>.

## ***Use Mitigation Programs to Reduce the Threat of Natural Disasters***

Hazard mitigation results from communities taking actions to reduce or eliminate long-term risk from hazards and their effects. Hazard mitigation includes building disaster resistance and resilience into communities. Disaster resistance is that portion of mitigation that improves the ability of structures and systems to withstand the effects of a given event. Building resistance into a community incorporates a variety of measures. A key step is establishing building codes aimed at reducing the probability that new structures will be destroyed or suffer catastrophic damage in the event of storms and other natural occurrences common to an area. Other examples include water control programs that improve drainage and protect against river and ocean flooding and statutes that require minimum distance between structures and forest lines to reduce the impact of wildfires.

The goal of mitigation is to minimize the impact of an event as opposed to simply increasing the response capability. Texas will continually assess the risk from all hazards across the state by using the national planning scenarios and scenarios based on other likely occurrences to help identify the most probable disasters and project their impact. These efforts will enable the state, regions, localities and private/commercial stakeholders to prioritize mitigation efforts based on each event's likelihood and scale of impact.

### **Goal Three: Prepare to Respond and Recover**

Although Texas has dedicated significant resources to the prevention of terrorist acts and protection of our CI/KR, not every disaster can be prevented. The state must continue to prepare to respond to and recover from manmade and natural disasters.

#### ***Improve the Use of the National Incident Management System***

The National Incident Management System (NIMS) unifies and institutionalizes a system of preparedness and response across the nation. It is the nationally-accepted framework for preparing for and responding to all hazards, regardless of nature, size or complexity. NIMS is a comprehensive, national approach to incident management that is applicable at all jurisdictional levels and across functional disciplines. NIMS allows officials in jurisdictions across the nation to use common terminology and command structures and share resources when responding to a hazard. NIMS comprises several components, including command and management, preparedness, resource management, communications and information management, supporting technologies and ongoing management and maintenance. NIMS incorporates common systems for incident command, multi-agency coordination and public information.

The governor adopted NIMS as Texas' statewide standard for incident management in Executive Order RP40, facilitating an effective, efficient, interlocking regional response system.

A program is in place to track the progress of NIMS implementation in all jurisdictions in Texas. The state continues to refine its incident management system, standardizing software applications and establishing common operating procedures.

### ***Expand Statewide Regional Response and Mutual Aid Network***

Texans respond to their neighbors' needs in times of crisis, whether they are in the next city, county, region or state. Most jurisdictions could not optimally respond to the impact of a large natural disaster or a terrorist incident without a broad regional approach to preparedness due to the size and scope of a potential incident as well as the potential need for specialized resources. Mutual aid agreements among more than 1,400 cities and counties help create an interlocking network of assistance that provides jurisdictions with the capability to identify and procure essential emergency management resources in the event of an emergency.

The state's 24 planning regions, individually and grouped into larger regions with similar interests, form the geographic areas for implementing county-wide, regional and multi-region mutual aid agreements which address all-hazards prevention, preparedness, response and recovery. These planning regions as shown in Figure 4 are known as Councils of Government (COG) and are assigned responsibility for bringing local governments together within regions to agree upon and execute mutual aid agreements and related implementation protocols. COGs are also charged with preparing and executing linked agreements between and among regions. In 2007, Senate Bill 11 created the Texas Statewide Mutual Aid System, providing statutory support for local authorities and COGs to provide mutual aid to local and regional governments throughout the state without the need to implement written agreements.



**Figure 4: Councils of government regions**

### ***Integrate Training***

In the event of an emergency, agencies across all jurisdictions and disciplines must respond as a team; thus, it is essential that they train and exercise as a team. Texas supports jurisdictions by establishing and implementing a training program that produces skilled and practiced first responders, emergency management leaders and other homeland security personnel throughout the state. The training strategy is to combine common and tailored training for first responders and leaders at every level including those in the private sector. The aim is to produce a corps of homeland security personnel who are trained to meet the unique needs of their specific communities and to integrate with leaders and responders throughout the state.

Texas follows the national standards for emergency response training and preparedness. These guidelines require individuals to receive designated coursework to maintain certifications in order for local jurisdictions to receive homeland security grant funding.

## ***Fully Integrate Homeland Security Exercises***

The state of Texas has a robust Homeland Security Exercise and Evaluation Program that helps stakeholders throughout the state plan, conduct and evaluate realistic exercises of all types, including exercises focused on natural disasters, criminal and terrorist attacks and catastrophic events. The aim of the program is to make exercises available that reflect and account for the complexity of the current homeland security environment.

The exercises are designed to support national and state homeland security strategic plans and are continually updated to add more rigors in areas where critical assessments of previous performance and capabilities found deficiencies. Performance and capability assessments provide jurisdictions and agencies with a means to determine areas needing improvement that will enhance their future ability to respond to natural disasters, criminal and terrorist attacks and other catastrophic events.

Hurricanes Ike, Gustav and Rita and Tropical Storms Edouard and Dolly reinforced the importance of planning and exercising urban area evacuations. Urban landscapes are constantly growing and changing, as are road networks. Because of these constant changes, state, regional and local officials must continually adapt the methods by which they expect to move the people in their communities to safety in response to—and ideally in front of—disasters of all kinds.

## ***Ensure that Emergency Plans Are in Place***

Texas' ability to prevent terrorist attacks, combat criminal enterprises and ensure disaster preparedness requires thorough, integrated planning at every level. Effective planning is the key to building the ability to shape the future. The plans that are developed as a result of this process are clear indicators of how well prepared jurisdictions, agencies and individuals are to prevent, protect, respond to and recover from all hazards.

For Texas jurisdictions, businesses and individual citizens need to be ready to handle the full array of hazards they may confront, and they must be familiar with the plans that concern them. They must routinely validate the effectiveness of their plans and ensure that a changing environment has not rendered a key portion of a critical plan un-executable.

## ***Maintain Alert Systems***

The public telephone system increasingly offers innovative opportunities for rapidly alerting and informing Texans of developing hazard situations. Officials can aggregate call locations and types to determine the spread of events and consequences, evacuee flows, road conditions and so forth. Capitalizing on the rapidly growing information sharing capabilities inherent in the public communications system—land line and cellular—will significantly advance the ability for Texans to get ahead and stay ahead of unfolding situations.

General warnings of terrorist threats are communicated to governments and the public through the federal Homeland Security Advisory System (HSAS). HSAS warnings are generated by the FBI and disseminated through the National Law Enforcement Telecommunications System and the Texas Law Enforcement Telecommunications System as well as through the media. Law enforcement is responsible for crisis management. The following actions may be used in response to a terrorist attack:

- ✚ Request that the Texas Security Alert and Analysis Center and DPS Special Crimes analyze threats and communicate with other law enforcement agencies;
- ✚ Release FBI warnings through the Homeland Security Advisory System and the National Law Enforcement Telecommunications System and the media and
- ✚ Delegate responsibility for managing the consequences of terrorist activities to fire service and local health or medical personnel.

## State of Texas Emergency Management Plan

The State of Texas Emergency Management Plan (Emergency Plan) was prepared by the Texas Division of Emergency Management (TDEM) pursuant to § 418.042 of the Government Code. It implements the general homeland security strategy described in the *Texas Homeland Security Strategic Plan*. It is intended to explain how the state will mitigate against, prepare for, respond to and recover from the impact of hazards to public health and safety including natural disasters, technological accidents, homeland security threats and other emergency situations.<sup>13</sup>

The Emergency Plan consists of the Basic Plan and 22 annexes that address individual sectors of emergency response (for example, Annex L is the Energy Annex). The plan establishes operational concepts and identifies tasks and responsibilities required to carry out a comprehensive emergency management program. The Basic Plan covers issues that are applicable statewide such as:

- ✚ Responsibilities of key officials and organizations;
- ✚ Direction and control of state emergency response and recovery operations;
- ✚ Readiness and response levels and
- ✚ Continuity of government.

The 22 annexes address coordination, responsibilities and emergency actions required during various phases of emergency management such as:

- ✚ Shelter and mass care;
- ✚ Communications;
- ✚ Evacuation;

---

<sup>13</sup> A full copy of the plan and its annexes may be found at <http://www.txdps.state.tx.us/dem/downloadable/forms.htm#stateplan>.



- ✚ Public information and
- ✚ Energy.

The Emergency Plan is supplemented by a series of plans that concentrate on more specific hazards and strategies.<sup>14</sup>

- ✚ State of Texas Hurricane Response Plan and attachments
- ✚ State of Texas Drought Plan
- ✚ State of Texas Hazard Mitigation Plan
- ✚ Texas Statewide Communications Interoperability Plan
- ✚ Local Emergency Management Plans and annexes

The Emergency Plan also provides for coordination with local officials concerning credible threats and the effective integration of state support for local emergency operations when local officials request state assistance. Local emergency management plans provide guidance for the employment of local emergency resources, mutual aid resources and specialized regional response resources under a local incident commander who may be supported by a local Emergency Operations Center. Local emergency plans include specific provisions for requesting and employing state resources to aid in managing and resolving emergency situations for which local resources are inadequate.

The Emergency Plan describes the integration of state response operations with federal agencies responding to emergency situations in Texas at the request of the governor pursuant to the *Federal Response Plan*, the *Federal Radiological Emergency Preparedness Plan*, the *National Contingency Plan* and other federal contingency plans, comprising the *National Response Plan*.

The Emergency Plan provides for requesting emergency assistance from or rendering emergency assistance to other states pursuant to the Emergency Management Assistance Compact and a number of specialized agreements to which the state of Texas is party.

---

<sup>14</sup> These plans may be found at <http://www.txdps.state.tx.us/dem/Preparedness/plansUnit.htm>.

The governor is the lead state-level emergency executive. Chapter 418 of the Government Code gives the governor the power to issue executive orders and suspend certain laws and rules. The statute establishes a State Emergency Management Council consisting of representatives of state agencies, boards, commissions and volunteer groups to assist and advise him.

The Chief of Emergency Management works with the governor in advance of a disaster to issue a disaster declaration, thereby activating the governor's emergency powers and the Emergency Plan. The Texas Division of Emergency Management, a division of the Texas Department of Public Safety (DPS), then activates the State Operations Center (SOC) where emergency personnel from each affected agency report and remain through the duration of the event. At the SOC, the Public Utility Commission (PUC) handles issues related to electricity and communications outages and restoration while the Railroad Commission (RRC) resolves problems with the maintenance, safety and delivery of oil, gasoline and other fuels, natural gas and propane.

The Emergency Plan is the basis for the state's response to an emergency, and it is composed of a Basic Plan and 22 subject-specific annexes. Each annex follows a statewide format prescribed by TDEM that includes Concept of Operations and Organization and Assignment of Responsibility sections. These sections define agency monitoring, response and recovery procedures as well as the duties of the supporting agencies, private industry and associations under their domain during emergency situations necessitating state assistance.<sup>15</sup>

### Annex L to the State Emergency Management Plan

Annex L is the Energy Annex, and it sets forth state emergency response measures applicable to the energy sector for emergencies of relatively short duration and scope. The PUC is the primary support agency and is focused on the generation, transmission and distribution of electricity. The RRC is a secondary support agency responsible for the production, processing, transportation and distribution of natural gas and petroleum. The State Energy Conservation Office (SECO) branch of the Comptroller's Office is the other secondary support agency, and it works with consumers, businesses and local governments to maximize energy conservation in the state. Annex L was updated in January 2011 and will remain in effect for five years.

Annex L is intended to:

1. Identify resource group tasks for the provision of energy during emergency situations;

---

<sup>15</sup> The annexes may be found online at <http://www.txdps.state.tx.us/dem/downloadableforms.htm#stateplan>.

2. Define the organization, responsibilities and procedures for facilitating the curtailment and/or restoration of service by energy providers and suppliers for service disrupted by an emergency situation and
3. Provide guidance for obtaining emergency energy for critical operational functions and facilities until energy service can be restored.

Highlights of Annex L include the following.

- ✚ Annex L applies to short-term, localized energy emergencies. Just like any emergency in the state, local resources must be exhausted or overwhelmed before requests can be made of energy officials at the regional, then state, then federal operations centers.
- ✚ Utilities are the first responders to restore service during a service outage or a disruption of service. State agencies work in a support role. Recovery from electric generation and transmission disruptions are generally handled by the Electric Reliability Council of Texas (ERCOT) or the appropriate regional transmission organization (RTO).
- ✚ The four sectors of the oil and natural gas industries are production, processing, transportation and distribution. Emergencies in the oil and gas sector generally result from severe weather conditions such as a hurricane or an ice storm.
- ✚ The PUC and RRC communicate with utilities regarding the size and duration of the emergency. The SOC or Disaster District Committee (DDC) may assist in determining impact and in taking population support measures.
- ✚ PUC and RRC responsibilities include:
  - ✚ Identifying and coordinating emergency staff;
  - ✚ Assisting in monitoring outages;
  - ✚ Keeping damage summaries and duration estimates;
  - ✚ Receiving, responding to and implementing assistance requests;
  - ✚ Collecting information from other support group members;
  - ✚ Coordinating emergency information and actions with utilities;
  - ✚ Assisting with damage assessment, facilitation, restoration;
  - ✚ Coordinating revisions to Annex L and
  - ✚ Assisting with public information.
- ✚ The RRC monitors natural gas and petroleum supplies in coordination with the Texas Energy Reliability Council (TERC). TERC's members include representatives including the RRC, producers, intrastate pipelines, gas distributors and ERCOT.
- ✚ The RRC may encourage industry to take certain actions to increase fuel supplies, reallocate supplies, locate alternative supplies or temporarily reduce demand during an emergency.

- ✚ SECO’s responsibility is to provide conservation information and technical assistance to the public.

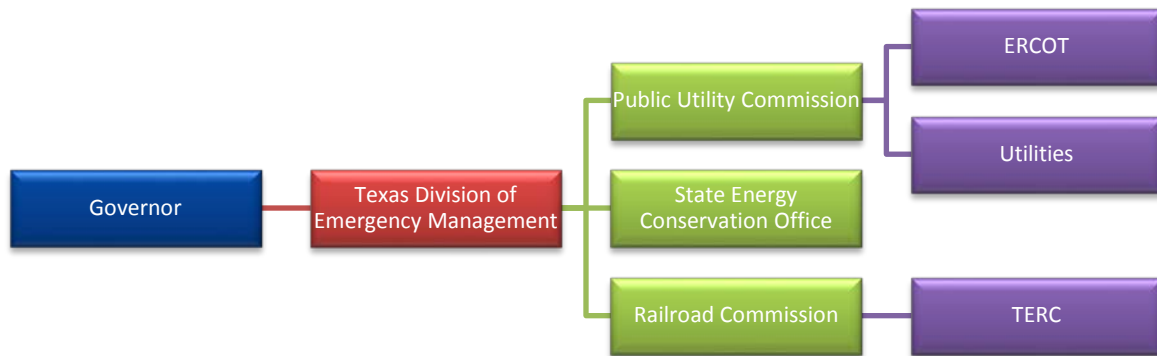

Figure 5: Texas energy emergency response hierarchy

The Emergency Plan establishes four response levels, depending on emergency conditions. Appendix 1 to Annex L tailors these response levels to energy emergency conditions as follows:

#### Response Level IV—Normal Conditions

- ✚ Promulgate rules requiring utilities to report major service outages to responsible agencies.
- ✚ Identify, train and equip agency personnel for emergency operations.
- ✚ Develop/maintain agency resource lists and emergency contact information.
- ✚ Maintain Annex L.
- ✚ Participate in emergency drills and exercises.

#### Response Level III—Increased Readiness Conditions

- ✚ Monitor the situation.
- ✚ Review emergency plans and procedures.
- ✚ Identify specific personnel to staff resource group positions in emergency facilities.
- ✚ Alert personnel for emergency duty.
- ✚ Ensure that staff rosters are up-to-date.
- ✚ Check emergency contact information for utilities, critical facilities and key staff.
- ✚ Ensure that utilities and energy providers are aware of the emergency situation, if it is not readily apparent.

#### Response Levels II and I—Escalated Response Conditions and Emergency Conditions

- ✚ Staff Energy resource group positions in designated emergency facilities.
- ✚ Assist in obtaining initial utility damage assessments including areas and number of customers affected and estimated out-of-service times.

- ✚ Obtain regular status reports from utilities serving the affected area.
- ✚ Provide periodic status reports to state and Disaster District Emergency Operations Centers.
- ✚ Identify priority service restoration needs requested by local governments or state agencies to utilities.
- ✚ Respond to requests for emergency energy/utility assistance, coordinating as necessary with other resource groups.
- ✚ Coordinate with utility, TDEM and agency public affairs personnel to provide information to the public on the emergency and, when appropriate, measures to deal with outages and to conserve energy.
- ✚ If requested, identify qualified personnel to assist in damage assessment for public non-profit utilities.
- ✚ If requested, coordinate with state agencies and local governments to facilitate utility emergency response including identifying lodging, food, fueling and equipment staging facilities.
- ✚ If requested, provide qualified personnel to participate in State Emergency Response Team (SERT) operations.

Hard copies of Annex L and related documents are kept by emergency personnel in the event of an electrical outage that makes the Internet unavailable.

## Other Annexes to the State Emergency Management Plan

The State Emergency Management Plan has 22 annexes dealing with a range of emergency response areas. Each annex designates a primary agency and secondary support agencies. A short discussion of relevant annexes follows.

- ✚ **Annex A—Warning:** Warnings may be issued for any perceived natural or man-made disaster. These potential disasters may impact energy facilities and supplies. Annex A defines warning responsibilities and locations for state, area and local parties. It identifies 14 separate warning systems used in Texas such as the Emergency Alert System, National and Texas Warning Systems and the Homeland Security Advisory System. TDEM is the primary agency for the Warning Annex.
- ✚ **Annex B—Communications:** Communications are a vital part of emergency response involving energy personnel and facilities. The primary support agency under this annex is the Department of Information Resources (DIR). DIR leads 11 support agencies. DIR maintains a list of state and volunteer communications equipment available to the state during an emergency.
- ✚ **Annex E—Evacuation:** The evacuation of population centers requires fuel for automobiles, buses, ambulances, helicopters and other means of transportation. The state coordinates with a group of private sector partners from the fuel industry who are represented in the SOC by a Fuel Coordinator. The purpose of the Fuel Coordination Team is to ensure availability and distribution of fuel during a crisis. Team members may include representatives from the Texas Oil and Gas Association, the Texas Petroleum Marketers and

Convenience Store Association, supply terminals, distributors, retailers and third party common carrier transporters. The team can arrange for non-traditional supply arrangements among carriers and retailers in order to meet the demand for fuel while consistently observing safety considerations. Annex E also mandates comfort stations along evacuation routes that will stock food, water and shelter information as well as provide medical assistance.

- ✚ **Annex F—Firefighting:** Electrical, natural gas and petroleum infrastructure is susceptible to fire, particularly during an emergency. Based on needs and operational capabilities, state assistance to local firefighters may consist of technical guidance, on-scene needs assessment, administrative support and/or full mobilization and deployment of personnel and equipment engaged in firefighting operations. The primary support agency is the Texas Forest Service. The Texas Engineering Extension Service assists with large industrial and structural fires. The Texas Catastrophic Fires Steering Committee and the Industrial Fires of State Significance Support Group also provide assistance.
- ✚ **Annex I—Public Information:** Keeping the public informed during energy outages and supply shortages is critical to public health and safety as well as the recovery process. Public information activities are coordinated through a Joint Information System which provides the mechanism for integrating public information activities among Joint Information Centers across jurisdictions and with private sector and non-governmental organizations. A state public information officer (PIO) from TDEM is stationed at the SOC. TDEM also operates a media center located near the SOC. The Center is available to the state PIO, the governor’s office and public information support agency members for updating the press and public about program-specific functions and activities. The use of the Media Center is coordinated through the state PIO.
- ✚ The PUC’s website, [www.puc.texas.gov](http://www.puc.texas.gov), contains extensive information about the agency, electricity and telecommunications issues, rulemakings and various other projects. Controlling legislation and PUC rules are available, and customers may find information regarding use of the PUC’s informal complaint resolution process for assistance with problems with service providers. All PUC open meetings and selected hearings and informational workshops are webcast and available for replay from links on the website. Included on the website is a permanent link for electricity conservation status. If disaster events create shortages of available electricity, then various levels of conservation alerts can be posted instantaneously. Specific alerts for public information and referral during disasters are coordinated by the Communications Director with the PUC emergency management response team and ERCOT or the appropriate RTO, along with other state agencies as needed.
- ✚ The RRC also maintains a website at [www.rrc.state.tx.us](http://www.rrc.state.tx.us) covering a host of material. The RRC’s website has links to RRC rules and regulations, maps, forms, tariffs, contact information, well records and logs, webcasts of RRC meetings and an oil and gas directory. During an emergency, the RRC will generally post relevant information on its home page. In particular, the RRC’s home page has a section titled “Land and Homeowner Information” which covers a wide range of topics of interest to consumers. The RRC also has a Media Affairs Officer through which public information is

disseminated via news releases to the media. During an emergency, such news releases would be posted on the RRC website.

- ✚ **Annex J—Recovery:** Recovery in the energy sector may involve reinstating damaged infrastructure to restore service to energy users. It may also involve re-establishing adequate sources of energy supply. Annex J describes the Joint Field Offices that serve as field headquarters and the Disaster Recovery Districts that provide direct assistance. The recovery effort may involve public, private and volunteer groups on the local, state and federal levels. The energy sector is reliant on private industry to repair its damaged facilities and to resolve most supply shortage situations. The PUC and RRC coordinate recovery activities with private industry, trade associations and reliability councils. Another objective of Annex J is to resupply storage fields and fuel inventories.
- ✚ **Annex K—Public Works and Engineering:** Following an emergency, highways are often damaged or cluttered with debris that may impede the repair of energy facilities. The Texas Department of Transportation is the lead agency of the Public Works and Engineering support group, which is responsible for clearing debris and repairing highways in order to expedite recovery operations. It also disseminates information on the status of transportation systems in the disaster area. The Public Works group also strategically deploys portable backup generators post-emergency.
- ✚ **Annex N—Direction and Control:** Annex N defines the chain of command from the governor to the SOC, DDC, mayor or county judge to the incident commander in the field. An organizational chart may be found in Appendix 1. TDEM is in charge of developing, maintaining and implementing the standard operating procedure for the SOC, the Emergency Management Council and other specialized recovery and response needs. Emergency Operating Centers may be established on the regional and local levels along with incident command posts in the field. Additional resources are available to the SOC such as Texas military forces, Civil Air Patrol, incident management teams, Texas Task Force One, mutual assistance programs and federal assistance. In addition to the Emergency Plan, Texas follows specialized contingency plans for specific emergency situations. The PUC and RRC emergency coordination staff work under TDEM’s direction at the SOC. RRC district office personnel may be deployed under the direction of the RRC SOC representative.
- ✚ **Annex Q—Hazardous Materials and Oil Spill Response:** During emergency situations, the probability of hazardous materials spills and oil spills increases. The Texas Commission on Environmental Quality (TCEQ) leads this support group to protect health, safety and the environment from pollution and contaminants. TCEQ is responsible for a wide range of hazardous materials affecting water, air and land. The General Land Office (GLO) is responsible for the oversight of coastal spills, and the RRC is responsible for oversight of inland oil, gas and mining spills.
- ✚ **Annex U—Terrorist Incident Response:** Energy infrastructure is a likely target of terrorist groups. DPS is the primary support group for Annex U while the PUC and RRC are among the many secondary support groups, providing key location and attribute data for industry infrastructure. The purpose of Annex U is to define organizational and operational concepts as well as the roles, responsibilities and procedures for emergency response to acts of terrorism including shootings, arson, hostage-taking, deployment of weapons of mass destruction and cyber attacks.

## Requests for Assistance

### ***Requests for Assistance from Local Governments***

In responding to an emergency, local governments are expected to utilize their own resources before calling on the state for assistance. These resources include resources owned, operated or controlled by local government, resources available from other parties pursuant to mutual aid agreements and resources provided by individuals, volunteer groups or businesses on an ad hoc basis. Local mayors and county judges are authorized to invoke certain emergency powers during major disasters. The powers provide them the capability to obtain additional local resources through emergency purchases and contracting and, under certain circumstances, to commandeer public and private property and personnel for emergency use. If the resources available to local government are insufficient or inappropriate to mitigate or resolve the emergency situation, the chief elected official may request assistance from the state. Cities must seek assistance from their counties before asking for state assistance.

### ***Disaster District Committee Response to Requests for Assistance***

Requests for state emergency response assistance must be submitted to the DDC chairperson having responsibility for the area where the incident is occurring. The DDC chair is expected to determine the validity of the request, use DDC resources to identify state resources in the district capable of meeting the need and to coordinate deployment of the most suitable state assets that can satisfy the local government request. Requests for activation of Texas National Guard and State Guard resources or use of the Civil Air Patrol are forwarded to TDEM for coordination.

### ***State Operations Center Response to Requests for Assistance***

If appropriate state response resources are not available within the DDC or if the resources available within the District are insufficient to meet the requirements of the emergency situation, the DDC chair will forward the request to the SOC in Austin for action. The chief of TDEM and/or the SOC staff will coordinate with representatives of the departments, agencies and organizations that comprise the State Emergency Management Council to identify suitable response assets to meet the need. TDEM is responsible for obtaining approval from the governor's office, where necessary, and coordinating with the requestor and agencies supplying and transporting resources regarding their delivery. State emergency support and assistance will be provided as quickly and as efficiently as possible, with due consideration given to the cost to the state.

### ***Requests for Assistance from State Agencies***

During an emergency event, the state Incident Commander (IC) will obtain additional resources through agency channels. The IC may coordinate minor assistance needed from other state



agencies directly with the local office of the agency concerned. If significant resources, technical assistance or information are required from other state agencies, the IC requests it through the DDC chair.

### ***Requests for Assistance from the Federal Government***

As a means to secure federal assistance and funds to reimburse state and local governments for authorized response and recovery-related expenditures, the governor will request federal assistance from the president through the FEMA Region VI director in accordance with the Stafford Act. The governor may request a Presidential Emergency Declaration prior to occurrence of the potentially catastrophic event (i.e., massive wildfires) and a Presidential Disaster Declaration soon after the actual occurrence of such an event.

- ✚ Following a request to the FEMA Region VI director, the Region's Emergency Response Team—Advance Element (ERT-A), consisting of representatives of federal agencies that provide response/recovery assistance, will deploy to the SOC to obtain an update on the situation and coordinate the state staff. If a federal emergency or disaster declaration is granted, the ERT-A will then deploy to the vicinity of the disaster to inspect facilities for a disaster field office.
- ✚ The Federal Response Plan (FRP) and associated Region VI Regional Response Plan (RRP) provide for federal response and recovery assistance through the coordinated actions of federal agencies. Federal agencies are also organized into emergency support functions (ESF) consisting of a primary agency and support agencies tasked to address related needs, requirements and capabilities.

## Energy Interdependency

Texas recognizes the critical nature of its role in the supply of the country's energy needs to be a matter of national security. The state is the leading crude oil producer, refines more than 25% of the nation's crude oil and produces more than 30% of the country's natural gas.<sup>16</sup> A significant blow to either the oil or gas industry in the state could breed disastrous effects throughout the state and nation.

In the Information Age, society revolves around its mechanized technology to an unprecedented degree, but our increasing reliance on it has advanced under the assumption that the delivery of electricity will also be reliable. In Texas, most electricity is fueled by natural gas and coal. Natural gas will not flow for long, however, without electricity. Coal will not arrive by railroad without diesel. Diesel cannot be refined without electricity. If any variable of the equation is removed for a sustained period, cascading failures could take the entire system down. This is the simplest description of the energy interdependencies Texas faces. The real picture is far more complicated.<sup>17</sup>

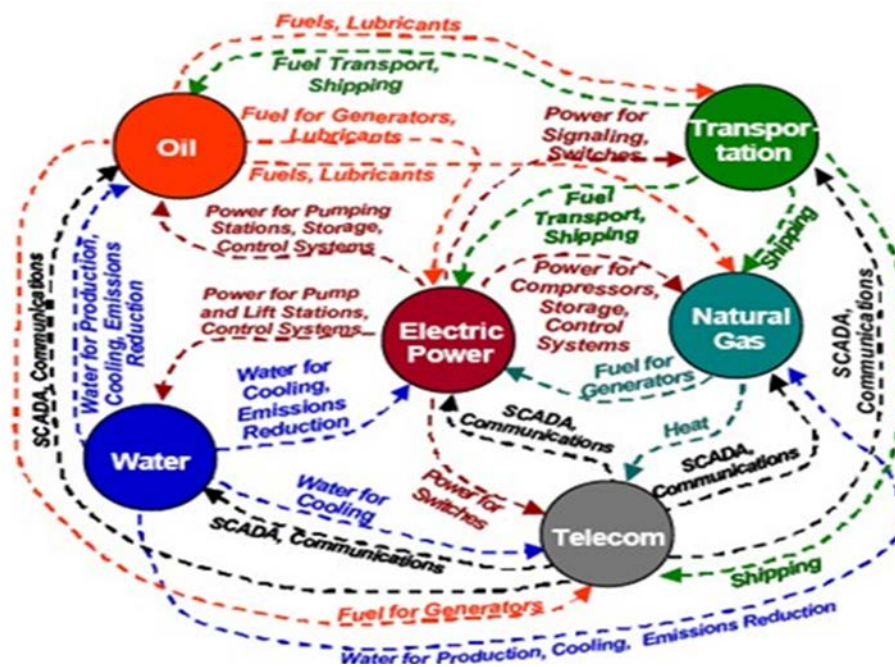

Figure 6: Basic interdependencies

If deliveries of natural gas ceased throughout the state, almost half of the electric generation would also cease. The grid could not operate (normally) without that fuel for generation. If the natural gas supply shortage in this scenario was not originally the problem, it would become

<sup>16</sup> <http://www.eia.gov/state/state-energy-profiles.cfm?sid=TX>.

<sup>17</sup> Diagram courtesy of the US Department of Energy Office of Electricity Delivery and Energy Reliability and NASEO.

the problem. If electricity were not being delivered, pumping units, natural gas processing and treating plants and electric gas compressors across the state would cease to operate. Pipeline pressure would fall, and natural gas deliveries would lag. If the electricity supply shortage in this scenario was not originally a problem of generation, it would become the problem. This is the interdependency currently receiving the most attention in Texas' energy agencies.

Electricity is regulated by a different agency than oil and gas in Texas, so a holistic approach to mitigating these interdependencies is more challenging to formulate than it may be in other states. The PUC and RRC have been working together toward remediating our interdependency issues within the constructs of state legislative and regulatory schemes in order to incentivize the industries and the markets to solve the potential problem. A primary focus of these efforts has been to educate the industries about each other's operations and foster communication among their components.

## Natural Gas as a Fuel Source for Electricity

The nation's increased reliance on natural gas as a fuel source for the generation of electricity is attributable to several factors.<sup>18</sup>

- ✦ Natural gas-fired unit technologies have resulted in more efficient generation units, resulting in a greater volume of electricity per unit of natural gas burned.
- ✦ The domestic supply of natural gas has grown dramatically, due primarily to technological advances in the development of shale gas production.
- ✦ Natural gas prices, although traditionally volatile, have been relatively stable and low over the past couple of years.
- ✦ The average capacity factors for natural gas combined-cycle generation units have increased, across all hours of the day, since 2005. Some natural gas combined-cycle units that previously served as peakers or intermediate-load serving units are now operating as baseload units.

It is likely that the nation's use of natural gas as a fuel source for electricity will continue to grow. In comparison to most other options, natural gas-fired generation facilities are quicker to build and require fewer initial capital outlays. Furthermore, the Environmental Protection Agency (EPA) recently enacted major air quality regulations that create some uncertainty about the country's ability to generate electricity, particularly with respect to coal. As a cleaner fuel source and as a source of firm, reliable power needed to back-up increased use of intermittent renewable resources, natural gas generation is projected to assume an even greater share of meeting the nation's electricity needs.

---

<sup>18</sup> Much of this section was taken from Draft Memorandum from the DOE Electricity Advisory Committee (July 12, 2011) (on file with author).

Despite electricity generators' increasing reliance on natural gas, contracts for natural gas delivery and/or supply to generation facilities sometimes offer discounted rates for "interruptible" service that are subject to interruption at the discretion of the supplier or transporter. The reduction or termination of natural gas supply to power plants during critical periods can have dire consequences. According to a recent study commissioned by ERCOT,<sup>19</sup> most natural gas is sold to electric power generation companies under firm, rather than interruptible, contracts with additional gas supplies purchased from the spot market, if available. During a natural gas supply disruption, however, natural gas might not be available on the spot market or might be available only at an unusually high price.

When siting a natural gas processing facility, the availability of reliable and affordable electric service is a critical consideration. Interruption of electric service to such a facility can have negative safety and financial consequences observable long after electric service is restored. According to EIA data,<sup>20</sup> as of 2009 there were 493 operational natural gas processing plants in the United States with a combined operating capacity of 77 billion cubic feet per day. The national average natural gas processing plant capacity showed a net increase of about 12% between 2004 and 2009 (not including the state of Alaska), and the nine largest plants in the country represented 31% of the nation's total processing capacity. The majority of large natural gas production and processing facilities utilize onsite generation of electricity. However, not all facilities do so, and interruption of electric service to a single large plant can substantially affect the country's total gas processing capacity.

Another complication is that the demand for electric service at a remote gas production and/or processing site can develop more rapidly than necessary electric infrastructure can be put into service because licensing and construction of large-scale electric generation and/or transmission infrastructure is often a multiple-year endeavor.

Given the interdependence of the nation's electric infrastructure with oil and natural gas infrastructure, items worthy of consideration by energy policy makers include:

- ✚ Coordination among oversight and policymaking agencies or other regulatory bodies;
- ✚ Identification of realistic alternative, redundant, and/or backup systems needed for reliable, continuous operation of the interdependent infrastructures;
- ✚ Testing of these systems routinely to ensure operational viability;
- ✚ Inclusion in cost-benefit impacts analyses on other infrastructures when considering policies and
- ✚ Periodic reassessment of the status of interdependent infrastructures to determine whether shifts in technology or policy have changed their relationship.

---

<sup>19</sup><http://www.ercot.com/content/news/presentations/2012/BV%20ERCOT%20Gas%20Study%20Report%20March%202012.pdf>.

<sup>20</sup> [http://www.eia.gov/pub/oil\\_gas/natural\\_gas/feature\\_articles/2010/ngpps2009/](http://www.eia.gov/pub/oil_gas/natural_gas/feature_articles/2010/ngpps2009/).

## February 2011 Rotating Outages

The February 2011 rotating outages in Texas highlighted the extent to which energy generation and delivery have become interdependent. Texas experienced an arctic cold front that brought unusually cold temperatures and gusty winds to the entire state for two days. Due to an unfortunate combination of weather-related factors, ERCOT lost roughly one-third of its generation fleet and ordered load shedding to prevent widespread, uncontrolled blackouts.<sup>21</sup> At the same time, natural gas production dropped due to freeze-offs and contractually-sanctioned reductions of natural gas deliveries to some customers with interruptible gas supply contracts.<sup>22</sup>

The Federal Energy Regulatory Commission's report stated that gas shortages were not a significant cause of the power generation problems nor were the rotating outages a primary cause of energy production decline. Even so, the severe weather event inspired action by the PUC and RRC, both individually and jointly. Jointly, the PUC and RRC collaborated on a number of projects with the goals of further exploring our energy interdependency and encouraging communication between the electric and natural gas industries so that they understand each other's constraints and can seek creative solutions by working together. A description of some of those projects follows.

### Joint PUC-RRC Interdependency Mitigation Efforts

- ✦ **August 24, 2010 Winter Storm Tabletop Exercise:** The PUC and RRC hosted a joint tabletop exercise with the stated purposes of (1) facilitating coordination between the two agencies, (2) testing proposed emergency operations plans and (3) identifying interdependency planning gaps. The scenarios were related to a hypothetical winter storm in the Dallas-Fort Worth area with a thread of cyber difficulties. Participants included gas distribution utilities and gas pipeline companies, the Texas Oil and Gas Association, ERCOT, Oncor, Texas New Mexico Power, Tri County Electric Cooperative, SECO, TDEM and DOE. The National Association of Regulatory Utility Commissioners (NARUC) funded and facilitated the exercise. Two of the main conclusions of the day were:
  - ✦ Gas and electric infrastructure are inextricably interdependent and
  - ✦ The PUC and RRC should continue to encourage communication among state and industry partners.
- ✦ **February 1-4, 2011 winter storm energy emergency operations:** PUC and RRC emergency personnel coordinated throughout this emergency. The *FERC/NERC Staff Report on the 2011 Southwest Cold Weather Event* noted that during the event, ERCOT requested that electricity transmission providers be careful to exempt gas facilities from the outage

---

<sup>21</sup> FERC/NERC, *Report on Outages and Curtailments during the Southwest Cold Weather Event of February 1-5, 2011*, 7 (August 2011).

<sup>22</sup> *Id.* at 9.

rotation to avoid problems with gas-fed generation, and it directed priority restoration efforts to areas where gas facilities had power outages.<sup>23</sup> The report stated that there would have been adequate gas during the two day cold snap even to supply the generators that failed for other reasons.<sup>24</sup> It concluded that “[g]as curtailment and gas pressure issues did not contribute significantly to the amount of unavailable generating capacity in ERCOT during the event.”<sup>25</sup>

- ✦ After the blackouts, the PUC and RRC coordinated efforts to encourage gas companies to communicate with their electric providers to ensure that no gas facilities critical to power generation suffer rotating outages in the future.
- ✦ Based on the concern about rotating outages to gas suppliers affecting power generation, ERCOT engaged Black & Veatch to study the interdependency.
- ✦ **March 1-2, 2011 Southern Energy Assurance Multi-State Exercise “Red Earth”:** The DOE organized a drill that included all of the states across the southeast. The Texas team was composed of the PUC, RRC, TDEM and SECO, and the primary purpose of the exercise was to test the draft Energy Assurance Plan. While the scenarios focused more on the interdependency between the electricity and oil industries than with gas, the team was struck by the scale of the country’s dependence on Texas energy. That lesson has shaped the state’s approach to energy assurance planning.
- ✦ **November 8-9, 2011 Winter Storm Functional Exercise:** Given the events of the previous February, the PUC and RRC felt strongly that the intrastate exercise should focus on a winter storm causing rotating outages so that the agencies could assess actions over the previous months to see what needed to be done before winter. Primary goals were to promote direct communication between the electricity and natural gas industries and to prevent interdependencies from producing cascading failures in an emergency. The highlights of the primary areas for improvement follow.
  - ✦ *Participants agreed that the 1973 RRC gas curtailment plan should be updated.* It has not been changed since the natural gas industry was deregulated, and power plants are near the bottom of the priorities list (power plants with interruptible contracts are at the bottom). While the governor has emergency authority to divert gas to a power plant, doing so would create a flood of litigation because pipeline companies no longer own the gas they transport, as they did years ago. The RRC and industry associations, particularly the Texas Pipeline Association, have been looking into this and are considering how to proceed.
  - ✦ *The electric industry should improve its curtailment plans and refine its list of critical nodes.* The PUC has been looking at this under Project 39140, *Review of TDU Curtailment Procedures and Service Restoration Priority Plans*. The agency has also been encouraging gas companies to inform their electric providers of their critical electricity-dependent facilities that should not be curtailed.

---

<sup>23</sup> *Id.* at pp. 91-92.

<sup>24</sup> *Id.* at p. 192.

<sup>25</sup> *Id.* at p. 197.

- ✦ *Both industries need to learn basic operational characteristics of the other to better understand and mitigate their interdependencies.* The PUC and RRC jointly sponsored a reliability workshop to this end on April 17, 2012. A video of the workshop is available on the Texas Admin website.<sup>26</sup>
- ✦ *Both the public and private sectors should evaluate the impact of interruptible and firm gas purchase and sales contracts and transportation agreements as they affect gas supply to power generation plants and competing entities.*
- ✦ **January 2012 ERCOT Gas Curtailment Risk Study:**<sup>27</sup> The RRC advised ERCOT in the request for proposal stage of this study in which Black & Veatch suggested that:
  - ✦ ERCOT and the RRC increase coordination to better capture data including development of communication pathways and reports for gas delivery incidents affecting power generation facilities and
  - ✦ Contractual agreements that require curtailment of gas supply to generators or mandatory curtailment policies, as defined by the RRC, both inhibit a power generator's ability and motivation to acquire firm gas supply and should be reviewed to determine whether new policies or regulations are required to increase the reliability of ERCOT generation.
- ✦ **April 17, 2012 Electricity/Natural Gas Reliability Workshop:** One of the goals formed at the Winter Storm Functional Exercise was to educate the electricity and natural gas industries on the operations and markets of each other's industry. To that end, the PUC and RRC jointly hosted the Electricity/Natural Gas Reliability Workshop. The morning session focused on the generation, transmission and distribution of electricity along with the roles of the PUC and ERCOT. The afternoon session focused on the production, processing, transportation and distribution of natural gas. Approximately 100 people representing private industry, government agencies and trade associations participated. The workshop was also broadcast online and is available on the Texas Admin website.
- ✦ **June 28, 2012 DOE Workshop:** The US Department of Energy and the National Association of State Energy Officials hosted the 2012 Energy Assurance Conference, and representatives of the PUC, RRC and SECO participated. The conference presented panel discussions of experts in a number of energy-related fields and offered a table top exercise with an oil shortage scenario. The conference served as the wrap-up session for state and city participants in the Energy Assurance grant, which officially closed on July 31, 2012. It provided an excellent opportunity for state and local energy officials to compare their different approaches and lessons learned.
- ✦ **State Operations Center activities:** The PUC and the RRC both play major roles at the SOC during emergency activations that have included hurricanes, wild fires, winter storms and drought conditions. Both agencies are part of the SOC's newly-formed Critical Infrastructure Protection Branch.

<sup>26</sup> [www.texasadmin.com](http://www.texasadmin.com).

<sup>27</sup> <http://www.ercot.com/content/news/presentations/2012/BV%20ERCOT%20Gas%20Study%20Report%20March%202012.pdf>.

 **GIS information sharing:** The two agencies share GIS data for emergency planning and management purposes.





## Mission

The mission of the Public Utility Commission of Texas is to protect customers, foster competition and promote high-quality utility infrastructure.

## History

In 1975, Texas became the last state in the country to provide for statewide comprehensive regulation of electric and telecommunications utilities by creating the Public Utility Commission of Texas (PUC) through the Public Utility Regulatory Act (PURA).<sup>28</sup> At that time, public utilities were considered to be, by definition, natural monopolies in the areas they served, and regulation of rates and services substituted for market forces to keep rates reasonable and service quality high. Since then as a result of key legislation and developing technology, Texas has emerged as a national leader in the progressive development of competitive markets in the electric industry. The PUC has responded to an ever-changing landscape to ensure that Texas customers continue to receive reliable, reasonably-priced electric services.

Significant changes have occurred in the power industry since the original enactment of PURA. In 1999, the legislature provided for restructuring the electric utility industry, changing the PUC's mission and focus. As a companion to these laws that changed the structure of the industry, the legislature also enacted laws to ensure that customers' rights continued to be protected in the new environment.

Retail competition began on schedule in ERCOT on January 1, 2002. Competition in other parts of Texas has been delayed indefinitely. As a result, the PUC now oversees competitive electric markets in ERCOT but continues traditional cost of service regulation in east Texas, the Panhandle and El Paso areas.

---

<sup>28</sup> The PUC Section of the EAP heavily relies on the following PUC reports: *Agency Strategic Plan for the Fiscal Years 2013-2017* (2012); *Report to the 82nd Texas Legislature: A Report on Advanced Metering as Required by House Bill 2129* (2011); *Report to the 83<sup>rd</sup> Legislature: Scope of Competition in Electric Markets in Texas* (2013); *Report to the 82nd Legislature: Scope of Competition in Electric Markets in Texas* (2011); *Agency Strategic Plan for the Fiscal Years 2011-2015* (2010); and *Study Regarding the Provision of Electricity during a Natural Disaster or Emergency* (2009).

## Duties, Jurisdiction and Authority

Since 1995, Texas wholesale electric markets have been open to competition, and the PUC possesses limited authority to ensure that the supply of electricity in Texas is adequate. The PUC does exercise statutory duties and authority in the following electric power activities:

- ✚ Within ERCOT, the PUC:
  - ✚ Oversees competitive wholesale and retail markets;
  - ✚ Oversees ERCOT, the independent system operator (ISO) responsible for managing the electric grid for approximately 85% of electricity load and 75% of the state's geographic area and for settling the transactions in competitive markets;
  - ✚ Asserts jurisdiction over ratemaking and quality of service of investor-owned transmission and distribution utilities;
  - ✚ Establishes wholesale transmission rates for investor-owned utilities (IOUs), cooperatives and municipally-owned utilities;
  - ✚ Licenses retail electric providers (REP);
  - ✚ Registers power generation companies and aggregators;
  - ✚ Implements a customer education program for retail electric choice;
  - ✚ Oversees the Competitive Renewable Energy Zone (CREZ) program, including monitoring the planning, designing, construction and energizing phases;
  - ✚ Orders the disgorgement of all excess revenue resulting from a market power abuse violation;
  - ✚ Enforces ERCOT rules and protocols and
  - ✚ Administers the System Benefit Fund, including the low income discount program with automatic enrollment of eligible customers;
- ✚ Outside ERCOT, the PUC regulates—including conventional rate regulation—vertically integrated IOUs until retail competition begins and actively participates in regional transmission organization and wholesale market development and
- ✚ Throughout the state, the PUC:
  - ✚ Issues certificates of convenience and necessity for service areas and proposed transmission lines;
  - ✚ Operates the Power-to-Choose website to assist Texans in choosing a REP;
  - ✚ Monitors industry progress in meeting the renewable energy mandate adopted in the 1999 legislation;
  - ✚ Resolves customer complaints using information processes whenever possible;

- ✦ Administers the System Benefit Fund, including administration of a low income discount program with automatic enrollment of eligible customers and
- ✦ Serves on the Southwest Power Pool Regional State Committee and Energy-Regional State Commission.

The PUC monitors Federal Energy Regulatory Commission (FERC) activities that have the potential to affect Texas consumers and businesses and participates in FERC proceedings by intervening and filing comments. Although most of the authority granted to the PUC in PURA is conferred exclusively on the PUC, the PUC must be aware of FERC activities in order to avoid duplicative effort, to ensure consistent and complementary policy decisions on the state and federal levels and to inform FERC of the Texas perspective before rendering decisions.

The federal Energy Policy Act of 2005 authorized federal electric reliability standards for the continental United States. The North American Electric Reliability Corporation (NERC), regulated by FERC, proposes, monitors, audits, investigates and enforces compliance with the NERC Reliability Standards through the Texas Reliability Entity (TRE). Since the PUC's rules and ERCOT protocols also address reliability matters, it is crucial that all applicable requirements are consistent. TRE is not under PUC jurisdiction, but the PUC serves as the hearing body for matters referred to it by TRE and issues recommendations to the TRE Chief Compliance Officer who makes the final ruling on compliance matters. Although the areas overseen by TRE, ERCOT and the PUC overlap, each entity has its own focus and areas of primary concern. The PUC staff carefully monitors proposed changes to the ERCOT protocols and the activities of FERC, NERC and TRE to ensure that regulations are consistent.

## Structure

The PUC is composed of three commissioners appointed by the governor with the advice and consent of the senate. The commissioners serve staggered six-year terms, and the governor designates the chairman. The agency employs an executive director who is responsible for the daily operations of the PUC and for coordinating activities with PUC staff.

The PUC's current organizational structure is based on the agency's major functional responsibilities and reflects the PUC's mission, goals and objectives as set out in its strategic plan. The major program area divisions are Customer Protection, Competitive Markets, Infrastructure and Reliability, Oversight and Enforcement, Rate Regulation, Legal and Commission Advising and Docket Management. An organizational chart may be found in Appendix 2. As of October 2012, the PUC had a total of 164.6 full-time employees (FTE). Of this total, 9 FTEs are paid entirely by federal funds, and all federally funded positions will expire no later than March 2013. Agency staff includes engineers, accountants, economists, attorneys and customer care specialists, and technical and paraprofessional personnel provide administrative support.

## Texas Transmission Grids

There are three interconnected electric grids in the contiguous United States—the Eastern Interconnect extending from the Atlantic seaboard to the Rocky Mountains, the Western Interconnect covering the western portion of the country and the Texas Interconnect. Figure 7 illustrates these interconnections.<sup>29</sup> The Eastern and Western Interconnects are composed of

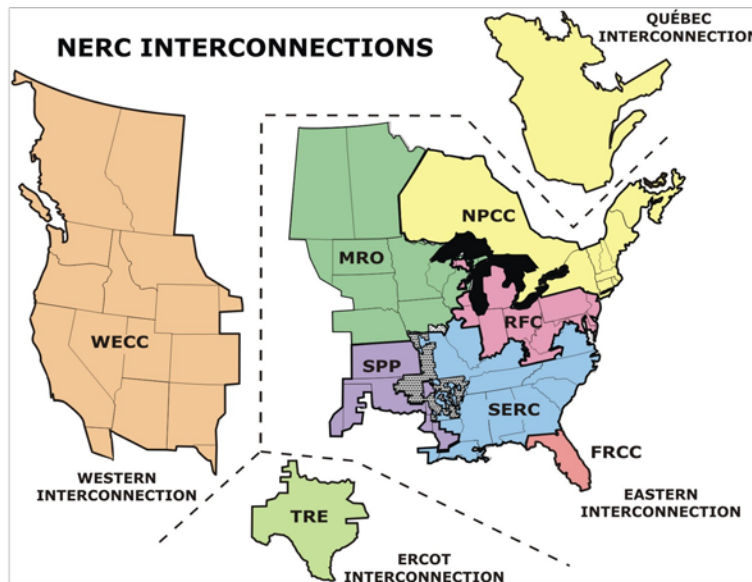
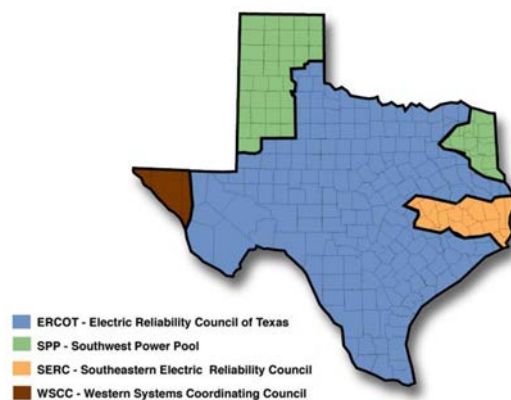

Figure 7: US electric interconnections

smaller electric grids run by a variety of entities known in different regions by different names like independent system operator or regional transmission operator. These entities may be individual utilities or networks of transmission providers. The Texas Interconnect is called the Electric Reliability Council of Texas (ERCOT), an independent system operator that manages the flow of electric power supplied by generators and conducted across transmission lines to the distribution systems serving Texas customers.

Four different electrical transmission grids, each of which is part of a separate electric reliability region under NERC, serve Texans. The largest Texas grid is ERCOT which serves about 85% of the electric load and covers approximately 75% of the geographic area of Texas (see Figure 8 for a map of the Texas grids). Within ERCOT, there are many companies that own and operate transmission and/or distribution systems.<sup>30</sup> Each of these systems is directly connected to one or more of the other systems, and they are all interconnected with each other as part of the larger ERCOT grid.

Figure 8: Map of Texas Grids



In 1999, the 76th Legislature passed Senate Bill 7 which introduced competition in electricity in Texas

<sup>29</sup> Available at <http://www.ercot.com/news/mediakit/maps/>.

<sup>30</sup> The terms “transmission” and “distribution” are distinguished by voltage level. In ERCOT, transmission refers to lines and equipment operated at or above 60,000 volts phase-to-phase, and distribution refers to facilities operated below 60,000 volts.

and permitted the PUC to delay retail competition in areas where deregulation would not result in fair competition and reliable service. Provisions of PURA that applied to El Paso Electric Company and Southwestern Public Service Company resulted in the delay of competition in the areas served by these companies. Relying on its discretion under Chapter 39 of PURA, the PUC delayed retail competition for the Entergy Gulf States service area (now Entergy Texas) and for the Southwestern Electric Power Company (SWEPCO) service area. The result was that retail competition was initiated within ERCOT but was delayed outside of ERCOT.

Senate Bill 7 recognized that it would be more difficult to implement retail competition in areas outside of ERCOT based on their lack of an independent organization and the concentration of ownership in the generation sector in some of the non-ERCOT areas. In particular, PURA §39.152 established competitive criteria that must be met for the PUC to certify a power region:

- ✚ A sufficient number of interconnected utilities in the power region are under the operational control of an independent organization;
- ✚ A generally applicable tariff guarantees open and nondiscriminatory access to transmission and distribution facilities in the region and
- ✚ No person owns and controls more than 20% of the installed generation capacity located in or capable of delivering electricity to the region.

The PUC has not certified that any area outside of ERCOT meets these criteria.

An important element in the success of a competitive energy market is an independent organization to manage transmission access and operate short-term energy and capacity markets to maintain the reliability of the electric system.<sup>31</sup> When competition was introduced in ERCOT, a regional transmission organization was operating in the Panhandle and northeast Texas. The Southwest Power Pool (SPP) was providing independent management of the transmission system in these areas, but it was not operating short-term energy and capacity markets to maintain reliability. In southeast Texas and the far west Texas area in and adjacent to El Paso, there was no independent system operator. SPP continues to operate in the Panhandle and northeast Texas, and today it operates a short-term energy market, the Energy Imbalance Service, and is planning to expand its market to include short-term capacity products. In southeast and far west Texas, there is still not an independent organization performing the transmission management and market functions.

SPP extends outside Texas to all or portions of seven other states in the central United States. The Southeastern Electric Reliability Council (SERC) covers southeast Texas and extends to 15

---

<sup>31</sup> PURA addresses the role of an independent organization in § 39.151.

other central and southeastern states. In far west Texas, the El Paso area is part of the Western Electric Coordinating Council (WECC) which serves 13 other western states as well as parts of Canada and Baja California in Mexico.<sup>32</sup>

Unlike the WECC, SERC and SPP grids, the ERCOT grid lies entirely within Texas. The grids have limited interconnection capabilities through direct current (DC) ties.<sup>33</sup> The transfer capacity of the DC ties means that there are limited physical pathways for electricity to flow into or out of ERCOT. It also means that ERCOT and the other grids are not synchronized electrically so establishing a direct electrical connection between the grids, even for purposes of temporary restoration of service, requires substantial coordination.

ERCOT is also unique with regard to regulatory authority. Whereas the other grids in Texas are regulated by FERC, ERCOT is regulated primarily by the PUC.<sup>34</sup> Market entities within ERCOT have long been reluctant to participate in any transmission facility project or power transaction that would flow power between ERCOT and any of the other regions for fear that the project or transaction would result in the extension of FERC jurisdiction into ERCOT. Before any such undertaking, it is common practice for entities to seek a written opinion from FERC that it would not claim jurisdiction in ERCOT as a result.

## The Electric Reliability Council of Texas

The Electric Reliability Council of Texas is the independent system operator that manages the flow of electric power to 23 million Texans with 550 generation units.<sup>35</sup> ERCOT is a nonprofit corporation governed by a board of directors under PUC and legislative oversight. The Technical Advisory Committee makes policy recommendations to the board of directors and is assisted by five standing subcommittees and numerous workgroups and task forces. ERCOT's mission is to serve the public interest by:

- ✚ Ensuring open access to transmission and distribution systems;
- ✚ Maintaining system reliability and operations;
- ✚ Enabling retail choice;

---

<sup>32</sup>The entire continental US electrical grid is comprised of the Eastern Interconnect, the Western Interconnect and ERCOT. SERC and SPP are part of the Eastern Interconnect and WECC is part of the Western Interconnect.

<sup>33</sup>DC ties are expensive transmission facilities that convert electricity from alternative current (AC) to DC and then back to AC. Currently available DC ties provide 1,100 megawatts (MW) of interchange capability which is less than two percent of the ERCOT peak demand.

<sup>34</sup>The ERCOT ISO and certain market participants that own, operate or use the bulk power system within Texas are required to register with NERC and must meet federal NERC reliability standards pursuant to the Energy Policy Act of 2005.

<sup>35</sup><http://www.ercot.com/content/news/presentations/2012/ERCOT%20Quick%20Facts%20-%20Jan%202012.pdf>.

- ✚ Operating fair and competitive wholesale markets;
- ✚ Maintaining the renewable energy credits registry and
- ✚ Providing leadership and independent expertise to improve system reliability and market efficiency.

ERCOT is the heartbeat of the Texas electric grid. Its state-of-the-art control room monitors the grid in real time to deploy energy and ancillary services to resolve capacity shortfalls and transmission congestion and to maintain system reliability. ERCOT manages 40,530 miles of high-voltage transmission with a total capacity of 84,000 megawatts (MW).<sup>36</sup>

The generation profile is weighted toward natural gas which represented 40% of the energy produced in 2011 (see Figure 9). Coal ranked second with 39%. Wind continues to pick up in the state. It generated 9,600 MW in 2011, the most in the nation and fifth most in the world. 46,000 MW of new generation have been added since 1999, and 7,500 MW are committed for the future. 35,000 MW of active generation requests are under review including 19,400 MW of wind; 9,000 MW of natural gas; 3,600 MW of coal and 2,640 MW of solar/biomass/other.<sup>37</sup>

Figure 9: Generation in ERCOT

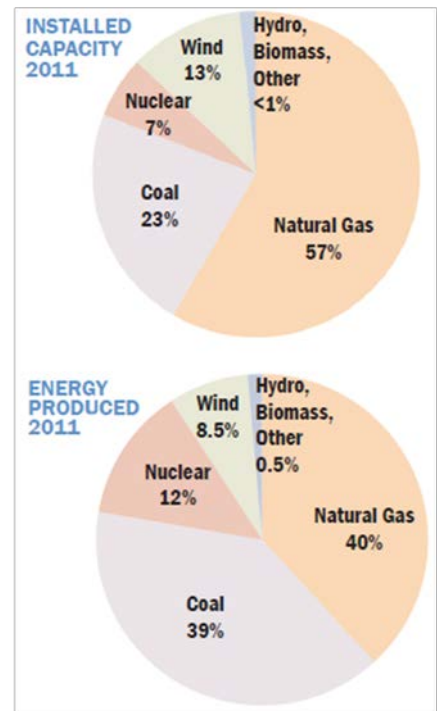

ERCOT's reserve margin is currently 13.75%. On August 3, 2011, extremely high temperatures caused a summer peak that broke a demand record of 68,379 MW.

## Transmission and Congestion and the Nodal Market

One of the most important functions of ERCOT is to manage the flow of power over the transmission network. Under the zonal market design, ERCOT had to manage two types of transmission congestion: zonal congestion, which limits the amount of power that can flow between zones, and local congestion caused by transmission constraints within a zone.

<sup>36</sup> *Id.*

<sup>37</sup> *Id.*



The Commission adopted a rule in 2005 directing ERCOT to implement a nodal market design and in 2006 approved the protocols for the operations of the nodal market. The nodal market went live on December 1, 2010.

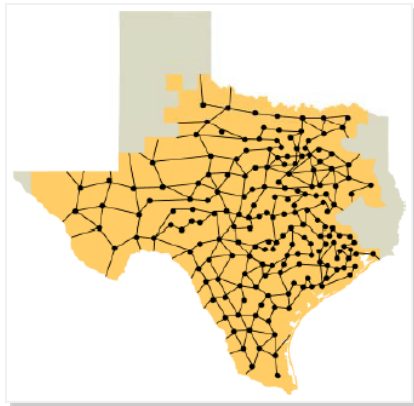

Figure 10: Nodal configuration

Ancillary Services include short-term capacity reserves and balancing energy used by ERCOT to balance load and generation at all times and to maintain a stable frequency in the system. In October 2008, ERCOT adopted a new methodology for the procurement of non-spinning reserves (capacity reserves that can come on line within 30 minutes) and started procuring non-spinning reserves on a 24-hour basis, whereas this service was previously procured during peak hours only. This change was made necessary by an increase in the frequency and size of sudden changes in output by wind generators as the amount of wind generation has increased. Moving into the nodal market, ERCOT was not considering any additional change in the procurement of

non-spinning reserves. ERCOT was anticipating a reduced requirement for Regulation Service under the nodal market. Regulation is deployed every four seconds to balance generation and load and maintain a stable frequency. Under the nodal market, the balancing energy has been replaced by a Security Constrained Economic Dispatch model that executes energy deployments orders every five minutes. The deployment of balancing energy at shorter intervals should result in a reduced requirement for Regulation Service. Once ERCOT acquires experience with regulation deployment needs under nodal, the methodology will be reevaluated and adjustments in the procurement of these short-term capacity reserves will be adopted as appropriate.

## Wholesale Market Entities

The participants in the Texas wholesale electricity markets may differ in terms of their ability to buy and sell electricity with other entities in the market. These differences result from statutory provisions, PUC rules or existing purchase power contracts between entities. To understand the potential ability of these entities to sell electricity during emergency conditions, it is important to understand their respective characteristics.<sup>38</sup>

✚ **Electric Utility:** Although “electric utility” is commonly used as a generic term, it is defined in PURA as a person or river authority that owns or operates for compensation in Texas,

<sup>38</sup> For a complete listing of wholesale market entities in Texas with contact information, visit [www.puc.state.tx.us/electric/directories/index.cfm](http://www.puc.state.tx.us/electric/directories/index.cfm).

equipment or facilities to produce, generate, transmit, distribute, sell or furnish electricity in the state.<sup>39</sup> Inside ERCOT, the term refers to the following “wires only” companies:

- ✦ CenterPoint Energy (CenterPoint),
- ✦ Oncor,
- ✦ American Electric Power (AEP),
  - ✦ Texas Central Company (TCC),
  - ✦ Texas North Company (TNC),
- ✦ Texas New Mexico Power (TNMP) and
- ✦ Sharyland Electric (Sharyland).<sup>40</sup>

As wires only companies, these entities do not own generating facilities, and they do not buy and sell power. Their wires carry power for end-users, but they do not sell power to end-users. Outside ERCOT, the term refers to the following vertically-integrated IOUs:

- ✦ Southwestern Public Service/Xcel Energy (SPS),
- ✦ AEP Southwestern Electric Power Company (SWEPCO),
- ✦ El Paso Electric (EPE),
- ✦ Entergy Texas, Inc. (ETI) and
- ✦ Sharyland.

These entities own generating facilities and transmission and distribution facilities, and they may buy and sell power in the wholesale market. They also sell power to end-use customers in their respective certificated service areas.

- ✦ **Municipally-Owned Utility (MOU):** An MOU is any utility owned, operated and controlled by a municipality or by a nonprofit corporation whose directors are appointed by one or more municipalities.<sup>41</sup> These entities own distribution facilities, and they may own generation and transmission facilities. MOUs can buy and sell power. Those that do not own generation obtain all their electricity through purchase power contracts with one or more power suppliers. These contracts may limit the MOUs’ ability to buy power from other power suppliers. There are 72 MOUs operating in the state.
- ✦ **Electric Cooperative (Co-op):** A co-op is a corporation organized and operating under the Texas Utilities Code, Chapter 161.<sup>42</sup> Co-ops are either “G&T” cooperatives, meaning that they own generation and transmission facilities, or “distribution” cooperatives, which have only distribution facilities. G&T co-ops have contracted to provide all or a specific portion of the power requirements of their member co-ops, and their contracts may limit the member co-ops’ ability to buy power from alternative sources. There are 69 electric co-ops operating in the state.

---

<sup>39</sup> ERCOT and certain market participants that own, operate or use the bulk power system within Texas are required to register with NERC and must meet federal NERC reliability standards pursuant to the Energy Policy Act of 2005.

<sup>40</sup> These entities can also be referred to as “Transmission and Distribution Utilities” (TDUs).

<sup>41</sup> P.U.C. SUBST. R. 25.5(71).

<sup>42</sup> P.U.C. SUBST. R. 25.5(35).

- ✦ **Qualifying Facility (QF):** A QF is a federal category of electricity generators that was created by the Public Utilities Regulatory Policies Act of 1978 (PURPA). QFs include co-generators who typically provide both electricity and steam to a host entity such as a manufacturing company. Co-generators sell excess power not needed by the host into the wholesale electricity market. QFs also include small power producers who generate power from renewable resource facilities (less than 80 MW) and sell it into the wholesale market.<sup>43</sup>
- ✦ **Power Generation Company (PGC):** A PGC generates electricity intended to be sold at wholesale but does not own a transmission or distribution facility in Texas, nor does it maintain a certificated service area.<sup>44</sup> The majority of the power in ERCOT is produced and sold by PGCs. There are 224 PGCs operating in the state.
- ✦ **Exempt Wholesale Generator (EWG):** EWG is another federal category of generators that allows affiliates of regulated utilities to generate power and sell it in the competitive wholesale market.<sup>45</sup>
- ✦ **Power Marketer:** A power marketer is a person that becomes an owner of electricity for the purpose of selling electric energy at wholesale and does not operate transmission or distribution facilities in Texas and does not maintain a certificated service area.<sup>46</sup>

Electricity rates in Texas are greatly affected by natural gas prices as gas is burned to generate about 40% of electricity in the state, with an even higher percentage during periods when electricity demand is high. Natural gas prices have fallen from a 2008 peak of about \$13 per MMBtu. With gas prices expected to average \$2.77 per MMBtu in 2012,<sup>47</sup> the most competitive offers in the Texas power market are below the 2001 levels, prior to the introduction of retail competition.

## Retail Market Entities

On January 1, 2002, retail competition in the sale of electricity began for all customers of IOUs in the ERCOT region of Texas. The new market structure envisioned by the 79th Legislature dramatically altered the provision of electricity to most retail customers in Texas.<sup>48</sup>

---

<sup>43</sup> Although PURPA provided that a QF had the right to sell electricity to the local utility, FERC has recently determined that the obligation to buy from a QF does not apply in areas where there is a sufficiently competitive wholesale market. Thus, the QF “put” no longer applies in ERCOT, but it may still apply in areas outside of ERCOT as determined by FERC.

<sup>44</sup> P.U.C. SUBST. R. 25.5(82).

<sup>45</sup> P.U.C. SUBST. R. 25.5(49).

<sup>46</sup> P.U.C. SUBST. R. 25.5(83).

<sup>47</sup> <http://www.eia.gov/forecasts/steo/>.

<sup>48</sup> Much of this section was taken from PUC, *Report to the 78<sup>th</sup> Legislature: Scope of Competition in Electric Markets of Texas* (2003).

Prior to the introduction of retail electric competition in ERCOT, all retail customers were served by IOUs, co-ops or MOUs, and very few customers had a choice of companies to supply their power. The PUC certificated the retail service area of utilities, co-ops and MOUs which had an exclusive right and obligation to serve customers in their service areas. The IOUs, co-ops and MOUs built and operated generation plants and transmission and distribution facilities and performed retail functions such as customer service, billing and collection. (Some of the smaller utilities did not own generation or transmission facilities and instead bought generation and transmission services from other utilities.) The PUC set electric rates and service rules for those utilities over which it had ratemaking authority. The objective of the ratemaking was to ensure just and reasonable rates and services for retail customers while providing utilities an opportunity to earn a reasonable rate of return on prudent investments and to recover reasonably incurred expenses.

In areas where retail competition has been introduced, electric customers may select a retail electric provider (REP). The production and wholesale selling of electricity by PGCs has also been deregulated. The IOUs that were formerly performing generation, transmission, distribution and retail sales functions have separated on functional lines, creating regulated transmission-distribution companies and unregulated PGCs and REPs. The governing boards of co-ops and MOUs were granted the authority to decide if and when to open their service areas to retail competition.

REPs buy electricity at wholesale from PGCs or power marketers, purchase transmission and distribution service from regulated utilities and market retail services to customers. REPs do not own facilities for the production or delivery of electricity, but they have a business and service relationship with their customers.

Outside the ERCOT region of Texas, retail competition was delayed, and the IOUs in northeast Texas, southeast Texas, the Panhandle and El Paso areas remain regulated.

New REPs have continued to enter the market, selling plans with an array of terms of service from one month to multiple years, up to 100% renewable energy, fixed rates, indexed rates and variable rates. In the residential sector, most retail customers have over 41 REPs offering as many as 208 different rate packages to choose from. Residential customers have about 2.5 times more options in plans than they did at the end of 2008.

As of June 2012, over 4 million individual customer premises were taking service from REPs other than the incumbent provider in their area, based on data reported to the PUC by the transmission and distribution utilities (TDU). This accounts for more than 59.66% of all

customers in service areas open to competition. Of these customers, 3,369,116 million are residential customers.

The highest rate of switching is in the TNMP service area, at 75.32%, and the lowest rate is in the Oncor service area, at 54.4%. Having achieved the switching rate of 50% in January 2010, Texas is the only state with retail competition where more than half of residential customers have chosen to be served by non-incumbent providers. This is further evidence that the state's well-structured competitive market is promoting competition among market participants to the economic benefit of customers. Competing REPs originally focused their efforts on winning customers in the large urban markets of Houston and Dallas-Fort Worth, but have now branched out with most residential REPs marketing throughout ERCOT.

## Statistical Description of Energy and Expenditures

2011 electricity prices were as follows.<sup>49</sup>

Type	Texas price	US average price
Residential	11.08 cents/kWh	11.60 cents/kWh
Commercial	8.83 cents/kWh	9.93 cents/kWh
Industrial	6.24 cents/kWh	6.60 cents kWh

2011 net electricity generation was as follows.

Net electricity generation	Texas
Total	435,476,924 MWh
Petroleum-fired	976,805 MWh
Natural gas-fired	200,500,149 MWh
Coal-fired	157,896,535 MWh
Nuclear	39,648,457 MWh
Hydroelectric	563,054 MWh
Solar thermal and photovoltaic	28,639 MWh

2011 consumption for electricity generation was as follows.

Consumption for electricity	Texas
Petroleum	1,616,080 barrels
Natural gas	1,555,401,834 million cu ft
Coal	110,426,481 short tons

<sup>49</sup> <http://www.eia.gov/electricity/data/state/>.

Since deregulation of the ERCOT region of the state, the focus of the PUC's regulatory attention has significantly narrowed, but it maintains tangential influence over most aspects of the Texas electric landscape. The PUC therefore works closely with market entities on a variety of issues.<sup>50</sup>

The IOUs are typically the market participants with the most business before the PUC. IOU personnel are in constant contact with several agency divisions on many topics ranging from rate increases to rulemakings. The IOUs operating within the ERCOT region of the state are:

✚ **American Electric Power:** AEP Texas serves more than one million customers from its headquarters in Corpus Christi.<sup>51</sup>

✚ AEP Texas Central's territory covers 44,000 square miles of south Texas with 24,916 miles of distribution lines and 4,300 miles of transmission lines. Major cities served include Corpus Christi, McAllen, Harlingen, Victoria and Laredo, and its meters number 761,022.

✚ AEP Texas North serves 184,775 west Texas customers in and around the cities of Abilene, Alpine, San Angelo and Vernon. Its territory covers 53,000 square miles with 12,592 miles of distribution lines and 4,589 miles of transmission.

Figure 11: AEP Texas



✚ **CenterPoint Energy:** CenterPoint provides electricity to 5,000 square miles of the Houston metropolitan area, metering 2.1 million customers.<sup>52</sup> It operates 48,232 miles of distribution lines and 3,754 of transmission lines.

Figure 12: Oncor



✚ **Oncor:** Oncor serves 3 million customers from east to west Texas and the north central region, including Dallas-Ft. Worth and the surrounding areas.<sup>53</sup> Other cities in its territory are Odessa, Midland, Killeen, Waco, Wichita Falls and Tyler. Oncor operates more than 117,000 miles of transmission and distribution lines.

✚ **Sharyland Electric:** Sharyland operates a small area in Hidalgo County along the Mexican border in the southern tip of the state. It has recently acquired utilities that serve parts of Midland-Odessa, the Hill Country and northeastern counties.

<sup>50</sup> A complete and current list of all market participants with their contact information can be found at [www.puc.state.tx.us/electric/directories/index.cfm](http://www.puc.state.tx.us/electric/directories/index.cfm).

<sup>51</sup> <http://www.aeptexas.com/info/facts/Facts.aspx>.

<sup>52</sup> <http://www.centerpointenergy.com/about/companyoverview/fastfacts/>.

<sup>53</sup> <http://www.oncor.com/electricity/default.aspx>.

- ✚ **Texas New Mexico Power:** TNMP provides electricity to 230,000 Texans from its headquarters in Lewisville, Texas. It maintains service areas in a number of compact regions scattered throughout northeast Texas, west Texas and the upper Gulf Coast.

Figure 13: TDUs in ERCOT

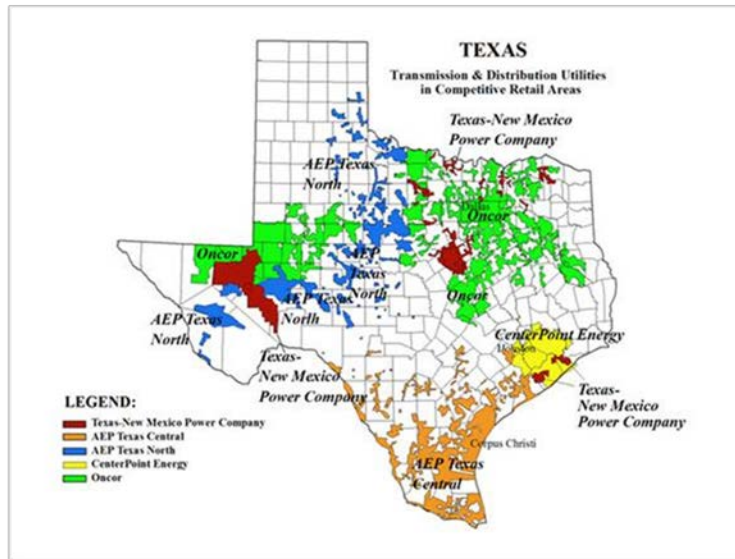

Utilities operating outside ERCOT include:

- ✚ **AEP Southwestern Electric Power Company:** SWEPCO serves 180,000 customers in the northeast corner of the state and a small pocket in the southeastern portion of the Panhandle region.
- ✚ **El Paso Electric:** EPE operates in the Rio Grande Valley of west Texas, providing electricity to 372,000 customers.
- ✚ **Entergy Texas, Inc.:** Entergy serves 403,000 customers from its headquarters in Beaumont. Its service area covers 15,000 square miles of the southernmost section of the Texas-Louisiana border across east Texas.
- ✚ **Southwestern Public Service/Xcel:** SPS operates along the northern and western Panhandle and serves 295,000 Texans from its headquarters in Amarillo.

## Mutual Assistance

Most customers would deem their access to electricity to be critical since its loss can cause economic damages and inconvenience, but to the government, certain components of infrastructure are critical on a larger scale. Disruptions can shut down water pumping stations, natural gas delivery, traffic lights, rail systems and other networks that can create severe public

health and safety crises. The IOUs own and operate their infrastructure and are responsible for its reliability, but the PUC partners with them to minimize the frequency and duration of outages and their effect on the public. Some of the PUC strategies to accomplish this task can be found in the Emergency Management section of this document. Ultimately, the IOUs are responsible for the repairs to their infrastructure, and they work diligently to restore their systems as quickly and efficiently as possible.

**Figure 14: Regional mutual assistance groups in the US**

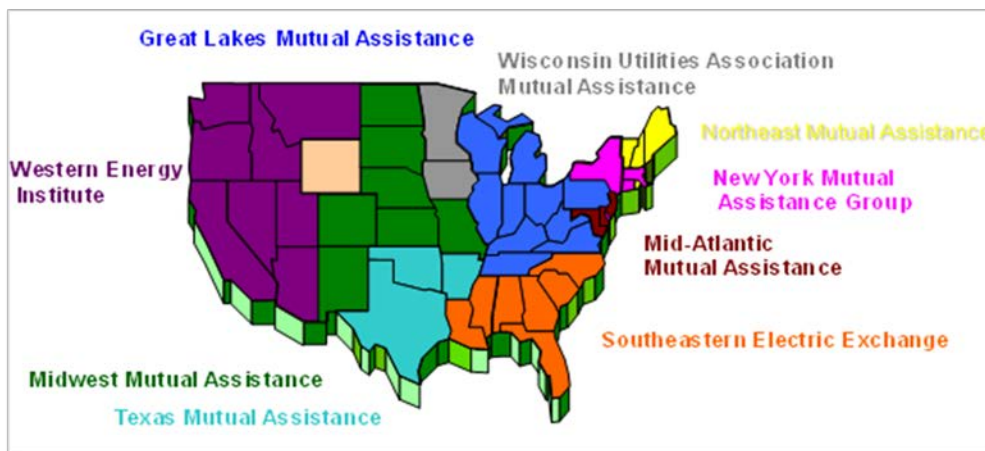

Electric service providers have a long history of providing mutual assistance during emergency events and natural disasters. Utilities and co-ops across the state belong to mutual assistance organizations, and both formal and informal arrangements exist to provide assistance during major disasters. There are nine regional mutual assistance groups in the United States. The three regional groups covering Texas and adjacent states are the Texas Mutual Assistance Group, the Southeastern Electric Exchange Group and the Midwest Mutual Assistance Group. Figure 14 depicts the mutual assistance groups across the nation.<sup>54</sup>

During major emergency events, electric service providers who experienced significant outages have called on unaffected industry entities for assistance and resources to cope with power outages. In the aftermath of Hurricane Ike, 2.87 million Texans were without electric power. Many utilities responded with 15,235 line crew and tree trimming personnel who included utility and mutual assistance personnel from over 25 states. Texas utilities recently returned the favor when they sent 509 employees, 227 contractors and 230



**Figure 15: Oncor crew in New Jersey after Hurricane Sandy**

<sup>54</sup> Map courtesy of James Nowak, AEP Emergency Restoration Planning Manager.



trucks to Maryland, New Jersey, New York and West Virginia to assist with recovery efforts after Hurricane Sandy. Figure 15 shows Oncor personnel enjoying lemonade and pretzels brought by grateful residents while restoring power in New Jersey on November 6, 2012.<sup>55</sup>

## Trade Associations

There are a number of state trade associations that work on issues ranging from safety to public policy on behalf of utilities and their employees. Some examples follow.

- ✚ The Southwest Electric Safety Exchange is a group of 15 utilities in seven states from Louisiana to Arizona and north to Colorado. The organization provides a forum to discuss industry accidents without official record-keeping and thus no fear of repercussion. The Exchange also shares information on equipment and training aids.
- ✚ Texas Electric Cooperatives is a statewide organization representing 74 Texas member co-ops that serve nearly 3 million Texans. TEC provides association services in the areas of government relations, communications, economic development, training and technical assistance. The organization also distributes new utility equipment and supplies, produces utility poles and provides laboratory services, hazardous waste disposal and environmental consulting services to its members.
- ✚ The Texas Society of Professional Engineers' mission is to promote the ethical, competent and licensed practice of engineering and to enhance the professional, social and economic wellbeing of its members through networking opportunities, political action at the state and local levels and student outreach. Utilities encourage membership for their engineers.
- ✚ The SouthWest Electric Distribution Exchange provides a forum to discuss the design, construction and operation of distribution facilities and to promote the establishment of industry standards. Its members represent several Texas utilities and co-ops.
- ✚ The Association of Electric Companies of Texas is a group composed of Texas utilities that advocates their policy interests with government officials and the public.
- ✚ The Texas Public Power Association represents the interests of public power providers in Texas including MOUs, river authorities, joint action agencies and some electric co-ops.

---

<sup>55</sup> Photo courtesy of Oncor.

### Infrastructure Policy Section of the PUC

The Infrastructure Policy Section is a component of the PUC's Infrastructure & Reliability Division. The team works closely with the Division Director, who serves as the PUC's Homeland Security Coordinator, and the Emergency Management Coordinator. It is responsible for issues surrounding utility and grid physical and cyber security. Team members:

- ✚ Participate in drills and exercises;
- ✚ Take part in training and other emergency management and homeland security educational opportunities;
- ✚ Monitor power and communications outages and
- ✚ Study, formulate and execute policy on security and reliability issues.

The Infrastructure Policy team participates in a variety of exercises on a regular basis. The team creates and runs internal drills to test the PUC's Emergency Management Response Team. Team members participate in larger drills that include other state and federal agencies as well as industry partners, and they observe each coastal IOU's annual hurricane exercise and attend other industry drills as they occur.

With the goal of building in-house expertise on a variety of issues related to security of the grid, team members have joined dozens of working groups and take part in an array of training opportunities. Some of the organizations in which team members are active are:

- ✚ NARUC Critical Infrastructure Staff Subcommittee;
- ✚ NERC Critical Infrastructure Protection group;
- ✚ NERC Severe Impact Resilience Task Force;
- ✚ The National Institute of Standards and Technology (NIST) Smart Grid Interoperability Panel (several task forces and working groups);
- ✚ ERCOT Critical Infrastructure Protection Working Group;
- ✚ Electric Power Research Institute's Smart Grid/Energy Efficiency Public Advisory Group;
- ✚ Department of Homeland Security Industrial Control System Joint Working Group;
- ✚ ERCOT Performance Disturbance Compliance Working Group and
- ✚ Federal Bureau of Investigation InfraGard.

Team members have taken part in educational sessions discussing cyber security, smart grid, homeland security, disaster response and other subjects that could affect electric reliability. The Infrastructure Policy Section has also sponsored workshops on cyber security,<sup>56</sup> storm hardening,<sup>57</sup> electric vehicles,<sup>58</sup> copper theft,<sup>59</sup> curtailments and restoration priorities,<sup>60</sup> smart grid opt-out<sup>61</sup> and vegetation management.<sup>62</sup>

As the smart grid develops, the PUC is focusing on cyber security to ensure that each component remains free from outside interference. In order to monitor the effectiveness of the industry's cyber security initiatives, team members have visited each IOU for a detailed description of its program and efforts to improve the security of its systems. One team member concentrates exclusively on cyber security, sharing information on current and coming threats with utility information technology personnel and monitoring their efforts to defend against the threats.

The Infrastructure Policy Section maintains close contact with the IOUs. The team keeps utility emergency contact information updated, monitors daily outages looking for patterns and areas of concern, reviews IOU emergency operations plans and addresses problems and potential problems through a productive working relationship with utility regulatory personnel.

In 2010, the PUC approved a storm hardening rule<sup>63</sup> that requires utilities to provide their plans for certain infrastructure improvements designed to protect against severe weather. In 2012, the PUC amended §25.181 to raise energy efficiency goals from 25% to 30% of the growth in demand in 2013.<sup>64</sup> As of 2012, the team is studying issues for possible rulemakings on smart grid progress, vegetation management and curtailment and restoration priorities. The team is also involved in PUC research on the development of renewable energy portfolios, distributed generation and energy efficiency.

---

<sup>56</sup> *Cyber Security Activities*, Project No. 37944.

<sup>57</sup> *Rulemaking for Utility Infrastructure Storm Hardening*, Project No. 37475.

<sup>58</sup> *Investigation of Issues Relating to Electric Vehicles*, Project No. 37953.

<sup>59</sup> *Copper Theft*, Project No. 37973.

<sup>60</sup> *Review of TDU Curtailment Procedures and Restoration Plans*, Project No. 39140.

<sup>61</sup> *Project Relating to Advanced Metering Issues*, Project No. 40190.

<sup>62</sup> *Vegetation Management*, Project No. 38257.

<sup>63</sup> P.U.C. SUBST. R. 25.95.

<sup>64</sup> *Rulemaking Proceeding to Amend Energy Efficiency Rules*, Project No. 39674.

# Emergency Response Structure

## State Response

In Texas, emergencies are considered local events in that local (city and county) officials have broad authority to address emergencies as they see fit. Mayors and county judges are granted the ability to exercise the governor's powers on a local scale.<sup>65</sup> If community resources are insufficient to handle the emergency, local officials may request assistance from the state.

Once the governor has declared a disaster, he or she may suspend the operation of state law and regulations<sup>66</sup> and commandeer any state or private property or personnel.<sup>67</sup> The disaster declaration also activates the State Emergency Management Plan.<sup>68</sup>

The State Emergency Management Plan<sup>69</sup> provides for the state's response to short-term emergencies. It is composed of a Basic Plan that covers general response and annexes detailing response by critical subject area. Annex L describes the energy component, the functions of which are performed by the PUC, the RRC and SECO. The State Emergency Management Plan is maintained and administered by the Texas Division of Emergency Management (TDEM), a division of the Department of Public Safety.<sup>70</sup> TDEM coordinates disaster response from the State Operations Center (SOC) where emergency personnel from relevant agencies gather to share information and to carry out the orders of TDEM and the governor.

## PUC Emergency Management Response Team

The utilities are prepared and equipped to assess and repair damage to their infrastructure. The role of the PUC in an emergency, therefore, is to gather information, disseminate and report on that information and facilitate requests for assistance. Once the SOC is activated, the PUC provides employees to staff the PUC desk as required throughout the course of the emergency. The PUC personnel who staff the SOC are members of the Emergency Management Response Team (EMRT), a 12 to 14 member group of PUC employees representing different divisions who are trained and drilled in PUC and state emergency protocols under the direction of the PUC Homeland Security Coordinator and Emergency Management Coordinator (EMC). At the SOC, the EMRT works with other state and federal agencies, TDEM personnel and industry representatives to:

---

<sup>65</sup> TEX. GOV'T CODE ANN. § 418.1015 (2011).

<sup>66</sup> TEX. GOV'T CODE ANN. § 418.016 (2011).

<sup>67</sup> TEX. GOV'T CODE ANN. § 418.017 (2011).

<sup>68</sup> TEX. GOV'T CODE ANN. § 418.015 (2011).

<sup>69</sup> <http://www.txdps.state.tx.us/dem/pages/downloadableforms.htm#stateplan>.

<sup>70</sup> TEX. GOV'T CODE ANN. § 418.042 (2011).

- ✚ Facilitate state initiatives;
- ✚ Share information on electricity outages and restoration estimates;
- ✚ Set priorities for restoration;
- ✚ Provide utilities with state assistance and
- ✚ Ensure that power is restored as quickly and efficiently as possible.

The EMRT also keeps PUC commissioners and state public information officers informed so that they can deliver up-to-date news about outages and power restoration to the community. The EMRT works a checklist of duties as an emergency unfolds to keep its members apprised of the situation. Should the emergency affect PUC operations, the EMRT implements the Business Continuity Plan.

When there is warning of an emergency, the EMRT closely monitors the situation. The EMC forwards weather updates and other pertinent information to the utilities, reviews their emergency operating plans (EOP), makes inquiries regarding their preparations and offers state assistance. EMRT personnel participate in twice daily SOC conference calls that begin in advance of the disaster and continue until the SOC deactivates. The purpose of the conference calls is to inform local government and state agencies of progress by the utilities on preparation, outages and restoration and to learn about local and state efforts in other sectors that might affect or be affected by power issues. As the event approaches, the EMC schedules EMRT members at the SOC.

Once the SOC is activated, EMRT members perform a number of duties. Their primary function is to communicate with industry personnel in order to report on power outages and restoration targets and to help establish restoration priorities. They also monitor the PUC outage database and utility websites to track the progress of the power restoration. EMRT members are available at the SOC to answer questions that arise and to submit the required situation reports through the SOC's Web EOC<sup>71</sup> program. Once reentry into the affected area begins, the EMRT works with the utilities to help Texas Department of Transportation crews clear a route for first responders.

## Industry Partners

Each utility has an emergency operations plan and is in the best position to assess the damage to its infrastructure and to formulate and execute restoration plans. Utilities maintain mutual

---

<sup>71</sup> WebEOC is the original web-enabled crisis information management system that provides secure real-time information sharing to help managers make sound decisions quickly. See <http://www.esi911.com>.

aid agreements with utilities inside and outside Texas and contract with vendors to fill the needs of employees and outside crews as they make their repairs in the affected area. They work with ERCOT to minimize the impact of the outages to the grid and to restore the system as efficiently as possible. When the SOC is activated, representatives of the major utilities in the impacted area are present to work with the PUC and other state agencies to help return the state to normal conditions in a safe and efficient manner.

## Emergency Outage Tracking

When an emergency situation results in a significant power outage, the PUC and the impacted utilities open direct lines of communication. The main tool of the EMRT is the PUC utility outage database. Utilities enter outage information by zip code which gives staff the ability to sort information by county as well. Most of the larger utilities also maintain detailed outage data maps on their websites in real time. That data feeds into the PUC's geospatial information system (GIS) database which compiles the maps for the largest population centers, with the exception of Oncor's territory in the Dallas-Ft. Worth region, into layers for use by the PUC as well as the public.

The emergency outage database is accessible to both utilities and PUC personnel through the PUC website. At the beginning of an emergency, the EMC emails a reminder to each utility of its login and password necessary to access the PUC's web portal. The EMC also sets up the event as a unique and self-contained incident in the database (as opposed to daily outage events) so that it can be tracked and studied. During an emergency, each affected utility is required to update its outage information on the database at least twice per day until the SOC deactivates.<sup>72</sup>

Figure 16 is a snapshot of the EMRT view of outages during Hurricane Alex on June 30, 2010. The utility—in this case AEP—entered the basic information, and a query was run on the database to display the data shown. At the moment the snapshot was taken, in ZIP code 78578, AEP served 5,994 customers, and ten were without electricity. The utility may project an expected restoration date and time, and in this example, it estimated July 2. As it turned out, all power was restored within hours. As time passes during an event, restoration times are refined and the utility will update its estimate accordingly.

---

<sup>72</sup> P.U.C. SUBST. R. 25.53 requires market entities and co-ops to “provide updates on the status of operations, outages and restoration efforts” during a SOC-declared emergency. The PUC's arrangement with the entities is to provide twice daily reporting.

Figure 16: Outage database reporting—current outages

Utility Outage Reporting (jhubbs) PUBLIC UTILITY COMMISSION TX  
User: jhubbs  
Last logged in: 7/13/2010 3:06:00 PM  
log out

Administration Home > Data Entry

**Current Outages**

Event: Hurricane Alex Company: AEP TEXAS CENTRAL COMPANY change

	Zip code	Customers	Outages	Expected Restoration	Last Updated	
<b>Update Cancel</b>						
<b>Edit</b>	78578	5,994	10	7/2/2010	7/1/2010 2:36 PM	Delete
<b>Edit</b>	78580	3,365	12	7/2/2010	7/1/2010 2:36 PM	Delete
<b>Edit</b>	78583	1,323	2	7/2/2010	7/1/2010 2:36 PM	Delete
<b>Edit</b>	78596	11,691	19	7/2/2010	7/1/2010 2:36 PM	Delete
<b>Edit</b>	78595	2,002	34	7/2/2010	7/1/2010 2:36 PM	Delete
<b>Edit</b>	78596	13,793	1	7/2/2010	7/1/2010 2:36 PM	Delete
<b>Edit</b>	78597	7,923	83	7/2/2010	7/1/2010 2:36 PM	Delete
<b>Edit</b>	78598	675	11	7/2/2010	7/1/2010 2:36 PM	Delete

K < Previous 1 2 3 4 Next > Page size: 10 38 items in 4 pages

Figure 17: Outage database reporting—executive summary

Utility Outage Reporting (jhubbs) PUBLIC UTILITY COMMISSION TX  
User: jhubbs  
Last logged in: 7/13/2010 3:06:00 PM  
log out

**Hurricane Alex** change event Type: Electric Dataset: 7/6/2010 3:57:00 PM

Executive Summary County Report Company Report Zip Code Report Peak Outages Zip Code Search

**Executive Summary Report**

Households Served	Households with No Service	Percent Out	Expected Restoration
358,702	1,241	0.35%	7/2/2010

Company	Peak Out	Current Out	Total Customers	% Out	Restore Date	Last Reported
BROWNSVILLE PUBLIC UTILITIES BOARD	33	33	45,576	0.1%	7/1/2010	7/1/2010
AEP TEXAS CENTRAL COMPANY	4,783	1,108	305,400	0.4%	7/2/2010	7/1/2010
NUECES ELECTRIC COOPERATIVE	100	100	7,726	1.3%	7/2/2010	7/2/2010

Figure 17 shows a view of the reporting feature of the outage database. Reports may be sorted by executive summary, county, company, ZIP code or peak outages. The executive summary report presents the data for the entire event. The first box totals the number of customers served by all of the affected utilities, the number of customers without service, the percentage of customers without power and the estimated restoration time. The second box breaks out the totals by company. Each column can be sorted, and each time EMRT personnel refresh the

reports, a historical snapshot is saved for future reference. Restoration for Hurricane Alex only took about 24 hours, but for a longer recovery period like Hurricane Ike, the charting feature of the database will graph the progress over time by either totals or company.

As the outage database compiles information for the EMRT at the SOC, it also pushes data to the PUC website for public consumption. Figure 18 shows the public view. If Texans have evacuated an area, they can check the outages and restoration estimates for their ZIP codes which may help them determine when to return. The search will also provide a link to the customer’s utility company website. In addition, the PUC GIS outage maps provide detail to the street level in areas where the utilities have that capability and feed it to the agency.

Figure 18: Outage database—public view

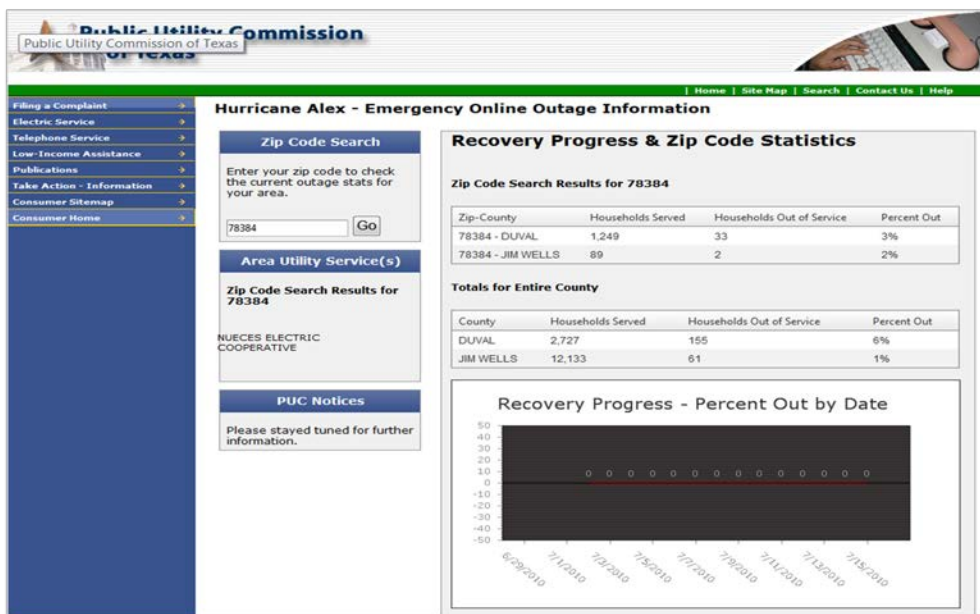

The SOC is moving toward a TxMAP/Google Earth platform so that it can display shelters, grocery stores, gas stations and so forth to see the likelihood of the area being without power. The Infrastructure Policy Section of the PUC has ensured that its GIS maps will be compatible with the SOC system.



### ERCOT Emergency Measures

PUC SUBST. R. 25.200 gives ERCOT the authority to manage load shedding, curtailments and redispatch. If ERCOT determines that a transmission constraint exists that may impair reliability, it acts to avoid interruption of service. Transmission providers and customers are bound to do as ERCOT directs. The rule also gives ERCOT and transmission providers the power to interrupt service on a non-discriminatory basis to correct any adverse condition or disturbance that may endanger persons or property, to prevent damage to generation or transmission facilities or to expedite restoration of service. If a customer fails to respond to established emergency load shedding and curtailment procedures to relieve emergencies on the system, he is liable and may be penalized by the PUC. From here, ERCOT establishes its own emergency measures.

ERCOT has several processes and procedures to respond to various events that could affect the ERCOT grid.<sup>73</sup> These events can range from shortages in power, localized power disruptions and severe storms to total system blackout. Section 5.6 of the ERCOT Protocols sets forth ERCOT's responsibilities in maintaining reliability during emergency operating conditions and communicating with transmission and distribution service providers (TDSP) and qualified scheduling entities (QSE) during emergency operating conditions.<sup>74</sup> Section 4 of the ERCOT Operating Guide describes communication procedures for ERCOT, TDSPs and QSEs during emergency conditions affecting the reliability of the ERCOT grid.<sup>75</sup> ERCOT's Operating Procedures detail processes and procedures for taking emergency action, including manuals related to ERCOT DC Tie Operations, Frequency Control Desk Operating Procedures, Operating Period and Day Ahead Desk Procedures and Transmission and Security Desk Operating Procedures.<sup>76</sup>

In order to convey system conditions to ERCOT market participants and the PUC, ERCOT issues a series of notices. Depending on the severity of the event, these are classified as a Control Room Advisory, Control Room Watch, Power Watch, Power Warning and Power Emergency.<sup>77</sup> ERCOT continuously maintains situational awareness and has developed a Black Start Restoration Plan to address the worst case scenario. In addition, ERCOT conducts an annual Black Start drill with transmission and generation companies to test this plan. ERCOT

---

<sup>73</sup> Letter from Kent Saathoff, ERCOT Vice President of Grid Operations and Planning, Nov. 23, 2010.

<sup>74</sup> <http://www.ercot.com/mktrules/protocols/current>.

<sup>75</sup> <http://www.ercot.com/mktrules/guides/operating/>.

<sup>76</sup> <http://www.ercot.com/mktrules/guides/procedures/>.

<sup>77</sup> The ERCOT Communications Matrix may be found at <http://www.ercot.com/content/news/presentations/2011/Energy%20Emergency%20Alert%20Communications%20Matrix.pdf>.

immediately contacts the PUC when issues develop, and the PUC maintains communications with ERCOT emergency personnel to ensure that all restoration concerns are being addressed. ERCOT also releases notices to other interested parties and the public via email, Twitter, Facebook and a newly developed app available for iPhones and Androids since summer 2012.

After an urgent situation has passed, the appropriate ERCOT working group, made up of utility representatives, REPs, other market participants, ERCOT personnel and PUC staff, runs an extremely detailed postmortem to determine how and why the problem occurred. These sessions remain off the record to encourage all parties to be absolutely forthright. The goal is to assess every bit of information to prevent the same or similar problem from arising again. Members have found these investigations to be very effective in reducing incidents and altering policy to avoid future incidents.

### **Buying and selling electricity during an emergency event**

The ability of a utility or co-op to buy electricity or for various entities in the wholesale market to sell electricity to a utility, MOU or co-op will be a function of (1) the availability of the seller's generating capacity and (2) the availability and capacity of a transmission and distribution pathway to the buyer's end-use customers, referred to as the load.

Electric generating facilities are built in discrete locations and therefore may be less likely to be damaged in an emergency unless the event, such as a tornado, occurs at the plant's specific location. Nuclear and coal plants are generally not subject to short-term disruption of fuel supplies, but natural gas plants may be curtailed or taken off line when pipeline supplies and operations are reduced during freezing weather or other hazardous conditions. Some natural gas plants can substitute fuel oil if their normal supplies are disrupted. Many natural gas plants cannot operate on fuel oil, however, and those that do may not maintain sufficient inventories. Even if a generating plant is fully operable and has adequate fuel supplies in an emergency, it cannot be started up if it is not connected to a fully operational transmission grid. Electricity is generated and consumed only in real time because there is no effective storage capability. Restoration of the transmission and distribution system is always the immediate concern in an emergency.

Within ERCOT, more than 90% of the electricity is sold through bilateral contracts between buyers and sellers. The remaining power requirements are met by ERCOT who purchases electricity through its ancillary service markets. Through the ERCOT market, buyers and sellers of electricity have the ability to make transactions in the long- or short-term, and ERCOT maintains enough installed capacity to meet requirements plus a reserve margin.

## Establishing interconnections during an emergency event

Transmission and distribution systems are vulnerable to disruption from natural disasters or other emergencies because they are located everywhere that electricity is needed, and damage to only one component of the system may have wider impact. This is particularly true of damage to transmission lines, but distribution system outages can also affect customers outside the immediate area. By design, transmission and distribution systems are looped so that most points in the system can receive power flows from more than one direction. This allows power to be rerouted when there is an outage in the system, reducing the impact on customers. Outages may be unavoidable in widespread emergencies, and restoration time will depend on the extent of damage. Power cannot be fed into a transmission or distribution system until the system can be operated in accordance with required specifications to prevent further damage to the system, generating equipment or customers' property.

Early restoration of service during an emergency is usually accomplished through load transfer. For example, if the wires that normally provide power to a load are out of service, it may be possible to serve the load by connecting it to a different set of wires, transferring the load from one system to another. The concept may sound simple, but in practice it can only be done in limited circumstances where the other system is close by, the proper electrical interconnection can be made and the load to be transferred can be fully isolated from its temporarily non-operating system so that there are no unintended power flows that could damage one or both systems. Load transfers can occur at the transmission level or the distribution level within a grid, or they can occur between grids. Figure 19 maps Texas' existing ties to neighboring grids.

Figure 19: Existing ties

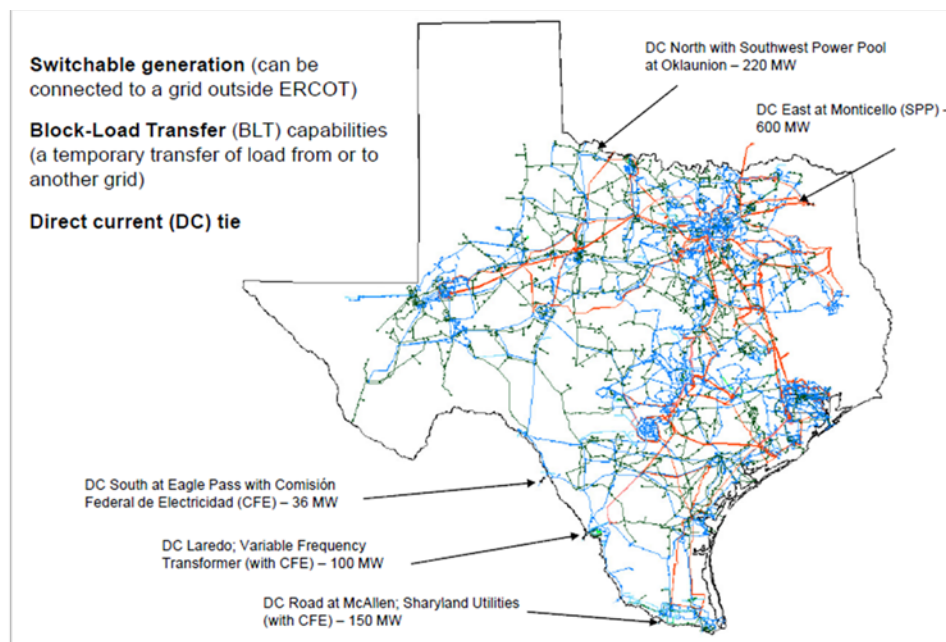

An emergency power transaction that takes place between the ERCOT power grid and one of the adjacent power grid regions requires significant coordination.<sup>78</sup> ERCOT staff and utilities have compiled a series of steps to facilitate the flow of emergency power across ERCOT and non-ERCOT areas when a natural disaster or other emergency occurs. ERCOT Systems Operations staff must take the following steps:

- ✚ Direct ERCOT and the non-ERCOT transmission service providers (TSP) that are involved in the transfer to obtain data and perform studies to ensure that the non-ERCOT load can be reliably integrated into the ERCOT system;
- ✚ Ensure that ERCOT obtains real-time SCADA data from the ERCOT TSP at the transfer point;
- ✚ Incorporate the transfer into ERCOT's computer systems including the network model, state estimator and real time contingency analysis;
- ✚ Determine if the appropriate DOE/FERC exemptions or approvals are in place (they must be obtained by the TSPs, not ERCOT) and
- ✚ Ensure that ERCOT's Market Operations and Client Services staff makes the necessary metering changes and QSE assignments to appropriately settle the transfer. Upon completion of these steps, the TSPs are then allowed to conduct the transfer.

ERCOT's Client Services staff would:

- ✚ Coordinate planning, communication and execution of the transfer through ERCOT's Legal, System Operations and Market Operations staff and all involved market participants;
- ✚ Make necessary entries and/or modifications in the registration system for settlement and record-keeping purposes based on the approved transfer plan and
- ✚ Communicate internally with ERCOT staff and externally with market participants during the transfer.

ERCOT's Market Operations staff would:

- ✚ Set up an ESI ID for the TSPs involved in the transfer in the ERCOT Lodestar computer system based on the information in the TSP's block load transfer registration form submitted to ERCOT and
- ✚ Remove the ESI ID from ERCOT's Siebel computer system to prevent inadvertent switches.

---

<sup>78</sup> ERCOT is not involved in distribution level transfers because all actions on lower voltage lines are taken by the Distribution Service Provider without a need for ERCOT involvement. ERCOT Systems Operations Staff is only notified of a distribution level transfer.

Utilities that have established an emergency interconnection in the past have taken the following steps:

- ✚ Obtain a request from the neighboring utility to provide emergency service;
- ✚ Notify DOE of the emergency and the need to interconnect ERCOT to the neighboring grid using the tie in question;
- ✚ Notify FERC, the PUC and ERCOT of the emergency and the intent to provide the emergency interconnection;
- ✚ Provide a draft order to the DOE for execution;
- ✚ Send a letter to DOE providing notice of the date and time of the emergency interconnection. A copy of the letter to the DOE is also provided to FERC, the PUC and ERCOT and
- ✚ Once the interconnection has been opened, send a letter to DOE providing notice of the date and time of the cessation of the emergency interconnection. A copy is also sent to the same entities that were provided notice.

## Industry Emergency Response

PUC rules govern the parameters of the utilities' response to an emergency situation but not necessarily every aspect of the method of their response. P.U.C. SUBST. R. 25.52 states that every utility shall make all reasonable efforts to prevent interruptions of service and to reestablish service within the shortest possible time when they do occur. Utilities must make reasonable provisions to manage emergencies and to train their employees in their emergency procedures in order to prevent or mitigate interruption or impairment of service. Utilities may interrupt service of some customers in order to provide necessary service to civil defense or other emergency service entities on a temporary basis, when such action is in the public interest. Section 25.52 further requires that utilities keep complete records of sustained interruptions of all classifications. When the interruptions are significant, the utility must notify the PUC as soon as reasonably possible, and if the interruption lasts longer than 24 hours, daily reports must be filed. During larger events, utilities report on outages and restoration times a minimum of twice per day. As discussed in the Emergency Management section, certain utilities provide personnel to staff the SOC with the PUC, and outage reports are more frequent. Up-to-the-minute outage information can also be found on the larger IOUs' websites which feed the PUC's GIS system and are available to the public.

P.U.C. SUBST. R. 25.53 requires certain market participants to file emergency operations plans summaries and annual updates with the PUC and to make the full plans available for inspection

upon PUC request. EOP summaries are filed confidentially and are thus not attached. A description of their contents as required by §25.53 follows. Utilities must include:

- ✚ A registry of critical load customers as defined by §25.497(a) including:
  - ✚ The location of the registry;
  - ✚ The process for maintaining an accurate registry;
  - ✚ The process for providing assistance to critical load customers in the event of an unplanned outage;
  - ✚ The process for communicating with the critical load customers and
  - ✚ A process for training staff with respect to serving critical load customers;
- ✚ A communications plan that describes the procedures for contacting the media, customers and critical load customers directly served as soon as reasonably possible either before or at the onset of an emergency affecting electric service. The plan should also address its telephone system and complaint-handling procedures during an emergency;
- ✚ Curtailment priorities, procedures for shedding load, rotating black-outs and planned interruptions;
- ✚ Priorities for restoration of service;
- ✚ A plan to ensure continuous and adequate service during a pandemic;
- ✚ A hurricane plan, including evacuation and reentry procedures (if the facilities are inside a hurricane evacuation zone);
- ✚ Emergency contact information;
- ✚ An assessment of the effectiveness of the annual drill and modifications to the EOP as needed and
- ✚ An affidavit from the entity's operations officer indicating that all relevant operating personnel are familiar with the contents of the EOP and such personnel are committed to following it in case of natural or manmade disasters.

A utility that owns or operates generation facilities and PGCs must include in its EOP:

- ✚ A summary of power plant weatherization plans and procedures;
- ✚ A summary of alternative fuel and storage capacity;
- ✚ Priorities for recovery of generation capacity;
- ✚ A pandemic preparedness plan;
- ✚ A hurricane plan, including evacuation and reentry procedures (if the facility is inside a hurricane evacuation zone);

- ✚ An affidavit from the operations officer indicating that all relevant operating personnel are familiar with the contents of the EOP and such personnel are committed to following it in case of natural or manmade disasters.
- ✚ An assessment of the effectiveness of its annual drill and modifications to the EOP as needed;
- ✚ Emergency contact information;
- ✚ (REPs only) An affidavit from an officer affirming that the REP has a plan that addresses business continuity should its normal operations be disrupted by a natural or manmade disaster, a pandemic or SOC declared event and
- ✚ (ERCOT only) An affidavit from a senior operations office affirming that:
  - ✚ ERCOT maintains Crisis Communications Procedures that address procedures for contacting media, governmental entities and market participants during events that affect the bulk electric system and normal market operations and include procedures for recovery of normal grid operations;
  - ✚ ERCOT maintains a business continuity plan that addresses returning to normal operations after disruptions caused by a natural or manmade disaster or a SOC declared event and
  - ✚ ERCOT maintains a pandemic preparedness plan.

Section 25.53 also requires each market entity to conduct or participate in an annual drill to test its emergency procedures if its emergency procedures have not been implemented in response to an actual event within the last 12 months. If the entity is in a hurricane evacuation zone, the drill must test its hurricane plan. The PUC sends representatives to observe these drills.

Entities are not required to and do not, in fact, share their supply resources systems for power generation with the PUC. The PUC no longer regulates power generation within the ERCOT region. Generators of electricity maintain contracts to provide redundancy, reserves and back-up alternatives with many layers of defense to security concerns. If generation does fail, ERCOT will replace the generation from alternative sources.

## The State

One of the PUC's primary missions is to improve reliability of the electric infrastructure, and it works toward that goal on a variety of fronts. The electricity industry is transforming as new technologies and paradigms support a cleaner, more efficient Texas. The PUC has adopted

rules both encouraging and requiring diversification of energy through the integration of renewable resources. Development of the smart grid is on track, and as it matures, it will increasingly enhance reliability and resiliency. Energy efficiency is an important focus of three state agencies, and the PUC has approved a series of rules mandating efficiency goals. Many of these topics will be discussed in detail in the New Energy Issues and New Energy Resources sections of the Plan. The PUC has taken other, more traditional steps toward enhanced reliability as well.

P.U.C. SUBST. R. 25.52 requires utilities to make reasonable efforts to prevent interruptions and to reestablish service as quickly as possible when they do occur. In the event of a significant interruption, the PUC must be timely notified. If a widespread emergency exists, utilities will staff the SOC alongside PUC staff. The rule also establishes a standard that the reliability index for each feeder line may be no worse than the system average of all feeder lines by more than 300% during any two consecutive reporting years.

Critical care and critical load customers are guaranteed certain protections by §25.497. Critical customers are divided into four classes, but they generally refer to customers with a serious medical condition requiring electricity to manage it or customers that provide a crucial public safety service. Critical customers are entitled to notification of interruptions or suspensions of service, and they are given priority in restoration plans during an outage. Each year, TDUs report the numbers of each class of critical customers to the PUC.

As a result of Hurricanes Rita and Ike, the PUC has allocated increased resources to hurricane preparedness and disaster recovery. Responding to the significant damage to utility infrastructure caused by these hurricanes, the PUC released a report in 2009 that examined the costs, utility benefits and societal benefits of utility infrastructure upgrades and storm hardening programs.<sup>79</sup>

The 81st Legislature passed Senate Bill 1492 which is reflected in P.U.C. SUBST. R. 25.94. The rule requires utilities to describe their activities during the prior year related to identifying areas in their service territories that are susceptible to damage during severe weather and what they have done to harden facilities in those areas and inspecting distribution poles.

In June 2010, the PUC adopted §25.95 requiring that each utility develop a Storm Hardening Plan that provides for the implementation of cost-effective strategies to increase the ability of its transmission and distribution facilities to withstand extreme weather conditions. Utilities must file summaries (or revisions to the summaries) of their five year plans to harden their systems annually with the PUC. The plans must include:

---

<sup>79</sup> [http://www.puc.state.tx.us/industry/electric/reports/provision/Study\\_Provision\\_Electricity.pdf](http://www.puc.state.tx.us/industry/electric/reports/provision/Study_Provision_Electricity.pdf).



- ✚ Construction standards, policies, procedures and practices to enhance the reliability of their systems, including overhead and underground transmission and distribution facilities;
- ✚ A vegetation management plan for distribution facilities that includes tree pruning methodology and pruning cycles, hazard tree identification, mitigation plans and customer education and notification practices;
- ✚ Plans and procedures to consider infrastructure improvements for distribution systems based on smart grid concepts that provide enhanced outage resilience, faster outage restoration and/or grid self-healing;
- ✚ Plans and procedures to enhance post-storm damage assessment, including enhanced data collection methods for damaged poles and fallen trees;
- ✚ Transmission and distribution pole construction standards, pole attachment policies and pole testing schedules;
- ✚ Distribution feeder inspection schedules;
- ✚ Plans and procedures to enhance the reliability of overhead and underground transmission and distribution facilities through the use of transmission and distribution automation;
- ✚ Plans and procedures to comply with the most recent National Electric Safety Code (NESC) wind loading standards in hurricane-prone areas for new construction and rebuilds of the transmission and distribution system;
- ✚ Plans and procedures to review new construction and rebuilds to the distribution system to determine whether they should be built to NESC Grade B (or equivalent) standards;
- ✚ Plans and procedures to develop a damage/outage prediction model for the transmission and distribution system;
- ✚ Plans and procedures for use of structures owned by other entities in the provision of distribution service, such as poles owned by telecommunications utilities and
- ✚ Plans and procedures for restoration of service to priority loads and for consideration of targeted storm hardening of infrastructure used to serve priority loads.

In order to address reliability and public safety concerns caused by vegetation interfering with electrical infrastructure, the PUC initiated Project 38257, *Vegetation Management*. After expert input and much deliberation, the PUC is poised to expand the reporting requirements of §25.95 for the collection of uniform data on utility vegetation management programs under new §25.96. The goal is to provide a baseline from which staff may assess programs and determine whether gains in reliability and public safety might be possible and cost-effective. One of the key provisions is budget and actual expenditures reporting to track whether vegetation management budgets are being diverted, possibly creating reliability issues down the road.

Texas has long been known as the Energy State because of its substantial presence in the oil and gas industries, and indications are that the state will retain the title as it continues to embrace the new century's outlook on energy. Texas is a leader in smart grid implementation and in developing and delivering renewable energy. Texas mandates aggressive energy efficiency standards, facilitates the integration of distributed generation and is preparing for more widespread use of electric vehicles.<sup>80</sup>

**Figure 20: Generation breakdown**

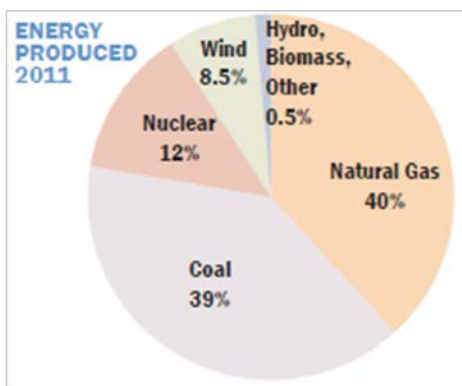

As Figure 20 illustrates, natural gas-fired and coal-fired power plants each account for approximately 40% of the electricity produced in Texas. Texas consumes more coal than any other state. Although Texas produces a substantial amount of coal from its 11 surface mines, including five of the 50 largest in the United States, the state relies on deliveries of sub bituminous coal from Wyoming for the majority of its supply. Nearly all of the coal mined in Texas is lignite, the lowest grade of coal, and all of it is consumed in the state, mostly in arrangements where a single utility operates both the mine and an adjacent coal-fired power plant.

Texas is also a major nuclear power generating state. Two nuclear plants, Comanche Peak and the South Texas Project, account for a little over one-tenth of the state's electric power production. Until the recent capacity increase of the number two reactor at Palo Verde in Arizona, the two South Texas Project nuclear reactors were the largest in the nation.

Texas leads the nation in fossil fuel reserves and in non-hydroelectric renewable energy potential. Texas also leads the country in renewable energy potential including wind, solar and biomass resources, as illustrated in Figure 21.<sup>81</sup> Wind resource areas in the Texas Panhandle, along the Gulf Coast south of Galveston and in the mountain passes and ridgetops of the Trans-Pecos offer Texas some of the greatest wind power potential in the United States. Solar power potential is also among the highest in the nation with high levels of direct solar radiation suitable to support large-scale solar power plants concentrated in west Texas. Due to its large agricultural and forestry sectors, Texas has an abundance of biomass energy resources.

<sup>80</sup> Much of the information about generation was taken from the Energy Information Administration website at [http://tonto.eia.doe.gov/state/state\\_energy\\_profiles.cfm?sid=TX#Datum](http://tonto.eia.doe.gov/state/state_energy_profiles.cfm?sid=TX#Datum).

<sup>81</sup> <http://www.seco.cpa.state.tx.us/re.htm>.

Although Texas is not known as a major hydroelectric power state, substantial untapped potential exists in several river basins including the Colorado River and the Lower Red River.

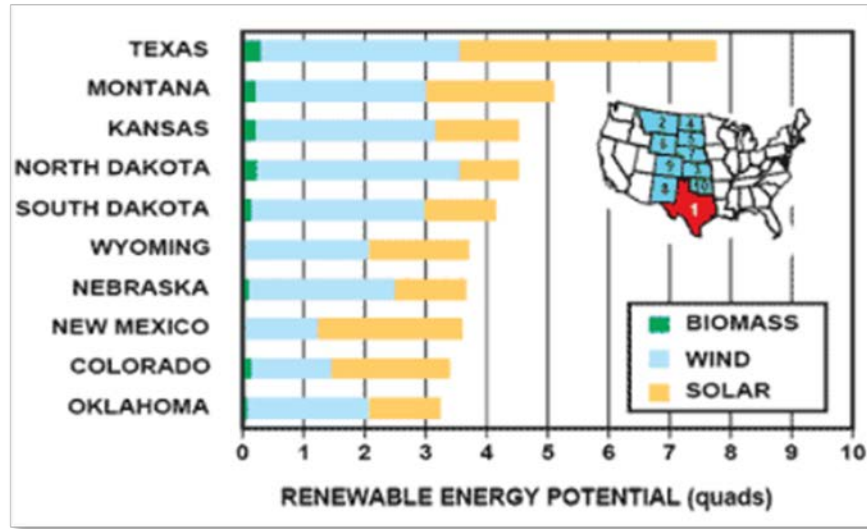

Figure 21: National renewable energy potential

Although renewable energy sources contribute minimally to the Texas power grid, Texas leads the nation in wind-powered generation capacity, and substantial new wind generation capacity is under construction. Texas became the country’s largest wind energy producer in 2006 when it surpassed California. There are over 2,000 wind turbines in west Texas alone, and the numbers continue to increase as development costs drop and wind turbine technology improves. In 2007, Texas became the first state to reach the milestone of one gigawatt of wind capacity installed in a single year. At 781 MW capacity, the Roscoe Wind Farm near Abilene (Figure 22)<sup>82</sup> is the largest land wind power facility in the world.

Figure 22: Roscoe wind farm



<sup>82</sup> Photo courtesy of E.ON Climate & Renewables.

Texas produces and consumes more electricity than any other state. Figure 23 depicts the types of generation and how they are deployed geographically within ERCOT. The Texas Interconnect power grid is largely isolated from the integrated power systems serving the eastern and western United States, and most areas of Texas have little ability to export or import electricity to and from other states. Texas per capita residential use of electricity is significantly higher than the national average due to high demand for electric air conditioning during the hot summer months and the widespread use of electricity as the primary energy source for home heating during the typically mild winter months.

Figure 23: Generation deployment

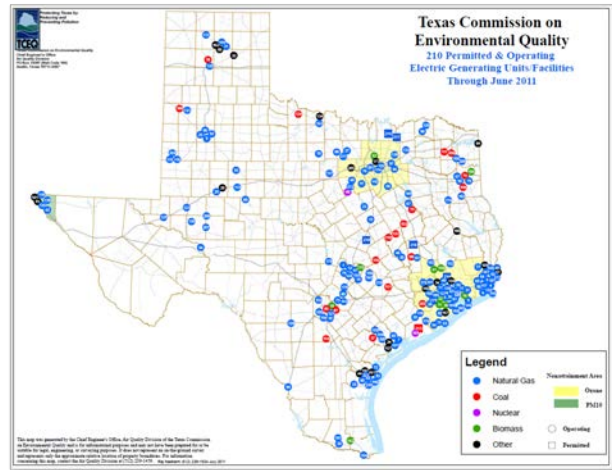

## Renewable Energy Mandate

Texas established a renewable energy portfolio standard through 1999 amendments to PURA. The amended statute established renewable energy goals and an implementation mechanism—renewable energy credits (REC). These credits are earned by companies that produce renewable energy (sun, wind, geothermal, hydro, wave or tidal and biomass), and they are required to be retired by REPs and electric utilities. The retail providers and utilities buy the credits from producers, and the sales and purchases of the credits establish a market value for the credits.

The original legislation established a goal of 2,000 MW of new renewable resource capacity by 2009. In 2005, PURA was amended to increase the goal to 5,880 MW of new renewable capacity by 2015. The amendments also established a target of 500 MW of non-wind renewable capacity by 2015 and 10,000 MW of renewable capacity of any type by 2025. Currently, 10,000 MW of new renewable capacity is in operation in Texas, so the 2015 goal and 2025 target have been met.

The PUC’s rules provide that a non-wind resource may earn both a renewable energy credit and a compliance premium for each megawatt-hour it generates. In 2010, the PUC evaluated the costs and benefits of additional incentives that could be added to its rules for non-wind renewable resources. The incentives could include one or more additional types of RECs that would reflect the higher costs of non-wind renewable resources. They could also include the

option for retail providers to make alternative compliance payments in lieu of meeting their REC requirements.

In 2005, the 79th legislature directed the PUC to designate Competitive Renewable Energy Zones (CREZ) and adopt a transmission plan to move renewable energy from these zones (areas of productive wind generation in west Texas) to other areas of Texas in a manner most beneficial and cost-effective to customers.<sup>83</sup> The PUC has designated CREZs in west Texas<sup>84</sup> and has adopted a transmission plan that will permit a significant increase in the production of wind energy in them and in the delivery of the wind energy to more populous areas of the state outside of west Texas.<sup>85</sup> The PUC has also designated the transmission companies to build the new facilities.<sup>86</sup> The transmission plan approved by the PUC is designed to permit about 18,400 MW of wind capacity to operate within ERCOT by late 2013 or early 2014. There are about 150 MW of qualifying non-wind resources currently in operation.

The best wind resource areas in Texas are primarily in west Texas and along the Gulf Coast between Corpus Christi and Brownsville. In many of these areas, investment in wind facilities has resulted in a significant increase in the property tax base for counties and school districts. The wind facilities have also generated employment in delivery, construction, operation and maintenance of wind turbines and supporting infrastructure, construction of towers and other components and other related jobs.

## Wind Generation

AWS Truewind conducted an analysis of wind generation potential in the state using a proprietary model called Mesomap. The model developed meteorological data that could be used to calculate turbine output for specific turbine models in areas of Texas. Exclusion zones including national parks and forests, other wilderness or protected areas, military reservations, areas within one mile of an inhabited area, water bodies and terrain with a slope greater than 20% were then identified and mapped. Using this GIS data, specific sites that had sufficient available land to support 100 MW of installed wind generation and a capacity factor above a specified minimum level of 33% were selected. AWS

Figure 24: 25 best wind areas

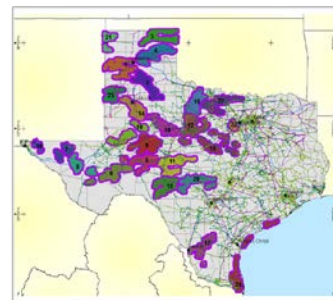

<sup>83</sup> PURA § 39.904(g) (2011).

<sup>84</sup> *Commission Staff Petition for Designation of Competitive Renewable Energy Zone*, Project No. 33672 Order on Rehearing (Oct. 7, 2008).

<sup>85</sup> *Id.*

<sup>86</sup> *Commission Staff Petition for Selection of Entities Responsible for Transmission Improvements Necessary to Deliver Renewable Energy from Competitive Renewable Energy Zones*, Docket No. 35665, Order on Rehearing (May 15, 2009).

Truwind identified the 40 best 100 MW sites in each zone with the highest annual capacity factors and clustered those sites into 25 areas with the best 4000 MW in each zone. Figure 24 depicts the results.

## Operational Challenges of Wind Generation

Texas has experienced a rapid and significant addition of renewable energy generation in recent years, primarily in the form of large-scale wind generation resources. At the end of June 2010, new renewable facilities in Texas reached approximately 10,073 MW, which exceeds the January 1, 2025 legislative target of 10,000 MW. Wind represents more than 10,000 MW of this renewable capacity installed since September 1, 1999. Wind capacity in the United States by June 2012 was 49,802 MW.<sup>87</sup> A new wind record of 8,521 MW occurred on November 10, 2012 when wind carried almost 26% of ERCOT’s load.<sup>88</sup>

Most wind generation development has occurred in west Texas, in areas with low population. Such expansion is necessary so that wind energy from current and future wind developments can be transported from west Texas to population centers in south, central and north Texas. This expansion of the electric transmission network is scheduled to be completed in the 2013-2014 timeframe. Wind developers are expected to synchronize the completion of their new generation projects in the CREZ zones of west Texas and the Panhandle to coincide with the completion of the transmission network, almost doubling the current wind capacity.

**Figure 25: Wind capacity installed by year, as of April 2012**

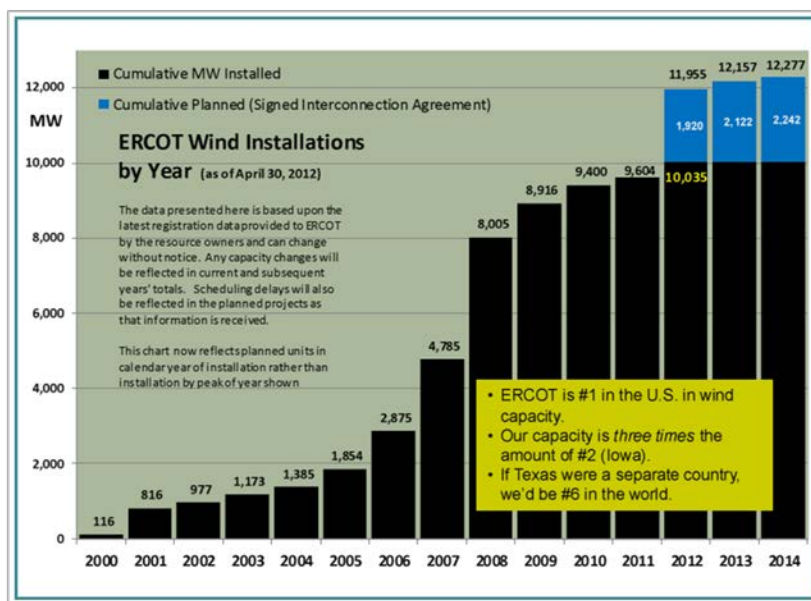

<sup>87</sup> American Wind Energy Association, *US Wind Industry Facts*, available at [http://www.awea.org/learnabout/industry\\_stats/index.cfm](http://www.awea.org/learnabout/industry_stats/index.cfm).

<sup>88</sup> [http://www.ercot.com/news/press\\_releases/show/26342](http://www.ercot.com/news/press_releases/show/26342).

It has been feasible to incorporate wind energy into the electric system operations at the relatively low levels of penetration of wind capacity that have occurred up to now. Today, wind resources constitute about 15% of the total capacity in the ERCOT region, but the completion of the CREZ transmission plan and the associated wind farms will roughly double the wind capacity in ERCOT. The output of the wind farms, like the level of wind, is intermittent and difficult to predict. These characteristics of the wind resource are expected to present challenges to the reliable operation of the electric network when the CREZ wind facilities are completed.

In the operation of an electrical network, the level of energy produced must match the level of energy demanded by customers at all times within a narrow tolerance. The matching of energy output and energy demand is achieved by increasing or decreasing the output of generation facilities as demand changes. “Base load” generating plants operate around the clock to serve the minimum level of energy demanded or the amount of demand that is present every hour of every day. Other plants, referred to as “cycling” plants, begin to operate and increase their output as the level of demand increases daily or seasonally. “Peaker” plants are brought on line to operate a limited number of hours when demand reaches very high levels.

In an integrated utility environment, the commitment, startup and planned output levels of generating units are under the control of the utility. In a competitive environment, a neutral third party typically has responsibility for the reliability of the transmission system and operates markets for energy and short-term capacity that it uses to match energy output and energy demand. These neutral organizations are usually ISOs or Regional Transmission Organizations.

Wind energy production characteristically becomes a significant part of total energy production during the off-peak seasons and in the winter which is when reliability is more likely to be impacted. For example, on June 12, 2010, wind energy production in ERCOT reached a then-record of 7,016 MW which represented 15.8% of system load at that time. On March 4, 2010, a non-peak period, wind production reached 6,272 MW which represented 19% of system load at that time. When wind production reaches a percentage of 20 to 30% of total system load, operational problems are increasingly likely to affect system reliability. ERCOT has implemented improvements in its operations to address the current levels of wind production such as improving the forecasting of wind production, and it continues to assess and develop measures that will allow it to continue to operate reliably as wind development continues in Texas with the completion of the CREZ transmission plan and associated wind farms.

## Forecast Uncertainty

It is important for ERCOT to be able to accurately forecast wind production so that it can dispatch resources to match generation and load at all times. ERCOT has acquired state-of-the-art forecasting tools to forecast wind generators’ output. Wind generators are now required to

use the wind production forecast provided by ERCOT in their daily resource plan submittals rather than to rely on their own forecast which can have varying degrees of sophistication and accuracy.

Even with the state-of-the-art forecast of wind production there is still some disparity between the forecasted production and actual production. The risks of load forecast error, wind forecast error and outages of the thermal generation and transmission facilities are mitigated by acquiring generation reserves that may be called into operation when needed, and it may become necessary for the system operator to quickly deploy these resources when a sudden change in wind production occurs. For example, on January 28, 2010, ERCOT experienced wind gusts throughout the day. The variability of wind generator output is shown in Figure 26. These wind speed changes led to the deployment and depletion of operating reserves (RRS in the figure). To address such events, ERCOT has adopted a new methodology to acquire additional operating reserves as the amount of wind generation increases. ERCOT is considering adding reserve services from quick-start generating units—units that can come on line within ten minutes. ERCOT currently has 1,000 MW of resources capable of reaching full capacity in ten minutes and 550 MW of announced resources with similar capability.

Figure 26: Wind output, regulation and RRS for Jan. 28, 2010

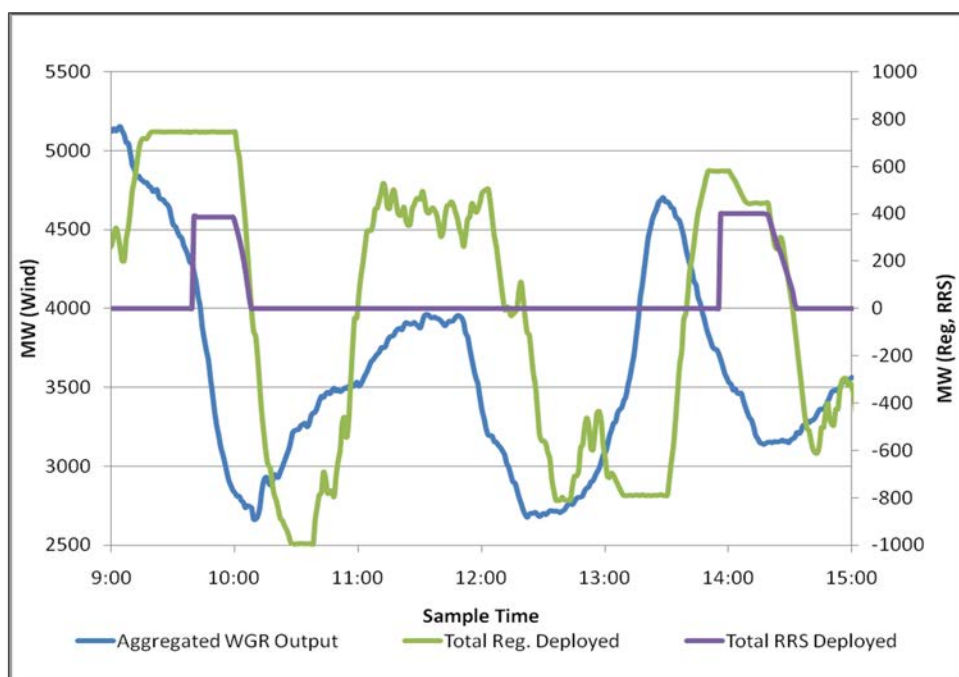

With the start-up of the nodal market on December 1, 2010, changes were implemented in market design that are expected to greatly improve ERCOT's ability to respond to wind variability. Previously, the ERCOT operator sent energy deployment instructions for energy resources approximately ten minutes ahead of each 15-minute interval, and these instructions could not change until the end of the 15-minute interval. With the nodal market, ERCOT sends



dispatch instructions at five-minute intervals, and if it detects changes in load or wind output within a five-minute interval, adjustments can be made to those instructions. It is expected that the shorter intervals will greatly improve ERCOT's flexibility and result in a reduced need for certain operating reserves which reduces market operating costs that are passed on to electric customers.

## System Stability

The expansion of wind energy production in Texas will bring about other reliability concerns. Wind generators historically have not contributed to stabilizing frequency following a disturbance as conventional generators do. As a result, when conventional generation is displaced by wind generation, the potential for more severe frequency disturbances increases because the remaining conventional generation has to overcome the disturbance without help from the wind generation. Technological improvements have brought a partial solution to this problem, and new wind turbines now come equipped with technology that allows these turbines to help restore the standard system frequency after a disturbance. New wind generators are now required by ERCOT rules to be equipped with such technology, and existing generators are required to retrofit their units if feasible.

Similarly, wind generators have not provided the quality of voltage support provided by conventional generators support that is needed to reliably maintain the flow of electricity through transmission lines. Technology is available to address this issue, and the new technology to address voltage support is now required of all new wind installations in ERCOT.

## Competitive Renewable Energy Zones

In 2008, the PUC designated five areas in west Texas as competitive renewable energy zones (CREZ) and identified the transmission improvements necessary to deliver over 18,000 MW of renewable energy to customers in ERCOT. In 2009, the PUC designated the transmission providers that would construct the CREZ transmission facilities and assigned them specific

**Figure 27: CREZ selection**

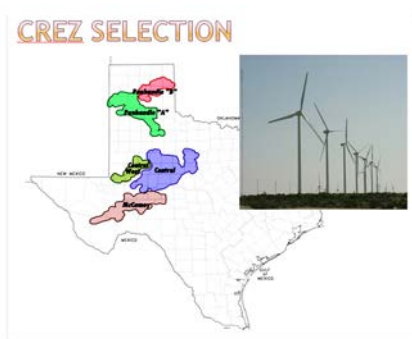

facilities to build. Many of the new transmission facilities require the issuance of certificates of convenience and necessity (CCN) prior to construction, and the PUC adopted a schedule for the filing of the CCNs for the CREZ facilities. As of the end of 2012, the agency has approved 36 CREZ CCNs and denied one. Some of these facilities involve transmission lines that span one hundred miles or more, and large numbers of landowners and local officials have participated in the CCN cases. The CREZ schedule calls for the completion of all CREZ transmission construction by the end of 2013.

PURA §39.904 directs the PUC to consider the level of financial commitment by renewable generators for each CREZ in determining whether to grant a CCN for a transmission project serving that zone. The PUC established five CREZs—three in west Texas and two in the Panhandle—and adopted a plan for major transmission improvements necessary to deliver 18,546 MW of renewable resources from the CREZs to customers in other areas of Texas where the major load centers are located. In December 2008, the PUC selected 14 companies to build and operate the CREZ transmission facilities.

Wind developers expressed a concern that the actual development of wind facilities in the CREZs might exceed the transmission capacity in the plan which could result in severe transmission congestion.<sup>89</sup> To address the overbuilding concern, the PUC amended §25.174(e) to specify the conditions under which it might initiate a proceeding to either limit interconnection to the grid or establish dispatch priorities that would afford preferential access to the transmission system to entities that, among other things, demonstrated financial commitment at an early stage of the proceedings.

To address financial commitment, the rule relies on installed generating capacity, evidence that the construction of new generation has been initiated and signed interconnection agreements as the best measures of renewable generator financial commitment and adopted a test that included these standards to evaluate the wind generators' financial commitment. Based on this test the PUC found that, for the three west Texas CREZs, the amount of renewable generation already developed, the amount of additional renewable generation under development and the renewable capacity represented by signed interconnection agreements demonstrated that sufficient financial commitments had been made for those three zones.

For the two Texas Panhandle CREZs, however, sufficient information concerning financial commitments by renewable generators had not yet been demonstrated because these areas are outside the existing ERCOT transmission grid and have very few existing generation facilities or signed interconnection agreements that can satisfy the test. Because the test could not be met with respect to the two Panhandle CREZs, additional commitments had to be made by renewable generators in the form of collateral postings before the PUC could determine that the CCN filings should proceed. In July 2010, the PUC found that there was sufficient evidence of financial commitment by renewable generators to grant CCNs for transmission facilities to serve the two Panhandles CREZs.<sup>90</sup>

---

<sup>89</sup> *Proceeding to Establish Policy Relating to Excess Development in Competitive Renewable Energy Zones*, Project No. 34577, Order Adopting Amendments to § 25.174 (October 15, 2009).

<sup>90</sup> *Commission Staff's Petition for Determination of Financial Commitment for the Panhandle A and Panhandle B Competitive Renewable Energy Zones*, Project No. 37567, Order (Jul. 30, 2010).

The PUC maintains a separate CREZ monitoring website<sup>91</sup> which provides information about each CREZ transmission project including the name of the transmission service provider (TSP), the region of the state where the project is being built, the date the TSP is filing its application to construct a line and the anticipated in-service date. The website also supplies the public with contact information for PUC and TSP staff familiar with CREZ project activities.

## Distributed Generation

Distributed generation (DG) is any electricity-generating technology installed by a customer or independent electricity producer that is connected at the distribution level of the electric grid. This includes all generation installed on sites owned and operated by utility customers such as solar photovoltaics serving a house or a cogeneration facility serving an office complex. Larger systems installed by developers may also be considered DG if they are connected to the distribution system rather than the transmission system. When a developer does so, he must first ensure that the distribution facilities have adequate capacity to carry the new generation.

Distributed generation systems may be comprised of one or more primary technologies like internal combustion engines, combustion turbines, photovoltaics and batteries. Innumerable combinations of DG technology/fuel options are possible to take advantage of synergies between individual technologies, making them as robust or cost-effective as possible. Most DG systems operate on hydrocarbon fuel to produce electricity as needed. Battery systems store electric energy from the grid for use when needed. Distributed renewable generation (DRG) derives power from wind, water, sun, geothermal or biomass. Just as DG may use more than one technology in a single installation, DRG may use a hybrid of renewable technologies and up to 25% fossil fuels while retaining the renewable classification.

The state of Texas has created a favorable climate for electric customers to employ distributed generation systems. PURA §39.916 requires a utility to allow interconnection of DRG if it has a five-year warranty against breakdown or undue degradation and if the rated capacity of the generation does not exceed the utility service capacity. The utility may not demand that the customer purchase liability insurance he would not already maintain, but it may charge the customer for the differential cost of the meter it must provide. The customer owns the renewable energy credit produced and may request to redeem the credit at any time. The customer must sell his excess energy to his retail electric provider at the cost agreed upon between the REP and the TDU. One important provision that was added during the 82nd legislative session allows customers whose net annual consumption is equal to or greater than the net annual production from registering or being certified as a REP, electric utility or PGC. All

---

<sup>91</sup> [www.texascrezprojects.com](http://www.texascrezprojects.com).

other DRG owners must receive the appropriate approval of the PUC before generating and selling excess electricity.

P.U.C. SUBST. R. 25.211 further details the state's policy on DRG by mandating that:

- ✦ No distribution line or transmission charges will be assessed to the customer for exporting energy to the utility system, except where preempted by federal law;
- ✦ The customer will not be charged for operation and maintenance of the utility's facilities for exporting the energy;
- ✦ An electric cooperative must allow the DRG owner or operator to use transmission and distribution facilities to transmit the electric power to another entity that is acceptable to the owner or operator in accordance with the PUC's open access rules and
- ✦ The utility may disconnect a distributed generation unit from its system only when:
  - ✦ The agreement expires or is terminated;
  - ✦ The generation facility does not comply with the technical requirements in § 25.212 or
  - ✦ Continued interconnection will endanger persons or property in an emergency.

Section 25.211 also requires that each utility file an annual report with the PUC identifying each distributed generation facility interconnected with and disconnected from its system during the prior year. The report must describe the capacity of each facility and the feeder or other point on the system at which the facility is connected. The DG owner is responsible for reporting any change in ownership of the facility and the cessation of operations of a facility within 14 days of such change.





Distributed generation offers the potential to forestall or avoid utility investments in distribution, transmission and generation facilities and improve service to customers. Some forms of DG, especially DRG, are currently not cost-effective absent subsidies or strategic requirements of the customer. Coordinating DG's potential with evolving technologies and using it to strengthen reliability of electric service remains an ongoing challenge, and the potential emergency restoration capabilities of distributed generation resources are still being explored.

Various electric utilities with service areas in central Texas have theorized that DG, including combined heat and power (CHP) systems and renewable generation with battery back-up, could strengthen reliability if grid access were impaired. They note that the degree of improved reliability would be largely dependent on the quantity of the resources. DG resources are currently very limited. One central Texas electric co-op has four 1.8 kilowatt (kW) residential windmill generators on its system and reports interest in larger-scale waste and solar generation though none has progressed past the proposal stage.

Oncor believes that additional DG will help alleviate the amount of load that would have to be served or restored in an emergency but not by much. This would also apply to customers using CHP where customers are serving their own loads. Oncor asserts that most customers with DG capability are using that capability as a back-up for their own loads and that these systems were not designed or intended to pick up load on the utility’s distribution circuits.

AEP North has a few companies and co-ops investigating potential sites for DG as well as CHP. One such company reported that the only DG in its service area was a set of back-up dairy generators, sized to the load to which they are attached. They would not provide parallel operation with the distribution system. AEP Central has no interconnected DG but does see the potential in the support of loads during and after natural disasters.

Existing CHP facilities in the state generally fall into three categories—industry, commercial/institutions and education. There are currently more than 137 CHP sites generating over 16,000 MW.<sup>92</sup> Examples include:

<b>Industrial</b>	<b>Commercial/Institutional</b>	<b>Education</b>
 BP Texas City Refinery	 Baytown Energy Center	 University of Texas, Austin
 Domain Industrial Park	 City of Lubbock	 Texas A&M University
 Shell Chemical Company	 Methodist Hospital, Houston	 Rice University
 Citgo Refining	 UT Health Science Center, Dallas	 Texas Tech University
 Baytown Energy Center	 Dell Children’s Hospital	 Texas State University

Most of the resources that are envisioned as providing energy and capacity in an electrical network are large or utility-scale resources. Smaller-scale, distributed resources at customers’ homes and businesses are now seen as resources that can provide several benefits, economically supplying the customer’s energy needs, enhancing reliability at the home or business and also supporting grid energy needs. Some resources, such as distributed solar energy, are also emission-free energy sources. Texas supports such efforts.

Installing distributed generation typically involves a significant up-front investment for a customer with the expectation that the investment will pay off by reducing the customer’s purchases from its retail provider, whether a utility or a competitive provider. Income tax benefits may be available for DRG to make an investment in such a resource more attractive.

<sup>92</sup> See [www.gulfcoastcleanenergy.org/STATES/Texas/tabid/1348/Default.aspx](http://www.gulfcoastcleanenergy.org/STATES/Texas/tabid/1348/Default.aspx).

Austin Energy, AEP and Oncor have provided incentives to customers to install solar DG, and most have provided incentives for solar DG as a part of their energy efficiency programs.

A number of issues may arise if a homeowner or business intends to install DG to supply a part of the energy needs of the home or business, beyond the cost of buying and installing the facilities, including:

- ✚ Regulatory obstacles such as registration requirements;
- ✚ Difficulty in obtaining approval from the utility that serves the customer to connect the DG facility to the utility delivery system;
- ✚ The cost of special metering facilities that will permit the measurement of energy that is delivered from the customer to the electric network and
- ✚ Lack of opportunity to sell any excess energy that is delivered to the electric network.

## Storage Technologies

In most utility networks, electricity cannot be stored, and energy production must match energy demand within narrow tolerances. Electric energy storage allows the warehousing of electricity for later use. As the electricity industry has developed renewable energy resources that are dependent on environmental forces like solar and wind energy, interest in energy storage has increased. Energy storage could assist in making higher levels of intermittent resources adaptable for use on large electricity networks.<sup>93</sup> Storage could provide the flexibility to adjust energy production or consumption to offset changes in wind and solar power production, allowing energy output and demand to be matched. Storage could also provide an economical means of relieving transmission constraints or meeting demand during peak periods.<sup>94</sup>

### Benefits and Applications

Storage could provide value to an electric network in several ways. It could do more than just balance the variable nature of wind and solar resources. Storage may be able to provide the following benefits.

- ✚ **Energy time-shift:** Electric power produced during off peak periods when prices are low could be stored for later use or sale when demand and prices are high.

---

<sup>93</sup> Testimony of Jon Wellingshoff, Chairman, Federal Energy Regulatory Commission before the Committee on Energy and Natural Resources, United States Senate, Dec. 10, 2009.

<sup>94</sup> Dan Rastler and Haresh Kamath, "Energy Storage: A Critical Asset to Enable Transformation to a Smart Grid" [www.electricenergyonline.com](http://www.electricenergyonline.com) (Aug. 2010).

- ✦ **Peak shaving:** Energy storage could be dispatched to meet times of high peak demand, possibly deferring or reducing the need to invest in new generation capacity.
- ✦ **Ancillary services:** Depending on the particular technology, energy storage has the capability to respond within seconds and to provide power for short or extended periods. It could provide energy to respond to changes in load or production from power plants, offsetting the loss of generation resources or transmission capability.
- ✦ **Transmission support:** Energy storage could improve transmission and distribution performance by compensating for disturbances on the system.
- ✦ **Transmission congestion:** Storage could alleviate congestion by storing energy when there is no congestion and discharging energy during peak demand periods.
- ✦ **Defer transmission and distribution upgrades:** Locating storage in an area where peak electric load is increasing and approaching the system's load carrying capacity could defer or eliminate the need for transmission and distribution upgrades. Backup power from a storage device can also give utilities the option to delay expensive upgrades in areas prone to loss of service.
- ✦ **Reliable power:** Storage could be used to provide highly reliable power. In the event of an outage, storage could be used to meet customers' needs for the duration of the outage, to facilitate an orderly shutdown process or to transfer power to on-site resources.<sup>95</sup>
- ✦ **Power quality:** Energy storage could quickly provide power to address voltage and frequency variations to protect customers' equipment from fluctuations in power quality.<sup>96</sup>

Although storage costs are higher than other traditional energy options, costs appear to be heading down. By performing several functions, energy storage may soon be a viable economic option for utility-scale applications.

## Barriers

The hurdles facing storage technology are the lack of industry experience in using it in a high voltage alternating current network and its cost. There is currently little information to guide industry and regulators concerning how to define storage devices and develop operational standards and compensation. While storage is capable of providing multiple services, it is difficult to assign it a role in a competitive environment in which utilities have been unbundled. Issues relating to cross-subsidization, competition and discrimination could arise if storage participated in multiple roles or functions at the same time. Requiring a storage facility not to perform some of the functions of which it is capable could address these concerns, but the result could be underutilizing storage devices or rendering them uneconomical.

---

<sup>95</sup> Sandia National Laboratories, *Energy Storage for the Electricity Grid: Benefits and Market Potential Assessment Guide*, xv, xvi (Feb. 2010).

<sup>96</sup> Challenges of Electricity Storage Technologies, APS Panel on Public Affairs, 8 (May 2007).

## Technology

Different storage technologies have different characteristics. Two important characteristics are the amount of energy that the storage device may deliver and the duration it is able to deliver energy. Currently three main types of energy storage are receiving most of the focus in the energy storage field: compressed air storage (CAES), batteries, especially Lithium-ion and Sodium-sulfur (NaS), and flywheels. Figure 27 shows the system ratings for several of the most common energy storage technologies.<sup>97</sup>

Figure 28: System ratings

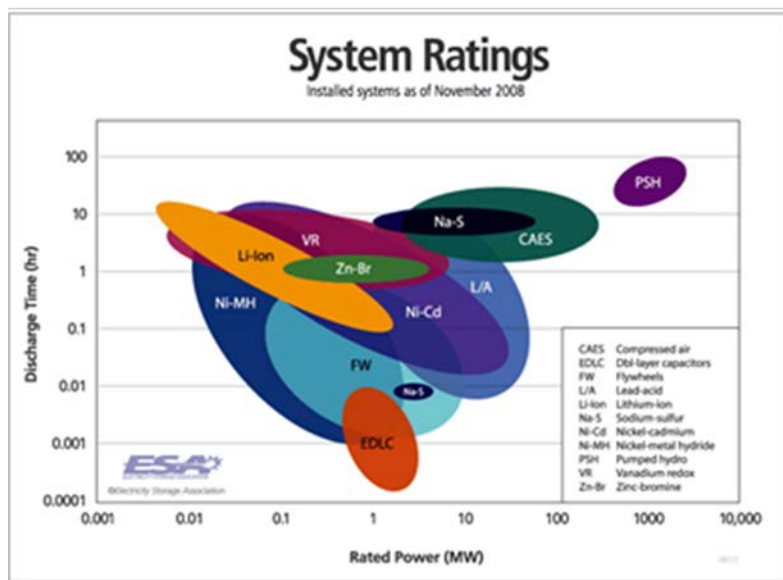

CAES is a proven bulk storage technology capable of a discharge lasting eight to ten hours. In this technology, air is compressed and stored in underground reservoirs such as caverns or salt domes. As demand rises, the stored air is released through a natural gas turbine to produce electricity or is used in a combustion turbine. (Pressurizing the air is like putting a turbocharger on a combustion engine, increasing the output of the turbine.) Texas is well suited for a future CAES system. Salt domes are common and could be used to store off peak wind energy for later use when demand is high.

NaS battery storage systems have a successful operating history worldwide and in Texas. The NaS battery uses molten sodium and sulfur. It has high energy density (the amount of energy that can be stored in a given volume or mass), efficiency and long cycle life and can discharge up to eight hours if needed. NaS batteries offer the power and energy required for a variety of utility power system applications including voltage control, reactive power support, back-up power and deferring grid investment. Like CAES, these batteries can also be used to store excess wind power when demand is low and discharge it later to meet peak demand.

<sup>97</sup> Electricity Storage Association, [www.electricitystorage.org/ESA/technologies/](http://www.electricitystorage.org/ESA/technologies/).



Lithium-ion batteries, commonly used in laptop computers, and lithium polymer, a similar technology, are being investigated for use in electric vehicles. Utility-level applications are emerging as research yields improvements that focus on energy density, durability, cost and safety.

A flywheel is a mechanical battery with a wheel that spins at a high rate. When energy is needed, the flywheel can be used to provide the mechanical energy to drive a generator, but it typically has a short sustainable output period (about 15 minutes). They are presently being considered for use for load following (regulation) services.

## Texas Policy

The past several years have seen increased interest in energy storage technologies and the potential benefits energy storage can provide in Texas. Energy storage captures energy during times of peak demand. Integrating this regulation ability and the ability to shift the time of dispatch could permit ERCOT to maximize the output potential of renewable generation and other low-cost resources for a more diverse portfolio. It could promote grid reliability, potentially lowering costs to ratepayers.

Under Project Number 39764, *Issues Relating to Energy Storage and Emerging Technologies*, the PUC considered ways to facilitate the appropriate deployment of energy storage facilities in ERCOT. In October 2011, the PUC held a workshop on issues such as the settlement of energy drawn from the system at the point of withdrawal, treatment of station power, ancillary service cost allocation and the value of a rule allowing ERCOT to establish pilot projects for storage facilities and other new technologies. Three rules emanated from what was learned.

- ✚ **Project 39657, *Rulemaking to Implement SB 943, Relating to Electric Energy Storage Equipment or Facilities*:** In November 2011, the PUC adopted amendments to §25.5, Definitions, and §25.109, Registration of Power Generation Companies and Self-Generators. The amendments added references to energy storage equipment and facilities as required by Senate Bill 943, passed in 2011. This rule included electric energy storage equipment or facilities under the definition of a power generation company and clarified the interconnection details.
- ✚ **Project 39917, *Rulemaking on Energy Storage Issues*:** In March 2012, the PUC adopted amendments to §25.192, Transmission Service Rates, and §25.501, Wholesale Market Design for ERCOT. The amendments require that energy storage equipment or facilities be settled at the node when charging and that such transactions be considered wholesale transactions, not subject to ancillary or transmission costs.

ERCOT protocols permit generators to be compensated for energy on a nodal pricing basis while loads pay for energy on a zonal basis. The nodal price, or the price of energy for any specific location, will change based on grid congestion. The zonal price is the average price

of the nodes within a particular zone. There are currently four zones in ERCOT. While energy storage acts as a load when it withdraws energy, the storage facility does not ultimately consume this energy but uses it for regeneration later. The PUC therefore sought to treat storage load at the nodal price instead of the zonal price which is applied to end-use consumption. The difference between nodal and zonal pricing could have diminished the economic efficiency with regard to the location and operation of storage technologies. Applying the nodal price to storage load would offer a locational signal for the efficient siting and economical operation of storage facilities.

The PUC recognized that a distinction of wholesale load for storage devices was reasonable where a storage device, regardless of the specific technology, takes power from the grid, converts it to potential energy and at a more opportune time transforms this potential energy back into electric energy which is returned to the grid (less conversion losses). Storage devices thus differ fundamentally from other loads in that the power taken from the grid is not consumed in the manufacturing of goods or the provision of services. In this respect, there is a clear distinction between storage assets and other types of load when taking energy from the grid. During the rulemaking, it became evident that the concept of an ERCOT pilot project should be investigated but that it deserved specific attention apart from the energy storage rule, so it was carved out of the rulemaking.

- ✚ **Project 40150, PUC Rulemaking Concerning an ERCOT Pilot Project:** In May 2012, the PUC adopted amendments to §25.361 that would give ERCOT the authority to conduct pilot projects and allow ERCOT to grant temporary exceptions from ERCOT rules to effectuate the projects. The rule is intended to give ERCOT better knowledge, understanding and comfort with new technologies and services. ERCOT can use the results to make changes to its protocols and rules.

## Deployment in Texas

In August 2008, Electric Transmission Texas (ETT) filed an application for regulatory approvals relating to installation of a sodium battery in Presidio, Texas.<sup>98</sup> The battery is intended to improve transmission reliability in Presidio and the surrounding areas where there have been several electrical outages and poor voltage service events. On March 31, 2010, ETT's four-MW NaS sodium sulfur battery system was energized to the ERCOT grid. Figure 28 shows the battery itself, and Figure 29 is a photograph of the building that houses the Presidio battery.<sup>99</sup> The battery is the first large-scale installation in ERCOT and the largest in the United States. This NaS battery allowed the utility to defer the planned replacement of a 69 kV transmission line that is the sole source of electricity for the town. ETT expects the battery to allow for more

---

<sup>98</sup> *Application of Electric Transmission Texas, LLC for Regulatory Approvals Related to Installation of Sodium Sulfur Battery at Presidio, Texas*, Docket No. 35994 (Aug. 12, 2008).

<sup>99</sup> Photos courtesy of Electric Transmission Texas LLC.

continuous service to the Presidio area, better response to voltage fluctuations and momentary outages and the ability to repair the transmission line to the area without disrupting service.<sup>100</sup>



Figure 29: Presidio battery



Figure 30: Building housing Presidio battery

When the utility sought PUC approval of the Presidio battery, issues concerning ownership and control of energy storage systems were raised. The PUC ruled that “ETT’s proposed use of the NaS battery is appropriate for a transmission utility because the battery system provides benefits associated with transmission service operations, including voltage control, reactive power and enhanced reliability.”<sup>101</sup>

## American Recovery and Reinvestment Act Funding

Recently the US Department of Energy increased funding for storage projects. In 2010, the DOE granted \$185 million in American Recovery and Reinvestment Act (ARRA) funds for Energy Storage Demonstration projects in order to show the effectiveness of a range of technologies, applications and deployment structures.<sup>102</sup> \$435 million in funding was made available for Smart Grid Regional Demonstrations, of which \$118 million will utilize energy storage.<sup>103</sup> The DOE directed \$2.4 billion in ARRA funding to promote advanced battery technology and electric-drive components. The goal is to reestablish US battery manufacturing, reduce battery cost and improve performance.<sup>104</sup>

ARRA funding has quickened the pace of research and development in energy storage technologies, drawing not only the participant’s matching funds but intense venture capital

<sup>100</sup> *Application of Electric Transmission Texas, LLC for Regulatory Approvals Related to Installation of Sodium Sulfur Battery at Presidio, Texas*, Docket No. 35994 (Aug. 12, 2008).

<sup>101</sup> *Application of Electric Transmission Texas, LLC for Regulatory Approvals Related to Installation of a Sodium Sulfur Battery at Presidio, Texas*, Docket No. 35994, Final order, pp. 3-4 (Apr. 6, 2009).

<sup>102</sup> Pike Research, David Link and Clint Wheelock, *Executive Summary: Energy Storage on the Grid* (3Q 2010).

<sup>103</sup> *Id.*

<sup>104</sup> “Through ARRA, DOE trying to re-establish US battery manufacturing,” <http://www.smartgridtoday.com> (May 13, 2010).

interest as well. Due to energy storage's ability to perform a variety of applications, the world market for energy storage could grow from \$1.5 billion in 2010 to an estimated \$35 billion in the next ten years. Much of this growth is expected to be driven by demand by the United States.<sup>105</sup>

---

<sup>105</sup> Pike Research, David Link and Clint Wheelock, *Executive Summary: Energy Storage on the Grid* (3Q 2010).

The PUC has aggressively met recent challenges presented by dramatic shifts in energy resources, technological advances and economic, societal and political dynamics. The agency has been working closely with stakeholders on a variety of fronts to give the industry the flexibility it needs to break new ground while simultaneously tending to the grid's growing pains and maintaining reliability. Some of these issues are described in this section.

### Smart Grid

#### Texas Policy

In 2005, the 79th Legislature passed HB 2129 to encourage the implementation of smart metering by directing the PUC to establish a nonbypassable surcharge for a utility to recover reasonable and necessary costs incurred in deploying advanced metering and metering information networks. Although HB 2129 did not require that smart meters be deployed by utilities in Texas, the intent was quite clear:

In recognition that advances in digital and communications equipment and technologies have the potential to increase the reliability of the regional electrical network, encourage dynamic pricing and demand response, make better use of generation assets and transmission and generation assets, and provide more choices for consumers, the legislature encourages the adoption of these technologies by electric utilities in this state.<sup>106</sup>

In 2007, the 80th Legislature reiterated this encouragement when it stated in HB 3693:

It is the intent of the legislature that net metering and advanced meter information networks be deployed as rapidly as possible to allow customers to better manage energy use and control costs and to facilitate demand response initiatives.<sup>107</sup>

Pursuant to HB 2129, the PUC adopted §25.130 that addresses: (1) the minimum functionality to qualify for a cost recovery surcharge; (2) the process for an electric utility to notify the PUC and REPs of the deployment of smart metering and (3) the cost recovery surcharge for AMI deployment.

---

<sup>106</sup> HB 2129 § 8(a), 79th Leg. R.S.

<sup>107</sup> HB 3693 § 20(i), 80th Leg. R.S.

Under §25.130, deployment of AMI by a utility is voluntary. The rule takes a flexible approach to AMI deployment in order to accommodate future innovations. The PUC concluded that a comprehensive set of AMI functions was necessary to achieve the benefits in HB 2129. Standardization of capabilities across ERCOT is also extremely important for REPs offering products to customers in multiple utility territories. Therefore, AMI deployed by a utility pursuant to §25.130(g)(1) must support the following functions:

- ✚ Automated meter reading;
- ✚ Two-way communications;
- ✚ Remote disconnection and reconnection capability;
- ✚ The capability to time-stamp meter data sent to ERCOT or a regional transmission organization for purposes of wholesale settlement;
- ✚ The capability to provide direct, real-time access to customer usage data to the customer and customer's REP;
- ✚ Means by which the REP can provide price signals to the customer;
- ✚ The capability to provide 15-minute data or shorter interval data to REPs, customers and ERCOT or a regional transmission organization;
- ✚ On-board meter storage of meter data that complies with nationally recognized non-proprietary standards such as ANSI C12.22;
- ✚ Capability to communicate with devices inside the premises including usage monitoring devices, load control devices and prepayment systems through a HAN based on open standards and protocols that comply with nationally recognized non-proprietary standards such as ZigBee, Home-Plug or the equivalent and
- ✚ The ability to upgrade these minimum capabilities as technology advances and they become economically feasible.

The rule includes requirements for access to meter data, the deployment plan filed by the utility and provisions for cost recovery. Since the rule was adopted in May 2007, the PUC has worked closely with utilities, REPs, consumer groups, ERCOT and other stakeholders to implement it.

HB 2129 states that the customer owns meter data.

All meter data, including all data generated, provided, or otherwise made available, by advanced meters and meter information networks, shall belong to a

customer, including data used to calculate charges for service, historical load data, and any other proprietary customer information.<sup>108</sup>

As AMI is deployed, customers will neither be assessed a fee nor be required to obtain permission to view their data. Currently, customers that have a smart meter and a HAN device installed may view their consumption data in real-time. HAN devices that show electrical usage may be purchased by the customer or may be provided by REPs or other third parties.

Since 2009, ERCOT, in compliance with the PUC's rule and HB 2129, has revised its settlement process. In late 2009, ERCOT implemented a new settlement solution that settles load entities' energy and capacity market obligations with usage data based on 15-minute intervals for customers equipped with advance meters. This provides significant benefits to both the customer and the REP. Settling on the basis of a customer's usage data in 15-minute intervals provides a more accurate settlement for REPs and allows them to design innovative pricing products including products that provide time-differentiated price signals. With increased visibility to both their usage patterns and time-differentiated price signals, customers may participate in demand response programs to shift load to off-peak, less costly hours or install more efficient appliances to reduce consumption, particularly peak-period consumption.

Fifteen-minute consumption data is now available in a centralized or common web portal called Smart Meter Texas (Figure 30) and may be accessed by customers, REPs and ERCOT. This means customers with an advanced meter in the Texas New Mexico Power (TNMP), AEP Texas, Oncor or CenterPoint utility footprint can go to the same website for their consumption information. This web portal, shared jointly by these utilities, was launched in the spring of 2010 and is ADA compliant. Customers can see their usage data in 15-minute increments and can connect an in-home device (IHD) or home area network (HAN) device to their meter through this web site. It is a tool for REPs to send signals to their customers with devices inside the home, provided those customers elect to receive those signals. This initiative was a huge undertaking as it provides a central clearinghouse of information for all the TDUs in ERCOT to provide information and tools to customers with a smart meter. This is the only web tool of its kind in the United States.

---

<sup>108</sup> PURA § 39.107(b) (2011).

Figure 31: SmartMeterTexas.com portal

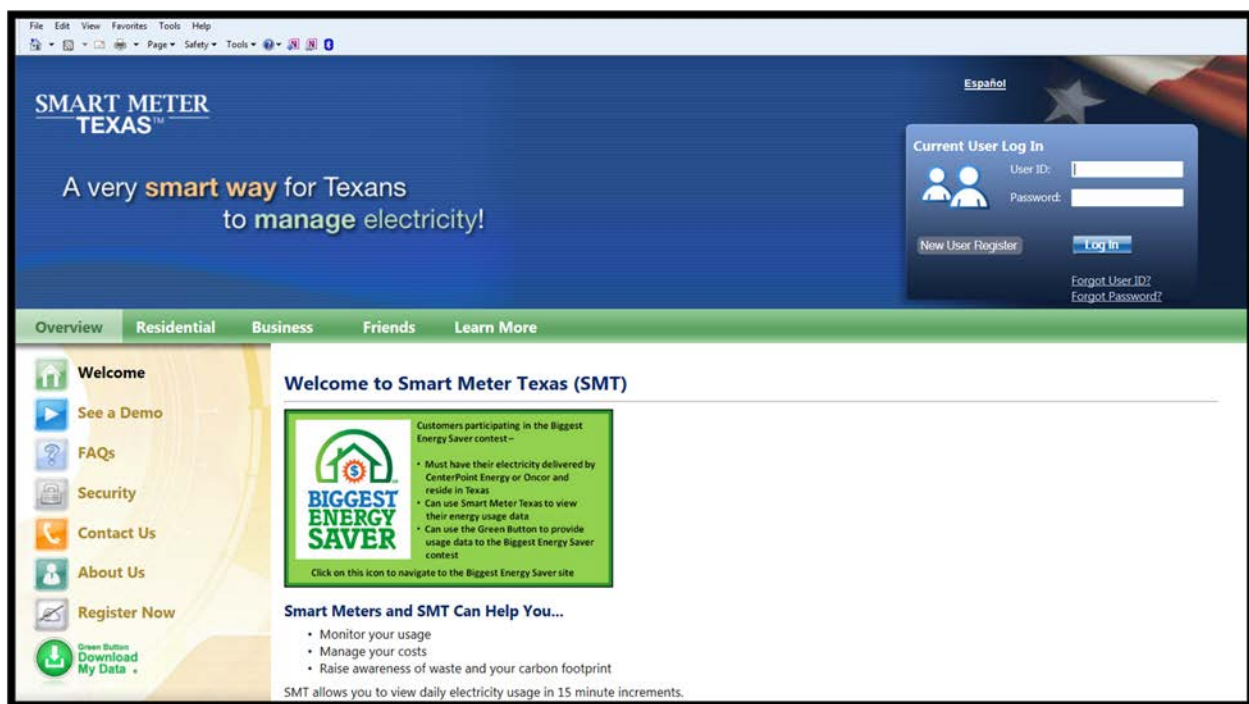

The installation of smart meters and associated systems is a building block to achieving significant improvements in customer service and lower costs. To fully realize the benefits of advanced metering systems (AMS), REPs and customers will need access to information that shows how much electricity the customers use and when they use it. The smart meters record this information, and a web site funded by the largest of the investor-owned utilities in ERCOT is making this information available to REPs and customers. Already, utilities are able to carry out customers' service orders to initiate or terminate service or switch to a different REP very quickly for customers with smart meters. REPs are beginning to offer service plans with rates that vary by time of day to reflect the price variations in the wholesale electricity market. Customers who elect such plans may be able to reduce their consumption in periods of high prices, thereby reducing their electricity costs.

Another benefit of smart meters is the ability of utilities to reduce outage times for customers when events occur that interrupt their electric service. The communications capability of smart meters gives utilities the ability to send a message to a meter and receive a response that indicates whether a customer has service at the home or business. Utilities are developing systems to incorporate this capability into their service restoration procedures. This capability should facilitate identifying the extent of an outage and planning the efficient restoration of service. The result will be quicker restoration of service in the case of equipment failures that result in loss of service for dozens of customers following a thunderstorm or equipment failure or loss of service for thousands of customers following a hurricane or tropical storm. Smart meters also automate meter reading, reducing the cost of electric delivery service and will



facilitate increased automation of the distribution system so that restoring service after some outages will be achieved without dispatching a service crew.

IOUs in Texas have installed nearly six million smart meters, but smart meters are not exclusively a Texas phenomenon. It is anticipated that 50 million smart meters will be in place in the US by 2015.<sup>109</sup> Legislation at the federal level has also addressed modernizing electricity infrastructure. The Energy Independence and Security Act of 2007 adopted a policy to “support the modernization of the Nation’s electricity transmission and distribution system to maintain a reliable and secure electricity infrastructure that can meet the future demand growth.” One of the key benefits envisioned from smart meters is that by giving customers better information about their consumption and retail rates that reflect wholesale costs, customer demand will be reduced as customers become more efficient in their use of electricity and shift consumption to lower cost hours, thus reducing the need for investment in new peak capacity.

## Smart Meters and the Smart Grid

Until the recent deployment of smart meters, most of the residential meters serving customers in the United States were simple electromechanical devices whose single function is to measure energy in kilowatt-hours consumed by the customer. This technology, developed in the late 1800s, predates the rotary phone. Change is underway to replace this aging technology with new smart meters.

Advanced meters or “smart” meters are digital devices that measure consumption and provide real-time feedback to customers on their electric usage. These meters have both information storage and continuously available, remote, two-way communication capability. This is in stark contrast to the aging electromechanical technology that must be individually read by utility personnel. With electromechanical meters, customers’ only feedback on their electric usage comes from their monthly bill.

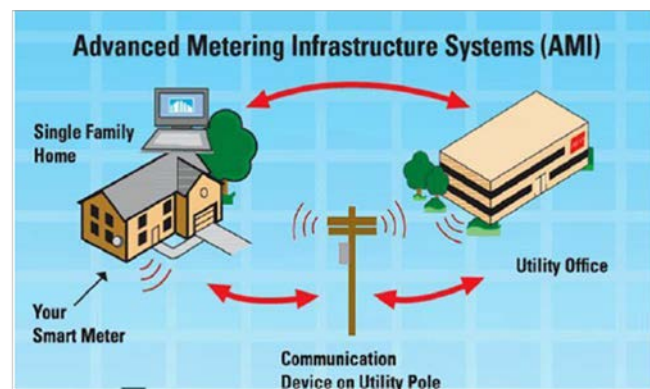

Figure 32: AMI/AMS System

<sup>109</sup> *A National Assessment of Demand Response Potential*, Staff Report, Federal Energy Regulatory Commission, 230 (Jun. 2009). A statement by Patricia Hoffman, Acting Assistant Secretary for Electricity Delivery and Energy Reliability, US Department of Energy to the Subcommittee on Energy and Environment, Committee on Science and Technology, July 23, 2009.

Smart meters are an integral part of a utility's advanced metering infrastructure (AMI or AMS). AMI refers to the entire measurement and collection system, which includes smart meters at the customer site, the associated hardware, software and back office communications systems and meter information networks for validating and processing meter information. Figure 31 illustrates the components.<sup>110</sup> Since the passage of HB 2129 by the 79th Legislature, advanced metering technology has matured, and AMI has become more sophisticated and cost effective.

AMI is an essential component of building a smart electricity grid.<sup>111</sup> The smart grid is much more than just smart meters. It is an efficient, dynamic and more resilient electrical and communications delivery system. Like the telecom and Internet revolutions, technology holds the key to the smart grid and its benefits. The smart grid and the technologies embodied within it are an essential set of investments that will help bring our electric grid into the 21st century using megabytes of data to move megawatts of electricity more efficiently, reliably and affordably. The electric system of today will move from a centralized, producer-controlled network to a less centralized, more consumer-interactive, more environmentally responsive model. The benefits will encompass the broad areas of reliability, power quality, health and safety, national security, economic vitality, efficiency and environmental impact.

**Figure 33: Oncor smart meter**



Smart meters are expected to provide information to a distribution utility that will help it determine the scope of an outage and expedite the restoration of service. They are also expected to foster customers' elective participation in demand response programs that will reduce demand when wholesale prices are high or the electrical system is stressed. The system will provide better real time information for grid operators about the status of the transmission lines which should permit the transmission system to operate at higher loadings and permit less expensive generating units to operate when conventional grid management procedures would indicate that the system is congested.

A smart grid relies on the accurate, up-to-date and predictable delivery of data between the customer and the utility. AMI is one of the conduits by which this information is exchanged. AMI enables operational benefits and efficiencies for utilities and provides data collection and support for demand response and energy efficient behavior by consumers. Smart meters record electricity consumption at predetermined intervals such as hourly, 30-minute, 15-minute or shorter as required. The meters then store and transmit the data through a secure network to utilities.

<sup>110</sup> Navigant Consulting, *Evaluation of Advanced Metering System (AMS) Deployment in Texas* (Jul. 30, 2010).

<sup>111</sup> Jeffrey D. Taft, *AMI: Smart Enough?*, *Public Utilities Fortnightly*, 55 (Jun. 2009).

The data recording and communications functions of AMI allow utilities to effectively meet business and operational requirements for accurate collection of consumption data by interval and for the billing period. Examples of the operational efficiencies AMI provides to utilities include remote meter readings and remote disconnection and reconnection of service. The bi-directional communications capability of AMI allows utilities to quickly and accurately pinpoint where outages have occurred. Outage information sent from smart meters allows the utility to determine the extent of an outage and isolate the location of the damage, in some cases right down to the piece of equipment causing the outage. In some outages, some customers will be returned to service quickly and without the dispatch of a repair crew. Not having to search for the location of the problem should reduce the duration of an outage for all affected customers. This feature will allow utilities to recover from major, widespread outages caused by hurricanes or other weather events more quickly than prior to deployment of AMI.

AMI provides customers with real-time feedback allowing them to better understand their energy consumption, make more informed choices about energy use and conservation and participate in demand response programs. Two-way communication gives AMI the capability to transmit real-time prices and consumption data between the customer, the REP and the utility and provides information that a customer can act on, if he chooses. To deliver AMI's full benefits to Texans, economic signals must be delivered to the retail customer in the form of prices that are differentiated by time of day, either as time-of-use prices that are based on price trends in the wholesale market or as real-time prices that are based on real-time wholesale prices. FERC has defined demand response as a "reduction in the consumption of electric energy by customers from expected consumption in response to an increase in the price of electric energy or to incentive payments designed to induce lower consumption of electric energy."<sup>112</sup>

Demand for electricity varies with time. To meet this demand, generation units with varying efficiencies and fuel sources are used to insure that adequate electricity is constantly available to customers. Some generating units are expected to run most of the year, and these entities typically have low fuel costs but high capital costs. Adequate generation capacity to serve peak demand must be maintained at all times. Certain generation units, due to their high fuel costs, operate during a relatively few hours per year when demand for electricity is the highest. These units characteristically have a low capital cost but high fuel cost. For this reason, the cost of service to customers is higher during peak hours than at other times.

Today's flat rates are average rates that do not directly reflect the time varying change in demand and real cost to serve customers. These rates mask the real cost to serve a customer at a particular time. As a result, there is no incentive on the customer's part to reduce or shift consumption during peak demand since the customers are not directly charged for the high cost of electricity during these hours. In a competitive market, flat rates include a premium

---

<sup>112</sup> See Order 719, 73 Fed. Reg. 64,100.

that reflects the risk that a retail provider bears in offering a flat, fixed retail rate in the face of wholesale prices that are not known and will fluctuate. This premium compensates service providers who must absorb the cost of hedging the uncertainty associated with volatile wholesale prices.<sup>113</sup>

Dynamic pricing (either time-of-use or real-time pricing) exposes retail customers who choose to participate in the pricing program to some of the volatility of wholesale prices. Prices are higher during peak periods to reflect the higher cost of providing electricity during those times and lower during off peak when it costs less to provide electricity. As a result, these customers have an incentive to reduce their consumption during peak periods when prices are expected to be high. Customers may reduce demand by installing more efficient equipment, by participating in a demand response program or simply by deciding to turn off appliances when retail prices are high. Demand flattens over time as customers reduce consumption or shift it to off peak hours, thereby reducing the need for investments in peaking generators. This demand response behavior is expected to lead to a lower clearing price for electricity.

Demand response through dynamic pricing is expected to be more effective when customers have ready access to price and consumption information through a mobile communications device or an IHD that communicates with the meter through a HAN. These small household devices provide real time energy consumption and can relay price signals based on the pricing plan the customer has elected. When used in conjunction with smart appliances, the demand response benefits are magnified even further. Customers can easily set preferences to control a smart appliance such as a programmable thermostat to respond to price signals and other electric power system conditions. AMI will enable customers to better understand their energy consumption and will provide the visibility customers need to make a demand response decision. It will be up to the customer or the customer's agent to make time-differentiated pricing plans and demand response programs available that will give customers the tools to act on the information received. The customer's agent could be the REP offering an innovative rate plan or demand response program or a third party offering a demand response program.

AMI is the cornerstone of a smart grid. A smart grid is an efficient, dynamic and more resilient electrical and communications delivery system. FERC Chairman Jon Wellinghoff summarized the smart grid this way: "the smart grid is best defined as providing consumers the opportunity to communicate with and participate in the electric system in ways that can control their costs."<sup>114</sup> A recent DOE assessment concluded that part of the vision for a smart grid is to make customers an integral part of the electric power system by enabling them to make informed decisions regarding their energy usage. By enabling informed participation through a bi-

---

<sup>113</sup> Rick Morgan, *Rethinking Dumb Rates*, Public Utilities Fortnightly, 35-37 (Mar. 2009). In theory, customers who take on the added risk of price volatility associated with dynamic pricing should be relieved of the burden of a hedge premium since service providers are not incurring those costs.

<sup>114</sup> *Smart Grid Heavy Hitters Series*, Green Monk (Apr. 15, 2010).

directional flow of both energy and information that allows customers to modify the way they use and purchase electricity, a smart grid helps balance supply and demand and increase system reliability.<sup>115</sup>

The creation of a smart grid is not a single event but occurs over time with AMI deployment and other upgrades and improvements to utilities' transmission and distribution systems. Working in conjunction with the National Energy Technology Laboratory (NETL), electric grid stakeholders representing utilities, technology providers, researchers, policymakers and customers have defined the following functions or attributes of a smart grid:

- ✚ Self-healing from power disturbance events;
- ✚ Enabling active participation by consumers in demand response;
- ✚ Operating resiliently against physical and cyber-attack;
- ✚ Providing power quality for 21st century needs;
- ✚ Accommodating all generation and storage options;
- ✚ Enabling new products, services and markets and
- ✚ Optimizing assets and operating efficiently.

As technology solutions are deployed that enable a smart grid to attain these attributes, a variety of far-reaching benefits follow. Benefits flow from the broad areas of reliability, power quality, health and safety, national security, economic vitality, efficiency and environmental impact. Some specific benefits include:

- ✚ Increased security and durability in response to attacks or natural disasters;
- ✚ Reduction in restoration time and reduced operation and maintenance costs due to better information about customers without service and the integration of predictive analytics, self-diagnosis and self-healing technologies;
- ✚ More efficient transmission and generation of electricity;
- ✚ Reduction in transmission congestion costs, leading to more efficient electricity markets;
- ✚ Improved power quality and reliability;
- ✚ Environmental benefits gained by more efficient grid operation;
- ✚ Increased capital investment efficiency due to tighter design limits and optimized use of grid assets;
- ✚ Increased integration of distributed generation and renewable energy;

---

<sup>115</sup> Statement of Patricia Hoffman, Acting Assistant Secretary for Electricity Delivery and Energy Reliability, US Department of Energy, Report to Subcommittee on Energy and Environment Committee on Science and Technology, US House of Representatives (Jul. 23, 2009).

- ✚ Higher transmission and distribution capacity utilization;
- ✚ Reduced peak demand and
- ✚ Improved US competitiveness resulting in lower prices for US goods and greater job creation.<sup>116</sup>

## Implementation of Smart Meters and Advanced Systems

The four large IOUs in ERCOT, CenterPoint, Oncor, AEP Texas and TNMP, have received approval from the PUC to deploy.

### Comparison of Deployments in ERCOT

	CenterPoint	Oncor	AEP TCC*	AEP TNC**	TNMP
Approximate meters deployed (total)	2 million	3 million	809,000	193,000	200,000
Completion of deployment	Complete	End of 2012	End of 2013	End of 2013	End of 2016
Total estimated savings	\$120.6 million	\$176 million	\$89.2 million	\$32.6 million	\$19.3 million
Estimated customer education expense	\$5.6 million	\$15.1 million	\$4 million	\$1 million	\$1.95 million
Residential surcharge amount (per month)	\$3.05	\$2.19	\$2.26	\$2.35	\$3.40

\* AEP TCC residential surcharge is \$3.15 during the first two years, \$2.89 during the next two years and \$2.26 for the remainder of the surcharge period.

\*\*AEP TNC Residential surcharge is \$3.15 for the first two years, \$2.27 during the next two years and \$2.35 for the remainder of the surcharge period.

## Industry Trends

### ***Reliance on Demand Response***

Demand response refers to the ability of customers to alter their normal consumption patterns in response to changes in the price of electricity or incentive payments designed to induce lower electricity use when prices are high or when system reliability is in jeopardy. Since electricity cannot be stored and has to be consumed instantly and because generation plants of varying efficiency are used to meet demand, the price of power varies by time of day, day of the week and season.

<sup>116</sup> National Energy Technology Laboratory, *Understanding the Benefits of the Smart Grid* (Jun. 18, 2010).

There are two types of demand response. Dispatchable demand response refers to planned changes to consumption that a customer agrees to make when directed by a program operator. This includes direct load control (DLC) of a customer's electrical equipment such as an air conditioner or water heater and larger-scale interruptible load programs for commercial (these programs are administered by the TDUs) and industrial (managed by ERCOT) customers who agree to reduce demand when requested to do so. DLC programs have been in place for decades. Historically, DLC has been used almost entirely as a reliability resource by utilities. The use of DLC as an economic resource, operating in conjunction with price responsive demand, is also expected to be available with smart meters. According to FERC:

The Smart Grid concept envisions a power system architecture that permits two-way communication between the grid and essentially all devices that connect to it, ultimately all the way down to large consumer appliances...Once that is achieved, a significant proportion of electric load could become an important resource to the electric system, able to respond automatically to customer-selected price or dispatch signals delivered over the Smart Grid infrastructure without significant degradation of service quality.<sup>117</sup>

Nondispatchable demand response occurs when the customer is no longer a passive consumer but chooses whether and when to consume, based on a retail rate that changes over time. These time-differentiated pricing programs reflect the variable cost of electricity and charge higher prices during peak demand hours and lower prices for other hours of the year.<sup>118</sup> The National Assessment of Demand Response Potential, released by FERC in June 2009, found that the existing operational demand response programs in the United States have the capacity to offset four percent of current US peak demand.<sup>119</sup> Most of the demand response programs operating today are driven by reliability concerns and involve either direct load control of residential loads or interruptible rates for large commercial and industrial customers. Nationwide, there is substantial geographic variation in the amount of demand response programs offered. If the current level of demand response were to expand to include areas with little or no demand response and customer participation were to reach levels representing today's best industry practices, the capacity to offset US peak demand could rise to nine percent.

The FERC assessment found that price-driven demand response such as dynamic pricing enabled by the deployment of AMI holds the greatest potential for peak load reductions. Dynamic pricing has very little market penetration today. In 35 of the 50 states, dynamic pricing currently has no impact. In the remainder of the states, the impact is minimal.

---

<sup>117</sup> Smart Grid Policy, 126 FERC ¶ 61,253, at P19 and n.23 (2009).

<sup>118</sup> *National Action Plan on Demand Response*, The Federal Energy Regulatory Commission Staff, Docket No. AD09-10 (Jun. 17, 2010).

<sup>119</sup> *A National Assessment of Demand Response Potential Staff Report*, Federal Energy Regulatory Commission (Jun. 2009).

Depending on how dynamic pricing is deployed, peak demand could be offset by 14% to 20%. Texas was identified as having the most potential for demand response as shown in Figure 33.<sup>120</sup>

Currently, Texas has very little demand response in place. Most of the demand response is motivated by system reliability concerns and comes from the large commercial and industrial sector. Existing demand response includes interruptible tariffs, load management programs as part of the state's energy efficiency programs and other demand response programs available in the

**Figure 34: > 18 GW of demand response potential in Texas by 2019**

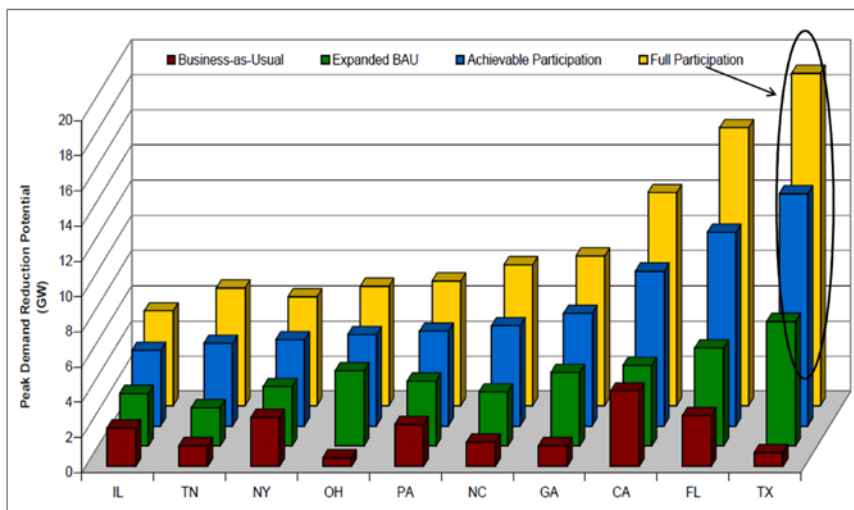

ERCOT market. DLC in the residential and small commercial sectors represents a very small portion of Texas' demand response. Demand response programs that rely on dynamic pricing or TOU rates are only just beginning to be offered in the state.

Texas has much to gain from increasing participation in demand response programs. Benefits to utilities, ERCOT and customers include reducing the need for expensive peaking capacity, improving system reliability and lowering power costs. REPs also have much to gain as they embrace demand response programs that can offer both competitive pricing and products to their customers and reduced exposure to price uncertainty because they can match their purchases in the wholesale market to their customers' demand with greater accuracy.

Texas leads the nation in energy consumption. In 2011, Texas' system peak demand was 68,369 MW, far exceeding system peak demand in any other state. This high system peak demand is due in large part to the state's robust industrial sector, high population and higher than average residential central air conditioning usage. Texas is uniquely positioned to increase demand response. The key drivers of the potential in Texas include the fact that very little demand response currently exists; the state has a higher than average saturation of residential air conditioning and AMI deployment leads the national average.

<sup>120</sup> FERC National Assessment of Demand Response, 42.



## ***Infrastructure Investment***

Evidence of the nation's economic downturn that began in late 2007 is still visible in the energy markets. Total electrical generation dropped by one percent in 2008 followed by a drop of three percent in 2009. Although other factors such as mild weather contributed to this decrease, it was the first time in 60 years since the US Energy Information Administration (EIA) began tracking this data that electricity use fell in two consecutive years.<sup>121</sup> Texas fared better than the rest of the nation. In 2008, electricity use increased by 1.7% and dropped only 1.3% in 2009.<sup>122</sup> History shows that in the short-term, demand for electricity fluctuates in response to business cycles and weather. The EIA expects demand for electricity to grow by an average of one percent per year through 2035 in response to both projected economic and population growth. ERCOT expects economic recovery in Texas to result in a one percent growth in demand in the short-term, rising to three percent around 2012 or 2013.

Demand for electricity continues to increase in Texas as economic development and continued population growth spurs growth in the Texas economy. Since growth in demand for all types of energy is on an upward trend, some analysts believe that the energy industry needs to prepare for a period of much higher capital expenditures.<sup>123</sup> This results from a confluence of factors:

- ✚ Shrinking generation reserve margins as the glut of surplus capacity from earlier in the decade decreases;
- ✚ Increased spending on pollution controls, especially to comply with nitrogen oxide, sulfur and mercury requirements;
- ✚ The perception that the federal government will enact carbon legislation;
- ✚ The need to replace aging transmission and distribution infrastructure, much of which was put in place 30-40 years ago and is nearing the end of its design life;
- ✚ Continued robust rates of population growth and economic growth in many parts of the United States, resulting in the need for system expansion and
- ✚ Technology spending on areas such as customer information systems and AMI and smart grid technologies.

The nation's infrastructure investment needs are at an all-time high. It is estimated that \$1.5 trillion will be required between 2010 and 2030. The estimated costs are broken out as follows:

- ✚ Distribution - \$582 billion

---

<sup>121</sup> EIA, *Annual Energy Outlook 2010*, 2, 65.

<sup>122</sup> Electric Reliability Council of Texas, *2009 Annual Report*, 18 (Jul. 15, 2010).

<sup>123</sup> Roger Wood, *Banking on the Big Build*, *Public Utilities Fortnightly*, 49 (Oct. 2007) and cited with approval in National Regulatory Research Institute report *Private Equity Buyouts of Public Utilities: Preparation for Regulators* (Dec. 2007) by Stephan G. Hill at p. 36.

- ✚ Transmission - \$298 billion
- ✚ AMI, energy efficiency and demand response - \$85 billion
- ✚ Generation - \$505 billion if there are no changes in carbon policy<sup>124</sup>

To ensure reliability and competitive functioning of the electricity market, Texas must rely upon an integrated approach that combines the traditional solutions of making infrastructure investments in new transmission and generation facilities with demand response solutions made possible by the deployment of AMI infrastructure that give customers the ability to better understand and control their usage. Demand response programs have the potential to permit customers' needs to be met with lower levels of investment in generation, transmission and distribution facilities. As customers choose to participate in demand response programs that reduce usage during periods of high demand and prices, fewer additions to generation, transmission and related facilities will be required than would otherwise in the absence of such a program. Besides reducing peak demand, demand response programs such as dynamic pricing provide a substantial benefit that as demand for expensive peaking energy declines, so does the price. This benefits not only the customers who choose to participate, but also those who do not.

## Smart Meter Opt-Out

In early 2012 as many utilities approached completion of their smart meter deployments, the opt-out debate formally arrived in Texas. In order to explore the feasibility of providing customers with the option of eschewing smart meters for their old analog meters, the PUC opened Project 40190, *Project Relating to Advanced Metering Issues*. Soon thereafter, smart meter opponents filed a petition asking that the PUC institute a moratorium on further deployment and mandate the removal of existing smart meters.<sup>125</sup> When the petitioners' request was denied due to technical deficiencies and because the PUC was already investigating the subject under Project 40190, they filed again with the same result.<sup>126</sup> In the alternative, petitioners requested that they be given the choice of opting out of smart meters.

Summarizing the comments filed under the three projects, opponents' arguments can generally be grouped into six categories:

- ✚ **Health issues**—commenters are concerned that radio/electromagnetic frequencies emitted by smart meters cause a wide variety of ailments from sore joints to cancer.

<sup>124</sup> *U.S. Transmission Investment: Policies and Prospects*, Peter Fox-Penner, The Brattle Group, April 28, 2009 and cited with approval in "Transforming America's Power Industry: The Investment Challenge 2010-2030" prepared for the Edison Financial Conference, November 10, 2008 by Marc Chupka et al.

<sup>125</sup> Project No. 40199, *Petition for Initiation of Rulemaking Proceedings Regarding Smart Meters*.

<sup>126</sup> Project No. 40404, *Petition for Initiation of Rulemaking Proceedings Regarding Smart Meters*.

- ✚ **Privacy issues**—commenters feel that smart meters infringe upon their right to privacy because they can be used as surveillance devices and because they believe that the data gathered may be sold without their permission.
- ✚ **Security issues**—commenters fear that others may hack the system and use the data for financial gain, to act on grudges, to know when to burglarize a home or for warfare.
- ✚ **Financial issues**—commenters are concerned that smart meters will produce no savings, that bills are erroneous and that dynamic pricing will lead to higher rates during peak usage hours.
- ✚ **Fires**—commenters suggest that fires have resulted from the installation of smart meters across the country.
- ✚ **Use issues**—commenters assert that smart meters can damage appliances and that they do not want to be coerced into participating in demand response.

On August 21, 2012, the PUC held a public forum to provide opponents with the opportunity to be heard by the commissioners, to answer their questions and to provide information. No vote was taken, but participation was vigorous. Smart meter opponents continue to submit comments under the project reiterating their concerns.

Under Project 40190, the PUC issued a series of questions to the utilities and the public about the effects of an opt-out program on the following subjects:

- |   |                                   |
|---|-----------------------------------|
| ✚ Legal and policy issues;                    | ✚ TDU infrastructure;             |
| ✚ TDU deployment plans;                       | ✚ TDU meter reading functions and |
| ✚ The TDU surcharge and savings calculations; | ✚ The electricity market.         |

Utilities commented that an opt-out program would create inefficiencies and eliminate substantial savings. Offering a smart meter opt-out program would affect the utility's deployment plan by reducing the benefits of the plan and ultimately increasing the costs of implementation. Utilities stated that an opt-out program would require them to reengage personnel to read meters, retain otherwise outdated computer systems to process the manual meter readings and implement additional processes for the communication of the manual meter readings to ERCOT.

Oncor provided more details on the impacts it anticipated by commenting that, depending on the number of customers who might choose to opt out in any given area of a utility's service territory, the system operational benefits contemplated by the deployment plan (including, for example, quicker outage restoration) could be adversely affected. Oncor also stated that even

customers with smart meters could be deprived of the full system operational benefits that could be achieved under its current deployment plan in the absence of an opt-out program.

The PUC is currently weighing all of the issues presented by smart meter opponents and proponents as well as the costs to individual customers and ratepayers as a whole before deciding whether and how to alter deployment schemes at this point. One thing is certain, an opt-out program would be costly, and the PUC would be hesitant to socialize the expense. Staff continues its research on the subject, and consideration is ongoing.

## Cyber Security

### PUC Role and Activities – An Overview

Cybersecurity for the electric sector traditionally has been a concern that was addressed at the federal level by the Federal Energy Regulatory Commission (FERC) through the North American Electric Reliability Corporation's Critical Infrastructure Protection (NERC CIP) standards that focus on the bulk electric system.<sup>127</sup> The Energy Independence and Security Act of 2007 (EISA)<sup>128</sup> vested the National Institute of Standards and Technology (NIST) and FERC with responsibilities related to coordinating the development and adoption of smart grid guidelines and standards, including those for cybersecurity for the remainder of the electric grid.

Since 2009, the state of Texas has played a significantly greater role in the endeavor of grid cybersecurity, with emphasis placed on the distribution portion of the electrical infrastructure. As part of its initial cybersecurity activities, PUC staff visited several IOUs to make informal inquiries into their security methodologies and practices. Because enhancing security is a continuous and iterative process, it will require an ongoing dialog which may include future visits. In the meantime, staff is engaged in the smart grid standards-creation process which mostly focuses on the distribution portion of the grid, and these efforts include pursuing standards for cybersecurity. This activity is being accomplished through several ongoing initiatives primarily focused on North America, especially the United States. Many other countries will likely in turn adopt a large portion of these standards, thereby making them international in scope.

At the PUC, cybersecurity was initially addressed in the Advanced Metering Infrastructure (AMI) rule<sup>129</sup> adopted in 2007 which required independent security audits of the IOUs within Texas

---

<sup>127</sup> <http://www.nerc.com/page.php?cid=2|20>.

<sup>128</sup> [http://frwebgate.access.gpo.gov/cgi-bin/getdoc.cgi?dbname=110\\_cong\\_bills&docid=f:h6enr.txt.pdf](http://frwebgate.access.gpo.gov/cgi-bin/getdoc.cgi?dbname=110_cong_bills&docid=f:h6enr.txt.pdf).

<sup>129</sup> P.U.C. SUBST. R. §25.130.

that are deploying AMI.<sup>130</sup> The requirement to have these audits performed specifically addressed customer and REP access to meter data. The IOUs are further required to have third-party end-to-end cybersecurity assessments of their AMI performed as a condition of their surcharge cases at the PUC,<sup>131</sup> to be performed on an annual basis thereafter. Staff has had input into determining the project scope of these assessments, reviewed terms and timetables and has also been engaged in both the process of reviewing prospective vendors' capabilities as well as ultimately selecting the winning bidders to execute the IOUs' respective AMI cybersecurity assessments. Staff reviews the outcome of the assessments. These assessments are different from the meter accuracy assessments that had been performed by Navigant Consulting in 2010 under Project Number 38053.<sup>132</sup>

Because much of the data gathered by each of the four IOUs' AMI systems is delivered to the Smart Meter Texas (SMT) portal,<sup>133</sup> the surcharge cases also required SMT to be subjected to yearly third-party security assessments. Staff is involved in determining the scope of these assessments and plays a significant role in the vendor selection process by reviewing vendors' capabilities and voting on the winning bidder. Staff oversees the Security Working Group (SWG) under the Advanced Metering Implementation Team (AMIT) and is involved with several other organizations working on the evolution of the smart grid.

PUC staff monitors the continued development of NERC CIP standards and their interpretation by the utilities, ERCOT and the other regional entities operating in the state and the Texas Reliability Entity (TRE). The PUC strives to remain apprised of whether the standards being developed are both meaningful and workable in the electricity industry of Texas.

Utilities should at least be aware of the ongoing development of smart grid standards, including those for cybersecurity, but the ideal would be for them to be intimately involved in these activities. The PUC hosts occasional workshops, visits utilities' management and maintains an open and continuous dialog with the utilities' cybersecurity practitioners. Staff also maintains contact with staff of other state commissions who are engaged in smart grid and cybersecurity policy.

PUC staff encourages individuals from Texas utilities and other stakeholders to be involved in the smart grid standards development process through their employees' membership in various industry technology groups, whether it is a subgroup of a broad-based international entity such as the Institute of Electrical and Electronics Engineers (IEEE),<sup>134</sup> the International Society of

---

<sup>130</sup> The four IOUs deploying AMI in Texas are Oncor, CenterPoint Energy, AEP Texas, and Texas-New Mexico Power.

<sup>131</sup> PUC Projects 35718, 35639, 36928, and 38306.

<sup>132</sup> Available at [http://interchange.puc.state.tx.us/WebApp/Interchange/application/dbapps/filings/pgSearch\\_Results.asp?TXT\\_CNTR\\_NO=38053&TXT\\_ITEM\\_NO=17](http://interchange.puc.state.tx.us/WebApp/Interchange/application/dbapps/filings/pgSearch_Results.asp?TXT_CNTR_NO=38053&TXT_ITEM_NO=17).

<sup>133</sup> SMT is the common portal that provides end-user access to energy usage data sourced from the AMI that was deployed by the respective utilities.

<sup>134</sup> <<http://www.ieee.org/index.html>>.

Automation (ISA)<sup>135</sup> or something specifically focused on smart grid, such as the GridWise Alliance<sup>136</sup> or the ZigBee Alliance.<sup>137</sup>

Beyond smart grid standards, staff has also become more actively engaged in industry conferences that revolve around cybersecurity and privacy for the electrical grid. Demonstrating leadership in smart grid policymaking, not merely being noted as a state where a relatively swift deployment of AMI has taken place, is important for promoting the agency's voice and maintaining its credibility in areas related to smart grid technology and policy. The PUC's Cyber Security Analyst has authored a report<sup>138</sup> under Project Number 40128 that builds on the cybersecurity topics discussed here. He has spoken at several conferences and assisted NARUC in educating other state commissions on cybersecurity issues.

**Figure 35: Organizations and roles for smart grid cybersecurity**

Organization	Primary Organization Goals	Realms	PUC Participation	Other participants
<b>AMIT/SMT SWG</b>	Inform, Share, Assess	AMI	Oversee, Contribute	ERCOT market participants
<b>DHS CSSP</b>	Inform, Share, Assist	Control systems, IT Infrastructure	Learn	Many stakeholder groups
<b>DHS ICSJWG</b>	Inform, Share, Learn	Control systems, IT Infrastructure	Contribute, Learn	Many stakeholder groups
<b>DOE</b>	Guide, Award Grants	Entire grid	Grant recipient	Many stakeholder groups
<b>DOE National Labs</b>	Research, Assist	Entire grid	Learn	Many stakeholder groups
<b>EPRI</b>	Research	Entire grid	Learn	Many stakeholder groups
<b>ERCOT CIPWG</b>	Inform, Share, Learn	Generation and Transmission	Observe, Learn, Share	Utilities, ERCOT
<b>Industry conferences - Utility</b>	Inform, Share, Learn	Entire grid, IT Infrastructure	Contribute, Learn	Many stakeholder groups
<b>Industry conferences - Cybersecurity</b>	Inform, Share, Learn	Entire Grid, IT Infrastructure	Contribute, Learn	Many stakeholder groups

<sup>135</sup> <<http://www.isa.org/>>.

<sup>136</sup> <<http://www.gridwise.org/index.asp>>.

<sup>137</sup> <<http://www.zigbee.org/>>.

<sup>138</sup> Available on the PUC website on the Project No. 40128 page.

<b>InfraGard</b>	Inform, Share, Learn	Critical Infrastructure	Learn	Many stakeholder groups
<b>NAESB</b>	Create standards	Entire grid, markets	Contribute	Utilities
<b>NARUC</b>	Inform, Share, Guide	Utility Regulation	Contribute	Commissions
<b>NERC CIP DT</b>	Create CS Standards	Generation and Transmission	Observe, Learn	Utilities, ISOs/RTOs
<b>NESCO</b>	Inform, Share	Entire grid	Learn	Utilities, ERCOT, Commissions
<b>NESCOR</b>	Review CS standards	Entire grid	Contribute, Learn	Many stakeholder groups
<b>NIST SGIP</b>	Review and Recommend SG standards	Entire grid, but mostly Distribution	Contribute, Learn	Many stakeholder groups
<b>NIST SGIP CSWG</b>	Review and Recommend CS standards	Entire grid, but mostly Distribution	Contribute, Learn	Many stakeholder groups
<b>UCAIug OpenSG</b>	Review and Recommend SG standards	Distribution	Contribute, Learn	Utilities, vendors
<b>UCAIug SG Security</b>	Review and Recommend CS standards	Entire Grid, but mostly Distribution	Contribute, Learn	Utilities, vendors
<b>TRE NSRS</b>	Inform, Share	Generation and Transmission	Observe	Utilities, TRE

## PUC Texas Staff Priorities

In the near-term, PUC staff priorities for cybersecurity are to:

- ✚ Remain engaged in what the electric utilities of the state and ERCOT are doing to secure their electrical infrastructure (including SMT);
- ✚ Be aware of relevant cybersecurity threats and discovered vulnerabilities;
- ✚ Be involved in what the utility industry as a whole is doing to address cybersecurity;
- ✚ Take part in the continuing efforts of the federal government and its contractors in this ever-evolving area;

- ✚ Stay abreast of the capabilities of the cybersecurity industry itself to protect our country's infrastructure and
- ✚ Maintain contact with other states' regulators regarding issues of smart grid and cybersecurity.

In regard to the mid- and long-term priorities of PUC staff for cybersecurity, one important part of standards development is devising appropriate testing and certification standards. From these standards, meaningful metrics must be devised so that asset owners can gauge the level of security being provided by their vendors and system integrators. In conjunction with this, utilities must eventually be able to demonstrate to regulators the maturity of their own security capabilities, as well as document the robustness and efficacy of their security systems and policies.

The goals of the PUC coincide with the need to address the challenges that the US General Accounting Office (GAO) enumerated on the current efforts to secure smart grid systems.<sup>139</sup> The conclusions in the GAO report are as follows:

- ✚ Aspects of the regulatory environment may make it difficult to ensure smart grid systems' cybersecurity.
- ✚ Consumers are not adequately informed about the benefits, costs and risks associated with smart grid systems.
- ✚ Utilities are focusing on regulatory compliance instead of comprehensive security.
- ✚ There is a lack of security features being built into certain smart grid systems.
- ✚ The electricity industry does not have an effective mechanism for sharing information on cybersecurity.
- ✚ The electricity industry does not have metrics for evaluating cybersecurity.

## PUC Policy Considerations

### *Jurisdiction*

The electrical system falls under several different jurisdictions, as shown in Figure 35.<sup>140</sup> The bulk electric system (BES) within ERCOT is generally defined as being traditional electric power generation (i.e., not distributed generation) and transmission above 69 kV. The BES falls under

---

<sup>139</sup> <http://www.ferc.gov/industries/electric/indus-act/smart-grid/gao-report.pdf>.

<sup>140</sup> Modification of original source: [http://upload.wikimedia.org/wikipedia/commons/4/41/Electricity\\_grid\\_simple\\_North\\_America.svg](http://upload.wikimedia.org/wikipedia/commons/4/41/Electricity_grid_simple_North_America.svg).



the purview of FERC and NERC and is therefore subject to NERC CIP Standards CIP-002 through CIP-009.

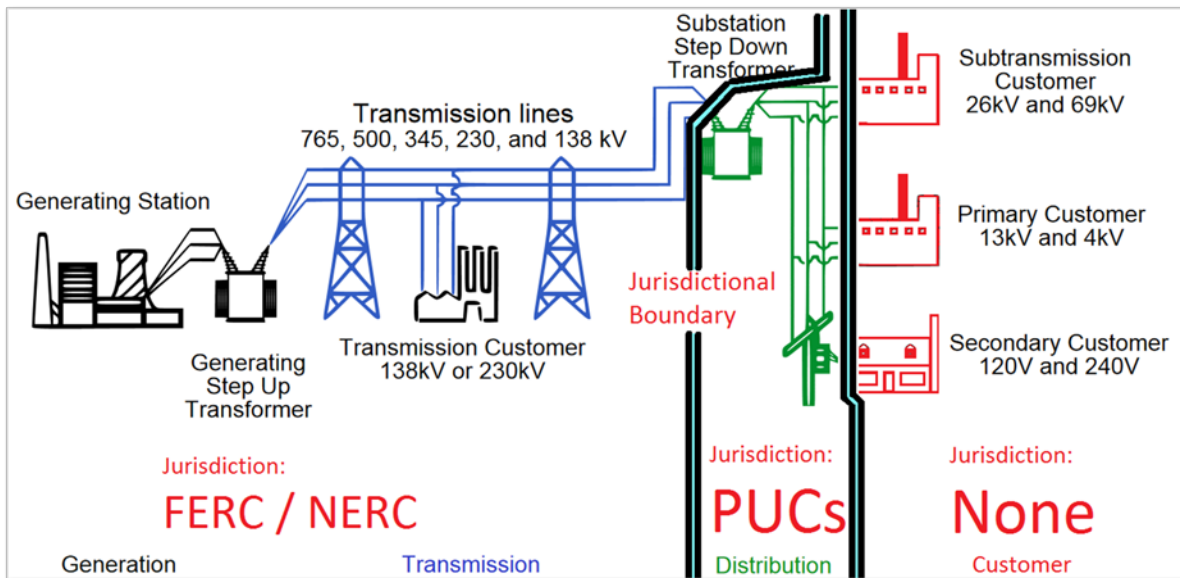

**Figure 36: Jurisdictions in the electric grid**

While the PUC is not in charge of NERC CIP oversight, keeping abreast of NERC CIP requirements and the challenges faced by utilities in complying with them is still important. The ERCOT CIP Working Group (CIPWG) facilitates monthly meetings with utilities and other interested parties, including PUC staff, to primarily discuss the existing NERC CIP standards, interpretations of the standards, pending updates (version 5 is currently under development) and other reliability activities of the federal agency. Other topics are also broached at CIPWG—newly discovered vulnerabilities, emerging threats to critical infrastructure, mission assurance for the military, pending federal legislation, cybersecurity standards from outside NERC and any cybersecurity training opportunities, conferences, workshops or exercises. Attendance is limited to those individuals who have signed a confidentiality agreement in advance.

Also discussed at CIPWG meetings are the NERC CIP compliance audits which are conducted by TRE on registered entities—namely ERCOT itself and the electric utilities within the ERCOT region. To avoid any potential for self-incrimination (in terms of NERC CIP auditing), those who work for TRE are barred from this portion of the meeting.

ERCOT hosts a mailing list on a LISTSERV for CIPWG discussions, and PUC staff is a frequent contributor to the list. As with many ERCOT mailing lists, membership is generally open to the public. There is also a restricted mailing list for CIPWG for more confidential information that can only be accessed by individuals who have signed a confidentiality agreement.

TRE's NERC Standards Review Subcommittee (NSRS) hosts monthly online meetings. NERC has a large number of reliability standards so PUC staff limits its monitoring of the call to subject matters relating to CIP.

Parts of Texas are within the territory of the Southwest Power Pool (SPP) reliability entity, and SPP also has a mailing list for its own CIPWG. The communications from that list are quite different in that it is primarily one-way and restricted by SPP, and the amount of communications traffic is much lower than ERCOT's mailing list.

The distribution portion of the grid presents its own set of challenges. Its presence is more obvious to consumers in that it is literally closer to home. The PUC has jurisdiction at that level, but it only goes as far as the electric meter. Beyond that, inside commercial and industrial buildings and within customer's homes, there is very little to no governmental oversight of electrical systems. At that point, electricity becomes the responsibility of the customer including the condition, maintenance and operation of equipment, appliances and any home energy management devices. Both the security and safety of these devices are the customer's responsibility.

### ***AMI and other Forms of Grid Modernization***

AMI is typically implemented as a pilot project before the company installing it does a full-scale deployment or adds an extensive amount of distribution automation (DA) to its system. Using a staged approach helps a utility gain a greater understanding of the impact of increased bandwidth demands on more localized communications systems that are used to gather and transport data to be processed and to assess potential operational issues associated with deploying a new technology. Initially concentrating on meter deployment helps to isolate any issues to a smaller and more contained area rather than allowing them to propagate upstream and system-wide since DA dictates a broader or more complex deployment than metering alone.

If the AMI meters being deployed have a remote disconnect feature, for security purposes the TDSP installing them should include mechanisms that will control the number of simultaneous connects and disconnects as well as limit how often these actions can happen to any one particular meter. All commands from the back office to the customer premises should be authenticated and all actions logged. Such information should be audited frequently but at odd intervals to ensure that outputs conform to expected results while somewhat randomizing when the sampling will occur. TDSPs will also need to secure any interfaces to REP data and their interfaces to ERCOT in order to ensure that one REP cannot see another REP's data.

Increased DA consists of the expansion and integration of SCADA systems, the automation of switches and capacitor banks and upgrades to station breakers, relays and feeders. The

deployment of such upgrades is typically first directed at urban areas to reap greater benefits upfront.

In any data transmission, a modern encryption algorithm should be employed that in turn uses keys that have an adequate number of bits to deter unauthorized deciphering. Utilities should contemplate an asymmetric public key infrastructure (PKI) and, if they do, it should be accomplished through the use of digital signatures or public (multiple) key exchanges.

An outage management system is also a key component to AMI deployment in that it will help drive efficiency in the restoration process through effective dispatch of repair crews.

In Texas, PUC rules state that customer data such as consumption information belongs to the customer<sup>141</sup> so maintaining its confidentiality and integrity holds a special importance to all parties.

### **Determining Risk**

Risk can be defined as the potential that a chosen action (or inaction) will lead to an undesirable outcome. If this is to be expressed in financial terms for a company, it would equate with monetary loss. Of course, the risk to an electrical utility goes beyond financial loss because it provides an essential service and is part of the critical infrastructure; loss of life is a potential outcome. Loss of public confidence and poor company reputation are also sensitivities.

In this context, risk is generally calculated as the product of three factors: the existence of a threat, an established vulnerability that could be exploited and the consequences of a successful attack. Figure 37 illustrates this concept. The factors in the equation are only estimations and involve a lot of uncertainty.

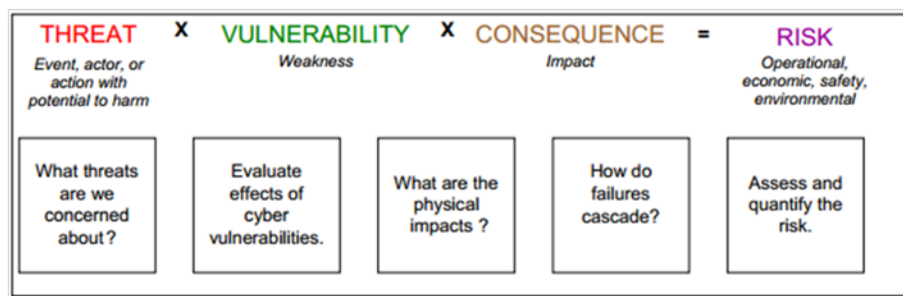

Figure 37: Calculating risk

The DOE, in collaboration with NIST and NERC, released the Electricity Subsector Cybersecurity Risk Management Process (RMP)<sup>142</sup> guideline in May 2012. The guideline was developed by a

<sup>141</sup> PURA § 39.107 (2011).

team of government and industry representatives to provide a consistent and repeatable approach to managing cybersecurity risk across the electricity subsector. It was intended to be used by companies that generate, transmit or distribute electric power as well as those who market it, plus supporting organizations such as vendors. The RMP is written to enable these organizations to apply effective and efficient risk management processes and to tailor them to meet their organizational requirements. The guideline may be used by a company to implement a new cybersecurity program or to build upon existing cybersecurity policies, standard guidelines and procedures.

A White House project titled the Electric Sector Cybersecurity Risk Management Maturity Initiative was launched January 5, 2012. The initiative was led by the DOE in partnership with the US Department of Homeland Security (DHS) to create a more comprehensive and consistent approach to protecting the nation's electric grid against cyber-attacks. The stated objective was to develop a common toolset which would enable utilities and grid operators to:

- Have their cybersecurity capabilities evaluated in a consistent manner;
- Communicate these cybersecurity capabilities in meaningful terms and
- Prioritize actions and investments to improve cybersecurity.

The effort resulted in the Electricity Subsector Cybersecurity Capability Maturity Model (ES-C2M2), a toolset intended for voluntary industry adoption and use.<sup>143</sup> Periodic updates will be posted on the Office of Electricity Delivery and Energy Reliability website.<sup>144</sup>

To develop the ES-C2M2 toolset, a common model was devised that evaluated cybersecurity capabilities within the electricity sector and how sector capabilities mature over time. It took a holistic risk-based approach to address cybersecurity risks with an appropriate balance of resilience, protection and restoration. The model built upon and tied together existing cybersecurity resources and was specifically tailored for the electricity sector. The model directly aligned with sector-specific and cross-sector strategic direction, including Roadmap to Achieve Energy Delivery Systems Cybersecurity<sup>145</sup> from DOE and the Cross-Sector Roadmap for Cybersecurity of Control Systems<sup>146</sup> from DHS.

---

<sup>142</sup> <http://energy.gov/oe/articles/doe-releases-electricity-subsector-cybersecurity-risk-management-process-rmp-guideline>.

<sup>143</sup> <http://energy.gov/oe/downloads/electricity-subsector-cybersecurity-capability-maturity-model-may-2012>.

<sup>144</sup> <http://energy.gov/oe/office-electricity-delivery-and-energy-reliability>.

<sup>145</sup> [http://energy.gov/sites/prod/files/Energy Delivery Systems Cybersecurity Roadmap\\_finalweb.pdf](http://energy.gov/sites/prod/files/Energy%20Delivery%20Systems%20Cybersecurity%20Roadmap_finalweb.pdf).

<sup>146</sup> [http://www.us-cert.gov/control\\_systems/pdf/Cross-Sector\\_Roadmap\\_9-30.pdf](http://www.us-cert.gov/control_systems/pdf/Cross-Sector_Roadmap_9-30.pdf).

# Cybersecurity Threats, Vulnerabilities and Consequences

## Threats

### The Ubiquity of the Internet

Every day, there are more people coming online for the first time, and the phenomenon is global in scope. This explosion in connectivity is compounded by the fact that there are more traditional computers and Internet-enabled mobile devices such as smart phones and tablets today than ever before, and the proliferation of these intelligent devices will continue well into the future. Cisco estimates that by 2016, there will be 4 billion Internet-capable mobile devices globally (see Figure 37).<sup>147</sup> Thus, almost everyone has the ability to establish a remote connection to a public network while some users have the additional capability of connecting to one or more private networks (such as those inside a company) and therefore have the potential to access any devices on those networks.

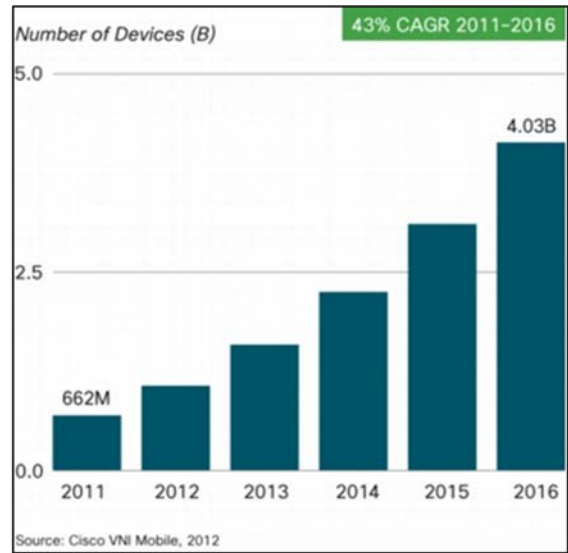

Figure 38: Projected number of mobile Internet-connected devices

This ubiquitous connectivity along with the rapid expansion in communications technology has resulted in a corresponding increase in the number of attack vectors—the means by which an adversary can gain unauthorized access to a computer or network. In other words, the more computers there are, the more there are to attack and hijack; and the more people there are using interconnected computers, the more potential unwitting victims there are. Because of these factors, the landscape of cybersecurity has changed forever.

### Being Found by SHODAN

Shodan is an Internet search engine that allows a user to find specific Internet-connected equipment including routers<sup>148</sup> and servers<sup>149</sup> and creates an index of these devices. A variety

<sup>147</sup> [http://www.cisco.com/en/US/solutions/collateral/ns341/ns525/ns537/ns705/ns827/white\\_paper\\_c11-520862.html](http://www.cisco.com/en/US/solutions/collateral/ns341/ns525/ns537/ns705/ns827/white_paper_c11-520862.html).

<sup>148</sup> In the simplest of terms, a router is a device that forwards packets of data between computer networks and is part of what enables data to reach its intended destination.

of filters is available on the site to narrow the search which can be used to find computers that are running a certain piece of software, for example.

Such a search engine is of particular concern to almost every industry including electrical utilities because just about all these industries utilize industrial control systems. The Shodan search engine<sup>150</sup> will therefore enable potential hackers to locate control systems that are connected to the Internet and then can also be used to identify which of those discovered systems have known vulnerabilities.

What is most alarming about this is the ultimate purpose of ICSs—to direct and control machinery. Namely, an ICS receives data through many various inputs and then makes decisions based on its programmed logic. Those decisions are then carried out in the physical world. Thus, the decisions of a computer are made manifest in the real world. In the case of an electrical utility, ICSs are used to control the operations side of the business—essentially the generation of electrons or directing where they should go, plus any supporting and/or auxiliary components which are known as the Balance of Plant (BOP) systems.<sup>151</sup>

## Stuxnet

Stuxnet was a computer worm<sup>152</sup> discovered in mid-2010 which spread indiscriminately via Microsoft Windows whose ultimate target was certain industrial control system software and equipment. The malware was designed to subvert the Siemens Step-7 software application which is used to monitor and control Siemens S7 programmable logic controllers (PLCs). PLCs are primarily used to automate processes and are typically used to control a smaller, more localized operation, such as Balance of Plant. PLCs have become increasingly sophisticated and more capable over the years, so the compromise of such systems is worrisome.

The Stuxnet worm is especially notable for several reasons, one of which is that it appeared to be specifically directed at PLCs with a specific configuration used to govern a particular process. Stuxnet was a significant development because it upped the ante, functioning as an apt demonstration of how industrial control systems are vulnerable to cyber-attacks and also how such an attack could be accomplished outside of a laboratory, becoming a real world scenario.

---

<sup>149</sup> A server is a computer that functions to serve the requests of other computers, including performing computational task on their behalf.

<sup>150</sup> <http://www.shodanhq.com/>.

<sup>151</sup> A BOP design depends on the specific kind of power generation or requirements that are specific to the facility's site and which are integrated into the power system. Thus, any disruption of BOP may result in any number of consequences, ranging from relatively benign to catastrophic.

<sup>152</sup> A computer worm is a self-replicating computer program that uses a computer network to send copies of itself to other computers.

## The Human Factor

One of the greatest dangers to a utility is acts committed by employees, whether intentional or unintentional. Threats may come from circumvention of policies out of convenience, modification of system settings or configuration, attempts to improve performance, the addition of wireless network devices or other activities performed without a review of the security considerations by appropriate personnel. Unfortunately, lax or non-existent controls in many organizations will fail to detect such violations, increasing the risk of exploitation. If we set aside these factors, the most egregious insider threat can come in the form of a disgruntled employee. Insiders know the most about a company's operations such as where its data and intellectual property are stored and how to access them. Data is vulnerable to alteration and exfiltration, and the impacts of these events could range from being a mere nuisance to an outright catastrophe. Companies need to vet prospective employees and contractors for risk and then monitor them for unusual or radically changed behavioral patterns once employed.

In the future, PUC staff may consider formulating questions about utilities' human resources practices as part of its informal information-gathering activities. One area under possible consideration is inquiring into the educational and security accreditations of employees who serve in a security function.

Third parties such as vendors who supply equipment or have service maintenance contracts with the firm may have access to business systems or the industrial control systems that govern the company's energy operations. The access that these third parties have been granted typically allows actions to be performed remotely, even from a location overseas. These supplier companies must also be screened and their employees vetted, and the selection process for these third party companies should be handled through a robust procurement process that keenly addresses security considerations. It would also be good practice to conduct a third party risk assessment on any external organization that has been given access to cyber assets within the company.

It bears repeating that the weakest link in cybersecurity is not necessarily the technology or equipment; it is the human beings who operate such systems. People may take errant actions or otherwise cause failures, or they may simply not adhere to established policies. But people can also be *tricked* into performing unwanted behaviors through social engineering.<sup>153</sup> It is wise for organizations to perform phishing<sup>154</sup> or other social engineering exercises in order to raise awareness, educate and prepare users for the eventuality of being solicited by nefarious characters. These exercises should be performed often enough to maintain their effectiveness but not so often that they desensitize the employees. They should also be done at odd

---

<sup>153</sup> In this context, it is the art of manipulating people into performing actions or divulging confidential information. In most cases the attacker never comes face-to-face with the victims.

<sup>154</sup> Phishing is a method of attempting to acquire personal information (such as passwords, etc.) through electronic communication, by masquerading as a trustworthy entity.

intervals so that they are not anticipated by the workforce, and certain high-level individuals within the organization should be informed before such exercises take place. Consideration should also be given to excluding particular individuals from the tests in order to reduce the likelihood of an adverse reaction to what amounts to a fictitious event.

## **Software Piracy**

Pirated software and the downloading of unauthorized software can present several challenges to cybersecurity. The most common method employed to obtain these types of software is file sharing websites. First, the sites themselves may host or contain malware that can be inadvertently and unknowingly downloaded by a visitor. Second, any files being offered for download most likely have not been screened for legitimacy or security threats and therefore may be compromised by malware.

If a user has not purchased a software product through legitimate means, then the user does not have an authentic End User Licensing Agreement in place and is therefore not entitled to support from the creator of the product, including being able to install updates or security patches. If security patches have not been installed, the software may be vulnerable to exploit.

## **Vulnerabilities**

Many of the industrial control systems (ICS) used in energy production and for support functions (commonly, but sometimes inaccurately, referred to as supervisory control and data acquisition or SCADA) are legacy systems<sup>155</sup> where long-known vulnerabilities have not been rectified. These vulnerabilities may have been left unmitigated for various reasons such as vendor discontinuation of future development and support of a hardware or software product.

Utilities have many computers as a part of their operations, and these computers run special programs, many of which function within the environment of the Microsoft Windows operating system. Thus, any such program would be subject to any of the vulnerabilities inherent in Windows. To make matters worse, vulnerabilities in the programs that utilities have on their systems are increasingly coming to light, and these vulnerabilities are exactly what attackers desire to exploit.

The public dissemination of automated hacking tools<sup>156</sup> provides aspiring attackers with more opportunities to cause havoc with less effort. While the defensive tools and tactics that are typically employed to protect the standard IT infrastructure arguably have been adequately keeping pace with modern threats, the distinct characteristics of legacy SCADA system

---

<sup>155</sup> A legacy system is a computer system that is still used although it is no longer the most modern or advanced because it would be prohibitively expensive or exceedingly difficult to replace it.

<sup>156</sup> Metasploit is one such tool: <http://www.metasploit.com>.



components, in addition to their inherent shortcomings, make the defense against such intruders a major challenge.

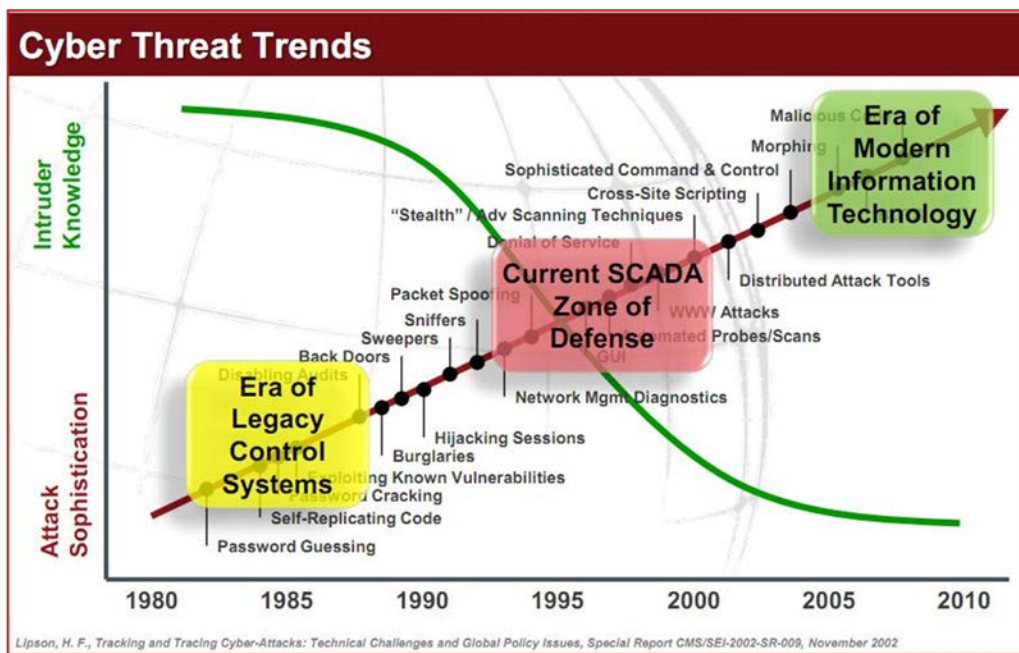

**Figure 39: Attack sophistication vs. intruder knowledge over time; current defense capabilities of SCADA vs. current defense capabilities of IT**

Figure 39 illustrates the alarming trends in cyber threats.<sup>157</sup> The declining green line signifies the amount of knowledge an intruder would require to attack or infiltrate a SCADA system while the red line illustrates the growing sophistication of attacks. The yellow field on the left side shows the technological era in which legacy SCADA systems exist. Meanwhile, the present-day level of SCADA system protection in the middle of the diagram shows that it still lags behind that of the era of modern IT (shown in green).

## Consequences

### ICS and the Energy Sector

There are many threats in the cyber realm. Figure 40 provides an overview of these threats as well as their potential impacts, if successful. The presence of threats in the typical business/office computer environment differs from that of the smart grid environment. In the smart grid, these threats may not be just limited to financial impact but may also have physical consequences and therefore affect the health and welfare of the populace.

<sup>157</sup> Joel Langill, ENGlobal Automation, *Defense-in-Depth Strategies for Secure Remote Access*, ICSJWG 2010 Fall Conference.

Figure 40: Types of threats against ICSs and their potential consequences

Type of Threats	Description	Impacts if Successful
<b>Modification of data in transit</b>	Modification of transactions across networks.	Erroneous or inconsistent process data, loss of process control, financial losses and breakdown in public trust.
<b>Denial of Service (DOS)</b>	Attacks that slow servers or networks down or bring them to a halt.	Stopped flow of process data, frustrated potential users, prevented business transactions and damaged credibility.
<b>Theft of information/ espionage</b>	Penetration attacks resulting in theft of information/intelligence.	Loss of intellectual property or proprietary data, breach of legal and regulatory requirements to maintain confidentiality, financial impacts, breakdown of public trust and damaged credibility.
<b>Unauthorized use of resources</b>	Penetration of systems to allow attackers to utilize services— computers, phones and data. This can also include taking control of servers, using them to send spam or launch distributed denial of services attacks.	Financial loss, potential liability, compromise of systems and networks and potential “leapfrogging” (moving ahead in order of service).
<b>Data tampering</b>	Modification of content/format of web pages and/or data.	Erroneous or inconsistent process data, loss of process control, damaged credibility and legal ramifications of the falsification of data.
<b>“Spoofing”</b>	Impersonating an address internal to a network to gain access. E-mail impersonation.	Potential compromise or destruction of system and damage to credibility.
<b>“Sniffing”</b>	Monitoring network traffic for information (passwords, credit card numbers, etc.)	Compromise or damage of systems and credibility.
<b>Viruses, Worms/ Internet vandals</b>	Malicious programs and code capable of damage and self-replication.	System down time, lost productivity and business expenses.
<b>Disasters (natural, technological, human-caused)</b>	Floods, fires, severe storms and acts of sabotage/terrorism.	Loss of life and/or critical resources, services to the public and property.
<b>Physical intruders, vandalism and theft of equipment and infrastructure</b>	Destruction or theft of equipment and waste of resources.	System down time, business expenses and lost productivity.

<b>Cyber intrusions directly into control systems</b>	Can potentially destroy equipment or disable control systems that could result in infrastructure failures or the use of infrastructure as vehicles of attack.	Loss of life and/or critical resources, services to the public and property and damage to critical control systems and equipment.
<b>“Information Warfare”</b>	<p>Deliberate offensive and defensive use of information and information systems to deny, exploit, corrupt or destroy an adversary’s information, information-based processes, information systems and computer-based networks while protecting one’s own. Primary means of conducting information warfare include:</p> <ul style="list-style-type: none"> <li>✚ Psychological operations to affect the adversary’s reasoning.</li> <li>✚ Electronic operations to deny accurate information to the adversary.</li> <li>✚ Deception operations to mislead about one’s own capabilities or intentions.</li> <li>✚ Physical destruction of the adversary’s information networks and systems.</li> <li>✚ Security measures to keep adversaries from learning about one’s own capabilities and intentions.</li> <li>✚ Information attack to directly corrupt an adversary’s information without being detected.</li> </ul>	Information warfare could utilize any of the threats listed in this table, conceivably achieving any or all of the impacts listed. Information warfare is most often used between nations or between major business competitors to gain an advantage in a major military operation or business competition.

Examples of such chaos made manifest are relays being triggered for no discernible reason, switching equipment being disrupted or a generator rapidly switching its phases, causing it to tear itself apart. The latter event was demonstrated in the “Aurora Experiment” which was conducted by the Idaho National Labs (INL) in March 2007 and was publicized by CNN.<sup>158</sup> The experiment consisted of a simulated hacker attack on a control system commonly found

<sup>158</sup> The link to the DHS video is <http://www.youtube.com/watch?v=fJyWngDco3g>.

throughout bulk electric systems. Figure 41 shows the generator that was destroyed in the experiment.<sup>159</sup>

INL drafted a report on behalf of the DOE's Office of Electricity Delivery and Energy (OE) National SCADA Test Bed (NSTB) program entitled the *Vulnerability Analysis of Energy Delivery Control Systems*<sup>160</sup> which describes common vulnerabilities found in assessments performed by the lab in the time period between 2003 and 2010. The top 10 general control system vulnerabilities it listed were:



Figure 41: Frame of Aurora Experiment video from INL

- ✚ Unpatched published vulnerabilities
- ✚ Web human-machine interface (HMI) vulnerabilities
- ✚ Use of vulnerable remote display protocols
- ✚ Improper access control
- ✚ Improper authentication
- ✚ Buffer overflows in SCADA services
- ✚ SCADA data and command message manipulation and injection
- ✚ SQL injection
- ✚ Use of standard IT protocols with clear-text authentication
- ✚ Unprotected transport of SCADA application credentials

### ***Motivations and Abilities of Attackers***

Cyber-attacks may be perpetrated by an individual for any number of reasons—entertainment, as a point of pride or personal challenge or to exact revenge. In contrast, large-scale attack operations are typically executed by some type of organization which may be motivated by the opportunity to exact illicit economic gains, as a method of terrorizing a populace or even as a form of covert warfare against a nation.

---

<sup>159</sup> *Id.*

<sup>160</sup> Available at: [http://energy.gov/sites/prod/files/Vulnerability Analysis of Energy Delivery Control Systems 2011.pdf](http://energy.gov/sites/prod/files/Vulnerability%20Analysis%20of%20Energy%20Delivery%20Control%20Systems%202011.pdf).

To a utility or its regulators, the likelihood of the attackers being successful and the consequences of those attacks are more important than the reasons for an attack. The likelihood of an attacker's success is governed by raw ability, the availability of time and resources and how opportunities are presented. Sometimes even luck plays a role.

The consequences of the successful attacks depend mostly on the kind of information gained by the attacker and what is ultimately done with it. With increasing capabilities, an attacker is more likely to infiltrate better defended data. One may presume that better defended data is also more valuable to an organization, especially if its value is measured by how much damage can be inflicted by its misuse.

The following chart segments attackers into three groups, each with increasing ability and greater availability of resources and sophistication, all of which in turn coincide with greater potential consequences.<sup>161</sup>

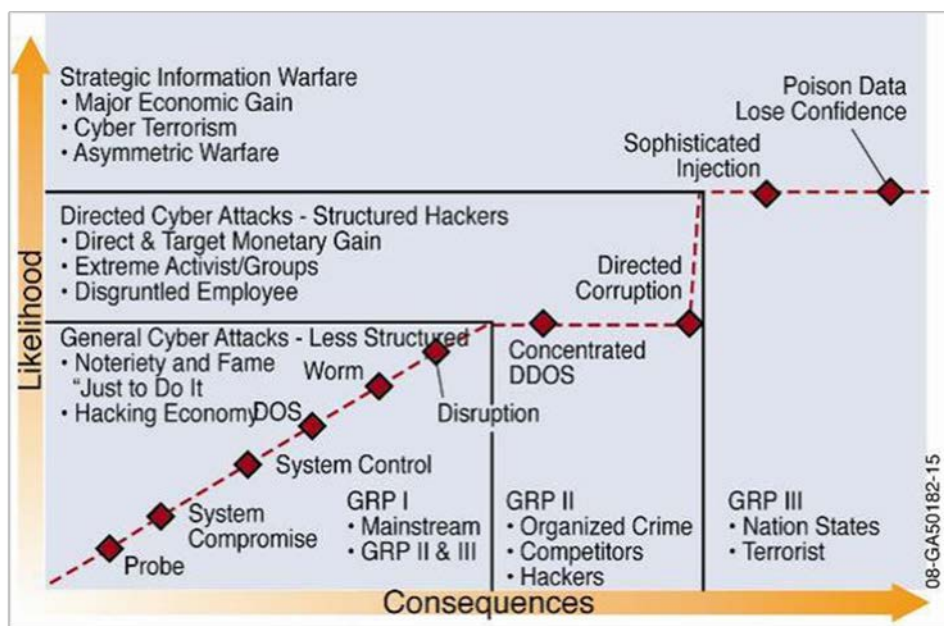

Figure 42: Likelihood of success vs. consequences of a successful attack

The attackers categorized under Group 1 are mainstream hackers, typically described as script kiddies—mischievous folks with limited knowledge who typically rely on simple attacks and the use of automated tools.

Group 2 consists of organized crime, unscrupulous industrial competitors and activist hacker groups. The attackers in this group have more structured operations and more resources available to them. These attackers typically employ sophisticated tools like a botnet, a

<sup>161</sup> [http://www.us-cert.gov/control\\_systems/pdf/Strategy%20for%20Securing%20Control%20Systems.pdf](http://www.us-cert.gov/control_systems/pdf/Strategy%20for%20Securing%20Control%20Systems.pdf).

collection of computers that are not in the physical possession of the attackers but which have been compromised by malware<sup>162</sup> and each connected to the Internet. The “bots” in the botnet are used to infiltrate and systematically gather sensitive and confidential information from a large number of computer systems. In the case of industrial targets, though, the attackers may be quietly pilfering from victims such information as facility layouts, control system usernames and passwords or product or process design documents. In the case of a utility, the intent may be to either interfere with operations or extort funds by threatening to do so, either of which may result in blackouts.

Group 3 attackers are typically nation-states or terrorist groups and therefore have the most resources available to them. Their aims are also more ambitious. Adversaries in this group are typically referred to as an advanced persistent threat (APT). APTs operate insidiously, maintaining a presence on a targeted entity’s systems to conduct espionage. The intelligence gathering being performed is not intended for immediate financial gain but is meant to be used for further infiltration and presumably to wait for an opportune moment to launch a full scale attack. In the case of an electrical utility or ISO/RTO<sup>163</sup> like ERCOT, the goal would probably be to cause system instability or even long-term and widespread outages.

With greater abilities and resources, an attacker has at his disposal more sophisticated methods of attack that are more difficult to detect, more likely to be successful and can have greater negative consequences.

## Challenges to Cybersecurity: Environment and Culture

One of the challenges of implementing cybersecurity for utilities is related to differences in technology. The electric utility industry itself has been around for more than a hundred years and predates the widespread incorporation of IT into the workplace by at least five decades. IT has been traditionally limited to improving efficiencies in the business portion of a company through office automation and the like and has only relatively recently been more extensively incorporated into operational technology (OT). OT can be defined as the technology used to run a facility, and in the utility business, this would naturally be the facilities necessary for electricity generation, transmission and distribution.

---

<sup>162</sup> Malware is a contraction of “malicious software” which is a computer program or script that is designed to disrupt the proper functioning of a computer, gather sensitive information or gain unauthorized access to computer systems.

<sup>163</sup> An ISO is an Independent System Operator and an RTO is a Regional Transmission Organization.

## ***Conventional IT versus ICS Environments***

Because ICS have ramifications in the physical world and work in real-time, deployed systems must be handled differently than IT systems used in the business/office part of an enterprise. For example, anti-virus programs that are installed on office PCs and enterprise servers with no adverse effect may cause computational processes in a functioning control system to bog down, increase network latencies and delay the responsiveness of field devices, all of which may result in disaster for an energy management system.

Another difference between a typical IT system and an ICS is expected lifetime. IT systems are typically refreshed on a three- to five-year cycle, while control systems traditionally have an expected lifetime measured in decades. Smart grid initiatives have introduced ever-evolving technologies into the energy production environment which in turn has made product obsolescence more of an issue than it has been traditionally. Thus the useful lifetimes of most industrial technology is also anticipated to shorten.

Because IT has become so ubiquitous over the years, many companies have developed specialized IT outsourcing services with lower cost structures, and many firms have taken advantage of this. In contrast, control systems still require special knowledge and involve more arcane technology so outsourcing is not as commonplace as it is in IT but is an increasing trend. The key takeaway is that utilities are becoming increasingly dependent upon their suppliers for support and therefore for reliable operations.

When security vulnerabilities are discovered in software, patches need to be developed by the vendor of the product to rectify the bugs. Control system vendors' patches tend to come slowly and at odd intervals. Microsoft's products, including Windows, are universal, so the company has a lot of pressure to issue these patches given that they affect many users. In contrast, the many different control systems vendors have many different products produced in a relatively low volume. This makes patch issuance quite a challenge for some vendors and has required these firms to begin reassessing their product development and support processes.

In an IT environment, change management is a regularly scheduled activity. Change management is an IT service management discipline that is employed to ensure that standardized procedures and methods are used to promptly and efficiently handle all changes to IT infrastructure. In the ICS field, changes happen more rarely and usually only when absolutely necessary. Thus, the change management processes may be different in such an environment or even seem downright alien to one visiting from the IT side of a business.

In an ICS environment, the criticality of time is much higher than it is in IT. Processes happen in real-time in ICS, so the timely arrival of data from sensors in the field, for example, is crucial. Emergency situations in which alarms are displayed or otherwise triggered immediately can prevent the loss of life. In an IT environment, a delay in the arrival of data is tolerable for the

most part. Experiencing latencies may try a user’s patience but will not result in fatal consequences. The availability of systems, just like the availability of electricity, is an absolute necessity in ICS and other real-time systems. It is just as critical that the computer processor be accessible to services that the operating systems (OS)<sup>164</sup> of the computer has requested to be run, as it is for a human operator to be able to press buttons on an HMI<sup>165</sup> and also see the results of his actions. The uptime of such a system must be 24 hours a day, and 7 days a week.

Security awareness tends to be rather good in conventional IT. The architecture has been in place long enough and the field of computer security is mature enough that practitioners are generally up to speed. The convergence of computer-based technologies with the electric production environment is new by comparison, so there is still room for significant improvement.

Physical security is something that IT-centric facilities have had enough time to master. Keeping a data center secure, for example, is of primary importance, and it is quite obvious that it must be locked down tight. Security systems are omnipresent and robust, and for the most part, the areas are heavily trafficked so it also provides for many witnesses; personnel tend to know who belongs and who does not. In energy operations, though, many facilities and the systems they contain tend to be remotely located and unmanned and therefore subject to incursion, vandalism and theft.

Figure 43 briefly describes the differences between the operational and maintenance requirements of IT systems versus control systems.<sup>166</sup>

**Figure 43: Information technology vs. control systems**

Topic	Information Technology	Control Systems
Anti-virus/mobile code	Common/widely used	Uncommon/impossible to deploy
Support technology lifetime	3-5 years	Up to 20 years
Outsourcing	Common/widely used	Rarely used
Application of patches	Regular/scheduled	Slow (vendor specific)
Change management	Regular/scheduled	Rare
Time critical content	Generally, delays accepted	Critical, due to safety
Availability	Generally, delays accepted	24 X 7 X 365, forever
Security awareness	Good	Poor, except for physical
Security testing/auditing	Scheduled & Mandated	Occasional testing for outages
Physical security	Secure	Remote and unmanned

<sup>164</sup> i.e., Microsoft Windows, UNIX, Linux.

<sup>165</sup> The interface in which a person can interact with an ICS; similar to what a mouse, keyboard and display is in regard to a conventional PC and its user.

<sup>166</sup> Patrick Miller, NESCO, NARUC Cyber Security Training, Indianapolis, IN (Dec. 1, 2011).



Rather than employing existing standard security practices that are typically put in place to protect the IT infrastructure of the business portion of an enterprise, these practices must be altered to accommodate the unique characteristics of the electrical infrastructure and tailored so that they will not cause a disruption in energy operations.

### ***Cultural Differences between IT and OT***

Another challenge of implementing cybersecurity in utilities is the industry's culture. Utility operations have traditionally been dominated by engineers who are educated and trained to understand the underlying science behind electricity as well as the systems and instrumentation used to measure, control and direct it. Similar to any office function, over the years, the engineering environment has incorporated an increasing amount of computer systems, and work processes have also been adapted to accommodate the use of IT.

It has been widely acknowledged in the United States that qualified engineers are increasingly difficult to come by. Students of the past few decades have had a diminished interest in pursuing science- and engineering-based courses of study, while other areas have generally become more attractive to them as a career path. Information technology, on the other hand, has a broader appeal as evidenced by increased student enrollments in college IT and Computer Science programs over the past two decades. IT has become more pervasive thereby offering what has been perceived by new students as more opportunities upon graduation. Further, web-based technologies have enabled the workforce to be more mobile—not just for the *users* of the technology but also for those who *create* it. A programmer can relocate to a community and then work remotely. An IT worker has many choices so in contrast to a typical utility worker, the tenure of a typical IT staffer at any given company is relatively short, and IT staff turnover is rather high.

As OT continues to automate, it is taking on more of the characteristics of IT. As a result of this convergence, management at utilities leans on their IT staffs for support in functions that would be ideally handled by someone with operational (i.e., OT) knowledge and experience. The problem with this is that IT staffers tend to be computer-focused in approach and do not possess the understanding of real-world processes that an engineer would have. Further, whereas IT security has developed in conjunction with business process automation over the past couple decades, OT Security is a relatively new concept. Solutions devised for an IT environment cannot just be plugged into the OT environment without the possibility of adverse consequences.

### ***Security versus Compliance***

When it comes to security considerations, the threat of fines that may be imposed upon utilities by NERC for noncompliance with its CIP standards can potentially take center stage in a dialog

about security. This is only natural since fines can be readily defined in terms of dollars taken from the company's bottom line.

One of the primary goals of the PUC is to ensure that the grid remains safe and reliable. To accomplish this goal, staff encourages utilities to promote a culture of security. One of the traps that a utility can fall into is having a mindset that is focused more on compliance than on security where the utility is doing the minimum necessary to meet an audit or to achieve regulatory compliance. In contrast, the pursuit of security is doing what is necessary, often within the compliance or audit structure, to reduce risk to an acceptable level as defined by the requirements of the business. Being able to discern the difference is important because mandating a compliance-based approach can be viewed as only an interim step that comes with the caveat that this alone may not save one from an attack.

Staff also encourages utilities to consider looking into the possibility of acquiring compliance reporting automation solutions to lessen the administrative burden of NERC CIP audits. That way, instead of committing substantial resources to dealing with the paperwork associated with demonstrating compliance, utilities' subject matter experts can instead concentrate on their security activities.

## Cybersecurity Standards

There are a handful of groups currently working to promote the development of cybersecurity standards for the smart grid. Governmental agencies such as the PUC can use adopted standards to provide a technological or scientific basis for regulations that promote reliability, safety and efficiency.

When developing standards, a stakeholder process ensures that market-led solutions are created. The process reflects the interests of all parties including those that are small or medium in size. It also includes the voice of consumers, regulators, industry and the environment. The stakeholder process promotes fair competition and avoids unhealthy concentrations of economic power.

Much of the cybersecurity standards work being done is to provide an alignment among existing standards to harmonize them. In other words, the efforts are to avoid reinventing the wheel and instead concentrate on assessing existing standards, finding any gaps in them and plugging the holes. An alternate way of looking at it is a melding of standards by way of putting them side-by-side and ensuring that there is a one-to-one correspondence for each aspect.

The stakeholder process can be contentious at times and can also take longer than a top-down process would where standards are imposed by an agency, which may be ultimately viewed in a somewhat authoritarian manner. In addition, some stakeholder groups may be outnumbered by others in the entire group as a whole or in the various subgroup activities. State regulatory

agencies such as the PUC may be among the stakeholders who are at risk of this, given that few states are participating in the standards efforts from the outset. The participants from states that are taking part have been generally spread rather thin and therefore have not been able to participate substantially in all the contemporaneous activities.

**Roles: Smart Grid Standards**

Figure 44 shows the many complex relationships among federal agencies and legislative committees that are involved in cybersecurity for the electric grid.<sup>167</sup>

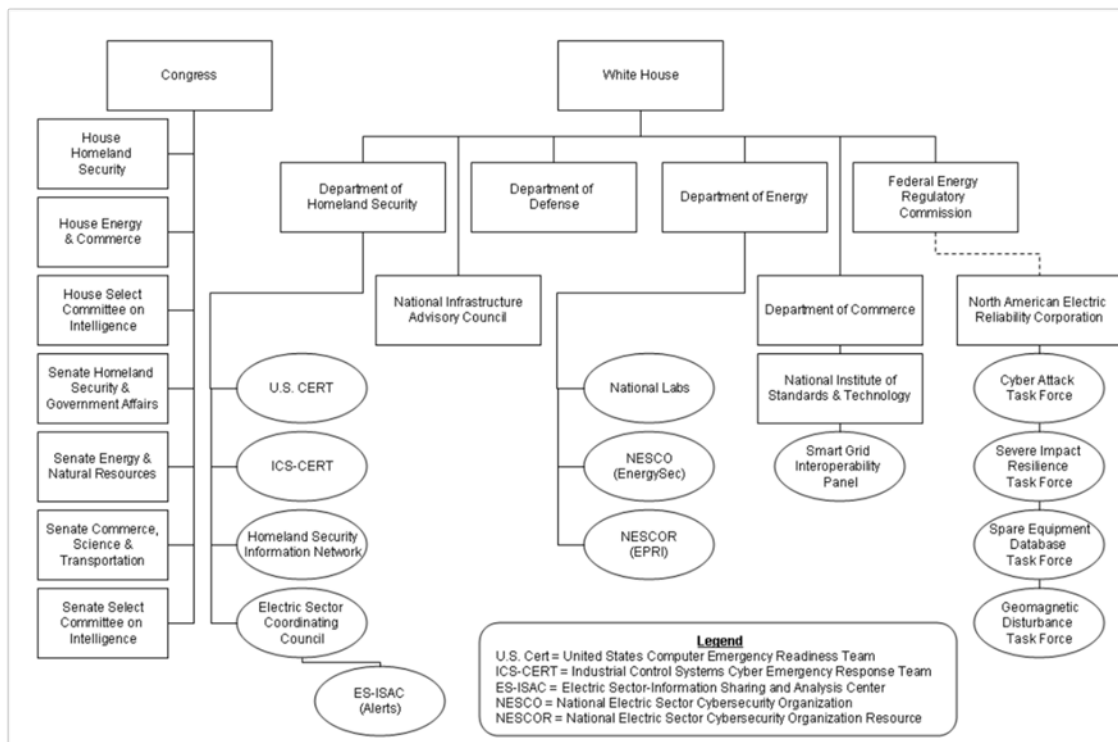

Figure 44: Organizations supporting smart grid and cybersecurity

**Procurement: Incorporating Security - Built-in or Bolted On?**

In order to be most effective, security needs to be built into acquired products and systems from the beginning rather than just being “bolted on” after the fact. It is vital that a utility clearly specify its security requirements to vendors. Any software and system must utilize fully-implemented security standards. This can only be accomplished if a customer is familiar with the terminology that demands demonstrable and thus contractually enforceable results. DHS

<sup>167</sup> *Id.*

has created a product that defines these terms as well as other guidance in its document, *DHS Cyber Security Procurement Language for Control Systems*.<sup>168</sup> The National Cyber Security Division of DHS also sponsors a website called “Build Security In”<sup>169</sup> which is a collaborative effort that provides practices, tools, guidelines, rules, principles and other resources for software developers, architects and security practitioners to build security into software in every phase of its development.

### ***Product Design and Certification***

A utility may believe that it has taken all reasonable measures to secure its own infrastructure, but what about its suppliers? How can a company be sure that the equipment it buys is secure and the firms it hires to integrate any new systems into its existing infrastructure have done all that they can to keep the overall system secure?

Utilities must find a way to secure their supply chains, and at the same time there is only a limited universe of companies that are capable of supplying the sophisticated products which are a part of the electrical infrastructure. Utilities are therefore somewhat at the mercy of their vendors whether these vendors manufacture products, provide software or supply services. A way of addressing this quandary is through standards that focus on secure product design and certification. One caveat must be mentioned before proceeding—any certification does not necessarily guarantee a product is completely secure. A certification is similar to taking a snapshot—it is a representation of a moment in time, but the threat landscape is ever-fluid and dynamic.

This issue of supply chain and vendor security capabilities is not unique to the electricity industry. In IT, such computer product security certification has been established previously through Common Criteria for Information Technology Security Evaluation,<sup>170</sup> an international standard: ISO/IEC 15408.

Several initiatives from industrial control have made progress in cybersecurity. For example, the ISA, currently the International Society of Automation but formerly known by several other names, has been developing the ISA99 series of standards along with associated technical reports, several of which have been publicly released by the American National Standards Institute (ANSI). ISA99 falls under the ISA’s Industrial Automation and Control System Security Committee. Work products from the ISA99 committee are also submitted to the International Electrotechnical Commission (IEC) for consideration to adopt as standards and specifications in what the IEC refers to as its IEC 62443 series.

---

<sup>168</sup> [http://www.us-cert.gov/control\\_systems/pdf/FINAL-Procurement\\_Language\\_Rev4\\_100809.pdf](http://www.us-cert.gov/control_systems/pdf/FINAL-Procurement_Language_Rev4_100809.pdf).

<sup>169</sup> <https://buildsecurityin.us-cert.gov/bsi/home.html>.

<sup>170</sup> <http://www.commoncriteriaportal.org/>.

## An Emerging Procurement Standard: IEC 62443-2-4

A cybersecurity standard currently under development is IEC 62443-2-4, part of a series of standards that address cybersecurity of control systems including those used in the smart grid. The standard's owner, the International Electrotechnical Commission (IEC), is the world's leading organization for the preparation and publication of international standards for all electrical, electronic and related technologies. The IEC provides a vehicle for key stakeholders to meet, discuss and develop standards. All standards are fully consensus-based, drawing input from companies, industries and governments of every nation participating in IEC work. Every member country, no matter how large or small, has one vote to decide what goes into an IEC international standard.<sup>171</sup>

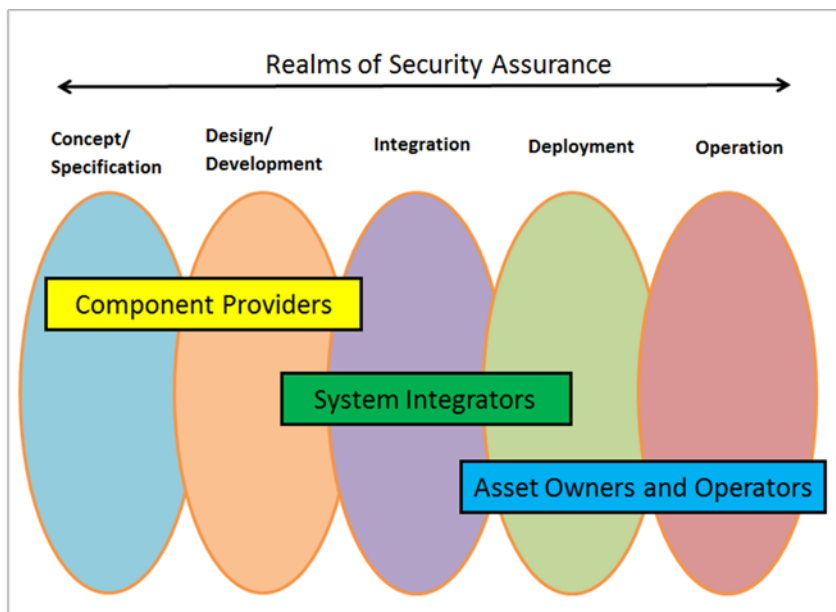

**Figure 45: Stakeholders and security assurance responsibilities throughout a product's lifecycle**

The IEC 62443 standards are organized into four categories that identify their intended primary audience. The first category, General, is applicable to all stakeholders and includes common information such as the concepts, models and terminology of the standard. Work products that describe security metrics are included in this category. Stakeholders assert a variable amount of influence on a product, depending on where that product is in its intended

lifecycle, and security is one of the considerations with which stakeholders need to be concerned. Figure 45 shows where the stakeholders fit into the product lifecycle and therefore where their roles in keeping such devices secure lie.

The second stakeholder category is the Asset Owners and Operators, and the work products from IEC 62443 are directed mainly toward addressing the various aspects of creating and maintaining a control system security program.

<sup>171</sup> <http://www.iec.ch/about/>.

System Integrators are primarily targeted by the third category, which includes standards and technical documents that lay out system design guidance, as well as the requirements to integrate control systems. The ISA refers to this as “the zone and conduit design” model. The fourth and final category, targeted at Component Providers, includes work products that call out technical and specific product development requirements of control system products. While this last category is primarily intended for vendors of control systems and components, it can also be used by integrators and asset owners to specify and procure secure products.

Electric utilities are viewed in the context of IEC 62443 as being Asset Owners, so as the regulator of these entities, our focus is primarily on the standards and activities of the Asset Owner category, namely the IEC 62443-2 series.

US commenters on IEC 62443-2-4 (which included PUC staff) assessed the proposed standard and submitted comments to ensure that it would be in alignment with NISTIR 7628 and NERC CIP.

## Plug-In Hybrid Electric Vehicles

Production of electricity for household, commercial and industrial uses has been one of the major uses of energy in Texas and the United States. Another major consumer of energy has been the transportation sector. Unlike the electric sector which relies to a great extent on domestic fuels such as coal and natural gas, the transportation sector relies heavily on

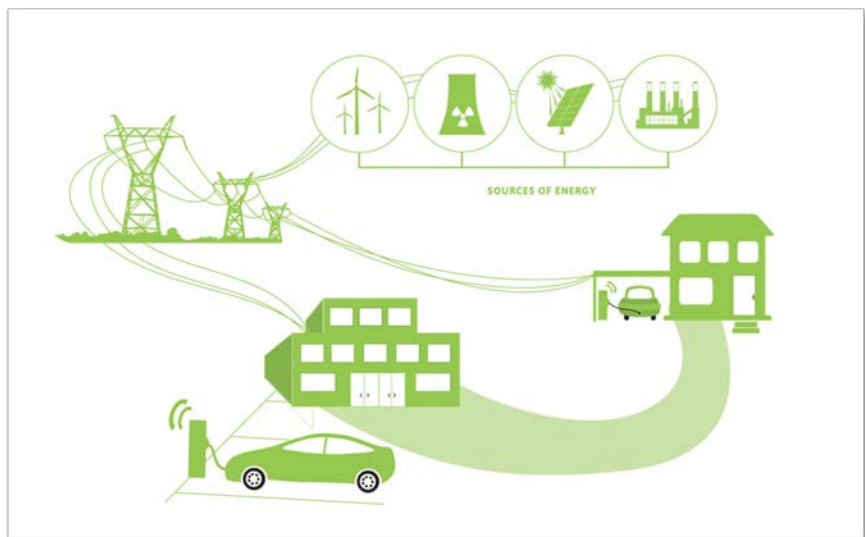

Figure 46: PEV fuel paradigm

crude oil produced outside of the US. Until recently, there was little connection between these two sectors. However, domestic and foreign automobile manufacturers have begun large-scale production of electric vehicles and are selling them in the US. Texas was an early market.

The potential benefits of a fundamental change in the way the transportation sector is fueled include reducing reliance on a single source of primarily imported fuel (crude oil), reducing

emissions of regulated pollutants in and near urban areas and reducing emissions of greenhouse gasses. Developing an alternative transportation fuel could pose significant challenges. The nation and the state have a broad infrastructure to distribute gasoline and diesel fuel for transportation use, but switching to a different fuel such as natural gas or hydrogen would require a new distribution infrastructure. The electric grid is already in place, and electrification in the transportation sector is less challenging than introducing a new fuel for which the current fueling infrastructure is not well suited. Texas homes and business have standard (120 volt) electrical outlets that are capable of charging the plug-in electric vehicles (PEV) that automakers are selling in Texas. Figure 45 illustrates the plug-in electric vehicle (PEV) fuel paradigm.<sup>172</sup> The prospect of sales of increasing numbers of electric vehicles does raise a few concerns for the electric industry, primarily related to when and how vehicle owners will recharge their vehicles' batteries.

To better serve Texans who are embracing electric vehicles and other alternative fuels, the PUC has linked to a GIS map of alternative fuel stations across the country, including EV charging stations. It is available through the PUC website. As of March 2012, there were 570 charging stations deployed in the state.<sup>173</sup>

## Near-Term Issues

The PUC conducted a workshop on electric vehicles on May 12, 2010, and several near-term issues emerged concerning the coming of PEVs to Texas. One of the concerns that participants identified was the need for automobile companies, utilities and other entities to work together to ensure a positive experience for PEV buyers and provide them information on matters like recharging options and costs. While this concern is one that primarily is the responsibility of the auto manufacturers and dealers, utilities and retail electric providers are affected because home charging stations could impact the electric network and local distribution facilities. Pricing options for electricity will likely be more important as electric consumption increases due to vehicle charging.

Based on customers' expectations and the lack of public facilities to recharge PEVs, the expectation is that initially most PEV charging will take place at home (Figure 47 depicts a Volt charging at a home station).<sup>174</sup> As demand for public charging stations emerges, public charging infrastructure will likely evolve.<sup>175</sup> All Texas homes with electric power have standard 120 volt outlets that will enable Level I "slow charging" of electric vehicles with a connector

---

<sup>172</sup> Graphic courtesy of Plug-In Texas.

<sup>173</sup> Environment Texas Research & Policy Center, *Charging Forward: the Emergency of Electric Vehicles and their Role in Reducing Oil Consumption*, at 15 (Summer 2012).

<sup>174</sup> Photo courtesy of ECOtality's Dave Aasheim.

<sup>175</sup> *Characterizing Consumers' Interest in and Infrastructure Expectations for Electric Vehicles: Research Design and Survey Results*, Electric Power Research Institute, 2-10 (2010).

cord. The main drawback of Level I charging is the time needed to charge an electric vehicle battery. The Chevrolet Volt, for example, takes six to eight hours to charge at 120 volts, and the Nissan Leaf takes up to 16 hours to charge. Texas homes will have the option of quicker Level II charging at 240 volts, but an Electrical Vehicle Supply Equipment (EVSE) unit would need to be installed. The EVSE equipment would charge batteries twice as fast as Level I charging, but older homes may not have internal wiring to support a 240 volt EVSE. Some automobile manufacturers that plan to market PEVs in Texas are partnering with private EVSE companies to offer residential Level II EVSEs.

The PUC hosted a follow-up workshop on August 16, 2010 to explore any system upgrade and cost allocation issues that the TDUs might encounter in their preparations for electric vehicle charging. The TDUs believe that the main distribution infrastructure components that will be affected by electric vehicle charging will be neighborhood transformers. If several electric vehicles are housed and recharged at homes in a neighborhood served from the same transformer, the transformer could be stressed. PEV charging requirements could affect transformers in two ways: (1) increasing the use of the transformers and thus their internally-generated heat and (2) reducing the cooling period that normally occurs at night when other electrical uses are lower. The additional thermal load could shorten the lifespan of these transformers. While night charging of electric vehicles may be detrimental at the local level, night charging should better fit customers' needs initially when public charging stations are not expected to be numerous or convenient to most customers. Most transmission utility representatives agree that the transmission and distribution system impacts, particularly the possibility of transformer overload, will be minimal during the initial phases of PEV adoption with the possible exception of some small regional pockets.<sup>176</sup>



**Figure 47: Charging a Volt**

While initially most charging is expected to be done at home, customers will want the ability to recharge quickly at public locations, and demand is expected to grow for public charging stations. As the standards for charging stations have evolved, the state has seen some issues develop. For instance, the Society of Automotive Engineers has approved a DC fast charging

---

<sup>176</sup> KEMA and CenterPoint Energy Whitepaper, *Electric Vehicles in Houston: Motivations, Trends, and Distribution System Impacts*, 48 (June 23, 2010). This report identifies specific areas in the Houston area that are expected to have higher saturation of PEVs.



standard for American-made PEVs while the Japanese adhere to a separate one. It is possible that existing fast charging stations in the Dallas and Houston areas may have to be retrofitted to handle the discrepancy.

## Long-Term Issues

In the long-term, if the number of PEVs in use increases significantly, there are likely to be questions about how PEVs interact with the electrical network. PEVs represent an additional load on the network that will need to be met by a diverse set of resources, but they also represent a potential resource for the network that could help provide reliable service for all customers. PEVs store electricity in their batteries, and they could send electricity back to the grid when aggregate or local electricity demand is high or energy is needed to deal with system problems. These possibilities are beyond the capabilities of the first electric vehicles that automakers are producing, but small pilot projects in other regions of the country are exploring how vehicle owners might receive compensation for supplying energy back to the electric grid.<sup>177</sup>

Attendees at the PUC workshop discussed the possibility of synchronizing plug-in electric vehicle charging with wind generation as car batteries, advanced metering and smart phone technologies develop. Synchronizing wind generation with electric vehicle charging could allow plug-in electric vehicle owners in Texas to take advantage of lower price energy because a large amount of wind generation typically occurs at night when demand from other electricity users is low. Researchers are also studying how PEVs might supply additional energy to offset a rapid reduction in output from wind farms. To achieve the synchronization of PEV charging to the grid, PEVs would have to be able to communicate with the grid and respond to signals that prices are low (because wind energy is abundant, for example) or that a problem has occurred for which the energy stored in PEV batteries could provide a solution. An advanced system of communications and control software could permit the independent electric system operator to send signals to the vehicle which could respond by allowing the PEV's battery to charge or discharge. The PEV would respond to system conditions based on the PEV owner's pre-selected preferences which would support the electric system when needed and draw energy from the electric system when energy is inexpensive. The possibility of electric vehicles giving energy back to the grid when needed is often referred to as vehicle to grid (V2G) technology.

---

<sup>177</sup> University of Delaware, *Vehicle to Grid Technology* (2009).

## Energy Efficiency

The PUC amended its existing rules relating to energy efficiency and adopted a new rule in 2012 to raise the electric utilities' energy efficiency goals from 20% of annual growth in the utilities' demand for electricity of residential and commercial customers to 25% of the growth in demand of these customers in 2012 and to 30% of the growth in demand in 2013.<sup>178</sup> The new rule also:

- ✚ Updated the cost-effectiveness standard by adjusting the avoided cost of capacity and the avoided cost of energy;
- ✚ Modified the calculation of a performance bonus for an electric utility that exceeds its goal;
- ✚ Added an evaluation, measurement and verification (EM&V) framework, and accompanying definitions will result in the PUC hiring an outside consultant(s) to develop a process that ensures accurate estimation of energy and demand impacts and will provide feedback to the PUC, utilities and stakeholders on program performance and
- ✚ Increased the set-aside for targeted low-income programs to ten percent of the utility's budget.

The new rule was adopted in late 2012 with the purpose of pacing the increase in the energy efficiency goal in a modest manner while capping the cost on a per kWh basis at a reasonable level to meet the new goals and subsequently providing the PUC the time to evaluate the continued cost-effectiveness of each program within a utility's portfolio.

The energy efficiency program under PURA §39.905 is designed to improve utility customers' energy use through measures that reduce electricity demand and energy consumption. This program is administered by the utilities and funded through an energy efficiency cost recovery factor paid for by customers. In 2011, the utilities spent approximately \$114 million on this program. The goals set forth in PURA for the energy efficiency program include:

- ✚ Electric utilities administer energy efficiency incentive programs in a market neutral, nondiscriminatory manner;
- ✚ All customers have a choice of and access to energy efficiency alternatives to reduce energy consumption, peak demand or energy costs and
- ✚ Cost-effective energy efficiency measures are to be acquired for residential and commercial customers.

---

<sup>178</sup> *Rulemaking Proceeding to Amend Energy Efficiency Rules*, Project No. 39674.

## Demand and Energy Goals

Eight of the ten participating utilities were eligible for bonuses for calendar year 2011 as utilities exceeded their demand reduction goals by 191%. The TDUs saved nearly 529,334 megawatt-hours of energy and exceed their goals by 214%. The TDUs' combined goal for reduction in growth in demand for calendar year 2011 was 141.24 MW, and the achieved demand reduction was 270.14 MW.

As a complement to the demand savings which are measured in megawatts the energy efficiency program resulted in energy savings measured in megawatt hours. These quantified energy savings are necessary in order to calculate the estimated emission reductions achieved through the energy efficiency programs and are provided to the Texas Commission on Environmental Quality (TCEQ) for possible State Implementation Plan (SIP) credit. Cumulatively, the utilities achieved total energy savings of 529,334 MWh in addition to 270.14 MW of demand savings during calendar year 2011.

The utilities spent a total of \$113,560,878 for energy efficiency programs implemented during 2011. Incentives were paid to energy efficiency service companies (ESCO) following their installation of energy efficiency measures and provision of any required verification of results. Reimbursements to ESCOs were based on installation of energy efficiency measures and calculation of the savings through a measurement and verification protocol or PUC-approved deemed savings values. Individual TDU demand and energy savings for calendar year 2011 are noted below.<sup>179</sup>

### 2011 Verified Savings by Utility

	Verified		Goals	
	MW	MWh	MW	MWh
SPS	3.88	13,821.00	3.86	6,761.00
Oncor	75.00	209,973.00	53.10	93,031.20
SWEPSCO	15.03	22,582.00	5.60	9,811.00
Sharyland	0.06	352.00	NA	NA
CenterPoint	110.24	146,091.70	39.21	68,694.00
AEP TCC	27.50	69,157.78	12.93	22,657.00
AEP TNC	4.44	9,968.28	-1.82	-3,194.00
Entergy Texas	16.20	22,235.00	12.40	21,725.00
El Paso	12.83	21,737.00	11.16	19,552.00
TNMP	4.96	13,416.00	4.80	8,266.00
<b>TOTAL</b>	<b>270.14</b>	<b>529,333.76</b>	<b>141.24</b>	<b>247,303.20</b>

<sup>179</sup> Project No. 40194, *Calendar Year 2011 Energy Efficiency Reports Pursuant to P.U.C. SUBST. R. 25.181(m)* (April 1, 2012).

## Emission Reductions from Utility Energy Efficiency Program

The utilities' energy efficiency programs are a broad series of measures designed to reduce electricity demand and energy consumption.<sup>180</sup> Reductions in energy consumption result in reduced electric production that contributes to lower emissions in non-attainment areas and affected counties. Areas are designated as non-attainment by the Environmental Protection Agency (EPA) when they do not meet the National Ambient Air Quality Standards for particular pollutants.

In compliance with the Clean Air Act, TCEQ has developed SIPs to address the Texas counties that do not meet EPA's national ambient air quality standards for ozone. Although the energy efficiency programs will result in the reduction of emissions of NO<sub>x</sub>, sulfur dioxide and carbon dioxide, the focus is the NO<sub>x</sub> emissions reductions.

To estimate NO<sub>x</sub> emissions reductions resulting from the energy efficiency program, the PUC relies on EGRID, a national database of air emissions that is maintained by the EPA, to link energy savings to emissions reductions. The Energy Systems Laboratory at Texas A&M University (ESL) will utilize EGRID in combination with the utilities' reported savings to estimate the annual and peak ozone day NO<sub>x</sub> emissions reductions. The energy efficiency programs are developed to achieve energy savings during the peak period of electrical consumption, May through September. Some of the measures also result in savings outside of the peak period. The peak energy consumption period generally corresponds to the ozone season. Utilities' efforts to meet the demand reduction mandate and the associated cost incurred to achieve the reported savings will also be discussed.

### **Regulatory Framework**

To meet the statutory requirements of PURA §39.905, Goal for Energy Efficiency, and Health and Safety Code §386.205, Evaluation of State Energy Efficiency Programs, the PUC continues to apply and amend P.U.C. SUBST. R. 25.181 and 25.183.

Section 25.181 governs the implementation of the energy efficiency program and requires that TDUs acquire energy efficiency savings equal to at least thirty percent of their growth in demand beginning in 2013. Utilities may acquire these savings through the administration of standard offer programs, targeted market transformation programs, self-delivered programs or pilot programs. Section 25.183 requires utilities to report their program results to the PUC which in turn provides them to the ESL to calculate the annual emissions reductions.

---

<sup>180</sup> PUC, *Report to TCEQ Concerning Emission Reductions from Utility Energy Efficiency Program* (Aug. 31, 2010).

PUC staff and utility program managers meet regularly with others who are interested in the energy efficiency program in an Energy Efficiency Implementation Project (EEIP) to assist in implementing the energy efficiency goals. These meetings serve as a forum for discussion of program changes and new technologies. PUC staff is working to formalize the EEIP process to address program design issues and to consider the recommendations of the EM&V evaluator to be hired by the PUC in early 2013.

### ***EGRID – Air Emissions Database***

The EPA’s Office of Atmospheric Programs Global Programs Division developed the model used to estimate the air emissions reductions from the energy efficiency program, relying on the fact that the Texas electric grid (ERCOT) is a closed system. This means that all electricity on the ERCOT grid is both generated and consumed in Texas. Outside of ERCOT, the electric companies in Texas—El Paso Electric, Southwestern Public Service, Entergy Texas and AEP Southwestern Electric Power—import and export electricity across state boundaries. To calculate emissions reductions in ERCOT, emission factors from EGRID will be used, based on an assumption that production from a set of ERCOT power plants would be reduced when energy consumption is reduced as a consequence of energy efficiency activities.

This methodology relies on the EPA’s EGRID database of measured power plant emission rates, historical relationships between the areas in which power is produced and the areas in which it is consumed and the operating characteristics of the power plants in the region. It reflects, for example, assumptions that coal and nuclear power plants do not change their operation as a consequence of reductions in energy consumption, although these assumptions may change due to new federal environmental regulations. The methodology assumes (based on historical experience of efficient plant dispatch) that gas-fired plants are the marginal units that respond to changes in energy consumption.

The emissions reductions are to be based on savings that the utilities reported for the previous calendar year. The methodology for quantifying the emissions reductions was developed through a collaborative process among the PUC, the EPA’s Office of Atmospheric Climate Protection Partnership Division, TCEQ and ESL. ESL will perform the actual calculations to estimate the emissions reductions utilizing information provided by the PUC and the EPA’s 2007 version of the EGRID database.

## **State Energy Conservation Office Initiatives**

The State Energy Conservation Office (SECO) helps reduce energy use in Texas by promoting technologies and procedures that encourage energy efficient operations. Implementation and

deployment of clean energy and energy efficient technologies can significantly reduce both the demand for electricity and the associated distribution problems with the grid. SECO is committed to improving the air we breathe by promoting the use of alternative energy and fuel sources.

As the state energy office, SECO partners with Texas consumers, businesses, educators and local governments to reduce energy costs and maximize efficiency. More information on SECO’s programs is available on its website.<sup>181</sup>

The Texas Powerful Smart website is its public outreach mechanism. SECO assisted in the development of the “Energy Security for Critical Buildings” program that enables critical structures to continue operating during an outage mandated by law. More information can be found at [www.txsecurepower.org](http://www.txsecurepower.org).

SECO program funding is directed toward publicly funded entities; by providing resources to update to more efficient technologies, all taxpayers receive the benefit.

The State Energy Program (SEP) provides grants to states and directs funding to state energy offices from technology programs in DOE's Office of Energy Efficiency and Renewable Energy. States use grants to address their energy priorities and program funding to adopt emerging renewable energy and energy efficiency technologies. There are five market areas/titles with the SEP.

1. **Efficiency Grants and Technical Assistance:** Promotes and provides energy efficiency services to reduce operating expenses for schools, and state and local governments, to increase energy efficiency and demand reductions through improved building design, code compliance, and proper planning and maintenance and to improve air quality through energy efficiency. There are four activities/programs within the Efficiency Grants and Technical Assistance market area:

Activity/Program	Purpose
1.1 Preliminary energy assessments for public facilities	Identify energy savings opportunities and support project implementation
1.2 Engineering assistance for LoanSTAR	Review plans, designs, implementation of retrofit projects and quality assurance during the process
1.3 Low to moderate income housing assistance	Increase energy efficiency through partnerships among nonprofit organizations, community action agencies, local governments, utility companies, public housing authorizes and

<sup>181</sup> <http://seco.cpa.state.tx.us/>.

	social service organizations
1.4 Local Government Energy Efficiency Grants	Provide simple energy efficiency retrofits grants that are too small for typical LoanSTAR projects

2. **Emerging Clean Energy Technology:** Promotes public awareness and acceptance of renewable energy technologies and alternative fueled vehicles while reducing air emissions and increasing clean energy companies. There are three activities/programs within the Emerging Clean Energy Technology market area:

Activity/Program	Purpose
2.1 Renewable energy technologies for public entities	Demonstrate solar, wind, geothermal and biomass technologies through small scale deployment activities in public facilities
2.2 Alternative fuels initiatives	Partner with local governments to transition vehicle fleets to alternative fuels and hybrid-electric vehicles
2.3 Clean energy business incubation	Grow and develop new markets for clean energy technologies through university-linked clean energy business incubators

3. **Energy Training and Education:** Promotes a consistent, transferable education pathway for community and junior colleges; supports a skilled workforce for various clean energy developments; introduces students at all levels to the benefits of renewable energy, energy efficiency and alternative fueled vehicles and allows greater reach and impact for targeted workshops, seminars and conferences. There are three activities/programs within the Energy Training and Education market area:

Activity/Program	Purpose
3.1 Collaborative technical training for renewable energy, building and facility energy performance	Provide building energy code training for contractors, homebuilders and local officials; curriculum development and support for collaborative technical training and public and industry education
3.2 On-line education opportunities	Provide on-line energy education for the classroom
3.3 Competitive Event Sponsorships	Sponsor energy efficiency, renewable energy or alternative fuel vehicle events

4. **LoanSTAR:** A competitive loan program for public entities including state agencies, school districts, higher education facilities, local governments and hospitals to be repaid through energy cost savings realized from projects. There is one activity/program within the LoanSTAR market area:

Activity/Program	Purpose
LoanSTAR Revolving Loans	Reduces operating expenses, increases energy efficiency and demand reductions and improves air quality through improved building design, code compliance, and proper planning and maintenance on public facilities

5. **Program Delivery:** Includes the administration, support and accounting for all activities/programs.

## Economic Variables

The PUC’s work is impacted by general economic conditions as well as technological advances and dramatic price swings in the underlying commodities that fuel power plants.

Texas residential consumers’ consumption is predominantly driven by seasonal weather factors with extended durations of severe heat or cold most significantly impacting usage. Residential consumers otherwise generally only change their consumption in response to dramatic changes in price or individual economic conditions. The retail price of electricity peaked in fiscal years 2008 and 2009 and has declined substantially due to markedly lower natural gas (and consequently electricity) prices and competitive market pressures. Currently, the average price per kilowatt-hour (kWh) for residential customers is 9.8 cents based on the average 12-month, fixed price contracted listed on the PUC’s Power-to-Choose website. This price compares favorably to the national average reported by the Energy Information Administration of 11.8 cents per kWh.

In response to higher prices and general economic conditions, retail electricity providers reported declines in average consumption by consumers during 2008 and 2009 and significantly increased usage during the extreme weather conditions of 2011. Texas entered the national recession later than the rest of the nation, experienced a less severe contraction and exited sooner, returning to pre-recession employment in early 2012. This relatively healthy economic environment has led to Texas experiencing increasing demand for electricity at a substantially higher rate than the rest of the country. This divergence is highlighted by the NERC 2012 summer assessment that forecasts an overall *decline* in peak electricity demand nationwide by 0.4% while the ERCOT region’s demand is forecasted to *increase* by 1.7%. As Texas is projected to continue to lead the nation in population and employment growth and substantial new business and manufacturing investment has been announced, this trend is unlikely to change in the near term.



The adequacy of electricity supply and the need for additional power plant capacity in the state is directly impacted by this growth. Since 2001, Texas' electricity markets in the majority of the state have been opened to competition, and the PUC has limited authority to ensure that the supply of electricity is adequate. This is an important change from two decades ago when the PUC was required by statute to produce a statewide forecast of electricity demand and approve the construction of new power plants by fully regulated utilities. While the PUC still performs these functions for regulated utilities in El Paso, the panhandle and east Texas, for the rest of the state, ERCOT performs semi-annual forecasts of electricity supply and demand expectations to inform the marketplace of the need for additional generation supplies. Substantial investment in new power plants in Texas has occurred over the last decade, led by a large amount of efficient natural gas generation in the early part of last decade, followed by substantial investments in new coal and wind facilities. Although Texas currently has an adequate and reliable supply of electricity available to meet projected demands through 2013, some projections have suggested that supplies may not provide for the traditional level of reliability in coming years. While the PUC remains convinced that properly functioning competitive markets should result in adequate generation capacity, the PUC and ERCOT have engaged in substantial work over the past 18 months to ensure that market rules are providing the proper signals.

Other economic conditions and factors can also impact development of new power plants. Capital markets are very different now than during the last several periods when new power plants were needed. Developers generally have a much more difficult time securing project financing for power plants that do not have long-term purchased power agreements with them. Additionally, new environmental regulations and certain provisions of the Dodd-Frank Act have introduced new complications and potential barriers to the permitting and financing of certain generation assets.

These efforts are ongoing, including the examination as to whether current caps on wholesale market prices should be raised in order to provide adequate incentives for companies to invest in new power plant capacity in ERCOT, as well as how additional demand response initiatives may help ensure reliability.

## Resource Adequacy

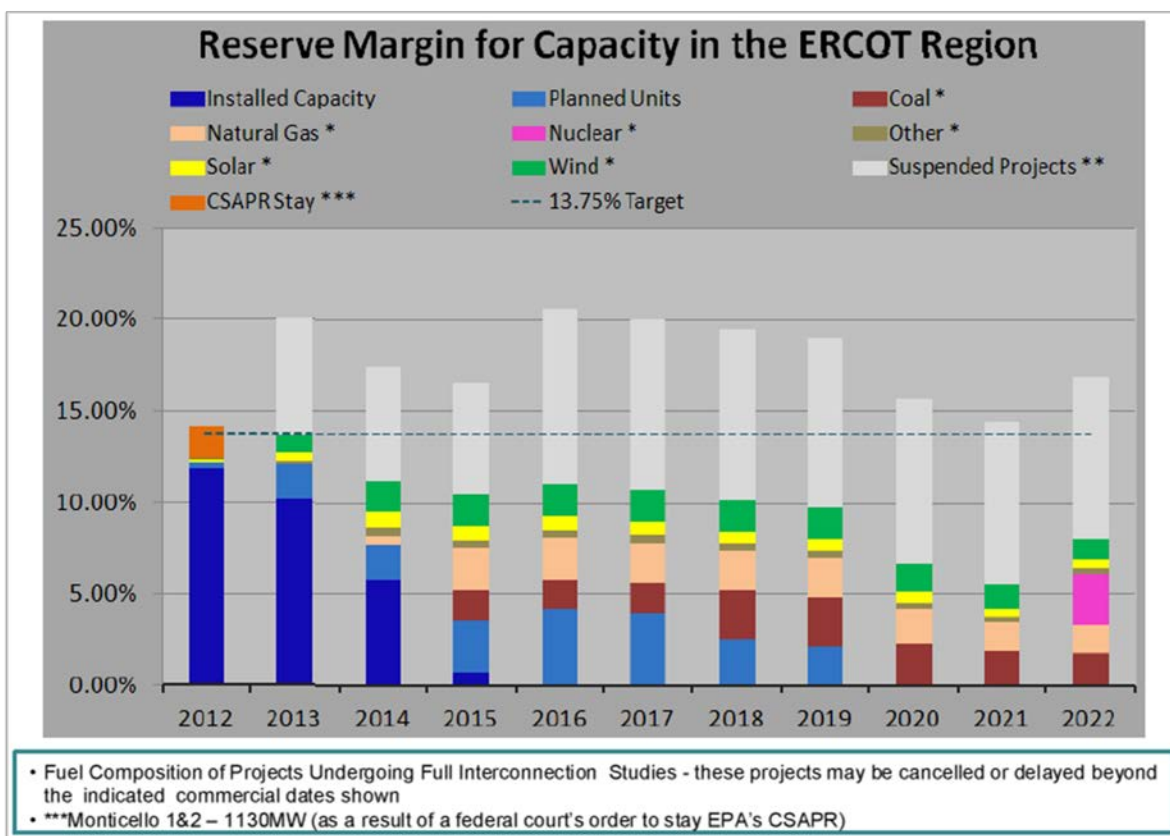

Figure 48: Reserve margin for capacity through 2022

Since 1995, the wholesale sphere of the Texas electric industry has gone through a process of deregulation, and free market forces currently determine the supply of energy and any additional standby reserves for the ERCOT region of Texas. In contrast to this competitive, energy-only wholesale market, other regions of the country adhere to market designs in which energy supplies are ensured by regulated, out-of-market forces. Such markets may be considered more reliable yet less competitive and efficient in economic terms. The PUC is tasked with ensuring a market design that balances the interests of a competitive wholesale market and end-use customers who expect reliable energy at reasonable prices.

Until a few years ago, the deregulated wholesale market was such that generators, in general, could realize the revenues that were required to ensure adequate wholesale and reserve resources in Texas. The resource adequacy outlook for coming years, however, may fall below

the desired reserve level of 13.75%.<sup>182</sup> Figure 48 illustrates the reserve margin through 2022.<sup>183</sup> Variables such as the decline in natural gas prices and an influx of low-priced wind generation have been driving factors that have cut into generator revenues needed to attract new investments in generation capacity. To understand this overall decline in generator revenues and the resulting decline in generation capacity, a further explanation of the interplay of the market clearing price mechanism, the recent decline in natural gas prices and the economic impact of increasing wind generation may be useful.

In the ERCOT region, wholesale generator revenues are a product of the market clearing price of energy for any given settlement interval and the amount that generators produce for each settlement interval. The market clearing price of energy is set by the offer price of the final marginal generation unit that is dispatched to meet load. For most settlement intervals, especially intervals in which large amounts of load appear on the system, natural gas units are dispatched, and these natural gas units set the market clearing price on which all generator revenues are based. Because the wholesale market is competitive, generators are incented to submit offers relatively close to their marginal production costs so that they will be dispatched to produce energy. ERCOT's dispatch software goes up the offer stack and chooses the lowest, most economic bids, absent of any transmission constraints, to meet the demand bids for energy. Because natural gas is the underlying fuel source for peaking natural gas units, the price of natural gas determines the production costs and, subsequently, the dollar amount of the offers submitted by peaking natural gas units. Because the dollar amount of the offer submitted by the peaking unit establishes the settlement price that determines overall generator revenues, the decline in natural gas prices is a significant factor contributing to the decline in overall generator revenues.

Exacerbating this reduction in generator revenues, more wind generators have been incented to produce at negative or zero priced offers due to the Federal Production Tax Credit which pays wind generators \$22 per MWh when they are producing generation.<sup>184</sup> A larger percentage of wind generation attributes to low settlement prices in off peak settlement intervals (at night) as well as the shoulder month seasons of spring and fall when wind is more predominant and electricity demand is lower.

Low gas prices and cheap wind generation have caused lower settlement prices that lead to lower overall generator revenues. As a result, existing generators have been less inclined to

---

<sup>182</sup>Brattle Group, *ERCOT Investment Incentives and Resource Adequacy* at 1 (2012), available at [http://www.brattle.com/\\_documents/UploadLibrary/Upload1047.pdf](http://www.brattle.com/_documents/UploadLibrary/Upload1047.pdf).

<sup>183</sup> Trip Doggett, *ERCOT's Challenges & Opportunities*, presentation to the Association of Electric Companies of Texas (May 17, 2012), available at <http://www.ercot.com/content/news/presentations/2012/Doggett-AECT%20May%2017%202012.pdf>.

<sup>184</sup> 26 U.S.C. § 45 (2012).

make capital investments in new generation capacity. Furthermore, the number of new entrants to the wholesale market has declined due in part to reluctance to invest in generation without the certainty and price signals that would indicate an adequate return on investments. Compounding the overall sense of urgency to ensure generation adequacy were the events of the summer of 2011, characterized by consecutive days of record heat and many hours of scarcity pricing.

The PUC, in response to declining settlement prices, has taken various actions to affect the pricing mechanisms that could bolster generator revenues and hence, investment in generation capacity. In Project Number 37897,<sup>185</sup> the PUC has hosted a number of workshops, hearing from various stakeholders such as wholesale generators, ERCOT, financial entities and consumer groups who have expressed concerns and offered suggestions regarding resource adequacy in ERCOT. The PUC has voted under this proceeding to raise the system-wide offer cap (the amount generators would be allowed to bid into the market) from \$3,000/MWh to \$4,500/MWh.

The PUC also initiated a rulemaking under Project Number 40268 to establish pricing mechanisms that would incent generation capacity over the long-term.<sup>186</sup> Under this rulemaking, the PUC would increase the high and low system-wide offer caps as well as a pricing mechanism called the peaker net margin, a standard peaking gas unit's cumulative profits over the course of an annual revenue cycle. Currently, if the peaker net margin goes over \$175,000 during the course of an annual cycle, the high system wide offer cap is recalibrated to the low system wide offer cap.<sup>187</sup> The peaker net margin and low system-wide offer cap act as a guardrail to prevent extreme prices in any one year. Under this rulemaking, the PUC proposed to gradually raise the high system-wide offer cap to \$9,000/MWh by 2015 and raise the low system-wide offer cap to \$2,000/MWh and raise the peaker net margin threshold to \$300,000 for 2012 and 2013 and to an amount calculated by ERCOT for future years. At the October 25, 2012 open meeting, the commissioners voted to raise the system-wide offer cap to \$9,000/MWh by 2015.

The PUC has also tasked ERCOT, through the wholesale stakeholder process, to develop the appropriate shape and slope of the scarcity pricing mechanism that raises the clearing price of energy to the system-wide offer cap when the ERCOT dispatch software has depleted all the offers submitted by generators to serve real-time load. This mechanism is known as the Power Balance Penalty Curve, and it is the pricing mechanism that is activated during scarcity situations (and some non-scarcity situations in which generator ramp rates are not sufficient to

---

<sup>185</sup> *PUC Proceeding Relating to Resource and Reserve Adequacy and Shortage Pricing.*

<sup>186</sup> *PUC Rulemaking to Amend PUC Subst. R. 25.505, Relating to Resource Adequacy in the ERCOT Region.*

<sup>187</sup> P.U.C. SUBST. R. 25.505.

meet sharp increases in load). The slope of this Power Balance Penalty Curve determines how quickly the clearing prices of energy ascend to the system-wide offer cap to act as a signal that generation is crucially needed and/or that load needs to come off the system quickly in order to avoid rotating outages.

ERCOT also hired the Brattle Group to undertake a study and provide recommendations on how best to ensure resource adequacy in the ERCOT market. The Brattle Group offered several options with the caveat that Texas regulators and policy-makers need to determine what level of reserve margin they desire and then determine the steps they want to take to ensure that desired reserve margin. The report laid out five possible market design options, each contingent upon what level of reserve margin the PUC seeks to maintain:

1. Energy-only with market-based reserve margin;
2. Energy-only with adders to support a target reserve margin;
3. Energy-only with backstop procurement at minimum acceptable reliability;
4. Mandatory resource adequacy requirement for load serving entities and
5. Resource adequacy requirement with a centralized forward capacity market.<sup>188</sup>

The Brattle Group suggested that, regardless of which policy the PUC chooses, it should also consider ten recommendations to further ensure market reliability and efficiency:

1. Increase the offer cap from the current \$3,000 to \$9,000 or a similarly high level consistent with the average value of lost load (VOLL) in ERCOT, but impose this price cap only in extreme scarcity events when load must be shed;
2. For pricing during shortage conditions when load shedding is not yet necessary, institute an administrative scarcity pricing function that starts at a much lower level such as \$500/MWh when first deploying responsive reserves, then increase gradually, reaching \$9,000 or VOLL only when actually shedding load;
3. Increase the peaker net margin threshold to approximately \$300/kW-year or a similar multiple of the cost of new entry, and increase the low system offer cap to a level greater than the strike price of most price-responsive demand in Texas;
4. Enable demand response to play a larger role in efficient price formation during shortage conditions by introducing a more gradually-increasing scarcity pricing function (as stated above) so loads can respond to a more stable continuum of high prices by enabling load reductions to participate directly in the real-time market and by preventing price reversal caused by reliability deployments;

---

<sup>188</sup> Brattle Group, *ERCOT Investment Incentives and Resource Adequacy* at 103 (2012).

5. Adjust scarcity pricing mechanisms to ensure that they provide locational scarcity pricing signals when appropriate;
6. Avoid mechanisms that trigger scarcity prices during non-scarcity conditions;
7. Address pricing inefficiencies related to unit commitment but without over-correcting;
8. Clarify offer mitigation rules;
9. Revisit provisions to ensure that retail electric providers can cover their positions as reserve margins tighten and price caps increase and
10. Continue to demonstrate regulatory commitment and stability.<sup>189</sup>

To fully consider the Brattle Report, the PUC held workshops on July 27, September 6, and October 25, 2012. Through all of these efforts, the PUC hopes to arrive at resource adequacy policy options that best serve both generators and electricity consumers in the state.

## Emergency Response Service

The Emergency Response Service (ERS), formerly known as Emergency Interruptible Load Service (EILS), is a mechanism available to ERCOT operators to forestall the need for firm load shed, or rotating outages, under conditions where demand exceeds available generation capacity. Under this program, large electricity customers or aggregations of smaller customers agree to have their electric service voluntarily curtailed in conditions of energy scarcity in exchange for a payment tied to their availability for curtailment and their actual performance during a deployment event.

EILS was first approved by adoption of a PUC rule in April 2007. When the service failed to attract sufficient bids to meet the initial requirement of 500 MW of capacity specified by the rule, it was amended to eliminate the minimum capacity provision. The service began operation in February 2008. Since then, EILS has successfully deployed twice: (1) during the cold weather event of February 2011 and (2) during a peak demand event in August 2011.

The initial version of the PUC's EILS rule was quite prescriptive and limited ERCOT's flexibility to modify the program to reflect experience gained through operation of the program. This proved to be a problem following the February 2011 event as EILS resources were completely exhausted very early in the contract period. ERCOT was unable to replenish EILS resources until

---

<sup>189</sup> *Id.* at 120.

the PUC adopted an emergency rule in March 2011. The PUC then initiated Project Number 39948 to consider changes to the rule governing the EILS program.<sup>190</sup>

The rule as ultimately adopted in March 2012 renamed the EILS program to Emergency Response Service and provides ERCOT with additional flexibility in changing the design and operation of the program. ERCOT can now adjust the duration of contract periods and renew the contracts of ERS resources in cases where their obligations have been exhausted before the end of the contract period. ERCOT also now has the flexibility to adopt payment mechanisms other than the current pay-as-bid mechanism (such as a market-clearing price mechanism) and to design ERS services that have deployment criteria other than the current ten-minute deployment requirement (such as a 30-minute deployment criterion recently approved on a trial basis by the ERCOT board). In addition, the new rule provides for the participation of certain unregistered distributed generation resources (such as backup generators located on customer premises) in the ERS program.

## Federal Issues

The PUC monitors Federal Energy Regulatory Commission (FERC), Environmental Protection Agency (EPA) and Commodities Future Trading Commission (CFTC) activities that have the potential to affect Texas' electricity markets, consumers and businesses. The PUC participates in FERC, EPA and CFTC proceedings by intervening and filing comments when deemed necessary. Although most of the authority granted to the PUC in PURA is conferred exclusively on the PUC, the PUC must be aware of FERC activities in order to avoid duplicative effort, ensure consistent and complimentary policy decisions on the state and federal levels and so that FERC can be made aware of the Texas perspective before rendering decisions. Regulations imposed by EPA and CFTC can have dramatic impacts on Texas electricity markets and because of the advanced state of competition in the industry in Texas, the PUC provides a valuable and unique perspective.

Various rules promulgated or proposed by the EPA under the Clean Air Act have significantly affected the electric industry in the last year and will continue to affect the industry over the next several years.

### Cross State Air Pollution Rule

In August 2010, the EPA published for public comment a proposed rule that later came to be known as the Cross State Air Pollution Rule (CSAPR) to address air emissions that cross state

---

<sup>190</sup> *Rulemaking to Amend Substantive Rule §25.507 Relating to ERCOT EILS.*

lines and contribute to ozone and particulate matter pollution in the eastern part of the US. The rule would have created federal implementation plans to reduce sulfur dioxide (SO<sub>2</sub>) and nitrogen oxide (NO<sub>x</sub>) emissions from electric power plants in 32 states including Texas through a combination of direct abatement standards and a limited voluntary cap and trade program. The new rule was proposed to replace the Clean Air Interstate Rule of 2005 and require the 32 states to cut power plant SO<sub>2</sub> emissions by 71% and NO<sub>x</sub> emissions by 52% from 2005 levels by 2014. Under the rule as proposed, the emissions reductions would have started in January 2012.

In the proposed rule, EPA did not include Texas among the states that contribute significantly to nonattainment or interfere with maintenance by a downwind area regarding certain “national ambient air quality standards” (NAAQS). However, in the rule adopted by EPA, the agency concluded that Texas did contribute significantly to downwind nonattainment with respect to certain NAAQS. This finding, made for the first time in the final rule, was based solely on modeling (rather than actual measurements) by EPA that Texas would in 2012 contribute significantly to nonattainment at a single air pollution monitoring site in Illinois. EPA concluded that, based on this modeling, Texas should be required to reduce emissions that would purportedly lead to this modeled contribution of nonattainment.

In challenging the rule before EPA and in federal court, the PUC, the Texas Commission on Environmental Quality (TCEQ), the General Land Office and the RRC argued that EPA failed to provide proper notice of the rule or a meaningful opportunity to comment as the rule applied to Texas. The EPA also failed to provide notice of key factual data and analysis used in the adopted rule which Texas would have challenged had it been included in the proposed rule. Finally, the PUC argued that given the problems with the final rule, EPA should grant a stay of the effective date of the rule as it applied to Texas. Without a stay, the PUC maintained, Texas would suffer irreparable harm because generation plants unable to meet the extremely aggressive compliance deadlines would be forced to cease operation which in turn would likely lead to rotating electricity outages through the ERCOT region. The final rule also required Texas electric generating units to comply with specific emission allocations beginning January 1, 2012 – less than five months after the final rule was published in the Federal Register.

At the request of the PUC, ERCOT studied the potential effects of CSAPR within ERCOT. In its September 2011 report, ERCOT concluded that even under the best case scenario, CSAPR would result in the loss of approximately 1200 to 1400 MW of generating capacity during the summer of 2012. If this loss of capacity had occurred during the peak season of 2011, ERCOT would have experienced rotating outages in August. ERCOT determined that implementation of CSAPR would significantly increase the likelihood of rotating outages in ERCOT in 2012 and



beyond, leaving swaths of Texas without electricity for indeterminate periods of time. The PUC argued that such a situation is *per se* irreparable harm.

The Texas agencies appealed CSAPR to the DC Circuit Court of Appeals, and the court granted a stay, thereby preserving 1200 to 1400 MW of capacity for summer 2012. The appeal of the CSAPR rule was decided in Texas' favor in August 2012.

## Mercury Air Toxic Rule

On April 16, 2011, the EPA's Mercury and Air Toxics Standards (MATS) went into effect. The final rule revised the new source performance standards for new fossil fuel-fired electric generating units (EGU) and large and small industrial commercial-institutional steam generating units. The rule set maximum achievable control technology emissions limits for existing, reconstructed and new units rated greater than 2 MW that are fired on coal, liquid oil or solid oil-derived (i.e., petroleum coke) fuels.

In their comments, the PUC, TCEQ and RRC noted that the new unit emission limits in the final rule are significantly more stringent than permitted emission limits for the same pollutants in recently issued permits for coal-fired or petroleum coke-fired units that will be classified as new units under the rule. Because these units will have to meet the new emissions limits, the owners of these plants will have to reevaluate the feasibility of building and operating units that have to meet drastically lower limits. At least some of the units, such as the proposed 620 MW Las Brisas unit, will likely not be built. Las Brisas has been included in ERCOT's capacity demand and reserve report as an available resource beginning in 2018. The failure of proposed new units to come online to meet expanding electric needs and replace older, less clean units could have devastating effects on the reliability of the electric grid, particularly in Texas which is isolated from most of the rest of the country's electric grids.

On April 13, 2012, the agencies filed an appeal of the MATS rule with the DC Court of Appeals along with many other interested parties. The court has consolidated the appeals but has not yet issued a procedural schedule.



### Mission

The mission of the Railroad Commission of Texas is to serve the state by its stewardship of natural resources and the environment, its concern for personal and community safety and its support of enhanced development and economic vitality for the benefit of Texans.<sup>191</sup>

### Goals

- ✦ **Energy Resources:** Support the development, management and use of Texas' oil and gas energy resources to protect correlative rights, provide equal and fair energy access to all entities, ensure fair gas utility rates and promote research and education on use of alternative fuels.
- ✦ **Safety Programs:** Advance safety in the delivery and use of Texas petroleum products through training, monitoring and enforcement.
- ✦ **Environmental Protection:** Assure that Texas fossil fuel energy production, storage and delivery is conducted to minimize harmful effects on the state's environment and to preserve natural resources.
- ✦ **Public Access to Information and Services:** Strive to maximize electronic government and to minimize paper transactions by developing technological enhancements that promote efficient regulatory programs and preserve and increase access to public information.<sup>192</sup>

### History

The Texas Legislature created the Railroad Commission of Texas in 1891 and gave the agency jurisdiction over rates and operations of railroads, terminals, wharves and express companies.<sup>193</sup> In 1917, the legislature declared pipelines to be common carriers, giving the RRC regulatory authority over pipelines. It also gave the Railroad Commission jurisdiction and responsibility to administer conservation laws relating to oil and natural gas production. During the 1920s, the RRC was given additional regulatory responsibility over motor carriers and natural gas utility companies.

---

<sup>191</sup> <http://www.rrc.state.tx.us/about/statplan10/stratplan2011-2015.pdf>.

<sup>192</sup> *Id.*

<sup>193</sup> The RRC Section of the EAP heavily relies on two RRC reports: *Strategic Plan of the Fiscal Years 2011-2015* and *Self Evaluation Report 2009*.

In the 1930s, additional regulations over oil and natural gas production were enacted, primarily to conserve natural resources and protect the correlative rights of mineral interest owners. The first pipeline safety regulations requiring odorization of natural gas were adopted during that decade as well. During the 1950s and 1960s, environmental concerns were addressed by the adoption of additional oil and gas operation regulations. Also during this period, safety authority over LP-gas was delegated to the RRC. In the 1970s, the RRC assumed authority over coal and uranium surface mining operations, and federal pipeline safety standards were adopted for natural gas pipelines. Throughout the 1980s and 1990s, additional environmental and safety responsibilities in the oil and gas production, natural gas utility, hazardous liquids pipelines, LP-gas and surface mining industries were delegated to the RRC.

In 1994, the motor carrier industry was deregulated, and the RRC's remaining motor carrier responsibilities were transferred to the Texas Department of Transportation (TxDOT). In 2005, the RRC's rail safety responsibilities were transferred to TxDOT. The RRC expanded its underground damage prevention to pipelines following legislation enacted by the 80th Legislature. Most recently, the RRC implemented an inactive well program that mandates surface equipment removal and established seven options to obtain well plugging exceptions. Following legislation enacted by the 81st Legislature, the RRC implemented a program to monitor the capture, injection, sequestration or geologic storage of carbon dioxide.<sup>194</sup>

**Figure 49: Remnants of an early cable tool rig**



## Jurisdiction and Public Service

The RRC is the state agency with primary regulatory jurisdiction over the oil and natural gas industry, pipeline transporters, natural gas and hazardous liquid pipeline industry, natural gas utilities, the LPG/LNG/CNG industries and coal and uranium surface mining operations.

<sup>194</sup> <http://www.rrc.state.tx.us/about/statplan10/stratplan2011-2015.pdf>.

Railroad Commission actions affect not only those industries regulated by the RRC but also many ancillary industries and general public groups including:

- ✚ Landowners,
- ✚ Mineral interest owners,
- ✚ Royalty owners,
- ✚ Exploration and production companies,
- ✚ Drilling contractors,
- ✚ Oil and gas transporters,
- ✚ Oilfield waste disposal transporters,
- ✚ Oil and gas pipe and equipment suppliers,
- ✚ Natural gas distribution companies,
- ✚ Natural gas consumers,
- ✚ Electric utilities,
- ✚ LPG/LNG/CNG suppliers and marketers,
- ✚ LPG/LNG/CNG consumers,
- ✚ LPG equipment manufacturers,
- ✚ Coal and uranium mining industries,
- ✚ Environmental associations,
- ✚ Safety associations,
- ✚ The Texas Legislature,
- ✚ Other local, state and federal agencies,
- ✚ Labor unions,
- ✚ Legal practitioners,
- ✚ The general public,
- ✚ Research and development organizations,
- ✚ Industry organizations,
- ✚ Professional organizations,
- ✚ The media,
- ✚ Business consulting firms,
- ✚ Information brokers,
- ✚ Hydrocarbon storage operators,
- ✚ Gas gathering and processing companies,
- ✚ Commercial disposal facilities and
- ✚ Oil and gas service companies and suppliers.

## Structure of the RRC

RRC authority is vested in three elected commissioners. While the RRC establishes policy, an executive director and a deputy executive director manage the activities of the RRC. The RRC is divided into five functional divisions, each directed by a division director.

The divisions are:

- ✚ Oil and Gas
- ✚ Pipeline Safety
- ✚ Gas Services
- ✚ Alternative Energy
- ✚ Surface Mining and Reclamation

Additional support groups include Information Technology Services, Human Resources, Administration, Office of General Counsel and an internal auditor. In 2010, the RRC operated with 662 employees<sup>195</sup> located at the Austin headquarters and thirteen field offices.<sup>196</sup> An organizational chart can be found in Appendix 3.

<sup>195</sup> [http://www.sunset.state.tx.us/82ndReports/RCT/RCT\\_FR.pdf2ndreports/rct/rct\\_sr.pdf](http://www.sunset.state.tx.us/82ndReports/RCT/RCT_FR.pdf2ndreports/rct/rct_sr.pdf).

## Regulated Infrastructure

The RRC has regulatory authority over a diverse range of petroleum-related infrastructure as shown below:

Oil and gas wells	395,000
Pipelines—miles	212,000
Natural gas liquid extraction facilities	2,160
Natural gas storage fields	37
Natural gas market hubs	7
Lignite coal mines	24
Uranium exploration permits (2009)	16
Gas utility audits	140
LP gas bulk plants	898

The Oil and Gas Division is responsible for oversight of the exploration, production, processing above ground storage, underground storage and transportation of oil and gas in Texas. The division is also responsible for oversight of oil and gas produced from offshore wells within Texas' jurisdictional waters. This includes oil field injection used for enhanced recovery projects or wells used for disposal; surface and near surface storage and disposal of oil and gas wastes and well plugging and site remediation of abandoned sites. In fiscal year 2011, there were 22,480 drilling permits filed with the RRC.<sup>197</sup>

The Pipeline Safety Division has oversight of 168,000 miles of intrastate pipelines out of the 212,000 miles of total pipelines in Texas, including natural gas pipelines and hazardous liquids pipelines. Texas has adopted federal pipeline safety rules and manages inspectors from regional offices to enforce the RRC's regulations.

The Gas Services Division has oversight of natural gas distribution rates and pipeline rates. The Alternative Energy Division has oversight of LPG, CNG and LNG. The division also researches

Figure 50: Workover rig



<sup>196</sup> The RRC has nine district field offices for oil and gas, one for pipeline safety, one for surface mining and two for alternative fuels.

<sup>197</sup> Much of the information from the previous 3.5 pages was taken from the RRC *Strategic Plan for the Fiscal Year 2011-2015* (June 18, 2010), at <http://www.rrc.state.tx.us/about/statplan10/stratplan2011-2015.pdf>.

and educates the public about propane as an environmentally and economically beneficial alternate fuel. The Surface Mining Division has oversight of surface mining for coal, uranium exploration and iron ore gravel. It also conducts a program for reclaiming lands that were mined and abandoned.

---

## State Emergency Coordinators

---

In Texas, emergency response starts on the local level with city mayors or county judges at the helm. If an emergency cannot be addressed at the local level, the mayor or judge may request assistance from the Disaster District Committee (DDC). The DDC is a state regional emergency management division stationed at each Department of Public Safety (DPS) office throughout Texas. The DDC chair is usually the ranking DPS officer of that region. If the emergency is beyond the scope of the DDC's resources, a request for assistance may be made to the state through the Texas Division of Emergency Management (TDEM).

**Figure 51: Blowout destroys drilling rig**



### Texas Division of Emergency Management

TDEM, a branch of DPS, is the authorized primary agency under the Direction and Control emergency support function (ESF). TDEM is responsible for the State Emergency Management Plan and is operationally in charge of the State Operations Center (SOC). During emergencies, TDEM activates the SOC, and representatives of numerous state agencies, including the RRC, convene as emergency responders under the direction of TDEM.

### RRC SOC Team Leader

The SOC Team Leader is the RRC's first point of contact following activation of the SOC and the RRC's lead emergency contact with TDEM and other emergency personnel. The SOC Team



Leader is backed up by a designated member of the RRC SOC Team. The SOC Team Leader also works on some of the agency's homeland security matters.

## RRC SOC Team

Under the direction of the SOC Team Leader, a trained team of RRC employees serves at the SOC during an emergency. These RRC employees, referred to as the SOC team, provide 24-hour coverage at the SOC in rotating shifts. The RRC maintains phone lists and an Emergency Process for the Gas Services Division, Oil and Gas Division, Pipeline Safety Division, Alternative Energy Division/LPG Operations and Human Resources Division with communication lines established between state interagency subject matter experts and private industry. Each SOC team member is familiar with the RRC's emergency contact lists, Division Emergency Processes and geospatial map that includes wells, pipelines and other critical infrastructure facilities. The SOC team coordinates emergency activities with RRC district office personnel located throughout the state. Resources available to the SOC team and district office field staff include the agency's vehicle fleet, laptop toughbook computers, air cards, cell phones, geospatial map data and access to private lands, where necessary. The SOC team may also assist gas distribution system operators and liquefied petroleum gas (LPG)/compressed natural gas (CNG)/liquefied natural gas (LNG) suppliers with initial rapid impact assessment activities, disaster area work crew mobility, logistical issues and waivers of state regulations applicable to non-licensed energy supply trucks.

## RRC District Offices

The RRC has multiple district offices throughout the state. Designated district office personnel maintain contact with the RRC's SOC team during an emergency. RRC district office personnel may be available to assist local governments, DDCs and the SOC team.



**Figure 52: RRC district office inspector with toughbook computer**

## RRC Gas Services Division Director

The RRC's Gas Services Division Director serves as the agency's liaison with the Texas Energy Reliability Council (TERC), a team of energy industry representatives. During an emergency, the agency's RRC/TERC liaison communicates with TERC, the SOC team and energy industry personnel regarding the supply of natural gas.

## RRC Emergency Communications Coordinator

The RRC/TERC liaison works closely with the RRC's Emergency Communications Coordinator (ECC), a Gas Services Division employee who oversees a team of natural gas specialists that gather and disseminate data during an emergency. The ECC is appointed by the RRC/TERC liaison and monitors, evaluates and distributes information pertaining to natural gas outages, damages, restoration time and curtailment to the RRC/TERC liaison that relays such information to the SOC team. The ECC also directs the Gas Services Division's Emergency Response Process maintained by the Director of the Gas Services Division.

## RRC Media Affairs Representative

The RRC Media Affairs Representative is designated to make public announcements on behalf of the Railroad Commission. The information may range from outage and restoration schedules for gas distribution systems to major damage, oil spills and fires to oil and gas facilities. The RRC Media Affairs Representative also works with the TDEM public information officer at the SOC, as required. The RRC is a support agency to the Public Information Resource Group.<sup>198</sup>

## Relationship to other Agencies

Developing relationships and open communication between agencies that share or overlap regulatory coverage can strengthen emergency management and ensure a more coordinated response.

The Texas Division of Emergency Management, during disaster activations and through its SOC has created an Infrastructure group. The Infrastructure Group includes the Railroad Commission, the Public Utilities Commission, the Texas Commission on Environmental Quality, the General Land Office and others. This structure encourages open communication between agencies who share sector jurisdiction by physically placing their representatives in close proximity to each other in the SOC council room. In this setting, representatives can

**Figure 53: The GLO coordinates with the Coast Guard on offshore oil spills**



<sup>198</sup> Much of the preceding information was taken from the updated Annex L.

verbally engage, share information and assist each other, when necessary.

## **Texas Commission on Environmental Quality**

The TCEQ is charged with protecting air quality, water quality and the environment related to its jurisdictional activities in Texas. Although the RRC regulates most of the petroleum industry, TCEQ has regulatory jurisdiction over refineries. TCEQ also has jurisdiction over air emissions associated with oil and gas activities. TCEQ is the lead agency for Annex Q, the Haz-Mat and Oil Spill Response section of the State Emergency Management Plan. In this annex, RRC and GLO are considered support agencies for TCEQ due to their subject matter expertise in petroleum related issues and their ability to respond appropriately for oil spill containment, recovery and waste disposal.

## **General Land Office**

One of the primary responsibilities of the Texas General Land Office is to lease state land and mineral holdings for energy and mineral development. Proceeds go to the Permanent School Fund to help pay for public education. The GLO has the lead role in responding to crude oil spills along the Texas Gulf Coast, including spills in bays and estuaries. During an oil spill response, GLO coordinates containment and recover efforts with the Coast Guard and coordinates waste disposal, when necessary, with the RRC.

The state of Texas had 10,377 businesses in the oil and gas industry as of June 2009.<sup>199</sup> These commercial entities include companies working in geology, geophysics, land acquisition, various disciplines of engineering, operating, financing, drilling, mud supply, logging, casing, cement, perforating, fracturing, acidizing, swabbing, well heads, tubing, sucker rods, pumps, pumping units, gathering lines, separators, tanks, meters, trucks, pipelines, compressors, water disposal wells, gas processing plants, refineries, underground and above ground storage, gas distribution and liquid fuel distribution. Figure 54 shows the number of active operators filing annual organization reports with the RRC over the past two decades.

Figure 54: Active Operators with Wells

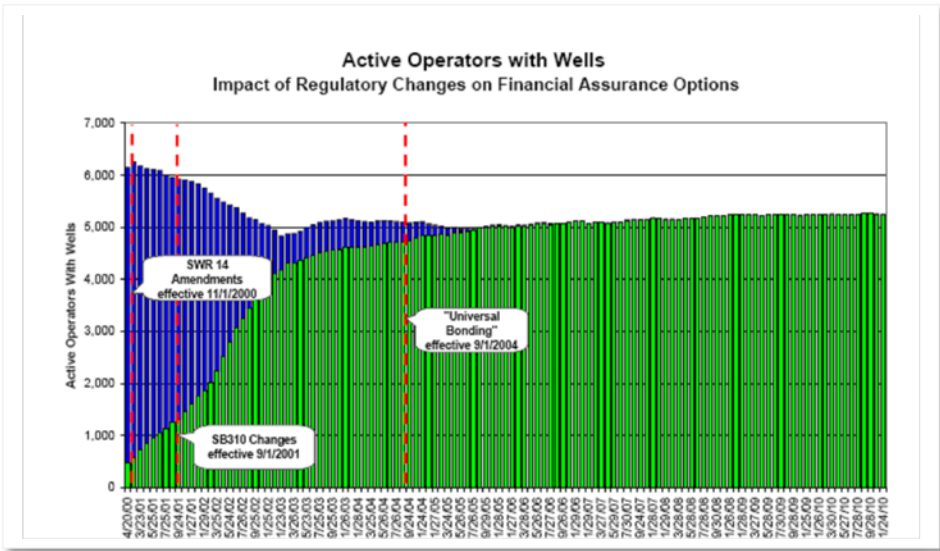

Oil and Gas Producers

Active operators of oil and gas wells include multinational corporations, mid-sized independents and small independents. The operators are responsible for well operations even though the ownership may be diverse. A list of the largest oil operators in Texas may be found in Figure 55 and a list of the largest gas operators in Texas is shown in Figure 56.<sup>200</sup>

<sup>199</sup> <http://www.rrc.state.tx.us/licenses/p5/chart4.pdf>.

<sup>200</sup> <http://www.rrc.state.tx.us/data/operators/topoperators/oglist11.pdf>.

Figure 55: Largest oil producers in Texas, January – December 2011

Rank	Name	% of production	12-month production in barrels	Daily average in barrels
1	Occidental Permian Ltd.	10.785	42,480,512	116,385
2	Kinder Morgan Production Co LLC	4.732	18,640,386	51,070
3	Apache Corp	4.585	18,060,793	49,482
4	EOG Resources, Inc.	3.911	15,403,838	42,202
5	Pioneer Natural Res USA Inc	3.667	14,444,721	39,575
6	XTO Energy Inc	3.304	13,015,070	35,658
7	Chevron U. S. A. Inc.	2.867	11,292,489	30,938
8	OXY USA WPT LP	2.711	10,676,916	29,252
9	COG Operating LLC	2.524	9,942,710	27,240
10	Endeavor Energy Resources LP	2.117	8,338,714	22,846
11	Sandridge Expl. and Prod., LLC	1.918	7,555,527	20,700
12	Hess Corporation	1.899	7,479,072	20,491
13	Energen Resources Corporation	1.840	7,247,673	19,857
14	Devon Energy Production Co. LP	1.381	5,441,449	14,908
15	Chesapeake Operating, Inc.	1.106	4,356,328	11,935
16	ConocoPhillips Company	1.057	4,161,897	11,402
17	Whiting Oil and Gas Corporation	1.040	4,096,650	11,224
18	Basa Resources Inc	0.957	3,770,363	10,085
19	OXY USA Inc.	0.935	3,680,988	10,085
20	Burlington Resources O & G Co LP	0.913	3,597,564	9,856
21	Fasken Oil and Ranch, LTD	0.857	3,375,167	9,247
22	Chevron Midcontinent, LP	0.793	3,123,598	8,558
23	Linn Operating, Inc.	0.777	3,060,681	8,385
24	Exxon Mobil Corporation	0.743	2,927,030	8,019
25	Williams, Clayton Energy, Inc.	0.675	2,659,964	7,288
26	Merit Energy Company	0.630	2,482,716	6,802
27	Laredo Petroleum – Dallas, Inc.	0.623	2,453,146	6,721
28	Anadarko E & P Company LP	0.596	2,347,691	6,432
29	Texland Petroleum, LP	0.580	2,286,026	6,263
30	Legacy Reserves Operating LP	0.578	2,277,138	6,239
31	Cimarex Energy Co	0.535	2,106,572	5,771
32	Hilcorp Energy Company	0.504	1,985,081	5,439
<b>TOP</b>	<b>32 TOTAL</b>	<b>62.140</b>	<b>244,768,470</b>	<b>670,600</b>

Figure 56: Largest gas producers in Texas, January – December 2011

Rank	Name	% of production	12-month production in Mcf	Daily average in Mcf
1	XTO Energy Inc	12.425	763,511,553	2,091,812
2	Devon Energy Production Co LP	10.639	653,752,979	1,791,104
3	Chesapeake Operating Inc	9.970	612,649,645	1,678,492
4	EOG Resources Inc	5.074	311,812,261	854,280
5	Quicksilver Resources, Inc.	2.463	151,321,112	414,578
6	Encana Oil & Gas (USA) Inc	2.323	142,737,844	484,163
7	Anadarko E & P Company, Inc.	2.166	133,097,518	364,651
8	ConocoPhillips Company	1.973	121,245,671	332,180
9	Enervest Operating, Inc.	1.796	110,392,119	302,444
10	Samson Lone Star, LLC	1.572	96,596,252	264,647
11	Sandridge Expl. and Prod., LLC	1.422	87,406,561	239,470
12	OXY USA, Inc.	1.383	84,981,607	232,826
13	Anadarko Petroleum Corporation	1.290	79,270,639	217,180
14	Forest Oil Corporation	1.275	78,370,920	214,715
15	Chevron U. S. A., Inc.	1.269	77,998,504	213,695
16	Burlington Res O & G Co LP	1.190	73,118,751	200,325
17	Pioneer Natural Res USA Inc	1.148	70,524,674	193,218
18	Exxon Mobil Corporation	1.076	66,116,037	181,140
19	Apache Corporation	1.069	65,710,265	180,028
20	BP America Production Company	1.014	62,295,795	170,673
21	Highmont Expl. & Prod. Texas, Inc.	0.932	57,279,047	156,929
22	Carrizo Oil & Gas, Inc.	0.928	57,014,972	156,205
23	Lewis Petro Properties	0.921	56,568,297	154,982
24	NRF Energy, LLC	0.919	56,448,438	154,653
25	Petrohawk Operating Company	0.909	55,863,659	153,051
26	Legend Natural Gas IV, LP	0.759	46,632,433	127,760
27	El Paso E & P Company, LP	0.723	44,423,592	121,708
28	SM Energy Company	0.721	44,277,617	121,309
29	Newfield Exploration Company	0.663	40,749,943	111,644
30	Cimarex Energy Co.	0.660	40,568,213	111,146
31	EXCO Operating Company, LP	0.599	36,835,139	100,918
32	Southwestern Energy Prod. Co.	0.586	35,999,459	98,629
<b>TOP</b>	<b>32 TOTAL</b>	<b>71.857</b>	<b>4,415,571,516</b>	<b>12,097,455</b>

## Crude Oil Purchasers

Figure 57: Crude oil pipeline road crossing marker



In Texas, crude oil is usually separated from water and gas at a central tank battery on individual leases. The crude oil is stored at the lease tank battery and measured and purchased at a defined delivery point by a crude oil purchaser. The purchaser takes possession and transports the crude oil with a tanker truck or pipeline to a pipeline terminal. The crude oil is then delivered and transported through a series of pipelines to a refinery. The price of the crude oil is usually tied to a standard price (such as West Texas Intermediate) and adjusted for the American Petroleum Institute (API) gravity and for contaminants entrained in the raw crude oil production.

## Refinery Operators

In 2010, Texas was home to 27 refineries, most of which are located along the Gulf Coast. In part, the location is due to the discovery of the Spindletop Field in 1901 near Beaumont, Texas. Valero is the largest refiner in the United States. Valero has seven refineries in Texas with a total capacity of 1,123,000 barrels of oil per day. ExxonMobil operates two refineries in Texas. One of these refineries is the largest single refinery in the US with a capacity of 557,000 barrels per day. Also, Shell, BP Products, ConocoPhillips, Lyondell, Motiva and Flint Hills Resources operate refineries with capacity between 229,000 and 460,000 barrels per day. A list of Texas Refineries is shown below:

Age Refining Inc	Petroleum Refinery
Alon USA LP	Big Spring Refinery
CITGO Refining and Chemicals Co LP	East Plant Refinery
CITGO Refining and Chemicals Co LP	West Plant Facility
Conoco Phillips Co	Borger Refinery
Conoco Phillips Co	Sweeny Refinery Petrochem
Delek Refining Ltd	Delek Tyler Refinery
Diamond Shamrock Refining Co LP	McKee Refinery
Diamond Shamrock Refining Co LP	Three Rivers Refinery
ExxonMobil Oil Corp	Beaumont Refinery
ExxonMobil Refining & Supply Co	Baytown Refinery
Flint Hills Resources Corpus Christi	Corpus Christi East Plant
Flint Hills Resources Corpus Christi	West Refinery
Houston Refining LP	Houston Refining Operation

Motiva Enterprises LLC	Port Arthur Refinery
Pasadena Refining System Inc	Pasadena Refining System
Shell Oil Co	Deer Park Plant
Valero Refining Texas LP	Complex 6B 7 8
Valero Refining Texas LP	Corpus Christi West Plant
Valero Refining Texas LP	Houston Refinery
Valero Refining Texas LP	Texas City Refinery
Valero Refining Texas LP	Valero Port Arthur Refinery
Western Refining Co LP	El Paso Refinery South Plant
Western Refining Co LP	Western Refining El Paso

## Natural Gas Purchasers

### *Casing Head or Oil Well Gas*

Most wells produce both oil and natural gas. The RRC has set a designation that a well is an oil well or associated gas well (associated with oil production) if it produces less than 100,000 cubic feet of natural gas per barrel of oil. A well is deemed to be a gas well if it produces more than 100,000 cubic feet of natural gas per barrel of oil.

Natural gas produced from an oil well is generally produced with gas liquids and other contaminants entrained in the gas. The rich oil well gas may be gathered, compressed and processed by a gas processing plant.

In the gas plant, the gas is treated, dehydrated, processed and the liquids are recovered. The gas plant then sells the liquids that consist of ethane, propane, iso-butane, normal butane and pentanes and heavier liquids. The plant also sells the residue which is primarily methane and is commonly known as natural gas. The gas plant may pay the producer a price per Mcf or MMBtu at the well delivery point or may pay the producer a price based on a percentage of the liquids and residue attributable to the producer's lease production. Atmos Energy Corporation, Valero Corporation and Enterprise Products Partners operate three of the major intrastate natural gas transmission companies in Texas.





**Figure 58: Natural gas pipeline meter and regulator station with pig launcher**

### ***Gas Well Gas***

Natural gas produced from a gas well may be of a quality and pressure that allows the purchaser to take possession of the gas at the delivery point near the well without treating or processing, except possibly dehydration. The gas is transported through major natural gas transmission lines at pressures of 800 to 1,000 pounds per square inch absolute (psia). Since the price of natural gas was deregulated and pipelines were required to haul gas for a fee, end-users may purchase natural gas in the field and pay pipeline companies to take delivery and redeliver the natural gas to end-users. Although the RRC has jurisdiction over oil and gas wells, pipelines and gas plants, it generally has little involvement in the contractual relationships between producers and purchasers. The Pipeline Safety Division of the RRC oversees safety aspects of intrastate pipelines in the state while the Gas Services Division develops pipeline rate proposals for consideration by the RRC.

### ***Natural Gas Distributors***

Natural gas distributors normally buy gas from natural gas marketing companies (often owned by pipeline companies) and distribute the gas to customers including residential, commercial, government, electric power plant and industrial users. Electric power generation companies and large industrial companies may buy their natural gas fuel directly from a natural gas pipeline company or a third party supplier. In Texas, incorporated municipalities have original jurisdiction over natural gas rates within their boundaries. In the event of an appeal, the RRC has appellate jurisdiction over municipal rates. The RRC has original jurisdiction over natural

gas rates outside of municipalities such as environs and special rate areas. The RRC also has rate jurisdiction at city gates, that is, the rates at which gas is sold to a city.

### **LPG Distribution**

Liquid petroleum gas (LPG) is extracted from natural gas and oil at gas processing plants and refineries or is imported through LPG terminals. It is used throughout the state, particularly in rural areas, for residential heating and irrigation. Propane use has increased for fueling private vehicles, school buses, forklifts and gas grills. Texans consumed 384.5 million barrels in 2008. LP-gas is marketed through distributors or jobbers, often with bobtail trucks. It is also marketed through canisters on the retail level. The Alternative Energy Division’s LP-gas safety rules apply to the design, construction, location and operation of LP-gas systems, equipment and appliances.

## **Gasoline, Diesel, Jet Fuel**

In 2010, Texas had 13,657 gasoline fuel stations and 42 ethanol fuel stations. Texas consumed 1.2 billion barrels of petroleum, representing 17.6% of national consumption.<sup>201</sup>

The table in Figure 59 shows a breakdown of the components that make up the cost of gasoline and diesel fuel, as of September 2010.<sup>202</sup> The price of gasoline and diesel fluctuate often in accordance with fluctuations in the price of crude oil.

**Figure 59: Fire department makes emergency response to an LPG tanker truck**



<sup>201</sup> [http://tonto.eia.gov/state/state\\_energy\\_profiles](http://tonto.eia.gov/state/state_energy_profiles).

<sup>202</sup> [http://www.eia.doe.gov/emeu/steo/pub/cf\\_tables/steotables.cfm?tableNumber=8&loadAction=Apply+Changes&periodType=Monthly&startYear=2010&endYear=2010&startMonth=9&startMonthChanged=true&startQuarterChanged=false&endMonth=12&endMonthChanged=false&endQuarterChanged=false&noScroll=false](http://www.eia.doe.gov/emeu/steo/pub/cf_tables/steotables.cfm?tableNumber=8&loadAction=Apply+Changes&periodType=Monthly&startYear=2010&endYear=2010&startMonth=9&startMonthChanged=true&startQuarterChanged=false&endMonth=12&endMonthChanged=false&endQuarterChanged=false&noScroll=false).

Figure 60: Cost of gas and diesel September 2012

Fuel	Price	Crude	Refining	Marketing	Taxes <sup>203</sup>
Gasoline	\$3.847/gal	65%	15%	8%	12%
Diesel	\$4.132/gal	60%	15%	12%	13%

The DOE reports that oil is used for 93% of the transportation energy consumption in the nation. Also, liquid petroleum is used for 30% of industrial energy, 7% for residential energy and 3% for electric power generation.<sup>204</sup>

Figure 61: Oil refinery



## Biomass

Biomass is a substance originating from plant or animal matter. It is used to make alternate sources of energy. Wood is biomass that has been used since early man for cooking and heating.<sup>205</sup> Due to its large agricultural and forestry sectors, Texas has an abundance of biomass energy resources within a wide variety of land, climate and soil conditions. Texas' biomass industry is already producing fuel, electricity, ethanol and bio-diesel fuels while creating jobs from clean, sustainable sources of energy. Figure 62 shows the sources of biomass.<sup>206</sup>

Figure 62: Types of biomass

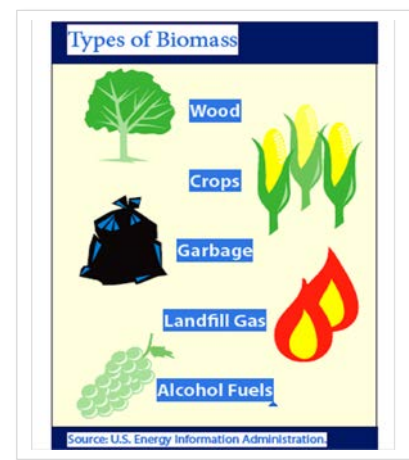

<sup>203</sup> <http://www.eia.gov/petroleum/gasdiesel/>.

<sup>204</sup> <http://www.eia.gov/consumption/>.

<sup>205</sup> <http://www.infinitepower.org/resbiomass.htm>.

<sup>206</sup> <http://www.window.state.tx.us/specialrpt/energy/renewable/biomass>.

During the 80<sup>th</sup> Session in 2007, the Texas Legislature focused on biomass power production and passed HB 1090 which authorized \$30 million annually for Department of Agriculture grants to farmers, loggers and diverters who provide qualified agricultural biomass, forest wood waste, urban wood waste or storm-generated biomass debris to facilities that use biomass to generate electrical energy. The bill provided funding for those who provide waste in the form of:

- ✚ Landfill diversions;
- ✚ Forest wood waste from logging operations;
- ✚ Storm debris;
- ✚ Urban wood waste;
- ✚ Landscape right-of-way trimmings and
- ✚ Other agricultural organic waste.

Figure 63 shows the regions of Texas from which most biomass production is concentrated.<sup>207</sup>

Figure 63: Biomass in Texas

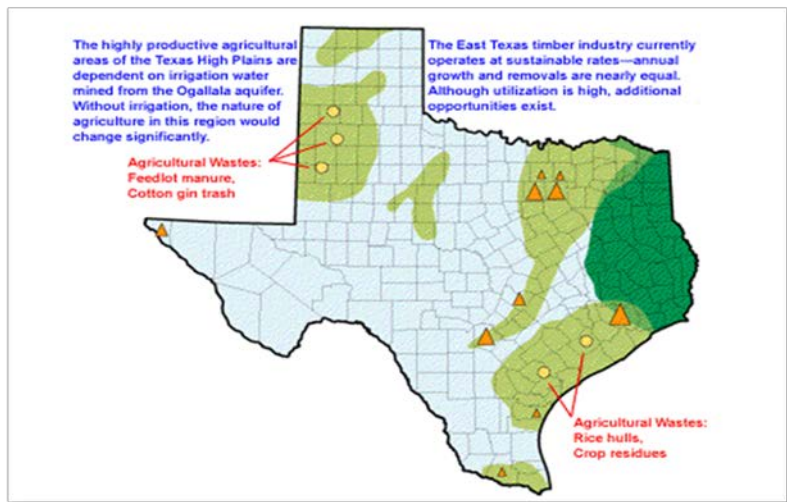

By far, the state’s major agricultural process residue is cotton gin trash. Cotton is grown throughout the state, but its production is concentrated in the Panhandle. Other locally abundant agricultural wastes include rice hulls, sugarcane bagasse and cottonseed hulls. Manures generated throughout the state also form an important resource. Wastes generated by the forest products industry of east Texas include logging residues left behind after harvest as well as bark, wood chips and sawdust generated at mills. Urban sources of biomass may represent some of the best opportunities for increasing its near-term presence in the energy mix. Wastes that would otherwise be landfilled are particularly good potential fuel sources since the producer is charged a tipping fee for their disposal.<sup>208</sup>

Figure 64: Biomass consumption

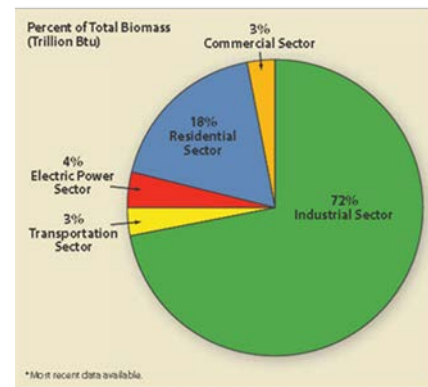

<sup>207</sup> <http://www.infinitepower.org/resbiomass.htm>.

<sup>208</sup> <http://www.infinitepower.org/resbiomass.htm>.

Figure 65 shows the great potential of biomass as an alternate fuel over the next ten years.<sup>209</sup>

**Figure 65: Alternative fuel potential over the next ten years**

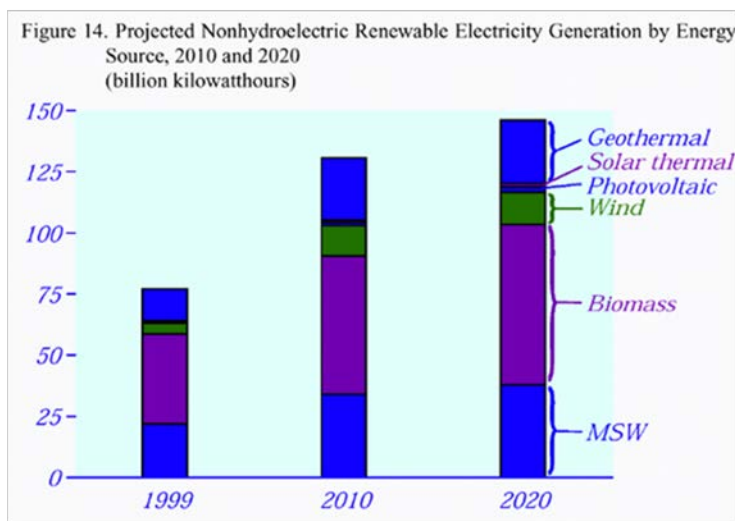

## Ethanol

Ethanol is biomass that uses primarily corn to create a liquid fuel. The largest single use of ethanol is as a motor fuel and fuel additive. In the US, flex-fuel vehicles can run on 0% to 85% ethanol (15% gasoline) since higher ethanol blends are not yet allowed or efficient. Ethanol combustion in an internal combustion engine yields many of the products of incomplete combustion produced by gasoline and, significantly, larger amounts of formaldehyde and related species such as acetaldehyde. This leads to a significantly larger photochemical reactivity that generates much more ground level ozone. These data have been assembled into the Clean Fuels Report comparison of fuel emissions and show that ethanol exhaust generates 2.14 times as much ozone as does gasoline exhaust. When this is added into the custom *Localized Pollution Index (LPI)* of the Clean Fuels Report, the local pollution (pollution that contributes to smog) is 1.7 on a scale where gasoline is 1.0 and higher numbers signify greater pollution. The United States fuel ethanol industry is based largely on corn.<sup>210</sup>

During 2008, ethanol consumption in Texas was 18.4 million barrels or 8% of the US total. Texas has one ethanol plant that produced 100 million gallons in 2008 which was 1.3% of the US total.

<sup>209</sup> [http://www.seco.cpa.state.tx.us/re\\_biomass.htm](http://www.seco.cpa.state.tx.us/re_biomass.htm).

<sup>210</sup> [http://en.wikipedia.org/wiki/Ethanol#As\\_a\\_fuel](http://en.wikipedia.org/wiki/Ethanol#As_a_fuel).

## **Bio-diesel**

Bio-diesel is biomass that uses vegetable oil and animal fat to make a diesel fuel. In Texas, imported soy bean oil is a primary source of feedstock for bio-diesel. Bio-diesel sales are booming in Texas, the country's largest producer of bio-diesel transportation fuel. Texas has a current production capacity of over 100 million gallons per year. As of 2008, Texas has more than 20 commercial bio-diesel plants with additional plants under construction or being expanded as well as over 50 retail bio-diesel fueling sites. Austin, the capitol of Texas, has the highest number of bio-diesel fueling stations of any city in the nation. In June 2008, the largest bio-diesel refinery in the United States, the Green Hunter Energy plant, opened at the Houston Ship Channel and eventually will produce 105 million gallons per year. The new facility is able to produce bio-diesel from animal fats, vegetable oils or a blend of the two, with zero emissions. A \$1 per gallon excise tax credit has helped the industry grow; however, the increased price of soy bean oil due to bio-diesel production has reduced production to 50% of capacity as of 2007.

Most bio-diesel is sold as B20, a blend that is 80% conventional diesel and 20% bio-diesel. Large trucks, buses, boats and power generation equipment require diesel engines, and B20 fuel can be used in these engines without modification. B20 is easy and inexpensive for a fueling station to sell because it can be stored in diesel tanks and pumped with diesel equipment.

Bio-diesel has contributed \$3.7 billion per year to the Texas economy. In procuring 536 million gallons per year, the industry has created jobs for 9,977 Texas workers.<sup>211</sup>

---

<sup>211</sup><http://biodieselcoalitionoftexas.org/documents>.

### Texas Oil and Gas Association

The Texas Oil and Gas Association (TXOGA) is a petroleum trade association that works with and represents the oil and gas industry in Texas. TXOGA was founded in 1919 and has grown to over 2,000 members representing all phases of the industry. TXOGA activities are focused on legislation, regulation and public/industry affairs. The Association utilizes members' expertise in a committee format to solve specific problems facing the industry. TXOGA is an active member of the State Fuel Coordination Team that directs supplies of gasoline and diesel fuel along evacuation routes during the threat of a hurricane. In this capacity, a representative from TXOGA is stationed at the SOC when it is activated by TDEM.<sup>212</sup>

### Texas Independent Producers and Royalty Owners Association

The Texas Independent Producers and Royalty Owners Association (TIPRO) is another trade association representing the interests of the oil and gas industry. Its mission statement is to preserve the ability to explore and produce oil and natural gas and to promote the general welfare of its members. Its core principles are to value all members, to communicate a consistent message for all Texas independents and to create networking and educational opportunities.<sup>213</sup>

### Texas Petroleum Marketers and Convenience Store Association

The Texas Petroleum Marketers and Convenience Store Association (TPCA) is a trade association representing companies in Texas that sell motor fuels and other petroleum products on a retail and wholesale basis. The Association represents over 300 companies with 35,000 employees. These companies operate over 10,000 retail facilities in Texas with sales of 9.8 billion gallons of gasoline and diesel fuel per year.<sup>214</sup> The companies generate over \$6.3 billion of taxable sales per year. The TPCA is also a member of the Fuel Coordination Team and assists with providing fuel during emergency evacuations.

---

<sup>212</sup> <http://www.txoga.org/categories/About-Us/>.

<sup>213</sup> <http://www.tipro.org/about-us/who-we-are>.

<sup>214</sup> <http://www.tpca.org/chrome/AboutUs-illustration.pdf>.

## Texas Energy Reliability Council

The Texas Energy Reliability Council (TERC) is an organization made up of RRC personnel, producers, intrastate pipelines, natural gas distributors and representatives from the electric industry. TERC is primarily responsible for the voluntary allocation of natural gas during an emergency that may potentially disrupt supply to a specific market.<sup>215</sup>

### Petroleum-Related Trade Associations Headquartered in Texas

- ✚ American Association of Professional Landmen (AAPL), Fort Worth
- ✚ Association of Energy Service Companies (AESC), Houston
- ✚ East Texas Producers and Royalty Owners Association, Kilgore
- ✚ International Association of Geophysical Contractors (AGC), Houston
- ✚ National Energy Services Association (NESA), Houston
- ✚ Natural Gas and Electric Power Society (NGEPS), Dallas
- ✚ Natural Gas Society of East Texas (NGSET), Tyler
- ✚ Natural Gas Society of the Permian Basin (NGSPB), Midland
- ✚ North American Energy Standards Board (NAESB), Houston
- ✚ Panhandle Producers and Royalty Owners Association (PPROA), Amarillo
- ✚ Permian Basin Geophysical Society (PBGS), Midland
- ✚ Permian Basin Landmen's Association, Midland
- ✚ Permian Basin Petroleum Association (PBPA), Midland
- ✚ Society of Independent Profession Earth Scientists (SIPES), Dallas
- ✚ Society of Petroleum Engineers (SPE), Richardson
- ✚ Society of Petroleum Evaluation Engineers (SPEE), Houston
- ✚ Society of Well Log Analysts (SPWLA), Houston
- ✚ South Texas Geological Society (STGS), San Antonio
- ✚ Southern Gas Association (SGA), Dallas
- ✚ Texas Alliance of Energy Producers, Wichita Falls
- ✚ Texas Independent Producers and Royalty Owners Association (TIPRO), Austin
- ✚ Texas Energy Reliability Council (TERC), Austin
- ✚ Texas Oil and Gas Association
- ✚ Texas Pipeline Association (TPA), Austin
- ✚ Texas Section of the American Institute of Professional Geologists, Texas
- ✚ West Central Texas Oil and Gas Association (WCTOGA), Wichita Falls
- ✚ West Texas Geological Society (WTGS), Midland

Many of the trade associations in the petroleum industry provide educational opportunities including speakers, courses and seminars. They also offer an opportunity for networking

---

<sup>215</sup> <http://www.rrc.state.tx.us/about/divisions/reliabilitycouncil/index.php>.



through various social venues. Many of the trade associations monitor local, state and federal legislation and regulation affecting the industry and actively lobby on behalf of the industry. RRC emergency response personnel often work with the industry through trade associations like TXOGA, TIPRO and TERC.

Texas is the second largest state in terms of population with almost 25 million people, yet Texas uses more energy than any other state. This is partially attributable to its population and its energy-intensive industry including aluminum, chemicals, forest products, glass and petroleum refining. Almost half of its electricity is generated from natural gas and most of the other half from coal, with contributions from nuclear power plants, wind generators and hydroelectric plants.

Figure 66: Texas petroleum consumption

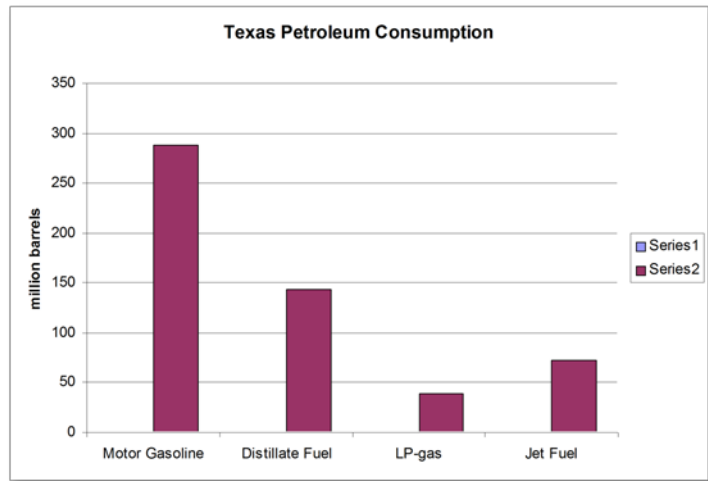

## Petroleum Consumption

Fuel	2010 consumption
Natural gas	3,344,934 MMcf
Petroleum	1,232.2 MM Bbls.
Coal	1,605.9 trillion Btu
TOTAL	10,695.4 trillion Btu

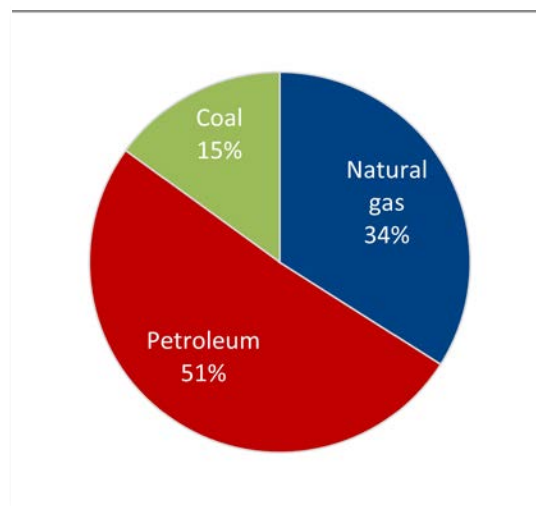
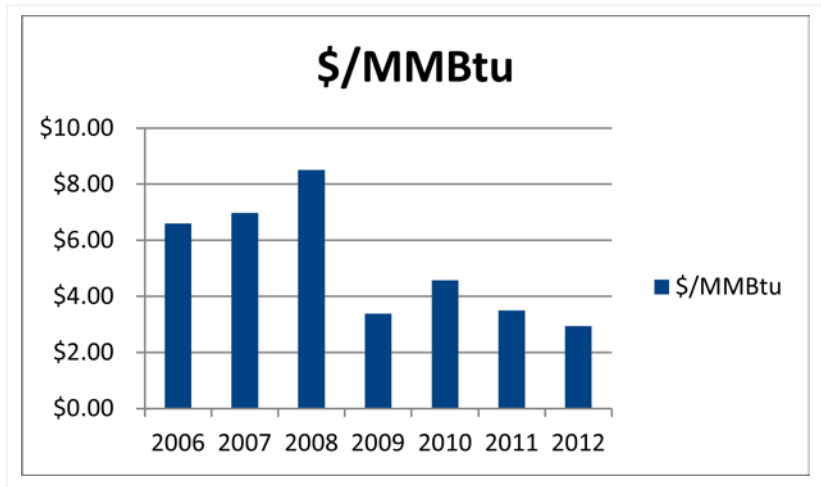

Figure 67: 2010 fuel consumption

## Producer Prices

The price of natural gas paid to producers is often tied to the price at a major pipeline hub such as the Henry Hub located in Erath, Louisiana, less a transportation charge from moving the gas from the well to the Hub. Pipeline quality gas has approximately 1,000 British Thermal Units (Btu) of heat content per cubic foot of gas volume, or on a larger scale, one million Btus per thousand cubic feet, typically stated as 1 MMBtu per 1 Mcf.<sup>216</sup> The historical average producer price of natural gas in Texas is shown in Figure 67.<sup>217</sup> Historically the rig count has been tied to the price of oil and gas. For Example the price of natural gas at the Henry Hub on September 10, 2012 had dropped to \$2.72<sup>218</sup> and the rig count during the previous year had dropped from 892 working rigs to 452 for a loss of 440 rigs. Over 75% of the active rigs are drilling for oil rather than gas despite the enormous shale gas plays that had become commercially viable with little geological risk.<sup>219</sup>

**Figure 68: Average producer price of natural gas (2011 est. based on 9/17/12 NYMEX)**



## Utility Prices

Municipalities have original jurisdiction over natural gas utility rates within the boundaries of the incorporated municipality. The RRC regulates rates in unincorporated areas and resolves appeals of municipal rate decisions. According to the US Energy Information Agency (EIA), natural gas prices to residential customers and city gate customers averaged:

<sup>216</sup> M is the Roman numeral for one thousand.

<sup>217</sup> <http://www.eia.gov/state/state-energy-profiles-data.cfm?sid=TX#Consumption>.

<sup>218</sup> <http://www.bloomberg.com/energy/>.

<sup>219</sup> <http://www.wtrg.com/rotaryrigs.html>.

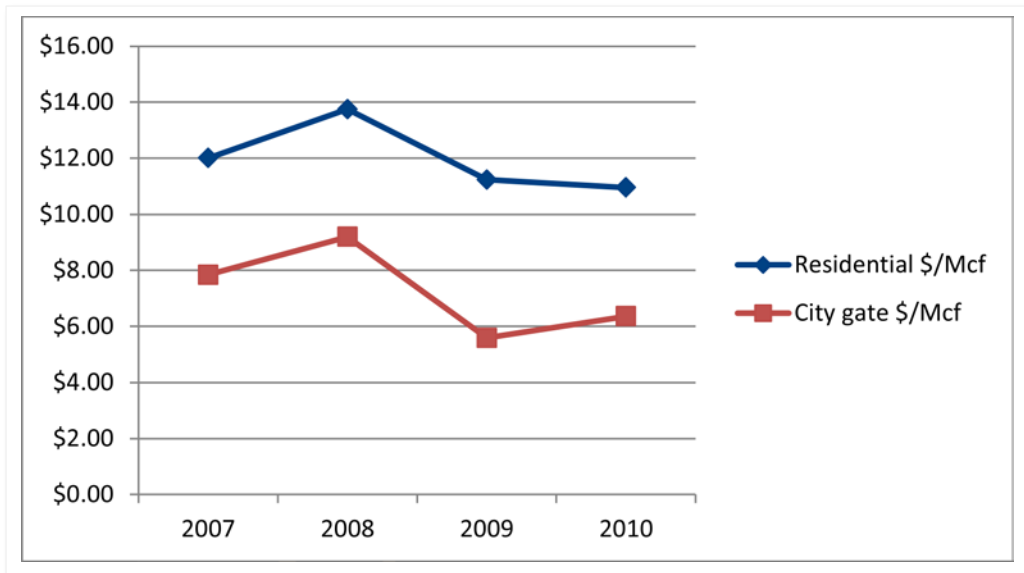

Figure 69: Utility prices

The price of natural gas is projected to remain relatively stable for the next three years with seasonal fluctuations. Additional supply coming from shale gas plays, extending from west Texas to New York, is expected to meet increased demand, particularly from increased economic activity in the industrial and electricity markets.

## Residential and Commercial Consumption

From 2007 to 2009, residential consumption of natural gas supplied by utilities in Texas was relatively stable with some fluctuation due to weather. In Texas, 43% of home heating is supplied by natural gas. Commercial consumption also remained relatively steady.

Residential	2006	2007	2008	2009	2010
Consumption Bcf <sup>220</sup>	166.2	199.8	192.7	192.0	234.0
No. of consumers-million	4.07	4.16	4.20	N/A	N/A
Avg (thousand) Mcf/consumer	408	480	459	N/A	N/A

Commercial	2006	2007	2008	2009	2010
Consumption Bcf	147.4	161.3	167.1	167.2	195.8
No. of consumers-M	329.9	326.8	324.5	N/A	N/A
Avg Mcf/consumer	4,468	4,936	5,149	N/A	N/A

<sup>220</sup> Bcf means billion cubic feet. Mcf means thousand cubic feet.

Consumption of residential and commercial natural gas in Texas is expected to grow along with the population. Price stability will further support continued consumption and potential growth of residential and commercial demand.<sup>221</sup>

## Total Natural Gas Consumption

In 2011, Texas sold over 7.0 trillion cubic feet (Tcf) of natural gas. Approximately half of that was sold intrastate, in the Texas market. Most of this natural gas was delivered to end-users through intrastate natural gas transmission pipelines. The overall disposition of gas deliveries is shown in Figure 70.

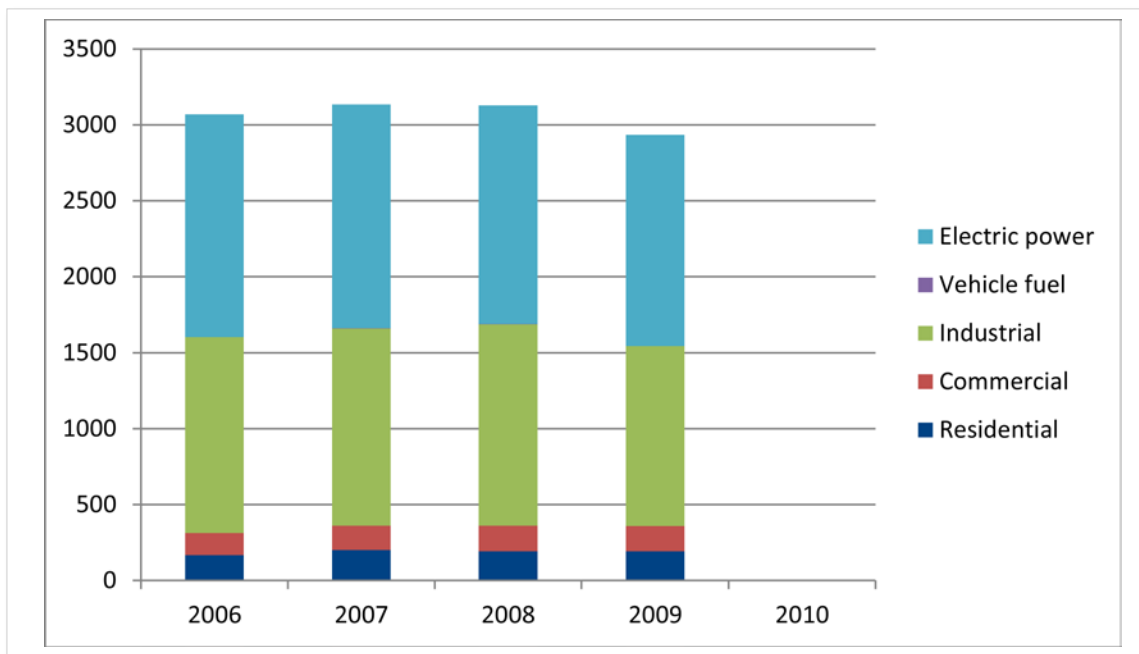

Figure 70: Natural gas consumption

Adding in oil and gas field consumption, including lease use and plant fuel, the total intrastate consumption in 2008 was 3.55 trillion cubic feet.<sup>222</sup>

Texas has approximately 200 natural gas local distribution companies in addition to a number of municipally-owned gas distributors. Local distribution companies are the retail sector of the natural gas industry. Atmos Energy Corporation, headquartered in Dallas, is the largest natural gas-only distributor in the US. City Public Service in San Antonio is the largest municipally-owned utility in the US. Among Texas' largest natural gas distribution companies are:

<sup>221</sup> [http://tonto.eia.gov/state/state\\_energy\\_profiles](http://tonto.eia.gov/state/state_energy_profiles).

<sup>222</sup> *Id.*

Company	Distribution areas
Atmos Energy	West Texas/Dallas/Waco
Texas Gas Service	Austin/Brownsville/El Paso
CenterPoint	Houston

Figure 71 shows Texas' natural gas consumption by end-user category.

Figure 71: Natural gas consumption

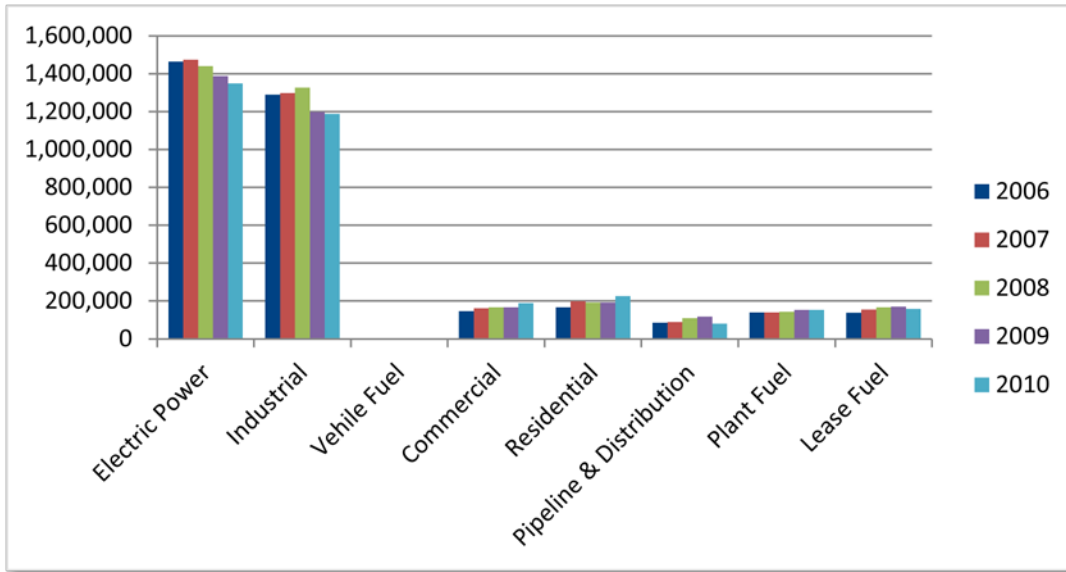

Industrial demand accounts for 35.5% and electric generation demand accounts for 40.3% for a combined total of 75.8% of total gas consumption in Texas in 2010.

# Threats, Interdependencies, Vulnerabilities and Consequences

---

The Railroad Commission of Texas has regulatory jurisdiction over most critical infrastructure in the state that pertains to oil and gas. The definition of critical infrastructure varies significantly when considered on a national, state or local level. In building its geospatial map for emergency response, the RRC has taken a conservative approach by using the critical infrastructure definition found in the State Emergency Management Plan. The 2004 Emergency Plan, authorized under Chapter 418 of the Government Code states:

Critical Infrastructure: Public or private assets, systems, and functions vital to the security, governance, public health and safety, economy, or morale of the state or nation.<sup>223</sup>

Virtually all oil and gas assets fall within this definition as these assets are vital to the security and governance of the state and nation. In addition, the flammable, explosive and life-threatening nature of oil and gas commodities can affect public health and safety. The Texas Division of Emergency Management works closely with local governments to define what infrastructure in each local jurisdiction qualifies as critical. The Federal Emergency Support Function #12, Energy Annex, emphasizes the importance of energy system infrastructure where it states:

The term “energy” includes producing, refining, transporting, generating, transmitting, conserving, building, distributing, maintaining, and controlling energy systems and system components. All energy systems are considered critical infrastructure.<sup>224</sup>

A draft of 2012 State Emergency Management Plan defines critical infrastructure and key resources as “systems and assets, whether physical or virtual, so vital to the State or jurisdiction that the incapacitation or destruction of such systems and assets would have a debilitating impact on State security, State or jurisdictional economic security, public health or safety, or any combination of those matters.”

---

<sup>223</sup> <http://www.txdps.state.tx.us/dem/pages/downloadableforms.htm>.

<sup>224</sup> <http://www.fema.gov/pdf/emergency/nrf/nrf-esf-12.pdf>.

## Characterization of the Industry

The RRC has jurisdiction over the following oil and gas infrastructure in Texas.

Figure 72: RRC jurisdiction

Oil and gas active wells	395,000
Intrastate pipelines—miles	168,000
Natural gas liquid extraction facilities	2,160
Natural gas storage fields	37
Natural gas market hubs	7
Lignite coal mines	24
Uranium exploration permits (2009)	16
Gas utility audits	140
LP gas bulk plants	989

According to the Energy Information Administration, Texas had reserves in 2009 as noted in Figure 73.<sup>225</sup>

Figure 73: Reserves

Reserves	Texas	Share
Crude oil	5,006 million barrels	24.2%
Dry natural gas	80,424 billion cubic feet	29.5%
Natural gas liquids	3,432 million barrels	38.4%
Recoverable coal, at producing mines	738 million short tons	4.2%

## Common Facility Components

Critical infrastructure under the jurisdiction of the RRC may include the following facility components.

<sup>225</sup> [http://tonto.eia.gov/state/state\\_energy\\_profiles](http://tonto.eia.gov/state/state_energy_profiles).



### ***Oil wells***

- ✚ Well bore
- ✚ Casing
- ✚ Tubing
- ✚ Sucker rod
- ✚ Pump
- ✚ Wellhead
- ✚ Pumping unit
- ✚ Electric motor
- ✚ Flow lines
- ✚ Three phase separator
- ✚ Oil tank
- ✚ Water tanks
- ✚ Meters

### ***Gas Wells***

- ✚ Well bore
- ✚ Casing
- ✚ Tubing
- ✚ Wellhead
- ✚ Flow lines
- ✚ Separator
- ✚ Water tank
- ✚ Meter

### ***Gathering System***

- ✚ Pipe
- ✚ Block valves
- ✚ Drips
- ✚ Free water knock outs
- ✚ Check and relief valves
- ✚ Dehydrators
- ✚ Compressors
- ✚ Electrical systems
- ✚ Tanks
- ✚ Meters

### ***Gas Plants***

- ✚ Inlet scrubber
- ✚ Compressors
- ✚ Amine units
- ✚ Refrigeration units
- ✚ Turbo-expanders
- ✚ Liquid pumps
- ✚ Product tanks
- ✚ Meters

### ***Transmission Pipelines***

- ✚ Pipe
- ✚ Block valves
- ✚ Free water knock outs
- ✚ Check and relief valves
- ✚ Dehydrators
- ✚ Compressors
- ✚ Pumps
- ✚ Electrical system
- ✚ Control system
- ✚ Pig launchers
- ✚ Tanks
- ✚ Meter

### ***Storage Facilities***

- ✚ Pipe
- ✚ Cavern, reservoir or tanks
- ✚ Block valves
- ✚ Compressors or pumps
- ✚ Meters

## ***Gas Distribution Systems***

- ✚ Pipe
- ✚ Block valves
- ✚ Meters
- ✚ Check and relief valves
- ✚ Odorizers

## ***LPG Distribution Centers***

- ✚ Pipe
- ✚ Tanks
- ✚ Block valves
- ✚ Check and relief valves
- ✚ Bobtail trucks

## ***Refineries***

- ✚ Pipe
- ✚ Pumps
- ✚ Process units
- ✚ Control systems
- ✚ Tanks

**Figure 74: Oil well pumping unit with counter balance and electric motor**



## **Natural Gas Metering**

For many years natural gas was measured in the residential and commercial market with bellows meters outfitted with a mechanical dial to record usage. Today some companies are installing radio based Automated Meter Reading (AMR). Using this technology, the meter sends a relatively short signal that is read by a meter reader in the street driving or walking by. The AMRs allow the gas meter to be read remotely without entering the premises. Some arguments have been made that safety is being compromised by the AMRs since the meter reader does not check the meter or smell for gas in the area when reading the meter.

The latest technology is called Advanced Metering Infrastructure (AMI). This system allows the gas to be measured and a signal is sent out to the company and is also available to the customer. “Gas AMI solutions collect time-synchronized interval meter data up to every hour, offer full two way communication to the meter and can extend communications to include

sensor technology placed along the gas distribution system.” Gas companies “can actively engage customers in their consumption decisions with real time access to usage information.”<sup>226</sup> The AMI technology is similar to the Smart Meters being used in the electric industry in that real time information regarding consumption is available to the distribution company and the customer. With this real time data the company and customer can make better and timely operating and consumption decisions.

## Threats

Principal threats and hazards to the Texas oil and gas industries include terrorism, criminal enterprise, natural hazards, industrial-related accidents and business cycle interruptions to normal supply and demand.<sup>227</sup>

### ***Terrorism***

Due to the major potential for loss of life and property damage, the oil and gas infrastructure is and will continue to be a target for terrorism. The border between Texas and Mexico runs 1,254 miles and has many points of entry. The Gulf Coast has many ports of entry. International terrorist groups could cross the border and inflict substantial damage on the oil and gas infrastructure. The potential for cyber warfare is a growing concern that could involve highly sophisticated multiple attacks. Also, domestic right-wing and left-wing extremist groups could pose a threat in seeking attention or retaliation for their causes.

### ***Criminal Enterprise***

Similar to terrorism, the oil and gas industries face the threat of criminal enterprise activity. This could range from extortion by a prison gang to sabotage by an aggressive group of oil and gas producers trying to control the actions of other producers.

Oil and gas pipelines and facilities have become increasingly dependent on supervisory control and data acquisition systems (SCADA). In some cases, valves are electronically opened and shut, compressors are remotely started up or shut down and pipeline and facility operations are remotely monitored. These systems are vulnerable to the threat of a cyber attack that could seriously impact major operations in the oil and gas industries.

---

<sup>226</sup> <http://pipelineandgasjournal.com/gas-advanced-metering-infrastructure-market-primed-innovation?page=show>.

<sup>227</sup> <http://www.rrc.state.tx.us/about/statplan10/stratplan2011-2015.pdf>.

## ***Natural Hazards***

Perhaps the greatest threat to the oil and gas infrastructure is natural hazards. Hurricanes, tornados, floods, ice storms, lightning, wildfires and earthquakes are natural hazards that pose a threat to the oil and gas infrastructure and to the supply of oil and gas products and by-products. Hurricanes are a particularly serious threat to the numerous refineries and facilities located along the Gulf Coast. Natural hazards can damage facilities, render control systems inoperable and disrupt supply. As previously mentioned, drought conditions with high winds resulted in numerous wildfires and extensive damage in 2011.

## ***Industrial Related Accidents***

Despite industry efforts to operate safely, accidents can occur at oil and gas wells, pipelines and facilities. Accidents may result in explosions, oil or product spills or toxic plumes that threaten public health and safety.

## ***Business Cycle Interruptions***

Strikes, embargos and global stock market fluctuations are business cycle interruptions that may threaten the normal energy supply.

## **Interdependencies**

The oil and gas infrastructure is interdependent with the electric infrastructure, the communications infrastructure and the water infrastructure. A few examples follow.

### ***Electricity Interdependency***

Electric generation companies require large quantities of natural gas and coal to produce electricity. Similarly, the production, processing, transportation and distribution of oil and gas (and coal) are largely dependent on electricity. Many oil and gas wells and facilities are dependent upon electricity as a power source to run control systems. Without electricity for pumping units, most oil wells would cease to produce oil, many natural gas compressors would stop functioning and crude oil and refined product pipeline pumping stations would become idle. Natural gas plants and oil refineries without back-up generation would shut down. Gasoline and diesel pumps at gas stations would also cease functioning.

Oil and gas field personnel drive vehicles requiring fuel to physically monitor and repair wells and travel to facilities. Drilling rigs, work-over rigs and other essential equipment rely on internal combustion engines that are powered by petroleum derived fuel. Trucks or trains,

requiring fuel, often transport crude oil, gasoline, diesel, LPG, jet fuel and other liquid products. Also, mining equipment, trucks and rail transport are essential elements of coal production. The trucks, trains and equipment used to produce oil, gas and coal in Texas are dependent on hydrocarbon fuels to continue production of energy.

As previously mentioned, almost half of the electricity in Texas is generated from natural gas and about 37% of electricity is generated from coal. Field personnel in the electric business are also largely dependent on fossil fuels to run trucks and equipment used in their day-to-day operations.

### ***Communications Interdependency***

The communications industry is dependent upon the energy sector to support its communications networks. Similarly, the oil and gas industries are heavily dependent upon landline communications, mobile communications and Internet access to respond to emergencies as well as to carry out day-to-day operations.

Natural gas and crude oil are traded as commodities on trading exchanges like the New York Mercantile Exchange (NYMEX). Gas and oil are traded both in the futures markets and in spot markets. Such trading is conducted electronically, for the most part, similar to the way in which stocks are traded electronically on the New York Stock Exchange. Commodities exchanges have highly sophisticated electronic capabilities requiring real time access to advanced communications capabilities as well as electricity. Without these exchanges, the trading of natural gas and oil as commodities could be disrupted as could the supply of natural gas as fuel to electric generation facilities and oil to other customers.

### ***Water Interdependency***

The treatment and distribution of water requires energy. Similarly, the energy industry is dependent upon access to water. Water is essential to oil and gas operations, particularly in the drilling and completion phase. During an emergency, if the water supply is interrupted, many oil and gas drilling operations would cease to function.

Electric generation facilities require large amounts of water for cooling and, to a lesser degree, for the production of hydroelectric power in Texas. Water is also needed for the production of nuclear power at the Comanche Peak and South Texas nuclear plants.

## Vulnerabilities

For the oil and gas industries, vulnerabilities are heightened in certain geographic areas. In addition, the combustible nature of fuels represents a vulnerability. There is also a vulnerability related to imports because such a large percentage of US oil is imported. Finally, the application of increasingly high levels of technology in the office and field create vulnerabilities requiring that cyber security measures be taken and continually updated. Major vulnerabilities regarding oil and gas entail the physical destruction of facilities, the compromising of cyber control systems and the distribution of supply chains.

As noted in the “Characterization” section, there is a massive oil and gas infrastructure in Texas that serves the state and the nation’s energy needs. As such, Texas’ vulnerabilities affect both the state and the nation. Because the Texas oil and gas infrastructure is huge and is so vital to the nation, the Texas infrastructure is relatively more attractive than other states as a target for malicious attack.

### Vulnerabilities Related to Geography

Perhaps the simplest way to describe Texas’ vulnerabilities is by geography.

- ✚ The Gulf Coast region, with its large number of oil and gas refineries, offshore rigs, wells, ports and pipelines, is a major area of vulnerability.
- ✚ Texas has three of the largest ten population centers in the US: Dallas, Houston and San Antonio. There may be a tendency for terrorists to target large population centers. In addition, the potential for loss of life and property damage due to a natural disaster is great, given the large population centers.
- ✚ The close proximity of the Barnett Shale to the Haynesville Shale in northeast Texas could make the vast network of pipelines in that area vulnerable because of its attractiveness as a target for malicious attack.
- ✚ Texas’ common border with Mexico presents a host of vulnerabilities like terrorism. There is a significant network of pipelines that cross into Mexico as the US imports oil and gas from that country.

### Vulnerability Related to Combustibility of Oil and Gas

Regardless of the vulnerability of a particular geographic region, a saboteur could ignite an oil or gas source, causing a fire or explosion that could damage or destroy the infrastructure, disrupt supply, jeopardize the lives of people and destroy property in the vicinity. In some cases, major oil and gas facilities are located in heavily populated areas.

## Vulnerability Related to Imports

To meet demand, the United States imports a considerable amount of foreign crude oil and refined petroleum products. This heavy reliance on imported oil creates a vulnerability of the crude oil supply. Figure 75 shows US crude oil production and the quantity of imports of crude oil and petroleum products. As shown, between 2006 and 2009, US imports of crude oil and refined products ranged from about 69% to 73% of domestically produced crude oil.

Figure 75: Imported vs. domestic oil

Year	2006	2007	2008	2009
Production, MMBbl	1,862	1,848	1,812	1,938
Imports, MMBbl	5,003	4,916	4,727	4,280
<b>TOTAL, MMBbl</b>	<b>6,865</b>	<b>6,764</b>	<b>6,539</b>	<b>6,218</b>
Imports	72.8%	72.7%	72.2%	68.8%

Despite the heavy dependence on foreign crude oil and refined products, PAD 3, a federal designation that includes Texas and other Gulf Coast states, has a diversified source of crude oil imports. The breakout for April 2010 of OPEC suppliers and non-OPEC suppliers as well as the major suppliers of crude oil to PAD 3 are shown in Figure 76.<sup>228</sup>

Supplier	MMBbls crude oil	% of imports
OPEC	102.2	58.3
Non-OPEC	73.2	41.7
TOTAL	175.4	100

Figure 76: 2010 Importers to PAD 3

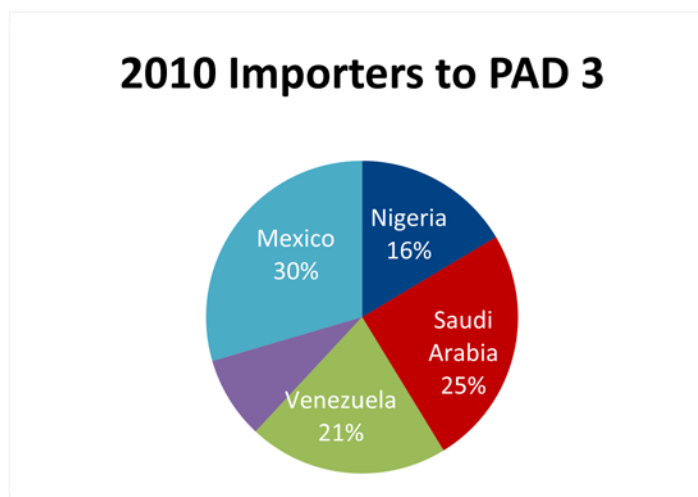

<sup>228</sup> [http://www.eia.gov/dnav/pet/pet\\_move\\_impcp\\_a2\\_r30\\_ep00\\_ip0\\_mbbbl\\_m.htm](http://www.eia.gov/dnav/pet/pet_move_impcp_a2_r30_ep00_ip0_mbbbl_m.htm).

PAD 3 imports less than 5% from each of the other supplier countries.<sup>229</sup>

While a vulnerability related to imports is usually thought of in terms of foreign imports, Texas also has vulnerabilities related to certain domestic imports. For example, more than a third of Texas' electricity is generated from coal, most of which is mined in Wyoming.<sup>230</sup> A railroad strike could significantly disrupt the state's supply of coal from Wyoming and, as a result, affect the production of electricity.

## Vulnerability Related to Cyber Security

During the last 20 years, the natural gas and liquid petroleum industries have applied increasing levels of technology. Digital measurement equipment is currently found in the field, pipelines and plants and is being implemented by some local distribution companies for residential customers. The private sector is using computer technology and SCADA systems to remotely operate many pipelines and facilities. Cyber security has become a necessity to protect the operation of these facilities and ensure supplies are available to energy markets. Attacks on corporate networks are also a concern in that such attacks may result in stolen or corrupted data or denial of service.

Cyber security risk involves threat, vulnerability and consequences. The motivation of most hackers is either to cause financial harm or to challenge or to cause embarrassment. Intruders may be amusement seekers, social engineers with a cause, insiders, organized criminals, terrorists or hostile governments.<sup>231</sup> Attacks may be attempted through office computers to attack control systems. Direct cyber attacks of control systems may come from remote sources or may occur onsite at the facility. Many cyber attacks go unnoticed for extended periods of time. Evidence suggests some sophisticated intruders have left malware in energy control systems with the intention of activating the malware at a future date.<sup>232</sup> Major consequences of energy systems cyber intrusion is supply disruption and possible facility damage.

One example of recent Cyber attacks include Night Dragon described below:

Starting in November 2009, coordinated covert and targeted cyber attacks have been conducted against global oil, energy, and petrochemical companies. These attacks have involved social engineering, spear-phishing attacks, exploitation of Microsoft Windows operating systems vulnerabilities, Microsoft Active Directory compromises, and the use of remote administration tools (RATs) in targeting and harvesting sensitive competitive proprietary operations and project-financing

<sup>229</sup> [http://tonto.eia.gov/state/state\\_energy\\_profiles](http://tonto.eia.gov/state/state_energy_profiles).

<sup>230</sup> [http://www.uccusa.org/assets/documents/clean\\_energy/Burning-Coal-Burning-Cash\\_full-report.pdf](http://www.uccusa.org/assets/documents/clean_energy/Burning-Coal-Burning-Cash_full-report.pdf), at page 44.

<sup>231</sup> DOE National Test Bed Program, *Introduction to Control System Cyber Security* (May 5, 2010).

<sup>232</sup> [http://www.us-cert.gov/control\\_systems/pdf/oil\\_gas1104.pdf](http://www.us-cert.gov/control_systems/pdf/oil_gas1104.pdf).



information with regard to oil and gas field bids and operations. We have identified the tools, techniques, and network activities used in these continuing attacks — which we have dubbed Night Dragon — as originating primarily in China. Through coordinated analysis of the related events and tools used, McAfee has determined identifying features to assist companies with detection and investigation. While we believe many actors have participated in these attacks, we have been able to identify one individual who has provided the crucial C&C infrastructure to the attackers.<sup>233</sup>

Another example released by the Department of Homeland Security in May 2012 states “A major cyber attack is currently under way aimed squarely at computer networks belonging to US natural gas pipeline companies, according to alerts issued to the industry by the US Department of Homeland Security. At least three confidential "amber" alerts – the second most sensitive next to "red" – were issued by DHS beginning March 29, all warning of a "gas pipeline sector cyber intrusion campaign" against multiple pipeline companies. But the wave of cyber attacks, which apparently began four months ago – and may also affect Canadian natural gas pipeline companies – is continuing.”<sup>234</sup>

Cyber security may be implemented through a combination of technical and administrative controls. These may include separation of control systems from corporate and Internet access, installation of network intrusion detection systems and logging the operational status of control networks. Other measures may include implementation of policy and procedures concerning cyber security, changing control and management practices and emergency response and recovery plans and exercises. Updating, maintaining and patching SCADA systems are required for ongoing cyber protection.<sup>235</sup>

Major players in the oil and gas cyber security forum include the American Gas Association, the Department of Energy, the Department of Homeland Security and the Idaho National Engineering and Environmental Laboratory. The RRC co-hosted an Oil and Gas Cyber Security Workshop in September 2012 to include speakers from the natural gas industry, ICS-CERT, FBI, academia and the state Department of Information.

Cyber attacks on energy commodity markets also pose a threat. False reporting of current prices, future prices and storage supplies both in domestic or foreign markets could result in havoc leading to supply disruption.<sup>236</sup>

---

<sup>233</sup> <http://www.mcafee.com/us/resources/white-papers/wp-global-energy-cyberattacks-night-dragon.pdf>.

<sup>234</sup> [http://www.msnbc.msn.com/id/47310697/ns/technology\\_and\\_science-christian\\_science\\_monitor/t/alerts-say-major-cyber-attack-aimed-gas-pipeline-industry/](http://www.msnbc.msn.com/id/47310697/ns/technology_and_science-christian_science_monitor/t/alerts-say-major-cyber-attack-aimed-gas-pipeline-industry/).

<sup>235</sup> [http://www.energybiz.com/magazine/article/111096/providing-cybersecurity?quicktabs\\_4=2&quicktabs\\_6=2](http://www.energybiz.com/magazine/article/111096/providing-cybersecurity?quicktabs_4=2&quicktabs_6=2).

<sup>236</sup> [http://www.ensec.org/index.php?option=com\\_content&view=article&id=243:canvassing-the-cyber-security-landscapewhy-energy-companies-need-to-payattention&catid=106:energysecuritycontent\\_0510&Itemid=361](http://www.ensec.org/index.php?option=com_content&view=article&id=243:canvassing-the-cyber-security-landscapewhy-energy-companies-need-to-payattention&catid=106:energysecuritycontent_0510&Itemid=361).

## Consequences

An energy emergency, whether caused by accident or due to malicious activities or extreme weather conditions, could have disastrous consequences, including loss of life, property damage and long-term economic impacts on a community, a region, the state and the nation. Supply disruptions could take months to remedy. A coordinated cyber attack on, or other disruption of, the electric grid, the communications network, the water supply or the oil and gas infrastructure could wreak havoc on any or all of these interrelated systems.

A mitigating factor is that the Texas oil and gas industry consists of many wells, pipelines and facilities with redundancy built into many companies' computer systems. The likelihood of simultaneously losing production of a debilitating amount of oil and gas infrastructure is small, but possible. Also, a significant part of the oil and gas infrastructure in Texas is located underground which provides some protection against threats and reduces vulnerability.

### International

The International Energy Agency (IEA) is an energy forum of 28 member countries that are committed to taking joint measures to meet oil supply emergencies.<sup>237</sup> IEA countries have agreed to share energy information, coordinate energy policies and cooperate in the development of energy programs. These provisions are embodied in the *Agreement on an International Energy Program*, a treaty pursuant to which the IEA was established in 1974. The objectives of the international treaty include:

- ✚ To maintain and improve systems for coping with oil supply disruptions;
- ✚ To promote rational energy policies in a global context through cooperative relations with non-member countries, industry and international organizations;
- ✚ To operate a permanent information system on the international oil market;
- ✚ To improve the world's energy supply and demand structure by developing alternative energy sources and increasing the efficiency of energy use;
- ✚ To promote international collaboration on energy technology and
- ✚ To assist in the integration of environmental and energy policies.

The 1974 agreement requires IEA member countries to hold oil stocks equivalent to *at least 90 days of net oil imports* and, in the event of a major oil supply disruption to, release stocks, restrain demand, switch to other fuels, increase domestic production or share available oil, as necessary.

To supplement mechanisms defined in the agreement, the IEA created flexible arrangements for coordinated use of drawing down stock, demand restraint and other measures which could be implemented in response to a disruption in oil supplies. IEA collective response actions are designed to mitigate the negative impacts of sudden oil supply shortages by making additional oil available to the global market through a combination of emergency response measures which include both increasing supply and reducing demand. Although supply shortages may bring about rising prices, prices are not a trigger for a collective response action, as these can be caused by other factors, and the goal of the response action is to offset an actual physical shortage, not react to price movements.

---

<sup>237</sup> As of 2010, member countries included Australia, Austria, Belgium, Canada, the Czech Republic, Denmark, Finland, France, Germany, Greece, Hungary, Ireland, Italy, Japan, Korea, Luxembourg, Netherlands, New Zealand, Norway, Poland, Portugal, Slovak Republic, Spain, Sweden, Switzerland, Turkey, United Kingdom, United States. Source: [www.iea.org](http://www.iea.org).

As an example, the IEA coordinated an international response of its 28 members to Hurricane Katrina which hit the Gulf Coast in 2005. The following measures were taken.

1. On September 2, 2005, IEA member countries agreed to make available to the market the equivalent of 60 million barrels of oil through a combination of emergency response measures including the use of emergency stocks, increased indigenous production and demand restraint.
2. Nearly 29 million barrels were drawn from public stocks. An additional 23 million barrels of oil were made available through the lowering of stockholding obligations on industry.
3. Almost half the volume of oil coming from the use of emergency stocks was in the form of refined product.
4. The IEA collective action successfully reinforced market functions by providing real barrels to relax tightness and offset interruption in supply.

## Domestic

### Short-Term Emergencies

Most short-term emergencies in Texas are weather related. These emergencies may be caused by hurricanes, ice storms, floods, tornados, fires from lightning storms and other natural causes. Also, small localized single strike terrorist attacks may cause a short-term emergency.

The greatest recurring causes of supply disruption in Texas are hurricanes and tropical storms along the Gulf Coast. When a hurricane enters the Gulf, offshore production and drilling platform personnel initiate Emergency Contingency Plans, triggering shutdown or shut-in procedures and crew evacuations. Refinery crews located along the Gulf Coast initiate emergency plans shutting down operations and preparing facilities for the storm. Natural gas processing plants initiate emergency shutdown procedures and many onshore wells are also secured and shut-in. Storage tanks are often filled with salt water to keep them on location during the storm.



Figure 77: Blowout preventer

When a hurricane or tropical storm threatens Texas, the Texas Division of Emergency Management (TDEM) activates the State Operations Center (SOC) and the State Emergency Management Council. Various response agencies, such as the RRC, PUC and TCEQ, are also convened. These regulatory agencies maintain open lines of communication with industry to

broadcast storm tracking information and state response actions so that any information industry has on emergency needs or the availability of private company resources can be quickly relayed through an agency's contacts within the SOC. Additionally, regulatory agencies have direct access to emergency resources and assets in the event industry needs state assistance. The SOC includes a representative from the RRC. The Director of Human Resources manages the rotation of RRC volunteers trained to participate in the SOC during emergencies. RRC staff comes prepared with a laptop computer, a geospatial map, a phone list and an Emergency Process for each Division providing the chain of command and protocol. The District offices are staffed with Directors, inspectors, plugging specialists, cleanup coordinators and maps with lease roads and oil and gas wells and facilities. The RRC serves on six Emergency Support Functions of the State Emergency Management Plan under the direction of TDEM. The RRC also works closely with several industry trade organizations to monitor oil and gas supply disruptions or shortages and to solve problems or provide solutions to allocating or reallocating natural gas and petroleum products.

Ice storms in north Texas are the state's second major source of short-term supply disruptions. Natural gas gathering systems, field compressor stations and distribution facilities may freeze up due to liquid condensation in the lines or facilities. Ice storms also cause roads to freeze over which limits the mobility of field personnel in all phases of the industry and also affects deliveries of LP-gas. The RRC Divisions and the RRC SOC Team monitor supplies and assist, as appropriate, with the restoration of deliveries of natural gas and petroleum products.

## Long-Term Emergencies

Emergencies resulting in long-term supply shortages include war, insurrection, strikes, earthquakes, embargos, massive terrorist and cyber attacks.

## Public Sector

Energy companies are usually the first to respond directly to an energy emergency. Often, an energy company's response is all that is needed to address an emergency. State government participates in responding to an energy emergency when the emergency threatens public health, safety or welfare or when the local governments and DDCs request assistance from the state. Given the speed and agility required for a state's energy industry to jointly respond to an energy emergency, a public private sector partnership is essential. Such a partnership underlies Texas' Energy Assurance Plan.

## Prevention and Mitigation, Public and Private Sectors

The state of Texas has a cross-section of laws, policies, rules and practices that serve to:

- ✦ Prevent or mitigate a future energy emergency from occurring and, if it does occur, to
- ✦ Prevent or mitigate the potential that a future energy emergency may impact energy customers.

**Figure 78: Natural gas pipeline road crossing marker**



In this section of the Energy Assurance Plan, such forward-looking laws, policies, rules and practices which are put into place months or years before an emergency occurs are summarized by industry or industry segments. Prevention and mitigation laws, policies, rules and practices are discussed beforehand as good planning precedes effective action. Emergency response actions that are implemented during and after the onset of an actual energy emergency are described separately. In some instances, there is an overlap in the discussion of prevention and mitigation laws, policies, rules and practices with emergency response procedures. This crucial distinction between forward-looking mitigation and prevention

and real time emergency response activities acknowledges the DOE's new emphasis on prevention and mitigation, building on the existing knowledge base applicable to emergency response.

As a first step in prevention and mitigation, the RRC includes safety training such as disaster preparedness training in its portfolio of in-house training for employees.<sup>238</sup> Safety training is offered to all employees. The RRC also offers training in hazardous waste operations and emergency response.

During an emergency, the RRC has an operational plan for carrying out its business. The RRC has a Continuity of Operations Plan allowing the RRC to continue functioning under severe emergency conditions such as destruction of their building.

### Natural Gas Distribution Systems

The state's laws, policies, rules and practices that are designed to prevent and mitigate a future energy emergency or to prevent and mitigate the impact of such an emergency as it relates to natural gas distribution companies are summarized in the table below. In most instances, these

<sup>238</sup> 16 Administrative Code § 20.602(c)(4) (2010).

provisions affect customers located in areas under the RRC’s jurisdiction, that is, all unincorporated areas in the state plus those incorporated areas that cede their jurisdictional authority to the RRC.

### Prevention and mitigation measures, natural gas distribution companies

Applies to energy emergencies that are	Short-term	Long-term
<b>Prevention policy:</b> Gas utilities are required to make all reasonable efforts to prevent interruptions of service. RRC Rule § 7.45(1)(A)(i).	✓	✓
<b>Restoration policy:</b> When service interruptions occur, utilities are required to reestablish service within the shortest possible time, consistent with prudent operating principles, so that the smallest number of customers is affected. § 7.45(1)(A)(i).	✓	✓
<b>Emergency training policy:</b> Each gas utility is required to issue instructions to its employees covering procedures to be followed in the event of an emergency in order to prevent or mitigate interruption or impairment of service. § 7.45(1)(A)(ii).	✓	✓
<b>Curtailment policy giving preference to emergency responders:</b> In the event of a national emergency or local disaster resulting in disruption of normal service, a gas utility may interrupt service to other customers to provide necessary service to civil defense or other emergency agencies on a temporary basis until normal service to these agencies is restored. § 7.45(1)(A)(iii).	✓	
<b>Curtailment priority of interstate customers:</b> Natural gas provided to certain interstate customers, as outlined in § 7.455, is to be the lowest priority in curtailment plans under the jurisdiction of the RRC.	✓	✓
<b>Curtailment policy establishing priorities:</b> In 1973, the RRC issued an order in Gas Utilities Docket No. 489 which required natural gas utilities to file a curtailment plan with the RRC and established curtailment priorities for such utilities. A copy of the order is available at <a href="http://www.rrc.state.tx.us/meetings/dockets/docket489.php">http://www.rrc.state.tx.us/meetings/dockets/docket489.php</a> .	✓	✓
<b>Preventing recurrence, records to be maintained:</b> Each utility is required to keep a record of service interruptions including, in part, a record of the remedy and steps taken to prevent recurrence. § 7.45(1)(B).	✓	✓
<b>Disconnection during an emergency.</b> A gas company is prohibited	✓	

from disconnecting natural gas service to a residential customer during an extreme weather emergency and is required to defer collection of bills that are due during an extreme weather emergency and is required to defer collection of bills that are due during an extreme weather emergency. Utilities Code § 104.258(c) and Rule § 7.460.		
<b>Extreme weather emergency defined:</b> The term “extreme weather emergency” means a period during which the previous day’s highest temperature is predicted to remain at or below that level for the next 24 hours according to the nearest National Weather Service reports. Utilities Code § 104.258(a)(1).	✓	
<b>Policy allowing recovery of costs to inform the public:</b> Certain limitations on the recovery of gas utility costs are not applicable to “advertising regarding service interruptions, safety measures, or emergency conditions.” Thus, gas utilities may request recovery of such costs. §7.5414(c)(3).	✓	✓

## Underground Storage of Natural Gas

The state’s laws, policies, rules and practices that are designed to prevent and mitigate a future energy emergency or to prevent and mitigate the impact of such an emergency, as it relates to underground storage of natural gas, are summarized below.

### Prevention and mitigation measures, underground storage of natural gas

Applies to energy emergencies that are	Short-term	Long-term
<b>Emergency suspension of storage permit:</b> In the event of an emergency that presents imminent danger to life or property and in certain other circumstances, the RRC or its designee may immediately suspend a storage facility’s permit to operate. §§ 3.96(g)(2) and 3.97(f)(2).	✓	✓



<p><b>Policies requiring emergency response plans:</b> The RRC requires each operator that stores natural gas in a productive or depleted reservoir to submit to the RRC a safety plan that includes emergency response procedures, <i>prevention</i> measures, provisions to provide security against unauthorized activity and gas release detection plans. § 3.96(i)(3).</p> <p>The RRC requires each operator that stores natural gas in an underground salt formation to submit to the RRC a written emergency response plan that addresses gas releases, fires, fire suppression capability, explosions, loss of electricity and loss of telecommunications services. § 3.97(h)(7).</p>	✓	✓
<p><b>Annual emergency drill:</b> Operators that store natural gas in underground salt formations are required to conduct an annual drill that tests the operator’s response to a simulated emergency and to invite local emergency response authorities to participate in all such drills. § 3.97(h)(9).</p>	✓	✓
<p><b>Emergency training policy:</b> Each operator of an underground storage facility is required to prepare and implement a plan to train and test each employee at each gas storage project on operational safety and emergency response procedures to the extent applicable to the employee’s duties and responsibilities. §§ 3.96(i)(4) and 3.97(h)(10)(A)</p>	✓	✓
<p><b>Policy requiring notice:</b> Operators that store natural gas in underground salt formations are required to report to the appropriate RRC district office any emergency, significant loss of gas or fluids, significant mechanical failure, other problem that increases the potential for an uncontrolled release of gas. Within 90 days of the incident, such operators are required to file with the RRC a report that describes operational changes, if any, that were or will be implemented to <i>reduce the likelihood of recurrence</i>. § 3.97(h)(8)(B).</p> <p>Operators that store natural gas in underground reservoirs are required to report to the appropriate RRC district office the discovery of any pressure changes or other monitoring data that indicate the presence of leaks in a well or the lack of confinement of the injected gases to the storage reservoir. § 3.96(m)(5).</p>	✓	

## Natural Gas Pipelines

The state’s laws, policies, rules and practices that are designed to prevent and mitigate a future energy emergency or to prevent and mitigate the impact of such an emergency, as it relates to natural gas pipelines, are summarized below.

## Prevention and mitigation measures, natural gas pipelines

Applies to energy emergencies that are	Short-term	Long-term
<b>Emergency defined:</b> In the context of the RRC’s underground pipeline damage prevention rules, the term “emergency” means a situation that endangers life, health or property or a situation in which the public need for uninterrupted service and immediate reestablishment of service if services are interrupted compels immediate action. § 18.2(3).	✓	✓
<b>Reporting pipeline emergencies:</b> The RRC requires operators of underground pipelines to report to the RRC pipeline damage caused by excavators. In addition, emergency responders and members of the general public are encouraged to report pipeline damage using procedures outlined in the RRC’s damage prevention rules. § 18.11.	✓	
<b>Emergency shut-in authority:</b> When an emergency exists due to an imminent threat of harm to people or property, the RRC may immediately shut-in a well or lease or direct the operator of a well or lease to shut-in a well or lease. § 3.73(k).	✓	✓
<b>Authority to require daily reports:</b> During an energy emergency, the RRC may need to encourage an increase in supply of an energy source. For any reason deemed urgent, the RRC may require oil and gas pipeline companies to furnish daily reports on the amount of oil or gas purchased or taken from different wells or parties. § 3.59(b).	✓	✓
<b>Verbal authority to transport:</b> When there is an imminent threat to public health and safety, a well operator may obtain verbal authority rather than written authority from the RRC to use a transporter not authorized for a particular property. § 3.58(a)(3).	✓	✓
<b>Policy requiring notice:</b> Operators of certain intrastate pipelines are required to notify the RRC of pipeline accidents involving crude oil, hazardous liquids other than crude oil and carbon dioxide as described in the RRC’s rules. § 8.301(a). A natural gas company is required to notify the RRC of any event that involves a release of gas from its pipelines, as described in the RRC’s rules. § 8.210.	✓	✓

<p><b>Policy on leak grading:</b> The purpose of a leak grading system is to determine the extent of the potential hazard resulting from gas leakage and to prescribe remedial actions. The RRC requires each pipeline operator to ensure that leak grading is conducted by individuals who possess training, experience and knowledge in the field of leak classification and investigation. §§ 8.203 and 8.207.</p>	✓	✓
<p><b>Policy requiring leak procedures:</b> The RRC requires gas companies to have written procedures that address the handling of natural gas leak complaints, as prescribed in the RRC's rules. § 8.205.</p>	✓	✓
<p><b>Policy on records availability:</b> The RRC requires each operator, officer, employee or representative of a gas company or liquids company to make available certain materials, as described in the RRC's rules, relevant to the investigation of an accident or leak involving an intrastate pipeline facility. § 8.130(c)(2).</p>	✓	✓
<p><b>Assessment of public threat:</b> As a part of its approach to pipeline integrity assessment, the RRC requires certain operators of intrastate transmission lines and certain hazardous liquids pipeline operators and certain natural gas pipeline operators to identify significant threats to the environment, public health and safety. § 8.101.</p>	✓	✓
<p><b>Public education:</b> Operators of natural gas pipelines and facilities, hazardous liquids pipelines and facilities and carbon dioxide pipelines and facilities or their designated representatives are required to conduct liaison activities with fire, police and other appropriate emergency response officials, as described in the RRC's rules and the Utilities Code. Utilities Code § 121.2015 and Rule §§ 8.310 and 8.235.</p>	✓	✓

**Figure 79: Gas well and meter run delivering to intrastate pipeline.**



## Liquefied Natural Gas

The state’s laws, policies, rules and practices that are designed to prevent and mitigate a future energy emergency or to prevent and mitigate the impact of such an emergency, as it relates to liquefied natural gas, are summarized below.

### Prevention and mitigation measures, liquefied natural gas

Applies to energy emergencies that are	Short-term	Long-term
<b>Policy requiring failsafe design:</b> The RRC requires that certain LNG facilities be designed to go into a failsafe condition in the event there is a power failure or other such failure. § 14.2510.	✓	✓
<b>Policy on LNG building egress:</b> To mitigate the possibility of congestion during an emergency, the RRC requires that buildings reserved exclusively for LNG fueling be constructed so that windows and doors are located to permit ready egress. § 14.2307(a)	✓	
<b>LNG facility impact determination:</b> Before an LNG container is installed in a heavily populated or congested area, the RRC determines whether the proposed installation poses a threat to the health, safety and welfare of the general public. § 14.2040(j)(3).	✓	
<b>Emergency refueling exemption:</b> To prevent delays in refueling of LNG vehicles during an emergency, the RRC exempts LNG emergency refueling vehicles from any requirement to register with the RRC. § 14.2310(d).	✓	
<b>Policy requiring emergency response manual:</b> The RRC requires each LNG operator to prepare a detailed emergency response manual that reflects the RRC’s minimum requirements, to keep the manual up-to-date, and to keep a copy of the manual in each LNG operating area. § 14.2131.	✓	✓
<b>Policy on emergency training:</b> The RRC requires LNG operators to conduct comprehensive training of their employees including, in part, training regarding the emergency response plan and training on emergency response situations, such as fires, leaks, and spills. §§ 14.2137 and §14.2131(d).	✓	✓

<b>Policy on emergency communications:</b> To aid emergency communications, the RRC requires LNG operators to provide emergency communications capability near LNG transfer locations. §14.2128.	✓	
<b>Policy on emergency coordination:</b> The RRC requires LNG operators to coordinate fire control measures with local fire and emergency response organization. § 14.2131(e).	✓	
<b>Reporting of LNG incidents/accidents:</b> The RRC requires that LNG incidents and accidents be reported to the RRC’s Pipeline Safety Division if there is a spill of 25 gallons or more, if there is property damage of \$1,000 or more, or if there is an injury requiring transport to a medical facility. § 14.2049.	✓	

## Liquefied Petroleum Gas

The state’s laws, policies, rules and practices that are designed to prevent and mitigate a future energy emergency or to prevent and mitigate the impact of such an emergency, as it relates to liquefied petroleum gas, are summarized below.

### Prevention and mitigation measures, liquefied petroleum gas

Applies to energy emergencies that are	Short-term	Long-term
<b>LP-gas defined:</b> The term “liquefied petroleum gas” means any material that is composed predominantly of any of the following hydrocarbons or mixtures of hydrocarbons: propane, propylene, normal butane, isobutane, and butylenes. Natural Resources Code § 113.002(4).	✓	
<b>Emergency waiver of requirement to obtain license, permit or certification:</b> Under certain emergency conditions outlined in the Texas Natural Resources Code, LP-gas trucks and operators may transport LP-gas into the state without obtaining a license, permit, or certification ordinarily required under Texas state law. Natural Resources Code § 113.083.	✓	
<b>Emergency waiver of inspection:</b> When there is an immediate need for LP-gas under emergency circumstances, the RRC’s Pipeline Safety Division may waive the requirement for an initial inspection of LP-gas facilities. Rule § 9.110.	✓	

<b>LP gas emergency mitigation:</b> The RRC’s rule on LP-gas emergencies describes the RRC’s processes for minimizing the severity of such disruptions. § 9.31.	✓	✓
<b>Policy regarding reporting of LP-gas incidents/accidents:</b> The RRC requires that LP-gas incidents and accidents be reported to the RRC’s Pipeline Safety Division, as outlined in the agency’s rules. § 9.36.	✓	
<b>Policy requiring emergency response procedures:</b> The RRC requires each LP-gas operator to maintain an emergency response procedure to be followed when any employee receives notification of a possible leak. The LP-gas operator is required to make its emergency response procedures available to emergency response agencies, in the manner outlined in the RRC’s rules. § 9.35(a). Certain operators are required to maintain detailed emergency procedures regarding a leaking cylinder. § 9.17(d)(1)(I).	✓	✓
<b>Policy on emergency training:</b> The RRC requires LP-gas operators to ensure that all employees are familiar with emergency response procedures and are authorized to implement the procedures without management oversight. § 9.35.	✓	✓
<b>Emergency mitigation:</b> If the RRC’s Gas Services Division determines that a proposed LP-gas installation may result in dangerous or combustible materials being located in an area that might be affected by an emergency situation, the Division is authorized by the RRC to impose additional restrictions or conditions on that proposed LP-gas installation. § 9.101(c)(2)(A)(vii).	✓	✓
<b>Emergency suspension of storage permit:</b> In the event of an emergency that presents imminent danger to life or property and in certain other circumstances, the RRC or its designee may immediately suspend a storage operator’s permit to store liquid or liquefied hydrocarbons in an underground salt formation. § 3.95(f)(2).	✓	✓
<b>Policy requiring emergency response plans:</b> The RRC requires each operator that stores liquid or liquefied hydrocarbons in underground salt formations to submit to the RRC a written emergency response plan that addresses spills and releases, fires, fire suppression capability, explosions, loss of electricity and loss of telecommunications services. § 3.95(h)(8).	✓	✓

<p><b>Policy requiring notice:</b> Operators that store liquid or liquefied hydrocarbons in underground salt formations are required to report to the appropriate RRC district office any emergency, significant loss of fluids, significant mechanical failure and other problem that increases the potential for an uncontrolled release of gas. Within 90 days of the incident, such operators are required to file with the RRC a report that describes operational changes, if any, that were or will be implemented to <i>reduce the likelihood of recurrence</i>. § 3.95(h)(9)(B).</p>	✓	
<p><b>Policy on public education:</b> Each operator that stores liquid or liquefied hydrocarbons in underground salt formations is required to establish a continuing educational program to inform residents within a one-mile radius of a hydrocarbon storage facility of emergency notification and evacuation procedures. § 3.95(h)(10).</p>	✓	✓
<p><b>Emergency training policy:</b> Each operator of a facility that stores hydrocarbons is required to prepare and implement a plan to train and test each employee at each underground hydrocarbon storage facility on operational safety including, in part, an emergency response plan, to the extent applicable to the employee’s duties and responsibilities. § 3.95(h)(12)(A).</p>	✓	✓
<p><b>Policy on warning system integration:</b> At hydrocarbon storage facilities, all leak detectors, fire detectors, heat sensors, pressure sensors and emergency shutdown instrumentation must be integrated with warning systems that are audible and visible to the local control room and at any remote control center. § 3.95(h)(13)(A).</p>	✓	✓
<p><b>Policy on recording emergency data:</b> Operators of hydrocarbon storage facilities are required to have equipment that electronically records all liquid and gas pressures, volumes, and flow rates at a frequency of at least once per minute and all actuation of the emergency shutdown valve. § 3.95(l)(5).</p>	✓	✓

## Compressed Natural Gas

The state’s laws, policies, rules and practices that are designed to prevent and mitigate a future energy emergency or to prevent and mitigate the impact of such an emergency, as it relates to compressed natural gas, are summarized below.

## Prevention and mitigation measures, compressed natural gas

Applies to energy emergencies that are	Short-term	Long-term
<b>Policy requiring emergency shutdown capability:</b> The RRC requires residential fueling facilities and operators of CNG compression, storage and dispensing systems to install equipment intended to mitigate the effects of an energy emergency including, in part, installation of an emergency manual shutdown of the gas supply and, for residential fueling facilities, electrical power. §§ 13.192(a) and §13.101.	✓	✓

## Surface Mining of Coal

The state’s laws, policies, rules and practices that are designed to prevent and mitigate a future energy emergency or to prevent and mitigate the impact of such an emergency, as it relates to the surface mining of coal, are summarized below.

### Prevention and mitigation measures, coal mining

Applies to energy emergencies that are	Short-term	Long-term
<b>Policy requiring identification of alternate water supply:</b> To mitigate the impact of a water supply disruption and the related effect on the production of energy, the RRC requires that an applicant requesting a permit to conduct underground coal mining operations or surface mining of coal identify whether such activities could result in contamination, diminution or interruption of an underground or surface source of water and, if so, to identify alternative sources of water. §§ 12.176 and §12.130.	✓	✓

## Petroleum Sector

The state’s laws, policies, rules and practices that are designed to prevent and mitigate a future energy emergency or to prevent and mitigate the impact of such an emergency, as it relates to the petroleum sector, are summarized below.



Figure 80: Pump jack on a shallow oil well



Prevention and mitigation measures, petroleum sector

Applies to energy emergencies that are	Short-term	Long-term
<p><b>Emergency suspension of reclamation permit:</b> In the event of an emergency that presents an imminent public safety threat, the RRC may suspend the permit of an operator of a reclamation plant until an order is issued pursuant to a hearing. A reclamation plant is a plant involved in the removal of tank bottoms or other hydrocarbon waste from any oil producing lease tank, pipeline storage tank or other production facility. § 3.57(e)(8).</p>	✓	✓
<p><b>Emergency waiver authority:</b> Under certain emergency circumstances identified in the RRC’s rules, the RRC may waive notice and hearing requirements pertaining to a certification or waiver allowing or disallowing a discharge into U.S. waters. § 3.93(d)(4).</p>	✓	✓
<p><b>Fire prevention:</b> The RRC has extensive fire prevention rules applicable to the petroleum sector. § 3.21.</p>	✓	✓

<b>Policy requiring notice:</b> Operators of oil wells, gas wells, geothermal wells, pipeline receiving tanks, storage tanks or receiving or storage receptacles into which crude oil, gas or geothermal resources are produced, received, stored, piped or transported must immediately notify the RRC of a fire, leak, spill, break or other such accident, as described in the RRC's rules. § 3.20.	✓	
<b>Authority to alter well spacing threshold:</b> The RRC establishes minimum space requirements for drilling of wells for oil, natural gas and geothermal resources. In the interest of protecting life, for example during an emergency, the RRC may increase or decrease the allowable distance for spacing of wells, as described in the RRC's rules. § 3.37(d).	✓	✓

## Geologic Storage of Carbon Dioxide

The state's laws, policies, rules and practices that are designed to prevent and mitigate a future energy emergency or to prevent and mitigate the impact of such an emergency, as it relates to the geologic storage of carbon dioxide (CO<sub>2</sub>), are summarized below.

### Prevention and mitigation measures, carbon dioxide

Applies to energy emergencies that are	Short-term	Long-term
<b>Emergency shutdown:</b> In the event of an emergency that endangers underground drinking water, life or property, the director of the RRC's Oil & Gas Division may immediately order suspension of the operation of a carbon dioxide geologic storage facility, as described in the RRC's rules. § 5.202(d)(2).	✓	
<b>Policy requiring emergency plan:</b> An applicant requesting a permit to operate a carbon dioxide geologic storage facility must submit to the RRC an emergency and remedial response plan, as described in the RRC's rules. §§ 5.203(l) and §5.206(g)(1).	✓	✓
<b>Policy requiring training:</b> Operators of carbon dioxide geologic storage facilities are required to train and test employees at each storage facility on, among other things, emergency response procedures, to the extent applicable to the employee's duties and responsibilities. §§ 5.203(l)(4) and §5.206(g)(2).	✓	✓

## Surface Mining of Uranium

Although the RRC has jurisdiction over surface mining of uranium,<sup>239</sup> there are no longer any uranium surface mines or mill sites in the state. In situ underground extraction of uranium, as opposed to surface mining of uranium, continues to occur in the state, and such extraction is under the jurisdiction of the Texas Commission on Environmental Quality. Uranium oxide must be converted to uranium metal through an “enrichment” process for which a very limited number of processing plants exist before it can be used in the production of nuclear power. Neither surface mining of uranium nor the enrichment of uranium is a short-term process. As such, state efforts to accelerate production and enrichment of uranium for the generation of nuclear power may not be feasible in response to an energy emergency.

### Private Sector

Businesses in the oil and gas industry have the responsibility to construct, maintain and operate their facilities in a safe manner. Failure to do so could result in criminal and civil penalties. Natural gas pipelines are built according to certain minimum codes. Engineers may design facilities with safety factors in mind beyond the minimum standards. Natural gas pipelines are operated in accordance with required operations and maintenance plans and emergency operating procedures as well as federal and state safety laws, rules and policies. Steps that might be employed by the private sector to prevent and mitigate the consequences of short-term emergencies and disasters include:

- ✚ Establishing an emergency chain of command;
- ✚ Training of management and field personnel in emergency response, prevention and mitigation;
- ✚ Acquiring accessible response equipment;
- ✚ Conducting emergency drills;
- ✚ Hardening critical infrastructure;
- ✚ Exceeding ASME and PHMSA engineering standards;
- ✚ Enhancing resiliency of assets;
- ✚ Increasing reliability;
- ✚ Developing efficiency;
- ✚ Employing updated cyber security measures;
- ✚ Employing physical security like high fences, lights and guards and
- ✚ Reporting suspicious incidents.

Steps that might be employed by the private sector to prevent and mitigate the consequences of long-term emergencies and disasters include:

---

<sup>239</sup> The approval, inspection and enforcement of uranium exploration and drilling are responsibilities of the RRC.

- ✚ Increasing production capability;
- ✚ Increasing and diversifying imported supplies;
- ✚ Maintaining line pack;
- ✚ Maintaining underground and tank storage at capacity;
- ✚ Installing backup compressors, pumps and other equipment;
- ✚ Installing backup power generation for critical facilities;
- ✚ Keeping updated curtailment plans;
- ✚ Retaining contingency purchase contracts for backup supply;
- ✚ Retaining interruptible supply contracts for backup supply;
- ✚ Retaining interruptible supply contracts with large users;
- ✚ Maintaining industry contacts for allocation, purchases and swaps;
- ✚ Utilizing TERC problem-solving and reallocation and
- ✚ Building participation in energy emergency mitigation and prevention activities through industry trade organizations.

## Critical Infrastructure Protection Council

The Texas Homeland Security Strategic Plan provides overarching guidance for state, regional and local homeland security and emergency management plans and operations. The main focus of the plan is to harness all the brainpower and assets available to the state to ensure expedient application of the right emergency response capabilities, in the right manner, at the right place, at the right time, for as long as needed.

The Texas legislature created several statewide advisory groups to support implementation of the Homeland Security Strategic Plan, one of which was the Critical Infrastructure Protection Council (CIPC). In September of 2010, the Texas Division of Emergency Management informed CIPC members that it would be split into two councils, the Homeland Security Council and the Private Sector Advisory Council. The Homeland Security Council is the main discussion forum and decision-making body for the Texas Homeland Security Strategic Plan. Members of the Homeland Security Council act as coordinators to provide their agencies' inputs and feedback to the collaborative development process.

The Private Sector Advisory Council is composed of private and public sector representatives from all critical infrastructure and key resource sectors in Texas. This Council is dedicated solely to issues related to the protection of critical infrastructure and key resources (CI/KR) through building and leveraging public-private partnerships.

## Critical Infrastructure Scope and Details

The working definition of critical infrastructure in this Plan is public or private assets, systems and functions vital to the security, governance, public health and safety, economy or morale of the state or nation. All agencies that operate critical state-owned infrastructure or regulate critical privately-owned infrastructure must maintain descriptive and location data as well as point of contact information for the facilities. The primary goal of the CI program is to locate critical infrastructure associated with energy supply systems in Texas. An off line computer system is used for the collection and maintenance of required critical infrastructure components. Location data for critical infrastructure is gathered in digital format for specific:

- ✚ Oil and Gas Wells
- ✚ Pipelines
- ✚ Gas Processing Plants and related facilities
- ✚ Natural Gas Compressors

- ✚ LPG/LNG and CNG facilities
- ✚ Underground storage
- ✚ Refineries
- ✚ Above Ground Storage

- ✚ Gas Distribution Systems
- ✚ Offshore Surface Locations
- ✚ Mines

The database allows the RRC to provide data to TDEM related to oil and gas energy facilities considered critical to the state and national infrastructure, in particular during emergency operations at the SOC.

The RRC collects data using a geospatial-mapping database referred to as XMap. XMap stores data in a layered map format. These layers cover jurisdictional wells, pipelines and facilities. This infrastructure information on is immediately accessible to key personnel in emergency conditions. (See the Map Tools section).

This program enhances agency in-house expertise by making the current CI data available and usable by the RRC's emergency response team rather than relying on obsolete, non-digital maps maintained in paper formats.

The RRC includes all regulated facilities in the XMap database. To isolate certain facilities that are defined as critical infrastructure, the RRC uses a facility size threshold. Jurisdictional and regulated Texas facilities include approximately:<sup>240</sup>

- ✚ 395,000 oil and gas wells;
- ✚ 212,000 miles of total pipelines (1/6th of U.S. pipelines);
- ✚ 168,000 miles of intrastate pipelines;
- ✚ 27 refineries;
- ✚ 2160 facilities producing gas liquids;
- ✚ 37 gas storage fields and
- ✚ 7 natural gas market hubs.

The RRC collects attribute data (such as pipeline diameter, quantity of material) on the above CI in order to allow filtering of facilities for inclusion on an XMap layer. Data that are collected and reported on XMap include geospatial data (location), emergency contact data and facility production data for certain oil and gas or energy related critical infrastructure.

The CI database located on XMap is exclusively for use in the SOC by trained emergency staff at the TDEM. XMap will not be available on the Internet and will be used on a stand-alone basis on an agency provided PC at the SOC. XMap will be used to train RRC emergency personnel who volunteer at the SOC during an emergency. All copies of the map will be under the control of the RRC Emergency Coordinator.

---

<sup>240</sup> <http://www.rrc.state.tx.us/about/statplan10/stratplan2011-2015.pdf>

## Geospatial Map and Database

One of the RRC's primary tasks with respect to the state's Energy Assurance initiative, is to provide accurate geospatial location data for the state's oil and gas storage facilities, gas plants and gas refinery locations. This includes any energy infrastructure defined as critical to the state. The RRC has implemented a process for efficient and effective critical infrastructure location data gathering with an emphasis on electronic data collection and maintenance. This initiative supports statewide activities to strengthen and expand state and local government energy assurance planning and resiliency efforts. The RRC's data is fully accessible to emergency first responders and emergency managers before, during and after an event involving RRC regulated critical infrastructure (CI).

### XMap Tools

#### Usage

Oil and gas wells, pipelines and other critical infrastructure data that are imported into XMap are based on the RRC's Oil and Gas Division district boundaries. Figure 81 shows counties that lie within associated RRC districts.

Figure 81: Oil and Gas Division district boundaries

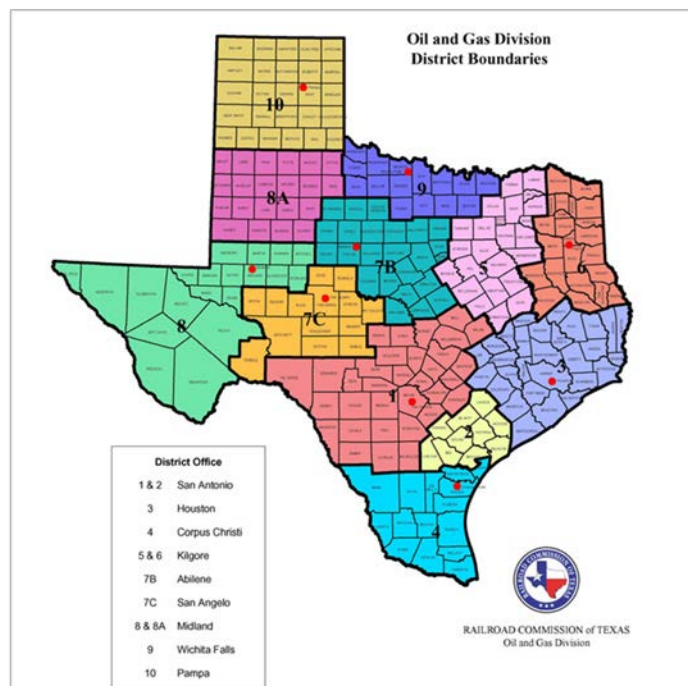

# Symbols

Figure 82: XMap symbols

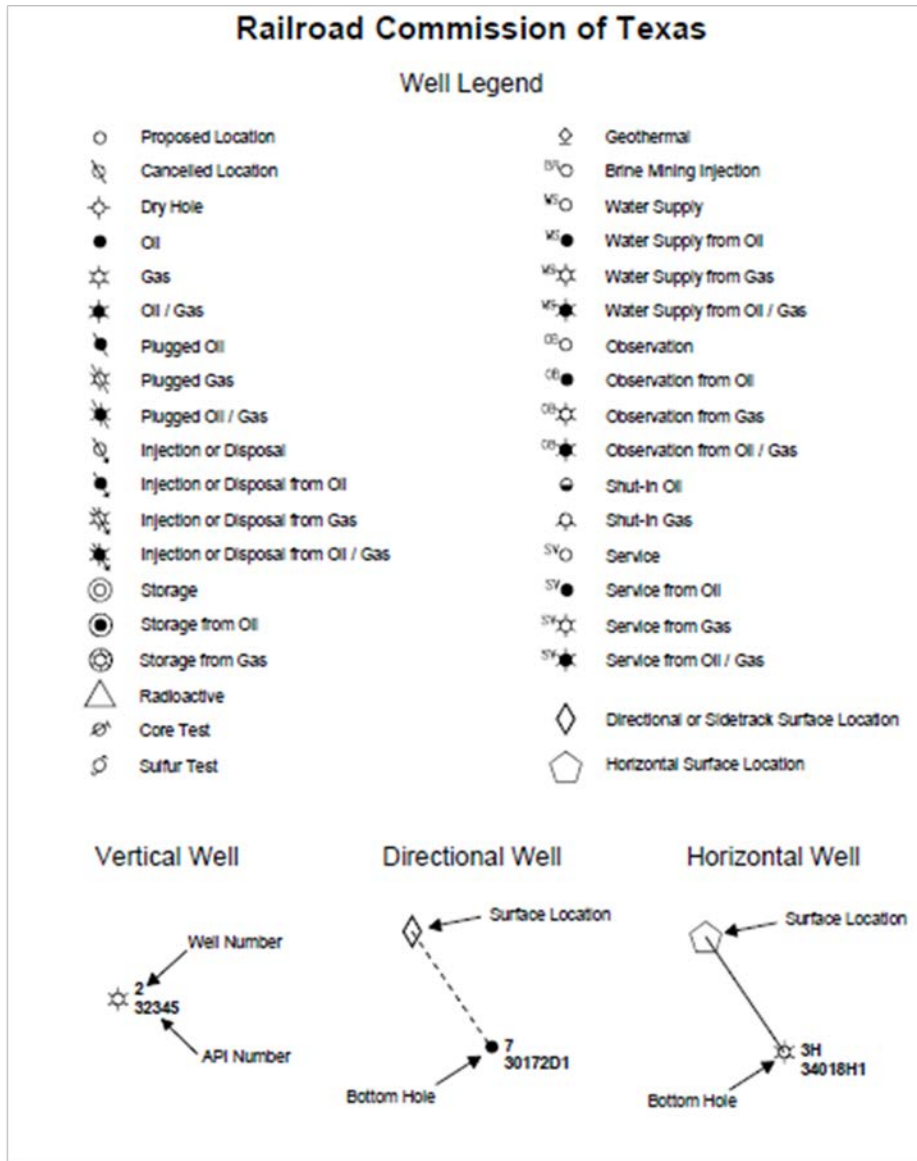



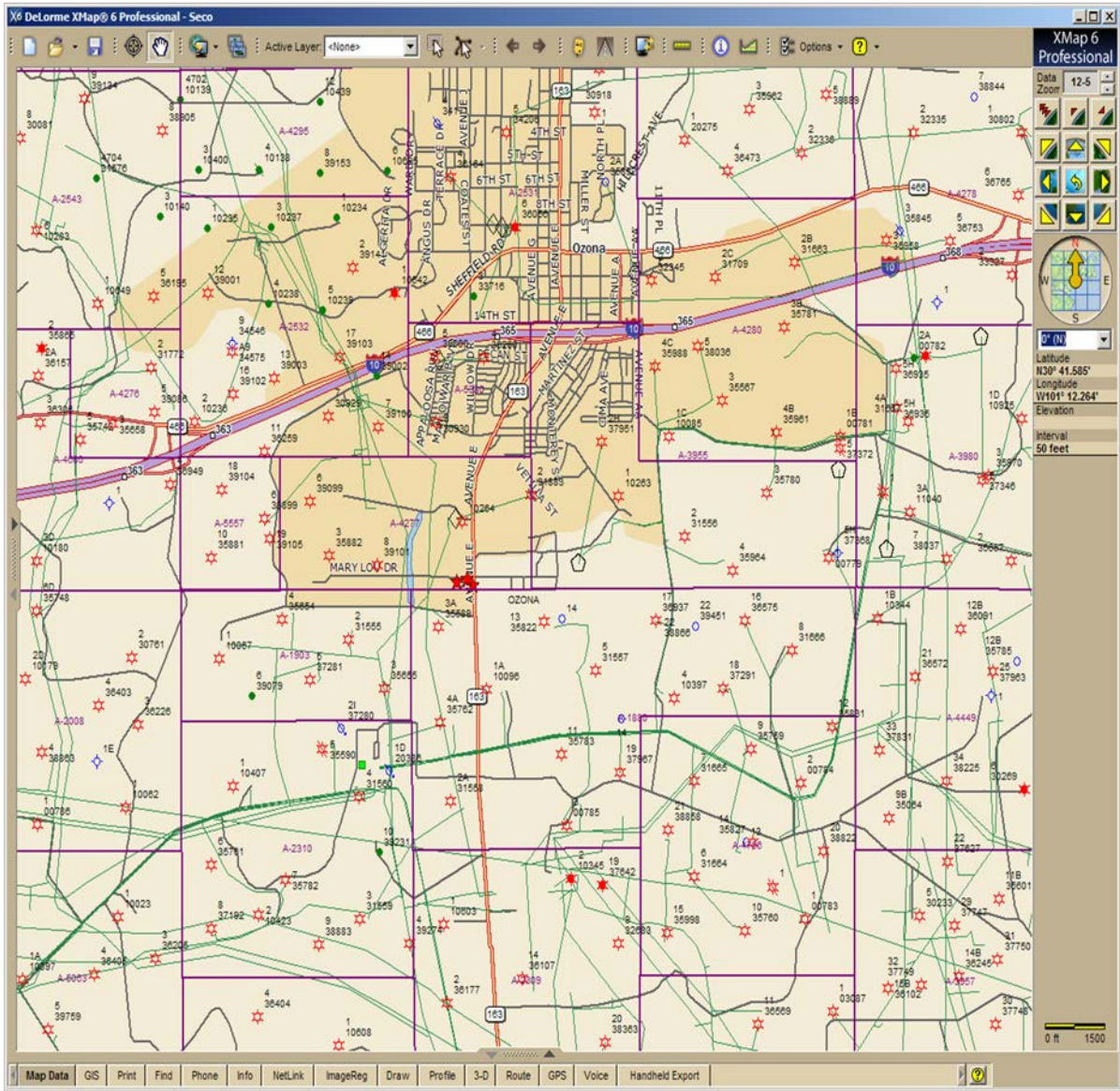
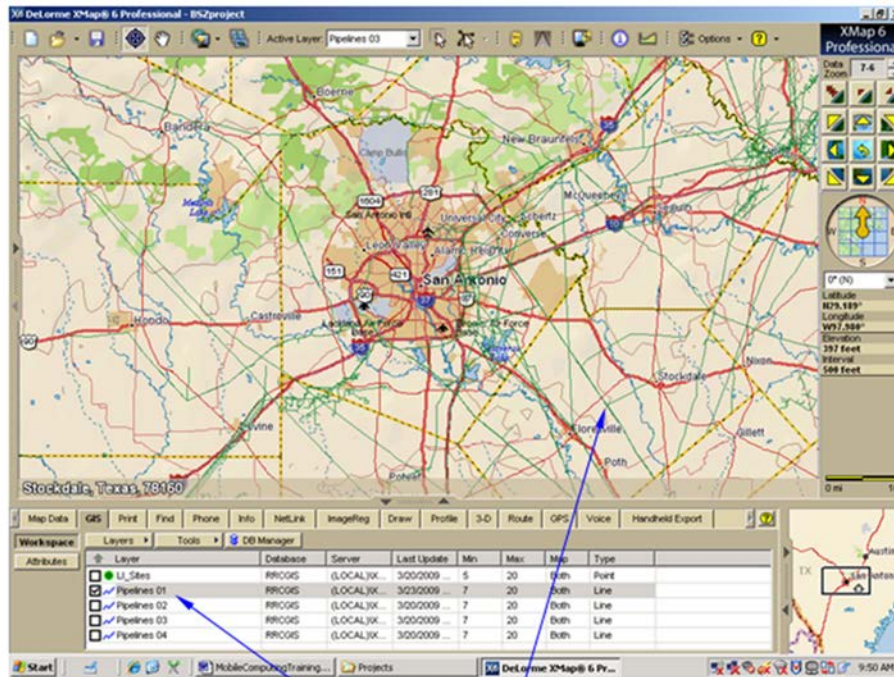

Figure 83: xMap

Samples

Figure 84: XMap pipeline layer sample



Pipeline in District 1 (Green lines in the map)

Viewing Facility Attributes

Figure 85: XMap features

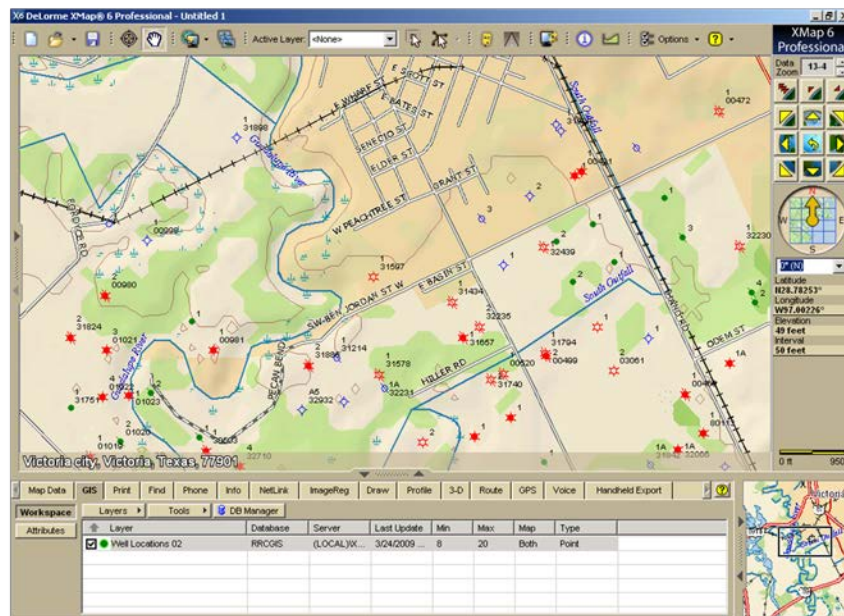

Figure 86: XMap features 2

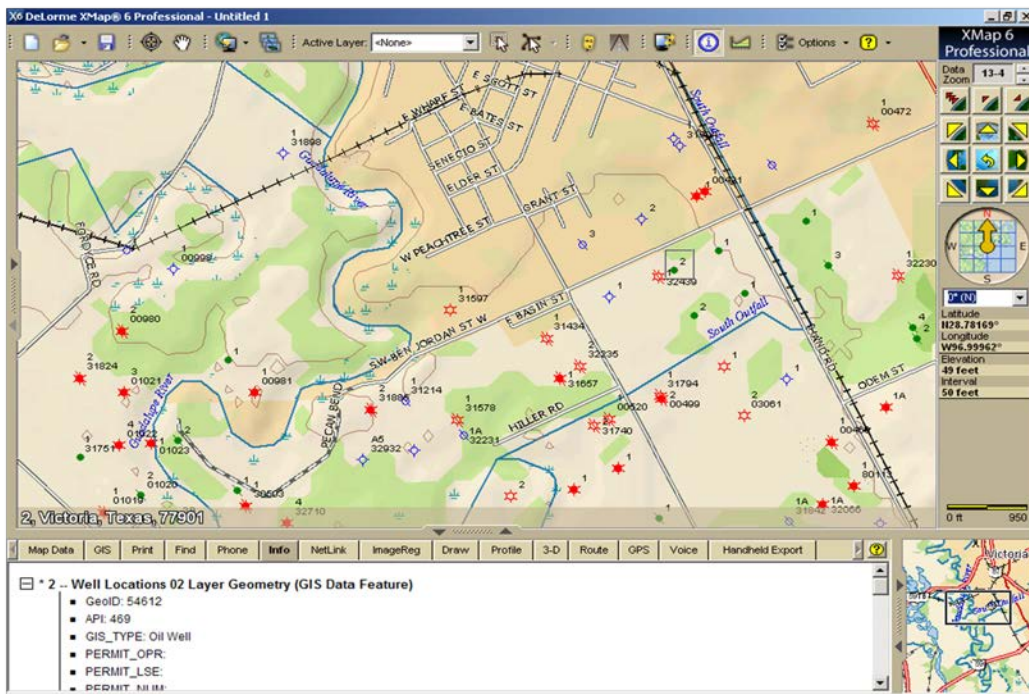
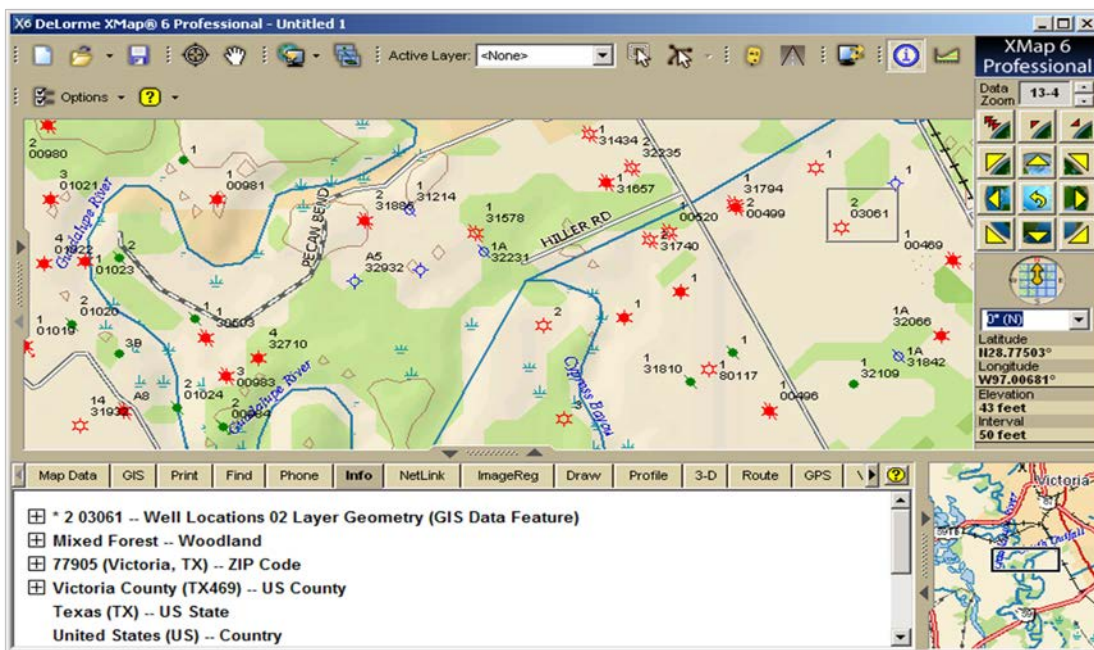

Figure 87: XMap features 3



# The Monitoring and Assessment of Energy Supplies

---

Effective energy assurance and emergency response require an ongoing understanding of the energy supply situation. To achieve this understanding, the RRC monitors energy supplies, shortages and recovery efforts.

## Natural Gas Utilities

The Gas Services Division requires natural gas utilities in Texas to keep a complete record of all emergency and scheduled interruptions in service. The record is required to show the cause, remedy and steps taken to prevent recurrence. The utility is required to notify the Gas Services Division within 48 hours of a service interruption that affects a system or major portion of a system for a period of more than four hours. The notification must include the cause of the interruption. These reports are usually received within 24 hours by the Pipeline Safety Division, the applicable District Office or directly through the RRC emergency phone number at 512-463-6788. The Pipeline Safety Division records reported incidents in the Pipeline Evaluation System (PES) database and notifies the Gas Services Division. The director of the Pipeline Safety Division has primary responsibility for data reported to and collected by the Pipeline Evaluation System.

**Figure 88: Drilling roughnecks at work**



The RRC Gas Services Division Director and the Emergency Communications Officer assess the situation by considering the number of people affected by the disruption, the projected time required for restoration, the current and projected weather conditions, the prospect of additional disruption, curtailment considerations and other factors that may be relevant to the outage. Following a supply disruption on a utility system, company representatives go from house to house relighting pilot lights and ensuring that resumption of service is safe. Monitoring and assessment continue until complete restoration is achieved.

## Natural Gas Pipelines

The Texas model of supply disruption tracking for intrastate gas exemplifies how the public and private sector work together to monitor and ensure supply to the Texas gas market. The State

Emergency Management Plan describes how the Texas Energy Reliability Council (TERC) monitors and informs the RRC of the status of natural gas supplies during energy emergencies. The RRC SOC Team keeps the State Operations Center informed of developments so that appropriate response decisions can be made. The RRC SOC Team also records and maintains a history of all activities involving the RRC at the SOC including notifications of disruptions from TERC or others. TERC facilitates the voluntary allocation of gas during these periods. The SOC, at the recommendation of the RRC and TERC, is authorized to require companies to allocate gas supplies if deemed necessary. In essence, the state of Texas is prepared to act in emergency situations based on information primarily provided by TERC. Texas also relies heavily on the natural gas industry to utilize the natural gas hubs, the storage facilities and line pack to voluntarily allocate natural gas as required to meet market demand. TERC is made up of representatives from the RRC, intrastate pipelines, gas distributors, oil and gas producers and electric utilities. In a letter dated February 26, 2009, the three Railroad Commissioners reiterated TERC's role and confirmed their support of TERC in acting to meet the natural gas supply requirements in Texas.

The State of Texas Emergency Management Plan (2011) states:

a. Natural Gas

1) Outages, damages, restoration, curtailments

The ECC appointed by the RRC/TERC liaison monitors, evaluates and distributes information pertaining to natural gas outages, damages, restoration time and curtailment to the RRC/TERC liaison who relays such information to the SOC team. The ECC also directs the Gas Services Division Staff, maintains contact lists and performs other duties described in the Gas Services Division's *Emergency Response Process* maintained by the Director of the Gas Services Division.

2) Natural gas supplies

TERC monitors natural gas supplies during an emergency and furnishes information about supplies and supply shortages to the RRC/TERC liaison. The RRC/TERC liaison reviews and analyzes information provided by TERC and relays this information to the SOC team. TERC, working with the RRC/TERC liaison, facilitates the voluntary allocation of natural gas resources to ensure that high priority needs of Texas consumers are met.

3) Supply shortages, short-term

For natural gas supply shortages of short duration, voluntary measures are coordinated by TERC and affected utilities to reduce natural gas consumption.

4) Supply shortages, extended

For natural gas supply shortages of an extended duration, members of TERC, the RRC/TERC liaison, the ECC and SOC team, working cooperatively, aided by Federal ESF #12, present recommendations to the Chief of TDEM, the State Director of Homeland Security and the Governor regarding what mandatory actions the State should take to respond to the shortage. These authorities take action to allocate supplies as required. Emergency actions may include:

- Diverting producer and/or pipeline supplies to specific areas of need;
- Directing storage operators to increase delivery rates; and
- Directing large industrial customers or electric generation plants to cut back on their gas consumption to allow supplies to go to higher priority users.

5) Demand management

The Chief of TDEM, State Director of Homeland Security and the Governor have authority to order cutbacks in the use of natural gas in state-owned facilities and to activate a campaign to encourage voluntary reductions in consumption by residential and other customers through public service announcements.

This system of monitoring and allocating gas through the direction of the Texas Energy Reliability Council has kept natural gas flowing to Texas markets through numerous hurricanes and ice storms. The RRC and TERC relationship represents a sound example of government working with industry to solve problems in emergency situations.

The Pipeline Safety Division receives reports of disruptions attributable to leaks, spills and other incidents. These incidents are recorded on the Pipeline Evaluation System (PES) and date back to 2004. The PES includes incident lists and incident reports involving intrastate transmission lines. The Pipeline Evaluation System continues to be updated as needed to provide management reports and metrics related to reported incidents and supply disruptions.

The RRC recently established a Supply Disruption Tracking Plan for natural gas pipelines and compressor stations. Using reports from the Energy Information Administration's *Energy Assurance Daily*, a spreadsheet is maintained containing the date, the company, the system or facility name, the reason for the disruption, action taken and the actual or projected recovery time. The date, company or facility provides a basis to sort the spreadsheet. The RRC also recently established a Supply Disruption Tracking Plan for Natural Gas Processing Plants. Again, reports from the Energy Information Administration's *Energy Assurance Daily* are used as a primary source of information to record disruptions on a spreadsheet. An Engineering

Specialist in the Oil and Gas Division is responsible for flagging and maintaining these records. These tracking systems were initiated in June 2010.

## Refineries

The Pipeline Safety Division receives and records supply disruptions of crude oil involving accidents, spills and other events. These records are maintained on the Pipeline Evaluation System under the direction of the Director of Pipeline Safety. The RRC has recently established a Supply Disruption Tracking Plan for Refineries. Using reports from the Energy Information Administration's *Energy Assurance Daily*, a spreadsheet is maintained containing the date, the company, the system or facility name, the reason for the disruption, the action taken and the actual or projected recovery time. This spreadsheet can be sorted by date, company or facility sequence. An Engineering Specialist from the Oil and Gas Division maintains the tracking spreadsheet.

## Gasoline

Although the Railroad Commission does not have jurisdiction over the retail distribution of gasoline, the agency is engaged with the Fuel Coordination Team at the SOC during emergency situations. This is another example of a state agency working together with private industry to manage emergencies and disasters.

The State Emergency Management Plan (2006), Annex E, states the following:

### Refueling

- a. The State will coordinate with a group of private sector partners from the fuel industry who will be represented in the State Operations Center by a Fuel Coordinator to address fuel issues. The purpose of this Fuel Coordination Team is to ensure availability and distribution of fuel during crisis. Team members are working with, and/or include, Texas Oil and Gas Association, the Texas Petroleum Marketers and Convenience Store Association, supply terminals, distributors, retailers, and third party Common Carrier transporters. The team can allow for non-traditional supply arrangements among carriers and retailers in order to meet the demand for fuel, while consistently observing safety considerations.
- b. A fuel demand model is under development to enhance industry predictions of traffic flow such that fuel re-supply can be placed ahead of the evacuee traffic surge.

- c. The State has committed up to 500 local and county law enforcement officers with GPS equipment to provide escort and expedite the delivery of fuel. Other isolated security issues can be conveyed to DPS via the fuel desk.
- d. Fuel vehicles will be diverted around areas with high traffic congestion, based upon air surveillance by the Fuel Team from the SOC.
- e. Incremental fuel storage at identified locations is possible through the deployment of bladders or other temporary tankage.
- f. The Fuel Coordination Team will assess the need for extra equipment to meet shortfalls and can request waivers as needed.
- g. After an evacuation, the Fuel Coordination Team will continue operations in the SOC to expedite fuel re-supply.

A representative of the Fuel Team (usually from TXOGA) works with the RRC SOC Team at the State Operations Center during hurricanes, ice storms and other potential disaster events. A Railroad Commission representative keeps a detailed log on all activities involving the RRC at the SOC. These logs represent another form of emergency monitoring and are on file with the RRC Safety Officer.

Within two hours of an accident, spill or other event involving a liquid petroleum product, the Pipeline Safety Division should receive notification of the incident. Records of these incidents are maintained in the Pipeline Evaluation System under the direction of the Director of Pipeline Safety. RRC staff logs the reported incident and potential disruption information into the Incident List and Incident Report portion of the Pipeline Evaluation System.

In summary, the Railroad Commission of Texas monitors supply disruptions related to gas utilities. These outages are recorded and maintained through the Pipeline Evaluation System database. During emergencies, the RRC works closely with and has representation on the Texas Energy Reliability Council (TERC) that monitors and allocates or reallocates natural gas through gas transmission lines throughout the state. During emergencies, the RRC works with the Fuel Team to locate liquid pipelines and assist in providing pipeline data. The Pipeline Evaluation System is also used to track supply disruptions of intrastate pipeline systems, crude oil pipelines and product pipelines due to accidents, leaks and other causes. The RRC has implemented a new manual process to track supply disruptions in intrastate pipelines, compressors, gas processing plants and refineries in Texas through the EIA *Energy Assurance Daily*. The value and effectiveness of these new systems will be evaluated on a regular basis.

Supply Disruption Tracking at the RRC will consist of three (3) major components:

1. Pipeline Evaluation System for electronic incident tracking and reporting.
2. Manually maintained spreadsheets that capture and track supply disruptions related to natural gas processing plants, pipelines and compressor stations and refineries—the data source being the Energy Information Administration's *Energy Assurance Daily*.



3. Activity logs from the SOC relating to oil and gas supply disruptions during emergency situations. These logs are archived and maintained by the RRC Safety Officer after each event and are used for post-event analysis and future resiliency planning.

The RRC is also building a geospatial map using an XMap base that will include layers of wells, pipelines, gas processing facilities, LPG, CNG and LNG storage, underground gas and liquid storage, refineries, above ground storage, compressors, gas distribution areas, offshore surface locations and lignite mines. Each of the pipelines, wells and facilities on the map will have a “pop up” attribute list that includes emergency contacts, location, type of facility, a measure of size or volumetric throughput and product information. The map is intended to allow the RRC emergency responders to immediately spot facilities experiencing supply disruptions due to natural or manmade disasters and to instantly provide emergency responders and decision makers with useful data regarding the facility.

## Severity of Shortage

In monitoring supplies, the RRC recognizes that shortages vary in the degree of severity. The severity of the shortage has a distinct bearing on the consequences of the shortage and the appropriate RRC response.

- Mild shortages:** A mild shortage is usually localized involving a relatively small geographic area and affecting a limited number of people. Mild shortages may occur due to supply disruption of gas or petroleum distribution systems. These disruptions may possibly emanate from damage to the distribution system or loss of upstream supplies. Mild shortages are generally handled on the local level with the reliance on the private energy company to remedy the energy shortage. The consequences of a mild shortage may result for a number of reasons, for example, a ruptured pipeline, obstructed truck deliveries or isolated terrorist activities.
- Moderate shortages:** Moderate shortages are more severe than mild shortages. They entail a greater geographic area and affect considerably more people. A moderate shortage usually will include the disruption of supply from multiple gas or petroleum facilities. During a moderate energy shortage, RRC representatives will normally be stationed at the State Operations Center working with TERC, TXOGA, TIPRO and individual private companies to alleviate the shortages in the affected region. Examples of moderate shortages include consequences of hurricanes, ice storms or coordinated terrorist activity.
- Severe shortage:** Severe shortages are generally longer lasting events and may affect the entire state and nation, affecting millions of people. Severe shortages would normally involve wide spread damage to energy facilities or involve extreme failure of supply sources. The RRC would be actively working with state agencies in the SOC and possibly with the federal ESF #12-Energy, FEMA and other federal and private entities to alleviate the energy shortage. Severe shortages could result from war, insurrection, embargos or cyber attacks by terrorist organizations.

Figure 89: Drilling rig floor



## Short-Term Emergency Response

The RRC participates in the preparation of Annex L to the State Emergency Management Plan. The Concept of Operations and the Organization of Assignment and Responsibilities sections of Annex L—Energy constitute the RRC’s short-term emergency response plan. The most current version of Annex L can be found in Attachment 2.

Since the last update of Annex L the RRC has expanded its emergency response to include not only the Gas Services Division that oversees gas distribution, but also the Oil and Gas Division which oversees wells, tanks and gas processing plants, the Alternative Energy Division that oversees LPG and the Pipeline Safety Division that oversees gas and liquids pipelines. Each Division has prepared a Division Emergency Process that defines the contacts and emergency response support provided to the RRC SOC Team member at the State Operations Center when activated. A phone list was prepared that includes many cell phone numbers in addition to office phones and e-mail addresses. In this manner, the RRC SOC Team member at the SOC can use X-map to locate and identify jeopardized critical infrastructure, contact the appropriate Division staff member and rely on the Division staff member to contact the well and facility operators or send out inspectors as deemed appropriate.

## Natural Gas, Long-Term Emergency Response

Although long-term energy emergencies rarely occur, the RRC recognizes the need to prepare for these potential disasters.

### Natural Gas Infrastructure

Texas leads the nation in natural gas production, accounting for 30% of the national production. Natural gas is produced in most areas of the state. Natural gas infrastructure is concentrated in these producing regions and also includes the natural gas transportation and distribution networks running to the State’s population centers.

1. **Producing wells:** The source infrastructure of natural gas is Texas’ 395,000 producing oil and gas wells. The gas well infrastructure includes the well-bore, casing, tubing, a wellhead, a two or three phase separator, measurement equipment and possibly a dehydrator and compressor.

Figure 90: Gas well blowout with remains of drilling rig



2. **Natural gas processing plants:** Texas has over 2,160 facilities that produce natural gas liquids. Many of these facilities are field compressor stations, JT (Joules Thompson) valves, drips, scrubbers or dehydrators. Approximately 200 of these facilities would actually qualify as natural gas processing plants, extracting substantial volumes of natural gas liquids which include ethane, propane, normal butane, iso-butane and pentanes plus.

3. **Gas treating plants:** Sour gas containing deadly hydrogen sulfide or CO<sub>2</sub> is usually treated upstream of the processing facility in an amine unit. Hydrogen sulfide is removed from the natural gas.

4. **Intrastate pipelines:** Texas has 168,000 miles of intrastate pipeline infrastructure. Many of the intrastate pipelines move natural gas from producing regions to end-users throughout the state. These are usually large diameter, high pressure pipelines that operate within the borders of the state. Transmission lines have major gas fired compression stations spaced along the pipeline route. Some compressors run continually to keep large volumes of gas flowing through the pipelines. Some compressor stations are on standby and are used during peak load to increase the throughput and meet the increased demand. Valves and compressor stations are often controlled from remote control rooms at the company's office in a major city. These major trunk lines deliver gas to power plants, large industrial users, agricultural users and local distribution companies.

5. **Natural gas hubs and storage fields:** There are seven natural gas hubs in Texas. A hub is an area where numerous natural gas pipelines physically come together. Pipelines have interconnections and valves that may be opened or shut to move gas from one pipeline to another. There are 37 natural gas storage fields in Texas. In the southeastern part of the state, there are 16 natural gas storage facilities formed from leached out salt caverns. There are 21 natural gas storage fields, primarily in west Texas, that are depleted fields that once produced hydrocarbons in commercial quantities.

Figure 92: Natural gas compressor station



Figure 91: Drilling rig



6. **Natural gas distributors:** Natural gas is distributed to residential, commercial, industrial, governmental and other customers by local distribution companies or through municipal distribution systems. Natural gas for municipal customers is delivered at city gates and flows through

smaller diameter pipelines operated at lower pressures. Meters are used to measure gas upon delivery to the customer.

The infrastructure of the natural gas industry in Texas, from the reservoir to the burner tip, is essential to maintain a dependable energy supply to a wide variety of end-users across the nation.

## Monitoring Supply and Demand

The RRC monitors long-term energy supply emergencies in a manner similar to the short-term monitoring process described in Annex L. The RRC's teamwork with the SOC and with TERC, as well as the supply disruption tracking process, provides the backbone of the monitoring function. During a long-term emergency, the RRC SOC team may follow Federal ESF #12—Energy to monitor interstate and intrastate natural gas supplies. Increases or decreases in natural gas prices are one indicator of supply shortages or surpluses. Volumes of gas delivered from or to storage are also indicators of the supply situation.

Figure 93: Natural gas wellhead "Christmas tree"



## Monitoring Response and Recovery

The RRC monitors response and recovery in the long-term in a manner similar to the short-term process described in Annex L. Under the direction of TDEM, SOC team representatives work with TERC to establish measures to respond and to assist in recovery of gas supplies. The Gas Services Division of the RRC communicates with the SOC and gas distribution companies to monitor restoration of gas service to utility customers until full restoration is achieved. The SOC team may also communicate directly with private companies. During a long-term emergency, the RRC SOC team may follow Federal ESF #12—Energy, as appropriate, to monitor recovery of intrastate and interstate pipelines.

## Managing Supply

### *Increasing supply*

During a long-term energy emergency, natural gas prices may spike upward, triggering a boom in drilling activity. As a result, short-term production of natural gas in Texas could significantly increase. Also, with higher prices, producers would have an incentive to install compressors to pull down the flowing tubing pressure, thereby increasing the flow. To further increase short-

term production, the RRC could consider increasing the Maximum Efficient Rate (MER) of flow of some gas wells and could consider reducing spacing requirements in certain fields to allow more wells to be drilled within a given drainage area. Intrastate pipelines still in operation could also increase compression to pull down field line pressure to increase production. Natural gas withdrawals from storage could be increased to supplement supplies. Imports of natural gas and LPG could also be increased.

### **Allocation**

TERC is authorized by the RRC to voluntarily allocate gas supplies between pipelines during a gas supply shortage. This entails monitoring the statewide supply situation and directing gas flows at the hubs, from the tailgates of processing plants and from storage fields to pipelines. The State Emergency Management Plans provides for mandatory allocation by SOC authorities, if voluntary efforts fail.

The RRC, working through TERC, TXOGA and TIPRO, could encourage producers to maximize gas production, to allow increased withdrawals from gas storage fields and caverns, to drill wells and to install compressors. The RRC could encourage intrastate pipelines to use backup compression, when possible. Pipelines could also make up delivery of gas from interstate pipelines under gas balancing agreements.

**Figure 94: Drilling rig floor with vertically stacked drill pipe**



RRC § 3.84, *Gas Shortage Emergency Response*, further provides action by the RRC, after notice and hearings, to authorize producers to meet increased demand throughout the shortage regardless of a well's assigned allowable subject to future resolution of correlative rights.

### **Reducing Demand**

During long-term energy emergencies, the RRC may recommend that SOC authorities take action with respect to state facilities to reduce demand of natural gas. Temperatures in state buildings may be reduced in winter or increased in summer. Telecommuting may be instigated, where possible, provided electricity and Internet service are available. Non-essential buildings may be shut down. Fuel switching may be required, where possible, such as switching from electricity to natural gas or from natural gas to propane.

The RRC, acting through the SOC or its Media Affairs Representative, may encourage residential and non-residential customers to enact conservation measures to conserve natural gas supplies

through temperature reduction in winter, insulation and other means available. Industrial users may also be encouraged to conserve natural gas through temperature reduction. They could also be encouraged to reduce output, particularly industrial processes using natural gas as feedstock.

During a long-term energy emergency, curtailment of interruptible natural gas to customers and low priority customers is more likely than during a short-term emergency. Natural gas utilities, including gas distribution companies and most intrastate pipelines, have curtailment plans. During an emergency, they may cease delivery of gas starting with the lowest priority customer and working to the highest priority customer until supply and demand is stabilized. The RRC's curtailment policy includes the following language:

Until such time as the RRC has specifically approved a utility's curtailment program, the following priorities in descending order shall be observed:

- A. Deliveries for residences, hospitals, schools, churches and other human need customers.
- B. Deliveries of gas to small industrials and regular commercial loads (defined as those customers using less than 3,000 MCF per day) and delivery of gas for use as pilot lights or in accessory or auxiliary equipment essential to avoid serious damage to industrial plants.
- C. Large users of gas for fuel or as a raw material where an alternate cannot be used and operation and plant production would be curtailed or shut down completely when gas is curtailed.
- D. Large users of gas for boiler fuel or other fuel users where alternate fuels can be used. This category is not to be determined by whether or not a user has actually installed alternate fuel facilities, but whether or not an alternate fuel "could" be used.
- E. Interruptible sales made subject to interruption or curtailment at Seller's sole discretion under contracts or tariffs which provide in effect for the sale of such gas as Seller may be agreeable to selling and Buyer may be agreeable to buying from time to time.

Curtailment category C and D above would include power plants that generate approximately 50% of the electricity in Texas. During an emergency, authorities at the SOC may be required to invoke mandatory allocation to balance the demand for natural gas and electricity.

# Petroleum, Long-Term Emergency Response

## Petroleum Infrastructure

Petroleum refers to refined petroleum products, unrefined crude oil and condensate. Refined products include propane, gasoline, diesel, fuel oil and jet fuel. Like natural gas, petroleum products are produced throughout the state.

## Crude Oil and Condensate

Crude oil or condensate is produced from the 395,000 active oil and gas wells in Texas. The primary infrastructure for oil wells includes the well-bore, casing, tubing, wellhead, sucker rods, pump, pumping unit, flow lines, three phase separator, water tanks, oil tanks and measurement equipment. In the case of water floods and CO<sup>2</sup>, flood injection wells, pumps, compressors and flow lines would be included as infrastructure. Other tangible infrastructure used to find and produce crude oil and condensate include seismic trucks, drilling rigs, work-over rigs and equipment used in cementing, logging, perforating, fracturing and acidizing wells. Also, field and office support personnel, equipment and supplies are necessary to achieve sustained production levels.

Figure 95: Tanker truck burning out of control



## Intrastate Pipelines and Refineries

Intrastate pipelines and refineries are an important part of the petroleum infrastructure in Texas. Intrastate pipelines receive crude oil and condensate from tanker trucks or field gathering lines. The unrefined oil is transported through intrastate pipelines to a refinery. The refinery produces many products from the crude oil including propane, gasoline, kerosene, heating oil, several grades of fuel oil, lubricants and other products. These products are stored in tanks at the refinery and are shipped to markets by truck, train or pipeline.

Figure 96: Intrastate pipeline





## Petroleum Storage

Another critical piece of the petroleum infrastructure is above-ground and underground storage facilities. The RRC receives monthly reports pertaining to above-ground storage in the State. The RRC also receives information on wells utilized in underground petroleum storage. A significant portion of the nation's Strategic Petroleum Reserve is located in Texas. Bryan Mound, a strategic petroleum reserve storage site located near Freeport, Texas, utilizes 20 caverns with a storage capacity of 254 million barrels of oil. It has a withdrawal capacity of 1.5 million barrels per day. Big Hill, another strategic petroleum reserve storage site located near Winnie, Texas has a capacity of 160 million barrels with a withdrawal capacity of 1.1 million barrels per day. This facility is planned to be expanded by 250 million barrels with an upgraded withdrawal capacity of 1.5 million barrels per day.<sup>20</sup>

## Monitoring Supply and Demand

During a long-term emergency, the RRC monitors energy supplies of petroleum products in a manner similar to the short-term monitoring process described above in Annex L. TXOGA and TIPRO may assist in monitoring crude oil supplies. TXOGA and other members of the Fuel Coordination Team may assist in monitoring petroleum products and fuels. During a long-term energy emergency, the RRC SOC team may work with the Federal ESF #12-Energy, as appropriate, to monitor supplies of crude oil, condensate and petroleum products. Movement of spot prices for crude oil may be used to gauge the supply and demand balance.

## Managing Supply

Short-term measures described in Annex L should be invoked during long-term emergencies to manage the available supply. This would include selectively removing or relaxing regulatory restrictions of well production where applicable, returning over-produced or shut-in wells to production, waiving driver hour limitations and allowing out-of-state petroleum deliveries within the state.

A long-term emergency will likely cause crude oil prices to soar. Soaring prices generally result in wells being drilled. At higher prices, wells with lower producing rates and reserves become economic to drill and produce. Significant increases in oil prices usually result in rig shortages that limit drilling activity. Where appropriate, the RRC could reduce well spacing requirements in certain fields and increase the maximum efficient rate (MER) of flow on selected wells to increase supply.

---

<sup>20</sup> The Strategic Petroleum Reserve was established in 1975, two years after the OPEC oil embargo. ([http://en.wikipedia.org/wiki/Strategic\\_Petroleum\\_Reserve](http://en.wikipedia.org/wiki/Strategic_Petroleum_Reserve)).

The RRC could encourage the private sector to increase imports of crude oil and refined products unless the emergency is caused by a limitation of imports.

## Reducing Demand

In the United States, 93% of transportation relies on petroleum fuels. During a long-term emergency, the RRC, through the SOC or the Media Affairs Officer, could encourage telecommuting, use of mass transit, carpooling, improved vehicle maintenance, and conservation through travel planning.

In severe long-term emergencies, the RRC could recommend that SOC authorities take more drastic steps such as reducing speed limits or establishing a “set aside program” to preserve necessary petroleum supplies for law enforcement, fire fighters and emergency responders. Other measures could include requiring gas station operators to flag their stations if they have petroleum supplies, establishing minimum and maximum fill up limits per vehicle and setting up a system allowing drivers to only fill up on certain days based on whether the last digit of their license tags is even or odd. Also, to conserve energy, the use of drive-through windows could be prohibited.

Although the prospect of a severe, long-term energy emergency is remote, Texas is prepared to respond, endure and recover from an interruption of the state’s energy supply.

## History

The first account of coal mining in Texas was documented in 1819. Most coal extraction consisted of small operations until the 1880s. Three classes of coal have been mined in Texas: bituminous, sub bituminous and lignite. Most coal mining conducted from the 1800s to the 1940s used underground methods where vertical shafts or sloped adits (tunnel entrances) provided access to the mine workings. Surface mining methods (strip mining) to extract coal were used starting in the 1950s.

Coal mining activity has been verified in 32 localities within 18 coal mining areas/regions. The current tally of historical coal mine sites stands at 316. Historical coal mining activity took place within 40 Texas counties.<sup>241</sup> Texas produces a substantial amount of lignite coal from its surface mines including five of the 50 largest in the United States.<sup>242</sup> However, the State relies on rail deliveries of 63% of its coal from Wyoming to fuel the state's power plants.<sup>243</sup>

## Production

Texas ranks sixth in the US in coal production with 40.2 million tons in 2008. Currently there are 24 coal mining permits administered by the RRC's Surface Mining and Reclamation Division. These mining permits, held by ten companies, cover over 285,000 acres in 20 counties. Recoverable reserves from existing mines in Texas were 752 million short tons in 2008.<sup>244</sup> The annual coal production from 1999 to 2008 averaged about 46 million short tons. Seven permitted mining operations no longer produce coal and are undergoing final land reclamation. The vast majority of coal mined in Texas, over 99%, is used as boiler fuel at electric power generation plants. Figure 97 shows the location of the coal mines in Texas.<sup>245</sup> The long-term fuel commitment required by existing electric power generation facilities suggests that the mining industry in Texas will remain relatively stable for the foreseeable future. This, however, can change if Wyoming Powder River Basin coal becomes a more economically viable fuel source. In 2008, the average price of coal in Texas was \$19.73/short ton.

---

<sup>242</sup> <http://www.rrc.state.tx.us/forms/maps/historical/historicalcoal.php>.

<sup>243</sup> [http://www.ucsusa.org/clean\\_energy/technology\\_and\\_impacts/impacts/burning-coal-burning-cash.html](http://www.ucsusa.org/clean_energy/technology_and_impacts/impacts/burning-coal-burning-cash.html).

<sup>244</sup> [http://tonto.eia.gov/state/state\\_energy\\_profiles.cfm?sid=TX](http://tonto.eia.gov/state/state_energy_profiles.cfm?sid=TX).

<sup>245</sup> <http://www.rrc.state.tx.us/forms/forms/smr/Map-TxCoal.pdf>.

Figure 97: Coal mines

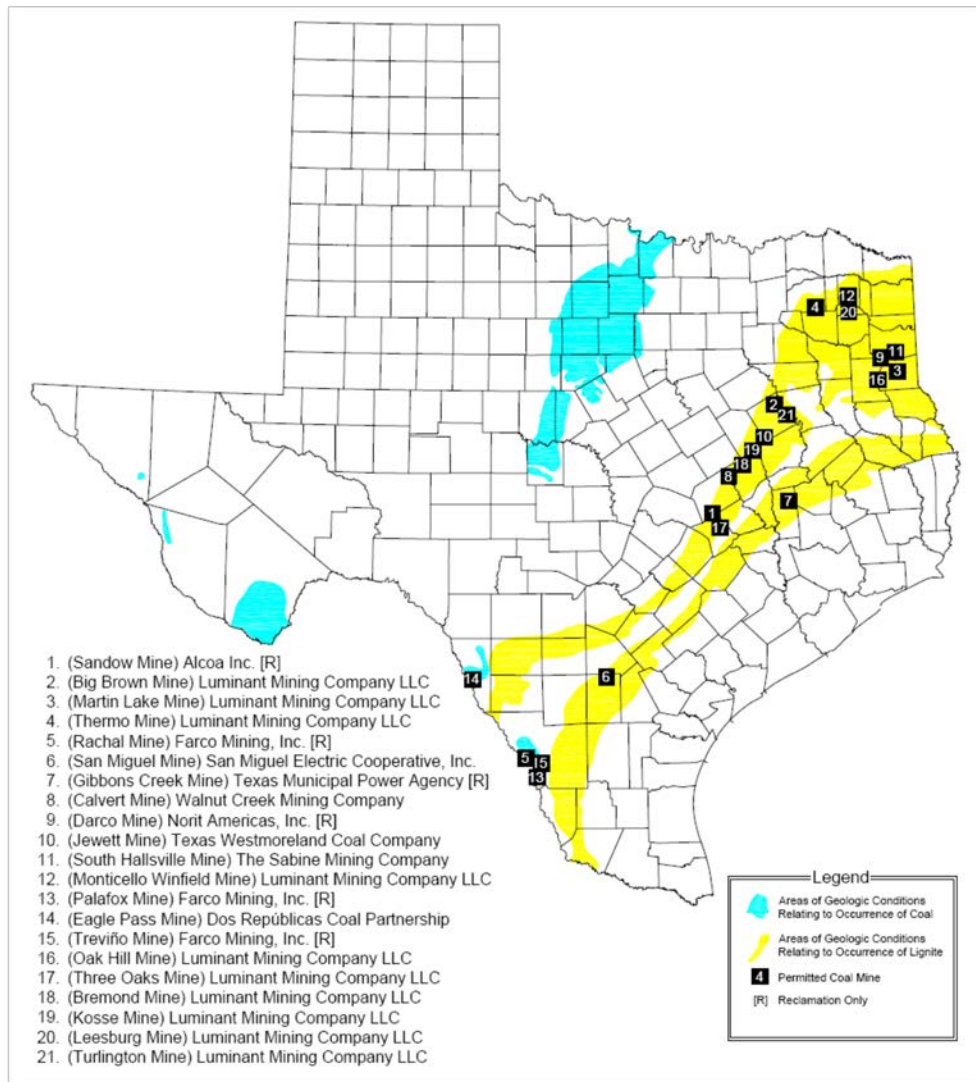

The expansion of mining areas at existing mines and the development of new deposits will enable annual coal production to remain relatively stable. This trend is expected to continue for the short and medium planning horizons. For the longer term, when economical Texas lignite deposits are depleted, this fuel source will be replaced with Wyoming Powder River Basin coal or other alternative fuels.

## Major Coal Mines in Texas

- ✚ Jewett Mine
- ✚ Texas Westmoreland Coal Co.
- ✚ Beckville Strip/Luminant Mining
- ✚ South Hallsville No. 1
- ✚ Sabine Mining Co.
- ✚ Oak Hill Strip/Luminant Mining

## Emergency Response

Lignite mines are considered critical infrastructure. The close proximity of power plants to Texas' lignite mines bodes well for the coal supply during an energy emergency. The location and descriptive attributes of the mines are included on the RRC's emergency response geospatial map for use at the State Operation Center during emergencies and disasters.

Forty-four uranium surface mines were permitted by the RRC during the 1970s and early 1980s. These mining operations covered more than 31,000 acres in and around Karnes County. Surface uranium mining ceased as the market price for uranium dropped in the early 1980s and made such mining uneconomical. Today, all remaining uranium production activities in Texas are confined to in situ mining techniques which are regulated by the Texas Commission on Environmental Quality.

The RRC continues to be responsible for the approval, inspection, and enforcement of uranium exploration drilling which increased after 2005 but has decreased amidst a recent economic downturn. Currently, there are 12 active uranium exploration permits in Texas that cover approximately 528,000 acres.

## Post Emergencies

---

Following an emergency, TDEM leads the recovery effort. On the energy front, the RRC's Gas Services Division and the RRC SOC Team work closely with industry representatives to monitor the restoration of service and to divert energy supplied, as needed. If an emergency arises due to extreme weather, the RRC's Media Representative may participate in an effort to notify the public of areas that are cleared for return, under TDEM's direction.

## Protecting Sensitive Data

---

In enacting an Emergency Management law, the Texas Legislature contemplated the need to secure certain information dealing with critical infrastructure and Homeland Security. Under Government Code § 418.177, the statute states:

Information is confidential if the information:

1. Is collected, assembled, or maintained by or for a governmental entity for the purpose of preventing, detecting, or investigating an act of terrorism or related criminal activity; and

2. Relates to an assessment by or for a governmental entity, or an assessment that is maintained by a governmental entity, of the risk or vulnerability of persons or property, including critical infrastructure, to an act of terrorism or related criminal activity.

The RRC's geospatial map showing the location and attributes of critical infrastructure is under the control of the RRC SOC Team. RRC policy is to limit access to the map to the RRC SOC team for use at the State Operations Center during activation. The map information is also periodically provided to the Texas Division of Emergency Management for use on its TxMAP that includes critical infrastructure from all sources throughout Texas.

### Legislation

#### Federal

1. Federal Power Act, 15 US Code § 791(a), et seq. (2012). Establishes federal regulation of interstate sales of power at wholesale, thereby limiting PUC's authority over the wholesale market in some areas of Texas.
2. Public Utility Regulatory Policies Act of 1978, Public Law 95-617 (codified as amended in scattered sections of 15, 16, 42 and 43 US Code) (2012). Requires state commissions to implement federal laws relating to purchases from and sales to qualifying facilities.
3. Energy Policy Act of 2005, Public Law 109-58 (2012).
4. Energy Independence and Security Act of 2007, Public Law 110-140 (2012).
5. American Recovery and Reinvestment Act of 2009, Public Law 111-5 (2012).
6. Internal Revenue Code, 26 US Code § 45 (2012). Provides for tax credit produced from renewable resources, which supports state goal of increasing output from renewable resources.

#### State

1. Texas Government Code Annotated § 418 (2011). Emergency Management.
2. Texas Government Code Annotated § 418.015 (2011). Effect of Disaster Declaration.
2. Texas Government Code Annotated § 418.016 (2011). Suspension of Certain Laws and Rules.
3. Texas Government Code Annotated § 418.017 (2011). Use of Public and Private Resources.
4. Texas Government Code Annotated § 418.042 (2011). State Emergency Management Plan.
5. Texas Government Code Annotated § 418.1015 (2011). Emergency Management Directors.
6. Texas Government Code Annotated § 421 (2011). Homeland Security.
6. Texas Health and Safety Code Annotated § 386.205 (2011). Evaluation of State Energy Efficiency Programs.



## Public Utility Commission

1. Public Utility Regulatory Act, Texas Utilities Code Annotated Title 2 (2011) (PURA). The PUC's enabling legislation, containing authority for most agency functions required under state law.
2. PURA, Texas Utilities Code Annotated, Title 4 (2011). Delivery of Utility Services.
2. PURA, Texas Utilities Code Annotated § 39.107 (2011). Metering and Billing Services.
3. PURA, Texas Utilities Code Annotated § 39.151 (2011). Wholesale Electric Market Monitor.
4. PURA, Texas Utilities Code Annotated § 39.152 (2011). Qualifying Power Regions.
5. PURA, Texas Utilities Code Annotated § 39.904 (2011). Goal for Renewable Energy.
6. PURA, Texas Utilities Code Annotated § 39.905 (2011). Goal for Energy Efficiency.
7. PURA, Texas Utilities Code Annotated § 39.916 (2011). Interconnection of Distributed Renewable Generation.
8. Texas Health and Safety Code Annotated § 386 (2011). Texas Emissions Reduction Plan.
9. House Bill 2129, 79th Legislature, Regular Session (Texas 2005).
10. House Bill 3693, 80th Legislature, Regular Session (Texas 2007).
11. House Bill 1831, 81st Legislature, Regular Session (Texas 2009).
12. Senate Bill 769, 81st Legislature, Regular Session (Texas 2009).
13. Senate Bill 1492, 81st Legislature, Regular Session (Texas 2009).

## Railroad Commission

1. Texas Utilities Code Annotated § 104.258 (2009). Disconnection of Gas Services.
2. Texas Utilities Code Annotated § 121 (2009). Gas Pipelines.
3. Texas Utilities Code Annotated § 251 (2009). Underground Facility Damage Prevention and Safety.
4. Texas Natural Resources Code Annotated § 81 (2009). Railroad Commission of Texas.
5. Texas Natural Resources Code Annotated § 81.051 (2009). Jurisdiction of Commission.
6. Texas Natural Resources Code Annotated § 85.206 (2009). Emergency Order.
7. Texas Natural Resources Code Annotated § 113.083 (2009). Liquefied Petroleum Gas Emergency.
8. Texas Business and Commerce Code Annotated § 2002.004 (2009). Filing or Refilling of Container by Nonowner.

## Rules

### Public Utility Commission

1. 16 Texas Administrative Code § 25.5 (2010). Definitions.
2. 16 Texas Administrative Code § 25.52 (2010). Reliability and Continuity of Service.

3. 16 Texas Administrative Code § 25.53 (2010). Electric Service Emergency Operations Plans.
4. 16 Texas Administrative Code § 25.94 (2010). Report on Infrastructure Improvement and Maintenance.
5. 16 Texas Administrative Code § 25.95 (2010). Electric Utility Infrastructure Storm Hardening.
6. 16 Texas Administrative Code § 25.109 (2010). Registration of Power Generation Companies and Self-Generators.
7. 16 Texas Administrative Code § 25.130 (2010). Advanced Metering.
8. 16 Texas Administrative Code § 25.173 (2010). Goal for Renewable Energy.
9. 16 Texas Administrative Code § 25.174 (2010). Competitive Renewable Energy Zones.
10. 16 Texas Administrative Code § 25.181 (2010). Energy Efficiency Goal.
11. 16 Texas Administrative Code § 25.183 (2010). Reporting and Evaluation of Energy Efficiency Program.
12. 16 Texas Administrative Code § 25.184 (2010). Energy Efficiency Incentive Program for Military Bases.
13. 16 Texas Administrative Code § 25.192 (2010). Transmission Service Rates.
14. 16 Texas Administrative Code § 25.200 (2010). Load Shedding, Curtailments, and Redispatch.
15. 16 Texas Administrative Code § 25.211 (2010). Interconnection of On-Site Distributed Generation.
16. 16 Texas Administrative Code § 25.212 (2010). Technical Requirements for Interconnection and Parallel Operation of On-Site Distributed Generation.
17. 16 Texas Administrative Code § 25.361 (2010). ERCOT.
18. 16 Texas Administrative Code § 25.497 (2010). Critical Care Customers.
19. 16 Texas Administrative Code § 25.501 (2010). Wholesale Market Design.

## **Railroad Commission**

1. 16 Texas Administrative Code § 3.20 (2010). Notification of Fire Breaks, Leaks, or Blow-outs.
2. 16 Texas Administrative Code § 3.21 (2010). Fire Prevention and Swabbing.
3. 16 Texas Administrative Code § 3.37 (2010). Statewide Spacing Rule.
4. 16 Texas Administrative Code § 3.57 (2010). Reclaiming Tank Bottoms, Other Hydrocarbon Wastes, and Other Waste Materials.
5. 16 Texas Administrative Code § 3.58 (2010). Certificate of Compliance and Transportation Authority; Operator Reports.
6. 16 Texas Administrative Code § 3.59 (2010). Oil and Gas Transporter's Reports.
7. 16 Texas Administrative Code § 3.73 (2010). Pipeline Connection; Cancellation of Certificate of Compliance; Severance.
8. 16 Texas Administrative Code § 3.84 (2010). Gas Shortage Emergency Response.
9. 16 Texas Administrative Code § 3.93 (2010). Water Quality Certification Definitions.
10. 16 Texas Administrative Code § 3.95 (2010). Underground Storage of Liquid or Liquefied Hydrocarbons in Salt Formations.

11. 16 Texas Administrative Code § 3.96 (2010). Underground Storage of Gas in Productive or Depleted Reservoirs.
12. 16 Texas Administrative Code § 5.202 (2010). Carbon Dioxide; Permit Required.
13. 16 Texas Administrative Code § 5.203 (2010). Carbon Dioxide; Application Requirements.
14. 16 Texas Administrative Code § 5.206 (2010). Carbon Dioxide; Permit Standards.
15. 16 Texas Administrative Code § 7.45 (2010). Quality of Service.
16. 16 Texas Administrative Code § 7.455 (2010). Curtailment Standards.
17. 16 Texas Administrative Code § 7.460 (2010). Suspension of Gas Utility Service Disconnection during an Extreme Weather Emergency.
18. 16 Texas Administrative Code § 7.5414 (2010). Advertising, Contributions, and Donations.
19. 16 Texas Administrative Code § 8.101 (2010). Pipeline Integrity Assessment and Management Plans for Natural Gas and Hazardous Liquids Pipelines.
20. 16 Texas Administrative Code § 8.130 (2010). Enforcement.
21. 16 Texas Administrative Code § 8.203 (2010). Supplemental Regulations.
22. 16 Texas Administrative Code § 8.205 (2010). Written Procedure for Handling Natural Gas Leak Complaints.
23. 16 Texas Administrative Code § 8.207 (2010). Leak Grading and Repair.
24. 16 Texas Administrative Code § 8.210 (2010). Reports.
25. 16 Texas Administrative Code § 8.235 (2010). Natural Gas Pipelines Public Education and Liaison.
26. 16 Texas Administrative Code § 9.17 (2010). Designation and Responsibilities of Company Representatives and Operations Supervisors.
27. 16 Texas Administrative Code § 9.31 (2010). LP-Gas Regional Supply Emergency Response.
28. 16 Texas Administrative Code § 9.35 (2010). Written Procedure for LP-Gas Leaks.
29. 16 Texas Administrative Code § 9.36 (2010). Report of LP-Gas Incident/Accident.
30. 16 Texas Administrative Code § 9.101 (2010). Filings Required for Stationary LP-Gas Installations.
31. 16 Texas Administrative Code § 9.110 (2010). Emergency Use of Proposed Stationary LP-Gas Installations.
32. 16 Texas Administrative Code §§ 12.130 and 12.176 (2010). Coal Mining Regulations; Alternative Water Supply Information.
33. 16 Texas Administrative Code §§ 13.101 and 13.192 (2010). Regulations for Compressed Natural Gas; Installation of Emergency Shutdown Equipment.
34. 16 Texas Administrative Code § 14.2040 (2010). Filings and Notice Requirements for Stationary LNG Installations.
35. 16 Texas Administrative Code § 14.2049 (2010). Report of LNG Incident/Accident.
36. 16 Texas Administrative Code § 14.2128 (2010). Communications and Lighting.
37. 16 Texas Administrative Code § 14.2131 (2010). Fire Protection.
38. 16 Texas Administrative Code § 14.2137 (2010). Employee Safety and Training.
39. 16 Texas Administrative Code § 14.2307 (2010). Indoor Fueling.
40. 16 Texas Administrative Code § 14.2310 (2010). Emergency Refueling.

41. 16 Texas Administrative Code § 14.2510 (2010). Emergency Failsafe.
42. 16 Texas Administrative Code §18.2 (2010). Definitions.
43. 16 Texas Administrative Code § 18.11 (2010). Reporting Requirements.
44. 16 Texas Administrative Code § 20.602 (2010). In-Service Instruction.

## Acronyms/Abbreviations

---

AC	Alternating Current
ADA	Americans with Disabilities Act
AEP	American Electric Power
AMI	Advanced Metering Infrastructure
AMS	Advanced Metering Systems
API	American Petroleum Institute
ARRA	American Recovery and Reinvestment Act of 2009
Bcf	Billion Cubic Feet
Btu	British Thermal Unit
CAES	Compressed Air Energy Storage
CCET	Center for the Commercialization of Electric Technologies
CCN	Certificate of Convenience and Necessity
CHP	Combined Heat and Power
CI	Critical Infrastructure
CIPC	Critical Infrastructure Protection Council
CMD	Competitive Markets Division of the PUC
CNG	Compressed Natural Gas
CPA	Texas Comptroller of Public Accounts
CREZ	Competitive Renewable Energy Zone
CSAPR	Cross State Air Pollution Rule
DC	Direct Current
DDC	Disaster District Committee
DG	Distributed Generation
DHS	US Department of Homeland Security
DIR	Texas Department of Information Resources
DLC	Direct Load Control
DLR	Dynamic Line Rating
DOE	US Department of Energy
DPS	Texas Department of Public Safety
DRG	Distributed Renewable Generation
ECC	Emergency Communications Coordinator
EEIP	Energy Efficiency Implementation Project
EIA	Energy Information Administration
EILS	Emergency Interruptible Load Service
EM&V	Evaluation, Measurement and Verification
EMC	Emergency Management Coordinator
EMRT	PUC's Emergency Management Response Team
EOP	Emergency Operating Plan
EPA	Environmental Protection Agency
EPE	El Paso Electric

ERCOT	Electric Reliability Council of Texas
ERS	Emergency Response Service
ERT-A	FEMA Emergency Response Team—Advance
ESCO	Energy Efficiency Service Companies
ESF	Emergency Support Function
ESL	Energy Systems Laboratory
EVSE	Electrical Vehicle Supply Equipment
FEMA	Federal Emergency Management Agency
FERC	Federal Energy Regulatory Commission
FBI	Federal Bureau of Investigation
FRP	Federal Response Plan
FTE	Full-Time Employee
GIS	Geospatial Information Systems
GLO	General Land Office
HAN	Home Area Network
HSAS	Homeland Security Advisory System
IC	Incident Commander
IEA	International Energy Agency
IED	Improvised Explosive Device
IG	Intelligent Grid
IHD	In Home Display
IOU	Investor-Owned Utility
IRD	Infrastructure and Reliability Division of the PUC
ISO	Independent System Operator
kW	Kilowatt
kWh	Kilowatt Hour
LNG	Liquid Natural Gas
LPI	Localized Pollution Index
LPG	Liquid Petroleum Gas
MATS	Mercury and Air Toxics Standards
Mbbls	Thousand Barrels
Mcf	Million Cubic Feet
MMBtu	Million Btu
MOU	Municipally-Owned Utility
MSW	Municipal Solid Waste
MW	Megawatt
MWh	Megawatt Hour
NAAQS	National Ambient Air Quality Standards
NARUC	National Association of Regulatory Utility Commissioners
NaS	Sodium-Sulfur
NERC	North American Electric Reliability Corporation
NESC	National Electric Safety Code
NETL	National Energy Technology Laboratory
NIMS	National Incident Management System

NIST	National Institute of Standards and Technology
NLETS	National Law Enforcement Telecommunications Center
NRP	National Response Plan
PAD3	Federal designation of certain Gulf Coast states
PES	Pipeline Evaluation System
PEV	Plug-in Electric Vehicles
PGC	Power Generation Company
PIO	Public Information Officer
PUC	Public Utility Commission of Texas
PURA	Public Utility Regulatory Act
PURPA	Public Utilities Regulatory Policies Act
QF	Qualifying Facility
QSE	Qualified Scheduling Entity
REC	Renewable Energy Credit
REP	Retail Electric Provider
RRC	Railroad Commission of Texas
RRP	FEMA Regional Response Plan
SECO	State Energy Conservation Office
SERC	Southeastern Electric Reliability Council
SERT	Special Emergency Response Team
SGDP	Smart Grid Demonstration Programs
SGIG	Smart Grid Investment Grant
SOC	State Operations Center
SPP	Southwest Power Pool
SPS	Southwestern Electric Power Company
SWEPCO	Southwestern Electric Power Company
TCEQ	Texas Commission on Environmental Quality
TDEM	Texas Division of Emergency Management
TDSP	Transmission Distribution Service Provider
TDU	Transmission and Distribution Utilities
TEC	Texas Electric Cooperatives
TERC	Texas Energy Reliability Council
TIPCC	Texas Infrastructure Protection Communications Center
TIPRO	Texas Independent Producers and Royalty Owners
TLETS	Texas Law Enforcement Telecommunications System
TNMP	Texas-New Mexico Power Company
TOU	Time of Use
TPA	Texas Pipeline Association
TPCA	Texas Petroleum Marketers and Convenience Store Association
TRE	Texas Reliability Entity
TSAAC	Texas Security Alert and Analysis Center
TSP	Transmission Service Provider
TxDOT	Texas Department of Transportation

TXOGA	Texas Oil and Gas Association
V2G	Vehicle To Grid
VBEID	Vehicle-Borne Improvised Explosive Devices
ViSAT	Vulnerability Identification Self-Assessment Tool
WECC	Western Electric Coordinating Council
WME	Weapons of Mass Effect



**Advanced Metering Infrastructure or System (AMI/AMS):** A system, including the associated hardware, software, associated system and data management. Includes the programming, communications devices that collect time-differentiated energy usage from advanced meters. The system collects, processes, and records the information, and makes the information available to REPs, ERCOT, customers, and the utility.

**Automated meter reading (AMR):** Automatic or automated meter reading allows a meter read to be collected without actually viewing or touching the meter with any other equipment. One of the most prevalent examples of AMR is mobile radio frequency whereby the meter reader drives by the property, and equipment in the vehicle receives a signal sent from a communication device under the glass of the meter.

**Cavern:** The storage space created in a salt formation by solution mining.

**Compressed natural gas (CNG):** Natural gas which is a mixture of hydrocarbon gases and vapors consisting principally of methane in gaseous form that is compressed and used, stored, sold, transported or distributed for use by or through a CNG system.

**Compressor:** A mechanical device used to move or pump through a pipeline.

**Conservation:** Conservation includes consumer actions or decisions to use less energy, perhaps by reconsidering priorities and eliminating some energy use. Actions could include turning off extra lights, raising thermostats a few degrees in the summer or lowering them in the winter, and taking pre-vacation steps such as turning off power strips or lowering water-heater temperatures.

**Critical infrastructure:** Public or private assets, systems and functions vital to the security, governance, public health and safety, economy or morale of the state or the nation.

**Critical peak pricing (CPP):** CPP rates are a hybrid of the time-of-use (TOU) and real-time pricing design. The basic rate structure is TOU. However, provision is made for replacing the normal peak price with a much higher CPP event price under specified trigger conditions (e.g., when system reliability is compromised or supply prices are very high).

**Demand:** Represents the requirements of a customer or area at a particular moment in time. Typically calculated as the average requirement over a period of several minutes to an hour, and thus usually expressed in kilowatts or megawatts rather than kilowatt-hours or megawatt-hours. Demand and load are used interchangeably when referring to energy requirements for a given customer or area.

**Demand response:** The planning, implementation, and monitoring of activities designed to encourage customers to modify patterns of electricity usage, including the timing and level of electricity demand. Demand response covers the complete range of load-shape objectives and customer objectives, including strategic conservation, time-based rates, peak load reduction, as well as customer management of energy bills.

**Demand response event:** A period of time identified by the demand response program sponsor when it is seeking reduced energy consumption and/or load from customers participating in the program. Depending on the type of program and event (economic or emergency), customers are expected to respond or decide whether to respond to the call for reduced load and energy usage. The program sponsor generally will notify the customer of the demand response event before the event begins, and when the event ends.

**Demand response load:** The load reduction that results from demand-response activities.

**Direct load control (DLC):** A demand response activity by which the program operator remotely shuts down or cycles customer's electrical equipment (e.g. air conditioner, water heater) on short notice. Direct load control programs are primarily offered to residential or small commercial customers.

**Disposal well:** A well into which salt water or spent chemical is pumped, most commonly part of a saltwater-disposal system.

**Enhanced oil recovery:** The use of any process for the displacement of oil from the reservoir other than primary recovery.

**Fixed network:** A fixed network refers to either a communication infrastructure which allows the utility to communicate with meters without visiting or driving by the meter location.

**Gas processing plant:** An installation that processes natural gas to recover natural gas liquids (condensate, natural gasoline and liquefied petroleum gas) and sometimes other substances such as sulfur. A gas processing plant is also known as a natural gas processing plant.

**Gas utility:** Under state regulatory law pertaining to the natural gas industry, the term generally encompasses the transmission and distribution of natural gas to the public.

**Home Area Network (HAN):** Network contained within a user's home that connects a person's digital devices, from multiple computers and their peripheral devices to telephones, VCRs and DVD players, televisions, video games, home security systems, "smart" appliances, fax machines and other digital devices that are wired into the network.

**Homeland security:** All activities aimed at preventing terrorist attacks within Texas, gathering intelligence and analyzing threats, reducing vulnerability, protecting our critical infrastructures and coordinating responses to all hazards.

**Injection well:** A well in which fluids have been injected into an underground stratum to increase reservoir pressure.

**Interval data:** Interval data is a fine-grained record of energy consumption, with readings made at regular intervals throughout the day, every day. Interval data is collected by an interval meter, which, at the end of every interval period, records how much energy was used in the previous interval period.

**Interval data collection:** For purposes including load research, demand response and on-demand reads, meter data is frequently collected in hourly or even 15-minute intervals. Short-term storage of this interval data takes place before the system communicates the data to the utility. In general, interval data can be collected at the meter, or at an intermediary spot such as

the fixed network collector unit that reads the meter's output. Finer resolution of data in smaller time increments requires communications systems that can transmit the data without bogging down.

**Intrastate pipeline facilities:** Pipeline facilities located within the state of Texas which are not used for the transportation of natural gas or hazardous liquids or carbon dioxide in interstate or foreign commerce.

**Lease:** An area of surface land on which exploration or production activity occurs. The area where production wells, stock tanks, separators and other production equipment are located.

**Liquefied natural gas (LNG):** Natural gas consisting primarily of methane that has been condensed to liquid by cooling.

**Liquefied petroleum gas (LPG):** A gas mainly composed of propane and butane that has been turned into a liquid.

**Load (Electric):** The amount of electric power delivered or required at any specific point or points on a system. The requirement originates at the energy-consuming equipment of the consumers.

**Load management:** Demand management practices directed at reducing the maximum kilowatt demand on an electric system and/or modifying the coincident peak demand of one or more classes of services to better meet the utility system capability for a given hour, day, week, season, or year.

**North American Electric Reliability Corporation (NERC):** The organization certified by the Federal Energy Regulatory Commission (FERC) as the reliability organization for the nation's bulk power grid. NERC consists of eight Regional Reliability Councils in the lower 48 states. The members of these Councils are from all segments of the electricity supply industry -investor-owned, federal, rural electric cooperative, state/municipal, and provincial utilities, independent power producers, and power marketers.

**Offshore:** the geographic area that lies seaward of the coastline.

**Open standards:** An agreed-upon method or implementation defining how part of a process, product, or solution should operate. An open standard is made available so that any interested party or organization may provide part of an open system.

**Operator:** A person, acting for himself or as an agent for others and designated to the RRC as the one who has the primary responsibility for complying with its rules and regulations in any and all acts subject to the jurisdiction of the RRC.

**Power line carrier (PLC):** Communication of meter data and other utility system data through power lines. PLC technology can be part of two-way systems.

**Refinery:** The physical plant and attendant equipment used in the process of manufacturing petroleum products from crude oil.

**Remote connect/disconnect:** Disconnecting and reconnecting a customer's electrical service without accessing the customer's premises or sending a service vehicle into the field. A hard

disconnect, that is, cutting off power to a premise by throwing a physical switch can be performed remotely, but requires additional specialized equipment at the meter. A virtual disconnect, that is, obtaining an on-demand meter read at the time a premise is vacated or occupied can be performed remotely through fixed network AMR systems. Virtual disconnect can also include monitoring of any consumption that should not be occurring after disconnect. In addition, some utilities are effectively utilizing mobile AMR systems to perform off-cycle, final reads associated with move-ins and move-outs.

**Real time pricing (RTP):** A retail rate in which the price for electricity typically fluctuates hourly reflecting changes in the wholesale price of electricity. RTP prices are typically known to customers on a day-ahead or hour-ahead basis.

**Smart grid:** Real-time visualization technologies on the transmission level and smart meter and communications technologies on the distribution level that enable demand response, distributed energy systems (generation, storage, thermal), consumer energy management systems, distributed automation systems and smart appliances.

**Smart metering:** See definition for Advanced Metering.

**Smart thermostat:** Thermostats that adjust room temperatures automatically in response to price changes or remote signals from retail electric providers, utilities, authorized third-parties, and system operators. Also known as programmable, communicating thermostats.

**Strategic petroleum reserve:** Underground storage facilities used to stockpile government-owned emergency crude oil.

**Time based rate:** A retail rate structure in which customers are charged different prices for different times during the day. Examples are time-of-use (TOU) rates, real time pricing (RTP), hourly pricing, and critical peak pricing (CPP).

**Time of use rate (TOU):** A rate with different unit prices for usage during different blocks of time, usually defined for a 24-hour day. TOU rates reflect the average cost of generating and delivering power during those time periods. Daily pricing blocks might include an on-peak, partial-peak, and off-peak price for non-holiday weekdays, with the on-peak price as the highest price, and the off-peak price as the lowest price.

**Transmission pipeline:** A large pipeline installed for the purpose of transmitting gas from a source of supply to a distribution center, a large volume customer or a pipeline used to interconnect sources of supply.

**Underground gas storage facility or storage facility:** A facility used for the storage of natural gas or any other gaseous substance in an underground salt formation, including surface and subsurface rights, appurtenances and improvements necessary for the operation of the facility.

**Underground hydrocarbon storage facility or storage facility:** A facility used for the storage of liquid or liquefied hydrocarbons in an underground salt formation, including surface and subsurface rights, appurtenances and improvements necessary for the operation of the facility.

# Appendix 1: State Emergency Direction and Control

## State Emergency Direction and Control System

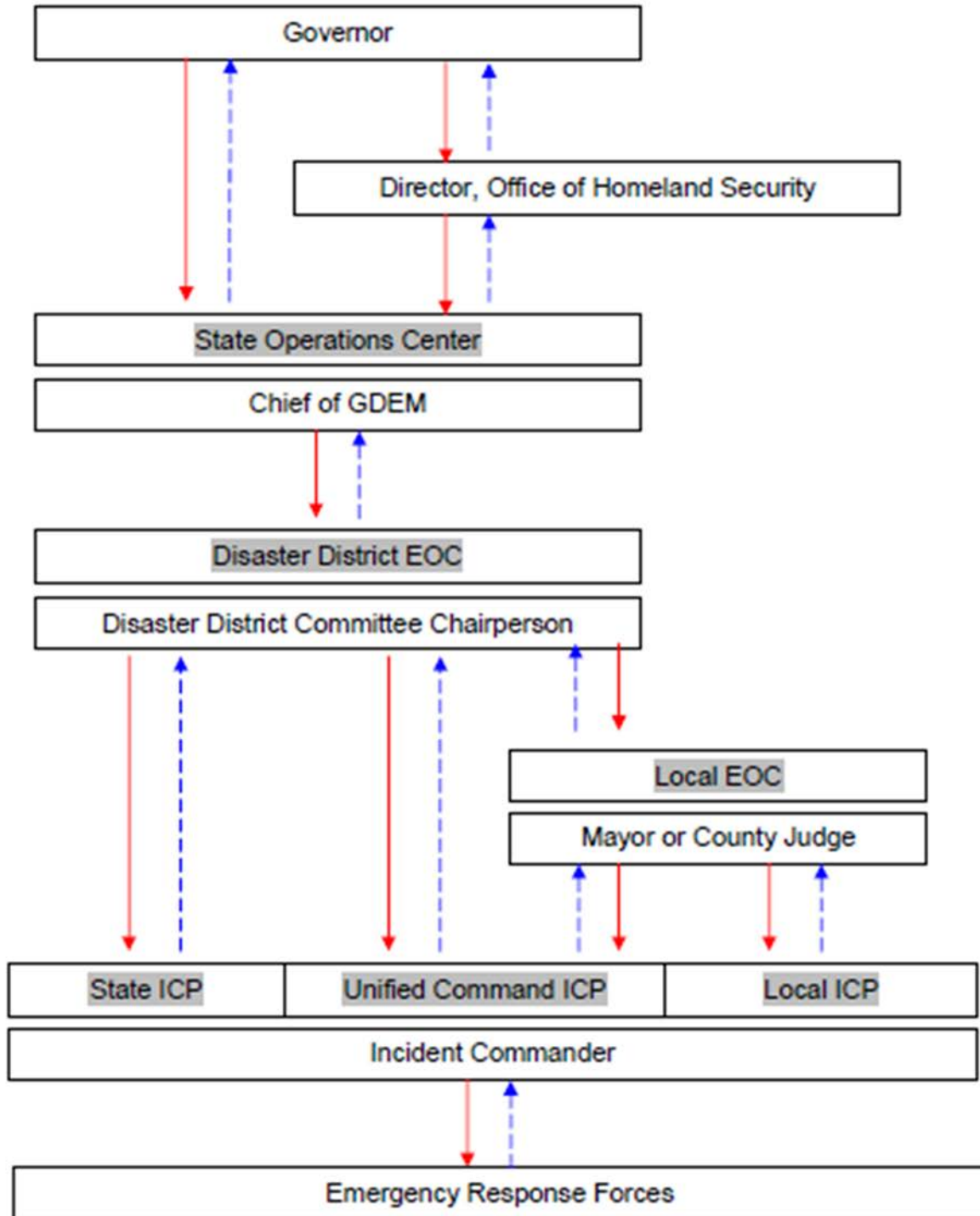

# Appendix 2: PUC Organizational Chart

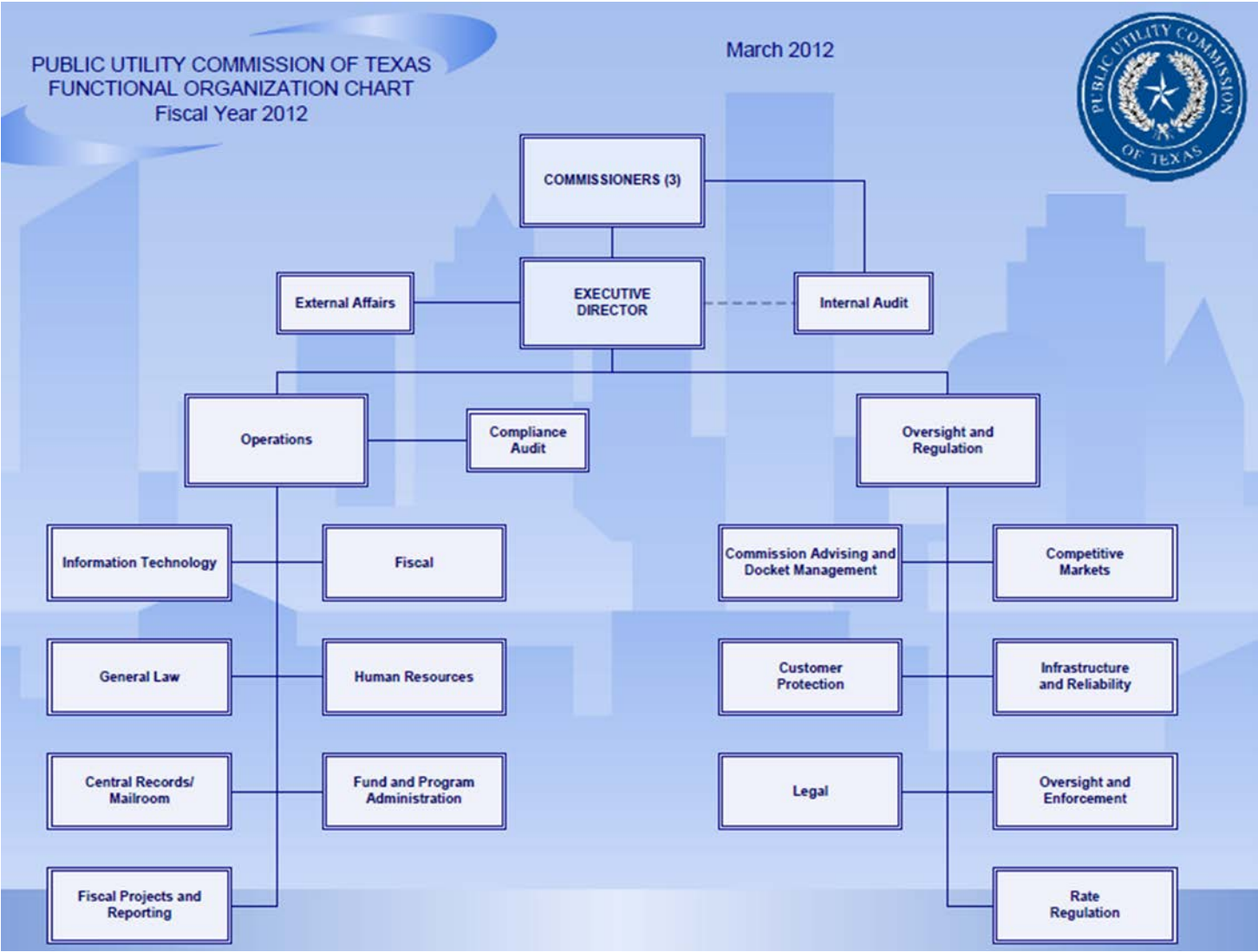

# Appendix 3: RRC Organizational Chart

The Railroad Commission of Texas – Overview  
Effective November 2012

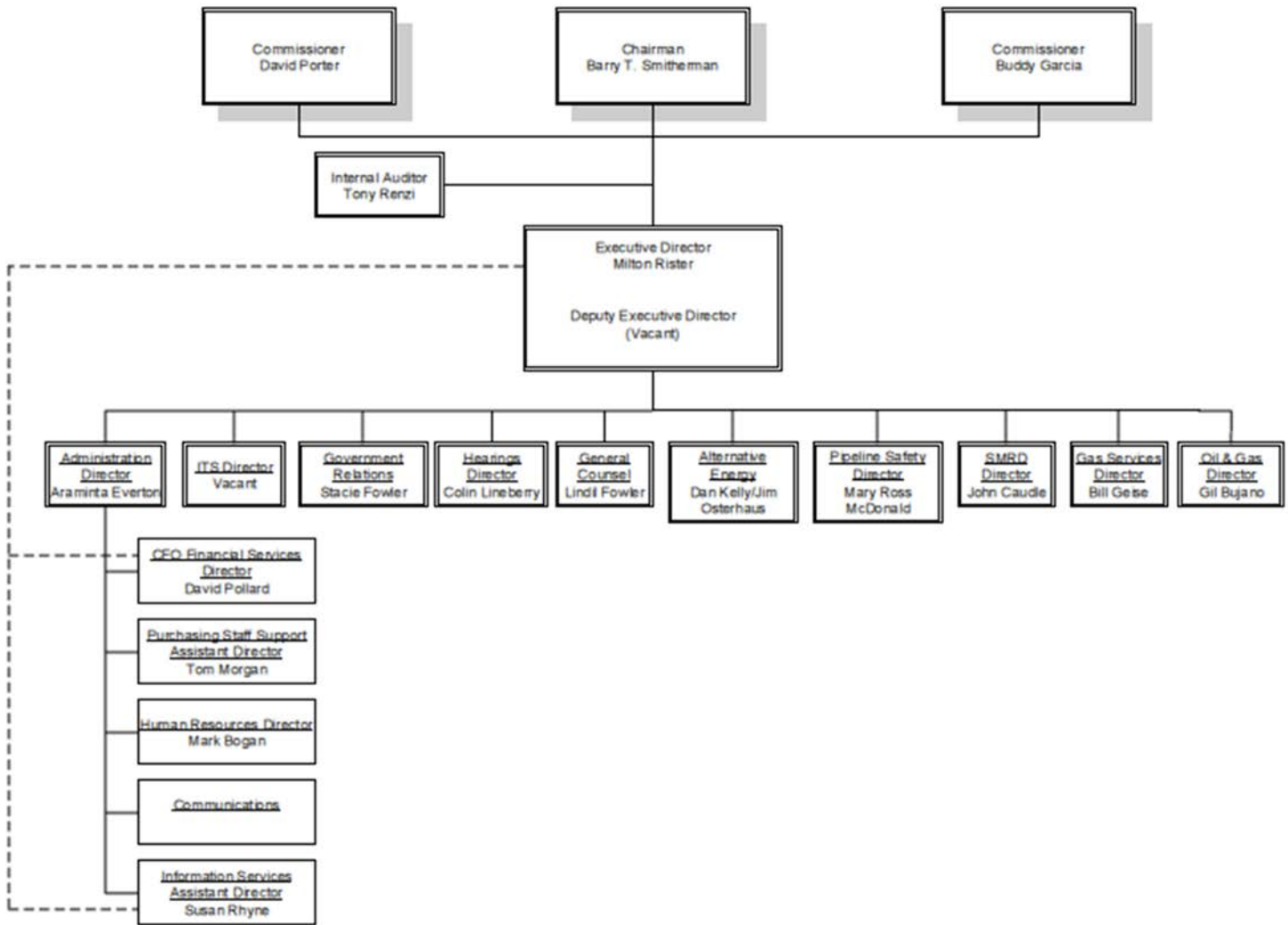

## Appendix 4: ERCOT Communications Matrix

### ERCOT Energy Emergency Alert Communications

Emergency Levels	Operating Reserves	Grid Operators' Actions	Automated Emergency Notifications	Follow-up Communications from External Affairs	Media/Public Notifications
Normal Conditions	Reserves > 3,000 MW	Normal operations			
Control Room Advisory	Reserves < 3,000 MW	Issue "Advisory" to utilities -- informational only -- no additional authority for operators' actions.	Public Utility Commission (PUC) and NERC regional entity (TRE) notified via grid report daily emails		
Control Room Watch	Reserves < 2,500 MW	Use quick-start capacity and non-spinning reserves (available within 30 minutes).	Automated Emergency Notification System phone call and email to PUC, the independent market monitor (IMM), TRE, and FERC	If potential emergency situation, additional information sent to the GridEmergency email list (SOC, PUC, OPC, RRC, TCEQ, Board, Govmt/Lege, IMM, TRE, FERC, and Market Participants' media contacts/PIOs)	
Energy Emergency Level 1 POWER WATCH - Conservation Needed (appeal optional if situation short-lived)	Reserves < 2,300 MW	Use capacity available from other grids (via asynchronous connections; 500 MW on average) and commit all available units.	Above plus State Operations Center (notifies city, county officials & law enforcement), Office of Public Utility Counsel, govmt/lege staff and ERCOT Board	If needed, notify GridEmergency list with additional information	News release, if appropriate; Emergency Alerts list,** Twitter and Facebook
Energy Emergency Level 2 POWER WARNING - Conservation Critical	Reserves < 1,750 MW	Deploy demand response resources: Load Resources under contract (1,000 MW on average) and/or Emergency Responsive Service* (400-500 MW on average), in either order. Begin block load transfers of load to other grids if appropriate.	Above plus major news services and media contacts for utilities	Same as above	News release, if appropriate; Emergency Alerts, Twitter and Facebook
Energy Emergency Level 3 POWER EMERGENCY - Rotating Outages	Reserves continuing to trend downward or frequency at or below 59.8 Hz	Instruct transmission operators to implement rotating outages. Areas affected are at the discretion of the utilities.	Same as above	Same as above	News release; Emergency Alerts list, Twitter and Facebook

\*Emergency Interruptible Load Service becomes Emergency Response Service on June 1, 2012.

\*\* Sign-up for Emergency Alerts and News Bulletins list at <http://lists.ercot.com>