



INSERT MANUAL



2023



CONTENTS

- 3 RATES/DEADLINES
- 4 MECHANICAL INSERT SPECS
- 5 MECHANICAL INSERT FORMATS
- 6 DISTRIBUTION ZONES
- 7 NATIONAL MAP
- 8 METRO EDITION MAP
- 9 GREATER TORONTO (GTA) MAP
- 10 ONTARIO MAP
- 11 TORONTO REGION MAP
- 12 NATIONAL FSA LIST
- 21 SHIPPING INSTRUCTIONS – MECHANICAL INSERTION
- 23 SHIPPING INSTRUCTIONS – HAND INSERTION
- 25 TERMS AND CONDITIONS



CONTACT US

TORONTO ONTARIO & MANITOBA

TEL: 1-800-387-9012 EMAIL advertising@globeandmail.com

EASTERN CANADA OTTAWA REGION, QUÉBEC, & ATLANTIC CANADA

TEL: 1-800-363-7526 EMAIL advertisingeasternca@globeandmail.com

BRITISH COLUMBIA

TEL: 1-800-663-1311 EMAIL advertisingwesternca@globeandmail.com

NORTHWEST TERRITORIES & NUNAVUT

TEL: 1-604-685-0308 EMAIL advertisingwesternca@globeandmail.com

ALBERTA & SASKATCHEWAN

TEL: 1-403-245-4987 or 1-403-774-8024 EMAIL advertisingwesternca@globeandmail.com

UNITED STATES & WORLDWIDE

TEL: 1-212-426-5932 EMAIL globemedia@ajrmediagroup.com

THIRD PARTY AD MAGAZINES

Michael Anderson TEL: 416-585-5455

EMAIL mwanderson@globeandmail.com

Fatima Wilson TEL: 416-585-3325

EMAIL fwilson@globeandmail.com

GLOBELINK.CA

CONTACT DIRECTORY

GLOBELINK.CA/DIRECTORY

INSERT INFORMATION

GLOBELINK.CA/INSERTS

YOU ALSO NEED TO KNOW: Any advertising published by The Globe and Mail in the newspaper or any of its other publications may, at our discretion, be published, displayed, retained and archived by us and anyone authorized (including any form of licence) by us, as many times as we and those authorized by us wish, in or on any product, media and archive (including print, electronic and otherwise).

All advertising must meet Globe and Mail terms and conditions, available on globelink.ca/termsandconditions, on the previous page, or please request a printed copy from your Globe and Mail representative.



INSERT RATES

MECHANICAL INSERT RATES - FRIDAY ONLY

NUMBER OF PAGES	COST PER THOUSAND	
	GENERAL (GROSS)	RETAIL (NET)
2-16	\$79.00	\$67.00
Over 16	\$115.00	\$97.00

Note: All insert products must meet our specifications in order to guarantee the insertion.

MECHANICAL INSERT MATERIAL DEADLINE: Thursday one week prior to the run date. Shipments arriving more than two weeks prior to the insertion date will be refused.

Spoilage

Please supply an additional 1.5% for mechanical inserts for spoilage.

Shipping Instructions

Mechanical Inserts – see pages 21 and 22

HAND INSERT RATES MON-THU ONLY

PRODUCT WEIGHT	COST PER THOUSAND (NET)
Under 450 grams	\$300.00
Over 450 grams*	\$400.00

*Up to a maximum of 700 grams

HAND-INSERT MATERIAL DEADLINE: FIVE BUSINESS DAYS prior to the run date. Shipments arriving more than two weeks prior will be refused.

Spoilage

Please supply an additional 2% for spoilage.

Shipping Instructions

Hand Inserts – see page 23 and 24.

Mechanical Inserts

The client should supply the recommended press run amount (plus spoilage) to ensure that all copies of the newspaper are inserted. Please note that our press run numbers can fluctuate on a daily basis due to market activity. The airline copies are not inserted in the Toronto market and these amounts are not included in the press run figures. Contact your sales representative for the latest press run figures.

All quotations exclude freight to The Globe and Mail plants. The client and/or agency will arrange for delivery and prepay all delivery expenses (including any customs brokerage fees).

All insert material must arrive at our printing plants during normal receiving hours. No deliveries will be accepted on Saturday, Sunday or statutory holidays.

Insert shipments do not require prior appointments for delivery except for the Vancouver Plant. Please call 604-527-9243 to make an appointment. You must provide the client name, insert title and run date. The shipment must be properly labelled and must arrive at our plants in good condition; otherwise the shipment will not be unloaded.

Any insert that is received past deadline or is improperly labelled or is received in a damaged condition will be cancelled and/or rescheduled. Any expenses incurred by The Globe and Mail will be charged to the client.

Any insert material remaining after the print run will be recycled immediately after the completion of insertion unless written arrangements are made at least five business days prior to the insertion date with The Globe and Mail. Pick-up must be completed within two business days of the insertion date.

Any cancelled inserts not removed from the plants by the client within three days of cancellation will be recycled unless prior written arrangements for re-scheduling or removal by the client are made. Late cancellation charges up to 50% of the original order will apply to all inserts cancelled less than seven business days prior to insertion.

The Globe and Mail reserves the right to reschedule the distribution date in the event of production problems or delays, inclement weather or other factors outside of its normal control that would result in a reduced delivery efficiency of The Globe and Mail newspaper. The Globe and Mail will promptly notify the client of any such circumstances and a new distribution date will be established at that time. Pricing will remain firm in the event of such an occurrence.

Industry standards allow for a margin of error up to 3% for the insertion and distribution of inserts.

Third party advertising

Rates on this page do not apply to inserts containing third party advertising. For a quote - please send a copy of your magazine to:

Michael Anderson
c/o The Globe and Mail
351 King Street East, 16th floor
Toronto, ON M5A 0N1
phone: 416-585-5455
email: mwanderson@globeandmail.com



Minimum Size: 4" wide x 7" deep.

Maximum size: 10" wide x 10" deep.

Maximum Weight: Up to 150 grams for a mechanical insert.

Maximum number of pages for all digest size inserts is 32 pages.

MINIMUM PAPER WEIGHT

Number of Pages

2 pages	7 pt. card stock
4 pages	70 lb stock
6 pages	60 lb stock
8 pages	50 lb stock
12+ pages	45 lb stock

Note: NO PERFECT-BOUND PRODUCTS. All newsprint products must be a minimum of 8 pages on 30 lbs stock or heavier and must be quarter-folded. All trimmed booklets must be quarterfolded, stitched or bound to prevent product separation during insertion. Inserts must have one closed edge to ensure proper insertion by our equipment. We do not accept accordion-style or plastic wrapped inserts for mechanical insertion. All inserts with perforations or die cuts must be tested prior to insertion.

MINIMUM SIZE

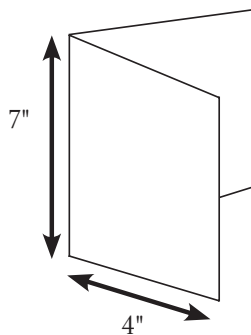

MAXIMUM SIZE

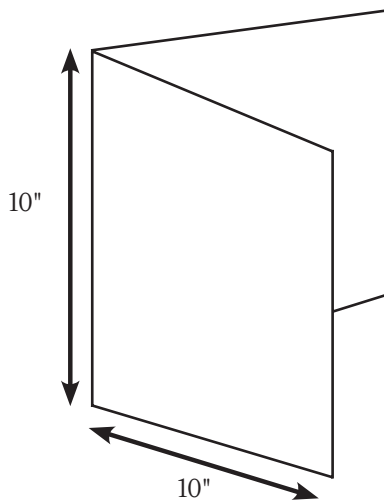

Coatings

Please note: certain AQ (Aqueous) coatings, such as SOFT TOUCH, that create a wax-like finish when applied while printing inserts intended for mechanical insertion may cause feeding problems on our inserting machines and possible production delays. These coated products tend to stick together and may result in multiple copies being inserted into the newspaper. In addition, some high gloss UV (ultra-violet) coatings may cause the opposite result by creating a slippery product that may slide easily out of the newspaper during insertion or delivery. If any insert or magazine product creates production problems or delays that would result in a reduced delivery efficiency of the Globe and Mail, we reserve the right to remove the product from insertion. The Globe and Mail will promptly notify the client of any such circumstances and a new distribution date will be established at that time. Pricing will remain firm in the event of such an occurrence. If you are unsure about the coating on your insert, please check with your printer and have them send at least five stock samples with the intended coating to The Globe and Mail for review.

Blow-In Inserts

Supplied inserts cannot contain blow-in inserts.

Envelopes

Envelopes cannot be less than 5" deep x 7" wide. Envelope contents must be of a uniform size and the envelope must be sealed.

Scented Inserts

Sales representatives with customers wanting to insert scented products must notify Michael Anderson at 416-585-5455 or email mwanderson@globeandmail.com.

Samples/Mock-Ups

All insert reservations must be accompanied by a mock-up or sample for approval within two weeks of booking. Any insert reservation that does not have an approved mock-up or sample provided is subject to cancellation anytime after two weeks from the date of booking. The mock-up does not have to be printed, but must be on the same paper stock, and be trimmed and folded to the final size of the insert. The sample can be either the final printed version of the insert or a copy of a previously inserted product that was approved for mechanical insertion. If your insert is a repeat of the same design and size of a previously approved insert, you must provide the run date of the previous insert in order to confirm your order.

All insert samples/mock-ups should be sent to:
Michael Anderson
c/o The Globe and Mail,
351 King Street East, 16th Floor
Toronto, Ontario M5A 0N1

Please include a contact name, phone number and email address with your sample. Inserts that do not meet our specifications may be hand inserted for home delivery only. An additional handling fee will apply.



STANDARD MECHANICAL INSERT FORMATS

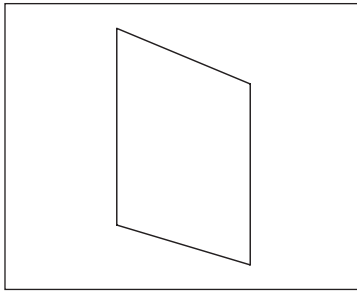

2 PAGE – NO FOLD
FLAT SINGLE SHEET
MINIMUM PAPER STOCK: 7 PT CARD
STOCK

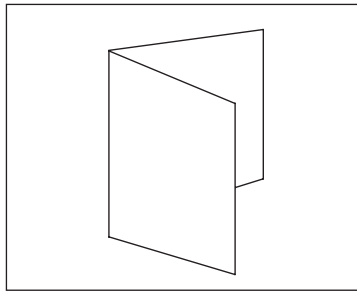

4 PAGE – ONE FOLD
SIMPLE FOLD
MINIMUM PAPER STOCK: 70 LBS

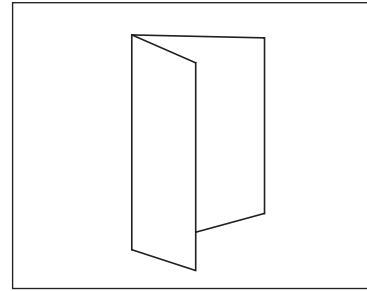

4 PAGE – ONE FOLD
SHORT FOLD (MINIMUM 4")
MINIMUM PAPER STOCK: 70 LBS

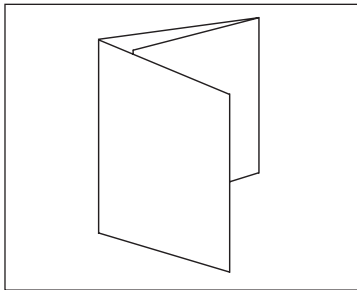

6 PAGE – TWO FOLDS
BARREL/LETTER FOLD
MINIMUM PAPER STOCK: 60 LBS

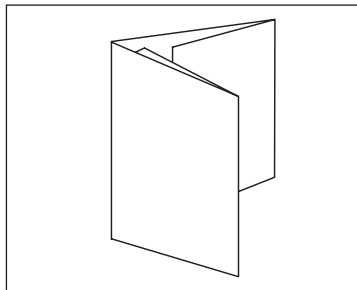

8 PAGE – THREE FOLDS
GATEFOLD
MINIMUM PAPER STOCK: 50 LBS

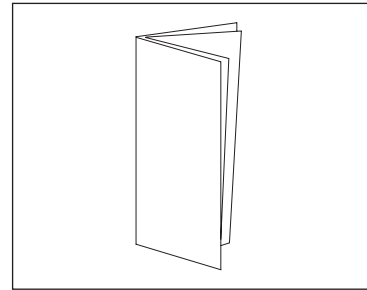

8 PAGE – TWO FOLDS
SIGNATURE/BOOKLET
MINIMUM PAPER STOCK: 50 LBS

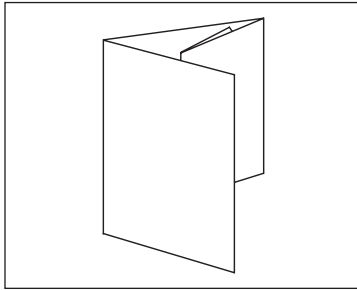

8 PAGE – THREE FOLDS
ROLL FOLD
MINIMUM PAPER STOCK: 50 LBS

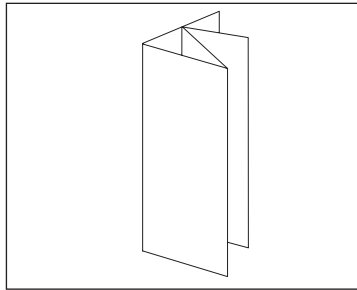

8 PAGE – THREE FOLDS
PARALLEL FOLD
MINIMUM PAPER STOCK: 50 LBS

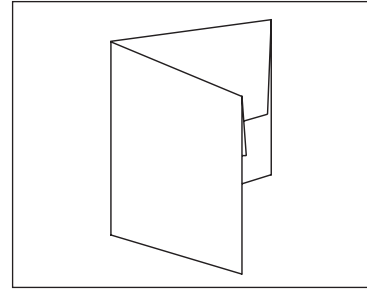

8 PAGE – TWO FOLDS
FRENCH FOLD
MINIMUM PAPER STOCK: 50 LBS

UNACCEPTABLE MECHANICAL INSERT FORMATS

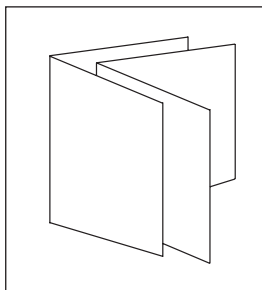

LOOSE BOOKLET

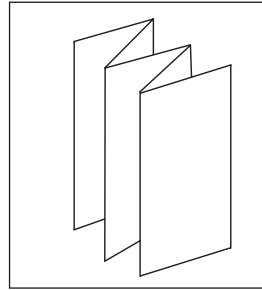

ACCORDION FOLD

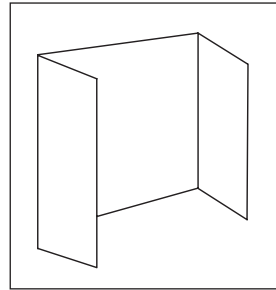

OPEN GATEFOLD

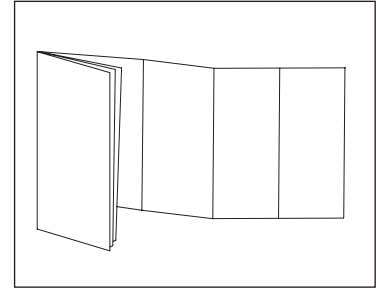

MULTIPLE COVER GATEFOLD



DISTRIBUTION ZONES

NATIONAL MECHANICAL INSERT ZONES

TORONTO	ZONE	FULL DELIVERY
METRO EDITION	MET	FRIDAY ONLY
GREATER TORONTO	GTA	FRIDAY ONLY

MONTREAL	ZONE	FULL DELIVERY
OTTAWA	OTT	FRIDAY ONLY
QUEBEC	QUE	FRIDAY ONLY

ESTEVAN	ZONE	FULL DELIVERY
MANITOBA	MAN	FRIDAY ONLY
SASKATCHEWAN	SAS	FRIDAY ONLY

CALGARY	ZONE	FULL DELIVERY
EDMONTON	EDM	FRIDAY ONLY
CALGARY	CAL	FRIDAY ONLY

VANCOUVER	ZONE	FULL DELIVERY
VANCOUVER	VAN	FRIDAY ONLY
VICTORIA	VIC	FRIDAY ONLY

NATIONAL HAND-INSERT SUB-ZONES

TORONTO	SUB-ZONE	HOME DELIVERY
TORONTO	TORONTO EAST	MON - THU ONLY
TORONTO	TORONTO WEST	MON - THU ONLY
TORONTO	DURHAM REGION	MON - THU ONLY
TORONTO	HALTON REGION	MON - THU ONLY
TORONTO	PEEL REGION	MON - THU ONLY
TORONTO	YORK REGION	MON - THU ONLY
TORONTO	CENTRAL ONT	MON - THU ONLY
TORONTO	EASTERN ONT	MON - THU ONLY
TORONTO	NORTHERN ONT	MON - THU ONLY
TORONTO	WESTERN ONT	MON - THU ONLY

MONTREAL	SUB-ZONE	HOME DELIVERY
MONTREAL	OTTAWA	MON - THU ONLY
MONTREAL	QUEBEC	MON - THU ONLY

ESTEVAN	SUB-ZONE	HOME DELIVERY
ESTEVAN	MANITOBA	MON - THU ONLY
ESTEVAN	SASKATCHEWAN	MON - THU ONLY

CALGARY	SUB-ZONE	HOME DELIVERY
CALGARY	EDMONTON	MON - THU ONLY
CALGARY	CALGARY	MON - THU ONLY

VANCOUVER	SUB-ZONE	HOME DELIVERY
VANCOUVER	VANCOUVER	MON - THU ONLY
VANCOUVER	VICTORIA	MON - THU ONLY



NATIONAL MAP

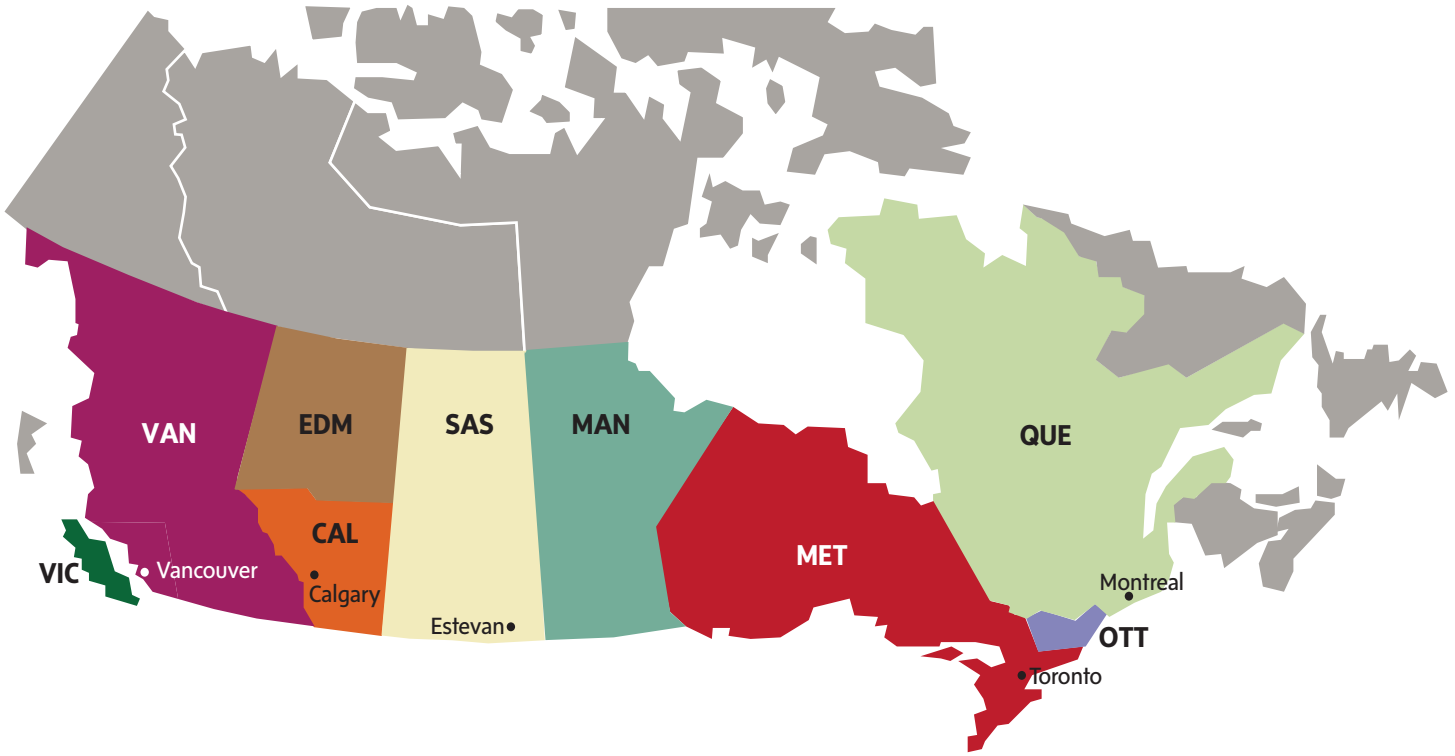

National Edition

TORONTO PLANT

Metro Edition | MET
Ontario (excluding Ottawa Region)

MONTREAL PLANT

Ottawa | OTT
Ottawa Region
Quebec | QUE
Hull, Montreal Region

ESTEVAN PLANT

Manitoba | MAN
Brandon, Winnipeg
Saskatchewan | SAS
Regina, Saskatoon

CALGARY PLANT

Edmonton | EDM
Edmonton, Red Deer
Calgary | CAL
Calgary, Lethbridge, Medicine Hat

VANCOUVER PLANT

Vancouver | VAN
Abbotsford, Chilliwack, Kamloops,
Kelowna, Penticton, Vancouver, Vernon
Victoria | VIC
Nanaimo, Victoria



METRO EDITION MAP FRIDAY ONLY

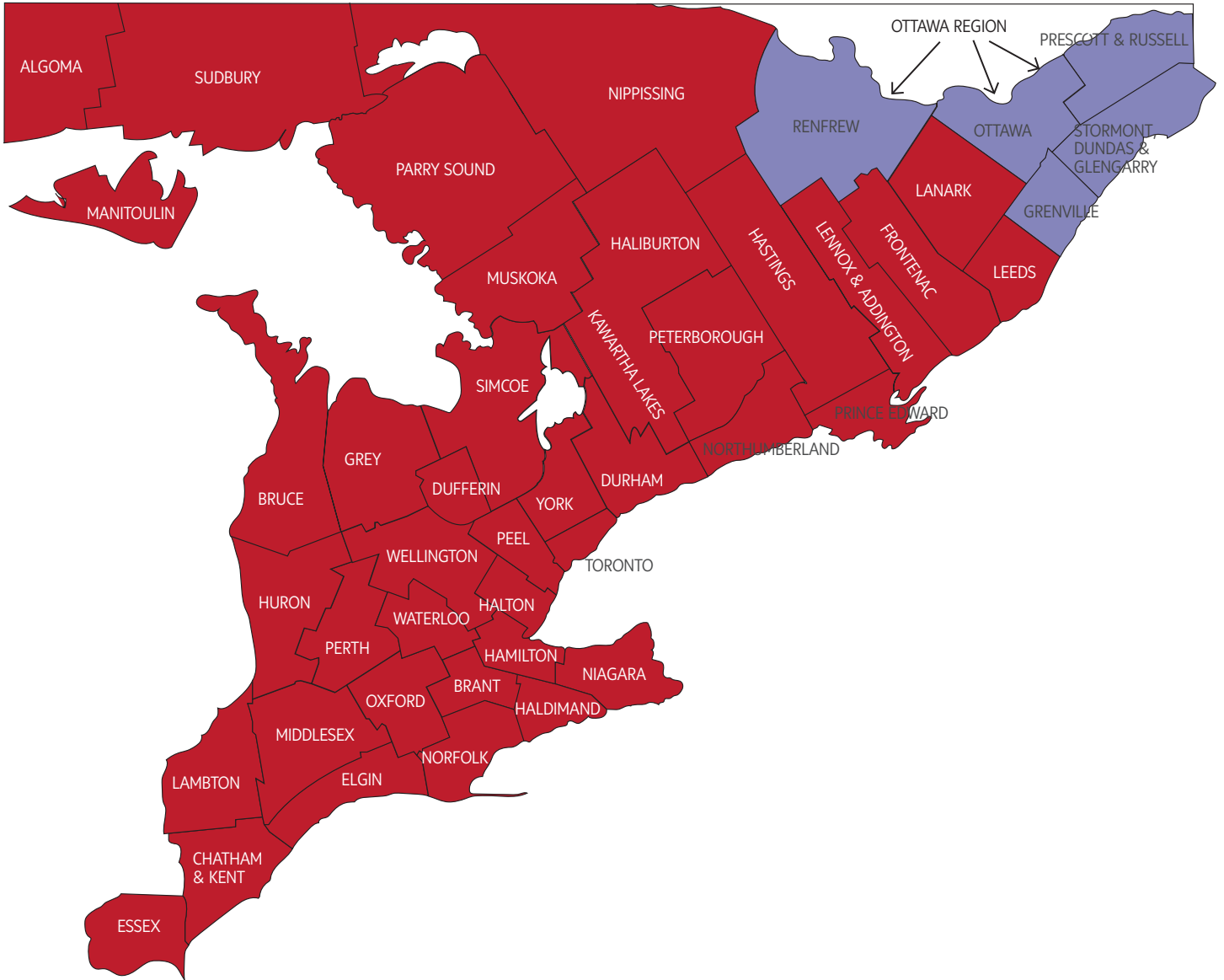

Note: Ottawa Region is serviced from the Montreal Plant.

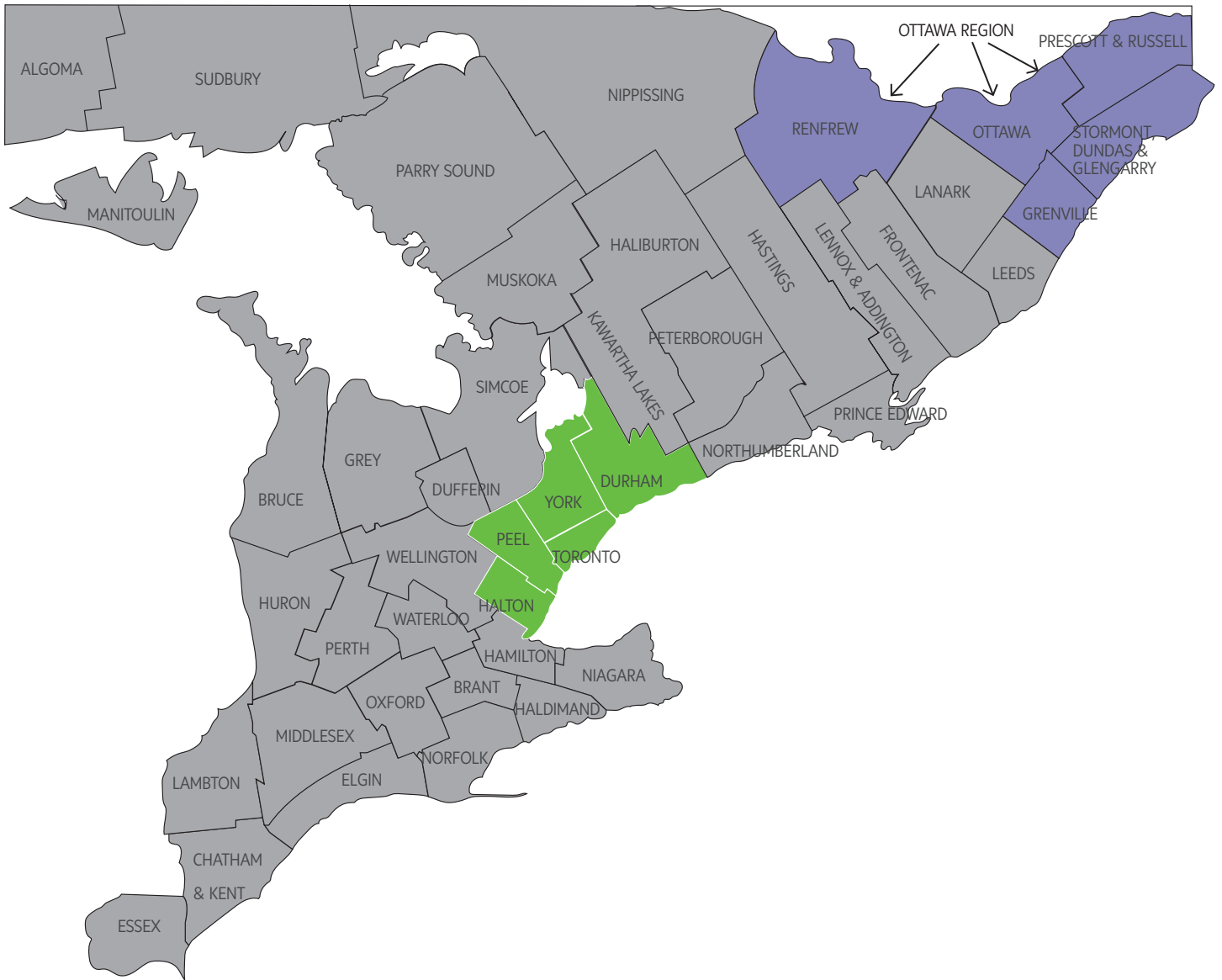

Note: GTA includes the City of Toronto plus Durham, Halton, Peel and York Region.



ONTARIO MAP MON-THU ONLY

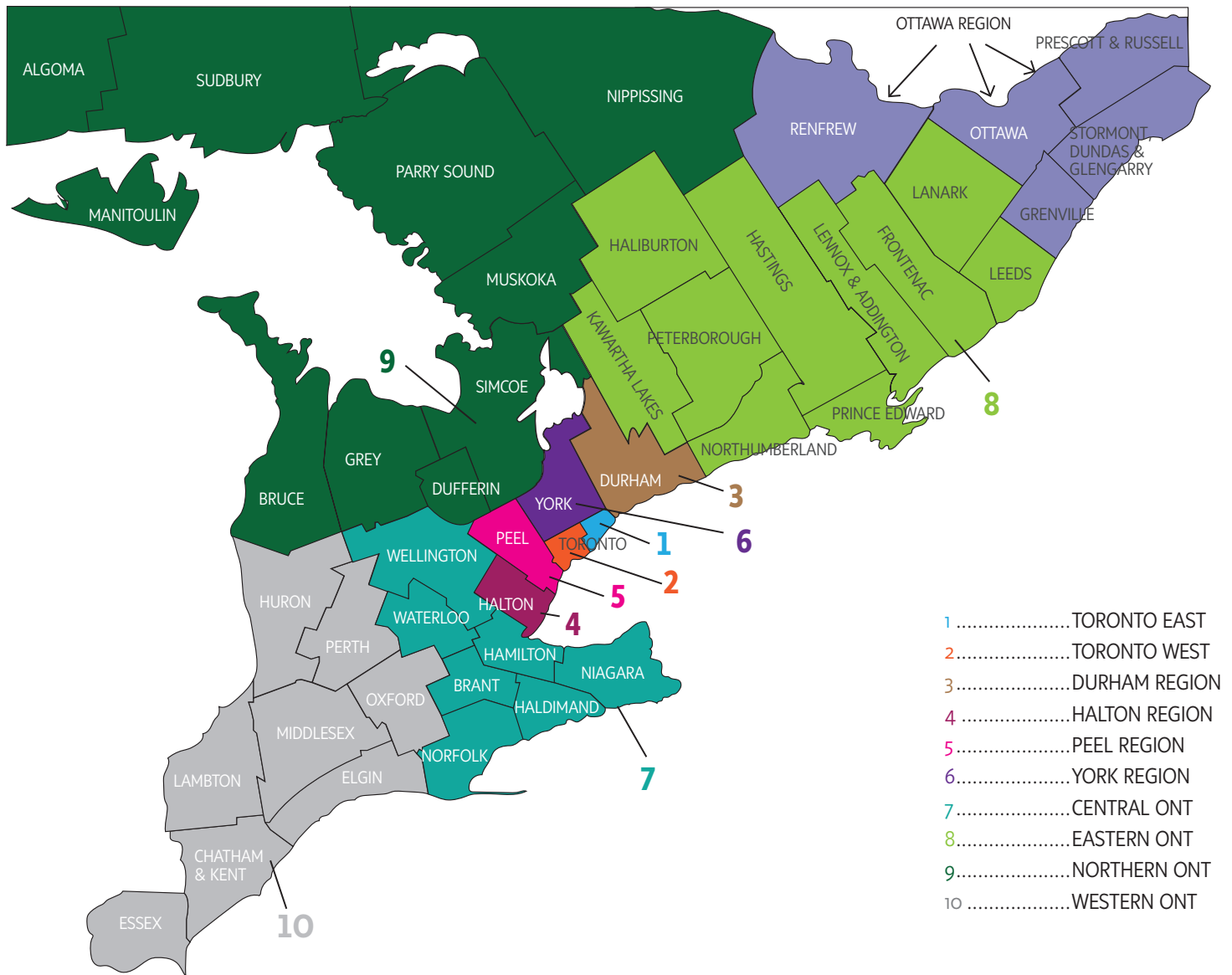

- 1TORONTO EAST
- 2TORONTO WEST
- 3DURHAM REGION
- 4HALTON REGION
- 5PEEL REGION
- 6YORK REGION
- 7CENTRAL ONT
- 8EASTERN ONT
- 9NORTHERN ONT
- 10WESTERN ONT

Note: Ottawa Region is serviced from the Montreal Plant.



TORONTO REGION MAP MON-THU ONLY

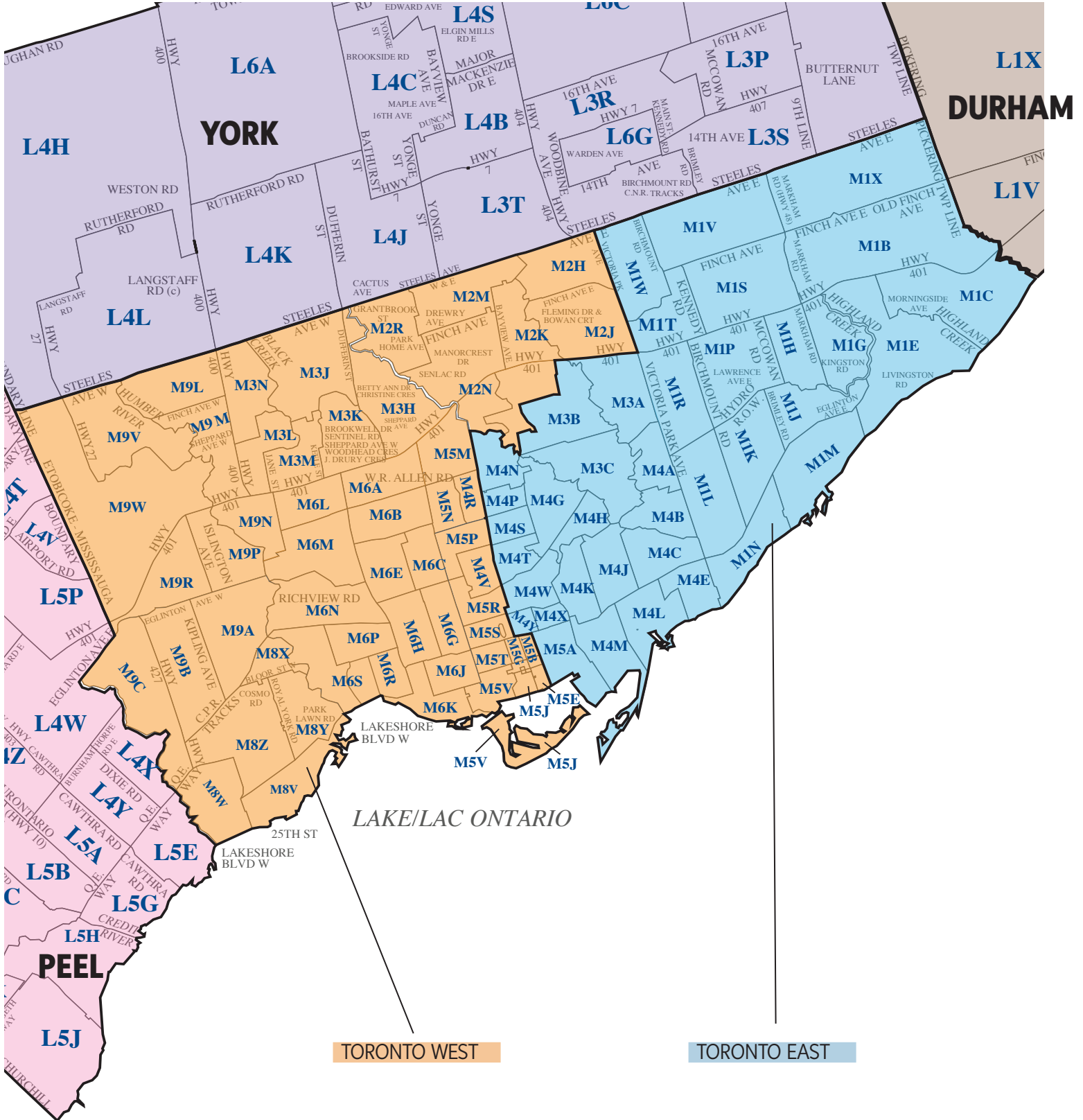



TORONTO PLANT

TORONTO EAST

- M1B..... SCARBOROUGH - MALVERN
- M1C..... SCARBOROUGH - ROUGE HILL
- M1E..... SCARBOROUGH - GUILDWOOD
- M1G..... SCARBOROUGH - WOBURN
- M1H..... SCARBOROUGH - CEDARBRAE
- M1J..... SCARBOROUGH - SCARBOROUGH VILLAGE
- M1K..... SCARBOROUGH - KENNEDY PARK
- M1L..... SCARBOROUGH - GOLDEN MILE
- M1M..... SCARBOROUGH - CLIFFSIDE
- M1N..... SCARBOROUGH - BIRCH CLIFF
- M1P..... SCARBOROUGH - DORSET PARK
- M1R..... SCARBOROUGH - WEXFORD
- M1S..... SCARBOROUGH - AGINCOURT
- M1T..... SCARBOROUGH - CLARKS CORNERS
- M1V..... SCARBOROUGH - MILLIKEN
- M1W..... SCARBOROUGH - STEELES WEST
- M1X..... SCARBOROUGH - UPPER ROUGE
- M3A..... NORTH YORK - YORK HEIGHTS
- M3B..... DON MILLS NORTH
- M3C..... DON MILLS SOUTH
- M4A..... NORTH YORK - SWEENEY PARK
- M4B..... EAST YORK - PARKVIEW HILL
- M4C..... EAST YORK - WOODBINE HEIGHTS
- M4E..... EAST TORONTO - EAST BEACHES
- M4G..... EAST YORK - LEASIDE
- M4H..... EAST YORK - THORNCLIFFE PARK
- M4J..... EAST TORONTO - DANFORTH EAST
- M4K..... EAST TORONTO - DANFORTH WEST
- M4L..... EAST TORONTO - WEST BEACHES
- M4M..... EAST TORONTO - STUDIO DISTRICT
- M4N..... CENTRAL TORONTO - LAWRENCE PARK
- M4P..... CENTRAL TORONTO - DAVISVILLE NORTH
- M4S..... CENTRAL TORONTO - DAVISVILLE
- M4T..... CENTRAL TORONTO - MOORE PARK
- M4W..... DOWNTOWN TORONTO - ROSEDALE
- M4X..... DOWNTOWN TORONTO - CABBAGETOWN
- M4Y..... DOWNTOWN TORONTO - CHURCH/WELLESLEY
- M5A..... DOWNTOWN TORONTO - REGENT PARK
- M5B..... DOWNTOWN TORONTO - RYERSON
- M5C..... DOWNTOWN TORONTO - ST JAMES TOWN
- M5E..... DOWNTOWN - BERCZY PARK

TORONTO WEST

- M2H..... NORTH YORK - HILLCREST VILLAGE
- M2J..... NORTH YORK - FAIRVIEW
- M2K..... NORTH YORK - BAYVIEW VILLAGE
- M2L..... NORTH YORK - YORK MILLS
- M2M..... WILLOWDALE EAST
- M2N..... WILLOWDALE SOUTH
- M2P..... NORTH YORK - YORK MILLS WEST
- M2R..... WILLOWDALE WEST
- M3H..... NORTH YORK - BATHURST MANOR
- M3J..... NORTH YORK - NORTHWOOD
- M3K..... DOWNSVIEW EAST
- M3L..... DOWNSVIEW WEST
- M3M..... DOWNSVIEW CENTRAL
- M3N..... DOWNSVIEW NW
- M4R..... CENTRAL TORONTO - NORTH TORONTO WEST
- M4V..... CENTRAL TORONTO - SUMMERHILL
- M5G..... DOWNTOWN TORONTO - CENTRAL BAY STREET
- M5H..... DOWNTOWN TORONTO - RICHMOND/ADELAIDE
- M5J..... DOWNTOWN TORONTO - HARBOURFRONT
- M5M..... NORTH YORK - BEDFORD PARK
- M5N..... CENTRAL TORONTO - ROSELAWN
- M5P..... CENTRAL TORONTO - FOREST HILL
- M5R..... CENTRAL TORONTO - ANNEX
- M5S..... DOWNTOWN TORONTO - UNIV OF TORONTO
- M5T..... DOWNTOWN TORONTO - KENSINGTON
- M5V..... DOWNTOWN TORONTO - KING/SPADINA
- M6A..... NORTH YORK - LAWRENCE MANOR
- M6B..... NORTH YORK - GLENCAIRN
- M6C..... YORK - HUMEWOOD
- M6E..... YORK - CALEDONIA
- M6G..... DOWNTOWN TORONTO - CHRISTIE
- M6H..... WEST TORONTO - DUFFERIN
- M6J..... WEST TORONTO - TRINITY
- M6K..... WEST TORONTO - EXHIBITION
- M6L..... NORTH YORK - NORTH PARK
- M6M..... YORK - KEELESDALE
- M6N..... YORK - JUNCTION
- M6P..... WEST TORONTO - HIGH PARK
- M6R..... WEST TORONTO - PARKDALE
- M6S..... WEST TORONTO - RUNNYMEDE
- M8V..... ETOBICOKE - MIMICO
- M8W..... ETOBICOKE - LONG BRANCH
- M8X..... ETOBICOKE - KINGSWAY
- M8Y..... ETOBICOKE - OLD MILL
- M8Z..... ETOBICOKE - QUEENSWAY
- M9A..... ETOBICOKE - ISLINGTON
- M9B..... ETOBICOKE - MARTIN GROVE
- M9C..... ETOBICOKE - BURNHAMPTHORPE
- M9L..... NORTH YORK - HUMBER
- M9M..... NORTH YORK - HUMBERLEA
- M9N..... WESTON
- M9P..... ETOBICOKE - WESTMOUNT
- M9R..... ETOBICOKE - RICHVIEW
- M9V..... ETOBICOKE - HUMBERGATE
- M9W..... ETOBICOKE - REXDALE

FSAs included within a specific delivery zone are subject to change.



TORONTO PLANT

DURHAM

LoB.....EAST DURHAM
 LoC.....WEST DURHAM
 LoH.....WHITBY REGION
 LiB.....BOWMANVILLE EAST
 LiC.....BOWMANVILLE WEST
 LiE.....COURTICE
 LiG.....OSHAWA CENTRAL
 LiH.....OSHAWA SE
 LiJ.....OSHAWA SW
 LiK.....OSHAWA EAST
 LiM.....WHITBY NORTH
 LiN.....WHITBY SE
 LiP.....WHITBY SW
 LiR.....WHITBY CENTRAL
 LiS.....AJAX SW
 LiT.....AJAX NW
 LiV.....PICKERING SW
 LiW.....PICKERING SOUTH
 LiX.....PICKERING CENTRAL
 LiY.....PICKERING NORTH
 LiZ.....AJAX EAST
 L9L.....PORT PERRY
 L9P.....UXBRIDGE

HALTON

LoP.....HALTON REGION
 L6H.....OAKVILLE NORTH
 L6J.....OAKVILLE NE
 L6K.....OAKVILLE EAST
 L6L.....OAKVILLE SOUTH
 L6M.....OAKVILLE WEST
 L7L.....BURLINGTON NE
 L7M.....BURLINGTON NORTH
 L7N.....BURLINGTON EAST
 L7P.....BURLINGTON WEST
 L7R.....BURLINGTON SE
 L7S.....BURLINGTON SOUTH
 L7T.....BURLINGTON SW
 L9T.....MILTON

PEEL

L4T.....MISSISSAUGA - MALTON
 L4V.....MISSISSAUGA - WILDWOOD
 L4W.....MISSISSAUGA - MATHESON
 L4X.....MISSISSAUGA - EAST APPLEWOOD
 L4Y.....MISSISSAUGA - WEST APPLEWOOD
 L4Z.....MISSISSAUGA - RATHWOOD
 L5A.....MISSISSAUGA - EAST COOKSVILLE
 L5B.....MISSISSAUGA - WEST COOKSVILLE
 L5C.....MISSISSAUGA - CREDITVIEW
 L5E.....MISSISSAUGA - CENTRAL LAKEVIEW
 L5G.....MISSISSAUGA - SW LAKEVIEW
 L5H.....MISSISSAUGA - PORT CREDIT
 L5J.....MISSISSAUGA - CLARKSON
 L5K.....MISSISSAUGA - WEST SHERIDAN
 L5L.....MISSISSAUGA - ERIN MILLS
 L5M.....MISSISSAUGA - CHURCHILL MEADOWS
 L5N.....MISSISSAUGA - LISGAR
 L5R.....MISSISSAUGA - WEST HURONTARIO
 L5S.....MISSISSAUGA - CARDIFF
 L5T.....MISSISSAUGA - COURTNEY PARK
 L5V.....MISSISSAUGA - EAST CREDIT
 L5W.....MISSISSAUGA - MEADOWVALE
 L6P.....BRAMPTON NORTH
 L6R.....BRAMPTON NW
 L6S.....BRAMPTON NORTH CENTRAL
 L6T.....BRAMPTON EAST
 L6V.....BRAMPTON CENTRAL
 L6W.....BRAMPTON SE
 L6X.....BRAMPTON SW
 L6Y.....BRAMPTON SOUTH
 L6Z.....BRAMPTON WEST CENTRAL
 L7A.....BRAMPTON WEST
 L7C.....CALEDON
 L7E.....BOLTON
 L7G.....GEORGETOWN
 L7J.....ACTON
 L7K.....CALEDON VILLAGE

FSA's included within a specific delivery zone are subject to change.



TORONTO PLANT

YORK

LoE.....LAKE SIMCOE SE SHORE
 LoGONTARIO CENTRE
 L3PMARKHAM CENTRAL
 L3RMARKHAM OUTER SW
 L3SMARKHAM - ARMADALE
 L3TTHORNHILL EAST
 L3XNEWMARKET SW
 L3YNEWMARKET NE
 L3ZBRADFORD
 L4ASTOUFFVILLE
 L4BRICHMOND HILL SE
 L4CRICHMOND HILL SW
 L4ERICHMOND HILL NORTH
 L4GAURORA
 L4HWOODBIDGE NORTH
 L4JTHORNHILL WEST
 L4KCONCORD
 L4LWOODBIDGE SOUTH
 L4PKESWICK
 L4SRICHMOND HILL CENTRAL
 L6AMAPLE
 L6BMARKHAM EAST
 L6CMARKHAM NW
 L6EMARKHAM NE
 L6GMARKHAM DOWNTOWN
 L7BKING CITY
 L9NHOLLAND LANDING

CEN ONT

LoR.....EAST HALDIMAND
 LoSSOUTH NIAGARA
 L2AFORT ERIE
 L2ENIAGARA FALLS CENTRAL
 L2GNIAGARA FALLS SE
 L2HNIAGARA FALLS WEST
 L2JNIAGARA FALLS NORTH
 L2MST CATHERINES - PORT WELLER
 L2NST CATHERINES - PORT DALHOUSIE
 L2PST CATHERINES - EAST QUEENSTON
 L2RST CATHERINES - DOWNTOWN
 L2SST CATHERINES - SE MARTINDALE
 L2TST CATHERINES - SOUTH GLENRIDGE
 L2VST CATHERINES - THOROLD
 L2WST CATHERINES - SW MARTINDALE
 L3BWELLAND EAST
 L3CWELLAND WEST
 L3KPORT COLBORNE
 L3MGRIMSBY
 L8BWATERDOWN
 L8EHAMILTON - CONFEDERATION PARK
 L8GHAMILTON - GREENFORD
 L8HHAMILTON - WEST KENTLY
 L8JHAMILTON - EAST ALBION
 L8KHAMILTON - EAST DELTA
 L8LHAMILTON - INDUSTRIAL SECTOR
 L8MHAMILTON - WEST DELTA

CEN ONT (CONT'D)

L8NHAMILTON - STINSON
 L8PHAMILTON - DURAND
 L8RHAMILTON - CENTRAL
 L8SHAMILTON - WESTDALE
 L8THAMILTON - SHERWOOD
 L8VHAMILTON - RALEIGH
 L8WHAMILTON - WEST ALBION
 L9AHAMILTON - CRERAR
 L9BHAMILTON - BARNSTOWN
 L9CHAMILTON - SOUTHAM
 L9GANCASTER WEST
 L9HDUNDAS
 L9KANCASTER EAST
 NoAWEST HALDIMAND
 NoBWELLINGTON
 NoEBRANT AND NORFOLK
 N1ADUNNVILLE
 N1CGUELPH SOUTH
 N1EGUELPH NORTH
 N1GGUELPH CENTRAL
 N1HGUELPH NW
 N1KGUELPH WEST
 N1LGUELPH EAST
 N1MFERGUS
 N1PCAMBRIDGE SOUTH
 N1RCAMBRIDGE CENTRAL
 N1SCAMBRIDGE SW
 N1TCAMBRIDGE EAST
 N2AKITCHENER EAST
 N2BKITCHENER NE
 N2CKITCHENER SOUTH CENTRAL
 N2EKITCHENER SW
 N2GKITCHENER CENTRAL
 N2HKITCHENER NORTH CENTRAL
 N2JWATERLOO SE
 N2KWATERLOO EAST
 N2LWATERLOO SOUTH
 N2MKITCHENER NW
 N2NKITCHENER WEST
 N2PKITCHENER SE
 N2RKITCHENER SOUTH
 N2TWATERLOO SW
 N2VWATERLOO NW
 N3ABADEN
 N3BELMIRA
 N3CCAMBRIDGE NE
 N3ECAMBRIDGE NW
 N3HCAMBRIDGE WEST
 N3LPARIS
 N3RBRANTFORD CENTRAL
 N3SBRANTFORD SE
 N3TBRANTFORD SW
 N3WCALEDONIA
 N3YSIMCOE

FSA's included within a specific delivery zone are subject to change.



TORONTO PLANT

EAST ONT

LoE.....LAKE SIMCOE SE SHORE
 KoESOUTH LEEDS - GRENVILLE
 KoHFRONTENAC - ADDINGTON
 KoKQUINTE - PRINCE EDWARD COUNTY
 KoL.....PETERBOROUGH - NORTH HASTINGS
 KoM.....KAWARTHA - HALIBURTON
 K6VBROCKVILLE
 K7A.....SMITHS FALLS
 K7GGANANOQUE
 K7HPERTH
 K7K.....KINGSTON - PITTSBURGH
 K7L.....KINGSTON - DOWNTOWN
 K7M.....KINGSTON - REDDENDALE
 K7NAMHERSTVIEW
 K7P.....KINGSTON - WESTBROOK
 K7R.....NAPANEE
 K8NBELLEVILLE EAST
 K8P.....BELLEVILLE WEST
 K8R.....BELLEVILLE - SE SIDNEY
 K8VTRENTON
 K9ACOBOURG
 K9HPETERBOROUGH CENTRAL
 K9JPETERBOROUGH SOUTH
 K9K.....PETERBOROUGH - FAIRBAIRN
 K9L.....PETERBOROUGH - TERRA VIEW
 K9VLINDSAY
 L1A.....PORT HOPE

NOR ONT

LoK.....LAKE SIMCOE NORTH
 LoLLAKE SIMCOE WEST
 LoNDUFFERIN
 L3VORILLIA
 L4MBARRIE NORTH
 L4NBARRIE SOUTH
 L4R.....MIDLAND
 L9MPENETANGUISHENE
 L9R.....ALLISTON
 L9S.....INNISFIL
 L9V.....ORANGEVILLE NORTH
 L9W.....ORANGEVILLE SOUTH
 L9X.....SPRINGWATER
 L9Y.....COLLINGWOOD
 L9Z.....WASAGA BEACH
 NoH.....BRUCE
 N4K.....OWEN SOUND
 N4L.....MEAFORD
 PoM.....ALGOMA
 P1ANORTH BAY SOUTH
 P1BNORTH BAY CENTRAL
 P1CNORTH BAY NORTH
 P1HHUNTSVILLE
 P1L.....BRACEBRIDGE
 P1P.....GRAVENHURST
 P2A.....PARRY SOUND
 P3A.....SUDBURY NEW SUDBURY
 P3B.....SUDBURY DOWNTOWN

NOR ONT (CONT'D)

P3C.....SUDBURY WEST END
 P3E.....SUDBURY LOCKERBY
 P3G.....SUDBURY MCFARLANE LAKE
 P3P.....SUDBURY HANMER
 P3Y.....SUDBURY LIVELY

WEST ONT

NoN.....LAMBTON
 NoRESSEX
 N4BDELHI
 N4G.....TILLSONBURG
 N4SWOODSTOCK CENTRAL
 N4TWOODSTOCK NORTH
 N4VWOODSTOCK SOUTH
 N4X.....ST MARYS
 N4ZSTRATFORD SOUTH
 N5ASTRATFORD NORTH
 N5C.....INGERSOLL
 N5P.....ST THOMAS NORTH
 N5R.....ST THOMAS SOUTH
 N5VLONDON NE
 N5WLONDON EAST
 N5XLONDON FANSHAWE
 N5Y.....LONDON WEST HURON
 N5ZLONDON GLEN CAIRN
 N6ALONDON NORTH
 N6BLONDON CENTRAL
 N6CLONDON SOUTH
 N6ELONDON SW
 N6G.....LONDON SUNNINGDALE
 N6H.....LONDON WEST
 N6J.....LONDON SOUTHCREST
 N6KLONDON RIVERBEND
 N6PLONDON TALBOT
 N7AGODERICH
 N7L.....CHATHAM NW
 N7M.....CHATHAM SE
 N7S.....SARNIA CENTRAL
 N7T.....SARNIA SW
 N7VSARNIA NW
 N7XSARNIA NE
 N8H.....LEAMINGTON
 N8N.....TECUMSEH OUTSKIRTS
 N8PWINDSOR EAST RIVERSIDE
 N8RWINDSOR EAST FOREST GLADE
 N8SWINDSOR RIVERSIDE
 N8TWINDSOR WEST FOREST GLADE
 N8WWINDSOR SOUTH WALKERVILLE
 N8X.....WINDSOR SOUTH CENTRAL
 N8YWINDSOR EAST
 N9AWINDSOR CITY CENTRE
 N9BWINDSOR UNIVERSITY
 N9CWINDSOR SANDWICH
 N9EWINDSOR SOUTH EAST MALDEN
 N9G.....WINDSOR ROSELAND
 N9H.....LA SALLE EAST
 N9J.....LA SALLE WEST
 N9VAMHERSTBURG

FSA's included within a specific delivery zone are subject to change.



MONTREAL PLANT

OTTAWA

KoA NATIONAL CAPITAL REGION
 KoG RIDEAU LAKES
 K1A GOVT OF CANADA
 K1B OTTAWA - BLACKBURN
 K1C OTTAWA - ORLEANS
 K1E OTTAWA - QUEENSWOOD
 K1G OTTAWA - RIVERVIEW
 K1H OTTAWA - ALTA VISTA
 K1J OTTAWA - BEACONHILL
 K1K OTTAWA - OVERBROOK
 K1L OTTAWA - VANIER
 K1M OTTAWA - ROCKCLIFFE
 K1N OTTAWA - LOWER TOWN
 K1R OTTAWA - DALHOUSIE
 K1S OTTAWA - THE GLEBE
 K1T OTTAWA - BLOSSOM PARK
 K1V OTTAWA - HERON GATE
 K1W OTTAWA - CHAPEL HILL
 K1Y OTTAWA - CIVIC HOSPITAL
 K1Z OTTAWA - WESTBORO
 K2A OTTAWA - HIGHLAND PARK
 K2B OTTAWA - BRITANNIA
 K2C OTTAWA - QUEENSWAY
 K2E OTTAWA - EAST
 K2G OTTAWA - DAVIDSON
 K2H OTTAWA - BELLS CORNERS
 K2J OTTAWA - BARRHAVEN
 K2K OTTAWA - BEAVERBROOK
 K2L OTTAWA - KATIMAVIK
 K2M OTTAWA - BRIDLEWOOD
 K2P OTTAWA - CENTRE TOWN
 K2R OTTAWA - FALLOWFIELD
 K2S OTTAWA - STITTSVILLE
 K2T OTTAWA - MARCHWOOD
 K2V OTTAWA - TERRY FOX
 K2W OTTAWA - NORTH MARCH
 K4A OTTAWA - FALLINGBROOK
 K4C OTTAWA - CUMBERLAND
 K4M OTTAWA - MANOTICK
 K4P OTTAWA - GREELEY
 K7C CARLETON PLACE

QUEBEC

H1G MONTREAL-NORD NORTH
 H1K ANJOU EAST
 H1M MERCIER WEST
 H1T ROSEMOUNT NORTH
 H1W HOCHELAGA
 H1X ROSEMOUNT CENTRAL
 H2G PETITE-PATRIE NE
 H2J PLATEAU MONT-ROYAL NORTH CENTRAL
 H2L CENTRAL-SUD SOUTH
 H2R VILLERAY SE
 H2S PETITE-PATRIE SW
 H2T PLATEAU MONT-ROYAL WEST
 H2V OUTREMONT
 H2W PLATEAU MONT-ROYAL SOUTH CENTRAL

QUEBEC (CONT'D)

H2X PLATEAU MONT-ROYAL SE
 H2Y OLD MONTREAL
 H3A DOWNTOWN MONTREAL NORTH
 H3C GRIFFINTOWN
 H3E L'ILE-DES-SOEURS
 H3G DOWNTOWN MONTREAL SE
 H3H DOWNTOWN MONTREAL SW
 H3J PETITE-BOURGOGNE
 H3L AHUNTSIC SW
 H3M CARTIERVILLE NE
 H3N PARC-EXTENSION
 H3P MOUNT ROYAL NORTH
 H3R MOUNT ROYAL CENTRAL
 H3S COTE-DES-NEIGES NORTH
 H3T COTE-DES-NEIGES NE
 H3V COTE-DES-NEIGES EAST
 H3W COTE-DES-NEIGES SW
 H3X HAMPSTEAD / COTE SAINT-LUC
 H3Y WESTMOUNT NORTH
 H3Z WESTMOUNT SOUTH
 H4A NOTRE-DAME-DE-GRACE NE
 H4B NOTRE-DAME-DE-GRACE SW
 H4C SAINT-HENRI
 H4G VERDUN NORTH
 H4H VERDUN SOUTH
 H4K CARTIERVILLE SW
 H4L SAINT-LAURENT INNER NE
 H4M SAINT-LAURENT EAST
 H4N SAINT-LAURENT OUTER NE
 H4P MOUNT ROYAL SOUTH
 H4R SAINT-LAURENT CENTRAL
 H4S SAINT-LAURENT SW
 H4T SAINT-LAURENT SE
 H4V COTE-SAINT-LUC WEST
 H4W COTE-SAINT-LUC EAST
 H4X MONTREAL WEST
 H7E DUVERNAY
 H7K AUTEUIL SOUTH
 H7L SAINTE-ROSE
 H7M VIMONT
 H7T CHOMEDEY NW
 H7V CHOMEDEY EAST
 H7W CHOMEDEY SOUTH
 H7X SAINTE-DOROTHEE
 H7Y ILES-LAVAL
 H8N LASALLE NW
 H8P LASALLE SE
 H8S LACHINE EAST
 H8T LACHINE WEST
 H8Y ROXBORO
 H8Z PIERREFONDS
 H9A DOLLARD-DES-ORMEAUX NW
 H9B DOLLARD-DES-ORMEAUX EAST
 H9C L'ILE-BIZARD NE
 H9E L'ILE-BIZARD SW
 H9G DOLLARD-DES-ORMEAUX SW
 H9H SAINTE-GENEVIEVE/PIERREFONDS

FSAs included within a specific delivery zone are subject to change.



MONTREAL PLANT

QUEBEC (CONT'D)

H9J.....KIRKLAND
H9P.....DORVAL OUTSKIRTS
H9R.....POINTE-CLAIRE
H9S.....DORVAL/L'ILE DORVAL
H9W.....BEACONSFIELD
H9X.....SAINTE-ANNE-DE-BELLEVUE
J0P.....VAUDREUIL-SOULANGES
J3H.....BELOEIL WEST
J3V.....SAINT-BRUNO-DE-MONTARVILLE
J4B.....BOUCHERVILLE
J4H.....LONGUEUIL WEST
J4J.....LONGUEUIL CENTRAL
J4L.....LONGUEUIL SE
J4N.....LONGUEUIL NE
J4P.....SAINT-LAMBERT NORTH
J4R.....SAINT-LAMBERT CENTRAL
J4S.....SAINT-LAMBERT SOUTH
J4V.....GREENFIELD PARK
J4W.....BROSSARD NW
J4X.....BROSSARD SW
J4Y.....BROSSARD SOUTH
J4Z.....BROSSARD NE
J5R.....LA PRAIRIE
J7A.....SAINTE-THERESE-DE-BLAINVILLE EAST
J7T.....VAUDREUIL-DORION RCM
J7V.....VAUDREUIL-DORION
J8T.....GATINEAU SW
J8V.....GATINEAU NW
J8X.....HULL SE
J8Y.....HULL CENTRAL
J8Z.....HULL NORTH
J9A.....HULL SW
J9B.....CHELSEA
J9H.....AYLMER SOUTH
J9J.....AYLMER NORTH

ESTEVAN PLANT

MANITOBA

R2C.....WINNIPEG - TRANSCONA
R2E.....EAST ST. PAUL
R2G.....WINNIPEG - RIVER EAST NORTH
R2H.....WINNIPEG - ST BONIFACE NW
R2J.....WINNIPEG - ST BONIFACE NE
R2K.....WINNIPEG - RIVER EAST CENTRAL
R2L.....WINNIPEG - RIVER EAST SOUTH
R2M.....WINNIPEG - ST VITAL NORTH
R2N.....WINNIPEG - ST VITAL SW
R2P.....WINNIPEG - SEVEN OAKS WEST
R2R.....WINNIPEG - INKSTER WEST
R2V.....WINNIPEG - SEVEN OAKS EAST
R2W.....WINNIPEG - POINT DOUGLAS EAST
R2X.....WINNIPEG - POINT DOUGLAS WEST
R2Y.....WINNIPEG - ST JAMES ASSINIBOIA NW
R3B.....WINNIPEG - CHINATOWN
R3C.....WINNIPEG - BROADWAY
R3G.....WINNIPEG - MINTO
R3H.....WINNIPEG - ST JAMES ASSINIBOIA NE
R3J.....WINNIPEG - ST JAMES ASSINIBOIA SE
R3K.....WINNIPEG - ST JAMES ASSINIBOIA SW
R3L.....WINNIPEG - RIVER HEIGHTS EAST
R3M.....WINNIPEG - CRESCENTWOOD
R3N.....WINNIPEG - RIVER HEIGHTS WEST
R3P.....WINNIPEG - FT GARRY NW
R3R.....WINNIPEG - ASSINIBOINE SOUTH
R3S.....WINNIPEG - WILKES SOUTH
R3T.....WINNIPEG - FORT GARRY NW
R3V.....WINNIPEG - FORT GARRY SOUTH
R3X.....WINNIPEG - ST BONIFACE SOUTH
R3Y.....WINNIPEG - FORT GARRY WEST
R7A.....BRANDON EAST
R7B.....BRANDON SOUTH
R7C.....BRANDON NW

SASKATCHEWAN

S4N.....REGINA NE AND EAST CENTRAL
S4P.....REGINA CENTRAL
S4R.....REGINA NORTH CENTRAL
S4S.....REGINA SOUTH
S4T.....REGINA WEST
S4V.....REGINA SE
S4W.....REGINA SW
S4X.....REGINA NW
S4Y.....REGINA OUTER NW
S7H.....SASKATOON EAST CENTRAL
S7J.....SASKATOON SOUTH CENTRAL
S7K.....SASKATOON NORTH CENTRAL
S7L.....SASKATOON WEST
S7M.....SASKATOON SOUTHWEST
S7N.....SASKATOON NE CENTRAL
S7S.....SASKATOON NE
S7T.....SASKATOON SOUTH
S7V.....SASKATOON SE
S7W.....SASKATOON CITY CENTRE

FSAs included within a specific delivery zone are subject to change.



CALGARY PLANT

EDMONTON

T4NRED DEER CENTRAL
T4PRED DEER NORTH
T4RRED DEER SOUTH
T5AEDMONTON WEST CLAREVIEW
T5BEDMONTON EAST NORTH CENTRAL
T5CEDMONTON CENTRAL LONDONDERRY
T5EEDMONTON WEST LONDONDERRY
T5GEDMONTON NORTH CENTRAL
T5HEDMONTON NORTH AND EAST DOWNTOWN
T5JEDMONTON NORTH DOWNTOWN
T5KEDMONTON SOUTH DOWNTOWN
T5LEDMONTON NORTH WESTMOUNT
T5MEDMONTON SOUTH WESTMOUNT
T5NEDMONTON GLENORA
T5PEDMONTON NORTH JASPER
T5REDMONTON CENTRAL JASPER
T5SEDMONTON WEST NORTHWEST
T5TEDMONTON WEST JASPER
T5WEDMONTON CENTRAL BEVERLY
T5XEDMONTON EAST CASTLEDOWNS
T5YEDMONTON LANDBANK
T5ZEDMONTON WEST LAKE
T6AEDMONTON NORTH CAPILANO
T6BEDMONTON SE CAPILANO
T6CEDMONTON CENTRAL BONNIE DOON
T6EEDMONTON SOUTH BONNIE DOON
T6GEDMONTON WEST UNIVERSITY
T6HEDMONTON SOUTHGATE
T6JEDMONTON KASKIYATO
T6KEDMONTON WEST MILL
T6LEDMONTON EAST MILL
T6MEDMONTON SOUTHWEST
T6NEDMONTON SOTH INDUSTRIAL
T6REDMONTON RIVERBEND
T6TEDMONTON MEADOWS
T6WEDMONTON HERITAGE VALLEY
T6XEDMONTON ELLERSLIE
T7XSPRUCE GROVE NORTH
T7ZSTONEY PLAIN
T8ASHERWOOD PARK WEST
T8BSHERWOOD PARK OUTER SOUTHWEST
T8HSHERWOOD PARK NORTHWEST
T8LFORT SASKATCHEWAN
T8NST ALBERT
T9ELEDUC

CALGARY

T1AMEDICINE HAT CENTRAL
T1BMEDICINE HAT SOUTH
T1CMEDICINE HAT NORTH
T1HLETHBRIDGE NORTH
T1JLETHBRIDGE WEST/CENTRAL
T1KLETHBRIDGE WEST/SOUTH
T1SOKOTOKS
T1WCANMORE
T1YCALGARY RUNDLE
T2ACALGARY PENBROOKE
T2CCALGARY LYNNWOOD
T2ECALGARY BRIDGELAND
T2GCALGARY INGLEWOOD
T2HCALGARY HIGHFIELD
T2JCALGARY QUEENSLAND
T2KCALGARY THORNCLIFFE
T2LCALGARY BRENTWOOD
T2MCALGARY MOUNT PLEASANT
T2NCALGARY KENSINGTON
T2RCALGARY CONNAUGHT
T2SCALGARY ELBOW PARK
T2TCALGARY SOUTH
T2VCALGARY OAKRIDGE
T2WCALGARY BRAESIDE
T2XCALGARY MIDNAPORE
T2YCALGARY MILLRISE
T2ZCALGARY DOUGLAS GLEN
T3ACALGARY DALHOUSIE
T3BCALGARY MONTGOMERY
T3CCALGARY ROSSCARROCK
T3ECALGARY LAKEVIEW
T3GCALGARY HAWKWOOD
T3HCALGARY DISCOVERY RIDGE
T3JCALGARY MARTINDALE
T3KCALGARY SANDSTONE
T3LCALGARY TUSCANY
T3MCALGARY CRANSTON
T3PCALGARY SYMONS
T3RCALGARY NORTHWEST
T3ZREDWOOD MEADOWS
T4AAIRDRIE EAST
T4BAIRDRIE WEST
T4CCOCHRANE

FSAs included within a specific delivery zone are subject to change.



VANCOUVER PLANT

VANCOUVER

- VoH SE OKANAGAN
- VoM HARRISON LAKE
- VoN GIBSONS
- V1B VERNON EAST
- V1H VERNON WEST
- V1M LANGLEY NORTH
- V1S KAMLOOPS SW
- V1T VERNON CENTRAL
- V1V KELOWNA NORTH
- V1W KELOWNA SW
- V1X KELOWNA EAST CENTRAL
- V1Y KELOWNA CENTRAL
- V1Z KELOWNA WEST
- V2A PENTICTON
- V2B KAMLOOPS NW
- V2C KAMLOOPS CENTRAL AND SE
- V2E KAMLOOPS SOUTH AND WEST
- V2H KAMLOOPS NORTH
- V2P CHILLIWACK CENTRAL
- V2R CHILLIWACK WEST
- V2S ABBOTSFORD SE
- V2T ABBOTSFORD SW
- V2V MISSION EAST
- V2X MAPLE RIDGE WEST
- V2Y LANGLEY
- V2Z LANGLEY SW
- V3A LANGLEY CITY
- V3B PORT COQUITLAM CENTRAL
- V3C PORT COQUITLAM SOUTH
- V3E PORT COQUITLAM NORTH
- V3G ABBOTSFORD EAST
- V3H PORT MOODY
- V3J COQUITLAM NORTH
- V3K COQUITLAM SOUTH
- V3L NEW WESTMINSTER NE
- V3M NEW WESTMINSTER SW - ANNACIS
- V3N BURNABY
- V3R SURREY NORTH
- V3S SURREY EAST
- V3T SURREY INNER NW
- V3V SURREY OUTER NW
- V3W SURREY UPPER WEST
- V3X SURREY LOWER WEST
- V3Y PITT MEADOWS
- V3Z SURREY
- V4A SURREY SW
- V4B WHITE ROCK
- V4C DELTA NE
- V4E DELTA EAST
- V4K DELTA NW
- V4L DELTA SE
- V4M DELTA SW
- V4N SURREY NE
- V4P SURREY SOUTH
- V4T WESTBANK
- V4V WINFIELD
- V4W LANGLEY EAST

VANCOUVER (CONT'D)

- V4X ABBOTSFORD WEST
- V5A BURNABY LAKE CITY
- V5B BURNABY PARKCREST
- V5C BURNABY HEIGHTS
- V5E BURNABY LAKEVIEW
- V5G BURNABY CASCADE
- V5H BURNABY MAYWOOD
- V5J BURNABY SUNCREST
- V5K VANCOUVER NORTH HASTINGS
- V5L VANCOUVER NORTH GRANDVIEW
- V5M VANCOUVER SOUTH HASTINGS
- V5N VANCOUVER SOUTH GRANDVIEW
- V5P VANCOUVER SE
- V5R VANCOUVER SOUTH
- V5S VANCOUVER KILLARNY
- V5T VANCOUVER EAST MOUNT PLEASANT
- V5V VANCOUVER WEST KENSINGTON
- V5W VANCOUVER RILEY PARK
- V5X VANCOUVER OAKRIDGE
- V5Y VANCOUVER WEST MOUNT PLEASANT
- V5Z VANCOUVER EAST FAIRVIEW
- V6A VANCOUVER STRATHCONA
- V6B VANCOUVER DOWNTOWN
- V6C VANCOUVER WATERFRONT
- V6E VANCOUVER SE WEST END
- V6G VANCOUVER NW WEST END
- V6H VANCOUVER WEST FAIRVIEW
- V6J VANCOUVER NW SHAUGHNESSY
- V6K VANCOUVER KITSILANO
- V6L VANCOUVER ARBUTUS RIDGE
- V6M VANCOUVER NW OAKRIDGE
- V6N VANCOUVER WEST KERRISDALE
- V6P VANCOUVER SE KERRISDALE
- V6R VANCOUVER REFREW
- V6S VANCOUVER DUNDAR
- V6T VANCOUVER UBC
- V6V RICHMOND NE
- V6W RICHMOND SE
- V6X RICHMOND NORTH
- V6Y RICHMOND CENTRAL
- V6Z VANCOUVER SW DOWNTOWN
- V7A RICHMOND SOUTH
- V7C RICHMOND NW
- V7E RICHMOND SW
- V7G NORTH VANCOUVER OUTER EAST
- V7H NORTH VANCOUVER INNER EAST
- V7J NORTH VANCOUVER EAST CENTRAL
- V7K NORTH VANCOUVER NORTH CENTRAL
- V7L NORTH VANCOUVER SOUTH CENTRAL
- V7M NORTH VANCOUVER SW CENTRAL
- V7N NORTH VANCOUVER NW CENTRAL
- V7P NORTH VANCOUVER SW
- V7R NORTH VANCOUVER NW
- V7S WEST VANCOUVER NORTH
- V7T WEST VANCOUVER SE
- V7V WEST VANCOUVER SOUTH
- V7W WEST VANCOUVER WEST

FSAs included within a specific delivery zone are subject to change.



VANCOUVER PLANT

VICTORIA

- VoRCENTRAL VANC ISLAND
- V8L.....VICTORIA NORTH SAANICH
- V8M.....VICTORIA CENTRAL SAANICH
- V8NVICTORIA EAST SAANICH
- V8PVICTORIA SE SAANICH
- V8RVICTORIA NORTH OAK BAY
- V8S.....VICTORIA SOUTH OAK BAY
- V8T.....VICTORIA QUADRA
- V8VVICTORIA COOK STREET
- V8WVICTORIA DOWNTOWN
- V8XVICTORIA SOUTH SAANICH
- V8YVICTORIA NE SAANICH
- V8ZVICTORIA MIDDLE SAANICH
- V9AVICTORIA ESQUIMALT
- V9BVICTORIA WEST HIGHLANDS
- V9CVICTORIA COLWOOD
- V9E.....VICTORIA EAST HIGHLANDS
- V9GLADYSMITH
- V9HCAMPBELL RIVER OUTSKIRTS
- V9KQUALICUM
- V9M.....COMOX
- V9NCOURTENAY CENTRAL
- V9P.....PARKSVILLE
- V9R.....NANAIMO SOUTH
- V9S.....NANAIMO CENTRAL
- V9T.....NANAIMO NORTH
- V9VNANAIMO NW
- V9WCAMPBELL RIVER CENTRAL
- V9XCEDAR

FSA's included within a specific delivery zone are subject to change.



SHIPPING INSTRUCTIONS – MECHANICAL FRIDAY ONLY

MATERIAL DEADLINE

MECHANICAL INSERTS (FRIDAY ONLY)

Thursday one week prior to the run date.

The client should supply the recommended press run amount (plus spoilage) to ensure that all copies of the newspaper are inserted. Please note that our press run numbers can fluctuate on a daily basis due to market activity. The airline copies are not inserted in the Toronto market and these amounts are not included in the press run figures. Contact your sales representative for the latest press run figures.

All quotations exclude freight to The Globe and Mail plants. The client and/or agency will arrange for delivery and prepay all delivery expenses (including any customs brokerage fees).

All insert material must arrive at our printing plants during normal receiving hours. No deliveries will be accepted on Saturday, Sunday or statutory holidays.

Insert shipments do not require prior appointments for delivery except for the Vancouver Plant. Please call 604-527-9243 to make an appointment. You must provide the client name, insert title and run date. The shipment must be properly labelled and must arrive at our plants in good condition; otherwise the shipment will not be unloaded.

Any insert that is received past deadline or is improperly labelled or is received in a damaged condition will be cancelled and/or rescheduled. Any expenses incurred by The Globe and Mail will be charged to the client.

Any insert material remaining after the print run will be recycled immediately after the completion of insertion unless written arrangements are made at least five business days prior to the insertion date with The Globe and Mail. Pick-up must be completed within two business days of the insertion date.

Any cancelled inserts not removed from the plants by the client within three days of cancellation will be recycled unless prior written arrangements for re-scheduling or removal by the client are made. Late cancellation charges up to 50% of the original order will apply to all inserts cancelled less than five days prior to insertion.

SPOILAGE

MECHANICAL INSERTS (FRIDAY ONLY)

Please supply an additional 1.5% for spoilage.

SHIPMENT LABELS

All inserts must be labelled with the following information:

- The Globe and Mail
- Client name and Insert title
- Date of insertion
- Total number of inserts shipped
- Total number of copies per bundle
- Number of inserts on each pallet
- Total number of pallets shipped
- Name, address and phone number of printer/shipper
- Name and phone number of client's customs broker (for cross-border shipments)

Note: All cross-border shipments should also include a description of goods (printed matter) and the value of the material on the waybill for quicker customs clearance. The client should notify their customs broker prior to shipment.

Please contact Michael Anderson at 416-585-5455, mwanderson@globeandmail.com or Fatima Wilson at 416-585-3325, fwilson@globeandmail.com regarding all production inquiries, cancellations or delivery delays www.globelink.ca/inserts.

PLANT ADDRESSES AND RECEIVING HOURS

Toronto Plant

The Globe and Mail
c/o TC Transcontinental Vaughan
100B Royal Group Crescent
Doors 2-6
Vaughan, Ontario L4H 1X9
7 AM - 4 PM Monday - Friday

Estevan Plant

The Globe and Mail
c/o Estevan Web
1 Breeze Street, Hwy 39 West
South East Bay Door
Estevan, Saskatchewan S4A 2L7
8 AM - 6 PM Monday - Friday

Montreal Plant

The Globe and Mail
c/o TC Transcontinental Transmag
10807 Rue Mirabeau
Anjou, Quebec H1J 1T7
7 AM - 5 PM Monday - Friday

Calgary Plant

The Globe and Mail
c/o TC Transcontinental Calgary
5516 Fifth Street SE
Calgary, Alberta T2H 1L3
8 AM - 4:30 PM Monday - Friday

Vancouver Plant

The Globe and Mail
c/o TC Transcontinental Vancouver
725 Hampstead Close
Annacis Island
Delta, B.C. V3M 6R6
7 AM - 5 PM Monday - Friday
604-527-9243*
***Delivery appointment required**



SHIPPING INSTRUCTIONS – MECHANICAL FRIDAY ONLY

- All inserts scheduled for mechanical insertion should be supplied bulk on skids and must not be cross-tied. Skids should be loaded (when possible) in equal quantities per skid.
- Two to 36 page inserts printed on glossy or uncoated stock should be stacked in bundles of 4" to 8" in height. Elastic banding and boxes allowed as needed.
- Inserts over 36 pages printed on glossy or uncoated stock should be stacked in bundles of 6" to 8" in height. Elastic banding and boxes allowed as needed. No compensation - all spines must be stacked in the same direction.
- Quarterfolded inserts printed on uncoated/newsprint stocks should be stacked in bundles of 4" to 8" high. Single plastic strapping or elastic banding is required on each bundle.
- Unstable inserts over 24 pages Digest sized (or smaller) printed on glossy stock should be supplied stacked in boxes. No plastic strapping allowed on products supplied in boxes. Elastic banding allowed as needed.
- All supplements must be brick stacked with interlocking layers.
- Corner boards should be used to prevent damage to the outside edges of the loaded skid. Life containers are acceptable.
- All inserts must be stacked on pallets in consistent lifts, be well-jogged, and all pallets should be securely banded and plastic stretch-wrapped or shrink-wrapped.
- Stacked inserts should cover pallet and never protrude beyond the edge of the pallet.

- Folded edges should be turned towards the inside of the load whenever possible.
- Product must be stacked on solid base, **48"x40" (industry standard)** non-returnable, four-way entry pallets in good condition. Two-way pallets may be used as needed to accommodate automated compression banding and wrapping equipment.
- A substantial protective cover should be placed on the pallet before stacking and another cover placed before topping.
- Cardboard sheets or binder sheets, not waxed or coated, should be placed between layers.
- Pallet tops must be wood or a sturdy equivalent the same size as the pallet base.
- Banding should be tight without pulling down and bending the top turn or pulling loose the pallet flooring. A minimum of four bands to be on each load.
- Clearance from floor to bottom of pallet base is a minimum of 4¹/₂" to maximum of 8".
- Maximum allowable loaded pallet height is 4' measured from floor to pallet top.
- Maximum acceptable weight per loaded pallet is 2,500 pounds.
- Shipment labels and a sample of the insert must be displayed on two adjacent sides of each pallet.
- Pallets must be loaded on the truck so that the pallet tag faces the fork lift operator. Pallets must be loaded on trucks for ease of unloading. Do not "double deck".

Correctly loaded skids



Incorrectly loaded skids. Additional costs will apply and damaged copies will not be inserted.



**SHIPPING INSTRUCTIONS – HAND INSERTS MON-THU ONLY****MATERIAL DEADLINE****HAND INSERTS (MON-THU ONLY)**

Five business days prior to the run date.

The client should supply the recommended press run amount (plus spoilage) to ensure that all copies of the newspaper are inserted. Please note that our press run numbers can fluctuate on a daily basis due to market activity. The airline copies are not inserted in the Toronto market and these amounts are not included in the press run figures. Contact your sales representative for the latest press run figures.

All quotations exclude freight to The Globe and Mail plants. The client and/or agency will arrange for delivery and prepay all delivery expenses (including any customs brokerage fees).

All insert material must arrive at our printing plants during normal receiving hours. No deliveries will be accepted on Saturday, Sunday or statutory holidays.

Insert shipments do not require prior appointments for delivery except for the Vancouver Plant. Please call 604-527-9243 to make an appointment. You must provide the client name, insert title and run date. The shipment must be properly labelled and must arrive at our plants in good condition; otherwise the shipment will not be unloaded.

Any insert that is received past deadline or is improperly labelled or is received in a damaged condition will be cancelled and/or rescheduled. Any expenses incurred by The Globe and Mail will be charged to the client.

Any insert material remaining after the print run will be recycled immediately after the completion of insertion unless written arrangements are made at least five business days prior to the insertion date with The Globe and Mail. Pick-up must be completed within two business days of the insertion date.

Any cancelled inserts not removed from the plants by the client within three days of cancellation will be recycled unless prior written arrangements for re-scheduling or removal by the client are made. Late cancellation charges up to 50% of the original order will apply to all inserts cancelled less than five days prior to insertion.

SPOILAGE**MECHANICAL INSERTS (MON-THU ONLY)**

Please supply an additional 2% for spoilage.

SHIPMENT LABELS

All inserts must be labelled with the following information:

- The Globe and Mail
- Client name and Insert title
- Date of insertion
- Total number of inserts shipped
- Total number of copies per bundle
- Number of inserts on each pallet
- Total number of pallets shipped
- Name, address and phone number of printer/shipper
- Name and phone number of client's customs broker (for cross-border shipments)

Note: All cross-border shipments should also include a description of goods (printed matter) and the value of the material on the waybill for quicker customs clearance. The client should notify their customs broker prior to shipment.

Please contact Michael Anderson at 416-585-5455, mwanderson@globeandmail.com or Fatima Wilson at 416-585-3325, fwilson@globeandmail.com regarding all production inquiries, cancellations or delivery delays www.globelink.ca/inserts.

PLANT ADDRESSES AND RECEIVING HOURS**Toronto Plant**

The Globe and Mail
c/o TC Transcontinental Vaughan
100B Royal Group Crescent
Doors 2-6
Vaughan, Ontario L4H 1X9
7 AM - 4 PM Monday - Friday

Estevan Plant

The Globe and Mail
c/o Estevan Web
1 Breeze Street, Hwy 39 West
South East Bay Door
Estevan, Saskatchewan S4A 2L7
8 AM - 6 PM Monday - Friday

Montreal Plant

The Globe and Mail
c/o TC Transcontinental Transmag
10807 Rue Mirabeau
Anjou, Quebec H1J 1T7
7 AM - 5 PM Monday - Friday

Calgary Plant

The Globe and Mail
c/o TC Transcontinental Calgary
5516 Fifth Street SE
Calgary, Alberta T2H 1L3
8 AM - 4:30 PM Monday - Friday

Vancouver Plant

The Globe and Mail
c/o TC Transcontinental Vancouver
725 Hampstead Close
Annacis Island
Delta, B.C. V3M 6R6
7 AM - 5 PM Monday - Friday
604-527-9243*

***Delivery appointment required**



BUNDLING CHART

HAND-INSERTS (2 - 24 pages) - cross-tied in bundles of 50*

POST-IT NOTES - supplied in pads of 50

HAND-INSERTS (over 24 pages) - cross-tied in bundles of 20*

SLEEVES - banded in bundles of 100

NOTE: Maximum bundle weight: 25 lbs. * Plastic cross-ties only – no rubber bands or cardboard boxes

- Corner boards should be used to prevent damage to the outside edges of the loaded skid. Life containers are acceptable.
- All inserts must be stacked on pallets in consistent lifts, be well-jogged, and all pallets should be securely banded and plastic stretch-wrapped or shrink-wrapped.
- Stacked inserts should cover pallet and never protrude beyond the edge of the pallet.
- Product must be stacked on solid base, **48"x40" (industry standard)** non-returnable, four-way entry pallets in good condition. Two-way pallets may be used as needed to accommodate automated compression banding and wrapping equipment.
- A substantial protective cover should be placed on the pallet before stacking and another cover placed before topping.
- Cardboard sheets or binder sheets, not waxed or coated, should be placed between layers.
- Folded edges should be turned towards the inside of the load whenever possible.
- Pallet tops must be wood or a sturdy equivalent the same size as the pallet base.
- Banding should be tight without pulling down and bending the top turn or pulling loose the pallet flooring. A minimum of four bands to be on each load.
- Clearance from floor to bottom of pallet base is a minimum of 4 1/2" to maximum of 8".
- Maximum allowable loaded pallet height is 4' measured from floor to pallet top.
- Maximum acceptable weight per loaded pallet is 2,500 pounds.
- Shipment labels and a sample of the insert must be displayed on two adjacent sides of each pallet.
- Pallets must be loaded on the truck so that the pallet tag faces the fork lift operator. Pallets must be loaded on trucks for ease of unloading. Do not "double deck".

Please contact **Michael Anderson at 416-585-5455, mwanderson@globeandmail.com** or **Fatima Wilson at 416-585-3325, fwilson@globeandmail.com** regarding all production inquiries, cancellations or delivery delays **www.globelink.ca/inserts**.



1) In these terms and conditions, "Publisher" means The Globe and Mail Inc. and "Advertiser" means the persons, companies, agencies or other entities placing advertising with Publisher.

2) These terms and conditions apply in respect of all advertising, including print, digital, insertions, or otherwise, and are deemed to be incorporated into every advertising agreement (also known as an insertion order) between Publisher and Advertiser. These terms and conditions shall apply in case of discrepancy between the terms and conditions and any advertising agreement. Placing an advertisement with Publisher constitutes the acceptance by Advertiser of these terms and conditions.

3) Advertiser hereby represents and warrants to Publisher that it has the full right and authority to enter into this agreement, and all advertisements provided to Publisher by Advertiser for publication under this agreement do not infringe copyright, trade-mark, personality, proprietary or any other third-party rights. By way of example but not limitation, this warranty by Advertiser covers all copyright related to any fonts used in any advertisement text, design and layout.

4) All advertisements are subject to review and approval by Publisher, including but not limited to with respect to content, subject matter, insertion date, placement, position, matter, space and location, in accordance with standards acceptable to Publisher. No contingency orders will be accepted by Publisher.

5) Publisher may require Advertiser to revise, edit or otherwise modify the advertisement, including but not limited to adding the word "advertisement", "an information supplement", or a similar title over, under or alongside any advertisement.

6) Publisher reserves the right to reject, revise, cancel, omit, discontinue, change position of, decline to publish or suspend any advertisement for any reason whatsoever in its sole discretion, without liability or penalty to Publisher, and without notice to the Advertiser. By way of example, but not limitation, Publisher in its sole discretion may:

i) Decline to publish any advertorial advertising that is not labeled ADVERTISEMENT, includes a by-line, or is designed to resemble the editorial pages of the publication – including the use of matching fonts or brand colours;

ii) Decline to publish any advertisement that advocates a political, social or other point of view that is not provided to Publisher at least 48 hours prior to publication deadline;

iii) Decline to publish any advertisement that promotes a contest that fails to comply with laws and regulations relating to contests; or

iv) Require Advertiser to upgrade, cancel or otherwise modify their insertion order within a publication, such as when Advertiser has requested an inside front cover double page spread and another advertiser requests an inside front cover gatefold position, Advertiser will be given the opportunity to upgrade its position to inside front cover gatefold position, move its double page spread to the next available double page spread, or cancel its order.

7) Advertiser is solely responsible for ensuring the advertisement (e.g. copy and materials) are received by Publisher by the deadlines specified to Advertiser. Publisher is not responsible for reviewing advertisements for quality or accuracy. Publisher is not responsible for returning advertising material to Advertiser and is not liable for the loss of advertising materials. All advertising materials produced by Publisher will remain the property of Publisher.

8) All advertising will be measured from cut-off rule to cut-off rule in respect of space, location and publication. Printing of key numbers is not guaranteed. Press limitations or other causes may

require Publisher to limit the availability of space, location, size, colour, insertion date, or other specifics of advertisement orders from time to time. Publisher reserves the right to inspect all replies solicited through any Publisher product via box numbers.

9) Publisher may at its discretion, provide electronic invoices (i.e. e-billing) and electronic images of the applicable published advertisement pages (i.e. e-tearsheets) rather than printed invoices and tearsheets to Advertiser. Failure to receive a (e-) tearsheet is not a valid reason for withholding payment

10) Publisher may, at its sole option, elect to invoice and collect payment directly from any client(s) of an Advertiser who is an advertising agency and Advertiser agrees to use its best efforts to assist in such collection. Payments shall be made to the Finance Department, Cash Office, 351 King St East, Toronto, ON M5A 0N1. All rates are stated in Canadian currency. Payment in foreign currency must be made at the prevailing Canadian rate of exchange. Any late payment shall bear interest rate allowed by law, accruing as of the first day Advertiser received notice from Publisher that such payment became overdue.

11) In the absence of an agreement to the contrary, including a credit arrangement, payment in respect of an advertisement order is due in advance of publication. The Publisher will require prepayment from any Advertiser that is an advertising agency that indicates that their client(s) is responsible for payment of the advertisement or if any kind of payment disclaimer is used or implied on advertising agency insertion orders.

12) All advertising orders are subject to credit approval by any means deemed by Publisher. The reasonable withholding of credit approval by Publisher shall not relieve Advertiser from carrying out its obligations under this agreement. On advertising where credit terms are granted by Publisher's Finance department, accounts are due and payable within 30 days from invoice date. Failure to comply with credit terms may result in the curtailing or withdrawal of credit privileges.

13) An advertising order not corresponding with the then current rates will be regarded as a clerical error and all advertising will be published at the current rates. For contract advertisers, yearly billings will be adjusted at the end of the year to reflect the actual volume and/or value run and where applicable, to reflect a lower or higher rate resulting in either a rebate or a short rate.

14) Agency commissions: A 15% commission will be allowed only to accredited agencies. No agency commission will be allowed on local, retail or classified advertising.

15) A cancellation charge of 50 per cent will be incurred by Advertiser for advertisements cancelled by Advertiser after the deadline specified to Advertiser. No cancellations will be accepted after press date.

16) Publisher reserves the right to increase advertising rates at any time and all contracts are accepted subject to this reservation. Advertiser reserves the right to cancel contract on written notice within 15 days after higher rates are made effective by Publisher. Furthermore, should publication of Publisher's products (including any edition of The Globe and Mail newspaper or any of Publisher's other print, electronic or other platforms) be modified, the rate quoted herein and the amount of space contracted for as well as the size, location, insertion date or volume of advertisement shall all be subject to revision or regulation by Publisher at any time without notice.

17) These terms and conditions set out the full extent of Publisher's obligations and liabilities to Advertiser with respect to the publishing of any advertisement. Publisher accepts no responsibility for loss of profit or any type of damages whatsoever. Publisher

accepts no liability in respect to loss or damage alleged to arise through either failure or delay in furnishing replies to Advertiser from box numbers, however caused, by negligence or otherwise. Publisher expressly disclaims all warranties, representations and conditions of any kind, express or implied, by statute or otherwise, to the fullest extent permitted by law. All of Publisher's limitations of liability and disclaimers set out in these terms and conditions shall apply notwithstanding the breach of a fundamental term or condition or a fundamental breach.

18) Advertiser agrees that Publisher's liability will be limited as follows, whether such error is due to the negligence of Publisher's employees, agents or otherwise: (i) for errors or omissions in the reproduction or delivery of an advertisement, to the amount paid for the space actually occupied by that portion of the advertisement in which the error occurred; and (ii) for non-insertion of an advertisement, to the amount actually received by Publisher for the insertion of that advertisement.

19) Advertiser will indemnify and hold harmless Publisher from and against any and all liabilities, losses, costs (including without limitation, legal fees and expenses), damages, judgments, claims, demands, suits, actions or other proceedings in any manner based upon, associated with or attributed to the publishing of an advertisement, including, without limitation, any claims related to misleading or prohibited advertising, or any material in the advertisement that is defamatory, libelous, obscene, infringes the copyright or other intellectual property, personality, privacy or any other third-party rights, or that would constitute hate speech pursuant to the laws of Canada or any province. This indemnity applies to all advertisements published, even if produced by Publisher, on behalf of Advertiser.

20) Advertiser shall effect and maintain, at its sole cost and expense, comprehensive general liability insurance to fulfill its obligations in this agreement, including against claims for libel, slander, defamation, breach of intellectual property, breach of confidentiality, privacy and personality rights, in an amount not less than \$2,000,000 CDN per occurrence, with a reputable insurer for the term of this agreement and will provide Publisher with evidence of such insurance upon written request).

21) Any advertising published by Publisher in Publisher's products (including The Globe and Mail newspaper or any of Publisher's other print, electronic or other platforms) may, at Publisher's discretion, be published, displayed, retained and archived by Publisher and anyone authorized by Publisher (including by any form of licence), as many times as Publisher and those authorized by Publisher wish, in and on any product, media and archive (including anything in print, electronic and other form).

22) Advertiser agrees to Publisher's privacy policy, which can be accessed at www.globeandmail.com/privacy. Advertiser agrees to comply with all applicable privacy laws and regulations in respect of any information about an identifiable individual, including any information that may tend to identify an individual through internet tracking or linking ("personal information"), collected, received or used by Advertiser in connection with any advertisement, and agree that personal information will not be used for any purpose without the prior express consent of the individual.

23) If either party hereto waives or modifies any term or condition of this agreement, such action will not void, waive or change any other term or condition, nor will the waiver by one party of any default hereunder by the other constitute the present or future waiver of any other default hereunder. This agreement will be governed and construed in accordance with the laws of the Province of Ontario and the laws of Canada applicable therein.