



**КРАСНОЯРСКИЙ
КРАЙ**

МИНИСТЕРСТВО
СПОРТА



26-30 мая 2021
Красноярск

XXXII

**Международный турнир
по вольной борьбе среди
мужчин и женщин серии**

**ГРАН-ПРИ
ИВАН ЯРЫГИН**

Дворец спорта им. И. Ярыгина

Сборник итоговых материалов



Grand Prix Ivan Yariguin International tournament Senior (FS&WW)



27-30 мая 2021

Yariguin Sports Palace

Russia • Krasnoyarsk

№	Licence	Pays Country	Noname - First name	Responsibility - Должность
1	МК	Минск (Беларусь)	SIULZHYN Valiantsin	UWW delegate
2	МК/ССВК	Санкт-Петербург	Коваленко Сергей Владимирович	Head of referees - главный судья
3	МК/ССВК	Красноярск	Чебодаева Татьяна Васильевна	Chief secretary - главный секретарь
4	МК/ССВК	Каспийск	Гадисов Тимур Асадович	mat chairman - руководитель ковра
5	МК/ССВК	Каспийск	Гасанов Гусейн Абдуллаевич	mat chairman - руководитель ковра
6	МК/ССВК	Москва	Григорьев Владимир Александрович	mat chairman - руководитель ковра
7	МК/ССВК	Владикавказ	Гульчеев Валерий Апонович	mat chairman - руководитель ковра
8	МК/ССВК	Москва	Чуенко Александр Николаевич	mat chairman - руководитель ковра
9	МК/ССВК	Уфа	Юльtimiров Борис Александрович	mat chairman - руководитель ковра
10	МК/ССВК	Москва	Мошков Станислав Владимирович	mat chairman - руководитель ковра
11	МК/ССВК	Челябинск	Нечаев Роман Игоревич	mat chairman - руководитель ковра
12	МК/ССВК	Улан-Удэ	Павлов Евгений Артурович	mat chairman - руководитель ковра
13	МК/ССВК	Воркута	Павлов Виталий Анатольевич	referee - арбитр
14	МК/ССВК	Кемерово	Секлецов Владимир Николаевич	referee - арбитр
15	МК/ССВК	Красноярск	Ситников Сергей Васильевич	referee - арбитр
16	МК/ССВК	Пятигорск	Карацев Алихан Сулейманович	referee - арбитр
17	МК/ССВК	Чита	Базаров Элбык Галсанбаирович	referee - арбитр
18	МК/ССВК	Улан-Удэ	Балдаев Дмитрий Кириллович	referee - арбитр
19	МК/ССВК	Назрань	Баркенхоев Исрапил Алаудинович	referee - арбитр
20	МК/ССВК	Томск	Бердников Евгений Аркадьевич	referee - арбитр
21	МК/ССВК	Владивосток	Даричев Юрий Владимирович	referee - арбитр
22	МК/ССВК	Назарово	Донзаланко Александр Владимирович	referee - арбитр
23	МК/ССВК	Москва	Жаринов Андрей Григорьевич	referee - арбитр
24	МК/ССВК	Чебоксары	Жирнова Елена Александровна	referee - арбитр
25	МК/ССВК	Тында	Чешкин Петр Павлович	referee - арбитр
26	МК/ССВК	Красноярск	Сучков Александр Васильевич	referee - арбитр
27	МК/ССВК	Владикавказ	Макоев Ахсарбек Борисович	referee - арбитр
28	МК/ССВК	Благовещенск	Мухамединов Руслан Уахитович	referee - арбитр
29	МК/ССВК	Владикавказ	Наниев Зураб Муратович	referee - арбитр
30	МК/ССВК	Саха (Якутия)	Николаев Николай Дмитриевич	referee - арбитр
31	МК/ССВК	Кызыл	Ооржак Мерген Чылбааевич	referee - арбитр
32	МК/СС1К	Красноярск	Курдюков Андрей Валентинович	referee - арбитр
33	МК/СС1К	Иркутск	Орбодоев Михаил Олегович	referee - арбитр
34	МК/СС1К	Иркутск	Осодоев Кирилл Георгиевич	referee - арбитр
35	МК/СС1К	Кызыл	Санаа Менги Михайлович	referee - арбитр
36	МК	Монголия	GAADAN Amarkhuu	referee - арбитр
37	МК	Монголия	GANBOLD Khaokhuu	referee - арбитр
38	МК	Казахстан	KISTAUBAYEV Yerzhan	referee - арбитр
39	МК	Пятигорск	Гасанов Ришад Ризван Оглы	referee - арбитр
40	ССВК	Абакан	Карамчакова Татьяна Алексеевна	referee - арбитр
41	ССВК	Назарово	Козлова Галина Ивановна	referee - арбитр
42	СС1К	Красноярск	Коптев Андрей Иванович	referee - арбитр
43	СС1К	Краснодар	Ващенко Марина Борисовна	referee - арбитр
44	СС1К	Улан-Удэ	Цыбикова Людмила Цыреновна	referee - арбитр
45	ССВК	Красноярск	Райков Виктор Кириллович	referee - арбитр
46	ССВК	Красноярск	Ронжина Наталья Васильевна	referee - арбитр

Главный судья, МК/ССВК

С. В. Коваленко, г. Санкт-Петербург

Главный секретарь, ССВК

Т.В. Чебодаева, г.Красноярск





Nombre d'engages par nation / Number of entries by country



XXXII Grand Prix Ivan Yarygin International tournament

27-30.05.2021



Russia, Krasnoyarsk

Pays - Country			50	53	55	57	59	62	65	68	72	76	TOTAL WW	57	61	65	70	74	79	86	92	97	125	TOTAL FS	TOTAL	
1	Belarus	BLR											0	1	1										2	2
2	Egypt	EGY										1	1												0	1
3	Greece	GRE											0										1	1	1	1
4	Kazakhstan	KAZ											0	1	1	3		1	2	1	1	2			12	12
5	Kyrgyzstan	KGZ											0						1						1	1
6	Moldova	MDA											0			1		1							2	2
7	Mongolia	MGL	2	1	2		2	1	1	1	2		12	1	1	1		2	1	1	1				8	20
8	Russia	RUS	7	6	6	3	3	4	4	4	3	3	43	18	19	23	23	19	13	14	15	12	8		164	207
9	Turkey	TUR											0			1									1	1
10	Uzbekistan	UZB											0									1			1	1
TOTAL			9	7	8	3	5	5	5	5	5	4	56	21	22	29	23	23	17	16	18	14	9	192	248	

Nombre de nations (domaines) / Number of countries (regions)

Head of referees, S. Kovalenko (IS)

Chief secretary, T. Chebodaeva



S. Kovalenko
T. Chebodaeva



WINNERS



Grand Prix Ivan Yariguin International tournament Senior (FS&WW)

WW 26-31.05.2021

Krasnoyarsk, RUS

WW

W C	Place	№	Wresler Country	Date of birth
50 kg				
50 kg	I	8	MAKHACHEVA DADASHEVA Milana RUS	20.02.1995
	II	2	CHUBANOVA Madina RUS	25.08.1997
	III	4	FEDOROVA Anzhelika RUS	05.11.1997
	III	7	CHEPSARAKOVA Valeriya RUS	31.01.1989
	V	1	TSYBENOVA Khanda RUS	26.07.2000
	V	6	DOLGORJAV Otgonjargal MGL	02.10.2001
53 kg				
53 kg	I	4	SKIRENKO Aleksandra RUS	06.05.1998
	II	1	KHVOSTOVA Daria RUS	26.10.1999
	III	2	BATKHUYAG Khulan MGL	20.11.1999
	IV	7	KARYMOVA Leila RUS	03.07.1998
	V	3	UKHEEVA Aiana RUS	19.07.2001
	VI	6	SULTANBEKOVA Aigerim RUS	20.10.1999
55 kg				
55 kg	I	2	VAULINA Viktoriia RUS	30.05.1998
	II	7	NAZAROVA Sevil RUS	05.06.1998
	III	3	NOVIK Tatiana RUS	07.09.1997
	III	5	ISAKOVA Ekaterina RUS	13.10.1998
	V	1	ABZALOVA Nailia RUS	18.11.1993
	V	8	BAYARAA Khaliunaa MGL	13.05.1999
57 kg				
57 kg	I	2	TSYREMPILOVA TCYRENOVA Zhargalma RUS	09.06.1989
	II	1	MURTUZALIEVA Khadizhat RUS	15.12.1989
	III	3	KONDRATEVA Kristina RUS	25.07.2000
59 kg				
59 kg	I	3	BAATARJAV Shoovdor MGL	20.11.1990
	II	5	ERKHEMBAYAR Davaachimeg MGL	22.03.1993
	III	4	NITSENKO Aleksandra RUS	03.03.1998
	IV	1	IAKOVLEVA Anastasiia RUS	23.02.1997
	V	2	ARTYSHKO Iuliia RUS	29.11.2001
62 kg				
62 kg	I	2	PAROKHINA Anastasiia RUS	23.11.2000
	II	3	TUKURENOVA Uliana RUS	23.03.1994
	III	4	KAZYMOVA Alina RUS	06.04.1998
	IV	1	ENKHBAT Gantuya MGL	25.05.1995
	V	5	SHCHERBAKOVA Anna RUS	20.09.1988
65 kg				
65 kg	I	5	ZORIGT Bolortungalag MGL	06.05.1992
	II	3	KUDAEVA SALIKHOVA Dinara RUS	21.04.1998
	III	1	KUZNETSOVA Mariia RUS	17.12.1997
	IV	4	APEVALOVA Evgeniia RUS	11.07.2000
	V	2	KLIMOVA Alina RUS	08.05.2001
68 kg				
68 kg	I	2	FEDOSEEVA Natalia RUS	13.05.1991
	II	5	OCHIRBAT Nasanburmaa MGL	14.04.1989
	III	3	SMOLIAK Tatiana RUS	15.10.1997
	IV	4	PARFIANOVICH Vusala RUS	30.06.2000
	V	1	KHRIPKOVA Albina RUS	22.06.2000
72 kg				
72 kg	I	3	BURAKOVA Kseniia RUS	25.03.1992
	II	2	STARODUBTSEVA Alena RUS	14.03.1985
	III	4	ENKH AMAR Davaanasan MGL	06.04.1998
	IV	5	MUTALIMOVA Leyla RUS	11.12.1998
76 kg				
76 kg	I	3	HAMZA Samar Amer Ibrahim EGY	04.04.1995
	II	1	BUKINA Ekaterina RUS	05.05.1987
	III	2	SHUMOVA Kristina RUS	24.07.1997

Head of referees, S. Kovalenko (IS)

Chief secretary, T. Chebodaeva



Скоп
Сы



Grand Prix Ivan Yariguin International tournament Senior (FS&WW)

26-31.05.2021

Krasnoyarsk, RUS

Yariguin Sports Palace

WEIGHT CLASS 50 KG

Qualification

Table with columns: No, Wrestler, COUNTRY, Birth date, and other details for 9 participants.

Qualification bracket diagram showing match results for 1|4-F and 1|2-F categories.

WW

F-1

WW F-1 bracket diagram showing match results for participants 02, 08, and 09.

Finalist Results

Table listing medalists: I Gold (MAKHACHEVA DADASHEVA Milana RUS), II Silver (CHUBANOVA Madina RUS), III Bronze (FEDOROVA Anzhelika RUS, CHEPSARAKOVA Valeriya RUS), V (TSYBENOVA Khanda RUS, DOLGORJAV Otgonjargal MGL, KARAMZINA Aleksandra RUS, BATBAATAR Enkhzul MGL, SANZHIEVA Darima Manievna RUS).

Repechage

Wrestlers who lost against the finalist of the upper part of bracket

Repechage bracket for the upper part of the bracket, showing a match between 1 and 4.

Wrestlers who lost against the finalist of the bottom part of bracket

Repechage bracket for the bottom part of the bracket, showing matches between 9 and 7.

Bronze Medal

Head of referees, S. Kovalenko (IS)

Handwritten signature of S. Kovalenko



Chief secretary, T. Chebodaeva

Handwritten signature of T. Chebodaeva



Feuille de competition / Competition Sheet

Grand Prix Ivan Yariguin International tournament Senior (FS&WW)



26-31.05.2021

Krasnoyarsk, RUS

WEIGHT CLASS

53 kg

WW

Group	№	Wrestler	Country	Date of birth	1 Round				2 Round				3 Round				PP	PT1	PT2	Place in a group	1/2 F				F-I-III				Place
					№	PP	PT1	PT2	№	PP	PT1	PT2	№	PP	PT1	PT2					№	PP	PT1	PT2	№	PP	PT1	PT2	
A	1	KHVOSTOVA Daria	RUS	26.10.1999	3	5	6	1	5	3	7	0	7	0	0	8	8	13	9	2	2	3	13	5	4	1	6	10	II
	3	UKHEEVA Aiana	RUS	19.07.2001	1	0	1	6	7	0	0	10	5	3	4	0	3	5	16	3									5
	5	LITVINIUK Viktoriia	RUS	25.05.1999	7	0	0	10	1	0	0	7	3	0	0	4	0	0	21	4									7
	7	KARYMOVA Leila	RUS	03.07.1998	5	4	10	0	3	5	10	0	1	3	8	0	12	28	0	1	4	1	2	6	2	1	2	5	4
B	2	BATKHUYAG Khulan	MGL	20.11.1999	4	4	13	3	6	3	10	6				7	23	9	1	1	1	5	13	7	3	5	2	III	
	4	SKIRENKO Aleksandra	RUS	06.05.1998	2	1	3	13				6	5	6	4	6	9	17	3	7	3	6	2	1	3	10	6	I	
	6	SULTANBEKOVA Aigerim	RUS	20.10.1999					2	1	6	10	4	0	4	6	1	10	16	2								6	

Head of referees, S. Kovalenko (IS)

Chief secretary, T. Chebodaeva



Скоп
Дж



Grand Prix Ivan Yariguin International tournament Senior (FS&WW)



26-31.05.2021

Krasnoyarsk, RUS

Yariguin Sports Palace

WEIGHT CLASS **55** KG

WW

1|4-F

PP Pt	No	Wrestler	COUNTRY	DATE OF BIRTH
0 0	01	ABZALOVA Nailia	RUS	18.11.1993
3 7	02	VAULINA Viktoriia	RUS	30.05.1998
3 5	03	NOVIK Tatiana	RUS	07.09.1997
1 2	04	BATTSOOJ Maral	MGL	04.06.2003
5 4	05	ISAKOVA Ekaterina	RUS	13.10.1998
0 0	06	SIMONYAN Marina	RUS	10.10.1996
5 4	07	NAZAROVA Sevil	RUS	05.06.1998
0 4	08	BAYARAA Khaliunaa	MGL	13.05.1999

1|2-F

F-1

3	02	P1	P2
4		1	3
0	03	P1	P2
0		0	0
0	05	P1	P2
1		1	0
5	07	P1	P2
9		5	4

5 4	02	VAULINA Viktoriia	RUS	P1	P2
				4	0
-	02	VAULINA Viktoriia	RUS	Gold Medal	
0 2	07	NAZAROVA Sevil	RUS	P1	P2
				2	0

Repechage

Wrestlers who lost against the finalist of the upper part of bracket

0 0	1	ABZALOVA Nailia	RUS	P1
3 8	3	NOVIK Tatiana	RUS	P1
				3

Bronze Medal

Wrestlers who lost again the finalist of the bottom part of bracket

0 0	8	BAYARAA Khaliunaa	MGL	P1
3 5	5	ISAKOVA Ekaterina	RUS	P1
				5

Bronze Medal

Cl No Wrestler COUNTRY

I		VAULINA Viktoriia	RUS
II		NAZAROVA Sevil	RUS
III		NOVIK Tatiana	RUS
III		ISAKOVA Ekaterina	RUS
V		1	ABZALOVA Nailia
V		8	BAYARAA Khaliunaa MGL
7		4	BATTSOOJ Maral MGL
8		6	SIMONYAN Marina



Head of referees, S. Kovalenko (IS)

S. Kovalenko

Chief secretary, T. Chebodaeva

T. Chebodaeva



Feuille de competition / Competition Sheet

Grand Prix Ivan Yariguin International tournament Senior (FS&WW)



26-31.05.2021

Krasnoyarsk, RUS

RESULTS

WEIGHT CLASS

57 KG

WW

Draw #	Last name, first name	D.O.B.	National rank	Round 1				Round 2				Round 3				Total points (PP)	TP won (PT1)	TP lost (PT2)	Rank
				№	PP	PT1	PT2	№	PP	PT1	PT2	№	PP	PT1	PT2				
1	MURTUZALIEVA Khadizhat RUS	15.12.1989	MC	2	0	0	3	3	4	11	0				4	11	3	II	
2	TSYREMPILOVA TSYRENOVA Zhargalma RUS	09.06.1989		1	3	3	0					3	3	9	0	6	12	0	I
3	KONDRATEVA Kristina RUS	25.07.2000						1	0	0	11	2	0	0	9	0	0	20	III

Head of referees, S. Kovalenko (IS)

Chief secretary, T. Chebodaeva



Handwritten signatures in blue ink.



Grand Prix Ivan Yariguin International tournament Senior (FS&WW)



26-31.05.2021

Krasnoyarsk, *RUS*

RESULTS

WEIGHT CLASS

59 KG

WW

Draw #	Last name, first name	D.O.B.	National rank	Round 1				Round 2				Round 3				Round 4				Round 5				Total points (PP)	TP won (PT1)	TP lost (PT2)	Rank
				№	PP	PT1	PT2	№	PP	PT1	PT2	№	PP	PT1	PT2	№	PP	PT1	PT2	№	PP	PT1	PT2				
1	IAKOVLEVA Anastasiia <i>RUS</i>	23.02.1997		2	3	8	3	5	3	8	6	4	0	0	6	3	0	0	5		6	16	20	4			
2	ARTYSHKO Iuliia <i>RUS</i>	29.11.2001	KMC	1	1	3	8	3	0	0	11	5	0	0	7		4	1	1	2	2	4	28	5			
3	BAATARJAV Shoovdor <i>MGL</i>	20.11.1990		4	4	10	0	2	4	11	0		1	3	5	0	5	3	8	6	14	34	6	I			
4	NITSENKO Aleksandra <i>RUS</i>	03.03.1998	MCMK	3	0	0	10		1	3	6	0	5	1	3	4	2	3	2	1	7	11	15	III			
5	ERKHEMBAYAR <i>Davaachimeg MGL</i>	22.03.1993			1	1	6	8	2	3	7	0	4	3	4	3	3	1	6	8	8	23	19	II			

Head of referees, S. Kovalenko (IS)

Chief secretary, T. Chebodaeva



S. Kovalenko
T. Chebodaeva



Feuille de compétition / Competition Sheet

Grand Prix Ivan Yariguin International tournament Senior (FS&WW)



26-31.05.2021

Krasnoyarsk, RUS

RESULTS

WEIGHT CLASS

62 KG

WW

Draw #	Last name, first name	D.O.B.	National rank	Round 1				Round 2				Round 3				Round 4				Round 5				Total points (PP)	TP won (PT1)	TP lost (PT2)	Rank
				№	PP	PT1	PT2	№	PP	PT1	PT2	№	PP	PT1	PT2	№	PP	PT1	PT2	№	PP	PT1	PT2				
1	ENKHBAT Gantuya MGL	25.05.1995		2	1	1	3	5	5			4	3	8	5	3	0	5	4		9	14	12	4			
2	PAROKHINA Anastasiia RUS	23.11.2000		1	3	3	1	3	3	2	2	5	5				4	3	2	2	14	7	5	I			
3	TUKURENOVA Uliana RUS	23.03.1994		4	1	5	7	2	1	2	2			1	5	4	5	5	5		12	11	14	II			
4	KAZYMOVA Alina RUS	06.04.1998		3	3	7	5					1	1	5	8	5	5		2	1	2	2	10	14	15	III	
5	SHCHERBAKOVA Anna RUS	20.09.1988	MC					1	0	0	0	2	0		4	0		3	0		0	0	0	5			

Head of referees, S. Kovalenko (IS)

Chief secretary, T. Chebodaeva



Смог
Дж



Feuille de competition / Competition Sheet

Grand Prix Ivan Yariguin International tournament Senior (FS&WW)



26-31.05.2021

Krasnoyarsk, RUS

RESULTS

WEIGHT CLASS

65 KG

WW

Draw #	Last name, first name	D.O.B.	National rank	Round 1				Round 2				Round 3				Round 4				Round 5				Total points (PP)	TP won (PT1)	TP lost (PT2)	Rank	
				№	PP	PT1	PT2	№	PP	PT1	PT2	№	PP	PT1	PT2	№	PP	PT1	PT2	№	PP	PT1	PT2					
1	KUZNETSOVA Mariia RUS	17.12.1997	МСМК	2	4	10	0	5	0	2	2	4	4	10	0	3	1	2	2					9	24	4	III	
2	KLIMOVA Alina RUS	08.05.2001	КМС	1	0	0	10	3	0	0	10	5	0	0	4						4	1	2	4	1	2	28	5
3	KUDAEVA SALIKHOVA Dinara RUS	21.04.1998	МС	4	4	10	0	2	4	10	0				1	3	2	2	5	0	2	12	11	24	14	II		
4	APEVALOVA Evgeniia RUS	11.07.2000	КМС	3	0	0	10					1	0	0	10	5	0	0	10	2	3	4	2	3	4	32	4	
5	ZORIGT Bolortungalag MGL	06.05.1992	0					1	5	2	2	2	5	4	0	4	4	10	0	3	5	12	2	19	28	4	I	

Head of referees, S. Kovalenko (IS)

Chief secretary, T. Chebodaeva



Скоп
ТШ



Feuille de competition / Competition Sheet

Grand Prix Ivan Yariguin International tournament Senior (FS&WW)



26-31.05.2021

Krasnoyarsk, RUS

RESULTS

WEIGHT CLASS

68 KG

WW

Draw #	Last name, first name	D.O.B.	National rank	Round 1			Round 2			Round 3			Round 4			Round 5			Total points (PP)	TP won (PT1)	TP lost (PT2)	Rank	
				Nb	PP	PT1	PT2	Nb	PP	PT1	PT2	Nb	PP	PT1	PT2	Nb	PP	PT1					PT2
1	KHRIPKOVA Albina RUS	22.06.2000	KMC	2	1	2	3	5	0	2	15	4	3	4	0	3	1	5	7	5	13	25	5
2	FEDOSEEVA Natalia RUS	13.05.1991	MC	1	3	3	2	3	1	2	4	5	3	5	2	4	3	2	0	10	12	8	I
3	SMOLIAK Tatiana RUS	15.10.1997		4	1	2	7	2	3	4	2	1	3	7	5	5	0	0	10	7	13	24	III
4	PARFIANOVICH Vusala RUS	30.06.2000	MC	3	3	7	2	1	0	0	4	5	3	5	4	2	0	0	2	6	12	12	4
5	OCHIRBAT Nasanburmaa MGL	14.04.1989		1	5	15	2	2	1	2	5	4	1	4	5	3	4	10	0	11	31	12	II

Head of referees, S. Kovalenko (IS)

Chief secretary, T. Chebodaeva



Скоф
ТШ



Feuille de competition / Competition Sheet

Grand Prix Ivan Yariguin International tournament Senior (FS&WW)



26-31.05.2021

Krasnoyarsk, RUS

RESULTS

WEIGHT CLASS 72 KG

Draw #	Last name, first name	D.O.B.	National rank	Round 1				Round 2				Round 3				Round 4				Round 5				Total points (PP)	TP won (PT1)	TP lost (PT2)	Rank
				№	PP	PT1	PT2	№	PP	PT1	PT2	№	PP	PT1	PT2	№	PP	PT1	PT2	№	PP	PT1	PT2				
1	DORJSUREN Tsogzolmaa MGL	20.08.2001		2	1	1	11	5	4	12	0	4	0	0	10	3	0	1	2			5	14	23	FFT		
2	STARODUBTSEVA Alena RUS	14.03.1985	MCMK	1	4	11	1	3	1	2	4	5	4	12	2					4	5	7	1	14	32	8	II
3	BURAKOVA Kseniia RUS	25.03.1992	MC	4	3	6	4	2	3	4	2				1	5	2	1	5	4	10	0	15	22	7	I	
4	ENKH AMAR Davaanasan MGL	06.04.1998		3	1	4	6					1	4	10	0	5	5	12	0	2	0	1	7	10	27	13	III
5	MUTALIMOVA Leyla RUS	11.12.1998	KMC					1	0	0	12	2	1	2	12	4	0	0	12	3	0	0	#	1	2	46	4

Head of referees, S. Kovalenko (IS)

Chief secretary, T. Chebodaeva



S. Kovalenko

T. Chebodaeva



Feuille de compétition / Competition Sheet

Grand Prix Ivan Yariguin International tournament Senior (FS&WW)



26-31.05.2021

Krasnoyarsk, RUS

RESULTS

WEIGHT CLASS

76 KG

WW

Draw #	Last name, first name	D.O.B.	National rank	Round 1				Round 2				Round 3				Total points (PP)	TP won (PT1)	TP lost (PT2)	Rank
				N _g	PP	PT1	PT2	N _g	PP	PT1	PT2	N _g	PP	PT1	PT2				
1	BUKINA Ekaterina RUS	05.05.1987	3MC	2	3	5	0	3	0	0	9	4	5		8	5	9	II	
2	SHUMOVA Kristina RUS	24.07.1997	MC	1	0	0	5	4	5			3	1	5	7	6	5	12	III
3	HAMZA Samar Amer Ibrahim EGY	04.04.1995		4	5	0	0	1	5	9	0	2	3	7	5	13	16	5	I
4	TALISMANOVA Rita RUS	15.01.2000	KMC	3	0	0	0	2	0			1	0		0	0	0		FFT

Head of referees, S. Kovalenko (IS)

Chief secretary, T. Chebodaeva



WINNERS

Grand Prix Ivan Yariguin International tournament Senior (FS&WW)



FS 26-31.05.2021

FS

Krasnoyarsk, RUS

Weighth	Place	No	Wrestler	COUNTRY	Date of bith
57kr					
57kr	I	2	TSIUTRYN Aryan	BLR	23.11.1994
	II	17	MEKHTIKHANOV Musa	RUS	16.10.1999
	III	1	GARMAEV Tamir	RUS	27.11.1995
	III	12	GAMZATOV Ramiz	RUS	17.07.1996
	V	5	DASHIEV Ananda	RUS	15.03.2000
	V	18	DONDUK OOL Khuresh Ool	RUS	22.11.1991
61kr					
61kr	I	21	MAGOMEDOV Abasgadzhi	RUS	15.03.1998
	II	1	KARAKHANOV Rustam	RUS	16.08.1994
	III	2	TIULIUSH Ezir	RUS	04.02.1996
	III	15	DAMDINOV Zhargal	RUS	03.08.1996
	V	8	ALEKSANDROV Nurgun	RUS	16.01.1995
	V	13	MONGUSH Kezhik Boyanovitch	RUS	14.03.1999
65kr					
65kr	I	16	KHADARTSEV Alik	RUS	10.02.2000
	II	13	SHARASTEPANOV Dasha	RUS	22.03.1993
	III	12	MONGUSH Chaiaan Buyanovitch	RUS	13.06.2000
	III	26	FERZALIEV Ramazan	RUS	19.02.1995
	V	4	GERGENOV Iulian	RUS	12.01.1993
	V	17	TAKHTAROV Dinislam	RUS	03.04.1998
70kr					
70kr	I	20	SHIRAEV Kurban	RUS	28.03.1999
	II	8	RASSADIN Viktor	RUS	07.11.1993
	III	6	KAZHAROV Rezuhan	RUS	02.09.2000
	III	19	BAEV David	RUS	07.11.1997
	V	3	GANISHOV Imam	RUS	17.06.2000
	V	12	AKHMEDOV Abdula	RUS	06.09.1997
74kr					
74kr	I	6	TAVAEV Aznaur	RUS	24.11.1998
	II	20	SUCHKOV Nikita	RUS	07.06.1996
	III	5	ABREGOV Aiub	RUS	19.07.1996
	III	13	BOGATYREV Ruslan	RUS	12.06.1996
	V	16	ELDAROV Khamzat	RUS	17.01.2002
	VI	10	ALIEV Gadzhibagomed	RUS	02.03.2002
79kr					
79kr	I	13	USMANOV Akhmed	RUS	16.09.1996
	II	2	GADZHIMAGOMEDOV Amanula	RUS	19.04.1995
	III	3	BUDAZHAPOV Arsalan	KGZ	21.05.1993
	III	10	AIDAEV Iusup Khadzhi	RUS	31.12.2001
	V	7	MAGOMAEV Magomed	RUS	11.04.2000
	V	14	SHEBZUKHOV Marik	RUS	15.06.1998
86kr					
86kr	I	13	BIIAKAEV Magomedsharif	RUS	06.08.1995
	II	6	MINKAILOV Zelimkhan	RUS	07.07.1993
	III	1	AKAEV Tazhitin Amilhanovitch	RUS	18.04.1995
	III	10	VALIEV Vladislav	RUS	25.04.1993
	V	8	NANIEV Slavik	RUS	14.02.1999
	V	14	MUSALALIEV Arsen Ali	RUS	25.05.1996
92kr					
92kr	I	6	CHERTKOEV Guram	RUS	06.11.1995
	II	10	TAPSIEV Tamerlan	RUS	07.08.1997
	III	8	SERGIN Nurgun Efimovitch	RUS	18.06.1996
	III	17	KARIMOV Zagid	RUS	04.06.2002
	V	2	DAGVADORJ Orgilokh	MGL	19.10.1999
	V	9	BAIGENZHEYEV Abdimanap	KAZ	04.12.1992
97kr					
97kr	I	12	MAGOMEDOV Magomedkhan	RUS	27.01.1998
	II	4	OVSIIANNIKOV Igor Alekseevitch	RUS	24.09.1995
	III	3	DZUGAEV Devid	RUS	05.12.1998
	III	10	GADZHIALIEV Shamil Imam	RUS	12.01.2003
	V	1	TAZHUDINOV Gadzhimagomed	RUS	13.07.1998
	V	11	TSKHAREBOV Artem	RUS	05.08.2000
125kr					
125kr	I	2	KHIZRIEV Zelimkhan	RUS	12.09.1995
	II	9	KHIZRIEV Khamzat	RUS	31.10.1996
	III	4	PASENOK Ostap	RUS	01.07.1987
	III	6	GOLOEV Vitalii	RUS	15.06.1996
	V	1	KHOSONOV Azamat	GRE	17.09.2000
	V	8	KORTIEV Shota	RUS	15.04.2001

Head of referees, S. Kovalenko (IS)

Chief secretary, T. Chebodaeva



Скоп

Скоп



Grand Prix Ivan Yariguin International tournament Senior (FS&WW)



26-31.05.2021

Krasnoyarsk, RUS

Yariguin Sports Palace

WEIGHT CLASS
Qualification

57

KG

FS

F-1

PP	Nº	Wrestler	COUNTRY	DATE OF BIRTH	PLACE OF BIRTH
0	1	GARMAEV Tamir	RUS	27.11.1995	MC
0	2	TSIUTRYN Aryan	BLR	23.11.1994	
0	3	POSTNIKOV Fedor	RUS	01.06.1996	
0	4	KARTBAY Meirambek	KAZ	14.03.1998	
0	5	DASHIEV Ananda	RUS	15.03.2000	KMC
0	6	PURVEE Dashtseren	MGL	26.06.2001	
0	7	KUZHUGET Chalai	RUS	17.12.2001	KMC
0	8	BELOLIUBSKII Aiaal	RUS	31.05.2000	
0	9	KOPYLOV Petr	RUS	24.08.1999	
0	10	CHEBODAEV Artur Sergeevitch	RUS	04.03.1999	MC
0	11	MUTALIEV Abubakar	RUS	27.10.1997	MC
3	12	GAMZATOV Ramiz	RUS	17.07.1996	MC
1	13	FEDOTOV Dulustan	RUS	07.11.1998	
0	14	UBAIDULAEV Akhmednabi	RUS	24.12.2003	KMC
5	15	CHAMZYN Amir	RUS	05.03.1999	KMC
0	16	SEDEN Kezhik	RUS	10.04.2000	KMC
4	17	MEKHTIKHANOV Musa	RUS	16.10.1999	KMC
10	18	DONDUK OOL Khuresh Ool	RUS	22.11.1991	MC
4	19	BAIANDUEV Zhargal	RUS	13.02.2002	KMC
10	20	KHUNKEROV Said	RUS	19.05.2001	KMC
0	21	IGNATEV Darkhan	RUS	04.02.2001	

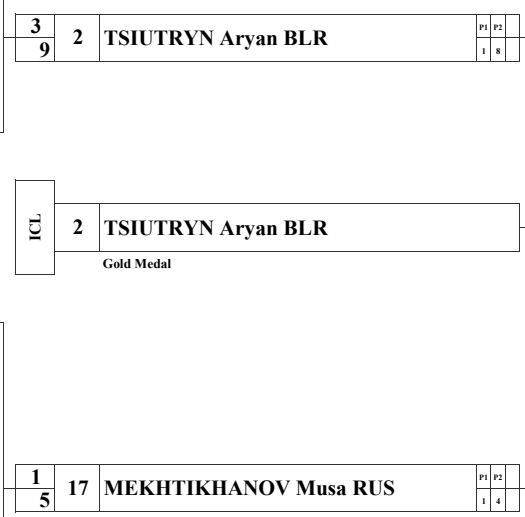
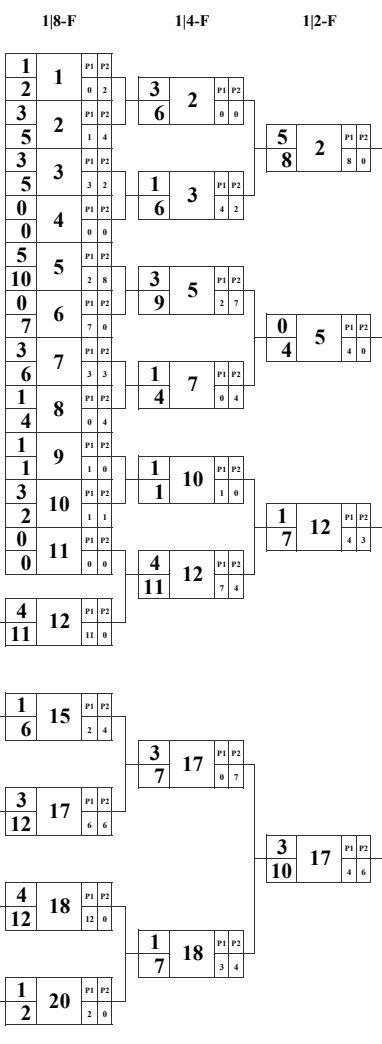

CL	Nº	Wrestler	COUNTRY
1	2	TSIUTRYN Aryan	BLR
1	17	MEKHTIKHANOV Musa	RUS
2	17	MEKHTIKHANOV Musa	RUS
1	1	GARMAEV Tamir	RUS
2	12	GAMZATOV Ramiz	RUS
V	5	DASHIEV Ananda	RUS
V	18	DONDUK OOL Khuresh Ool	RUS
7	15	CHAMZYN Amir	RUS
8	3	POSTNIKOV Fedor	RUS
9	16	SEDEN Kezhik	RUS
10	20	KHUNKEROV Said	RUS
11	7	KUZHUGET Chalai	RUS
12	10	CHEBODAEV Artur Sergeevitch	RUS
13	8	BELOLIUBSKII Aiaal	RUS
14	21	IGNATEV Darkhan	RUS
15	9	KOPYLOV Petr	RUS
16	13	FEDOTOV Dulustan	RUS
17	6	PURVEE Dashtseren	MGL
18	4	KARTBAY Meirambek	KAZ
19	19	BAIANDUEV Zhargal	RUS
20	11	MUTALIEV Abubakar	RUS
FFT	14	UBAIDULAEV Akhmednabi	RUS

Repechage

Wrestlers who lost against the finalist of the upper part of bracket

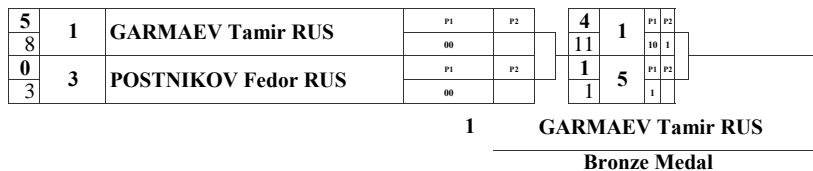

Wrestlers who lost against the finalist of the bottom part of bracket

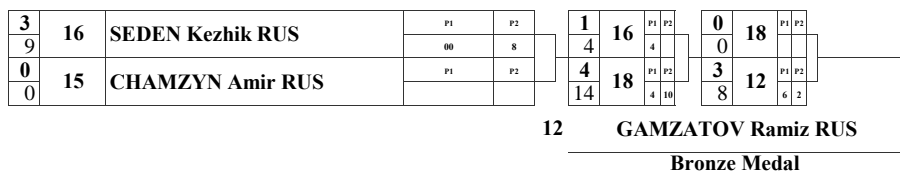

Head of referees, S. Kovalenko (IS)

Chief secretary, T. Chebodaeva



26-31.05.2021

Krasnoyarsk, RUS

Yariguin Sports Palace

WEIGHT CLASS 61 KG Qualification

FS F-1

Table with columns: PP, №, Wrestler, COUNTRY, Birth date, Sex, 1|8-F, 1|4-F, 1|2-F, F-1. Includes qualification results and medalists: KARAKHANOV Rustam RUS (Gold), MAGOMEDOV Abasgadzhi RUS (Silver), DAMDINOV Zhargal RUS (Bronze).

Repechage

Wrestlers who lost against the finalist of the upper part of bracket

Repechage match results table showing matches between wrestlers who lost to the upper bracket finalist.

Bronze Medal

Wrestlers who lost against the finalist of the bottom part of bracket

Repechage match results table showing matches between wrestlers who lost to the bottom bracket finalist.

Bronze Medal

Head of referees, S. Kovalenko (IS)

Chief secretary, T. Chebodaeva



Handwritten signatures of officials.

Final medalist list table with columns: №, Wrestler, COUNTRY. Lists winners of Gold, Silver, and Bronze medals.



26-31.05.2021

Krasnoyarsk, RUS

Yariguin Sports Palace

WEIGHT CLASS **65** KG

Qualification

PP Pt	No	Wrestler	COUNTRY	DATE OF BIRTH	PLACE OF BIRTH
0	1	KHARCHILAVA Daniil	RUS	16.06.2003	KMC
0	2	SHARASTEPANOV Erdem Valerevitch	RUS	22.05.1999	KMC
0	3	TINAEV Gasrat	RUS	22.12.2000	KMC
3	4	GERGENOV Iulian	RUS	12.01.1993	MC MK
1	5	GUSEINOV Shamil Mutalipovitch	RUS	18.09.1990	MC
10	6	POTAPOV Aisen	RUS	28.11.1998	
5	7	KHAIDAPOV Beligto	RUS	23.02.1998	KMC
0	8	ABDURAKHMANOV Ibragim	RUS	07.03.1999	MC
1	9	KUULAR Nachyn Sergeevitch	RUS	09.06.1995	MC MK
3	10	OMAROV Gadzhimurad Magomedovitch	RUS	15.09.1999	KMC
3	11	KAZYRYK Saiyn	RUS	21.09.1998	MC MK
8	12	MONGUSH Chaiaan Buyanovitch	RUS	13.06.2000	MC
1	13	SHARASTEPANOV Dasha	RUS	22.03.1993	MC
1	14	OGANNISSYAN Azat	KAZ	06.02.1997	
3	15	KAPRYNOV Konstantin	RUS	24.03.1999	
7	16	KHADARTSEV Alik	RUS	10.02.2000	MC
3	17	TAKHTAROV Dinislam	RUS	03.04.1998	MC
1	18	SACULTAN Maxim	MDA	18.11.1996	
6	19	BUDAZHANAEV Erdem	RUS	09.09.1996	MC
3	20	ERDENEBAT Tugsjargal	MGL	03.04.2001	
3	21	OSPANOV Adil	KAZ	24.09.1999	
6	22	SAIBOTALOV Rifat	KAZ	19.08.1996	
0	23	BYRYNAI Irbish Aydysovitch	RUS	17.05.1999	KMC
0	24	VALIEV Elbrus	RUS	05.12.1996	MC
3	25	ERDOGAN Cengizhan	TUR	13.06.1987	
4	26	FERZALIEV Ramazan	RUS	19.02.1995	MC
11	27	CHYMBA Kezhik	RUS	05.08.1996	MC
0	28	KHATUEV Turpal Ali	RUS	07.09.2002	KMC
3	29	ABUTALIMOV Ibragim	RUS	17.12.2002	KMC

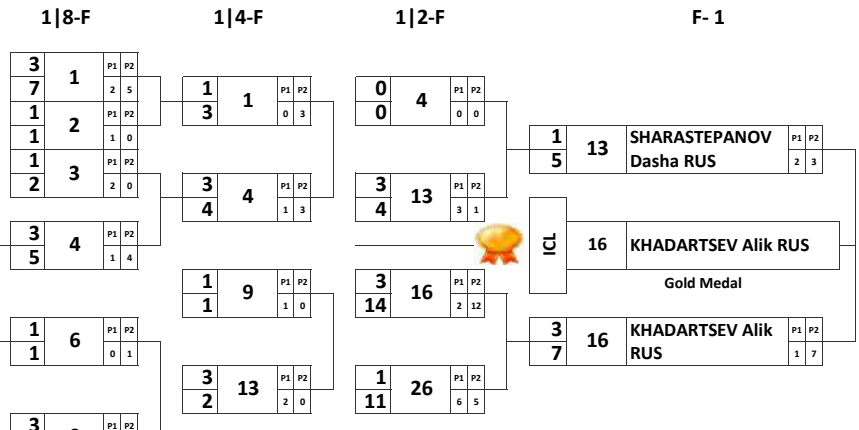

CL	No	Wrestler	COUNTRY
I	16	KHADARTSEV Alik	RUS
II	13	SHARASTEPANOV Dasha	RUS
III	12	MONGUSH Chaiaan Buyanovitch	RUS
III	11	FERZALIEV Ramazan	RUS
5	4	GERGENOV Iulian	RUS
5	17	TAKHTAROV Dinislam	RUS
7	20	ERDENEBAT Tugsjargal	MGL
8	22	SAIBOTALOV Rifat	KAZ
9	9	KUULAR Nachyn Sergeevitch	RUS
10	6	POTAPOV Aisen	RUS
11	14	OGANNISSYAN Azat	KAZ
12	1	KHARCHILAVA Daniil	RUS
13	10	OMAROV Gadzhimurad Magomedovitch	RUS
14	28	KHATUEV Turpal Ali	RUS
15	25	ERDOGAN Cengizhan	TUR
16	19	BUDAZHANAEV Erdem	RUS
17	5	GUSEINOV Shamil Mutalipovitch	RUS
18	29	ABUTALIMOV Ibragim	RUS
19	18	SACULTAN Maxim	MDA
20	21	OSPANOV Adil	KAZ
21	8	ABDURAKHMANOV Ibragim	RUS
22	3	TINAEV Gasrat	RUS
23	2	SHARASTEPANOV Erdem Valerevitch	RUS
24	11	KAZYRYK Saiyn	RUS
25	15	KAPRYNOV Konstantin	RUS
26	24	VALIEV Elbrus	RUS
27	23	BYRYNAI Irbish Aydysovitch	RUS
28	7	KHAIDAPOV Beligto	RUS
29	27	CHYMBA Kezhik	RUS

Repechage
Wrestlers who lost against the finalist of the upper part of bracket

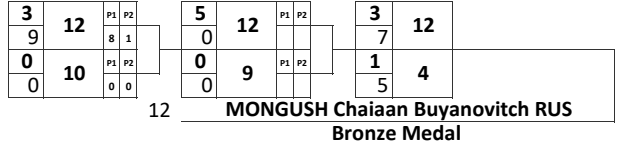

Wrestlers who lost against the finalist of the bottom part of bracket



Head of referees, S. Kovalenko (IS)



Chief secretary, T. Chebodaeva



Feuille de competition / Competition Sheet

Grand Prix Ivan Yariguin International tournament Senior (FS&WW)



26-31.05.2021

Krasnoyarsk, RUS

Yariguin Sports Palace

WEIGHT CLASS

70

KG

FS

F- 1

Qualification

PP Pr	Nº	Wrestler	COUNTRY	Date of birth	Discipline
0	1	DZBOEV Vladimir	RUS	20.02.1999	MC
0	2	DORZHIEV Ochir	RUS	19.05.1997	MC
0	3	GANISHOV Imam	RUS	17.06.2000	KMC
0	4	OMAROV Shamil Omarovitch	RUS	23.02.1998	KMC
0	5	SAT Arbak Tchetchek Oolovitch	RUS	13.12.1994	MC
0	6	KAZHAROV Rezuhan	RUS	02.09.2000	KMC
0	7	KORNEEV Kirill	RUS	19.04.1998	MC
0	8	RASSADIN Viktor	RUS	07.11.1993	
0	9	ZHARGALOV Nikita	RUS	27.07.2000	KMC
3	10	SEKINAEV Georgii	RUS	05.09.1999	KMC
1	11	TOPSHINOEV Konstantin Valentinovitch	RUS	14.02.2001	KMC
2	12	AKHMEDOV Abdula	RUS	06.09.1997	
4	13	YAKUBOV Ramazan	RUS	30.10.1999	KMC
10	14	TSKHOVREBOV Batyrbek	RUS	12.11.2003	
0	15	ZHENDAEV Ruslan	RUS	01.06.1997	MC
3	16	BALAIAN Arsen	RUS	29.12.2003	KMC
7	17	ARSLANOV Biisoltan	RUS	09.06.1999	KMC
1	18	UPKHOEV Igor	RUS	25.02.2002	KMC
1	19	BAEV David	RUS	07.11.1997	MCMK
4	20	SHIRAEV Kurban	RUS	28.03.1999	MCMK
11	21	BANZARAKTSAEV Buianto	RUS	04.03.2000	KMC
4	22	SHIKHSHABEKOV Iman	RUS	13.05.2002	MC
10	23	ABDULAEV Abdulkерim	RUS	15.12.2002	MC

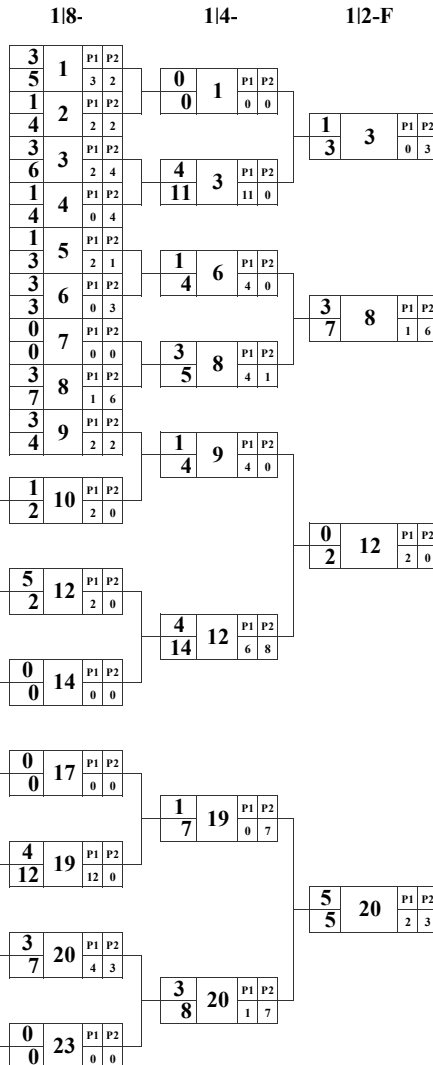

CL	Nº	Wrestler	COUNTRY
1	8	RASSADIN Viktor	RUS
20	20	SHIRAEV Kurban	RUS
3	20	SHIRAEV Kurban	RUS
20	20	SHIRAEV Kurban	RUS
8	8	RASSADIN Viktor	RUS
6	6	KAZHAROV Rezuhan	RUS
19	19	BAEV David	RUS
V	3	GANISHOV Imam	RUS
V	12	AKHMEDOV Abdula	RUS
7	23	ABDULAEV Abdulkерim	RUS
8	9	ZHARGALOV Nikita	RUS
9	10	SEKINAEV Georgii	RUS
10	17	ARSLANOV Biisoltan	RUS
11	14	TSKHOVREBOV Batyrbek	RUS
12	1	DZBOEV Vladimir	RUS
13	2	DORZHIEV Ochir	RUS
14	4	OMAROV Shamil Omarovitch	RUS
15	16	BALAIAN Arsen	RUS
16	5	SAT Arbak Tchetchek Oolovitch	RUS
17	11	TOPSHINOEV Konstantin Valentinovitch	RUS
18	15	ZHENDAEV Ruslan	RUS
19	7	KORNEEV Kirill	RUS
20	13	YAKUBOV Ramazan	RUS
21	22	SHIKHSHABEKOV Iman	RUS
22	18	UPKHOEV Igor	RUS
23	21	BANZARAKTSAEV Buianto	RUS

Repechage

Wrestlers who lost against the finalist of the upper part of bracket

1	7	KORNEEV Kirill	RUS	P1	P2	3	6	P1	P2
1	1			1		4	1	3	
3	6	KAZHAROV Rezuhan	RUS	P1	P2	1	3	P1	P2
9	9			2	7	2	3	2	

6 KAZHAROV Rezuhan RUS

Bronze Medal

Wrestlers who lost against the finalist of the bottom part of bracket

0	21	BANZARAKTSAEV Buianto	RUS	P1	P2	1	23	P1	P2
0	0					3	3		
4	23	ABDULAEV Abdulkерim	RUS	P1	P2	3	19	P1	P2
10	10			10		8	4	4	

BAEV David RUS

Bronze Medal

Head of referees, S. Kovalenko (IS)

Chief secretary, T. Chebodaeva



Handwritten signatures and initials.



Grand Prix Ivan Yariguin International tournament Senior (FS&WW)

26-31.05.2021

Krasnoyarsk, RUS

Yariguin Sports Palace

WEIGHT CLASS **74** KG

FS

Qualification

PP Pt	№	Wrestler	COUNTRY	DOB	FC
0	1	BODIEV Tumen	RUS	20.08.2002	KMC
0	2	DIBIRGADZHIEV Magoma	RUS	18.05.1997	MC
0	3	TCYRENOV Buian	RUS	14.03.1998	MC
0	4	DZUKAEV Robert	RUS	06.05.2000	KMC
0	5	ABREGOV Aiub	RUS	19.07.1996	KMC
0	6	TAVAEV Aznaur	RUS	24.11.1998	MC
0	7	KUMYKOV Abdar Rakhman	RUS	02.05.2001	
0	8	TAZHIGALI Aidyn	KAZ	05.01.1996	
0	9	DARKHANBAYAR Tengis	MGL	18.02.2000	
3	10	ALIEV Gadzhibagomed	RUS	02.03.2002	KMC
17	11	DONZALENKO Nikolai	RUS	01.01.1999	MC
14	12	KHIZRIEV Nadirbeg Halidovitch	RUS	14.09.1990	MC/MC
1	13	BOGATYREV Ruslan	RUS	12.06.1996	
3	14	KARDANOV Magomet	RUS	02.02.2002	KMC
4	15	NIKOLAEV Timur Illarionovitch	RUS	03.02.1994	
10	16	ELDAROV Khamzat	RUS	17.01.2002	MC
0	17	OLONBAYAR Suldkhuu	MGL	20.04.2001	
0	18	SHADAPOV Buianto	RUS	16.08.2001	MC
4	19	MUTALIEV Umar	RUS	15.10.2000	KMC
12	20	SUCHKOV Nikita	RUS	07.06.1996	MC/MC
3	21	BORZIN Valentin	MDA	07.05.1999	
0	22	ABDULKADYROV Magomed	RUS	09.10.2001	MC
3	23	BUDAEV Soslanbek	RUS	23.11.2001	

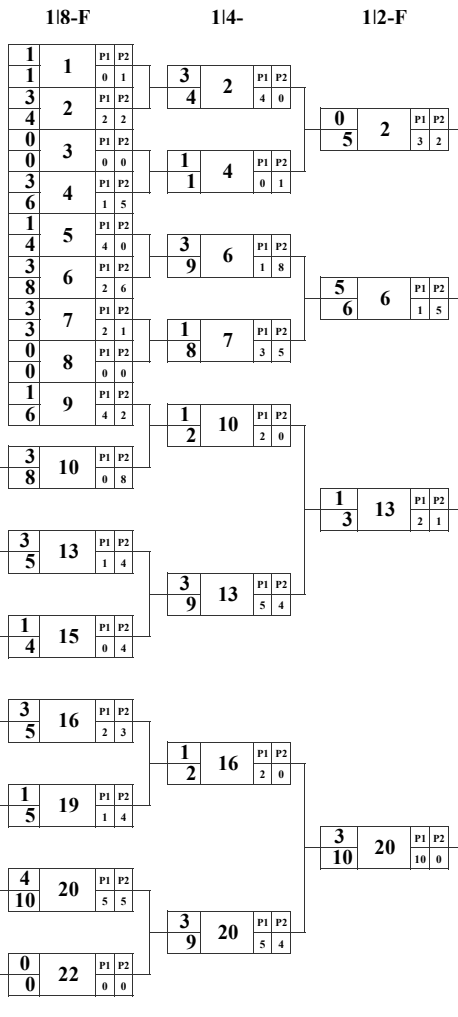

CL	№	Wrestler	COUNTRY
I	6	TAVAEV Aznaur	RUS
II	20	SUCHKOV Nikita	RUS
III	6	ABREGOV Aiub	RUS
III	13	BOGATYREV Ruslan	RUS
V	16	ELDAROV Khamzat	RUS
6	10	ALIEV Gadzhibagomed	RUS
7	22	ABDULKADYROV Magomed	RUS
8	19	MUTALIEV Umar	RUS
9	7	KUMYKOV Abdar Rakhman	RUS
10	15	NIKOLAEV Timur Illarionovitch	RUS
11	4	DZUKAEV Robert	RUS
12	11	DONZALENKO Nikolai	RUS
13	23	BUDAEV Soslanbek	RUS
14	9	DARKHANBAYAR Tengis	MGL
15	21	BORZIN Valentin	MDA
16	14	KARDANOV Magomet	RUS
17	12	KHIZRIEV Nadirbeg Halidovitch	RUS
18	1	BODIEV Tumen	RUS
19	8	TAZHIGALI Aidyn	KAZ
20	3	TCYRENOV Buian	RUS
21	17	OLONBAYAR Suldkhuu	MGL
22	18	SHADAPOV Buianto	RUS
DSQ	2	DIBIRGADZHIEV Magoma	RUS

Repechage

Wrestlers who lost against the finalist of the upper part of bracket

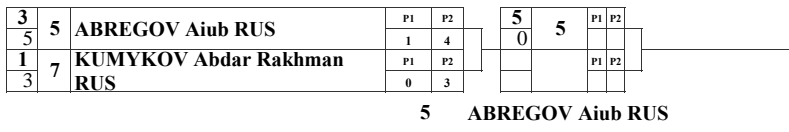

Bronze Medal

Wrestlers who lost against the finalist of the bottom part of bracket

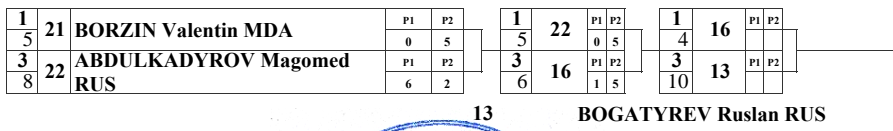

Bronze Medal

Head of referees, S. Kovalenko (IS)

Chief secretary, T. Chebodaeva



S. Kovalenko
T. Chebodaeva



26-31.05.2021

Krasnoyarsk, RUS

Yariguin Sports Palace

WEIGHT CLASS 79 KG

FS

Qualification

Table with columns: PP/Pt, No, Wrestler, COUNTRY, Date of Birth, and other details for 17 wrestlers.

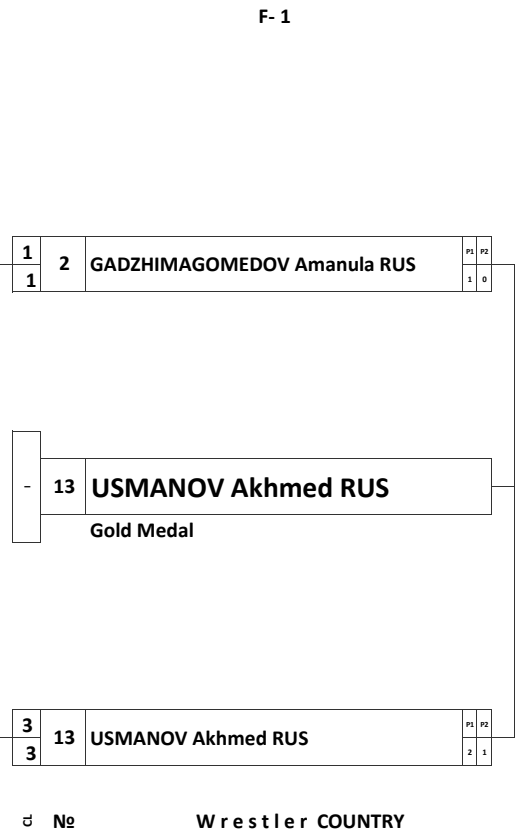
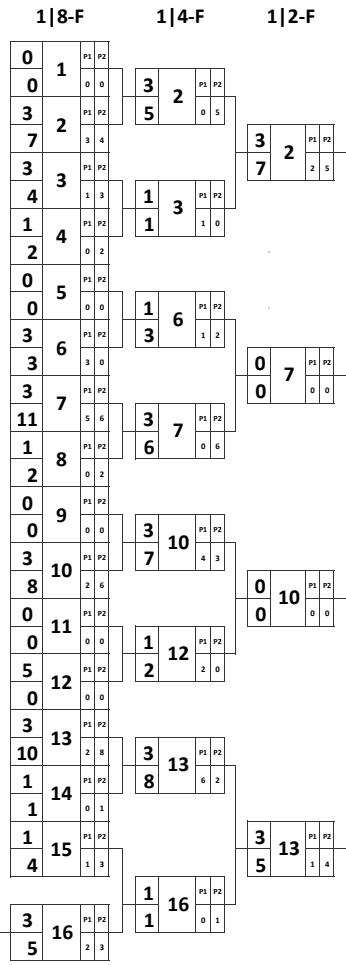

Repechage

Wrestlers who lost against the finalist of the upper part of bracket

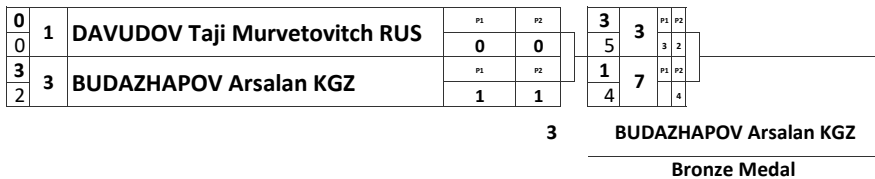

Wrestlers who lost against the finalist of the bottom part of bracket



Final medal list table with columns: No, Wrestler, COUNTRY, and medal icons (Gold, Silver, Bronze).

Head of referees, S. Kovalenko (IS)

Chief secretary, T. Chebodaeva



Handwritten signatures in blue ink.



Feuille de competition / Competition Sheet

Grand Prix Ivan Yariguin International tournament Senior (FS&WW)



26-31.05.2021

Krasnoyarsk, RUS

Yariguin Sports Palace

WEIGHT CLASS
1|8-F

86

KG

PP	No	Wrestler	COUNTRY	1 4-F	1 2-F	F-1
3	1	AKAEV Tazhitin Amilhanovitch RUS	18.04.1995	MC	3 7	1 1
4	2	APSHEV Renat RUS	19.12.1997	KMC	7 4	3 1
1	3	ULIMBASHEV Azret RUS	15.07.1995	MC	1 2	3 1
12	4	BAZAROV Baras Batoevitch RUS	13.05.1988	MC	2 3	0 2
1	5	MIKOLAICHUK Vladislav KAZ	17.12.1998		3 6	1 5
0	6	MINKAILOV Zelimkhan RUS	07.07.1993	MC	6 1	5 0
3	7	BADDOEV Astik RUS	25.12.1999	MC	1 2	8 0
1	8	NANIEV Slavik RUS	14.02.1999	MC	2 8	0 2
3	9	MAKIEV Zaur RUS	24.03.1992	MCMK	3 5	10 0
0	10	VALIEV Vladislav RUS	25.04.1993	3MC	5 10	0 5
3	11	MENDBILEG Temuujin MGL	14.06.2001		1 2	12 1
7	12	GADZHIEV Khabib RUS	16.10.1995	KMC	2 12	1 1
3	13	BIIAKAEV Magomedsharif RUS	06.08.1995	KMC	5 0	13 0
1	14	MUSALALIEV Arsen Ali RUS	25.05.1996	MC	0 13	0 0
1	15	MAGOMEDOV Shamil Abakarovitch RUS	04.02.2002	KMC	0 0	15 0
3	16	BAGAEV Arslan RUS	21.10.2003	KMC	0 0	15 0

1	2	6	MINKAILOV Zelimkhan RUS	P1	P2
				1	1

-	13	BIIAKAEV Magomedsharif RUS
---	----	----------------------------

Gold Medal

3	3	13	BIIAKAEV Magomedsharif RUS	P1	P2
				0	3

№ Wrestler COUNTRY

13	BIIAKAEV Magomedsharif RUS	
6	MINKAILOV Zelimkhan RUS	
1	AKAEV Tazhitin Amilhanovitch RUS	
10	VALIEV Vladislav RUS	
V	8	NANIEV Slavik RUS
V	14	MUSALALIEV Arsen Ali RUS
7	3	ULIMBASHEV Azret RUS
8	12	GADZHIEV Khabib RUS
9	11	MENDBILEG Temuujin MGL
10	16	BAGAEV Arslan RUS
11	4	BAZAROV Baras Batoevitch RUS
12	7	BADDOEV Astik RUS
13	2	APSHEV Renat RUS
14	9	MAKIEV Zaur RUS
15	5	MIKOLAICHUK Vladislav KAZ
FFT	15	MAGOMEDOV Shamil Abakarovitch RUS

Repechage

Wrestlers who lost against the finalist of the upper part of bracket

0	5	MIKOLAICHUK Vladislav KAZ	P1	P2	1 8	P1	P2
0					1		
3	8	NANIEV Slavik RUS	P1	P2	3 4	P1	P2
4					4		

1 AKAEV Tazhitin Amilhanovitch RUS
Bronze Medal

Wrestlers who lost against the finalist of the bottom part of bracket

5	14	MUSALALIEV Arsen Ali RUS	P1	P2	1 14	P1	P2
0					1		
0	15	MAGOMEDOV Shamil Abakarovitch RUS	P1	P2	3 2	P1	P2
0					2		

10 VALIEV Vladislav RUS
Bronze Medal

Head of referees, S. Kovalenko (IS)



Chief secretary, T. Chebodaeva



26-31.05.2021

Krasnoyarsk, RUS

Yariguin Sports Palace

WEIGHT CLASS

92

KG

FS

Qualification

Table with columns: №, Wrestler, COUNTRY, Birth date, and other details for 18 wrestlers.

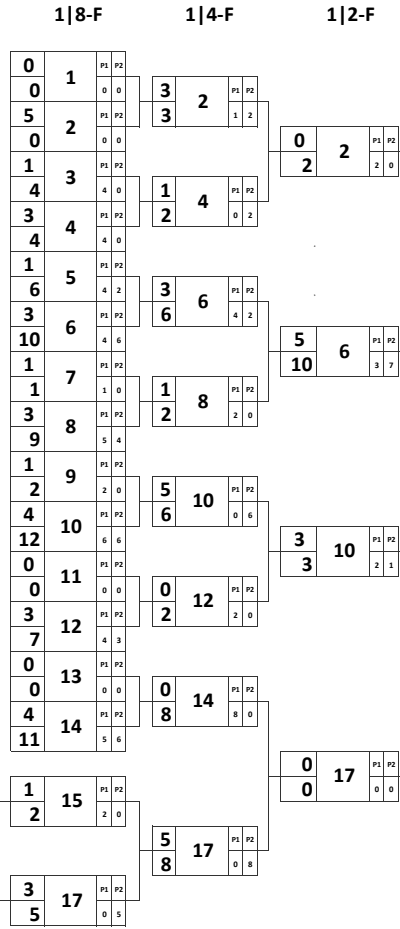

Final results table showing scores and names of winners: CHERTKOEV Guram RUS (Gold Medal), TAPSIEV Tamerlan RUS.

Final ranking table with medals and names: 6 CHERTKOEV Guram RUS (Gold), 10 TAPSIEV Tamerlan RUS (Silver), 8 SERGIN Nurgun Efimovitch RUS (Bronze), 17 KARIMOV Zagid RUS (Bronze), 2 DAGVADORJ Orgilokh MGL, 9 BAIGENZHEYEV Abdimanap KAZ, 14 ANISHCHIK Alexey RUS, 12 KONDRATOV Aleksandr RUS, 15 PSHENICHNIKOV Konstantin RUS, 4 TOLPAROV Aslan RUS, 5 OMAROV Suleyman Mukhtarovitch RUS, 3 KHARONOV Lambert RUS, 16 BAGAEV Alan RUS, 7 RAKHIMOV Mukhammadrasul UZB, 15 IVANOV Yurii Nikolaevitch RUS, 16 18 KILCHUKOV Islam RUS, 17 13 ZHMYKHOV Mikhail RUS, FFT 1 KTSOEV Soslan RUS.

Repechage

Wrestlers who lost against the finalist of the upper part of bracket

Repechage match results table for the upper bracket.

Wrestlers who lost against the finalist of the bottom part of bracket

Repechage match results table for the bottom bracket.

Head of referees, S. Kovalenko

Chief secretary, T. Chebodaeva

Handwritten signature of S. Kovalenko



Handwritten signature of T. Chebodaeva



Feuille de competition / Competition Sheet
Grand Prix Ivan Yariguin International tournament Senior (FS&WW)



26-31.05.2021

Krasnoyarsk, RUS

Yariguin Sports Palace

WEIGHT CLASS **97** KG

Qualification

PP Pt	No	Wrestler COUNTRY	DOB	Club
00	1	TAZHUDINOV Gadzhimagomed RUS	13.07.1998	KMC
00	2	KHUGAEV Artik RUS	21.08.1999	KMC
13	3	DZUGAEV Devid RUS	05.12.1998	MC
33	4	OVSIIANNIKOV Igor Alekseevitch RUS	24.09.1995	MCMK
11	5	TOLMACHEV Maksim RUS	19.06.1998	MC
36	6	GAZZAEV Aslanbek RUS	03.06.1999	MC
12	7	CHILAYEV Iliskhan KAZ	06.04.1995	
412	8	KOTSOEV Tamerlan RUS	07.03.2000	
11	9	IBRAGIMOV Mamed KAZ	09.06.1992	
32	10	GADZHIALIEV Shamil Imam RUS	12.01.2003	KMC
00	11	TSKHAREBOV Artem RUS	05.08.2000	MC
410	12	MAGOMEDOV Magomedkhan RUS	27.01.1998	MCMK
14	13	KURBANOV Abdulla RUS	07.02.2002	
35	14	ALIEV Ali Magomedovitch RUS	29.03.2002	MC

1 4-F	1 2-F
3 1 P1 P2 7 5 2	1 1 P1 P2 2 2 0
1 2 P1 P2 1 0 1	
3 4 P1 P2 4 4 0	3 4 P1 P2 8 0 8
0 6 P1 P2 0 0 0	
1 8 P1 P2 1 0 1	1 10 P1 P2 1 1 0
3 10 P1 P2 4 3 1	
3 12 P1 P2 6 2 4	3 12 P1 P2 6 2 4
0 14 P1 P2 0 0 0	

FS
F- 1

No	Wrestler	COUNTRY	P1	P2
1 2	4	OVSIIANNIKOV Igor Alekseevitch RUS	1	1
12	MAGOMEDOV Magomedkhan RUS			
3 8	12	MAGOMEDOV Magomedkhan RUS	4	4

Gold Medal

Repechage

Wrestlers who lost against the finalist of the upper part of bracket

No	Wrestler	COUNTRY	P1	P2
3 3	DZUGAEV Devid RUS		1	2
1 6	GAZZAEV Aslanbek RUS		1	1

Bronze Medal

DZUGAEV Devid RUS

Wrestlers who lost against the finalist of the bottom part of bracket

No	Wrestler	COUNTRY	P1	P2
3 7	11	TSKHAREBOV Artem RUS	1	7
1 3	14	ALIEV Ali Magomedovitch RUS	3	2

Bronze Medal

GADZHIALIEV Shamil Imam RUS



No	Wrestler	COUNTRY
12	MAGOMEDOV Magomedkhan RUS	
4	OVSIIANNIKOV Igor Alekseevitch RUS	
3	DZUGAEV Devid RUS	
10	GADZHIALIEV Shamil Imam RUS	
V 1	TAZHUDINOV Gadzhimagomed RUS	
V 11	TSKHAREBOV Artem RUS	
7 8	KOTSOEV Tamerlan RUS	
8 14	ALIEV Ali Magomedovitch RUS	
9 6	GAZZAEV Aslanbek RUS	
10 13	KURBANOV Abdulla RUS	
11 7	CHILAYEV Iliskhan KAZ	
12 9	IBRAGIMOV Mamed KAZ	
13 5	TOLMACHEV Maksim RUS	
14 2	KHUGAEV Artik RUS	

Head of referees, S. Kovalenko (IS)

Chief secretary, T. Chebodaeva





Grand Prix Ivan Yariguin International tournament Senior (FS&WW)

26-31.05.2021

Krasnoyarsk, RUS

Yariguin Sports Palace

WEIGHT CLASS **125** KG

Qualification

pp Pt	No	Wrestler COUNTRY	Date of Birth	MC
0	01	KHOSONOV Azamat GRE	17.09.2000	
0	02	KHIZRIEV Zelimkhan RUS	12.09.1995	MC
0	03	ALIZHUDINOV Gamza RUS	30.07.2001	KMC
0	04	PASENOK Ostap RUS	01.07.1987	MC
0	05	ZASSEEV Arsamag RUS	17.06.2002	MC
0	06	GOLOEV Vitalii RUS	15.06.1996	MCMK
0	07	KHUBAEV Khasan RUS	21.09.1996	MC
0	08	KORTIEV Shota RUS	15.04.2001	KMC
3	09	KHIZRIEV Khamzat RUS	31.10.1996	MC

1 4-F		1 2-F		F-1	
1	01	P1	P2		
5	01	1	4		
4	02	P1	P2	3	02
15	02	6	9	2	02
0	03	P1	P2		
0	03	0	0		
3	04	P1	P2	0	04
7	04	3	4	0	04
1	05	P1	P2		
2	05	2	0	1	06
4	06	P1	P2	6	06
12	06	10	2		
0	07	P1	P2		
0	07	0	0		
5	09	P1	P2	3	09
0	09	0	0	10	09

No	Wrestler	COUNTRY	P1	P2
3	02	KHIZRIEV Zelimkhan RUS	3	5
-	02	KHIZRIEV Zelimkhan RUS		
Gold Medal				
1	09	KHIZRIEV Khamzat RUS	2	5

Repechage

Wrestlers who lost against the finalist of the upper part of bracket

1	1	KHOSONOV Azamat GRE	P1	P2		
1	1		1			
3	4	PASENOK Ostap RUS	P1	P2		4
4	4			4		

PASENOK Ostap RUS
Bronze Medal

Wrestlers who lost against the finalist of the bottom part of bracket

5	8	KORTIEV Shota RUS	P1	P2		0	8	P1	P2
0	8		5			0	8	0	
0	7	KHUBAEV Khasan RUS	P1	P2		5	6	P1	P2
0	7		0			6	6	6	

GOLOEV Vitalii RUS
Bronze Medal

No	Wrestler	COUNTRY
2	KHIZRIEV Zelimkhan RUS	RUS
9	KHIZRIEV Khamzat RUS	RUS
4	PASENOK Ostap RUS	RUS
6	GOLOEV Vitalii RUS	RUS
V	1	KHOSONOV Azamat GRE
V	8	KORTIEV Shota RUS
7	5	ZASSEEV Arsamag RUS
8	3	ALIZHUDINOV Gamza RUS
FFT	7	KHUBAEV Khasan RUS

Head of referees, S. Kovalenko (IS)



Chief secretary, T. Chebodaeva

Отчет
по итогам участия в XXXII Международном турнире
по спортивной борьбе (дисциплина - вольная борьба)
серии Гран-при «Иван Ярыгин»

(мужчины, женщины), Россия, г. Красноярск, 26-31.05.2021

Количество стран участниц _____ 10 _____
 Количество спортсменов _____ всего - 248 из них: муж. -192 жен. - 56 _____

Количественный состав российской спортивной делегации

руководители _____ 10 _____ чел.
 тренеры _____ 44 _____ чел.
 Судьи _____ 66 _____ чел.
 врачи, массажисты _____ 3 _____ чел.
 другие специалисты _____ 22 _____ чел.
 спортсмены _____ 248 _____ чел.
 Итого _____ 393 _____ чел.

Результаты выступления российских спортсменов на соревнованиях

№ п/п	Фамилия, Имя	Год рожд.	Дисциплина	Занятое место	Примечание
1	Махачева Дадашева Милана	1995	Женская борьба	1	50 кг
2	Чубанова Мадина	1997	Женская борьба	2	50 кг
3	Федорова Анжелика	1997	Женская борьба	3	50 кг
4	Чепсаракова Валерия	1989	Женская борьба	3	50 кг
5	Скиренко Александра	1998	Женская борьба	1	53 кг
6	Хвостова Дарья	1999	Женская борьба	2	53 кг
7	Ваулина Виктория	1998	Женская борьба	1	55 кг
8	Назарова Севиль	1998	Женская борьба	2	55 кг
9	Новик Татьяна	1997	Женская борьба	3	55 кг
10	Исакова Екатерина	1998	Женская борьба	3	55 кг
11	Цыремпилова Цыренова Жаргалма	1989	Женская борьба	1	57 кг
12	Муртузалиева Хадижат	1989	Женская борьба	2	57 кг
13	Кондратьева Кристина	2000	Женская борьба	3	57 кг
14	Ниценко Александра	1998	Женская борьба	3	59 кг
15	Парохина Анастасия	2000	Женская борьба	1	62 кг
16	Тукурунова Ульяна	1994	Женская борьба	2	62 кг
17	Казымова Алина	1998	Женская борьба	3	62 кг
18	Кудаева Салихова Динара	1998	Женская борьба	2	65 кг
19	Кузнецова Мария	1997	Женская борьба	3	65 кг
20	Федосеева Наталия	1991	Женская борьба	1	68 кг
21	Смоляк Татьяна	1997	Женская борьба	3	68 кг
22	Буракова Ксения	1992	Женская борьба	1	72 кг
23	Стародубцева Алена	1985	Женская борьба	2	72 кг
24	Букина Екатерина	1987	Женская борьба	2	76 кг
25	Шумова Кристина	1997	Женская борьба	3	76 кг

26	Мехтиханов Муса	1999	Вольная борьба	2	57 кг
27	Гармаев Тамир	1995	Вольная борьба	3	57 кг
28	Гамзатов Рамиз	1996	Вольная борьба	3	57 кг
29	Магомедов Абасгаджи	1998	Вольная борьба	1	61 кг
30	Караханов Рустам	1994	Вольная борьба	2	61 кг
31	Тюлюш Эзир	1996	Вольная борьба	3	61 кг
32	Дамдинов Жаргал	1996	Вольная борьба	3	61 кг
33	Хадарцев Алик	2000	Вольная борьба	1	65 кг
34	Шарастепанов Даша	1993	Вольная борьба	2	65 кг
35	Монгуш Чайан Буянович	2000	Вольная борьба	3	65 кг
36	Ферзалиев Рамазан	1995	Вольная борьба	3	65 кг
37	Шираев Курбан	1999	Вольная борьба	1	70 кг
38	Рассадин Виктор	1993	Вольная борьба	2	70 кг
39	Кажаров Резуан	2000	Вольная борьба	3	70 кг
40	Баев Давид	1997	Вольная борьба	3	70 кг
41	Таваев Азнаур	1998	Вольная борьба	1	74 кг
42	Сучков Никита	1996	Вольная борьба	2	74 кг
43	Абрегов Аюб	1996	Вольная борьба	3	74 кг
44	Богатырев Руслан	1996	Вольная борьба	3	74 кг
45	Усманов Ахмед	1996	Вольная борьба	1	79 кг
46	Гаджимагомедов Аманула	1995	Вольная борьба	2	79 кг
47	Арсалан Будажапов	1993	Вольная борьба	3	79 кг
48	Айдаев Юсуп Хаджи	2001	Вольная борьба	3	79 кг
49	Биякаев Магомедшариф	1995	Вольная борьба	1	86 кг
50	Минкайлов Зелымхан	1993	Вольная борьба	2	86 кг
51	Акаев Тажитин Амилханович	1995	Вольная борьба	3	86 кг
52	Валиев Владислав	1993	Вольная борьба	3	86 кг
53	Черткоев Гурам	1995	Вольная борьба	1	92 кг
54	Тапсиев Тамерлан	1997	Вольная борьба	2	92 кг
55	Сергин Ньургун Ефимович	1996	Вольная борьба	3	92 кг
56	Каримов Загид	2002	Вольная борьба	3	92 кг
57	Магомедов Магомедхан	1998	Вольная борьба	1	97 кг
58	Овсянников Игорь Алексеевич	1995	Вольная борьба	2	97 кг
59	Дзугаев Дэвид	1998	Вольная борьба	3	97 кг
60	Гаджиалиев Шамиль Имам	2003	Вольная борьба	3	97 кг
61	Хизриев Зелымхан	1995	Вольная борьба	1	125 кг
62	Хизриев Хамзат	1996	Вольная борьба	2	125 кг
63	Пасенок Остап	1987	Вольная борьба	3	125 кг
64	Голоев Виталий	1996	Вольная борьба	3	125 кг

Итоги соревнований (олимпийские дисциплины)

Место	Страна	Количество медалей			Всего медалей	Очков
		Золото	Серебро	Бронза		
1	Россия	16	18	30	64	475
2	Монголия	2	2	2	6	154
3	Беларусь	1			1	25
3	Египет	1			1	25
5	Киргизия			1	1	15
6	Казахстан					18
7	Греция					10
8	Молдова					
9	Узбекистан					
10	Турция					

Всего завоевали медали спортсмены: 73	Стран: 5	74	
--------------------------------------------------	-----------------	-----------	--