

# **PACCAR TRANSMISSIONS**

## **TX-8**

**8 Speed  
Transmission**

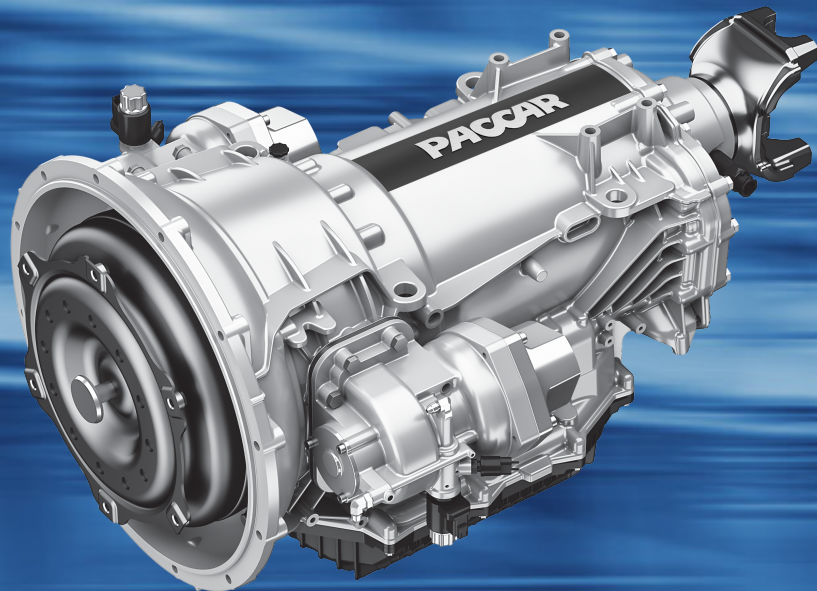

# **Operator's Manual**

<b>Safety</b>	<b>1</b>
<b>Features</b>	<b>2</b>
<b>Indications</b>	<b>3</b>
<b>Controls</b>	<b>4</b>
<b>Operation</b>	<b>5</b>
<b>Maintenance</b>	<b>6</b>
<b>Specifications</b>	<b>7</b>

## © 2024 PACCAR Inc. - All Rights Reserved

This manual illustrates and describes the operation of features or equipment which may be either standard or optional on this vehicle. This manual may also include a description of features and equipment which are no longer available or were not ordered on this vehicle. Please disregard any illustrations or descriptions relating to features or equipment which are not on this vehicle. PACCAR reserves the right to discontinue, change specifications, or change the design of its vehicles at any time without notice and without incurring any obligation. The information contained in this manual is proprietary to PACCAR. Reproduction, in whole or in part, by any means is strictly prohibited without prior written authorization from PACCAR Inc.

# Chapter 1 | SAFETY

Using this Manual.....	5
Safety Messages and Notes.....	5
Illustrations.....	6
General Safety Instructions.....	6

## Using this Manual

Please take the time to get acquainted with your vehicle by reading this Operator's Manual. We recommend that you read and understand this manual from beginning to end before you operate this equipment. This manual contains useful information for the safe and efficient operation of this equipment. It also provides service information, with an outline for performing safety checks and basic preventive maintenance inspections. When replacement parts are needed, we recommend using only genuine PACCAR parts.

We have tried to present the information needed to learn about functions, controls, and operation—and to present it as clearly as possible. Occasionally, you may need to reference this manual, and we hope you find it is easy to use.

	<b>NOTE</b>
After you have read this manual, it should be stored in the cab for con-	

venient reference and remain with this truck when sold.

Your vehicle may not have all the features or options mentioned in this manual. Therefore, you should pay careful attention to the instructions that pertain to just your vehicle. In addition, if your vehicle is equipped with special equipment or options not discussed in this manual, consult your dealer or the manufacturer of the equipment.

There are several tools built into this manual to help you find what you need quickly and easily; first is the Table of Contents. Located at the front of the manual, this table arranges the subject matter into chapters, which can be quickly referenced using the numbers shown in the outer margin. The first page of each chapter presents a list of the major subjects contained in that chapter. Cross-referenced citations can also help you find information. If more information on the current subject is located elsewhere in the manual, a cross-reference may be provided, such as "see [Safety Messages and Notes](#) on page 5." Finally, you will find a helpful index at the back of the manual which lists the subjects covered alphabetically.

All information contained in this manual is based on the latest production information available at the time of publication. If you find differences between your instruments and the information in this manual, contact an authorized PACCAR dealer. PACCAR reserves the right to make changes at any time without notice.

## Safety Messages and Notes

Read and follow ALL safety messages in this manual. When followed, injury to yourself and others, damage to equipment and/or property, or other unknown hazards are reduced. Both safety messages and notes are emphasized using a safety message symbol and one of three signal words: WARNING, CAUTION, or NOTE. **Do not** ignore any of these messages.

### Warnings



Safety messages that follow this symbol and signal word provide a warning concerning operating procedures, actions, or a lack of action that could result in death

or injury. An unheeded warning may also result in damage to equipment, property, or the environment. Warning messages will identify the hazard, how to avoid it, and the probable consequence of not avoiding the hazard.

Example:

 <b>WARNING</b>
DO NOT change hot engine oil as you could be burned. Let the engine cool down before changing the engine oil. Failure to comply may result in death, personal injury, equipment damage, or property damage.

### Cautions



Safety messages that follow this symbol and signal word provide a caution against operating procedures, actions, or a lack of action that could result in equipment, property, or environmental damage. Caution messages will identify the hazard, how to avoid it, and the probable consequence of not avoiding the hazard.

Example:

 <b>CAUTION</b>
DO NOT operate your vehicle with insufficient oil pressure as this will cause serious engine damage. Failure to comply may result in equipment or property damage.

### Notes



Messages that follow this symbol and signal word provide important information that, while not safety related, should still be followed. A note will provide information that may be useful to the reader: clarifying the topic, providing valuable insight into the topic or process, or saving the reader time and effort.

Example:

 <b>NOTE</b>
Pumping the accelerator pedal will not assist in starting the engine.

## Illustrations

Some of the illustrations found in this manual are generic, and may not look exactly like the parts or assemblies you find installed on your vehicle.

When an illustration differs from what you see physically present on your vehicle, the language describing the procedure will still be correct for your application.

## General Safety Instructions

 <b>WARNING</b>
Improper practices, carelessness, or ignoring safety messages – Warnings and Cautions – may cause death, personal injury, or equipment and property damage.

Before performing any repair, read and understand all of the safety precautions and warnings. The following is a list of general safety precautions that must be followed to provide personal safety. Failure to follow these instructions may cause

death or injury. Special safety precautions are included in the procedures when they apply.

Keep in mind that even a well-maintained vehicle must be operated within the range of its mechanical capabilities and the limits of its load ratings. See the Weight Ratings label on the driver's door edge.

Every new vehicle is designed to conform to all Federal Motor Vehicle Safety Standards applicable at the time of manufacture. Even with these safety features, continued safe and reliable operation depends upon regular vehicle maintenance. Follow the maintenance recommendations found in the Maintenance section. Following maintenance recommendations will help your vehicle maintain quality conditions. Make sure your vehicle is in top working condition before heading out on the road, it is the driver's duty to do so. Inspect the vehicle according to the Driver's Check List:

- Work areas should be dry, well lit, well ventilated; free from clutter, loose tools, parts, ignition sources, and hazardous substances.
- Wear protective glasses and protective shoes when working.

- Wear protective gloves when working with hot liquids or surfaces, and when working with components that have sharp edges.
- DO NOT wear loose-fitting or torn clothing. Tie back and/or tuck in long hair. Remove all jewelry when working.
- Before beginning any repair, disconnect the battery (negative [-] cable) and discharge any capacitors.
- Put a "DO NOT OPERATE" tag in the operator's compartment or on the controls.
- Allow the engine to cool before slowly loosening the coolant fill cap to relieve the pressure from the cooling system.

 **WARNING**

Removing the fill cap on a hot engine can cause scalding coolant to spray out and burn you badly. If the engine has been in operation within the previous 30 minutes, be very careful in removing the fill cap. Protect face,

hands, and arms against escaping fluid and steam by covering the cap with a large, thick rag. DO NOT try to remove it until the surge tank cools down or if you see any steam or coolant escaping. Always remove the cap very slowly and carefully. Be ready to back off if any steam or coolant begins to escape. Failure to comply may result in death, personal injury, equipment or property damage.

- Always use wheel chocks or proper jack stands to support the vehicle or vehicle components before performing any service work. DO NOT work on anything that is supported only by lifting jacks or a hoist. Before resting a vehicle on jack stands, be sure the stands are rated for the load you will be placing on them.
- Before removing or disconnecting any lines, fittings, or related items, relieve all pressure in the air, oil, fuel, and cooling systems. Remain alert for possible pressure when disconnecting any device from a system that contains pressure.

- High-pressure oil or fuel can cause death or personal injury.
- Always wear protective clothing when working on any refrigerant lines and make sure that the workplace is well ventilated. Inhalation of fumes can cause death or personal injury. To protect the environment, liquid refrigerant systems must be properly emptied and filled using equipment that prevents the release of refrigerant gas. Federal law requires capturing and recycling refrigerant.
- When moving or lifting any heavy equipment or parts, make sure to use proper techniques and assistance. Ensure all lifting devices such as chains, hooks, or slings are in good condition and are rated for the correct load capacity. Make sure all lifting devices are positioned correctly.
- Corrosion inhibitors and lubricating oils may contain alkali. DO NOT get the substance in eyes and avoid prolonged or repeated contact with skin. DO NOT swallow. If ingested, seek immediate medical attention. DO NOT induce vomiting. In case of contact, immediately wash skin with soap and water. In case of harmful contact, immediately contact a physician. Always keep any chemicals OUT OF REACH OF CHILDREN.
- When working on the vehicle, be alert for hot parts on systems that have just been turned off, exhaust gas flow, and hot fluids in lines, tubes, and compartments. Contact with any hot surface may cause burns.
- Always use tools that are in good condition. Make sure you have the proper understanding of how to use the tools before performing any service work. Use only genuine replacement parts from PACCAR.
- Always use the same fastener part number (or equivalent) when replacing items. DO NOT use a fastener of lesser quality if replacements are necessary. (e.g., DO NOT replace a Metric 10.9 grade with 8.8 grade fastener).
- Always torque fasteners and fuel connections to the required specifications. Overtightening or under-tightening can allow leakage.
- Close the manual fuel valves prior to performing maintenance and repairs, and when storing the vehicle inside.
- DO NOT perform any repair when impaired, tired, fatigued, or after consuming alcohol or drugs that can impair your functioning.
- Some state and federal agencies in the United States of America have determined that used engine oil can be carcinogenic and can cause reproductive toxicity. Avoid inhalation of vapors, ingestion, and prolonged contact with used engine oil.
- Coolant is toxic. If not reused, dispose of coolant in accordance with local environmental regulations.

**CAUTION**

Corrosive chemicals can damage the engine. DO NOT use corrosive chemicals on the engine. Failure to comply may result in equipment or property damage.



**California Proposition 65 Warning**

- Diesel engine exhaust and some of its constituents are known to the State of California to cause cancer, birth defects, and other reproductive harm.
- The catalyst substrate located in the Diesel Particulate Filter (DPF) contains vanadium pentoxide, which has been determined by the State of California to cause cancer. Always wear protective clothing and eye protection when handling the catalyst assembly. Dispose of the catalyst in accordance with local regulations. If catalyst material gets into the eyes, immediately flood eyes with water for a minimum of 15 minutes. Avoid prolonged contact with skin. In case of contact, immediately wash skin with soap and water. In case of harmful contact, immediately contact a physician.
- Other chemicals in this vehicle are also known to the State of California to cause cancer, birth defects, or other reproductive harm.

- Battery posts, terminals, and related accessories contain lead and lead compounds, chemicals known to the State of California to cause cancer and reproductive harm. Wash hands after handling.

**Repairs**

 **WARNING**

DO NOT attempt maintenance or repair work without sufficient training, proper tools, and up to date service instructions. Perform only those tasks you are fully qualified to do. Failure to comply could place personnel at risk or make the vehicle unsafe, which may result in death, personal injury, equipment damage or property damage.

 **WARNING**

Modifying your vehicle can make it unsafe. Some modifications can affect your vehicle's electrical system, stability control system, or other important functions. Before modifying your vehicle, check with your dealer to make

sure it can be done safely. Failure to comply may result in death, personal injury, equipment damage, or property damage.

 **CAUTION**

The installation of electronic devices to the On-board Diagnostics (OBD) connector, the vehicle Controller Area Network (CAN), or their associated wiring is not permitted. Doing so can adversely affect vehicle performance and/or cause fault codes to be recorded. The OBD connector is provided for temporary connection of service tools and for diagnostic purposes only.

Your dealer's service center is the best place to have your vehicle repaired. You can find dealers all over the country with the equipment and trained personnel to get you back on the road quickly—and keep you there.

Your vehicle is a complex machine. Anyone attempting repairs on it needs good mechanical training and the proper tools. However, all warranty repairs must be performed by a PACCAR Powertrain

distributor. If you aren't an experienced technician, or don't have the right equipment, please leave all repairs to a PACCAR Powertrain distributor. They are the ones best equipped to do the job safely and correctly.

### **Maintenance Manuals**

If you decide to do any complex repair work, you'll need the maintenance manuals. Order them from your PACCAR Powertrain distributor. Please provide your Chassis Serial Number when you order, to be sure you get the correct manuals for your vehicle. Allow about four weeks for delivery. There will be a charge for these manuals.

### **Final Chassis Bill of Material**

A complete, non-illustrated computer printout listing of the parts used to custom-build your vehicle is available through the dealer from whom you purchased your vehicle.



## Chapter 2 | FEATURES

Auto-neutral.....	13
Adaptive Driving Mode.....	13
Adaptive Starting Gear.....	13
Auto-park (option).....	13
Engine Overspeed Protection.....	14
Engine Underspeed Protection.....	14
Hill Start Aid (HSA) (option).....	14
Low Mode.....	14
Neutral Idle Control Plus (NIC+).....	14
Parking Pawl (option).....	15
Transmission Power Take-off (PTO) (option).....	15

## Auto-neutral

The Auto-neutral feature will automatically shift the transmission into Neutral if it is left in a forward or reverse mode (such as Low, Drive, or Reverse) and the parking brake is set. The transmission gear display shows **AN** when Auto-neutral is activated.

## Adaptive Driving Mode

This feature will adjust the transmission shift schedule, changing the shift points, based on

- Road grade
- Engine rpm
- Accelerator pedal position
- Vehicle weight (load)

These inputs help determine when to smoothly (and efficiently) shift between gears, improving fuel economy and performance. The transmission then retains the new shift schedule when making future shifting decisions. If vehicle load changes, load-based shifting will need to set a new shift schedule, adjusting the shift points after the first few shifts.

If the operator selects a gear that will result in engine lugging or overspeeding, the shift will be denied.

## Adaptive Starting Gear

This feature will automatically select the start gear depending on the following conditions:

- Vehicle weight (load)
- Road grade
- Axle/transmission ratio

The start gear selection can be changed using an upshift or downshift request, as long as the selection requested would not cause transmission damage or engine lugging.

Unacceptable start gear request will be denied (see [Start Gears](#) on page 25).

### NOTE

If the driver attempts to select a non-neutral mode without applying the service brake, the transmission will not shift into gear. If this is attempted, the driver will need to re-select Neutral

**(N)**, and then press the service brake before a new mode can be selected.

### NOTE

If vehicle weight drops (load is removed), this feature will maintain the start gear used before dropping weight unless a 30-second key cycle is performed (or if equipped with a Park Mode, remaining in Park **(P)** for one minute). This will adapt the feature to the new weight.

## Auto-park (option)

This feature prevents unintentional rolling should the operator forget to place the vehicle in Park. If equipped with a parking pawl, Auto-park will automatically place the transmission in Park **(P)** if the operator moves the ignition switch to **OFF** while the vehicle is stationary.

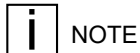

NOTE

If Auto-park has been activated, the transmission will not exit Park (P) until the shifter is first moved to P before selecting another transmission mode.

## Engine Overspeed Protection

The transmission will upshift to prevent an engine overspeed condition. Engine Overspeed Protection is active in Drive, Manual, and Low modes.

## Engine Underspeed Protection

The transmission will downshift to prevent engine lug (driving in high gear at low rpm) and a potential stall during an engine underspeed condition. Engine underspeed protection is active when in Drive or Manual Mode.

## Hill Start Aid (HSA) (option)

Hill Start Aid (HSA) prevents unwanted vehicle movement on steep grades when transitioning from the brake to throttle pedal. HSA can be disabled using the Hill Start Aid Disable switch (see [Hill Start Aid \(HSA\) Disable Switch \(option\)](#) on page 23).

HSA activates by default on a road grade of 3% or greater and whenever Neutral Idle Control Plus (NIC+) is active. See [Hill Start Aid Operation \(HSA\)](#) on page 25 for use.

## Low Mode

Low Mode restricts the transmission to first gear, providing additional torque. If activated while moving, Low Mode will downshift the transmission, slowing the vehicle, until first gear is achieved (see [Low Mode Operation](#) on page 25 for use). Use Low Mode to

- Stop the vehicle when carrying a heavy load while remaining in gear – this is assisted by activating the engine brake.

- Maintain smooth, continuous power when going up or down steep grades at a low vehicle speed (10 mph or less).



NOTE

Overspeed protection remains active while Low Mode is engaged.

## Neutral Idle Control Plus (NIC+)



NOTE

NIC+ is only available for vehicles equipped with air brakes.

This transmission will shift into neutral when the vehicle is stationary, and the service or parking brake is applied. NIC+ absolves the engine from providing power to the drivetrain when the vehicle has stopped, saving fuel and reducing the braking effort required by the operator to keep the vehicle stationary. When the parking or service brake is released, the transmission gradually, and automatically,

shifts back into gear, allowing the vehicle to creep forward normally.

## Parking Pawl (option)

This transmission may be equipped with a park setting that prevents the vehicle from rolling. The parking pawl is activated using the gear shift lever and can also be engaged (by spring force) when the vehicle is at a standstill and the ignition switch is turned to **OFF**. The parking pawl uses the pawl to lock the transmission output that engages in the meshing of the output shaft. This locks the rear wheels by means of the driveshaft.

### Parking Pawl Manual Release (option)

Transmissions with a Park Mode are also equipped with a way to disengage the parking pawl directly at the transmission. Using the manual release places the transmission in neutral and is useful when the transmission will not respond to gearing requests (for example, when the engine will not start) and the vehicle must be rolled. See [Manually Releasing the Parking Pawl](#) on page 25.

#### NOTE

Activating the parking pawl manual release will allow the vehicle to roll if the Parking Brake is not set. Make sure that the vehicle is prepared to be rolled, or that the Parking brake is set, prior to activating the manual release.

## Transmission Power Take-off (PTO) (option)

The transmission may have a PTO installed. (See [Stationary PTO Operation](#) on page 26 for use).

# Chapter 3 | INDICATIONS

3

Digital Display.....	17
Hill Start Aid (HSA) Disabled Warning Light (option).....	18



## Digital Display

### Primary Gauges View

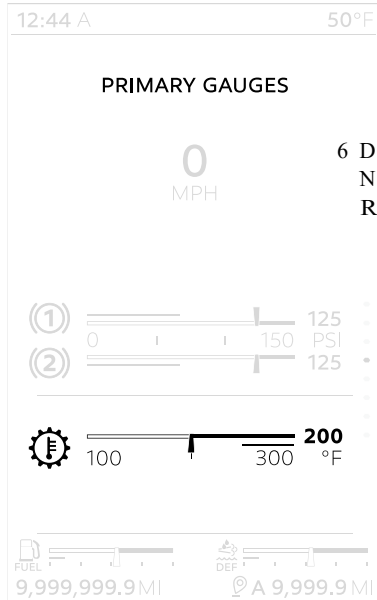

The digital display shows the following indications related to the transmission:

M 6 D  
 ▲ N Transmission Gear Display  
 R

 Transmission Temperature

### Transmission Gear Display

M 6 D  
 ▲ N  
 R

The Transmission Gear Display is located on the digital display and can show the transmission mode, current gear, and important transmission conditions:

The following indications appear next to **D** (Drive), when the feature or condition is active:

- 1 – 8 Forward Gear
- AN Auto Neutral
- L Low Mode

- M** Manual Mode
- Shift Position Unknown

The following indications appear next to **R** (Reverse), when the feature or condition is active:

- 1 Multi-reverse Gear
- Shift Position Unknown

The following indications appear in the Transmission Gear Display when the feature or condition is active:

- ! ≡ Critical Error

### Transmission Oil Temperature Gauge



The Transmission Temperature Gauge indicates the temperature of the oil in the transmission. Watch this gauge to know when the transmission is overheating. If so, have it checked by an authorized service representative.

3

### Hill Start Aid (HSA) Disabled Warning Light (option)



This warning means that the Hill Start Aid (HSA) feature is disabled. This may be from use of the Hill Start Aid Disable switch (see [Hill Start Aid Disable Switch](#)) or a fault with the HSA feature.



## Chapter 4 | CONTROLS

Column Shifter.....	21
Hill Start Aid (HSA) Disable Switch (option).....	23
Power Take-off (PTO) Switch (option).....	23

## Column Shifter

The column shifter, located on the right-hand side of the steering column, lets the operator perform the following transmission functions:

- Switch transmission modes
- Upshift and Downshift
- Activate Manual Mode

### Transmission Modes

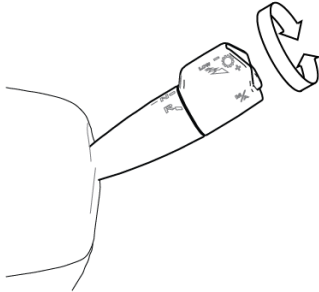

Select the transmission mode by rotating the shifter outer knob. There is a position

for Drive (**D**), Neutral (**N**), Reverse (**R**), and for some vehicles, Park (**P**).

Rotating the knob to the Park (**P**) or Reverse (**R**) position while the vehicle is moving forward, or to the Park (**P**) or Drive (**D**) position while the vehicle is moving backward, will not change the transmission mode to those selections.

The Digital Display will indicate the corresponding mode.



#### NOTE

Vehicles without a Park (**P**) Mode must be in Neutral (**N**) to start the engine.

## Upshifting and Downshifting

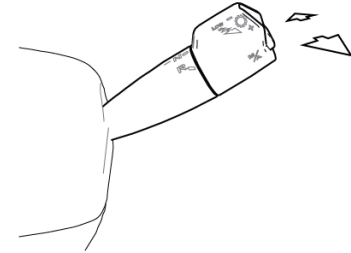

The transmission gear can be selected manually to accommodate the driving needs of the operator. The transmission mode must be in Drive to manually select the gear.

When in Automatic Mode

- Pushing or pulling the shifter will briefly upshift or downshift the transmission (for about four seconds); after which, the transmission will return to the ideal gearing for the current vehicle speed and engine use.

- Pushing and holding the shifter away will engage the Low Mode (see [Low Mode Operation](#) on page 25).

When in Manual Mode

- Pulling the shifter towards the operator (+) will upshift.
- Pushing the shifter away (-) will downshift.
- Pushing and holding the shifter away (-) will engage Low Mode (see [Low Mode Operation](#) on page 25).

The selected gear will appear on the Transmission Gear Display (see [Transmission Gear Display](#) on page 17).

### Manual and Automatic Modes

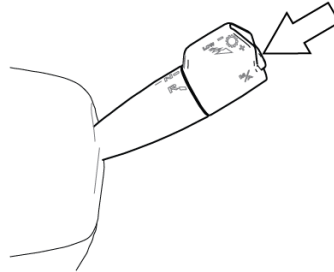

Pressing this button places the transmission in Manual Mode. Manual Mode allows the operator to select the gear (See [Upshifting and Downshifting](#) on page 21).

To activate, place the column shifter in Drive Mode (D), and then depress the Manual Mode button. When Manual Mode is selected, an **M** is shown in the Transmission Gear Display (See [Transmission Gear Display](#) on page 17).

### Exiting Manual Mode

To exit Manual Mode:

- Press the Manual Mode button
- Place the column shifter in Neutral (N)

### Manual Mode

Use Manual Mode when driving conditions make it preferable to select a particular gear instead of allowing the transmission to select it automatically.

The operator manually selects the start gear and uses the up/downshift request to change gears. The system will hold the current gear until another upshift or downshift request is made, except when the conditions for a *Transmission Manual Override* occur (see [Transmission Manual Override](#) on page 23).



#### NOTE

Multiple upshift or downshift requests may be allowed when the upshift/downshift request procedure is performed multiple times in succession. Each push or pull of the column shifter equals one gear change request.

For optimal vehicle performance, it is recommended the vehicle be operated in Automatic Mode.

### Transmission Manual Override

If the vehicle is being back-driven and the engine is approaching a higher than acceptable engine operation range, the transmission system will override Manual Mode and perform an upshift.

	<b>NOTE</b>
The transmission initiates upshifts from Manual Mode for engine over-speed protection.	

If the start gear is changed and it causes the engine to lug at takeoff, the transmission system will override Manual Mode and perform a downshift.

### Hill Start Aid (HSA) Disable Switch (option)

Two-position Switch



Positions:

- **OFF** (temporary position)
  - (center, resting position)
- OFF** Pressing the switch up temporarily disables the Hill Start Aid feature. Disabling Hill Start Aid presents both a notification and a warning light (see [Hill Start Aid \(HSA\) Disabled Warning Light \(option\)](#) on page 18).

Hill Start Aid is automatically re-enabled after the first successful launch.

### Power Take-off (PTO) Switch (option)

Two-position Switch



Positions:

- **ON**
  - **OFF**
- ON** Enables the PTO, starting the PTO activation process.
- OFF** Disables the PTO.

This vehicle may be equipped with a dash-mounted switch that controls PTO

engagement/disengagement. When the operator activates the switch for the PTO, the status indicator light (located on the switch) will immediately illuminate even though PTO engagement may not have occurred. If the PTO is engaged and the operator turns the switch **OFF**, the PTO status indicator light (located on the switch) will turn off immediately even though PTO disengagement may not have occurred.

	<b>CAUTION</b>
Increasing engine rpm before the PTO is engaged can prevent the PTO from engaging and/or cause PTO damage.	

## Chapter 5 | OPERATION

Start Gears.....	25
Hill Start Aid Operation (HSA).....	25
Low Mode Operation.....	25
Manually Releasing the Parking Pawl.....	25
PTO Operation.....	26
Snow/Ice Operation.....	26
Start-Up and Power Down.....	26
Vehicle Towing.....	27



## Start Gears

This transmission can be launched in the following start gears:

Drive 1<sup>st</sup> – 2<sup>nd</sup>

Reverse R1



### NOTE

The start gear selection will depend of conditions like the vehicle weight (load), the road grade, and the axle/ transmission ratio.

## Hill Start Aid Operation (HSA)

The Hill Start Aid feature is enabled by default but can be temporarily disabled by pressing and releasing the Hill Start Aid Disable Switch (see [Hill Start Aid \(HSA\) Disable Switch \(option\)](#) on page 23).

## Low Mode Operation



### WARNING

On slippery surfaces, minimize engine braking in Low Mode. Excessive engine braking at higher engine rpm may cause a loss of traction and vehicle control. Failure to comply may result in property damage, personal injury, or death.

The vehicle must be in Drive (**D**) to activate Low Mode.

1. Push and hold the shifter in the downshift position until **L** appears on the Transmission Gear Display, and then release the service brake.

The vehicle will remain in Low Mode until the operator either:

- Presses the Manual Mode button (see [Manual and Automatic Modes](#) on page 22).
- Pushes the column shifter away until **L** is removed from the Transmission Gear Display (see [Upshifting and Downshifting](#) on page 21).

- Shifts into (or through) Neutral (**N**).
- Turns the ignition switch to **OFF**.

## Manually Releasing the Parking Pawl

Releasing the parking pawl manually, at the transmission, requires use of the manual release lever. This procedure should not be performed without this lever.

- Manual release lever (only available as a service part)

5

### Parking Pawl Manual Release

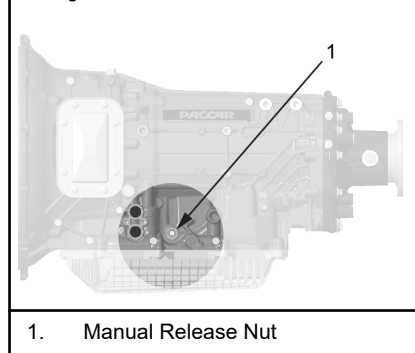

1. Manual Release Nut

Located at the midpoint, driver's side of the transmission.

1. Remove nut and washer at parking pawl release (1).
2. Attach the manual release lever and tighten nut (only two threads) (max torque – 7 lb·ft (9.5 N·m)).

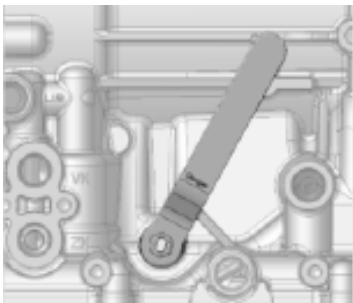

3. Turn lever clockwise until the lever hits stopping surface (maximum actuation torque – 11.8 lb·ft (16 N·m)).
4. Reapply nut and washer then tighten nut.

Until the manual release lever is repositioned to allow the parking pawl to engage, Park Mode will not be available.

## PTO Operation

### Stationary PTO Operation

The PTO is geared to the transmission torque converter, so the PTO will run at speeds proportional to engine rpm.

1. Bring the vehicle to a complete stop and apply the parking brake.



### WARNING

Apply parking brake and follow vehicle manufacturer parking instructions. Failure to follow these instructions could cause unintended vehicle movement resulting in death, serious injury or damage to property.

2. Select **N** (or **P**) on the column shifter.
3. Select the transmission PTO switch.
4. Raise engine speed as required to operate PTO.



### NOTE

Use the transmission PTO switch to disengage the PTO.

## Snow/Ice Operation

This transmission is designed to work in coordination with the Automatic Traction Control (ATC) system to ensure optimal operation. However, if the driver observes low friction road conditions (such as snow, rain, ice) and does not want the transmission to shift, risking wheel slippage, the driver should select Manual Mode. Manual Mode holds the current gear position under most operating conditions- the transmission will only shift when the driver makes an upshift or downshift request. Once road conditions improve, the driver should revert back to Drive Mode.

## Start-Up and Power Down

### Starting the Engine

The information provided in this topic is intended to enhance or amend the engine

start-up procedure located in the engine operator's and chassis operator's manuals specific for your vehicle. Familiarize yourself with the information in this topic, and then make the appropriate adjustments to those procedures, if necessary, when starting the engine.

- When instructed to set the transmission mode (shift lever) to Neutral (**N**), if your vehicle has a Park setting, Park (**P**) must be selected.

**NOTE**

The engine will not start if Neutral (or Park) is not selected on the gear-shift lever.

- When instructed to set the transmission mode or gear, press the service brake while selecting a new transmission mode using the gear-shift lever.

**Engine Shutdown**

The information provided in this topic is intended to enhance or amend the Engine Shutdown Procedure, Stopping the Vehicle, and Final Stopping Procedures

located in the Engine Operator's Manual and Chassis Operator's Manual specific for your vehicle. Familiarize yourself with the information in this topic, and make the appropriate adjustments to those procedures, if necessary, when shutting down the engine.

- If your vehicle has a Park setting, when instructed to set the transmission mode to Neutral (**N**), Park (**P**) or Neutral (**N**) may be selected. The Gear Display will reflect the appropriate transmission mode: **N** or **P**.

**NOTE**

If the gear display does not show a solid **N** (or **P**), the appropriate gear has not yet been obtained.

**NOTE**

Neutral (or Park) should always be reached before initiating power down, except in cases of emergency.

**Vehicle Towing**

When towing the vehicle, the output shaft of the transmission must not be allowed to spin or turn. If the vehicle is towed with the drive wheels still in contact with the road surface, the vehicle axle shafts or driveline must be removed or disconnected.

**CAUTION**

Always follow proper manufacturer towing procedures. Failure to follow proper towing procedures could result in damage to the transmission.

# Chapter 6 | MAINTENANCE

Automatic Transmission Maintenance.....	29
Preventative Maintenance.....	30
Peak Operational Temperature: 221°F (105°C).....	31
Peak Operational Temperature: 203°F (95°C).....	33
Peak Operational Temperature: 185°F (85°C).....	34
Lubrication.....	36
Troubleshooting.....	39

## Automatic Transmission Maintenance

An automatic transmission is a complex and expensive vehicle component requiring operational attention and proper maintenance to ensure long-lasting performance. This performance is impacted greatly by the quality of its lubricating fluid, which reduces friction between its many parts, facilitates gear shifting, and cools down the transmission components.

The chief factor that affects the durability of a lubricating fluid is temperature. When the operating temperature of the transmission increases, this fluid begins to break down, degrading its lubricating properties. Without proper lubrication, friction between components increases, breaking them down and building up sludge in the transmission. This will eventually result in transmission failure, requiring it to be replaced.

A transmission's peak operating temperature can be defined as its maximum general operating temperature and is determined by how the transmission is used. The "hard use" associated with

some truck applications — such as the stop-and-go conditions of CITY DELIVERY, or the hauling of heavy loads and trailer use associated with many VOCATIONAL and highway applications — will increase this peak operating temperature, and hasten the break down of the transmission lubricant.

Therefore, **it is essential** that proper lubrication maintenance is performed for the operational temperature specific for your transmission use.

Operational temperature data for this transmission can be collected by your PACCAR Powertrain distributor technician early in the truck's life (collected during the first 5,000 miles of operation (see First 3,000 – 5,000 mi interval)). The value of this data will depend on whether this early temperature data – which is based on truck application – is representative of how the vehicle will be used for the life of the truck.

### NOTE

If vehicle application changes significantly, the vehicle should be re-evaluated for a new peak operational temperature, and if necessary, observe the maintenance intervals associated with the new peak temperature.

Once the peak operating temperature is known, the appropriate maintenance tables can be observed. If the peak operating temperature has not been determined, assume the 95°C peak operating temperature intervals.

Unlike engine oil, transmission fluid serves as both a lubricant and a hydraulic fluid. The hydraulic pressure needed to shift gears smoothly (and avoid gear slippage) requires that the operator maintain transmission fluid in the proper range (see [Checking Transmission Fluid Level](#) on page 36). The operator should check their transmission fluid regularly, required as part of their weekly checks (see Weekly Checks in your chassis operator's manual).

## Preventative Maintenance

Preventive maintenance begins with the daily checks listed in your vehicle operator's manual. Routine vehicle checks can help avoid many large, expensive, and time consuming repairs, and will contribute to better, safer, and longer vehicle operation. Neglect of recommended maintenance can void your vehicle's warranty. Some maintenance operations demand skills and equipment you may not have. For such situations, please take your vehicle to a PACCAR Powertrain distributor.



### WARNING

Before attempting any procedure in the engine compartment, stop the engine and let it cool down. Hot fluids and components can burn skin on contact. Failure to comply may result in death, personal injury, equipment damage, or property damage.



### WARNING

If the engine must be running to inspect, be alert and cautious around the engine at all times. Failure to comply may result in death, personal injury, equipment or property damage.



### WARNING

If work must be done with the engine running, always:

- Ensure that the transmission is in neutral (**N**) or park (**P**)
- Set the parking brake
- Block the wheels

Failure to comply may result in death, personal injury, equipment or property damage.



### WARNING

DO NOT wear neckties, jewelry, and/or loose clothing, and secure long hair to avoid getting caught in the fan blades or other moving engine parts. Failure to comply may result in death,

personal injury, equipment damage, or property damage.



### WARNING

Always support the vehicle with appropriate safety stands if it is necessary to work underneath the vehicle. A jack is not adequate for this purpose. Failure to comply may result in death, personal injury, equipment or property damage.

 **WARNING**

When working underneath the vehicle with the wheels on the ground (not supported), make sure that

- The vehicle is on hard, level ground.
- The parking brake is applied.
- All wheels are blocked (front and rear).
- The ignition key is removed to prevent the engine from starting.

Failure to comply may result in death, personal injury, equipment damage or property damage.

 **WARNING**

NEVER start or let the engine run in an enclosed, unventilated area. Engine exhaust fumes contain carbon monoxide, a colorless and odorless gas. Carbon monoxide can be fatal if inhaled. Failure to comply may result

in property damage, personal injury, or death.

The tables on the following pages contain maintenance tasks. These tasks should be performed at the interval labeled at the top of the table, which are based either on vehicle mileage, or vehicle mileage and time passed since the last time that task was performed. Some tasks depend on vehicle application -- or how and where the vehicle is operated. These tasks will have the words ON-HIGHWAY, OFF-HIGHWAY, CITY DELIVERY, or VOCATIONAL after the description and should be performed if the vehicle is operated for that application:

- ON-HIGHWAY – Applications where the vehicle is only used on paved roads during normal operation.
- OFF-HIGHWAY – Applications where the vehicle may be driven off the pavement on a regular basis, even if it is an infrequent basis and/or for a brief time period.
- CITY DELIVERY – Applications where frequent start and stopping is required during normal operation, and highway use is infrequent and for short intervals.

- VOCATIONAL – Applications based on truck configuration and use and not on operating environment. Vocational vehicle components must meet the requirements needed for its specific application (such as delivery, construction, fire service, refuse, and busing). A truck can be Vocational in addition to other application types. Vehicles that fall into more than one application category should observe the earliest and more limiting application's maintenance requirements.

If there are questions regarding which intervals to follow, please contact a PACCAR Powertrain distributor. Consult the supplier for specific recommendations where discrepancies develop between the recommendations in the following maintenance tables and the component supplier recommendations.

## Peak Operational Temperature: 221°F (105°C)

**First 3,000-5,000 mi / 4,800-8,000 km**

Main and Auxiliary Transmission

- Take vehicle to a PACCAR Powertrain distributor to determine the peak operating temperature for specific vehicle application. This temperature will determine which transmission maintenance intervals should be used for this vehicle (see [Automatic Transmission Maintenance](#) on page 29).

**Every 60,000 mi / 96,000 km / 6 mos**

Main and Auxiliary Transmission – Oil Cooler

- Clean the fins (air-to-oil type) and body. Check the hose condition and for leaks: replace as required. (Refer to Cooling System Maintenance in your chassis operator's manual maintenance instructions.)

**Every 37,000 mi / 60,000 km / 3 yr**

Main and Auxiliary Transmission – (VOCATIONAL and OFF-HIGHWAY)

- Drain lubricant while warm. Flush each unit with clean flushing oil and refill. Contact your PACCAR Powertrain distributor to drain the transmission.



**Every 74,000 mi / 120,000 km / 4 yr**

Main and Auxiliary Transmission – (CITY DELIVERY)

- Drain lubricant while warm. Flush each unit with clean flushing oil and refill. Contact your PACCAR Powertrain distributor to drain the transmission.

**Every 111,000 mi / 180,000 km / 4 yr**

Main and Auxiliary Transmission – (ON-HIGHWAY)

- Drain lubricant while warm. Flush each unit with clean flushing oil and refill. Contact your PACCAR Powertrain distributor to drain the transmission.

**Peak Operational  
Temperature: 203°F (95°C)**

**First 3,000-5,000 mi / 4,800-8,000 km**

Main and Auxiliary Transmission

- Take vehicle to a PACCAR Powertrain distributor to determine the peak operating temperature for specific vehicle application. This temperature will determine which transmission maintenance intervals should be used for this vehicle (see [Automatic Transmission Maintenance](#) on page 29).

**Every 60,000 mi / 96,000 km / 6 mos**

Main and Auxiliary Transmission – Oil Cooler

- Clean the fins (air-to-oil type) and body. Check the hose condition and for leaks: replace as required. (Refer to Cooling System Maintenance in your chassis operator's manual maintenance instructions.)

Main and Auxiliary Transmission – (VOCATIONAL and OFF-HIGHWAY)

- Drain lubricant while warm. Flush each unit with clean flushing oil and refill. Contact your PACCAR Powertrain distributor to drain the transmission.

**Every 120,000 miles / 193,000 km / 4 yr**

Main and Auxiliary Transmission – (CITY DELIVERY)

- Drain lubricant while warm. Flush each unit with clean flushing oil and refill. Contact your PACCAR Powertrain distributor to drain the transmission.

**Every 223,000 miles / 360,000 km / 4 yr**

Main and Auxiliary Transmission – (ON-HIGHWAY)

- Drain lubricant while warm. Flush each unit with clean flushing oil and refill. Contact your PACCAR Powertrain distributor to drain the transmission.

**Peak Operational  
Temperature: 185°F (85°C)**

**First 3,000-5,000 mi / 4,800-8,000 km**

Main and Auxiliary Transmission

- Take vehicle to a PACCAR Powertrain distributor to determine the peak operating temperature for specific vehicle application. This temperature will determine which transmission maintenance intervals should be used for this vehicle (see [Automatic Transmission Maintenance](#) on page 29).

**Every 60,000 mi / 96,000 km / 6 mos**

Main and Auxiliary Transmission – Oil Cooler

- Clean the fins (air-to-oil type) and body. Check the hose condition and for leaks: replace as required. (Refer to Cooling System Maintenance in your chassis operator's manual maintenance instructions.)

**Every 111,000 mi / 180,000 km / 3 yr**

Main and Auxiliary Transmission – (VOCATIONAL and OFF-HIGHWAY)

- Drain lubricant while warm. Flush each unit with clean flushing oil and refill. Contact your PACCAR Powertrain distributor to drain the transmission.

**Every 223,000 mi / 360,000 km / 4 yr**

Main and Auxiliary Transmission – (CITY DELIVERY)

- Drain lubricant while warm. Flush each unit with clean flushing oil and refill. Contact your PACCAR Powertrain distributor to drain the transmission.

**Every 335,000 mi / 540,000 km / 4 yr**

Main and Auxiliary Transmission – (ON-HIGHWAY)

- Drain lubricant while warm. Flush each unit with clean flushing oil and refill. Contact your PACCAR Powertrain distributor to drain the transmission.

6

**Lubrication**

Proper lubrication procedures are key to a good all-around maintenance program. If the lubricant is not doing its job or if the lubricant level is ignored, all other maintenance procedures are not going to keep the transmission running or assure long transmission life.

Transmission internal parts are amply lubricated if these procedures are closely followed:

1. Maintain lubricant level and inspect regularly.

2. Follow maintenance intervals (see [Preventative Maintenance](#) on page 30).
3. Use the correct grade and type of lubricant, see [Lubricant Specifications](#) on page 42.
4. Buy lubricant from an approved dealer.

2. Idle engine at 600 rpm to 800 rpm until transmission temperature reaches 104°F ( 40°C).

**Checking Transmission Fluid Level**

Required tools:

- Clean cloth or paper towel
1. Park vehicle on level surface, engage parking brake, and start engine.

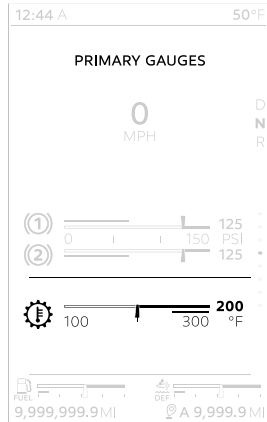

3. Unlatch hood hold-downs, and open hood.
  4. Find the red-handled transmission-fluid dipstick, located drivers-side, outward of the engine.
  5. Twist and remove dipstick, and wipe clean using towel or cloth.
  6. Reinsert dipstick fully and remove again.
- Be careful, fluid may be hot.
7. Check fluid level in the Warm range.

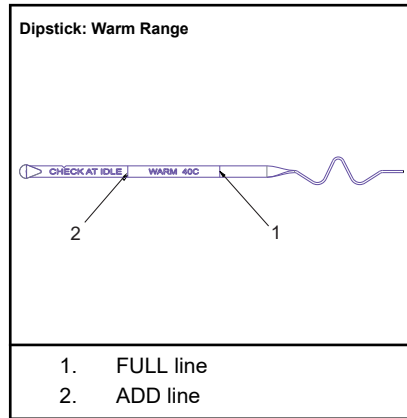

**i** NOTE

Observe markings at end of dipstick. Your dipstick has a full and add line for three temperature ranges: hot, warm, and cold. The hot and cold ranges are on one side, the warm range on the other.

8. If fluid level is not at the full line, add transmission fluid (see [Adding Transmission Fluid](#) on page 37).

9. Close hood and latch hood hold-downs.

### Adding Transmission Fluid

Required tools:

- Clean cloth or paper towel
- Automatic Transmission Fluid (See [Lubricant Specifications](#) on page 42)
- 3/4" (18mm) Wrench
- Oil pump
- O-ring (new)

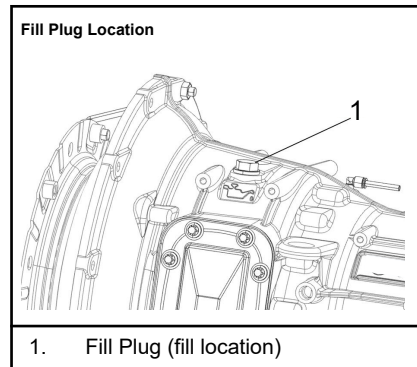



**CAUTION**

Acceptable transmission fluids vary depending on transmission design. Prior to adding fluid, be sure to locate the dipstick tag for the fluid type compatible with your vehicle's transmission. Information about the transmission fluid can also be found on the transmission type plate. This can be viewed from under the truck: "TE-ML31" = ATF818/ZF Lifeguard Hybrid 2. "TE-ML26" = ZF-Ecofluid Life Plus. Transmission oils should never be mixed. Adding incompatible fluid can result in poor transmission shifting quality, decreased transmission performance, or both. For any questions or concerns, contact a PACCAR service location for more details. Below is an example of the location of the dipstick tag with the approved fluid type for this vehicle. Failure to comply may result in equipment or property damage.

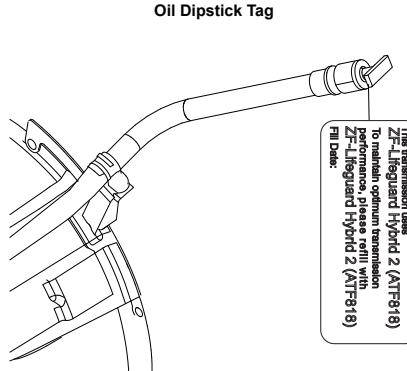

Oil Dipstick Tag

**This transmission uses ZF-Lifeguard Hybrid 2 (ATF818)**  
**To maintain optimum transmission performance, please refill with ZF-Lifeguard Hybrid 2 (ATF818)**  
**Fill Date:**

- Using an oil pump, add a small amount of fluid at fill location.



**NOTE**

**DO NOT** add fluid into dipstick housing.

- Find the red-handled transmission-fluid dipstick, located drivers-side, outward of the engine.
- Twist and remove the dipstick and wipe clean with a towel or cloth.
- Continue to fill and then check until fluid level on the dipstick indicates **FULL**.



**NOTE**

**DO NOT** fill past the **FULL** line.

- Apply transmission fluid to the new O-ring and replace the O-ring at fill location.
- Clean, then replace plug at fill location. Tighten the plug to 25.8 lb-ft (35 N·m).

Dispose of cloth/towel and old O-ring properly.

### Draining the Transmission

Draining lubricating fluid from the transmission should only be performed during fluid replacement or a repair. Take your vehicle to a PACCAR Powertrain distributor for maintenance processes that require draining transmission lubricant. See [Transmission Lubricant Capacities](#) on page 41 and [Lubricant Specifications](#) on page 42 for more information on the amount and type of lubricant required for this transmission.

## Troubleshooting

### Diagnostics

In the event there is a problem with this transmission, there are three primary tasks the driver should perform:

1. Note the driving condition under which the problem occurred.
2. Note the condition of the transmission under which the problem occurred (such as operation mode (Drive, Manual, Low), current gear, and engine speed).
3. Reset system.

### Transmission Reset Procedure

In some cases, proper transmission operation can be restored by “resetting” the Transmission Control Module (TCM). Use the following procedure to reset the TCM.

1. Continue to drive the vehicle to a safe location before selecting neutral (**N**).

	<b>NOTE</b>
Once neutral ( <b>N</b> ) is selected, a gear engagement may not be allowed depending on the specific problem.	

2. Place the transmission in neutral (**N**).
3. Set the vehicle parking brake.

	<b>WARNING</b>
Apply parking brake and follow vehicle manufacturer parking instructions. Failure to follow these instructions could cause unintended vehicle movement resulting in death, serious injury or damage to property.	

4. Turn the vehicle ignition switch to **OFF**.

5. Wait at least 2 minutes.
6. Restart the engine.
7. If the problem continues, contact a service facility to have the vehicle and transmission system evaluated.

# Chapter 7 | SPECIFICATIONS

General Model Information.....	41
Transmission Lubricant Capacities.....	41
Lubricant Specifications.....	42
Roadside Assistance.....	43



## General Model Information

### Model Nomenclature

Following is a nomenclature tree that describes the multiple configurations of the transmission model numbers:

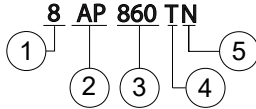

- 1 Number of Gears
- 2 Automatic Powershift
- 3 Maximum Engine Torque (lb•ft)
- 4 Application  
T = Truck  
B = Bus  
P = Pickup
- 5 North America

### Transmission Identification Tag

All transmissions are identified by the model and serial number. This information is stamped on the transmission identification tag and affixed to the case.

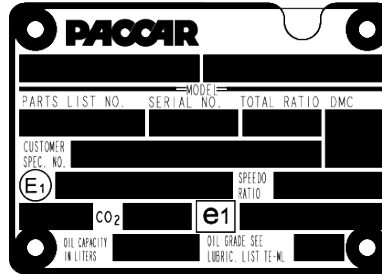

**i** NOTE

Do not remove or destroy the transmission identification tag.

The blank spaces provided below are for recording transmission identification data. Have these reference numbers handy when ordering replacement parts or requesting service information:

Transmission Model \_\_\_\_\_

Transmission Serial Number \_\_\_\_\_

## Transmission Lubricant Capacities

The oil capacities listed here reflect the approximate total amount required to maintain transmission lubrication in the operating range for the stated vehicle and hood configuration. The oil capacity listed on the transmission label plate is the amount needed to fill the transmission *only* and does not include the additional amount needed for hosing and/or an oil cooler.

### Medium Duty

Hood Type	Pints (US)	Liters
Standard	37.8	17.9
Aero	37.8	17.9
Vocational	40.0	18.9

Transmissions equipped with Power Take-off (PTO) have larger capacities than those listed here.

### Lubricant Specifications



#### CAUTION

Only use lubricants approved for this transmission. Failure to use an approved lubricant can break down both lubrication and transmission components, resulting in degraded performance and equipment damage, and may affect warranty coverage



#### CAUTION

DO NOT use additives or friction modifiers. Neither are approved for this transmission. Using an additive or friction modifier can break down both lubrication and transmission components, resulting in degraded performance and equipment damage, and may affect warranty coverage.

PACCAR approves the use of **ATF818/ZF Lifeguard Hybrid 2** synthetic transmission fluid for the TX-8 transmission.

Use of ATF818/ZF Lifeguard Hybrid 2,

- Saves fuel
- Reduces operating and maintenance costs
- Increases shift comfort
- Is environmentally friendly
- Works in both hot and cold climates.



#### CAUTION

Acceptable transmission fluids vary depending on transmission design.

Prior to adding fluid, be sure to locate the dipstick tag for the fluid type compatible with your vehicle's transmission. Information about the transmission fluid can also be found on the transmission type plate. This can be viewed from under the truck: "TE-ML31" = ATF818/ZF Lifeguard Hybrid 2. "TE-ML26" = ZF-Ecofluid Life Plus. Transmission oils should never be mixed. Adding incompatible fluid can result in poor transmission shifting quality, decreased transmission performance, or both. For any questions or concerns, contact a PACCAR service location for more details. Below is an example of the location of the dipstick tag with the approved fluid type for this vehicle. Failure to comply may result in equipment or property damage.

Oil Dipstick Tag

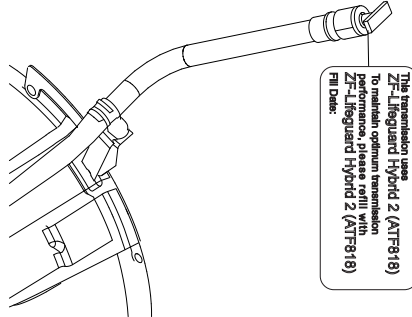

This transmission uses  
**ZF-Lifeguard Hybrid 2 (ATF818)**  
 To maintain optimum transmission  
 performance, please refill with  
**ZF-Lifeguard Hybrid 2 (ATF818)**  
 Fill Date:



**CAUTION**

Avoid mixing different lubricants. Failure to use an approved lubricant can break down both, lubrication and transmission components, resulting in degraded performance, equipment or property damage.



**NOTE**

The maintenance intervals contained in this manual assume the use of ATF818/ZF Lifeguard Hybrid 2. Use of another lubricant invalidates the extended oil change intervals presented.

## Roadside Assistance

Open 24 hours a day, 365 days a year, call toll-free to talk to someone at the PACCAR Vehicle Support Center:

- Kenworth customers  
**1-800-KW-Assist**  
**(1-800-592-7747)**
- Peterbilt customers  
**1-800-4Peterbilt**

**(1-800-473-8372)**

The PACCAR Vehicle Support Center

- Uses a custom mapping system that locates PACCAR Powertrain distributors and Independent Service Providers (ISPs) near you, listing services offered, hours of operation, and contact information.
- Assists with jump and pull starts, tires, trailers, fines and permits, chains, towing, hazardous clean-up, out of fuel (roadside), mechanical repairs and preventive maintenance services.
- Employs multilingual agents and has access to a translation service, ensuring quality assistance for customers in many languages.
- Places you in contact with a PACCAR Powertrain distributor who can answer your warranty questions.
- Provides these services for FREE.

# Index

## A

- Adaptive Driving Mode [13](#)
- Adaptive Starting Gear [13](#)
- Adding Transmission Fluid [37](#)
- Auto-neutral [13](#)
- Auto-park [13](#)
- Automatic Mode, See Manual and Automatic Modes
- Automatic Transmission Maintenance [29](#)

## C

- Changing gears, See Column Shifter
- Checking Transmission Fluid Level [36](#)

### Column Shifter

- Manual and Automatic Modes [22](#)
- Transmission Modes [14](#), [21](#)

## D

- Diagnostics [39](#)
- Digital Display
  - Transmission Gear Display [17](#)
  - Transmission Temperature Gauge [17](#)
- DNRP, See Transmission Modes

## E

- Emergency Release, See Manually Releasing the Parking Pawl
- Engine Overspeed Protection [14](#)

- Engine Shutdown [27](#)
- Engine Underspeed Protection [14](#)

## F

- Final Chassis Bill of Material [10](#)

## G

- Gear Display [17](#)
- General Safety Instructions [6](#)

## H

### Hill Start Aid

- Disable Switch [23](#)
- Hill Start Aid (HSA) Disabled Warning Light [18](#)
- Operation [25](#)

## I

- Identification Tag [41](#)
- Illustrations [6](#)

## L

### Low Mode

- Low Mode [14](#)

Low Mode Operation [25](#)  
Lubricant Specifications [42](#)

## Lubrication

Draining the Transmission [39](#)

## M

Maintenance Manuals [10](#)  
Manual and Automatic Modes [22](#)  
Manual Mode [22](#)  
Manually Releasing the Parking Pawl [25](#)  
Model Nomenclature [41](#)

## N

Neutral Idle Control, *See* Neutral Idle Control Plus  
Neutral Idle Control Plus (NIC+) [14](#)

## O

Override [23](#)

## P

Parking Pawl [15](#)  
Parking Pawl Manual Release [15](#)  
Parking Pawl Release, *See* Manually Releasing the Parking Pawl  
Peak Operational Temperature: 185°F (85°C)

Every 111,000 mi / 180,000 km / 3 yr [34](#)  
Every 223,000 miles / 360,000 km / 4 yr [34](#)  
Every 335,000 miles / 540,000 km / 4 yr [34](#)  
Every 60,000 mi / 96,000 km / 6 mos [31](#), [33](#), [34](#)  
First 3,000-5,000 mi / 4,800-8,000 km [31](#), [33](#), [34](#)

Peak Operational Temperature: 203°F (95°C)

Every 120,000 miles / 193,000 km / 4 yr [33](#)

Peak Operational Temperature: 203°F (95°C) (*continued*)

Every 223,000 miles / 360,000 km / 4 yr [33](#)  
Every 60,000 mi / 96,000 km / 6 mos [31](#), [33](#), [34](#)  
First 3,000-5,000 mi / 4,800-8,000 km [31](#), [33](#), [34](#)

Peak Operational Temperature: 221°F (105°C)

Every 111,000 mi / 180,000 km / 4 yr [31](#)  
Every 37,000 mi / 60,000 km / 3 yr [31](#)  
Every 60,000 mi / 96,000 km / 6 mos [31](#), [33](#), [34](#)  
Every 74,000 mi / 120,000 km / 4 yr [31](#)  
First 3,000-5,000 mi / 4,800-8,000 km [31](#), [33](#), [34](#)

Power Take-off (PTO)

PTO Switch [23](#)

Preventative Maintenance [30](#)

## R

Repairs [9](#)  
Roadside Assistance [43](#)

## S

Safety Messages and Notes [5](#)  
Shifter, *See* Column Shifter  
Shutting Down the Engine, *See* Engine Shutdown  
Start Gears [25](#)  
Starting the Engine [26](#)  
Stationary PTO Operation [26](#)

## T

Transmission Gear Display [17](#)  
Transmission Lubricant Capacities [41](#)

Transmission Modes

Low [14](#)

Transmission Oil Temperature Gauge [17](#)  
Transmission Reset Procedure [39](#)

## U

Upshifting and Downshifting [21](#)

Using this Manual [5](#)

## V

Vehicle Towing [27](#)

**PACCAR**<sup>inc</sup>  
Powertrain  
P.O. Box 1518  
Bellevue, WA 98009

Y53-1331-1B1