



(86) Date de dépôt PCT/PCT Filing Date: 2000/10/04
 (87) Date publication PCT/PCT Publication Date: 2001/04/26
 (85) Entrée phase nationale/National Entry: 2002/04/09
 (86) N° demande PCT/PCT Application No.: US 2000/027270
 (87) N° publication PCT/PCT Publication No.: 2001/029573
 (30) Priorité/Priority: 1999/10/19 (60/160,326) US

(51) Cl.Int.⁷/Int.Cl.⁷ G01C 21/00, G06F 17/30, G06F 19/00
 (71) Demandeur/Applicant:
 AMERICAN CALCAR INC., US
 (72) Inventeurs/Inventors:
 OBRADOVICH, MICHAEL L., US;
 PIRTLE, JOHN D., US;
 SCHEBESCH, STEVEN W., US
 (74) Agent: MBM & CO.

(54) Titre : TECHNIQUE DE NAVIGATION EFFICACE BASEE SUR DES PREFERENCES D'UTILISATEURS
 (54) Title: TECHNIQUE FOR EFFECTIVE NAVIGATION BASED ON USER PREFERENCES

(57) **Abrégé/Abstract:**

In a navigation device (100) in accordance with the invention, user profiles may be stored and used to navigate a user who may be driving in a vehicle, on foot, or in other mode of transportation. Each user profile corresponds to one of the user's personae. For example, the user business profile (113) corresponding to the user's business persona may be different from the user personal profile (203) corresponding to the user's personal persona. For instance, the user business profile may include fine dining type restaurants (215) for business meetings while the user personal profile may instead include fast-food type restaurants for personal dining.

(12) INTERNATIONAL APPLICATION PUBLISHED UNDER THE PATENT COOPERATION TREATY (PCT)

(19) World Intellectual Property Organization
International Bureau



(43) International Publication Date
26 April 2001 (26.04.2001)

PCT

(10) International Publication Number
WO 01/29573 A2

- (51) International Patent Classification⁷: **G01S**
- (21) International Application Number: PCT/US00/27270
- (22) International Filing Date: 4 October 2000 (04.10.2000)
- (25) Filing Language: English
- (26) Publication Language: English
- (30) Priority Data:
60/160,326 19 October 1999 (19.10.1999) US
- (71) Applicant (for all designated States except US): **AMERICAN CALCAR INC.** [US/US]; Suite 105, 3511 Silverside Road, Wilmington, DE 19810 (US).
- (72) Inventors; and
- (75) Inventors/Applicants (for US only): **OBRADOVICH, Michael, L.** [US/US]; 1904 Aveneda Salvador, San Clemente, CA 92672 (US). **PIRTLE, John, D.** [US/US]; 29262 Hazelbell, Silverado, CA 92676 (US). **SCHEBESCH, Steven, W.** [US/US]; 23411 Summerfield #42J, Aliso Viejo, CA 92656 (US).
- (74) Agent: **YIP, Alex, L.**; Kaye, Scholer, Fierman, Hays & Handler, LLP, 425 Park Avenue, New York, NY 10022 (US).
- (81) Designated States (*national*): AE, AG, AL, AM, AT, AU, AZ, BA, BB, BG, BR, BY, BZ, CA, CH, CN, CR, CU, CZ, DE, DK, DM, DZ, EE, ES, FI, GB, GD, GE, GH, GM, HR, HU, ID, IL, IN, IS, JP, KE, KG, KP, KR, KZ, LC, LK, LR, LS, LT, LU, LV, MA, MD, MG, MK, MN, MW, MX, MZ, NO, NZ, PL, PT, RO, RU, SD, SE, SG, SI, SK, SL, TJ, TM, TR, TT, TZ, UA, UG, US, UZ, VN, YU, ZA, ZW.
- (84) Designated States (*regional*): ARIPO patent (GH, GM, KE, LS, MW, MZ, SD, SL, SZ, TZ, UG, ZW), Eurasian patent (AM, AZ, BY, KG, KZ, MD, RU, TJ, TM), European patent (AT, BE, CH, CY, DE, DK, ES, FI, FR, GB, GR, IE, IT, LU, MC, NL, PT, SE), OAPI patent (BF, BJ, CF, CG, CI, CM, GA, GN, GW, ML, MR, NE, SN, TD, TG).
- Published:**
— Without international search report and to be republished upon receipt of that report.
- For two-letter codes and other abbreviations, refer to the "Guidance Notes on Codes and Abbreviations" appearing at the beginning of each regular issue of the PCT Gazette.

(54) Title: **TECHNIQUE FOR EFFECTIVE NAVIGATION BASED ON USER PREFERENCES**

(57) Abstract: In a navigation device in accordance with the invention, user profiles may be stored and used to navigate a user who may be driving in a vehicle, on foot, or in other mode of transportation. Each user profile corresponds to one of the user's personae. For example, the user business profile corresponding to the user's business persona may be different from the user personal profile corresponding to the user's personal persona. For instance, the user business profile may include fine dining type restaurants for business meetings while the user personal profile may instead include fast-food type restaurants for personal dining. The inventive navigation device provides the user with a navigated route, together with information concerning the favorite facilities and events surrounding the navigated route, which satisfy the preferences in a selected user profile. In accordance with an aspect of the invention, blockages may also be established using the device to avoid selected areas, e.g., high crime areas, in the navigated route, or to block transmission of selected information concerning, e.g., uninteresting facilities and events, to the inventive navigation device.

WO 01/29573 A2

Description**TECHNIQUE FOR EFFECTIVE NAVIGATION
BASED ON USER PREFERENCES**Field of the Invention

5 The invention relates to a navigation technique, and more particularly to a technique for navigation subject to user preferences.

Background of the Invention

10 Recently, navigation systems based on global positioning system (GPS) technology were developed for use in an automobile. Such navigation systems are capable of receiving signals from a constellation of satellites which is part of the GPS. Based on the received signals, one such navigation system identifies
15 the automobile's location, e.g., in latitude and longitude. The navigation system also detects the automobile's speed and direction. With geographic information stored in an on-board computer in the automobile, the navigation system is capable of audio-
20 visually communicating to a user instructions for reaching a given destination.

 Similarly, a GPS navigation device in hand-held form enables a user carrying the device to monitor his/her planned route leading to a given destination.
25 Nowadays, in general, hand-held devices for information organization and communications are popular and have been proliferating. For example, use of cellular phones for communications is ubiquitous. Use of personal data assistants (PDAs), e.g., PALM type hand-held devices, is
30 equally ubiquitous for organizing personal information including meeting schedules, telephone listing, address information, etc. More recently, hand-held communicators emerged which have cellular communication and modem facilities integrated into a PDA, thereby enabling a user

-2-

to communicate data in a wireless manner, e.g., to send and receive email, and to upload and download information from websites via the Internet.

Summary of the Invention

5 Traditionally, a navigation device, e.g., a GPS navigation system used in an automobile, provides a user with directions to a given destination. The navigation typically provides the shortest navigated route in terms of distance to the given destination. However, we have
10 expanded the concept of the traditional navigation to broadly include providing a navigated route subject to user preferences, together with information concerning facilities and events surrounding the navigated route for the user's convenience. The navigated route is selected
15 to satisfy a trip's purpose. Such a trip's purpose may be (1) to reach a given destination as in prior art, and/or (2) to perform certain tasks enroute or at the destination, which may include purchasing business supplies, shopping for gifts, dining, obtaining
20 entertainments, etc. To realize (2), the navigator arrangement in accordance with the invention allows for storage of user profiles including user preferences such as preferred types of restaurants, shops, entertainments, etc.

25 In accordance with an aspect of the invention, each user profile corresponds to one of the user's personae. For example, the user business profile corresponding to the user's business persona may be different from the user personal profile corresponding to
30 his/her personal persona. For instance, the user business profile may include fine-dining type restaurants for business meetings while the user personal profile may instead include fast-food type restaurants for personal dining. Thus, the navigator arrangement in accordance

-3-

with the invention provides a navigated route, together with information concerning the favorite facilities and events surrounding the navigated route, which satisfy the preferences in a selected user profile.

5 In accordance with another aspect of the invention, the user can adopt a second person's profile for a trip's purpose particular to that second person, thereby temporarily assuming the second person's persona to achieve such a trip's purpose.

10 In accordance with yet another aspect of the invention, the actual navigated route selected by the inventive navigator arrangement may depend on the mode of transportation specified by the user. For example, driving and walking are two different modes of
15 transportation. The selected route for driving may be very different from that for walking, even though they may accomplish the same trip's purpose. The routes from which the inventive navigator arrangement selects for driving have to be passable by an automobile, which
20 exclude, e.g., foot bridges, and walk paths through buildings, parks, fields, forests, etc. On the other hand, the routes from which the inventive navigator arrangement selects for walking have to be safe to pedestrians, which exclude, e.g., highways, freeways,
25 etc.

 In accordance with still yet another aspect of the invention, the actual route selected by the inventive navigator arrangement may also depend on external conditions, e.g., traffic, weather and road conditions.
30 Thus, based on the information concerning such external conditions received from, say, a server via the Internet, the inventive navigator arrangement selects the most time-efficient route, e.g., one that requires the least travel time, to accomplish the trip's purpose despite any
35 adverse traffic, weather and road conditions.

-4-

In accordance with a further aspect of the invention, a user may prescribe one or more roadblocks specifying certain prohibited areas or paths from which the route selected by the inventive navigator arrangement deviates. For example, it may be sensible to place roadblocks around high crime areas especially when the user is new in town and unfamiliar with those areas. A roadblock may be permanent or temporary. For example, a temporary roadblock may be placed on certain streets where a parade is held which lasts for several hours. Similar to a roadblock, a blockade may be imposed to block transmission of certain information to the inventive navigator arrangement which concerns, e.g., uninteresting facilities or events.

15

Brief Description of the Drawing

Further aspects, features and advantages of the invention will become apparent from the following detailed description taken in conjunction with the accompanying drawing showing an illustrative embodiment of the invention, in which:

Fig. 1 is a block diagram of a navigator arrangement in accordance with the invention;

Fig. 2 illustrates a registration page shown on a display in the arrangement of Fig. 1;

Fig. 3 illustrates a profile setting page shown on the display;

Fig. 4 illustrates the format of a user record stored in a memory of the arrangement of Fig. 1;

Fig. 5 illustrates a setup where the arrangement of Fig. 1 communicates with a remote server through a communications network;

Fig. 6 illustrates a personal favorite list shown on the display;

Fig. 7 illustrates preset profiles shown on the

-5-

display;

Fig. 8 illustrates a navigation page shown on the display;

Fig. 9 illustrates a directions page shown on
5 the display;

Fig. 10 is a flow chart depicting a navigation process based on certain information in the record of Fig. 4;

Fig. 11 illustrates a map viewer page shown on
10 the display;

Fig. 12 illustrates a restaurant page shown on the display;

Fig. 13 illustrates a restaurant menu page shown on the display; and

Fig. 14 illustrates an inquiry page where a
15 user is presented a choice of blockades in accordance with the invention.

Detailed Description

Fig. 1 illustrates navigator arrangement 100
20 embodying the principles of the invention for navigation subject to user preferences. Navigator arrangement 100 in this instance is realized as a hand-held device, which may be "docked" or connected to another device or system to enhance its functionality, which may include a
25 terminal, workstation, computer system, or an automobile system described, e.g., in U.S. Patent No. 6,009,355 issued to Obradovich et al. on December 28, 1999.

As shown in Fig. 1, navigator arrangement 100 includes processor 103, memory 108, display driver 111,
30 display 113, user interface 115, external interfaces 117, GPS receiver 119, communication unit 120. Memory 108 is used to store software and data for processor 103 to carry out various operations of arrangement 100. In this instance, the stored software includes a navigator

-6-

browser similar to the well known NETSCAPE NAVIGATOR or MICROSOFT INTERNET EXPLORER web browser for browsing information provided, e.g., by servers connected to the Internet. In particular, the navigator browser works
5 compatibly with the standard hypertext transfer protocol (HTTP), hypertext markup language (HTML), virtual reality markup language (VRML), graphics interchange format (GIF), JAVA applets, etc.

Display 113 may include a conventional liquid
10 crystal display (LCD). Through display driver 111, processor 103 controls the display of text and graphics on display 113 in a predetermined format. User interface 115 may comprise conventional audio circuitry including a microphone and speaker for the user to communicate with
15 arrangement 100 via audio media. User interface 115 may also comprise an indicator device, e.g., a mouse, touchpad, roller ball, or a combination thereof, which enables a user to move a cursor on display 113 and to, e.g., point and click at a displayed option or an icon to
20 select same. In addition, interface 115 may incorporate well-known touch-screen circuitry (not shown). With this circuitry, the user can interact with processor 103, e.g., using a finger or a stylus to touch the surface of display 113 which is tactile-sensitive. Processor 103
25 receives from the touch screen circuitry a signal identifying the location on display 113 where it has been touched. If such a location matches the predetermined location of one of displayed options or icons, processor 103 determines that the option or icon has been selected.
30 Otherwise, a cursor is placed at the touched location on display 113, prompting for an input from the user.

The user input may be realized using a virtual keyboard shown on display 113 also provided by the touch-screen circuitry. In a well known manner, characters are
35 input by touching the corresponding keys on the virtual

-7-

keyboard. Alternatively, processor 103 may be programmed to recognize handwritten characters, and may receive through the touch-screen circuitry images of characters drawn by the user on display 113. Any recognized
5 characters corresponding to the drawn images then become the user input. Still alternatively, through one of external interfaces 117, arrangement 100 can be connected to a keyboard device or a personal computer (PC) having a keyboard for user input.

10 However, we have recognized that the traditional ways of inputting data to a hand-held device are inefficient. For example, user input by drawn images of characters is often susceptible to inaccurate
15 character recognition by the device, thus requiring repeated input of the same characters, which is frustrating. Limited by the size of a display in a hand-held device, a virtual keyboard does not afford much room to each character key thereon. As a result, data entry using the virtual keyboard is also error prone.
20 Inputting data to a hand-held device using a physical keyboard connected thereto is undesirable because of the bulkiness of the keyboard, which defeats the purpose of having the hand-held device for its easy transportability in the first place.

25 However, navigator arrangement 100 is designed pursuant to an object to minimize data entry by the user. To the extent possible, databases in arrangement 100 are pre-populated with data, which the user may edit to satisfy his/her needs. In addition, arrangement 100
30 allows for downloading of data from a remote source to supplement and update the databases in arrangement 100, and to provide thereto just-in-time information, including, e.g., latest traffic, weather, map and other information. To that end, transceiver 121 in
35 communication unit 120 includes, e.g., cellular telephone

- 8 -

circuitry for transmitting and receiving information via a wireless communications network, e.g., the well known advanced mobile phone service (AMPS) network, digital AMPS network, personal communications service (PCS) network, global system for mobile communications (GSM) network, etc. Modem 123 is used for modulating and demodulating carriers carrying the information through data channels, e.g., cellular digital packet data (CDPD) channels, in the wireless communications network.

10 Traditionally, a navigation device, e.g., a GPS navigation system used in an automobile, provides a user with directions to a given destination. The navigation typically provides the shortest navigated route in terms of distance to the given destination. However, we have
15 expanded the concept of the traditional navigation to broadly include providing a navigated route subject to user preferences, together with information concerning facilities and events surrounding the navigated route for the user's convenience. The navigated route is selected
20 to satisfy a trip's purpose. Such a trip's purpose may be (1) to reach a given destination as in prior art, and/or (2) to perform certain tasks enroute or at the destination, which may include purchasing business supplies, shopping for gifts, dining, obtaining
25 entertainments, etc. To realize (2), navigator arrangement 100 in accordance with the invention allows for storage of user profiles including user preferences such as preferred types of restaurants, shops, entertainments, etc.

30 In accordance with an aspect of the invention, each user profile corresponds to one of the user's personae. For example, the user business profile corresponding to the user's business persona may be different from the user personal profile corresponding to
35 his/her personal persona. For instance, the user

-9-

business profile may include fine-dining type restaurants for business meetings while the user personal profile may instead include fast-food type restaurants for personal dining. Other profiles may include a vacation profile which corresponds to the user's vacation persona and may include a different set of preferred restaurants, shops, entertainments, etc.

In accordance with another aspect of the invention, the user can adopt a second person's profile for a certain trip's purpose, thereby temporarily assuming the second person's persona, especially when arrangement 100 is shared by more than one person. For example, where a husband and wife share the use of arrangement 100, the husband may utilize the wife's profile in arrangement 100 to shop for a gift for the wife's birthday. Based on the profile corresponding to the wife's personal persona, arrangement 100 provides a navigated route, together with information concerning the wife's personal favorite shops surrounding the route. Of course, each user's profiles may be protected against uninvited intruders. In that case, access to the profiles may require verification of a personal identification number (PIN) or password, or other well known secure access measures. Profiles may also be imported or downloaded into arrangement 100 from an external source or from another arrangement similar to arrangement 100.

Thus, in accordance with the invention, arrangement 100 provides a navigated route, together with information concerning the favorite facilities and events surrounding the navigated route, which satisfy the preferences in a selected user profile. In this instance, such information comes from an external source, e.g., a server connected to the Internet, and is communicated to arrangement 100 through communication

-10-

unit 120.

In accordance with another aspect of the invention, the actual navigated route selected by arrangement 100 may depend on the mode of transportation specified by the user. For example, driving and walking are two different modes of transportation. The selected route for driving may be very different from that for walking, even though they may accomplish the same trip's purpose. The routes from which arrangement 100 selects for driving have to be passable by an automobile, which exclude, e.g., foot bridges, and walk paths through buildings, parks, fields, forests, etc. On the other hand, the routes from which arrangement 100 selects for walking have to be safe to pedestrians, which exclude, e.g., highways, freeways, etc.

In accordance with yet another aspect of the invention, the actual route selected by arrangement 100 may also depend on external conditions, e.g., traffic, weather and road conditions. Thus, based on the information concerning such external conditions received from, say, a server via the Internet, arrangement 100 selects the most time-efficient route, e.g., one that requires the least travel time, to accomplish the trip's purpose despite any adverse traffic, weather and road conditions.

In accordance with still yet another aspect of the invention, a user may prescribe one or more roadblocks specifying certain prohibited areas or paths from which the route selected by arrangement 100 deviates. For example, it may be sensible to place roadblocks around high crime areas especially when the user is new in town and unfamiliar with those areas. A roadblock may be permanent or temporary. For example, a temporary roadblock may be placed on certain streets where a parade is held which lasts for several hours.

-11-

Similar to a roadblock, a blockade may be imposed to block transmission of certain information to arrangement 100 which concerns, e.g., uninteresting facilities or events.

5 When a user initially utilizes arrangement 100 for navigation in accordance with the invention, the navigator browser in arrangement 100 opens a REGISTRATION page on display 113. Fig. 2 illustrates such a REGISTRATION page where the user is prompted for entering
10 his/her personal data, e.g., his/her name, age, sex, marital status, occupation, city, education, religion and number of children.

 After the entry of the personal data, the navigator browser opens a PROFILE SETTING page on display
15 113. Fig. 3 illustrates such a PROFILE SETTING page for the user to set up a profile corresponding to one of his/her personae. The user here is afforded a choice of "business", "personal" and "vacation" personae in box 203. By way of example, the user in this instance wants
20 to set up a "personal" profile which includes preferences of the user while on personal travel (as opposed to business travel or vacation travel). Thus, the user may use a stylus to touch the "personal" option (as opposed to the "business" or "vacation" option) in box 203 on
25 display 113 to select the option.

 In addition, the user is prompted to select preferences in different categories to be included in his/her personal profile. For example, these categories may comprise MUSIC category 205, ENTERTAINMENT category
30 207, SHOPPING category 209, RECREATION category 211, SPORTS category 213, RESTAURANTS category 215 and SERVICES category 217. In this instance, the user selects COUNTRY option 231, and JAZZ option 235 in MUSIC category 205 for his/her music preferences. Similarly,
35 the user may also select any options in other categories

-12-

for inclusion in his/her personal profile. Each selected option is illustratively indicated by a check mark at the option. Other profiles such as a business profile and vacation profile may be similarly set up.

5 Continuing the above example, after setting up his/her personal profile, the user selects SUBMIT option 241. In response, processor 103 in Fig. 1 obtains from GPS receiver 119 data concerning the GPS coordinates of the current location of arrangement 100. Based on the
10 signals from a constellation of satellites which form part of the GPS, receiver 119 in a well known manner determines the GPS coordinates in question. Processor 103 then creates a record associated with the user. Fig. 4 illustrates the format of such a record (denoted 400)
15 created by processor 103 in memory 108. Record 400 comprises section 503 containing the aforementioned personal data including, among others, the user's name which identifies record 400. Section 505 contains any business profile set up by the user. Section 507 in this
20 instance contains the personal profile described above. Section 509 contains any vacation profile set up by the user. Section 511 contains the aforementioned GPS data indicating the current location of arrangement 100. Section 513 contains map and related information, based
25 on which processor 103 is capable of generating maps which correspond to different modes of transportation, e.g., by automobile, on foot or by rail. Such map and related information also includes identities of facilities and events, and the GPS coordinates
30 identifying the locations of such facilities and events on the maps. Section 515 contains business favorites which are determined based on the personal data in section 503, business profile in section 505 and GPS data in section 511. Similarly, section 517 contains personal
35 favorites which are determined based on the personal data

-13-

in section 503, personal profile in section 507 and GPS data in section 511; and section 519 contains vacation favorites which are determined based on the personal data in section 503, vacation profile in section 509 and GPS data in section 511. It should be noted at this point that the information in sections 513, 515, 517 and 519 is provided by a navigation server connected to the Internet.

Continuing the above example, processor 103 in this instance causes the navigator browser in arrangement 100 to generate a request to the navigation server for the map and related information in section 513 and personal favorites in section 517. This request contains the personal data in section 503, personal profile in section 507, GPS data in section 511, a pre-assigned Internet protocol (IP) address for identifying the browser as the request originator, and a predetermined uniform resource locator (URL) identifying the navigation server on the Internet. It should be noted that the GPS data in section 511 is refreshed continually and in particular each time immediately before a request is sent to the navigation server to reflect the most current location of arrangement 100. The request is formatted in accordance with the requisite protocols including the well known transmission control protocol/Internet protocol (TCP/IP) in this instance.

Referring to Fig. 5, processor 103 causes communication unit 120 in navigator arrangement 100 to establish a dial-up connection through wireless communications network 613 to access server 622 maintained by an Internet service provider (ISP). The aforementioned request is then transmitted to access server 622 through the established connection. Upon receipt of the request, based on the URL therein, access server 622 routes the request to navigation server 630

-14-

identified by the URL. It should be noted at this point that server 622 may not be the only access server on the Internet serving arrangement 100 and the like. It will be appreciated that more access servers similar to server 5 622 are geographically distributed for effective communications with arrangement 100 and the like.

Navigation server 630 which may be a host computer provides the navigation service in accordance with the invention. Among other things, server 630 10 receives data from different sources and maintains numerous databases therein including a map database, a weather database, a traffic database, a road-condition database, a subscriber database, a non-subscriber database, etc.

15 The map database provides data concerning maps covering various geographic areas. Each map includes layers corresponding to different modes of transportation. For example, a first map layer corresponds to travel by automobile; a second map layer 20 corresponds to travel on foot; a third map layer corresponds to travel by rail; etc. The map layers can be combined to facilitate travel by more than one mode of transportation. Buildings, locations, streets, roadways and the like in the map layers are defined and identified 25 in the database by their GPS coordinates.

The weather database contains data concerning weather conditions in various geographic areas, which is collected and updated by server 630 from time to time using such systems as the United States satellite 30 systems, Delta radars, local area radars, etc. The data concerning the weather conditions is stored in the weather database according to the GPS coordinates defining the areas affected by the weather conditions, respectively. As such, each weather condition is readily 35 mapped to the area defined by the corresponding GPS

-15-

coordinates in the map layers.

Similarly, the traffic and road-condition databases each contain data concerning traffic and road conditions, which is updated and derived by server 630
5 from official traffic and road-condition reports furnished by local departments of transportation, and from data provided by well known radar systems such as line-of-sight radars, and Doppler radars each with terrain following capabilities, to sense surrounding
10 traffic and road conditions. The data concerning the traffic conditions (road conditions) is stored in the traffic (road-condition) database according to the GPS coordinates defining the areas affected by the traffic conditions (road conditions), respectively. As such,
15 each traffic condition (road condition) is readily mapped to the area defined by the corresponding GPS coordinates in the map layers.

The subscriber database in server 630 contains data concerning commercial facilities and events, e.g.,
20 department stores, gas stations, concerts, etc., which subscribe to the navigation service. With payment of a subscription fee, the subscribers may appear in the map layers for promotional purposes. The identities of the subscribers are stored in the subscriber database
25 according to the GPS coordinates of the locations of such subscribers, along with other information concerning their address, contact phone number, web URL, business hours, advertisement, promotion, directory, etc.

The non-subscriber database in server 630
30 contains data concerning public facilities (e.g., parks, hospitals and rest stops) and civic and charity events which are selected to appear in the map layer without payment of a subscription fee. The identities of such non-subscribers are stored in the non-subscriber database
35 according to the GPS coordinates of their locations,

-16-

along with other information concerning their address, contact phone number, web URL, charity or civic functions, etc.

Continuing the above example, upon receiving
5 the request from arrangement 100, based on the personal data, personal profile and GPS data therein, server 630 determines the user's personal favorites as requested, e.g., favorite personal facilities and events, within a limited navigation coverage, e.g., defined by a
10 predetermined radius from the GPS coordinates identified by the GPS data. Such favorite facilities and events may be selected from the above-described subscriber and non-subscriber databases. In addition, based on the map, weather, traffic, road-condition, subscriber and non-
15 subscriber databases, server 630 provides the requested map and related information, which concerns (i) the map layers affording the limited navigation coverage, (ii) the weather, traffic and road conditions relevant to the coverage, (iii) the subscribers and non-subscribers
20 appear in the coverage, and (iv) a time stamp indicating when the map and related information is provided. Since even with the same navigation coverage, the weather, traffic and road conditions in (ii) vary with time. As such, the map and related information is time-sensitive
25 and thus includes the time stamp in (iv) to ensure its just-in-time provision.

Server 630 then transmits a response which contains (a) the IP address of the navigator browser in arrangement 100 to which the response is destined, (b)
30 the personal favorite facilities and events just determined, and the GPS coordinates thereof, and (c) the map and related information, in accordance with the predetermined protocols. Upon receiving the response, processor 103 in arrangement 100 causes the received (b)
35 and (c) to be stored in sections 517 and 513 of record

-17-

400, respectively.

When the content of section 517 is modified, as is in this case, the resulting list of personal favorites is automatically displayed for the user's review. Fig. 6 illustrates such a personal favorite list (denoted 651) shown on display 113 which includes, e.g., "Home Depot," "Wells Fargo," "Vons," "Chevron," "Jack in the Box,"

It should be noted at this point that the personal favorites selected by server 630 may vary with the GPS data identifying the current location of arrangement 100, even though the personal data and personal profile remain the same. This stems from the fact that the selected favorite facilities and events may be limited to certain areas. When such facilities or events are outside the current navigation coverage, they are either eliminated or substituted by server 630 with similar facilities or events, in accordance with predetermined program instructions in server 630. For example, "Jack in the Box" which is a popular fast food restaurant in California but unavailable in New York may be substituted with "Wendy's" when the navigation coverage includes New York. In addition, server 630 may add to the personal favorite list those facilities and events which satisfy the personal data and personal profile, and which would otherwise be unavailable had it not been the current navigation coverage.

Advantageously, when a user travels from one navigation coverage to another, based on the same personal data and personal profile and the current personal favorite list, server 630 can "clone" personal favorite lists which correspond to different navigation coverages. Similarly, server 630 can clone business favorite lists corresponding to different navigation coverages based on the same personal data and business profile and the current business favorite list, and vacation favorite

-18-

lists corresponding to different navigation coverages based on the same personal data and vacation profile and the current vacation favorite list. Thus, with arrangement 100, the user's lifestyle is maintained as much as possible despite traveling from place to place.

List 651 in Fig. 6 tends to be overinclusive. The user is afforded EDIT option 653 to modify the list to satisfy his/her needs. For example, to delete an item in list 651, the item is selected, followed by a selection of EDIT option 653. Processor 103 overwrites the content of section 517 of record 400 with the resulting list of personal favorites.

As mentioned before, the user may sometimes want to adopt another person's profile for a certain trip's purpose, e.g., buying a gift for that person. Thus, the user is also afforded preset profiles in arrangement 100, from which the user may select. Such preset profiles may be accessed by selecting PRESET PROFILE option 239 on the PROFILE SETTING page of Fig. 3. Fig. 7 illustrates preset Profiles 1 through 6 corresponding to profiles of a typical "Man," "Woman," "Business Man," "Business Woman," "Senior Citizen," and "Teenager." For example, the user may be a female and want to buy a gift for a man in a business setting. In that case, the user may want to view the preferences in Profile 3 of a business man using VIEW option 703, and may select such a profile using SELECT option 705, thereby assuming a man's business persona. After such a selection, a list of favorites corresponding to Profile 3 would be downloaded from navigation server 630 for the user's review in a manner described above. The user may then get a gift idea from the favorite list, and request arrangement 100 to navigate her to a selected favorite facility to buy the gift.

It should be noted that the user may also start

-19-

with one or more of preset profiles in Fig. 7, which the user may edit to become his/her business, personal and/or vacation profile described above.

Referring back to Fig. 6, after the business,
5 personal and/or vacation favorite list is established, the user may select NAVIGATE option 657 for navigation by arrangement 100 in accordance with the invention. Upon such a selection by the user, the navigator browser in arrangement 100 opens a NAVIGATION page on display 113.
10 Fig. 8 illustrates the NAVIGATION page where the user is prompted to select the mode of transportation (e.g., "By Automobile," "On Foot," or "By Rail" in box 803), and the list of favorites (e.g., "Personal," "Business" or "Vacation" favorites in box 807) used during the current
15 navigation episode.

By way of example, the user in this instance is on a personal road trip and thus selects "By Automobile" as the mode of transportation, and "Personal" as the favorite list used. In response, the navigator browser
20 opens a DIRECTIONS page on display 113. Fig. 9 illustrates such a DIRECTIONS page where the user is prompted to enter an origination address at query 903, where the navigation starts. In this instance, the user adopts the default response to query 903 which is the
25 location identified by the GPS data in section 511 of record 400. Otherwise, the user may enter a different origination address. The user is also prompted to enter a destination address at query 905. The user in this instance enters a home address as the destination
30 address. To avoid re-entering the same address in the future, the user may select LOCATIONS option 910 to save the address. In that case, the user is prompted to assign an icon, e.g., icon 915, and a designation, e.g., "HOME," to the home address. Thus, in the future, the
35 user may select icon 915 in location box 907 to retrieve

-20-

the corresponding home address in response to query 903 or 905. Similarly, in location box 907 icon 909 corresponds to a previously saved address of a delicatessen; and icon 911 corresponds to a previously saved address of a fitness center.

Alternatively, addresses in locations box 907 may be saved by clicking at icons elsewhere and duplicating same in box 907. For example, icon 913 in location box 907 corresponding to a Wells Fargo bank address results from clicking at icon 1103e in favorites box 1103 (described below with Fig. 11) and duplicating same in box 907.

After learning the origination address and destination address responsive to queries 903 and 905, respectively, processor 103 analyzes the map and related information stored in section 513 of record 400. Specifically, processor 103 determines whether the navigation coverage based on the map layer corresponding to automobile travel in this instance, includes the origination and destination addresses, and whether the stored map and related information is fresh, as indicated at step 1003 in Fig. 10. If the navigation coverage includes the origination and destination addresses in question, and the period elapsed from the time stamp of the stored map and related information does not exceed a predetermined period (i.e., the stored map and related information is fresh), based on such map and related information, processor 103 at step 1006 selects the route from the origination address to the destination address which is the most time-efficient, i.e., fastest by automobile in this instance, taking into account the relevant weather, traffic, and road conditions along the selected route, together with any roadblocks set up by the user in a manner to be described. Such a selection process is achieved by analyzing the portion of the map

-21-

and related information concerning the weather, traffic and road conditions and roadblocks in the navigation coverage, and involves predictions concerning the effects of such conditions on the automobile travel along the selected route at different points in time. At step 1009, processor 103 causes turn-by-turn instructions 917 concerning the selected route to be shown on the DIRECTIONS page.

Otherwise, if the stored map and related information does not cover the origination and/or destination address in question, and/or if the map and related information is not fresh, processor 103 at step 1013 establishes a communication connection to navigation server 630. At step 1016, processor 103 causes a transmission of a request for fresh map and related information for an appropriate navigation coverage through the established connection. This request contains, among other things, the personal favorites in section 517, personal data in section 503 and personal profile in section 507 of record 400, in addition to the origination and destination address information. In response to such a request, navigation server 630 prepares new map and related information for the coverage from at least the origination address to the destination address. In addition, based on the new map and related information, the received personal favorite list, personal data and personal profile, server 630 "clones" a personal favorite list from the received list. As discussed before, this cloned list may be different from the received list to reflect any geographic differences between the previous and current navigation coverages. At step 1019, processor 103 receives from server 630 the new map and related information and cloned personal favorite list. Processor 103 at step 1021 stores them in sections 513 and 517 of record 400, respectively. Again,

-22-

the user is afforded a chance to edit the cloned personal favorite list in a manner described before. Processor 103 then proceeds to step 1006 described above.

Referring back to Fig. 9, the user in this instance may rely on turn-by-turn instructions 917 to reach home by automobile. If arrangement 100 is "docked" or connected to the aforementioned automobile system, the turn-by-turn instructions would be communicated by the automobile system via audio media to the user when the automobile traversing the navigated route approaches each turn.

In addition, the user is afforded VIEW option 919 to view an image of a map including the navigated route. Upon selection of option 919, the navigator browser opens a MAP VIEWER page on display 113. Fig. 11 illustrates such a MAP VIEWER page including map 1101 which corresponds to automobile travel. Map 1101 is also derived from the map and related information currently stored in section 513 of record 400. The navigated route (denoted 1102) for which instructions 917 are given is highlighted on the MAP VIEWER page, with preselected icon 1107 indicating the origination address previously entered, and icon 915 described above indicating the destination address previously entered.

In addition, favorites box 1103 on the MAP VIEWER page lists the personal favorites currently stored in section 517 of record 400. The icons which are associated with such personal favorites are populated on map 1101 to indicate the locations of such personal favorites. For example, icon 1103a in box 1103 associated with the personal favorite "Chevron" is also shown on map 1101 to indicate its location thereon. Icon 1103b in box 1103 associated with "Vons" is also shown on map 1101 to indicate its location thereon. Icon 1103c in box 1103 associated with "Comp USA" is also shown on map

-23-

1101 to indicate its location thereon. Icon 1103d in box 1103 associated with "Kmart" is also shown on map 1101 to indicate its location thereon. Icon 1103e in box 1103 associated with "Wells Fargo" is also shown on map 1101 to indicate its location thereon.

Scene box 1105 lists "scenic" facilities and events which may serve as landmarks along the navigated route, as the icons associated with such scenic facilities and events are also populated on map 1101.

Some scenic facilities and events may be important to the user such as a rest stop indicated by icon 1105a, or "McDonald's" indicated by icon 1105b in case the user is hungry when traveling along the navigated route which is not close to any of his/her favorite restaurants in this instance. Some scenic facilities and events may be of marginal interest to the user such as the "Charity Walkathon" indicated by icon 1105c. If indeed the user decides to adopt any scenic facility or event as one of his/her favorites, the user may use an indicator device to click at the icon associated with the scenic facility or event in either box 1105 or map 1101 and drag same into box 1103. For example, if after trying McDonald's Restaurant indicated by icon 1105b, the user decides to add the restaurant to his/her favorite list, he/she may then click at icon 1105b in either box 1105 or map 1101 and drag same into box 1103 to effect such an addition.

In this instance, the user is afforded PHONE option 1109 to contact personnel of any listed facilities or events by phone. For example, a selection by the user of icon 1105b, followed by a selection of telephone option 1109, causes processor 103 to look up, from the map and related information stored in section 513 of record 400, the phone number of McDonald's Restaurant associated with icon 1105b. Processor 103 then causes transceiver 121 to place a voice call to McDonald's

-24-

Restaurant using the phone number just looked up. Accordingly, the user may talk to the personnel of the restaurant over the phone connection.

Alternatively, the user is afforded INFO option
5 1111 to obtain further information regarding any listed facilities or events. For example, a selection by the user of icon 1105b, followed by a selection of INFO option 1111, causes processor 103 to access the stored map and related information in section 513 for video and
10 sound clips, graphics and textual information concerning McDonald's restaurant associated therewith. In this instance, the processor 103 causes user interface 115 to announce, "Welcome to McDonald's," and/or the navigator browser to play a commercial of McDonald's Restaurant
15 based on the video and sound clips. The navigator browser then opens a MCDONALD'S RESTAURANT page on display 113.

Fig. 12 illustrates the MCDONALD'S RESTAURANT page containing directions to McDonald's Restaurant
20 associated with icon 1105b, and information concerning the restaurant service hours, phone number, facility, any promotion, etc.

NAVIGATE key 1205, BACK key 1209, RESTAURANT WEBSITE key 1213 and RESTAURANT MENU key 1215 are also provided on
25 the RESTAURANT page. A selection of NAVIGATE key 1205 causes processor 103 to provide the user with a DIRECTIONS page similar to Fig. 9 described before, including turn-by-turn instructions to the restaurant.

A selection of BACK key 1209 enables the user
30 to return to the previous page, i.e., the MAP VIEWER page. Key 1213 represents a hyperlink to the website of the restaurant. Thus, a selection of key 1213 causes the navigator browser to open the restaurant home page on display 113. In addition, a selection of key 1215
35 enables the user to access the RESTAURANT MENU page,

-25-

which is illustrated in Fig. 13.

As shown in Fig. 13, the RESTAURANT MENU page enumerates types of food and beverages served in the restaurant. Each food and beverage entry may be highlighted by selecting same. The user may order ahead the highlighted food and beverages by selecting ORDER key 1305. Upon selection of key 1305, the navigator browser causes the order information to be transmitted through Internet 650 to a restaurant server at a predetermined URL for processing the order. Thus, the resulting order awaits the user's arrival at the restaurant.

Referring back to Fig. 11, the user is also afforded BLOCK option 1113, whereby the user can prevent or limit the appearance of certain subscribers and non-subscribers in navigation by arrangement 100. For example, a selection by the user of icon 1105b, followed by a selection of BLOCK option 1113, causes the navigator browser to send to server 630 a request for blocking transmission of information concerning McDonald's Restaurant to arrangement 100. Upon receiving such a request, server 630 returns to the navigator browser an INQUIRY page, which the browser then opens on display 113.

Fig. 14 illustrates such an INQUIRY page where the user is afforded a choice of a PERMANENT BLOCKADE and a TEMPORARY BLOCKADE. In this instance, a selection by the user of the PERMANENT BLOCKADE causes a permanent prevention of transmission of information concerning any McDonald's Restaurant in the world to arrangement 100. An alternative selection of the TEMPORARY BLOCKADE needs to be accompanied by a specification of a time period during which the blockade is effective. For example, the user may have grown tired of McDonald's food and thus may want to use the TEMPORARY BLOCKADE to prevent transmission of information concerning any McDonald's

-26-

Restaurant in the world to arrangement 100 for a specified period.

Any blockade choice by the user is communicated by the navigator browser in arrangement 100 to server 5 630. The latter stores the blockade choice in a record identified by the IP address of the navigator browser. In each subsequent navigation episode, server 630 transmits to the navigator browser information concerning subscribers and non-subscribers in a selective manner, 10 reflecting any blockade choice stored in the associated record.

Similarly, the user is afforded ROADBLOCK option 1115 to preclude certain roadways or areas from navigation consideration by arrangement 100 as the 15 roadways may be hazardous for driving and the areas may have a high crime rate. For example, to set up roadblocks, after selecting ROADBLOCK option 1115, the user may use a stylus to trace any roadway or define any area on display 113 to be excluded from the navigation 20 consideration. In this instance, the user chooses to block a portion of the Ortega Highway denoted 1131 and indicated by crosses thereon, and area 1133 shown shaded in Fig. 11. In response, the navigator browser may open an inquiry page similar to Fig. 14 where the user may 25 specify whether each roadblock is a permanent blockade or temporary blockade. Processor 103 stores the user's choices of blockade and the GPS coordinates defining road portion 1131 and area 1133 in section 513 of record 400. Based on such stored information, processor 103 30 accordingly selects routes circumventing road portion 1131 and area 1133 in navigation.

The user is also afforded DELETE option 1117 to remove certain displayed items in the MAP VIEWER page. For example, a selection by the user of icon 1105b, 35 followed by a selection of DELETE option 1117 causes a

-27-

deletion of icon 1105b from both box 1105 and map 1101, along with any information associated therewith.

The foregoing merely illustrates the principles of the invention. It will thus be appreciated that those
5 skilled in the art will be able to devise numerous other arrangements which embody the principles of the invention and are thus within its spirit and scope.

For example, navigator arrangement 100 is disclosed herein in a form in which various functions are
10 performed by discrete functional blocks. However, any one or more of these functions could equally well be embodied in an arrangement in which the functions of any one or more of those blocks or indeed, all of the functions thereof, are realized, for example, by one or
15 more appropriately programmed processors.

-28-

Claims

1. Navigation apparatus comprising:
 - a memory for storing at least one profile, the at least one profile including preferences;
 - 5 a device for providing data identifying a location of the apparatus, favorites being determined based on the data and the preferences in the at least one profile;
 - an interface for receiving a navigation request; and
 - a processor responsive to the navigation request for
 - 10 providing navigation information which includes information concerning at least one of the favorites.
2. The apparatus of claim 1 wherein the at least one profile includes a personal profile which contains preferences relating to personal activities.
- 15 3. The apparatus of claim 1 wherein the at least one profile includes a business profile which contains preferences relating to business activities.
4. The apparatus of claim 1 wherein the at least one profile includes a vacation profile which contains
- 20 preferences relating to vacation activities.
5. The apparatus of claim 1 wherein the at least one profile includes a preset profile which allows for editing.
6. The apparatus of claim 1 wherein the favorites
- 25 concern selected facilities.
7. The apparatus of claim 6 wherein the selected facilities include selected restaurants.

-29-

8. The apparatus of claim 1 wherein the favorites concern selected events.

9. The apparatus of claim 1 wherein the navigation information also includes information concerning a navigated route and a geographic relation of the at least one of the favorites to the navigated route.

10. The apparatus of claim 1 wherein the data includes global positioning system (GPS) based data.

11. The apparatus of claim 1 comprising a hand-held device.

12. Navigation apparatus comprising:
a device for providing data concerning a location of the apparatus;
an interface for selecting a mode of transportation;
and
a processor for providing map related information based on the data and a selected mode of transportation.

13. The apparatus of claim 12 wherein the selected mode of transportation includes walking.

14. The apparatus of claim 12 wherein the selected mode of transportation includes transportation by vehicle.

15. The apparatus of claim 12 wherein the selected mode of transportation includes public transportation.

16. The apparatus of claim 12 wherein the map related information includes information concerning traffic conditions.

-30-

17. The apparatus of claim 12 wherein the map related information includes information concerning road conditions.

18. The apparatus of claim 12 wherein the map
5 related information includes information concerning weather conditions.

19. The apparatus of claim 12 wherein the map related information is organized according to GPS coordinates.

10 20. Apparatus for receiving a navigation request comprising:

a memory for storing at least one profile including preferences;

15 a device for providing data indicating a location of the apparatus,

an interface for providing navigation information, the navigation information including a set of favorites which is identified based on the preferences and the location of the apparatus; and

20 a processor responsive to the navigation request for determining based on the data whether the location of the apparatus is outside a predetermined range of a current location of the apparatus, the interface providing navigation information which includes a second set of
25 favorites when it is determined that the location of the apparatus is outside the predetermined range of the current location of the apparatus, the second set of favorites being identified based on the preferences and the current location of the apparatus.

30 21. Navigation apparatus comprising:

a first interface for receiving a request for map

-31-

related information concerning an area;

a second interface responsive to the request for providing the map related information, the map related information including data concerning at least one of
5 facilities and events in the area, the data being received from an external source; and

a processor for providing an option to avoid receipt of data concerning the at least one of the facilities and events.

10 22. The apparatus of claim 21 wherein the option includes an option to avoid the receipt of the data within a selected period.

23. Navigation apparatus comprising:

a first interface for receiving a request for a
15 route to a destination;

a second interface for defining at least one area to be avoided; and

a processor for planning the route, which avoids the at least one area, the processor causing an output of
20 information concerning the planned route.

24. The apparatus of claim 23 wherein a period during which the at least one area is to be avoided is also defined.

25 25. A system serving a device for providing navigation information comprising:

a first interface for receiving a request from the device, the request including at least one profile, and data concerning a location of the device, the profile comprising preferences;

30 a processor responsive to the request for identifying favorites based on the data and the

-32-

preferences in the at least one profile; and
a second interface for providing the favorites to the device for incorporation of the favorites into the navigation information.

5 26. The system of claim 25 wherein the request is received through a communications network.

 27. The system of claim 26 wherein the communications network includes an Internet.

 28. A method for use in a navigation apparatus, the
10 method comprising:

 storing at least one profile, the at least one profile including preferences;

 providing data identifying a location of the apparatus;

15 determining favorites based on the data and the preferences in the at least one profile;

 receiving a navigation request; and

 in response to the navigation request, providing navigation information which includes information

20 concerning at least one of the favorites.

 29. The method of claim 28 wherein the at least one profile includes a personal profile which contains preferences relating to personal activities.

 30. The method of claim 28 wherein the at least one
25 profile includes a business profile which contains preferences relating to business activities.

 31. The method of claim 28 wherein the at least one profile includes a vacation profile which contains preferences relating to vacation activities.

-33-

32. The method of claim 28 wherein the at least one profile includes a preset profile which allows for editing.

33. The method of claim 28 wherein the favorites
5 concern selected facilities.

34. The method of claim 33 wherein the selected facilities include selected restaurants.

35. The method of claim 28 wherein the favorites concern selected events.

10 36. The method of claim 28 wherein the navigation information also includes information concerning a navigated route and a geographic relation of the at least one of the favorites to the navigated route.

15 37. The method of claim 28 wherein the data includes GPS based data.

38. A method for use in a navigation apparatus, the method comprising:
providing data concerning a location of the apparatus;
20 selecting a mode of transportation; and
providing map related information based on the data and a selected mode of transportation.

39. The method of claim 38 wherein the selected mode of transportation includes walking.

25 40. The method of claim 38 wherein the selected mode of transportation includes transportation by vehicle.

-34-

41. The method of claim 38 wherein the selected mode of transportation includes public transportation.

42. The method of claim 38 wherein the map related information includes information concerning traffic
5 conditions.

43. The method of claim 38 wherein the map related information includes information concerning road conditions.

44. The method of claim 38 wherein the map related
10 information includes information concerning weather conditions.

45. The method of claim 38 wherein the map related information is organized according to GPS coordinates.

46. A method for use in an apparatus for receiving a
15 navigation request, the method comprising:

storing at least one profile including preferences;
providing data indicating a location of the

apparatus,

providing navigation information, the navigation
20 information including a set of favorites which is identified based on the preferences and the location of the apparatus;

in responsive to the navigation request, determining based on the data whether the location of the apparatus
25 is outside a predetermined range of a current location of the apparatus; and

providing navigation information which includes a second set of favorites when it is determined that the location of the apparatus is outside the predetermined
30 range of the current location of the apparatus, the

-35-

second set of favorites being identified based on the preferences and the current location of the apparatus.

47. A method for use in a navigation apparatus, the method comprising:

5 receiving a request for map related information concerning an area;

in response to the request, providing the map related information, the map related information including data concerning at least one of facilities and events in the area, the data being received from an external source; and

10 providing an option to avoid receipt of data concerning the at least one of the facilities and events.

48. The method of claim 47 wherein the option includes an option to avoid the receipt of the data within a selected period.

49. A method for use in a navigation apparatus, the method comprising:

20 receiving a request for a route to a destination; defining at least one area to be avoided; and planning the route, which avoids the at least one area; and

causing an output of information concerning the planned route.

25 50. The method of claim 49 wherein a period during which the at least one area is to be avoided is also defined.

51. A method for serving a device for providing navigation information, the method comprising:

30 receiving a request from the device, the request

-36-

including at least one profile, and data concerning a location of the device, the profile comprising preferences;

5 in response to the request, identifying favorites based on the data and the preferences in the at least one profile; and

providing the favorites to the device for incorporation of the favorites into the navigation information.

10 52. The method of claim 51 wherein the request is received through a communications network.

53. The method of claim 52 wherein the communications network includes an Internet.

FIG. 1

100

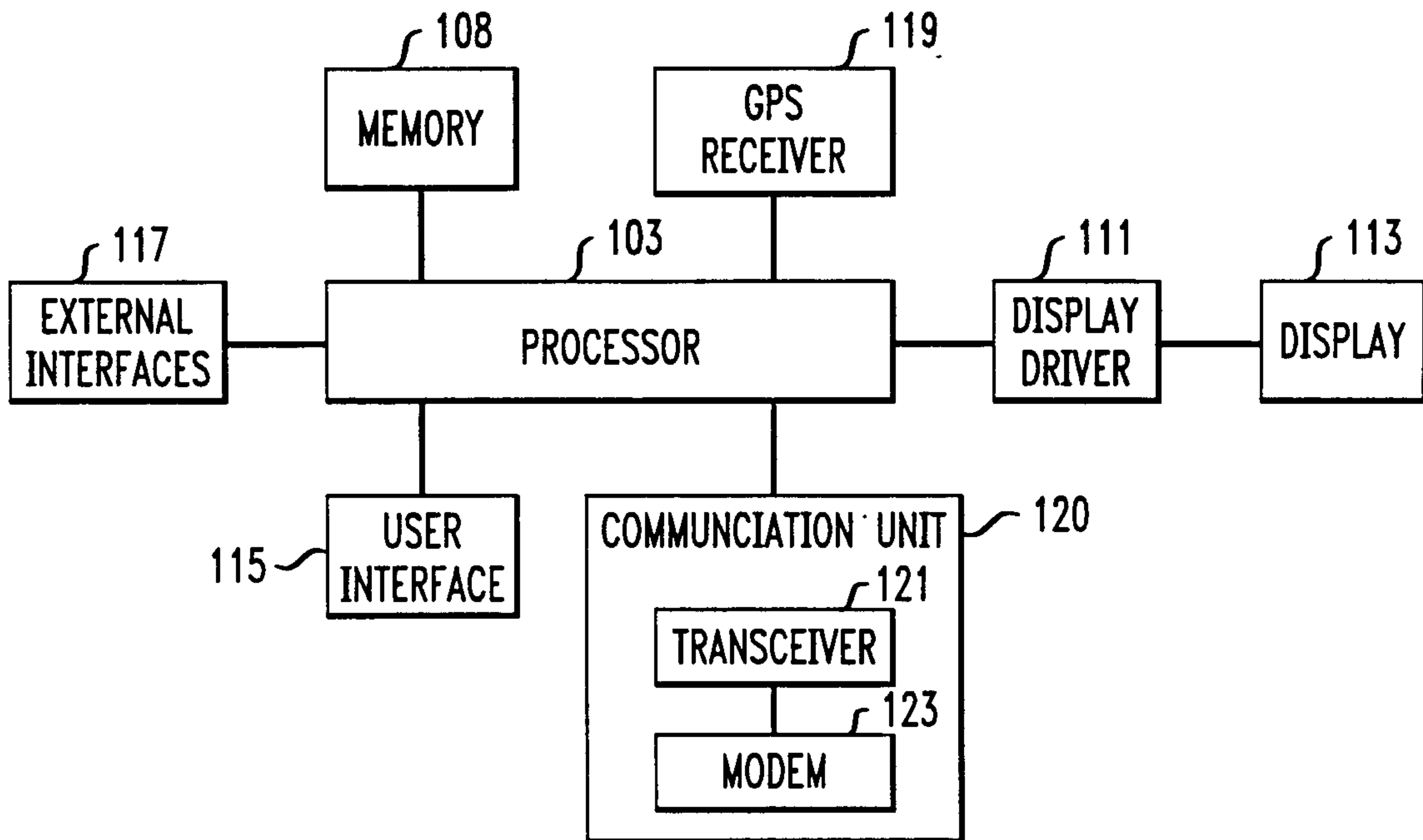

FIG. 2

REGISTRATION 113

NAME	STEVE
AGE	33
SEX	MALE
MARITAL STATUS	SINGLE
OCCUPATION	GRAPHIC ARTIST
CITY	ALISO VIEJO
EDUCATION	COLLEGE DIPLOMA
RELIGION	NONE
CHILDREN	NONE

FIG. 3

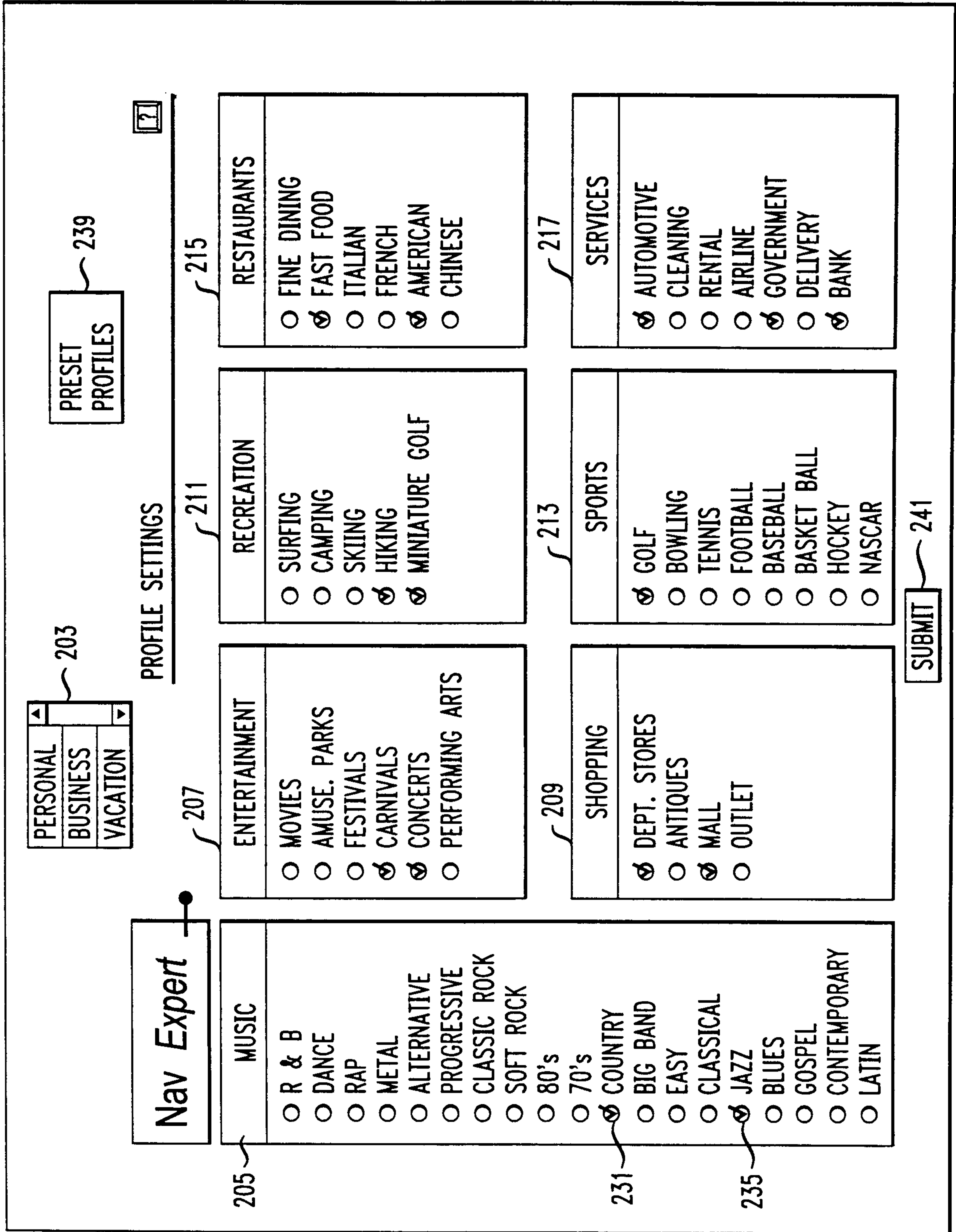

FIG. 4

400

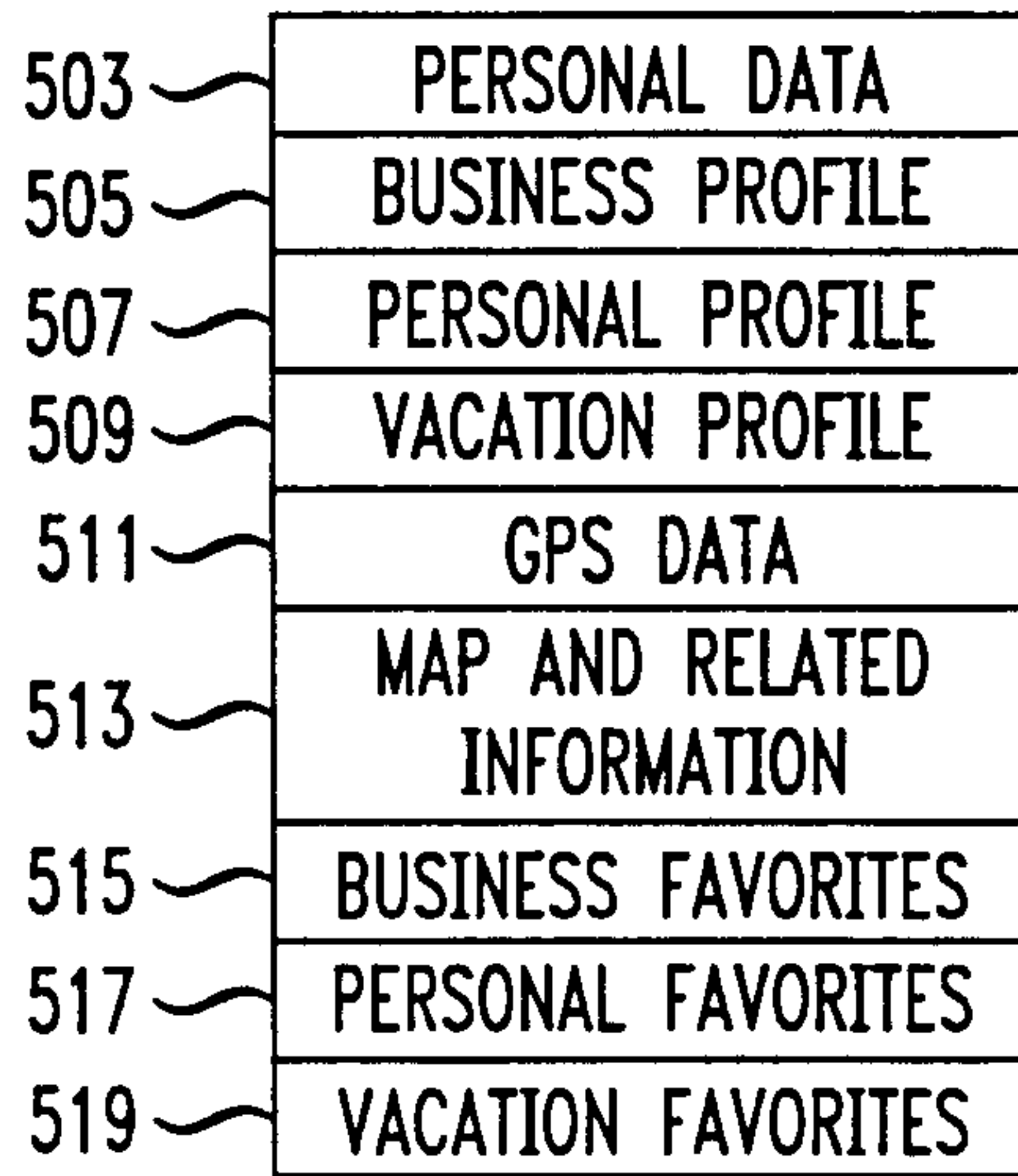

FIG. 5

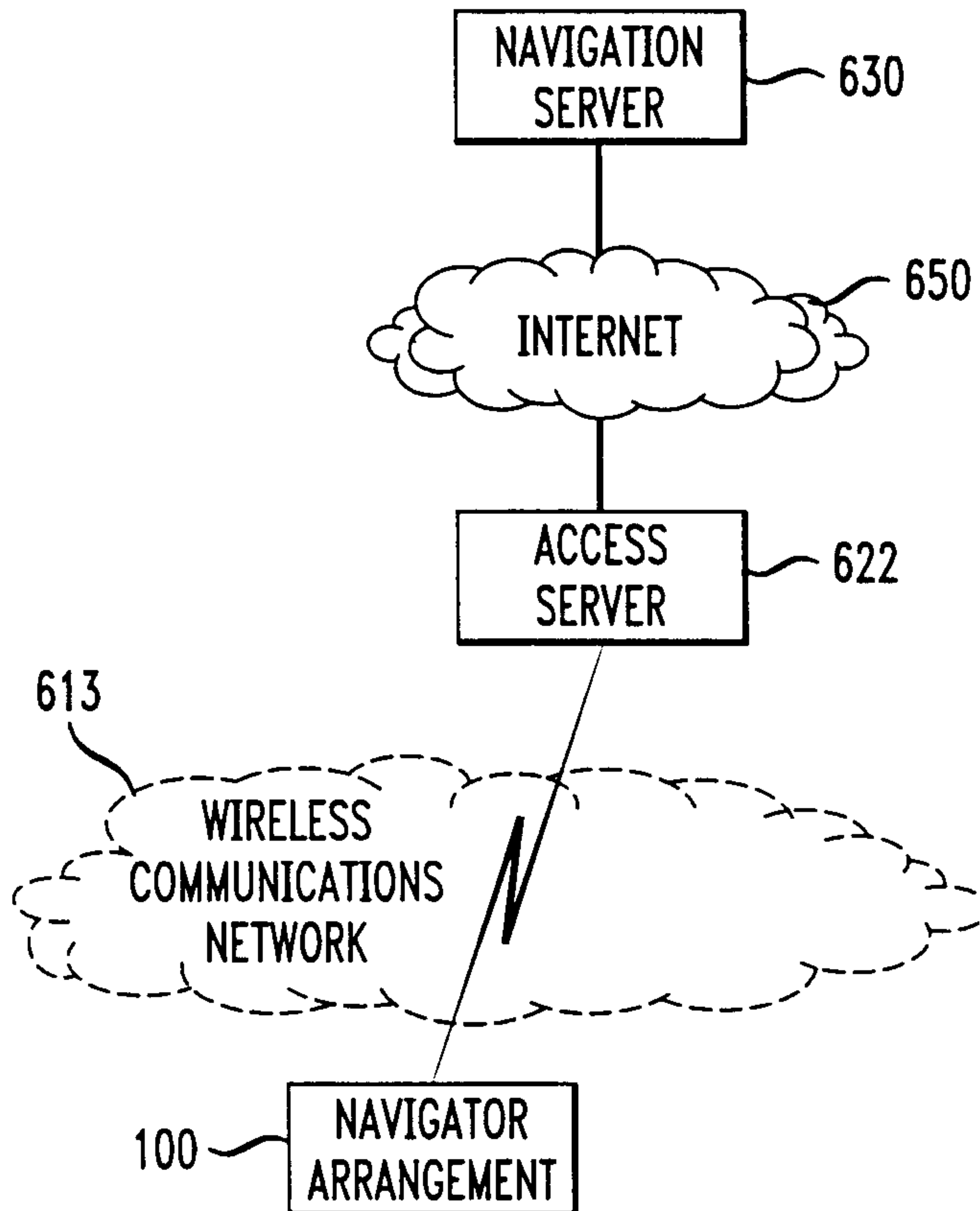

FIG. 6

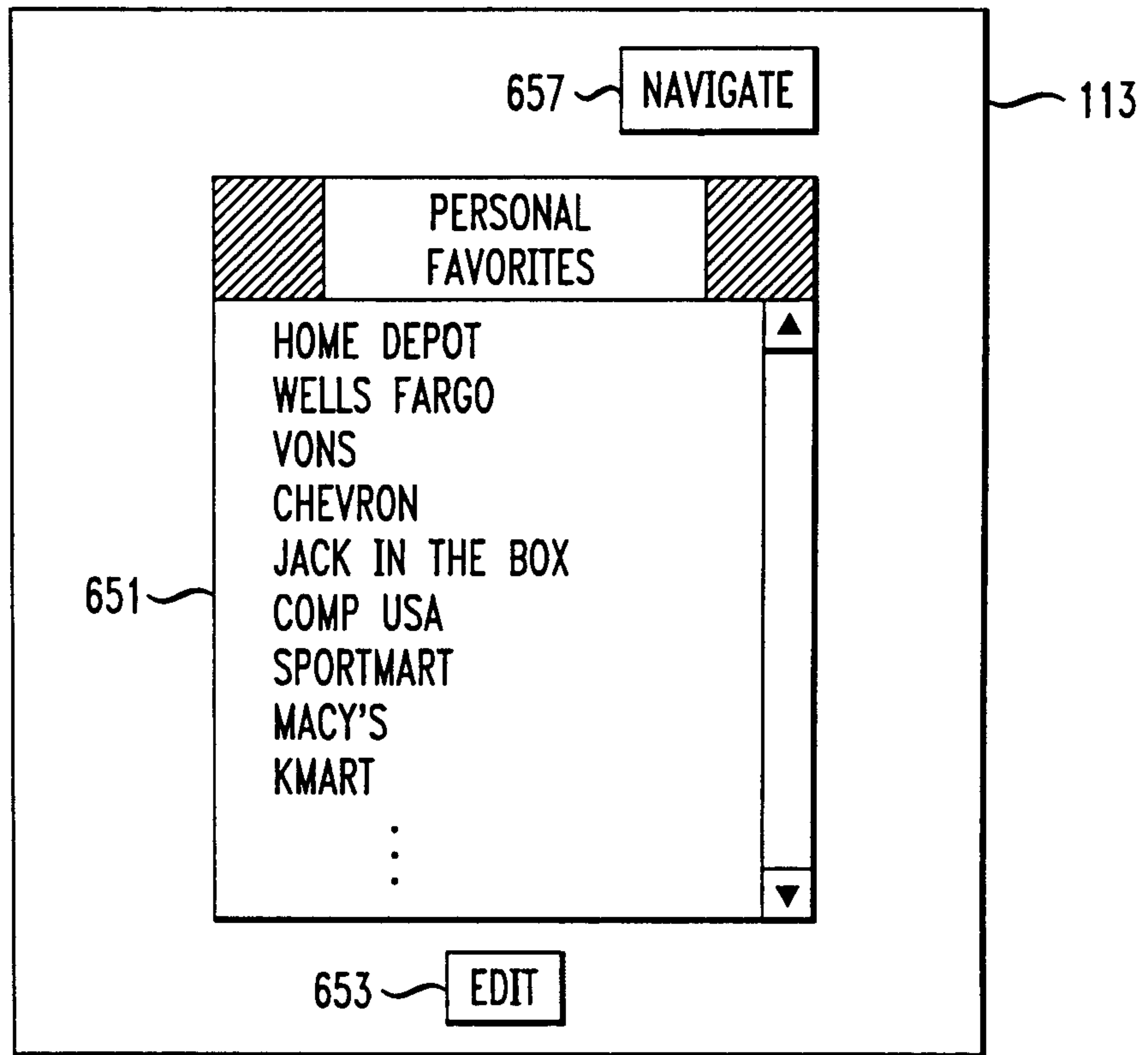
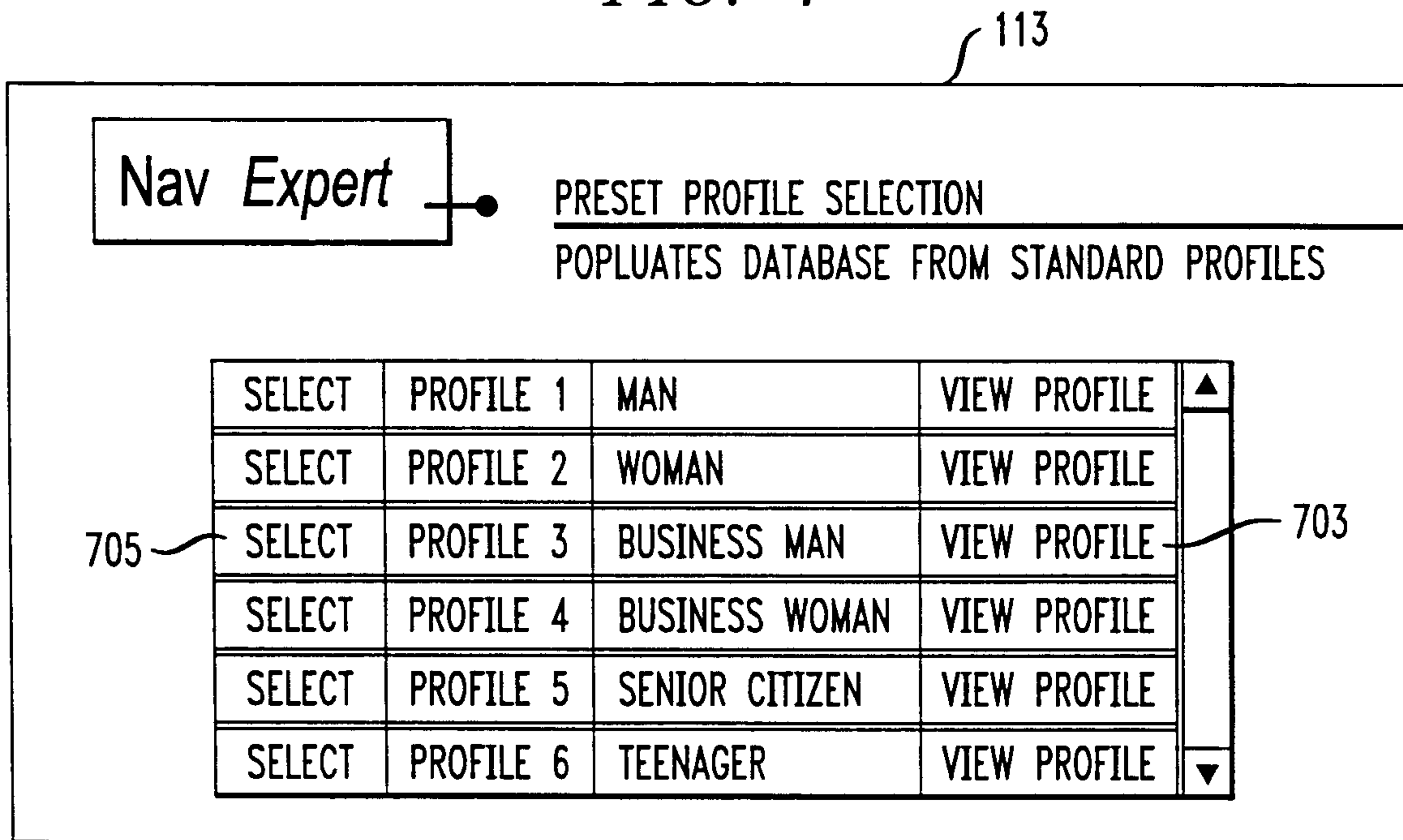

FIG. 7



5/8

FIG. 8

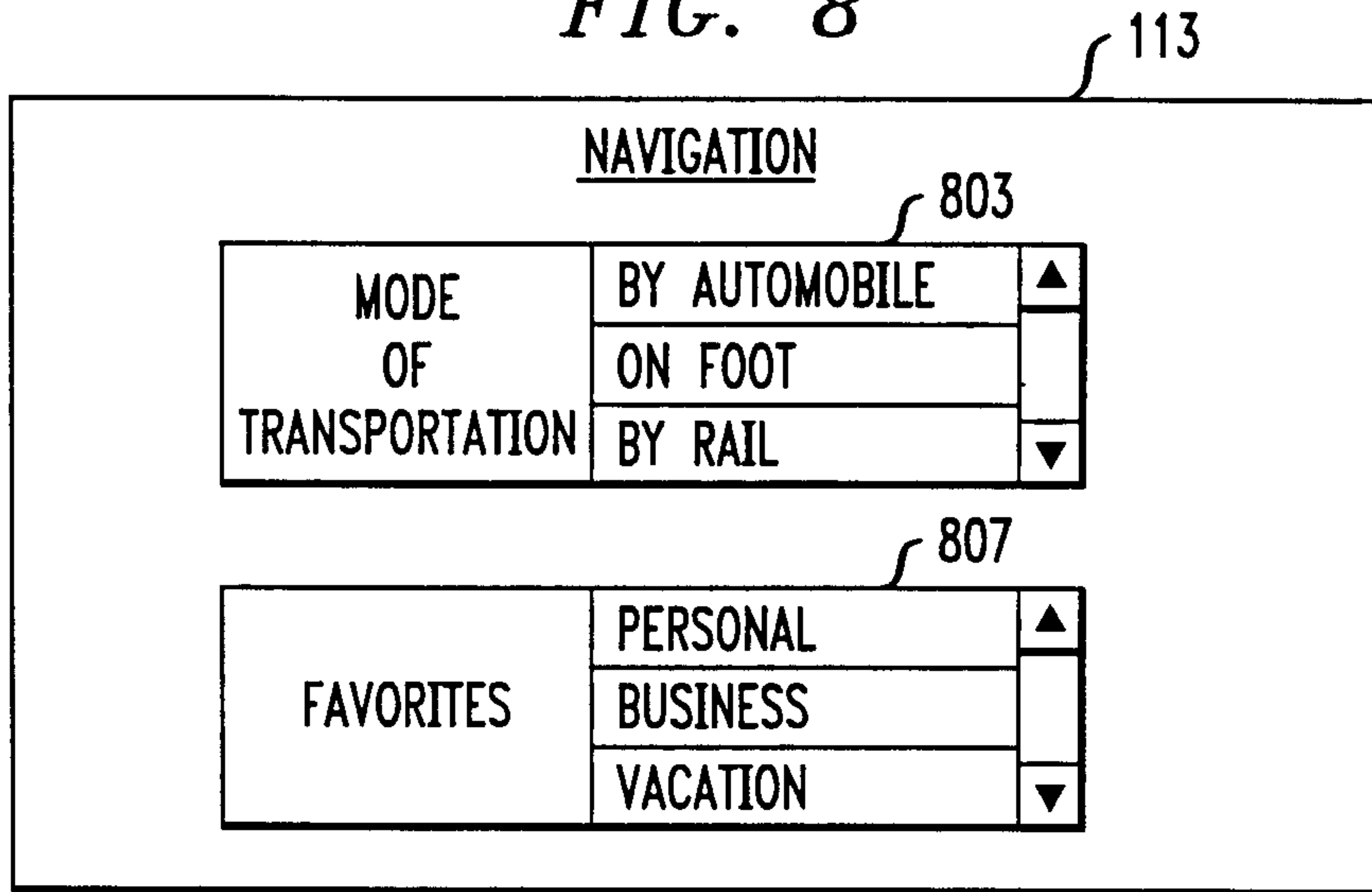

FIG. 10

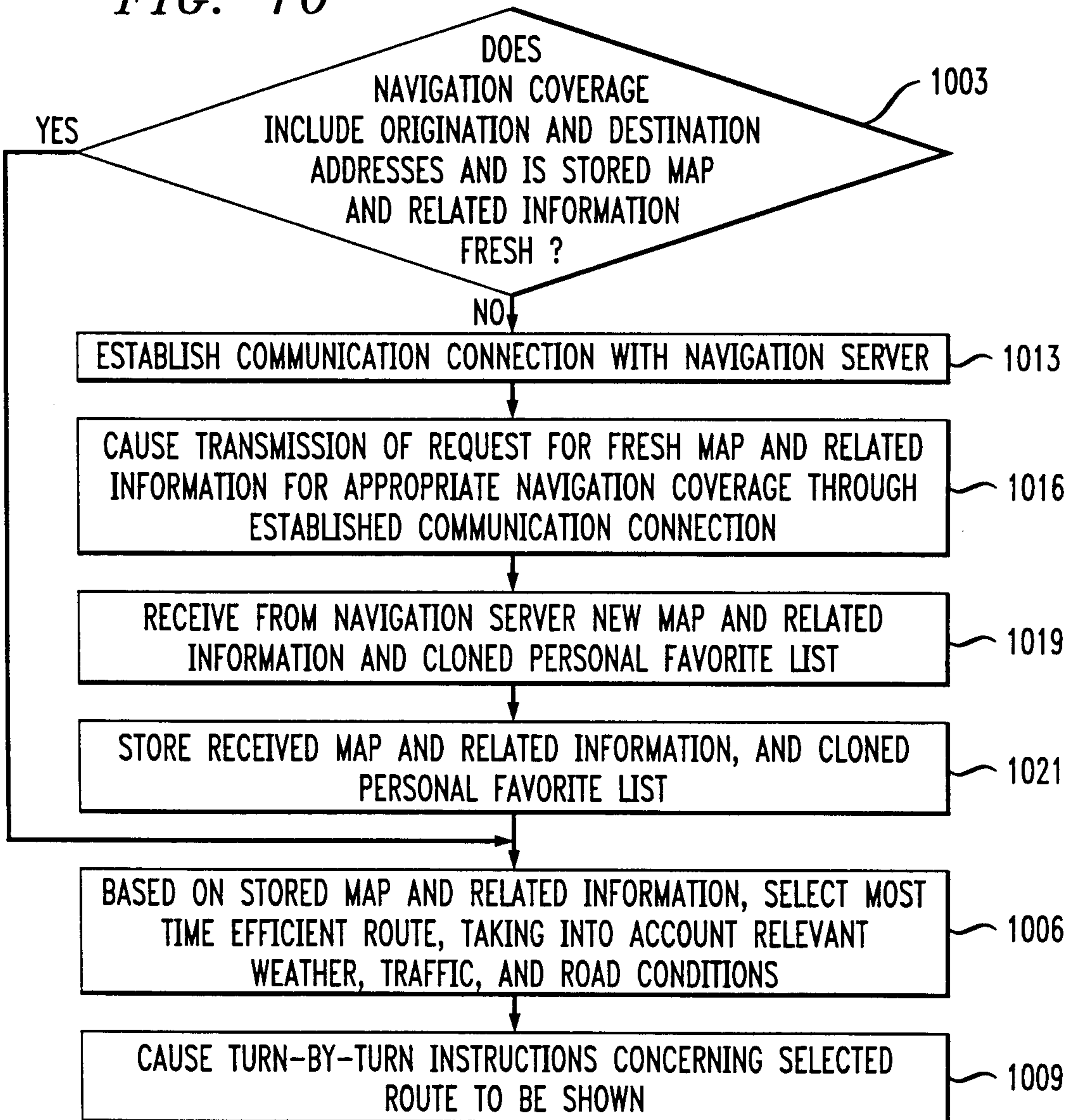

FIG. 9

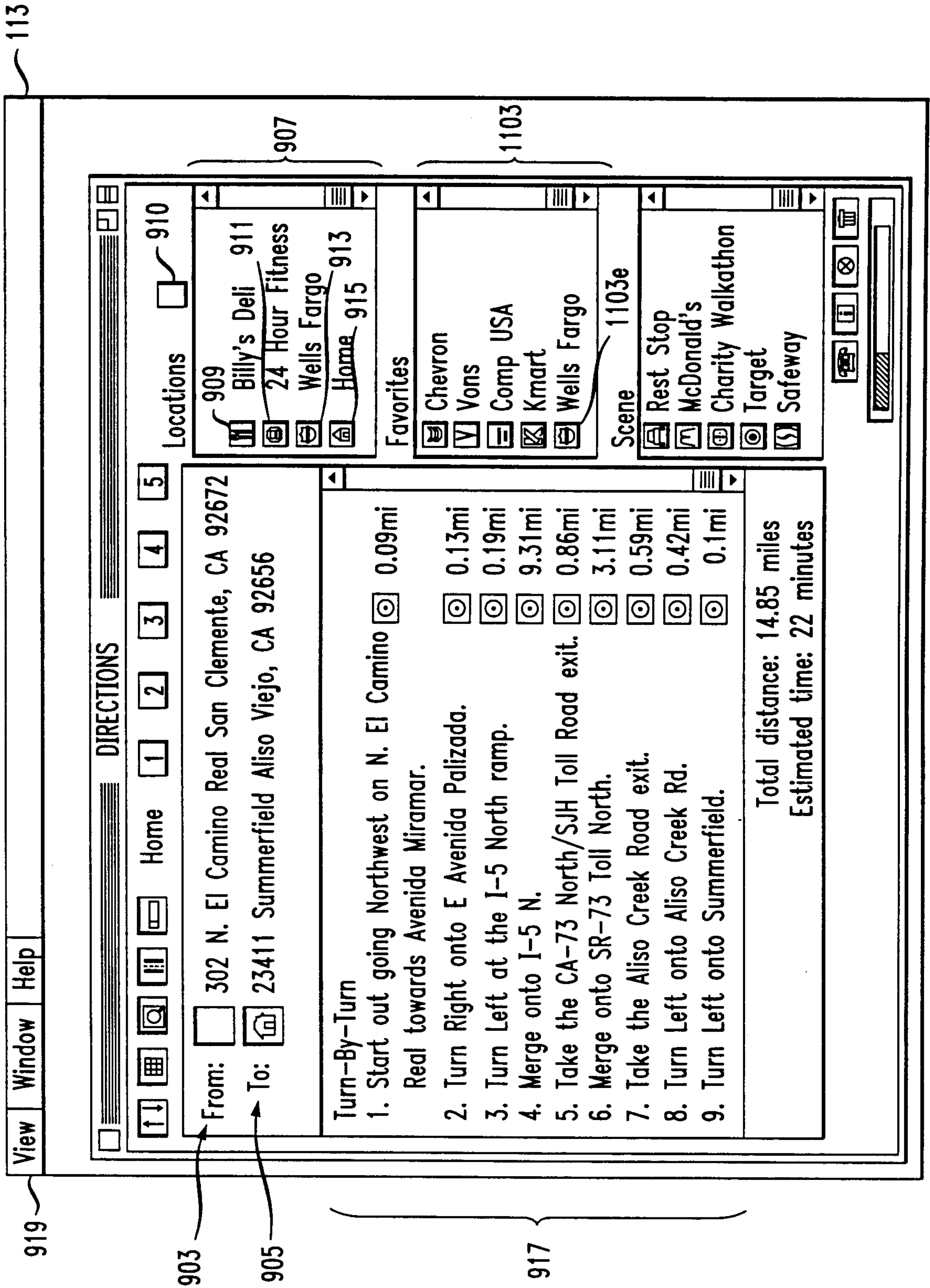

FIG. 11

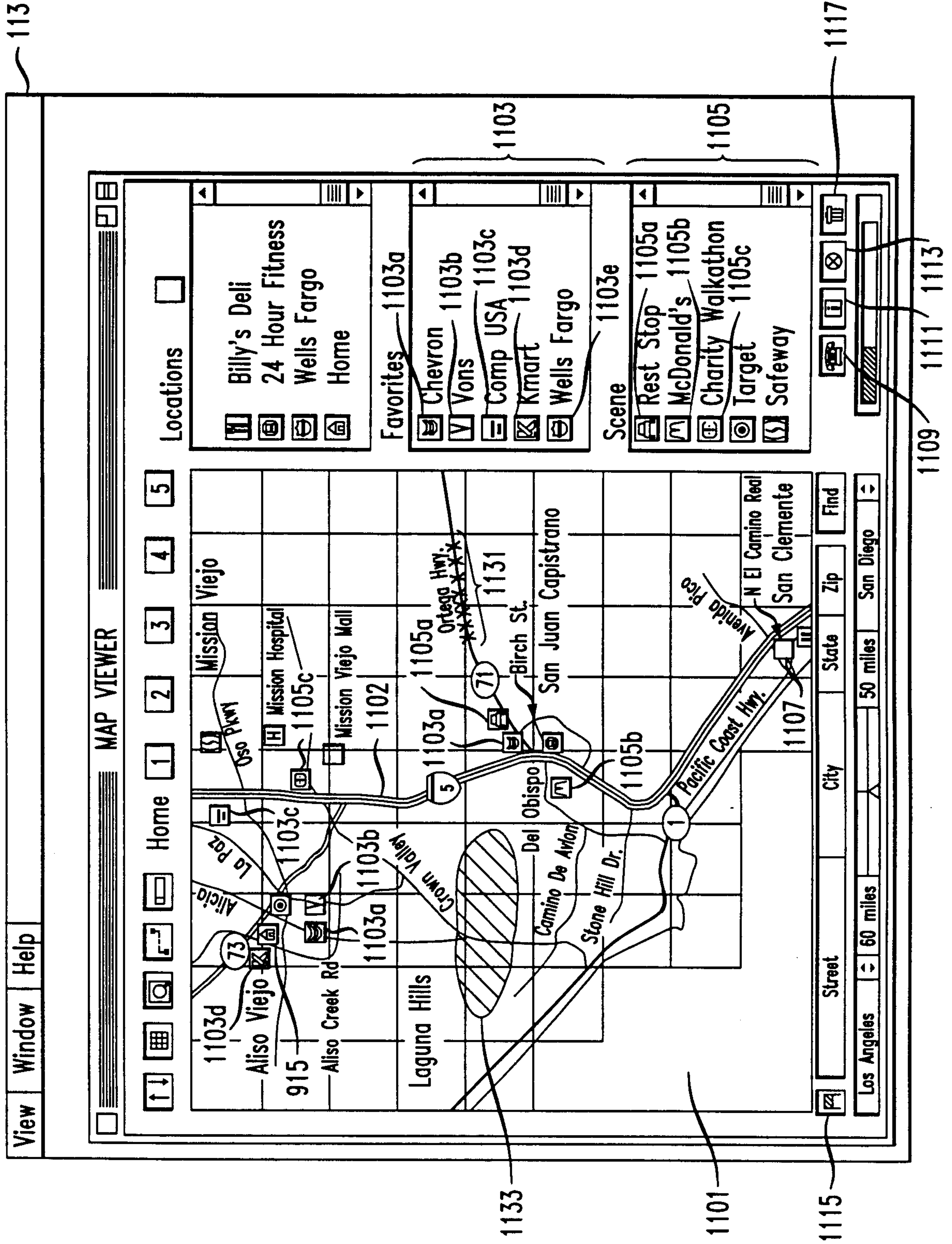

FIG. 12

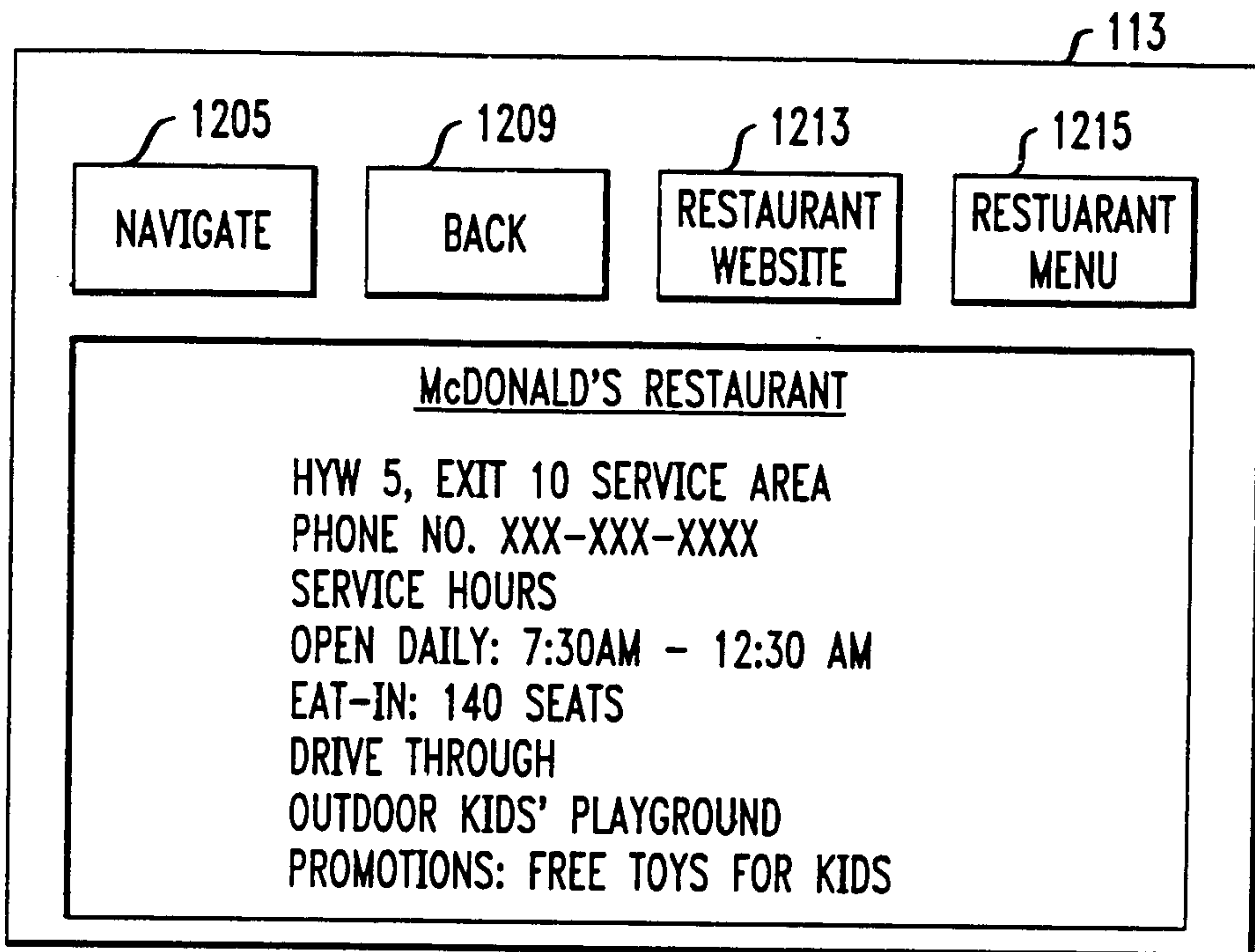

FIG. 13

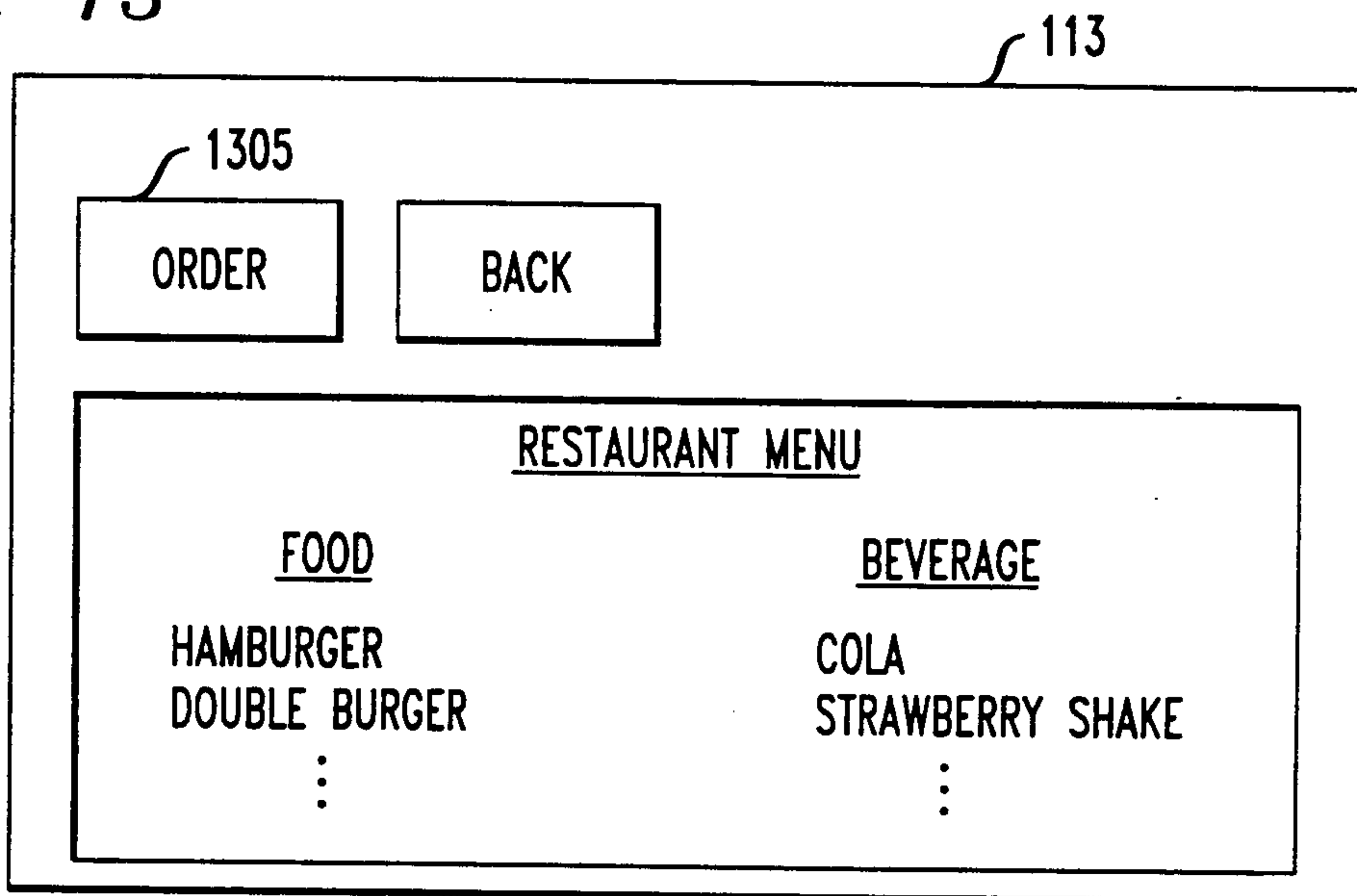

FIG. 14

