

2024 WOMEN'S TENNIS ASSOCIATION

# OFFICIAL RULEBOOK





# 2024 Official Rulebook

Copyright 2024 WTA Tour, Inc.  
All Rights Reserved

WTA and WTA Tour are registered trademarks of WTA Tour, Inc.

Printed in the United States of America



# TABLE OF CONTENTS

<b>I.</b>	<b>INTRODUCTION</b>	<b>5</b>
	A. DESCRIPTION	5
	B. ADMINISTRATION	5
	C. RULES	5
	D. POLICIES	6
<b>II.</b>	<b>PLAYER COMMITMENT</b>	<b>9</b>
	A. WTA 1000 MANDATORY AND WTA 500 TOURNAMENTS	9
	B. WTA FINALS	10
	C. YEARS OF SERVICE	11
	D. PLAYERS SUBJECT TO THE AGE ELIGIBILITY RULE	11
	E. INTEGRITY RULES	13
<b>III.</b>	<b>TOURNAMENT ENTRY, TOURNAMENT ACCEPTANCE, AND WILD CARDS</b>	<b>15</b>
	A. TOURNAMENT ENTRY	15
	B. TOURNAMENT ACCEPTANCE	25
	C. WILD CARDS	35
<b>IV.</b>	<b>WITHDRAWALS AND RETIREMENTS</b>	<b>45</b>
	A. WITHDRAWALS	45
	B. RETIREMENTS	56
	C. RESTRICTIONS, EXCEPTIONS, AND PROCEDURES	57
<b>V.</b>	<b>TOURNAMENT DRAWS AND SCHEDULING</b>	<b>61</b>
	A. DRAWS	61
	B. SCHEDULING	83
<b>VI.</b>	<b>WTA FINALS</b>	<b>91</b>
	A. RACE TO THE FINALS	91
	B. WTA FINALS	92
<b>VII.</b>	<b>PLAYER RESPONSIBILITIES/ON-COURT RULES AND PROCEDURES</b>	<b>103</b>
	A. ACES PROGRAM	103
	B. MEDIA/SPONSOR/PUBLIC RELATIONS RESPONSIBILITIES	111
	C. CLOTHING AND EQUIPMENT	120
	D. TOILET/CHANGE OF ATTIRE BREAKS	131
	E. WTA MEDICAL RULE	132

## TABLE OF CONTENTS

F.	CODE OF CONDUCT	132
G.	CONTINUOUS PLAY	132
H.	HINDRANCE RULE	133
I.	DEFAULTS	134
J.	FINE APPEALS	135
<b>VIII.</b>	<b>WTA RANKING SYSTEM</b>	<b>137</b>
A.	GENERAL	137
B.	RULES AND PROCEDURES	144
C.	WTA SPECIAL RANKING RULE	148
D.	TADP RETURN TO COMPETITION SPECIAL RANKING RULE	160
E.	RETIRING FROM THE WTA	164
<b>IX.</b>	<b>PRIZE MONEY</b>	<b>165</b>
A.	DISTRIBUTION	165
B.	AMATEURISM	167
C.	WITHDRAWALS, BYES, WALKOVERS, AND DEFAULTS	167
D.	TOURNAMENT CANCELLATION OR EARLY TERMINATION	170
E.	PRIZE MONEY BREAKDOWNS	170
<b>X.</b>	<b>AGE ELIGIBILITY AND PLAYER DEVELOPMENT</b>	<b>171</b>
A.	AGE ELIGIBILITY RULE	171
B.	PLAYER DEVELOPMENT PROGRAMS	182
C.	VIOLATIONS	191
<b>XI.</b>	<b>WTA PLAYER MEMBERSHIP</b>	<b>193</b>
A.	MEMBERSHIP QUALIFICATIONS	193
B.	MEMBERSHIP BENEFITS	194
C.	MEMBER RESPONSIBILITIES	195
D.	MEMBERSHIP AND INSURANCE ENROLLMENT PERIOD AND PAYMENT OPTIONS	197
E.	PENSION PLAN INFORMATION	199
F.	MEMBERSHIP/INSURANCE/PENSION CONTACTS, ADDRESSES AND NUMBERS	200
<b>XII.</b>	<b>WTA TOURNAMENT MEMBERSHIPS</b>	<b>203</b>
A.	WTA CALENDAR	203
B.	APPLICATION FOR A NEW TOURNAMENT ON THE WTA	203
C.	CONDITIONS OF TOURNAMENT MEMBERSHIP	205
D.	ANNUAL PROCEDURES FOR AN EXISTING WTA TOURNAMENT	206
E.	REASONS FOR REJECTION	208

## TABLE OF CONTENTS

F. TOURNAMENT PRIORITY	208
G. NO RELEASE	210
H. TERMINATION OF TOURNAMENTS	214
I. TOURNAMENT OWNERSHIP	215
<b>XIII. WTA TOURNAMENT RESPONSIBILITIES/BENEFITS TO WTA</b>	<b>229</b>
A. WTA SPONSOR PRODUCT CATEGORY EXCLUSIVITIES	229
B. COMMERCIAL BENEFITS GRANTED TO WTA	229
C. FAILURE TO PROVIDE COMMERCIAL BENEFITS	237
D. SPONSORSHIP RESTRICTIONS	237
E. PRE-TOURNAMENT RESPONSIBILITIES	238
<b>XIV. PRIZE MONEY FORMULA</b>	<b>239</b>
A. INDIAN WELLS, MIAMI, MADRID, AND BEIJING WTA 1000 MANDATORY TOURNAMENTS	239
B. ALL OTHER WTA 1000 MANDATORY AND WTA 500 TOURNAMENTS	239
C. WTA 250 TOURNAMENTS	265
D. NOT A MAXIMUM	266
E. AMENDMENT	267
<b>XV. TOURNAMENT FINANCIAL OBLIGATIONS</b>	<b>269</b>
A. TOURNAMENT FINANCIAL OBLIGATIONS	269
B. TOURNAMENT FINANCIAL COMMITMENT	270
C. FINANCIAL SECURITY REQUIREMENTS	270
D. TOURNAMENTS PAYING PRIZE MONEY IN EXCESS OF THE MINIMUM PRIZE MONEY LEVEL	272
E. MONETARY AND NON-MONETARY AWARDS	273
F. CONDITIONS	273
G. LATE PAYMENTS	273
<b>XVI. WTA FINANCIAL RESPONSIBILITIES TO TOURNAMENTS</b>	<b>275</b>
A. COMMERCIAL BENEFITS PAYMENTS	275
B. PAYMENT DATES	275
<b>XVII. CODE OF CONDUCT</b>	<b>277</b>
A. GENERAL PRINCIPLES	277
B. DEFINITIONS	278
C. APPLICABILITY, AVAILABILITY, AND RECIPROCITY	279
D. RULES AND PENALTIES – PLAYERS	281

## TABLE OF CONTENTS

E. EXHIBITION/NON-WTA EVENT RULE	292
F. DISHONORABLE OR UNPROFESSIONAL CONDUCT OF TOURNAMENT SUPPORT PERSONNEL	294
G. PROCEDURES FOR PLAYER AND TOURNAMENT SUPPORT PERSONNEL VIOLATIONS	295
H. PROCEDURES FOR PLAYER SUPPORT TEAM MEMBERS AND CREDENTIALLED PERSONS	300
<b>XVIII. STANDARDS</b>	<b>307</b>
A. TOURNAMENT STANDARDS OF PERFORMANCE	307
B. MEDICAL SECTION	353
C. ELECTRONIC REVIEW	376
D. COACHING	380
E. INTERNATIONAL MEDIA RIGHTS POOL	381
F. WTA TELEVISION BROADCAST STANDARDS	390
G. CODE OF CONDUCT FOR OFFICIALS	404
<b>XIX. FINAL DISPUTE RESOLUTION</b>	<b>405</b>
A. GOVERNING LAW	405
B. ARBITRATION	405
C. CONFIDENTIALITY	405
D. INVALIDITY	406
<b>APPENDICES</b>	<b>407</b>
WTA CONTACT INFORMATION	407
WTA REPRESENTATIVES	409
MEMBERSHIP LEASE MANDATORY TERMS	415
WTA BETTING, FANTASY & GAMBLING SPONSORSHIP RULES	417
WTA 125 TOURNAMENT STANDARDS OF PERFORMANCE	427
ROOF POLICY	475
WTA PLAYER AND TOURNAMENT FINES	477
ON-COURT SIGNAGE	481
COURT AND LIGHT MEASUREMENTS	487
UNITED CUP RULES	489
GLOSSARY	507
ITF RULES OF TENNIS	513
ANTI-DOPING CONTROL STATION	549
<b>INDEX</b>	<b>551</b>

# INTRODUCTION

## I. INTRODUCTION

### A. DESCRIPTION

The Women's Tennis Association ("WTA") is an international award competition open to all women tennis players.

The tournaments comprising the WTA ("WTA Tournaments") are connected by a points system in which players earn ranking points based on a tournament's category and the player's performance.

### B. ADMINISTRATION

The WTA is administered and governed by the WTA Tour, Inc. ("WTA Tour" or "WTA"), a US registered corporation whose members are the players, its recognized WTA 1000 Mandatory, WTA 500, and WTA 250 Tournaments worldwide, and the International Tennis Federation ("ITF"). The Chief Executive Officer ("CEO") of the WTA Tour is responsible for the day-to-day operations of the WTA. The Board of Directors of the WTA Tour is comprised of three (3) Player Board Representatives, three (3) Tournament Board Representatives, one (1) ITF Board Representative, and the CEO. The Board of Directors is responsible for establishing the long-term strategic plan for the WTA. Alternate Board Representatives for each member class may also attend Board of Directors meetings as determined by the CEO.

### C. RULES

In accordance with the rules ("Rules") set forth in this WTA Official Rulebook ("Rulebook"), as amended from time to time and updated online at [www.wtatennis.com/wta-rules](http://www.wtatennis.com/wta-rules), the WTA Tour selects and schedules WTA Tournaments and is responsible for the resolution of any matter of dispute pertaining to the WTA, including imposition of penalties on players, WTA Tournaments, tournament officials, player relatives and representatives, coaches, and other credentialed persons.

The ITF Rules of Tennis shall apply to all WTA Tournaments except as amended by the Rules. An excerpt of the ITF Rules of Tennis is set forth in Appendix M. For the complete and current ITF Rules of Tennis, please visit [www.itftennis.com/en/about-us/governance/rules-and-regulations/](http://www.itftennis.com/en/about-us/governance/rules-and-regulations/).

The Rules may be altered, amended, or repealed by the WTA pursuant to the WTA By-Laws. Capitalized terms have the meanings set forth in this Rulebook, including Section VII.C – Clothing and Equipment, Section XIV – Prize Money Formula, Section VIII – WTA Ranking System, Section X – Age Eligibility and Player Development, Section XVII - Code of Conduct, Section XVIII –



## INTRODUCTION

Standards, and Appendix L - Glossary. The headings and titles to the Sections contained herein are inserted solely for convenience purposes and shall not affect the meaning or construction of the Rules.

Any action of the WTA Tour pursuant to these Rules or otherwise with respect to the WTA shall be deemed effective only when the parties affected thereby shall have been sent notice of the action, or, in the case of any action of general applicability, notice thereof shall have been published in a manner that will ensure wide circulation. PlayerZone and TournamentZone postings and Player and Tournament Alerts shall be considered official forms of WTA communication with its members that are published in a manner that ensures wide circulation.

The WTA may impose appropriate sanctions, including monetary sanctions, upon any person or entity subject to these Rules who participates in or aids and abets any violation of these Rules. Any violations of these Rules which do not specify a process for imposition of a penalty shall be decided by the CEO and such decision of the CEO may be appealed to the Board of Directors.

All monetary terms are in United States dollars unless otherwise stated.

English is the official language of the WTA.

### D. POLICIES

#### 1. Open Competition/No Discrimination

Entry into Tournaments shall be open to all eligible women tennis players based on merit and without discrimination, subject only to the conditions in the WTA By-Laws and these Rules, including but not limited to the Age Eligibility Rules and Gender Participation Policy.

#### 2. Gender Participation Policy

All players are subject to the WTA Gender Participation Policy (“Gender Participation Policy”), as amended from time to time, which addresses the gender eligibility requirements for entry into and participation in WTA Tournaments. For the complete and current Gender Participation Policy, please reference [www.wtatennis.com/wta-rules](http://www.wtatennis.com/wta-rules).

#### 3. Nationality

For WTA purposes, including on all WTA platforms, a player’s nationality is: (a) the issuing country of the valid passport or in exceptional

## INTRODUCTION

circumstances other valid proof of nationality, citizenship, domicile, or residence she provides to the WTA with her Annual Player Form; (b) if she does not have a passport or other official documentation and she provides her birth certificate and photographic identification, the country of birth on her birth certificate; or (c) in exceptional circumstances, as the WTA determines. To request a change in nationality after the start of the Tour Year, a player must submit a copy of her valid passport or in exceptional circumstances other valid proof of nationality, citizenship, domicile, or residence issued by the country to which she is requesting a change. A player who changes her nationality after the start of the Tour Year may not request a subsequent change in nationality for the remainder of the current Tour Year except in exceptional circumstances, as the WTA determines.

#### **4. Eligibility**

All players must meet the eligibility requirements of the Tennis Anti-Doping Programme (the “TADP”) and the Tennis Anti-Corruption Program (the “TACP” and together with the TADP, the “Integrity Rules”) and these Rules to enter and participate in WTA Tournaments.



# PLAYERS

## II. PLAYER COMMITMENT

### A. WTA 1000 MANDATORY AND WTA 500 TOURNAMENTS

Subject to the Age Eligibility Rule, the Years of Service Rule, the Long-Term Injury Rule, and the Integrity Rules, all players must play the WTA Tournaments below if they are accepted, or would have been accepted if they had entered or been eligible to enter, into the Singles Main Draw at the Tournament's entry deadline ("Commitment Tournaments"). A player will receive a zero (0) ranking point result for each Commitment Tournament she does not play, which must count on her WTA Singles Ranking (see Section VIII – WTA Ranking System).

#### 1. WTA 1000 Mandatory Tournaments

- a. All players who are accepted into the Main Draw of a WTA 1000 Mandatory Tournament as a direct acceptance (or would have been a direct acceptance but for a period of ineligibility), as a Qualifier, as a Special Exempt, as a Lucky Loser, or by Special Ranking must play that WTA 1000 Mandatory Tournament.
- b. See Section VIII.A.4.a.ii - Long-Term Injury for the effects of a Long-Term Injury on a player's WTA 1000 Mandatory Commitment Tournament requirements.

#### 2. WTA 500 Tournaments

- a. All players who are accepted, or would have been accepted if they had entered, as a direct acceptance into the Main Draw at six (6) or more WTA 500 Tournaments' entry deadlines must play six (6) WTA 500 Tournaments. Players who are accepted, or would have been accepted if they had entered, as a direct acceptance into the Main Draw at less than six (6) WTA 500 Tournaments have WTA 500 Commitment Tournament requirements as follows:

<b>Number of WTA 500 Tournaments a player is accepted into or would have been accepted into if she had entered</b>	<b>WTA 500 Commitment Tournament Requirement</b>
5	5
4	4
3	3
2	2
1	1
0	0

**PLAYERS**  
**SECTION II - PLAYER COMMITMENT**

- b. If a player is not accepted as a direct acceptance into the Main Draw of a WTA 500 Tournament at the entry deadline but she plays its Qualifying or was accepted into Qualifying but plays in the Main Draw as a Wild Card, then that WTA 500 Tournament counts toward meeting her WTA 500 Commitment Tournament requirement.
  - c. If a player participates in United Cup, then that Tournament counts toward meeting her WTA 500 Commitment Tournament requirement.
  - d. If a player is on site at a WTA 500 Tournament, withdraws from the Main Draw due to a Medical Condition in accordance with the requirements and restrictions of Section IV, and completes promotional activities for the Tournament as determined by WTA over the first two (2) days, then that WTA 500 Tournament counts toward meeting her WTA 500 Commitment Tournament requirement.
  - e. If a player does not participate in any Tennis Event for thirty (30) consecutive days during a calendar year and withdraws from a WTA 500 Tournament Main Draw in accordance with the requirements and restrictions of Section IV within those thirty (30) days, then that Tournament counts toward meeting her WTA 500 Commitment Tournament requirement. The thirty (30) days begins as follows:
    - i. the Monday of Week 1 if the player has not played a Tennis Event in the current calendar year; or
    - ii. the Monday after the last Tennis Event played if the player has played any Tennis Event in the current calendar year.
- If a player's absence from Professional Tennis reaches eight (8) consecutive weeks, the Long-Term Injury Rule takes effect, superseding rather than adding to the above.
- f. See Section VIII.A.4.a.ii - Long-Term Injury for the effects of a Long-Term Injury on a player's WTA 500 Commitment Tournament requirements.

**B. WTA FINALS**

A player who qualifies for the singles competition of the WTA Finals must play in accordance with Section VI.

**PLAYERS**  
**SECTION II - PLAYER COMMITMENT**

**C. YEARS OF SERVICE**

A player thirty-four (34) years of age or older as of January 1 of a Tour Year ("Years of Service Player") will not receive a zero (0) ranking point result for any WTA 500 Commitment Tournament she does not play during that Tour Year.

A Years of Service Player must play all WTA 1000 Mandatory Commitment Tournaments and will receive a zero (0) ranking point result for each WTA 1000 Mandatory Commitment Tournament she does not play.

**D. PLAYERS SUBJECT TO THE AGE ELIGIBILITY RULE**

For the purposes of this Rule, a player's age is determined by her age as of the date of the start of a Tournament's singles Main Draw.

A player subject to the Age Eligibility Rule will not receive a zero (0) ranking point result for certain Commitment Tournaments she does not play during a Tour Year as explained below. Subject to Section X.A.2.a.ii, a player under 15 years of age may not participate in WTA Tournaments by direct acceptance.

See Section X for the Age Eligibility Rule and Player Development Programs.

**1. Indian Wells, Miami, Madrid, and Beijing WTA 1000 Mandatory Commitment Tournaments**

A player who by ranking qualifies for acceptance into the Main Draw of an Indian Wells, Miami, Madrid, or Beijing WTA 1000 Mandatory Tournament will be entered automatically.

**a. Under 17 Years of Age**

A player under 17 years of age is not required to play an Indian Wells, Miami, Madrid, or Beijing WTA 1000 Mandatory Commitment Tournament. If a player opts out of an Indian Wells, Miami, Madrid, or Beijing WTA 1000 Mandatory Tournament before the Main Draw Entry Deadline, she will not receive a zero (0) ranking point result or any Late Withdrawal penalties (e.g., fines, forfeiture of ranking points for playing another Tournament in the same week). If a player does not opt out but later withdraws from an Indian Wells, Miami, Madrid, or Beijing WTA 1000 Mandatory Tournament or opts out of an Indian Wells, Miami, Madrid, or Beijing WTA 1000 Mandatory Tournament and plays an Exhibition/Non-WTA event in the same week, then she

## PLAYERS

### SECTION II - PLAYER COMMITMENT

will receive a zero (0) ranking point result and any applicable Late Withdrawal penalties.

b. 17 Years of Age

A player 17 years of age must comply with Indian Wells, Miami, Madrid, and Beijing WTA 1000 Mandatory Commitment Tournament requirements in Section II.A.1.a. To be clear, her maximum WTA 1000 Mandatory Commitment Tournaments is four (4), consisting of Indian Wells, Miami, Madrid, and Beijing, regardless of the number of WTA 1000 Mandatory Tournaments that occur during the Tour Year. Unless a player has played all Indian Wells, Miami, Madrid, and Beijing WTA 1000 Mandatory Commitment Tournaments, her failure to play an Indian Wells, Miami, Madrid, or Beijing WTA 1000 Mandatory Commitment Tournament that occurs when she is 17 years of age, even if due to ineligibility under the Age Eligibility Rule, will result in a zero (0) ranking point result for such player.

c. 18 Years of Age and Older

A player 18 years of age or older must comply with all WTA 1000 Mandatory Commitment Tournament requirements in Section II.A.1.a. A player's failure to play a WTA 1000 Mandatory Commitment Tournament that occurs when she is 18 years of age or older will result in a zero (0) ranking point result for such player.

## 2. All Other WTA 1000 Mandatory Commitment Tournaments

a. Under 18 Years of Age

A player under 18 years of age is not required to play any of the WTA 1000 Mandatory Commitment Tournaments other than Indian Wells, Miami, Madrid, and Beijing ("All Other WTA 1000 Mandatory Commitment Tournaments") and will not receive a zero (0) ranking point result for not playing an All Other WTA 1000 Mandatory Commitment Tournament.

b. 18 Years of Age and Older

A player 18 years of age or older must comply with all WTA 1000 Mandatory Commitment Tournament requirements in Section II.A.1.a, including All Other WTA 1000 Mandatory Commitment Tournaments. A player's failure to play a WTA 1000 Mandatory Commitment Tournament that occurs when she is 18 years of age or older will result in a zero (0) ranking point result for such player.

## **PLAYERS**

### **SECTION II - PLAYER COMMITMENT**

#### **3. WTA 500 Commitment Tournaments**

a. Under 18 Years of Age

A player under 18 years of age is not required to play WTA 500 Commitment Tournaments and will not receive a zero (0) ranking point result for not playing a WTA 500 Commitment Tournament.

b. 18 Years of Age and Older

- i. Between a player's 18th birthday and the day before the start of the first Tournament in Week 1 of the first Tour Year following her 18th birthday, she is not required to play WTA 500 Commitment Tournaments and will not receive a zero (0) ranking point result for not playing a WTA 500 Commitment Tournament.
- ii. Beginning with the start of the first Tournament in Week 1 of the first Tour Year following a player's 18th birthday, she must comply with the WTA 500 Commitment Tournament requirements in Section II.A.1.c. A player's failure to play a WTA 500 Commitment Tournament will result in a zero (0) ranking point result for such player.

#### **E. INTEGRITY RULES**

Players who are not eligible to enter or participate in WTA Tournaments under the Integrity Rules remain subject to Commitment Tournament requirements and applicable zero (0) ranking point results during their period of ineligibility.





## PLAYERS

### III. TOURNAMENT ENTRY, TOURNAMENT ACCEPTANCE, AND WILD CARDS

#### A. TOURNAMENT ENTRY

##### 1. General

###### a. WTA Responsibility

The WTA is responsible for processing all player applications for entry into all WTA Tournaments and Grand Slam events (in accordance with Grand Slam Rules) and notifying WTA Tournaments and Grand Slams of their player fields in a timely fashion. (Grand Slam events may also require players to sign their individual tournament entry forms prior to playing their first matches.)

###### b. WTA Administrative Fee for Non-Members of the WTA and Women's Tennis Benefit Association

Any player who is not a member of the WTA and the Women's Tennis Benefit Association ("WTBA") will be charged a \$250 administrative fee for each WTA Tournament she plays.

###### c. Player Entry and Commitment to Rules

Any player who enters or participates in any WTA Tournament consents and agrees to the following:

###### i. Compliance with Rules

Each player must comply with and is bound by all of the provisions of the Rulebook and the WTA By-Laws, including but not limited to all amendments thereto.

###### ii. Compliance with the Integrity Rules

The TADP and TACP shall apply to and be binding upon all players and shall govern players' entry into and participation in WTA Tournaments (together with the Rules, each of them applying concurrently and without prejudice to the other) as well as the other events specified in the TADP and TACP. Players must complete any tennis integrity or anti-doping education programs mandated by the WTA or the International Tennis Integrity Agency (the "ITIA").

## PLAYERS

### SECTION III - TOURNAMENT ENTRY, TOURNAMENT ACCEPTANCE, AND WILD CARDS

The ITIA may conduct anti-doping testing at WTA Tournaments under the TADP. Players shall submit to the jurisdiction and authority of the ITIA to manage, administer, and enforce the TADP on behalf of the ITF and to the jurisdiction and authority of the ITIA, the Anti-Doping Tribunal, and the Court of Arbitration for Sport, as applicable, to determine any charges brought under the TADP.

Players shall submit to the jurisdiction and authority of the ITIA to manage, administer, and enforce the TACP and to the jurisdiction and authority of the ITIA, Anti-Corruption Hearing Officer, and the Court of Arbitration for Sport, as applicable, to determine any charges brought under the TACP.

The WTA will honor and enforce any penalties or sanctions, and/or other measures taken against players under the TADP or TACP, including in relation to provisional suspensions.

#### iii. Written Consent

Each calendar year, all players shall, as a condition of entering or participating in any event organized or sanctioned by the WTA, in conjunction with their execution of the Annual Player Form, consent to and agree to comply with the Rulebook, TADP, and TACP.

#### d. Entry Conditions

##### i. Annual Player Form

A player must complete the Annual Player Form prior to playing her first match in each Tour Year and ensure that at all times the WTA has a copy of her valid passport or, if a player does not have a valid passport, a copy of her birth certificate and a photographic ID.

Under no circumstances will a player be able to participate in a WTA event or receive prize money until she has completed and returned the Annual Player Form and confirmed that the WTA has a copy of such documentation.

##### ii. Entries

All players must submit an official entry to gain acceptance into WTA Tournaments. Official entries may be submitted to WTA Operations via one (1) of the following:

## PLAYERS

### SECTION III - TOURNAMENT ENTRY, TOURNAMENT ACCEPTANCE, AND WILD CARDS

- (a) PlayerZone online entry; or
  - (b) Email request (tourops@wtatennis.com).
- iii. The WTA will accept entries from players and/or designated coaches and agents. Regardless of whom a player designates to act upon her behalf, ultimately the player is responsible for all of her entries and withdrawals.
  - iv. No entry will be accepted unless and until the player's participation in the Tournament complies with the Gender Participation Policy and the Age Eligibility Rule, the player is eligible to participate in the Tournament under the Integrity Rules, and the player has satisfied her Player Development requirements.
  - v. Pursuant to the Integrity Rules, a player serving a period of ineligibility or provisional suspension under the TADP or TACP, as applicable, is not eligible to enter a Tournament, or be entered automatically into a WTA 1000 Mandatory Tournament or Grand Slam, that will take place during her period of ineligibility or provisional suspension. If a player is challenging her provisional suspension under the TADP or TACP, as applicable, she may remain on the entry list(s) for any WTA Tournament she entered prior to the effective date of the provisional suspension until the Qualifying Sign-In Deadline of such WTA Tournaments, at which point the player will be withdrawn automatically from the relevant WTA Tournament(s) if she is still ineligible.
  - vi. All outstanding fines from prior Tour Years must be paid in full before a player can enter or compete in a WTA Tournament in the current Tour Year.
  - vii. Rankings
    - (a) Singles
      - (i) WTA 1000 Mandatory and WTA 500 Tournaments  

Players must have a WTA Singles Ranking or Singles Special Ranking of 500 or better at the entry deadline to enter singles at a WTA 1000 Mandatory or WTA 500 Tournament.
      - (ii) WTA 250 Tournaments  

Players must have a WTA Singles Ranking or Singles

## PLAYERS

### SECTION III - TOURNAMENT ENTRY, TOURNAMENT ACCEPTANCE, AND WILD CARDS

Special Ranking of 750 or better at the entry deadline to enter singles at a WTA 250 Tournament.

(iii) WTA 125 Tournaments

Players must have a WTA Singles Ranking or Singles Special Ranking at the entry deadline to enter singles at a WTA 125 Tournament.

(b) Doubles

(i) WTA 1000 Mandatory, WTA 500, and WTA 250 Tournaments

Players must have a WTA Singles Ranking, Singles Special Ranking, WTA Doubles Ranking, or Doubles Special Ranking of 750 or better at the entry deadline to enter doubles at a WTA 1000 Mandatory, WTA 500, or WTA 250 Tournament.

(ii) WTA 125 Tournaments

Players must have a WTA Singles Ranking, Singles Special Ranking, WTA Doubles Ranking, or Doubles Special Ranking at the entry deadline to enter doubles at a WTA 125 Tournament.

The foregoing cutoffs do not apply to players accepted via Wild Card.

- viii. Each singles player with a WTA ranking who is not a WTA member is required to subscribe to the PlayerZone each calendar year prior to entry in her first WTA Tournament of that calendar year. The subscription fee is \$200 per calendar year, and payment is due ten (10) business days prior to the WTA Tournament entry deadline that triggers the subscription requirement. Entries will not be accepted without payment in full of the subscription fee.

## 2. Entry Deadlines

All references to entry deadlines refer to 5:00 p.m. Eastern Time (New York, USA Time) unless specified differently.

## PLAYERS

### SECTION III - TOURNAMENT ENTRY, TOURNAMENT ACCEPTANCE, AND WILD CARDS

#### a. Main Draw Singles

##### i. WTA Tournaments

Main Draw Entry Deadlines for WTA 1000 Mandatory, WTA 500, WTA 250, and WTA 125 Tournaments are four (4) weeks prior to the Monday of the week in which each Tournament's Main Draw starts unless otherwise determined by the WTA. This deadline shall not apply to the WTA Finals. (See Section VI.)

##### ii. Grand Slams

Main Draw Entry Deadlines for Grand Slams are six (6) weeks prior to the Monday of the week in which each event's Main Draw starts.

#### b. Qualifying Singles

##### i. WTA Tournaments

Qualifying Entry Deadlines for WTA 1000 Mandatory, WTA 500, WTA 250, and WTA 125 Tournaments are three (3) weeks prior to the Monday of the week in which each Tournament's Main Draw starts unless otherwise determined by the WTA.

##### ii. Grand Slams

Qualifying Entry Deadlines for Grand Slams are four (4) weeks prior to the Monday of the week in which each event's Main Draw starts.

#### c. Doubles

All doubles-only players must sign an Official WTA Entry Form prior to the commencement of the doubles event or enter online via PlayerZone. This requirement does not apply to the WTA Finals (see Section VI for entry and acceptance Rules at the WTA Finals).

All doubles entries using a Special Ranking must be submitted to (i) the Supervisor in writing if entering on site; or (ii) [tourops@wtatennis.com](mailto:tourops@wtatennis.com) by the applicable entry deadline if using the advance entry system (see Section III.A.2.c.i below). Players may use their Doubles Special Rankings for advance entry and Singles or Doubles Special Rankings for on-site entry. (See Section VIII.C - WTA Special Ranking Rule.)

## PLAYERS

### SECTION III - TOURNAMENT ENTRY, TOURNAMENT ACCEPTANCE, AND WILD CARDS

#### i. Advance Entry

The deadline for advance entry into the doubles Main Draw of any WTA Tournament is 5:00 p.m. Eastern time (New York, USA time) on the Monday two (2) weeks prior to the singles Main Draw start date of such Tournament (“Doubles Advance Entry Deadline”) unless otherwise determined by the WTA. A player may only enter one (1) Tournament per week through the doubles advance entry system. A player who is entered or accepted into the singles Main Draw or singles Qualifying of a Tournament as of the Doubles Advance Entry Deadline may only enter doubles at that same Tournament in that week.

#### ii. On-Site Entry

The deadline for on-site entry into the doubles Main Draw (“Doubles Sign-In Deadline”) is:

- (a) for all WTA 1000 Mandatory, WTA 500, or WTA 250 Tournaments, 6:00 p.m. tournament local time two (2) days before the start of the doubles Main Draw at such Tournament (unless the Official WTA Tournament Fact Sheet states otherwise); and
- (b) for all WTA 125 Tournaments, 12:00 noon tournament local time on the day before the start of the doubles Main Draw at such Tournament (unless the Official WTA Tournament Fact Sheet states otherwise).

A team must sign in by contacting (in person or by a telephone conversation) the on-site Supervisor, Supervisor at an event at which one of the team’s players is competing, or WTA Operations. A team may sign in beginning the day prior to the day sign-in closes. Each team is ultimately responsible for confirming that the Supervisor or WTA Operations has received its sign-in before the Doubles Sign-In Deadline.

### 3. More Than One Tournament Per Week

If a player enters more than one (1) Tournament per week, the following rules apply:

#### a. Indicating Choices

The player must indicate which Tournament is her first, second, or third choice. If she fails to do so, the Tournament in the highest

## PLAYERS

### SECTION III - TOURNAMENT ENTRY, TOURNAMENT ACCEPTANCE, AND WILD CARDS

Tournament category will be indicated as her first choice; however, if two (2) Tournaments entered are in the same category, the Tournament that is listed first on the Official WTA Calendar will be entered as her first choice. All applicable withdrawal Rules will apply.

If entering via the PlayerZone, a player may use the “within option” to indicate that if she is within one (1) to four (4) spots of being in the Main Draw or Qualifying of her first preference Tournament, she will remain on the Tournament’s Alternate List and be removed from all other Tournaments she was accepted into that week.

#### b. Main Draw Entries and Acceptances

If at the time of the Main Draw entry deadline, a player is accepted into the Main Draw of any of the Tournaments she entered in the same week (based on her order of choice), then she will be withdrawn automatically from all other Tournaments entered that week.

If at the time of the Main Draw entry deadline, a player is not accepted into the Main Draw of any Tournaments, then she will remain on all Alternate Lists up until three (3) weeks prior to the Tournament and she can change her preferences at any time up until the Qualifying entry deadline, provided she makes the change before she moves into the Main Draw. If she moves into a Main Draw of any Tournament between the Main Draw entry deadline and the Qualifying entry deadline, she will be removed from all other Main Draw Alternate Lists.

If a player is not accepted into the Main Draw of any Tournaments at three (3) weeks prior to the Tournament, she will either:

- i. remain only on the Main Draw Alternate List of the Tournament in which she was accepted into Qualifying and be removed from all other Main Draw Alternate Lists;
- ii. remain only on the Main Draw Alternate List of her first choice Qualifying Tournament where she is a Qualifying Alternate and be removed from all other Alternate Lists; or
- iii. if not entered into any Qualifying Tournaments, remain only on the Main Draw Alternate List of her first preference Main Draw Tournament.

#### c. Qualifying Entries and Acceptances

If at the time of the entry deadline, a player is accepted into the Qualifying Draw of any of the Tournaments entered in the same week



## PLAYERS

### SECTION III - TOURNAMENT ENTRY, TOURNAMENT ACCEPTANCE, AND WILD CARDS

(based on her order of choice) she will be withdrawn automatically from all other Tournaments entered that week.

If a player is not accepted into the Qualifying Draw of any Tournaments entered in the same week, she will remain on the Qualifying Alternate List of her first choice Tournament and will be withdrawn automatically from all other Tournaments.

#### d. Second Week of a Grand Slam/WTA 1000 Mandatory Tournament

A player is allowed to play in a WTA 125 Tournament or a Women's ITF World Tennis Tour event during the second week of a Grand Slam or a WTA 1000 Mandatory Tournament only if the player:

- i. was accepted into the Main Draw (singles or doubles) of the Grand Slam or WTA 1000 Mandatory Tournament by any method, has not withdrawn from such Tournament, and
  - (a) for the Singles Main Draw in the second week, has lost in all draws in which she played of the Grand Slam or WTA 1000 Mandatory Tournament (i) on the day of the Qualifying Sign-In Deadline of the WTA 125 Tournament, or if there is no Qualifying, on the day before the Main Draw begins or (ii) by the qualifying sign-in deadline of the Women's ITF World Tennis Tour event; or
  - (b) for the Doubles Main Draw in the second week, has lost in all draws in which she played of the Grand Slam or WTA 1000 Mandatory Tournament (i) by the Doubles On-Site Sign-In deadline of the WTA 125 Tournament or (ii) by the doubles sign-in deadline of the Women's ITF World Tennis Tour event; or
- ii. was not accepted by any method into the Main Draw of the Grand Slam or WTA 1000 Mandatory Tournament and is not signed in as a Lucky Loser at such Tournament; or
- iii. has a Special Ranking and is making her Return to Competition according to the requirements of Section VIII.C.5.c.ii(b).

A player who would have been a Main Draw acceptance but did not play in a Grand Slam or WTA 1000 Mandatory Tournament is not allowed to compete in a WTA 125 Tournament or a Women's ITF World Tennis Tour event during the second week of such Grand Slam or WTA 1000 Mandatory Tournament except pursuant to iii above.

## PLAYERS

### SECTION III - TOURNAMENT ENTRY, TOURNAMENT ACCEPTANCE, AND WILD CARDS

The WTA 125 Tournament may wait to hold its singles or doubles draws so that it can determine which players are eligible. Players still competing after the day of the Qualifying Sign-In Deadline, or if there is no Qualifying, on the day the Main Draw begins, will be withdrawn automatically from the WTA 125 Tournament.

If a player violates this Rule, upon the first occurrence, the player will receive the lesser of the ranking points earned from the two (2) Tournaments. Upon the second and subsequent occurrences, the player will not be awarded any ranking points.

A player will not be permitted to withdraw from any WTA Tournament to play a Women's ITF World Tennis Tour event, except as permitted under Section VIII.C.5.c.ii(b).

e. **Playing Two (2) Singles Tournaments in One (1) Week**

A player is not allowed to compete in singles in two (2) Tournaments held in the same week and will be withdrawn from the second Tournament by the appropriate entry authority (i.e., a player may not play the Qualifying of a WTA Tournament, lose, and then play the Main Draw of a Women's ITF World Tennis Tour event in the same week). If a player does play two (2) singles Tournaments in one (1) week, upon the first occurrence, the player will receive the lesser of the ranking points earned from the two (2) Tournaments. Upon the second and subsequent occurrences, the player will not be awarded any ranking points, and she will be subject to a fine of up to \$10,000 for Unsportsmanlike Conduct.

f. **Playing Two (2) Doubles Tournaments in One (1) Week**

A player is not allowed to compete in doubles in two (2) Tournaments held in the same week, at which ranking points are awarded. If a player does play two (2) doubles Tournaments in one (1) week, upon the first occurrence, the player will receive the lesser of the ranking points earned from the two (2) Tournaments. Upon the second and subsequent occurrences, the player will not be awarded any ranking points, and she will be subject to a fine of up to \$10,000 for Unsportsmanlike Conduct.

g. **Playing Singles/Doubles the Same Week in Different Tournaments**

A player is allowed to play singles in one (1) Tournament and doubles in another Tournament in the same week, provided the player has been eliminated from one (1) Tournament by the Doubles Sign-In

## PLAYERS

### SECTION III - TOURNAMENT ENTRY, TOURNAMENT ACCEPTANCE, AND WILD CARDS

Deadline of the other Tournament. A player may not participate in both Tournaments at the same time.

#### h. WTA Tournament and Grand Slam Qualifying in the Same Week

##### i. Entry, Player's Choice, and Automatic Withdrawal

Any player who enters both a WTA Tournament and the Qualifying of a Grand Slam in the same week may not remain on the entry list(s) (i.e., Main Draw, Main Draw Alternate, Qualifying, Qualifying Alternate, Doubles Advance, Doubles On-Site, or Wild Cards) of both the WTA Tournament and the Grand Slam Qualifying after the Qualifying Sign-In deadline of the applicable WTA Tournament (or, if the player entered only doubles of the applicable WTA Tournament, after the Doubles Sign-In deadline). If a player is on the entry list(s) of both the WTA Tournament and the Grand Slam Qualifying at the Qualifying Sign-In deadline (or Doubles Sign-In deadline, if applicable), then the player will remain on the Grand Slam Qualifying list(s), WTA automatically will withdraw the player from all WTA Tournament entry lists for that week, and the player will not be permitted to enter doubles on-site at any WTA Tournament that week.

##### ii. Wild Cards

A player may not accept a Wild Card into the Qualifying or Main Draw (singles or doubles) of a WTA Tournament occurring during the same week as a Grand Slam Qualifying if she is on the Qualifying List for such Grand Slam or has accepted a Wild Card into such Grand Slam Qualifying. Regardless of Section III.A.3.e, after giving her best effort and losing in the Qualifying or Main Draw (singles, doubles, or both) of a WTA Tournament occurring during the same week as a Grand Slam Qualifying, a player who subsequently receives an offer for a Wild Card into such Grand Slam Qualifying may accept such Wild Card and participate in such Grand Slam Qualifying.

##### iii. Sanctions

A player is not subject to a late withdrawal fine for her automatic withdrawal from a WTA Tournament under Section III.A.3.h.i above.

# PLAYERS

## SECTION III - TOURNAMENT ENTRY, TOURNAMENT ACCEPTANCE, AND WILD CARDS

### B. TOURNAMENT ACCEPTANCE

#### 1. Direct Acceptance

Direct acceptance players are players accepted directly into the draw. Tournament acceptances are based on the WTA Rankings and Special Rankings as of the applicable entry deadline unless otherwise determined by the WTA, subject to the WTA 250 and WTA 125 Tournament entry restrictions, the Age Eligibility Rule, and the Integrity Rules. Once a player has been accepted into a Tournament, she will not be removed from the Acceptance List unless she officially withdraws from the Tournament or except where otherwise stated in the Rules.

##### a. Singles

###### i. WTA 1000 Mandatory Tournaments and Grand Slams

All eligible players who by WTA Singles Ranking qualify for acceptance into the Main Draw of a WTA 1000 Mandatory Tournament will be entered automatically into such WTA 1000 Mandatory Tournament.

The WTA automatically will enter the eligible top 200 singles players in the WTA Rankings at the entry deadline of any Grand Slam into the Main Draw entry list of such Grand Slam. Players must enter Grand Slam Qualifying (see the Grand Slam Rules).

For players subject to the Age Eligibility Rule, see Section X.A.2.f – Grand Slams and Commitment Tournaments.

Players entering a WTA 1000 Mandatory Tournament or Grand Slam using their Special Rankings must submit an official entry to WTA Operations.

###### ii. WTA 500 Tournaments

In any weeks in which both a WTA 500 Tournament and WTA 250 Tournament are scheduled, a player whose WTA Singles Ranking is 1-30 at the Tournament's Main Draw entry deadline ("Top 30 Player") may not play the WTA 250 (singles or doubles) if she qualifies for acceptance into the WTA 500 based on her WTA Singles Ranking unless she receives a WTA 250 Play Down Exemption (up to two (2) per Tour Year).

## PLAYERS

### SECTION III - TOURNAMENT ENTRY, TOURNAMENT ACCEPTANCE, AND WILD CARDS

#### iii. WTA 250 Tournaments

##### (a) WTA 250 Tournaments in the Same Week as WTA 500 Tournaments

Top 30 Players (as defined above) who do not qualify for acceptance into the WTA 500 Tournament in the same week may play the WTA 250 Tournament.

Top 30 Players who qualify for acceptance into the WTA 500 Tournament may only play the WTA 250 Tournament (singles or doubles) if they receive a WTA 250 Play Down Exemption by meeting one of the following criteria (collectively, "Exemption Players"):

- (i) Player is such Tournament's prior year singles champion ("Defending Champion");
- (ii) Player's Nationality (in accordance with Section I.D.3) is the same country as such Tournament's location ("Local Player"); or
- (iii) Player's WTA Singles Ranking is 11-30 as of the Main Draw entry deadline ("11-30 Player").

A WTA 250 Tournament in the same week as a WTA 500 Tournament may accept only one (1) Exemption Player from each category; provided, however, that if a Defending Champion or Local Player does not enter, then the Tournament may accept an additional 11-30 Player.

A WTA 250 Tournament in the same week as a WTA 500 Tournament may accept only one (1) player whose WTA Singles Ranking is 1-10 at the Tournament's Main Draw entry deadline ("Top 10 Player") to play singles and/or doubles, inclusive of the Defending Champion and Local Player.

##### (b) WTA 250 Tournaments in Weeks Without WTA 1000 Mandatory or WTA 500 Tournaments

WTA 250 Tournaments in weeks without WTA 1000 Mandatory or WTA 500 Tournaments may accept one (1) Top 10 Player to play singles and/or doubles. Players whose

## PLAYERS

### SECTION III - TOURNAMENT ENTRY, TOURNAMENT ACCEPTANCE, AND WILD CARDS

WTA Singles Ranking is 11+ at the Tournament's Main Draw entry deadline may play the WTA 250 Tournament.

- (c) Acceptance Procedure for Exemption Players and Top 10 Players
  - (i) Prior to the Main Draw Entry Deadline

Prior to its Main Draw Entry Deadline, a WTA 250 Tournament in the same week as a WTA 500 Tournament must approve Exemption Players and a WTA 250 Tournament in a week without a WTA 1000 Mandatory or WTA 500 Tournament must approve Top 10 Player entries. If a WTA 250 Tournament wants to secure a particular Exemption Player or Top 10 Player (as applicable), then by 2:00 p.m. Eastern Time (New York, USA time) on the day of its Main Draw Entry Deadline, the Tournament must submit a Play Down Exemption Form or Top 10 Confirmation Form (as applicable) listing:

- For a WTA 250 Tournament in the same week as a WTA 500 Tournament, Exemption Players of the Tournament's choice who have submitted an Exemption Player Acceptance Form ("Confirmed Exemption Players") and any other Local Player or 11-30 Players the Tournament has chosen to have next priority for acceptance ("Alternate Exemption Players"); or
- For a WTA 250 Tournament in a week without a WTA 1000 Mandatory or WTA 500 Tournament, the Top 10 Player of the Tournament's choice who has requested entry into and submitted a Top 10 Acceptance Form for the Tournament ("Confirmed Top 10 Player") and any other Top 10 Players the Tournament has chosen to have next priority for acceptance ("Alternate Top 10 Players").

If the Tournament has Confirmed Exemption Players or a Confirmed Top 10 Player (as applicable) at 2:00 p.m. on the day of the Main Draw Entry Deadline, then the Alternate Exemption Players or Alternate Top 10 Players and all other Top 30 Players or Top 10 Players (as applicable) who entered the Tournament but were not accepted will remain on an Exemption/Top 10

## PLAYERS

### SECTION III - TOURNAMENT ENTRY, TOURNAMENT ACCEPTANCE, AND WILD CARDS

Alternate List unless they withdraw their entries or are accepted into another Tournament in the same week.

If the Tournament does not have one (1) Confirmed Exemption Player or a Confirmed Top 10 Player at 2:00 p.m. on the day of the Main Draw Entry Deadline, then the highest-ranked Top 30 Player or Top 10 Player (as applicable) who entered the Tournament will be accepted.

The first Alternate Exemption Player or Alternate Top 10 Player listed on the Tournament's Play Down Exemption Form or Top 10 Confirmation Form (as applicable) will become a Confirmed Exemption Player or Confirmed Top 10 Player and must submit an Exemption Player Acceptance Form or Top 10 Acceptance Form (as applicable) if: (a) the Tournament's original Confirmed Exemption Player is not a Top 30 Player or the Tournament's original Confirmed Top 10 Player is not a Top 10 Player at the Main Draw Entry Deadline; or (b) the Tournament's original Confirmed Exemption Player or Confirmed Top 10 Player withdraws prior to the Main Draw Entry Deadline.

(ii) Between the Main Draw Entry Deadline and Qualifying Sign-In Deadline

If a Confirmed Exemption Player or Confirmed Top 10 Player withdraws after the Main Draw Entry Deadline but prior to the Qualifying Sign-In Deadline, then the following players will be accepted in the following order:

- The first Alternate Exemption Player on the Exemption/Top 10 Alternate List from the same category as the withdrawing player or the first Alternate Top 10 Player on the Exemption/Top 10 Alternate List (as applicable); or if there are no Alternate Exemption Players or Alternate Top 10 Players on the Exemption/Top 10 Alternate List, then
- The highest-ranked Top 30 Player or Top 10 Player (as applicable) on the Alternate List; or if there are no applicable players on the Alternate List, then
- The next-in Main Draw player.

## PLAYERS

### SECTION III - TOURNAMENT ENTRY, TOURNAMENT ACCEPTANCE, AND WILD CARDS

- (iii) After the Qualifying Sign-In Deadline Until the Draw is Made

If a Confirmed Exemption Player or a Confirmed Top 10 Player who was a direct acceptance withdraws after the Qualifying Sign-In Deadline, then the Tournament may replace that player until the Main Draw is made according to Section V.A.3.a.i Exemption Player/Top 10 Player Replacement.

See Appendix F for WTA 250 Play Down Exemption and Top 10 Player entry examples.

- (d) Player Restrictions

A Top 30 Player may receive two (2) WTA 250 Play Down Exemptions per Tour Year.

In 2024, a Top 10 Player may play three (3) WTA 250 Tournaments, inclusive of any WTA 250 Play Down Exemptions she received. Starting in 2025, a Top 10 Player may play three (3) WTA 250 Tournaments per Tour Year only if she played all her WTA 500 Commitment Tournaments in the prior Tour Year. If she did not play all her WTA 500 Commitment Tournaments in the prior Tour Year, she may play only two (2) WTA 250 Tournaments in the current Tour Year.

If an Exemption Player or Top 10 Player withdraws from a WTA 250 Tournament any time after (i) becoming a Confirmed Exemption Player or Confirmed Top 10 Player, (ii) the entry deadline, or (iii) accepting a Wild Card, then the WTA 250 Tournament counts as one (1) of her maximum allowed WTA 250 Tournaments unless she withdraws because of a Long-Term Injury.

- iv. WTA 125 Tournaments

Top 10 Players at the Main Draw Entry Deadline of a WTA 125 Tournament may not enter, accept a Wild Card into, or compete in singles or doubles of that WTA 125 Tournament.

- (a) In the Same Week as a WTA 1000 Mandatory Tournament

Players who qualify for Main Draw acceptance into a WTA 1000 Mandatory Tournament at the Main Draw Entry



## PLAYERS

### SECTION III - TOURNAMENT ENTRY, TOURNAMENT ACCEPTANCE, AND WILD CARDS

Deadline may not enter, accept a Wild Card into, or compete in singles or doubles of a WTA 125 Tournament scheduled the same week.

- (b) In the Second Week of a WTA 1000 Mandatory Tournament or Grand Slam

Players ranked 11+ may enter and compete in singles or doubles of a WTA 125 Tournament in the second week of a WTA 1000 Mandatory Tournament or Grand Slam.

- (c) In the Same Week as a WTA 500 or WTA 250 Tournament

Players ranked 1-75 who qualify for Main Draw acceptance at the Main Draw Entry Deadline of a WTA 500 or WTA 250 Tournament scheduled the same week as a WTA 125 Tournament may not enter, accept a Wild Card into, or compete in singles or doubles of that WTA 125 Tournament.

- (d) In Weeks 45-52 (“Off Season”) or a Week Without a WTA 1000 Mandatory, WTA 500, or WTA 250 Tournament

Players ranked 1-50 at the Main Draw Entry Deadline of a WTA 125 Tournament cannot enter that Tournament, but players ranked 21-50 may receive WTA-approved Wild Cards in singles and doubles (subject to Wild Card maximums). (See Section III.C - Wild Cards.)

Players who qualify for the WTA Finals (including the two confirmed WTA Finals Alternates) cannot enter, accept a Wild Card into, or compete in singles or doubles in a WTA 125 Tournament scheduled the same week as the WTA Finals even if they withdraw from the WTA Finals.

<b>WTA 125 Tournament Acceptance Summary</b>	
<b>WTA 125 Tournament Timing</b>	<b>Players Prohibited from Entering the WTA 125 Tournament</b>
In the same week as a WTA 1000 Mandatory	Players who qualify for Main Draw acceptance into the WTA 1000 Mandatory Tournament
In the second week of a WTA 1000 Mandatory Tournament or Grand Slam	Top 10 Players
In the same week as a WTA 500 or WTA 250 Tournament	Players ranked 1-75 who qualify for Main Draw acceptance into the WTA 500 or WTA 250 Tournament

## PLAYERS

### SECTION III - TOURNAMENT ENTRY, TOURNAMENT ACCEPTANCE, AND WILD CARDS

In a week without a WTA 1000 Mandatory, WTA 500, or WTA 250 Tournament	Players ranked 1-20 (Players ranked 21-50 may only play via Wild Card)
In the same week as WTA Finals	Players who qualify for the WTA Finals and players ranked 1-20 (Players ranked 21-50 may only play via Wild Card)
In the Off Season	Players ranked 1-20 (Players ranked 21-50 may only play via Wild Card)

#### b. Doubles

A player may not enter (Advance Entry or On-Site Entry) with more than one (1) partner.

##### i. Advance Entry

- (a) Acceptance at each Tournament is determined by the highest combined WTA Doubles Rankings, which may include Doubles Special Rankings, of the players on each team as of the Doubles Advance Entry Deadline for that Tournament. For players who only have a WTA Singles Ranking or Singles Special Ranking, the WTA will assign a Doubles Ranking of one (1) plus the ranking of the lowest player on the WTA Doubles Rankings applicable to acceptance.
- (b) A team may withdraw from the advance entry list or Advance Entry Alternate List via PlayerZone without penalty prior to:
  - (i) 4:00 p.m. tournament local time on the day of the Qualifying Sign-In;
  - (ii) 4:00 p.m. Eastern time on the Friday prior to the start of Main Draw if no Qualifying Draw; or
  - (iii) 2:00 p.m. Eastern time on the day before the Qualifying Sign-In Deadline if the Qualifying Sign-In Deadline and the Doubles Sign-In Deadline are on the same day (as applicable, the "Doubles Freeze Deadline").
- (c) If a withdrawing team has been accepted into the doubles Main Draw of the Tournament at the time of withdrawal, it must indicate the withdrawing player upon withdrawal, and:
  - (i) the withdrawing player may not: (i) re-enter that Tournament (except by Wild Card); and (ii) enter or

## PLAYERS

### SECTION III - TOURNAMENT ENTRY, TOURNAMENT ACCEPTANCE, AND WILD CARDS

accept a Wild Card into the doubles draw of another WTA Tournament in the same week unless she has been accepted into the singles draw of that other WTA Tournament via Wild Card; and

- (ii) the non-withdrawing player may re-pair with another partner before the Doubles Freeze Deadline, re-enter that Tournament or enter another Tournament on site with another partner, or accept a Wild Card into the doubles draw of any WTA Tournament in the same week (including the Tournament from which her partner withdrew).

The WTA automatically will withdraw a team from the advance entry list or Advance Entry Alternate List if one player on that team is accepted via Wild Card into either the singles Main Draw or Qualifying at another WTA Tournament in the same week. The team may enter the doubles draw on-site at the Tournament at which one or both of its players have been accepted via Wild Card into the singles Main Draw or Qualifying.

- (d) If a player withdraws from the Advance Entry List, her non-withdrawing partner may re-pair with another partner until the Doubles Freeze Deadline (see sub-Section (b) above). The new partner cannot already be accepted into the doubles draw and if she is on the Advance Entry Alternate List, then she must withdraw before the newly re-paired team can enter. The newly re-paired team must have a higher combined WTA Doubles Ranking as of the Doubles Advance Entry Deadline than the first team on the Advance Entry Alternate List at the time of re-pairing. If the non-withdrawing partner chooses not to re-pair, the next team on the Advance Entry Alternate List moves into the draw at the Doubles Freeze Deadline or when the non-withdrawing partner notifies WTA Operations in writing that she is not re-pairing, whichever comes first.
- (e) All openings after the Doubles Freeze Deadline are filled by On-Site Entry.

#### ii. On-Site Entry

- (a) In accordance with the chart in Section V.A.1.c below, acceptance at each Tournament is determined by using the highest of the combined WTA Singles or Doubles Rankings,

## PLAYERS

### SECTION III - TOURNAMENT ENTRY, TOURNAMENT ACCEPTANCE, AND WILD CARDS

which may include Special Rankings, of the players on each team as of the week prior to the start of that Tournament. However, if a player is accepted using her WTA Singles Ranking or Singles Special Ranking and would have been accepted using her WTA Doubles Ranking or Doubles Special Ranking, the entry will count as if the player used her WTA Doubles Ranking or Doubles Special Ranking.

- (b) Teams that enter a Tournament but are not accepted into the draw become Alternates for the sign-in day of that Tournament. The On-Site Entry Alternate List will be in order of the highest combined WTA Singles or Doubles Rankings, which may include Special Rankings, of the players on each entering team as of the week prior to the start of that Tournament. To remain eligible for subsequent days, Alternates must have entered in accordance with Section III.A.2.c above and must follow the procedures for Openings in the Draw in Section V.A.3.c below.
- (c) If a player is accepted using her WTA Singles Ranking or Singles Special Ranking, plays in a doubles match, and subsequently withdraws from the doubles Main Draw, she forfeits her eligibility to use her WTA Singles Ranking or Singles Special Ranking to enter the doubles Main Draw at any WTA Tournament for the remainder of that Tour Year unless: (i) she also withdraws or retires from singles at the same Tournament; (ii) she is declared unfit to play; or (iii) she finished competing in singles at the same Tournament and she also withdraws from playing singles in a Tournament to be held the following week.

## 2. Tournament Acceptance Procedure if Rankings Tied

### a. Singles

- i. If two (2) or more players' WTA Singles Rankings are tied at the time of Tournament acceptances, then the following player receives priority:
  - (a) the player with the highest WTA Singles Ranking from the previous week; then
  - (b) the player with the most WTA Singles matches won over the previous 52-week period; then
  - (c) the player who is drawn randomly.

## PLAYERS

### SECTION III - TOURNAMENT ENTRY, TOURNAMENT ACCEPTANCE, AND WILD CARDS

- ii. If two (2) or more players' Special Rankings are tied at the time of Tournament acceptances, then the following player receives priority:
  - (a) the player with the highest current WTA Singles Ranking; then
  - (b) the player with the highest WTA Singles Ranking from the previous week; then
  - (c) the player with the highest WTA Singles Ranking from the week prior to the start of her Out-of-Competition Period; then
  - (d) the player who is drawn randomly.
  
- b. Doubles
  - i. Entries Using Combined WTA Doubles Rankings

If two (2) or more teams' combined WTA Doubles Rankings, which may include Doubles Special Rankings, are tied as of the Doubles Advance Entry Deadline, then the following team receives priority:

    - (a) the team with the greatest combined total WTA doubles ranking points counting on their rankings; then
    - (b) the team with the highest combined WTA Doubles Rankings from the week prior to the WTA Doubles Rankings applicable to acceptance; then
    - (c) the team with the fewest Tournaments played as a team in the previous 52-week period; then
    - (d) the team that is drawn randomly.
  
  - ii. Entries Using Combined WTA Singles or Doubles Rankings

If two (2) or more teams' combined WTA Singles or Doubles Rankings, which may include Special Rankings, are tied as of the Doubles Sign-In Deadline, then the following team receives priority:

    - (a) the team using two (2) WTA Singles Rankings or Singles Special Rankings to enter; then

## **PLAYERS**

### **SECTION III - TOURNAMENT ENTRY, TOURNAMENT ACCEPTANCE, AND WILD CARDS**

- (b) the team using one (1) WTA Singles Ranking or Singles Special Rankings to enter; then
- (c) the team using two (2) WTA Doubles Rankings or Doubles Special Rankings to enter.

If after applying these priority procedures two (2) or more teams are tied for qualification under (a) or (b), then the team with the highest-ranked (as of the WTA Rankings applicable to acceptance) singles player receives priority. If after applying these procedures two (2) or more teams are tied for qualification under (c), then Section III.B.2.b.i above determines the team that receives priority.

#### **3. Distribution of Acceptance Lists**

Initial Tournament Acceptance Lists are distributed to individual Tournament Directors immediately upon their availability and will be posted on the PlayerZone and TournamentZone websites.

#### **4. Tournament Status**

Tournament status is available to players on the PlayerZone website, via a WTA Operations staff member in the Florida office, or through an on-site Supervisor.

#### **5. Administrative Error on Acceptance Lists**

##### **a. Player Omitted**

If an administrative error has been made on an Acceptance List resulting in a player being omitted from the list, the player will be placed at the top of the Next-In List(s) for Main Draw and/or Qualifying based on the appropriate ranking used for player movement.

##### **b. Too Many Players Accepted**

See Section V.A.4 - On-Site Draw Procedure for Administrative Error – Preliminary Match.

### **C. WILD CARDS**

#### **1. Definition**

Wild Cards are those players named by the Tournament Director to fill designated spots in the draw. The WTA must approve all Wild Card

## PLAYERS

### SECTION III - TOURNAMENT ENTRY, TOURNAMENT ACCEPTANCE, AND WILD CARDS

nominations in regard to player eligibility under the Age Eligibility Rule and Integrity Rules, and other Rule limitations. Wild Cards are not considered official until approved by the WTA.

#### a. Nomination Deadlines

##### i. Singles

Tournaments are required to submit a tentative list of Wild Card nominations to WTA Operations one (1) week prior to the start of the Main Draw. The Tournament Director must advise the WTA or the Supervisor in writing of the singles Wild Card nominations and Alternate Wild Card nominations by the Qualifying Sign-In Deadline. Wild Cards named by the Tournament Director prior to the deadline will be tentative until the Qualifying Sign-In deadline.

If the Main Draw is made prior to the Qualifying Sign-In deadline or if there is no Qualifying, Wild Card nominations must be made in writing at least one (1) hour before the Main Draw is made.

##### ii. Doubles

Final Wild Card nominations must be named in writing thirty (30) minutes before the Doubles Sign-In Deadline.

#### b. Confirmation of Wild Card Acceptance

##### i. Tournament Responsibility

Before advising the WTA or Supervisor of the Wild Cards, the Tournament Director shall have confirmed with the player that she will accept the Wild Card.

##### ii. Player Responsibility

###### (a) Singles

In addition to confirming to the Tournament Director that she will accept a Wild Card, if offered, the player also must provide written notification of the Wild Card acceptance to the on-site Supervisor at the relevant Tournament or to WTA Operations by the Qualifying Sign-In Deadline (email is sufficient).

If a player accepts a Wild Card and subsequently withdraws prior to her first match played, the Wild Card will not count

## PLAYERS

### SECTION III - TOURNAMENT ENTRY, TOURNAMENT ACCEPTANCE, AND WILD CARDS

toward her Wild Card allotment. A player will be subject to a Late Withdrawal fine only if the withdrawal occurs after the start of Qualifying or, if there is no Qualifying, after the Main Draw is made.

#### (b) Doubles

In order for a player to accept a Wild Card, she must provide written notification to the on-site Supervisor at the relevant Tournament by the Doubles Sign-In deadline (email is sufficient).

If the player accepts the Wild Card and subsequently withdraws after the on-site Doubles Sign-In deadline, the Wild Card will not count toward her Wild Card allotment but she will be subject to a Late Withdrawal fine.

## 2. Tournament Restrictions

### a. WTA 500 and WTA 250 Tournaments

#### i. Singles

WTA 500 and WTA 250 Tournaments receive “Exemption Wild Card” spots, which can only be used by Top 30 Players, former WTA No. 1 ranked singles players, Grand Slam singles champions from within the last ten (10) years, WTA Finals singles champions from within the last ten (10) years, and/or WTA 1000 Mandatory Tournament singles champions from within the last five (5) years as follows:

- (a) For WTA 500 Tournaments, the Tournament Director may award the Exemption Wild Card to any Top 30 Player, former WTA No. 1 ranked singles player, Grand Slam singles champion from within the last ten (10) years, WTA Finals singles champion from within the last ten (10) years, and/or WTA 1000 Mandatory Tournament singles champion from within the last five (5) years. If the Tournament does not use the Exemption Wild Card(s), the Wild Card spot(s) revert(s) to the next player(s) waiting to get into the draw.
- (b) For WTA 250 Tournaments, the Tournament Director must award the Exemption Wild Card to any Top 30 Player, former WTA No. 1 ranked singles player, Grand Slam singles champion from within the last ten (10) years, WTA Finals singles champion from within the last ten (10) years,



## PLAYERS

### SECTION III - TOURNAMENT ENTRY, TOURNAMENT ACCEPTANCE, AND WILD CARDS

and/or WTA 1000 Mandatory Tournament singles champion from within the last five (5) years who requests it prior to the Freeze Deadline.

In awarding Exemption Wild Cards to Top 30 Players, former WTA No. 1 ranked singles players, Grand Slam singles champions from within the last ten (10) years, WTA Finals singles champions from within the last ten (10) years, and/or WTA 1000 Mandatory Tournament singles champions from within the last five (5) years under this Section III.C.2.a.i(b), Tournaments must adhere to the following procedures:

- (i) If more than two (2) eligible players request an Exemption Wild Card, the Tournament shall decide which eligible player it awards the Exemption Wild Card;
  - (ii) If only one eligible player requests an Exemption Wild Card, the Tournament must award one Exemption Wild Card to the eligible player making the request, and the second Exemption Wild Card will revert to the next player waiting to get into the draw;
  - (iii) If there are no eligible players requesting an Exemption Wild Card, the Tournament can award one Exemption Wild Card to any player as per the rules in this section, and the second Exemption Wild Card will revert to the next player waiting to get into the draw.
  - (iv) If neither of the Exemption Wild Cards are awarded, both Exemption Wild Card spots revert to the next players waiting to get into the draw.
- (c) The awarding of the Exemption Wild Card shall be subject to the Wild Card Maximums, Age Eligibility Rule, and Integrity Rules.

<b>Singles Main Draw - WTA 1000 Mandatory, WTA 500, WTA 250</b>			
<b>Draw Size§</b>	<b>Regular Wild Cards</b>	<b>Exemption Wild Cards</b>	<b>Total Wild Cards</b>
WTA 1000 Mandatory 96	8	0	8
WTA 1000 Mandatory 48/56	4	0	4
WTA 500 48/56!*	3	1	4
WTA 500 28/30/32! WTA 250 32*	2	2	4

## PLAYERS

### SECTION III - TOURNAMENT ENTRY, TOURNAMENT ACCEPTANCE, AND WILD CARDS

Qualifying Draw - WTA 1000 Mandatory, WTA 500, WTA 250	
Draw Size§	Wild Cards
48	6
24/32	4
16/8	2

§ See Section VI for Wild Cards for the WTA Finals.

! See Section III.C.2.a.i(a) & (b) for unused Wild Cards at WTA 1000 Mandatory and WTA 500 Tournaments.

\* See Section III.C.2.a.i(c) for unused Wild Cards at WTA 250 Tournaments.

#### ii. Doubles

WTA 1000 Mandatory and WTA 500 Tournaments will receive one (1) Wild Card spot which can only be granted to a doubles team on which one (1) player is a Top 30 Player, former WTA No. 1 ranked singles or doubles player, Grand Slam singles champion from within the last ten (10) years, and/or WTA Finals singles champion from within the last ten (10) years ("Doubles Exemption Wild Card"). If there is no request for a Doubles Exemption Wild Card at a WTA 1000 Mandatory or WTA 500 Tournament, or a WTA 1000 Mandatory or WTA 500 Tournament does not grant a Doubles Exemption Wild Card to an eligible team, the unused Doubles Exemption Wild Card(s) will go to the next-in on-site entry team in accordance with Section III.B.1.b.ii.

WTA 250 Tournaments will receive one (1) Doubles Exemption Wild Card. If there is no request for a Doubles Exemption Wild Card at a WTA 250 Tournament, the unused Doubles Exemption Wild Card will revert to the Tournament as an additional Doubles Wild Card. However, if one (1) or more eligible team(s) requests the Doubles Exemption Wild Card but the Tournament does not grant it to them, the unused Doubles Exemption Wild Card will go to the next-in on-site entry team in accordance with Section III.B.1.b.ii.

Notwithstanding any other Wild Card rule, any player accepting a Doubles Exemption Wild Card who subsequently withdraws or retires from the doubles draw shall forfeit any right she may have to unlimited Doubles Wild Cards (i.e., eligible only for the annual maximum of three (3) Doubles Wild Cards), unless: (a) the player also withdraws/retires from the singles draw; (b) the player is declared unfit to play; or (c) the player also withdraws

## PLAYERS

### SECTION III - TOURNAMENT ENTRY, TOURNAMENT ACCEPTANCE, AND WILD CARDS

from playing singles in a Tournament she entered to be held the following week.

<b>Doubles Main Draw - WTA 1000 Mandatory, WTA 500, WTA 250</b>			
<b>Draw Size§</b>	<b>Regular Wild Cards</b>	<b>Exemption Wild Cards</b>	<b>Total Wild Cards</b>
WTA 1000 Mandatory 28/30/32**	2	1	3
WTA 500 16/24**	1	1	2
WTA 250 16**	1	1	2

§ See Section VI for Wild Cards for the WTA Finals.

\*\* See Section III.C.2.a.ii for unused Doubles Wild Cards.

#### b. WTA 125 Tournaments

##### i. Singles

Each WTA 125 Tournament will receive four (4) regular Wild Card spots. In addition, WTA 125 Tournaments in weeks without a WTA 1000 Mandatory, WTA 500, or WTA 250 Tournament or in the Off Season will receive two (2) “WTA 125 Exemption Wild Card” spots, which can only be used by players with a WTA Singles Ranking of 21-50 at the Main Draw Entry Deadline because those players may only play a WTA 125 Tournament if they receive a Wild Card.

<b>WTA 125 Date</b>	<b>Regular Wild Cards</b>	<b>WTA 125 Exemption Wild Cards</b>	<b>Total Wild Cards</b>
In the same week as WTA 1000 Mandatory Tournament	4	0	4
In the second week of a WTA 1000 Mandatory Tournament or Grand Slam	4	0	4
In the same week as a WTA 500 or WTA 250 Tournament	4	0	4
In a week without a WTA 1000 Mandatory, WTA 500, or WTA 250 Tournament <sup>^</sup>	4	2	6
In the same week as WTA Finals* <sup>^</sup>	4	2	6
In the Off Season <sup>^</sup>	4	2	6

\* See Section III.B.1.a.iv for restrictions for players who qualify for WTA Finals.

<sup>^</sup> Maximum of four (4) players ranked 21-50 may play the Tournament, including singles and doubles combined.

# PLAYERS

## SECTION III - TOURNAMENT ENTRY, TOURNAMENT ACCEPTANCE, AND WILD CARDS

If not awarded, vacant WTA 125 Exemption Wild Card spots revert to the next players waiting to get into the draw.

WTA 125 Qualifying Wild Cards	
Draw Size	Regular
8, 16	2
24, 32	4

ii. Doubles

Each WTA 125 Tournament will receive one (1) doubles Wild Card spot.

### 3. Player Restrictions

a. Singles

A player may not be awarded more than one (1) singles Wild Card in any calendar week.

Except as otherwise set forth herein, the maximum number of Wild Cards a player may receive into singles WTA 1000 Mandatory, WTA 500, and WTA 250 Tournaments during a Tour Year is six (6), with a maximum of three (3) allowed in the Main Draw. This maximum does not apply to Wild Cards accepted into Grand Slams. Wild Cards accepted into Women's ITF World Tennis Tour events and WTA 125 Tournaments count separately.

The maximum number of Wild Cards a player may receive into singles WTA 125 Tournaments during the calendar year is three (3). These Wild Cards are in addition to the maximum number of Wild Cards allowed in WTA 1000 Mandatory, WTA 500, and WTA 250 Tournaments.

It is the player's responsibility to track the number of Wild Cards she has used.

b. Doubles

Except as otherwise set forth herein, the maximum number of Wild Cards a player may receive into doubles WTA 1000 Mandatory, WTA 500, and WTA 250 Tournaments during a Tour Year is three (3). This maximum does not apply to Wild Cards accepted into Grand Slams.

## PLAYERS

### SECTION III - TOURNAMENT ENTRY, TOURNAMENT ACCEPTANCE, AND WILD CARDS

Wild Cards accepted into Women's ITF World Tennis Tour events and WTA 125 Tournaments count separately.

The maximum number of Wild Cards a player may receive into doubles WTA 125 Tournaments during the calendar year is three (3). These Wild Cards are in addition to the maximum number of Wild Cards allowed in WTA 1000 Mandatory, WTA 500, and WTA 250 Tournaments.

It is the player's responsibility to track the number of Wild Cards she has used.

#### 4. Exceptions

The following exceptions apply to both singles and doubles Wild Cards where indicated:

- a. Subject to the Age Eligibility Rule, if a player is a Top 10 Player at any time during a Tour Year, then she may accept an unlimited number of Wild Cards into singles and doubles for the remainder of that Tour Year.
- b. Players will forfeit any ranking points earned at WTA Tournaments by the acceptance of Wild Cards above these limits.
- c. Players who have competed in at least six (6) WTA 1000 Mandatory, WTA 500, or WTA 250 Tournaments or Grand Slam Tournaments per Tour Year for ten (10) Tour Years or more (not necessarily consecutively) will be allowed three (3) additional Wild Cards, either in Main Draw or in Qualifying, in both singles and doubles at WTA Tournaments (including WTA 1000 Mandatory, WTA 500, WTA 250, and WTA 125 Tournaments); provided, however, that each year prior to 2019 in which a player competed in at least one (1) WTA 1000 Mandatory, WTA 500, or WTA 250 Tournament or Grand Slam counts toward the ten (10) Tour Years required in this Rule.
- d. Any player who is a past singles champion of the WTA Finals or a Grand Slam will be allowed to accept an unlimited number of Singles Main Draw Wild Cards, including Exemption Wild Cards and WTA 125 Exemption Wild Cards if such player has a WTA Singles Ranking of 21-50 at a Tournament's Main Draw Entry Deadline.
- e. Any player who is a past doubles champion of the WTA Finals or a Grand Slam will be allowed to accept an unlimited number of Doubles Wild Cards, including Doubles Exemption Wild Cards if such player is

## PLAYERS

### SECTION III - TOURNAMENT ENTRY, TOURNAMENT ACCEPTANCE, AND WILD CARDS

a Top 30 Player, former WTA No. 1 ranked singles or doubles player, Grand Slam singles champion within the last ten (10) years, and/or WTA Finals singles champion within the last ten (10) years.

- f. Pursuant to the Age Eligibility Rule, players under the age of 17 are restricted in the number and level of Wild Cards they may receive. (See Section X.A.2 - Event Participation.)
- g. Pursuant to the Anti-Doping Program, players who have retired may not receive a Wild Card until they have satisfied the applicable anti-doping testing requirements.

#### 5. Filling Vacant Wild Card Spots

##### a. Main Draw Singles

If a Main Draw Wild Card withdraws from the Tournament after the Wild Card nomination deadline, the Tournament Director can replace her with either a previously named or a new Wild Card up until the draw is made. The replacement singles Wild Card cannot be a player who is in the Qualifying Draw after Qualifying begins.

If the Tournament does not name another Wild Card, a Lucky Loser will fill the open spot.

##### b. Qualifying Singles

Until the start of Qualifying, the Tournament Director will be allowed to fill a vacated Qualifying Wild Card spot with an alternate Wild Card nominated prior to the Qualifying Wild Card nominations deadline in the following instances:

- i. If at any time prior to the scheduled start of Qualifying, a Wild Card or Wild Card team is accepted into the Qualifying or Main Draw based upon her or their WTA Ranking or Special Ranking or as a Special Exempt; or
- ii. If a Wild Card has withdrawn from the Tournament prior to the scheduled start of Qualifying.

##### c. Doubles

If a Main Draw Wild Card team withdraws from the Tournament after the Wild Card nomination deadline, the Tournament Director can replace the team with either a previously named or new Wild Card team up until the draw is made.

## PLAYERS

### SECTION III - TOURNAMENT ENTRY, TOURNAMENT ACCEPTANCE, AND WILD CARDS

#### 6. Additional Wild Cards

At Tournaments where there are no on-site Alternates, openings in the Qualifying Draw, singles Main Draw at Tournaments with no Qualifying, and doubles Main Draw may be filled by additional Tournament Wild Cards (“Additional Wild Cards”). These Wild Cards will count towards a player’s yearly allotment of Wild Cards.

Players and teams waiting to get into the draw as Additional Wild Cards must:

- a. Submit a request to the Tournament Director and be approved as an Additional Wild Card; and
- b. Sign in with (or notify, as applicable) the Supervisor or a WTA Operations staff member by:
  - i. For Qualifying, the Qualifying Sign-In Deadline;
  - ii. For singles Main Draw at Tournaments with no Qualifying, at least one (1) hour before the Main Draw is made; or
  - iii. For doubles Main Draw, the Doubles Sign-In Deadline; and
- c. Sign in with the Supervisor/Referee thirty (30) minutes prior to the scheduled start of play each day to be eligible for any openings in the draw that day.

# PLAYERS

## IV. WITHDRAWALS AND RETIREMENTS

### A. WITHDRAWALS

#### 1. Requirements for all Withdrawals

##### a. Player Responsibility

The WTA will accept withdrawals from a player or her designated coach or agent, but the player is ultimately responsible for all of her entries and withdrawals.

##### b. Withdrawal Submission

A player's withdrawal from a Tournament is effective only if:

- i. she is on site, completes a WTA Medical Information Form with WTA Sport Sciences and Medicine staff, and submits a WTA Withdrawal Form to the on-site Supervisor; or
- ii. she is not on site and submits the withdrawal in writing or via the PlayerZone to WTA Operations.

If a player submits a withdrawal from the next week's Tournament between 5:00 p.m. Friday and 9:00 a.m. Monday Eastern Time (New York, USA Time), she also must email it to the on-site Supervisor at that Tournament.

##### c. Withdrawal Statements

- i. At the time of a withdrawal, a player must provide a statement containing the reason for her withdrawal and a suitable, in WTA Communications Department's discretion, quotation that the WTA may release to the media and public.
- ii. Failure to submit a withdrawal statement will result in the following penalties:
  - (a) If a player withdrew under an Excused Withdrawal or a Prize Money Withdrawal, the withdrawal will not count as an Excused Withdrawal or Prize Money Withdrawal and she will be fined the applicable Late Withdrawal fine plus the applicable fine below; or
  - (b) If a player withdrew under a Late Withdrawal, she will be



**PLAYERS**  
**SECTION IV - WITHDRAWALS AND RETIREMENTS**

fined the applicable Late Withdrawal fine plus the applicable fine below.

Draw	WTA 1000 Mandatory, WTA 500, WTA 250	WTA 125
Singles Qualifying	\$500	\$250
Singles Main Draw	\$1,000	
Doubles Main Draw	\$1,000	

iii. Any player who publicly announces a withdrawal from a Tournament prior to submitting her official withdrawal to the WTA in accordance with this Section IV.A.1 will be fined for Dishonorable or Unprofessional Conduct under the Code of Conduct.

d. WTA Responsibility

Except as otherwise provided in these Rules, the WTA will not withdraw a player from any WTA Acceptance List unless the WTA has received notice of her withdrawal in accordance with this Section IV.A.1. The WTA also will not automatically withdraw a player from any WTA Tournament because of her entry in a Women's ITF World Tennis Tour event during that same or the following week.

e. Player Withdrawals from Automatic Entry Tournaments

If an eligible player is automatically entered into the Main Draw of a WTA 1000 Mandatory Tournament or Grand Slam, she must follow the procedures set forth in this Section to withdraw from such Tournament. If the player withdraws or is withdrawn automatically from such Tournament, then she will receive zero (0) ranking points for the Tournament in accordance with Section VIII.A.4.a.i(a) and will be subject to the Late Withdrawal fines set out in Section IV.A.3.b.

**2. Additional Requirements for On-Site Withdrawals**

- a. In addition to the withdrawal requirements in Section IV.A.1 above, if a player withdraws on site, she is required to:
  - i. Meet with the on-site PHCP and the Tournament Physician for an evaluation and assessment of the injury or illness prior to leaving the Tournament city;
  - ii. Within twenty-four (24) hours, participate in one (1) post-withdrawal activity not to exceed one (1) hour, which may

**PLAYERS**  
**SECTION IV - WITHDRAWALS AND RETIREMENTS**

include the following or any similar activity as requested by the Tournament:

- (a) Sponsor visit;
- (b) Autograph session;
- (c) Meet and greet;
- (d) Content feature; or
- (e) Kids clinic.

**b. Penalties**

Failure to comply with the above requirements will result in the following penalties:

- i. If a player withdrew under an Excused Withdrawal or a Prize Money Withdrawal, the withdrawal will not count as an Excused Withdrawal or Prize Money Withdrawal and she will be fined the applicable Late Withdrawal fine plus the applicable fine below; or
- ii. If a player withdrew under a Late Withdrawal, she will be fined the applicable Late Withdrawal fine plus the applicable fine below.

<b>WTA Ranking at Entry Deadline</b>	<b>WTA 1000 Mandatory, WTA 500, WTA 250</b>	<b>WTA 125</b>
1-10	\$5,000	
11-25	\$2,000	\$125
26-50	\$1,000	
51-100	\$500	
101+	\$250	
Doubles with any WTA Ranking	\$125	\$75
Qualifying with any WTA Ranking	\$100	\$50

**3. Main Draw Late Withdrawals**

**a. Definition**

A Main Draw withdrawal is a Late Withdrawal if a player withdraws:

**PLAYERS**  
**SECTION IV - WITHDRAWALS AND RETIREMENTS**

<b>Singles Players</b>	after acceptance into the Main Draw
<b>Doubles Players</b>	after the Doubles Freeze Deadline

b. Fines

i. Procedures

- (a) Except as otherwise provided below, all players will receive automatic fines for Late Withdrawals from the Main Draw of a Tournament.
- (b) All Late Withdrawal and No-Show Offense fines shall be retained by the WTA, with the exception of Late Withdrawal and No-Show Offense fines assessed against Top 10 Players, which shall be split 50/50 between the WTA and the Tournaments from which they withdrew.

ii. Amounts

The amount of a player's automatic Main Draw Late Withdrawal fine is based on the chart below:

<b>WTA Ranking at Entry Deadline</b>	<b>WTA 1000 Mandatory</b>	<b>WTA 500</b>	<b>WTA 250</b>	<b>WTA 125</b>
1-10	\$20,000	\$7,500	\$5,000	N/A
11-25	\$10,000	\$5,000	\$3,750	\$500
26-50	\$5,000	\$2,500	\$2,500	\$500
51-100	\$2,500	\$2,500	\$2,500	\$500
101+	\$2,500	\$2,500	\$1,000	\$500
Doubles with any WTA Ranking (fine is per player)	\$2,500	\$2,500	\$1,000	\$250

Fines double with each subsequent offense in a Tournament category.

iii. The following Late Withdrawal fines are not subject to doubling:

- (a) Late Withdrawal fines resulting from a player still competing in another WTA Tournament or Grand Slam on the day of the Qualifying Sign-In deadline of the following week's WTA Tournament, as long as her participation in the WTA Tournament or the Grand Slam ends on the day of the Qualifying Sign-In (e.g., wins, loses, withdraws, or retires)

## PLAYERS

### SECTION IV - WITHDRAWALS AND RETIREMENTS

after the Qualifying Sign-In deadline and the player submits her withdrawal within ninety (90) minutes after the end of her participation in the WTA Tournament or the Grand Slam (i.e., the end of her match);

- (b) Late Withdrawal Fines resulting from a player's selection to her Billie Jean King Cup team in the same week as a WTA Tournament; and
- (c) Late Withdrawal fines resulting from a player's acceptance of a Wild Card into a Grand Slam Qualifying after the Qualifying Sign-In deadline (or Doubles On-Site Sign-In deadline if she entered only doubles) but before her first match at the WTA Tournament.

#### c. No-Show Offense

A player who is entered and accepted into the Main Draw of a Tournament, does not withdraw, and fails to attend her first match commits a No-Show Offense. The automatic fine for a No-Show Offense is 50% greater than the applicable Late Withdrawal fine.

## 4. Qualifying Late Withdrawals

#### a. Definition

A Qualifying withdrawal is a Late Withdrawal if a player withdraws after her acceptance into the Qualifying Draw; provided, however, that if a player accepted into the Qualifying Draw withdraws and is subsequently accepted into the Main Draw or receives a Wild Card in accordance with Section IV.A.9.a.i, she will not be fined for a Qualifying Late Withdrawal.

#### b. Fines

##### i. Procedures

Alternates waiting to get into Qualifying who are accepted into Qualifying any time up until the Freeze Deadline are obligated under these Rules to play the Tournament and thus are subject to the same sign-in procedure and No-Show Offense fines. (See Section V.A.1.b.iii(a).)

##### ii. Amounts

The amount of a player's automatic Qualifying Late Withdrawal

**PLAYERS**  
**SECTION IV - WITHDRAWALS AND RETIREMENTS**

fine is \$500 (\$250 at WTA 125 Tournaments).

c. **No-Show Offense**

A player commits a No-Show Offense if she is entered and accepted into the Qualifying Draw of a Tournament, does not withdraw, and (i) fails to sign in by the Qualifying Sign-In deadline (4:00 p.m. Tournament local time on the day prior to the start of Qualifying) or (ii) calls the Supervisor to sign in and fails to attend her first match. The automatic fine for a first No-Show Offense is \$600 (\$300 at WTA 125 Tournaments), which doubles for each subsequent offense she commits in a Tournament category in the current Tour Year (i.e., \$1,200, \$2,400).

**5. Excused Withdrawals**

a. **Definition**

Excused Withdrawals include each of the following:

i. **Singles Excused Withdrawals**

Subject to the procedures and restrictions in sub-Section b below, no more than two (2) times per Tour Year, a player may withdraw from the singles competition at a WTA Tournament without receiving a Late Withdrawal fine ("Singles Excused Withdrawal"), provided the WTA receives her official withdrawal before the start of her first match (Qualifying or Main Draw).

ii. **Doubles Excused Withdrawals**

Subject to the procedures and restrictions in sub-Section b below, no more than four (4) times per Tour Year, a player may withdraw from the doubles competition at a WTA Tournament without receiving a Late Withdrawal fine ("Doubles Excused Withdrawal"), provided the WTA receives her official withdrawal before her first match.

iii. **Off-Season Excused Withdrawals**

Subject to the procedures and restrictions in sub-Section b below, each player may use one (1) additional Singles Excused Withdrawal and one (1) additional Doubles Excused Withdrawal to withdraw from a WTA 125 Tournament that occurs during November or December of a calendar year ("Off-Season Excused Withdrawals").

**PLAYERS**  
**SECTION IV - WITHDRAWALS AND RETIREMENTS**

b. Procedures and Restrictions

The following procedures and restrictions apply to sub-Section a above:

- i. A player must use best efforts to withdraw under an Excused Withdrawal at least twelve (12) hours before the start of her first match. If she uses an Excused Withdrawal within twelve (12) hours before her first match, the WTA, in its sole discretion, may impose a Late Withdrawal fine; provided, however, that if the WTA imposes a Late Withdrawal fine, the withdrawal will not count as an Excused Withdrawal.
- ii. If a player withdraws from both singles and doubles at the same Tournament, it counts as one (1) Singles Excused Withdrawal and one (1) Doubles Excused Withdrawal;
- iii. No player may use an Excused Withdrawal for the WTA Finals; and
- iv. If applicable, a player using an Excused Withdrawal to withdraw from a WTA Tournament still will receive zero (0) ranking points for that Tournament in accordance with Section VIII.A.4.a.i.

**6. Prize Money Withdrawals**

a. Definition

Prize Money Withdrawals include each of the following:

i. Singles Prize Money Withdrawal

Subject to the procedures and restrictions in sub-Section b below, no more than two (2) times per Tour Year, a player who is on site may withdraw from the singles competition (Qualifying or Main Draw, as applicable) at a WTA Tournament without receiving a Late Withdrawal fine, provided that the WTA receives her official withdrawal within the applicable time (“Singles Prize Money Withdrawal”):

- (a) For Qualifying, on or after the day of the Qualifying Sign-In but prior to her first Qualifying match;
- (b) For Main Draw at Tournaments with Qualifying, after the start of Qualifying but prior to her first singles Main Draw match; or

**PLAYERS**  
**SECTION IV - WITHDRAWALS AND RETIREMENTS**

(c) For Main Draw at Tournaments with no Qualifying, on or after the day the Main Draw starts but prior to her first singles Main Draw match.

ii. Doubles Prize Money Withdrawal

Subject to the procedures and restrictions in sub-Section b below, no more than two (2) times per Tour Year, a doubles player who is on site and who used or could have used her doubles ranking for acceptance may withdraw from the doubles competition at a WTA Tournament without receiving a Late Withdrawal fine, provided that the WTA receives the official withdrawal after the draw is made but prior to the team's first match ("Doubles Prize Money Withdrawal").

b. Procedures and Restrictions

The following procedures and restrictions apply to sub-Section a above:

- i. If a player or team elects a Prize Money Withdrawal, then the next eligible Lucky Loser (or Alternate, as applicable) will move into the draw in accordance with Section V.A.3.
- ii. The withdrawing players and Lucky Losers or Alternates will receive prize money in accordance with Section IX.C.1.a.i(b).
- iii. A player using a Prize Money Withdrawal is not subject to any Late Withdrawal fine but, if applicable, still will receive zero (0) ranking points for the Tournament (see Section VIII – WTA Ranking System).
- iv. A player may not use a Prize Money Withdrawal at two (2) consecutive WTA Tournaments in which she has entered.
- v. If a player is Out of Competition in accordance with the Special Ranking Rule, the use of a Prize Money Withdrawal restarts her Out-of-Competition Period.
- vi. If a player was accepted into a Tournament using her Special Ranking and uses a Prize Money Withdrawal, the Tournament will count as one (1) of her maximum Tournaments to use her Special Ranking (see Section VIII.C – WTA Special Ranking Rule).

## PLAYERS

### SECTION IV - WITHDRAWALS AND RETIREMENTS

- vii. If a player is subject to the Age Eligibility Rule and uses a Prize Money Withdrawal, that Tournament will count as one (1) of her maximum Tournaments in which she may participate under the Age Eligibility Rule (see Section X.A – Age Eligibility Rule).
- viii. If a player withdraws from a WTA Tournament using a Prize Money Withdrawal and subsequently plays in any WTA Tournament, Grand Slam Tournament, ITF World Tennis Tour event (including Juniors, 15s+, and Billie Jean King Cup), Olympic or Olympic Qualification event, or Exhibition/Non-WTA Event, regardless of whether ranking points are awarded, in the same week as that Tournament, she must pay a fine equal to double the amount of prize money she received for the withdrawal.
- ix. Except for the first Tournament she plays in a Tour Year, a withdrawing player who has not participated in any WTA Tournament, Grand Slam Tournament, ITF Professional Circuit event, Billie Jean King Cup event, or Olympic event within sixty (60) days prior to (and including) the day of the applicable Tournament's Qualifying Sign-In day cannot use a Prize Money Withdrawal.
- x. A player who uses a Prize Money Withdrawal for singles or doubles may only participate in the other competition at the same WTA Tournament if the match is not on the same day as the withdrawal or scheduled match from which she withdrew.
- xi. A player may not use a Prize Money Withdrawal at the WTA Finals.
- xii. A withdrawing player who is not eligible to use a Prize Money Withdrawal is subject to any and all requirements and penalties for her withdrawal under these Rules.

## 7. Consecutive Withdrawals

### a. Definition

Subject to the requirements and restrictions in sub-Section b below, if a player withdraws by any method from a WTA Tournament for a medical illness or a musculoskeletal injury that warrants medical evaluation or medical treatment (“Medical Condition”), she may withdraw from the next WTA Tournament(s) in which she has entered without using any additional Excused Withdrawals or Prize Money Withdrawals or paying any additional Late Withdrawal fines as long



**PLAYERS**  
**SECTION IV - WITHDRAWALS AND RETIREMENTS**

as she withdraws before the start of Qualifying or, for Tournaments with no Qualifying, before the Main Draw is made ("Consecutive Withdrawal").

- b. Requirements and Restrictions
- i. If the player's initial withdrawal occurs on site at any WTA Tournament, then she must meet the withdrawal requirements in Section IV.A.2 above.
  - ii. If the player's initial withdrawal does not occur on site at a WTA Tournament, then in addition to the withdrawal requirements in Section IV.A.1 above, she must:
    - (a) meet with an accredited physician for an evaluation and assessment of the Medical Condition;
    - (b) within ten (10) days of her initial withdrawal:
      - (i) submit to WTA Sport Sciences and Medicine a WTA Medical Information Form, which must be written in English and completed by an accredited physician, indicating the nature of the Medical Condition and verifying that she is unable to play in the Tournament;
      - (ii) attach copies of the records of the clinical visit to the physician, including the physician's notes/documentation and all relevant laboratory tests in English; and
      - (iii) personally sign the Medical Information Form warranting that she was unable to play in the Tournament from which she withdrew; and
    - (c) provide a suitable quotation, in WTA's reasonable discretion, about her inability to play in the initial Tournament from which she withdrew and authorize the WTA to publicly release the quotation and the basis for her withdrawal.
  - iii. The player cannot play any WTA Tournament, Grand Slam Tournament, ITF World Tennis Tour event (including Juniors, 15s+, and Billie Jean King Cup), Olympic or Olympic Qualification event, or Exhibition/Non-WTA Event, regardless of whether ranking points are awarded, during the Consecutive Withdrawal.
  - iv. A player who uses an Off-Season Excused Withdrawal cannot withdraw from a Tournament in the next calendar year by

**PLAYERS**  
**SECTION IV - WITHDRAWALS AND RETIREMENTS**

Consecutive Withdrawal until she first uses a new Excused Withdrawal or Prize Money Withdrawal or pays the applicable Late Withdrawal fine.

- v. If applicable, a player withdrawing from a WTA Tournament by Consecutive Withdrawal still will receive zero (0) ranking points for that Tournament in accordance with Section VIII.A.4.a.i.

c. **Failure to Comply**

If at any time during a Consecutive Withdrawal a player does not comply with the requirements and restrictions in this Section IV.A.7, then the Consecutive Withdrawal immediately ends, she must use an Excused Withdrawal or Prize Money Withdrawal or pay a Late Withdrawal fine for her next withdrawal from a WTA Tournament, and she is subject to all applicable fines and penalties under these Rules.

**8. Inability to Arrive for First Match**

- a. A player's withdrawal from the Qualifying of a WTA Tournament is not considered a Qualifying Late Withdrawal if she is unable to arrive at her first scheduled match for the following reasons:
  - i. On the day of such WTA Tournament's Qualifying Sign-In Deadline, she is participating in the previous week's WTA Tournament, Women's ITF World Tennis Tour event, or Billie Jean King Cup event; or
  - ii. She was selected to her Billie Jean King Cup team after such WTA Tournament's entry deadline and the Billie Jean King Cup team captain confirms the date of her late selection.

In either of the above situations, (a) the player must fill out the proper Withdrawal Form indicating the reason for her withdrawal; and (b) such player will be allowed to play doubles at any WTA Tournament or singles and/or doubles at another Women's ITF World Tennis Tour event scheduled the same week.

- b. If a player is unable to arrive at her first scheduled Main Draw match of a WTA Tournament or withdraws from the Main Draw of a WTA Tournament due to her participation in a Billie Jean King Cup event, the player must follow the procedures set forth in this Section to withdraw from such Tournament and the player is subject to the Late Withdrawal fines set out in Section IV.A.3.b.

**PLAYERS**  
**SECTION IV - WITHDRAWALS AND RETIREMENTS**

**9. Prohibition Against Withdrawing from One Tournament to Play Another**

- a. Once a player has been accepted into the Main Draw or Qualifying of a WTA Tournament, she may not withdraw to play singles or doubles in another Tournament in the same week, except as follows:
  - i. a player may withdraw from the Qualifying of a WTA Tournament and play in another Tournament in the same week if she accepts a Wild Card into:
    - (a) the Main Draw of any WTA Tournament; or
    - (b) the Qualifying of a WTA Tournament in a higher category according to the table below:

<b>Tournament at which player withdraws from the Qualifying</b>	<b>Tournament at which player accepts a Wild Card into the Qualifying</b>
WTA 125	WTA 250, WTA 500, or WTA 1000 Mandatory
WTA 250	WTA 500 or WTA 1000 Mandatory

- ii. a player may withdraw from the doubles Main Draw of a WTA Tournament and play in another Tournament in the same week in accordance with sub-Section i above or Section III.B.1.b.i(b).

If a player is discovered at any time to have violated this prohibition, she will (a) forfeit any ranking points received (singles and doubles) from the other Tournament in which she played; and (b) receive the applicable Late Withdrawal fine.

- b. If a player withdraws from a WTA Tournament and subsequently plays singles or doubles in an Exhibition/Non-WTA Event in the same week, then (a) if she is ranked 1-50 at the Tournament's Main Draw Entry Deadline or meets Exemption Wild Card criteria, she is subject to the applicable Late Withdrawal fine and fine under the Exhibition/Non-WTA Event Rule; and (b) if she is ranked 51+ at the Tournament's Main Draw Entry Deadline, she is subject to a fine in an amount equal to double the applicable Late Withdrawal fine.

**B. RETIREMENTS**

If a player retires from a match, she is required to:

- a. Prior to retiring from the match, call for the PHCP and the Supervisor to provide the reason for the retirement;

**PLAYERS**  
**SECTION IV - WITHDRAWALS AND RETIREMENTS**

- b. Immediately following the retirement,
  - i. meet with the on-site PHCP and the Tournament Physician for an evaluation and assessment of the injury or illness and complete a WTA Medical Information Form prior to leaving the Tournament city;
  - ii. submit a WTA Withdrawal Form to the on-site Supervisor; and
  - iii. provide a statement containing the reason for her withdrawal and a suitable, in WTA Communications Department's discretion, quotation that the WTA may release to the media and public.

**C. RESTRICTIONS, EXCEPTIONS, AND PROCEDURES**

**1. The Following Week's Tournament**

A player may only enter and compete in one (1) WTA Tournament or Women's ITF World Tennis Tour event per Tournament week. Once a player enters and is accepted into the singles or doubles Main Draw or signs in or enters and is accepted into the Qualifying competition, she is committed to play that Tournament to completion or elimination for that week.

A player who has lost in a Tournament ("Current Tournament") may play the Qualifying for a Tournament scheduled for the next week ("Following Week Tournament").

A player may not withdraw or retire from any draw of a Current Tournament to play in any Following Week Tournament. However, if a player is forced to withdraw or retire from a draw in a Current Tournament for a Medical Condition and she is entered in a Following Week Tournament, she must receive a medical examination from the Tournament Physician and PHCP at the Current Tournament and submit her medical examination to the Tournament Physician and PHCP at the Following Week Tournament. To be eligible to compete in the Following Week Tournament, the player must receive a medical examination by the Tournament Physician and PHCP at the Following Week Tournament.

A player will automatically be withdrawn from a Following Week Tournament if:

- a. She has withdrawn or retired from a draw in the Current Tournament without cause or for unprofessional reasons;
- b. She fails to provide proof of medical examination by submitting

**PLAYERS**  
**SECTION IV - WITHDRAWALS AND RETIREMENTS**

a signed WTA Medical Information Form from the Tournament Physician and PHCP at the Current Tournament to the Tournament Physician and PHCP at the Following Week Tournament;

- c. She fails to receive a medical examination from the Tournament Physician and PHCP at the Following Week Tournament; or
- d. Her next match in the Current Tournament is scheduled on the same day as or later than her first match in the Following Week Tournament.

Any player who is discovered to have contravened this Rule shall not receive ranking points for the Following Week Tournament and will be subject to a fine as permitted under these Rules. This Rule does not apply to a player whose partner in doubles has been forced to withdraw or retire from their match.

**2. Matches Scheduled Same Day**

- a. A player who withdraws or retires from singles can play doubles as long as her doubles match has not been scheduled and called on the same day as her singles withdrawal or retirement.
- b. If a player has both singles and doubles matches scheduled on the same day, she can withdraw from doubles before playing her singles match.

**3. Withdrawal of Seeds**

See Section V.A.6.d – Withdrawal of a Seed.

**4. Prize Money and Ranking Points**

See Section VIII.B.3 – Withdrawals, Byes, Walkovers, and Defaults.

**5. Unsportsmanlike Conduct**

- a. In addition to the requirements set out above, for each Main Draw first round retirement (singles and/or doubles) in excess of two (2) per Tour Year, a player will be subject to a fine in accordance with the Unsportsmanlike Conduct section of the Code of Conduct.
- b. Any player who fails to give her best effort in the Qualifying or Main Draw (singles or doubles) of a WTA Tournament and plays in a Grand Slam Qualifying in the same week commits a Player Major Offense of Aggravated Behavior and is subject to the penalties in

**PLAYERS**  
**SECTION IV - WITHDRAWALS AND RETIREMENTS**

Section XVII.D.13.b, including a fine in an amount up to the greater of \$25,000 or the prize money she wins at the WTA Tournament and/or suspension from play in a Tournament or event for a minimum period of twenty-one (21) days and a maximum period of one (1) year.

**6. Unprofessional Conduct**

If a player's withdrawal is for unprofessional reasons or is damaging to the WTA's image, she is subject to a disciplinary review and penalties.

**7. Extraordinary Circumstances**

In an extreme personal emergency (e.g., a death in the family or a serious illness or life-threatening situation for the player or her family) or similar extraordinary circumstances ("Extraordinary Circumstances"), a player has the right to appeal a Late Withdrawal fine or the use of an Excused Withdrawal to the Code of Conduct Committee in accordance with Section XVII of these Rules. The player must submit her appeal, which must include documentation that substantiates the Extraordinary Circumstances, within twenty-one (21) days after the date she receives notice of the Late Withdrawal fine or the date she withdraws using an Excused Withdrawal.



# PLAYERS

## V. TOURNAMENT DRAWS AND SCHEDULING

### A. DRAWS

#### 1. Composition

##### a. Main Draw Singles

The Main Draw will consist of some or all of the following:

##### i. Direct Acceptance

See Section III.B.1 – Direct Acceptance.

##### ii. Qualifiers

Those players accepted into the draw based on their success in the Qualifying competition. Following are the number of Qualifiers based on the draw size:

Main Draw Size	Qualifying Draw Size	Number of Qualifiers
128	128	16
96	48 (2 rounds)	12
48/56/64	32 (2 rounds)	8
28/30/32	32 (2 rounds)	4
28/30/32	24 (2 rounds)	6
28/30/32	16 (2 rounds)	4
32	8 (1 round)	4

##### iii. Wild Cards

See Section III.C – Wild Cards.

##### iv. Alternates

Any Main Draw Alternate not in the Qualifying Draw or at a Tournament with no Qualifying must reconfirm her intention to play the Tournament by contacting (either in person, by a telephone conversation, or via e-mail) WTA Operations or the on-site Supervisor by 4:00 p.m. tournament local time on the day prior to the start of Qualifying or, if no Qualifying, 4:00 p.m. Eastern time on the Friday prior to the start of Main Draw. The player must leave her contact number with the WTA Operations staff member or Supervisor with whom she speaks. If a player



## PLAYERS

### SECTION V - TOURNAMENT DRAWS AND SCHEDULING

fails to contact WTA Operations or the on-site Supervisor by the requisite deadline, her entry will be withdrawn automatically from the Main Draw Alternate List.

v. Byes

Those positions allocated in the draw to byes based on the draw size of the Tournament. Byes will be given to seeded players in descending order. (See Section V.A.5.d - Byes for the number of byes in a draw.)

vi. Lucky Losers

Lucky Losers are players who are placed in the Main Draw to fill vacancies after they have been eliminated (lost, retired, or withdrawn) from the Qualifying, provided they meet the eligibility requirements in (a) below. Lucky Losers shall be selected based on the round reached in Qualifying and the WTA Singles Rankings from the week prior to the start of the Tournament (Special Rankings are not considered).<sup>\*</sup> If there are no Main Draw vacancies before the Qualifying has been completed, then the order of the Lucky Losers shall be determined by their WTA Singles Rankings in descending order. If there is one vacancy in the Main Draw before Qualifying is completed, then the order of the two (2) highest ranked Lucky Losers shall be drawn randomly, and thereafter the order shall follow the Lucky Losers' rankings, unless there are two (2) or more withdrawals at the time Qualifying is completed in which case the size of the random draw will be the number of withdrawals plus one (1). If before Qualifying is completed the number of vacancies in the Main Draw equals or exceeds the number of players who will lose in the final round of Qualifying, the highest-ranked Lucky Loser(s) from the previous Qualifying round(s) will be placed into the random draw to determine the order of the Lucky Losers.

<sup>\*</sup>If two or more players do not have a WTA Singles Ranking, they will be drawn randomly to determine their ranking order.

(a) Eligibility

A player who is not entered and has not competed in Qualifying cannot be considered for a Lucky Loser status.

A player who has been eliminated from the Qualifying may retain her right to Lucky Loser status for the duration of the Tournament provided that:

## PLAYERS

### SECTION V - TOURNAMENT DRAWS AND SCHEDULING

- (i) She signs in with the Supervisor by the Lucky Loser deadline;
  - (ii) She receives a medical examination from the Tournament Physician and PHCP if she retired or withdrew; and
  - (iii) The Main Draw match is not scheduled for the same day she retired/withdrew from her Qualifying match.
- (b) Procedures
- (i) All Lucky Losers are subject to first-round prize money deductions because of Prize Money Withdrawals in accordance with Section IX.C.1.a.i(b)(ii).
  - (ii) Lucky Loser positions in the Main Draw will not be released until the completion of the Qualifying event, unless Qualifying has not been completed by the time the Schedule of Play is released. In that event, the Supervisor may release a player's position where necessary and schedule players who have been accepted into the Main Draw.
  - (iii) If there are withdrawals from the Main Draw after Qualifying has begun and before Qualifiers have been drawn to the Main Draw, Qualifiers and Lucky Losers will be drawn together by lot to determine their positions in the Main Draw, except that only Qualifiers will be drawn for positions with a bye until no Qualifiers remain to fill such positions.\*

\*For Main Draw Wild Card withdrawals see Section III.C.5 – Filling Vacant Wild Card Spots.

- (iv) At Tournaments where the last round of Qualifying and the first round of Main Draw are played on the same day and there is a withdrawal in the Main Draw Matches scheduled for the cross-over day, the Qualifier and Lucky Loser positions should be determined as follows:
  - If there is one withdrawal, the spot having to play on the cross-over day will be filled by a Lucky Loser and all Qualifiers shall be drawn by lot to the Qualifier spots.
  - If there are two or more withdrawals, the spot(s)

## PLAYERS

### SECTION V - TOURNAMENT DRAWS AND SCHEDULING

required to play on the cross-over day will be drawn among the Lucky Losers. All Qualifiers and remaining Lucky Losers will be drawn together by lot to fill the remaining spots in the Main Draw.

- (v) When the last round of Qualifying and the first round Main Draw are played on the same day, Lucky Losers must sign in no later than thirty (30) minutes after the conclusion of the last Qualifying match.
- (vi) If a Main Draw spot becomes available prior to the start of the last singles match of the day, the Lucky Loser/Alternate will be determined by the Sign-In for that day. However, where there are no Lucky Losers/Alternates signed in and the match affected by the withdrawal is not scheduled for that day, the following day's Sign-In will be used to fill the vacant spot.

If the spots become available after the start of the last singles match of the day/night, the spot will be filled by the highest ranked player or team who signs in the following day.

- (vii) If a Lucky Loser/Alternate is currently involved in or scheduled for another event/match pertaining to the Tournament, then the Lucky Loser/Alternate's match or other scheduled match may be rescheduled at the discretion of the Supervisor. Where Qualifying has not been completed or a Lucky Loser is unable to be determined, the match may be rescheduled.
- (viii) The first Lucky Loser or Alternate must be ready to play a match within fifteen (15) minutes of the original No Show or default. If the first on-site Lucky Loser/Alternate fails to be ready to play within fifteen (15) minutes, the next on-site Lucky Loser/Alternate must be ready to play within five (5) minutes of the time her match is called. Any subsequent on-site Lucky Loser/Alternate must be ready to play within five (5) minutes of the time her match is called. If a Lucky Loser or an Alternate chooses not to sign in one (1) day, she may still sign in the next day. However, if she signs in, her match is called, and she fails to show for the match (for any reason), she forfeits her Lucky Loser or Alternate status for the duration of the Tournament.

## PLAYERS

### SECTION V - TOURNAMENT DRAWS AND SCHEDULING

- (ix) If a player retires/withdraws from her Qualifying match on the same day an open Lucky Loser position is on the schedule, thereby relinquishing her Lucky Loser status for that day, the open Lucky Loser position will go to the next eligible Lucky Loser for that day.

#### vii. Special Exempt Spots

One (1) Special Exempt Spot shall be held at each WTA Tournament (excluding WTA 125 Tournaments that occur during the second week of WTA 1000 Mandatory Tournaments or Grand Slams). A “Special Exempt Spot” is a singles Main Draw spot reserved for a singles player who is unable to compete in the Qualifying of a WTA Tournament in which she has been accepted as a direct acceptance by the Qualifying Sign-In Deadline (“Special Exempt Tournament”) because she is still competing in a Qualified Singles Event. “Qualified Singles Event” means the singles event of a Tournament in the week before the Special Exempt Tournament in accordance with the following chart:

<b>Special Exempt Tournament</b>	<b>Qualified Singles Event Tournament</b>
WTA 1000 Mandatory	WTA 1000 Mandatory or Grand Slam
WTA 500	WTA 500 (including United Cup), WTA 1000 Mandatory, or Grand Slam
WTA 250	WTA 250, WTA 500 (including United Cup), WTA 1000 Mandatory, or Grand Slam
WTA 125*	WTA 125, WTA 250, WTA 500 (including United Cup), WTA 1000 Mandatory, or Grand Slam

\*Excluding WTA 125 Tournaments that occur during the second week of WTA 1000 Mandatory Tournaments or Grand Slams.

#### (a) Application Process

Eligible singles players must apply for a Special Exempt Spot prior to the Qualifying Sign-In deadline at the Special Exempt Tournament. A Special Exempt Request Form must be submitted to the WTA Supervisor at the Tournament where a player is still competing, to the WTA Supervisor at the Special Exempt Tournament, or through a WTA Operations staff member.

A player who is still competing at the Qualifying Sign-In

## PLAYERS

### SECTION V - TOURNAMENT DRAWS AND SCHEDULING

deadline will only be eligible to receive a Special Exempt Spot if:

- (i) she is in the finals at the Qualified Singles Event;
- (ii) she wins her match at the Qualified Singles Event; or
- (iii) her match is re-scheduled to be on the first day of Qualifying at the Special Exempt Tournament due to weather or other unforeseen circumstances.

Matches scheduled and played on the Qualifying Sign-In day which finish past midnight will not be considered as being played on the first day of Qualifying and will not make a player eligible for a Special Exempt Spot.

#### (b) Selection Process

If more than one (1) player is eligible for the Special Exempt Spot, selection will be based on a player's WTA Singles Ranking as of the week prior to the Special Exempt Tournament, or a player's Special Ranking if used to enter the Special Exempt Tournament, with the highest ranked applicant selected first.

Once a player is selected for a Special Exempt Spot, she is committed to the Special Exempt Tournament and subject to all late withdrawal rules and penalties.

If Qualifying has not started and the player selected for the Special Exempt Spot subsequently withdraws from the Tournament or moves into the Main Draw of the Tournament with her WTA Ranking as a direct acceptance, the next player eligible for the Special Exempt Spot moves into the draw. If there are no other players eligible for the Special Exempt Spot, the next player from the Main Draw Alternate List moves into the draw. After the start of Qualifying, a Lucky Loser will fill the open spot in the draw.

#### (c) Draw Procedures

If prior to the Main Draw Entry Deadline of a WTA Tournament, it is established that there will be no Special Exempt Spots due to a lack of Qualified Singles Events in the previous week, the reserved spot shall be filled with a Direct Acceptance from the original acceptance list.

## PLAYERS

### SECTION V - TOURNAMENT DRAWS AND SCHEDULING

If at any time up until the Qualifying Sign-in Deadline it is determined that no players will be eligible for the Special Exempt Spot, the reserved spot shall be immediately filled by the next in player from the main draw alternate list.

#### b. Qualifying Singles

The Qualifying Draw will consist of some or all of the following:

##### i. Direct Acceptance

See Section III.B.1 – Direct Acceptance.

##### ii. Wild Cards

See Section III.C – Wild Cards.

If a Qualifying Wild Card withdraws before the Qualifying Draw has started, the Tournament Director may name an alternate Wild Card, even if the Wild Card nomination deadline has passed. (See Section III.C.5 - Filling Vacant Wild Card Spots.)

##### iii. Alternates

###### (a) Sign-In Procedures

The Qualifying Alternate Next-In List will be frozen at the Freeze Deadline. If there is no Qualifying draw, the Freeze Deadline will be 2:00 p.m. Eastern Time (New York, USA Time) on the Thursday before the Tournament week. After the Freeze Deadline, no more Alternates will be moved into the Qualifying Draw and such alternate players are no longer committed to play the Tournament. Players on the Alternate List can preserve their eligibility for possible Qualifying Draw positions by signing in with a WTA Operations staff member or the Supervisor by 4:00 p.m. tournament local time on the day before the start of the Qualifying Draw.

(i) The Sign-In deadline for Alternates is thirty (30) minutes prior to the scheduled start of play for the day.

(ii) An Alternate or Lucky Loser is not required to sign in one day to be eligible as an Alternate/Lucky Loser another day. (This applies to singles and doubles Alternates and to Lucky Losers.)

## PLAYERS

### SECTION V - TOURNAMENT DRAWS AND SCHEDULING

- (iii) An on-site Alternate is eligible to substitute for all first round matches and for second round matches when the player or team has had a first round bye.
  
- (b) The first Lucky Loser/on-site Alternate must be ready to play within fifteen (15) minutes of being called for a match. If the first on-site Alternate fails to be ready to play within fifteen (15) minutes, the next on-site Alternate must be ready to play within five (5) minutes of the time her match is called. Any subsequent on-site Alternate must be ready to play within five (5) minutes of the time her match is called. Matches will not be held for Alternates still competing in another ITF event or WTA Tournament. If an on-site Alternate fails to show for a match, she will be considered a No Show.
  
- (c) On-Site Alternates Acceptance Priority
  - (i) Players who have entered the Tournament by the applicable deadline and appear on the Alternate List will be accepted based on the entry list order;
  
  - (ii) After the Freeze Deadline (see Section V.A.1.b.iii(a)), players who are not entered but sign-in on site will be accepted based on their current WTA Singles Ranking or Singles Special Ranking (subject to the ranking requirements detailed in Section III.A.1.d.vii);
  
  - (iii) WTA Full Members who sign in on site will be accepted in order of their current WTA Singles Rankings or Singles Special Rankings (not subject to the ranking requirements detailed in Section III.A.1.d.vii), or if no WTA Singles Rankings, according to the following order:
    - Player with the most WTA singles ranking points;
  
    - Player with the highest WTA Doubles Ranking;
  
    - Player with the most WTA doubles ranking points; and
  
    - Player who is drawn randomly.

Section III.B.2 will be used in the event of ties. Entries using a Special Ranking must be submitted to (i) the Supervisor in

**PLAYERS**  
**SECTION V - TOURNAMENT DRAWS AND SCHEDULING**

writing if entering on site or (ii) [tourops@wtatennis.com](mailto:tourops@wtatennis.com) by the applicable entry deadline.

iv. Byes

If there are open spots in the draw and no on-site Alternates or Additional Wild Cards, byes will be given to seeded players in descending order.

c. Doubles

The following chart outlines the composition of the doubles draw for each WTA Tournament level and draw size:

<b>DOUBLES DRAW COMPOSITION</b>					
<b>Tournament Level</b>	<b>Draw Size</b>	<b>Regular Wild Cards</b>	<b>Exemption Wild Cards</b>	<b>Advance Entry Spots (Doubles Combined Ranking)</b>	<b>On Site Entry Spots (Singles or Doubles Combined Ranking)</b>
WTA 1000 Mandatory	32	2	1	24	5
WTA 1000 Mandatory	28	2	1	20	5
WTA 500	24	1	1	18	4
WTA 500	16	1	1	11	3
WTA 250	16	1	1	11	3
WTA 125	16	1	0	11	4
WTA 125	8	1	0	4	3

The Main Draw will consist of some or all of the following:

i. Direct Acceptance Teams

Teams accepted in accordance with Section III.B.1.b above are direct acceptance teams.

ii. Wild Cards

See Section III.C – Wild Cards.

iii. Alternates

See Section III.B.1.b.



**PLAYERS**  
**SECTION V - TOURNAMENT DRAWS AND SCHEDULING**

iv. Byes

Those positions allocated in the draw to byes based on the draw size of the Tournament. Byes will be given to seeded teams in descending order.

**2. Sign-In Deadlines**

a. Qualifying Singles

i. Qualifiers

Each Qualifier must sign in by 4:00 p.m. tournament local time on the day prior to the start of Qualifying (“Qualifying Sign-In Deadline”) or she will not be placed in the draw. A player must sign in by contacting (either in person, by email, or by a telephone conversation) the on-site Supervisor, a Supervisor at an event at which she is competing, or WTA Operations. Each player is ultimately responsible for confirming that the Supervisor or WTA Operations has received her sign-in before the Qualifying Sign-In Deadline. (See also Section V.B.6 - No Postponement of First Round Qualifying of WTA Tournament.)

ii. On-Site Alternates

On-site Alternates must have signed in as set forth in Section V.A.1.b.iii(a). If an Alternate has not been accepted into the Qualifying Draw, she must sign in with or contact the Supervisor before thirty (30) minutes prior to the scheduled start of play each day. An on-site Alternate is eligible to substitute for all first round matches and for second round matches when there are first round byes. A player (Alternate or Lucky Loser) will not lose her Alternate/Lucky Loser status if she chooses not to sign in each day.

b. Doubles

See Section III.A.2.c.ii.

**3. Openings in the Draw**

a. Main Draw Singles\*

i. Exemption Player/Top 10 Player Replacement

If an Exemption Player or Top 10 Player who was a direct

## PLAYERS

### SECTION V - TOURNAMENT DRAWS AND SCHEDULING

acceptance withdraws after the Qualifying Sign-In Deadline, a Tournament may replace that Exemption Player or Top 10 Player with another Exemption Player or Top 10 Player based on the WTA Rankings as of the Main Draw entry deadline who is eligible (subject to WTA 250 Tournament entry restrictions) up until the Main Draw is made. The replacement Exemption Player or Top 10 Player does not have to have previously entered the Tournament but must not have entered another Tournament in the same week. Once the replacement Exemption Player or Top 10 Player is confirmed, she fills the Main Draw spot vacated by the withdrawing Exemption Player or Top 10 Player. If the Tournament does not secure a replacement Exemption Player or Top 10 Player, the vacated Main Draw spot is filled according to parts ii and iii of this Section V.A.3.a.

#### ii. Before Qualifying Begins

Next-In Main Draw Alternates, in order of their position on the Alternate List, will fill any such openings.

If there are no Main Draw Alternates, players in the Qualifying Draw, in order of their position on the Qualifying Acceptance List, will fill any such openings.

#### iii. After Qualifying Begins

Lucky Losers will fill any such openings in the Main Draw, except in the following cases:

- (a) An Alternate Wild Card replacement (see Section III.C.5 - Filling Vacant Wild Card Spots);
- (b) The correction of a WTA administrative error (see Section V.A.4 - On-Site Draw Procedure for Administrative Error - Preliminary Match); or
- (c) There are more Main Draw withdrawals than there are Lucky Losers (see Section V.A.1.b.iii - Alternates).

#### iv. Tournaments with No Qualifying

For Tournaments at which there is no Qualifying and no on-site Main Draw Alternates, players who are not entered but sign in on site no later than one (1) hour before the Main Draw is made will fill any such openings.

## PLAYERS

### SECTION V - TOURNAMENT DRAWS AND SCHEDULING

- (a) Players who sign in on site will be accepted based on their current WTA Singles Ranking or Singles Special Ranking (subject to the ranking requirements detailed in Section III.A.1.d.vii).
- (b) After any players who meet the ranking requirements in Section III.A.1.d.vii sign in, then WTA Full Members who sign in on site will be accepted in order of their current WTA Singles Rankings or Singles Special Rankings (not subject to the ranking requirements detailed in Section III.A.1.d.vii), or if no WTA Singles Rankings, according to the following order:
  - (i) Player with the most WTA singles ranking points;
  - (ii) Player with the highest WTA Doubles Ranking;
  - (iii) Player with the most WTA doubles ranking points; and
  - (iv) Player who is drawn randomly.
- (c) Section III.B.2 will be used in the event of ties. Entries using a Special Ranking must be submitted to the Supervisor in writing if entering on site.
- (d) If there are still openings after any on-site sign-ins, then see Section III.C.6 - Additional Wild Cards.

\*See Section V.A.6.d - Withdrawal of a Seed for the procedures to be followed when a seeded player withdraws from a Tournament.

#### b. Qualifying Singles

##### i. Before the Freeze Deadline

Any such openings are filled by Next-In Qualifying Alternates based on the WTA Rankings or Special Rankings used for Alternate Status.

##### ii. After the Freeze Deadline but before Qualifying Sign-In

Any such openings are filled by Alternates who have signed in with a WTA Operations staff member or the Supervisor based on the On-site Alternates Acceptance procedure set forth in Section V.A.1.b.iii.

**PLAYERS**  
**SECTION V - TOURNAMENT DRAWS AND SCHEDULING**

iii. After the Qualifying Sign-In

These openings are filled by On-site Alternates who were not accepted into the draw based on the order determined at the Qualifying Sign-In Deadline using the On-site Alternates Acceptance procedure set forth in Section V.A.1.b.iii above. Players must have signed in as set forth in Section V.A.1.b.iii to maintain eligibility for any openings.

The first on-site Alternate must be ready to play within fifteen (15) minutes of being called for a match. Matches will not be held for Alternates still competing in another ITF event or WTA Tournament.

If a Qualifying spot becomes available prior to the start of the last qualifying match of the day, the Alternate will be determined by the Sign-In for that day. However, where there are no Alternates signed in and the match affected by the withdrawal is not scheduled for that day, the following day's Sign-In will be used to fill the vacant spot. If a spot becomes available after the start of the last qualifying match of the day/night, the spot will be filled by the highest ranked player who signs in the following day.

iv. Additional Wild Cards

For Tournaments at which there are no on-site Alternates, see Section III.C.6 - Additional Wild Cards.

c. Doubles\*

i. Advance Entry List

See Section III.B.1.b.i.

ii. On-Site Entry

(a) At Sign-In Deadline

Openings in the Main Draw will be filled by the next team on the On-Site Entry Alternate List.

(b) After Sign-In Deadline

If openings occur after the day of Sign-In deadline, in order to be eligible, the team must sign in as an Alternate with or contact the on-site Supervisor thirty (30) minutes prior to the

## PLAYERS

### SECTION V - TOURNAMENT DRAWS AND SCHEDULING

start of doubles play each day or by the Doubles Alternate Sign-In deadline determined by the on-site Supervisor/Referee and indicated on the order of play.

An on-site Alternate team is eligible to substitute for all first round matches and for second round matches when there are first round byes. If a team chooses not to sign in on one day, it will not lose its eligibility to sign in for subsequent days.

(i) Prior to the Start of the Last Doubles Match of Day

If a spot becomes available prior to the start of the last doubles match of the day/night, the Alternate will be determined by the Sign-In for that day. However, where there are no Alternates signed in, and the match affected by the withdrawal is not scheduled for that day, the following day's Sign-In will be used to fill the vacant spot.

(ii) After the Start of the Last Doubles Match of Day

If the spot becomes available after the start of the last doubles match of the day/night, the spot will be filled by the highest ranked team that signs in the following day using the highest of its players' combined WTA Singles or Doubles Rankings, which may include Special Rankings, as of the week prior to the start of the Tournament.

(c) Additional Wild Cards

For Tournaments at which there are no on-site Alternates, see Section III.C.6 - Additional Wild Cards.

\* See Section V.A.6.d - Withdrawal of a Seed for the procedures to be followed when a seeded team withdraws from a Tournament.

#### **4. On-Site Draw Procedure for Administrative Error – Preliminary Match**

If an administrative error has been made in a Tournament acceptance list (Main Draw Singles, Qualifying Singles, or Doubles) and too many players have been accepted into the Tournament, the following procedures will be followed:

## PLAYERS

### SECTION V - TOURNAMENT DRAWS AND SCHEDULING

- a. The last two (2) players accepted into the Tournament based upon the entry list, regardless of whether the draw has been made (excluding Wild Cards and Qualifiers), will play a preliminary match for one (1) spot in the draw.
- b. The loser of the preliminary match will receive first round prize money (paid by the WTA) and first round ranking points.
- c. The winner of the preliminary match will receive prize money and ranking points for the round reached in the draw. In addition, the player will receive 25% of second round prize money (paid by the WTA) and 35% of second round ranking points.

The WTA will reimburse per diem expenses to the loser of the preliminary match per the Rules.

#### 5. Making a Draw

- a. Place

The draw, which the public will be allowed to attend, is to be made by the Supervisor or the Referee (a person so designated by the Tournament and approved by the WTA) at a site selected by the Tournament Director in consultation with the Supervisor. Whenever possible, all draws should have a player present to witness the making of the draw, however, if a player is not available, the Supervisor or Referee may perform the draw in the presence of a WTA Player Relations staff member who will serve as the player representative.

- b. Time

- i. Main Draw Singles

The Singles Main Draw will be made no earlier than the Qualifying Sign-In deadline and no later than 3:00 p.m. tournament local time the day before the Main Draw starts. (Any exception must have the approval of the WTA.)

- ii. Qualifying Singles

The Singles Qualifying Draw will be made immediately after the Qualifying Sign-In closes, or if deemed necessary, may be delayed by the Supervisor.

**PLAYERS**  
**SECTION V - TOURNAMENT DRAWS AND SCHEDULING**

iii. Doubles

The Doubles Main Draw will be made after the Doubles Sign-In closes.

c. Tournaments

All Tournaments will have a seeded draw. (See Section V.A.6.a.i.)

d. Main Draw Byes

i. The number of byes shall be based on draw size as follows:

Main Draw Size	Number of Byes
96	32
56	8
48	16
30	2
28	4
24	8
16/32/64	0

ii. Awarding of Byes

(a) Prior to the draw being made

Byes will be given automatically to the seeded players in descending order.

Once byes have been given to the seeds in any size draw, any remaining byes will be drawn and evenly distributed into each quarter of the draw.

(b) Once the draw is made

(i) If there are withdrawals and no Alternates to fill the spots, further byes will be assigned to the line from which a player withdrew and not to the remaining seeds in descending order.

(ii) In Qualifying, if a player's opponent withdraws and there is no Alternate to fill her spot, the player will be assigned a first round bye for ranking purposes, not a default. (See Section VIII.B.3 - Withdrawals, Byes, Walkovers, and Defaults.)

**PLAYERS**  
**SECTION V - TOURNAMENT DRAWS AND SCHEDULING**

**6. Seeds**

a. General Principles

i. All Main and Qualifying Draws will have a seeded draw.

(a) Singles

Seeding is based on players' WTA Singles Rankings as of the week prior to the start of the Tournament. If two (2) or more players' rankings are tied, the following player receives priority:

- (i) player with the highest WTA Singles Ranking from the previous week; and
- (ii) player who is drawn randomly.

(b) Doubles

Seeding is in order of the accepted teams' combined WTA Doubles Rankings as of the week prior to the start of the Tournament. If two (2) or more teams' rankings are tied, then Section III.B.2.b.i above determines the team that receives priority.

- ii. Wild Cards are eligible for seeding. Qualifiers and Lucky Losers are not eligible for seeding.
- iii. Seeding will not be official until the draw is made.

b. Number of Seeds

The number of players to be seeded will be as follows:

Main Draw		Qualifying	
Draw Size	Seeds	Draw Size	Seeds
96/128	32	48 (12 qualifiers)	24
48/56/64	16	32 (8 qualifiers)	16
28/30/32	8	32 (4 qualifiers)	8
16	4	24 (6 qualifiers)	12
8	2	16 (4 qualifiers)	8
		8 (4 qualifiers)	4



**PLAYERS**  
**SECTION V - TOURNAMENT DRAWS AND SCHEDULING**

c. Seeding Procedures

Seeds shall be placed or drawn as set out below.

i. For All Main Draws

(a) Place Seed 1 on line 1 and Seed 2 on line 16 (16 draw), line 32 (32 draw), line 64 (64 draw), or line 128 (128 draw).

(b) To determine the placement of the remaining seeds, draw in pairs of two (Seeds 3 and 4), groups of four (Seeds 5-8, 9-12, 13-16), or groups of eight (Seeds 17-24 and 25-32) from top to bottom and place seeds, in the order drawn, on the lines indicated in the following table:

	<b>16 Draw 4 seeds</b>	<b>32 Draw 8 seeds (includes draw of 28 or 30 players or teams</b>	<b>64 Draw 16 seeds (includes draw of 48, 56, or 60 players)</b>	<b>128 Draw 32 seeds (includes draw of 96 players)</b>
<b>Seeds</b>	<b>Line Placement on Draw Sheet</b>			
3-4	5 12	9 24	17 48	33 96
5-8		8 16 17 25	16 32 33 49	32 64 65 97
9-12			9 25 40 56	17 49 80 112
13-16			8 24 41 57	16 48 81 113
17-24				9 24 41 56 73 88 105 120

**PLAYERS**  
**SECTION V - TOURNAMENT DRAWS AND SCHEDULING**

25-32				8 25 40 57 72 89 104 121
Available lines for Special Ranking Additional Seeds (see Section VIII.C.5.g)	3 7 9 13	3 5 11 13 19 21 27 29	3 5 11 13 19 21 27 29 35 37 43 45 51 53 59 61	
Note: Special Ranking Additional Seeds do not apply to 48 or 96 Draws				

- ii. For Main Draws with Special Ranking Additional Seeds
  - (a) Draw traditional seeds in accordance with sub-Section i.
  - (b) Place applicable byes in the draw, including players with performance byes, if any.
  - (c) Draw Additional Seeds to open lines that do not play against a seeded player in the first round (as indicated in the table above) by placing chips for all available lines together and drawing one (1) chip for each Additional Seed, indicating the line on which to place the Additional Seed.
  - (d) No Additional Seeds will be added to the draw once the making of the draw begins.
- iii. For Other Odd Numbered Draws
 

The WTA will determine the number of seeds.
- iv. For All Qualifying Draws
  - (a) All Qualifying Draws will be drawn in sections.

## PLAYERS

### SECTION V - TOURNAMENT DRAWS AND SCHEDULING

- (b) The number of sections and seeds shall be determined by the number of Qualifiers. There shall be two (2) seeds per section and one (1) Qualifier per section.
- (c) The first seed shall be placed at the top of the first section; the second seed shall be placed at the top of the second section and so on until all sections have one (1) seed on the top line of each section.
- (d) The remaining seeds shall be drawn as one (1) group. The first drawn shall be placed on the bottom line of the first section; the second drawn shall be placed on the bottom of the second section and so on until all sections have one (1) seed on the bottom of each section.
- (e) If there is an insufficient number of seeded players to fill all the positions for seeds in the draw, the section(s) with the highest seeds shall not have a second seeded player. If no players are seeded, all players are drawn randomly.

#### v. For WTA Finals Seeding

See Section VI.B.3.

#### d. Main Draw – Withdrawal of a Seed

##### i. Prior to the Release of the Schedule of Play

If a seeded player or team withdraws from the Main Draw of a Tournament after the draw has been made but prior to the release of the schedule of play for the first day, then the following procedure applies.

- (a) If the withdrawing seeded player or team does not have a bye, then:
  - (i) The next player or team eligible to be seeded takes the withdrawing seeded player's or team's position in the draw; and
  - (ii) The next player or team eligible to move into the draw (i.e., Qualifier, Lucky Loser, or Alternate as applicable) takes the remaining open position in the draw.
- (b) If the withdrawing seeded player or team has a bye, and:

## **PLAYERS**

### **SECTION V - TOURNAMENT DRAWS AND SCHEDULING**

- (i) If every seed in the draw has a bye, then:
  - The next player or team eligible to be seeded takes the withdrawing seeded player's or team's position in the draw; and
  - The next player or team eligible to move into the draw (i.e., Qualifier, Lucky Loser, or Alternate as applicable) takes the remaining open position in the draw; or
- (ii) If not every seed in the draw has a bye, then:
  - The next seeded player or team eligible to receive a bye takes the withdrawing seeded player's or team's position in the draw; and
  - The next player or team eligible to be seeded takes the open seeded position in the draw; and
  - The next player or team eligible to move into the draw (i.e., Qualifier, Lucky Loser, or Alternate as applicable) takes the remaining open position in the draw.

#### **ii. After the Release of the Schedule of Play**

If a seeded player or team withdraws from the Main Draw of a Tournament after the draw has been made, after the release of the schedule of play for the first day, and before the first match of the applicable draw has commenced, then the following procedure applies.

- (a) If the withdrawing seeded player or team does not have a bye, then
  - (i) The next player or team eligible to be seeded takes the withdrawing seeded player's or team's position in the draw; and
  - (ii) The next player or team eligible to move into the draw (i.e., Qualifier, Lucky Loser, or Alternate as applicable) takes the remaining open position in the draw.
- (b) If the withdrawing seeded player or team has a bye, then:

## PLAYERS

### SECTION V - TOURNAMENT DRAWS AND SCHEDULING

- (i) The next seeded or unseeded (as applicable) player or team eligible to receive a bye takes the withdrawing seeded player's or team's position in the draw; and
- (ii) The next player or team eligible to move into the draw (i.e., Qualifier, Lucky Loser, or Alternate as applicable) takes the remaining open position in the draw.

#### iii. After Play Has Commenced

If a seeded player or team withdraws from the Main Draw of a Tournament after the first match of the applicable draw has commenced, then the next player or team eligible to move into the draw (i.e., Qualifier, Lucky Loser, or Alternate as applicable) takes the open position in the draw.

#### e. Qualifying – Withdrawal of a Seed

If a seeded player withdraws from the Qualifying Draw of a Tournament after the draw has been made, then the next Alternate player eligible to move into the draw takes the open position in the draw.

#### f. Seeding Errors

Errors in seeding may be corrected only if the error is discovered before the first match of the applicable draw has commenced.

##### i. A Player is Unseeded in Error

- (a) If only some seeds have a bye and the player unseeded in error should receive a bye, then that player should be placed in the position of the last seeded player who received a bye, the displaced player then takes the place of the last seeded player, who finally takes the position vacated by the player unseeded in error.
- (b) If every seed has a bye, no seed has a bye, or some seeds have a bye but the player unseeded in error should not receive a bye, then the player unseeded in error takes the position of the last seeded player, who then takes the position vacated by the player unseeded in error.
- (c) If a player eligible for an Additional Seed was not given an Additional Seed position, the error shall be corrected by randomly drawing on which line of the draw the Additional

## **PLAYERS**

### **SECTION V - TOURNAMENT DRAWS AND SCHEDULING**

Seed player should be placed according to the procedure in Section V.A.6.c.ii(c) above. The displaced player shall take the vacated position of the player who did not receive an Additional Seed position in error.

- ii. Error in Seeding Order
  - (a) If only some seeds have a bye and a seeded player should have received a bye but did not due to an error in the seeding order, then the last player who received a bye and the seeded player who should have received a bye shall switch positions.
  - (b) If every seed has a bye, no seed has a bye, or the error in seeding does not affect a seeded position with a bye, then the error in seeding shall be corrected by switching the positions of the affected players; however, if the error only affects players within the same seeding group (in reference to the placement of seeds in the draw (e.g., within seeding group 5-8 or 13-16)), then no adjustment is made.

## **B. SCHEDULING**

### **1. WTA Responsibility**

The Supervisor, in consultation with the Tournament Director, is responsible for match scheduling. All match time requests must go through the Supervisor.

Match scheduling will take into account relevant factors including television contracts, the possibility and timing of day matches the following day, the actual start time for the night matches, and other relevant factors.

### **2. Player Obligations**

- a. Players will be expected to play when scheduled. Players may be required to play both singles and doubles any day of a Tournament.
- b. Players may also be required to play several night matches in both singles and doubles during a Tournament week.
- c. Players are required to play a minimum of two (2) singles night matches during a Tournament if requested to do so.
- d. When weather or other unavoidable circumstances cause a disruption in the schedule, a player may not be expected to play more than

**PLAYERS**  
**SECTION V - TOURNAMENT DRAWS AND SCHEDULING**

three (3) matches in a day without her consent.

- e. A player must be available to play on the first day of a Tournament unless she played in the singles or doubles final or was competing on the final day of play of a Tournament ending the preceding day.
- f. All players must be prepared to play doubles on the first day of play, regardless of whether or not they have received a bye in singles.
- g. Players may be required to play doubles before singles if necessary due to scheduling difficulties in completing the Tournament in time.

However, there must be a minimum of two (2) matches scheduled in between the doubles and singles. In no case may there be less than one (1) hour in between matches unless all players agree.

**3. Late Start Requests**

Previous Tournament commitments or illness are the primary considerations in granting late start requests. If a request is due to illness, the player must be evaluated by the PHCP and Tournament Physician. A request made due to illness or loss of luggage does not guarantee a player a late start.

**4. Television**

When a Tournament is televised, the television commitments will be taken into scheduling consideration.

**5. Doubles Match Scheduling**

- a. When the singles and doubles finals are to be played on the same day, the doubles final shall be scheduled approximately two (2) hours prior to the published start time of the singles final. If the singles final is scheduled at 12:00 noon tournament local time or earlier, the doubles final may be played following the singles final.
- b. It is recommended that i) each session (day and night) open with a doubles match; and ii) a minimum of one (1) doubles match per day be scheduled on a televised court. If there is only one (1) televised court, then the match may be played on the next largest court from a seating capacity standpoint.
- c. The following shall be considered valid exceptions to the doubles scheduling requirements set forth in sub-Sections a and b above:
  - i) contractual television obligations; ii) weather or other major

**PLAYERS**  
**SECTION V - TOURNAMENT DRAWS AND SCHEDULING**

scheduling interruptions; iii) combined event with the ATP World Tour (“ATP”); iv) security issues; and v) unforeseen circumstances as determined by the Supervisor. In addition, exceptions to sub-Section a above shall be permitted when at least one (1) of the doubles players is also a singles finalist.

**6. No Postponement of First Round Qualifying of WTA Tournament**

- a. The WTA will not postpone any WTA Tournament Qualifying match for a player who is still participating in the prior week’s WTA Tournament, Grand Slam, Women’s ITF World Tennis Tour event, or Billie Jean King Cup event.
- b. A player is eligible to play the Qualifying of a WTA Tournament if she has lost in or, consistent with these Rules, she has withdrawn or retired (or been released, in the case of Billie Jean King Cup) from both the singles and doubles competitions of the prior week’s WTA Tournament, Grand Slam, Women’s ITF World Tennis Tour event, or Billie Jean King Cup event no later than the day of the Qualifying Sign-In deadline for such WTA Tournament.

A player is also eligible to play the Qualifying of a WTA Tournament if such WTA Tournament is held at the same venue as the prior week’s WTA Tournament or Women’s ITF World Tennis Tour event and the following conditions are met:

- i. the player has lost (which does not include a withdrawal or retirement) from both the singles and doubles competitions of the prior week’s WTA Tournament or Women’s ITF World Tennis Tour event no later than the first day of Qualifying for such WTA Tournament;
  - ii. the player’s final match in both the singles and doubles competitions of the prior week’s WTA Tournament or Women’s ITF World Tennis Tour event is completed before her first Qualifying match at such WTA Tournament; and
  - iii. no extraordinary scheduling is required of either such WTA Tournament or the prior week’s WTA Tournament or Women’s ITF World Tennis Tour event to allow for the player to play the Qualifying of such WTA Tournament.
- c. A player may sign in for the Qualifying of a WTA Tournament while she is still participating in the prior week’s WTA Tournament, Grand Slam, Women’s ITF World Tennis Tour event, or Billie Jean King Cup event only if her next singles and doubles match in the prior week’s



**PLAYERS**  
**SECTION V - TOURNAMENT DRAWS AND SCHEDULING**

Tournament or event will occur no later than the day of the Qualifying Sign-In deadline for such WTA Tournament (or the first day of Qualifying for such WTA Tournament if it is held at the same venue as the prior week's WTA Tournament or Women's ITF World Tennis Tour event); and she determines that she is able to arrive in time to play a match on the first day of Qualifying at such WTA Tournament.

- d. If a player signs in for the Qualifying of a WTA Tournament while she is still participating in the prior week's WTA Tournament, Grand Slam, Women's ITF World Tennis Tour event, or Billie Jean King Cup event and subsequently loses, withdraws, or retires (or is released, in the case of Billie Jean King Cup) from the prior week's Tournament or event but does not participate in such Qualifying, then her failure to participate is subject to all applicable requirements and penalties under these Rules, including but not limited to the requirements and penalties in Section IV of these Rules (e.g., withdrawal requirements, Late Withdrawal and No-Show Offense fines, etc.).

**7. Rescheduling of Matches**

- a. Under extenuating circumstances, a match may be rescheduled at the discretion of the Supervisor, in consultation with the Tournament Director.
- b. Matches may not be rescheduled due to illness, injury, or loss of luggage.
- c. A player who personally and directly notifies the Supervisor or Referee of her impending tardiness sufficiently in advance in the opinion of the Supervisor or Referee, may at the latter's discretion, secure a release from reporting within fifteen (15) minutes of her match being called and not be subject to default and penalties.

**8. Rescheduling of Finals**

If, due to Extreme Weather Conditions or extraordinary circumstances, a Tournament cannot be completed on the final day as scheduled, the Tournament shall be required to extend for one (1) day to complete the singles and/or doubles events unless the Tournament, players and WTA all agree to abandon the Tournament on the day the final was originally scheduled to be played. (The event must be extended even if only one (1) entity wants to play the final.) No further extension will be permitted without the approval of the WTA.

**PLAYERS**  
**SECTION V - TOURNAMENT DRAWS AND SCHEDULING**

a. Tournaments Scheduled the Week Prior to a Grand Slam

WTA events scheduled the week prior to a Grand Slam shall schedule their finals no later than Saturday. The Tournament may be extended by one (1) day, only if:

- i. each player in the finals has one day off between the re-scheduled finals and her first match at the Grand Slam; or
- ii. each player does not have one day off or the Grand Slam schedule of play has not been released and all players in the finals agree to extend the Tournament by one (1) day.

b. Player Penalties for Failure to Play Postponed Final

An additional fine of \$5,000 shall be assessed to any player who fails to play a postponed final match in singles or doubles on the day following the originally scheduled final day of the Tournament concerned. All such fines shall be automatic and non-appealable, except in the case of Extraordinary Circumstances. Fine appeals must be filed within twenty-one (21) days from the date of notice.

c. Alternate Indoor Venue

Where a Tournament cannot be completed outdoors, and where a suitable indoor facility exists, the Tournament should be played to completion. If Tournament play is interrupted or postponed, players will be required to play on the day following the originally scheduled final day of the Tournament pursuant to sub-Section a above. Any final scheduling decisions will be made by the Supervisor who has the authority (in consultation with the Tournament Director) to move a match to another court, indoors or outdoors, regardless of surface.

**9. Changing Courts/Surface**

If it is deemed necessary to move a match, the Supervisor, in consultation with the Tournament Director, has the authority to delay the start of the match or to move a match to another court, indoors or outdoors, regardless of surface. The Referee, in consultation with the Supervisor, may decide if a match shall be moved to another court if circumstances so require.

During the course of a match, if conditions or circumstances merit, players may be required by the Supervisor or Referee to move to another court.

**PLAYERS**  
**SECTION V - TOURNAMENT DRAWS AND SCHEDULING**

**10. Light and Weather**

The Referee, in consultation with the Supervisor, shall decide when play will be halted in view of weather conditions or bad light. (See Section XVIII.B.7 - Extreme Weather Conditions and Lightning.)

**11. Stadiums with Retractable Roofs**

See Appendix G.

**12. Time Between Matches**

Players are entitled to a minimum of thirty (30) minutes between matches when their singles and doubles matches are consecutive and one (1) hour when consecutive singles matches must be played.

**13. Interruptions and Breaks**

a. Interruptions

If Tournament play is interrupted or postponed, players must be prepared to play when play is resumed. If play is interrupted or postponed, the period of re-warm up shall be as follows:

<b>Delay</b>	<b>Re-Warm Up</b>
0-15 minutes	No re-warm up
15-30 minutes	Three (3) minutes re-warm up
30 or more minutes	Four (4) minutes re-warm up

b. Breaks

i. Change of Ends

When changing ends, a maximum of ninety (90) seconds shall elapse from the moment the ball goes out of play at the end of the game until the time the first serve is struck for the next game. If such first serve is a fault, the second serve must be struck by the server without delay.

However, after the first game of each set and during a tie-break, play shall be continuous, and the players shall change ends without a rest period.

## **PLAYERS**

### **SECTION V - TOURNAMENT DRAWS AND SCHEDULING**

#### ii. Set Break

At the conclusion of each set, regardless of the score, there shall be a set break of 120 seconds from the moment the ball goes out of play at the end of the game until the time the first serve is struck for the next game. If a set ends after an even number of games, there shall be no change of ends until after the first game of the next set.

#### iii. Televised Matches

During televised matches, the Chair Umpire may extend the change of ends and set breaks where necessary.



# PLAYERS

## VI. WTA FINALS

The Tour Year culminates with the WTA Finals. All players who qualify for the WTA Finals must comply with the player responsibilities in this Section VI.

### A. RACE TO THE FINALS

To determine qualification for the WTA Finals singles and doubles competitions, the Race to the Finals Leaderboard ranks (a) each singles player according to her Singles Race Points; and (b) each doubles team according to their Doubles Race Points (collectively, "Race Points") earned from Tournaments beginning the week before the previous year's WTA Finals through and including Tournaments beginning two weeks before the current year's WTA Finals ("Race Year").

#### 1. Singles Race Points

Subject to the Long-Term Injury Rule and Special Ranking Rule, a player's Singles Race Points are determined by calculating her total ranking points, including any applicable zero (0) ranking point results pursuant to Section II.A, from eighteen (18) Tournament results during the current Race Year, which must include:

- four (4) Grand Slams;
- six (6) WTA 1000 Mandatory combined/virtually combined Tournaments;
- one (1) WTA 1000 Mandatory Tournament (WTA only); and
- best seven (7) results from all WTA 1000 Mandatory, WTA 500, and WTA 250 Tournaments.

A player's WTA 125 and ITF ranking point results do not count toward her Singles Race Points and will be replaced by her next best results from WTA 1000 Mandatory, WTA 500, or WTA 250 Tournaments.

#### 2. Doubles Race Points

Doubles Race Points are a team's best twelve (12) Tournament ranking point results earned as a team at Grand Slams, WTA 1000 Mandatory, WTA 500, or WTA 250 Tournaments during the current Race Year.

**PLAYERS**  
**SECTION VI - WTA FINALS**

**B. WTA FINALS**

**1. Singles and Doubles Competition Formats**

The singles and doubles competitions both are a draw of eight (8) players and teams, respectively, in a round robin format with two (2) groups of four (4) players and teams. The winner and runner-up from each group qualify for a single-elimination-format semifinal and final.

**2. Qualification; Attendance; Alternates**

a. Qualified Players – Singles

To qualify for the WTA Finals, a player must have played at least eight (8) WTA 1000 Mandatory or WTA 500 Tournaments during the Race Year unless she qualifies for Long-Term Injury (see Section VIII.A.4.a.ii).

The following players qualify for the WTA Finals (each a “Finals Singles Qualified Player”):

- i. The top seven (7) players on the Race to the Finals Leaderboard; then
- ii. The highest-ranked current-year Grand Slam winner who is 8-20 on the Race to the Finals Leaderboard and who is not already qualified.

If a player in the top seven (7) on the Race to the Finals Leaderboard withdraws, the following player fills the vacated spot as a Finals Singles Qualified Player:

- iii. the second-highest-ranked current-year Grand Slam winner who is 8-20 on the Race to the Finals Leaderboard and who is not already qualified; and if no player qualifies under this criteria, then
- iv. the next player ranked 8 or below on the Race to the Finals Leaderboard.

b. Qualified Players – Doubles Teams

To qualify for doubles at the WTA Finals, a player must have played doubles in at least six (6) WTA Tournaments during the Race Year (with any partner) unless she qualifies for Long-Term Injury (see Section VIII.A.4.a.ii) and a team must have played doubles as a team

**PLAYERS**  
**SECTION VI - WTA FINALS**

in at least two (2) Tournaments (inclusive of Grand Slams) during the Race Year.

The following teams qualify for the WTA Finals (each team a “Finals Qualified Team” and each player a “Finals Doubles Qualified Player”):

- i. The top seven (7) teams on the Race to the Finals Leaderboard; then
- ii. The highest-ranked current-year Grand Slam winning team who is 8-20 on the Race to the Finals Leaderboard and who is not already qualified.

If a team in the top seven (7) on the Race to the Finals Leaderboard withdraws, the following team fills the vacated spot as a Finals Qualified Team:

- iii. the second-highest-ranked current-year Grand Slam winning team who is 8-20 on the Race to the Finals Leaderboard and who is not already qualified; and if no team qualifies under this criteria, then
- iv. the next team ranked 8 or below on the Race to the Finals Leaderboard.

A Finals Doubles Qualified Player who qualifies with two (2) or more Finals Qualified Teams may choose the Finals Qualified Team with which she participates, and any player with whom she does not choose to participate is ineligible to be a Finals Doubles Qualified Player unless such player qualifies with another Finals Qualified Team.

c. Qualification Tie-Break

- i. Singles

If two (2) or more players are tied for qualification, the following player is the Finals Singles Qualified Player:

- (a) The player with the most ranking points from all WTA 1000 Mandatory Tournaments counting toward her Race Points; or if still tied
- (b) The player with the highest ranking point result from any WTA 1000 Mandatory Tournament counting toward her Race Points; or if still tied



**PLAYERS**  
**SECTION VI - WTA FINALS**

- (c) The player with the highest ranking point result from any WTA 500 Tournament counting toward her Race Points; or if still tied
- (d) The player with the highest ranking point result from any WTA 250 Tournament counting toward her Race Points.

ii. Doubles

If two (2) or more teams are tied for qualification, the following team is the Finals Qualified Team:

- (a) The team with the most ranking points as a team from all WTA 1000 Mandatory Tournaments counting toward their Race Points; or if still tied
- (b) The team with the highest ranking point result as a team from any WTA 1000 Mandatory Tournament counting toward their Race Points; or if still tied
- (c) The team with the highest ranking point result as a team from any WTA 500 Tournament counting toward their Race Points; or if still tied
- (d) The team with the highest ranking point result as a team from any WTA 250 Tournament counting toward their Race Points.

d. Mandatory Participation; Penalties

Finals Singles and Doubles Qualified Players are required to attend and compete at the WTA Finals and participate in all mandatory functions. Each Finals Singles and Doubles Qualified Player must be in the WTA Finals city at least three (3) days prior to the start of the singles or doubles competition, as applicable; provided, however, that if she is competing at another WTA Tournament on or after her required day of arrival, she must use best efforts to be in the WTA Finals city no later than the day after she finishes competing at such other WTA Tournament. Any Finals Singles Qualified Player who fails to attend and compete at the WTA Finals must pay a fine of \$125,000 and receives zero (0) ranking points for the WTA Finals, which must count as one (1) of her best sixteen (16) Tournament results in calculating her WTA Ranking. If a Finals Qualified Team fails to attend and compete at the WTA Finals, the withdrawing Finals Doubles Qualified Player must pay a fine of \$25,000. Finals Singles and Doubles Qualified Players may not withdraw by Excused

**PLAYERS**  
**SECTION VI - WTA FINALS**

Withdrawal, Prize Money Withdrawal, or Consecutive Withdrawal from the WTA Finals.

If a Finals Singles or Doubles Qualified Player fails to attend and compete at the WTA Finals, the WTA will suspend the full amount of her applicable fine(s) if she participates in promotional activities, including but not limited to media and sponsor activities, autograph sessions, photo opportunities, video news releases, charity activities, and similar activities ("Finals Make-Up Activities"), for the benefit of the WTA or the WTA Finals either:

- i. At the current WTA Finals over two (2) days for a minimum of three (3) hours per day ("On-Site Option"); or
- ii. Any time prior to the WTA Finals of the following Tour Year over two (2) days for a minimum of three (3) hours per day at the location(s) WTA designates in its sole, reasonable discretion in consultation with the WTA Finals promoter and such player ("Off-Site Option").

WTA will designate the details of the Finals Make-Up Activities in its sole, reasonable discretion in consultation with the WTA Finals promoter and such player. Such player is responsible for all costs related to attending the Finals Make-Up Activities, except that for the On-Site Option, she is entitled to one (1) round-trip, first-class airline ticket to the WTA Finals city and one (1) hotel room, on-site meals, and tournament-related ground transportation for each day during which she participates in Finals Make-Up Activities for at least three (3) hours. If such player fails to perform the Finals Make-Up Activities to the WTA's sole, reasonable satisfaction:

- iii. The WTA may reinstate all applicable fine(s) and may collect such fine(s) through any legal means, including from the prize money she earns at any future Tournament beginning (a) immediately after the current WTA Finals for the On-Site Option; or (b) with the WTA Finals of the following Tour Year for the Off-Site Option; and
- iv. She will be suspended from competing in all WTA Tournaments through the next two (2) WTA 1000 Mandatory/WTA 500 Tournament weeks, including any WTA 250 Tournaments in that time period, beginning (a) the first day after the completion of the current WTA Finals for the On-Site Option; (b) with the WTA Finals of the following Tour Year for the Off-Site Option; or (c) on such other date that the WTA CEO determines in his or

**PLAYERS**  
**SECTION VI - WTA FINALS**

her sole discretion will prevent the circumvention or perceived circumvention of these Rules.

e. Alternates

After the Finals Singles Qualified Players and Finals Qualified Teams are set, the next two (2) highest-ranked singles players on the Race to the Finals Leaderboard qualify as alternates for the WTA Finals (“Finals Alternates”) and the next one (1) highest-ranked doubles team on the Race to the Finals Leaderboard qualifies as an alternate team for the WTA Finals (“Finals Alternate Team”). If any Finals Singles Qualified Player or Finals Qualified Team is unable to compete, Finals Alternates or Finals Alternate Teams, as applicable, will move into the competition in order of the Race to the Finals Leaderboard, and the WTA may designate additional Finals Alternates or Finals Alternate Teams according to the above qualification criteria. Finals Alternates and Finals Alternate Teams are subject to the same obligations and fines as Finals Singles Qualified Players and Finals Doubles Qualified Players regardless of whether they move into the competition. However, zero (0) ranking point results apply only if a Finals Alternate or Finals Alternate Team becomes a Finals Singles Qualified Player or Finals Qualified Team.

Finals Alternates and Finals Alternate Teams must be in the WTA Finals city on the day of the WTA Finals draw ceremony, attend the draw ceremony and all other mandatory functions; provided, however, that if she is competing at another WTA Tournament on or after her required day of arrival, she must use best efforts to be in the WTA Finals city no later than the start of the WTA Finals. Finals Alternates and Finals Alternate Teams must be on site and available to substitute for a maximum of one (1) Final Singles Qualified Player or one (1) Finals Qualified Team from the start of the WTA Finals through the completion of the round robin matches. If a Finals Alternate or Finals Alternate Team has not moved into the competition by the completion of the round robin matches, her WTA Finals obligations will cease and she may depart the WTA Finals city. A Finals Alternate or Finals Alternate Team who plays any match(es) becomes a Finals Singles Qualified Player or Finals Qualified Team, as applicable, and will receive a round robin standing, WTA Ranking points, and prize money in accordance with the prize money breakdown. All Finals Alternates and Finals Alternate Teams also will receive per diem for any days that they are required to be on site until their WTA Finals obligations cease.

**PLAYERS**  
**SECTION VI - WTA FINALS**

f. **Withdrawal and Notification**

Any Finals Singles or Doubles Qualified Player or Finals Alternate or Alternate Team withdrawing from the WTA Finals must provide written notice to the WTA and must not make any public announcement concerning her participation until the WTA has confirmed receipt of such notice.

**3. Round Robin Seeding**

a. **Basis for Seeding**

Seeding for Finals Singles Qualified Players and Finals Qualified Teams is according to the Race to the Finals Leaderboard.

b. **Seeding Procedures**

i. Place seed 1 in Group A and seed 2 in Group B.

ii. Draw from and place the remaining seeds in pairs as follows:

(a) Seeds 3 and 4 (place first drawn seed in Group A and remaining seed in Group B);

(b) Seeds 5 and 6 (place first drawn seed in Group A and remaining seed in Group B); and

(c) Seeds 7 and 8 (place first drawn seed in Group A and remaining seed in Group B).

c. **Withdrawal of a Seed**

Seeds are not moved once the draw has been made; provided, however, that the draw is remade if the two (2) top seeds from the same group withdraw before the schedule is released.

**4. Final Standings of Round Robin Competition**

a. **Treatment of Defaults, Retirements, and Withdrawals**

i. In determining the final standings of each round robin group,

(a) the result of a default or withdrawal for which a Finals Alternate or Finals Alternate Team is unavailable to replace the defaulting or withdrawing player or team is a straight-set win or loss.

**PLAYERS**  
**SECTION VI - WTA FINALS**

- (b) the result of a default or retirement for which the defaulting or retiring player or team has won a set is two (2) sets won and one (1) set lost for the advancing player or team, but games won or lost in such matches do not count in calculating the percentage of games won.
  - ii. A player or team who retires during a round robin match because of illness or injury may continue in the competition if the Tournament Physician approves.
  - iii. A player or team who withdraws from any round robin match is eliminated from the competition and a Finals Alternate or Finals Alternate Team will replace her or them. If no Finals Alternate or Finals Alternate Team is available as a replacement, the non-withdrawing player or team in such match receives a walkover win for such match.
- b. Final Standings

The first of the following methods that applies determines the final standings of each group in the round robin competition:

- i. Greatest number of wins; then
- ii. Greatest number of matches played; then
- iii. Head-to-head results if only two (2) players or teams are tied; or
- iv. If three (3) players or teams are tied:
  - (a) Highest percentage of sets won (the doubles match tie-break counts as one (1) set); if after the calculation two (2) players or teams remain tied, head-to-head results; then
  - (b) If after applying (a) all three (3) players or teams remain tied, a player or team completing less than all three (3) round robin matches is automatically eliminated; if two (2) players or teams remain tied, head-to-head results; then
  - (c) If after applying (a) and (b) all three (3) players or teams remain tied, highest percentage of games won (the doubles match tie-break counts as one (1) game); if after the calculation two (2) players or teams remain tied, head-to-head results; then

**PLAYERS**  
**SECTION VI - WTA FINALS**

(d) If after applying (a), (b), and (c) all three (3) players or teams remain tied, the Race to the Finals Leaderboard.

c. Semifinal Seeding

The winners of Group A and B are placed on lines 1 and 4, respectively. The runners-up of Group A and B are placed on lines 3 and 2, respectively.

**5. Semifinal/Final Withdrawal**

a. Match Format after Withdrawal

i. Semifinals

On the day of the semifinals, the third player and team in the final standings of each round robin group must be on site and ready to replace a semifinalist from her or their round robin group if that semifinalist is unable to play.

A replacement player or team in the semifinals is eligible to advance in the competition.

ii. Finals

On the day of the finals, each losing semifinalist player and team must be on site and ready to play an exhibition match if her/their opponent in the semifinals withdraws from the finals.

If any player or team withdraws from the finals, the remaining finalist must play the exhibition match or the finalist also will be subject to the forfeiture of prize money for withdrawing in accordance with sub-section c below. Any match with any replacement player or team is a best of three (3) sets exhibition with No-Ad scoring in the first two (2) sets and a 10-point match tie-break as the third set.

b. Penalty

i. Semifinals

If a Finals Singles or Doubles Qualified Player who is required to be on site and ready to replace a withdrawing semifinalist is not on site and ready to play, she must pay a fine of 50% of the prize money she earns at the WTA Finals.

**PLAYERS**  
**SECTION VI - WTA FINALS**

ii. Finals

If a Finals Singles or Doubles Qualified Player who is required to be on site and ready to play an exhibition match for a withdrawing finalist is not on site and ready to play, she must pay a fine of 50% of the prize money she earns at the WTA Finals.

c. Prize Money

If a player or team withdraws from the finals, she or they forfeit(s) the following amount of prize money to which she or they otherwise would have been entitled for reaching the finals:

<b>Prize Money Forfeited</b>	
<b>Competition</b>	<b>Finals</b>
Singles	\$100,000
Doubles	\$25,000 (per player)

Forfeited prize money will be paid to the replacement player or team.

**6. Scoring**

The singles competition is the best of three (3) tie-break sets. The doubles competition is the best of three (3) sets with No-Ad scoring in the first two (2) sets and a 10-point match tie-break as the third set.

**7. Ranking Points**

The ranking points that a Finals Singles Qualified Player earns at the WTA Finals count as a bonus Tournament in calculating her WTA Ranking (her WTA Ranking includes nineteen (19) Tournaments).

The ranking points that a Finals Doubles Qualified Player earns at the WTA Finals count towards her WTA Ranking if they are part of her best twelve (12) results.

The WTA Finals ranking points for the singles and doubles competitions are 200 points for each round robin win, 400 points for a semifinal win, and 500 points for the final win, as summarized below:

**PLAYERS**  
**SECTION VI - WTA FINALS**

	<b>Wins</b>	<b>Losses</b>	<b>Points</b>
<b>Winner</b>			1500*
<b>Finalist</b>			1000*
<b>Semifinalist</b>			600*
<b>Round Robin</b>	3	0	600
<b>Round Robin</b>	2	1	400
<b>Round Robin</b>	2	0	400
<b>Round Robin</b>	1	2	200
<b>Round Robin</b>	1	1	200
<b>Round Robin</b>	1	0	200
<b>Round Robin</b>	0	3	0
<b>Round Robin</b>	0	2	0
<b>Round Robin</b>	0	1	0

\*If undefeated.

## 8. Media Requirements

At the WTA Finals, players are responsible for all of the standard media, sponsor, and promotional activities in Section VII of this Rulebook, including but not limited to ACES commitments, plus the following media, sponsor, and promotional activities:

### a. Media before the WTA Finals

On or around September 15 of each Tour Year, the WTA will designate four (4) players who are required to participate in a full media day before the WTA Finals. The WTA and each player will agree on the date of her media day. The WTA may designate as many as six (6) additional players who are required to participate in a media activity such as a conference call, internet chat, interview, or similar activity. While these media days and activities are not part of a player's ACES requirements, a player who fails to participate in these media days or activities must pay a fine in accordance with the ACES Program in Section VII.A.6 of this Rulebook.

### b. Media Session on the Day Prior to the Start of Play

As part of their ACES commitments, all Finals Singles and Doubles Qualified Players are required to participate in a media availability session for a maximum of one and one half (1.5) hours on the day prior to the start of play.

### c. Mandatory non-ACES Commitments in addition to ACES



**PLAYERS**  
**SECTION VI - WTA FINALS**

commitments:

- i. All Finals Singles and Doubles Qualified Players must attend and participate in their respective WTA Finals official draw ceremonies and official WTA Finals photo opportunities;
  - ii. All Finals Singles and Doubles Qualified Players must attend the WTA Finals party if required to be in the WTA Finals city on the day of such party;
  - iii. All singles and doubles competition finalists must attend media and sponsor functions immediately following and during the evening after their finals; and
  - iv. The singles and doubles competition winners must attend media and sponsor functions on the day following their victories for a minimum of three (3) hours.
- d. Fines

Any player who does not attend and participate in each mandatory activity in Sections VI.B.8.b and c above must pay a fine of \$20,000 for each mandatory activity she misses. A player may appeal any such fine no later than twenty-one (21) days after receiving notice of such fine.

# PLAYERS

## VII. PLAYER RESPONSIBILITIES/ON-COURT RULES AND PROCEDURES

### A. ACES PROGRAM

All ACES must comply with the WTA Betting, Fantasy & Gambling Sponsorship Rules.

#### 1. Responsibilities

All Main Draw singles and doubles players must make themselves available for media/sponsor/WTA-related activities at each Tournament (“ACES”), including any activities involving Tournament or WTA sponsors that conflict with players’ personal sponsors unless, in WTA’s reasonable discretion, the players’ participation in such activities will jeopardize their relationships with their personal sponsors. All ACES shall be arranged by the WTA’s Communications and Marketing Departments.

#### 2. ACES Commitments

Except at the WTA Finals, a player will have fulfilled her total ACES commitment at each Tournament when she completes the first of either (a) three (3) hours of ACES or (b) four (4) full ACES. A Player will have fulfilled her total ACES commitment at the WTA Finals when she completes four (4) full ACES.

#### 3. Division/Usage of ACES

The division and usage of ACES shall be as follows:

- a. 50% for use by, and to be decided upon, by each individual Tournament; and
- b. 50% for use by, and to be decided upon, by the WTA; it being understood that at the WTA Finals, WTA 1000 Mandatory, and WTA 500 Tournaments, Pre-Tournament Media Availability shall count towards the WTA’s ACES allotment.

For any player who is required to perform an odd number of ACES (e.g., three (3) activities), the WTA and Tournament shall mutually agree upon the best use of the remaining ACE after utilizing all other ACES per the formula described above.

## PLAYERS

### SECTION VII - PLAYER RESPONSIBILITIES/ON-COURT RULES AND PROCEDURES

#### 4. Planning

##### a. WTA Responsibility

- i. All ACES must be organized through the WTA Communications Department. If a Tournament arranges activities directly with a player, agent, or coach the activities are not enforceable under the ACES Program.
- ii. To maximize the effectiveness of the ACES Program and to make the best use of player time, the WTA shall:
  - (a) Develop a list of “high impact” and “low impact” activities, in consultation with the Tournaments and players; and
  - (b) Develop a list of player activity preferences, in consultation with players.

The WTA and the Tournaments then shall seek to customize activities to match up with such preferences where possible.

##### b. Tournament Responsibility

##### i. Requirements

Tournaments are required to designate an ACES manager to coordinate the ACES Program with the WTA Communications Department and must:

- (a) Submit an ACES planning form at least six (6) months before the start of their Tournaments to share information regarding ACES preparations;
- (b) Submit final ACES Program requests and information regarding contractual appearances at least three (3) weeks before the start of their Tournaments; and
- (c) Execute ACES at a quality commensurate with the level of Tournament (factors to determine quality of execution may include but are not limited to: reasonable scheduling; appropriate transportation; adequate security; suitable staff; and applicable provision of equipment or supplies).

## PLAYERS

### SECTION VII - PLAYER RESPONSIBILITIES/ON-COURT RULES AND PROCEDURES

#### ii. Penalties

Tournaments failing to comply with the scheduling requirements in (a) and (b) above (i) will be fined according to the following chart and (ii) will not be guaranteed player participation in Tournament-related ACES.

<b>Tournament Category</b>	<b>ACES Planning Form Only</b>	<b>Final ACES Requests Only</b>	<b>ACES Planning Form and Final ACES Requests</b>
WTA 1000 Mandatory	\$2,500	\$5,000	\$10,000
WTA 500	\$1,500	\$3,000	\$6,000
WTA 250	\$1,000	\$2,000	\$4,000
WTA 125	\$500	\$1,000	\$2,000

Tournaments failing to comply with the quality standards in (c) above will be fined according to the following chart for each non-compliant ACE.

<b>Tournament Category</b>	<b>ACES Quality Standards</b>
WTA 1000 Mandatory	\$2,500
WTA 500	\$1,500
WTA 250	\$1,000
WTA 125	\$500

#### c. Player Responsibility

Previously scheduled personal player sponsor commitments cannot override WTA-designated mandatory activities, provided the player has been notified of the mandatory activities at least one (1) week in advance.

- i. Unless otherwise designated by the WTA, all players receiving byes must be available for ACES in the Tournament city by 12:00 p.m. Tournament local time on the first day of the Main Draw for Pre-Tournament Media Availability and any other ACES scheduled at the Tournament on the first day of the Main Draw.
- ii. Finalists from the immediately preceding Tournament will be expected to participate in Pre-Tournament Media Availability at a rescheduled time, as determined by the WTA Communications Department. If a player cannot be in attendance on Monday, she must arrange with the WTA and the Tournament, prior

## PLAYERS

### SECTION VII - PLAYER RESPONSIBILITIES/ON-COURT RULES AND PROCEDURES

to the Tournament, acceptable alternative measures to help the WTA and Tournament with promotion either before the Tournament or once she arrives. Expenses associated with such appearances or activities, such as player travel if necessary, are the responsibility of the Tournament.

#### 5. Mandatory and Optional ACES

##### a. Mandatory Activities

When a Communications Manager, in consultation with the Tournament, requests one (1) of the following activities, it shall be considered mandatory by the WTA for all WTA Tournaments, the WTA Finals, and Grand Slams.

##### i. Pre-Tournament Media Availability

###### (a) Definition

All players, when requested, are required to participate for up to ninety (90) minutes in Pre-Tournament Media Availability consisting of any combination of the following media activities:

- (i) Press conference or roundtable;
- (ii) Host broadcaster television interview;
- (iii) Home broadcaster television interview;
- (iv) WTA Newsfeed interview;
- (v) Tournament social media interview or video appearance;
- (vi) Local radio or television interview;
- (vii) One-on-one interview; and
- (viii) Autograph session.

###### (b) WTA Finals

All players will be required to participate in Pre-Tournament Media Availability.

## PLAYERS

### SECTION VII - PLAYER RESPONSIBILITIES/ON-COURT RULES AND PROCEDURES

#### (c) WTA 1000 Mandatory and WTA 500 Tournaments

Any player requested for Pre-Tournament Media Availability must participate; provided, however, that such players will not be required to participate in Pre-Tournament Media Availability on a day in which they are scheduled to play a singles match.

#### ii. Tournament/WTA Sponsor Autograph Sessions and Hospitality Visits

All players shall be required, if requested, to participate in hospitality visits, autograph sessions, or other similar sponsor-related activities.

#### iii. Satellite TV/Radio Tours

All players shall be required, if requested, to participate in satellite television and radio tours.

#### iv. One-on-One Interviews

All players shall be required, if requested, to conduct a minimum of six (6) one-on-one interviews per Tour Year (in addition to Pre-Tournament Media Availability). One (1) of the one-on-one media interviews shall be designated by the WTA, and the remaining five (5) shall be jointly agreed upon by the WTA and the player.

#### v. Photo Opportunities

All players shall be required, if requested, to participate in a minimum of two (2) photo opportunities per Tour Year. Each such photo opportunity shall be jointly agreed upon by the WTA and the player.

#### vi. Sponsor/WTA Special Events and WTA Awards Ceremony

All players shall be required, if requested, to participate in a minimum of two (2) sponsor/WTA special events, including the WTA Awards Ceremony, per Tour Year. The WTA shall provide at least sixty (60) days' notice of the date and location of any sponsor/WTA special event.

## PLAYERS

### SECTION VII - PLAYER RESPONSIBILITIES/ON-COURT RULES AND PROCEDURES

#### vii. Home Country Media/Sponsor Activity

All players are required, if requested, to participate in a minimum of two (2) media/sponsor activities for the WTA's title sponsor in or for such player's home country market media per Tour Year.

#### viii. Green Screen Sessions

All players are required, if requested, to participate in a minimum of two (2) short-form content capture green screen sessions per Tour Year, not to exceed thirty (30) minutes per session.

#### ix. Photo Shoots

All players are required, if requested, to participate in the annual WTA photo shoot each Tour Year, not to exceed two (2) hours.

#### x. Special Events

During the year, the WTA may also designate other activities as mandatory, including, but not limited to:

- (a) Tournament special dedication ceremonies or events;
- (b) Sponsor and WTA-related off-court activities, such as award ceremonies, player parties, and sponsor special events; and
- (c) Marketing and publicity activities for the WTA or WTA sponsors; however, each such marketing or publicity activity at a Tournament shall not exceed one (1) hour.

#### b. Optional Activities

All other WTA and Tournament ACES requests made of players shall be considered optional activities. Such activities include, but are not limited to:

- i. One-on-one print, television, and radio media interviews and open photo shoots above the minimum required under mandatory activities; and
- ii. Publicity events and charity activities (i.e., hospital visits, celebrity photo opportunities).

Players have the right to decline any of these requests as long as they fulfill their required ACES commitment via other ACES opportunities.

## PLAYERS

### SECTION VII - PLAYER RESPONSIBILITIES/ON-COURT RULES AND PROCEDURES

For those players who have not fulfilled their ACES commitment, they must agree to at least one (1) out of every three (3) of the optional activities which are proposed by the WTA or a Tournament.

Once a player has committed to an optional event, it becomes an “arranged activity” and falls under the same requirements as mandatory activities.

When possible, players will be notified by letter or email of all confirmed requests surrounding a given Tournament no later than one (1) week prior to the Tournament. Please note that due to unknown play schedules, requests may continue to arise during the Tournament.

#### 6. ACES Fines

##### a. Issuing of Fines

A player will be fined if she: (i) fails to fulfill the total ACES commitment; (ii) fails to appear for a mandatory or arranged activity; or (iii) is materially late to a mandatory or arranged activity.

Each ACES violation will result in a separate fine.

##### b. Fine Procedure

###### i. Notification of Supervisor

In the event a fine is to be issued, the appropriate Communications Manager will notify the on-site Supervisor and supply the necessary documentation and details.

###### ii. Notification of Player

The player will then be issued a fine notice by the Supervisor. The fine will be deducted from the player's prize money at the current Tournament or next appropriate Tournament.

##### c. Fine Schedule for Singles Players

ACES fines are based on the player's WTA Singles Ranking at the entry deadline. In each instance, fines shall be issued in accordance with the following:



## PLAYERS

### SECTION VII - PLAYER RESPONSIBILITIES/ON-COURT RULES AND PROCEDURES

Player Ranking at Entry Deadline	1st and 2nd Offenses (per Tour Year)	3rd and Subsequent Offenses (per Tour Year)
1-10	\$2,500	\$5,000
11-25	\$2,000	\$4,000
26-50	\$1,500	\$3,000
51-100	\$1,000	\$2,000
101+	\$500	\$1,000

The ACES fine at WTA 125 Tournaments shall be \$500 per violation.

d. Fines for Doubles Players

Fines for doubles players will be based on the player's WTA Doubles Ranking. The amount of the fine shall be 50% of the singles fine set out above.

The ACES fine for a doubles player at WTA 125 Tournaments shall be \$250 per violation.

## 7. Exceptions

Players who do not appear for, or are materially late to, mandatory or arranged activities will be exempt from ACES fines under the following circumstances with appropriate notice:

- a. Schedule of play change creates timing conflict; it being understood that practice time is not an excusable absence.
- b. Player has been eliminated from singles and doubles, if applicable, at the Tournament, her ACES were scheduled for more than twenty-four (24) hours after her elimination from the Tournament, and she has left the event market.
- c. Withdrawal from Tournament due to injury or illness; it being understood that if the WTA Communications Department determines that a commitment is still achievable in the event market or via telephone at the present Tournament, or where feasible, in person at the player's next scheduled Tournament (in addition to that Tournament's ACES), then the player is expected to fulfill the commitment during such Tournament, or in person at the player's next scheduled Tournament. In no event will a player be required to remain in an event market for more than twenty-four (24) hours after she withdraws in order to fulfill any ACES requirements.

## **PLAYERS**

### **SECTION VII - PLAYER RESPONSIBILITIES/ON-COURT RULES AND PROCEDURES**

- d. Extenuating circumstances including delayed or cancelled flights; it being understood that every attempt must be made to reschedule commitments upon arrival.
- e. Failure of the Communications staff or a Tournament to provide reasonable notice of a mandatory activity.

#### **8. Appeals**

Players may appeal ACES fines to the Code of Conduct Committee. All fine appeals must be filed within twenty-one (21) days from the date of notice.

#### **9. ACES Rewards Program**

In recognition of players' ACES commitment, the WTA shall present a year-end award to the player who has demonstrated the greatest commitment to the ACES Program for the Tour Year. The WTA shall determine which player is selected based on a points system throughout the Tour Year.

#### **10. Non-ACES Program Mandatory Activities**

It is understood and agreed that players are required to perform additional non-ACES Program mandatory activities as set forth in this Rulebook, including but not limited to activities set forth in Media/Sponsor/Public Relations Responsibilities below and in Section VI.B.8 - Media Requirements at the WTA Finals.

### **B. MEDIA/SPONSOR/PUBLIC RELATIONS RESPONSIBILITIES**

#### **1. Additional Player Responsibilities Beyond ACES**

In addition to ACES requirements, all Main Draw singles and doubles players must make themselves available for the activities set forth in sub-Sections a through e below, including any activities involving Tournament or WTA sponsors that conflict with players' personal sponsors unless, in WTA's reasonable discretion, the players' participation in such activities will jeopardize their relationships with their personal sponsors.

- a. Pre-Match Interview

Players are required to conduct one (1) pre-match host broadcaster television interview, which shall be coordinated by the WTA. Such interview shall be no more than three (3) minutes in length and shall

## PLAYERS

### SECTION VII - PLAYER RESPONSIBILITIES/ON-COURT RULES AND PROCEDURES

be conducted prior to the start of the match at one (1) of the following locations:

- i. The on-court entrance;
  - ii. The practice courts; or
  - iii. A mobile location convenient to the player.
- b. Post-Match Media Activities

i. Scope

Players are required to be available for at least twenty (20) minutes but no more than sixty (60) minutes to participate in post-match media activities, win or lose, which may include any combination of the following:

- (a) One (1) post-match press conference;
- (b) One (1) host broadcaster television interview;
- (c) One (1) WTA Newsfeed interview ;
- (d) One (1) home broadcaster interview;
- (e) One (1) host broadcaster studio visit per week, if requested;
- (f) One (1) sponsor meet and greet session, if requested, if a player wins a match on a main stadium court, except the last evening match of a day; and
- (g) One (1) radio interview; provided however, that if a player has fulfilled the other media activities in (a)-(e) and (f), if applicable, above, the radio interview is optional.

ii. Timing

A player is required to begin her singles or doubles post-match media activities within sixty (60) minutes following her match, except if:

- (a) She is given an extension by a member of the WTA Communications staff;

## PLAYERS

### SECTION VII - PLAYER RESPONSIBILITIES/ON-COURT RULES AND PROCEDURES

- (b) She is scheduled for another match within one (1) hour following her first match, in which case she must complete her post-match media activities after the completion of both matches; or
- (c) She is scheduled to play two (2) matches, singles or doubles, on the same day.

In this case, or under extenuating circumstances, as determined by the WTA staff, a player may choose to do the required media activities immediately following her second match. However, if a player elects to do the required media activities immediately following her second match, she must provide a statement and/or quotes for the media within sixty (60) minutes following the completion of the first match. In addition, if the player's second match is held overnight (due to darkness, rain, or other reasons), the player shall be obligated to conduct the required media activities that evening, if requested.

In any event, if a player is scheduled in the doubles and/or the singles semifinal or final, she will be required to do fifteen (15) minutes of post-match media activities following the singles semifinal or final (win or lose) and prior to the doubles (or vice versa depending on the match order).

#### c. WTA Content Feature

All players are required, if requested, to participate in a minimum of two (2) WTA-driven content features per Tour Year.

#### d. Practices

Players shall be required to allow filming of their on-site practices by photo and broadcast media, provided such media remain off court.

#### e. WTA Public Relations and Charity Programs

Players are asked for their best efforts to participate in such programs, unless designated as mandatory under the ACES Program.

#### f. Player Media/Sponsor/PR Responsibility Fines

Failure to comply with the requirements in sub-Sections a through e above will result in the following fines.

## PLAYERS

### SECTION VII - PLAYER RESPONSIBILITIES/ON-COURT RULES AND PROCEDURES

#### i. Fine Schedule for Singles Players

Player media/sponsor/PR responsibility fines are based on the player's WTA Singles Ranking at the entry deadline. In each instance, fines shall be issued in accordance with the following:

Player Ranking at Entry Deadline	1st and 2nd Offenses	3rd and Subsequent Offenses
1-10	\$2,500	\$5,000
11-25	\$2,000	\$4,000
26-50	\$1,500	\$3,000
51-100	\$1,000	\$2,000
101+	\$500	\$1,000

The player media/sponsor/PR responsibility fine at WTA 125 Tournaments shall be \$500 per violation.

#### ii. Fines for Doubles Players

Fines for doubles players will be based on the player's WTA Doubles Ranking. The amount of the fine shall be 50% of the singles fine set out above.

The player media/sponsor/PR responsibility fine at WTA 125 Tournaments shall be \$250 per violation.

## 2. Marketing Activity

#### a. Requirement

All players are required, if requested, to participate in one (1) activity per Tour Year (not to exceed five (5) hours, including travel time) for major marketing or publicity purposes for the WTA or a WTA sponsor that takes place in or around a Tournament in which a player is entered or at such other mutually-agreeable date and location, subject to the following restrictions:

- i. The five (5) hours must be within a single eight (8)-hour period, unless otherwise approved by the player;
- ii. The activity must be in conjunction with the promotion of the WTA and/or Tournaments;
- iii. The activity cannot involve a WTA sponsor that is in category conflict with an existing player sponsor;

## PLAYERS

### SECTION VII - PLAYER RESPONSIBILITIES/ON-COURT RULES AND PROCEDURES

- iv. The activity cannot constitute a direct individual endorsement by the player of a commercial product;
  - v. The player must be given the opportunity to select the activity photographs to be used; and
  - vi. For activities involving player photography, where the WTA can clear the rights without expense, players shall be permitted to utilize photographs for non-commercial purposes on their personal websites and in player promotional materials, following a possible hold-back period set by the WTA. In no event shall a player utilize the photographs in conjunction with a sponsor or third-party activity or allow a sponsor or other third party to utilize the photographs.
- b. Procedures
- i. For activities scheduled at a WTA Tournament, the player shall not be required to play her first match until the second day after the scheduled activity.
  - ii. The player shall be provided with a minimum of thirty (30) days' notice, unless the player agrees to less notice.
  - iii. Notice to the player shall include a description of the marketing activity, including current creative plans, an approximation of the total time commitment (within the restrictions set out above), and a description of the purpose and proposed use of the resulting creative.
  - iv. Where appropriate, the WTA shall utilize professional stylists to prepare players for the activity.
  - v. If the activity occurs at a Tournament, it will count as one (1) ACE. If a player is required to travel solely to perform the activity, the WTA will book and pay for her travel arrangements, including airline, hotel, and ground transportation, as applicable.
- c. Fines

A player failing or refusing to perform a marketing activity will be fined in accordance with the following chart:

# PLAYERS

## SECTION VII - PLAYER RESPONSIBILITIES/ON-COURT RULES AND PROCEDURES

Player Ranking at Time of Notification of the Activity	Fine Amount
1-10	\$50,000
11-25	\$20,000
26-50	\$15,000
51-100	\$10,000
101+	\$5,000

### 3. Media Responsibilities of Grand Slam Participants

See the Grand Slam Rulebook for Media Responsibilities related to the Grand Slams.

### 4. WTA Finals Media Responsibilities

See Section VI.B.8 - Media Requirements at the WTA Finals.

### 5. Player Responsibilities Upon Withdrawal or Retirement

Upon a player's withdrawal or retirement from a Tournament, she is required to submit a statement containing the reason for the withdrawal or retirement and a suitable quotation that the WTA may release to the media and public in accordance with Section IV.A.1.c.

Upon a player's on-site withdrawal, she also is required to participate in one (1) post-withdrawal activity prior to leaving the Tournament city in accordance with Section IV.A.2.a.ii.

### 6. Tournament Payment for Additional Services

Tournaments are responsible for player fees for media/sponsor/promotional services rendered in addition to the above detailed player responsibilities. The fee shall be determined based upon the value of a given player in a given market.

### 7. WTA Commercial Rights, Promotions, and Endorsements

- a. Player Group Licensing Rights - WTA Title/Presenting/Premier Sponsor

Each player who participates on the WTA agrees that the WTA Tour, WTA title/presenting/premier sponsor, and WTA Tournaments may use or grant to others the right to use her name, photograph, likeness,

## PLAYERS

### SECTION VII - PLAYER RESPONSIBILITIES/ON-COURT RULES AND PROCEDURES

signature, voice, picture, and/or biographical information (collectively, "Player Likeness"), alone or in conjunction with the name, photograph, likeness, signature, voice, picture, and/or biographical information of others, for the purpose of promoting the WTA in newspapers, magazines, motion pictures, programs, player and tournament yearbooks, broadcasts and telecasts, educational materials, and all other publicity and promotional materials and media, including publicity and promotion in connection with a commercial product, as long as such publicity and promotion in connection with a commercial product is directly related to the publicity and promotion of the WTA or WTA Tournaments and does not constitute a direct individual endorsement of such commercial product.

WTA title/presenting/premier sponsor shall utilize a minimum of three (3) players or a series of three (3) players in each use.

#### b. Player Group Licensing Rights - Other WTA Sponsors

Except in the categories of tennis apparel, tennis shoes, and tennis equipment (i.e., racquets, racquet bags, grips, strings, and balls), the WTA shall have the right to enter into sponsorship contracts in which a non-title/presenting/premier sponsor ("GLA Sponsor") is granted the right to use any Player Likeness for the purpose of promoting the WTA, including publicity and promotion in connection with a commercial product, so long as such publicity and promotion of a commercial product is directly related to the publicity and promotion of the WTA or a WTA Tournament and does not constitute a direct or implied individual endorsement of any commercial product ("Group Licensing Authorization" or "GLA") subject to the following:

- i. The GLA Sponsor must use a minimum of five (5) players in each use.
- ii. Absent approval from an individual player, her Player Likeness shall not be used in advertising materials by (a) more than three (3) GLA Sponsors in a single calendar year; and/or (b) more than 50% of the WTA sponsorships. For the purposes of this section, a WTA title/presenting/premier sponsor shall be counted in calculating the total number of sponsorships but shall not be counted in calculating the number of WTA sponsorships in which a player is being used. Any GLA Sponsors existing as of December 31, 2010, shall be grandfathered from the restriction in sub-Section (b); however, no new GLA Sponsors will be permitted to utilize an individual Player Likeness in violation of sub-Sections (a) or (b).



## PLAYERS

### SECTION VII - PLAYER RESPONSIBILITIES/ON-COURT RULES AND PROCEDURES

- iii. No later than October 1 of each year, each player will advise the WTA in writing of the categories in which the player has a personal, exclusive sponsorship or endorsement contract for the following calendar year. The player shall make the contract available to the WTA upon request on a confidential basis. Provided the player has a binding contract or bona fide written and detailed letter of intent, term sheet, or offer letter, as determined in good faith by the WTA, the Player Likeness for that player shall be unavailable to GLA Sponsors for the specified category or categories for the following calendar year (starting on January 1). For letters of intent, term sheets, and offer letters, the player shall promptly notify the WTA when a binding contract has been finalized or negotiations have ceased.
- iv. Players shall be notified in writing by the WTA when included in a GLA ("GLA Notice").
- v. A player who has entered into an agreement after October 31 but before receiving a GLA Notice can enter into an exclusive deal with a conflicting sponsor. Once a player receives a GLA Notice, she can non-exclusively enter into an agreement with a conflicting sponsor for the balance of the current opt out year and may subsequently maintain the sponsorship on an exclusive basis after the end of the opt out year.
- vi. GLA Sponsors shall be required to make reasonable efforts to cease distribution of promotional materials featuring opt-out players within thirty (30) days following the start of the opt-out year.
- vii. For each GLA Sponsor contract entered into after September 1, 2010, 25% of any financial consideration (specifically excluding barter) paid by or on behalf of the GLA Sponsor under the contract shall be paid to the WTBA, which shall distribute or otherwise use such proceeds for the benefit of the players. This percentage reflects an aggregate allocation for player GLA rights, and shall not vary depending upon the particular rights granted under any individual GLA Sponsor contract. Any payments made to individual players by a GLA Sponsor, under the sponsorship contract or any individual contract the GLA Sponsor may otherwise have with the player, are separate from and shall not be included as part of this calculation.
- viii. Any player preventing a GLA Sponsor from utilizing her Player Likeness for any reason other than a conflicting sponsorship under sub-Section v above, shall annually be issued a fine

## PLAYERS

### SECTION VII - PLAYER RESPONSIBILITIES/ON-COURT RULES AND PROCEDURES

equal to the payment such player would have received under sub-Section vii above. Players that are subsequently utilized in advertising materials by such GLA Sponsor shall be entitled to compensation in accordance with sub-Section vii above.

- ix. Any action by WTBA members, not including the exercise of any opt-out rights hereunder, that results in an inability of the WTBA to timely provide all or a portion of the GLA Sponsor benefits described in this provision, shall result in a reduced WTBA payment, proportionate to such reduction of GLA Sponsor benefits. Before the WTBA payment is reduced, the WTA shall make efforts to allow the failure to be cured.
  - x. Approval of the Board of Directors shall be required for any WTA non-title/presenting/premier sponsorship contract which (a) includes player GLA rights; and/or (b) deviates from the requirements of this provision.
  - xi. GLA rights shall be limited to existing player photography. As such, player participation in photography or video shoots for GLA Sponsors shall be optional.
  - xii. A GLA Sponsor shall be limited to utilizing player images which have been approved by a player for WTA use. In addition, players shall have approval rights over the use of her images within the GLA Sponsor's advertising materials.
  - xiii. GLA rights covered by this provision do not include any player appearances or other personal services that may be rendered by players under the ACES Program, other Rules, or any personal contractual arrangements a player otherwise may have.
- c. Television Rights

Each player also conveys to the WTA Tour any television rights she may own in all WTA events in which she participates. This includes, but is not limited to, WTA Tournaments, Grand Slams (subject to their prior approval), and the WTA Finals.

### 8. Sponsorship Restrictions

Products that are distasteful or embarrassing to WTA members, including but not limited to tobacco (including electronic cigarettes and similar products), firearms, pornographic material, or similar items shall be prohibited as a player sponsor, without prior approval of the WTA.

# PLAYERS

## SECTION VII - PLAYER RESPONSIBILITIES/ON-COURT RULES AND PROCEDURES

### C. CLOTHING AND EQUIPMENT

#### 1. Definitions

a. Identification

For the purposes of this Section VII.C, “identification” means any sort of identification associated with, or intended to be associated with, a commercial sponsor, a clothing or equipment manufacturer, or any other person or entity, regardless of the trademark registration status of the identification, and shall include any and all forms of writing.

b. Commercial

For the purposes of this Section VII.C, “commercial” means any non-manufacturer of the clothing or equipment in question, including social media usernames, hashtags, and URLs.

c. Manufacturer

For the purpose of this Section VII.C, the “manufacturer” means the entity that distributes, or offers for sale, tennis racquets, clothing, strings, or shoes.

d. Standard Manufacturer Identification

A standard manufacturer identification is a manufacturer identification of a size typically manufactured on the clothing or equipment in question.

e. Player ID

For a tennis clothing collection that includes a player’s name, initials, or other identifier that is solely used for tennis clothing and accessories (“Player ID”), such Player ID may be used interchangeably with the clothing manufacturer identification wherever manufacturer identifications are permitted under this rule.

f. Size Determination

The size limitations of identifications in this section VII.C are ascertained by determining the area of the actual patch or other addition to a player’s clothing without regard to the color of the same. In determining the area, depending on the shape of the patch or other addition, a circle, triangle, or rectangle shall be drawn around the same, and the size of the patch for the purpose of this rule shall be

## PLAYERS

### SECTION VII - PLAYER RESPONSIBILITIES/ON-COURT RULES AND PROCEDURES

the area within the circumference of the circle or the perimeter of the triangle or rectangle as the case may be.

#### 2. General Appearance

A player must present herself in a professional manner and wear appropriate tennis attire, at the discretion of the Supervisor or Referee, during practice, warm-up, and matches. A player may be asked to change if the Supervisor or Referee deems it necessary. Failure to do so may result in default from a Tournament and/or a fine.

A player's clothing and equipment must comply with the appearance and identification provisions contained in this Section C during a match or at any press conference or Tournament ceremony.

#### 3. Clothing, Equipment, and Identification

No identification is permitted on players, their clothing, or equipment on court during a match or at any press conference or Tournament ceremony except as follows:

##### a. Shirts, Sweaters, Jackets

##### i. With Sleeves

Once a player has competed in the first match of her first WTA Tournament in a calendar year with a commercial identification on her shirt front or collar, she may not change commercial brands at any other WTA Tournaments that calendar year unless approved by WTA. No new commercial identification may be added to the shirt front for events following the US Open through the WTA Finals.

##### (a) Front, Collar, Back

Manufacturer or commercial identifications may be placed on the front, collar, and back as follows:

- (i) Two (2) manufacturer or commercial identifications, each not exceeding six (6) square inches (or 39 sq. cm), may be placed on the front or collar; or
- (ii) One (1) manufacturer or commercial identification, which may not exceed six (6) square inches (39 sq. cm), may be placed on the front or collar and one (1) manufacturer identification, not to exceed four (4)

## PLAYERS

### SECTION VII - PLAYER RESPONSIBILITIES/ON-COURT RULES AND PROCEDURES

square inches (26 sq. cm), may be placed on the back.

(b) Sleeves

Two (2) positions, each not exceeding six (6) square inches (39 sq. cm), are available on each sleeve for commercial or manufacturer identifications. A maximum of two (2) identifications may be placed in each position.

(c) Other

A clothing manufacturer identification without the name of the manufacturer or any other writing may be placed once or repeatedly within an area not to exceed 12 square inches (78 sq. cm) in one (1) of the following positions:

(i) On each of the shirt sleeves (which replaces one (1) of the positions available for commercial or manufacturer identifications on each shirt sleeve as described above);  
or

(ii) Down the outer seams (side of torso) of the shirt.

Any player who chooses to have a clothing manufacturer identification appear in either area must wear the WTA or WTA/sponsor patch on her shirt as required in Section VII.C.5, without exception.

ii. Without Sleeves

Once a player has competed in the first match of her first WTA Tournament in a calendar year with a commercial identification on her shirt collar, she may not change commercial brands at any other WTA Tournaments that calendar year unless approved by WTA.

(a) Front, Collar, Back

Manufacturer or commercial identifications may be placed on the front, collar, and back as follows:

(i) Four (4) manufacturer or commercial identifications, each not exceeding six (6) square inches (39 sq. cm), may be placed on the front or collar of the shirt, provided that no more than three (3) identifications may be placed on the front and no more than two (2)

## PLAYERS

### SECTION VII - PLAYER RESPONSIBILITIES/ON-COURT RULES AND PROCEDURES

of the identifications on the front may be commercial identifications; or

- (ii) Three (3) manufacturer or commercial identifications, not exceeding six (6) square inches (39 sq. cm), may be placed on the front or collar and one (1) manufacturer identification, not to exceed four (4) square inches (26 sq. cm), may be placed on the back of the shirt, provided that no more than two (2) of the identifications on the front may be commercial identifications.

(b) Other

A clothing manufacturer identification without the name of the manufacturer or any other writing may be placed once or repeatedly within an area not to exceed 12 square inches (78 sq. cm) down the outer seams (side of torso) of the shirt.

Any player who chooses to have a clothing manufacturer identification appear down the outer seams must wear the WTA or WTA/sponsor patch on her shirt as required in Section VII.C.5, without exception.

iii. Other

A player's name and/or a number may be placed on the back of a shirt (with or without sleeves) with WTA approval in its sole discretion.

b. Skirts, Shorts, or Pants

Manufacturer identifications may be placed on skirts, shorts, or pants as follows:

- i. Two (2) manufacturer identifications only, neither of which exceeding two (2) square inches (13 sq. cm), may be placed on the front or back; or
- ii. One (1) manufacturer identification, which may not exceed four (4) square inches (26 sq. cm), may be placed on the front and one (1) manufacturer identification, which may not exceed four (4) square inches (26 sq. cm), may be placed on the back.

Leggings or compression shorts may be worn without a skirt, dress, or shorts as long as they reach mid-thigh at minimum and comply with the manufacturer identification restrictions above. (For leggings

## PLAYERS

### SECTION VII - PLAYER RESPONSIBILITIES/ON-COURT RULES AND PROCEDURES

or compression shorts worn underneath a skirt, dress, or shorts, see sub-Section d below.)

c. Dress

A dress, for the purposes of permissible identification, is treated as a combination of a skirt and shirt (dividing dress at waist).

d. Undergarments

For tennis undergarments, for compression sleeves, and for leggings or compression shorts worn under a skirt, dress, or shorts, two (2) manufacturer identifications of up to two (2) square inches (13 sq. cm) or one (1) manufacturer identification of up to four (4) square inches (26 sq. cm) may be visible in addition to the manufacturer identifications allowed on the applicable piece of clothing under which the undergarment is worn.

e. Footwear

Standard manufacturer identifications may be placed on each sock and shoe.

i. Grass Court Shoes

In Tournaments played on grass courts, players may wear only shoes with rubber soles and without heels, ribs, or coverings.

Players may wear special grass court shoes only with the express approval of the WTA; such approval will be granted only if the shoes comply with the following specifications:

(a) Diameter

The pimples or studs on the base of the sole are vertical from the outsole and have a maximum top diameter of three (3) millimeters and a minimum top diameter of two (2) millimeters.

(b) Height and Slope

The maximum height of the pimples or studs is two (2) millimeters from the base of the shoe.

## PLAYERS

### SECTION VII - PLAYER RESPONSIBILITIES/ON-COURT RULES AND PROCEDURES

#### (c) Hardness and Maximum Number

The hardness of any pimple or stud is between fifty-five (55) and sixty (60) based on a shore "A" scale. The number of pimples per square inch is no less than fifteen (15) and no more than twenty-eight (28).

No pimples or studs may be visible when the shoe is placed on a flat horizontal surface and viewed vertically. The foxing/side wall can be contoured only in the medial forefoot and medial toe area but only within the following restrictions: the contoured area may begin in the transition area between the outsole and the sidewall but can only extend to a maximum of 1.5 cm up the sidewall as measured from the base of the outsole; and the contoured area must be smooth (not textured or undulating) but can be stepped with no more than five (5) steps, each no more than 1 mm in depth.

Forefoot and heel areas may be separated, but there should be no more than a 2 mm step in the outsole of the shoe.

As an alternative to the above specifications, players may use the special grass court shoes developed, tested, and approved by Wimbledon. Players desiring approval of special grass court shoes for WTA Tournaments must submit a sample shoe to the WTA at least ninety (90) days in advance of the grass court WTA Tournament at which they seek to wear such shoes.

#### ii. Clay Court Shoes

In Tournaments played on clay courts, players must wear tennis shoes generally accepted for play on clay courts or granular surfaces. The Supervisor has the authority to determine that a tennis shoe sole does not conform to such customs and standards and may prohibit its use at any WTA Tournament.

Grass court shoes may not be worn during a match on a clay court.

#### iii. Hard Court Shoes

In Tournaments played on hard courts, players' shoes must not cause damage to the court other than what is expected during the normal course of a match or practice. Damage to a court may be considered as physical or visible, which may include a



## PLAYERS

### SECTION VII - PLAYER RESPONSIBILITIES/ON-COURT RULES AND PROCEDURES

shoe that leaves a mark beyond what is considered acceptable. The Supervisor has the authority to determine that a shoe does not meet these criteria and may prohibit its use at any WTA Tournament.

f. Headwear and Wristbands

i. Commercial Identification

One (1) commercial identification, which may contain writing but may not exceed four (4) square inches (or 26 sq. cm), may be placed over the ear on the side of the headwear.

Once a player has competed in the first match of her first WTA Tournament in a calendar year with a commercial identification on her headwear, she may not change commercial brands at any other WTA Tournaments that calendar year unless approved by WTA.

ii. Manufacturer Identification

One (1) manufacturer identification, which may contain writing but may not exceed four (4) square inches (or 26 sq. cm), may be placed on headwear and wristbands.

g. Racquet

Standard identifications of the manufacturer of the racquet and/or strings are allowed on the racquet and the strings.

h. Bags, Towels, or Other Equipment or Paraphernalia

Standard identifications of the tennis equipment manufacturers, or the WTA Logo, are allowed on each item. In addition, two (2) commercial identifications on one (1) bag, neither of which exceeds six (6) square inches (39 sq. cm), are allowed.

i. Drink Containers

Players may use a reasonably sized drink container on court if the drink container:

- i. has no identifications; or
- ii. has one (1) manufacturer identification not exceeding four

## PLAYERS

### SECTION VII - PLAYER RESPONSIBILITIES/ON-COURT RULES AND PROCEDURES

(4) square inches (26 sq. cm.), provided that the container manufacturer:

- (a) is not a drink manufacturer; or
- (b) is also a drink manufacturer, and
  - (i) is the official drink sponsor of the Tournament; or
  - (ii) is not in the same beverage category as the advertised drink sponsor(s) of the Tournament.

#### j. Electronic Devices

A player is not allowed to use any electronic device from the start of warm-up to the end of the match (including during a toilet/change of attire break, Medical Time-Out, heat rule break, or any pause in play) unless it is approved by the WTA Supervisor/Referee; provided, however, that use of an electronic device is allowed while play is officially suspended. Use of any WTA-approved electronic device and/or ITF-approved Player Analysis Technology is subject to the coaching provisions and penalties in the Code of Conduct (see Section XVII.D.4.a.vii) and the WTA Coaching Rules (see Section XVIII.D) and the ITF Rules of Tennis regarding Coaching (Rule 30) and Player Analysis Technology (Rule 31, Appendix III). If there is a conflict between the WTA Rules and the ITF Rules of Tennis regarding electronic devices and related coaching, the WTA Rules and the decisions of the WTA Supervisor/Referee will control.

#### k. Other Events

Notwithstanding anything to the contrary, the identification by use of the name, emblem, logo, trademark, symbol, or other description of any tennis circuit, series or tennis exhibition, tennis special event or tournament other than the WTA, or any other sport or entertainment property may not appear on the player, her clothing, or her equipment at any WTA Tournament or the WTA Finals unless approved in advance by the WTA.

#### l. Sanctioned Entities

Players are prohibited from wearing or otherwise publicly displaying a Sanctioned Entity's identification on or off court during a WTA Tournament into which her entry has been accepted, whether at the Tournament site or not, or during any other WTA event in which she participates.

# PLAYERS

## SECTION VII - PLAYER RESPONSIBILITIES/ON-COURT RULES AND PROCEDURES

### m. General

All patches must be firmly and professionally attached at all points on the clothing or equipment. Players may not tape over patches.

If the use of any of the permitted identifications above would violate the sponsorship restrictions set forth in Section VII.B.8, the TACP, or any governmental regulation (including with respect to television), then the identification shall be prohibited.

## 4. Penalties

Any player who violates this Section VII.C may be ordered by the Chair Umpire, Referee, or Supervisor to change her attire or equipment immediately. Failure to comply with such an order may result in a fine and/or default from a Tournament.

A player who violates this Section VII.C and is not defaulted is subject to fines up to the following amounts:

Violation	WTA 1000 Mandatory	WTA 500	WTA 250	WTA 125
Unacceptable Attire	\$60,000	\$40,000	\$30,000	\$1,000
Other Event	\$60,000	\$40,000	\$30,000	\$5,000
Commercial Identification	\$60,000	\$40,000	\$30,000	\$2,000
Manufacturer Identification	\$60,000	\$40,000	\$30,000	\$500

\*The maximum fine will double for each consecutive violation during the same calendar year.

Fine appeals must be filed within twenty-one (21) days from the date of notice.

## 5. WTA Patch Rule

### a. Patch Requirement, Placement, and Size

Except as provided in sub-Section b below, each player must wear horizontally the WTA patch that the WTA designates for the entirety of every match she plays at WTA Tournaments in one (1) of the following visible locations:

- i. on the sleeve, chest, or front collar of her shirt or dress, and the WTA patch must be four (4) square inches (26 sq. cm) in size; or

## PLAYERS

### SECTION VII - PLAYER RESPONSIBILITIES/ON-COURT RULES AND PROCEDURES

- ii. on the front or side (over the ear) of her hat, headband, or other acceptable headwear (“headwear”), and the WTA patch must be three (3) square inches (19 sq. cm) in size.

While a player may comply with this Rule by wearing the patch in either location, the WTA prefers that she wear the patch on her shirt. In either location, the player may wear the WTA patch in addition to the maximum allowable number of manufacturer or commercial patches, and the clothing or headwear manufacturer may incorporate the WTA patch into the design and color scheme of the headwear subject to WTA approval of the visibility of the patch. Each player is responsible for having the patch visible and properly adhered to her clothing or headwear for the entirety of her match. WTA staff members are not responsible for delivering patches to players on court but may do so at their discretion.

- b. Exception - Player Clothing Contracts Prohibiting Non-Manufacturer Identification

If a player has a clothing manufacturer contract that prohibits her from wearing any identification other than manufacturer identification in the locations in sub-Sections a.i and a.ii above (or in sub-Section a.ii and the player does not wear headwear consistently during the match), then the WTA may require her to provide benefits commensurate with the value of wearing the patch, including but not limited to:

- i. one (1) or more full days of WTA appearances when the player is not at a Tournament;
- ii. participation in one (1) or more Pro-Ams or clinics when the player is not at a Tournament; or
- iii. appearances/endorsements in one (1) or more WTA advertisements.

In addition, subject to the player’s clothing manufacturer contract, the WTA requests that any player claiming this exception uses reasonable efforts to wear the WTA patch in a less prominent place (e.g., on her shorts, skirt, strap, wristband, etc.). A player’s performance of such benefits does not entitle her to any compensation from the WTA and is in addition to her ACES commitments.

A player claiming this exemption must submit to the WTA written proof of the clothing manufacturer contract to substantiate her claim, which the WTA may accept or reject in its reasonable discretion.

## PLAYERS

### SECTION VII - PLAYER RESPONSIBILITIES/ON-COURT RULES AND PROCEDURES

#### c. Non-Compliance During Matches

If contractually permitted, any player who does not wear a WTA patch throughout a WTA Tournament match also must participate in the WTA identification program, which includes but is not limited to:

- i. wearing the WTA patch on her shirt during post-match press appearances and commitments;
- ii. carrying a WTA-branded water bottle or towel (subject to individual Tournament approval); or
- iii. wearing a headband or hat conforming to the requirements in sub-Section a.ii above onto court before matches and during post-match press appearances and commitments.

#### d. Patch Rule Violations

Violation of any provision of this Rule will subject a player to the following sanctions (which accrue on an annual Tour Year basis):

<b>Violation</b>	<b>Penalty</b>
1st Offense	Official Warning
2nd Offense	\$100
3rd Offense	\$500
4th+ Offense	Fine up to \$25,000 in the WTA's discretion
Not wearing the patch for the duration of the match	\$100 (after 5 warnings)
Violation in any televised match from quarterfinals on, regardless of whether there have been prior violations	Fine up to \$50,000 in the WTA's discretion

Failure to provide the benefits in sub-Section b above will subject a player to the sanctions in the chart above for each match at which she does not wear the patch.

#### e. Appeals

Fine appeals must be filed within twenty-one (21) days after the date of notice.

# PLAYERS

## SECTION VII - PLAYER RESPONSIBILITIES/ON-COURT RULES AND PROCEDURES

### D. TOILET/CHANGE OF ATTIRE BREAKS

A player may request permission to leave the court for a toilet break, a change of attire break, or both, (“Authorized Break”) but for no other reason.

#### 1. Number of Authorized Breaks Allowed

a. Singles

Each player is entitled to a maximum of one (1) Authorized Break per match.

b. Doubles

Each team is entitled to a maximum of two (2) Authorized Breaks per match. If partners leave the court together, it counts as one (1) of the team’s Authorized Breaks.

#### 2. Timing of Breaks

a. A player may take an Authorized Break at the following times only:

Authorized Break	Timing	Time Limit*
Toilet break only	On a set break or before the player’s own service game	3 minutes
Change of attire break only	On a set break	5 Minutes
Change of attire break taken with a toilet break	On a set break	5 Minutes

\*An Authorized Break is timed from when the player enters the toilet or change area to when she leaves the toilet or change area.

b. If a player’s Authorized Break exceeds the allowed time, she will be penalized with back-to-back Time Violations in accordance with Section VII.G.2.a.

c. Breaks taken beyond a player’s or team’s Authorized Break(s) or taken at times other than those permitted for Authorized Breaks (“Additional Breaks”) will be penalized with back-to-back Time Violations in accordance with Section VII.G.2.a if the player or team is not ready to play within the applicable time.

d. Any time a player leaves the court for a toilet break or change of attire break after a warm-up has started, it is considered an Authorized Break or Additional Break, regardless of whether the player’s opponent has left the court.

# PLAYERS

## SECTION VII - PLAYER RESPONSIBILITIES/ON-COURT RULES AND PROCEDURES

- e. A player may not take a toilet break or change of attire break and a Medical Time Out consecutively, unless approved by the Referee/Supervisor.

### 3. Denial of a Player Request

The Referee and/or Supervisor shall have the authority to deny a player permission to leave the court during a match for a toilet break if it is interpreted by the Referee and/or Supervisor as gamesmanship and/or flagrant abuse of the Rules.

### 4. Abuse of Rule

Players will be penalized in accordance with the Point Penalty Schedule for any abuse of this Rule. (See Section XVIII.A.23 - Officials and Officiating; see also Section B.1 of Appendix B - Supervisor.)

## E. WTA MEDICAL RULE

See Section XVIII.B.6 - Medical Procedures.

## F. CODE OF CONDUCT

An on-court code offense, under the Code of Conduct, may be declared by the Chair Umpire acting on his or her own or when instructed by either the Supervisor or Referee.

For full information, see Section XVII - Code of Conduct.

## G. CONTINUOUS PLAY

### 1. Start of Match Violations

A player will receive a warning for her first violation and a \$250 fine for each subsequent violation per Tournament of the following time limits:

Event	Time Limit
Reaching the net for pre-match meeting (time starts when second player reaches her bench/chair after entering the court)	60 seconds
Warm-up (time starts at the conclusion of the pre-match meeting)	4 minutes
Start of play (time starts at the conclusion of warm up)	60 seconds

### 2. In-Match Violations

Monetary fines are not applicable.

## PLAYERS

### SECTION VII - PLAYER RESPONSIBILITIES/ON-COURT RULES AND PROCEDURES

#### a. Time Violation

A player is subject to a Time Violation if she is not ready to play within the following time limits:

<b>Breaks in Play</b>	<b>Time Limit</b>
Between points	25 seconds
Change of ends	90 seconds (120 seconds for TV change of ends)
Set breaks	120 seconds
Heat rule break between 2nd and 3rd singles sets	10 minutes

A serving player will receive a Time Violation warning for the first offense and a Time Violation fault for all subsequent infractions thereafter. A receiving player will receive a Time Violation warning for the first offense and a Time Violation loss of point for all subsequent infractions thereafter.

A player may not receive back-to-back Time Violations, and consecutive delays shall be penalized by a Delay of Game Code Violation (see sub-section b below); except, however, that if a player is late after the ten- (10) minute heat rule break, an Authorized Break, or an Additional Break, then she may receive back-to-back Time Violations and, after she receives a Time Violation warning for the first offense of a match, she will receive a Time Violation loss of point for all subsequent offenses resulting from such break regardless of whether she is the server or receiver.

#### b. Code Violation

A Delay of Game Code Violation shall be assessed in accordance with the Point Penalty Schedule when a violation occurs immediately after (i.e., before the next point is played) a medical treatment or Medical Time-Out (see Section XVIII.B.6.c) or is a result of a refusal to play, not returning to the court within the allowed time (see Sections VII.D.2.b), or a consecutive delay other than those that receive back-to-back Time Violations (see sub-section a above).

## H. HINDRANCE RULE

A hindrance may result from a corrected call by an official or an event on the court that may be ruled involuntary or deliberate. Any continual distraction of regular play, such as grunting, shall be dealt with in accordance with this Section H.



# PLAYERS

## SECTION VII - PLAYER RESPONSIBILITIES/ON-COURT RULES AND PROCEDURES

### 1. Corrected Call

- a. If a call is corrected from “Good” to “Out,” then the point is ended and there is no hindrance.
- b. If a call is corrected from “Out” to “Good,” then a let must be called unless the Chair Umpire determines in his/her sole discretion that the ball was a clear ace or a clear winning shot that the player could not have retrieved. If there is any reasonable possibility that the ball could have been played, then the player must be given the benefit of the doubt.
- c. If a foot fault is called before a serving player hits the ball, then a let must be called.

### 2. Involuntary Hindrance

- a. A let should be called the first time a player has created an involuntary hindrance (e.g., ball falling out of pocket, hat falling off, etc.), and the player should be told that any such hindrance thereafter will be ruled deliberate.
- b. A let should be called if a player is hindered by an event outside of her control (e.g., ball rolling onto the court, paper blowing onto the court, etc.) during play or her service motion.
- c. Noise, “out” calls, or other similar distractions from spectators are not considered a hindrance and the point should stand as played.

### 3. Deliberate Hindrance

Any hindrance caused by a player that is ruled deliberate will result in the loss of a point.

## I. DEFAULTS

### 1. Procedure

- a. The Supervisor may declare a default for either a single violation of the Code of Conduct or pursuant to the Point Penalty Schedule set out in the Code of Conduct.
- b. If no later than the end of the next change of ends the Chair Umpire receives a report of a serious violation that may warrant an immediate default, the Chair Umpire may call the Supervisor to discuss an

## **PLAYERS**

### **SECTION VII - PLAYER RESPONSIBILITIES/ON-COURT RULES AND PROCEDURES**

immediate default. The Supervisor may declare an immediate default for a violation witnessed or not witnessed by the Chair Umpire.

- c. In all cases of default, the Supervisor's decision shall be final and non-appealable.
- d. Except as excluded below, a default assessed for violation of the Code of Conduct by a doubles player shall be assessed against both players on the team.

#### **2. Penalties**

- a. See Defaults under Section XVII.D.8 - Code of Conduct. (Also see Section XVIII.B.5.d - Resumption of Play and Penalties for Rule Violations.)
- b. Any player who is defaulted as per the Code of Conduct shall lose all prize money and ranking points earned for that event at that Tournament, in addition to any or all other fines levied with respect to the offending incident.
- c. In addition, at the Supervisor's discretion, any player who is defaulted (or partner of a doubles player who is defaulted) for a single violation of the Code of Conduct which causes or could have caused an immediate default as per the Code of Conduct may be defaulted from all other events, if any, in that Tournament, except when the offending incident:
  - i. Involves only a violation of the Punctuality or Clothing and Equipment provisions;
  - ii. Results from a medical condition; or
  - iii. Involves a member of a doubles team who did not cause any of the misconduct which resulted in the team being defaulted, in which case, such doubles player shall receive ranking points and prize money from the previous round.

#### **J. FINE APPEALS**

Fine appeals must be filed within twenty-one (21) days from the date of notice.



# WTA RANKING SYSTEM

## VIII. WTA RANKING SYSTEM

### A. GENERAL

#### 1. Description

The worldwide computer rankings for women's Professional Tennis ("WTA Rankings") reflect a player's participation and performance in Tournament play and determine player acceptances and seeding for all Tournaments. The WTA Rankings are computed and published weekly by the WTA from its Florida Office.

All Rules in this Section VIII are subject to the Rules in Section VI regarding the WTA Finals.

#### 2. Eligibility

##### a. Age Requirements

###### i. Players under the age of 14

Players under the age of 14 cannot obtain a WTA Ranking. If a player under the age of 14 plays singles or doubles in a Tournament, that Tournament and the points acquired during play will not be counted for ranking purposes for that player.

###### ii. Players aged 14 through 17

If a player plays singles or doubles in a Tournament that exceeds the number permitted to be played under the Age Eligibility Rule (see Section X.A), that Tournament and the points acquired during play will not be counted for ranking purposes for that player.

##### b. Number of Tournaments

Players must earn (i) ranking points in at least three (3) valid Tournaments, or (ii) a minimum of ten (10) singles ranking points or ten (10) doubles ranking points in one (1) or more valid Tournaments, in order to appear on the WTA Rankings.

**WTA RANKING SYSTEM**  
**SECTION VIII - WTA RANKING SYSTEM**

**3. Processing of Rankings**

- a. WTA 1000 Mandatory, WTA 500, WTA 250, and WTA 125 Tournaments

WTA 1000 Mandatory, WTA 500, WTA 250, and WTA 125 Tournaments are processed on a weekly basis, except that rankings are not processed during two (2)-week events.

- b. WTA Finals

Year-End Rankings are processed immediately after the WTA Finals.

- c. ITF W100, W75, and W50 Events

If an ITF W100, W75, or W50 event is completed by 11:59 p.m. U.S. Eastern time on the Sunday of that week or 11:59 p.m. U.S. Eastern time on the Saturday preceding a Grand Slam event, such Tournament is processed in the current week's rankings.

If the Singles Final only of an ITF W100, W75, or W50 event is not completed by Sunday 11:59 p.m. U.S. Eastern time or Saturday 11:59 p.m. U.S. Eastern time preceding a Grand Slam event, the current week's rankings will include the event results through the semifinals, plus each of the singles finalists will receive finalist points in the current week's rankings. The winner's points will be adjusted in the next rankings.

- d. ITF W35 and W15 Events

ITF W35 and W15 events are processed a minimum of one (1) week following the completion of the tournament.

- e. Points stay valid for 52 weeks from the week in which a Tournament is included in the WTA Rankings totals, except that ranking points a player earns from a WTA Finals drop off upon the Monday after the final WTA Tournament occurring before the start of the following year's WTA Finals.

**WTA RANKING SYSTEM**  
**SECTION VIII - WTA RANKING SYSTEM**

**4. Tournament Results Comprised in Rankings**

a. Singles

i. Tournaments

Subject to the Long-Term Injury Rule and Special Ranking Rule, a player's WTA Singles Ranking is determined by calculating her total ranking points, including any applicable zero (0) ranking point results pursuant to Section II.A, from eighteen (18) Tournament results during a rolling, 52-week period, which must include:

- four (4) Grand Slams;
- six (6) WTA 1000 Mandatory combined/virtually combined Tournaments;
- one (1) WTA 1000 Mandatory Tournament (WTA only);
- best seven (7) results from all WTA 1000 Mandatory, WTA 500, WTA 250, and WTA 125 Tournaments and ITF W15+ events; and
- if she played the WTA Finals, the player's results will be added to her total points as a bonus Tournament.

For each Grand Slam or WTA 1000 Mandatory Tournament that a player is not required to count on her ranking as described below, the number of results from all other Tournaments that count on her ranking is increased by one (1).

(a) Grand Slams and WTA Finals

If a player is accepted into the Main Draw of a Grand Slam or the WTA Finals as a direct acceptance (or would have been a direct acceptance but for a period of ineligibility), as a Qualifier, as a Special Exempt, as a Lucky Loser, or by Special Ranking, her ranking point result (including zero (0) ranking point results) for that Tournament must count on her ranking and remain on her ranking for 52 weeks regardless of whether she participates in that Tournament; provided, however, that if a player enters using her Special Ranking and withdraws before the start of Qualifying, she will not receive a zero (0) ranking point result for that Tournament.

**WTA RANKING SYSTEM**  
**SECTION VIII - WTA RANKING SYSTEM**

If a player is accepted into the Main Draw of a Grand Slam by Wild Card, her ranking point result for that Tournament must count on her ranking only if she participates in that Tournament.

(b) WTA 1000 Mandatory Tournaments

Any zero (0) ranking point results received from a WTA 1000 Mandatory Commitment Tournament must count on a player's ranking and remain on her ranking for 52 weeks unless and until she is meeting her WTA 1000 Mandatory Commitment Tournament requirements for that Tour Year.

(c) WTA 500 Tournaments

Any zero (0) ranking point results received from a WTA 500 Commitment Tournament must count on a player's ranking but are replaced once the player has results from a WTA 500 Tournament the following Tour Year.

ii. Long-Term Injury

(a) Definition

A Long-Term Injury is an absence from play in any form of women's professional tennis, including WTA Tournaments, Grand Slams, Billie Jean King Cup, Women's ITF World Tennis Tour events, and any Exhibition/Non-WTA Event ("Professional Tennis") due to a Medical Condition (as defined in Section IV.A.7.a) for at least eight (8) consecutive weeks within the calendar year, counting from the player's last Tournament played.

(b) Qualification

In order to qualify for a Long-Term Injury, if requested a player must submit a WTA Medical Information Form to WTA Operations, which must be written in English, and completed by an accredited physician, indicating the nature of the Medical Condition and verifying that the player is unable to play for at least eight (8) consecutive weeks.

(c) Application of Zero Ranking Point Results

If a player qualifies for a Long-Term Injury,

**WTA RANKING SYSTEM**  
**SECTION VIII - WTA RANKING SYSTEM**

- (i) she must count on her ranking all applicable zero (0) ranking point results received from Grand Slams and the WTA Finals;
- (ii) she is not required to count on her ranking any zero (0) ranking point results received from WTA 1000 Mandatory Tournaments that occurred during her Long-Term Injury; and
- (iii) such player's WTA 500 Commitment Tournament requirement is:
  - reduced to a maximum of four (4) WTA 500 Commitment Tournaments if her Long-Term Injury is at least eight (8) consecutive weeks but less than sixteen (16) consecutive weeks within the calendar year;
  - reduced to a maximum of two (2) WTA 500 Commitment Tournaments if her Long-Term Injury is at least sixteen (16) consecutive weeks but less than twenty-six (26) consecutive weeks within the calendar year; and
  - reduced to zero (0) WTA 500 Commitment Tournaments if her Long-Term Injury is at least twenty-six (26) consecutive weeks within the calendar year;

provided, however, that if the player does not participate in Professional Tennis after the US Open of a calendar year (Week 36) because of her Long-Term Injury and subsequently participates in Professional Tennis (including Exhibition/Non-WTA Events) before the second Monday after the completion of the WTA Finals of that calendar year (Week 46), then all zero (0) ranking point results she received after the US Open of that calendar year must count on her ranking.

Note: all zero (0) ranking point results will be applied to a player's ranking per the Rules until the player's absence from play reaches eight (8) consecutive weeks and she meets the qualification requirements in sub-Section (b) above, then the zero (0) ranking point results will be replaced or removed as applicable.



**WTA RANKING SYSTEM**  
**SECTION VIII - WTA RANKING SYSTEM**

iii. Lifted Provisional Suspensions

If a player receives a zero (0) ranking point result while provisionally suspended under the Integrity Rules and subsequently the provisional suspension is lifted, then

- (a) she must count on her ranking all applicable zero (0) ranking point results received from Grand Slams; and
- (b) she is not required to count on her ranking any zero (0) ranking point results received from WTA 1000 Mandatory or WTA 500 Tournaments that occurred during her provisional suspension.

b. Doubles

A player's WTA Doubles Ranking is determined by calculating her total points from her best twelve (12) Tournament results during a rolling, 52-week period.

**5. Number of Tournament Ranking Points Awarded**

The following table details the number of ranking points awarded to players by round, including Qualifying, and by Tournament for both singles and doubles play. See Section VI and Appendix K for ranking points awarded at the WTA Finals and United Cup respectively.

**WTA RANKING SYSTEM**  
**SECTION VIII - WTA RANKING SYSTEM**

2024 WTA RANKING POINT CHART												
SINGLES AND DOUBLES RANKING POINTS BY ROUND												
---- Description ----	W	F	SF	QF	R16	R32	R64	R128	QLFR	Q3	Q2	Q1
Grand Slam (128 Singles)	2000	1300	780	430	240	130	70	10	40	30	20	2
Grand Slam (64 Doubles)	2000	1300	780	430	240	130	10	-	-	-	-	-
WTA 1000 (96M, 48Q) (Singles)	1000	650	390	215	120	65	35	10	30	-	20	2
WTA 1000 (56M, 32Q) (Singles)	1000	650	390	215	120	65	10	-	30	-	20	2
WTA 1000 (32/28D) (Doubles)	1000	650	390	215	120	10	-	-	-	-	-	-
WTA 500 (48M, 24Q) (Singles)	500	325	195	108	60	32	1	-	25	-	13	1
WTA 500 (30/28M, 24/16Q) (Singles)	500	325	195	108	60	1	-	-	25	-	13	1
WTA 500 (24D) (Doubles)	500	325	195	108	60	1	-	-	-	-	-	-
WTA 500 (16D) (Doubles)	500	325	195	108	1	-	-	-	-	-	-	-
WTA 250 (32M, 24/16Q) (Singles)	250	163	98	54	30	1	-	-	18	-	12	1
WTA 250 (16D) (Doubles)	250	163	98	54	1	-	-	-	-	-	-	-
WTA 125 (32M, 16Q) (Singles)	125	81	49	27	15	1	-	-	6	-	4	1
WTA 125 (32M, 8Q) (Singles)	125	81	49	27	15	1	-	-	6	-	-	1
WTA 125 (16D) (Doubles)	125	81	49	27	1	-	-	-	-	-	-	-
WTA 125 (8D) (Doubles)	125	81	49	1	-	-	-	-	-	-	-	-
<b>ITF WTT EVENTS</b>												
W100 (32M, 32Q) (Singles)	100	65	39	21	12	1	-	-	5	-	3	-
W100 (48M, 32/24Q) (Singles)	100	65	39	21	12	7	1	-	5	-	3	-
W100 (16D) (Doubles)	100	65	39	21	1	-	-	-	-	-	-	-
W75 (32M, 32Q) (Singles)	75	49	29	16	9	1	-	-	3	-	2	-
W75 (48M, 32/24Q) (Singles)	75	49	29	16	9	5	1	-	3	-	2	-
W75 (16D) (Doubles)	75	49	29	16	1	-	-	-	-	-	-	-
W50 (32M, 32Q) (Singles)	50	33	20	11	6	1	-	-	2	-	1	-
W50 (48M, 32/24Q) (Singles)	50	33	20	11	6	3	1	-	2	-	1	-
W50 (16D) (Doubles)	50	33	20	11	1	-	-	-	-	-	-	-
W35 (32M, 64/48/32/24Q) (Singles)	35	23	14	8	4	-	-	-	1	-	-	-
W35 (48M, 32/24Q) (Singles)	35	23	14	8	4	2	1	-	1	-	-	-
W35 (16D) (Doubles)	35	23	14	8	1	-	-	-	-	-	-	-
W15 (32M, 64/48/32/24Q) (Singles)	15	10	6	3	1	-	-	-	-	-	-	-
W15 (16D) (Doubles)	15	10	6	3	-	-	-	-	-	-	-	-

**WTA RANKING SYSTEM**  
**SECTION VIII - WTA RANKING SYSTEM**

**B. RULES AND PROCEDURES**

**1. Ranking Order**

Players are ranked on the basis of their total ranking points in accordance with Section VIII.A.

**2. Ranking Points Generally**

- a. Players are awarded ranking points for the highest round they reach.
- b. Players who receive Wild Cards receive the same ranking points as any other player.
- c. Qualifiers earn Main Draw ranking points based on the highest round reached in the Main Draw plus the ranking points specified in the Qualifier (QLFR) column on the ranking points table in Section VIII.A.5, except that:
  - i. Qualifiers who have not played a match in the Qualifying Draw and advance to the Main Draw will receive only Main Draw points.
  - ii. Qualifiers who lose in the first round of the Main Draw will receive only Qualifier points.
- d. Lucky Losers earn Main Draw ranking points based on the highest round reached in the Main Draw plus the ranking points earned in Qualifying, unless they lose in the first round of the Main Draw, in which case they receive only the ranking points earned in Qualifying.

**3. Withdrawals, Byes, Walkovers, and Defaults**

- a. Withdrawals
  - i. Singles
    - (a) If a player withdraws or is withdrawn automatically from a Tournament before playing her first match, she will not receive ranking points unless it is a Grand Slam or a Commitment Tournament, in which case she will receive zero (0) points and the Tournament will count on her ranking.
    - (b) If a player withdraws from a Tournament after the start of her first match, she will receive ranking points for reaching

**WTA RANKING SYSTEM**  
**SECTION VIII - WTA RANKING SYSTEM**

the round in which she withdrew, except that a Qualifier who withdraws in the first round of the Main Draw will receive only Qualifier points.

ii. Doubles

- (a) If a team withdraws from a Tournament before playing their first match, they will not receive ranking points.
- (b) If a doubles team withdraws from a Tournament after the start of their first match, they will receive ranking points as follows:
  - (i) the non-withdrawing partner will receive ranking points per the round her partner withdrew; and
  - (ii) the partner causing the withdrawal will receive ranking points from the previous round, unless one of the following apply, in which case the withdrawing partner will receive ranking points per the round she withdrew:
    - the player withdraws/retires from a singles match which was scheduled during the same Tournament;
    - the player is declared unfit to play singles or doubles at the same Tournament;
    - the player also withdraws from playing singles in a Tournament to be held the following week at the time she withdraws from doubles; or
    - the player does not play singles in a tennis event the following week.
  - (iii) The team will receive points per the round they withdrew towards their Final Race Standings.

b. Byes

- i. If a player or team receives one (1) or more consecutive byes and loses her/their first match played, the player or team will receive first round losers' points.
- ii. If a player or team receives one (1) or more consecutive byes and defaults or withdraws from her/their first match, the player or team will not receive ranking points unless it is a WTA

**WTA RANKING SYSTEM**  
**SECTION VIII - WTA RANKING SYSTEM**

1000 Mandatory Tournament, Grand Slam, or Commitment Tournament, in which case she will receive zero (0) points and the Tournament will count on her ranking.

c. Walkovers

- i. If a player or team receives a walkover in the first round, and there is no Alternate or Lucky Loser to take the spot, the player or team will receive ranking points from the round preceding her/their elimination.
- ii. If a player or team receives a walkover in a subsequent round without having yet played a match, the player or team will receive ranking points from the round preceding her/their elimination.
- iii. If a player or team receives a walkover in any round except the first round after having played and won a match, the player or team will receive ranking points for the round reached.

d. Defaults

For any disciplinary default occurring in a Tournament after the match begins,

- i. The advancing player or team will receive ranking points for the round reached; and
- ii. The defaulting player or team will lose all ranking points earned for that event at that Tournament, except that if one member of a doubles team did not cause the default, she will receive ranking points from the previous round.

**4. Tournament Cancellation or Early Termination**

a. Tournament Cancellation Without Play Occurring

If the singles or doubles event of a Tournament is cancelled, and there has been no play, players will not receive any ranking points.

b. Tournament Cancellation After Play Has Begun

If play has commenced and is terminated before the first round is completed, players will not receive any ranking points. However, if the first round has been completed, all players will receive ranking points earned through the last completed round.

**WTA RANKING SYSTEM**  
**SECTION VIII - WTA RANKING SYSTEM**

c. **Tournament Cancellation Without Completion of Finals**

If a Tournament is officially terminated before the finals have been completed, each finalist will receive finalist's ranking points.

**5. Tie-breaking Procedures**

a. **Singles**

When two (2) or more players have the same number of ranking points, the tie for the ranking position will be decided according to the following priorities:

- i. The player with the most combined total points from Grand Slams, WTA 1000 Mandatory Tournaments, and the WTA Finals;
- ii. The player with the most total points from all WTA Tournaments (including the WTA Finals) and Grand Slams;
- iii. The player with the fewest number of Tournaments in a 52-week period (counting any Tournaments for which she received a zero (0) ranking point result); and
- iv. The highest number of points from one (1) Tournament, then if needed, the second highest and so on.

b. **Doubles**

When two (2) or more players have the same number of ranking points, the tie for the ranking position will be decided according to the following priorities:

- i. If two (2) of the players have the same ranking points and they earned their best eleven (11) doubles results in the previous 52-week period as a team, then the players will be tied for the same ranking position based on those best eleven (11) doubles results in that 52-week period;
- ii. The player with the most total points from all WTA and Grand Slam Tournaments, including the WTA Finals;
- iii. The player with the fewest number of Tournaments in a 52-week period; and

**WTA RANKING SYSTEM**  
**SECTION VIII - WTA RANKING SYSTEM**

- iv. The highest number of points from one (1) Tournament, then if needed, the second highest and so on.

If the results of all tie-breaks under a or b are the same, the rank for such players will be considered tied for that ranking position. The WTA Rankings will list the tied players alphabetically, last name followed by first name. If both the first and last names are the same, the players will be listed according to whichever player is encountered first during the ranking process.

## **6. Clarification of Ranking Points Rules and Procedures**

For further information contact:

Cade McLogan  
cmclogan@wtatennis.com

## **C. WTA SPECIAL RANKING RULE**

### **1. Definitions**

Unless the context otherwise requires, the following capitalized terms in this Section VIII.C have the following meanings:

- a. "Additional Seed" means a player in the Main Draw who does not play another seeded player in the first-round of that draw.
- b. "Medical Condition" means a medical illness or a musculoskeletal injury that warrants medical evaluation or medical treatment.
- c. "Out of Competition" means:
  - i. not participating in any Tennis Event other than an Exhibition/ Non-WTA Event for which a player was granted a waiver pursuant to sub-Section 6 below; and
  - ii. not competing in any other organized sport.
- d. "Out-of-Competition Period" means a period during which a player is Out of Competition because of a Medical Condition, Pregnancy, or Parental Start for a minimum of twenty-six (26) weeks, which for a particular player is calculated using the last day of the last Tennis Event that she played or at which she received prize money, whichever is later, and the date of her Return to Competition.

**WTA RANKING SYSTEM**  
**SECTION VIII - WTA RANKING SYSTEM**

A player may not count any period of suspension or period of ineligibility for violation of the Rules, TADP, or TACP toward her Out-of-Competition Period.

- e. "Parental Start" means adoption, surrogacy, or becoming the legal guardian of a person under the age of eighteen (18).
- f. "Pregnancy" means the medically-diagnosed condition of being pregnant.
- g. "Return to Competition" means the earlier of:
  - i. playing or competing in
    - (a) any Tennis Event other than an Exhibition/Non-WTA Event for which a player was granted a waiver pursuant to sub-Section 6 below; or
    - (b) any other organized sport; or
  - ii. acceptance into a Tournament using a Special Ranking and subsequently using a Prize Money Withdrawal; or
  - iii. for a Special Ranking for a Parental Start, the date that is 52 weeks after the beginning of a player's original Out-of-Competition Period; or
  - iv. the date that is 104 weeks after:
    - (a) for a Special Ranking for a Medical Condition, the beginning of a player's original Out-of-Competition Period; or
    - (b) for a Special Ranking for Pregnancy, the end of the Pregnancy.
- h. "Special Ranking" means a player's ranking as of the WTA Rankings published immediately after:
  - i. the points of the last Tournament she played before her Out-of-Competition Period began have been added to the WTA Rankings (see Section VIII.A.3 – Processing of Rankings); or
  - ii. the last Tennis Event she played or at which she received prize money, whichever is later, before her Out-of-Competition Period began.



**WTA RANKING SYSTEM**  
**SECTION VIII - WTA RANKING SYSTEM**

- i. “Special Ranking Application” has the meaning that Section VIII.C.3.a assigns to that term.
- j. “Special Ranking Period” has the meaning that Section VIII.C.5.b.ii assigns to that term.
- k. “Tennis Event” means any WTA Tournament, Grand Slam, ITF (including World Tennis Tour and Billie Jean King Cup) event, Olympic or Olympic Qualification event, or Exhibition/Non-WTA Event, regardless of whether ranking points are awarded.

Unless the context otherwise requires, all other capitalized terms in this Section VIII.C have the meanings that these Rules assign to those terms.

## **2. Eligibility**

To be eligible for a Special Ranking in either singles or doubles, a player must:

- a. have an Out-of-Competition Period;
- b. have a WTA Ranking of 1-750 in singles or doubles immediately after the points of the last Tournament she played have been added to the WTA Rankings (see Section VIII.A.3 – Processing of Rankings);
- c. submit documentation of a Medical Condition, Parental Start, or Pregnancy in accordance with this Section VIII.C.

For clarity, unless granted a waiver to participate in an Exhibition/Non-WTA Event pursuant to sub-Section 6 below, if a player participates in a Tennis Event or competes in any other organized sport within twenty-six (26) weeks of the purported start of her Out-of-Competition Period, she is not eligible for a Special Ranking.

## **3. Application Procedure and Timing**

- a. Application

To apply for a Special Ranking, a player must submit the following documentation (“Special Ranking Application”) in English to WTA Operations for approval:

- i. a completed and signed Special Ranking application form;
- ii. a public release statement;

**WTA RANKING SYSTEM**  
**SECTION VIII - WTA RANKING SYSTEM**

- iii. if applicable, medical documentation, including:
  - (a) the diagnosis of the Medical Condition or Pregnancy;
  - (b) a copy of clinical visit documentation;
  - (c) physician's notes/documentation; and
  - (d) all relevant laboratory tests and applicable surgical reports; and
- iv. if applicable, evidence (e.g., legal documentation) demonstrating the Parental Start.

WTA in its sole discretion reserves the right to require a player to submit additional documentation to verify the Medical Condition, Parental Start, or Pregnancy. If a player is applying for a Special Ranking for more than one (1) Medical Condition or for a combination of a Medical Condition(s) and a Parental Start or Pregnancy, she must submit documentation for each Medical Condition and Parental Start or Pregnancy.

b. Timing

Each player applying for a Special Ranking must submit her Special Ranking Application:

- i. within twenty-six (26) weeks after the start of her Out-of-Competition Period; and
- ii. at least thirty (30) calendar days before the entry deadline for the first Tournament that she wants to enter using her Special Ranking.

**4. Requests for Subsequent Status Reports and Documentation Handling**

WTA may request subsequent medical and legal (as applicable) status reports written in English, and if a player fails to comply promptly with such requests, the WTA may revoke her Special Ranking. WTA will keep all medical and legal documentation confidential.

**WTA RANKING SYSTEM**  
**SECTION VIII - WTA RANKING SYSTEM**

**5. Usage Criteria and Guidelines**

a. Number of Tournaments

A player whose Out-of-Competition Period is at least twenty-six weeks but less than thirty-nine (39) weeks may use her Special Ranking in up to eight (8) Tournaments (singles or doubles, as applicable). A player whose Out-of-Competition Period is at least thirty-nine (39) weeks but less than fifty-two (52) weeks may use her Special Ranking in up to ten (10) Tournaments (singles or doubles, as applicable). A player whose Out-of-Competition Period is fifty-two (52) weeks or longer may use her Special Ranking in twelve (12) Tournaments (singles or doubles, as applicable).

A player may use her Special Ranking to participate in a maximum of five (5) WTA 1000 Mandatory Tournaments and two (2) Grand Slams as part of her maximum Tournaments to use her Special Ranking, and she may use her Special Ranking to participate in each WTA 1000 Mandatory Tournament and Grand Slam only one (1) time per Special Ranking.

b. Timing

- i. The earliest a player's Return to Competition may occur is in a match scheduled during the same calendar week in which her Out-of-Competition Period reaches twenty-six (26) weeks.
- ii. A player has fifty-two (52) weeks from the date of her Return to Competition to use her Special Ranking ("Special Ranking Period").
- iii. The latest a player may use her Special Ranking is at a Tournament scheduled the same calendar week in which her Special Ranking expires.
- iv. If a player has both singles and doubles Special Rankings, her Return to Competition for both Special Rankings begins at the same time.

c. Procedures

i. Special Ranking Freeze Petition

(a) Subsequent Medical Condition

If any player's Return to Competition occurs and before

**WTA RANKING SYSTEM**  
**SECTION VIII - WTA RANKING SYSTEM**

her Special Ranking expires she subsequently is Out of Competition for a minimum of thirteen (13) weeks because of a Medical Condition, she may request to “freeze” her Special Ranking Period by completing and submitting another Special Ranking Application; provided, however, that regardless of any “freeze,” a player’s Special Ranking expires no later than the date that is 156 weeks after:

- (i) for a Special Ranking originally for a Medical Condition or Parental Start, the beginning of a player’s original Out-of-Competition Period; and
- (ii) for a Special Ranking originally for Pregnancy, the end of the Pregnancy.

(b) Subsequent Pregnancy or Parental Start

If before a player’s Special Ranking expires (but regardless of whether her Return to Competition has occurred) she subsequently is Out of Competition for Pregnancy or a Parental Start, she may complete and submit another Special Ranking Application to request either:

- (i) to “freeze” her Special Ranking Period for her current Special Ranking until the date that is 104 weeks after the end of her Pregnancy or 52 weeks after the beginning of her Out-of-Competition Period for a Parental Start; or
- (ii) a new Special Ranking.

(c) Restrictions

- (i) A player may not “freeze” her Special Ranking during any period of suspension for violation of the Rules, TADP, or TACP.
- (ii) A player may “freeze” her Special Ranking Period a maximum of two (2) times per Special Ranking. Upon a player’s second and third Return to Competition, she will have the same number of Tournaments and the same time remaining in her Special Ranking Period and the same number of Tournaments remaining in which to use her eligibility as an Additional Seed as she had when the “freeze” went into effect.

**WTA RANKING SYSTEM**  
**SECTION VIII - WTA RANKING SYSTEM**

ii. Tournament Entry and Acceptance

A player must submit all requests to use her Special Ranking to enter WTA Tournaments, Grand Slams, or Women's ITF World Tennis Tour events to WTA Operations by the applicable WTA or Grand Slam entry deadline or by the Monday prior to the applicable ITF entry deadline. The WTA will not accept requests submitted after entry deadlines.

A player may use her Special Ranking and actual WTA Ranking interchangeably for singles entry and Doubles Advance Entry, but she may not change the ranking she uses to enter a Tournament after that Tournament's entry deadline; provided, however, that if a player enters a WTA Tournament, a Grand Slam, or Women's ITF World Tennis Tour event with her Special Ranking and she would have been accepted into that Tournament using her actual WTA Ranking as of the completion of the first round of Qualifying (or if no Qualifying, then as of the completion of the first round of Main Draw), then her Special Ranking entry will not count towards her maximum Tournaments to use her Special Ranking. If multiple players with the same WTA Ranking enter the same Tournament, the player using her actual WTA Ranking will be accepted before the player using her Special Ranking.

(a) All WTA Tournaments

If a player has both a singles and doubles Special Ranking and she uses her singles Special Ranking for on-site entry into the doubles competition of a WTA Tournament, it will not count toward her maximum allowed singles entries at Tournaments using her singles Special Ranking (but will count toward her maximum allowed doubles entries at Tournaments using a Special Ranking). If a player uses her singles Special Ranking to enter singles (Main Draw or Qualifying) and doubles at the same WTA Tournament, such entries count as one (1) of her maximum allowed singles entries and as one (1) of her maximum allowed doubles entries at Tournaments under the Special Ranking Rule. If a player only has a singles Special Ranking and she uses it for on-site entry into the doubles competition of a WTA Tournament, it will count toward both her maximum allowed singles entries and her maximum allowed doubles entries at Tournaments using her singles Special Ranking.

**WTA RANKING SYSTEM**  
**SECTION VIII - WTA RANKING SYSTEM**

(b) WTA 1000 Mandatory Tournaments

If a player enters and is accepted into the singles Main Draw of a WTA 1000 Mandatory Tournament using her Special Ranking and she subsequently withdraws after the applicable withdrawal deadline in Section VIII.C.5.e below, she will receive zero (0) ranking points for the Tournament, which must count as one (1) of her best sixteen (16) Tournament results in calculating her WTA Ranking.

If a player has a Special Ranking, her Return to Competition has not yet occurred, and her actual WTA Ranking automatically enters her into a 2-week WTA 1000 Mandatory Tournament, then:

- (i) her Return to Competition may occur at a WTA 125 Tournament or Women's ITF World Tennis Tour event during the second week of that WTA 1000 Mandatory Tournament; and
- (ii) she will not be subject to any Late Withdrawal fines or any prohibition against withdrawing from one Tournament to play another (see Section IV.A) for her failure to play that WTA 1000 Mandatory Tournament, except that she will receive zero (0) ranking points for the Tournament, which must count as one (1) of her best sixteen (16) Tournament results in calculating her WTA Ranking.

(c) WTA Finals

A player may not qualify for the WTA Finals using a Special Ranking.

(d) Grand Slams

A player may use her singles Special Ranking to enter doubles and/or mixed doubles at a Grand Slam, which will not count toward her two (2) allowed singles entries at Grand Slams using her singles Special Ranking (but will count toward her two (2) allowed doubles entries at Grand Slams using a Special Ranking).

If a player uses her singles or doubles Special Ranking to enter only mixed doubles at a Grand Slam, such entry counts as one (1) of her two (2) allowed doubles entries at Grand Slams under the Special Ranking Rule. If a player uses her

**WTA RANKING SYSTEM**  
**SECTION VIII - WTA RANKING SYSTEM**

singles or doubles Special Ranking to enter doubles and mixed doubles at the same Grand Slam, such entries count as one (1) of her two (2) allowed doubles entries at Grand Slams under the Special Ranking Rule.

If a player enters the singles Main Draw of a Grand Slam using her Special Ranking and she subsequently withdraws after the applicable withdrawal deadline in Section VIII.C.5.e below, she will receive zero (0) ranking points for the Grand Slam, which must count as one (1) of her best sixteen (16) Tournament results in calculating her WTA Ranking.

(e) Olympics

A player may use her Special Ranking for acceptance into the Olympic tennis event, which will count as one (1) of her maximum Tournaments to use her Special Ranking.

d. Automatic Entry into WTA 1000 Mandatory Tournament

WTA does not automatically enter a player into a WTA 1000 Mandatory Tournament using her Special Ranking. To enter a WTA 1000 Mandatory Tournament using her Special Ranking, a player must notify WTA Operations in writing before the applicable entry deadline.

e. Tournament Withdrawal

If a player is accepted into a Tournament using her Special Ranking but withdraws from singles or doubles by any method other than a Prize Money Withdrawal, then the Tournament will not count as one (1) of her maximum Tournaments to use her Special Ranking, but she is subject to all withdrawal requirements, any applicable Late Withdrawal or No-Show fines, and any resulting zero (0) ranking point results on her WTA Rankings.

f. Wild Cards

If a player is accepted into a Tournament using her Special Ranking, she may accept a Wild Card into such Tournament before 4:00 p.m. tournament local time on the day of the Qualifying Sign-In.

g. Seeding

A player's Special Ranking may qualify her as an Additional Seed at any WTA Tournament according to this Section; provided, however,

**WTA RANKING SYSTEM**  
**SECTION VIII - WTA RANKING SYSTEM**

that regardless of any “freeze,” a player’s eligibility as an Additional Seed expires no later than the date that is: (i) for a Special Ranking originally for a Medical Condition, 156 weeks after the beginning of a player’s original Out-of-Competition Period; (ii) for a Special Ranking originally for Pregnancy, 156 weeks after the end of the Pregnancy; and (iii) for a Special Ranking originally for a Parental Start, 104 weeks after the beginning of a player’s original Out-of-Competition Period.

i. Singles

Upon a player’s Return to Competition, if she is accepted into the singles Main Draw of a WTA Tournament, her singles Special Ranking is 1-100, and her Special Ranking would qualify her for seeding in the draw (regardless of whether she was accepted using her Special Ranking), then she will be an Additional Seed in the draw, subject to the procedures below and in Section V.A.6.c.ii:

- (a) A player is eligible as an Additional Seed only at the first eight (8) WTA Tournaments after her Return to Competition;
- (b) Only singles Main Draws of 28, 30, 32, 56, 60, and 64 may contain Additional Seeds; singles Main Draws of 48 and 96 cannot contain Additional Seeds; and
- (c) If an Additional Seed withdraws after the draw is made, then the next player eligible to move into the draw (i.e., Qualifier, Lucky Loser, or Alternate as applicable) takes the open position.

ii. Doubles

Upon a player’s Return to Competition, if her team is accepted into the doubles Main Draw of a WTA Tournament, her doubles Special Ranking is 1-50, and her doubles Special Ranking combined with her partner’s doubles ranking would qualify her team for seeding in the draw (regardless of whether she was accepted using her doubles Special Ranking), then her team will be an Additional Seed in the draw, subject to the procedures below and in Section V.A.6.c.ii:

- (a) A player’s team is eligible as an Additional Seed only at the first eight (8) WTA Tournaments after her Return to Competition;



**WTA RANKING SYSTEM**  
**SECTION VIII - WTA RANKING SYSTEM**

- (b) Only doubles draws of 16, 28, and 32 may contain Additional Seeds; doubles draws of 8 cannot contain Additional Seeds; and
- (c) If an Additional Seed withdraws after the draw is made, then the next team eligible to move into the draw takes the open position.

iii. Tournament Withdrawal

If a player is eligible as an Additional Seed but withdraws from singles or doubles by any method other than a Prize Money Withdrawal, then the Tournament will not count as one (1) of the eight (8) Tournaments at which she can be an Additional Seed.

h. Lucky Loser Status

A player's actual WTA Ranking, not her Special Ranking, determines her Lucky Loser position or status.

i. Top 10 Players

Special Rankings will not be used to determine Top 10 Players.

j. Player Responsibilities

i. Upon Return to Competition

Upon her Return to Competition, a player must report to the WTA the first Tennis Event in which she participates.

ii. Tracking Tournament Usage

Each player is responsible for tracking the Tournaments in which she uses her Special Ranking. If a player exceeds the maximums in this Section VIII.C, she will forfeit any ranking points she earned at all WTA Tournaments, Grand Slams, and Women's ITF World Tennis Tour events in which she used her Special Ranking that exceed those maximums.

k. Missed Tournament Ranking Point Replacement

A player who during her Out-of-Competition Period misses any Tournament(s) that must count as one (1) of her best eighteen (18)

**WTA RANKING SYSTEM**  
**SECTION VIII - WTA RANKING SYSTEM**

Tournament results in calculating her WTA Ranking may replace any zero (0) ranking point results for such Tournament(s) with the results she obtains at Tournaments after her Return to Competition only after she has eighteen (18) Tournaments comprising her WTA Singles Ranking.

I. Abuse of Special Ranking

If at any time WTA determines in its sole discretion that a player has abused or is abusing her Special Ranking status, WTA has the authority to (i) revoke the player's Special Ranking; (ii) revoke any ranking points the player earned from the abuse of her Special Ranking status; and (iii) penalize the player under Section XVII.D.13.b. A player is entitled to appeal any penalty issued under this Section VIII.C.5.I in accordance with Section XVII.D.13.c and Section XVII.G, as applicable.

**6. Exhibition/Non-WTA Event Waiver**

Any Player subject to this Special Ranking Rule may apply to the WTA for a waiver to participate in one (1) Exhibition/Non-WTA Event (as defined in Section XVII.E) that will not restart her Out-of-Competition Period or start her Return to Competition, which application the WTA may grant in its sole and absolute discretion. A player must submit a waiver request, applicable medical documentation, and medical clearance from her doctor. All materials are requested thirty (30) days in advance but must be received by the WTA no later than one (1) day prior to the Exhibition/Non-WTA Event.

The WTA may consider such waiver requests according to the individual circumstances presented. In considering whether to grant a waiver, the WTA may take into account, among other factors, (i) the current length of a player's Out-of-Competition Period, (ii) the timing of the Exhibition/Non-WTA Event in comparison to the player's planned Return to Competition, and (iii) the format of the Exhibition/Non-WTA Event, the number of days over which it is scheduled, and the number of matches the player is likely to play. As a general rule, waivers may be granted more freely in cases of bona fide charity events, bona fide team competitions, events with Pro-Am formats, and events with non-traditional tennis scoring.

Players ranked 1-50 are also subject to Section XVII.E – Exhibition/Non-WTA Event Rule.

**WTA RANKING SYSTEM**  
**SECTION VIII - WTA RANKING SYSTEM**

**D. TADP RETURN TO COMPETITION SPECIAL RANKING RULE**

**1. Definitions**

The following capitalized terms in this Section VIII.D have the following meanings:

- a. “Qualifying TADP Matter” means players who (i) have been provisionally suspended for an apparent Anti-Doping Rule Violation (as defined in the TADP) or receive a period of ineligibility from an Anti-Doping Organisation (as defined in the TADP) or first-instance panel for an Anti-Doping Rule Violation, and (ii) have been found to have not committed or to bear No Fault (as defined in the TADP) or Negligence (as defined in the TADP) for a violation by an Anti-Doping Organisation, first-instance panel, or appeal panel (as applicable), and therefore no period of ineligibility applies.
- b. “TADP Return to Competition” means the earlier of:
  - i. playing or competing in any Tennis Event; or
  - ii. the date that is eighteen (18) weeks after the player regains eligibility under the TADP.
- c. “TADP Out-of-Competition Period” means a period during which a player is ineligible to compete because of a Qualifying TADP Matter, which for a particular player is calculated from the date the provisional suspension or period of ineligibility started until the date the player regains eligibility under the TADP.
- d. “TADP Special Ranking” means a player’s WTA Ranking as of the date on which the player’s provisional suspension or period of ineligibility came into effect; provided, however, that in either case, a player’s Special Ranking will exclude any results that are disqualified as a result of an Anti-Doping Rule Violation.
- e. “Tennis Event” means any WTA Tournament, Grand Slam, ITF (including World Tennis Tour and Billie Jean King Cup) event, Olympic or Olympic Qualification event, or Exhibition/Non-WTA Event, regardless of whether ranking points are awarded.

Unless the context otherwise requires, all other capitalized terms in this Section VIII.D have the meanings that these Rules assign to those terms.

**WTA RANKING SYSTEM**  
**SECTION VIII - WTA RANKING SYSTEM**

**2. Eligibility**

To be eligible for a TADP Special Ranking in either singles or doubles, a player must: (a) have been subject to a TADP Out-of-Competition Period; (b) have a WTA Ranking of 1-750 in singles or doubles as of the start of the TADP Out-of-Competition Period; and (c) meet the eligibility requirements of the Integrity Rules, including the repayment of any forfeited prize money to the ITIA, and these Rules to enter and participate in WTA Tournaments.

WTA may request documents concerning the Qualifying TADP Matter, including any appeal that may be pending, and if a player fails to comply promptly with such requests, the WTA may revoke her TADP Special Ranking.

If before a player's TADP Special Ranking expires (but regardless of whether her TADP Return to Competition has occurred), the player no longer meets the eligibility requirement in sub-Section 1.a.(ii) above, her TADP Special Ranking will be void.

**3. Usage Criteria and Guidelines**

a. Number of Tournaments

- i. A player whose TADP Out-of-Competition Period is less than fourteen (14) weeks may use her TADP Special Ranking in up to four (4) Tournaments (singles or doubles, as applicable); provided that a player may use her TADP Special Ranking to participate in a maximum of one (1) WTA 1000 Mandatory Tournament and one (1) Grand Slam.
- ii. A player whose TADP Out-of-Competition Period is at least fourteen (14) weeks, but less than twenty-six (26) weeks may use her TADP Special Ranking in up to six (6) Tournaments (singles or doubles, as applicable); provided that a player may use her TADP Special Ranking to participate in a maximum of two (2) WTA 1000 Mandatory Tournaments and one (1) Grand Slam.
- iii. A player whose TADP Out-of-Competition Period is at least twenty-six (26) weeks, but less than thirty-nine (39) weeks may use her TADP Special Ranking in up to eight (8) Tournaments (singles or doubles, as applicable); provided that a player may use her TADP Special Ranking to participate in a maximum of three (3) WTA 1000 Mandatory Tournaments and two (2) Grand Slams.

**WTA RANKING SYSTEM**  
**SECTION VIII - WTA RANKING SYSTEM**

- iv. A player whose TADP Out-of-Competition Period is at least thirty-nine (39) weeks, but less than fifty-two (52) weeks may use her TADP Special Ranking in up to ten (10) Tournaments (singles or doubles, as applicable); provided that a player may use her TADP Special Ranking to participate in a maximum of four (4) WTA 1000 Mandatory Tournaments and two (2) Grand Slams.
- v. A player whose TADP Out-of-Competition Period is fifty-two (52) weeks or longer may use her TADP Special Ranking in twelve (12) Tournaments (singles or doubles, as applicable); provided that a player may use her TADP Special Ranking to participate in a maximum of five (5) WTA 1000 Mandatory Tournaments and two (2) Grand Slams.

A player may use her TADP Special Ranking to participate in each WTA 1000 Mandatory Tournament and Grand Slam only one (1) time per TADP Special Ranking Period.

b. Timing

- i. A player must use her TADP Special Ranking within the following period as applicable (“TADP Special Ranking Period”):
  - (a) If a player’s TADP Out-of-Competition Period is less than twenty-six (26) weeks, she has twenty-six (26) weeks from the date of her TADP Return to Competition to use her TADP Special Ranking; and
  - (b) If the TADP Out-of-Competition Period is at least twenty-six (26) weeks, a player has fifty-two (52) weeks from the date of her TADP Return to Competition to use her TADP Special Ranking.
- ii. The latest a player may use her TADP Special Ranking is at a Tournament scheduled the same calendar week in which her TADP Special Ranking expires.
- iii. If a player has both singles and doubles TADP Special Rankings, her TADP Return to Competition for both TADP Special Rankings begins at the same time.

c. Procedures

- i. Special Ranking Freeze Petition

**WTA RANKING SYSTEM**  
**SECTION VIII - WTA RANKING SYSTEM**

(a) Subsequent Medical Condition

If any player's TADP Return to Competition occurs and before her TADP Special Ranking expires she subsequently is Out of Competition for a minimum of thirteen (13) weeks because of a Medical Condition, she may request to "freeze" her TADP Special Ranking Period; provided, however, that regardless of any "freeze," a player's TADP Special Ranking expires no later than the date that is 104 weeks after she regains eligibility under the TADP.

(b) Subsequent Pregnancy or Parental Start

If before a player's TADP Special Ranking expires (but regardless of whether her TADP Return to Competition has occurred) she is subsequently Out of Competition for Pregnancy or a Parental Start, she may request to "freeze" her TADP Special Ranking Period until the date that is 104 weeks after the end of her Pregnancy or 52 weeks after the beginning of her Out-of-Competition Period for a Parental Start.

(c) Restrictions

A player may "freeze" her TADP Special Ranking Period a maximum of one (1) time. Upon a player's second Return to Competition, she will have the same number of Tournaments and the same time remaining in her TADP Special Ranking Period as she had when the "freeze" went into effect.

ii. Tournament Entry and Acceptance

Same as regular Special Ranking Rule. (See Section VIII.C.5.c.ii.)  
[Note: Olympic use TBD by Olympic Committee].

d. Automatic Entry into WTA 1000 Mandatory Tournament

Same as regular Special Ranking Rule. (See Section VIII.C.5.d.)

e. Tournament Withdrawal

Same as regular Special Ranking Rule. (See Section VIII.C.5.e.)

f. Wild Cards

Same as regular Special Ranking Rule. (See Section VIII.C.5.f.)

**WTA RANKING SYSTEM**  
**SECTION VIII - WTA RANKING SYSTEM**

g. Seeding

A player's actual WTA Ranking, not her TADP Special Ranking, determines her seeding in the singles or doubles Main Draw of a WTA Tournament. Additional seeding does not apply.

h. Lucky Loser Status

Same as regular Special Ranking Rule. (See Section VIII.C.5.h.)

i. Top 10 Players

Same as regular Special Ranking Rule. (See Section VIII.C.5.i.)

j. Player Responsibilities

Same as regular Special Ranking Rule. (See Section VIII.C.5.j.)

k. Missed Tournament Ranking Point Replacement

Same as regular Special Ranking Rule. (See Section VIII.C.5.k.)

l. Abuse of TADP Special Ranking

Same as regular Special Ranking Rule. (See Section VIII.C.5.l.)

**E. RETIRING FROM THE WTA**

If a player has decided to retire, she must submit the Player Retirement Form to the WTA in order to officially retire. Unless a player submits the Player Retirement Form to the WTA, the player continues to be bound by and required to comply with the TADP and, until two years after the last Event (as defined in the TACP) at which she enters or participates in, the TACP save where the player is subject to a period of ineligibility under the TACP or the TADP. Notwithstanding the forgoing, while serving any period of ineligibility under the TACP or the TADP, a player remains bound by all of the provisions of the TACP. A retired player will be removed from the WTA Rankings at the end of the calendar year in which she officially retires or on the date listed by the Player on the Player Retirement Form, whichever is earlier. Players who have submitted a Player Retirement Form shall not be eligible to compete in a Tournament until they have satisfied all applicable requirements under these Rules and the Integrity Rules.

# FINANCIAL

## IX. PRIZE MONEY

### A. DISTRIBUTION

#### 1. Equal Opportunity

Payment of the same prize money must be available to all competitors without discrimination.

#### 2. Timing and Process

##### a. Tournament Obligations

###### i. Prize Money Spreadsheet

The WTA must receive a completed prize money spreadsheet, electronically, no later than 9:00 a.m. Eastern Time (New York, USA Time) on the Monday following the conclusion of the Tournament.

###### ii. Wire Transfer of Payment

Tournaments are required to wire net prize money to the bank trust account designated by the WTA to ensure receipt by the Wednesday (Thursday for tournaments with Main Draws of 96 or greater) following their respective Tournaments, and to provide a prize money breakdown from the Tournament to the WTA.

Prize money payments not made by the due dates specified herein are subject to a late charge due to the WTA of 2% per month, pro-rated for partial months. Tournaments that pay five (5) or more business days late will be required to pre-pay the following year's prize money (minus estimated taxes to be withheld) at least twenty-one (21) days prior to the start of the Tournament.

###### iii. Taxes

The Tournament shall be responsible for withholding and payment of any taxes consistent with all laws concerning withholding taxes.

###### (a) Income Tax on Players

Each Tournament is required to give at least ninety (90) days' notice to the WTA of the percentage of the applicable



**FINANCIAL**  
**SECTION IX - PRIZE MONEY**

player income tax deduction. No other tax deduction(s) by the Tournaments will be permitted from the prize money paid to a player.

(b) Additional Taxes

The Tournament shall be responsible for any additional taxes imposed.

(c) Tax Receipts and Forms

Tournaments must make best efforts to supply tax receipts or forms to the players before they collect their prize money. If tax forms are not available, players should be told when they will receive them and who they can contact from the Tournament if they have a problem. Players must receive the Tournament tax forms required by local law by the last day of the Tour Year or such other date as required by local law.

Players are solely responsible for their taxes and for providing current tax information on Tournament tax forms or for providing other official documentation to the Tournament directly if requested. The WTA does not maintain current tax information pertaining to players nor does the WTA assume liability for conveying players' tax status or tax information to Tournaments. Tournaments may provide blank electronic tax forms along with instructions for completing the forms to the WTA for posting on the PlayerZone. Players may complete and return these forms to the Tournament's designated contact and should do so prior to the Tournament. The WTA is not responsible for providing tax forms to players or collecting them from players and cannot make adjustments or modifications to the tax forms supplied by Tournaments or give advice on completing them.

b. Qualifying Prize Money at WTA 125 Tournaments

i. Payment Currency and Method

Qualifying prize money at WTA 125 Tournaments shall be paid on-site, unless otherwise approved by the WTA.

ii. Withholding

In addition to the player's applicable income tax deduction,

**FINANCIAL**  
**SECTION IX - PRIZE MONEY**

each WTA 125 Tournament shall also withhold from Qualifying prize money any non-member service fees, fines, or other WTA expenses designated by the WTA.

c. Summary of Distribution

See Section XVIII.A.1 - Accounting.

d. General

- i. Players receive prize money for the round reached, subject to any exceptions in this Section IX.
- ii. Qualifiers receive Main Draw prize money only.

e. Wild Cards

Players or teams who receive Wild Cards receive the same prize money as any other player.

**B. AMATEURISM**

Each player is solely responsible for maintaining her amateur status and eligibility to compete at the collegiate level in accordance with any non-WTA rules or regulations. If a player would like to limit the amount of prize money she receives at a Tournament, she must complete and submit to the on-site WTA Supervisor an Amateur Prize Money Form, which is available in the on-site WTA office.

Any unpaid prize money earned by an amateur at a Tournament will be divided evenly between the WTA and that Tournament, which must make payment to the WTA within thirty (30) days of the conclusion of the Tournament.

**C. WITHDRAWALS, BYES, WALKOVERS, AND DEFAULTS**

**1. Withdrawals**

a. Singles

i. Prior to First Match

- (a) A player who withdraws from a Tournament prior to her first match will not receive any prize money, except when using a Prize Money Withdrawal.

**FINANCIAL**  
**SECTION IX - PRIZE MONEY**

(b) Singles Prize Money Withdrawals

(i) Withdrawing Players

If a player withdraws using the Prize Money Withdrawal Rule, she will receive Qualifying or Main Draw first round prize money, as applicable, regardless of whether she has a bye.

(ii) Players Moving into the Draw

If any players withdraw using the Prize Money Withdrawal Rule, the last Lucky Losers (or Alternates, as applicable) moving into the draw, regardless of their position in the draw, will receive any prize money they earn in Qualifying, if applicable, and the Main Draw less the Qualifying or Main Draw first round prize money paid to players using a Prize Money Withdrawal.

ii. After Start of First Match

A player who withdraws from a Tournament after she starts her first match will receive prize money for reaching the round in which she withdrew, except that a Qualifier withdrawing in the first round of the Main Draw receives prize money equal to last round Qualifying prize money.

b. Doubles

i. Prior to First Match

(a) A doubles team who withdraws from a Tournament prior to their first match will not receive any prize money, except when using a Prize Money Withdrawal.

(b) Doubles Prize Money Withdrawals

(i) Withdrawing Teams

If a doubles player withdraws using the Prize Money Withdrawal Rule, she will receive her first round prize money regardless of whether her team had a bye.

(ii) Teams Moving into the Draw

If any teams withdraw using the Prize Money Withdrawal Rule, the last Alternates moving into the draw, regardless

**FINANCIAL**  
**SECTION IX - PRIZE MONEY**

of their position in the draw, will receive any prize money they earn in the Main Draw less the first round prize money paid to the player(s) using a Prize Money Withdrawal.

ii. After Start of First Match

A doubles team who withdraws from a Tournament after they start their first match will receive prize money as follows:

- (a) the non-withdrawing partner will receive prize money per the round her partner withdrew; and
- (b) the partner causing the withdrawal will receive prize money from the previous round, unless one (1) of the following apply, in which case the withdrawing partner will receive prize money per the round she withdrew:
  - (i) the player withdraws/retires from a singles match which was scheduled during the same Tournament;
  - (ii) the player is declared unfit to play singles or doubles at the same tournament;
  - (iii) the player also withdraws from playing singles in a Tournament to be held the following week at the time she withdraws from doubles; or
  - (iv) the player does not play singles in a Tennis Event the following week.

The Tournament will retain the difference in prize money.

c. WTA Finals

For withdrawals during the WTA Finals, see Section VI.

**2. Byes**

- a. A player or team who receives one (1) or more consecutive byes and loses her/their first match played will receive prize money for the round reached.
- b. A player or team who receives one (1) or more consecutive byes and defaults or withdraws from her/their next round will not receive any prize money.

**FINANCIAL**  
**SECTION IX - PRIZE MONEY**

**3. Walkovers**

A player or team who receives a walkover in any round will receive prize money for the round reached.

**4. Defaults**

For any disciplinary default occurring in a Tournament after the match begins,

- a. The advancing player or team will receive prize money for the round reached; and
- b. The defaulting player or team will lose all prize money earned for that event at that Tournament, except that if one member of a doubles team did not cause the default, she will receive prize money from the previous round.

**D. TOURNAMENT CANCELLATION OR EARLY TERMINATION**

**1. Tournament Cancellation Without Play Occurring**

Except under the No Release Rule (Section XII.G), if the singles or doubles event of a Tournament is cancelled and there has been no play, players will receive first round prize money.

**2. Tournament Cancellation After Play Has Begun**

If play has commenced and is terminated before the Tournament is concluded, players will receive prize money for the individual round reached.

**3. Tournament Cancellation Without Completion of Finals**

If a Tournament is officially terminated before the finals have been completed, each finalist will receive finalist's prize money. The difference between the winner's and finalist's prize money will revert back to the Tournament. (See Section V.B.8 – Rescheduling of Finals.)

**E. PRIZE MONEY BREAKDOWNS**

The Prize Money Breakdowns are available on the official WTA website as well as on the PlayerZone and TournamentZone websites.

Any Tournament whose prize money or draw does not fall into one of the breakdowns should contact the WTA for an approved breakdown.

## **AGE ELIGIBILITY AND PLAYER DEVELOPMENT**

### **X. AGE ELIGIBILITY AND PLAYER DEVELOPMENT**

#### **A. AGE ELIGIBILITY RULE**

Player Development requirements and the Age Eligibility Rule (“AER”) are applicable to competition in Professional Tennis Tournaments worldwide.

##### **1. Definitions**

###### **a. Competition in a Professional Tennis Tournament**

For the purposes of this Rule, competition in a Professional Tennis Tournament is defined as participation in the singles or doubles Main Draw or Qualifying Draw of any Tournament at which a player earns WTA ranking points (singles or doubles) or, but for the operation of the WTA Rules or the player’s violation of the WTA Rules, would have earned WTA ranking points. Participation in a Professional Tennis Tournament counts toward a player’s AER Tournament Allotment. If a player participates in the Qualifying Draw and qualifies for the Main Draw, it will count as only one (1) Tournament. Similarly, if a player is competing in both the singles and doubles draws, it will count as only one (1) Tournament.

Competition in a Professional Tennis Tournament under the AER does not include: (i) participation in the draws of the Women’s ITF World Tennis Tour events in which a player does not earn WTA ranking points; (ii) participation in the draws of Women’s ITF World Tennis Tour W15 events before August 5, 2019; or (iii) receiving a zero (0) ranking point result for not participating in a Grand Slam or Commitment Tournament.

###### **b. Age**

For the purposes of this Rule, a player’s age is determined by her age as of the date of the start of a Tournament’s singles Main Draw.

A player 18 years of age or older no longer is subject to sub-Section A of this Rule but is required to continue participating in Player Development (sub-Section B) until she receives notification of graduation from a WTA representative.

**AGE ELIGIBILITY AND PLAYER DEVELOPMENT**  
**SECTION X - AGE ELIGIBILITY AND PLAYER DEVELOPMENT**

**2. Event Participation**

- a. AER Tournament Allotment and AER Wild Card Allotment at Professional Tennis Tournaments

Subject to Merited Increases in sub-Section 4 below, a player under 18 years of age may participate in the specified number of Professional Tennis Tournaments (“AER Tournament Allotment”) and accept the specified number of Wild Cards (“AER Wild Card Allotment”) per birth year (i.e. birthday to birthday) as described below. If a player receives a Wild Card into a Professional Tennis Tournament, participation in that Tournament will count toward her AER Tournament Allotment.

- i. Under 14 Years of Age

A player who has not yet reached the date of her 14th birthday may not participate in any Professional Tennis Tournament.

- ii. 14 Years of Age

Between the date of a player’s 14th birthday and the day before her 15th birthday, she may earn a WTA Ranking, but she may not participate in WTA Tournaments by direct acceptance or participate in the WTA Finals by direct acceptance or Wild Card.

The AER Tournament Allotment and AER Wild Card Allotment for a player 14 years of age are as follows.

- (a) AER Tournament Allotment

A player may participate in a maximum of eight (8) Professional Tennis Tournaments, no more than three (3) of which may be at W75 events (including 2023 W60 events) and above.

- (b) AER Wild Card Allotment

A player may accept a maximum of three (3) Wild Cards as follows:

- (i) One (1) Wild Card for use into the Main Draw or Qualifying Draw of a WTA 250 Tournament, WTA 125 Tournament, or Women’s ITF World Tennis Tour event;

**AGE ELIGIBILITY AND PLAYER DEVELOPMENT**  
**SECTION X - AGE ELIGIBILITY AND PLAYER DEVELOPMENT**

- (ii) One (1) Wild Card for use into the Main Draw or Qualifying Draw of a WTA 125 Tournament or Women's ITF World Tennis Tour event; and
- (iii) One (1) Wild Card exclusively for use into the Main Draw or Qualifying Draw of any Women's ITF World Tennis Tour event.

iii. 15 Years of Age

Between the date of a player's 15th birthday and the day before her 16th birthday, her AER Tournament Allotment and AER Wild Card Allotment are as follows.

(a) AER Tournament Allotment

A player may participate in a maximum of ten (10) Professional Tennis Tournaments.

(b) AER Wild Card Allotment

A player may accept a maximum of three (3) Wild Cards as follows:

- (i) One (1) Wild Card for use into the Main Draw or Qualifying Draw of any category of WTA Tournament or Women's ITF World Tennis Tour event; and
- (ii) Two (2) Wild Cards for use into the Main Draw or Qualifying Draw of any WTA 250 Tournament, WTA 125 Tournament, or Women's ITF World Tennis Tour event.

iv. 16 Years of Age

Between the date of a player's 16th birthday and the day before her 17th birthday, her AER Tournament Allotment and AER Wild Card Allotment are as follows.

(a) AER Tournament Allotment

A player may participate in a maximum of twelve (12) Professional Tennis Tournaments.



**AGE ELIGIBILITY AND PLAYER DEVELOPMENT**  
**SECTION X - AGE ELIGIBILITY AND PLAYER DEVELOPMENT**

(b) AER Wild Card Allotment

A player may accept a maximum of four (4) Wild Cards into any WTA Tournament or Women's ITF World Tennis Tour event, provided, however, that she may not exceed the WTA or Women's ITF World Tennis Tour maximum calendar year limits for singles or doubles, Main Draw or Qualifying Wild Cards.

v. 17 Years of Age

Between the date of a player's 17th birthday and the day before her 18th birthday, her AER Tournament Allotment and AER Wild Card Allotment are as follows.

(a) AER Tournament Allotment

A player may participate in a maximum of sixteen (16) Professional Tennis Tournaments.

(b) AER Wild Card Allotment

Once a player reaches 17 years of age, she may accept the WTA and Women's ITF World Tennis Tour calendar year Wild Card maximums. (See Section III.C.3 for information on WTA Wild Card maximums.) The number of Wild Cards she may accept pursuant to the Wild Card Rule is calculated over the course of the Tour Year in which she turned 17 (i.e., any Wild Cards used under the AER by the player in that Tour Year prior to turning 17 will count toward the total number of Wild Cards permitted under the Rules).

vi. 18 Years of Age and Older

(a) AER Tournament Allotment

A player 18 years of age or older may participate in an unlimited number of Professional Tennis Tournaments.

(b) AER Wild Card Allotment

A player may accept the WTA and Women's ITF World Tennis Tour calendar year Wild Card maximums.

**AGE ELIGIBILITY AND PLAYER DEVELOPMENT**  
**SECTION X - AGE ELIGIBILITY AND PLAYER DEVELOPMENT**

b. WTA Finals

Pursuant to Section X.A.2.a.ii, a player 14 years of age may not participate in the WTA Finals.

A player 15 years of age or older is eligible to participate in the WTA Finals. Participation in the WTA Finals by direct acceptance by a player between 15 and 17 years of age will not count toward her AER Tournament Allotment.

c. Billie Jean King Cup (any level of competition)

A player 14 years of age or older is eligible to participate in any level of competition at Billie Jean King Cup events. Participation in Billie Jean King Cup by a player between 14 and 17 years of age will not count toward her AER Tournament Allotment.

d. Olympic Participation

The Age Eligibility restrictions with respect to the Women's Tennis Competition will be detailed in the 2024 WTA Age Eligibility Rule and the ITF Olympic Tennis Event 2024 Regulations.

e. Exhibition/Non-WTA Events

All players are subject to the Exhibition/Non-WTA Event Rule (see Section XVII.E), including players who are subject to the AER.

f. Grand Slams and Commitment Tournaments

A player subject to the AER is responsible for planning her competition schedule to include Grand Slams and Commitment Tournaments within her AER Tournament Allotment. Unless she qualifies for a Merited Increase pursuant to sub-Section 4 below, a player who has reached her AER Tournament Allotment prior to a Grand Slam or Commitment Tournament will not be allowed to exceed her AER Tournament Allotment.

A player who is a direct acceptance into and fails to play a Grand Slam will receive a zero (0) ranking point result.

See Section II.A.4 for Tournament Commitment requirements for players subject to the AER.

**AGE ELIGIBILITY AND PLAYER DEVELOPMENT**  
**SECTION X - AGE ELIGIBILITY AND PLAYER DEVELOPMENT**

**3. Wild Cards**

a. Wild Card Qualification

To accept a Wild Card into any WTA Tournament, a player must: (i) have submitted the Annual Player Form and the Wild Card Player Acceptance Form; (ii) have submitted all requisite documentation (i.e., proof of identity (copy of her passport or birth certificate), proof of meeting her minimum educational requirements, etc.); and (iii) be current with all Player Development requirements.

Under no circumstances will a player be allowed to exceed the calendar year WTA or Women's ITF World Tennis Tour Wild Card maximums for singles or doubles.

Wild Cards accepted at Grand Slams do not count toward a player's AER Wild Card Allotment.

b. Wild Cards Accepted at Separate Tournaments

Wild Cards accepted at separate Tournaments count toward a player's AER Wild Card Allotment, regardless of whether the Wild Card is for singles or doubles.

c. Wild Cards Accepted at the Same Tournament

If a player 14-16 years of age accepts both a singles and doubles Wild Card at the same Tournament, it will count as only one (1) Wild Card. The singles Wild Card will be used to determine how it is counted (Main Draw or Qualifying).

d. Doubles Wild Card at Tournament where Singles Entry by Direct Acceptance

In the event a player 14-16 years of age is accepted into the singles draw (Main Draw or Qualifying) by direct acceptance and accepts a Wild Card into the doubles draw, the following guidelines shall apply:

- i. If the player earns points in the singles draw (Main Draw or Qualifying), the doubles Wild Card will not count toward her AER Wild Card Allotment.
- ii. If the player does not earn points in the singles draw (Main Draw or Qualifying), the doubles Wild Card will count toward her AER Wild Card Allotment.

**AGE ELIGIBILITY AND PLAYER DEVELOPMENT**  
**SECTION X - AGE ELIGIBILITY AND PLAYER DEVELOPMENT**

- e. WTA Tournament Wild Card Awarded through Pre-Qualifying Event/Circuit

In the event a player wins a pre-qualifying event/circuit that awards a Wild Card into a WTA Tournament, the player may accept the Wild Card if:

- i. The pre-qualifying event/circuit has been accredited by the WTA (please contact the WTA Legal or Player Development Departments for full details and guidelines regarding accredited events); and
- ii. Acceptance of the Wild Card does not result in the player exceeding her AER Wild Card Allotment or AER Tournament Allotment.

**4. Merited Increases**

Merited Increases are: (i) Tournaments that a player may play in addition to her AER Tournament Allotment (“Tournament Merited Increases”) and (ii) Wild Cards that a player may accept in addition to her AER Wild Card Allotment but that count toward her AER Tournament Allotment (“Wild Card Merited Increases”). A player who earns Wild Card Merited Increases may not exceed the calendar year WTA or Women’s ITF World Tennis Tour Wild Card maximums for singles or doubles. Subject to sub-Section b.ii(a) below, a player who earns both WTA 1000 Mandatory/Grand Slam Tournament Merited Increases and Pro Path Tournament Merited Increases may combine them but may not exceed four (4) total Tournament Merited Increases per birth year.

A player must remain current with her Player Development requirements to qualify for Merited Increases. An eligible player’s use of Merited Increases is contingent upon her and her Support Team completing the requirements prior to these additional events.

Merited Increases may be earned as follows:

- a. WTA 1000 Mandatory/Grand Slam Tournament Merited Increase
  - i. A WTA 1000 Mandatory/Grand Slam Tournament Merited Increase is earned when a player 15-17 years of age has completed all of her Player Development requirements to-date and earned her way into the Main Draw or Qualifying of a WTA 1000 Mandatory Tournament or Grand Slam by a direct acceptance.

**AGE ELIGIBILITY AND PLAYER DEVELOPMENT**  
**SECTION X - AGE ELIGIBILITY AND PLAYER DEVELOPMENT**

ii. However, participation in a WTA 1000 Mandatory Tournament or a Grand Slam is not a Tournament Merited Increase and counts toward a player's AER Tournament Allotment if the player is:

(a) 14 years of age;

(b) 15-17 years of age and was accepted by direct acceptance but has not completed her Player Development requirements prior to competing in the WTA 1000 Mandatory Tournament or Grand Slam; or

(c) accepted by Wild Card.

b. Pro Path Merited Increases

i. Year-End Top 5 ITF Junior Ranking

A player 14-17 years of age who is ranked in the Top 5 of the ITF World Tennis Tour Junior Rankings as of the final week of the prior calendar year is eligible for Pro Path Merited Increases as follows:

(a) A player 14 years of age may earn four (4) Pro Path Tournament Merited Increases and three (3) Pro Path Wild Card Merited Increases that may be used during her 15th birth year.

(b) A player 15 years of age may earn four (4) Pro Path Tournament Merited Increases and three (3) Pro Path Wild Card Merited Increases that may be used during her 15th birth year.

(c) A player 16 years of age may earn four (4) Pro Path Tournament Merited Increases and two (2) Pro Path Wild Card Merited Increases that may be used during her 16th birth year.

(d) A player 17 years of age may earn four (4) Pro Path Tournament Merited Increases that may be used during her 17th birth year.

A player ranked in the Top 5 of the ITF World Tennis Tour Junior Rankings in one (1) birth year also earns Pro Path Tournament Merited Increases in each subsequent year, but she may not exceed four (4) Tournament Merited Increases per birth year. Subject to sub-Section (a) above, Pro Path Wild Card Merited

## **AGE ELIGIBILITY AND PLAYER DEVELOPMENT**

### **SECTION X - AGE ELIGIBILITY AND PLAYER DEVELOPMENT**

Increases earned as a Top 5 Junior in one (1) birth year may be carried over to subsequent birth years provided that the player does not exceed the calendar year WTA or Women's ITF World Tennis Tour Wild Card maximums.

- ii. ITF Junior Grand Slam Singles Finalist and ITF World Tennis Tour Junior Finals Singles Finalist

When a player 14-17 years of age has reached the final round of an ITF Junior Grand Slam Singles event (i.e., Australian Open Junior Championships, Roland Garros Junior Championships, The Championships (Wimbledon) Junior Championships, and US Open Junior Championships) or the ITF World Tennis Tour Junior Finals Singles event and remains current with her Player Development requirements, she may earn Pro Path Merited Increases as follows:

- (a) A player 14 years of age may earn one (1) Pro Path Tournament Merited Increase and one (1) Pro Path Wild Card Merited Increase for each singles finalist appearance at an ITF Junior Grand Slam or the ITF World Tennis Tour Junior Finals up to a maximum of two (2) Pro Path Tournament Merited Increases and two (2) Pro Path Wild Card Merited Increases regardless of the number of appearances; provided, however, that the player may use such increase(s) only when she is 15 years of age (i.e., the player cannot use such increase(s) at 14, 16, or 17 years of age).
- (b) A player 15 years of age may earn one (1) Pro Path Tournament Merited Increase and one (1) Pro Path Wild Card Merited Increase for each singles finalist appearance at an ITF Junior Grand Slam or the ITF World Tennis Tour Junior Finals up to a maximum of two (2) Pro Path Tournament Merited Increases and two (2) Pro Path Wild Card Merited Increases regardless of the number of appearances or the Merited Increases earned at 14 and 15 years of age.
- (c) A player 16 years of age may earn one (1) Pro Path Tournament Merited Increase and one (1) Pro Path Wild Card Merited Increase for each singles finalist appearance at an ITF Junior Grand Slam or the ITF World Tennis Tour Junior Finals up to a maximum of three (3) Pro Path Tournament Merited Increases and two (2) Pro Path

## AGE ELIGIBILITY AND PLAYER DEVELOPMENT

### SECTION X - AGE ELIGIBILITY AND PLAYER DEVELOPMENT

Wild Card Merited Increases regardless of the number of appearances.

- (d) A player 17 years of age may earn one (1) Pro Path Tournament Merited Increase for each singles finalist appearance at an ITF Junior Grand Slam or the ITF World Tennis Tour Junior Finals up to a maximum of three (3) Pro Path Tournament Merited Increases regardless of the number of appearances.

Subject to sub-Section (a) above, Pro Path Tournament Merited Increases and Pro Path Wild Card Merited Increases earned as a finalist at a Junior Grand Slam or the ITF World Tennis Tour Junior Finals in one (1) birth year may be carried over to subsequent birth years provided that a player does not exceed:

- (e) four (4) total Tournament Merited Increases at 15, 16, and 17 years of age;
- (f) three (3) Wild Card Merited Increases at 15 years of age; and
- (g) two (2) Wild Card Merited Increases at 16 years of age.

### Summary

The following table provides a summary of the event participation and Merited Increases Rules detailed in sub-Sections 2 and 4 above. Note that Grand Slam events and Commitment Tournaments may impose additional regulations and/or restrictions on players subject to the AER. (See sub-Section A.2.f above for further details.)

Age	AER Tournament Allotment <sup>^</sup>	Maximum Tournament Merited Increases <sup>§</sup>	Maximum Professional Tournaments (AER Tournament Allotment plus Tournament Merited Increases)	AER Wild Card Allotment <sup>±</sup> √	Maximum Wild Card Merited Increases <sup>§</sup>	Maximum Wild Cards (AER Wild Card Allotment plus Wild Card Merited Increases)*
18‡	Unlimited	Not Applicable	Unlimited	According to WTA & ITF Rules	Not Applicable	According to WTA & ITF Rules
17‡	16	4	20 + WTA Finals, BJK Cup, Olympics, Exhibition/ Non-WTA Events	According to WTA & ITF Rules	Not Applicable	According to WTA & ITF Rules

**AGE ELIGIBILITY AND PLAYER DEVELOPMENT**  
**SECTION X - AGE ELIGIBILITY AND PLAYER DEVELOPMENT**

16	12	4	16 + WTA Finals, BJK Cup, Olympics, Exhibition/ Non-WTA Events	4	2	6
15	10	4	14 + WTA Finals, BJK Cup, Olympics, Exhibition/ Non-WTA Events	3	3	6
14	0 WTA Tournaments, except by Wild Card  8 ITF events#	0†	8# + BJK Cup, Exhibition/Non-WTA Events	3	0†	3
13	0	0	0	0	0	0

^ See Sections X.A.1.a – Competition in a Professional Tennis Tournament and X.A.2 – Event Participation.

§ See Section X.A.4 – Merited Increases.

± See Section X.A.2 – Event Participation.

√ For Rules regarding Wild Card usage, including treatment of singles and doubles Wild Cards, see Section X.A.3 – Wild Cards.

\* Subject to Section III.C.3 – Wild Card Player Restrictions.

# See Section X.A.2.a.ii(a) for restrictions.

‡ See Section II.A.4 for Commitment Tournament requirements. Players may contact a Player Development representative in the Florida office for specific details.

† A player may earn Tournament Merited Increases and Wild Card Merited Increases when she is 14 years of age, but she may use such increases only when she is 15 years of age. See Sections X.A.4.b.i(a) and ii(a).

**5. Player Activity On-Site at Tournaments**

**a. Evening Play**

The WTA and WTA Tournaments shall use best efforts not to schedule any player under 16 years of age for a match after 9:00 p.m. Tournament local time.

**b. Media Requirements**

A player under 18 years of age may not engage in an excess of four (4) total hours of media requests and engagements per Tournament week. This time is to include: i) one-on-one media requests; ii) WTA requests; and iii) Tournament functions. However, if a player reaches the Tournament’s final match, she must participate in the trophy ceremony regardless of whether she has completed four (4) hours of media requests and engagements during that Tournament week.



**AGE ELIGIBILITY AND PLAYER DEVELOPMENT**  
**SECTION X - AGE ELIGIBILITY AND PLAYER DEVELOPMENT**

c. Personal Endorsement Commitments

A player's personal endorsement commitments are at the discretion of the player but must not conflict with her: i) match schedule; ii) Player Development requirements; iii) professional appearance obligations or iv) physiological limitations.

**B. PLAYER DEVELOPMENT PROGRAMS**

**1. Program Overview and Process**

Player Development programs are divided into the following five (5) phases:

- a. Pro Path (elective phase);
- b. Introductory;
- c. Rookie;
- d. Elite; and
- e. Premier.

The specific player participation requirements of each phase are detailed below. All players 18 years of age and under and players who remain subject to Player Development requirements (regardless of age) are required to check in with the on-site WTA Office staff on the first day of Qualifying, no later than the Qualifying Sign-In Deadline (4:00 p.m. Tournament local time, the day prior to the start of Qualifying) to confirm their Player Development requirements due at that event.

**2. Pro Path Phase**

a. Eligibility and Timing

A player who has achieved a Top 5 Year-End ITF Junior Ranking or has reached a final at an ITF Junior Grand Slam or ITF World Tennis Tour Junior Finals Singles event may elect, but is not required, to participate in the Pro Path Phase. A player must participate in and complete Pro Path Phase Player Development requirements to be eligible to use the Pro Path Merited Increases detailed above. A player and her Support Team must still complete all other Player Development requirements regardless of whether she elects to participate in the Pro Path Phase. A player participating in the Pro

**AGE ELIGIBILITY AND PLAYER DEVELOPMENT**  
**SECTION X - AGE ELIGIBILITY AND PLAYER DEVELOPMENT**

Path Phase is subject to Player Development and AER requirements at all Professional Tennis Tournaments.

b. Pro Path Phase Requirements

i. Each player must complete assigned online and/or in-person Player Development coursework and pass an examination covering such material.

ii. Minimum Educational Requirements

Each player must submit to the WTA an official certificate from her country of legal residence verifying that she is meeting or has met her country's minimum educational requirements. A player must submit updated documentation annually until she reaches 18 years of age.

iii. Mandatory Physical Examination

Each player must undergo a mandatory physical examination annually in accordance with Section XVIII.B.1.

iv. Approved Schedule

Each player must meet with representatives of the WTA for the purpose of developing and agreeing upon the player's schedule (including but not limited to Professional Tennis Tournaments, Billie Jean King Cup, Olympics, and Exhibitions/Non-WTA Events) for the next twelve (12) months. The player must submit her projected schedule via the online ScheduleZone module, including details on the player's off-season, pre-competition weeks, active rest and recovery weeks, and appropriate developmental blocks for review and approval. Once approved by the WTA, the player and her coach must also agree to the schedule. Changes to the agreed upon schedule must be submitted to the WTA for approval no less than four (4) weeks prior to such requested change. The approved schedule is subject to review, and failure to comply with the schedule will subject the player to penalties as outlined in Section X.C.2.

Each player also must acknowledge in writing that she has a full understanding of the Singles Commitment Tournament requirements and Player Development Programs.

v. It is a player's responsibility to advise the WTA of any changes in her Player Support Team Members, including coach or agent.

**AGE ELIGIBILITY AND PLAYER DEVELOPMENT**  
**SECTION X - AGE ELIGIBILITY AND PLAYER DEVELOPMENT**

- vi. Player Support Team Member Requirements
  - (a) A Pro Path Coach must complete the Player Development health and safety modules, including but not limited to “ScheduleZone” and “Safety & Security.”
  - (b) A Pro Path Coach must agree in writing to abide by the WTA Rules.
  - (c) A Pro Path Coach must be in good standing.
  - (d) A Pro Path Coach must work with the player and WTA representatives to review, agree to, and execute the approved, submitted schedule.
  - (e) A coach who is nominated by a Player Development player to act as her Pro Path Coach must provide proof of Qualification/Certification from a recognized organization or governing body (e.g., a National Federation, the ITF, PTR). A copy of the current certification or confirmation from the governing body that the coach is current and in good standing will be required to receive a WTA player-coach credential.

**3. Introductory Phase**

a. Eligibility and Timing

The Introductory Phase begins when a player 18 years of age or younger enters her first WTA Tournament. Requirements for this phase must be completed as she completes the Annual Player Form process and by the end of her first WTA Tournament (WTA 1000 Mandatory, WTA 500, WTA 250, or WTA 125 Tournament).

b. Introductory Player Requirements

- i. Each player must complete assigned online and/or in-person Player Development coursework and pass an examination covering such material.
- ii. Minimum Educational Requirements

Each player must submit to the WTA an official certificate from her country of legal residence verifying that she is meeting or has met her country’s minimum educational requirements. A player

## **AGE ELIGIBILITY AND PLAYER DEVELOPMENT**

### **SECTION X - AGE ELIGIBILITY AND PLAYER DEVELOPMENT**

must submit updated documentation annually until she reaches 18 years of age.

#### iii. Mandatory Physical Examination

Each player must undergo a mandatory physical examination annually in accordance with Section XVIII.B.1.

#### iv. Each player must participate in and pass the SS&M On-Site Activities portion of the 'Rookie Hours' Player Orientation.

#### v. It is a player's responsibility to advise the WTA of any changes in her Player Support Team Members, including coach or agent.

#### vi. A coach who is nominated by a Player Development player to receive and subsequently applies for a WTA player-coach credential must provide proof of Qualification/Certification from a recognized organization or governing body (e.g., a National Federation, the ITF, PTR). A copy of the current certification or confirmation from the governing body that the coach is current and in good standing will be required to receive a WTA player-coach credential.

## **4. Rookie Phase**

### a. Eligibility and Timing

The Rookie Phase begins when a player 18 years of age or younger participates in:

- i. Two (2) or more WTA singles events in a 52-week period;
- ii. A WTA 1000 Mandatory singles event (Main Draw or Qualifying);  
or
- iii. A Grand Slam singles event (Main Draw or Qualifying).

A player must complete her Rookie Phase requirements within three (3) additional WTA Tournaments or six (6) months of the Tournament which has triggered her enrollment in the Rookie Phase, whichever comes first.

### b. Rookie Phase Player Requirements

- i. Each player must participate in WTA professional orientation, including:

**AGE ELIGIBILITY AND PLAYER DEVELOPMENT**  
**SECTION X - AGE ELIGIBILITY AND PLAYER DEVELOPMENT**

- (a) Complete assigned online and/or in-person Player Development coursework and pass an examination covering such material; and
  - (b) Complete the On-Site Activities portion of the 'Rookie Hours' Player Orientation.
- ii. Each player must participate in Educational Programs offered through Player Development.
  - iii. Each player must meet with representatives of the WTA for the purpose of developing and agreeing upon the player's schedule (including but not limited to Professional Tennis Tournaments, Billie Jean King Cup, Olympics, and Exhibitions/Non-WTA Events) for the next twelve (12) months. The player must submit her projected schedule via the online ScheduleZone module, including details on the player's off-season, pre-competition weeks, active rest and recovery weeks, and appropriate developmental blocks for review and approval. Once approved by the WTA, the player and her coach must also agree to the schedule. Changes to the agreed upon schedule must be submitted to the WTA for approval no less than four (4) weeks prior to such requested change. The approved schedule is subject to review, and failure to comply with the schedule will subject the player to penalties as outlined in Section X.C.2.

Each player also must acknowledge in writing that she has a full understanding of the Singles Commitment Tournament requirements and Player Development Programs.

- iv. Each player must submit to the WTA an official certificate from her country of legal residence verifying that she is meeting or has met her country's minimum educational requirements. A player must submit updated documentation annually until she reaches 18 years of age.
- v. Each player must undergo a mandatory physical examination annually in accordance with Section XVIII.B.1.
- vi. It is a player's responsibility to advise the WTA of any changes in her Player Support Team Members, including coach or agent.

**AGE ELIGIBILITY AND PLAYER DEVELOPMENT**  
**SECTION X - AGE ELIGIBILITY AND PLAYER DEVELOPMENT**

c. Player Support Team Member Requirements

i. Parent(s)

At least one (1) parent or guardian/chaperone of each player under 18 years of age who has qualified to meet all the requirements of participation on the WTA is required to do the following:

- (a) Complete assigned online and/or in-person Player Development coursework and pass an examination covering such material within a maximum time period of three (3) months;
- (b) Agree in writing to abide by the Rules; and
- (c) Comply with all requirements of any Player Support Team program established by the WTA.

ii. Coaches, Agents, and Credentialed Individuals

Coaches and agents of and individuals being credentialed through Player Development players under 18 years of age must:

- (a) Complete assigned online and/or in-person Player Development coursework and pass an examination covering such material within a maximum time period of three (3) months.
- (b) Agree in writing to abide by the Rules.
- (c) Comply with all requirements of any Player Support Team program established by the WTA.
- (d) Sign in at the WTA office on site prior to the beginning of a WTA Tournament.
- (e) A coach who is nominated by a Player Development player to receive and subsequently applies for a WTA player-coach credential must provide proof of Qualification/Certification from a recognized organization or governing body (e.g., a National Federation, the ITF, PTR). A copy of the current certification or confirmation from the governing body that the coach is current and in good standing will be required to receive a WTA player-coach credential.

**AGE ELIGIBILITY AND PLAYER DEVELOPMENT**  
**SECTION X - AGE ELIGIBILITY AND PLAYER DEVELOPMENT**

**5. Elite Phase**

a. Eligibility and Timing

The Elite Phase begins when a player 18 years of age or younger moves into the Top 150 of singles on the WTA Rankings.

A player must continue to participate and fulfill the requirements offered through Player Development until notification of graduation.

b. Elite Phase Player Requirements

- i. Each player must complete assigned online and/or in-person Player Development coursework and pass an examination covering such material.
- ii. Each player must participate in a meeting with the WTA CEO or President and one or more Player Board Representatives.
- iii. Each player must participate in the WTA Mentor Program (e.g., attend Billie Jean King Power Hour, etc.).
- iv. Within one (1) month of eligibility, each player must meet with representatives of the WTA for the purpose of developing and agreeing upon the player's schedule (including but not limited to Professional Tennis Tournaments, Billie Jean King Cup, Olympics, and Exhibitions/Non-WTA Events) for the next twelve (12) months. The player must submit her projected schedule via the online ScheduleZone module, including details on the player's off-season, pre-competition weeks, active rest and recovery weeks, and appropriate developmental blocks for review and approval. Once approved by the WTA, the player and her coach must also agree to the schedule. Changes to the agreed upon schedule must be submitted to the WTA for approval no less than four (4) weeks prior to such requested change. The approved schedule is subject to review, and failure to comply with the schedule will subject the player to penalties as outlined in Section X.C.2.

Each player also must acknowledge in writing that she has a full understanding of the Singles Commitment Tournament requirements and Player Development Programs.

- v. Each player must participate in educational programs offered through Player Development, including but not limited to a Fundamental Financial Planning course, introduction to Tennis

**AGE ELIGIBILITY AND PLAYER DEVELOPMENT**  
**SECTION X - AGE ELIGIBILITY AND PLAYER DEVELOPMENT**

Integrity program, Advanced Media Training, and Career Development programs.

- vi. Each player must undergo a mandatory physical examination annually in accordance with Section XVIII.B.1.
  - vii. Each player must submit to the WTA an official certificate from her country of legal residence verifying that she is meeting or has met her country's minimum educational requirements. A player must submit updated documentation annually until she reaches 18 years of age.
  - viii. It is a player's responsibility to advise the WTA of any changes in her Player Support Team Members, including coach or agent.
- c. Player Support Team Member Requirements
- i. Coaches
    - (a) Continue to comply with all requirements of any Player Support Team program established by the WTA.
    - (b) Continue to sign in at WTA Tournaments.
    - (c) Participate in Player Development online and/or in-person education, as required.
    - (d) Pass the WTA Rules test.
    - (e) A coach who is nominated by a Player Development player to receive and subsequently applies for a WTA player-coach credential must provide proof of Qualification/Certification from a recognized organization or governing body (e.g., a National Federation, the ITF, PTR). A copy of the current certification and/or confirmation from the governing body that the coach is current and in good standing will be required in order to receive a WTA player-coach credential.
    - (f) Complete the Player Development requirements within a maximum of three (3) months.
  - ii. Parents and Agents
    - (a) Continue to comply with all requirements of any Player Support Team program established by the WTA.



**AGE ELIGIBILITY AND PLAYER DEVELOPMENT**  
**SECTION X - AGE ELIGIBILITY AND PLAYER DEVELOPMENT**

- (b) Sign a Code of Ethics.
- (c) Complete the Orientation.
- (d) Sign in at WTA Tournaments.
- (e) Continue participating in Player Development education, as required.
- (f) Complete the Player Development requirements within a maximum of three (3) months.

**6. Premier Phase**

a. Player Requirements

A player who is ranked in the Top 100 of singles on the WTA Rankings at 18 years of age and younger must participate in Premier Player education and any other relevant Player Development activities, including:

- i. Complete the Financial Planning Course.
- ii. Participate in a meeting with the WTA CEO or President.
- iii. Participate in related educational programs offered through Player Development.
- iv. Undergo a mandatory physical examination annually in accordance with Section XVIII.B.1.
- v. Submit to the WTA an official certificate from her country of legal residence verifying that she is meeting or has met her country's minimum educational requirements. A player must submit updated documentation annually until she reaches 18 years of age.
- vi. Within one (1) month of eligibility, meet with representatives of the WTA for the purpose of developing and agreeing upon the player's schedule (including but not limited to Professional Tennis Tournaments, Billie Jean King Cup, Olympics, and Exhibitions/Non-WTA Events) for the next twelve (12) months. The player must submit her projected schedule via the online ScheduleZone module, including details on the player's off-season, pre-competition weeks, active rest and recovery weeks, and appropriate developmental blocks for review and approval.

## **AGE ELIGIBILITY AND PLAYER DEVELOPMENT**

### **SECTION X - AGE ELIGIBILITY AND PLAYER DEVELOPMENT**

Once approved by the WTA, the player and her coach must also agree to the schedule. Changes to the agreed upon schedule must be submitted to the WTA for approval no less than four (4) weeks prior to such requested change. The approved schedule is subject to review, and failure to comply with the schedule will subject the player to penalties as outlined in Section X.C.2.

Each player also must acknowledge in writing that she has a full understanding of the Singles Commitment Tournament requirements and Player Development Programs.

- vii. It is a player's responsibility to advise the WTA of any changes in her Player Support Team Members, including coach or agent.
- b. Player Support Team Requirements

A coach who is nominated by a Player Development player to receive and subsequently applies for a WTA player-coach credential must provide proof of Qualification/Certification from a recognized organization or governing body (e.g., a National Federation, the ITF, PTR). A copy of the current certification and/or confirmation from the governing body that the coach is current and in good standing will be required in order to receive a WTA player-coach credential.

## **C. VIOLATIONS**

### **1. Forfeiture of Ranking Points**

If a player plays in a Tournament that exceeds the number or level permitted to be played under the AER or enters a Tournament that in any way conflicts with the AER or Player Development Programs, she will automatically forfeit any ranking points received from that Tournament.

### **2. Penalties**

- a. Players who do not comply with any of the provisions of the AER or the requirements of the Player Development Programs are subject to:
  - i. a fine of up to the lesser of (a) the amount of prize money earned at a Tournament that was played in violation of the AER or (b) \$25,000; and

**AGE ELIGIBILITY AND PLAYER DEVELOPMENT**  
**SECTION X - AGE ELIGIBILITY AND PLAYER DEVELOPMENT**

- ii. suspension from competing in or attending WTA Tournaments and, subject to ITF agreement, Women's ITF World Tennis Tour events for up to six (6) months.
  
- b. Additionally, Player Support Team Members who do not comply with any of the requirements of the Player Development Programs are deemed in violation and are subject to the penalties of Section XVII.H.

A player or Player Support Team Member may appeal any penalty issued under this Section X.C.2 in accordance with Section XVII – Code of Conduct.

**3. Clarification of Player Development and Age Eligibility Rule**

For any questions relating to Age Eligibility and Player Development, please contact the WTA Player Development or Legal Department.

# PLAYERS

## XI. WTA PLAYER MEMBERSHIP

### A. MEMBERSHIP QUALIFICATIONS

#### 1. Full Membership

##### a. Eligibility

A player is eligible for Full Membership status if she:

- i. is in good standing; and
- ii. has:
  - (a) earned a year-end WTA Ranking of 150 or better in singles or 50 or better in doubles in one (1) of the past two (2) Tour Years; and
  - (b) played in a minimum of six (6) WTA Tournaments (including Grand Slams but not WTA 125 Tournaments) in the most recent Tour Year.

##### b. Benefits

This membership entitles players to all the benefits and voting privileges available to Full Members of the WTA and the WTBA. (See Section XI.B.)

##### c. Annual Dues

The annual membership dues are \$1,500.

#### 2. Associate Membership

Associate Membership is not available to any player who qualifies for Full Membership.

##### a. Eligibility

A player is eligible for Associate Membership status if she:

- i. is in good standing; and
- ii. within the previous twelve (12) months has:
  - (a) earned a WTA Singles Ranking of 500 or a WTA Doubles

**PLAYERS**  
**SECTION XI - WTA PLAYER MEMBERSHIP**

Ranking of 175 for at least one (1) week; and

- (b) played in a minimum of three (3) WTA Tournaments (including Grand Slams but not WTA 125 Tournaments).

If, based on her 2021 results, a player was eligible for Associate Membership status in 2022 and would have been eligible for Associate Membership status in 2023 under the 2022 Rules, she will maintain her Associate Membership status in 2023 regardless of whether she meets the eligibility requirements above.

If, based on her 2022 results, a player would have been eligible for Associate Membership status in 2023 and 2024 under the 2022 Rules, she will maintain her Associate Membership status in 2023 and 2024 regardless of whether she meets the eligibility requirements above.

b. **Benefits**

This membership entitles players to all the benefits available to Associate Members of the WTA and the WTBA. (See Section XI.B.)

c. **Annual Dues**

The annual membership dues are \$650.

**B. MEMBERSHIP BENEFITS**

**1. Full and Associate Member Benefits**

- a. Personal access to the PlayerZone.
- b. Important WTA information and Tournament updates via email.
- c. Optional worldwide medical, dental, and vision insurance.
- d. Waiver of \$250 administrative fee at all WTA Tournaments.

**2. Additional Full Member Benefits**

- a. Optional Disability Insurance.
- b. Eligibility to participate in the Player Pension Plan.
- c. Opportunity to vote for or serve as a Players' Council member.

**PLAYERS**  
**SECTION XI - WTA PLAYER MEMBERSHIP**

A complete list of membership benefits, including player discounts and sponsor programs, is available on the PlayerZone.

**C. MEMBER RESPONSIBILITIES**

**1. Good Standing**

- a. As a condition of WTA membership, players must be in good standing. Players are in good standing with WTA if they:
  - i. Abide by the Rules and the Integrity Rules, including the penalties set forth therein;
  - ii. Pay all monies owed to the WTA, including fines;
  - iii. Comply with applicable Commitment Tournament requirements under the Rules;
  - iv. Comply with the WTA Finals responsibilities under the Rules if eligible and qualified as a Finals Qualified Player or Finals Alternate, unless otherwise approved by WTA;
  - v. Fulfill all required ACES commitments and Media/Sponsor/Public Relations responsibilities under the Rules, if applicable; and
  - vi. Are otherwise confirmed to be in good standing by the WTA CEO.
- b. Penalties for not being in good standing with WTA will result in a player:
  - i. Not being eligible to participate in any bonus program; and
  - ii. Not being entitled to the Full Member benefits in Section XI.B.1.c-d and B.2.

**2. Attendance at Mandatory Meetings**

There will be two (2) mandatory meetings per calendar year for Full Members participating in the Main Draw singles or doubles of the Tournament where the meetings are held. A meeting may be made mandatory for all Full Members or for specific ranking groups of Full Members, as determined by the WTA. If a meeting is mandatory for a player and the player collects her credentials at the Tournament where

**PLAYERS**  
**SECTION XI - WTA PLAYER MEMBERSHIP**

the meeting is being held, the player will be deemed to be available to attend the meeting.

a. Penalty for Non-Attendance

Failure to attend will result in a fine being assessed based on the player's ranking at the time of the Tournament as outlined below:

<b>Player Ranking</b>	<b>Fine Amount</b>
1-10	\$4,000
11-20	\$2,000
21-50	\$1,000
51-100	\$500
101+	\$250

All such fines shall be automatic and non-appealable, except in the case of Extraordinary Circumstances.

b. Appeals

All fine appeals must be filed within twenty-one (21) days from the date of notice.

**3. Completion of New Full Member Orientation**

a. Participation Requirements

Each player eligible for Full Membership for the first time must complete required online and on-site orientation courses related to her participation in the WTA ("New Member Orientation"). On-site New Member Orientation will be no more than three (3) days, with the WTA arranging and covering associated travel costs (e.g., economy flight, hotel, meals) for participating players.

b. Deadlines and Penalties

i. Online

Beginning in 2023, a player must complete the online portion of New Member Orientation by March 31 of the first Tour Year in which she is eligible for Full Membership. If a player fails to complete the online portion of New Member Orientation by the deadline, then she is not entitled to the waiver of the

**PLAYERS**  
**SECTION XI - WTA PLAYER MEMBERSHIP**

administrative fee at WTA Tournaments until she completes such requirement.

ii. **On-Site**

Beginning in 2024, a player must complete the on-site portion of New Member Orientation by the end of the first Tour Year in which she is eligible for Full Membership. If a player fails to complete the on-site portion of New Member Orientation by the deadline, then she will not be deemed to be in good standing until she completes such requirement.

**D. MEMBERSHIP AND INSURANCE ENROLLMENT PERIOD AND PAYMENT OPTIONS**

**1. Membership**

a. All Current Full and Associate Members

All current Full and Associate Members must pay for their Membership for the following Tour Year as follows:

- i. Via their PlayerZone account beginning September 1 of the year prior to the applicable Tour Year;
- ii. With the on-site Supervisor at a WTA Tournament no later than the end of the WTA Elite Trophy; or
- iii. By returning the completed and signed Membership Application Form, plus payment, to WTA headquarters in Florida, USA by December 15 prior to the start of the applicable Tour Year.

Please note that New Full Members, whose eligibility for Full Membership is only confirmed after the WTA year-end rankings, must pay the difference between Associate and Full Membership by March 31 of the following Tour Year.

b. New Associate Members

New Associate Members may join at any time throughout the year by returning the completed and signed Membership Application Form, plus payment, to an on-site Supervisor or to the WTA headquarters in Florida, USA.

Regardless of the date of joining, new Associate Members must renew their Memberships for the following Tour Year by December



**PLAYERS**  
**SECTION XI - WTA PLAYER MEMBERSHIP**

15 of the year prior to the applicable Tour Year for which they are purchasing Memberships.

c. Late Fee

Any current member who does not pay her membership dues by the December 15 deadline will be charged a \$100 late fee for each payment.

**2. Insurance**

All Full and Associate Members of the WTA and WTBA have the option to purchase insurance (currently through Aetna Global PPO) as part of the membership benefit package.

a. Coverage Dates

Insurance coverage is for the calendar year, January 1 to December 31.

b. Coverage Included

i. Full Members

The insurance package for Full Members includes worldwide Medical, Dental, Vision, and Disability coverage, and Full Members also have the option to purchase Disability Insurance only.

ii. Associate Members

The insurance package for Associate Members includes worldwide Medical, Dental, and Vision coverage.

c. Additional Requirement for Disability Coverage

To qualify for Disability Coverage during the current calendar year, players will need the Disability Application Physical Form to be completed by SS&M staff or a personal physician. (WTA physical examinations may be offered at designated Tournaments during the Tour Year.)

d. Enrollment Period

All current Full and Associate Members can purchase insurance:

**PLAYERS**  
**SECTION XI - WTA PLAYER MEMBERSHIP**

- i. By credit card through their PlayerZone accounts; or
  - ii. By sending the completed and signed Membership/Insurance Application Form, plus payment, to WTA headquarters in Florida, USA by December 15.
- e. Late Fee

Any current member who does not pay her insurance fees by the December 15 deadline will be charged a \$100 late fee for each payment.

**E. PENSION PLAN INFORMATION**

**1. Qualification for Pension Plan**

A player must be a Full Member and have five (5) years of Vesting Service to begin receiving 100% of the money in her Pension Plan account when she turns fifty (50) years of age.

**2. Initial Eligibility**

A Full Member initially is eligible for the Pension Plan if she has played at least twelve (12) singles (Main Draw or Qualifying) or ten (10) doubles (Main Draw or Qualifying, only if Qualifying counts for ranking points, excluding mixed doubles) at WTA Tournaments (including Grand Slams but not WTA 125 Tournaments) in one (1) calendar year.

**3. Vesting Service**

After fulfilling her initial eligibility, in subsequent years a Full Member may earn years of Vesting Service by competing in a minimum of six (6) singles (Main Draw or Qualifying) or five (5) doubles (Main Draw or Qualifying, only if Qualifying counts for ranking points, excluding mixed doubles) at WTA Tournaments (including Grand Slams but not WTA 125 Tournaments). Each year of Vesting Service counts towards the five (5) years of Vesting Service that are required to be eligible to begin receiving the money in her account when she turns fifty (50) years of age.

**4. Eligibility to Receive an Allocation from the Plan**

Only Full Members who have competed in either twelve (12) singles (Main Draw or Qualifying) or ten (10) doubles (Main Draw or Qualifying, only if Qualifying counts for ranking points, excluding mixed doubles) at WTA Tournaments, including Grand Slams, in one (1) calendar year will be eligible to receive an allocation from the Pension Plan.

**PLAYERS**  
**SECTION XI - WTA PLAYER MEMBERSHIP**

**5. Allocation from Pension Plan**

The amount of a player's Pension Plan allocation is based on the number of points she receives in each year of Vesting Service. The player earns points at a rate of:

- a. One (1) point for each WTA Tournament (including Grand Slams but not WTA 125 Tournaments) in which the player competed in the Main Draw; and
- b. One-half (½) point for each WTA Tournament (including Grand Slams but not WTA 125 Tournaments) in which the player competed only in the Qualifying event.

**6. Maximum Allocation**

The maximum amount of allocation points that can be earned in a Year are eighteen (18) for singles and fifteen (15) for doubles. Points for singles and doubles are tallied separately and will not be interchangeable.

A Full Member may receive a singles and/or doubles allocation depending upon her individual points earned in that year.

**7. Pension Plan Distributions**

A player must have five (5) years of Vesting Service to receive the amount in her Pension Plan. Payout of that money begins when a player turns fifty (50) and, in most cases, the money is paid as a monthly annuity over twenty (20) years. Specific exceptions, which are set forth in the Plan Document, may apply.

**F. MEMBERSHIP/INSURANCE/PENSION CONTACTS, ADDRESSES AND NUMBERS**

**1. Membership, Insurance Fees, and Pension Plan**

All player questions regarding Membership, Insurance fees, and the Pension Plan should be directed to:

Michaela Oldani  
Player Relations, WTA Tour, Inc.  
100 Second Avenue South, Suite 300N  
St. Petersburg, Florida 33701 USA  
+1 (727) 502-1271  
moldani@wtatennis.com

**PLAYERS**  
**SECTION XI - WTA PLAYER MEMBERSHIP**

**2. Medical and Dental Insurance Claims**

All player claim questions for Medical and Dental Insurance should be directed to:

Aetna Global Benefits/Aetna  
P.O. Box 981543  
El Paso, TX 79998-1543 USA  
+1 (800) 231-7729 or +1 (813) 775-0190  
agbservice@aetna.com

**3. Disability Insurance**

All player questions concerning Disability Insurance should be directed to:

Kelly Price  
EPIC Entertainment & Sports  
5909 Peachtree Dunwoody Road, Suite 800  
Atlanta, Georgia 30328 USA  
+1 (678) 324-3340  
kelly.price@epicbrokers.com



# TOURNAMENTS

## XII. WTA TOURNAMENT MEMBERSHIPS

### A. WTA CALENDAR

Visit [www.wtatennis.com/tournaments/2023](http://www.wtatennis.com/tournaments/2023) for the current 2023 WTA Calendar.

### B. APPLICATION FOR A NEW TOURNAMENT ON THE WTA

Before an application for a new Tournament Class Membership can be considered by the WTA, the prospective owner of a new WTA Tournament must meet all of the obligations enumerated below.

Applicants are advised that the WTA will grant a new membership only if, in the WTA's sole discretion, the new Tournament is geographically and temporally appropriate, within the requirements of the WTA By-Laws and otherwise serves the best interests of the WTA.

#### 1. WTA Application Form

##### a. Deadline

A WTA Tournament Application must be submitted to the WTA by February 28 in the year prior to the Tour Year in which the Tournament is to be conducted.

##### b. Process

The application must be complete in order to ensure that the applicant is in good standing. No application will be acted upon until the WTA has received all information, along with the applicable deposit set forth in sub-Section 2 below.

Prior to consideration of the application by the Board of Directors, the CEO shall conduct such investigation as he/she deems appropriate and shall have the right to require the applicant to furnish any information the CEO deems appropriate.

##### c. Late Applications

Applications received after the due date may be entitled to consideration under the following circumstances:

- i. As replacements for any approved Tournaments which have been cancelled or disqualified as provided in these Rules;

**TOURNAMENTS**  
**SECTION XII - WTA TOURNAMENT MEMBERSHIPS**

- ii. If deemed necessary to fulfill playing opportunities; or
- iii. If it fulfills a geographic market goal of the WTA.

**2. Application Fee and Letter of Credit**

An applicant must submit to the WTA:

- a. A non-refundable application fee in the amount of US\$5,000; and
- b. An irrevocable letter of credit (or other financial vehicle approved by the WTA), which must be valid for three (3) years with three (3) annual draws in the amount of the event's annual prize money pursuant to Section XV.C - Financial Security Requirements ("Letter of Credit").

The Letter of Credit will be cancelled should the Board of Directors not approve the Tournament application.

**3. Approval from National Tennis Association or Federation**

An applicant should make every effort to contact and seek approval from their National Tennis Association or Federation. However, this approval is not required for acceptance onto the WTA.

**4. Site Check**

An applicant must be immediately available, upon request of the WTA, to organize one (1) or more site checks of the proposed venue for hosting the new Tournament. The site check(s) shall be completed prior to the Board of Director's consideration of application. If one (1) or more site checks are deemed necessary by the WTA, the applicant shall pay the cost of such site check(s) (including travel, lodging, food, and other reasonable expenses).

**5. Security Risk Assessment**

An applicant must pay the cost of any security risk assessment(s) prepared by the WTA's Security Director or a professional security consulting firm that the WTA designates if the WTA deems such security risk assessments necessary.

**6. Letter of Agreement**

The WTA will send to the applicant a Letter of Agreement indicating provisional approval of the Tournament and the terms and conditions.

**TOURNAMENTS**  
**SECTION XII - WTA TOURNAMENT MEMBERSHIPS**

This Letter of Agreement must be signed by the applicant and returned before the application will be considered for final approval.

**7. Membership Fee**

Upon approval of the application, the applicant must pay the required membership fee to the WTA (information regarding the amount to be provided by the WTA) and must abide by Section XV.C - Financial Security Requirements.

**C. CONDITIONS OF TOURNAMENT MEMBERSHIP**

A Tournament Class Membership is contingent upon the following conditions:

**1. Governing Agreements**

The Tournament agrees to abide by and be bound by all of the following: the Rules; Code of Conduct; WTA By-Laws; WTA contracts; and any other relevant agreements.

**2. Prize Money**

The Tournament agrees to the minimum prize money levels.

**3. Equal Opportunity**

The Tournament is open to all categories of women tennis players without discrimination.

**4. Minimum Draw Size**

The Tournament agrees to a minimum draw for singles and doubles as set forth in these Rules and as determined in the sole discretion of the WTA.

**5. WTA Application Terms & Provisions**

The Tournament signs and agrees to abide by the terms and provisions of the WTA Tournament Application.

**6. Product Exclusivities**

The Tournament abides by any Product Exclusivities as set forth in Section XIII.A.



**TOURNAMENTS**  
**SECTION XII - WTA TOURNAMENT MEMBERSHIPS**

**7. Supervisor Visit**

If requested by the WTA, the Tournament must pay for the Supervisor's time and travel (lodging, food, and other reasonable expenses) for the week prior to the first edition of the Tournament.

**D. ANNUAL PROCEDURES FOR AN EXISTING WTA TOURNAMENT**

**1. Tournament Information Form**

The Annual Tournament Information Form for existing Tournaments must be submitted no later than February 28 prior to the start of the applicable Tour Year. Any Annual Tournament Information Form submitted after the February 28 deadline must be accompanied by a late fee of US\$1,000. The Annual Tournament Information Form shall be distributed annually by the WTA at least sixty (60) days before the deadline.

**2. Prize Money Currency**

Each Tournament must comply with the following provisions (subject to change) regarding prize money. Revised provisions, if any, will be distributed by the WTA.

a. US Dollars or Euros

Prize money listed in Tournament applications shall be expressed in US dollars. Prize money must be paid in US dollars in the amount stated on the applications and approved by the WTA, except for Tournaments held in Euro Monetary Countries, which must pay the on-site prize money in Euros, but all Tournament-related fees (e.g., tour fees, ELC, etc.) must be paid in US dollars.

The on-site prize money levels for Tournaments held in Euro Monetary Countries will be annually set at the rate of 1.15 US Dollars to 1 Euro. However, this conversion rate does not apply to the Mutua Madrid Open WTA 1000 Tournament.

b. Non-US Dollars or Non-Euros

A Tournament, however, may pay its prize money in non-US dollars (or a non-Euro currency for Euro Monetary Countries) if a written request is made to the WTA at least three (3) months in advance of the Tournament. The WTA reserves the right to deny the request based upon factors including: the stability of the currency against the US dollar (or Euro); the international popularity of the currency; the

**TOURNAMENTS**  
**SECTION XII - WTA TOURNAMENT MEMBERSHIPS**

players' convenience in converting that currency to US dollars (or Euros) or other currency; and the efficiency of the banking system upon which the prize money checks are drawn.

Upon approval of the Tournament's request to pay prize money in a non-US currency (or a non-Euro currency for Euro Monetary Countries), the WTA will confirm the authorized rate of exchange to that Tournament based on the six-month average exchange rate to the US dollar (or the Euro for Euro Monetary Countries) as listed at the internet site [www.oanda.com/converter/cc\\_table](http://www.oanda.com/converter/cc_table) and corresponding to the dates in the following table:

<b>Tournament Beginning</b>	<b>Average 6-Month Exchange Rate Ending On:</b>
January 1 - March 31	October 1
April 1 - June 30	January 1
July 1 - September 30	April 1
October 1 - December 31	July 1

If, seven (7) days prior to the first day of the Tournament, there is a fluctuation in the authorized rate of exchange of at least 5% up or down, then such exchange rate shall be adjusted up or down, as the case may be, according to the following table:

<b>Exchange Rate Fluctuation</b>	<b>Exchange Rate Adjustment</b>
Less than 5%	none
Between 5-10%	5%
10% or greater	One-half the exchange rate percentage fluctuation*

\*For example, if the currency fluctuates 11% down from the authorized exchange rate, the exchange rate will be adjusted by 5.5% (e.g., a 1.36 exchange rate will be adjusted as  $1.36 + (1.36 \times -5.5\%) = 1.2852$ ).

Each Tournament paying on-site prize money in a specific non-US currency (or a non-Euro currency for Euro Monetary Countries) shall obtain from the WTA the official rate for the Tournament as provided above prior to the start of the Qualifying of the Tournament, and shall use the same. Round-by-round prize money breakdowns shall be prominently posted on site and shall include a reference to the corresponding breakdown in US dollars.

**TOURNAMENTS**  
**SECTION XII - WTA TOURNAMENT MEMBERSHIPS**

**3. Additional Tournament Requirements**

In addition to the above requirements, each Tournament must:

- a. Comply with WTA Sponsor Product Category Exclusivities (as set forth in Section XIII.A).
- b. Pay the cost of any security risk assessment(s) prepared by the WTA's Security Director or a professional security consulting firm that the WTA designates if the WTA deems such security risk assessments necessary.
- c. Comply with the Financial Security Requirements applicable to WTA Tournaments owned for three (3) years or less. (See Section XV.C.)

**E. REASONS FOR REJECTION**

**1. Tournament Membership Request**

Any one (1) of the following shall be a valid and adequate reason for not granting a Tournament Class Membership to an applicant: (a) failure to meet the Conditions of Tournament Membership as set forth in Section XII.C; (b) failure to accept or abide by the Rules and the Tournament Commitment herein set forth; (c) previous failure to meet its financial commitments or comply with the Rules; (d) lack of space on the WTA Calendar; (e) direct or indirect ownership by a person or entity which would exceed the Limitations on Ownership (see Section XII.I.7); or (f) other good causes clearly and demonstrably contrary to the integrity of tennis or the WTA.

**2. Calendar Date or Tournament Class Request**

The reasons enumerated in sub-Section 1 above also shall be considered valid and adequate for not assigning the category or WTA Calendar date requested by a Tournament.

**F. TOURNAMENT PRIORITY**

**1. Applicable Situations**

The WTA shall apply guidelines in determining which Tournaments merit priority in the following situations: (a) Tournament Class Membership grants; (b) WTA Calendar rescheduling; and (c) new Tournament approval.

**TOURNAMENTS**  
**SECTION XII - WTA TOURNAMENT MEMBERSHIPS**

**2. WTA Guidelines**

The priority guidelines applied by the WTA include:

- a. Whether an applicant has filed a timely application in full compliance with the requirements published by the WTA.
- b. Geographical practicality and balance in view of:
  - i. The travel convenience of players;
  - ii. The need for mobility between Tournament categories; and
  - iii. The desire to preserve the international concept and growth of the WTA.
- c. The history of the applicant including such factors as:
  - i. The number of years the applicant or its predecessor has operated a tournament at the location, or in the market, where it is currently located;
  - ii. Its promotion of the WTA's sponsor interest;
  - iii. Its status as a national title event;
  - iv. Its record as a women's tournament administered by the WTA;
  - v. Its record of financial responsibility;
  - vi. Its compliance with the Rules and Code of Conduct; and
  - vii. Its involvement with Exhibitions/Non-WTA Events (in the case of a new applicant).
- d. Television exposure and whether there exists a finalized television commitment or a substantial prospect for same.
- e. The relative quality of playing and spectator facilities, including whether the type of playing surface helps to maintain the desirable balance between the variety of playing surfaces in the game.
- f. Marketing consideration consistent with the obligations to and objectives of the WTA.

**TOURNAMENTS**  
**SECTION XII - WTA TOURNAMENT MEMBERSHIPS**

- g. Exposure adequate to promote the objectives and goals of the WTA and women's tennis.
- h. Which application, in the judgment of the WTA, best serves the interest of the sport as a whole.
- i. The applicant's participation in, or aiding and abetting, violations of these Rules.

**G. NO RELEASE**

**1. No Release Deadline**

The "No Release Deadline" for each Tournament shall correspond to the following table:

<b>Tournament Beginning</b>	<b>No Release Deadline</b>
January 1 - June 30	October of previous year
July 1 - December 31	March 15 of same year in which the tournament is to occur

**2. Tournament Release Request**

A member may only be released from its obligation to conduct its Tournament under the following circumstances:

a. Prior to No Release Deadline

The WTA shall approve a member's request to be released from conducting its Tournament provided the request:

- i. Is made in writing;
- ii. Is made on or before the requesting Tournament's No Release Deadline as outlined in sub-Section 1 above;
- iii. Includes the reason for the request;
- iv. Is accompanied by payment to the WTA in the amount of the Tournament's prize money ("Announced Prize Money") as set forth on the Tournament Application or Annual Tournament Information Form, as applicable; and
- v. Is a first-time request from the Tournament.

**TOURNAMENTS**  
**SECTION XII - WTA TOURNAMENT MEMBERSHIPS**

If the member complies with the foregoing requirements, it shall retain its Tournament Class Membership and shall be entitled to conduct a Tournament in the following Tour Year without a change in its status or category.

b. After the No Release Deadline

i. Tournament Obligations

The WTA shall approve a member's request to be released from conducting its Tournament provided the request:

- (a) Is made in writing;
- (b) Is made after the requesting Tournament's No Release Deadline as outlined in sub-Section 1 above;
- (c) Includes the reason for the request; and
- (d) Is accompanied by payment to the WTA of the Tournament's Announced Prize Money.

ii. Additional Tournament Implications

- (a) The Tournament Class Membership shall automatically be suspended, and the member shall have no right to operate a Tournament on the WTA until its Tournament Class Membership is reinstated by the Board.
- (b) Within thirty (30) days of the suspension of the Tournament Class Membership, the member may make a written application for reinstatement to the Board of Directors. The Board of Directors may accept or reject an application for reinstatement in its sole and absolute discretion.
- (c) If a member's request for reinstatement is denied by the Board of Directors, or if the member fails to apply for reinstatement in the designated time frame, the member shall have a limited opportunity to sell its Tournament Class Membership, provided the proposed transfer:
  - (i) Is for the entire Tournament Class Membership (partial sales, leases, and management agreements are not permitted);

## TOURNAMENTS

### SECTION XII - WTA TOURNAMENT MEMBERSHIPS

- (ii) Is a bona fide arm's length transaction with an unrelated or unaffiliated third party;
- (iii) Complies in all respects with the Rules relating to transfer of ownership, including the WTA's approval rights and the WTA's right of first refusal, with the exception of the applicable Transfer Fee, which is addressed in sub-Section (v) below.

For the avoidance of doubt, nothing herein shall be construed:

- To alter or amend the member's obligation to seek and obtain the WTA's prior approval for any Tournament transfer according to the Rules;
  - To limit or restrain WTA's rights to approve, deny, or match a proposed Tournament transfer according to the Rules; or
  - As requiring the WTA to approve any proposed transfer of the membership;
- (iv) Is complete and consummated, including approval by the Board of Directors (if any), prior to the following year's No Release Deadline;
  - (v) Shall be subject to a Transfer Fee calculated at the maximum scheduled Transfer Fee percentage, regardless of the member's tenure with the WTA; and
  - (vi) Stipulates the proposed transferee shall conduct the Tournament in the week on the WTA Calendar in the following Tour Year designated for the Tournament by the Board of Directors.

In the event any of the preceding six (6) conditions is not met, the membership shall be forfeited. (See Section XII.G.6.b - Tournament Implications.)

#### c. Extenuating Circumstances

Under extenuating circumstances, a member may apply to the Board of Directors for an extension of the deadline in sub-Section b.ii.(c)(iv) above, which application the Board of Directors may accept or reject

**TOURNAMENTS**  
**SECTION XII - WTA TOURNAMENT MEMBERSHIPS**

in its sole and absolute discretion. The Board of Directors may attach conditions to the acceptance of such an application including, without limitation, a requirement that the member pay the Announced Prize Money for the following Tour Year.

d. **Second or Subsequent Request from Tournament Class Member**

The same provisions set out in Section XII.G.2.b. – After the No Release Deadline – also apply to a Member making a second or subsequent request to be released from its obligation to conduct its Tournament.

Nothing herein shall either exempt or absolve the member from i) its obligation to pay the Announced Prize Money to the WTA, or ii) its other financial obligations set forth in the Rules.

e. **Tournament Cancellation Due to Health, Safety, or other Matters**

The WTA may cancel or adjust a Tournament's schedule or procedures due to health, safety, or other matters involving risk to players, staff, and/or spectators. Before cancellation of a Tournament pursuant to this sub-Section e, the WTA will consult with the Tournament as well as the local health, law enforcement, or other government authorities, where applicable. Cancellation should be undertaken as a last resort, and the WTA should use great discretion before taking such action. In the event of cancellation by the WTA pursuant to this sub-Section e, the No Release Rule will not apply; provided the reason for the cancellation was outside of the control or prevention of the Tournament. (See Section IX.D.1 for payment of prize money.)

**3. Appeal to Board of Directors**

A member may appeal to the Board of Directors for a waiver or reduction of the requirements and penalties set forth above in the event of a fire, flood, act of war, terrorist act, or similar event which is outside the control or prevention of the Tournament.

However, the decision to grant such waiver or reduction shall be in the sole discretion of the Board of Directors.

**4. WTA Payments to Tournament Class Members**

Should a member not conduct its Tournament in a Tour Year, the WTA shall not make any payments to that member for such Tour Year,



**TOURNAMENTS**  
**SECTION XII - WTA TOURNAMENT MEMBERSHIPS**

including payments for Commercial Benefits, media rights, or any other financial payment otherwise due from the WTA.

**5. Distribution of Collected Prize Money**

All prize money collected in connection with the No Release Rule will be divided evenly between the WTA and the WTBA.

**6. Forfeiture of Membership**

a. Causes

A Tournament Class Membership shall be forfeited immediately in the event a member:

- i. Fails to conduct its Tournament for any reason; and
- ii. Fails to comply with the release requirements set out above.

b. Tournament Implications

Upon forfeiture, a member shall have no future rights or privileges with the WTA and shall lose the right to conduct a Tournament on the WTA.

**H. TERMINATION OF TOURNAMENTS**

**1. Tournament Disqualification**

The WTA may disqualify any Tournament from participation in the WTA if the Tournament commits any of the below acts.

a. Grounds for Disqualification

- i. The Tournament fails to meet the prize money commitments.
- ii. The Tournament fails to provide the commercial identification required pursuant to all relevant agreements.
- iii. The Tournament fails to demonstrate financial responsibility to conduct a Tournament.
- iv. The Tournament fails to pay all expenses or prize money of a Tournament it has conducted.

**TOURNAMENTS**  
**SECTION XII - WTA TOURNAMENT MEMBERSHIPS**

- v. The Tournament fails to fulfill in a timely manner its financial obligations or breaches any other term or condition of the Rules, including Standards of Performance Requirements, or any relevant agreement.

b. Disqualification Process

The WTA must provide the Tournament thirty (30) days' written notice (via email or certified mail) prior to disqualification, unless a Tournament already has been advised that it will not be able to hold its Tournament at the time it has been appointed.

**2. Letter of Credit in Lieu of Disqualification**

In lieu of disqualification for any of the financial failures detailed in sub-Section H.1.a above, the WTA, in its sole discretion, may require a Tournament to post a letter of credit in the full amount of the Tournament's prize money upon thirty (30) days' written notice.

Failure to post a satisfactory letter of credit will result in disqualification from participation in the WTA.

**I. TOURNAMENT OWNERSHIP**

**1. Definition of Ownership**

Ownership of a full Tournament Class Membership is a continuing right, provided the Tournament is in good standing. Each Tournament has the Tournament ownership rights provided in Schedule I of the WTA By-Laws.

**2. Transfer of Ownership**

a. Approval Process

- i. Any member seeking to sell, transfer, assign, convey, or otherwise dispose of, directly or indirectly, whether by operation of law or otherwise, its ownership interest, in whole or in part, in a Tournament Class Membership (a "Transfer") shall satisfy the following steps, as part of the Transfer approval process:

- (a) Submission of a written request for approval of the Transfer to the CEO prior to the attempted transfer and no later than sixty (60) calendar days (unless WTA otherwise agrees in its sole discretion) prior to the next scheduled meeting of the Board of Directors;

**TOURNAMENTS**  
**SECTION XII - WTA TOURNAMENT MEMBERSHIPS**

- (b) Promptly furnishing all information requested by WTA Management;
  - (c) Furnishing information that is accurate and not misleading;
  - (d) Organizing, completing, and paying (including travel, lodging, food, and other reasonable expenses) for one (1) or more site checks if there will be a new venue;
  - (e) Cooperating with any investigation conducted by WTA Management in evaluating the proposed Transfer; and
  - (f) Providing a binding offer to sell the membership to the WTA for a purchase price equal to the amount to be paid by the proposed purchaser solely for the membership interest (without regard to any employment, consulting, or other arrangements and subject to the WTA's right to pay the purchase price as and when it would have been due from the proposed purchaser) (the "Right of First Refusal Offer").
- ii. Upon completion of all the steps required under sub-Section 2.a.i above, the CEO shall submit the proposed Transfer and the Right of First Refusal Offer to the Board of Directors for its approval, acceptance, or other action, except that if the proposed Transfer will not result in the transferee possessing, directly or indirectly, a membership interest of 25% or more, the CEO shall have the power to approve or disapprove the proposed Transfer or accept the Right of First Refusal Offer without submitting it to the Board of Directors for approval or acceptance. The Board of Directors or CEO, as the case may be, shall have the right to disapprove a Transfer in its or his/her sole discretion; however, such approval or acceptance shall not be unreasonably withheld.
- iii. If the WTA elects to accept the Right of First Refusal Offer in sub-Section 2.a.i(f), the WTA shall notify the member in writing of its acceptance within thirty (30) days after the Board of Directors meeting at which the Transfer request is considered (the "Right of First Refusal Period"). If the WTA exercises its Right of First Refusal, the WTA and the member shall thereafter fix a mutually acceptable date for the consummation of the transaction. If the WTA does not notify the member of its intention to exercise the Right of First Refusal during the Right of First Refusal Period, during the sixty (60) days following the expiration of the Right of First Refusal Period, the member may sell its membership interest to the proposed purchaser upon the terms of the offer, but if the sale is not consummated with the proposed purchaser

**TOURNAMENTS**  
**SECTION XII - WTA TOURNAMENT MEMBERSHIPS**

within that sixty- (60) day period, then the provisions of this sub-Section 2.a shall apply again.

- iv. Notwithstanding anything to the contrary in the preceding sub-Sections 2.a.i-iii, in the event a member wishes to transfer its membership interest, but has no satisfactory bona fide prospective purchaser, the member may at any time request that the WTA solicit prospective purchasers on its behalf. A request under this sub-Section 2.a.iv shall be made in writing to the CEO.

The member shall have no obligation to accept any offer that may be obtained by the WTA on its behalf, and the member may withdraw its request under this paragraph at any time.

- v. At any time that a member consummates a Transfer with respect to a Tournament Class Membership interest, the applicable Transfer Fee percentage (set forth in the following table) – assessed to the value of the consideration for the membership provided by the proposed purchaser to the member – shall be imposed by the Board of Directors.

<b>Number of Full Tournaments Conducted to Conclusion Under the Current Ownership</b>	<b>Transfer Fee Percentage<sup>^</sup></b>
1	20%
2	15%
3	15%
4	10%
5	5%
6	5%
7	5%
8 (or More)	3%

<sup>^</sup> The Board of Directors retains the discretion to assess a lesser fee where appropriate, as determined in its sole discretion. The relevant Transfer Fee will be waived for (i) Transfers that take place among members of the same immediate family, (ii) Transfers between entities under common ownership, and (iii) Transfers undertaken as part of a corporate restructuring provided there is no change in the ultimate ownership, including percentages of interests held, of the Tournament Class Membership, should the Transfer be approved pursuant to the Rules.

- vi. If the purchaser of a Tournament Class Membership interest is not currently promoting or operating any WTA Tournament(s) or is not a member, as a precondition to approval of any Transfer under this sub-Section 2.a, the purchaser must agree in writing

**TOURNAMENTS**  
**SECTION XII - WTA TOURNAMENT MEMBERSHIPS**

that it will deposit or provide a letter of credit guaranteeing payment of 100% of the first year's prize money. Payment will be made under this letter of credit in the event the Tournament is not held; if the Tournament is held, payment will be made under the letter of credit only to the extent of a shortfall in prize money payments. Any payment under the letter of credit will be non-refundable.

- vii. The purchaser of a Tournament Class Membership, as a precondition to approval of any Transfer under this sub-Section 2.a, must also agree in writing that it will pay for the Supervisor's time and travel (lodging, food, and other reasonable expenses) for the week prior to the first edition of the Tournament under the new ownership.
- b. Violations of Transfer Rule
- i. WTA Management shall determine whether an attempted Transfer violates sub-Section 2.a in its sole discretion.
  - ii. If WTA Management determines that there has been a violation of sub-Section 2.a, WTA Management shall decide whether to impose a fine in the range of \$100,000 to \$500,000, taking into consideration factors such as the severity of the violation, the size of the transaction, and such other factors as it deems appropriate.
  - iii. In such circumstance, WTA Management shall notify the member of the violation and fine and provide the member the opportunity to submit additional information and to request a waiver or reduction in the fine by the Board of Directors.
  - iv. In connection with submitting the Transfer request to the Board of Directors for consideration (or as soon thereafter as reasonably possible), the CEO shall notify the Board of Directors of the violation and fine.
  - v. The Board of Directors may decide whether to waive or reduce the fine. Any such fine shall be assessed in addition to any Transfer Fee (if the Transfer is approved) or on its own (if the Transfer is disapproved).
  - vi. Approval of any Transfer shall be conditioned on payment of both any Transfer Fee and any fine (subject to a decision by the Board of Directors to waive or reduce the fine).

**TOURNAMENTS**  
**SECTION XII - WTA TOURNAMENT MEMBERSHIPS**

- vii. Any purported Transfer made without full compliance with this Section 2 and/or the WTA's approval shall be voidable by WTA in its sole discretion and, in such case, any such purported Transfer shall be null and void without any force or effect.
  
- viii. Should WTA learn of facts or circumstances constituting a violation of this Section 2 following a purported Transfer and/or approval of a Transfer, WTA has continuing jurisdiction to assess and collect any fine and Transfer Fee in accordance with the foregoing.

**3. Membership Lease**

All Leases shall be subject to the written approval of the WTA and no Lease shall be deemed effective until such approval is provided. No member shall be permitted, directly or indirectly, to enter into or become subject to a Lease, or any amendment or other modification to any Lease, except in accordance with and subject to the provisions set forth in this Section 3. For purposes of this Section, "Lease" shall mean an agreement, arrangement or other transaction whereby the right to operate or manage a Tournament is transferred, in whole or in part, directly or indirectly, by operation of law or otherwise, to an individual or entity that is not the owner of the applicable Tournament Class Membership.

For clarity, a "Lease" shall include any agreement, arrangement or other transaction pursuant to which a member receives any direct or indirect consideration or other benefit from a third party in exchange for (i) a third party managing all or substantially all of the operations of a Tournament and/or (ii) assigning to a third party any material operating or management rights for a Tournament, but shall exclude service agreements or arrangements for ordinary course operations (e.g., concessions, security, ticketing, cleaning, etc.); provided, however, that the CEO shall have the right, taking into account the terms of any such agreement or arrangement and the circumstances related thereto, to determine whether any agreement, arrangement or other transaction shall be deemed a Lease for purposes of this Rule. Members may appeal the CEO's determination to the Board of Directors.

For the avoidance of doubt, any agreement, arrangement or other transaction whereby a member transfers, assigns or leases any "ownership interest" (as defined in Section XII.1.7.c), in whole or in part, shall be considered a Transfer, and therefore subject to the Transfer approval process set forth in Section XII.1.2. Further, for clarity, no member may lease or assign, or delegate to or provide any lessee or other person or entity the right to direct or control, any of its voting rights,

**TOURNAMENTS**  
**SECTION XII - WTA TOURNAMENT MEMBERSHIPS**

whether pursuant to a Lease or otherwise, except in the context of a Transfer in compliance with Section XII.I.2.

- a. Prior to entering into or executing any Lease (or any amendment or modification to any Lease), the member/lessor shall request the written approval of the WTA. Any purported Lease or amendment or modification to any Lease made without full compliance with this Section XII.I.3 shall be null and void, without any force or effect, and may not be performed. The member/lessor wishing to apply for approval of the Lease shall submit a written request for approval of the Lease to the CEO and shall furnish to the CEO the following information and documentation (subject to limited redactions as needed to protect financially sensitive information, if any):
  - i. The name and address of each party to the Lease and each officer, director, and beneficial owner of each of those parties;
  - ii. A written statement certifying the material terms of the proposed Lease, including, without limitation, all potential payments (cash, in-kind benefits or otherwise) by the lessee (or any of its affiliates) to the member (or any of its affiliates);
  - iii. Evidence of the proposed lessee's ability (financial or otherwise) and experience to fulfill the obligations associated with the rights granted in the Lease;
  - iv. Copies of any agreements relating to the Lease; and
  - v. Any other information the CEO deems necessary and requests from time to time for (A) purposes of making a recommendation to the Board of Directors or (B) ensuring that the Lease and arrangement between the member and the lessee are in compliance with the Rules and/or in the best interest of the WTA.

All information and materials submitted to the CEO shall be subject to review by the CEO, and, as the CEO deems appropriate, by WTA legal representatives. Notwithstanding the forgoing, to the extent the CEO deems it necessary to confirm compliance with WTA Rules, the CEO may request any redacted information or materials from a member. In such event, members shall be required to provide such requested information and materials to the CEO on an un-redacted basis; provided, however, that any un-redacted information so provided (i) may only be reviewed by the CEO and, as the CEO deems appropriate, WTA legal representatives, and (ii) shall remain confidential.

**TOURNAMENTS**  
**SECTION XII - WTA TOURNAMENT MEMBERSHIPS**

Notwithstanding the terms and conditions set forth in any Lease, the member/lessor shall separately notify the CEO prior to the extension or renewal of any Lease and/or the exercise of any right of first negotiation, refusal or relocation or other back-end right, and WTA approval shall be independently required at such time:

- (a) to amend, extend the term of, or renew, any Lease by any party thereto, whether by an option, right of first refusal or otherwise;
  - (b) to relocate, or exercise any rights related to relocation of, a Tournament; and
  - (c) to transfer, assign, pledge, mortgage, grant a security interest or other direct or indirect disposition or encumbrance of any Lease or any rights or obligations of any party thereunder.
- b. Upon receipt of the information required under sub-Section 3.a above, the CEO shall conduct such inquiry as deemed appropriate and shall submit to the Board of Directors (i) the CEO's recommendation for approval, acceptance, or other action with respect to the proposed Lease, (ii) the identity of each party to the Lease and relevant background information for each such party, (iii) the term of the Lease, and (iv) any other information the CEO deems necessary for the Board of Director's consideration of the proposed Lease consistent with the confidentiality provisions of Section XII.1.3.a above. The Board of Directors shall have the right, in its sole discretion, to approve or disapprove a Lease or delegate to the CEO the right to approve or disapprove a Lease. Any such approval or acceptance by the Board of Directors or the CEO may be given, withheld or conditioned in the sole discretion of the Board of Directors or the CEO, as applicable. Conditions to approval may include, without limitation, (A) the Lease containing mandatory lease terms (in addition to those set forth in Appendix C) as prescribed by the Board of Directors or the CEO from time to time, and (B) any other condition to ensure that the Lease is in compliance with the Rules and/or in the best interest of the WTA.
- c. For the avoidance of doubt, approval of a Lease by the CEO or the Board of Directors shall not extend to any Subsequent Transaction, whether or not contemplated by the terms of a Lease or otherwise. For purposes of this Section, "Subsequent Transaction" means (i) any amendment or modification to, or extension or renewal of, any Lease or any agreement related thereto, (ii) the exercise by any person or entity of any rights of first negotiation or refusal, relocation



**TOURNAMENTS**  
**SECTION XII - WTA TOURNAMENT MEMBERSHIPS**

rights, other back-end rights or any purchase or sale rights, and (iii) any sale, transfer, assignment, pledge or other disposition or encumbrance by any person or entity of any Lease or any "ownership interest." Any such Subsequent Transaction shall be subject to separate and independent approval by the WTA in accordance with the Rules at the time that any such terms are sought to be triggered and/or exercised by any party.

- d. All Leases shall be required to include, as an attachment or rider thereto, the language set forth in Appendix C (or language in form and substance substantially similar thereto, modified only as necessary to conform to the defined terms in the applicable agreement).
- e. The WTA may in its discretion waive any or all of the requirements of this Section 3.
- f. Any violation of this Section 3 shall be a violation of a Condition of Membership (as defined in the WTA By-Laws) and shall, among other things, be subject to the imposition of sanctions under Section 2.6 of the WTA By-Laws. In such circumstance, WTA Management shall notify the member of the violation and sanction and provide the member with the opportunity to submit additional information. In the event that the WTA learns or becomes aware of facts or circumstances constituting a violation of this Section 3 following finalization of a purported Lease or an amendment or modification to any Lease and/or approval of a Lease, the WTA has continuing jurisdiction to assess any sanction in accordance with the foregoing.
- g. Each member shall be responsible for ensuring compliance with the provisions of this Section 3 in connection with any Lease directly or indirectly relating to it. Furthermore, notwithstanding anything to the contrary in any Lease or otherwise (i) the entering into or enjoyment of any Lease by a member shall not relieve such member of any of its obligations under the Rulebook, the WTA By-Laws, any decision, ruling or action by the WTA Tour (including by the Board of Directors, any authorized committee of the Board of Directors, or the CEO, with respect to matters within their respective jurisdictions), any resolution or policy adopted by the Board of Directors or any other agreement or arrangement between such member and the WTA, (ii) each member shall be responsible for the acts of any lessee or counterparty to any Lease and all payments and other obligations to the WTA, and (iii) any and all lessees or counterparties to any Lease shall be required to comply with all of the terms and provisions of the Rules. All requests and payments made by any member to the WTA shall be made directly by the member/lessor, unless otherwise expressly approved or directed by WTA. Unless otherwise directed

**TOURNAMENTS**  
**SECTION XII - WTA TOURNAMENT MEMBERSHIPS**

by the member/lessor, WTA Management shall have the right, but not the obligation, to communicate and coordinate directly with any lessee of any Lease, including, without limitation, with respect to the operational elements of the applicable Tournament.

- h. In the event a lessee defaults with respect to any of the financial or other obligations in the Rulebook applicable to Tournaments, including the prize money requirements and Tournament Standards of Performance, the lessor shall, at all times, remain liable for such defaults and any penalties for such defaults shall be imposed against the lessor's Tournament Class Membership.
- i. The requirements set out above shall be waived for any Lease entered into before November 3, 2008; provided, however, that the CEO shall have the right at any time, and from time to time, to request copies of any Lease entered into before such date and/or any other information related thereto that the CEO deems reasonably necessary for purposes of making a recommendation to the Board of Directors or ensuring that the Lease and arrangement between the member and the lessee are in compliance with the Rules and/or in the best interest of the WTA, and each member shall be required to furnish all such documentation and information upon request. Any modification, amendment or extension to such a Lease shall be subject to the provisions of this Section XII.I.3.

**4. Request for Change**

All proposed changes to location, date, or other Tournament information as set forth on the Tournament Application or Annual Tournament Information Form must be approved by the WTA. All requests that would impact the WTA Calendar for the next Tour Year must be submitted to the WTA for approval no later than thirty (30) days prior to the Board of Directors meeting at which such WTA Calendar is to be reviewed and approved. If any Tournament or prospective new owner seeks a change it must:

- a. Register a notice requesting the change with the WTA no later than four (4) months (unless otherwise agreed by the WTA in its discretion) after the conclusion of the previous year's Tournament. (Request for Change Forms are available from the WTA);
- b. Furnish the WTA with full details of the proposed change, as determined by the WTA;
- c. Pay the cost of one (1) or more site checks (travel, lodging, food, and other reasonable expenses) if deemed necessary by the WTA;

**TOURNAMENTS**  
**SECTION XII - WTA TOURNAMENT MEMBERSHIPS**

- d. Pay the cost of any security risk assessment prepared by the WTA's Security Director or a professional security consulting firm that the WTA designates if the WTA deems such security risk assessments necessary;
- e. Pay for the Supervisor's time and travel (lodging, food, and other reasonable expenses) for the week prior to the first edition of the Tournament at the new location; and
- f. Be subject to Financial Security Requirements and a loss of Top 10 Player Delivery, as set forth herein.

For any proposed change of location for a membership which has been in the same location for less than five (5) years, if approved by the Board of Directors, such approval shall be subject to payment of a fee in accordance with the below schedule (a "First Change of Location"). The Board of Directors retains the discretion to waive or reduce such fee or collect all or part of the fee in installments.

<b>WTA 1000 Mandatory</b>	<b>WTA 500</b>	<b>WTA 250</b>
\$675,000	\$105,000	\$50,000

If a member makes a request for a change of location for a membership within five (5) years after the start of the calendar year in which an approved First Change of Location takes effect (i.e. the requested change of location would be effective prior to the fifth edition of the Tournament in its current location) and the Board of Directors approves the request (a "Second Change of Location"), such approval shall be subject to payment of a fee in accordance with the below schedule. The Board of Directors retains the discretion to waive or reduce such fee and/or collect all or part of the fee in installments.

<b>WTA 1000 Mandatory</b>	<b>WTA 500</b>	<b>WTA 250</b>
\$1,350,000	\$210,000	\$100,000

If a member makes a request for a change of location for a membership within five (5) years after the start of the calendar year in which an approved Second Change of Location takes effect (i.e. the requested change of location would be effective prior to the fifth edition of the Tournament in its current location), the WTA will have the right to purchase such membership at a price equal to the average purchase price paid solely for memberships of the same Tier level and within the same geographic region (i.e., Americas, Europe, or Asia-Pacific) over the same 5-year period. If the Board of Directors elects not to exercise the right to purchase such membership and approves the request (a "Third

**TOURNAMENTS**  
**SECTION XII - WTA TOURNAMENT MEMBERSHIPS**

Change of Location”), such approval shall be subject to payment of a fee in accordance with the below schedule. The Board of Directors retains the discretion to waive or reduce such fee and/or collect all or part of the fee in installments.

<b>WTA 1000 Mandatory</b>	<b>WTA 500</b>	<b>WTA 250</b>
\$2,700,000	\$420,000	\$200,000

If a member makes a request for a change of location for a membership within five (5) years after the start of the calendar year in which an approved Third Change of Location or any subsequent change of location takes effect (i.e. the requested change of location would be effective prior to the fifth edition of the Tournament in its current location), the WTA will have the right to purchase such membership as set out above for a Third Change of Location or, in the alternative, if the Board of Directors elects not to exercise the right to purchase such membership and approves the request, such approval shall be subject to payment of double the full amount of the fee applicable to the immediately prior change of location. The Board of Directors retains the discretion to waive or reduce such fee and/or collect all or part of the fee in installments.

The following shall not be deemed a change of location for the purpose of this Section 4: (a) a change of venue within 125 miles of the original venue unless otherwise determined by the Board of Directors; (b) Tournaments which have been pre-approved to annually alternate or rotate locations; and (c) location changes made at the request of the WTA. In determining whether a change of venue is a change of location, the Board of Directors may consider the following factors: (i) distance between venues; (ii) defined media markets; (iii) time zones; (iv) climates; (v) topographies; (vi) governments; (vii) predominant languages; (viii) economic specializations; and (ix) international political areas.

A change of location made in conjunction with an approved Transfer shall be deemed a change of location for the purposes of this Section 4.

In connection with any approval of a change of location for a membership and in addition to any rights set forth above, the Board of Directors shall have the right to impose any condition on any change of location that it deems in the best interests of the WTA.

**5. Simultaneous Transfer of Ownership and Location**

A proposed change of location made in conjunction with a request for a transfer of ownership must be made simultaneously, and those requests will be considered jointly. In addition, the change of location fee will not

**TOURNAMENTS**  
**SECTION XII - WTA TOURNAMENT MEMBERSHIPS**

apply to a proposed location change in conjunction with a request for Transfer of ownership; however, the Transfer set out in Section XII.1.2 shall apply.

**6. WTA Action**

- a. If ownership is transferred, the new owner will succeed to the rights and obligations of the former owner. However, if change of location is involved, the new owner's rights and obligations will be the same as the owner of a new Tournament.
- b. Regarding proposed changes of location, if the WTA approves such a change in connection with a Transfer of ownership, it will make best efforts to assign an appropriate date, and the Tournament will then become part of the WTA.

**7. Limitations on Ownership**

- a. No person or entity (or group of persons or entities acting in concert) shall, directly or indirectly, own or control (by contract or otherwise) an "ownership interest" in more than five (5) WTA Tournaments, of which no more than two (2) may be multi-week combined men's and women's events of the same or similar category (e.g., WTA 1000 Mandatory Tournament).

Additionally, no person or entity (or group of persons or entities acting in concert) shall, directly or indirectly, own or control (by contract or otherwise) an ownership interest in more than 45% of WTA Tournaments in the European Geographic Region or the Americas Geographic Region or the Asia-Pacific Geographic Region (as these Regions are defined by the WTA for the purposes of Top 10 Player Delivery); and/or:

- i. 25% of all WTA 1000 Mandatory Tournaments; or
  - ii. 25% of all WTA 500 Tournaments; or
  - iii. 40% of all WTA 250 Tournaments.
- b. Any entity having ownership interests in WTA Tournaments that exceed any of the limitations set forth in sub-Section a above as of June 23, 1999, will be grandfathered as to any such Tournaments above such limitations. However, if such entity sells its ownership interest in a Tournament, it thereafter will not have the right to purchase or obtain an ownership interest in any additional WTA Tournament

**TOURNAMENTS**  
**SECTION XII - WTA TOURNAMENT MEMBERSHIPS**

without WTA approval, if such entity has ownership interests at or above any of the limitations set forth in sub-Section a above.

- c. For purposes of this Rule, the words “ownership interest” shall mean:
- i. Any direct or indirect proprietary interest in a Tournament other than an interest of 5% or less in any call of the equity or debt securities of a member whose shares are traded on an internationally recognized securities exchange (a “proprietary interest”); or
  - ii. With respect to any Tournament in which the relevant person, entity, or group does not have a proprietary interest, the right to:
    - (a) Exercise the Tournament’s voting rights;
    - (b) Apply to the WTA for a change in the venue or geographic location of the Tournament;
    - (c) Serve as or appoint the Tournament’s designated representative; or
    - (d) Transfer any of the rights described in sub-Sections (a)-(c) above, or apply to the WTA for approval to Transfer any direct or indirect proprietary interest in the Tournament.
- d. Without limiting the generality of sub-Section c.i, a person or entity shall be deemed to have an ownership interest in a Tournament if it has a direct or indirect interest in the proceeds resulting from the sale of that Tournament or in the operating income or losses of that Tournament. But a person or entity providing services or guaranteed payments to a Tournament in consideration of an interest in the operating income or losses of that Tournament during the period it is providing those services or payments shall not be deemed to have an ownership interest in the Tournament, provided the CEO has approved the terms of such agreement between any such person or entity and any Tournament. Such agreement shall not be approved if it is found to be an attempt to circumvent Section XII.I.1 – Definition of Ownership.
- e. Discovery and Sanctions for Non-Compliance

If the WTA has reason to believe that a person or entity may own or control multiple Tournaments in addition to those already disclosed to the WTA, it may request such person or entity to provide information that will confirm or negate the existence of such ownership or control.

**TOURNAMENTS**  
**SECTION XII - WTA TOURNAMENT MEMBERSHIPS**

If the person or entity fails to provide such information in a timely fashion or provides inaccurate or incomplete information, the WTA may, in the reasonable exercise of its discretion i) consider such non-compliance in determining whether to impose sanctions; and/ or ii) conclude – based on such non-compliance – that the person or entity does in fact have an ownership interest in the Tournament or Tournaments in question.

**J. TOURNAMENT MINIMUM INSURANCE REQUIREMENTS**

Tournaments are required to participate in the mandated Tournament insurance program. This program will provide for full compliance of all mandated insurance requirements. Coverage costs will be set by WTA's designated insurer each Tour Year. Tournament insurance payments are due to the WTA (or its assigned designee) no later than thirty (30) days prior to the start of the Tournament's Main Draw.

## **TOURNAMENTS**

### **XIII. WTA TOURNAMENT RESPONSIBILITIES/BENEFITS TO WTA**

#### **A. WTA SPONSOR PRODUCT CATEGORY EXCLUSIVITIES**

All Tournaments will have certain responsibilities relating to their sponsorship activities and must act in compliance with the Rules.

WTA sponsorship agreements may not vitiate any Tournament's conflicting, pre-existing sponsorship or exposure agreements, but may preclude the renewal of any such agreements except title and presenting sponsorship agreements.

Conflicting, pre-existing, title and presenting sponsors will be grandfathered in connection with this rule.

A Tournament shall be required, upon request by the WTA, to immediately supply any pre-existing contract with a Tournament sponsor that conflicts with a WTA sponsorship. The Tournament shall be entitled to conceal any competitively sensitive financial information in such a pre-existing contract prior to disclosure to the WTA.

The WTA will pay eligible Tournaments a Commercial Benefit payment in exchange for certain commercial benefits.

#### **B. COMMERCIAL BENEFITS GRANTED TO WTA**

The following sub-Section B provides an overview of Commercial Benefits granted to WTA. Any Tournament requested by WTA to provide Commercial Benefits must do so consistent with this sub-Section B, as may be established by the Board of Directors, and in accordance with the Commercial Benefits and Brand Guidelines for WTA Tournaments that is provided annually to Tournaments and published on the TournamentZone. Please refer to the Commercial Benefits and Brand Guidelines for a complete list of Commercial Benefits applicable to each Tournament.

##### **1. WTA Identification**

Each Tournament shall clearly and prominently identify itself to the public as being part of the WTA and give its full cooperation to the WTA in furthering general public awareness of the competition. Any Tournaments which are combined or back-to-back with an ATP event, shall provide a level of WTA branding which is equal to or greater than the branding provided for the ATP as determined by the WTA; however, in



## **TOURNAMENTS**

### **SECTION XIII - WTA TOURNAMENT RESPONSIBILITIES/BENEFITS TO WTA**

no instance shall such branding fall below the minimums required herein. Each Tournament shall assume all costs associated with compliance hereunder.

#### **2. WTA Name and Logo**

##### **a. Identification on Printed Promotional Materials and Signage**

The WTA shall receive identification via the WTA name and/or logo (including the name of any Title/Premier/Presenting sponsor, if applicable) (“WTA Logo” or “Tour Logo”) on all Tournament promotional materials and informational signage where a Tournament’s title and/or presenting sponsor is identified, including, but not limited to: (i) official notices; (ii) all advertising (including digital advertising, e.g., banner ads); (iii) press releases; (iv) posters; (v) program covers; (vi) tickets; (vii) counter cards; (viii) direct mail pieces; (ix) display materials; (x) brochures; (xi) announcements; (xii) invitations; (xiii) credentials/accreditation badges; (xiv) ticket brochures/offers; (xv) stationery (letterhead, envelopes, etc.); (xvi) interview backdrops; (xvii) draw boards; (xviii) sponsor boards; (xix) welcome entry signs; (xx) vehicles; (xxi) website and social media pages; (xxii) television graphics; (xxiii) video board ads, etc.; and (xxiv) Tournament videos where graphics, animation, and/or open or end slates are inserted. (See Section XIII.E - Pre-Tournament Responsibilities.)

##### **b. Tournament Website and Other Digital Platforms**

Each Tournament must identify the WTA on its website and other digital platforms by prominently placing the WTA Logo and a link to the WTA’s official website on the Tournament’s website and other digital platforms.

##### **c. Conformity to WTA and Sponsor Trademark Guidelines**

All Tournament use of the WTA Logo (including the name and logos of any WTA sponsors, whether composite or stand alone) must conform to the WTA and sponsor branding and trademark guidelines.

##### **d. Size and Shape**

The Tournament logo is the official identity of the Tournament that includes the Tournament name (“Tournament Logo”). When a text alternative of the Tournament Logo is used, it will be regarded as the Tournament Logo and the rules below will continue to apply. When a Tournament Logo is used repeatedly, or if both Tournament Logo and Tournament title are used, application rules will apply to

## TOURNAMENTS

### SECTION XIII - WTA TOURNAMENT RESPONSIBILITIES/BENEFITS TO WTA

the largest Tournament Logo or title. For multiple page documents, wherever the Tournament Logo or name appears, that page must also include the WTA Logo.

The WTA Logo must be a minimum of 40% of the surface area of the Tournament Logo. For combined events, the WTA Logo must be the same size as the ATP name/logo and together these two (2) logos must be a minimum of 60% of the surface area of the Tournament Logo.

e. Positioning

The WTA Logo must appear as a stand alone and must not be included in an associate sponsor or government logo strip. It is recommended that the WTA Logo be placed closest to the Tournament Logo and that no sponsor, federation, or series logo be placed closer to the Tournament Logo than the WTA Logo.

f. Public Address Announcements

In all public address announcements in which the Tournament is identified, it will be identified as a part of the WTA/sponsor. In addition, Tournaments shall broadcast a WTA thirty-second (:30) spot once per hour on each match court video board.

g. Message Board Announcements and Player Introductions

The WTA/sponsor shall also receive references in message board announcements and exposure in player introductions (i.e., "currently ranked 'x' on the WTA").

h. Identification on Chair Umpire Uniforms

The officiating clothing provided by WTA must be worn by Chair Umpires. Except for the WTA Logo, no other commercial branding may be applied to the Chair Umpire clothing, scoring tablet, scoring tablet holder, or microphone without the WTA's and the applicable Tournament's prior approval.

### 3. Banners On Court

a. Number, Size, and Location

At each Tournament the WTA shall be entitled to two (2) on-court banners measuring three (3) feet by seven (7) feet (.91 meters by 2.12 m) on all courts used for television broadcasts. In addition to the foregoing, WTA shall be entitled to two (2) on-court banners on

## **TOURNAMENTS**

### **SECTION XIII - WTA TOURNAMENT RESPONSIBILITIES/BENEFITS TO WTA**

all courts used for live streaming broadcasts, with the banners to be scaled relative to the size of the court.

#### **b. Placement on Court**

One (1) banner must be in direct television view, to be located either:

- i. On the backdrop; or
- ii. Between the service line and the backdrop (on the side with maximum television exposure).

In addition, each Tournament is required to provide the WTA with a schematic of the on-court banner placement no later than thirty (30) days prior to the start of the Qualifying.

#### **c. Designated Promotional Usage**

As notified by the WTA, the banners may be used to promote the WTA and/or a WTA sponsor (provided there is no conflict as addressed in Section XIII.A – WTA Sponsor Product Category Exclusivities).

#### **d. Production**

The Tournament shall be responsible for the cost of producing such signage consistent with the design, coloring, and quality of the other court signage produced by the Tournament.

### **4. Net Post Signs**

WTA/sponsor shall receive exclusive net post signage at both ends of the net on all competition courts. The WTA will provide specifications to each Tournament prior to production deadlines. (See Section XVIII.A.22 - Net.) If WTA/sponsor elects to provide the signage, the Tournament shall be responsible for storing the signage so that it may be used again the following year. Any lost or misplaced signs will be reproduced by WTA/sponsor at the expense of the Tournament.

### **5. Other On-Court Signage**

#### **a. Court Surface**

Where possible, and with individual Tournament approval, a WTA Logo may be painted or fixed to the court surface. Costs associated with application and removal of such logo will be borne by the WTA.

## **TOURNAMENTS**

### **SECTION XIII - WTA TOURNAMENT RESPONSIBILITIES/BENEFITS TO WTA**

#### **b. Back Walls, Sidewalls, and/or Scoreboards**

##### **i. Website Logo**

Where possible, and with individual Tournament approval, each Tournament may place the WTA website logo on its back walls, sidewalls, and/or scoreboards.

##### **ii. WTA Logo**

Where possible, and with individual Tournament approval, each Tournament may place the WTA Logo on its back walls, sidewalls, video boards, and/or scoreboards in order to expose its affiliation with the WTA.

#### **6. Signage Within Precincts of Center Court**

Each Tournament will prominently display one (1) WTA/sponsor sign or banner measuring a maximum of three (3) feet by seven (7) feet (.91 m by 2.12 m) bearing the WTA Logo as close to the precincts of center court so as to maximize its visibility to tennis patrons without dislocating any commercial or sponsor banners that have been sold by or are obligations of the Tournament Director.

#### **7. Press Area/Interview Room**

WTA/sponsor shall receive exposure on satellite interview backdrops and on the press area/interview room backdrops and microphone flags at each Tournament.

#### **8. On-Site Display**

##### **a. Tournament Obligations**

At each Tournament, WTA/sponsor shall have the right to a complimentary on-site display space for sampling, couponing, demonstration, promotion, sale of product or merchandise, etc.

This right to on-site display space will be available at all Tournament sessions for such activities and shall be at no charge to WTA/sponsor so long as the display space consists of at least a basic structure with lighting and a lockable storage area and is consistent with the equipment and services provided to other Tournament display sponsors.

## **TOURNAMENTS**

### **SECTION XIII - WTA TOURNAMENT RESPONSIBILITIES/BENEFITS TO WTA**

b. WTA/Sponsor Obligation

WTA/sponsor will be liable for the cost of staffing and decoration of the on-site display.

c. Substitution

In the event that WTA/sponsor informs the WTA that it will not use its on-site display space, the WTA may be substituted in its place.

d. Additional or Specific Requests

i. From WTA/Sponsor

Should WTA/sponsor require additional space or a specific structure, this will be negotiated with the Tournament on a case-by-case basis.

ii. From WTA

At each Tournament, the WTA may request additional on-site display space for Tour use. Costs shall be borne by the WTA at no greater than the Tournament's cost plus 15%.

## **9. Tournament Program Pages**

a. Number and Placement

WTA/sponsor shall receive, free of charge, four (4) full color pages in total in each Tournament program, one (1) of which must be placed in the first third of the program. Whenever possible, two (2) additional pages should also be placed in the first third of the Tournament program.

b. Additional Pages

At the Tournament's discretion, it shall provide one (1) additional full color page for use by the WTA to identify its sponsors, licensees, and international television broadcasters. Each Tournament may also offer the WTA additional pages if available, the cost of which will be borne by the WTA at no greater than the Tournament's cost plus 15%.

c. Production

In the event production of a Tournament event program is not

## TOURNAMENTS

### SECTION XIII - WTA TOURNAMENT RESPONSIBILITIES/BENEFITS TO WTA

done, the Tournament must provide WTA with notice at least six (6) weeks prior to the start of the Tournament and provide WTA with an alternative means for fulfilling its obligations in a and b above.

#### 10. Seats/Tickets

##### a. Prime Location and Box Seats

For every session of the Tournament, WTA/sponsor shall receive, at no charge: (i) at least six (6) box seats; and (ii) six (6) reserved seats in a prime location.

WTA/sponsor also will be given priority in purchasing, at a discount, additional seats in prime location.

##### b. Upper Level Stadium Tickets

WTA/sponsor shall also receive 200 upper level stadium tickets to one (1) evening session early in the week of each Tournament, provided that the stadium seating capacity is at least 3,000. One hundred (100) of those seats may be allocated over two (2) or three (3) early week evening sessions. If the stadium seating capacity is less than 3,000, the WTA/sponsor shall receive 100 upper level stadium tickets to an evening session early in the week.

##### c. Player and WTA Credentials and Tickets

In addition to the foregoing, each Tournament shall provide the required tickets and credentials to players, player guests, the WTA, and official guests of the WTA as set out under the Tournament Responsibilities. (See Section XVIII.A.10 - Credentials/Tickets/Seating.)

#### 11. Hospitality

WTA/sponsor shall have access to hospitality at all sessions for the six (6) box seat holders. If the Tournament does not have VIP hospitality, it shall offer the six (6) box seat holders the same hospitality, free of charge, as it offers other box seat holders.

In addition, WTA/sponsor shall receive a complimentary hospitality area for a minimum of two (2) sessions.

In North America, food and beverage cost and special tentage and décor costs shall be borne by WTA or sponsor.

## **TOURNAMENTS**

### **SECTION XIII - WTA TOURNAMENT RESPONSIBILITIES/BENEFITS TO WTA**

#### **12. Credentials and Parking**

a. Credentials

WTA/sponsor representatives shall receive six (6) credentials for access to the following areas: i) Press Room; ii) WTA Operations; iii) Hospitality; and iv) Players' Lounge, etc.

b. Parking

WTA/sponsor also shall receive eight (8) VIP parking passes.

#### **13. Pro-Ams**

WTA/sponsor shall receive six (6) spots in the Tournament Pro-Am, where available, or a clinic for twelve (12) hosted by players during the Tournament week.

#### **14. Awards Ceremony**

A WTA executive and a sponsor representative shall be entitled to inclusion and recognition in on-court Tournament award presentations.

#### **15. Press Releases**

The WTA (in connection with its sponsors) has the right to produce and distribute press releases about or relating to the WTA at each and all of the Tournaments provided that press releases relating to a particular Tournament will be approved by that Tournament prior to distribution.

#### **16. Video/Film Rights**

Each Tournament shall make available to the WTA five (5) minutes of film footage as long as it is used for non-commercial purposes, with the exception that film footage may be used for commercial purposes if it is to promote the WTA (e.g., television highlight shows, vignettes, video news releases, etc.).

The WTA will be responsible for duplication and shipping costs.

#### **17. Race to the Finals Leaderboard**

Each Tournament shall post a "Race to the Finals" singles and doubles leaderboard in a prominent location on-site. The WTA will provide specifications to each Tournament prior to production deadlines.

## **TOURNAMENTS**

### **SECTION XIII - WTA TOURNAMENT RESPONSIBILITIES/BENEFITS TO WTA**

#### **18. Doubles Promotion**

Each Tournament shall provide the following benefits:

- a. Prominent on-site display of the doubles draw;
- b. Inclusion of the doubles draw and a featured doubles match in daily draw sheets (if any); and
- c. Doubles section on the Tournament's website.

In addition, it is recommended that Tournaments schedule ACES which are specifically targeted for the utilization of Doubles players.

#### **C. FAILURE TO PROVIDE COMMERCIAL BENEFITS**

All on-court and in-venue Commercial Benefits signage must be completed prior to the start of Qualifying. Failure to provide or timely provide all or a portion of the above Commercial Benefits granted to the WTA will be considered a breach of the Tournament Standards of Performance and will subject the Tournament to, among other things, a reduced Sponsor Benefit Payment. Additional penalties may be imposed in accordance with Section XVIII.A.49 – Breach of Tournament Standards of Performance. Before the reduction of any Commercial Benefits payment, every effort will be made by the WTA and the Tournament to cure the breach.

#### **D. SPONSORSHIP RESTRICTIONS**

In addition to the sponsorship restrictions set forth above and any applicable governmental regulation (including with respect to television), products that are distasteful or embarrassing to WTA members, including but not limited to tobacco (including electronic cigarettes and similar products), firearms, pornographic material, or similar items shall be prohibited as a WTA Tournament sponsor and shall not otherwise be promoted in connection with any WTA Tournament without prior approval of the WTA. In addition, a WTA Tournament is prohibited from displaying the identification of any Sanctioned Entity in Tournament promotional materials, in on-court or in-venue signage or advertisements at the Tournament, on its owned or operated media platforms (e.g., websites, social media accounts, etc.), or on Tournament Support Personnel uniforms.

For gambling sponsorships, Tournaments must comply with the WTA Betting, Fantasy & Gambling Sponsorship Rules (see Appendix D).



## **TOURNAMENTS**

### **SECTION XIII - WTA TOURNAMENT RESPONSIBILITIES/BENEFITS TO WTA**

#### **E. PRE-TOURNAMENT RESPONSIBILITIES**

##### **1. Operations**

Each Tournament must complete a Tournament Fact Sheet and return it to WTA Operations no later than seven (7) weeks prior to the start of the Tournament Main Draw.

##### **2. Sport Sciences & Medicine**

Each Tournament must complete the Tournament Director Information SmartSheet and return it to a WTA Performance Health staff member no later than ninety (90) days prior to the start of the Tournament Main Draw.

##### **3. Communications**

Each Tournament must meet its ACES requirements in accordance with Section VII.A.4.b.

##### **4. Promotional Materials and Signage**

Each Tournament must provide the WTA with proofs of the promotional materials no later than seven (7) weeks prior to the start of the Tournament Main Draw for WTA review and approval.

##### **5. Tournament Match Scheduling**

Each Tournament must provide the WTA with the match schedule plan and TV schedule, including daily start times and night sessions (if applicable), no later than sixty (60) days prior to the start of the Tournament Main Draw for WTA review and approval.

##### **6. Non-WTA Events**

Each Tournament must provide the WTA with the schedule of any and all proposed exhibitions or non-WTA/ATP matches to be held immediately before, during, or immediately after the Tournament no later than thirty (30) days prior to the start of the Tournament Main Draw for WTA review and approval.

## FINANCIAL

### XIV. PRIZE MONEY FORMULA

Each WTA 1000, WTA 500, and WTA 250 Tournament occurring during the 2023 Tour Year is required to pay players a minimum amount of compensation pursuant to this Section XIV.

For the purpose of this Section XIV, the term “Minimum Player Compensation” or “MPC” shall mean, with respect to any Tournament, the Tournament’s minimum gross publicized compensation paid to players (i.e., announced prize money). For the avoidance of doubt, Barter (as defined below) shall not constitute compensation for purposes of this paragraph.

Sub-sections B.1-4 and C do not apply in 2024 and are under review for future application.

#### A. INDIAN WELLS, MIAMI, MADRID, AND BEIJING WTA 1000 MANDATORY TOURNAMENTS

The MPC for the Indian Wells, Miami, Madrid, and Beijing WTA 1000 Mandatory Tournaments shall be equal to the total on-site prize money paid to men tennis players participating in such event; provided, however, that if such WTA 1000 Mandatory Tournament does not have a corresponding men’s event, the MPC shall be equal to the amount stated in such WTA 1000 Mandatory Tournament’s sanction, membership, or other written agreement between the WTA and such WTA 1000 Mandatory Tournament but in any event shall be no less than the lowest amount of MPC paid by the Indian Wells, Miami, Madrid, or Beijing WTA 1000 Mandatory Tournaments.

#### B. ALL OTHER WTA 1000 MANDATORY AND WTA 500 TOURNAMENTS

All WTA 1000 Mandatory Tournaments other than Indian Wells, Miami, Madrid, and Beijing (“All Other WTA 1000 Mandatory Tournaments”) and WTA 500 Tournaments are required to pay players MPC in the amounts determined by the Board of Directors in 2024 and, in subsequent years prior to achieving equal on-site prize money, pursuant to the prize money formula in this Section XIV.B (“PMF”) (each a “Minimum MPC”). Unless otherwise determined by the Board of Directors, the Minimum MPC increases by three percent (3%) each Tour Year (rounded to the nearest \$1,000).

##### 1. All Other WTA 1000 Mandatory Tournaments

Except as this Section XIV.B otherwise states, the Minimum Player Compensation for each of the All Other WTA 1000 Mandatory Tournaments

**FINANCIAL**  
**SECTION XIV - PRIZE MONEY FORMULA**

equals the amount next to the applicable Tour Year in the following table:

2023	An individual Tournament's 2022 MPC multiplied by that Tournament's PSI Growth from (x) that Tournament's average PSI for 2019, 2020, and 2021 to (y) that Tournament's average PSI for 2020, 2021, and 2022, as determined pursuant to Section XIV.B.7 below and subject to adjustment pursuant to Sections XIV.B.3 and 4 below, but not less than \$3,183,000.
2024	An individual Tournament's 2023 MPC multiplied by that Tournament's PSI Growth from (x) that Tournament's average PSI for 2020, 2021, and 2022 to (y) that Tournament's average PSI for 2021, 2022, and 2023, as determined pursuant to Section XIV.B.7 below and subject to adjustment pursuant to Sections XIV.B.3 and 4 below, but not less than \$3,278,000.

**2. WTA 500 Tournaments**

Except as this Section XIV.B otherwise states, the Minimum Player Compensation for each individual WTA 500 Tournament equals the amount next to the applicable Tour Year in the following table:

2023	An individual Tournament's 2022 MPC multiplied by that Tournament's PSI Growth from (x) that Tournament's average PSI for 2019, 2020, and 2021 to (y) that Tournament's average PSI for 2020, 2021 and 2022, as determined pursuant to Section XIV.B.7 below and subject to adjustment pursuant to Section XIV.B.3 below, but not less than \$926,000.
2024	An individual Tournament's 2023 MPC multiplied by that Tournament's PSI Growth from (x) that Tournament's average PSI for 2020, 2021, and 2022 to (y) that Tournament's average PSI for 2021, 2022 and 2023, as determined pursuant to Section XIV.B.7 below and subject to adjustment pursuant to Section XIV.B.3 below, but not less than \$954,000.

**3. Special Circumstances**

a. New Tournaments and Existing Tournaments that Change Locations

If an existing All Other WTA 1000 Mandatory or WTA 500 Tournament changes locations and the new location is within 125 miles of the prior location, the MPC calculations shall include the actual results of the Tournament for each applicable year, subject to the PMF Committee's discretion.

If a new All Other WTA 1000 Mandatory or WTA 500 Tournament is approved to enter the WTA Tour calendar or an existing All Other WTA 1000 Mandatory or WTA 500 Tournament changes locations and the new location is greater than 125 miles from the prior location,

## FINANCIAL

### SECTION XIV - PRIZE MONEY FORMULA

such Tournament's MPC will be determined as follows:

- i. Year 1: MPC will be equal to the MPC of the prior location or, if it is a new All Other WTA 1000 Mandatory or WTA 500 Tournament, the minimum 2020 MPC in the table in Section XIV.B.1, 2, or 3.b, as applicable.
  - ii. Year 2: Year 1 MPC increased by 3%.
  - iii. Year 3: Year 2 MPC multiplied by the respective Tournament's PSI Growth from (x) Year 1 to (y) Year 2.
  - iv. Year 4: Year 3 MPC multiplied by the respective Tournament's PSI Growth from (x) average PSI for Year 1 and Year 2, to (y) average PSI for Year 2 and Year 3.
  - v. Year 5: MPC to be calculated in accordance with this Section XIV.B.
- b. Tournaments that Annually Rotate Between Venues Greater than 125 Miles Apart (e.g., Rogers Cup)

Unless the Board of Directors otherwise determines, for any Tournament that annually rotates between venues that are greater than 125 miles apart, that Tournament's Minimum Player Compensation equals the amount next to the applicable Tour Year in the following table:

2023	An individual Tournament's 2022 MPC multiplied by that Tournament's PSI Growth from (x) that Tournament's average PSI for 2020 and 2021 to (y) that Tournament's average PSI for 2021 and 2022, as determined pursuant to Section XIV.B.7 below and subject to adjustment pursuant to this Section XIV.B.3 and Section XIV.B.4 below, but not less than (a) \$3,183,000 for an All Other WTA 1000 Mandatory Tournament and (b) \$926,000 for a WTA 500 Tournament.
2024	An individual Tournament's 2023 MPC multiplied by that Tournament's PSI Growth from (x) that Tournament's average PSI for 2021 and 2022 to (y) that Tournament's average PSI for 2022 and 2023, as determined pursuant to Section XIV.B.7 below and subject to adjustment pursuant to this Section XIV.B.3 and Section XIV.B.4 below, but not less than (a) \$3,278,000 for an All Other WTA 1000 Mandatory Tournament and (b) \$954,000 for a WTA 500 Tournament.

**FINANCIAL**  
**SECTION XIV - PRIZE MONEY FORMULA**

- c. Tournaments that Annually Rotate Between All Other WTA 1000 Mandatory and WTA 500 Tier Levels (e.g., Doha and Dubai)

In calculating a particular Tour Year's MPC for any Tournament that annually rotates between All Other WTA 1000 Mandatory and WTA 500 Tier levels, the following Rules apply.

- i. A Tournament's MPC for a particular Tour Year will be calculated based on that Tournament's Tier level for that Tour Year as if that Tournament operated at that Tier level for all applicable Tour Years (i.e., as if that Tournament never changed Tier levels), subject to the Tier level minimums for each Tour Year.

For example, in calculating a Tournament's 2023 MPC at the WTA 500 Tier level, its prior Tour Years' MPC amounts shall be calculated, and restated as necessary, as if that Tournament was a WTA 500 event each Tour Year. Similarly, in calculating a Tournament's 2023 MPC at the All Other WTA 1000 Mandatory Tier level, its prior Tour Years' MPC amounts shall be calculated, and restated as necessary, as if the that Tournament was an All Other WTA 1000 Mandatory event each Tour Year.

- ii. In calculating a Tournament's PSI Growth, a Tournament may choose to have either:
- (a) all applicable Tour Years' PSI reflect the payments from the WTA for commercial benefits and television based on the respective Tier level in which the Tournament operates in that particular Tour Year; or
  - (b) all applicable Tour Years' PSI reflect the actual payments that the Tournament received from the WTA for commercial benefits and television in each particular Tour Year;

provided, however, that once a Tournament elects either (a) or (b) above, it cannot change its election for three (3) Tour Years and must apply to the PMF Committee for any such change, which application the PMF Committee may approve or reject in its sole discretion.

For example, in calculating a Tournament's 2023 PSI Growth when it will be operating at the All Other WTA 1000 Mandatory Tier level, its PSI for all applicable Tour Years may include either:

- the WTA payments to All Other WTA 1000 Mandatory Tournaments for commercial benefits and television (even

**FINANCIAL**  
**SECTION XIV - PRIZE MONEY FORMULA**

if that Tournament operated at the WTA 500 Tier level in a prior Tour Year); or

- the actual WTA payments for commercial benefits and television that the Tournament received in each Tour Year (e.g., WTA 500 payments in 2022, All Other WTA 1000 Mandatory payments in 2021, WTA 500 payments in 2020, etc.).
- d. Tournaments that Combine with or Separate from ATP Events

Subject to the approval of the Board of Directors, if a Tournament that previously (i) was combined with an ATP event (regardless of the category or tier level of such ATP event) transitions to a WTA-only Tournament or (ii) was a WTA-only Tournament combines with an ATP event (regardless of the category or tier level of such ATP event), then the Tournament's MPC will be determined as follows:

- i. Year 1 of new Tournament: MPC will be equal to the MPC of the prior Tournament.
  - ii. Year 2 of new Tournament: Year 1 MPC increased by 3%.
  - iii. Year 3 of new Tournament: Year 2 MPC multiplied by the respective Tournament's PSI Growth from (x) Year 1 to (y) Year 2.
  - iv. Year 4 of new Tournament: Year 3 MPC multiplied by the respective Tournament's PSI Growth from (x) average PSI for Year 1 and Year 2, to (y) average PSI for Year 2 and Year 3.
  - v. Year 5 of new Tournament: MPC to be calculated in accordance with this Section XIV.B.
- e. Unanticipated Consequences of the PMF

After the WTA or the Independent Accountant notifies a Tournament of its MPC for a Tour Year, the Tournament may request that the PMF Committee adjust its MPC because of: (i) a one-year, extreme decrease in the Tournament's PSI; or (ii) unanticipated consequences of the PMF that the PMF Committee did not contemplate when creating the PMF. The Tournament must submit such request in writing to the WTA or the Independent Accountant with relevant documentation to substantiate the one-year, extreme decrease in PSI or unanticipated consequences, as applicable.

**FINANCIAL**  
**SECTION XIV - PRIZE MONEY FORMULA**

Upon receiving a request under this Section XIV.B.3.e, the Player Representative Member, Tournament Representative Member, and CEO shall review it and, notwithstanding any of the provisions of Section XIV.B.6, vote to determine whether a one-year, extreme decrease in PSI or unanticipated consequences exist, with a simple majority carrying the vote. If the outcome of such a vote is that a one-year, extreme decrease in PSI or unanticipated consequences do not exist, then the request must be denied. If the outcome of such a vote is that a one-year extreme decrease in PSI or unanticipated consequences do exist, then in accordance with Section XIV.B.6.c the PMF Committee may make any or no adjustments to MPC as a result of the request in its sole discretion. For clarity, a determination that a one-year extreme decrease in PSI or unanticipated consequences exist does not obligate the PMF Committee to make any adjustment to the Tournament's MPC.

**4. Top 10 Player Delivery**

Notwithstanding the foregoing provisions, any increase in the Minimum Player Compensation for the All Other WTA 1000 Mandatory Tournaments will be subject to the following adjustments in the event any Tournament in such category does not receive the Top 10 Player Delivery provided for in Section II.B. In the event any Tournament does not receive Top 10 Player Delivery in a particular Tour Year ("Prior Year"), such Tournament will be considered an "Exempt Tournament" for purposes of the PMF and, in the Tour Year immediately following the Prior Year ("Next Year"), such Tournament will be required to pay player compensation equal to the Tournament's Minimum Player Compensation calculated for the Prior Year.

For purposes of calculating the Exempt Tournament's MPC for a subsequent Tour Year (in which the Tournament received Top 10 Player Delivery and is thus not an Exempt Tournament for such subsequent Tour Year), the Tournament's PSI Growth will be multiplied by the Prior Year's MPC as if the Tournament received Top 10 Player Delivery in all prior years. The below examples in sub-Sections a through d include the following assumptions:

Assumptions for Tournament X:

2017 MPC	\$3,000,000
PSI Growth for 2017	5.00%
PSI Growth for 2018	4.00%
PSI Growth for 2019	5.00%

**FINANCIAL**  
**SECTION XIV - PRIZE MONEY FORMULA**

- a. Example #1 – Calculation of 2019 MPC with Top 10 Player Delivery Received in both 2017 and 2018

2019 MPC: If Tournament X receives Top 10 Player Delivery in both 2017 and 2018, when determining 2019 MPC, PSI Growth will be multiplied by 2018 MPC calculated as if the Tournament received Top 10 Player Delivery in prior years. In this case, 2019 MPC would be \$3,276,000, calculated as follows:

- i. Calculate 2018 MPC as if the Tournament received Top 10 Player Delivery in prior years - 2017 MPC of \$3,000,000 increased by 5%, which is the PSI Growth for 2017.

2017 MPC	\$3,000,000
PSI Growth for 2017	5.00%
2018 MPC	\$3,150,000

- ii. Calculate 2020 MPC by increasing the 2019 MPC calculated in i. above by 4%, which is the PSI Growth for 2019 MPC.

2018 MPC	\$3,150,000
PSI Growth for 2018	4.00%
2019 MPC	\$3,276,000

- b. Example #2 – Calculation of 2019 and 2020 MPC with Missed Top 10 Player Delivery in both 2017 and 2018

2019 MPC: If Tournament X does not receive Top 10 Player Delivery in 2017 and 2018, then its MPC for 2019 will be \$3,000,000, which is equal to its MPC for 2017 and 2018 (no increase in 2019 MPC due to missed Top 10 Player Delivery in 2017 and 2018) and is calculated as follows:

2017 MPC	\$3,000,000	
PSI Growth for 2017	5.00%	not applied because of missed Top 10 Player Delivery in 2017
2018 MPC	\$3,000,000	
PSI Growth for 2018	4.00%	not applied because of missed Top 10 Player Delivery in 2018
2019 MPC	\$3,000,000	

2020 MPC: If Tournament X does not receive Top 10 Player Delivery in 2017 and 2018, when determining 2020 MPC, PSI Growth will be multiplied by 2018 and 2019 MPC calculated as if the Tournament



**FINANCIAL**  
**SECTION XIV - PRIZE MONEY FORMULA**

received Top 10 Player Delivery in 2017 and 2018. In this case, 2020 MPC would be \$3,439,800, calculated as follows:

2017 MPC	\$3,000,000
PSI Growth for 2017	5.00%
2018 MPC	\$3,150,000
PSI Growth for 2018	4.00%
2019 MPC	\$3,276,000
PSI Growth for 2019	5.00%
2020 MPC	\$3,439,800

not actual 2018 MPC (actual was \$3,000,000, which is equal to 2017 MPC); calculated solely for determining 2020 MPC

not actual 2019 MPC (actual was \$3,000,000, which is equal to 2017 MPC and 2018 MPC); calculated solely for determining 2020 MPC

- c. Example #3 – Calculation of 2019 MPC with Missed Top 10 Player Delivery in 2018 Only

2019 MPC: If Tournament X does not receive Top 10 Player Delivery in 2018, then its MPC for 2019 will be \$3,150,000, which is equal to its MPC for 2018 (no increase in 2019 MPC due to missed Top 10 Player Delivery in 2018) and is calculated as follows:

- i. Calculate 2018 MPC as if the Tournament received Top 10 Player Delivery in prior years - 2017 MPC of \$3,000,000 increased by 5%, which is the PSI Growth for 2017.

2017 MPC	\$3,000,000
PSI Growth for 2017	5.00%
2018 MPC	\$3,150,000

- ii. Calculate 2019 MPC as equal to the 2018 MPC calculated in i. above because of the missed Top 10 Player Delivery in 2018.

2018 MPC	\$3,150,000
PSI Growth for 2018	4.00%
2019 MPC	\$3,150,000

not applied because of missed Top 10 Player Delivery in 2018

- d. Example #4 – Calculation of 2019 MPC with Missed Top 10 Player Delivery in 2017 Only

2019 MPC: If Tournament X does not receive Top 10 Player Delivery in 2017, when determining 2019 MPC, PSI Growth will be multiplied by 2018 MPC calculated as if the Tournament received

**FINANCIAL**  
**SECTION XIV - PRIZE MONEY FORMULA**

Top 10 Player Delivery in 2017. In this case, 2019 MPC would be \$3,276,000, calculated as follows:

- i. Calculate 2018 MPC as equal to 2017 MPC because of the missed Top 10 Player Delivery in 2018.

2017 MPC	\$3,000,000
PSI Growth for 2017	5.00%
2018 MPC	\$3,000,000

not applied because of missed Top 10 Player Delivery in 2017

- ii. Calculate 2019 MPC as if the Tournament received Top 10 Player Delivery in prior years - 2017 MPC of \$3,000,000 increased by 5%, which is the PSI Growth for 2017, and 2018 MPC increased by 4%, which is the PSI Growth for 2018.

PSI Growth for 2017	5.00%
2018 MPC	\$3,150,000
PSI Growth for 2018	4.00%
2019 MPC	\$3,276,000

not actual 2018 MPC; calculated solely for determining 2019 MPC

A Tournament will only be an Exempt Tournament for the Tour Year immediately following the Tour Year in which such Tournament did not receive its Top 10 Player Delivery.

The terms of this sub-Section 4 shall not apply to Indian Well, Miami, Madrid, or Beijing WTA 1000 Mandatory Tournaments, as to which any absence of Top 10 Player Delivery shall result in the consequences specified in Section II.B.

**5. Definitions**

- a. Primary Sources of Income

“Individual Tournament Primary Sources of Income” or “Individual Tournament PSI” for any individual Tournament, as applicable, in any Tour Year shall be equal to, without duplication:

- i. the aggregate revenues in respect of any advertising, sponsorship and promotion relating to such Tournament (including the value of any property or services from any Barter), net of all Taxes (as defined below), receivable by such Tournament or their Tournament Affiliates (as defined below) in respect of such Tour Year (as determined by the PMF Committee (as defined

**FINANCIAL**  
**SECTION XIV - PRIZE MONEY FORMULA**

below)), including all revenues from any Tournament sponsor or advertiser in any form, irrespective of how such revenues are characterized by the Tournament or Tournament Affiliate (e.g., including any payments in respect of tickets, premium seating, hospitality, naming rights, etc. by any sponsor that are made in connection with such sponsor's arrangement with the Tournament or Tournament Affiliate, in each case, subject to Section XIV.B.8.f); plus

- ii. the aggregate revenues (including the value of any property or services from any Barter) in respect of any sale, licensing or other exploitation of Television Rights, net of all Taxes, receivable by such Tournament or their Tournament Affiliates in respect of such Tour Year (as determined by the PMF Committee); plus
- iii. the aggregate revenues (including the value of any property or services from any Barter) in respect of any sale, lease or license of, without duplication, (i) tickets and other gate receipts, (ii) luxury suites, premium or club seating and seat licenses, (iii) hospitality packages, and (iv) any other form of admission (including any payments or rebates from any ticketing agent), in each case, net of Taxes and any Ticketing Fees (as defined below), receivable by such Tournament or their Tournament Affiliates in respect of such Tour Year (as determined by the PMF Committee) (collectively, "Admission Rights"); plus
- iv. the aggregate payments receivable by such Tournament or their Tournament Affiliates from the WTA (except for any payments for which the WTBA is due a like-kind amount, which shall be accounted for as Non-WTA revenues, and except for payments from the WTA related to missed Top 10 Player Delivery, which shall be accounted for as Non-PSI revenues), including, without limitation, payments from the WTA for commercial benefits or television; minus
- v. for each Tournament that received a Capital Credit (as defined below) for such Tour Year, the product of (x) such Capital Credit, multiplied by (y) a fraction, the numerator of which shall be the total player compensation paid by such Tournament for such Tour Year, and the denominator of which shall be the total actual, estimated or projected (as applicable) PSI of such Tournament and its Tournament Affiliates for such Tour Year. The Capital Credits may not reduce the increase in any Tournament's PSI below \$0.

**FINANCIAL**  
**SECTION XIV - PRIZE MONEY FORMULA**

- vi. Notwithstanding the foregoing provisions of this Section XIV.B.5.a, PSI for any individual Tournament shall always equal or exceed 85% of such Tournament's Aggregate WTA Revenues (defined below) (as determined by the PMF Committee, subject to Section XIV.B.6.f). In the event PSI would otherwise be less than 85% of the Tournament's Aggregate WTA Revenues, the PMF Committee shall adjust the calculation of PSI by including the Tournament's next largest revenue category (from among those identified in the following sentence) in the calculation of PSI until the PSI for the Tournament equals or exceeds 85% of the Tournament's Aggregate Revenues, and any revenue categories so included shall continue to be included in the calculation of the PSI for the Tournament going forward. The eligible revenue categories include, but are not limited to (i.e., new or currently unknown categories may be included), merchandise, parking and food and beverage. For purposes of this calculation, any Barter which is excluded from the calculation of PSI pursuant to sub-Sections XIV.B.5.e.i(a), (b), and (c) shall not be included in the Tournament's Aggregate Revenues.

"Tournament Aggregate WTA Revenues" shall be the sum of PSI and Non-PSI. "Non-PSI" shall be defined as any and all revenues related to the Tournament other than those revenues included in PSI, including, but not limited to, merchandise, parking, food and beverage, and any contributions received from, or investments made by, a concessionaire pursuant to a concessionaire agreement (with such contributions and investments included in Non-PSI on an amortized basis over the entire term (or remaining term if a contribution or investment occurs after the first year of the term) of the applicable concessionaire agreement).

Any and all revenues unrelated to the Tournament shall be considered "Non-WTA" and are not to be included in the determination of "Tournament Aggregate WTA Revenues". Examples of Non-WTA revenues may include, but not be limited to, developmental tennis academies or activities, rentals or other revenues related to non-WTA events held at the stadium throughout the year but outside of the Tournament period, and any Barter which is excluded from the calculation of PSI pursuant to sub-Sections XIV.B.5.e.i(a), (b), and (c).

- vii. If any Tournament or Tournament Affiliate receives payment from the WTA related to a tier downgrade or other sanction, such payment(s) shall be classified as Non-WTA revenues and excluded from the calculation of PSI, Non-PSI and Tournament Aggregate WTA Revenues.

**FINANCIAL**  
**SECTION XIV - PRIZE MONEY FORMULA**

b. PSI Growth

“PSI Growth” from Period A to Period B shall be equal to the sum of (i) one, plus (ii) the percentage difference, expressed as a decimal and rounded to the nearest hundredth of 1%, between PSI for Period A and PSI for Period B (the “PSI Percentage Increase”), minus (iii) an “Expense Credit”, expressed as a decimal, determined as follows:

<b>PSI Percentage Increase</b>	<b>Expense Credit</b>
Less than 7.00%	3.00%
Equal to or greater than 7.00% but less than 7.50%	2.00%
Equal to or greater than 7.50% but less than 8.00%	1.50%
Equal to or greater than 8.00%	1.00%

provided, however, that in no event may the result of a Tournament’s PSI Growth calculation for any period be less than zero.

c. Capital Credits

The purpose of “Capital Credits” is to provide an incentive for Tournaments to make capital investments in their stadia and other facilities. For 2023, the Capital Credit for any Tournament shall be equal to the actual amount of depreciation for all capital items (determined in accordance with IFRS or US GAAP (as such terms are defined below), as applicable) for Pre-Approved Capital Projects (as defined below) to the extent recorded by a Tournament or its Tournament Affiliate in accordance with IFRS or US GAAP (as applicable), applied on a straight-line method over the depreciable life of the applicable capital item (not to exceed 20 years) commencing with the first Tour Year in which such capital item is placed in service by the applicable Tournament or Tournament Affiliate.

For any Tournament that has multiple Capital Credits, the Capital Credits each year are limited to the amount of the Tournament’s annual PSI increase. Any unused or unrealized Capital Credits will not be carried forward to subsequent years.

For example, if a Tournament has Capital Credits of \$45,000 in 2022 and \$25,000 in 2023, the Tournament’s PSI increase before the Capital Credit would have to be at least \$45,000 in 2022 and \$70,000 (\$45,000 plus \$25,000) in 2023 in order to receive the full Capital Credit. If the Tournament’s PSI increase from 2022 to 2023 before the Capital Credit was \$55,000, its Capital Credit would be limited to \$55,000.

**FINANCIAL**  
**SECTION XIV - PRIZE MONEY FORMULA**

“IFRS” means International Financial Reporting Standards, consistently applied.

“Pre-Approved Capital Projects” are those capital projects that (a) are placed in service by a Tournament or Tournament Affiliate on or after January 1, 2009, (b) constitute improvements to a Tournament’s tennis stadium, arena or other facility that the Tournament demonstrates to the satisfaction of the PMF Committee is likely to result in growth in PSI, and (c) are approved in advance by the Board of Directors upon the recommendation of the PMF Committee.

“US GAAP” means United States generally accepted accounting principles, consistently applied.

d. Tournament Affiliates

For purposes of this Section XIV, the term “Tournament Affiliate” means, with respect to any Tournament, any entity that is (a) involved in the operation, marketing or broadcast of such Tournament’s event and (b) either (i) an operator of such Tournament, or an owner of, or an entity that controls, in either case whether directly or indirectly, a 30% or greater equity interest in such Tournament (an “Owner/Operator”), (ii) an entity in which an Owner/Operator owns, directly or indirectly, a 30% or greater equity interest, or (iii) otherwise in control of, controlled by or under common control with any Owner/Operator.

Any and all revenues received by a Tournament Affiliate of any Tournament shall be included in the calculation of PSI, as if such revenues had been received by such Tournament itself, subject to exclusions for Non-WTA activity as described below.

The PMF Committee shall review all of a Tournament’s transactions with its Tournament Affiliates that the Tournament reports in accordance with Section XIV.B.7 and determine whether any revenue from those transactions is, or should be, PSI.

e. Other Definitions

For purposes of this Section XIV:

- i. The term “Barter” shall mean the value of any trade for goods or services receivable by a Tournament or Tournament Affiliate in exchange for any of the revenues that are included in the calculation of PSI under Section XIV.B.5.a. All Barter, regardless of whether the Barter is utilized by the Tournament or by the

**FINANCIAL**  
**SECTION XIV - PRIZE MONEY FORMULA**

Tournament Affiliate, shall be included in the calculation of PSI, except for the following:

- (a) any Barter consisting of media commitments for promotional time or space that are not for resale and are used solely (a) to promote the Tournament, (b) to promote the WTA or any related event or activity of the Tournament that generates PSI, (c) to promote charitable or not-for-profit organizations or agencies that are unrelated to the Tournament or Tournament Affiliate, or (d) for public service announcements;
  - (b) any Barter that is both used to satisfy the Tournament Standards of Performance and is for the direct benefit of the players. Such direct player benefits include, but are not limited to, hotel accommodations; player transportation; player food, meals and beverages; lounge for players; internet access for players; and gifting and on-court supplies for players; and
  - (c) any Barter that is transferred to a third party as part of an agreement that produces revenues that are included in the calculation of PSI under Section XIV.B.5.a.
- ii. The term "Television Rights" means any and all rights to transmit the audio-visual depictions of matches, whether whole or partial, for reception by the public by any means and in any form now known or hereafter devised. "Television Rights" shall include the right to transmit such depictions to "in-flight" devices, computers, cellular telephones, handhelds, PDAs and other mobile devices capable of receiving the transmission of such depictions.
  - iii. The term "Taxes" means any and all taxes, surcharges, levies, impositions and other charges imposed or assessed on any Tournament or Tournament Affiliate by any governmental or quasi-governmental authority that are not refunded to, or otherwise received as a benefit by, such Tournament or Tournament Affiliate in any form, except for any taxes, surcharges, levies, impositions and other charges that (x) are imposed or assessed on the total income or revenues of any person or entity, or (y) are imposed or assessed specifically on or against the activities conducted by such Tournament or Tournament Affiliate at the site of the event, or any income, revenues, profits or other consideration generated there from (unless the tax, surcharge, levy, imposition or charge applies to the same or similar activities conducted by a reasonably broad range of other businesses or

**FINANCIAL**  
**SECTION XIV - PRIZE MONEY FORMULA**

persons in the applicable jurisdiction or income, revenues, profits or other consideration therefrom, and otherwise qualifies under this definition of "Taxes").

- iv. The term "Ticketing Fees" means any and all fees, convenience charges, surcharges or other charges imposed on any Tournament or Tournament Affiliate by any ticketing agent on the purchase of tickets or other Admission Rights that are not refunded to such Tournament or Tournament Affiliate.

**6. PMF Committee**

- a. A committee ("PMF Committee") shall be appointed as provided below to assist in all matters relating to the establishment, implementation, interpretation, administration and calculation of the PMF.
- b. The PMF Committee will consist of (a) one (1) Player Board Representative selected by a majority vote of the Player Board Representatives (the "Player Representative Member"), (b) one (1) designee of the Player Board Representatives, who shall be selected by a majority vote of the Player Board Representatives and shall have experience in accounting matters (together with the Player Representative Member, the "Player Committee Members"), (c) one (1) Tournament Board Representative selected by a majority of the Tournament Board Representatives (the "Tournament Representative Member"), (d) one (1) designee of the Tournament Board Representatives, who shall be selected by a majority vote of the Tournament Board Representatives and shall have experience in accounting matters (together with the Tournament Representative Member, the "Tournament Committee Members"), and (e) the CEO. Members of the PMF Committee (other than the CEO) may be removed and replaced at any time by (x) in the case of any Player Committee Member, a majority vote of the Player Board Representatives, and (y) in the case of any Tournament Committee Member, a majority vote of the Tournament Board Representatives. Only the Player Representative Member and the Tournament Representative Member shall be entitled to vote in any proceedings or deliberations of the PMF Committee. The other members of the PMF Committee will be entitled to participate in all such proceedings and deliberations (unless otherwise mutually determined by the Player Representative Member and the Tournament Representative Member) but shall not be entitled to vote.
- c. Subject to Section XIV.B.6.f below, the PMF Committee will be responsible, in the first instance, for determining any and all issues that may arise from time to time with respect to the establishment,



**FINANCIAL**  
**SECTION XIV - PRIZE MONEY FORMULA**

interpretation, implementation, administration or calculation of the PMF. All decisions and actions of the PMF Committee shall be determined by the unanimous vote of the Player Representative Member and the Tournament Representative Member. In the absence of such a unanimous vote, the PMF Committee shall not be deemed to have made any decision or taken any action. A quorum shall exist only when both the Player Representative Member and the Tournament Representative Member are present; in the absence of such a quorum, the PMF Committee shall not conduct any business whatsoever. The PMF Committee shall, if requested by any member of the PMF Committee or any member of the Board of Directors, set forth its decision in a written memorandum. Notwithstanding anything to the contrary in this Section XIV.B.6.c, for any PMF Committee decision or action that requires the unanimous vote of the Player Representative Member and the Tournament Representative Member, the PMF Committee may make such decision or take such action without a meeting upon the unanimous consent of the Player Representative Member and the Tournament Representative Member, which may be written or electronic and, as long as it is submitted with information from which authorization can be determined, will have the same effect as the unanimous vote of the Player Representative Member and the Tournament Representative Member.

- d. The PMF Committee shall also be responsible for (a) appointing an independent accounting firm (the "Independent Accountant") to assist the PMF Committee in developing and overseeing the system of Tournament reporting, to perform certain procedures on Tournament reports, to report on the results of such procedures and to assist the PMF Committee in its calculation of the Minimum Player Compensation utilizing information reported by the Independent Accountant through such procedures (together with any other information otherwise received by the Independent Accountant and as the PMF Committee may determine from time to time), (b) recommending in advance any Capital Credits for eligible capital projects, and (c) reviewing and ratifying the Independent Accountant's calculation of the Minimum Player Compensation for each Tour Year in accordance with this Section XIV.
- e. The PMF Committee shall meet or consult with representatives of the Independent Accountant at least four (4) times (quarterly) during each Tour Year, including (a) at least once prior to March 31 of the Tour Year to review the scope of the Procedures (as defined below) and (b) again to review the results of the Procedures prior to finalizing the calculation of Minimum Player Compensation for Individual Tournaments the following Tour Year.

**FINANCIAL**  
**SECTION XIV - PRIZE MONEY FORMULA**

- f. If the PMF Committee does not resolve an issue by the unanimous vote of the Player Representative Member and the Tournament Representative Member required under Section XIV.B.5.c within 90 days after the issue has been disclosed to the PMF Committee (unless such period is extended for a further defined period by the PMF Committee in accordance with Section XIV.B.6.c above), the matter shall be referred to an independent mediator (the "Mediator"). The Mediator shall not have any relationship to the WTA (including, without limitation, any relationship to or with any member of the WTA, any member of the PMF Committee, the Independent Accountant or WTA management) that could reasonably be expected to interfere with the exercise of such person's independent judgment. The Mediator shall be appointed by the unanimous consent of the Board of Directors, after consultation with the CEO. If the Board of Directors is unable to agree on the appointment of the Mediator within a reasonable period of time, either the Player Representative Member or the Tournament Representative Member may request that the Mediator be appointed by the AAA. The Mediator shall serve for a defined term of no less than one (1) year (or a term of one (1) year, if appointed by the AAA), but may be discharged at any time by the unanimous consent of the Player Board Representatives and the Tournament Board Representatives. All proceedings conducted by or otherwise involving the Mediator shall be conducted in a cost-effective manner, with presentations by videoconference whenever such means are less costly than a live hearing. The Mediator shall set forth his or her recommended resolution in a written memorandum within sixty (60) days of the date the mediation commenced (unless such period is extended for a further defined period with the unanimous consent of the Board of Directors). If the issue is not fully resolved by the unanimous vote of the Player Representative Member and the Tournament Representative Member required under Section XIV.B.5.c within ten (10) days after the Mediator's issuance of his or her recommended resolution, any Player Board Representative, any Tournament Board Representative, the WTBA or any Tournament may refer the issue to arbitration for final and binding resolution in accordance with Section XIX.A below. The recommendation of the Mediator shall be kept strictly confidential, and shall not be disclosed to or considered by any arbitrator appointed pursuant to Section XIX.B.

**7. Reporting System**

- a. On an annual basis, each Tournament shall prepare and submit to the Independent Accountant and PMF Committee a complete report of its actual PSI and other financial results for such event (including all business and operations related to the event conducted by any

**FINANCIAL**  
**SECTION XIV - PRIZE MONEY FORMULA**

Tournament Affiliate), in the form prescribed from time-to-time by the PMF Committee (a “Final Report”) no later than 120 days after the conclusion of the Tournament; provided, however, that a Tournament may apply to the PMF Committee for a reasonable extension of the deadline to file its Final Report in extraordinary circumstances (e.g., force majeure, significant data loss or system failure, etc.), which the PMF Committee may approve or reject in its sole discretion. A Tournament that fails to submit its Final Report within 120 days after its conclusion is subject to a fine in accordance with Section XIV.B.10.

- b. Unless otherwise determined by the PMF Committee, all Final Reports and Supplemental Information (as defined below) shall be prepared in accordance with IFRS (or, with respect to any Tournament held in the United States, US GAAP), this Section XIV, and the instructions to the Final Reports and Supplemental Information (collectively, including IFRS or US GAAP (as applicable) and this Section XIV, the “Reporting Requirements”). To the extent of any conflict or inconsistency between IFRS or US GAAP and the terms of this Section XIV or any instructions to the Final Reports or Supplemental Information, the terms of this Section XIV or such instructions shall control.
- c. All Final Reports shall be certified by the principal owner of the Tournament and the Tournament’s tournament director as fairly presenting, in all material respects, the results of operations of the Tournament (including all business and operations conducted by any Tournament Affiliate), in accordance with the Reporting Requirements. If at any time the principal owner, tournament director, or any accounting or financial employee, contractor, or agent of a Tournament learns of an error in a Final Report or any other document or information submitted to the PMF Committee, the Tournament must disclose the error to the PMF Committee and the Independent Accountant. For clarity, each principal owner and tournament director must advise its accounting and financial employees, contractors, and agents of their obligations to disclose such errors, and each Tournament is solely responsible for the contents of its Final Report and any other documents or information it submits to the PMF Committee.
- d. The Independent Accountant shall review each Tournament’s financial results and the reasonableness of any estimates or projections of revenues, expenses or Capital Credits included in the Final Reports and may propose adjustments to such estimates or projections as the Independent Accountant deems appropriate; provided, however, that subject to Section XIV.B.6.f, the determination of all calculations shall

**FINANCIAL**  
**SECTION XIV - PRIZE MONEY FORMULA**

be made by the PMF Committee. Furthermore, the PMF Committee may require any Tournament to submit such supplemental financial or other information or reports as the PMF Committee may request from time-to-time ("Supplemental Information").

- e. The Independent Accountant shall issue a report on each Tournament's Final Report (and Supplemental Information, as applicable) to the PMF Committee. The PMF Committee shall determine each Tournament's Minimum Player Compensation for the following Tour Year in accordance with the PMF and based on the actual PSI and other financial results set forth in the Final Report (and Supplemental Information, as applicable). Such determinations shall be calculated individually for each Tournament and communicated to each Tournament as follows:
  - i. Projected calculation of the following Tour Year's MPC will be provided to the Tournament within 30 days after the Tournament's submission of their Final Report for the prior year; and
  - ii. The final level of MPC for the following Tour Year will be provided to the Tournament at the next quarterly meeting of the PMF Committee.
- f. The PMF Committee may from time-to-time, subject to Section XIV.B.6.f, promulgate, amend and modify rules and interpretations under this Section XIV, including, without limitations, financial reporting procedures and requirements and the forms for the Final Reports.

**8. Accounting Rules**

- a. PSI shall be calculated exclusively pursuant to the accrual method of financial accounting and not, for any purpose, the cash method of financial accounting.
- b. For the purpose of calculating PSI, any Barter shall be valued at the fair market value of the goods or services received by the Tournament or Tournament Affiliate.
- c. If any Tournament or Tournament Affiliate receives guaranteed cash payments (including any up-front or lump-sum payment) in the first year of any agreement that produces PSI that exceeds the average annual guaranteed cash payments due under such agreement (which average shall be calculated by dividing the aggregate guaranteed cash payments payable under such agreement, including the guaranteed

**FINANCIAL**  
**SECTION XIV - PRIZE MONEY FORMULA**

cash payments payable in the first year, by the total number of years of the scheduled term of the agreement, excluding options to extend and customary early termination rights), the amount of such excess shall be deemed to have been received ratably by such Tournament or Tournament Affiliate over the scheduled term of such agreement, unless such scheduled term exceeds seven (7) years, in which case, such amount shall be deemed to have been received ratably over the first seven (7) years of such scheduled term, with interest at an appropriate rate determined by the PMF Committee.

- d. If any Tournament or Tournament Affiliate receives guaranteed cash payments in any other year of any such agreement that exceed the average annual guaranteed cash payments due under such agreement (calculated as described in Section XIV.B.8.c above), the PMF Committee may, subject to Section XIV.B.6.f, allocate such excess over any period during the scheduled term of the agreement as the PMF Committee deems appropriate. Furthermore, if the PMF Committee determines that the payment schedule in any multi-year agreement is disproportionate to the allocation of rights or benefits receivable or conveyed thereunder (allowing for reasonable annual payment increases), the PMF Committee may, subject to Section XIV.B.6.f, reallocate such payments over such period as the PMF Committee deems appropriate.
- e. Any and all revenues receivable by a Tournament Affiliate of any Tournament shall be included in the calculation of PSI, as if such revenues had been receivable by such Tournament itself, subject to Section XIV.B.8.f below.
- f. PSI shall only include those revenues that are attributable to a WTA Tournament and shall exclude revenues to the extent they are attributable to any other events (other than events that are held as a part of, or in connection with, a WTA Tournament, such as, without limitation, a concert held at the Tournament site during and as part of the Tournament). For clarity, revenues (including but not limited to admission rights, sponsorship, and broadcast revenues) from celebrity pro-ams, legends matches, and similar events held during the WTA Tournament week at the Tournament's facilities (whether before, during, or after Tournament sessions) are PSI. The PMF Committee shall, subject to Section XIV.B.6.f, determine the allocation of any payments receivable by any Tournament or Tournament Affiliate between (x) those amounts that are attributable to a WTA Tournament and (y) those amounts that are attributable any ATP or other men's tournament held by such Tournament or any of its Tournament Affiliates or any other events for which the payor has acquired rights.

**FINANCIAL**  
**SECTION XIV - PRIZE MONEY FORMULA**

- g. For Tournaments that are played simultaneously with an ATP tournament (combined) or before/after an ATP tournament (back-to-back), any domestic broadcasting and/or sponsorship contracts sold by the parent company that include broadcasting/sponsorship elements combined for both the WTA and ATP events shall be recorded in PSI at 50% of the total value of the shared contracts.

If a Tournament has domestic broadcasting contracts which separately cover the WTA and ATP events, PSI shall include 100% of the revenues related to the WTA contract and all revenues related to the ATP contract shall be excluded from PSI.

Any other revenues which are generated during the ATP and WTA tournaments (e.g., admission rights) shall be recorded in PSI at 50%, unless the Tournament is able to specifically identify the revenues related to only the WTA Tournament, in which case these WTA specific revenues shall be included in PSI at 100%.

Subject to Section XIV.B.3.d, this methodology shall be applied consistently for each reporting Tour Year.

- h. If the PMF Committee determines that any Tournament or any of its Tournament Affiliates has entered into one or more transactions for the purpose of circumventing the PMF, the Tournament shall be subject to an appropriate remedy as determined by the Board of Directors upon the recommendation of the PMF Committee (including, without limitation, the imposition of an appropriate Fine and/or the reallocation or imputation of PSI in one or more Tour Years).
- i. Complimentary tickets and other Admission Rights shall be excluded from PSI, up to a maximum per Tour Year determined on an annual basis by the PMF Committee based on historical averages.
- j. Any recovery by any Tournament or Tournament Affiliate under any business interruption insurance policy or any other insurance policy shall be included in PSI, but solely to the extent that such recovery compensates such Tournament or Tournament Affiliate for lost revenues that would otherwise have been included in PSI. The amount of such recovery shall be included in PSI net of any premiums paid for the policies under which such party recovers, any deductible and any unreimbursed out-of-pocket expenses arising out of or related to the events giving rise to such recovery.
- k. All revenues described in this Section XIV shall be based on the Tournament's local currency; provided, however, that if a

**FINANCIAL**  
**SECTION XIV - PRIZE MONEY FORMULA**

Tournament's local currency is not the U.S. dollar, then any revenues received in U.S. dollars (e.g., payments from the WTA for commercial benefits and television) must be converted to the Tournament's local currency based on the average daily exchange rate for the 12-month period immediately prior to the Tournament's end date in a given Tour Year (or, with respect to any revenues accrued but not actually received, the year of such accrual).

I. Discovery of and Adjustments for Prior Year Transactions

If at any time the PMF Committee discovers that an amount of a Tournament's revenue from a prior Tour Year was misstated because either it should have been included in its PSI and was not included in its PSI for that Tour Year or it should not have been included in its PSI and was included in its PSI for that Tour Year, then beginning with the first Tour Year in which the applicable revenue was misstated (up to a maximum of three (3) Tour Years prior to the current Tour Year unless the PMF Committee determines that a material amount of revenue was excluded from an earlier Tour Year) ("Misstatement Year"):

- i. the Tournament's PSI for each Tour Year from the Misstatement Year through the Tour Year immediately preceding the current Tour Year must be restated with the correct revenue ("Restated PSI"); then
- ii. the Tournament's MPC for all Tour Years from the Misstatement Year through the Tour Year immediately preceding the current Tour Year must be recalculated using the applicable Restated PSI ("Restated MPC"); then
- iii. the total difference between the prior Tour Years' original (i.e., not using the Restated PSI) and Restated MPCs ("Prior Year True-Up") must be applied as an increase or decrease to the current Tour Year's MPC calculation, resulting in an "Adjusted MPC" for the current Tour Year (which cannot be less than the Tournament's minimum MPC for the current Tour Year per Section XIV.B.1, 2, or 3.b, as applicable); then
- iv. the Restated MPC for all applicable Tour Years (including the current Tour Year) must be used to calculate the Tournament's MPC for all future Tour Years (i.e., the Prior Year True-Up and current Tour Year's Adjusted MPC must not be used in calculating the MPC for any future Tour Year); and then

**FINANCIAL**  
**SECTION XIV - PRIZE MONEY FORMULA**

- v. if any misstatement or omission
- (a) by an All Other WTA 1000 Mandatory Tournament causes its Restated PSI in any Tour Year to be at least three and one-half percent (3.5%) higher or lower than its original PSI from that Tour Year; or
  - (b) by a WTA 500 Tournament causes its Restated PSI in any Tour Year to be at least five percent (5%) higher or lower than its original PSI from that Tour Year

(either of the foregoing a “Material Misstatement”), then the Tournament is subject to disciplinary action in accordance with Section XIV.B.10 below.

As an example, assume that WTA 500 Tournament A had a 2017 MPC of \$816,121 and a 2018 MPC of \$846,632 and during the 2018 Tour Year reported to the PMF Committee that \$40,000 of taxes should have been included in its 2016 PSI reporting as a \$40,000 decrease to its 2016 total PSI of \$6,550,000.

Tournament A’s 2019 (current Tour Year) MPC would be calculated by:

- restating its 2016 PSI as \$6,510,000 to reflect the \$40,000 error in taxes (i.e.,  $\$6,550,000 - \$40,000 = \$6,510,000$ ); then
- recalculating its 2017 MPC with its 2016 Restated PSI, resulting in a Restated 2017 MPC of \$813,497, and then subtracting its original 2017 MPC from its Restated 2017 MPC to yield a 2017 Prior Year True-Up of \$2,624 (i.e.,  $\$813,497 - \$816,121 = (-\$2,624)$ ); then
- recalculating its 2018 MPC using its Restated 2017 MPC, resulting in a Restated 2018 MPC of \$844,028, and then subtracting its original 2018 MPC from its Restated 2018 MPC to yield a 2018 Prior Year True-Up of \$2,604 (i.e.,  $\$844,028 - \$846,632 = (-\$2,604)$ ); then
- adding the 2017 Prior Year True-Up and 2018 Prior Year True-Up to yield a total Prior Year True-Up of (-\$5,228) (i.e.,  $(-\$2,624) + (-\$2,604) = (-\$5,228)$ ); then
- calculating the Tournament’s Restated 2019 MPC using the Restated 2017 MPC and Restated 2018 MPC (assume the result is a 2019 Restated MPC of \$859,286); then



**FINANCIAL**  
**SECTION XIV - PRIZE MONEY FORMULA**

- adding the total Prior Year True-Up to its Restated 2019 MPC, resulting in a 2019 Adjusted MPC of \$854,058 (i.e.,  $\$859,286 + (-\$5,228) = \$854,058$ ).

For 2019, Tournament A's 2019 Adjusted MPC (\$854,058) would be the MPC that the PMF Committee recommends to the Board of Directors.

For calculating Tournament A's 2020 MPC and all future Tour Years' MPCs, its 2019 Restated MPC (\$859,286) is used and its 2019 Adjusted MPC (\$854,058) is ignored.

As its 2016 Restated PSI is approximately 0.61% ( $1 - (\$6,510,000 / \$6,550,000) = .0061 = .61\%$ ) lower than its original 2016 PSI and its 2019 Adjusted MPC is approximately 0.61% ( $1 - (\$854,058 / \$859,286) = .0061 = 0.61\%$ ) lower than its 2019 Restated MPC, Tournament A would not be subject to a fine in accordance with Section XIV.B.10 below.

- m. The PMF Committee may, subject to Section XIV.B.6.f, develop such additional accounting rules and procedures as it may deem appropriate from time-to-time.

**9. Review Procedures**

The PMF Committee (through the Independent Accountant) and the WTBA (through an independent public accounting firm selected and engaged by the WTBA for such purpose ("WTBA Accountant")) shall each have the right to perform procedures on the books and records of each Tournament and its Tournament Affiliates to confirm that such Tournament's Final Reports are complete and accurate, subject to and in accordance with the provisions of this Section XIV.B.9.

The PMF Committee shall agree upon and instruct the Independent Accountant to perform certain procedures on the Final Reports and other financial information submitted by the Tournaments, which procedures may be modified or supplemented by the PMF Committee from time-to-time ("Procedures"). Each Tournament shall be subject to the Procedures at least once every three (3) years, but the PMF Committee may instruct the Independent Accountant to perform the Procedures on any Tournament more frequently if it so determines in its discretion.

For any Tour Year, the WTBA shall have the right to require the Independent Accountant to perform the Procedures on any Tournament on which it has not yet performed the Procedures for such Tour Year. In addition, after the Independent Accountant performs the Procedures on

**FINANCIAL**  
**SECTION XIV - PRIZE MONEY FORMULA**

a specific Tournament, the WTBA Accountant (at the WTBA's direction and expense) shall have the right to review the Independent Accountant's work papers for such Procedures and, together with a representative of the Independent Accountant and the WTA and in accordance with the Procedures, to require additional data and documentation from and to conduct on-site interviews with the tournament director and staff of such Tournament regarding issues that, in the PMF Committee's discretion, are relevant to the calculation of such Tournament's MPC and the PMF. The WTBA's rights under this paragraph extend to a maximum of three (3) Tournaments per Tour Year; provided, however, that the WTBA shall not exercise such rights on a specific Tournament more than once in any three (3) Tour Year period unless the previous Procedures by the Independent Accountant or review by the WTBA Accountant revealed that such Tournament's Final Report contained any material misstatement or material omission (as determined by the PMF Committee, subject to Section XIV.B.6.f).

Each Tournament and its Tournament Affiliates shall make available to the PMF Committee, the Independent Accountant, the WTBA Accountant (subject to the immediately preceding paragraph of this Section XIV.B.9), and their respective agents copies of all documents, agreements, financial statements, books and records relating to the Tournament's PSI, Non-PSI, Non-WTA revenues, Capital Credits and other financial results, including any and all work papers of its accountants. No Tournament or Tournament Affiliate shall enter into any agreement that would prohibit or restrict such Tournament or Tournament Affiliate from providing such materials to such parties, limit such parties' access to such materials, or otherwise preclude or impair the ability of the PMF Committee to calculate or review the Minimum Player Compensation.

Any Procedures performed on a Tournament undertaken by the PMF Committee (through the Independent Accountant) or review by the WTBA under this Section XIV.B.9 may encompass such Tournament's three (3) most recently completed Tour Years and will include all transactions and other information directly or indirectly related to such Tournament's event with respect to those Tour Years, but may not include any transactions or other information that relates exclusively to any prior period. In the event that the Independent Accountant or the WTBA Accountant requests any document or other information from any Tournament or Tournament Affiliate with respect to any transaction that the Tournament asserts relates exclusively to a period prior to the start of the three (3) most recently completed Tour Years, the PMF Committee may require the Tournament to make a sufficient showing of the pertinent time period of such transaction without having to disclose to the Independent Accountant or WTBA Accountant the substance of the underlying transaction (e.g., by disclosing the time period or "term" provision of a requested contract).

**FINANCIAL**  
**SECTION XIV - PRIZE MONEY FORMULA**

**10. Compliance**

- a. Any Tournament that fails to submit its Final Report to the PMF Committee by its 120-day deadline is subject to a fine in accordance with the following chart:

Tournament Category	Fine Amount	
	Missed Deadline	Increase for Each 7 Calendar Days after Deadline
All Other WTA 1000 Mandatory	\$10,000	\$1,000
WTA 500	\$5,000	\$500

In addition, for each consecutive Tour Year in which a Tournament misses its 120-day deadline, its applicable Missed Deadline fine in the chart above doubles.

For example, if an All Other WTA 1000 Mandatory Tournament misses its 120-day deadline in a Tour Year, does not submit its Final Report until 14 calendar days after that deadline, and met its deadline the prior Tour Year, then its applicable fine is \$12,000 ( $\$10,000 + (\$1,000 \times 2) = \$12,000$ ).

As another example, if a WTA 500 Tournament misses its 120-day deadline for the second consecutive Tour Year and does not submit its Final Report until 28 calendar days after that deadline, then its applicable fine is \$12,000 ( $(\$5,000 \times 2) + (\$500 \times 4) = \$12,000$ ).

- b. Any Tournament that submits to the PMF Committee or the Independent Accountant a Final Report, Supplemental Information, or any other document or information on which the PMF Committee or Independent Accountant reasonably relies in determining its MPC that contains any Material Misstatement(s) is in breach of the Tournament Standards of Performance and is subject to disciplinary action in accordance with Section XVIII.A.49 that, subject to the PMF Committee's discretion, must include a fine equal to the greater of \$2,500 or fifty percent (50%) of its Prior Year True-Up related to such Material Misstatement(s), but no greater than \$100,000.
- c. If in its sole discretion the PMF Committee determines that a Tournament otherwise violates the PMF, then the Tournament is in breach of the Tournament Standards of Performance and is subject to disciplinary action in accordance with Section XVIII.A.49.

**FINANCIAL**  
**SECTION XIV - PRIZE MONEY FORMULA**

- d. A Tournament shall pay any fine(s) levied under Sections XIV.B.10.a-c above in accordance with Section XVIII.A.49.b.iv. A Tournament may appeal any fine(s) or other sanction(s) levied under Sections XIV.B.10.a-c above in accordance with Section XVIII.A.49.
- e. In addition to any sanctions under Sections XIV.B.10.a-c above, any willful noncompliance with the terms of the PMF is grounds for disqualification under and in accordance with Section XII.H.1.

**11. Expiration**

Notwithstanding anything to the contrary in this Section XIV or any other provision of this Rulebook, all of the provisions of this Section XIV.B shall be applicable for the 2023 Tour Year and automatically extend for additional Tour Years subject to this Section XIV.B.11.

No later than January 31 of any Tour Year either the Player Board Representatives or the Tournament Board Representatives may submit a request to the CEO for a meeting between the Player Board Representatives and the Tournament Board Representatives to discuss whether to terminate the provisions of this Section XIV.B following the end of such Tour Year. Following such meeting, either (a) a majority of the Player Board Representatives or (b) a majority of the Tournament Board Representatives may each elect to terminate the provisions of this Section XIV.B by giving written notice to the other members of the Board of Directors not later than May 31 of such Tour Year. In the event such a termination notice is given, the provisions of this Section XIV.B shall remain effective notwithstanding such notice through the end of the Tour Year in which such notice is given and such termination shall become effective on the start of the immediately following Tour Year. However, unless a termination notice is delivered by May 31 of any Tour Year, this Section XIV.B shall automatically be extended and shall remain in effect for the entirety of the following Tour Year (in which case, the guaranteed minimum amounts in Section XIV.B will be increased for each successive Tour Year in the same proportion as the prior increases in such amounts).

**C. WTA 250 TOURNAMENTS**

**1. Minimum Player Compensation**

For the 2023 Tour Year, each WTA 250 Tournament must pay MPC of at least \$318,000. The MPC for WTA 250 Tournaments increases by three percent (3%) each Tour Year (rounded to the nearest \$1,000).

**FINANCIAL**  
**SECTION XIV - PRIZE MONEY FORMULA**

**2. Increased Prize Money**

WTA 250 Tournaments shall have the option to increase their prize money to allow more than one (1) Top 10 Player to play singles and/or doubles in the Tournament. Tournaments must increase prize money by \$250,000 for each additional Top 10 Player accepted into the draw. Prize money increases will be distributed in accordance with Section XV.D. Tournaments may notify the WTA anytime up until the Qualifying Sign-In deadline of their decision to increase prize money above the minimum.

The WTA will not accept additional Top 10 Player entries until the Tournament provides written notice to the WTA confirming the required prize money increase.

Regardless of whether any Top 10 Player(s) withdraw(s), a WTA 250 Tournament may not reduce its prize money if:

- a. the Tournament accepts an additional Top 10 Player at the Main Draw Entry Deadline;
- b. the Tournament publicly announces the prize money increase; or
- c. the Qualifying Sign-In Deadline has passed.

**3. Top 10 Player Delivery**

An increase in the WTA 250 Tournament's minimum prize money will not alter the Top 10 Player Delivery requirements set out in Section II.B above.

**D. NOT A MAXIMUM**

Nothing in this Section XIV shall prevent a Tournament from paying player compensation in excess of the Minimum Player Compensation. For the avoidance of doubt, in the event any Tournament has been approved to pay player compensation in excess of the Minimum Player Compensation, and the Minimum Player Compensation increases from the prior Tour Year, such Tournament will not be required to increase its player compensation further. (For example, if a Tournament is paying 110% of the Minimum Player Compensation and the Minimum Player Compensation increases by 5%, such Tournament will not be required to increase its player compensation for that Tour Year.)

If in any Tour Year a Tournament voluntarily pays player compensation greater than its PMF-calculated MPC for that Tour Year, the calculation of that Tournament's MPC in future Tour Years must use its PMF-calculated

**FINANCIAL**  
**SECTION XIV - PRIZE MONEY FORMULA**

MPC for all prior Tour Years (i.e., any player compensation greater than its PMF-calculated MPC that the Tournament voluntarily paid is not included in the calculation of its MPC in future Tour Years). For example, if a WTA 500 Tournament's 2023 PMF-calculated MPC is \$1,200,000 but it pays 2023 player compensation of \$1,500,000, then for purposes of calculating that Tournament's 2024 MPC, its 2023 MPC is \$1,200,000 (and not \$1,500,000).

**E. AMENDMENT**

Notwithstanding anything to the contrary in this Section XIV or any other provision of this Rulebook, the terms of this Section XIV may only be amended by the Board of Directors in its sole discretion, provided, that any amendment to this Section XIV shall be deemed to be a "Supermajority Matter" for purposes of the By-laws and this Rulebook.



## FINANCIAL

### XV. TOURNAMENT FINANCIAL OBLIGATIONS

#### A. TOURNAMENT FINANCIAL OBLIGATIONS

##### 1. WTA 1000 Mandatory, WTA 500, and WTA 250 Tournaments

Each WTA 1000 Mandatory, WTA 500, and WTA 250 Tournament is obligated to pay:

- a. Prize money (must be paid in US dollars unless authorized by the WTA); and
- b. WTA Fees, without deduction for any taxes.

##### 2. WTA 125 Tournaments

Each WTA 125 Tournament is obligated to pay:

- a. Prize money (must be paid in US dollars unless authorized by the WTA, see Section XII.D.2.a); and
- b. WTA license fees, without deduction for any taxes.

Prize money and WTA license fees shall be in the amounts stated in a WTA 125 Tournament's written agreement with the WTA.

##### 3. WTA 1000 Mandatory and WTA 500 Tournaments

Each WTA 1000 Mandatory and WTA 500 Tournament must participate in Tournament Financial Disclosure. Tournaments that fail to comply will be subject to a fine and/or other disciplinary action.

##### 4. Payment Information

All payments must be directed to:  
Chief Operating Officer | Treasurer  
WTA Tour, Inc.  
100 Second Avenue South, Suite 1100-S  
St. Petersburg, Florida 33701 USA  
+1 727 895 5000

Wire transfer information will be provided by the WTA upon request.



**FINANCIAL**  
**SECTION XV - TOURNAMENT FINANCIAL OBLIGATIONS**

**B. TOURNAMENT FINANCIAL COMMITMENT**

**1. Fee Purpose and Collection Process**

WTA Fees help to fund WTA Operations and Player Services. WTA Fees are deducted from each Tournament's minimum prize money.

**2. Payment Schedule and Amount**

Due Date	Financial Requirement	Amount in Cash, USD		
		WTA 250	WTA 500	WTA 1000 Mandatory
October 15 year prior or 6 months prior to start of Main Draw	WTA Fee 1st Installment	\$4,500	\$12,000	\$22,500
No later than 30 days prior to start of Main Draw	WTA Fee 2nd Installment	\$18,750	\$53,100	\$303,800
	Bonus Pool Fund	n/a	n/a	n/a
	Marketing Fund	n/a	n/a	n/a

**C. FINANCIAL SECURITY REQUIREMENTS**

**1. Timing and Specifications**

Unless otherwise determined by the WTA, each existing Tournament that has owned its membership for three (3) years or less, and all new or transferred memberships for the first three (3) years must submit to the WTA within thirty (30) days after approval on the WTA Calendar, an approved Irrevocable Letter of Credit, or other financing vehicle approved by the WTA, in form and substance satisfactory to the WTA, for 100% of the Announced Prize Money.

All Letters of Credit must conform to the following format and shall not be amended unless approved by the WTA:

**LETTER OF CREDIT**

Issue Date:

Letter of Credit Number:

Applicant Reference Number:

Please utilize the following information to instruct your bank to issue an IRREVOCABLE Letter

**FINANCIAL**  
**SECTION XV - TOURNAMENT FINANCIAL OBLIGATIONS**

of Credit in our favor. If there are any questions regarding these instructions, please contact us immediately.

A. Advising Bank: JPMorgan Chase Bank, N.A.  
131 South Dearborn Street  
Chicago, Illinois 60515  
ATTN: Standby LC Unit

Required to request JPMorgan Chase Bank, N.A. to add its confirmation

B. Applicant: <insert legal name and full address>

C. Beneficiary: WTA Tour, Inc.  
100 Second Avenue South  
Suite 1100-S  
St. Petersburg, Florida 33701 USA

Wire To: JPMorgan Chase Bank, N.A.  
SWIFT: CHASUS33

D. CURRENCY: UNITED STATES DOLLARS: <INSERT AMOUNT IN NUMBERS AND WORDS>

E. TRANSFER: THE CREDIT IS NOT TRANSFERABLE.

F. BANK CHARGES: ALL BANK CHARGES INSIDE/OUTSIDE OF BENEFICIARY'S COUNTRY ARE FOR APPLICANT'S ACCOUNT.

G. REQUIRED DOCUMENTS: SEE BELOW.

H. EXPIRATION DATE: <INSERT DATE – NOT LESS THAN 0 DAYS AFTER FINAL MATCH OF RD YEAR>

WE HEREBY ESTABLISH THIS IRREVOCABLE LETTER of Credit No. \_\_\_\_\_ in favor of WTA Tour, Inc. for an aggregate amount not to exceed the amount indicated above, expiring at <our/ our Advising Bank> counters with our close of business on <insert expiry date>.

This Irrevocable Letter of Credit is available with JPMorgan Chase Bank, N.A., against presentation of beneficiary draft at sight drawn on Advising Bank, when accompanied by the documents indicated herein.

Beneficiary's dated statement signed by its Chief Executive Officer (signed as such) indicating this Irrevocable Letter of Credit number and reading as follows: We certify that <insert Applicant name> has failed to pay, in whole or in part, prize money to players or any required WTA membership or WTA fees.

**FINANCIAL**  
**SECTION XV - TOURNAMENT FINANCIAL OBLIGATIONS**

Multiple drawings permitted. Drawings not to exceed total under Section D. Currency above in aggregate.

We hereby agree with the Beneficiary that any draft under and in compliance with the terms and conditions of this letter of credit will be duly honored.

This Irrevocable Letter of Credit is issued subject to the international standby practices 1998, International Chamber Publication 590 (ISP 9).

The number and date of our credit and the name of our bank must be quoted on all drafts required.

Irrevocable Letter of Credit is to be issued in English.

**2. Penalties for Missed Deadline**

Unless otherwise determined by the WTA, failure to provide financial security within the deadline specified will result in: a) cancellation of the Tournament; b) forfeiture of all fees paid to date; and c) possible revocation of the Tournament membership.

**D. TOURNAMENTS PAYING PRIZE MONEY IN EXCESS OF THE MINIMUM PRIZE MONEY LEVEL**

Each WTA Tournament may submit a request to the WTA to pay prize money in excess of the minimum prize money level for such Tournament, but this requirement must be no later than six (6) months in advance of the Tournament (unless otherwise agreed by the WTA). The WTA will respond to requests as soon as possible after they are received, but it is preferred that requests are made at the time the Tournament Information Form is submitted for the following year.

Any excess prize money shall be distributed as follows:

**1. For WTA 250 Tournaments that increase their prize money to at least \$500,000 and WTA 500 Tournaments:**

- a. 40% to singles semi-finals and finals prize money;
- b. 40% into on-site prize money according to prize money breakdowns; and
- c. 20% to the WTBA, not to exceed \$200,000, with any excess amount to be distributed in on-site prize money according to prize money breakdowns.

**FINANCIAL**  
**SECTION XV - TOURNAMENT FINANCIAL OBLIGATIONS**

**2. For WTA 1000 Mandatory Tournaments:**

- a. 80% into on-site prize money according to prize money breakdowns; and
- b. 20% to the WTBA, not to exceed \$200,000, with any excess amount to be distributed in on-site prize money according to prize money breakdowns.

**3. For WTA 250 Tournaments that increase their prize money to less than \$500,000 and WTA 125 Tournaments, 100% into on-site prize money according to prize money breakdowns.**

**E. MONETARY AND NON-MONETARY AWARDS**

A Tournament may give monetary or non-monetary awards to the winners of its singles and doubles events, but if any such award is valued at \$5,000 or greater, the Tournament must submit it to the WTA for approval at least six (6) weeks before the start of the Tournament.

**F. CONDITIONS**

Payment of all fees and deposits is a continuing condition for inclusion in the WTA. Each Tournament must comply with all government, federal, state, and local laws, regulations, and ordinances affecting the facility and the conduct of that Tournament.

**G. LATE PAYMENTS**

In the event any payment is not timely, the WTA is under no obligation to: (i) provide Top 10 Player Delivery to the offending Tournament or (ii) further hold the dates of the Tournament.

If any payment other than prize money (by a Tournament or the WTA) is not made on or before the respective due date, the aggrieved party shall be entitled to a late penalty of \$200 per week. Said fines begin to accrue within seven (7) days after notice (via e-mail or registered mail) by the aggrieved party. This penalty shall apply when the required WTA Fees are not paid by a Tournament.

The fines apply singularly to each category of payment that is in arrears. In cases of disputes, it is desirable (but not obligatory) that before any arbitration is instituted, the dispute be brought to the WTA for consideration and discussion.



## FINANCIAL

### XVI. WTA FINANCIAL RESPONSIBILITIES TO TOURNAMENTS

#### A. COMMERCIAL BENEFITS PAYMENTS

In consideration of the commercial benefits granted to the WTA by WTA Tournaments, the WTA may make payments to eligible Tournaments as determined by the Tournament Council.

Unless otherwise agreed, eligible Tournaments must have been on the published WTA Calendar at the end of the previous Tour Year and be in good standing with the WTA.

#### B. PAYMENT DATES

If payments are to be made, the WTA will make payments directly to each eligible Tournament according to the following schedule:

<b>Tournament Completion Date</b>	<b>Subsequent July 15</b>	<b>Subsequent December 15</b>
June 30	50%	50%
November 30	n/a	100%



# CODE OF CONDUCT

## XVII. CODE OF CONDUCT

### FOR WOMEN PROFESSIONAL TENNIS PLAYERS ADMINISTERED BY THE WTA

It is the purpose of this Code of Conduct, as it may be amended from time to time (the "Code"), to serve as a guide for the acceptable professional behavior of players, Tournament Support Personnel, Player Support Team Members, and other Credentialed Persons as it relates to the promotion of the positive image of women's Professional Tennis.

#### A. GENERAL PRINCIPLES

##### 1. Tournament Acceptance

A player shall be accepted into a Tournament if she has applied in writing to play in that Tournament and the WTA has accepted her application in writing, whether or not the player has received written notice of that acceptance.

##### 2. Deadlines

Unless otherwise noted, all times refer to local time at the Tournament site, and the official WTA Clock located in the on-site WTA office shall determine the time.

##### 3. Fines

###### a. Payment Currency

All fines are established and payable in United States dollars.

###### b. Collection Method

The WTA may deduct player fines from player prize money at Tournaments to be determined by the WTA, in its sole discretion.

###### c. Process for Appeals

All permitted fine appeals must be filed within twenty-one (21) days from the date of notice.



**CODE OF CONDUCT**  
**SECTION XVII - CODE OF CONDUCT**

**B. DEFINITIONS**

**1. Key Terms**

- a. "TACP" refers to the Tennis Anti-Corruption Program, the full text of which can be found at [itia.tennis/tacp/](http://itia.tennis/tacp/).
- b. "TADP" refers to the ITF Tennis Anti-Doping Programme, the full text of which can be found at [itia.tennis/tadp/](http://itia.tennis/tadp/).
- c. The term "automatic" as it relates to fines, refers to fines (if determined to have occurred), for which the player shall receive notice from the WTA, and which shall be non-appealable, except in the case of Extraordinary Circumstances as defined in Section IV.C.7.
- d. "ITF Rules of Tennis" shall refer to the rules of tennis promulgated by the ITF, the full text of which can be found at [www.itftennis.com/en/about-us/governance/rules-and-regulations/](http://www.itftennis.com/en/about-us/governance/rules-and-regulations/).
- e. "Player" or "player" means any professional or amateur woman tennis player, whether a member of the WTA/WTBA or not, who applies to enter a Tournament.
- f. "Player Support Team Member" shall mean any coach, trainer, manager, agent, medical, paramedical, family member, tournament guest, or other similar associate of any Player.
- g. "Tournament" means any singles or doubles tennis competition administered by the WTA, or approved as a WTA Ranking event by the WTA.
- h. "Withdraw" means the written communication by a Player after her acceptance into a Tournament of the Player's inability or unwillingness to play given to any staff member of the WTA Operations Department or Rules and Competitions Department.

**2. Key Decision-Making Bodies**

- a. The "Committee" shall refer to the WTA Code of Conduct Committee, the body comprised of WTA staff members, Player representatives, Tournament representatives, and an ITF representative which shall hear appeals of Code violations and fines and consider changes to the Code.
- b. The "Board of Directors" shall refer to the Board of Directors of the WTA.

**CODE OF CONDUCT**  
**SECTION XVII - CODE OF CONDUCT**

**3. Key Tournament Personnel**

- a. "Chair Umpire" shall have the meaning used in the ITF Rules of Tennis.
- b. "Referee" shall mean any official so designated by the WTA and/or Tournament at which this Code is in effect.
- c. "Supervisor" shall mean any official so designated or approved by the WTA at any Tournament at which this Code is in effect.
- d. "Tournament Director" or "Tournament Owner" means the person or persons so designated by the Tournament.
- e. "Tournament Support Personnel" shall mean any Tournament Director, Tournament Owner, Tournament operator, Tournament employee, or any designated agent of the Tournament.

**C. APPLICABILITY, AVAILABILITY, AND RECIPROCITY**

**1. Applicability**

- a. Tournaments

The Code shall apply in all Professional Tennis matches of any Tournament and where appropriate, the WTA may take action on any Code violation that occurs outside of a WTA event.

- b. Players

Players shall at all times be subject to the Code, the ITF Rules of Tennis, the Anti-Corruption Program, and the Anti-Doping Program, as may be adopted by the WTA. Each Player who is accepted to play in a Tournament (singles or doubles, including Wild Cards) must have signed an Official WTA Entry Form prior to commencement of play in the Tournament. The entry form provides that acceptance of the Rules, including the Rules that apply to Tournament entries, acceptance, withdrawals and scheduling, are binding on the player.

- c. Tournament Support Personnel

The Code, Anti-Corruption Program, and Anti-Doping Program shall apply to all Tournament Support Personnel.

- d. Player Support Team Members and Other Credentialed Persons

The Code, Anti-Corruption Program and Anti-Doping Program shall

**CODE OF CONDUCT**  
**SECTION XVII - CODE OF CONDUCT**

apply to all Player Support Team Members, and other persons credentialed at Tournaments.

**2. Availability**

A copy of the Code, Anti-Corruption Program, and Anti-Doping Program will be provided to any player, Player Support Team Member, Tournament Support Personnel, or other credentialed persons upon request. A copy of the Code shall also be available on site at every Tournament.

**3. Reciprocity**

a. Sanctions by Other Tennis Organizations

Notwithstanding the WTA By-Laws or any other provision of the Code, the Committee reserves the right to affirm, modify, or reject with respect to any or all WTA Tournaments a suspension or other sanction issued against an individual or entity subject to the Code ("Covered Person") either by or on behalf of any other tennis organization, including but not limited to the Association of Tennis Professionals, the Grand Slam Board, and the International Tennis Federation. The Committee may suspend provisionally any Covered Person until the completion of the Committee's final determination under this paragraph and any subsequent appeal. A Covered Person may appeal to the Board of Directors for discretionary review of a determination by the Committee under this paragraph. Such appeal must be in writing, state in detail the basis for such appeal, and be filed with the WTA within twenty-one (21) days after the WTA mails notice of the violation to the Covered Person. Upon receipt, the WTA promptly shall forward such appeal to the Board of Directors. As soon as reasonably possible (but no later than thirty (30) days) after the Board of Directors receives such appeal, it shall designate a time and place for the hearing of such appeal and shall notify the Covered Person no less than ten (10) days before the hearing date (unless the Covered Person waives such 10-day requirement). The Covered Person's attendance at the hearing is not mandatory. At such hearing, the Covered Person may be represented by counsel, present relevant evidence to the Board of Directors, call witnesses to testify on his or her behalf, and examine witnesses testifying against him or her. The Board of Directors may determine that, in the interest of fairness, an interpreter is required at the hearing and may retain such interpreter at WTA's expense. The Board of Directors may affirm, reverse, or modify the Committee's determination on appeal, and the Board of Directors' decision shall be final, binding, and non-appealable.

**CODE OF CONDUCT**  
**SECTION XVII - CODE OF CONDUCT**

b. Sharing of Information

The WTA reserves the right to share information concerning a complaint and/or conduct an investigation in conjunction with any other tennis organization or any other relevant authorities. The WTA may also refer any complaint and/or information received during the course of investigating an allegation or prosecuting a charge to any authorities it considers appropriate in its absolute discretion. The WTA shall have the absolute discretion, where it deems appropriate, to stay in its own investigation pending the outcome of investigations being conducted by other tennis organizations and/or relevant authorities.

**D. RULES AND PENALTIES – PLAYERS**

**1. Entry**

All players shall abide by the rules for entries set forth in the Rules. For tournaments not subject to the Rules, all players shall abide by the rules for entries published for such tournaments.

**2. Withdrawals**

Any Late Withdrawal by a player from a Tournament for reasons other than an Excused Withdrawal, a Prize Money Withdrawal, a Consecutive Withdrawal, or Extraordinary Circumstances shall constitute a violation of the Code automatically punished by the fines listed in this Code.

For full explanation of the following, refer to the corresponding sections enumerated below:

a. Withdrawal Fines

See Section IV.A - Withdrawals for Late Withdrawal fines.

b. No-Show Fines

See Sections IV.A.3.c and IV.A.4.c - No-Show Offense.

c. Prohibition Against Withdrawing from One Tournament to Play Another

See Section IV.A.9 – Prohibition Against Withdrawing from One Tournament to Play Another.

**CODE OF CONDUCT**  
**SECTION XVII - CODE OF CONDUCT**

d. Excused Withdrawals

See Section IV.A.5 - Excused Withdrawals.

e. Prize Money Withdrawals

See Section IV.A.6 - Singles Prize Money Withdrawals.

f. WTA Finals Fines

See Section VI.B.2.d - WTA Finals Mandatory Participation; Penalties.

**3. Point Penalty Schedule**

The Point Penalty Schedule to be used for violations of the Code is as follows:

<b>1st Offense</b>	Warning
<b>2nd Offense</b>	Point Penalty
<b>3rd and Subsequent Offenses</b>	Game Penalty

However, after the third Code violation, the Supervisor/Referee shall determine whether each subsequent offense shall constitute a default.

Point penalties must be appealed on site to the Supervisor/Referee, whose decision shall be final. Any monetary penalties imposed in conjunction with a point penalty may be appealed in accordance with Section XVII.G - Procedures for Player and Tournament Support Personnel Violations.

**4. Player On-Court and Off-Court Behavior**

(Except at Grand Slam events which apply Grand Slam rules and procedures.)

a. Player On-Court Offenses

i. Visible Obscenity

- (a) Players shall not make obscene gestures of any kind within the precincts of the Tournament site. Visible obscenity is defined as the making of signs by a Player with hands and/or racquet or balls that commonly have an obscene meaning.

**CODE OF CONDUCT**  
**SECTION XVII - CODE OF CONDUCT**

- (b) Violations of this Section shall subject a Player to a fine up to \$5,000 for each violation. In addition, if such violation occurs during a match, the Player shall be penalized in accordance with the Point Penalty Schedule.

In circumstances that are flagrant and particularly injurious to the success of the Tournament, or are singularly egregious, a single violation of this Section shall also constitute the Player Major Offense of Aggravated Behavior.

ii. Audible Obscenity

- (a) Players shall not use an audible obscenity within the precincts of the Tournament site. Audible obscenity is defined as the use of words commonly known and understood to be profane and uttered clearly and loudly enough to be heard.
- (b) Violations of this Section shall subject a Player to a fine up to \$5,000 for each violation. In addition, if such violation occurs during a match, the Player shall be penalized in accordance with the Point Penalty Schedule.

In circumstances that are flagrant and particularly injurious to the success of the Tournament, or are singularly egregious, a single violation of this Section shall also constitute the Player Major Offense of Aggravated Behavior.

iii. Abuse of Racquet or Equipment

- (a) Players shall not violently, dangerously, or with anger hit, kick, or throw a racquet or other equipment within the precincts of the Tournament site. For the purposes of this rule, abuse of racquets or equipment is defined as intentionally, dangerously, and violently hitting the net, court, umpire's chair, or other fixture during a match out of anger.
- (b) Violations of this Section shall subject a Player to a fine up to \$2,500 for each violation. In addition, if such violation occurs during a match, the Player shall be penalized in accordance with the Point Penalty Schedule. The Player also will be liable for the repair or replacement of destroyed or damaged Tournament property.

iv. Abuse of Balls

- (a) Players shall not violently, dangerously, or with anger hit,

**CODE OF CONDUCT**  
**SECTION XVII - CODE OF CONDUCT**

kick, or throw a tennis ball while on the grounds of the Tournament site except in the reasonable pursuit of a point during a match (including warm up). For the purposes of this rule, abuse of balls is defined as intentionally or recklessly hitting a ball out of the enclosure of the court, hitting a ball dangerously or recklessly within the court, or hitting a ball with disregard of the consequences.

- (b) Violations of this Section shall subject a Player to a fine up to \$2,500 for each violation. In addition, if such violation occurs during a match, the Player shall be penalized in accordance with the Point Penalty Schedule.

v. Physical Abuse

- (a) Players shall not at any time physically abuse any official, opponent, spectator, or other person within the precincts of the Tournament site. For the purposes of this rule, physical abuse is the unauthorized touching of an official, opponent, spectator, or other person.
- (b) Violations of this Section shall subject a Player to a fine up to \$10,000 for each violation. In addition, if such violation occurs during a match, the Player shall be penalized in accordance with the Point Penalty Schedule.

In circumstances that are flagrant and particularly injurious to the success of the Tournament, or are singularly egregious, a single violation of this Section shall also constitute the Player Major Offense of Aggravated Behavior.

vi. Verbal Abuse

- (a) Players shall not at any time directly or indirectly verbally abuse any official, opponent, sponsor, spectator, or any other person within the precincts of the Tournament site. Verbal abuse is defined as any statement about an official, opponent, spectator, or any other person that implies dishonesty or is derogatory, insulting, or otherwise abusive.
- (b) Violations of this Section shall subject a Player to a fine up to \$10,000 for each violation. In addition, if such violation occurs during a match, the Player shall be penalized in accordance with the Point Penalty Schedule.

**CODE OF CONDUCT**  
**SECTION XVII - CODE OF CONDUCT**

In circumstances that are flagrant and particularly injurious to the success of the Tournament, or are singularly egregious, a single violation of this Section shall also constitute the Player Major Offense of Aggravated Behavior.

vii. Coaching and Coaches

- (a) Players may receive coaching during a match (including warm up) in accordance with Section XVIII.D. Communication of any kind, audible or visible, between a Player and a coach other than that permitted in Section XVIII.D and the use of any electronic device (excluding a WTA-approved electronic device under Section VII.C.4.d - Electronic Devices or an official WTA electronic device authorized for Coaching) constitutes a coaching violation.

Players shall prohibit their coaches on site from: i) using an audible obscenity or making obscene gestures of any kind; ii) abusing any official, opponent, spectator, or other person, verbally or physically; iii) engaging in conduct contrary to the integrity of the game of tennis. Conduct contrary to the integrity of the game of tennis shall include, but not be limited to, public comments, whether or not to the media, that unreasonably attack or disparage a Tournament, sponsor, player, official, or the WTA.

Responsible expressions of legitimate disagreements with WTA policies are not prohibited. However, public comments that one of the stated persons above knows, or should reasonably know, will harm the reputation or financial best interest of a Tournament, players, sponsor, official, or the WTA are expressly covered by this Section.

- (b) Violations of this Section shall subject a Player to a fine up to \$5,000 for each violation. In addition, if such violation occurs during a match, the Player shall be penalized in accordance with the Point Penalty Schedule.

In circumstances that are flagrant and particularly injurious to the success of the Tournament, or are singularly egregious, the Supervisor/Referee shall have the authority to relocate the position of a coach if there is reasonable belief that non-permitted coaching is occurring, or the Supervisor/Referee may order the coach to be removed from the match site or Tournament site and upon his/her failure to comply with such order, may declare an immediate default of such Player.



**CODE OF CONDUCT**  
**SECTION XVII - CODE OF CONDUCT**

viii. Unsportsmanlike Conduct

- (a) Players shall at all times conduct themselves in a sportsmanlike manner and give due regard to the authority of officials and the rights of opponents, spectators, and others. Unsportsmanlike conduct is defined as any misconduct by a Player that is clearly abusive or detrimental to the success of a Tournament, the WTA, and/or the sport. In addition, unsportsmanlike conduct shall include, but not be limited to, the giving, making, issuing, authorizing, or endorsing any public statement having, or designed to have, an effect prejudicial or detrimental to the best interest of the Tournament and/or the officiating thereof.
- (b) Violations of this Section shall subject a Player to a fine up to \$10,000 for each violation. In addition, if such violation occurs during a match, the Player shall be penalized in accordance with the Point Penalty Schedule.

In circumstances that are flagrant and particularly injurious to the success of the Tournament, or are singularly egregious, a single violation of this Section shall also constitute the Player Major Offense of Aggravated Behavior.

ix. Best Efforts

- (a) A Player shall use her best efforts during a match when competing in a Tournament.
- (b) Violation of this Section shall subject a Player to a fine up to \$10,000 for each violation. For the purposes of this rule, the Supervisor/Referee and/or Chair Umpire shall have the authority to penalize a Player in accordance with the Point Penalty Schedule.

In circumstances that are flagrant and particularly injurious to the success of a Tournament, or are singularly egregious, a single violation of this Section shall also constitute the Player Major Offense of Aggravated Behavior.

x. Leaving the Court

- (a) A Player shall not leave the court area during a match (including warm up) without the permission of the Chair Umpire or Supervisor/Referee.

**CODE OF CONDUCT**  
**SECTION XVII - CODE OF CONDUCT**

- (b) Violation of this Section shall subject a Player to a fine up to \$3,000 for each violation. In addition, the Player may be defaulted and shall be subject to the additional penalties for Failure to Complete Match.

xi. Failure to Complete Match

- (a) A Player must complete a match in progress unless she is reasonably unable to do so.
- (b) Violation of this Section shall subject a Player to a fine up to \$5,000 for each violation. Violation of this Section also shall subject a Player to immediate default and shall constitute the Player Major Offense of Aggravated Behavior.

xii. Punctuality

Players shall be ready when their matches are called.

- (a) Any Player not ready to play within 10 minutes after her match is called shall be fined \$250 for each violation.
- (b) For televised matches with an announced “walk-on” time, players not ready to walk-on at the announced time may be issued a fine in the range of \$1,000-\$5,000, and in extreme cases up to a maximum of \$10,000, for each violation at the sole discretion of the WTA Supervisor.
- (c) Any Player not ready to play within 15 minutes after her match is called may be fined up to an additional \$750 and shall be defaulted unless the Supervisor, after consideration of all relevant circumstances, elects not to declare a default.

b. Other On-Court Offenses

A Player also can be reported to the WTA for inappropriate off-court behavior if a Player’s behavior or obscene language during a match is not observed or heard by on-court officials, but causes a negative impact to the image of the game because it is seen on television.

c. Sexual Abuse

- i. Players shall not sexually abuse any player or other person. Sexual abuse is defined as the forcing of sexual activity by one person on another person (a) of diminished mental capacity or

**CODE OF CONDUCT**  
**SECTION XVII - CODE OF CONDUCT**

(b) by the use of physical force, threats, coercion, intimidation or undue influence.

- ii. A violation of this Section shall constitute the major player offense of Aggravated Behavior and may result in the termination of membership.
- d. Sexual Harassment
- i. Players shall not engage in sexual harassment (for example, by making unwelcome advances, requests for sexual favors, or other verbal or physical conduct of a sexual nature where such conduct may create an intimidating, hostile, or offensive environment).
  - ii. A violation of this Section shall constitute the major player offense of Aggravated Behavior.
- e. Additional Fine and Appeal Procedures
- i. Monetary fines do not apply for Code violations received due to loss of physical conditioning or as a result of medical treatment not being complete within the allocated time, unless it is interpreted by the Referee/Supervisor as gamesmanship.
  - ii. If a Player's on-court behavior is reported to the WTA by another Player, an umpire, or a Tournament official, such Player will be subject to the applicable fine, even if a warning was not issued during play.
  - iii. The WTA shall determine the fine, which may be appealed to the Committee, provided an appeal is filed within twenty-one (21) days from the date of notice.
  - iv. Player fines may be deducted from player prize money at the Tournament at which the fine is levied or any subsequent tournament.

**5. Media Obligations**

See Section VII - Player Responsibilities for details on media/promotional/sponsor responsibilities with which each Player must comply.

**CODE OF CONDUCT**  
**SECTION XVII - CODE OF CONDUCT**

**6. Hindrance Rule**

See Section VII.H for the Hindrance Rule.

**7. Toilet/Change of Attire Break**

See Section VII.D for Toilet/Change of Attire Rules.

**8. Defaults**

The Supervisor may declare a default for either a single violation of this Code (immediate default) or pursuant to the Point Penalty Schedule set out in Section XVII.D.3. In all cases of default, the decision of the Supervisor/Referee shall be final and non-appealable.

**9. WTA Medical Rule**

See Section XVIII.B.5 for the WTA Medical Rule and penalties.

**10. WTA Clothing and Equipment**

See Section VII.C for the WTA Clothing and Equipment Rules and penalties.

**11. Delay of Game**

See Section VII.G.2.b for Delay of Game Rule.

**12. Age Eligibility Rule and Player Development Programs**

See Section X for the Age Eligibility Rule and Player Development Programs.

**13. Dishonorable or Unprofessional Conduct**

a. Player Responsibilities

i. Player Conduct

A Player shall at all times, but particularly during a Tournament or event into which her entry has been accepted, whether at the Tournament site or not, refrain from engaging in conduct detrimental to the WTA or the WTA Tour or contrary to the integrity of the game of tennis. Conduct detrimental to the WTA or the WTA Tour or contrary to the integrity of the game of tennis shall include, but not be limited to, public comments, whether

**CODE OF CONDUCT**  
**SECTION XVII - CODE OF CONDUCT**

or not to the media, which unreasonably attack or disparage any person, group of people, Tournament, sponsor, player, official, the WTA, or the WTA Tour. Responsible expressions of legitimate disagreement with WTA policies are not prohibited. However, public comments that a player knows, or should reasonably know, will harm the reputation or financial best interests of a Tournament, player, sponsor, official, the WTA, or the WTA Tour are expressly prohibited by this Section.

Without limiting the generality of the foregoing, Players also must comply with the following:

(a) Proper Attire

A Player shall dress and present herself in a professional manner at all times on the Tournament site or any official practice site.

(b) Payment of Personal Expenses

A Player shall pay all of her just debts incurred in connection with her travel to and from, housing at, and participation in Tournaments, including telephone, food, medical, and racquet stringing charges.

In addition to being responsible for paying all unauthorized telephone charges made during a Tournament at a Tournament site, a Tournament hotel, or a private home, a Player also will be assessed a fine of \$250 regardless of the dollar amount of the unauthorized calls. These charges and fine may be deducted from the offending player's prize money. A Player shall be assessed a fine of \$20 if she fails to pay her racquet stringing bill before leaving the Tournament city.

(c) Avoidance of Criticism in Public or Media

A Player shall not address criticism of a Tournament, sponsor, player, official, the WTA, or the WTA Tour to the media or public. All such complaints should be forwarded to the Supervisor, Player Relations, or WTA Operations.

(d) Confidentiality

A Player shall not disclose to any WTA non-members information identified as confidential in an official WTA

**CODE OF CONDUCT**  
**SECTION XVII - CODE OF CONDUCT**

communication (“Confidential Information”) unless otherwise authorized by the WTA in writing or until such time that the information becomes publicly available through WTA-authorized means.

ii. Penalties

Failure to comply with any one of the above shall constitute a violation of the Code and shall subject the offending player to (a) a fine not to exceed the amounts set forth in the following table, (b) default according to the procedures provided for in Section XVII.D.4 - Player On-Court and Off-Court Behavior, and (c) suspension from participating in professional tennis for a specified period of time as determined by the Board of Directors:

<b>Per Tour Year</b>	<b>Fine</b>
Each Offense	Up to \$10,000

b. Aggravated Behavior

No Player shall engage in Aggravated Behavior, as defined below:

i. Definition

- (a) One (1) or more incidents of behavior designated in this Code as constituting Aggravated Behavior.
- (b) An incident of behavior that is flagrant and particularly injurious to the success of a Tournament, the WTA, or the WTA Tour, or is singularly egregious, including the sale of a credential or the unauthorized disclosure of Confidential Information.
- (c) A series of two (2) or more violations of the Code within a 12-month period which singularly do not constitute Aggravated Behavior, but when viewed together establish a pattern of conduct that is collectively egregious and is detrimental or injurious to the Tournaments, the WTA, or the WTA Tour.

ii. Penalties

Violation of this Section shall subject a Player to a fine up to \$25,000 or the amount of prize money won at the Tournament, whichever is greater, and/or suspension from

**CODE OF CONDUCT**  
**SECTION XVII - CODE OF CONDUCT**

play in a Tournament or event for a minimum period of twenty-one (21) days and a maximum period of one (1) year. The suspension will commence on the Monday after the expiration of the time within which an appeal may be filed, or, in the case of appeal, commencing on the Monday after a final decision on appeal.

c. **Decision-Making Authority**

The WTA shall have sole authority to declare a Player's violation under this Section acting upon a formal and substantiated complaint. The WTA decision may be appealed to the Committee, with the exception of appeals involving monetary penalties of \$50,000 or more or appeals of major offenses, such as suspension from the Tour, in which case the matter will be referred to the Board of Directors for a decision.

**14. WTA Hotel Room Policy**

See Section XVIII.A.13 for the WTA Hotel Room Policy and penalties.

**E. EXHIBITION/NON-WTA EVENT RULE**

**1. Definition**

An Exhibition/Non-WTA Event is regarded as any tennis competition involving one (1) or more Players who compete in Professional Tennis tournaments whether or not the Player or Players receive remuneration for their participation in the event, which is not a part of the WTA or Women's ITF World Tennis Tour and is not recognized on the WTA or ITF Women's calendars. These events include single-day, multiple-day, week-long, seasonal team competitions and charity events.

**2. Applicability to Players under the Age Eligibility Rule**

Participation in Exhibition/Non-WTA Events by Players under the age of 18 is also subject to Section X.A - Age Eligibility Rule.

**3. Player Participation**

Unless granted a waiver pursuant to sub-Section 6 below, a Player is not permitted to play in an Exhibition/Non-WTA Event if it is scheduled as follows:

- a. Within sixty (60) days before or thirty (30) days after a WTA 1000 Mandatory, WTA 500, or WTA 250 Tournament (including the

**CODE OF CONDUCT**  
**SECTION XVII - CODE OF CONDUCT**

WTA Finals) and the Exhibition/Non-WTA Event is located either (i) within 125 miles/200 kilometers, measured linearly, of the site of the Tournament, or (ii) within the same generally recognized market area of the Tournament, as determined by the CEO;

- b. During the same week a WTA 1000 Mandatory, WTA 500, or WTA 250 Tournament (including the WTA Finals) is scheduled; or
- c. During the same week as a WTA 125 Tournament in which the player is entered, including the Sunday night after the final.

**4. Exception**

Notwithstanding anything to the contrary herein, as long as a Player is not competing in a WTA Tournament in the week preceding a Grand Slam, she may participate in an Exhibition/Non-WTA Event on the Saturday or Sunday prior to the commencement of the Grand Slam Main Draw, if that Exhibition/Non-WTA Event is promoted by the Grand Slam.

**5. Fine and Appeal Procedures**

A Player in violation of the Exhibition/Non-WTA Event Rule shall be automatically fined in accordance with the following schedule, based on her WTA Singles Ranking or Singles Special Ranking, whichever is better at the Tournament's Singles Main Draw Entry Deadline, or her meeting the Exemption Wild Card criteria:

<b>WTA Singles Ranking or Singles Special Ranking</b>	<b>Fine</b>
1-10	\$100,000
11-20	\$75,000
21-35	\$50,000
36-50	\$25,000
Players who do not meet ranking criteria above but do meet Exemption Wild Card criteria	\$75,000

- a. Exhibition/Non-WTA Event fines will be shared equally between the WTA and the Tournament Council, which the Tournament Council can use in its discretion, including distribution in whole or in part to an aggrieved Tournament. If the Tournament Council determines in its sole discretion that an aggrieved Tournament had any involvement with the Exhibition/Non-WTA Event, the Tournament Council may choose to forego a distribution of the collected fines to the aggrieved Tournament and direct the undistributed money into the Tournament Council Fund.



**CODE OF CONDUCT**  
**SECTION XVII - CODE OF CONDUCT**

- b. A Player shall not be subject to the applicable Exhibition/Non-WTA Event fine if her entry in the applicable week would not have been accepted into the respective Tournament by virtue of the better of her WTA Singles Ranking or Singles Special Ranking being below the cutoff at the Main Draw Entry Deadline.

**6. Waiver Consideration**

Any Player subject to this Exhibition/Non-WTA Event rule may apply to the CEO for a waiver of the rule with respect to one (1) or more Exhibition/Non-WTA Events, which application the CEO may grant in his/her sole and absolute discretion. Waiver requests should be submitted at least six (6) weeks prior to the Exhibition/Non-WTA Event but no later than one (1) week prior to the Exhibition/Non-WTA Event.

The CEO may consider such waiver requests according to the individual circumstances presented, including, without limitation, (i) the number of days over which the Exhibition/Non-WTA Event is scheduled, (ii) the television coverage of the Exhibition/Non-WTA Event, (iii) any marketplace conflicts, (iv) whether the Exhibition/Non-WTA Event could be reasonably expected to promote fan and media interest, excitement, and attendance at those WTA Tournaments nearest to where the event is to take place, and (v) the extent to which a Player's participation in the Exhibition/Non-WTA Event would (a) negatively impact the overall health of the WTA Tour or (b) lead to confusion among tennis fans, media, and others about the logic, flow, and progression of the WTA circuit and the importance of participation in WTA Tournaments.

The written notification to a Player of the CEO's decision on a waiver request shall include the reasons for such decision.

**F. DISHONORABLE OR UNPROFESSIONAL CONDUCT OF TOURNAMENT SUPPORT PERSONNEL**

The favorable public reputation of the WTA, the WTA Tour, the Tournaments, and the Players is a valuable asset and creates tangible benefits for all WTA members.

**1. Tournament Obligation**

Accordingly, it is an obligation for Tournament Support Personnel to refrain from engaging in conduct detrimental to the WTA or the WTA Tour or contrary to the integrity of the game of tennis and to ensure that Tournament partners adhere to the same standard in the activation of their partnership with the Tournament.

**CODE OF CONDUCT**  
**SECTION XVII - CODE OF CONDUCT**

a. Definition

Conduct detrimental to the WTA or the WTA Tour or contrary to the integrity of the game of tennis shall include, but not be limited to, public comments, whether or not to the media, and marketing and promotional campaigns and messaging, which unreasonably attack or disparage a Tournament, sponsor, player, official, the WTA, or the WTA Tour.

Responsible expressions of legitimate disagreement with WTA policies are not prohibited. However, public comments that one (1) of the stated persons above knows, or should reasonably know, will harm the reputation or financial best interests of a Tournament, Player, sponsor, official, or the WTA are expressly prohibited by this Section.

Tournament Support Personnel shall not disclose to any WTA non-members Confidential Information unless otherwise authorized by the WTA in writing or until such time that the information becomes publicly available through WTA-authorized means.

b. Penalties

Violation of this Section shall subject a Tournament and/or Tournament Support Personnel to a fine of up to \$25,000, denial of privileges or exclusion of the person in question from any or all Tournaments, and/or loss or change in membership status, and/or forfeiture of all sums, if any, previously paid to the WTA.

**2. Appeals Process**

The WTA shall have sole authority to declare a violation under this Section acting upon a formal and substantiated complaint. The WTA decision may be appealed to the Committee, with the exception of appeals involving monetary penalties of \$50,000 or more or appeals of major offenses, such as a change in membership status, in which case the matter will be referred to the Board of Directors for a decision.

**G. PROCEDURES FOR PLAYER AND TOURNAMENT SUPPORT PERSONNEL VIOLATIONS**

**1. On-court Adjudication**

Any violation of this Code that must by its nature be adjudicated prior to continuation of Tournament play shall be decided immediately by the official or officials given that authority under this Code. Any appeal of

**CODE OF CONDUCT**  
**SECTION XVII - CODE OF CONDUCT**

such decisions shall be made to the official making the decision, and the official's judgment with respect to any penalties other than fines shall be final in all cases. The fine portion of any on-court violation may be appealed to the Committee as set out below.

**2. Complaints**

a. Process and Timing for Reporting Alleged Player Violations

Reporting a Player's violation of this Code by a Player may originate with the WTA, any Player, or a Tournament official. Violations of the sexual abuse and sexual harassment rules may also be reported by the victim of the violation, in the case of a minor, by his or her parents or legal guardians, or by anyone who witnessed the violation. Complaints shall be directed to the WTA. Complaints must be received by the WTA within twenty-one (21) days of the alleged conduct and, where feasible, must be acted upon prior to the time of the next scheduled Committee meeting. No complaint, except for violations of the Exhibition/Non-WTA Event Rule, Anti-Corruption Program, Anti-Doping Program, or sexual abuse and sexual harassment rules, lodged more than twenty-one (21) days following knowledge or reason to know of the incident or activity allegedly in violation of the Code may be considered by the WTA.

b. Process and Timing for Reporting Alleged Tournament Support Personnel Violations

Reporting a violation of this Code by Tournament Support Personnel may originate with the WTA, any Player, or a Tournament official. Complaints shall be directed to the WTA. Complaints must be received by the WTA within twenty-one (21) days of the alleged conduct and, where feasible, must be acted upon prior to the time of the next scheduled Committee meeting.

**3. Review, Appeal, and Hearing**

For those offenses which require the WTA to conduct a thorough investigation, the WTA may do so either prior or subsequent to notification being given to the Player or Tournament involved.

The WTA and the Committee shall keep accurate records of all complaints and the disposition thereof and shall be responsible for recording all penalties imposed upon Players during any Tour Year.

**CODE OF CONDUCT**  
**SECTION XVII - CODE OF CONDUCT**

- a. Review Process for Players
  - i. Player Notification of Charges

If the WTA determines there are grounds for the complaint of misconduct under this Code, the Player so charged shall thereupon be notified orally, if possible, and in writing, specifying: a) the provisions which she is charged as having violated and b) the penalty such a violation carries if so specified in the Code.

If the penalty is not so specified, the Player shall be advised that the penalty will be determined by the WTA. This notification and any other in the course of a disciplinary proceeding shall be delivered to the player in person, sent to her by registered or certified mail, overnight delivery with confirmed delivery or sent by e-mail at her address as shown in the records of the WTA or on the most recent Tournament entry application submitted by the Player prior to the notification. All such notices shall be deemed given five (5) days after mailing.

- ii. Player Response to Charges

After receipt of notification of the charges and the potential penalties, a Player charged with misconduct for which a fine is not automatic, shall have twenty-one (21) days from the date of notice to respond in writing to the allegations. Failure to respond to the charges within the time limit cited above will subject the charged Player to the imposition of the fines as determined by the WTA, if the WTA determines that the Player committed the violation with which she is charged, and such Player fails to appeal to the Committee as outlined in this Code.

- iii. Player Request for Hearing

Any Player sanctioned for an offense which is subject to appeal, may request a hearing before the Committee or, in the case of an appeal involving monetary penalties of \$50,000 or more, a Player Major Offense potentially resulting in suspension from play, or other sanction of similar magnitude, a Player may request a hearing before the Board of Directors. The WTA must receive a request for a hearing within twenty-one (21) days following notification to the player of the fine or complaint against her.

**CODE OF CONDUCT**  
**SECTION XVII - CODE OF CONDUCT**

b. Review Process for Tournament Support Personnel

i. Tournament Support Personnel Notification of Charges

If the WTA determines there are grounds for a complaint of misconduct under this Code, the Tournament Support Personnel so charged shall thereupon be notified orally, if possible, and in writing, specifying a) the provisions which he/she is charged as having violated and b) the penalty such a violation carries if so specified in the Code.

If the penalty is not so specified, the Tournament Support Personnel shall be advised that the penalty will be determined by the WTA. This notification and any other in the course of a disciplinary proceeding shall be delivered to the Tournament Support Personnel in person, sent to him/her by registered or certified mail, overnight delivery with confirmed delivery or sent by e-mail at his/her address as shown in the records of the WTA. All such notices shall be deemed given five (5) days after mailing.

ii. Tournament Support Personnel Response to Charges

After receipt of notification of the charges and the potential penalties, Tournament Support Personnel charged with misconduct shall have twenty-one (21) days in which to respond in writing to the allegations. Failure to respond to the charges within the time limit cited above will subject the charged party to the imposition of the fines as determined by the WTA.

iii. Tournament Support Personnel Request for Hearing

Any Tournament Support Personnel charged with an offense for which a sanction was levied may request a hearing before the Board of Directors. The WTA must receive a request for a hearing within twenty-one (21) days following notification to the Tournament Support Personnel of the sanction.

c. Hearing Process and Timing

i. Notification of Hearing Time and Place

A Player or Tournament Support Personnel requesting a hearing (as outlined in sub-Sections a.iii and b.iii above) shall be given at least ten (10) days' notice of the time and place of the hearing. Attendance at the appeal hearing is not mandatory.

**CODE OF CONDUCT**  
**SECTION XVII - CODE OF CONDUCT**

It is intended that the hearing requested take place as soon as possible. If he/she wishes to shorten the time required for notice, the Committee or Board of Directors will cooperate in good faith.

ii. Hearing Procedures

At the hearing, he/she may call witnesses testifying on his/her behalf and examine witnesses testifying against him/her. He/she may, if he/she chooses, be represented by counsel at the hearing. The Committee or Board of Directors may determine that an interpreter is required in the interest of fairness. If so, they may retain such person at the expense of the WTA. The Committee or Board of Directors, as appropriate, shall make a determination, which shall be supported by written findings.

d. Meetings of the Committee

The Committee shall be scheduled to meet in person or by teleconference at least two (2) times per year, at least one (1) meeting of which shall be scheduled to be held outside the United States, unless there are no matters scheduled to be heard at the time of any such meeting. All expenses of the Committee shall be borne by the WTA.

e. Notification of Decisions

Within thirty (30) days of its decision, the Committee or Board of Directors shall give written notice to the Player or Tournament Support Personnel of its decision and the penalty to be imposed, if any, regardless of whether or not a hearing was requested. The decision of the Committee or Board of Directors shall be final and non-appealable.

f. Request for New Hearing

Notwithstanding Section XVII.G.3.e above, after the Committee or Board of Directors renders a decision on a Player's or Tournament Support Personnel's violation of this Code, the WTA, applicable Player, or applicable Tournament Support Personnel may submit a request to the WTA for the Committee or Board of Directors, as applicable, to grant a new hearing ("New Hearing") of such violation because of the discovery of information that: (i) was not known to the WTA or applicable Player or Tournament Support Personnel at the time of the Committee's or Board of Directors' original hearing on his or her violation; and (ii) is capable of causing the Committee or Board of Directors, as applicable, to render a different decision on the

**CODE OF CONDUCT**  
**SECTION XVII - CODE OF CONDUCT**

violation ("New Information"). Such request must be submitted to the WTA no later than ninety (90) days after notice of the Committee's or Board of Directors' original decision unless the Committee or Board of Directors otherwise agrees.

The Committee or Board of Directors, as applicable, has no obligation to grant a New Hearing and has sole, absolute discretion in determining whether a New Hearing request contains any New Information and whether to grant a New Hearing on a violation. The decision regarding a New Hearing by the Committee or Board of Directors, as applicable, is final and non-appealable. If the Committee or Board of Directors, as applicable, grants a New Hearing, the provisions of Sections XVII.G.3.c and e will apply to that hearing.

**g. Payment of Fines**

Any fine imposed must be paid to the WTA within thirty (30) days of the final imposition, unless written extension of time is granted by the WTA. All unpaid fines at the end of the year will be subject to a penalty of 15% interest on the outstanding balance. Filing of an appeal will not prevent the WTA from deducting fines from player prize money or any payments due from the WTA to Tournaments, nor shall it delay the due date of any fine invoice.

**H. PROCEDURES FOR PLAYER SUPPORT TEAM MEMBERS AND CREDENTIALLED PERSONS**

**1. Player Support Team**

Player Support Team members are expected to conduct themselves in a professional manner at all times. In this regard, a Code of Conduct has been established to set out the rules by which all Player Support Team members must abide at all times.

**a. Competence**

- i.** Player Support Team members shall provide services only within the boundaries of their competence, based on their education, training, supervised experience, or appropriate professional experience.
- ii.** Player Support Team members who perform services for a Player shall strive to increase their level of proficiency and skill by remaining current and seeking continuing education and certification (e.g., by one (1) or more recognized tennis

**CODE OF CONDUCT**  
**SECTION XVII - CODE OF CONDUCT**

professional associations) on safety, health, training, and other developments relevant to tennis.

- iii. Player Support Team members who perform services for a Player shall seek advice and counsel of colleagues and experts, whenever such consultation is in the best interests of the Player.
  - iv. Player Support Team members shall strive to protect the health, safety, and psychological and physical well-being of a Player under their direction by ensuring that all of the activities under their control are conducted for the Player's psychological and physical welfare.
- b. Unfair and/or Discriminatory Conduct
- i. Player Support Team members shall not engage in unfair or unethical conduct, including any attempt to injure, disable, or intentionally interfere with the preparation or competition of any Player.
  - ii. Player Support Team members shall not discriminate in the provision of services on the basis of race, ethnicity, gender, national origin, religion, age, or sexual orientation.
- c. Abuse of Authority; Abusive Conduct
- i. Player Support Team members shall not abuse their position of authority or control and shall not compromise or attempt to compromise the psychological, physical, or emotional well-being of any Player.
  - ii. Player Support Team members shall not engage in abusive conduct, either physical or verbal, or threatening conduct or language directed towards any Player, Tournament official, WTA staff member, on-court official, coach, parent, spectator, or member of the press/media.
  - iii. Player Support Team members shall not exploit any Player relationship to further personal, political, or business interests at the expense of the best interest of the Player.
- d. Sexual Conduct
- In order to prevent sexual abuse and the negative consequences resulting from the imbalance of a dual relationship, sexual conduct of any kind between a player and her Player Support Team



**CODE OF CONDUCT**  
**SECTION XVII - CODE OF CONDUCT**

members expressly is discouraged. In addition, the following conduct specifically is prohibited:

- i. Player Support Team members shall not advance towards, or have any sexual contact with, any player who is a) under the age of 17 or b) under the age of legal majority in the jurisdiction where the conduct takes place or where the player resides.
  - ii. Player Support Team members shall not sexually abuse a player of any age. Sexual abuse is defined as the forcing of sexual activity by one (1) person on another person a) of diminished mental capacity or b) by the use of physical force, threats, coercion, intimidation, or undue influence.
  - iii. Player Support Team members shall not engage in sexual harassment (for example, by making unwelcome advances, requests for sexual favors, or other verbal or physical conduct of a sexual nature where such conduct may create an intimidating, hostile, or offensive environment).
  - iv. Player Support Team members shall not share a hotel room with a player who is a) under the age of 17 or b) under the age of legal majority in the jurisdiction where the hotel is located or where the player resides, unless such Player Support Team member is the player's legal guardian or is related to the player. Hotel room per diems shall be withheld from any underage player who is found to have violated this Hotel Room Policy. Such penalty shall be in addition to any penalties that may be imposed on the Player Support Team member pursuant to sub-Section 3 below.
- e. Criminal Conduct

Player Support Team members shall comply with all relevant criminal laws. For greater certainty and without limiting the foregoing, this obligation is violated if Player Support Team members have been convicted of or entered a plea of guilty or no contest to a criminal charge or indictment for an offense involving:

- i. Use, possession, distribution, or intent to distribute illegal drugs or substances;
- ii. Sexual misconduct, harassment, or abuse; or
- iii. Child abuse.

**CODE OF CONDUCT**  
**SECTION XVII - CODE OF CONDUCT**

Further, this obligation may be violated if, depending upon the nature of the crime, a Player Support Team member has been convicted of or entered a plea of guilty or no contest to an offense that is a violation of any law specifically designed to protect minors.

f. Anti-Doping Activity

Player Support Team members shall comply with the Anti-Doping Program and shall not aid or abet in any way a player's violation of the Anti-Doping Program.

g. Anti-Corruption Program

Player Support Team members shall comply with the Anti-Corruption Program and shall not aid or abet in any way a player's violation of the Anti-Corruption Program.

h. General Conduct and Requirements

i. Player Support Team members shall be familiar with, and agree to abide by, the Rules and encourage players to abide by the same.

ii. Player Support Team members must comply with all requirements of any Player Support Team member registration program established by the WTA.

iii. Player Support Team members shall at all times, whether at a Tournament site or not, refrain from engaging in conduct detrimental to the WTA or the WTA Tour or contrary to the integrity of the game of tennis. Conduct detrimental to the WTA or the WTA Tour or contrary to the integrity of the game of tennis shall include, but not be limited to, public comments, whether or not to the media, which unreasonably attack or disparage any person, group of people, Tournament, sponsor, player, official, the WTA, or the WTA Tour. Responsible expressions of legitimate disagreement with WTA policies are not prohibited. However, public comments that a Player Support Team member knows, or should reasonably know, will harm the reputation or financial best interests of a Tournament, player, sponsor, official, the WTA, or the WTA Tour are expressly prohibited by this Section.

iv. Player Support Team members shall not disclose to any WTA non-members Confidential Information unless otherwise authorized by the WTA in writing or until such time that the

**CODE OF CONDUCT**  
**SECTION XVII - CODE OF CONDUCT**

information becomes publicly available through WTA-authorized means.

**2. Credentialed Persons**

No person who has been given a credential by a Tournament, including members of the media, may at any time during the Tournament engage in abusive conduct directed towards any player, official, spectator, or Tournament or WTA staff.

**3. Violations/Procedures**

The following procedures shall apply to all complaints and violations under this sub-Section H.

a. Process and Requirements for Reporting Alleged Violations

Any individual who believes that any Player Support Team member or Credentialed Person has failed to meet his or her obligations under this Code may file a written complaint with the CEO. That complaint shall be signed and shall state specifically the nature of the alleged misconduct.

b. Review or Investigation of Alleged Violations

Upon receipt of such a signed complaint, the CEO promptly shall initiate a review of the matter. The CEO also may initiate an investigation on the basis of a suspension or other disciplinary action taken against Player Support Team members or Credentialed Persons by a National Federation or other tennis organization or a conviction or plea of guilty or no contest to a criminal charge or indictment.

c. CEO Findings and Action

Upon review of the complaint and, where appropriate, additional investigation, the CEO may determine that the complaint does not merit further action.

However, if the CEO determines the complaint does merit further action, after giving the accused individual the opportunity to present his or her views to the CEO or his/her designee, either in person or in writing, at the CEO's discretion, the CEO may impose appropriate sanctions including:

**CODE OF CONDUCT**  
**SECTION XVII - CODE OF CONDUCT**

- i. Denial of privileges or exclusion of the person in question from any or all Tournaments; or
- ii. Such other sanctions including monetary sanctions as the CEO may deem appropriate.

In addition, the CEO shall have authority to issue a provisional suspension, pending the completion of the investigation and issuance of a final decision on the matter.

d. Appeal Process

Decisions of the CEO may be appealed to the Board of Directors. The Board of Directors shall decide whether to review the appeal based solely on the CEO's investigation or whether to hold a hearing in which the accused will be given the opportunity to present his/her views directly to the Board of Directors. The CEO shall not be entitled to a vote in any Board of Directors appeal decisions under this Section.

Any appeals to the Board of Directors under this Section must be filed in writing within twenty-one (21) days from the date of notice of the CEO's decision, which is the subject of the appeal. The decision of the Board of Directors shall be final and non-appealable.



# STANDARDS

## XVIII. STANDARDS

### A. TOURNAMENT STANDARDS OF PERFORMANCE

All WTA Tournaments must be staged in a first-class professional manner. Standards are required unless otherwise noted or approved. Tournaments must apply to the WTA at least three (3) months in advance for an exemption from any Tournament Standard of Performance.

No experimental procedures or products can be used or offered to the players without prior written approval from the WTA. All procedures and products must be in compliance with the Rules.

Unless otherwise noted, all facilities and standards required hereunder must be ready by 9:00 a.m. on the day of Qualifying Sign-In.

Any Tournament that is combined with an ATP event of any level or back-to-back with an ATP event of an equal level shall provide a level of Tournament Standards that is equal to or greater than the level of Tournament Standards provided for at its ATP event; however, in no instance shall such Standards fall below the minimum required herein.

WTA 125 Tournaments must comply with the WTA 125 Tournament Standards (see Appendix E).

#### 1. Accounting

Within fourteen (14) days following the conclusion of the Tournament, the Tournament shall submit to the WTA a full report of all aspects of the Tournament including: a) a copy of the prospectus; b) a completed program; and c) a statement showing all monies disbursed on site for prize money and traveling expenses as allowed under Section IX - Prize Money.

#### 2. Animals

No animals will be allowed in the Player Restaurant, Locker Room, Treatment/Training Room, or WTA Office. Animals on site must be restrained (either by leash or carry case). Facility rules regarding animals on site shall be enforced.

#### 3. Anti-Doping Testing Facilities and On-Site Personnel Assistance

##### a. On-Site Doping Control Station

Each Tournament, when selected to host testing of players, is

## STANDARDS

### SECTION XVIII - TOURNAMENT STANDARDS OF PERFORMANCE

obligated to provide, at its own cost, the facilities in Appendix N.

b. Chaperones Provided by the Tournament

Each Tournament, when selected to host testing of players, is obligated to provide, at its own cost, adult female staff members and/or volunteers who can assist the Official Anti-Doping Personnel and Supervisor with the notification and observation of players selected for testing. The Tournament shall be notified of the chaperone schedule at least seven (7) days prior to the start of the Tournament.

#### 4. Ball Persons

It is recommended that a coordinator be appointed to recruit and assign Ball Persons. There shall be a minimum of six (6) ball persons per match in the Main Draw and Qualifying. Ball persons may not wear any predominantly white, yellow, or other light color clothing that may interfere with the players' vision, unless otherwise approved by the WTA. Ball persons' uniforms should not be identical to the Line Umpires' uniforms.

#### 5. Balls

a. Ball Type and Specifications

i. ITF-approved Type 2 Regular Duty balls from the WTA approved ball list are to be used at all WTA Tournaments unless otherwise approved by the WTA. At least twelve (12) weeks prior to the start of its Main Draw, each Tournament must confirm with the WTA the ball it intends to use. Failure to comply may result in a Tournament Standards Violation and/or other sanctions.

High-altitude balls are not to be used unless conditions require, and such use must be approved by the WTA and must be stated on the Tournament Fact Sheet.

ii. WTA Tournaments which are played the week before a Grand Slam are required to use the same ball (brand and commercial denomination) as that Grand Slam.

iii. Pressurized balls only will be used on the WTA.

b. Number and Procedure for Rotation during All Match Play

At all Tournaments for all matches in both Qualifying Singles and Main Draw singles and doubles, six (6) balls shall be used and changed after the first seven (7) games and thereafter every nine (9) games.

# STANDARDS

## SECTION XVIII - TOURNAMENT STANDARDS OF PERFORMANCE

c. Availability

Balls of the make to be used in the Tournament must be provided on site free of charge at least two (2) days prior to the commencement of Qualifying for players in both the Main Draw and Qualifying until they are eliminated (see daily allocation in sub-Section d below). Three (3) days prior to the commencement of Qualifying balls must be available for players to purchase.

d. Daily Allotted Number of Practice Balls

Main Draw and Qualifying players are entitled to new practice balls as set out in the following chart:

Tournament Category	Player Daily Allotment of New Practice Balls			
	Main Draw Players While Competing	Main Draw Players After Elimination	Qualifying Players While Competing	Qualifying Players After Elimination
WTA 1000 Mandatory, WTA 500	12	6	6	3
WTA 250	9	6	6	3

If the practice courts are located off site, it is recommended that practice balls be provided at the practice site.

### 6. Betting Sponsorships

Tournaments must comply with the WTA Betting, Fantasy & Gambling Sponsorship Rules. (See Appendix D.)

### 7. Chairs/Umbrellas

Chairs must be provided on court for player use during the change of ends. At outdoor Tournaments, umbrellas must be provided to shade the players' chairs.

### 8. Cleaning

- a. Tournaments must retain a dedicated cleaning staff that is trained and provided the equipment necessary to clean, disinfect, and sanitize Tournament facilities in accordance with local health regulations.
- b. Procedures must be in place for cleaning and disinfecting equipment, training fixtures, uniforms, and high-traffic and high-contact areas, particularly following use.



## STANDARDS

### SECTION XVIII - TOURNAMENT STANDARDS OF PERFORMANCE

- c. Procedures must be tailored to the specific needs and challenges of cleaning, disinfecting, sanitizing, and ventilating each unique Tournament area.
- d. Locker rooms, dining facilities, and healthcare-related areas of the Tournament facilities must be cleaned and disinfected regularly throughout each day of the Tournament. The floors of locker rooms and all healthcare-related areas must be cleaned at least each night after completion of treatments and before they are open for use the following day.

## 9. Court

- a. Court Specifications
  - i. Court Surface
    - (a) Tournaments must be played on a surface that is approved by the WTA, including, but not limited to, the color of the court surface. Tournaments must submit a written request for approval to the WTA prior to making any changes to the existing surface and pay the cost of any testing deemed necessary by the WTA.
    - (b) If a new surface is being considered, approval must be given by the WTA. If the Tournament fails to utilize the surface recommended by the WTA, individual players may refuse to participate in the Tournament, in which case the WTA neither is responsible for such action by a player nor subject to any penalties.
    - (c) The surface must be maintained to the satisfaction of the Supervisor/Referee.
    - (d) Tournaments must ensure that the same surface is used for Main Draw and Qualifying. If there are circumstances beyond the control of the Tournament Director, Qualifying matches may be held on a different surface, only with approval of the WTA. All practice courts, with a minimum of one (1) on site, must be of the same surface and condition (i.e., indoor/outdoor) as the Main Draw match court(s). (See the chart in sub-Section b below for practice court requirements.)
    - (e) Unless otherwise approved by the WTA, outdoor courts shall be laid out with the long axis north and south; geographic

## STANDARDS

### SECTION XVIII - TOURNAMENT STANDARDS OF PERFORMANCE

considerations may modify this orientation in order to minimize the adverse effect of serving into the sun.

#### ii. Court Measurements

- (a) There must be at least 12 feet (or 3.66 meters) at each side of the doubles sideline and 21 feet (or 6.40 meters) behind each baseline. (This does not include the publicity/ advertising placed around the line umpires' chairs). It is recommended that show courts have 15 feet (4.57 meters) at each side of the doubles sideline and 27 feet (8.23 meters) behind each baseline. At indoor Tournaments, the ceiling must be a minimum of 40 feet (or 12.19 meters) in height.
- (b) Court Dimensions must comply with those set out under the ITF Rules of Tennis. It is the responsibility of the Tournament Director to ensure, upon final preparation of the tennis courts before the Tournament commences, that all court specifications, including court measurements, comply with the standards set forth in Appendix J – Court and Light Measurements. All court measurements shall be made to the outside of the lines and all lines of the court shall be white.

#### b. Minimum Numbers of Match and Practice Courts

##### i. Combined Tournaments with the ATP

For all combined Tournaments with the ATP other than WTA 1000 Mandatory Tournaments, minimum numbers of match and practice courts must be approved by the WTA at least six (6) months prior to the Tournament.

##### ii. Indoor Tournament

Draw Size	Show Courts	Additional Match Courts	Practice Courts (on-site and off-site)	On-Site Practice Courts
48	1	2	4	1
32/30/28	1	1	3	1

**STANDARDS**  
**SECTION XVIII - TOURNAMENT STANDARDS OF PERFORMANCE**

iii. Outdoor Tournament

<b>Draw Size</b>	<b>Show Courts</b>	<b>Additional Match Courts</b>	<b>Practice Courts (on-site and off-site)</b>	<b>On-Site Practice Courts</b>
96 Combined 12-day	3	6	16	8
96	2	4	8	4
64 Combined	2	5	12	6
64/60/56	1	4	5	3
48	1	3	4	2
32/30/28	1	2	3	1

iv. Availability

Practice courts must be available for use for practice by 8:00 a.m. two (2) days prior to the commencement of Qualifying (10:00 a.m. for grass court Tournaments), and match courts must be available for use for practice by 8:00 a.m. the day of Qualifying Sign-In (10:00 a.m. for grass court Tournaments).

c. Court Signage

i. On the Court Surface

- (a) There can be no commercial identification on the surface of the court, except that the name of the court manufacturer and the Tournament’s host locality (as further described below) are permitted to be placed on the court surface with prior approval from the WTA. A Tournament must request WTA approval for the placement of the WTA Logo and host locality signage and/or court manufacturer identification and provide full details of all signage (text and placement) to the WTA at least ninety (90) days prior to the event.
- (b) Tournaments may place on court the name of their host locality, which may include one (1) of the following: city, region (i.e., state or county), or country subject to the placement and size restrictions set forth below. The preferred font is Din Condensed, but tournaments may use the official logo or font of the host country, city, or region with the prior approval of the WTA. Signage must be consistent with the texture and feel of the court surface so as not to affect play or pose a safety hazard.

## STANDARDS

### SECTION XVIII - TOURNAMENT STANDARDS OF PERFORMANCE

The position, size, and font of the host locality signage shall be in accordance with one (1) of the following two (2) options; and, in either case, the Tournament must include the WTA Logo as specified below:

#### HOST LOCALITY NAME OPTION 1: BASE LINE OPTION (not applicable to clay court tournaments)

- Upper case in white
- Displayed on one (1) line facing the main camera
- Written on one (1) or both ends of the court behind the baseline
- Centered between the singles sidelines
- Nearest distance from the baseline: 3 m/9.85 feet
- Height of lettering: Not greater than 80 cm/31.5 inches (50 cm/19.7 inches at combined events)
- Width: No restriction

#### HOST LOCALITY NAME OPTION 2: SIDELINE OPTION

- Upper case in white
- Displayed on one (1) or two (2) lines, facing the main camera
- Written on the right and/or left side of the court at the service line for hard or grass courts or centered between the net post and the service line for hard, grass, or clay courts, outside of the doubles sidelines. If the text is displayed on two (2) lines, they should together be centered on the service line (line spacing should be 20 cm/7.9 inches).
- Height of lettering: Not greater than 50 cm/19.7 inches (40 cm/16 inches at combined events)
- Distance from the doubles sideline: minimum of 40 cm/16 inches (maximum of 40 cm/16 inches at combined events)
- Width: No restriction
- The text should be elongated by 27% for improved television visibility.
- If used on a clay surface, the text must not protrude above the surface of the court.

#### WTA LOGO (FOR OPTIONS 1 AND 2)

- Placement:
  - (i) One (1) WTA Logo painted on the court, at least 40 cm/16 inches outside of the doubles sidelines half

## STANDARDS

### SECTION XVIII - TOURNAMENT STANDARDS OF PERFORMANCE

- way between the net and the service line, on the side of and facing the main camera; or
- (ii) WTA Logos in at least two (2) corners of the backdrops, with a minimum of one (1) on the backdrop facing the main camera and one (1) in side camera view;\* or
  - (iii) At least two (2) WTA Logos in a position immediately above and behind the backdrops with a minimum of one (1) on the end facing the main camera and one (1) in side camera view;\* or
  - (iv) Any other position proposed by the Tournament and agreed by the WTA.
- Logo Dimensions if Painted on the Court: At least 44.2 cm (17.4 inches) x 94 cm (37 inches)
  - Logo Dimensions if on or Behind Backdrop: At least 29 cm (11.4 inches) x 37.7 cm (14.84 inches)
  - Artwork: WTA Logo; same application as for backdrop/sidewall signage with a dark background
  - Combined and Back-to-Back Events: WTA Logo must be at least the same visual size as the ATP logo (i.e., cover the same surface area)

\*The WTA may substitute the WTA Logo positioned on the back fence with 3-D signage placed on-court as a mat where the Net Umpire chair surrounding is normally placed.

- (c) Two (2) identifications of the court manufacturer (maximum 20.13 square feet/1.87 square meters) may be permitted on the side of the court surface parallel to the sidelines. Such logo must be placed at least 1.5 meters (4.92 feet) from the doubles sideline. If used on a clay surface, the text must not protrude above the surface of the court.

(See examples in Appendix I – On-Court Signage.)

#### ii. Behind the Court

The back fences, back walls, net, net posts, line umpire boxes, and other fixtures on a court shall not be predominantly white, gray, yellow, or any other light color that can interfere with the vision of the players as determined by the Supervisor.

#### iii. Banners

There can be no banners with predominantly white, gray, yellow, or any other light color backgrounds behind the ends

## STANDARDS

### SECTION XVIII - TOURNAMENT STANDARDS OF PERFORMANCE

of the court. Background and lettering on rotating/LED banners should be consistent with the color of the back walls. If placed in front of back walls, rotating/LED banners can change only after completion of any game. If placed in front of side walls, rotating banners can change between any point. In either case, banners must not change once a player is ready to serve.

When lighter lettering needs to be used on a darker background, PMS Color "Cool Gray" 4 to 6 (5 to 6 for outdoor tournaments) are the preferred colors. No colors can be used that interfere with the vision of the players as determined by the Supervisor.

Banners must comply with the WTA Betting, Fantasy & Gambling Sponsorship Rules. (See Appendix D).

#### d. Court Preparation

Clay and loose surface courts must be swept, watered, and lines cleared before the start of all matches, if the Supervisor or Referee deems it necessary. Clay courts also may need to be watered and/or swept between sets if requested by the Supervisor or Referee.

#### e. Seating

##### i. Color of Box Seats and Seats at Ends of the Court

It is recommended that spectator seating not have any white, gray, yellow, or other light colors that can interfere with the vision of the players and that any such light colored seating be covered.

##### ii. Spectator Movement During Play

Spectators above the lowest tier of seating will be allowed to move freely to and from their seats at any time during play. The Tournament Director and Supervisor at each Tournament will determine this lowest tier of seating. Where there is no clear break, the Tournament Director and Supervisor will determine the most logical designation for spectator movement during play. (See Appendix B.1 - Supervisor.)

#### f. Smoking

Except where prohibited by law, smoking shall not be permitted within the lower level of seating around the courts and in all restricted player areas as well as the WTA and Officials' offices.

## STANDARDS

### SECTION XVIII - TOURNAMENT STANDARDS OF PERFORMANCE

#### 10. Credentials/Tickets/Seating

In addition to the ticket allocation requirement as part of the Commercial Benefits granted to the WTA/sponsor (see Section XIII.B.10 - Seats/Tickets) and the WTA Television Broadcast Standards requirements (see Section XVIII.F.4 - Tournament Facilities), each Tournament will provide the following:

- a. Players, Coaches, Guest, and WTA Staff
  - i. Each Participating Player:
    - (a) One (1) credential;
    - (b) Two (2) player guest/coaches credentials; and
    - (c) Two (2) tickets for each day for which the player remains in the Tournament.

A designated seating area in the grandstand for players and players' coaches, relatives, or guests to sit and watch matches also must be provided at all sessions. Best efforts should be made for a minimum of ten (10) seats. This reserved seating area shall be in addition to the match box seats.

Player credentials shall be valid through the end of the Tournament. Player guest/coach credentials shall be valid as long as the player remains at the Tournament.

- ii. Each WTA staff member, massage therapist, WTA sponsor: One (1) credential.
- iii. Any official guest of the WTA: One (1) credential, at WTA's request (provided such requests are reasonable and access limited as appropriate for security).
- iv. WTA: Ten (10) tickets per session in a preferred location (need to be box seats or best available after box seats).
- v. WTA player members not in the Tournament: On-site access is allowed, but such players are not permitted to use the site amenities and practice facilities without the Tournament Director's permission.
- vi. Each WTA Tournament Director: On-site access to all WTA Tournaments.

# STANDARDS

## SECTION XVIII - TOURNAMENT STANDARDS OF PERFORMANCE

- vii. At WTA/ATP combined events, WTA alumnae players: One (1) credential each, at the Tournament's discretion.
  
- b. Match Court Seats
  - i. A match box shall be provided to the guests of each player participating in the scheduled match. The boxes should offer identical views, have a minimum of six (6) seats, and be of equal position and size to each other but located at opposite ends of the court near the baseline or the back of the court on the same end as the player's seat to accommodate Off-Court Coaching.
  
  - ii. To the Supervisor, PHCP, and WTA Communications Manager: One (1) seat each close to the entrance of each court during all matches with easy access to the court.

Each person granted a credential to access secure player areas (other than participating players who receive a credential pursuant to Section XVIII.A.10.a.i(a)) must comply with WTA's credentialing requirements. Tournaments must implement and comply with credentialing requirements established by the WTA.

The following table summarizes the above requirements for credentials, tickets, and seating:

<b>Group Designation</b>	<b>Credentials</b>	<b>Tickets/Seats</b>
WTA Players	1 player badge and 2 guest/coach badges	2 each day while competing
WTA Staff <sup>^</sup>	1 per staff member and local massage therapist	3 seats by court entrance with easy access to the court
WTA	1 credential for any official guest	10 tickets per session in a preferred location
WTA Sponsor	1 per sponsor	n/a
WTA Members	On-site access	n/a
WTA Tournament Directors	On-site access	n/a

<sup>^</sup> The seats near the court entrance shall be designated for the Supervisor, PHCP, and Communications Manager for all matches.

### 11. Fitness Center

Access to a complimentary fitness center is required at all Tournaments for all players and credentialed coaches, located within reasonable proximity to the site or the Tournament hotel. The fitness center should include a variety of cardiovascular equipment (bicycles, treadmills, stair-stepers) and strengthening equipment (free weights, nautilus,



## STANDARDS

### SECTION XVIII - TOURNAMENT STANDARDS OF PERFORMANCE

resistance bands, rubber medicine balls (weight range 1kg to 4kg), and anti-burst swiss balls), as well as an area for flexibility and relaxation (stretching mats and foam rollers) with a full-length mirror. If there is no accessible fitness center on site, there must be a warm-up area that includes cardiovascular equipment (bicycles, treadmills, etc.) and an area for flexibility and relaxation.

#### 12. Food and Beverage Service

Each Tournament must provide complimentary food and drinks beginning one (1) hour before the start of the first scheduled match until one (1) hour after the start of the last match, for WTA staff and for all players (Main Draw and Qualifying) plus a minimum of one (1) guest per player from the first day of Qualifying until the player is eliminated. The Tournament shall assure that food and drinks are available on-site on the day before the start of Qualifying. If the Tournament hosts a night session, it is acceptable to provide complimentary food only to players scheduled for that night, as well as players involved in delayed day session matches, and to WTA staff.

##### a. Food Storage, Service, and Preparation

- i. All food and beverages must be prepared, stored, maintained, and served in accordance with local health regulations.
- ii. Low-fat cooking methods should be used (baked, broiled, roasted, with no added butter or oil).
- iii. Seasonings should be light; offer extra salt, pepper, garlic, etc. on the side.

##### b. Supplements

No nutritional or dietary supplements may be provided to players in any form (e.g. food, drink, tablets, powder), including common products such as vitamins, minerals, amino acids, medicinal herbs, hemp and poppy seeds or similar substances.

Drinks and bars which present a high risk under the TADP must be subject to a suitable quality assurance program (e.g., Informed Sport; NSF Certified for Sport, HASTA).

##### c. Water and Electrolyte Replacement Drinks

Bottled, non-carbonated water and WTA-approved carbohydrate-electrolyte replacement drinks in individual-use sealed containers

## STANDARDS

### SECTION XVIII - TOURNAMENT STANDARDS OF PERFORMANCE

must be provided at all times in the player restaurant, Locker Room, private, medical treatment area, Players' Lounge, and on the practice and match courts unless otherwise approved by WTA.

#### d. Daily Meal Planning

- i. When providing meals, a variety of quality, international cuisine and seasonal food choices are preferred on a daily basis.
- ii. In addition to daily meals, performance snacks (e.g., fruits, breads, pretzels, low-fat snack bars, cheeses, yogurts, crackers, nuts, and dried fruit) should be provided throughout the day and evening in the player restaurant and Players' Lounge.
- iii. Mineral water, a variety of 100% fruit juices, chocolate milk (1%, low fat, or skim) and chocolate soy milk, and a selection of coffees, teas, hot chocolate, and soft drinks (decaffeinated, preferred) should also be available in the player restaurant and Players' Lounge.
- iv. If morning practices and matches are played, breakfast items also should be available (e.g., cold cereals, bagels, breads, yogurt, and fruit).
- v. Suggested lunch and dinner menus should include the following selections:
  - (a) Three (3) carbohydrate selections (one (1) rice option, one (1) potato option, and one (1) pasta option); and
  - (b) Three (3) protein selections (one (1) red meat option, one (1) white meat option, and one (1) meatless option). (See sub-Sections 10.e.i and ii - Recommended Food Groups – Carbohydrates and Proteins below)
- vi. Practice hours and match schedule will determine when meals and/or performance snacks are served. Allow for one (1) hour before the start of the first scheduled match and up to one (1) hour after the start of the last match. Limited meal times, outside of this schedule require the pre-approval of the Supervisor, and, in such instances, the Tournament must arrange for alternate on-site player and staff meals until the player restaurant reopens.

#### e. Recommended Food Groups

The following is a list of recommended food groups:

## STANDARDS

### SECTION XVIII - TOURNAMENT STANDARDS OF PERFORMANCE

i. Carbohydrates (60% of total calorie intake)

(a) Breads and Cereals

Assorted wheat breads, rolls, and gluten free bread; oatmeal or porridge; bagels; crackers; low-sugar cereals; muesli; pasta and gluten free pasta; baked (white and sweet) potatoes; barley, quinoa, couscous, and rice.

(b) Fruits and Vegetables

Assorted fresh fruit salad; dried fruits; whole fresh fruits; and fresh-cut raw vegetables. Salad bar: tomatoes; potatoes; lettuce (variety); cucumbers; sprouts; mushrooms; carrots; peas; beans; etc. with a variety of dressings on the side.

ii. Proteins (15% of total calorie intake)

(a) Meat and Alternatives

Chicken (white meat); turkey (white meat); beef and lamb (red meat); fish (assorted variety); eggs; legumes; nuts; and tofu.

(b) Dairy Products and Alternatives

Soft and hard cheeses; low-fat cottage cheese; low-fat plain and fruit-flavored yogurt; low-fat milk and soy milk.

iii. Fats and Oils (25% of total calorie intake)

Limit intake of fats and oils high in saturated and/or trans fatty acids.

iv. Miscellaneous

(a) A selection of international condiments (e.g., jam, honey, peanut butter, vegemite, salsa, ketchup, curry sauce, soy sauce, and sweet chili sauce).

(b) Low-fat soups (e.g., minestrone, chicken noodle, vegetable).

(c) All sauces and dressings should be served on the side.

(d) Low-fat dessert options, such as fruit breads, muffins, and crumbles.

## STANDARDS

### SECTION XVIII - TOURNAMENT STANDARDS OF PERFORMANCE

#### 13. Hotel Rooms/Per Diem – Player

a. Official Hotel Location and Transport Requirements

Tournaments will establish an official hotel that meets the standard requirements of the WTA. Hotels must be located in a secure and safe area. Motels or any accommodations that require entrance to rooms from the street or public outdoor walkways are not acceptable. Transport must be provided to and from the official hotel to the Tournament site.

b. Hotel Rates and Availability

Each Tournament should use its best effort to arrange for discounted or complimentary accommodations. If the official hotel daily rate for a double room (2 persons in room) including taxes and excluding breakfast is higher than the per day maximums below, then an alternative player hotel must be provided with a rate equal to or less than the rates below:

- i. US\$270 (€250 in Europe) at WTA 1000 Mandatory Tournaments;
- ii. US\$225 (€110 in Europe) at WTA 500 Tournaments; and
- iii. US\$200 (€185 in Europe) at WTA 250 Tournaments.

The maximum rates above are increased by \$15 (€15 in Europe) if breakfast is included.

Rates should be available the day before Qualifying commences until the conclusion of the Tournament.

Tournaments may apply to the WTA for relief from these hotel rate standards, which may be granted by the WTA on a case-by-case basis, depending upon local considerations which make compliance with such standards impractical and unrealistic.

c. Alternate Hotel Location and Transport Requirements

The alternate hotel should be no more than 10-15 miles (or 10-15 minutes) from the Tournament site. Tournament transportation must be provided from the alternate hotel.

d. WTA Notification of Hotel Accommodations and Room Lists

The Supervisor should be notified by the Tournament of all housing

## STANDARDS

### SECTION XVIII - TOURNAMENT STANDARDS OF PERFORMANCE

arrangements. In addition, each Tournament shall provide the WTA with an official hotel room list.

e. Player Hotel Room Entitlement

Under the per diem rule, each player competing in the Main Draw (singles or doubles) at all WTA Tournaments and the Qualifying at WTA 1000 Mandatory, WTA 500, and WTA 250 Tournaments shall be entitled to a double room, including room taxes, at one of the official hotels selected by the Tournament, provided that the player reserves her room through the Tournament's designated hotel booking process. Specific hotels for Qualifying and Main Draw may be designated by a Tournament.

If multiple players elect to share a room, each player in such room is still entitled to receive full per diem, with the players' per diem nights combined for such room. If a player does not use her per diem nights in her own room or a shared room, then she may designate the entirety of the nights in her per diem room to one (1) Player Support Team Member. In either case, per diem shall begin in accordance with sub-section h or i below. A player requesting either alternate arrangement should inform the Tournament at the time of hotel booking, but the arrangement is not guaranteed.

The Tournament shall only pay the per diem allowances through the official hotel(s). Payment to the players is prohibited. Tournaments may apply to the WTA for relief from this requirement, which will only be granted by the WTA if the Tournament agrees to make secure arrangements for per diem payments to underage athletes.

Players who reserve a hotel room through the Tournament's designated hotel booking process may not knowingly share their room with individuals who are provisionally suspended or serving a period of ineligibility under the Integrity Rules or these Rules unless it cannot reasonably be avoided. If a player is found to be in violation of this Rule, she will be fined an amount equal to her per diem for that Tournament. Such penalty shall be in addition to any penalties that may be imposed for violating the prohibited association rules of the Integrity Rules.

f. Reservation Process and Deadlines

If a player does not make her hotel reservation in accordance with the Tournament's designated hotel booking process and by the deadline stated on the Tournament Fact sheet, she is not guaranteed a room or any discounted rate.

## STANDARDS

### SECTION XVIII - TOURNAMENT STANDARDS OF PERFORMANCE

The hotel booking process must be clearly described on the Tournament Fact Sheet. The Tournament must ensure that a contact person is available by telephone and email starting at least six (6) weeks before the Tournament and the contact details must appear on the Tournament Fact Sheet.

g. Required Length and Timing of Hotel Stay

i. Minimum Per Diem Nights

The minimum numbers of nights for which singles and doubles Main Draw players shall receive hotel room/per diem is listed in the table below.

<b>Tournament Category</b>	<b>Singles Main Draw</b>	<b>Singles Qualifying</b>	<b>Doubles Main Draw</b>
WTA 1000 Mandatory - 10+ days	10	2	5
WTA 1000 Mandatory - 9 days	8	2	5
WTA 500 with a Qualifying draw of 24 or less	6	3	4
WTA 500 with a Qualifying draw greater than 24	6	2	4
WTA 250 with a Qualifying draw of 24 or less	5	3	4
WTA 250 with a Qualifying draw greater than 24	5	2	4
WTA 125	4	0	2

ii. Exception for Combined Events with ATP

WTA player hotel room/per diem at combined events shall be consistent with the WTA per diem rules, except where per diem provided under the ATP rules is greater, in which case the ATP per diem rule shall apply.

h. Per Diem for Main Draw Players

A player's Main Draw per diem nights: (i) begin three (3) days\* before the start of a Tournament's Main Draw or the day that she registers, whichever is later; and (ii) continue through the night of her final exit from the Tournament (e.g. last match, withdrawal, etc.) or the night that she reaches the minimum per diem nights to which she is entitled under this Rule, whichever is later. In all cases, the last night for which any player will receive per diem is the night of

## STANDARDS

### SECTION XVIII - TOURNAMENT STANDARDS OF PERFORMANCE

the Tournament's final match, whether or not she has received her minimum per diem nights.

\*If the Main Draw starts Wednesday, then per diem begins Sunday; if the Main Draw starts Tuesday, then per diem begins Saturday; if the Main Draw starts Monday, then per diem begins Friday; if the Main Draw starts Sunday, then per diem begins Thursday; if the Main Draw starts Saturday, then per diem begins Wednesday; and so on.

i. Per Diem for Qualifying Players

Per diem nights for Qualifying will be counted from the day of the Qualifying Sign-In deadline.

Qualifiers shall be afforded hotel room/per diem through the later of the minimum number of nights or the night of the player's final exit from the Qualifying Draw, and successful Qualifiers shall be afforded the same hotel room/per diem as Main Draw players. However, nights used under the Qualifying per diem shall count towards the minimum number of nights to which a player is entitled under the Main Draw per diem. Regardless of the number of days played to qualify, successful Qualifiers shall receive per diem from the day of the Qualifying Sign-In through the night of a player's final exit (e.g., last match, withdraw, etc.) from the Main Draw, or until the minimum number of nights for a singles Main Draw player has been provided, whichever is later.

Players who play in the Qualifying but who do not qualify and then play in the Doubles Main Draw shall receive the applicable nights for Qualifying per the table in sub-Section g above in addition to the standard Doubles Main Draw per diem allowance.

j. Per Diem for Lucky Losers and Alternates

Each day, the highest ranked among the Lucky Losers (see Section V.A.1.a.vi) and Doubles Alternates (and singles Main Draw Alternates if there is no Qualifying) who have signed in to preserve their eligibility shall receive hotel/per diem the same as Main Draw players.

This hotel/per diem starts as follows and continues through the night following the last day a Lucky Loser or Alternate, as applicable, is eligible to be awarded a spot in the Main Draw.

## STANDARDS

### SECTION XVIII - TOURNAMENT STANDARDS OF PERFORMANCE

- i. For singles, hotel/per diem begins:
  - (a) For the highest ranked Lucky Loser, on the day the Main Draw starts; or
  - (b) For the highest ranked Alternate, on the day before the Main Draw starts.
- ii. For doubles, hotel/per diem for the highest ranked Doubles Alternate begins on the day of the Doubles Sign-In Deadline.

The hotel/per diem will fall to the next highest-ranked Lucky Loser or Alternate, as applicable, in the event the highest-ranked Lucky Loser or Alternate, as applicable, moves off the list (e.g., moves into the Main Draw), with the hotel/per diem beginning on the day the highest-ranked Lucky Loser or Alternate, as applicable, moves off the list.

- k. Per Diem for Players Who Withdraw On-Site for a Medical Condition

Players who have withdrawn by any method for a Medical Condition on site before starting to compete (and such doubles players' partners) shall receive hotel/per diem as follows, provided that they have complied with all requirements of the applicable withdrawal according to Section IV.A.

<b>Draw</b>	<b>Nights</b>
Singles Qualifying	1
Singles Main Draw	2
Doubles Main Draw	2

At WTA/ATP combined events, Main Draw (singles and doubles) and Qualifying players who have withdrawn on-site for a Medical Condition before starting to compete and who are examined by the on-site Tournament Physician shall receive hotel/per diem through the night of the examination.

- I. Hotel Upgrade or Per Diem in Lieu of Accommodation Request

If the official hotel designated by the Tournament does not meet the standard requirements, the WTA may request an upgrade in accommodations to a hotel of that standard rating.

If the Tournament is unable or refuses to comply with this rule, then the WTA may choose the per day per diem (see Section XVIII.A.13.b)



## **STANDARDS**

### **SECTION XVIII - TOURNAMENT STANDARDS OF PERFORMANCE**

in lieu of hotel accommodations for a player who is entitled to a complimentary room.

m. **Player Responsibility for Personal Expenses**

A player is responsible for all hotel charges over and above those for the room rate and tax (double room or double room cost).

#### **14. Hotel Rooms and Per Diem – WTA Staff**

a. **General**

All rooms below shall be provided from the day before the Qualifying Sign-In through the final day of the Tournament. The Tournament shall be responsible for payment of hotel room taxes and resort or similar fees and the WTA staff and Supervisors shall be responsible for all incidental expenses. In addition, each Tournament should use best efforts to arrange for the player rate at the official hotel to be offered to WTA staff working at the Tournament.

b. **WTA Tournaments**

WTA Tournaments are required to provide three (3) complimentary hotel rooms for the WTA staff, which may be divided among the Supervisor, PHCP staff, and Massage Therapist. The allocation of WTA staff rooms, however, shall be determined by the WTA and communicated to the Tournament by the Supervisor.

c. **WTA/ATP Combined Events**

At WTA/ATP combined events, where ATP Supervisors receive a complimentary hotel room, per diem, and laundry service, the equal number of WTA Supervisors shall also receive similar complimentary accommodations and benefits. In addition to the complimentary hotel rooms and benefits provided to the tour Supervisors, all WTA/ATP combined events must provide the WTA and ATP each one (1) complimentary hotel room, which may be used for a PHCP or Massage Therapist.

#### **15. Internet Communication**

In each instance in the Rules where a high-speed internet connection is required, it shall consist of an always-on, high-speed internet connection. A minimum total 1Mb/sec (mega bit per second) of available bandwidth must be available for the WTA offices and staff, including the Player Development and medical offices (e.g., Tournament Physician, PHCP,

# STANDARDS

## SECTION XVIII - TOURNAMENT STANDARDS OF PERFORMANCE

and Massage Therapist), unless otherwise approved by the WTA. User access via Ethernet or WiFi is recommended.

Tournaments are recommended to use web filtering technology to restrict access to internet gambling sites in all areas where internet access is provided by the Tournament.

### 16. Laptop Computers

The use of laptop computers within the confines of the Tournament match courts is strictly forbidden. The exception to this provision is properly credentialed media, Tournament vendors, and Tournament staff when used in the performance of their duties.

### 17. Laundry Service

Each Tournament shall provide laundry service to participating players from the first day of Qualifying until the completion of the Tournament. Laundry service may be limited to 'next-day wash & fold' service and may be provided on site and handled by the locker room attendants, or directly at the official hotel. Laundry service costs should be reasonable (whether per item or per bag), and must be approved by the WTA at least one (1) month prior to the Tournament.

### 18. Lighting

#### a. Specifications and Measurements

Lighting must be distributed evenly on the court, with the minimum and recommended standards as stated in the chart below.

	Required
Light Measurements	
Lux (averaged over 15 readings)	1,076
Lux Outside Court Lines (averaged over 8 readings)	500
Foot Candles	100
Ratio between highest/lowest reading	1 x 1.5
Light Pole Heights	
All Courts	40 feet*

\*Or no lower than other non-show court lights at the facility.

## **STANDARDS**

### **SECTION XVIII - TOURNAMENT STANDARDS OF PERFORMANCE**

It is the responsibility of the Tournament Director to ensure, upon final preparation of the tennis courts before the Tournament commences, that all court specifications, including lighting measurements, comply with the standards set forth in Appendix J – Light Measurements.

Measurements should be taken from approximately three (3) feet (0.914 meters) above the court.

The Supervisor has the authority to suspend play on any court if the intensity of illumination, in his/her judgment, is insufficient for Professional Tennis.

#### **b. Second Court for Outdoor Night Matches**

If an outdoor Tournament holds night sessions, a second match court with lighting that meets Tour standards will be required.

### **19. Live Scoring**

Beginning with the Qualifying, each Tournament shall be responsible for providing live scoring services including the set up and maintenance of an encrypted scoring network with a signal throughout the venue, based on specifications provided by WTA, to support the live scoring services for each match of the event and will provide the WTA access to such signal and assist WTA in its efforts to produce and host the live score data generated from each match, including but not limited to by delivering the live scoring data directly to the WTA (or its designees) in the on-site TV compound. Each Tournament hereby consents to WTA's non-exclusive use of such live score data, subject to the restrictions below. Each Tournament must use a company approved by the WTA.

Tournaments shall not allow or authorize the dissemination, transmission, publication, or release from the grounds of the Tournament of any live match scores or related statistical data, including without limitation the live score data from the scoring network, by a third party until thirty (30) seconds after the actual occurrence of the incident of match play or action that leads to such live score update (e.g. a point being scored), such delay shall not be applicable to the live audio and/or visual broadcast or streaming by any method or means (i.e. moving pictures and/or sound/ audio reporting of actual on-court action) and purposes related to such broadcast of any match. Tournaments may only supply match related data or information to gambling entities through WTA's approved data reseller. In addition, each Tournament shall notify WTA in advance of any third party to whom the Tournament has granted access to the network used for live scoring for the purpose of accessing the live score data. Persons who are or work for data resellers shall not be issued credentials.

# STANDARDS

## SECTION XVIII - TOURNAMENT STANDARDS OF PERFORMANCE

### 20. Locker Room

#### a. Facility Requirements

Each Tournament must provide a secure “Players Only” locker room facility (including toilets, showers, and other standard locker room amenities) adjacent to the Tournament site, suitable for women’s use, to which only players and WTA staff will be admitted.

The locker room should have good ventilation and temperature control and must include changing and bathing rooms and afford privacy to the players. Lockers or other similar storage units must be provided in order for the players to lock up and secure their belongings.

Showers must have hot/cold water with appropriate reserves for players’ use. It is recommended that locker rooms have individual showers with privacy stalls/curtains to allow for player privacy. Towels must be provided near the showers in the locker room.

The locker room must be kept clean, and sanitary and towel bins must be provided.

Additionally, it is requested that a submersion bath be located in the shower area for recovery purposes and emergency cooling of players at Tournaments where Extreme Weather Conditions exist. (See Section XVIII.B.7.a.) At WTA/ATP combined events, if a submersion bath is provided to ATP players, no fewer than the equal number of submersion baths also must be provided to WTA players.

#### b. Amenities to be Provided

Toiletries should be provided, including dispensed soap and paper towels for sanitary purposes for players’ use. Additionally, it is requested that shampoo, hair conditioner, shower gel, tampons, and sanitary pads be provided for the players’ use.

See beverage requirements in Section XVIII.A.12 – Food and Beverage Service.

#### c. Security and Oversight

A female attendant must be in charge, and there must be sufficient security to i) prevent unauthorized entry and ii) protect the players’ personal belongings from the start of play until the completion of play.

**STANDARDS**  
**SECTION XVIII - TOURNAMENT STANDARDS OF PERFORMANCE**

d. Additional Facility for Coaches

Tournaments should make best efforts to provide locker room facilities for both women and men coaches.

**21. Media Facilities**

All Tournaments, including the WTA Finals, must comply with the WTA Television Broadcast Standards requirement (see Section XVIII.F.4 - Tournament Facilities) and also must provide a full service media center, including:

- a. Media working area;
- b. Separate interview room (multiple rooms at WTA 1000 Mandatory Tournaments);
- c. Separate media lounge, where appropriate;
- d. Transcription service (WTA 1000 Mandatory and WTA 500 Tournaments only);
- e. High-speed internet access (must be wireless at WTA 1000 Mandatory Tournaments); and
- f. Multiple shared television monitors, telephones, and printers.

In addition, the media center at WTA 1000 Mandatory Tournaments must include the following: (i) dedicated photographer area, including transmission capabilities; (ii) individual media work stations with high-speed internet, telephone, and television monitor; and (iii) shared statistical system computer with printer.

All media facilities must be ready by 9:00 a.m. tournament local time, on the day of Qualifying Sign-In.

In addition to the above, all Tournaments, including the WTA Finals, must provide the following for the use of the WTA Communications staff: i) a telephone line; ii) a high-speed internet access line for each Communications staff member; and iii) a printer. The Tournament shall be responsible for the cost of installing the telephone lines and internet access lines.

All media areas shall be gambling-free zones and any persons credentialed for such areas, if found to be gambling on tennis or passing insider information to third parties for use in connection with gambling, shall have

## **STANDARDS**

### **SECTION XVIII - TOURNAMENT STANDARDS OF PERFORMANCE**

their credentials revoked. Media credentials must contain a provision whereby the media member acknowledges and agrees that he/she will not disseminate, transmit, publish, or release from the grounds of the Tournament any live match score or related live statistical data until thirty (30) seconds after the actual occurrence of the incident of match play or action that leads to such live score update (e.g., a point being scored), and that such use shall be solely for news reporting and editorial use.

Any media known to be working for gambling companies shall not be issued credentials. If found to be working for a gambling company after issuance of the credential, the credential shall be revoked.

#### **22. Net**

##### **a. Specifications**

The net, posts, cord, cable, strap, singles sticks, and band all must be to the requirements of the ITF Rules of Tennis. The net band shall be cloth or canvas (not plastic or vinyl), and the net shall extend to the ground.

##### **b. Advertising and Signage Restrictions**

WTA/sponsor net post signage must be erected consistent with the specifications provided by the WTA. There shall be no advertisement on the strap, band, singles sticks, or net posts.

Advertisement is permitted on the net as long as it is placed on the part of the net that is within three (3) feet (0.914 meters) from the center of the net posts and is produced in such a way that it does not interfere with the vision of the players or the playing conditions (per the ITF Rules of Tennis). This advertising may not contain white or yellow. (See also Section XIII.B.4 - Net Post Signs.)

#### **23. Officials and Officiating**

All WTA Tournaments are required to appoint, in consultation with the WTA, an internationally certified Referee and Chief of Umpires to work in conjunction with the Supervisor.

All Chair Umpires appointed as designates for WTA Tournaments are internationally certified Chair Umpires. All appointed officials are required to be fully conversant with WTA Rules and procedures, the ITF Rules of Tennis, and the Code for Officials, and together with the Supervisor, ensure they are observed. All appointed officials must also be fluent in English.

## STANDARDS

### SECTION XVIII - TOURNAMENT STANDARDS OF PERFORMANCE

At WTA/ATP joint events: (a) the selection of additional certified Chair Umpires must be coordinated and approved by the Officiating Departments of both the WTA and ATP; and (b) the Supervisors of the WTA and ATP will be responsible for the daily assignments, using the designates from both the WTA and ATP and the additional officials recruited by the Chief of Umpires.

a. Referee

The Referee shall:

- i. Be readily available to resolve any on-court dispute without delay, supervise Medical Time Outs, and enforce the Code of Conduct.
- ii. Decide, in consultation with the Supervisor, if a court is fit for play.
- iii. Assign and replace, when necessary, Chair Umpires, Line Umpires, and Net Umpires. The assigning of these officials (but not their replacements) may be delegated to the Chief of Umpires, but the Supervisor has final say on all assignments.
- iv. Liaise with the Chief of Umpires and decide on the competence of officials.
- v. If necessary, conduct a clinic for local Chair Umpires and Line Umpires.
- vi. In the absence of the Supervisor, be responsible for all matters of tennis law. His/her decision is final. (See Appendix B.1 - Supervisor.)
- vii. Measure the courts, net posts/singles sticks, and lights and check the quality of the nets and the availability of spare nets/straps prior to the start of Qualifying.
- viii. Be responsible for conducting evaluations of Chair Umpires and Chief of Umpires.
- ix. Arrive on-site at the Tournament either by 12:00 noon on the Qualifying Sign-In day or on time for the Main Draw ceremony, whichever is earlier.
- x. Arrive each day at least one (1) hour before the first scheduled match, remain on-site at all times during matches, and leave no earlier than thirty (30) minutes after the end of play.

## **STANDARDS**

### **SECTION XVIII - TOURNAMENT STANDARDS OF PERFORMANCE**

- xi. Confirm that all updated draws and the order of play have been distributed at the end of play each day.
  - xii. Be responsible for calling matches, including designating a visible timepiece at a fixed location as the “official clock,” designating a specific area from which matches shall be called, determining a meeting point for players once the match is called, and coordinating security escorts to/from match courts.
  - xiii. When possible, assist the Supervisor in coordinating pre-match interviews with the players and host broadcasters.
  - xiv. Not act as a Chair Umpire or Chief of Umpires for the Tournament.
  - xv. Be familiar with all WTA electronic forms and Officiating Arena content.
- b. Chief of Umpires

The Chief of Umpires shall:

- i. Be conversant in the local language.
- ii. Have hired prior to the Tournament, in consultation with the Tournament Director and with the approval of the Officiating Department, sufficiently certified, additional Chair Umpires, and competent Line Umpires and Net Umpires (when no electronic net device is available) and provide the list of additional Chair Umpires to the WTA Supervisor and the Officiating Department at least twenty-eight (28) days prior to the Tournament.
- iii. Conduct meetings with the Line Umpires to specify assignments and specific procedures.
- iv. Schedule the on-court assignments for all Chair Umpires in consultation with the Referee and approval by the Supervisor, except at combined events where the WTA and ATP Supervisors are responsible for the daily assignments.
- v. Coordinate the evaluations of all officials (Chair Umpires and Line Umpires) with the Supervisor and Referee.
- vi. Not act as a Chair Umpire or a Line Umpire for the Tournament.
- vii. Be able to assist the Referee and the Supervisor wherever needed and be present on site at all times during play.



## STANDARDS

### SECTION XVIII - TOURNAMENT STANDARDS OF PERFORMANCE

- viii. If necessary, conduct a clinic for the local Chair Umpires and Line Umpires.
  - ix. Arrive on-site at the Tournament by 12:00 noon on the Qualifying Sign-In day.
  - x. Arrive at least one (1) hour before the first scheduled match, remain on-site at all times during matches, and leave after the end of play.
  - xi. Coordinate the uniforms for Lines Umpires and Chair Umpires and collect sizes from all in advance. Inform the officials at least two (2) weeks prior to the event about the dress code and/or uniform provided by the Tournament, if any, using the specific "On-Site Conditions" Form.
  - xii. Send all arrival/departure details of designated officials to the WTA at least twenty-one (21) days prior to the Tournament.
  - xiii. Send information about on-site conditions such as transportation, hotel, and meals to the designated officials at least seven (7) days prior to the Tournament.
  - xiv. Be familiar with all WTA electronic forms and Officiating Arena content.
- c. Chair Umpire

The Chair Umpire shall:

- i. Ensure that the on-court rules are observed by the players, Line Umpires, and Ball Persons. He/She must control the match in all respects. He/She can be overruled by the Referee/Supervisor only in matters of interpretation of law, not in matters of fact.
- ii. Promptly and accurately score matches using the handheld or other method provided by the WTA. Be competent in using the scoring system. Track and record when balls are to be changed.
- iii. Take charge of all Line Umpires and Ball Persons when on court.
- iv. Be responsible for, in the absence of a Net Umpire or net device, the calling of net cord service lets.
- v. Ensure that play is continuous within the Rules by:
  - (a) Maintaining the 90- and/or 120-second change of ends,

## STANDARDS

### SECTION XVIII - TOURNAMENT STANDARDS OF PERFORMANCE

while having the authority to delay the resumption of play until the completion of the 90- and/or 120-second change of ends during televised matches;

- (b) Maintaining a maximum of 25 seconds from when the ball goes out of play at the end of the point until the time the ball is struck for the first serve of the next point. If such a serve is a fault, then the second service must be struck by the server without delay; and
  - (c) Observing an approved warm-up period not to exceed four (4) minutes.
- vi. Determine if a court continues to be fit for play. If a change in condition occurs during a match that the Chair Umpire considers sufficient to make the court unfit for play or if weather conditions require stoppage of play, the Chair Umpire should stop play and immediately notify the Supervisor.
  - vii. Give the result of the match to the Referee and Supervisor immediately upon completion of the match and any action taken under the Code of Conduct during the match.
  - viii. If necessary, overrule a Line Umpire. He/She must do so when a clear mistake has been made and must give a decision when a Line Umpire is unsighted.
  - ix. Provide a detailed report on any Code of Conduct penalty issued in connection with the relevant match(es).
  - x. Wear and use the officiating clothing, tablet, tablet holder, and microphone provided by the WTA. Except for the WTA Logo, no other commercial branding may be applied to the Chair Umpire clothing, scoring tablet, scoring tablet holder, or microphone without the WTA's and the applicable Tournament's prior approval.
- d. Line Umpires
- i. Responsibilities

The responsibilities for Line Umpires shall be as follows:

- (a) Base, Side, Center Service, and Service Line Umpires call "Out" and "Fault" for their respective lines.
- (b) Base, Side, and Center Service Line Umpires call "Foot

## STANDARDS

### SECTION XVIII - TOURNAMENT STANDARDS OF PERFORMANCE

Fault” on their respective lines.

- (c) The Net Umpire calls all net cord services and assists with measuring the net and with ball changes.
  - (d) To give the recognized safe signal to acknowledge that a ball is good.
  - (e) To give the recognized unsighted hand signal when their view of the ball landing is obstructed.
  - (f) To correct their call immediately upon realizing they have made a mistake.
  - (g) To report immediately to the Chair Umpire any breach of the Code of Conduct.
  - (h) To defer questions from players to the Chair Umpire. A Line Umpire shall not enter into any discussions with players.
- ii. Numbers of Line Umpires per Match

The Tournament is required to provide the minimum numbers of Line Umpires per match as listed in the table below. Where possible, it is recommended the minimum number of Line Umpires per match should be seven (7).

Qualifying	Main Draw through QF	Main Draw SF and Finals
5	7	7

iii. Clothing of Line Umpires

Line Umpires may not wear any predominantly white, yellow or other light color clothing that may interfere with the players' vision, unless otherwise approved by the WTA. Line Umpires' uniforms should not be identical to the ball persons' uniforms.

e. Standards of Officiating

All officials must be certified and approved by the WTA. The WTA will hire and designate the internationally certified Chair Umpires and Review Officials for all Tournaments. Each Tournament is required to provide additional Chair Umpires (approved by the WTA) for Qualifying and for some Main Draw matches not covered by the designated Chair Umpires hired by the WTA. The Tournament Directors, in agreement with the Officiating Department, will hire a

## STANDARDS

### SECTION XVIII - TOURNAMENT STANDARDS OF PERFORMANCE

Referee and Chief of Umpires. Following are the minimum required Standards of Officiating for each level of Tournament:\*

<b>Tournament Category (Singles Draw Size)</b>	<b>Referee</b>	<b>Chief of Umpires</b>	<b>Designated Chair Umpires (1)(2)</b>
WTA Finals (8 draw)	1 Gold	1 Gold	4
WTA 1000 Mandatory (60/64 draw)	1 Gold	1 Gold	7
WTA 1000 Mandatory (96 draw)	1 Gold	1 Gold	8
WTA 1000 Mandatory, WTA 500 (32 draw)	1 Gold	1 Gold/Silver	4
WTA 1000 Mandatory, WTA 500 (56 draw)	1 Gold	1 Gold/Silver	6
WTA 250 (32 draw)	1 Silver	1 Silver	4
WTA 250 (56 draw)	1 Silver	1 Silver	6

\*Unless otherwise agreed upon by WTA and ATP for combined events.

(1) A minimum of one (1) experienced and certified Review Official (minimum Bronze Badge) will be designated by the WTA Officiating Department at Tournaments implementing an Electronic Line Calling System. The number of review officials needed for each event will be based on the number of courts (with a minimum of one (1) per court with ELC) and the match schedule plan, especially when night sessions are held.

(2) In addition to the designates, the Chief of Umpires will recruit a sufficient quantity of additional Chair Umpires for Qualifying and Main Draw based on the following guidelines:

<b>Tournament Category</b>	<b>Minimum Badge Level for 2 of the Additional Chair Umpires</b>	<b>Minimum Badge Level for the Remaining Additional Chair Umpires</b>
WTA 250	Bronze	White
WTA 500	Silver	Bronze
WTA 1000 Mandatory	Silver	Bronze

Green Badge, National, and uncertified Chair Umpires are not approved to work at WTA Tournaments.

## STANDARDS

### SECTION XVIII - TOURNAMENT STANDARDS OF PERFORMANCE

f. Chairs – Chair Umpire

The Chair Umpire's Chair is recommended to be a minimum of six (6) feet (1.82 meters) and a maximum of eight (8) feet (2.44 meters) in height. The chair shall be centered along an extension of the net approximately three (3) feet (0.9 meters) from the net post. The chair must be stable and safe.

The Chair Umpire's microphone must have an on/off switch and must be easily adjustable and not hand held. If the Chair Umpire's microphone has a flag, the WTA Logo is the only permitted branding. The on-court announcer's microphone, if any, also must have an on/off switch.

For outdoor Tournaments, the Umpire's Chair on all courts shall be positioned on the west side of the court, unless otherwise agreed by the WTA, and there should be a sunshade available. Each Chair Umpire's chair must have an electrical outlet to power and recharge handheld PDAs and other similar electronics to be used by the Chair Umpire.

The Chair Umpire's chair must have a writing table attached on all match courts to provide a platform for the Chair Umpires to place their hardware, such as their PDA for live scoring, walkie-talkie, and/or net device.

g. Conditions for Officials

Each WTA designated official should be provided with the following, from the day prior to the first day of matches (at the earliest) to the morning after their last match (at the latest), free of charge:

- i. Airport pick-up (or taxi reimbursement);
- ii. Single hotel room at the official hotel or another hotel approved by the Supervisor and Officiating Department;
- iii. Breakfast, lunch, and dinner (at the hotel, on-site, or by pre-agreed per diem procedure) from the night prior to the start of the assignment until the morning after the last day of the assignment;
- iv. Complimentary laundry service for their tennis uniforms;
- v. Transportation between the hotel and Tournament site;

## **STANDARDS**

### **SECTION XVIII - TOURNAMENT STANDARDS OF PERFORMANCE**

- vi. Airport drop-off (or taxi reimbursement); and
- vii. Access to high speed internet on site.
- h. Protection of Match Data and Information

Officials agree not to, and shall not authorize or assist any third party to, disseminate, transmit, publish, or release any match related data or information to or for any third party without the express written consent of WTA. Further, each official agrees that any and all work or data he/she collects or creates in connection with any match shall constitute a “work made for hire” and any and all rights attributable to such work shall be retained by, or if necessary automatically assigned to, WTA and its members.

#### **24. On-Court Supplies**

At all times throughout play, each court must have one (1) cooler on each side supplied with bottled, non-carbonated water, WTA-approved carbohydrate-electrolyte replacement drinks in sealed containers and plastic bags filled with ice for players’ medical needs. Those items must not be shared and must be routinely checked after each match, and any unsealed bottles and drinks or other products not supplied by the Tournament must be removed from the court/coolers.

Each Tournament must provide spill kits, which are maintained by court services, for the proper clean up and disposal of biohazardous material on each court and hand sanitizer which is available for use by ball persons following handling of used towels. Court services personnel must be trained in the proper handling of biohazardous waste. In Extreme Heat Conditions, fans and ice towels are required to reduce players’ body temperature and implement safety precautions.

#### **25. On-Site Tennis Gambling and Gambling Company Credentials**

Allowing gambling companies, directly or through a third party, to accept any tennis wagers on the Tournament digital platforms or at the Tournament site or any Tournament-related event is prohibited.

Persons working for gambling companies that accept any tennis wagers (electronically or otherwise) shall not be issued credentials except as set forth in the WTA Betting, Fantasy & Gambling Sponsorship Rules. If found to be working for a gambling company after issuance of the credential, the credential shall be revoked.

## **STANDARDS**

### **SECTION XVIII - TOURNAMENT STANDARDS OF PERFORMANCE**

#### **26. Parking**

Each Tournament should provide, conveniently located to the locker room, a reserved parking area for the players.

#### **27. Personnel**

The Tournament shall provide the personnel necessary for the proper conduct of a tennis tournament. In countries where English is not the local language, tournament personnel interacting with players, Player Support Team members, WTA staff, WTA broadcasters, or WTA vendors are expected to be conversant in English at a level sufficient to comfortably perform their duties.

#### **28. Physician**

The Tournament Director must appoint a Chief Tournament Physician in accordance with Section XVIII.B.5 – Physician.

#### **29. Player Entry**

Tournaments must provide reasonable assistance to players, player support personnel, and the WTA in obtaining any necessary visas or work permits required for such individuals to attend and participate in the Tournament. Visa or work permit information should be communicated to players and the WTA at least two (2) months prior to the Tournament. If an official invitation letter must be provided by the Tournament, the Tournament shall be responsible for the cost of providing that letter. All other visa or work permit-related costs as well as completing the visa or work permit process shall be the responsibility of the player. It is recommended that Tournaments provide an English-speaking person to assist with the visa or work permit process inquiries.

#### **30. Players' Lounge**

Each Tournament must provide a furnished Players' Lounge (i.e., sofas, tables).

See snack and beverage requirements in Section XVIII.A.12 - Food and Beverage Service.

It is recommended that magazines, newspapers, and a television be provided in the Players' Lounge and that there be a telephone somewhere on site (other than the WTA telephone lines) which players can use to charge calls. At least two (2) computers with print capabilities and highspeed access to the internet for players' use must be provided

## **STANDARDS**

### **SECTION XVIII - TOURNAMENT STANDARDS OF PERFORMANCE**

at all Tournaments and must include WTA's online learning site as a trusted site. It is also strongly recommended to have a secured wireless internet set up in the Players' Lounge for players to use their own laptops to access the internet.

#### **31. Player Services/Welcome Desk**

A Player Services/Welcome Desk should be provided where players can seek assistance with practice court bookings and other general Tournament information (e.g., pick up meal tickets, tennis balls, match and guest tickets). All necessary Tournament telephone numbers and Tournament information should be provided for players prior to the start of Qualifying, it is recommended to have the key telephone numbers, such as the WTA office, transportation services and practice booking services printed on the back of players' credentials. When not in an English-speaking country, the Tournament should provide an English-speaking representative to distribute the information and to host this area.

#### **32. Player Treatment Area**

See Section XVIII.B.2 for the requirements of the Player Treatment Area/ Training Room.

#### **33. Practice Facilities**

- a. Each Tournament must provide practice facilities for players during the stated hours to be arranged with the Supervisor. Practice courts must be the same surface and condition (i.e., indoor/outdoor) as used for matches and preferably should be on site. (See Section XVIII.A.9.a - Court Specifications.)
- b. Tournaments are strongly recommended to provide Tournament personnel to allocate and supervise practice bookings, working in liaison with the Supervisor.
- c. Practice courts should have nets in good condition equipped with net straps and singles sticks, as well as adequate running room surrounding the court and ceiling height.
- d. All practice courts at indoor events should be heated and ventilated.
- e. Practice balls are to be provided to players in the numbers specified (see Section XVIII.A.5 - Balls) and preferably at the practice facility, if located off site.



## STANDARDS

### SECTION XVIII - TOURNAMENT STANDARDS OF PERFORMANCE

- f. All new off-site practice courts must be located within a reasonable travelling distance from the Tournament site.

#### 34. Scoreboards/Video Screens

Scoreboards must be provided on all match courts. The scoreboard will be placed at the corner or side of the court and must not obscure the playing visibility. The scoreboard must be a dark color. The scoreboard on all broadcast courts must be electronic. It is recommended that electronic scoreboards are controlled directly by the Chair Umpire's scoring device.

Scoreboards and video screens may be placed a minimum of forty (40) feet (12.19 meters) above the court surface, as long as they do not interfere with play and/or present a distraction to the players.

#### 35. Shot Clocks

All WTA 1000 Mandatory, WTA 500, and WTA 250 Tournaments must provide electronic timing devices controlled directly by the Chair Umpire's tablet ("shot clocks") on each match court from the first day of Qualifying through the Main Draw finals.

It is optional for WTA 125 Tournaments to provide shot clocks. If a WTA 125 Tournament provides shot clocks, they must be provided on each match court from the first day of Qualifying through the Main Draw finals.

##### a. Size

Each shot clock panel should be a minimum of two (2) feet by two (2) feet (0.6 meters by 0.6 meters) and a maximum of three (3) feet by two (2) feet (0.91 meters by 0.6 meters).

##### b. Number and Placement

Each court is required to have a minimum of two (2) shot clocks clearly visible to the players and the Chair Umpire. The shot clock panels must be placed on the back wall or corner of the court on the left far and right far side from the Chair Umpire.

##### c. Additional Positions

In addition to the two (2) shot clock placements specified above, each Tournament may show the shot clock timing in other locations on or around the court and spectator areas.

**STANDARDS**  
**SECTION XVIII - TOURNAMENT STANDARDS OF PERFORMANCE**

**36. Scoring System**

- a. All Singles (Main Draw and Qualifying) matches in all WTA Tournaments are the best of three (3) tie-break sets. All Main Draw Doubles matches in all WTA Tournaments are the best of three (3) sets with No-Ad scoring in the first two (2) sets and a 10-point match tie-break as the third set. The WTA has the right to authorize the use of alternative scoring systems at WTA Tournaments and to award appropriate ranking points.
- b. The organizing committee of each Grand Slam Tournament will decide which scoring system will be used at each Grand Slam.
- c. There will be no rest period before the final set except when the Extreme Weather Condition Rule is in effect. (See Section XVIII.B.7 - Extreme Weather Conditions and Lightning.)
- d. The ITF Rules of Tennis will apply in their entirety except where noted in these Rules.

**37. Seating – Minimum**

The minimum center court seating capacity shall be as follows:

Tournament Category	Venue Type	
	Outdoor	Indoor
WTA 1000 Mandatory	10,000	WTA Approved
WTA 500	5,000	4,000
WTA 250	2,500	2,500

**38. Security and Credentialing Systems**

The WTA has considered Tournament security issues and has determined that the Tournaments and players are the appropriate parties to bear the responsibility for Tournament security. Each Tournament shall be responsible for providing on-site security for players, Tournament staff, officials, and spectators and shall, if requested, promptly provide the WTA with detailed information about security plans.

As part of each Tournament's security plan, a photo credentialing system must be established. Tournaments must include and take reasonable steps to enforce the following policy on all non-media persons issued credentials: No credentialed person may continually collect, disseminate, transmit, publish, or release from the grounds of the Tournament any match scores or related statistical data during match play (from the

## **STANDARDS**

### **SECTION XVIII - TOURNAMENT STANDARDS OF PERFORMANCE**

commencement of a match through its conclusion) for any commercial or gambling purposes. Such policy shall be printed on all Tournament credentials or otherwise notified to credentialed persons.

Use of video surveillance systems must comply with Section XVIII.A.46.

Players shall cooperate with Tournament security measures.

#### **39. Stringing**

Each Tournament must provide quality racquet stringing services on-site from the day before the start of Qualifying until the completion of the Tournament. The stringer must be available on site each day matches are scheduled until thirty (30) minutes after the end of the last match. The stringing costs per racquet and the stringer's hours of availability must be approved by the WTA at least one (1) month prior to the Tournament.

At WTA/ATP combined events, the stringer must be available on site each day two (2) hours prior to the starting time of the first scheduled match. The recommended maximum fee per racquet is US\$20 (or €20) at combined events. If play has been scheduled at an approved alternate site during a combined event, then access to the stringing service must be provided at such alternate site from the start of play until play has been completed at that site.

#### **40. Television and Digital Media**

Tournaments must comply with the Television and Digital Media requirements set forth in Sections XVIII.E and F.

#### **41. Ticketing**

Tournaments must include and take reasonable steps to enforce the following policy on all ticket holders: No ticket holder may continually collect, disseminate, transmit, publish, or release from the grounds of the Tournament any match scores or related statistical data during match play (from the commencement of a match through its conclusion) for any commercial or gambling purposes. Such policy shall be printed on all Tournament tickets or otherwise notified to ticket holders prior to purchase. Tournaments should also have notices posted in the local language and in English at all tournament entrances, VIP hospitality areas, player areas, and throughout the Tournament grounds.

#### **42. Tournament Director**

The Tournament Director shall be approved in advance by the WTA

## STANDARDS

### SECTION XVIII - TOURNAMENT STANDARDS OF PERFORMANCE

and shall be responsible for the overall conduct and organization of the Tournament and other such personnel as necessary for the proper conduct of a tennis tournament including, but not limited to, the Tournament Physician, Referee, Chief of Umpires, Chair Umpires, Line Umpires, and Ball Persons. New Tournament Directors that have not previously been approved by the WTA must attend a one (1) day orientation session at a WTA designated office or WTA Tournament. Each Tournament Director must complete the Tennis Integrity Protection Programme module prior to the start of the Tournament. Tournament Directors are prohibited from playing in their own Tournament.

#### 43. Towels and Sheets

Each Tournament must provide an adequate supply of already washed (with antimicrobial soap and hot water), absorbent, bath-sized towels that will accommodate i) all locker room (shower) needs, ii) SS&M staff (PHCP, Tournament Physician, and Massage Therapist) and iii) on-court needs. Each Massage Therapist will require a minimum of thirty (30) sheets and thirty (30) towels per day.

#### 44. Towel Bins

Tournaments must provide on-court player towel bins, the design and location of which is subject to Supervisor approval. The Chair Umpire must assign towel bins to players before each match, and players must use only their assigned towel bins to place towels during each match. Each player must handle her own towels and must not request towels from, or give her towels to, any ball person at any time before, during, or after a match.

##### a. Design

Towel bins must be clearly identifiable for each player/team. Tournaments may place branding on towel bins.

##### b. Location

For all match courts, eight (8) towel bins must be available with two (2) towel bins located in each corner of the court. Depending on the court configuration, the towel bins should:

- i. Be easily accessible and raised high enough that players do not need to bend down;
- ii. Be placed either against the side wall outside the extension of

## **STANDARDS**

### **SECTION XVIII - TOURNAMENT STANDARDS OF PERFORMANCE**

the baseline or against the back wall outside the extension of the doubles sideline, whichever location is the shortest distance for the players;

- iii. Be located away from spectators and on-court personnel;
- iv. Be placed at least 20 cm/7.9 inches apart; and
- v. Not block scoreboards or court branding.

#### **45. Transport**

##### **a. Airport Transportation**

Unless otherwise agreed upon by the WTA, airport transportation must be provided to Qualifying and Main Draw players, as well as Player Support Team members when traveling with a player, beginning the day before the Qualifying Sign-In deadline (as long as 24-hour notice is given to the Tournament) until the morning following the final day of the Tournament.

Airport transportation must be provided to WTA staff, associates, and contractors working at the Tournament.

##### **b. Transportation between Hotels and Tournament Site**

Tournaments are required to provide transportation for players, credentialed guests, coaches, and WTA staff between the official hotel (and alternative hotel, if provided) and the Tournament site and practice facility on a regularly scheduled shuttle, beginning the day before the Qualifying Sign-In deadline. Transportation must be available up to one (1) hour after the last match is completed.

If private housing is provided, the Tournament has the responsibility to advise players of the transportation available, if any. The Supervisor also should be advised of any other available local transportation. It is recommended that all Tournaments arrange for a player discount with a local car rental agency.

#### **46. Video Cameras**

Closed-circuit television (“CCTV”) and video surveillance systems (including security drones) are used at Tournaments for general public security, crime prevention, and other specified purposes. As use of such systems collects and processes individuals’ personal and biographical data, a Tournament’s collection, use, and disclosure of surveillance

## STANDARDS

### SECTION XVIII - TOURNAMENT STANDARDS OF PERFORMANCE

footage (including captured audio) must (a) comply with all applicable laws and regulations and (b) be fair, transparent, and respect an individual's right to privacy.

CCTV and video surveillance cameras must not be placed in private areas where there is a reasonable expectation of privacy, including (but not limited to): locker rooms, nursing rooms, bathrooms, and treatment rooms. In all other areas, Tournaments must assess whether the placement of CCTV and video surveillance cameras is appropriate in the circumstances, taking into account the reasonable expectations of individuals and the potential impact on their rights and freedoms.

If CCTV or video surveillance cameras are used in credential-restricted areas, including fitness and warm down areas, the cameras must be visible and signs must be placed prominently to inform individuals that they are in an area where a camera is in operation. Signs must be placed more prominently and frequently in areas where individuals are less likely to expect that they will be monitored. Signs in areas accessed by players must include the purpose of the camera's use if other than for security.

Tournaments must make information available about the location of CCTV and video surveillance systems (including any use of security drones) in player areas and how the footage will be used and provide individuals a mechanism to raise complaints or concerns and view footage captured of them.

A Tournament's disclosure of CCTV and video surveillance footage to third parties must be consistent with the purpose(s) communicated with the individuals. Tournaments may not publicly release the following types of CCTV and video surveillance footage without an individual's consent: (a) footage captured in an area where an individual would reasonably expect privacy and cameras are not visible and/or signs placed; (b) footage that would reasonably be deemed to be extremely sensitive or inappropriate, and (c) footage that if released could reasonably place the player at a competitive disadvantage.

Tournaments must make CCTV and video surveillance footage available upon request to the WTA and ITIA for use in connection with Rules and Integrity Rules investigations and proceedings.

#### **47. Walkie-Talkies**

Each Tournament must provide one (1) walkie-talkie for each Supervisor, PHCP, Communications Manager, WTA IT Staff, Live Scoring vendor, Referee, Chief of Umpires, and Tournament Physician, and two (2) walkie-talkies for each match court. Each Tournament also must provide

## STANDARDS

### SECTION XVIII - TOURNAMENT STANDARDS OF PERFORMANCE

one (1) walkie-talkie to the Massage Therapists for their shared use. In addition, each Tournament must provide walkie-talkies, in accordance with the WTA Television Broadcast Standards requirements (see Section XVIII.F.4 - Tournament Facilities). It is requested that a private medical channel is provided for use by the PHCPs, Massage Therapists, and Tournament Physicians. Separate channels are required for:

- a. The collective use of the Supervisor(s), officiating staff, PHCPs, and Massage Therapists to ensure direct and private communication for on-court matters among them; and
- b. The use of the Electronic Review Official and the Chair Umpire to ensure a direct and private communication for on-court matters between them (each court with Electronic Review must have a different channel).

#### 48. WTA Office

- a. Location and Security Requirement

The Supervisor shall be provided with a private and secure office with a desk from which the Supervisor can base him/herself in order to carry out his/her duties. Players and associated people conveniently should be able to access the Supervisor and WTA information in the WTA office. It is also a place for Officials and Tournament staff to meet, when necessary.

- b. Office Equipment/Communication and Installation Timing

Each Tournament must provide the Supervisor with a printer and a minimum of one (1) international telephone line in the WTA office and high speed internet connections operational by 9:00 a.m. tournament local time the day of Qualifying Sign-In. The Supervisor shall notify the Tournament at least eight (8) weeks prior to the start of Qualifying of the exact number of telephone lines and internet connections needed. At a minimum, each Tournament must provide one (1) high speed internet connection for each staff permanently located in the WTA Office during the Tournament (Supervisors and Player Relations staff), wireless access is acceptable. The Tournament shall be responsible for the cost of installing the telephone lines and internet connections.

It is recommended that telephone number(s) be available at the time the Tournament Fact Sheet is published seven (7) weeks prior to each Tournament (one (1) week prior to the official entry deadline). Telephone numbers, however, must be available one (1) week prior

## **STANDARDS**

### **SECTION XVIII - TOURNAMENT STANDARDS OF PERFORMANCE**

to the Qualifying Sign-In day. A photocopy machine also should be available in the WTA office or in a nearby convenient location.

c. **Office Furniture and Setup**

The appropriate number of working positions must be prepared for each Supervisor and/or Player Relations representative working on site. The office should have adequate wall/table space or bulletin boards available for Tour information and must have a live score monitor. A locking drawer or a cabinet must also be provided for the Supervisor's use.

#### **49. WTA Coach Program**

Each Tournament must comply with and provide all Tournament-related benefits under the WTA Coach Program Rules available on PlayerZone, TournamentZone, and [www.wtatennis.com/wta-rules](http://www.wtatennis.com/wta-rules). For questions about the WTA Coach Program, please contact the WTA Coach Program Manager at [coach@wtatennis.com](mailto:coach@wtatennis.com).

#### **50. Breach of Tournament Standards of Performance**

a. **General**

The provisions of the Tournament Standards of Performance shall be strictly applied by the WTA. Each WTA Tournament must follow, abide by, and conform to all requirements set forth in the Tournament Standards of Performance unless otherwise approved in writing by the WTA.

Tournaments seeking an exemption from any of the Tournament Standards of Performance must request the exemption from the WTA at least three (3) months in advance of the Tournament. Exemption requests must be sent in writing.

Breaches of the Tournament Standards of Performance and/or an apparent lack of ability to solve documented problems affecting the quality of the presentation of the Tournament shall result in a disciplinary penalty and/or loss or change in a Tournament's status as provided herein.

b. **Violations/Procedures**

i. **Investigation of Alleged Violations**

The WTA shall investigate any alleged violation of the Tournament



## STANDARDS

### SECTION XVIII - TOURNAMENT STANDARDS OF PERFORMANCE

Standards of Performance requirements.

#### ii. WTA Determination

The imposition of a warning, fine, or other penalty shall be determined by the WTA. Upon the completion of its investigation, the WTA shall determine the potential wrongfulness of the conduct of the Tournament involved and shall notify the Tournament of any violations and penalties. A copy of the WTA's decision shall be delivered to the Tournament.

Where a violation is capable of being cured in a timely manner, with timeliness being based on the circumstances, the WTA will provide the Tournament with the opportunity to cure a violation prior to issuing a determination.

#### iii. Possible Penalties

Violations of the Tournament Standards of Performance shall subject a Tournament to one (1) or more of the following: (a) a warning; (b) a fine; (c) being placed on "Probationary" status; (d) loss or change in membership status; (e) forfeiture of all sums, if any, paid to the WTA; and/or (f) any other reasonable penalties. In addition to the foregoing, when a Tournament or Tournament partner uses a Player Likeness in violation of Section VII.B.7.a, then the affected Player may request that such Tournament shall be precluded from using her likeness in any and all advertising the following year of the Tournament provided that such request is made at least six (6) months prior to the start of such Tournament.

Violations of the Tournament Standards of Performance shall be classified by the WTA by Tournament category and by Violation Level. Please see Appendix H for a chart detailing Violation Levels and corresponding fines. If a Tournament receives a warning in a Supervisor Report for a violation and that violation is not remedied the following year, then the Tournament will be fined according to the chart in Appendix H.

#### iv. Payment of Fines

All fines for violations of the Tournament Standards of Performance shall be paid by the Tournament to the WTA, to the attention of the Chief Operating Officer, within twenty-one (21) days after receipt of written notice thereof. Fines not paid within twenty-one (21) days may be deducted from Commercial

## **STANDARDS**

### **SECTION XVIII - TOURNAMENT STANDARDS OF PERFORMANCE**

Benefits or other payments due from the WTA to the Tournament.

All Tournament Standards of Performance fines shall be retained by the WTA, with the exception of those fines assessed against a Tournament due to a violation which directly affects the players (i.e., violations due to insufficient courts, hotel facilities, medical staff, or Section D.2 of the WTA Betting, Gambling and Fantasy Sponsorship Rules), which shall be split 50/50 between the WTA and the WTBA.

In addition to the foregoing, for fines assessed against a Tournament because the Tournament used a Player Likeness in violation of Section VII.B.7.a or Section D.3 of the WTA Betting, Gambling and Fantasy Sponsorship Rules, then the entirety of such fine shall go to the WTBA.

v. Board of Directors Decision on Recommended Loss of Membership

In the event that the WTA recommends that the penalty imposed on the Tournament should be the loss of the Tournament's membership, such recommendation shall be reviewed by the Board of Directors, prior to the imposition of the penalty and the Board of Directors may affirm, modify or reverse the WTA's recommendation.

vi. Subsequent Violations

Subsequent violations of the Tournament Standards of Performance by a Tournament previously placed on probation may result in a revocation of its WTA membership in accordance with the procedures set forth in sub-Section v immediately above. In addition, fines double for violations of the same Issue (see Appendix H) in consecutive Tour Years.

c. Review and Appeal Process

i. Tournament Request for Appeal

After paying all fines as provided above, any Tournament sanctioned for a breach of the Tournament Standards of Performance may request a hearing before the Standards Committee, with the exception of appeals involving monetary penalties of \$50,000 or more or a loss or change in membership status, in which case the matter will be referred to the Board of Directors for a decision.

## **STANDARDS**

### **SECTION XVIII - TOURNAMENT STANDARDS OF PERFORMANCE**

This petition shall be in writing and must be filed with the CEO within twenty-one (21) days after notice of the penalty is received by the Tournament from the WTA. Such petition shall state in detail the basis for such appeal.

#### **ii. Hearing Procedures**

The Tournament shall be advised of the date, time and place for the hearing of such appeal; however, attendance is not mandatory. In addition to submitting a written submission of the basis for its appeal, a Tournament may also request in writing to send a representative to the hearing to orally present its appeal.

On appeal, the Standards Committee or the Board of Directors may affirm, reverse, or modify the decisions of the WTA. The decision of the Standards Committee or the Board of Directors shall be final and non-appealable.

#### **iii. Request for New Hearing**

Notwithstanding Section XVIII.A.49.c.ii above, after the Standards Committee or Board of Directors renders a decision on a Tournament's breach of the Tournament Standards of Performance, the WTA or any applicable Tournament Support Personnel may submit a request to the WTA for the Standards Committee or Board of Directors, as applicable, to grant a new hearing ("New Hearing") of such breach because of the discovery of new information that: (i) was not known to the Tournament at the time of the Standards Committee's or Board of Directors' original hearing on the breach; and (ii) is capable of causing the Standards Committee or Board of Directors, as applicable, to render a different decision on the breach ("New Information"). Such request must be submitted to the WTA no later than ninety (90) days after notice of the Committee's or Board of Directors' original decision unless the Committee or Board of Directors otherwise agrees.

The Standards Committee or Board of Directors, as applicable, has no obligation to grant a New Hearing and has sole, absolute discretion in determining whether a New Hearing request contains any New Information and whether to grant a New Hearing on a breach. The decision regarding a New Hearing by the Committee or Board of Directors, as applicable, is final and non-appealable. If the Standards Committee or Board of Directors, as applicable, grants a New Hearing, the provisions of this Section XVIII.A.49.c will apply to that hearing.

## STANDARDS

### SECTION XVIII - TOURNAMENT STANDARDS OF PERFORMANCE

#### B. MEDICAL SECTION

##### 1. Mandatory Physical Examination

Each player participating in a WTA Tournament must complete all components of a mandatory physical examination as required by the WTA no more than once per Tour Year unless WTA SS&M reasonably determines that any further follow-up related to the mandatory physical examination is medically necessary. If the examination is not performed by the SS&M staff, physical and disability examinations will be at the expense of the player. Each player's medical doctor will be required to complete the WTA mandatory physical examination online using the WTA medical documentation system or as otherwise directed by the WTA and provide any supportive documentation such as vaccination records in English.

###### a. Timing

If a mandatory physical examination is required in a particular Tour Year, the completed physical examination documentation (provided by the WTA) must be submitted to the SS&M Department by March 31 of the current Tour Year.

###### b. Medical Documentation Handling

This and all medical information will be maintained in a secure and confidential online medical documentation system and/or filed with the SS&M Department.

###### c. Penalties

If the examination is not completed by the deadline, the player may be subject to a \$500 fine, and if the player has purchased disability insurance from the WTA, the player will not be eligible for disability coverage under the WTA Plan.

##### 2. Player Treatment Area/Training Room

Each Tournament must provide a secure, private medical treatment area. This area should be easily accessible to the locker room and the match courts and should have good ventilation and temperature control, as well as a sink for sanitary purposes.

###### a. Specifications

The following size specifications are recommended based on draw sizes:

**STANDARDS**  
**SECTION XVIII - TOURNAMENT STANDARDS OF PERFORMANCE**

<b>Singles Draw Size</b>	<b>Recommended Area of Treatment Room</b>
30 or 32	500 square feet (46.45 square meters)
56 or 64	650 square feet (60 square meters)
96 or 128	1000 square feet (93 square meters)

b. Required Setup

This area is for treatment of players only and must be large enough to accommodate the SS&M staff and the Massage Therapists. A separate area for physician examinations should be provided.

If two (2) training rooms are designated for player treatments, all of the requirements herein must be provided in both training rooms according to the number of PHCPs/Massage Therapists servicing each training room.

c. Required Equipment and Supplies

i. Automated External Defibrillator

Automated External Defibrillators (“AEDs”) must be available on site, accessible at all times, and operational (batteries charged and adhesive on pads). AEDs should be located:

- (a) within the Tournament Physician’s on-site office; and
- (b) within three (3) minutes of each practice and competition court.

ii. Physician Area

The following must be provided:

- (a) Padded treatment table, desk, chair, and lockable cabinet; and
- (b) Access to a telephone and internet connection (connection of a minimum of 1MB/second of download and upload speed) for necessary medical documentation, confidential correspondence, and consultations.

iii. PHCP Area

- (a) One (1) padded adjustable treatment table (electric or hydraulic) in good repair and sanitary condition for each

## STANDARDS

### SECTION XVIII - TOURNAMENT STANDARDS OF PERFORMANCE

PHCP at WTA 1000 Mandatory and WTA 500 Tournaments.\*

One (1) padded adjustable treatment table (preferably electric or hydraulic) in good repair and sanitary condition for each PHCP at WTA 250 Tournaments;

- (b) A desk, tables, or a counter top for medical supplies;
- (c) One (1) chair and/or rolling stool for each PHCP;
- (d) A lockable cupboard; and
- (e) An adequate supply of towels, sheets, and ice; and
- (f) Non-carbonated water and WTA-approved carbohydrate-electrolyte replacement drinks.

Only WTA-approved sports bars may be supplied to players in the player treatment area; however, players should not be permitted to eat any food in the treatment area.

Additionally, it is recommended that a large mirror be available in the training room.

\*At the WTA Finals, it is required that one (1) padded, adjustable (hydraulic or electric) treatment table per PHCP is provided at both the official hotel and on-site.

#### iv. Massage Therapy Area

Each Massage Therapist also will require:

- (a) A separate supply of towels (minimum of twenty (20) per day at WTA 125 Tournaments and thirty (30) per day at all other WTA Tournaments); and
- (b) A minimum of twenty (20) sheets per day at WTA 125 Tournaments and thirty (30) sheets per day at all other WTA Tournaments.

Easy access to proper hand washing and toilet facilities is requested. Also requested are: i) a desk or lockable cupboard; ii) waste bins; iii) chairs for players; and iv) one (1) rolling stool per Massage Therapist.

For all Tournaments, the WTA will provide WTA-approved Massage Therapy lotion to be used by the Massage Therapist(s)

## STANDARDS

### SECTION XVIII - TOURNAMENT STANDARDS OF PERFORMANCE

in order to be compliant with the TADP.

#### v. Sanitation Requirements

Dispensed, liquid soap and paper towels are needed in the training room for proper hand washing. It is recommended that Tournaments provide metal waste bins with lids and be pedal-controlled in order to reduce the handling of infected waste. The locker room and training room must be cleaned regularly, including the floors.

#### vi. Communication Needs

The Tournament shall provide:

- (a) A walkie-talkie with adequate reception for each PHCP and for the Tournament Physician. A separate channel is required for the collective use of the Supervisor, officiating staff and PHCP to ensure direct and private communication for on-court matters among them.
- (b) An international telephone line in each training room, if more than one, for the PHCP for emergency purposes. The Tournament shall be responsible for the cost of installing the telephone lines.
- (c) Access to a constant and reliable high-speed or wireless internet connection (connection of a minimum of 1MB/second of download and upload speed) for each PHCP, Core Massage Therapist, and Tournament Physician assigned to the Tournament. This can be provided through individual DSL/ADSL connections, a single ADSL line with a router and cabling to provide individual connections, or a wireless router providing adequate internet service to the group. This should be provided in each training room, if more than one. The Tournament shall be responsible for the cost of installing the internet connection.
- (d) A walkie-talkie or telephone line for the Massage Therapy Area if the Massage Therapists are working in isolation.

Additionally, it is requested that a live score monitor be provided during match play.

#### d. Timing and Installation

All requirements must be ready and operable by 9:00 a.m. tournament

## STANDARDS

### SECTION XVIII - TOURNAMENT STANDARDS OF PERFORMANCE

local time the day of Qualifying Sign-In (i.e., the day before Qualifying matches begin).

e. Accessibility and Security

Locker room and training room areas and the office of the Tournament Physician must be accessible to players and WTA personnel and the Massage Therapist(s) only. Security must be provided at all times, from the day before Qualifying through to the completion of the Tournament, outside the training room and locker room. The training room and office of the Tournament Physician should be locked or secured when the Tournament is not in session. No animals are permitted in the player treatment area/training room or locker room.

f. Treatment

Treatment in the official WTA locker room or player treatment area/training room will be given only by the WTA-approved personnel.

g. Area for Player Personal Health Care and Fitness Providers

Where space is available at WTA 1000 Mandatory and WTA 500 Tournaments, a private room/area with a partition and treatment table should be provided for players to receive treatment from their personal health care providers and fitness professionals. The room/area should be accessible and professional (i.e., not under stairwells or in player lounges, hallways, general gym areas, or Tournament staff areas). This area should be set up by the first day of Qualifying.

Players' health care providers are required to provide their own equipment and medical supplies.

### 3. Mental Health and Performance Room

Each WTA 1000 Mandatory and WTA 500 Tournament must provide a separate, secure, and private Mental Health & Performance ("MHP") room. The MHP room is for treatment and training of players only and must be staffed only by the WTA's qualified MHP practitioners.

a. Specifications

The MHP room must be large enough to accommodate one (1) MHP staff member and up to three (3) players and PST members. The MHP room must facilitate confidentiality by preventing anyone outside the room from hearing or seeing into the room and must contain a lockable door. A partially private room or the use of room partitions is not sufficient.



## **STANDARDS**

### **SECTION XVIII - TOURNAMENT STANDARDS OF PERFORMANCE**

Each Tournament must use best efforts to locate the MHP room in close proximity to the locker room, the player treatment area/training room, and the restroom and provide good ventilation and temperature control.

#### **b. Required Setup, Equipment, and Supplies**

The following must be provided:

- i. One (1) sofa or two (2) armchairs, one (1) coffee table or similar, one (1) table or table-height desk with drawer, and one (1) ergonomic/adjustable desk chair;
- ii. Overhead lighting and at least one (1) table or floor lamp; and
- iii. Access to a reliable internet connection (minimum of 1 Mb/second of download and upload speed) for messaging, telehealth sessions, and scheduling;

Supplies including a white board or easel with pad and appropriate markers, a power strip with multiple plug-in functionality, boxes of tissues, bottles of water, hand sanitizer, and waste bin are strongly recommended.

#### **c. Timing and Installation**

All requirements must be ready and operable by 9:00 a.m. tournament local time the day of Qualifying Sign-In.

#### **d. Accessibility and Security**

The MHP room must be accessible to players and WTA personnel only. The MHP room must be locked or secured by the WTA MHP staff member when not in use during the Tournament. No animals are permitted in the MHP room.

### **4. Treatment On Court**

Only WTA-approved personnel are permitted to provide treatment on court. Unauthorized personnel shall not be allowed on court during a match, Medical Time-Out, or when a player is being treated by a PHCP, Tournament Physician, or Emergency Services.

### **5. Physician**

The Tournament Director must appoint a Chief Tournament Physician

## STANDARDS

### SECTION XVIII - TOURNAMENT STANDARDS OF PERFORMANCE

to coordinate the local medical team. Each Tournament Physician must complete the Tournament Physician SmartSheet and provide it to a SS&M Department, Tournament Relations staff member no later than ninety (90) days prior to the event.

The local medical team should include no more than two (2) assistant physicians. The Tournament Physician may assist in providing medical care for spectators and Tournament staff; however, the priority will be to care for the Players. Therefore, it is recommended that separate medical staff, such as first aid or paramedics, be appointed to care for spectators and Tournament staff. Also, it is recommended that the emergency medical staff is either able to respond within a five (5) minute transit time to the Tournament site or available on-site at all times during play.

#### a. Physician Skills and Medical Qualifications

The Tournament Physician must:

- i. Specialize in orthopedic, internal medicine, or primary care sports medicine and tennis;
- ii. Be licensed in the country and jurisdiction of the Tournament;
- iii. Have admitting privileges at the local hospital;
- iv. Be fluent in both English and the local language;
- v. Possess a current CPR certification and Emergency Response certification (or the international equivalent); and
- vi. Carry professional medical liability (malpractice) insurance in an amount equal to the lower of US\$1,000,000 (US\$250,000 for WTA 125 Tournaments) or the maximum amount of coverage available in the Tournament host country with a reputable insurance carrier for the duration of the Tournament.

Such insurance policy must provide coverage for the Tournament Physician while performing services for WTA players and/or at the Tournament venue. All Tournament Physicians must email proof of license, certifications, and insurance upon request by WTA.

#### b. Physician Responsibilities

The Tournament Physician must be prepared to perform the required duties established by the WTA and will be evaluated by the

## STANDARDS

### SECTION XVIII - TOURNAMENT STANDARDS OF PERFORMANCE

WTA Senior Vice President, SS&M and Transitions, and Medical Advisor(s).

#### i. Duties Prior to the Tournament

- (a) Each Tournament Physician must participate in a pre-tournament telephone orientation and acknowledge that he/she understands all information provided on SS&M Zone, the official site for all SS&M Services information. This orientation also includes an online medical documentation training session with a SS&M Department, Tournament Relations staff member at least two (2) weeks prior to the start of the event.
- (b) Each Tournament Physician must complete the Tennis Integrity Protection Programme module prior to the start of the Tournament.

#### ii. Duties During the Tournament

##### (a) Schedule and Availability

- (i) The Tournament Physician shall be on site at all times during play for both Qualifying and Main Draw matches at all Tournaments.
- (ii) A Tournament Physician must be on site one (1) hour before matches begin and must remain on site until the end of play or after all players requiring physician care have been treated, whichever is later. On the first day of Qualifying, a Tournament Physician must be on site at least one (1) hour and thirty (30) minutes before the start of play to participate in a medical emergency execution plan.
- (iii) The Tournament Physician must be available on call after hours, including the day before Qualifying matches start.
- (iv) The Tournament Physician must be on site from 2:00 p.m. to 6:00 p.m. (Tournament local time) on the day of Qualifying Sign-In.

##### (b) Referrals to Other Local Medical Specialists

The Tournament Physician should have a local referral list of

## **STANDARDS**

### **SECTION XVIII - TOURNAMENT STANDARDS OF PERFORMANCE**

other medical specialists available during the Tournament.

(c) **Medical Documentation**

The Tournament Physician shall submit Tournament Physician evaluation and treatment documentation to the PHCP or enter such evaluation, diagnostic, and treatment documentation (digital diagnostic tests when possible) into the online WTA medical documentation system as directed by the PHCP. In either case, all such information must be in English and submitted or entered by the end of each Tournament day.

It is required that all Tournament Physicians participate in a training session, in order to access the WTA online medical documentation system. Best efforts will be made to include this training as part of the pre-Tournament orientation.

(d) **WTA Mandatory Physical Examination**

The Tournament Physician shall be available to assist in completing the WTA Mandatory Physical Examinations.

iii. **Duties Upon Conclusion of the Tournament**

In addition to the daily medical treatment documentation required during the Tournament, all off-site testing or treatment procedure documentation referred by the Tournament Physician must be submitted to the PHCP upon completion of the Tournament.

iv. **Medical Supplies and Equipment**

The Tournament Physician must have the standard medical supplies and equipment that are required by the SS&M Department and communicated to the Tournament Physician in advance of the Tournament. All medical supplies must be within their expiration dates.

c. **Treatment Procedures**

i. Medical procedures undertaken by the Tournament Physician must comply with the Anti-Doping Program.

ii. Treatment provided by the Tournament Physician to the players on-site must be free of charge.

## STANDARDS

### SECTION XVIII - TOURNAMENT STANDARDS OF PERFORMANCE

- iii. Players, however, are responsible for the payment of off-site treatment, medical testing, or prescriptions, if they are necessary.
- d. Additional Requirement for the WTA Finals

During the WTA Finals, an Internal Medicine/Primary Care Physician and an Orthopedic Surgeon must be appointed to provide medical coverage for the entire Tournament.

## 6. Medical Procedures

- a. Medical Conditions

A medical condition is a medical illness or a musculoskeletal injury that warrants medical evaluation or medical treatment by the PHCP in conjunction with the Tournament Physician, if appropriate, during the warm-up or the match.

- i. Treatable Medical Conditions

- (a) Acute Medical Condition

The sudden development of a medical illness or musculoskeletal injury during the warm-up or the match that requires immediate medical attention.

- (b) Non-Acute Medical Condition

A medical illness or musculoskeletal injury that develops or is aggravated during the warm-up or the match and requires medical attention at the change of ends or set break.

- ii. Non-Treatable Medical Conditions

Players may not receive treatment at any time during the match (or warm-up) for the following conditions:

- (a) Any medical condition that cannot be treated appropriately.
- (b) Any medical condition (inclusive of symptoms) that will not be improved by available medical treatment within the time allowed, specifically chronic conditions such as overuse injuries and recurring injuries.
- (c) General player fatigue.

## STANDARDS

### SECTION XVIII - TOURNAMENT STANDARDS OF PERFORMANCE

- (d) Any medical condition requiring injections, intravenous infusions, or supplemental oxygen, except for diabetes for which prior medical certification has been obtained or Tournament Physician evaluation has been completed and for which subcutaneous injections of insulin may be administered.

#### b. Medical Evaluation

##### i. Purpose

The purpose of the medical evaluation is to determine if a player has sustained or aggravated a treatable medical condition and, if so, to determine when medical treatment is warranted and whether a Medical Time-Out (as further described in sub-Section c below, "MTO") is necessary. The development of the condition need not be witnessed by the Chair Umpire.

##### ii. Player Request and Process

If at any time during the warm-up or the match, the player believes that medical evaluation and treatment are required, she may request, through the Chair Umpire only, to see a PHCP.

The Chair Umpire may ask the player if she is able to continue playing; however, the Chair Umpire is under no obligation to do so.

The player has the option to:

- (a) Stop play and wait until the PHCP arrives, only in the case that a player believes she has developed an acute, treatable medical condition necessitating an immediate stop in play; or
- (b) Wait until the next change of ends or set break to see the PHCP, if the injury is a non-acute, treatable medical condition.

The player is expected to be forthright about whether she believes she suffers with an acute medical condition that warrants a stop in play; otherwise, she is subject to a penalty in accordance with the Unsportsmanlike Conduct section of the Code of Conduct.

## STANDARDS

### SECTION XVIII - TOURNAMENT STANDARDS OF PERFORMANCE

#### iii. Timing and Location of Evaluation

Accompanied on the court by the Supervisor (or Referee), the PHCP will begin, and the Chair Umpire shall begin to time, the evaluation when the PHCP commences communication with the player.

Evaluations by the PHCP shall be performed within a reasonable length of time, balancing player safety on the one hand and continuous play on the other (recommended not to exceed three (3) minutes), and may take place off court, if the PHCP so requests.

Once the evaluation is completed, the PHCP will inform the Chair Umpire if treatment is needed and when treatment is to begin.

#### iv. Involvement of Tournament Physician

At the discretion of the PHCP, should further evaluation be required by the Tournament Physician, this shall be a separate evaluation, also of a reasonable length of time.

#### v. Potential Outcomes of Evaluation

##### (a) Non-Treatable Medical Condition

If after evaluation, the PHCP determines the player has a non-treatable medical condition, then the player will be advised that no medical treatment will be allowed. Medical treatment, including medication, is allowed only for treatable medical conditions.

##### (b) Treatable Medical Condition Requiring MTO

The PHCP may authorize for that condition a one- (1) time, three- (3) minute MTO, which would take place during a change of ends or set break, unless the PHCP determines it is an acute medical condition that requires immediate medical treatment.

##### (c) Treatable Medical Condition not Requiring MTO

If the PHCP determines that the player has a treatable medical condition, but that a MTO is not needed in cases such as illness or muscle cramping, then the PHCP may,

## STANDARDS

### SECTION XVIII - TOURNAMENT STANDARDS OF PERFORMANCE

following the evaluation, begin treatment if time remains in the change of ends or set break. If necessary, the PHCP may treat the player for this medical condition for two (2) additional change of ends, not necessarily consecutive.

#### vi. Medical Treatment

A player may only receive on-court medical evaluation, treatment, and/or supplies from the PHCP (who may request assistance from the Tournament Physician) during any 90-second change of ends or 120-second set break (not necessarily consecutive) for each treatable medical condition.

Players may not receive medical treatment for non-treatable medical conditions.

##### (a) Definition

PHCP on-court medical evaluation, treatment, or supplies shall include:

- (i) Adjustment of medical support and/or tape;
- (ii) Provision of medication; or
- (iii) Supplies for contact lenses.

##### (b) Process and Timing

All such requests for treatment must be made through the Chair Umpire, who shall notify the PHCP and Supervisor (or Referee) of a player's request to see the PHCP and will time the change of ends (or set break) as the usual 90 (or 120) seconds. Medical treatment is limited to two (2) change of ends (or set breaks) for each treatable condition, before or after a MTO (defined below) and need not be consecutive. If adjustment of medical equipment is necessary during or immediately following the warm-up, the player must request an adjustment immediately following the warm-up, limited to 90 seconds.

This treatment should not exceed two (2) changes of ends, which need not be consecutive. During a warm-up, if adjustment of medical equipment is necessary it must be done at the end of the warm-up (90 seconds).



## STANDARDS

### SECTION XVIII - TOURNAMENT STANDARDS OF PERFORMANCE

#### (c) Non-Medical Equipment

Any non-medical equipment (e.g., hair accessories, food, drinks, etc.) requested by a player while on court must be given to an on-court official by a PHCP or Supervisor/Referee to be delivered to the player.

#### vii. Additional Administrative Procedures Applicable to Change of Ends or Set Break

If evaluation takes place on a change of ends, prior to "Time" being called, the Chair Umpire will ask the PHCP if she is continuing the evaluation. The PHCP will indicate:

- (a) If yes, the PHCP clearly will state if she is continuing the evaluation, or if she is starting a MTO. If the evaluation is completed before "Time" has been called, the remaining time of the change of ends may be added to the three (3) minutes for the MTO.
- (b) If no, the Chair Umpire will call "Time" at sixty (60) seconds (change of ends) or ninety (90) seconds (set break). Once "Time" is called, the player has thirty (30) seconds in which to resume play.

#### c. Medical Time-Out

A MTO is granted by the Supervisor or Chair Umpire when the PHCP has evaluated the player and has determined that additional time for medical treatment is required. The MTO takes place during a change of ends or set break, unless the PHCP determines the player has developed an acute medical condition that requires immediate medical treatment.

#### i. Player Allowance

A player is allowed one (1) MTO per match for each distinct treatable medical condition. The following shall be considered as one (1) treatable medical condition:

- (a) All treatable musculoskeletal injuries that manifest and are assessed as part of a kinetic chain continuum; and
- (b) Any and all clinical manifestations of heat illness and cramping subject to the following:

## STANDARDS

### SECTION XVIII - TOURNAMENT STANDARDS OF PERFORMANCE

- (i) A player may receive treatment for muscle cramping only during the time allotted for change of ends and/or set breaks. Players may not receive a MTO for muscle cramping. In cases where there is doubt about whether it is (x) an acute medical condition, (y) non-acute medical condition, inclusive of muscle cramping, or (z) non-treatable medical condition, the decision of the PHCP in conjunction with the Tournament Physician, if appropriate, is final. If a player exhibits symptoms of an illness or heat illness (i.e., heat stroke or heat exhaustion) and cramping is one of the manifested symptoms, a MTO may be taken, which will be determined by the PHCP at the time of evaluation.
- (ii) A player who has stopped play by claiming an acute medical condition, but is determined by the PHCP, in conjunction with the Tournament Physician, if appropriate, to have muscle cramping, shall be ordered by the Supervisor/Referee or Chair Umpire to resume play immediately. If the player cannot continue playing due to severe muscle cramping, the player may forfeit the point or game(s) needed to get to a change of ends or set break in order to receive treatment.\* There may be a total of two (2) change of ends treatments for muscle cramping in a match, not necessarily consecutive. If it is determined by the Chair Umpire or Supervisor/Referee that gamesmanship was involved, then a Code Violation for Unsportsmanlike Conduct may be issued.

\*The chair umpire will announce to the players and spectators: "Miss/Mrs. \_\_\_\_ is requesting immediate medical treatment for cramping. She may receive this treatment only on a change of ends/set break and therefore is conceding all points and games up to the next change of ends/set break."

#### ii. Time and Duration of Treatment

Should the MTO take place, it will not exceed three (3) minutes. It shall begin after the completion and diagnosis of medical condition by the PHCP and Tournament Physician, if required, and be timed from the moment when the PHCP is ready to commence treatment.

#### iii. Off-Court Treatment

At the discretion of the PHCP, and for reasons of privacy and

## STANDARDS

### SECTION XVIII - TOURNAMENT STANDARDS OF PERFORMANCE

modesty, treatment during a MTO may be performed off court in the most private location nearest the court and may proceed in conjunction with the Tournament Physician.

In such a case, the Chair Umpire and/or Supervisor shall be responsible for notifying the PHCP of time remaining. At the conclusion of the three- (3) minute, off-court treatment, the player will immediately return to court.

#### iv. Provisions for Players with Diabetes

Players with diabetes with prior medical written certification obtained from a primary care physician or endocrinologist and submitted to the Anti-Doping Program administrator may be allowed to use devices to check blood sugar during the reasonable time evaluation period and administer insulin (if needed) during the MTO. Players who have not submitted prior medical certification of diabetes must be evaluated by the Tournament Physician before checking blood sugar or administering insulin and must retroactively submit documentation to the Anti-Doping Program administrator if insulin is injected.

#### v. Additional MTO Administrative Procedures

- (a) At the commencement of the MTO the Chair Umpire will announce publicly, "Miss/Mrs. \_\_\_\_ is now receiving a Medical Time-Out" and start timing.
- (b) The Chair Umpire will announce to the players and the PHCP the following:
  - (i) "Two (2) minutes remaining."
  - (ii) "One (1) minute remaining."
  - (iii) "Thirty (30) seconds remaining."
  - (iv) "Time" (publicly).
- (c) Should the MTO take less than the permitted three (3) minutes, the PHCP shall inform the Chair Umpire when treatment has finished, and the Chair Umpire shall announce to the players: "Treatment complete" and then publicly: "Time."
- (d) When treatment takes the full three (3) minutes, the Chair

## STANDARDS

### SECTION XVIII - TOURNAMENT STANDARDS OF PERFORMANCE

Umpire shall announce "Treatment complete" and then publicly: "Time." After "treatment complete," is announced, if needed, the player should be given the time necessary to put on her socks and shoes before "Time" is called.

- (e) If a player is unable to play after thirty (30) seconds, then the player will be subject to a Code of Conduct violation (in accordance with the Point Penalty Schedule).
- (f) At the conclusion of the MTO, the PHCP shall leave the court. The player may receive treatment on two (2) additional change of ends, which need not be consecutive, for each MTO taken.
- (g) Following the match, the player must meet with the on-site PHCP, and the Tournament Physician if the PHCP deems necessary, for an evaluation and assessment of the injury or illness.

#### vi. Consecutive MTOs

A total of two (2) consecutive MTOs may be allowed by the Supervisor or Chair Umpire for the special circumstance in which the PHCP determines the player has developed at the same time at least two (2) distinct treatable medical conditions.

##### (a) Circumstances Allowing for Consecutive MTOs

Such circumstances may include:

- (i) A medical illness in conjunction with a musculoskeletal injury; or
- (ii) Two (2) or more distinct musculoskeletal injuries.

##### (b) Process and Timing

In such cases, the PHCP will perform a medical evaluation for the two (2) or more treatable medical conditions during a single evaluation, and may then determine that two (2) consecutive MTOs are required, advising the Chair Umpire accordingly.

The Chair Umpire will count down the MTOs separately, making appropriate announcements for the commencement of each MTO (e.g., "Miss/Mrs. \_\_\_\_ is taking a second

## STANDARDS

### SECTION XVIII - TOURNAMENT STANDARDS OF PERFORMANCE

#### Medical Time-Out").

#### d. Resumption of Play and Penalties for Rule Violations

After completion of a MTO or medical treatment, any delay in resumption of play shall be penalized as a Code of Conduct violation for Delay of Game.

Any player abuse of this Medical Rule will be subject to penalty in accordance with the Unsportsmanlike Conduct Section of the Code of Conduct.

#### e. Additional Administrative Procedures

##### i. Biohazardous Materials

The Chair Umpire will suspend play and call for the PHCP when Biohazardous Materials (blood and vomit) are present on the court. Play is suspended until the court is cleaned by the appropriate Tournament Personnel, with proper disposal of Biohazardous Materials using the Tournament-provided spill kits.

##### (a) Bleeding

If a player is bleeding, the Chair Umpire must stop play as soon as possible and call the PHCP to the court for evaluation and treatment. The PHCP, in conjunction with the Tournament Physician, if appropriate, will evaluate the source of the bleeding and request a MTO for treatment, if necessary.

If requested by the PHCP and/or Tournament Physician, the Supervisor or Chair Umpire may extend the MTO and allow up to a total of five (5) minutes to assure control of the bleeding.

If within five (5) minutes, the bleeding is not controlled, the PHCP may advise that continued play is detrimental to the player's health. In that case, the Supervisor/Referee may retire the player from the match.

If blood has spilled onto the court or its immediate vicinity, play should not resume until the blood spill has been cleaned appropriately.

## STANDARDS

### SECTION XVIII - TOURNAMENT STANDARDS OF PERFORMANCE

#### (b) Vomiting

If a player is vomiting, the Chair Umpire must stop play if vomit has spilled onto the court, or if the player requests medical evaluation.

If the player requests medical evaluation, then the PHCP shall determine if the player has a treatable medical condition.

If vomiting is continuous, the PHCP may advise that continued play is detrimental to the player's health. In that case, the Supervisor/Referee may retire the player from the match.

If vomit has spilled onto the court, play must not resume until the vomit spill has been cleaned appropriately.

#### ii. Physical Incapacity

During the match, if there is an emergency medical condition, and the player involved is unable to make a request for a PHCP, the Chair Umpire immediately shall call for the PHCP and Tournament Physician to assist the player.

Either before or during a match, if a player is considered physically unable to compete, or poses a serious health risk to players, officials, or Tournament staff, the PHCP and/or Tournament Physician should inform the Supervisor and recommend that the player be ruled unable to compete in the match to be played, or retired from the match in progress.

The Supervisor/Referee shall use great discretion before taking this action and should base the decision on the best interests of Professional Tennis, as well as taking all medical advice and any other information into consideration.

Subject to the restrictions set forth in Section IV.C.2 - Matches Scheduled Same Day, the player subsequently may compete in another event at the same tournament if the Tournament Physician determines the player's condition has improved to the extent that the player may safely physically perform at an appropriate level of play and no longer poses a serious health risk to players, officials or Tournament staff.

## STANDARDS

### SECTION XVIII - TOURNAMENT STANDARDS OF PERFORMANCE

#### iii. Medically-Warranted Clothing Change

If during an on-court evaluation or MTO the PHCP deems it medically-warranted for the player to change her clothing, the PHCP could include this during the MTO (performed off court at the closest/most private location); otherwise, a clothing change only may be taken at the end of a set.

#### iv. Simultaneous Court Calls

In the event there are simultaneous court calls, when a second PHCP is not covering the Tournament, the PHCP will go to the first request, unless otherwise advised of a medical emergency.

If there are two (2) court calls on the same court the following procedure will occur:

- (a) The PHCP will go to the first request or medical emergency, administer a complete evaluation and MTO, if indicated, then;
- (b) Go to the second request and administer a complete evaluation and MTO, if indicated; and
- (c) The PHCP will rotate treatments on the change of ends, if necessary, beginning with the player who had the first request, until the process is complete.

In the event the PHCP determines both court calls to be muscle cramping, the PHCP will treat the player who had the first request for sixty (60) seconds (as timed by the Chair Umpire) and then treat the second player for the remaining sixty (60) seconds of the 120 second change of ends, or treat each player for ninety (90) seconds during a set break.

#### v. Warm-Up Period

With regard to the Medical Rule, the match includes both the warm-up and play; thus, any medical condition incurred during the warm-up is considered a medical condition during the match.

If a player sustains an acute treatable medical condition during the warm-up that prevents the player from starting the match as scheduled, the player can receive either a MTO or ninety- (90) second treatment period at the end of the warm-up, prior to the start of the match.

# STANDARDS

## SECTION XVIII - TOURNAMENT STANDARDS OF PERFORMANCE

If the MTO is taken during the warm-up, the four- (4) minute warm-up shall be suspended until the conclusion of the MTO. If it is clear the player is not physically able to compete after receiving treatment, then the match should not begin.

### 7. Extreme Weather Conditions and Lightning

#### a. Definitions

##### i. Measurement Methods

Extreme Weather Conditions shall be defined as when the Heat Stress Index (Wet-Bulb Globe Temperature (WBGT)) meets or exceeds the levels stated below for Extreme Weather Conditions - Modification of Play and Extreme Weather Conditions - Suspension of Play. If a WBGT meter is not available for measuring the Heat Stress Index (WBGT), then the Heat Index (Apparent Temperature) should be calculated based on the chart below.

Air Temperature (Celsius/Fahrenheit)											
	21.1°C 70°F	23.9°C 75°F	26.7°C 80°F	29.4°C 85°F	32.2°C 90°F	35.0°C 95°F	37.8°C 100°F	40.6°C 105°F	43.3°C 110°F	46.1°C 115°F	48.9°C 120°F
Relative Humidity	<b>Heat Index (Apparent Temperature)</b> (combined index of air temperature and relative humidity)										
	0%	17.8°C 64°F	20.6°C 69°F	22.8°C 73°F	25.6°C 78°F	28.3°C 83°F	30.6°C 87°F	32.8°C 91°F	35.0°C 95°F	37.2°C 99°F	39.4°C 103°F
10%	18.3°C 65°F	21.1°C 70°F	23.9°C 75°F	26.7°C 80°F	29.4°C 85°F	32.2°C 90°F	35.0°C 95°F	37.8°C 100°F	40.6°C 105°F	43.3°C 111°F	46.7°C 116°F
20%	18.9°C 66°F	22.2°C 72°F	25.0°C 77°F	27.8°C 82°F	30.6°C 87°F	33.9°C 93°F	37.2°C 99°F	40.6°C 105°F	44.4°C 112°F	48.9°C 120°F	54.4°C 130°F
30%	19.4°C 67°F	22.8°C 73°F	25.6°C 78°F	28.9°C 84°F	32.2°C 90°F	35.6°C 96°F	40.1°C 104.2°F	45.0°C 113°F	50.6°C 123°F	57.2°C 135°F	64.4°C 148°F
40%	20.0°C 68°F	23.3°C 74°F	26.1°C 79°F	30.0°C 86°F	33.9°C 93°F	38.3°C 101°F	43.3°C 110°F	50.6°C 123°F	58.3°C 137°F	66.1°C 151°F	
50%	20.6°C 69°F	23.9°C 75°F	27.2°C 81°F	31.1°C 88°F	35.6°C 96°F	41.7°C 107°F	48.9°C 120°F	57.2°C 135°F	65.6°C 150°F		
60%	21.1°C 70°F	24.4°C 76°F	27.8°C 82°F	32.2°C 90°F	37.8°C 100°F	45.6°C 114°F	55.6°C 132°F	65°C 149°F			
70%	21.1°C 70°F	25.0°C 77°F	29.4°C 85°F	33.9°C 93°F	41.1°C 106°F	51.1°C 124°F	62.2°C 144°F				
80%	21.7°C 71°F	25.6°C 78°F	30.0°C 86°F	36.1°C 97°F	45.0°C 113°F	57.8°C 136°F					
90%	21.7°C 71°F	26.1°C 79°F	31.1°C 88°F	38.9°C 102°F	50.0°C 122°F						
<b>Extreme Heat Condition – Modification of Play</b>											
<b>Extreme Heat Condition – Suspension of Play</b>											



## STANDARDS

### SECTION XVIII - TOURNAMENT STANDARDS OF PERFORMANCE

#### ii. Modification of Play

Extreme Weather Condition - Modification of Play shall be defined as when the Heat Stress Index (WBGT) meets or exceeds 30.1 degrees Celsius/86.2 degrees Fahrenheit or when the Heat Index (Apparent Temperature) meets or exceeds 34.0 degrees Celsius/93.2 degrees Fahrenheit.

#### iii. Suspension of Play

Extreme Weather Condition - Suspension of Play shall be defined as when the Heat Stress Index (WBGT) meets or exceeds 32.2 degrees Celsius/90.0 degrees Fahrenheit or when the Heat Index (Apparent Temperature) meets or exceeds 40.1 degrees Celsius/104.2 degrees Fahrenheit.

#### b. Procedures for Measuring/Monitoring Weather Conditions

The WBGT Index or Apparent Temperature should be measured by the PHCP a minimum of three (3) times, and a maximum of five (5) times, per day. The readings will be determined by the PHCP and the Supervisor prior to the start of play and will be posted in the Supervisor's office. Measurements should be taken every two (2) hours, but at a minimum, three (3) readings should be taken at the following times:

- i. One-half hour before match play begins;
- ii. Middle of the scheduled day; and
- iii. Just prior to beginning of the last match of the day, or prior to the start of the first evening match.

The WBGT Index or Apparent Temperature also should be measured under the following circumstances:

- iv. Following any suspension of play; and
  - v. At the discretion of the Supervisor, in consultation with the Tournament Physician and/or PHCP.
- #### c. Modification of Play Timing and Weather Condition Change

When the Extreme Weather Condition Modification of Play is in effect before the start of a match, the procedures set out below in sub-Section d, shall be followed.

## STANDARDS

### SECTION XVIII - TOURNAMENT STANDARDS OF PERFORMANCE

In the event that during the day there is a change in weather conditions as determined by this periodic monitoring, the Extreme Weather Condition Rule can be put into effect at any time on all courts, including matches already in progress. Once notified that the Extreme Weather Condition Rule is in effect, the Chair Umpire must inform the players at the next opportunity, no later than the next change of ends.

If there is a sudden change in weather conditions and the Rule is lifted, those matches already in progress will continue under the Extreme Weather Condition Rule. In the case of rain or interruption to play, the Supervisor and PHCP can re-assess the Extreme Weather Condition Rule.

d. Modification of Play Procedures, Singles

A 10-minute break will be allowed between the second and third sets if either player requests such a break. If neither player requests such a break, then play will continue.

The Supervisor, in consultation with the PHCP, also may choose to delay the starting time for matches until such a time as the Extreme Weather Condition Modification of Play no longer is in effect.

i. During the ten (10) minute break

- (a) A player may leave the court for a toilet or change of attire break and it will not be counted toward her allotment of toilet/change of attire breaks.
- (b) Medical evaluations, MTOs, or medical treatments will not be allowed, unless approved by the Referee/Supervisor prior to leaving the court or before the end of the second set, in which case treatment may be conducted off court.

A player, however, may be allowed to receive an adjustment of medical support (including re-taping), medical equipment, and/or medical advice from the PHCP.

ii. Immediately following the ten (10) minute break

- (a) Any delay in resumption of play shall subject a player to back-to-back Time Violations in accordance with Section VII.G.
- (b) No re-warm up will be allowed. (This rule also applies to any

## STANDARDS

### SECTION XVIII - TOURNAMENT STANDARDS OF PERFORMANCE

MTO or toilet or change of attire breaks allowed during the match.)

- (c) A player may not receive medical evaluations, MTOs, or medical treatments, unless approved by the Referee/Supervisor prior to leaving the court or before the end of the second set.

#### iii. Consecutive Breaks

An Extreme Weather Condition ten (10) minute break and a Bathroom/Change of Attire break may not be taken consecutively.

#### e. Suspension of Play Procedures

When the Extreme Weather Condition Suspension of Play is in effect, the Supervisor, in consultation with the Tournament Physician, PHCP, and Tournament Director, may suspend play according to the suspension policy then in effect, until the temperature falls below the criterion for Suspension of Play.

#### f. Lightning

The Supervisor has the authority to suspend play when lightning is sighted. Play shall resume when the likelihood of a lightning strike has passed.

### 8. Consecutive Withdrawals

See Section IV.A.7 - Consecutive Withdrawals.

## C. ELECTRONIC REVIEW

### 1. Required Use

A WTA-approved electronic system for reviewing line calls and/or overrules ("ELC System") is authorized for use at WTA Tournaments with the court surface for which the ELC System was approved.

#### a. WTA/ATP Combined WTA 1000 Mandatory Tournaments

Use of an ELC System is required at minimum on center court during the Main Draw at all WTA 1000 Mandatory hard court Tournaments. In addition, if a court will be equipped with an ELC System for the Main Draw and that court also will be used for Qualifying, then the ELC System is required to be used on that court during Qualifying.

## STANDARDS

### SECTION XVIII - TOURNAMENT STANDARDS OF PERFORMANCE

- b. All Other WTA 1000 Mandatory and WTA 500 Tournaments

Use of an ELC System is required at minimum on center court for the Main Draw at all WTA 1000 Mandatory and WTA 500 hard and grass court Tournaments.

#### 2. Reviewable Points

A request for an Electronic Review of a line call or overrule by a player (team) shall be allowed only on either a point-ending shot or when a player (team) stops playing the point during a rally. (Returns are permitted, but then the player immediately must stop.)

#### 3. Doubles Appeal to Chair Umpire

In doubles, the appealing player must make her appeal in such a way that either play stops or the Chair Umpire stops play. If an appeal is made to the Chair Umpire, then he/she must first determine that the correct appeal procedure was followed. If it was not correct, or if it was late, then the Chair Umpire may determine that the opposing team was hindered deliberately, in which case the appealing team loses the point.

#### 4. Number of Challenges Allowed

Each player (team) shall receive three (3) incorrect challenges per set and one (1) extra challenge in case of a tie-break. In doubles, when a ten (10) point match tie-break is played in lieu of a final set, the number of challenges is reset to three (3) at the beginning of the match tie-break.

#### 5. Additional Challenge for Tie-Break Game

During the tie-break game in any set, each player (team) shall receive one (1) additional challenge. This is in addition to any challenges not lost, if any, during the set.

#### 6. Clear Communication to Umpire of Intent to Challenge

To challenge a line call or overrule, the player must show to the Chair Umpire an immediate interest in making a challenge and must do so in a timely manner. The player must make her intention to challenge known to the Chair Umpire either verbally or visually (e.g., by using her racquet, arm, or hand). The Chair Umpire will:

- a. Reconfirm with the player her intent to challenge;
- b. Confirm that the player has challenges remaining; and

## STANDARDS

### SECTION XVIII - TOURNAMENT STANDARDS OF PERFORMANCE

- c. Proceed with the Electronic Review.

#### **7. No Electronic Review Decision Available**

The original call or overrule always will stand if the Electronic Review is unable, for whatever reason, to make a decision on that line call or overrule. In this case, the player shall not have her available number of challenges reduced.

#### **8. Electronic Review in Lieu of Call from On-Court Officials**

If there is no call made from the on-court officials (unsighted Line Umpire, and Chair Umpire cannot make the call) on a point-ending shot, the Chair Umpire may call for a review, and the result of the review will not affect the remaining challenges of either player.

#### **9. Final Decision**

The decision of the Electronic Review is final and cannot be appealed. In the situation where the written ruling (IN/OUT) on the video board differs from the graphic shown (ball mark digital imagery), then the ball mark imagery determines whether the ball is IN or OUT, not the written ruling, however, the Chair Umpire must contact the review official to get the final confirmation on the call.

#### **10. Review Official**

A certified official, approved by the Supervisor, shall act as the review official, whose duties shall include, but are not limited to:

- a. Determining which impact shall be reviewed by the system.
- b. Monitoring the system to ensure it is functioning properly.
- c. Notifying the Chair Umpire immediately in the case of a system failure or any other condition that prohibits or brings into question the ability of the system to review a challenged call. In this case, the Chair Umpire immediately shall notify both players that review is not available until further notice.
- d. Acting as the final authority on the number of challenges each player has remaining. Communicating with the Chair Umpire, at first possible opportunity, when one (1) challenge is left, and confirming the one (1) remaining challenge.

## **STANDARDS**

### **SECTION XVIII - TOURNAMENT STANDARDS OF PERFORMANCE**

The review official and supporting technology staff shall be located within the stadium or arena in a secured area and with an unobstructed view of the court.

#### **11. Video Board**

For each court that is using a review system, there shall be a minimum of one (1) video board, of sufficient size, located in a position where the Chair Umpire, players, and spectators may view the results of the challenge.

#### **12. Review Booth**

The following specifications are recommended for the electronic system review booth:

- a. The booth must be located in direct line of sight to the court, in order to provide an unobstructed view of the court. It should preferably be at the back (North or South end) of the court when possible.
- b. The Review Official must have a full view of the whole court and line umpires.
- c. The booth must have direct audio from the Chair Umpire's microphone (not from the television feed).
- d. The Review Official should be able to hear the line umpire calls from the court.
- e. The booth must have room for five (5) persons plus equipment (minimum of 25 sq. meters (82 sq. feet) with a minimum court frontage of 5 meters (16.5 feet) as required by review vendor).
- f. The booth should have full air conditioning for equipment and personnel, unless technically unable to do so, and approved by the WTA and the vendor.
- g. Access to the booth must be reasonably easy and safe.
- h. Appropriate communication with the Supervisor, Chair Umpire, and Video Board operator (if not in the same room) must be available.
- i. Tables, chairs, and high stools must be provided as requested by the ELC team.

# STANDARDS

## SECTION XVIII - TOURNAMENT STANDARDS OF PERFORMANCE

### D. COACHING

Provided the following rules and procedures are followed, Off-Court Coaching will be allowed during play in a nondisruptive manner.

#### 1. Coach Seats

- a. Each Tournament must provide player/coach box seats in accordance with Section XVIII.A.10.b.
- b. Coaching is allowed only from the designated player/coach box.
- c. Any Player Support Team member authorized to sit in the designated player/coach box must comply with this Section XVIII.D.

#### 2. Manner of Coaching

- a. Brief verbal coaching is allowed only when a player is at the same end of the court as her designated player/coach box.
- b. Subtle, non-verbal coaching (defined as hand signals or gestures that do not hinder the opponent) is allowed when a player is at the same or the opposite end of the court as her designated player/coach box.
- c. A player may not approach her coach or engage in conversation with her coach other than permitted brief verbal coaching during play, changeovers, or set breaks.
- d. A player may approach her coach and engage in conversation with her coach during an opponent's MTO or toilet/change of attire break or another break approved by the Chair Umpire during which the players have remained on court.
- e. If a coach's verbal coaching, hand signals, or gestures begin to interrupt play or become a hindrance to the opponent(s), the Supervisor will notify the coach of the escalation prior to action being taken against the player. If the distractions persist, the player may be subject to coaching penalties and fines in accordance with Section XVII.D.4.a.vii.
- f. Coaches may not speak to their players when the player leaves the court for any reason (except as permitted during a rain delay).

**STANDARDS**  
**SECTION XVIII - TOURNAMENT STANDARDS OF PERFORMANCE**

**E. INTERNATIONAL MEDIA RIGHTS POOL**

All WTA Tournaments must participate in the official WTA international media rights pool ("Media Pool") consistent with the rights and obligations set forth in these Standards and as may be established by the Board of Directors.

**1. Definitions**

a. Additional Matches

Any Matches which (i) are not Produced Matches and (ii) are produced and delivered by the WTA (or anyone acting under its authority) for broadcast.

b. Clean Feed

The Clean Feed shall mean the "clean" TV video and audio signal of the Produced Matches. The audio feed shall be in stereo and shall consist of one track with natural sound (mixed without commentary) and one track with the Host Broadcaster or production partner commentary for both guide and broadcast purposes. The video feed shall be continuous without (i) commercials, Host Broadcaster promotional material, commentators "in-vision," Host Broadcaster logo, or domestic network identification; or (ii) Host Broadcaster graphics (scoring and statistical) unless otherwise requested by the WTA no later than one (1) week prior to the start of the Main Draw. The video feed shall include the ELC system if in operation at the Tournament, the rights for which must be cleared by the Tournament.

c. Dirty Feed

The Clean Feed augmented with the official WTA graphics.

d. Domestic Area

The country in which a Tournament is held unless approval has been provided in writing by the WTA for an expanded Domestic Area.

e. Host Broadcaster

A telecaster that has been granted all or a portion of the Tournament Media Rights in the Domestic Area by a Tournament.

f. Host Broadcaster Feed

The Host Broadcaster Feed is a video and audio TV signal of Matches



## STANDARDS

### SECTION XVIII - TOURNAMENT STANDARDS OF PERFORMANCE

produced by a Host Broadcaster or production partner appointed by a Tournament, (i) including the Host Broadcaster graphics (scoring and statistical) and ELC system if in operation at the Tournament; and (ii) excluding Host Broadcaster logo and domestic network identification.

g. Matches

The tennis matches from a Tournament.

h. Media Distribution

Any and all forms, means, or modalities of electronic or other tangible or non-tangible exhibition of audio, visual, or audiovisual content to or from any location including by any means, whether now known or hereafter developed, including cable, wire, fiber, or other fixed (permanent and temporary) forms of distribution or connectivity, any form of wireless distribution or technology, satellite, terrestrial broadcast systems and technologies, IPTV, the internet, or any other form of IP-delivery (via any connection, technology and/or device), open video systems, any and all forms of mobile telecommunications, and/or mobile broadcast technologies in any frequency band, in-flight and ship-at-sea, and any other electronic or non-tangible medium via analogue, digital, mobile, and any other forms of distribution and communication technologies, where the audio, visual, or audiovisual programming is produced, distributed, or otherwise made available in any format, resolution, or quality including 3D Technology, HDTV transmission (or any other form of enhanced transmission), Standard Definition distribution, or distribution in any other quality, code, or form for use, display, or viewing on any device in any context and made available on any basis including free or pay (including subscription and pay-per-view), encrypted or unencrypted, time-shifted, interactive, or any other means or basis. Media Distribution shall include, without limitation, viewing enhancements that allow a person watching a Match to modify the exhibition or otherwise enhance the viewing of a Match (e.g. by selecting the camera angles). In-flight and in-ship distribution shall be deemed to be distributed in the home country of the vessel that carries the Matches.

i. Outside Court Feeds

Feeds of Produced Matches from courts that are not designated for the World Feed by the WTA (or its designees). These matches shall be produced according to the Outside Court Running Order provided to the Tournament by the WTA (or its designees) at least sixty (60) days prior to the start of the event.

## STANDARDS

### SECTION XVIII - TOURNAMENT STANDARDS OF PERFORMANCE

j. Produced Matches

All Matches that are produced by a Tournament's Host Broadcaster or production partner appointed by a Tournament at the site of the Tournament, which shall include (i) all main draw singles Matches; and (ii) each semifinal and final round doubles Match if a production court is available at the Tournament's standard production cost at the time such Match is played.

k. Television Revenues

The revenues generated by the Media Pool.

l. Virtual Advertising

The manipulation by computer of authentic images, either live or delayed, and the substitution of various elements of those images with the purpose of implementing advertising messages into the feed of the Matches, or the electronic insertion (as opposed to laying over) into the feed of the Matches of video images not present at the site of a Tournament, in the form of synthetic advertising boards, panels, and/or signs.

m. World Feed

The feed of a select number (in accordance with Section XVIII.F.1) of Produced Matches designated by the WTA (or its designees). These matches shall be produced according to the World Feed Running Order provided to the Tournament by the WTA (or its designees) at least sixty (60) days prior to the start of the event.

## 2. Match Distribution Rights and Obligations

a. Tournament Media Rights

Subject to the Television Broadcast Standards in Section XVIII.F, each Tournament reserves the following rights with respect to the Matches at its event:

- i. Subject to Sub-section v below, the exclusive rights of transmission, distribution, and exploitation of the Host Broadcaster Feed of the Matches exercisable throughout the Domestic Area for reception by the public via any form of Media Distribution (collectively, "Tournament Media Rights").
- ii. The non-exclusive, perpetual right to (i) utilize up to five (5)

## STANDARDS

### SECTION XVIII - TOURNAMENT STANDARDS OF PERFORMANCE

minutes of footage of each Produced Match after the completion of the Match throughout the world solely for the purposes of advertising and/or promoting the WTA, the Tournament, or women's tennis; and (ii) use and permit others to use in the Domestic Area, up to three (3) minutes of footage from each Produced Match after the completion of the Produced Match for any purpose provided that in both cases the Tournament shall not receive any consideration for such use, except that use of clips of Produced Matches in the context of sponsorship or similar arrangements where the Tournament receives consideration in respect of the arrangement taken as a whole shall not be prohibited so long as no sponsor is permitted to make use of any such clips in the context of any product or service which is produced for onward sale to a third party. Nothing herein shall prevent Tournaments from permitting their Host Broadcaster from distributing clips from its Produced Matches in the Event Domestic Area as part of a free or subscription based news service.

- iii. The right to incorporate Virtual Advertising in the broadcast exploitation of the Tournament Media Rights in the Domestic Area as long as (a) the Virtual Advertising does not negatively alter, impair, or obstruct any signage of the WTA or WTA sponsor(s), (b) the Virtual Advertising does not negatively alter, impair, or obstruct any competitive elements of a Match, including but not limited to court surface, players (including their attire and equipment), balls, net, lines and officials, or interfere with the integrity of the competitive presentation of the Match, and (c) the Clean Feed delivered to the WTA (or anyone acting under its authority) for international broadcast does not contain any such Virtual Advertising; and
- iv. The right to incorporate into the Tournament's domestic telecast, logos of the Host Broadcaster or domestic network, billboards, graphics, and other audio and visual elements consistent with professional tennis television programming, provided that no reference to a Tournament's sponsor shall be made in a manner that appears to the public that such Tournament sponsor is a WTA sponsor.
- v. Notwithstanding the foregoing exclusivity, the WTA (or anyone acting under its authority) shall at all times have the (i) right to stream the Matches worldwide on a pay basis; and (ii) the exclusive right to provide a stream of the Matches to betting service operators, provided such operators only offer access to the Matches to its customers that have an account with

## STANDARDS

### SECTION XVIII - TOURNAMENT STANDARDS OF PERFORMANCE

such operator. In the Tournament Domestic Area, such Match streaming to betting service operators may only be streamed at download speeds no greater than six hundred kilobits per second (600 Kbps) and displayed in a view having a total area of not more than 200,000 pixels.

#### b. WTA Media Rights

- i. As a member of the Media Pool, each Tournament grants the WTA an exclusive, perpetual license under copyright throughout the world except for the Domestic Area to:
  - (a) Transmit, distribute, and exploit, and authorize third parties to transmit, distribute, and exploit, the Produced Matches for reception by the public via any form of Media Distribution (collectively, "WTA Media Rights");
  - (b) Exploit the WTA Media Rights to promote WTA feed graphics sponsor(s) in such capacity; and
  - (c) Incorporate the official WTA graphics (in the positions that the Media Pool approves from time to time) in the exploitation of the WTA Media Rights; provided, however, that such official WTA graphics must not negatively alter, impair, or obstruct the on-site signage of any Tournament sponsor(s).
- ii. The non-exclusive, perpetual worldwide right to exploit and permit others to exploit (a) excerpts of up to three (3) minutes per Match, anytime after the completion of the Match; and (b) up to five (5) minutes of footage of each Match to promote the WTA and/or WTA sponsors and for use by the WTA in educational programs and for internal purposes. Any revenues from the sale of highlights shall be included in Television Revenues.

#### c. Obligations

- i. All Produced Matches must meet the production level requirements detailed in Section XVIII.F - WTA Television Broadcast Standards.
- ii. Each Tournament shall ensure the production of a Clean Feed for all Produced Matches and shall provide the WTA (or anyone acting under its authority) with access to the Clean Feed and a redundant backup of the Clean Feed by providing the necessary cabling from the Clean Feed point of origin to the on-site

## STANDARDS

### SECTION XVIII - TOURNAMENT STANDARDS OF PERFORMANCE

Graphics Office (see Section XVIII.F.4.h.iii(c)). In addition, if the Host Broadcaster or production partner chooses to deliver the Dirty Feed from the on-site Graphics Office to the Clean Feed point of origin, the Host Broadcaster or production partner must provide all necessary cabling for such delivery. The WTA (or its designees) is responsible for the cabling necessary to carry the Dirty Feed from the on-site Graphics Office to the on-site transmission point; provided, however, that each Tournament shall introduce the WTA (or its designees) to its facilities provider so that the WTA (or its designees) may contract directly with such facilities provider for such cabling.

- iii. All Produced Matches must be made available to the WTA (or anyone acting under its authority) at no cost, including the redundant backup of the Clean Feed.
- iv. All necessary measures, including geo-blocking technology, must be employed to assure that each audiovisual media service is only capable of being received in the applicable territories and is not capable of being received by reception devices outside such territories.
- v. The WTA and each Tournament shall promote the domestic and international television and online broadcast schedules on their respective websites.

### 3. Overspill

The natural and incidental reception of broadcast and streaming transmissions from either the WTA or its licensees within the Domestic Area or a Tournament or its licensees outside of the Domestic Area will not (a) constitute a violation of these Standards as long as there is no marketing, promotion, advertising, or support of such Overspill, or (b) give rise to any additional payments by the WTA to a Tournament or any damages, remedies, setoff rights, or holdback rights.

### 4. Match Schedule

- a. At least 120 days before the commencement of a Tournament, the Tournament shall provide the WTA (and its designees) with a preliminary outline of the times of the Produced Matches, which outline may change.
- b. Not less than sixty (60) days prior to the commencement of a Tournament, the Tournament shall provide the WTA (and its designees) with a final outline of the times of the Produced Matches

## STANDARDS

### SECTION XVIII - TOURNAMENT STANDARDS OF PERFORMANCE

and the name and telephone number of the production coordinator of the Host Broadcaster.

- c. The WTA (or its designees) must be advised immediately of any scheduling change that affects the Produced Matches.

#### 5. Per Match Fees

- a. If a Tournament fails to make available to the WTA (or its designees) a Clean Feed (other than failure pursuant to sub-Section c below), the Covered Tournament shall pay a per match fee of up to \$100,000 (the "Per Match Fee") for each Match for which the relevant feed was not made available.
- b. If a Tournament fails to make available to the WTA (or its designees) a Clean Feed materially in accordance with Section XVIII.F - Television Broadcast Standards, for any Produced Match (other than failure pursuant to sub-Section c below), the Tournament shall pay the Per Match Fee for each feed that is not materially in accordance with the Television Broadcast Standards.
- c. If one or more of the Produced Matches are (i) cancelled or not completed due to a weather-related or other incident (such as a rainout, blackout, player strike, player labor action, player injury, or other failure of players to play) outside the control of the Tournament (or anyone acting under its authority), and not directly or indirectly attributable to the fault of the Tournament (or anyone acting under its authority) and (ii) not rescheduled, and the Tournament as a result of such incident fails to make available to the WTA a Clean Feed, any Per Match Fee charged for each Produced Match for which a Clean Feed was not made available, shall be paid for out of the Television Revenues before allocation of the WTA's share.
- d. Upon a Tournament's failure to produce a Produced Match Feed and/or a Clean Feed and/or provide access to a Clean Feed, the WTA may, in its sole discretion and election, offset against a Tournament's share of the Television Revenues (i) the actual out-of-pocket costs incurred in remedying or attempting to remedy such failure plus an amount equal to 20% of the amount paid to remedy such failure, and/or (ii) an amount equal to any Per Match Fees due pursuant to sub-Sections a or b above as the result of such failure.
- e. The payments specified above (and/or permitted offset pursuant to sub-Section d) shall be made no later than thirty (30) days following receipt by the Tournament of an invoice issued by the WTA.

## STANDARDS

### SECTION XVIII - TOURNAMENT STANDARDS OF PERFORMANCE

f. Additional Matches

- i. If the WTA (or any of its designees) desires to broadcast any Additional Matches from a Tournament, the production costs shall be borne by the WTA. The Host Broadcaster or Tournament production partner shall pay for any Additional Matches that it requests for production, but the WTA (or its designee) shall provide a production contribution fee on a per-match basis in accordance with the following schedule:

TOURNAMENT PRODUCTION OPTIONS				
Option	Tournament Media Rights	Host Broadcaster/ Production Partner	Additional Technical Fees	Production Costs
1	Included in Media Pool on a non-exclusive basis	WTA (or its designees)	N/A	Covered by Perform
2	Excluded from the Media Pool	WTA (or its designees)	Tournament is responsible for a \$750.00 per match technical access fee for its Domestic Area broadcast partner to access Matches on site; access to Matches via satellite may incur additional fees.	Covered by Perform
3	Included in Media Pool on a non-exclusive basis	Appointed by Tournament	N/A	Perform will pay the following production contribution fees on a per match basis: <ul style="list-style-type: none"> <li>• World Feed Matches: WTA 1000 - \$8,000; WTA 500 - \$5,000; WTA 250 - \$3,000</li> <li>• Non-World Feed Matches: WTA 1000/WTA 500 - \$1,000; WTA 250 - \$500</li> </ul>
4	Excluded from the Media Pool	Appointed by Tournament	N/A	Perform will pay the following production contribution fees on a per match basis: <ul style="list-style-type: none"> <li>• World Feed Matches: WTA 1000 - \$4,000; WTA 500 - \$2,500; WTA 250 - \$1,500</li> <li>• Non-World Feed Matches: WTA 1000/WTA 500 - \$1,000; WTA 250 - \$500</li> </ul>

## **STANDARDS**

### **SECTION XVIII - TOURNAMENT STANDARDS OF PERFORMANCE**

- ii. The broadcast of an Additional Match will not entitle a Tournament to an additional share of the Television Revenues. All revenues received by the WTA for such Additional Matches, shall be included in Television Revenues.

#### **6. Exploitation of Rights**

- a. Tournaments must not take any action that interferes with or impairs the rights granted hereunder to WTA.
- b. Neither a Tournament nor its Host Broadcaster or production partner shall at any time claim any legal ownership in respect of the exploitation of the rights granted to the WTA, or any other aspect or activity of WTA.
- c. Upon request, a Tournament shall execute such documents and instruments evidencing or affecting the WTA's license of rights and shall cooperate with the WTA to encourage its Host Broadcaster or production partner to execute any such similar documents and instruments as requested from time to time.

#### **7. Clearances**

- a. Each Tournament shall procure all necessary consents, clearances, permissions, licenses, and waivers from all individuals in attendance at the Tournament whose image might be broadcast.
- b. With respect to the inclusion of Host Broadcaster or production partner commentary language in the Clean Feed for broadcast use, if English is the Host Broadcaster language, the Tournament must clear any applicable contractual restrictions at its expense (i.e., consents, residuals, etc.); however, for commentary in all other languages, the Tournament shall only be required to clear the commentary for broadcast use if requested by the WTA.
- c. The WTA shall have the non-exclusive, worldwide right in perpetuity to use and grant others the right to use the Tournament's name and reproductions of the Tournament's facilities in exploiting the rights granted to the WTA and in promoting the Tournament, the WTA, and WTA sponsors in their capacity as sponsors of the WTA.

#### **8. Breach of Standards**

A Tournament's failure to meet any of its requirements in this Section XVIII.E is a breach of the Tournament Standards of Performance and subject to the procedures and sanctions in Section XVIII.A.49 of these Rules.



# STANDARDS

## SECTION XVIII - TOURNAMENT STANDARDS OF PERFORMANCE

### F. WTA TELEVISION BROADCAST STANDARDS

The definitions of the capitalized terms which are used but not defined in these Television Broadcast Standards are set forth in sub-Section E above.

#### 1. Minimum Broadcast Requirements by Tournament Category Level

- a. Each WTA 1000 Mandatory Tournament shall assure production of a minimum of thirty-five (35) World Feed Matches, including the four (4) singles quarterfinal, two (2) singles semifinal, and singles final matches across a minimum of two (2) courts. Any main draw singles Matches not designated for the World Feed must be produced in accordance with the Minimum Production Requirements in the table below.
- b. Each WTA 500 Tournament shall assure production of a minimum of twenty (20) World Feed Matches, including the four (4) singles quarterfinal, two (2) singles semifinal, and singles final matches. Any main draw singles Matches not designated for the World Feed must be produced in accordance with the Minimum Production Requirements in the table below.
- c. Each WTA 250 Tournament shall assure production of a minimum of ten (10) World Feed Matches, including the four (4) singles quarterfinal, two (2) singles semifinal, and singles final matches. Any main draw singles Matches not designated for the World Feed must be produced in accordance with the Minimum Production Requirements in the table below.
- d. In addition, while production of all doubles Matches is not a requirement, all Tournaments shall produce, at a minimum, each semifinal and final round doubles Match in accordance with the Minimum Production Requirements in the table below if a production court is available at the Tournament's standard production cost at the time such Match is played. For clarity, if a production court is not available at the Tournament's standard production cost at the time a semifinal or final round doubles Match is played, then the Tournament is not required to produce such Match. In accordance with the chart in Section XVIII.E.5.f.i, each Tournament that has chosen Option 3 or Option 4 will receive a Non-World Feed Match contribution fee for each doubles Match it produces.
- e. All Produced Matches must be fully produced (excluding graphics and commentary) and delivered to the WTA (or its designees) on site.

**STANDARDS**  
**SECTION XVIII - TOURNAMENT STANDARDS OF PERFORMANCE**

PRODUCTION ITEM	TOURNAMENT LEVEL		
	WTA FINALS, WTA 1000 Mandatory	WTA 500	WTA 250
World Feed	Main Draw pre-Quarterfinals: 5 Cameras  Main Draw Quarterfinals through Finals: 8 Cameras	Main Draw pre-Quarterfinals: 5 Cameras  Main Draw Quarterfinals through Finals: 8 Cameras	Main Draw pre-Quarterfinals: 3 Cameras*  Main Draw Quarterfinals through Finals: 5 Cameras
Outside Court Feed; Doubles Matches	3 Cameras	3 Cameras	3 Cameras
Production Coverage and Distribution	All Main Draw singles Matches required; all doubles semifinal and final Matches required if a production court is available at Tournament's standard production cost; all other doubles Matches encouraged	All Main Draw singles Matches required; all doubles semifinal and final Matches required if a production court is available at Tournament's standard production cost; all other doubles Matches encouraged	All Main Draw singles Matches required; all doubles semifinal and final Matches required if a production court is available at Tournament's standard production cost; all other doubles Matches encouraged
Commentary (provided by WTA or its designees, subject to availability for pre-semifinal round doubles Matches)	Commentators at all Produced Matches  Co-Commentators at all Produced Matches on Center Court	Commentators at all Produced Matches  Co-Commentators at all Produced Matches during the last 3 Main Draw Days	Commentators at all Produced Matches
Graphics (provided by WTA or its designee)	All Produced Matches	All Produced Matches	All Produced Matches
Newsfeed (provided by WTA or its designees)	All Main Draw Days	Last 5 Main Draw Days	Last 2 Main Draw Days

\* NOTE: To reach the minimum ten (10) World Feed Matches required under Section XVIII.F.1.d above, each WTA 250 Tournament must use five (5) cameras in the production of three (3) Main Draw pre-quarterfinals Matches.

**2. Host Broadcaster's Responsibilities**

Each Tournament must incorporate the following terms within its new or renewed contract with a Host Broadcaster or production partner:

**a. Broadcast Recordings**

Each Tournament's Host Broadcaster or production partner shall provide the WTA (or its designees) with USB3 external hard drives containing one (1) clean recording of each semifinal and final round singles Match that the Host Broadcaster or production partner produced for broadcast within one (1) hour after the completion of

## STANDARDS

### SECTION XVIII - TOURNAMENT STANDARDS OF PERFORMANCE

each such Match. If future license agreements require the WTA to provide additional recordings of first round through quarterfinal round Matches, each Tournament's Host Broadcaster or production partner shall provide such recordings to the WTA (or its designees) at no cost to the WTA (or its designees).

b. Data Collection and Resale

With respect to any live match scores or related statistical data provided to a Host Broadcaster by WTA (or its designees), or collected by the Host Broadcaster, such Host Broadcaster shall agree (i) not to onward supply, sublicense, or otherwise make such scores and data available to any third party for use not related to the broadcast, and (ii) to restrict their use of such scores and data to use on a contemporaneous basis within their live broadcast of any match; any other use shall be subject to a delay of at least thirty (30) seconds. All Tournament agreements with Host Broadcasters must comply with, and shall be subject to all WTA Rules as amended from time-to-time.

c. Compliance with WTA Rules

All Tournament agreements with Host Broadcasters and production partners must comply with, and shall be subject to, the Rules as amended from time to time.

d. Production and Access of Feeds

i. The Host Broadcaster or production partner appointed by a Tournament shall, at no cost to the WTA (or its designees), produce a Clean Feed for all Produced Matches and provide the WTA (and its designees) with access to the Clean Feed and the back-up feed for the Clean Feed (total of at least two (2) feeds for every produced court).

ii. Access to the Clean Feed shall:

(a) begin not less than fifteen (15) minutes prior to the scheduled start time of a Match with a wide shot of the court before the players walk on the court and conclude not less than five (5) minutes after the players walk off the court at the conclusion of the Match for all quarterfinal, semifinal, and final Produced Matches; and

(b) begin not less than seven and a half (7.5) minutes prior to the scheduled start time of a Match with a wide shot of the

## STANDARDS

### SECTION XVIII - TOURNAMENT STANDARDS OF PERFORMANCE

court before the players walk on the court and conclude not less than two and a half (2.5) minutes after the players walk off the court at the conclusion of the Match for all other Produced Matches.

- iii. At no cost to the WTA (or its designees), the Host Broadcaster or production partner must provide all necessary cabling to deliver the Clean Feed (and a back-up of the Clean Feed) to the on-site Graphics Office. In addition, if the Host Broadcaster or production partner chooses to deliver the Dirty Feed from the on-site Graphics office to the Clean Feed point of origin, the Host Broadcaster or production partner must provide all necessary cabling for such delivery. The WTA (or its designees) is responsible for the cabling necessary to carry the Dirty Feed from the on-site Graphics Office to the on-site transmission point; provided, however, that each Tournament shall introduce the WTA (or its designees) to its facilities provider(s) so that the WTA (or its designees) may contract directly with such facilities provider(s) for such cabling.
  - iv. The Clean Feed must be the primary source for all subsequent feeds. Any Host Broadcaster Feed must be augmented downstream of the Clean Feed.
- e. Feed Content
- i. The Clean Feed provided to the WTA (or its designees) shall contain no graphics or insertions with the exception of the WTA transition wipe.
  - ii. The WTA (and anyone acting under its authority) shall have the right to incorporate into the Clean Feed, for purposes of creating the World Feed and Outside Court Feed delivered to viewers, the WTA Logo, logos of one or more of its licensees' billboards, graphics, and other audio and visual elements consistent with professional tennis television programming, provided that no incorporation of the WTA Logo or other element containing any reference to a WTA sponsor shall be made in a manner that appears to the public that such WTA sponsor is a sponsor of the Tournament, provided further, however, that no such incorporation shall be permitted for any WTA sponsor if such use would be contrary to any contractual restrictions imposed on the Tournament by its Title or Presenting Sponsor (such restrictions must be made known to WTA in writing).
  - iii. The Clean Feed will contain all commercial identification visible

## STANDARDS

### SECTION XVIII - TOURNAMENT STANDARDS OF PERFORMANCE

at a Tournament's site. A Tournament shall be entitled to place on site any and all logos, sponsor credits, advertising, signage, and other commercial identification and the WTA shall not be entitled to any revenues on the sale of such logos, sponsor credits, advertising, signage, and other commercial identification.

- iv. Neither the WTA nor any of its licensees shall utilize or permit the utilization of Virtual Advertising into the Clean Feed without the approval of the majority of the Media Pool Tournaments.
  
- f. Match Start Times
  - i. A specific start time, or an appropriate not before time, must be designated for all quarterfinal, semifinal, and final Matches. In the event that two (2) quarterfinal or semifinal Matches are scheduled to run back-to-back, a specific start time, or not before time, must only be specified for the first Match.
  
  - ii. A not before time must be specified if a doubles semifinal or final Match will precede a Match and at combined events where an ATP match precedes a Match. Unless otherwise approved by the Supervisor, a minimum of two hours (2:00) should be allowed for each preceding match before scheduling the not before time for a regular Match and a minimum of two and a half hours (2:30) should be allowed for each preceding Match before scheduling a not before time for a singles semifinal or final.

- g. Broadcast Signal

The Tournament's Host Broadcaster or production partner shall produce a broadcast signal in High Definition (HD), which should be filmed and produced in a 14x9 (graphics/title safe) aspect ratio.

- h. Camera Plan

The Tournament's Host Broadcaster must provide the WTA with a camera plan showing the location of the cameras on all production courts at least thirty (30) days prior to the start of the Main Draw.

### 3. Technical Requirements

Each Tournament must incorporate the following technical terms within its Host Broadcaster or production partner contract. These conditions represent the minimum technical standards necessary to produce a quality broadcast, and each Tournament shall ensure that its Host

## STANDARDS

### SECTION XVIII - TOURNAMENT STANDARDS OF PERFORMANCE

Broadcaster or production partner produces its matches at standards that are equal to or greater than these minimum technical standards.

a. Cameras

i. Each Tournament shall comply with the Minimum Broadcast Requirements in the table in Section XVIII.F.1 above for all Produced Matches.

ii. Cameras 1, 2, 3, 4, and 5 must be in the following positions:

(a) Camera 1

Provides a traditional master shot and must be positioned high up in the stands (center court line).

Positioning must be correct for optimal main angle camera coverage. In order to calculate this, a guideline ratio of 4:1 should be used, where 4 is the distance from the base of the net to the bottom of the camera platform and 1 is the height of the camera lens from the ground. This gives an angle of 12 degrees.

(b) Camera 2

Provides coverage/close up and must be positioned approximately three (3) rows lower below Camera 1 (center court line) either in a central position or an off center position toward the side where Cameras 3 and 4 are positioned. The camera's position should give the effect of looking over the player's shoulder as she serves from that side of the court.

(c) Cameras 3 and 4

Provide player close-ups for cutting into coverage and isos and may be positioned courtside on the same or opposite side from where the players sit down on the change of ends. The camera objective lens height should be approximately one (1) meter.

(d) Camera 5

Low-angle camera positioned on court behind the baseline, in line with the sideline.

## STANDARDS

### SECTION XVIII - TOURNAMENT STANDARDS OF PERFORMANCE

b. Tripods, Camera Mounts, and Irises

All cameras must be on secure tripods with fully-rotating camera mounts and remotely-controlled irises.

c. Lenses

i. Center and Show Courts with five (5) camera coverage or above

(a) Lens for Camera 1 should be a minimum of 22:1,

(b) Lens for Camera 2 should be a minimum of 50:1,

(c) Lenses for Cameras 3 and 4 should be a minimum of 40:1 (or similar) with a 2x extender and must be able to provide extreme close ups.

(d) Lens for Camera 5 should be a minimum of 14:1.

ii. Outside Court Coverage with less than five (5) camera coverage

Lens for Camera 1 should be a minimum of 14:1.

d. Production

Tournaments must have full unilateral production on all courts where there is a main draw singles Match.

e. Microphones

i. Center and Show Courts with five (5) camera coverage or above

A minimum of twelve (12) audio microphones.

ii. Outside Court Coverage with less than five (5) camera coverage

A minimum of six (6) audio microphones.

#### 4. Tournament Facilities

Each Tournament must comply with the following requirements:

a. Access

i. Each Tournament shall grant free access to personnel of the WTA (and its designees) and shall provide the WTA (and its

## STANDARDS

### SECTION XVIII - TOURNAMENT STANDARDS OF PERFORMANCE

designees) with such passes or tickets as are required for such access.

- ii. At no cost to the WTA (or its designees), each Tournament shall provide the WTA (and its properly credentialed designees) with access to the player areas, and the site at which awards are to be made.
- b. Lighting
- i. Each Tournament shall cause all Matches staged on courts where Produced Matches are staged to be lighted in a manner such that high quality, color telecasting can be conducted.
  - ii. To the extent any Produced Matches are staged on courts other than those equipped to be lighted for television production, the WTA (or its designees) shall be responsible for the costs associated with any lighting (including equipment) that may be required for such matches.
  - iii. If the Tournament is held indoors, the Tournament shall cause the use of strobe lights on any "still" photographic equipment to be discouraged at the site. The indoor playing surface must be illuminated evenly at a minimum 1076 lux. The light source must be from either side of the court and must not be perpendicular to the inside of the playing area. The best type of lamp source is a tungsten lamp with a color temperature of 3200 Kelvin. The tungsten light source offers a far more stable color temperature than discharge lamps and is far more reliable. The most suitable luminaries are flood lights with a symmetrical reflector and 1.5 kw. Depending upon the reflective values of surfaces within the area and the distance between the luminaries and the playing surface, 60-80 (30-40 on each side) luminaries are required. If 80 lamps are required, the total power requirements are 120 kw. A venue requires a minimum of 200A 415V supply.

c. Public Address System

At no cost to WTA (or its designees), each Tournament shall provide the WTA (and its designees) with audio pick-up access to all public address system announcements during the Tournament.

d. Security

At no cost to the WTA (or its designees), each Tournament shall take reasonable customary measures to provide the WTA (and its



## STANDARDS

### SECTION XVIII - TOURNAMENT STANDARDS OF PERFORMANCE

designees) with 24-hour security for the duration of the Tournament necessary to help provide for the safety of the equipment and personnel of the WTA (and its designees) at the site.

e. Walkie-Talkies

At no cost to WTA (or its designees), each Tournaments shall provide WTA (and its designees) a total of seven (7) walkie-talkies (one (1) for the on-site WTA Broadcast office, one (1) for outside court production, two (2) for the on-site production office, one (1) for center court production, one (1) for the newsfeed production office, and one (1) for a technical manager.

f. Other Facilities

Upon the request of the WTA (or its designees), a Tournament shall, at no cost to the WTA and if not otherwise prohibited by contractual restrictions or space constraints, provide to the WTA (and its designees) any other production facilities or equipment which may be required by the WTA (or its designees).

g. Commentary Positions

i. Each Tournament shall, at no cost to the WTA (or its designees), and if not otherwise prohibited by Host Broadcaster or other agreements, provide to the WTA (and its designees) all physical space and utilities reasonably necessary to permit one (1) or more on-camera unilateral commentary positions at the site of the Tournament for foreign language broadcasts.

ii. At a minimum, each Tournament shall, at no cost to the WTA, provide to the WTA all facilities reasonably necessary to permit one (1) or more on-camera unilateral commentary positions, for World Feed production on each court that is supporting a World Feed production and to display a reasonably sized temporary banner near the commentary position in a location approved by the WTA and Tournament.

iii. The facilities shall include, without limitation, cameras, color monitors, microphones, camera operators, directors, switchers, an audio mixer, technicians, high speed internet, and business telephones, with the understanding that the WTA (and/or its designees) will be charged no more than the Tournament's then-current rate card prices for the use of those facilities and personnel.

## STANDARDS

### SECTION XVIII - TOURNAMENT STANDARDS OF PERFORMANCE

- iv. The WTA (and/or its designees) shall specify the number, location, and size of the commentary positions as soon as possible prior to commencement of the Tournament. At the request of WTA (or its designees), the Tournament shall cause the commentary positions to be fully equipped (or partially equipped in the manner specified by WTA or its designees). At a minimum, the commentary positions shall be equipped with a table (large enough for two people), two (2) chairs, wiring for a minimum of three (3) telephones, two (2) television monitors, and the technical television equipment necessary to broadcast.
  - v. If a commentary box is constructed, it should be positioned on the same gantry as that used for Camera 1. The commentary box shall not be positioned at the end opposite from Camera 1.
- h. Production Space
- i. Each Tournament shall provide, at no cost to the WTA (or its designees), the following production facilities and spaces for the WTA (or its designees):
    - (a) WTA Broadcast Office: Office space located within the TV compound that is at least 10 feet x 32 feet and includes at least two (2) desks, two (2) chairs, access to four (4) power outlets, access to a minimum 4 Mbps wireless internet connection via a router in the Broadcast Office, a configurable 32" multi-view HD monitor that can access the World Feed and Outside Court Feeds (including embedded audio), and one (1) international telephone line. The office space must be able to be securely locked.
    - (b) WTA Interview Studio: A room to be used as a post-match interview studio, which is conveniently located near the players' exit from the stadium court and the press room. The space should have good sound proofing from the crowd, plumbing, electrical and/or car noises, have easy access to power, and be able to be securely locked.
  - ii. In addition, in the event it is necessary to bring in an uplink truck for providing transmission service of the signal, the Tournament shall allocate space and power for this purpose at no cost to WTA (or its designees).
  - iii. Subject to space restraints and contractual restrictions and, except as this Section XVIII.F.h.iii otherwise states, at the cost of the WTA (or its designees), each Tournament shall provide any

## STANDARDS

### SECTION XVIII - TOURNAMENT STANDARDS OF PERFORMANCE

other production facilities and production space that the WTA (or its designees) deems necessary for production personnel and equipment used in connection with the broadcast of the Tournament (e.g., production trucks, satellite equipment, camera equipment, mobile units, tape units, switchers, microphones), including but not limited to the power required for use of such equipment; provided, however, that the WTA (or its designees) is responsible for the cost of power only to the extent that the WTA's (or its designees') power requirements exceed the greater of the industry-standard adequate power supply or an amount of power equivalent to the power supplied to the Host Broadcaster. The WTA (and its designees) must not be charged more than the Tournament's cost for all such production facilities (including power) and production space. The following outlines the standard production facilities and production space requirements:

- (a) **Transmission Office:** Office space within the TV compound, which is at least 10 feet x 15 feet and contains two (2) long work tables (approximately 6 feet x 3 feet), seven (7) chairs, access to four (4) power outlets, Host Broadcaster cabling of the Clean Feed (including back-up feed), a configurable 31" multi-view HD, two (2) cabled high-speed internet line connections, and access to a minimum 4 Mbps wireless internet connection via a router in the Transmission Office. The office space must be able to be securely locked. Where a fiber rack is the chosen method of delivery, WTA shall designate the location for the fiber rack, and two (2) 16 amp diverse single phase c-form connector power sources must also be available in the same location. Except for lighting, power (including the aforementioned c-form connector power sources), telephone, internet, and other utilities (each of which must be operational 24 hours per day), WTA (or its designees) is responsible for all costs of the Transmission Office.
- (b) **Newsfeed Production Office:** An office space located within the TV compound in close proximity to the Host Broadcaster truck to be used for recording match highlights, producing the newsfeed, and managing the distribution of the newsfeed globally. The office space should be at least 12 feet x 22 feet, contain at least three (3) long work tables (approximately 6 feet x 3 feet), two (2) desks, seven (7) chairs, two (2) cabled high speed internet lines, an international telephone line, four (4) power outlets, a TV monitor with multi-view, a "Matches in Progress" feed, and access to a minimum 4 Mbps wireless

## STANDARDS

### SECTION XVIII - TOURNAMENT STANDARDS OF PERFORMANCE

internet connection via a router in the Newsfeed Production Office. The office space must be able to be securely locked. Except for lighting, power, telephone, internet, and other utilities (each of which must be operational 24 hours per day), WTA (or its designees) is responsible for all costs of the Newsfeed Production Office.

In addition to the foregoing, the following internet connection must be provided to the following specifications for the Newsfeed Production Office:

- (i) Minimum 100 Mbps (Megabits per second) or greater upload speed.
- (ii) Dedicated connection for the sole use of delivering the newsfeed.
- (iii) Static public IP Address.
- (iv) Dedicated hardwired access point (not a wireless access point) CAT5 internet connection with RJ45 connectors to the workstation area.
- (v) Open connection without any logins, usernames, or passwords and direct internet access with no homepage or payment redirection features.
- (vi) Details of ISP or provider with support contact number and escalation process.
- (vii) If the connection provided is shared with the venue, the necessary upload must be segmented to guarantee the dedicated bandwidth for the stream.
- (viii) The connection type (e.g., Leased Line/EFM Circuit/SHDSL/Fiber/Microwave, etc.) must be communicated in the setup to determine the suitability of the connection for delivery of broadcast files.

For the purpose of testing and determining the optimum entry points, the public IP address (and/or subnet mask and/or gateway IP address) must be provided as soon as available but not later than 9:00 a.m. on the day of Qualifying Sign-In.

## STANDARDS

### SECTION XVIII - TOURNAMENT STANDARDS OF PERFORMANCE

- (c) Graphics Office: Office space within the TV compound that is at least 10 feet x 15 feet and contains two (2) long work tables (approximately 6 feet x 3 feet), three (3) chairs, access to four (4) power outlets, Host Broadcaster cabling of the Clean Feed, two (2) cabled high-speed internet line connections, and access to a minimum 4 Mbps wireless internet connection via a router in the Graphics Office. The office space must be able to be securely locked. Except for the lighting, power, telephone, internet, and other utilities (each of which must be operational 24 hours per day), WTA (or its designees) is responsible for all costs of the Graphics Office.
  
- (d) Court Production Office: At all Tournaments where the WTA (or its designees) is selected as the Tournament's production partner, the Tournament shall provide office space within the TV compound that is at least 10 feet x 23 feet and contains six (6) long work tables (approximately 6 feet x 3 feet), six (6) chairs, access to one (1) 32 amp single phase on c-form connectors, and six (6) domestic power outlets. The office space must be able to be securely locked. Where a fiber rack is the chosen method of delivery, WTA shall designate the location for the fiber rack, and two (2) 16 amp diverse single phase c-form connector power sources must also be available in the same location. The office must have access via a router to generic tournament wireless internet (minimum ten (10) Mbps upload speed). Except for lighting, power (including the aforementioned c-form connector power sources), telephone, internet, and other utilities (each of which must be operational 24 hours per day), WTA (or its designees) is responsible for all costs of the Court Production Office.
  
- (e) Additional Office Space: At all tournaments where the WTA (or its designees) is selected as the Tournament's production partner, the Tournament shall provide any additional office space that the WTA (or its designees) requests beyond the office spaces in Sections (a) through (d) above, but WTA (or its designees) shall pay the costs of such additional office space (excluding lighting, power, telephone, internet (including access to a minimum 4 Mbps wireless internet connection via a router in the Additional Office Space), and other utilities, each of which must be operational 24 hours per day).

## STANDARDS

### SECTION XVIII - TOURNAMENT STANDARDS OF PERFORMANCE

#### i. Utilities

- i. Each Tournament shall provide the WTA (and its designees) with access to, and the right to utilize, all existing lighting, power, and telephone systems servicing the site of the Tournament during the Tournament, including reasonable setup time before and reasonable tear down time after the Tournament.
- ii. All office spaces provided to the WTA (or its designees) in the TV compound shall have adequate air conditioning (a minimum of two (2) 4kW units per office space).
- iii. A Tournament shall be responsible for all utilities charges, except that the WTA (or its designees) shall be responsible for all long distance telephone service charges incurred by it.
- iv. Each Tournament shall provide WTA (and its designees) an introduction to, and contact details of, their internet (ISP) and/or fiber providers, and shall assure that WTA (or its designees) has access to preferred tournament rate card costs and adequate bandwidth to distribute Match footage.

#### j. Parking

Three (3) parking passes within the TV compound, or as close as possible to the TV compound if space within the compound is not available. WTA shall provide the names of individuals to which the parking passes will be assigned.

#### k. Equipment

- i. The WTA (and its designees) shall have the right to install, operate, maintain, and remove such platforms, cables, wires, equipment, and other apparatus as may be reasonably necessary for the broadcast of the Tournaments. In accordance with a Tournament's rights and obligations under its site agreement, a Tournament shall allow the WTA and its designees adequate "set up time" and "tear down time" for the installation, testing, and removal of all such platforms, cables, wires, equipment, and other apparatus.
- ii. Subject to applicable law and/or union regulations, the WTA (and its designees) shall designate the personnel who shall install, operate, maintain, and remove the equipment of the WTA (or its designees) at a Tournament.

## **STANDARDS**

### **SECTION XVIII - TOURNAMENT STANDARDS OF PERFORMANCE**

#### **I. Health and Safety**

Tournaments shall provide the following at their own cost:

- i. Fire extinguishers in all areas of the TV compound in which crew are working or equipment is stored;
- ii. Trackways/level surfaces suitable for cabins/trucks; and
- iii. Lighting for a safe environment.

#### **5. Broadcast and Ratings Information**

To the extent available, each Tournament shall provide the WTA with the ratings and broadcast schedule of the Host Broadcaster's broadcasts of the Produced Matches selected by the WTA (or its designees) for broadcast in the Domestic Area.

#### **6. Breach of Standards**

A Tournament's failure to meet any of the requirements in this Section XVIII.F is a breach of the Tournament Standards of Performance and subject to the procedures and sanctions in Section XVIII.A.49 of these Rules.

#### **G. CODE OF CONDUCT FOR OFFICIALS**

The WTA, the Grand Slam Tournaments, the ATP, and the ITF as members of the Joint Certification Programme require a high standard of professionalism from all Certified Officials (Green, White, Bronze, Silver, and Gold) and all other officials (together "Officials") working at ATP, Grand Slam, ITF, and WTA events.

For the complete ITF Code of Conduct for Officials, please reference [www.itftennis.com/en/growing-the-game/officiating/](http://www.itftennis.com/en/growing-the-game/officiating/).

# FINAL DISPUTE RESOLUTION

## **XIX. FINAL DISPUTE RESOLUTION**

### **A. GOVERNING LAW**

Any dispute between or among the WTA, WTA Tournaments, or WTA players (including, but not limited to, matters concerning the arbitrability of disputes) arising out of the application of any provision of this Rulebook (“Dispute”) shall be governed by the laws of the State of New York without reference to New York conflict of laws principles.

### **B. ARBITRATION**

1. Any Dispute (with the exception of any Dispute relating to or arising out of a change in Tournament Class Membership status) which is not finally resolved by applicable provisions of this Rulebook, shall be submitted exclusively to the American Arbitration Association (“AAA”) for final and binding arbitration before a single arbitrator in accordance with the Expedited Procedures of the AAA’s Commercial Arbitration Rules in effect on the date that a demand for arbitration is filed with the AAA. Any request for arbitration shall be filed with AAA within twenty-one (21) days of the action which is the subject of the dispute.
2. The parties shall select the arbitrator by mutual agreement from the AAA’s National Roster, provided, however, that if the parties are unable to agree, the arbitrator will be selected by the AAA according to its expedited procedures for the appointment of an arbitrator (Rule E-4).
3. The non-prevailing party will be responsible for paying the AAA’s administrative fees and the fees and expenses of the arbitrator. Each party will be individually responsible for its own costs and expenses, including its attorney’s fees.

### **C. CONFIDENTIALITY**

Except as required by law or other form of legal process, any proceedings related to a Dispute before the Code of Conduct Committee, Standards Committee, the Board of Directors, or an arbitrator, including any submissions and any written reasons for the decision, shall remain non-public and confidential. For the avoidance of doubt, the fact of the dispute and the outcome of the proceedings shall not be considered confidential information.



**FINAL DISPUTE RESOLUTION**  
**SECTION XIX - FINAL DISPUTE RESOLUTION**

**D. INVALIDITY**

In the event any provision of this Section is determined invalid or unenforceable, the remaining provisions shall not be affected. This Section shall not fail because any part of it is held invalid.

## APPENDIX A

### APPENDICES WTA CONTACT INFORMATION

#### WTA

**Steve Simon**

Chief Executive Officer & Chairman of the Board

**USA Headquarters**

100 Second Avenue South  
Suite 300N  
St. Petersburg, Florida 33701 USA  
+1 727 895 5000

**WTA Beijing**

Beijing, China

**WTA Shenzhen**

Shenzhen, China

#### WTA PLAYER CLASS BOARD REPRESENTATIVES

**Anja Vreg**

Player Class Director  
avreg@wtatennis.com

**Kurt Zumwalt**

Player Class Director  
kzumwalt@wtatennis.com

**Brandon Burke**

Player Class Alternate  
bburke@wtatennis.com

#### WTA TOURNAMENT CLASS BOARD REPRESENTATIVES

**Adam Barrett**

Tournament Class Director  
Tournament Council Chairperson  
abarrett@wtatennis.com

**Cameron Pearson**

Tournament Class Director  
cpearson@wtatennis.com

**Peter-Michael Reichel**

Tournament Class Director  
pmreichel@wtatennis.com

**Bob Moran**

Tournament Class Alternate  
bmoran@wtatennis.com

#### INTERNATIONAL TENNIS FEDERATION

**David Haggerty, President** (Federation Class Director)

david.haggerty@itftennis.com or dhaggerty@wtatennis.com

**Jackie Nesbitt, Senior Executive Director** (Federation Class Alternate)

jackie.nesbitt@itftennis.com or jnesbitt@wtatennis.com



## APPENDIX B

### WTA REPRESENTATIVES

The WTA may have representatives including, but not limited to, a Supervisor, PHCP, Massage Therapist, and Communications representative present at all times during a Tournament to ensure it is conducted pursuant to these Rules. The ITF Rules of Tennis will be enforced on site by the Supervisor with any modifications previously approved by the WTA.

#### 1. Supervisor

- a. The Supervisor has final authority on site. The Supervisor shall:
  - i. Know, understand, and be conversant with the ITF Rules of Tennis, the Rules and, in conjunction with or in the absence of the Referee, ensure they are observed, as well as enforce the Code of Conduct.
  - ii. Make the draws for all Tournaments in accordance with the Rules.
  - iii. Oversee the inspection of the facilities.
    - (a) All features of the facilities and the playing area, including lighting and the press facilities, shall be subject to inspection by the Supervisor and must be in operation by the morning of the commencement of Tournament play (which includes Qualifying).
    - (b) The approval of the Supervisor or the Referee shall be a condition precedent to commencement of play.
  - iv. In consultation with the Tournament Director, liaise on television issues and scheduling and draw up a daily order of play by arranging the first matches on various courts at a specified time and subsequent matches on a "followed by" basis.
  - v. In consultation with the Referee and the Tournament Director, determine the lowest tier of seats that surround the playing area at the courts in which spectators will be allowed to move freely during play.
  - vi. Determine and notify competitors of the conditions of play (number of balls, type of balls, type of surface, and other items of interest) prior to the commencement of the Tournament and/or Qualifying competition.

**APPENDIX B**  
**WTA REPRESENTATIVES**

- vii. Act as Practice Liaison. (See Section XVIII.A.33 - Practice Facilities.)
  - viii. Act as final arbiter in all on-site matters concerning the conduct of the Tournament, players, and staff and be available to assist where an on-court dispute develops.
  - ix. In conjunction with WTA Operations, notify the Tournament Director of changes to his or her player field for each Tournament.
- b. Whenever the Supervisor is not available for a particular WTA Tournament, the duties above will be assigned to the WTA Representative or the designated WTA Tournament Referee.

**2. Primary Health Care Provider/Massage Therapist**

- a. Primary Health Care Provider

The WTA will provide a Primary Health Care Provider (“PHCP”) for the Qualifying (including the Qualifying Sign-In day) and Main Draw singles and doubles of all Tournaments. The PHCP is a licensed Physical Therapist and Certified Athletic Trainer (or the international equivalent specializing in sports medicine).

The PHCP will provide on-site medical/health care services for the players beginning one (1) hour before match play each day until the completion of all matches, with the assistance of the local Tournament Physician.

Players are treated on a first-come, first-served basis, with priority given to players getting ready for matches. The PHCP and the local Physician will be available after hours for emergency care, throughout the Tournament.

- b. Massage Therapist

The WTA will provide one (1) or more licensed/certified (or international equivalent) and formally-trained Sports Massage Therapists for the Qualifying and Main Draws of all WTA 1000 Mandatory, WTA 500, and WTA 250 Tournaments.

At WTA 250 Tournaments not assigned a WTA Core Massage Therapist, the WTA will provide a licensed/certified (or international equivalent) and formally-trained local Sports Massage Therapist for the Qualifying and Main Draws.

## **APPENDIX B**

### **WTA REPRESENTATIVES**

All Massage Therapists must be available throughout match play each day to provide massage therapy services to the players on a daily sign-up basis. The Massage Therapist will be required to submit all treatment documentation to the Core Massage Therapist and PHCP or enter such evaluation and treatment documentation into a WTA online medical documentation system as directed by the Core Massage Therapist or PHCP. In either case, all such medical documentation must be in English and submitted or entered by the end of each Tournament.

### **3. Communications Manager**

The WTA will provide Communications staff for the Main Draw of all WTA 1000 Mandatory and WTA 500 Tournaments, as well as certain WTA 250 Tournaments.

#### **a. Pre-Tournament Responsibilities**

No later than six (6) weeks prior to the Tournament, the Communications Manager, in cooperation with the Supervisor, will be responsible for approving the Mandatory Party, Pro-Am, and Clinics, as well as the Draw Ceremony.

#### **b. On-Site Responsibilities**

On-site, the Communications staff shall:

- i. Escort players to post-match media activities;
- ii. Provide local media with information on the WTA and its players, including player bios, current rankings, and statistics;
- iii. Arrange one-on-one interviews;
- iv. Compile and distribute match notes;
- v. Send out results via email to the WTA's international distribution list; and
- vi. Coordinate player appearances at sponsor and Tournament functions as outlined under the ACES Program.

### **4. Player Relations**

The WTA will provide Player Relations staff at various Tournaments throughout the calendar year.

## **APPENDIX B**

### **WTA REPRESENTATIVES**

Player Relations staff serve as the on-site communications liaison with the players, educating them on the WTA, player, and administrative issues. Player Relations staff assist the Supervisor with on-site operations functions at the Tournaments and may serve as the player representative at the making of the draw when a player is unavailable to attend. Player Relations provide feedback from the players to the WTA administration and staff.

#### **5. Player Development Representative**

The WTA will provide Player Development staff at various Tournaments throughout the calendar year.

##### **a. Player Development Program Activities**

Player Development representatives serve as on-site facilitators of Player Development programs. These programs enhance the development of professional skills and educate WTA players and their Player Support Teams about all aspects of WTA life. Player Development representatives on-site provide guidance and assistance to all levels of players to enable them to develop professional skills and coping mechanisms so that they can fully participate in all their professional responsibilities.

Player Development programs include:

- i. The Age Eligibility Rule;
  - ii. Orientation Sessions for players and Player Support Team members (including, but not limited to, coaches, parents, and agents);
  - iii. Mentor/Protégé Functions;
  - iv. Media Training; and
  - v. Other On-site Educational Activities such as interactive seminars, WTBA Transitions Programs, and instructional training for players and Player Support Team members.
- b. On-Site Office Requirements**

If requested by the WTA, it is required that a private space, with a desk, lockable cabinet, three (3) chairs, a telephone line, and a high-speed internet connection be made available for Player Development

**APPENDIX B**  
**WTA REPRESENTATIVES**

staff members either near the WTA Office (e.g., a discreet corner area with positions in or near the Players' Lounge) or in or near the player treatment area. The Tournament shall be responsible for the cost of installing the telephone lines and internet connection.

Any such request will be made with a minimum of three (3) months' notice to the Tournament; specific locations will be recommended when possible.





## APPENDIX C

### MEMBERSHIP LEASE MANDATORY TERMS

#### WTA Requirements

- (a) **Subject to WTA Rules.** This Agreement shall be subject to WTA Rules in all respects. In the event of any conflict between the terms of this Agreement and the WTA Rules (as defined below) in effect from time to time, the WTA Rules shall govern and control in all respects. [Lessee] acknowledges that [Lessee] has carefully reviewed all of the terms and provisions of the WTA Rules and agrees that [Lessee] shall be subject to each of the obligations and requirements created thereunder with respect to [the Tournament]. [Lessee] further acknowledges and agrees that [Lessee] is not an intended third-party beneficiary of any WTA Rule and that the WTA shall owe no duty to [Lessee] in connection with this agreement or otherwise.

For purposes of this [Section / Attachment / Appendix], “WTA Rules” means the WTA By-Laws, the WTA Rulebook, all decisions, rulings and actions of the WTA Board of Directors (including by any authorized committee of the WTA Board of Directors), or the WTA CEO, with respect to matters in their respective jurisdictions, and any other agreements or arrangements to which the WTA shall be (or after the date hereof may become) bound, in each case, as they may be adopted, amended or modified from time to time.

- (b) **Amendments.** Any amendment or modification to this Agreement shall be subject to the WTA Rules and WTA's approval. Notwithstanding any option, right of first negotiation or refusal or other back-end right that a party may have hereunder, any extension or renewal of the terms of this Agreement and the exercise of any such option or right by any party is subject to subsequent and independent WTA approval, regardless of whether any such extension renewal or option is contemplated herein.
- (c) **Assignment.** Neither party to this Agreement may assign or otherwise transfer this Agreement, or any of its rights or obligations hereunder, without the prior written consent of the WTA. Further, any assignment or transfer by [Lessee] shall also require the prior written consent of [Member/Lessor], and if such consent is so provided, [Member/Lessor] shall promptly deliver a copy thereof to the WTA. In the event that this Agreement, or any right or obligation of either party hereunder, is assigned or transferred to any person or entity, [Member/Lessor] and [Lessee] acknowledge and agree that this [Section / Attachment / Appendix] shall be incorporated into the terms of any agreement consummating, effectuating or otherwise related to the assignment or transfer and attached thereto, and that any assignee or transferee shall be bound by all of the provisions in this [Section / Attachment / Appendix].

**APPENDIX C**  
**MEMBERSHIP LEASE MANDATORY TERMS**

- (d) **No Third-Party Beneficiary Rights.** [Lessee] agrees that it is not a third-party beneficiary of any agreement between or involving the WTA and [Member/Lessor] and that it has no rights as against the WTA.
- (e) **No Recourse Against WTA.** Each of [Lessee] and [Member/Lessor] acknowledges that it shall have no recourse against, and hereby covenants not to bring any claim against, the WTA, any of its members (other than [Member/Lessor]) or any of their respective Affiliates, members, owners, shareholders, partners, officers, directors, employees, agents or representatives as a result of any breach of this Agreement by any party hereto, [Lessee]'s operation of any aspect of the Tournament, or any other act or omission by any other party to this Agreement or, in the case of [Lessee], the WTA.
- (f) **Governing Law.** Without limiting the foregoing, the parties acknowledge and agree that any action or claim asserted against or by the WTA, any of its members (other than [Member/Lessor]) or any of their respective Affiliates, members, owners, shareholders, partners, officers, directors, employees, agents or representatives arising out of or in connection with this Agreement shall be governed by the internal laws of the State of New York applicable to agreements made and to be performed entirely in New York, notwithstanding any conflict of law doctrines of such state or other jurisdiction to the contrary.
- (g) **Arbitration.** To the extent notwithstanding the foregoing there arises any dispute or controversy under or in connection with this Agreement involving the WTA, it shall be settled exclusively by arbitration, conducted before a single arbitrator in New York City, New York, in accordance with the Commercial Arbitration Rules of the American Arbitration Association then in effect (unless otherwise provided in the WTA Rulebook (as amended or updated from time to time)). The decision of the arbitrator will be final and binding upon the parties hereto. Any action that seeks injunctive or other equitable relief or confirmation of an award rendered in an arbitration involving the WTA may only be brought by suit, action or proceeding before any federal or state court located in New York, New York, and each party hereby submits to the jurisdiction of such courts for the purpose of any such suit, action or proceeding and agrees that New York, New York is the proper venue for such action or proceedings.

## APPENDIX D

### WTA BETTING, FANTASY & GAMBLING SPONSORSHIP RULES

Modified as of January 17, 2023

WTA tournaments may enter sponsorship agreements with a Tennis Betting Operator or Tennis Betting Brand (a “Betting Sponsor”) subject to the terms and conditions stated below and the WTA rules applicable to all tournament sponsorships.

If a betting, casino, lottery or fantasy sport-branded company is not a Tennis Betting Operator but the proposed sponsorship will promote a Tennis Betting Brand, these rules shall apply to the sponsorship.

If a betting, casino, lottery or fantasy sport-branded company is not a Tennis Betting Operator and the proposed sponsorship will not promote a Tennis Betting Brand, these rules shall not apply to the sponsorship except that WTA approval shall still be required and Tournament Support Personnel shall still comply with the TACP (as defined below). If, during the term of the sponsorship, the company becomes a Tennis Betting Operator or the sponsorship will promote a Tennis Betting Brand, the sponsorship must comply with these rules.

Combined and back-to-back tournaments with a Betting Sponsor must also comply with the ATP Fantasy Sport and Betting Sponsorship Rules with respect to their men’s events; if there is a discrepancy between these rules and the ATP rules, the more stringent rule must be followed with respect to the women’s event, including payment of an equivalent percentage of the sponsor fee (based on gross revenue) to WTA as a contribution toward initiatives aimed at addressing harms associated with sports betting such as the social media abuse of players and problem gambling. Pre-existing, multi-year agreements with Betting Sponsors that received WTA approval in 2021 shall be grandfathered in connection with this provision but only for the original term approved by WTA.

The ITIA will be assessing whether agreements with Betting Sponsors have any negative effects on the integrity of the sport. As a result, agreements between WTA tournaments and Betting Sponsors shall not extend beyond December 31, 2026.

Please contact Courtney McBride if you have any questions (cmcbride@wtatennis.com).

#### A. Defined Terms

“ITIA” refers to the International Tennis Integrity Agency.

“Player Support Team Member” includes any coach, trainer, therapist,

**APPENDIX D**  
**WTA BETTING, FANTASY & GAMBLING SPONSORSHIP RULES**

physician, management representative, agent, family member, tournament guest, or other affiliate or associate of any WTA player.

“TACP” refers to this Tennis Anti-Corruption Program located at <https://www.itia.tennis/tacp/>.

“Tennis Betting Brand” refers to the name, symbol, logo, design or other mark (i) of a Tennis Betting Operator or a Tennis Betting product or service, or (ii) that, in the ITIA’s discretion, is confusingly similar to the public comparison to the name, symbol, logo, design or other mark of a Tennis Betting Operator or a Tennis Betting product or service.

“Tennis Betting Operator” refers to any entity that directly offers and/or accepts Tennis Betting, including, without limitation, bookmakers and any person or entity who operates websites, applications, retail, credit, telephone, online and/or mobile Tennis Betting services; casinos operating sports books with Tennis Betting; and lotteries operating sports books with Tennis Betting.

“Tennis Betting” refers to placing a Wager in connection with the outcome or any other aspect of any tennis competition. “Tennis Betting” expressly excludes all of the following to the extent that they do not involve a Wager: fantasy sports, prize or prediction competitions, sweepstakes, console, computer, online, social, social media or mobile games or applications.

“Tournament Support Personnel” includes any tournament director, official, owner, operator, employee, agent, contractor or any similarly situated person.

“Wager” refers to any arrangement involving a real money stake or financial risk (which includes, without limitation, hard and digital currencies) and/or any other form of financial speculation on the outcome of an unpredictable event.

**B. Approval Process**

Tournaments must apply to and secure written approval from WTA prior to entering into an agreement with a gambling sponsor of any nature.

Tournaments must disclose to WTA ([cmcbride@wtatennis.com](mailto:cmcbride@wtatennis.com)) the proposed sponsorship benefits, activations, links to tennis wagering, and compensation structure (subject to limited redactions as needed to protect financially sensitive information, if any). Tournaments must assist WTA’s due diligence process.

WTA approval may be given, withheld or conditioned. Conditions to

**APPENDIX D**  
**WTA BETTING, FANTASY & GAMBLING SPONSORSHIP RULES**

approval may include, without limitation, (i) the agreement containing mandatory terms, and (ii) any other condition to ensure that the agreement is in compliance with these rules.

Renewal / extension / material amendment of an agreement requires notification to, and pre-approval of, WTA.

**C. Compliance with the TACP - Tournament Support Personnel**

The TACP currently provides that no Tournament Support Personnel shall, directly or indirectly, facilitate, encourage and/or promote Tennis Betting. Examples of prohibited activities can be found in the footnote to Section D.1.b of the 2023 TACP.

Actions by Tournament Support Personnel which are taken not in an individual capacity but solely in furtherance of and/or pursuant to a Tournament's WTA-approved agreement with a Betting Sponsor shall not be deemed to violate the TACP.

**D. Prohibited and Permitted Sponsorship Activities and Benefits**

Tournaments with Betting Sponsors must comply with the following:

- 1) No Betting Sponsor as title and/or presenting sponsor of a tournament;
- 2) No naming rights to player areas, including the players' lounge, locker room, and player services/welcome desk;
- 3) No player/Player Support Team Member/official activation of any nature, this includes:
  - No appearances at a Betting Sponsor information booth or box;
  - No autograph sessions;
  - No wearing or otherwise publicly displaying Betting Sponsor logos or brand images on or off court;
  - No attending events hosted by a Betting Sponsor;
  - No attending or participating in events sponsored by or involving only the Betting Sponsor;
  - No grant of rights to a Betting Sponsor to use player/Player Support Team Member/official names, images, likenesses or marks (including still images and match and non-match footage) in any manner that suggests or implies that a Betting Sponsor

**APPENDIX D**  
**WTA BETTING, FANTASY & GAMBLING SPONSORSHIP RULES**

is a sponsor or has a direct or indirect relationship with such individual or that such individual endorses or has any relationship with the Betting Sponsor;

- No social media posts by player/Player Support Team Member/official mentioning the Betting Sponsor or linking to the Betting Sponsor's website or digital platforms;
  - No Betting Sponsor promotions offering player-autographed items in connection with the Tournament;
  - No provision of gear or merchandise with Betting Sponsor logos or branding for use on or off the court (e.g., towels, water bottles, tape);
  - No provision of hospitality or gifts, free or subsidized travel, or any other personal benefit to a player/Player Support Team Member/official from the Betting Sponsor; and
  - No provision of Betting Sponsor informational or promotional materials to players/Player Support Team Member/officials/Tournament Support Personnel;
- 4) No use of identifiable player/Player Support Team Member/official images in Tournament advertisements/collateral/social media content that includes only the branding of the Betting Sponsor (Note: WTA can provide examples of permitted images and footage such as ball bouncing, toss, and racquet or an unrecognizable player as determined by WTA);
  - 5) No Betting Sponsor logo or brand images on chair umpire or line umpire clothing;
  - 6) No direct linking from a Tournament digital or social media platform to a Betting Sponsor website page or app where a Wager on tennis can be placed (i.e., two (2) clicks);
  - 7) No displaying live odds for matches on a Tournament digital or social media platform (excluding in a simultaneous live match stream broadcast shown on such platform);
  - 8) No offering or accepting tennis wagers on any Tournament digital or social media platform or otherwise;
  - 9) No displaying live odds for tennis matches on-site at a Tournament (does not apply to display of local television broadcast);

**APPENDIX D**  
**WTA BETTING, FANTASY & GAMBLING SPONSORSHIP RULES**

- 10) No, directly or through a third party, offering and accepting in-person tennis wagers on-site or at any official Tournament-related event (e.g., at a booth or party);
- 11) No in-person tennis wagering available at official player hotels;
- 12) Betting Sponsor on-court signage:
  - No signage or banners on or in the immediate physical vicinity of the chair umpire or line umpire chair (see attached diagram);
  - No signage or banners on or in the immediate physical vicinity of the player benches (see attached diagram);
  - No ads on videoboards when players are on court warming up or when playing (excluding changeovers and set breaks);
  - Betting Sponsor logo cannot be the only logo/mark on backwall signage;
  - Betting Sponsor logo may be placed on the shot clock and serve speed box subject to the restrictions in the attached diagram;
  - No more than 40% of total on-court fixed signage (excluding LED) or 40% of total display time; and
  - No signage or banners on the player entrance arch;
- 13) No Betting Sponsor “call to action” advertising (in-stadia, on-site or on Tournament social media or digital platforms) that encourages placing Wagers on tennis or opening a sports betting account (e.g., go to website and place a bet now);
- 14) Betting Sponsor may have informational booth in vendor area, which may include information on downloading the sponsor’s app but should not directly encourage placing of bets or promote a Betting Sponsor website URL;
- 15) Credentials for Betting Sponsor representatives limited to non-player restricted areas (i.e., no access to player lounge or locker room; access to player restaurant and press conferences permitted if accompanied by Tournament staff);
- 16) Betting Sponsor representatives may not participate in or be privy to non-public information pertaining to the making of Tournament draws, including the naming of Tournament Wild Cards;



**APPENDIX D**  
**WTA BETTING, FANTASY & GAMBLING SPONSORSHIP RULES**

- 17) Betting Sponsor and Tournament advertising in and on broadcast (and shoulder programming) must comply with WTA Rules and broadcast and local restrictions (i.e., in the event a territory does not allow the broadcast to be shown due to a ban on sports betting advertising, the Tournament should have the right to opt out of such sponsorship agreement);
- 18) Betting Sponsor logo on media backdrops must be the same size as and appear no more frequently than other logos on the backdrop, and must be dispersed throughout the backdrop; and
- 19) Betting Sponsors may only use the WTA logo in advertisements when using the WTA-Tournament lockup logo, provided that (i) the lockup logo may not be used with the image of an identifiable tennis player (regardless of whether the individual in the image competes on the WTA Tour) and (ii) upon request, application of the lockup logo is submitted for WTA review and approval.

**E. Tournament Requirements**

Tournaments with Betting Sponsors must comply with the following:

- 1) No Tournament shall receive compensation linked to the sponsorship from the Betting Sponsor based upon revenue or betting volume of their event;
- 2) Tournament Support Personnel who regularly have direct contact with players and/or are privy to non-public information about players must complete the Tennis Integrity Protection Programme (the "TIPP"). Such staff likely includes, but is not limited to, the Credentials Coordinator, Accommodation Coordinator, IT Coordinator, Head of Security, Media Director, Player Desk Staff and Massage Therapists; and
- 3) Tournaments shall discuss in good faith with the WTA how to promote responsible gambling (in-stadia, on-site or on tournament digital platforms).

**F. Repute and Integrity of Betting Sponsors**

In order to assure the quality of the Betting Sponsors, Tournaments with Betting Sponsors must comply with the following requirements:

- 1) Betting Sponsor must purchase official live WTA scores from WTA's authorized partner (<https://www.statsperform.com/wta/>) or an authorized reseller, or only utilize delayed WTA scores;

**APPENDIX D**  
**WTA BETTING, FANTASY & GAMBLING SPONSORSHIP RULES**

- 2) Only betting exchanges that also offer sportsbook betting are permitted as a Betting Sponsor;
- 3) Betting Sponsor must be registered/licensed by appropriate legal authority in the territories it offers betting;
- 4) Betting Sponsor must employ industry standard measures (e.g. geo-gating and age-restrictions) to prevent unauthorized users from engaging in unlawful sports wagering for the term of the sponsorship;
- 5) No targeting minors;
- 6) Betting Sponsor shall not be:
  - entities engaged in the collection, publication or other exploitation of material that would reasonably be expected to have a material adverse effect on tennis integrity (as determined by WTA);
  - currently the subject of an investigation or proceeding for betting-related corruption or betting-related criminal offense or any other materially significant betting integrity-related investigation brought by the ITIA or any relevant betting-integrity, governmental, regulatory or gaming authority;
  - currently an adverse party in litigation or arbitration involving WTA or any of WTA events in respect of unofficial data or betting;
  - currently the subject of legal proceedings brought by any of the seven (7) major tennis stakeholders in respect of any unauthorized in-stadium collection or exploitation of unofficial data;
  - entities that have been convicted of betting-related corruption, betting-related criminal offense by the ITIA or any relevant betting-integrity, governmental, regulatory or gaming authority within the prior three (3) years; and
  - entities that have a current sanction from any relevant betting-integrity related, governmental, regulatory or gaming authority as to a material violation or series of violations that could reasonably be expected to call the applicable entity's betting-related integrity into question;
- 7) Betting Sponsor must agree to cooperate and coordinate with WTA, WTA's official data partner, and the ITIA with respect to any suspicious betting patterns or other integrity-related issues, and

## **APPENDIX D**

### **WTA BETTING, FANTASY & GAMBLING SPONSORSHIP RULES**

must make available to the ITIA any betting-related information that the ITIA reasonably requests and have an MOU with the ITIA (if requested);

- 8) Betting Sponsor must agree to comply with these rules; and
- 9) Agreement must include a termination right if (a) the Betting Sponsor's license in the Tournament's domestic market is lost or suspended, (b) the Betting Sponsor is no longer in compliance with applicable laws and regulations (including advertising), (c) the Betting Sponsor violates these rules, (d) the Betting Sponsor combines unofficial WTA data with official WTA data, (e) the Betting Sponsor fails to reasonably cooperate with any integrity-related ITIA requests or ITIA investigations, and (f) the WTA rules change prohibiting sponsorships in this category.

# APPENDIX D

## WTA BETTING, FANTASY & GAMBLING SPONSORSHIP RULES

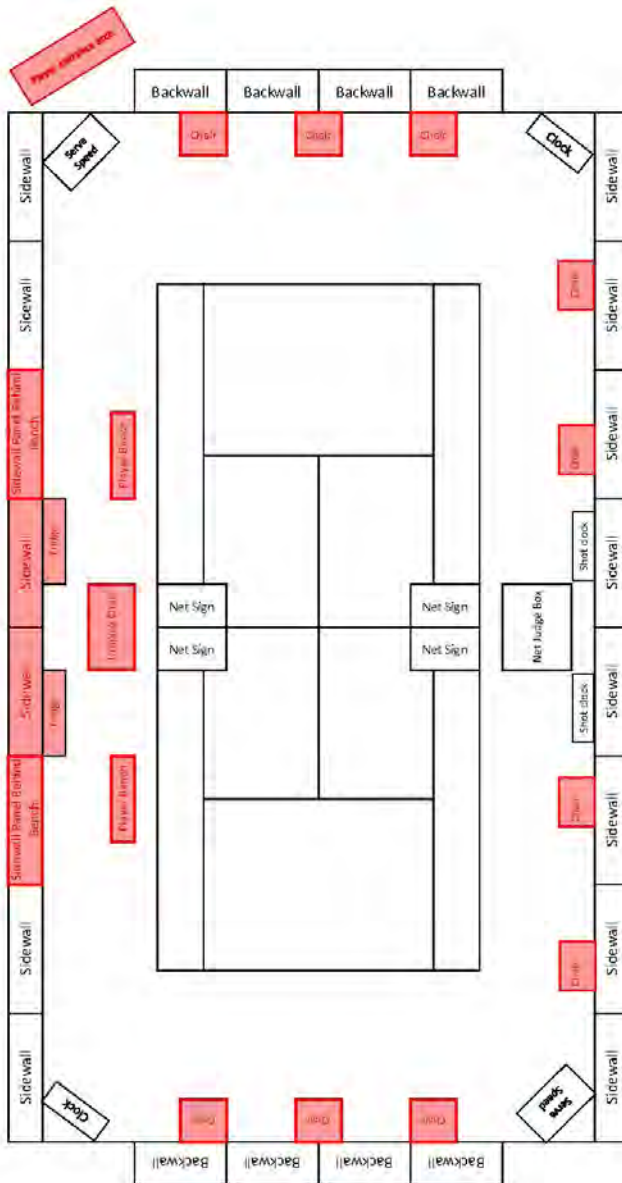



## APPENDIX E

### WTA 125 TOURNAMENT STANDARDS OF PERFORMANCE

#### A. WTA 125 TOURNAMENT STANDARDS OF PERFORMANCE

All WTA Tournaments must be staged in a first-class professional manner. Standards are required unless otherwise noted or approved. Tournaments must apply to the WTA at least three (3) months in advance for an exemption from any Tournament Standard of Performance.

No experimental procedures or products can be used or offered to the players without prior written approval from the WTA. All procedures and products must be in compliance with the Rules.

Unless otherwise noted, all facilities and standards required hereunder must be ready by 9:00 a.m. on the day of Qualifying Sign-In.

Any Tournament that is combined with an ATP event of any level or back-to-back with an ATP event of an equal level shall provide a level of Tournament Standards that is equal to or greater than the level of Tournament Standards provided for at its ATP event; however, in no instance shall such Standards fall below the minimum required herein.

#### 1. Accounting

Within fourteen (14) days following the conclusion of the Tournament, the Tournament shall submit to the WTA a full report of all aspects of the Tournament including: a) a copy of the prospectus; b) a completed program; and c) a statement showing all monies disbursed on site for prize money and traveling expenses as allowed under Section IX - Prize Money.

#### 2. Animals

No animals will be allowed in the Player Restaurant, Locker Room, Treatment/ Training Room, or WTA Office. Animals on site must be restrained (either by leash or carry case). Facility rules regarding animals on site shall be enforced.

#### 3. Anti-Doping Testing Facilities and On-Site Personnel Assistance

##### a. On-Site Doping Control Station

Each Tournament, when selected to host testing of players, is obligated to provide, at its own cost, the facilities in Appendix N.

**APPENDIX E**  
**WTA 125 TOURNAMENT STANDARDS OF PERFORMANCE**

b. Chaperones Provided by the Tournament

Each Tournament, when selected to host testing of players, is obligated to provide, at its own cost, adult female staff members and/or volunteers who can assist the Official Anti-Doping Personnel and Supervisor with the notification and observation of players selected for testing. The Tournament shall be notified of the chaperone schedule at least seven (7) days prior to the start of the Tournament.

**4. Ball Persons**

It is recommended that a coordinator be appointed to recruit and assign Ball Persons. There shall be a minimum of three (3) ball persons per match in the Main Draw and Qualifying. Ball persons may not wear any predominantly white, yellow, or other light color clothing that may interfere with the players' vision, unless otherwise approved by the WTA. Ball persons' uniforms should not be identical to the Line Umpires' uniforms.

**5. Balls**

a. Ball Type and Specifications

i. ITF-approved Type 2 Regular Duty balls from the WTA approved ball list are to be used at all WTA Tournaments unless otherwise approved by the WTA. At least twelve (12) weeks prior to the start of its Main Draw, each Tournament must confirm with the WTA the ball it intends to use. Failure to comply may result in a Tournament Standards Violation and/or other sanctions.

High-altitude balls are not to be used unless conditions require, and such use must be approved by the WTA and must be stated on the Tournament Fact Sheet.

ii. WTA Tournaments which are played the week before a Grand Slam are required to use the same ball (brand and commercial denomination) as that Grand Slam.

iii. Pressurized balls only will be used on the WTA.

iv. WTA reserves the right to determine the tennis ball brand and model to be used and will notify Promoter at least 12 weeks prior to the Main Draw of the Tournament if exercising such right. Any tennis ball manufacturer designated by WTA will not be entitled to any sponsorship or other benefits at the Tournament unless otherwise agreed to by Promoter.

**APPENDIX E**  
**WTA 125 TOURNAMENT STANDARDS OF PERFORMANCE**

- v. If Promoter enters into an agreement with a sponsor company that manufactures tennis balls prior to the 12 week-deadline, the sponsorship agreement must incorporate WTA's right to provide the tennis balls to be used in practice and competition at the Tournament, which balls, where possible, will be unbranded.
- vi. If a Tournament or manufacturer wants approval to use a ball not currently on the List, the ball must first go through the WTA's ball testing process. A ball that successfully passes the ball testing process will be approved for use and included on the List immediately.

b. Number and Procedure for Rotation during All Match Play

At all Tournaments for all matches in both Qualifying Singles and Main Draw singles and doubles, six (6) balls shall be used and changed after the first seven (7) games and thereafter every nine (9) games.

c. Availability

Balls of the make to be used in the Tournament are to be available on site at least three (3) days prior to the commencement of the Qualifying for players in both the Main Draw and Qualifying until they are eliminated. Prior to the Qualifying Sign-In, players shall be required to purchase the balls. Beginning on the day of the Qualifying Sign-In, players are entitled to receive the complimentary daily allocation of practice balls in accordance with sub-Section d below.

d. Daily Allotted Number of Practice Balls

Main Draw and Qualifying players are entitled to practice balls as set out in the following chart:

Tournament Category	Player Daily Allotment of Practice Balls	
	While Competing in Tournament	After Elimination
WTA 125	6 new	3 used

If the practice courts are located off site, it is recommended that practice balls be provided at the practice site.



**APPENDIX E**  
**WTA 125 TOURNAMENT STANDARDS OF PERFORMANCE**

**6. Betting Sponsorships**

Tournaments must comply with the WTA Betting, Fantasy & Gambling Sponsorship Rules. (See Appendix D.)

**7. Chairs/Umbrellas**

Chairs must be provided on court for player use during the change of ends. At outdoor Tournaments, umbrellas must be provided to shade the players' chairs.

**8. Cleaning**

- a. Tournaments must retain a dedicated cleaning staff that is trained and provided the equipment necessary to clean, disinfect, and sanitize Tournament facilities in accordance with local health regulations.
- b. Procedures must be in place for cleaning and disinfecting equipment, training fixtures, uniforms, and high-traffic and high-contact areas, particularly following use.
- c. Procedures must be tailored to the specific needs and challenges of cleaning, disinfecting, sanitizing, and ventilating each unique Tournament area.
- d. Locker rooms, dining facilities, and healthcare-related areas of the Tournament facilities must be cleaned and disinfected regularly throughout each day of the Tournament. The floors of locker rooms and all healthcare-related areas must be cleaned at least each night after completion of treatments and before they are open for use the following day.

**9. Court**

- a. Court Specifications
  - i. Court Surface
    - (a) Tournaments must be played on a surface that is approved by the WTA, including, but not limited to, the color of the court surface. Tournaments must submit a written request for approval to the WTA prior to making any changes to the existing surface and pay the cost of any testing deemed necessary by the WTA.

## APPENDIX E

### WTA 125 TOURNAMENT STANDARDS OF PERFORMANCE

- (b) If a new surface is being considered, approval must be given by the WTA. If the Tournament fails to utilize the surface recommended by the WTA, individual players may refuse to participate in the Tournament, in which case the WTA neither is responsible for such action by a player nor subject to any penalties.
  - (c) The surface must be maintained to the satisfaction of the Supervisor/Referee.
  - (d) Tournaments must ensure that the same surface is used for Main Draw and Qualifying. If there are circumstances beyond the control of the Tournament Director, Qualifying matches may be held on a different surface, only with approval of the WTA. All practice courts, with a minimum of one (1) on site, must be of the same surface and condition (i.e., indoor/outdoor) as the Main Draw match court(s). (See the chart in sub-Section b below for practice court requirements.)
  - (e) Unless otherwise approved by the WTA, outdoor courts shall be laid out with the long axis north and south; geographic considerations may modify this orientation in order to minimize the adverse effect of serving into the sun.
- ii. Court Measurements
- (a) There must be at least 12 feet (or 3.66 meters) at each side of the doubles sideline and 21 feet (or 6.40 meters) behind each baseline. (This does not include the publicity/advertising placed around the line umpires' chairs). It is recommended that show courts have 15 feet (4.57 meters) at each side of the doubles sideline and 27 feet (8.23 meters) behind each baseline. At indoor Tournaments, the ceiling must be a minimum of 30 feet (or 9.14 meters) in height.
  - (b) Court Dimensions must comply with those set out under the ITF Rules of Tennis. It is the responsibility of the Tournament Director to ensure, upon final preparation of the tennis courts before the Tournament commences, that all court specifications, including court measurements, comply with the standards set forth in Appendix J – Court and Light Measurements. All court measurements shall be made to the outside of the lines and all lines of the court shall be white.

**APPENDIX E**  
**WTA 125 TOURNAMENT STANDARDS OF PERFORMANCE**

b. Minimum Numbers of Match and Practice Courts

i. Combined Tournaments with the ATP

At combined Tournaments with 48 Draws, the minimum number of match courts is seven (7). The minimum numbers of match and practice courts must be approved by the WTA at least six (6) months prior to the Tournament.

ii. Indoor Tournament

<b>Draw Size</b>	<b>Show Courts</b>	<b>Additional Match Courts</b>	<b>Practice Courts (on-site and off-site)</b>	<b>On-Site Practice Courts</b>
WTA 125 (48)	1	2	3	1
WTA 125 (32)	1	1	2	1

iii. Outdoor Tournament

<b>Tournament Category</b>	<b>Show Courts</b>	<b>Additional Match Courts</b>	<b>Practice Courts (on-site and off-site)</b>	<b>On-Site Practice Courts</b>
WTA 125 (48)	1	3	3	1
WTA 125 (32)	1	2	2 (3 recommended)	1

iv. Availability

For hard and clay court Tournaments, practice courts must be available for use for practice by 8:00 a.m. the day prior to Qualifying Sign-In, and match courts must be available for use for practice by 8:00 a.m. the day of Qualifying Sign-In. For grass court Tournaments, practice courts must be available for use for practice by 10:00 a.m. the day prior to Qualifying Sign-In, and match courts must be available for use for practice by 10:00 a.m. the day of Qualifying Sign-In.

c. Court Signage

i. On the Court Surface

- (a) There can be no commercial identification on the surface of the court, except that the name of the court manufacturer and the Tournament's host locality (as further described

## **APPENDIX E**

### **WTA 125 TOURNAMENT STANDARDS OF PERFORMANCE**

below) are permitted to be placed on the court surface with prior approval from the WTA. A Tournament must request WTA approval for the placement of the WTA Logo and host locality signage and/ or court manufacturer identification and provide full details of all signage (text and placement) to the WTA at least ninety (90) days prior to the event.

- (b) Tournaments may place on court the name of their host locality, which may include one (1) of the following: city, region (i.e., state or county), or country subject to the placement and size restrictions set forth below. The preferred font is Din Condensed, but tournaments may use the official logo or font of the host country, city, or region with the prior approval of the WTA. Signage must be consistent with the texture and feel of the court surface so as not to affect play or pose a safety hazard.

The position, size, and font of the host locality signage shall be in accordance with one (1) of the following two (2) options; and, in either case, the Tournament must include the WTA Logo as specified below:

#### **HOST LOCALITY NAME OPTION 1: BASE LINE OPTION (not applicable to clay court tournaments)**

- Upper case in white
- Displayed on one (1) line facing the main camera
- Written on one (1) or both ends of the court behind the baseline
- Centered between the singles sidelines
- Nearest distance from the baseline: 3 m/9.85 feet
- Height of lettering: Not greater than 80 cm/31.5 inches (50 cm/19.7 inches at combined events)
- Width: No restriction

#### **HOST LOCALITY NAME OPTION 2: SIDELINE OPTION**

- Upper case in white
- Displayed on one (1) or two (2) lines, facing the main camera
- Written on the right and/or left side of the court at the service line for hard or grass courts or centered between the net post and the service line for hard, grass, or clay courts, outside of the doubles sidelines. If the text is

## APPENDIX E

### WTA 125 TOURNAMENT STANDARDS OF PERFORMANCE

displayed on two (2) lines, they should together be centered on the service line (line spacing should be 20 cm/7.9 inches).

- Height of lettering: Not greater than 50 cm/19.7 inches (40 cm/16 inches at combined events)
- Distance from the doubles sideline: minimum of 40 cm/16 inches (maximum of 40 cm/16 inches at combined events)
- Width: No restriction
- The text should be elongated by 27% for improved television visibility.
- If used on a clay surface, the text must not protrude above the surface of the court.

#### WTA LOGO (FOR OPTIONS 1 AND 2)

- Placement:
  - (i) One (1) WTA Logo painted on the court, at least 40 cm/16 inches outside of the doubles sidelines half way between the net and the service line, on the side of and facing the main camera; or
  - (ii) WTA Logos in at least two (2) corners of the backdrops, with a minimum of one (1) on the backdrop facing the main camera and one (1) in side camera view;\* or
  - (iii) At least two (2) WTA Logos in a position immediately above and behind the backdrops with a minimum of one (1) on the end facing the main camera and one (1) in side camera view;\* or
  - (iv) Any other position proposed by the Tournament and agreed by the WTA.
- Logo Dimensions if Painted on the Court: At least 44.2 cm (17.4 inches) x 94 cm (37 inches)
- Logo Dimensions if on or Behind Backdrop: At least 29 cm (11.4 inches) x 37.7 cm (14.84 inches)
- Artwork: WTA Logo; same application as for backdrop/sidewall signage with a dark background
- Combined and Back-to-Back Events: WTA Logo must be at least the same visual size as the ATP logo (i.e., cover the same surface area)

\*The WTA may substitute the WTA Logo positioned on the back fence with 3-D signage placed on-court as a mat where the Net Umpire chair surrounding is normally placed.

**APPENDIX E**  
**WTA 125 TOURNAMENT STANDARDS OF PERFORMANCE**

- (c) Two (2) identifications of the court manufacturer (maximum 20.13 square feet/1.87 square meters) may be permitted on the side of the court surface parallel to the sidelines. Such logo must be placed at least 1.5 meters (4.92 feet) from the doubles sideline. If used on a clay surface, the text must not protrude above the surface of the court.

(See examples in Appendix I – On-Court Signage.)

- ii. Behind the Court

The back fences, back walls, net, net posts, line umpire boxes, and other fixtures on a court shall not be predominantly white, gray, yellow, or any other light color that can interfere with the vision of the players as determined by the Supervisor.

- iii. Banners

There can be no banners with predominantly white, gray, yellow, or any other light color backgrounds behind the ends of the court. Background and lettering on rotating/LED banners should be consistent with the color of the back walls. If placed in front of back walls, rotating/LED banners can change only after completion of any game. If placed in front of side walls, rotating banners can change between any point. In either case, banners must not change once a player is ready to serve.

When lighter lettering needs to be used on a darker background, PMS Color “Cool Gray” 4 to 6 (5 to 6 for outdoor tournaments) are the preferred colors. No colors can be used that interfere with the vision of the players as determined by the Supervisor.

Banners must comply with the WTA Betting, Fantasy & Gambling Sponsorship Rules. (See Appendix D.)

- d. Court Preparation

Clay and loose surface courts must be swept, watered, and lines cleared before the start of all matches, if the Supervisor or Referee deems it necessary. Clay courts also may need to be watered and/or swept between sets if requested by the Supervisor or Referee.

**APPENDIX E**  
**WTA 125 TOURNAMENT STANDARDS OF PERFORMANCE**

e. Seating

i. Color of Box Seats and Seats at Ends of the Court

It is recommended that spectator seating not have any white, gray, yellow, or other light colors that can interfere with the vision of the players and that any such light colored seating be covered.

ii. Spectator Movement During Play

Spectators above the lowest tier of seating will be allowed to move freely to and from their seats at any time during play.

The Tournament Director and Supervisor at each Tournament will determine this lowest tier of seating. Where there is no clear break, the Tournament Director and Supervisor will determine the most logical designation for spectator movement during play. (See Appendix B.1 - Supervisor.)

f. Smoking

Except where prohibited by law, smoking shall not be permitted within the lower level of seating around the courts and in all restricted player areas as well as the WTA and Officials' offices.

**10. Credentials/Tickets/Seating**

In addition to the ticket allocation requirement as part of the Commercial Benefits granted to the WTA/sponsor (see Section XIII.B.10 - Seats/Tickets) and the WTA Television Broadcast Standards requirements (see Section XVIII.F.4 - Tournament Facilities), each Tournament will provide the following:

a. Players, Coaches, Guest, and WTA Staff

i. Each Participating Player:

(a) One (1) credential;

(b) Two (2) player guest/coaches credentials; and

(c) Two (2) tickets for each day for which the player remains in the Tournament.

**APPENDIX E**  
**WTA 125 TOURNAMENT STANDARDS OF PERFORMANCE**

A designated seating area in the grandstand for players and players' coaches, relatives, or guests to sit and watch matches also must be provided at all sessions. Best efforts should be made for a minimum of ten (10) seats. This reserved seating area shall be in addition to the match box seats.

Player credentials shall be valid through the end of the Tournament. Player guest/coach credentials shall be valid as long as the player remains at the Tournament.

- ii. Each WTA staff member, massage therapist, WTA sponsor: One (1) credential.
  - iii. Any official guest of the WTA: One (1) credential, at WTA's request (provided such requests are reasonable and access limited as appropriate for security).
  - iv. WTA: Ten (10) tickets per session in a preferred location (need to be box seats or best available after box seats).
  - v. WTA player members not in the Tournament: On-site access is allowed, but such players are not permitted to use the site amenities and practice facilities without the Tournament Director's permission.
  - vi. Each WTA Tournament Director: On-site access to all WTA Tournaments.
  - vii. At WTA/ATP combined events, WTA alumnae players: One (1) credential each, at the Tournament's discretion.
- b. Match Court Seats
- i. A match box shall be provided to the guests of each player participating in the scheduled match. The boxes should offer identical views, have a minimum of six (6) seats, and be of equal position and size to each other but located at opposite ends of the court near the baseline or the back of the court on the same end as the player's seat to accommodate Off-Court Coaching.
  - ii. To the Referee, Supervisor, PHCP, and Tournament Physician: One (1) seat each close to the entrance of each court during all matches with easy access to the court.



**APPENDIX E**  
**WTA 125 TOURNAMENT STANDARDS OF PERFORMANCE**

Each person granted a credential to access secure player areas (other than participating players who receive a credential pursuant to Appendix E Section A.10.a.i(a)) must comply with WTA’s credentialing requirements. Tournaments must implement and comply with credentialing requirements established by the WTA.

The following table summarizes the above requirements for credentials, tickets, and seating:

<b>Group Designation</b>	<b>Credentials</b>	<b>Tickets/Seats</b>
WTA Players	1 player badge and 2 guest/coach badges	2 each day while competing
WTA Staff <sup>^</sup>	1 per staff member and local massage therapist	3 seats by court entrance with easy access to the court
WTA	1 credential for any official guest	10 tickets per session in a preferred location
WTA Sponsor	1 per sponsor	n/a
WTA Members	On-site access	n/a
WTA Tournament Directors	On-site access	n/a

<sup>^</sup> The seats near the court entrance shall be designated for the Referee, Supervisor, PHCP, and Tournament Physician for all matches.

The Tournament must assist WTA in securing additional tickets if requested by WTA.

**11. Fitness Center**

Access to a complimentary fitness center is required at all Tournaments for all players and credentialed coaches, located within reasonable proximity to the site or the Tournament hotel. The fitness center should include a variety of cardiovascular equipment (bicycles, treadmills, stair-steppers) and strengthening equipment (free weights, nautilus, resistance bands, rubber medicine balls (weight range 1kg to 4kg), and anti-burst swiss balls), as well as an area for flexibility and relaxation (stretching mats and foam rollers) with a full-length mirror. If there is no accessible fitness center on site, there must be a warm-up area that includes cardiovascular equipment (bicycles, treadmills, etc.) and an area for flexibility and relaxation.

**12. Food and Beverage Service**

Each Tournament must provide complimentary food and drinks beginning one (1) hour before the start of the first scheduled match until one (1) hour after the start of the last match, for WTA staff and for all players

## **APPENDIX E**

### **WTA 125 TOURNAMENT STANDARDS OF PERFORMANCE**

(Main Draw and Qualifying) from the first day of Qualifying until the player is eliminated. The Tournament shall assure that food and drinks are available for purchase on-site on the day before the start of Qualifying. If the Tournament hosts a night session, it is acceptable to provide complimentary food only to players scheduled for that night, as well as players involved in delayed day session matches, and to WTA staff. Additional meal tickets for coaches and guests should be available for purchase at a reasonable cost (\$10 - \$20).

#### **a. Food Storage, Service, and Preparation**

- i. All food and beverages must be prepared, stored, maintained, and served in accordance with local health regulations.
- ii. Low-fat cooking methods should be used (baked, broiled, roasted, with no added butter or oil).
- iii. Seasonings should be light; offer extra salt, pepper, garlic, etc. on the side.

#### **b. Supplements**

No nutritional or dietary supplements may be provided to players in any form (e.g. food, drink, tablets, powder), including common products such as vitamins, minerals, amino acids, medicinal herbs, hemp and poppy seeds or similar substances.

Drinks and bars which present a high risk under the Tennis Anti-Doping Programme must be subject to a suitable quality assurance program (e.g., Informed Sport; NSF Certified for Sport, HASTA).

#### **c. Water and Electrolyte Replacement Drinks**

Bottled, non-carbonated water and WTA-approved carbohydrate-electrolyte replacement drinks in individual-use sealed containers must be provided at all times in the player restaurant, Locker Room, private, medical treatment area, Players' Lounge, and on the practice and match courts unless otherwise approved by WTA.

#### **d. Daily Meal Planning**

- i. When providing meals, a variety of quality, international cuisine and seasonal food choices are preferred on a daily basis.

**APPENDIX E**  
**WTA 125 TOURNAMENT STANDARDS OF PERFORMANCE**

- ii. In addition to daily meals, performance snacks (e.g., fruits, breads, pretzels, low-fat snack bars, cheeses, yogurts, crackers, nuts, and dried fruit) should be provided throughout the day and evening in the player restaurant and Players' Lounge.
  - iii. Mineral water, a variety of 100% fruit juices, chocolate milk (1%, low fat, or skim) and chocolate soy milk, and a selection of coffees, teas, hot chocolate, and soft drinks (decaffeinated, preferred) should also be available in the player restaurant and Players' Lounge.
  - iv. If morning practices and matches are played, breakfast items also should be available (e.g., cold cereals, bagels, breads, yogurt, and fruit).
  - v. Suggested lunch and dinner menus should include the following selections:
    - (a) Two (2) carbohydrate selections (one (1) pasta option and one (1) gluten-free option); and
    - (b) Two (2) protein selections, and for Tournaments in regions where there is a doping risk from meat, one (1) additional meatless protein option must also be provided. (See sub-Sections 10.e.i and ii - Recommended Food Groups – Carbohydrates and Proteins below).
  - vi. Practice hours and match schedule will determine when meals and/ or performance snacks are served. Allow for one (1) hour before the start of the first scheduled match and up to one (1) hour after the start of the last match. Limited meal times, outside of this schedule require the pre- approval of the Supervisor, and, in such instances, the Tournament must arrange for alternate on-site player and staff meals until the player restaurant reopens.
- e. Recommended Food Groups

The following is a list of recommended food groups:

- i. Carbohydrates (60% of total calorie intake)
  - (a) Breads and Cereals

Assorted wheat breads, rolls, and gluten free bread; oatmeal

**APPENDIX E**  
**WTA 125 TOURNAMENT STANDARDS OF PERFORMANCE**

or porridge; bagels; crackers; low-sugar cereals; muesli; pasta and gluten free pasta; baked (white and sweet) potatoes; barley, quinoa, couscous, and rice.

(b) Fruits and Vegetables

Assorted fresh fruit salad; dried fruits; whole fresh fruits; and fresh-cut raw vegetables. Salad bar: tomatoes; potatoes; lettuce (variety); cucumbers; sprouts; mushrooms; carrots; peas; beans; etc. with a variety of dressings on the side.

ii. Proteins (15% of total calorie intake)

(a) Meat and Alternatives

Chicken (white meat); turkey (white meat); beef and lamb (red meat); fish (assorted variety); eggs; legumes; nuts; and tofu.

(b) Dairy Products and Alternatives

Soft and hard cheeses; low-fat cottage cheese; low-fat plain and fruit-flavored yogurt; low-fat milk and soy milk.

iii. Fats and Oils (25% of total calorie intake)

Limit intake of fats and oils high in saturated and/or trans fatty acids.

iv. Miscellaneous

(a) A selection of international condiments (e.g., jam, honey, peanut butter, vegemite, salsa, ketchup, curry sauce, soy sauce, and sweet chili sauce).

(b) Low-fat soups (e.g., minestrone, chicken noodle, vegetable).

(c) All sauces and dressings should be served on the side.

(d) Low-fat dessert options, such as fruit breads, muffins, and crumbles.

**APPENDIX E**  
**WTA 125 TOURNAMENT STANDARDS OF PERFORMANCE**

**13. Hotel Rooms/Per Diem – Player**

a. Official Hotel Location and Transport Requirements

Tournaments will establish an official hotel that meets the standard requirements of the WTA. Hotels must be located in a secure and safe area. Motels or any accommodations that require entrance to rooms from the street or public outdoor walkways are not acceptable. Transport must be provided to and from the official hotel to the Tournament site.

b. Hotel Rates and Availability

Each Tournament should use its best effort to arrange for discounted or complimentary accommodations. If the official hotel daily rate for a double room (2 persons in room) including taxes and excluding breakfast is higher than US\$175 (€160 in Europe) per day at WTA 125 Tournaments, then an alternative player hotel must be provided with a rate equal to or less than the rate above. The maximum rate is increased by \$15 (€15 in Europe) if breakfast is included.

Rates should be available the day before Qualifying commences until the conclusion of the Tournament.

Tournaments may apply to the WTA for relief from these hotel rate standards, which may be granted by the WTA on a case-by-case basis, depending upon local considerations which make compliance with such standards impractical and unrealistic.

c. Alternate Hotel Location and Transport Requirements

The alternate hotel should be no more than 10-15 miles (or 10-15 minutes) from the Tournament site. Tournament transportation must be provided from the alternate hotel.

d. WTA Notification of Hotel Accommodations and Room Lists

The Supervisor should be notified by the Tournament of all housing arrangements. In addition, each Tournament shall provide the WTA with an official hotel room list.

e. Player Hotel Room Entitlement

Under the per diem rule, each player competing in the Main Draw (singles or doubles) at WTA 125 Tournaments shall be entitled to

**APPENDIX E**  
**WTA 125 TOURNAMENT STANDARDS OF PERFORMANCE**

a double room, including room taxes, at one of the official hotels selected by the Tournament, provided that the player reserves her room through the Tournament's designated hotel booking process. Specific hotels for Qualifying and Main Draw may be designated by a Tournament.

If multiple players elect to share a room, each player in such room is still entitled to receive full per diem, with the players' per diem nights combined for such room. If a player does not use her per diem nights in her own room or a shared room, then she may designate the entirety of the nights in her per diem room to one (1) Player Support Team Member. In either case, per diem shall begin in accordance with sub-section h or i below. A player requesting either alternate arrangement should inform the Tournament at the time of hotel booking, but the arrangement is not guaranteed.

The Tournament shall only pay the per diem allowances through the official hotel(s). Payment to the players is prohibited. Tournaments may apply to the WTA for relief from this requirement, which will only be granted by the WTA if the Tournament agrees to make secure arrangements for per diem payments to underage athletes.

Players who reserve a hotel room through the Tournament's designated hotel booking process may not knowingly share their room with individuals who are provisionally suspended or serving a period of ineligibility under the Integrity Rules or these Rules unless it cannot reasonably be avoided. If a player is found to be in violation of this Rule, she will be fined an amount equal to her per diem for that Tournament. Such penalty shall be in addition to any penalties that may be imposed for violating the prohibited association rules of the Integrity Rules.

f. Reservation Process and Deadlines

If a player does not make her hotel reservation in accordance with the Tournament's designated hotel booking process and by the deadline stated on the Tournament Fact sheet, she is not guaranteed a room or any discounted rate.

The hotel booking process must be clearly described on the Tournament Fact Sheet. The Tournament must ensure that a contact person is available by telephone and email starting at least six (6) weeks before the event and the contact details must appear on the Tournament Fact Sheet.

**APPENDIX E**  
**WTA 125 TOURNAMENT STANDARDS OF PERFORMANCE**

g. Required Length and Timing of Hotel Stay

i. Minimum Per Diem Nights

The minimum numbers of nights for which singles and doubles Main Draw players shall receive hotel room/per diem is listed in the table below.

<b>Tournament Category</b>	<b>Singles Main Draw</b>	<b>Singles Qualifying</b>	<b>Doubles Main Draw</b>
WTA 125	4	0	2

ii. Exception for Combined Events with ATP

WTA player hotel room/per diem at combined events shall be consistent with the WTA per diem rules, except where per diem provided under the ATP rules is greater, in which case the ATP per diem rule shall apply.

h. Per Diem for Main Draw Players

A player's Main Draw per diem nights: (i) begin two (2) days\* before the start of a Tournament's Singles Main Draw or one (1) day before the start of a Tournament's Doubles draw or the day that she registers, whichever is later; and (ii) continue through the night of her final exit from the Tournament (e.g. last match, withdrawal, etc.) or the night that she reaches the minimum per diem nights to which she is entitled under this Rule, whichever is later. In all cases, the last night for which any player will receive per diem is the night of the Tournament's final match, whether or not she has received her minimum per diem nights.

\*If the Main Draw starts Wednesday, then per diem begins Monday; if the Main Draw starts Tuesday, then per diem begins Sunday; if the Main Draw starts Monday, then per diem begins Saturday; if the Main Draw starts Sunday, then per diem begins Friday; if the Main Draw starts Saturday, then per diem begins Thursday; and so on.

i. Per Diem for Qualifying Players

Successful qualifiers receive retroactive Singles Main Draw per diem from two (2) days before the start of Main Draw.

**APPENDIX E**  
**WTA 125 TOURNAMENT STANDARDS OF PERFORMANCE**

j. Per Diem for Lucky Losers and Alternates

Each day, the highest ranked among the Lucky Losers (see Section V.A.1.a.vi) and Doubles Alternates (and Singles Main Draw Alternates if there is no Qualifying) who have signed in to preserve their eligibility shall receive hotel/per diem the same as Main Draw players.

This hotel/per diem starts as follows and continues through the night following the last day a Lucky Loser or Alternate, as applicable, is eligible to be awarded a spot in the Main Draw.

- i. For singles, hotel/per diem begins:
  - (a) For the highest ranked Lucky Loser, on the day the Main Draw starts; or
  - (b) For the highest ranked Alternate, on the day before the Main Draw starts.
- ii. For doubles, hotel/per diem for the highest ranked Doubles Alternate begins on the day of the Doubles Sign-In Deadline.

The hotel/per diem will fall to the next highest-ranked Lucky Loser or Alternate, as applicable, in the event the highest-ranked Lucky Loser or Alternate, as applicable, moves off the list (e.g., moves into the Main Draw), with the hotel/per diem beginning on the day the highest-ranked Lucky Loser or Alternate, as applicable, moves off the list.

k. Per Diem for Players who Withdraw On-Site for a Medical Condition

Main Draw players who have withdrawn by any method for a Medical Condition on site before starting to compete (and such doubles players' partners) shall receive hotel/per diem as follows, provided that they have complied with all requirements of the applicable withdrawal according to Section IV.A.

<b>Draw</b>	<b>Nights</b>
Singles Main Draw	2
Doubles Main Draw	1



**APPENDIX E**  
**WTA 125 TOURNAMENT STANDARDS OF PERFORMANCE**

I. Hotel Upgrade or Per Diem in Lieu of Accommodation Request

If the official hotel designated by the Tournament does not meet the standard requirements, the WTA may request an upgrade in accommodations to a hotel of that standard rating.

If the Tournament is unable or refuses to comply with this rule, then the WTA may choose the per day per diem (see Section 13.b above) in lieu of hotel accommodations for a player who is entitled to a complimentary room.

m. Player Responsibility for Personal Expenses

A player is responsible for all hotel charges over and above those for the room rate and tax (double room or double room cost).

**14. Hotel Rooms and Per Diem – WTA Staff**

a. General

All rooms below shall be provided from the day before the Qualifying Sign-In through the final day of the Tournament. The Tournament shall be responsible for payment of hotel room taxes and resort or similar fees and the WTA staff and Supervisors shall be responsible for all incidental expenses. In addition, each Tournament should use best efforts to arrange for the player rate at the official hotel to be offered to WTA staff working at the Tournament.

b. WTA Tournaments

WTA Tournaments are required to provide two (2)<sup>1</sup> complimentary hotel rooms for the WTA staff, which may be divided among the Supervisor and PHCP staff. The allocation of WTA staff rooms, however, shall be determined by the WTA and communicated to the Tournament by the Supervisor.

c. WTA/ATP Combined Events

At WTA/ATP combined events, where ATP Supervisors receive a complimentary hotel room, per diem, and laundry service, the equal number of WTA Supervisors shall also receive similar complimentary accommodations and benefits. In addition to the complimentary

---

<sup>1</sup> Three (3) hotel rooms at Combined 48 Main Draw events. The Supervisor at combined events must receive no less than the same complimentary accommodations and benefits provided to ATP Supervisor.

**APPENDIX E**  
**WTA 125 TOURNAMENT STANDARDS OF PERFORMANCE**

hotel rooms and benefits provided to the tour Supervisors, all WTA/ ATP combined events must provide the WTA and ATP each one (1) complimentary hotel room, which may be used for a PHCP or Massage Therapist.

**15. Internet Communication**

In each instance in the Rules where a high-speed internet connection is required, it shall consist of an always-on, high-speed internet connection. A minimum total 1Mb/sec (mega bit per second) of available bandwidth must be available for the WTA offices and staff, including the Player Development and medical offices (e.g., Tournament Physician, PHCP, and Massage Therapist), unless otherwise approved by the WTA. User access via Ethernet or WiFi is recommended.

Tournaments are recommended to use web filtering technology to restrict access to internet gambling sites in all areas where internet access is provided by the Tournament.

**16. Laptop Computers**

The use of laptop computers within the confines of the Tournament match courts is strictly forbidden. The exception to this provision is properly credentialed media, Tournament vendors, and Tournament staff when used in the performance of their duties.

**17. Laundry Service**

Each Tournament shall provide laundry service to participating players from the first day of Qualifying until the completion of the Tournament. Laundry service may be limited to 'next-day wash & fold' service and may be provided on site and handled by the locker room attendants, or directly at the official hotel. Laundry service costs should be reasonable (whether per item or per bag), and must be approved by the WTA at least one (1) month prior to the Tournament.

**18. Lighting**

a. Specifications and Measurements

Lighting must be distributed evenly on the court, with the minimum and recommended standards as stated in the chart below.

**APPENDIX E**  
**WTA 125 TOURNAMENT STANDARDS OF PERFORMANCE**

	Required	Recommended
Light Measurements		
Lux (averaged over 15 readings)	750	1,076
Lux Outside Court Lines (averaged over 8 readings)	500	500
Foot Candles	70	100
Ratio between highest/lowest reading	1 x 1.5	1 x 1.5
Light Pole Heights		
All Courts	30 feet*	40 feet*

\*Or no lower than other non-show court lights at the facility.

It is the responsibility of the Tournament Director to ensure, upon final preparation of the tennis courts before the Tournament commences, that all court specifications, including lighting measurements, comply with the standards set forth in Appendix J – Light Measurements.

Measurements should be taken from approximately three (3) feet (0.914 meters) above the court.

The Supervisor has the authority to suspend play on any court if the intensity of illumination, in his/her judgment, is insufficient for Professional Tennis.

b. **Second Court for Outdoor Night Matches**

If an outdoor Tournament holds night sessions, a second match court with lighting that meets Tour standards will be required.

**19. Live Scoring**

The Tournament shall assist WTA (or its designee) in its efforts to produce and host the live score data generated from each match, WTA will provide the scoring device(s) used by the Chair Umpires.

Tournaments shall not allow or authorize the dissemination, transmission, publication, or release from the grounds of the Tournament of any live match scores or related statistical data, including without limitation the live score data from the scoring network, by a third party until thirty (30) seconds after the actual occurrence of the incident of match play or action that leads to such live score update (e.g. a point being scored), such delay shall not be applicable to the live audio and/or visual broadcast or streaming by any method or means (i.e. moving pictures and/or sound/

**APPENDIX E**  
**WTA 125 TOURNAMENT STANDARDS OF PERFORMANCE**

audio reporting of actual on-court action) and purposes related to such broadcast of any match. Tournaments may only supply match related data or information to gambling entities through WTA's approved data reseller. In addition, each Tournament shall notify WTA in advance of any third party to whom the Tournament has granted access to the network used for live scoring for the purpose of accessing the live score data. Persons who are or work for data resellers shall not be issued credentials.

**20. Locker Room**

a. Facility Requirements

Each Tournament must provide a secure "Players Only" locker room facility (including toilets, showers, and other standard locker room amenities) adjacent to the Tournament site, suitable for women's use, to which only players and WTA staff will be admitted.

The locker room should have good ventilation and temperature control and must include changing and bathing rooms and afford privacy to the players. Lockers or other similar storage units must be provided in order for the players to lock up and secure their belongings.

Showers must have hot/cold water with appropriate reserves for players' use. It is recommended that locker rooms have individual showers with privacy stalls/curtains to allow for player privacy. Towels must be provided near the showers in the locker room.

The locker room must be kept clean, and sanitary and towel bins must be provided.

Additionally, it is requested that a submersion bath be located in the shower area for recovery purposes and emergency cooling of players at Tournaments where Extreme Weather Conditions exist. (See Section XVIII.B.7.a.) At WTA/ATP combined events, if a submersion bath is provided to ATP players, no fewer than the equal number of submersion baths also must be provided to WTA players.

b. Amenities to be Provided

Toiletries should be provided, including dispensed soap and paper towels for sanitary purposes for players' use. Additionally, it is requested that shampoo, hair conditioner, shower gel, tampons, and sanitary pads be provided for the players' use.

**APPENDIX E**  
**WTA 125 TOURNAMENT STANDARDS OF PERFORMANCE**

See beverage requirements in Appendix E Section A.12 – Food and Beverage Service.

c. Security and Oversight

A female attendant must be in charge, and there must be sufficient security to i) prevent unauthorized entry and ii) protect the players' personal belongings from the start of play until the completion of play.

d. Additional Facility for Coaches

Tournaments should make best efforts to provide locker room facilities for both women and men coaches.

**21. Media Facilities**

All Tournaments, including the WTA Finals, must comply with the WTA Television Broadcast Standards requirement (see Section XVIII.F.4 - Tournament Facilities) and also must provide a full service media center, including:

- a. Media working area;
- b. Separate interview room;
- c. Separate media lounge, where appropriate;
- d. High-speed internet access; and
- e. Multiple shared television monitors, telephones, and printers.

All media facilities must be ready by 9:00 a.m. tournament local time, on the day of Qualifying Sign-In.

In addition to the above, all Tournaments, including the WTA Finals, must provide the following for the use of the WTA Communications staff if on site: i) a telephone line; ii) a high-speed internet access line for each Communications staff member; and iii) a printer. The Tournament shall be responsible for the cost of installing the telephone lines and internet access lines.

All media areas shall be gambling-free zones and any persons credentialed for such areas, if found to be gambling on tennis or passing insider information to third parties for use in connection with gambling,

**APPENDIX E**  
**WTA 125 TOURNAMENT STANDARDS OF PERFORMANCE**

shall have their credentials revoked. Media credentials must contain a provision whereby the media member acknowledges and agrees that he/she will not disseminate, transmit, publish, or release from the grounds of the Tournament any live match score or related live statistical data until thirty (30) seconds after the actual occurrence of the incident of match play or action that leads to such live score update (e.g., a point being scored), and that such use shall be solely for news reporting and editorial use.

Any media known to be working for gambling companies shall not be issued credentials. If found to be working for a gambling company after issuance of the credential, the credential shall be revoked.

**22. Net**

a. Specifications

The net, posts, cord, cable, strap, singles sticks, and band all must be to the requirements of the ITF Rules of Tennis. The net band shall be cloth or canvas (not plastic or vinyl), and the net shall extend to the ground.

b. Advertising and Signage Restrictions

WTA/sponsor net post signage must be erected consistent with the specifications provided by the WTA. There shall be no advertisement on the strap, band, singles sticks, or net posts.

Advertisement is permitted on the net as long as it is placed on the part of the net that is within three (3) feet (0.914 meters) from the center of the net posts and is produced in such a way that it does not interfere with the vision of the players or the playing conditions (per the ITF Rules of Tennis). This advertising may not contain white or yellow. (See also Section XIII.B.4 - Net Post Signs.)

**23. Officials and Officiating**

All WTA Tournaments are required to appoint, in consultation with the WTA, an internationally certified Referee and Chief of Umpires to work in conjunction with the Supervisor.

All Chair Umpires appointed as designates for WTA Tournaments are internationally certified Chair Umpires. All appointed officials are required to be fully conversant with WTA Rules and procedures, the ITF Rules

**APPENDIX E**  
**WTA 125 TOURNAMENT STANDARDS OF PERFORMANCE**

of Tennis, and the Code for Officials, and together with the Supervisor, ensure they are observed. All appointed officials must also be fluent in English.

At WTA/ATP joint events: (a) the selection of additional certified Chair Umpires must be coordinated and approved by the Officiating Departments of both the WTA and ATP; and (b) the Supervisors of the WTA and ATP will be responsible for the daily assignments, using the designates from both the WTA and ATP and the additional officials recruited by the Chief of Umpires.

a. Referee

The Referee shall:

- i. Be readily available to resolve any on-court dispute without delay, supervise Medical Time Outs, and enforce the Code of Conduct.
- ii. Decide, in consultation with the Supervisor, if a court is fit for play.
- iii. Assign and replace, when necessary, Chair Umpires, Line Umpires, and Net Umpires. The assigning of these officials (but not their replacements) may be delegated to the Chief of Umpires, but the Supervisor has final say on all assignments.
- iv. Liaise with the Chief of Umpires and decide on the competence of officials.
- v. If necessary, conduct a clinic for local Chair Umpires and Line Umpires.
- vi. In the absence of the Supervisor, be responsible for all matters of tennis law. His/her decision is final. (See Appendix B.1 - Supervisor.)
- vii. Measure the courts, net posts/singles sticks, and lights and check the quality of the nets and the availability of spare nets/straps prior to the start of Qualifying.
- viii. Be responsible for conducting evaluations of Chair Umpires and Chief of Umpires.

**APPENDIX E**  
**WTA 125 TOURNAMENT STANDARDS OF PERFORMANCE**

- ix. Arrive on-site at the Tournament either by 12:00 noon on the Qualifying Sign-In day or on time for the Main Draw ceremony, whichever is earlier.
  - x. Arrive each day at least one (1) hour before the first scheduled match, remain on-site at all times during matches, and leave no earlier than thirty (30) minutes after the end of play.
  - xi. Confirm that all updated draws and the order of play have been distributed at the end of play each day.
  - xii. Be responsible for calling matches, including designating a visible timepiece at a fixed location as the “official clock,” designating a specific area from which matches shall be called, determining a meeting point for players once the match is called, and coordinating security escorts to/from match courts.
  - xiii. When possible, assist the Supervisor in coordinating pre-match interviews with the players and host broadcasters.
  - xiv. Not act as a Chair Umpire or Chief of Umpires for the Tournament.
  - xv. Be familiar with all WTA electronic forms and Officiating Arena content.
- b. Chief of Umpires

The Chief of Umpires shall:

- i. Be conversant in the local language.
- ii. Have hired prior to the Tournament, in consultation with the Tournament Director and with the approval of the Officiating Department, sufficiently certified, additional Chair Umpires, and competent Line Umpires and Net Umpires (when no electronic net device is available) and provide the list of additional Chair Umpires to the WTA Supervisor and the Officiating Department at least twenty- eight (28) days prior to the Tournament.
- iii. Conduct meetings with the Line Umpires to specify assignments and specific procedures.
- iv. Schedule the on-court assignments for all Chair Umpires in consultation with the Referee and approval by the Supervisor,



**APPENDIX E**  
**WTA 125 TOURNAMENT STANDARDS OF PERFORMANCE**

except at combined events where the WTA and ATP Supervisors are responsible for the daily assignments.

- v. Coordinate the evaluations of all officials (Chair Umpires and Line Umpires) with the Supervisor and Referee.
  - vi. Not act as a Chair Umpire or a Line Umpire for the Tournament.
  - vii. Be able to assist the Referee and the Supervisor wherever needed and be present on site at all times during play.
  - viii. If necessary, conduct a clinic for the local Chair Umpires and Line Umpires.
  - ix. Arrive on-site at the Tournament by 12:00 noon on the Qualifying Sign-In day.
  - x. Arrive at least one (1) hour before the first scheduled match, remain on-site at all times during matches, and leave after the end of play.
  - xi. Coordinate the uniforms for Lines Umpires and Chair Umpires and collect sizes from all in advance. Inform the officials at least two (2) weeks prior to the event about the dress code and/or uniform provided by the Tournament, if any, using the specific "On-Site Conditions" Form.
  - xii. Send all arrival/departure details of designated officials to the WTA at least twenty-one (21) days prior to the Tournament.
  - xiii. Send information about on-site conditions such as transportation, hotel, and meals to the designated officials at least seven (7) days prior to the Tournament.
  - xiv. Be familiar with all WTA electronic forms and Officiating Arena content.
- c. Chair Umpire

The Chair Umpire shall:

- i. Ensure that the on-court rules are observed by the players, Line Umpires, and Ball Persons. He/She must control the match in all respects. He/She can be overruled by the Referee/Supervisor only in matters of interpretation of law, not in matters of fact.

**APPENDIX E**  
**WTA 125 TOURNAMENT STANDARDS OF PERFORMANCE**

- ii. Promptly and accurately score matches using the handheld or other method provided by the WTA. Be competent in using the scoring system. Track and record when balls are to be changed.
- iii. Take charge of all Line Umpires and Ball Persons when on court.
- iv. Be responsible for, in the absence of a Net Umpire or net device, the calling of net cord service lets.
- v. Ensure that play is continuous within the Rules by:
  - (a) Maintaining the 90- and/or 120-second changeover, while having the authority to delay the resumption of play until the completion of the 90- and/or 120-second changeover during televised matches;
  - (b) Maintaining a maximum of 25 seconds from when the ball goes out of play at the end of the point until the time the ball is struck for the first serve of the next point. If such a serve is a fault, then the second service must be struck by the server without delay; and
  - (c) Observing an approved warm-up period not to exceed four (4) minutes.
- vi. Determine if a court continues to be fit for play. If a change in condition occurs during a match that the Chair Umpire considers sufficient to make the court unfit for play or if weather conditions require stoppage of play, the Chair Umpire should stop play and immediately notify the Supervisor.
- vii. Give the result of the match to the Referee and Supervisor immediately upon completion of the match and any action taken under the Code of Conduct during the match.
- viii. If necessary, overrule a Line Umpire. He/She must do so when a clear mistake has been made and must give a decision when a Line Umpire is unsighted.
- ix. Provide a detailed report on any Code of Conduct penalty issued in connection with the relevant match(es).
- x. Wear and use the officiating clothing, tablet, tablet holder, and microphone provided by the WTA. Except for the WTA Logo, no other commercial branding may be applied to the Chair Umpire

**APPENDIX E**  
**WTA 125 TOURNAMENT STANDARDS OF PERFORMANCE**

clothing, scoring tablet, scoring tablet holder, or microphone without the WTA's and the applicable Tournament's prior approval. If no uniform is provided, the Chair Umpires must wear white polo shirts with the WTA magnet, khaki pants, and tennis shoes.

d. Line Umpires

i. Responsibilities

The responsibilities for Line Umpires shall be as follows:

- (a) Base, Side, Center Service, and Service Line Umpires call "Out" and "Fault" for their respective lines.
- (b) Base, Side, and Center Service Line Umpires call "Foot Fault" on their respective lines.
- (c) The Net Umpire calls all net cord services and assists with measuring the net and with ball changes.
- (d) To give the recognized safe signal to acknowledge that a ball is good.
- (e) To give the recognized unsighted hand signal when their view of the ball landing is obstructed.
- (f) To correct their call immediately upon realizing they have made a mistake.
- (g) To report immediately to the Chair Umpire any breach of the Code of Conduct.
- (h) To defer questions from players to the Chair Umpire. A Line Umpire shall not enter into any discussions with players.

ii. Numbers of Line Umpires per Match

The Tournament is required to provide the minimum numbers of Line Umpires per match as listed in the table below. Where possible, it is recommended the minimum number of Line Umpires per match should be seven (7).

**APPENDIX E**  
**WTA 125 TOURNAMENT STANDARDS OF PERFORMANCE**

Qualifying	Main Draw through QF	Main Draw SF and Finals
5	5	7

iii. Clothing of Line Umpires

Line Umpires may not wear any predominantly white, yellow or other light color clothing that may interfere with the players' vision, unless otherwise approved by the WTA. Line Umpires' uniforms should not be identical to the ball persons' uniforms.

e. Standards of Officiating

All officials must be certified and approved by the WTA. The WTA will hire and designate the internationally certified Chair Umpires and Review Officials for all Tournaments. Each Tournament is required to provide additional Chair Umpires (approved by the WTA) for Qualifying and for some Main Draw matches not covered by the designated Chair Umpires hired by the WTA. The Tournament Directors, in agreement with the Officiating Department, will hire a Referee and Chief of Umpires. Following are the minimum required Standards of Officiating:

Tournament Category (Singles Draw Size)	Referee	Chief of Umpires	Designated Chair Umpires (1)(2)
WTA 125 (32 draw)	1 Silver	1 Silver	4 (2 paid by WTA)
WTA 125 (48 draw)	1 Silver	1 Silver	6 (3 paid by WTA)
WTA 125 (48 draw combined Tournament)	1 Silver	1 Silver	8 (2 paid by WTA, 2 paid by ATP)

- (1) A minimum of one (1) experienced and certified Review Official (minimum Bronze Badge) will be designated by the WTA Officiating Department at Tournaments implementing an Electronic Line Calling System. The number of review officials needed for each event will be based on the number of courts (with a minimum of one (1) per court with ELC) and the match schedule plan, especially when night sessions are held.
- (2) In addition to the designates, the Chief of Umpires will recruit a sufficient quantity of additional Chair Umpires for Qualifying and some Main Draw matches not covered by Designated Chair Umpires at WTA 125 Tournaments (Gold, Silver, Bronze, or White Badge). Green Badge, National, and uncertified Chair Umpires are not approved to work at WTA Tournaments.

**APPENDIX E**  
**WTA 125 TOURNAMENT STANDARDS OF PERFORMANCE**

f. Chairs – Chair Umpire

The Chair Umpire's Chair is recommended to be a minimum of six (6) feet (1.82 meters) and a maximum of eight (8) feet (2.44 meters) in height. The chair shall be centered along an extension of the net approximately three (3) feet (0.9 meters) from the net post. The chair must be stable and safe.

The Chair Umpire's microphone must have an on/off switch and must be easily adjustable and not hand held. If the Chair Umpire's microphone has a flag, the WTA Logo is the only permitted branding. The on-court announcer's microphone, if any, also must have an on/off switch.

For outdoor Tournaments, the Umpire's Chair on all courts shall be positioned on the west side of the court, unless otherwise agreed by the WTA, and there should be a sunshade available. Each Chair Umpire's chair must have an electrical outlet to power and recharge handheld PDAs and other similar electronics to be used by the Chair Umpire.

The Chair Umpire's chair must have a writing table attached on all match courts to provide a platform for the Chair Umpires to place their hardware, such as their PDA for live scoring, walkie-talkie, and/or net device.

g. Conditions for Officials

Each WTA designated official should be provided with the following, from the day prior to the first day of matches (at the earliest) to the morning after their last match (at the latest), free of charge:

- i. Airport pick-up (or taxi reimbursement);
- ii. Single hotel room at the official hotel or another hotel approved by the Supervisor and Officiating Department;
- iii. Breakfast, lunch, and dinner (at the hotel, on-site, or by pre-agreed per diem procedure) from the night prior to the start of the assignment until the morning after the last day of the assignment;
- iv. Complimentary laundry service for their tennis uniforms;
- v. Transportation between the hotel and Tournament site;

**APPENDIX E**  
**WTA 125 TOURNAMENT STANDARDS OF PERFORMANCE**

- vi. Airport drop-off (or taxi reimbursement); and
  - vii. Access to high speed internet on site.
- h. Protection of Match Data and Information

Officials agree not to, and shall not authorize or assist any third party to, disseminate, transmit, publish, or release any match related data or information to or for any third party without the express written consent of WTA. Further, each official agrees that any and all work or data he/ she collects or creates in connection with any match shall constitute a “work made for hire” and any and all rights attributable to such work shall be retained by, or if necessary automatically assigned to, WTA and its members.

**24. On-Court Supplies**

At all times throughout play, each court must have one (1) cooler on each side supplied with bottled, non-carbonated water, WTA-approved carbohydrate-electrolyte replacement drinks in sealed containers and plastic bags filled with ice for players’ medical needs. Those items must not be shared and must be routinely checked after each match, and any unsealed bottles and drinks or other products not supplied by the Tournament must be removed from the court/coolers.

Each Tournament must provide spill kits, which are maintained by court services, for the proper clean up and disposal of biohazardous material on each court and hand sanitizer which is available for use by ball persons following handling of used towels. Court services personnel must be trained in the proper handling of biohazardous waste. In Extreme Heat Conditions, fans and ice towels are required to reduce players’ body temperature and implement safety precautions.

**25. On-Site Tennis Gambling and Gambling Company Credentials**

Allowing gambling companies, directly or through a third party, to accept any tennis wagers on the Tournament digital platforms or at the Tournament site or any Tournament-related event is prohibited.

Persons working for gambling companies that accept any tennis wagers (electronically or otherwise) shall not be issued credentials except as set forth in the WTA Betting, Fantasy & Gambling Sponsorship Rules. If found to be working for a gambling company after issuance of the credential, the credential shall be revoked.

**APPENDIX E**  
**WTA 125 TOURNAMENT STANDARDS OF PERFORMANCE**

**26. Parking**

Each Tournament should provide, conveniently located to the locker room, a reserved parking area for the players.

**27. Personnel**

The Tournament shall provide the personnel necessary for the proper conduct of a tennis tournament. In countries where English is not the local language, tournament personnel interacting with players, Player Support Team members, WTA staff, WTA broadcasters, or WTA vendors are expected to be conversant in English at a level sufficient to comfortably perform their duties.

**28. Physician**

The Tournament Director must appoint a Chief Tournament Physician in accordance with Section XVIII.B.5 – Physician.

**29. Player Entry**

Tournaments must provide reasonable assistance to players, player support personnel, and the WTA in obtaining any necessary visas or work permits required for such individuals to attend and participate in the Tournament. Visa or work permit information should be communicated to players and the WTA at least two (2) months prior to the Tournament. If an official invitation letter must be provided by the Tournament, the Tournament shall be responsible for the cost of providing that letter. All other visa or work permit- related costs as well as completing the visa or work permit process shall be the responsibility of the player. It is recommended that Tournaments provide an English-speaking person to assist with the visa or work permit process inquiries.

**30. Players' Lounge**

Each Tournament must provide a furnished Players' Lounge (i.e., sofas, tables).

See snack and beverage requirements in Appendix E Section A.12 - Food and Beverage Service.

It is recommended that magazines, newspapers, and a television be provided in the Players' Lounge and that there be a telephone somewhere on site (other than the WTA telephone lines) which players

**APPENDIX E**  
**WTA 125 TOURNAMENT STANDARDS OF PERFORMANCE**

can use to charge calls. At least two (2) computers with print capabilities and highspeed access to the internet for players' use must be provided at all Tournaments and must include WTA's online learning site as a trusted site. It is also strongly recommended to have a secured wireless internet set up in the Players' Lounge for players to use their own laptops to access the internet.

**31. Player Services/Welcome Desk**

A Player Services/Welcome Desk should be provided where players can seek assistance with practice court bookings and other general Tournament information (e.g., pick up meal tickets, tennis balls, match and guest tickets). All necessary Tournament telephone numbers and Tournament information should be provided for players prior to the start of Qualifying, it is recommended to have the key telephone numbers, such as the WTA office, transportation services and practice booking services printed on the back of players' credentials. When not in an English-speaking country, the Tournament should provide an English-speaking representative to distribute the information and to host this area.

**32. Player Treatment Area**

See Section XVIII.B.2 for the requirements of the Player Treatment Area/ Training Room.

**33. Practice Facilities**

- a. Each Tournament must provide practice facilities for players during the stated hours to be arranged with the Supervisor. Practice courts must be the same surface and condition (i.e., indoor/outdoor) as used for matches and preferably should be on site. (See Appendix E Section A.9.a - Court Specifications.)
- b. Tournaments are strongly recommended to provide Tournament personnel to allocate and supervise practice bookings, working in liaison with the Supervisor.
- c. Practice courts should have nets in good condition equipped with net straps and singles sticks, as well as adequate running room surrounding the court and ceiling height.
- d. All practice courts at indoor events should be heated and ventilated.
- e. Practice balls are to be provided to players in the numbers specified



**APPENDIX E**  
**WTA 125 TOURNAMENT STANDARDS OF PERFORMANCE**

(see Appendix E Section A.5 - Balls) and preferably at the practice facility, if located off site.

- f. All new off-site practice courts must be located within a reasonable travelling distance from the Tournament site.

**34. Scoreboards/Video Screens**

Scoreboards must be provided on all match courts. The scoreboard will be placed at the corner or side of the court and must not obscure the playing visibility. The scoreboard must be a dark color. The scoreboard on all broadcast courts must be electronic. It is recommended that electronic scoreboards are controlled directly by the Chair Umpire's scoring device.

Scoreboards and video screens may be placed a minimum of forty (40) feet (12.19 meters) above the court surface, as long as they do not interfere with play and/or present a distraction to the players.

**35. Shot Clocks**

It is optional for WTA 125 Tournaments to provide shot clocks. If a WTA 125 Tournament provides shot clocks, they must be provided on each match court from the first day of Qualifying through the Main Draw finals.

a. Size

Each shot clock panel should be a minimum of two (2) feet by two (2) feet (0.6 meters by 0.6 meters) and a maximum of three (3) feet by two (2) feet (0.91 meters by 0.6 meters).

b. Number and Placement

Each court is required to have a minimum of two (2) shot clocks clearly visible to the players and the Chair Umpire. The shot clock panels must be placed on the back wall or corner of the court on the left far and right far side from the Chair Umpire.

c. Additional Positions

In addition to the two (2) shot clock placements specified above, each Tournament may show the shot clock timing in other locations on or around the court and spectator areas.

**APPENDIX E**  
**WTA 125 TOURNAMENT STANDARDS OF PERFORMANCE**

**36. Scoring System**

- a. All Singles (Main Draw and Qualifying) matches in all WTA Tournaments are the best of three (3) tie-break sets. All Main Draw Doubles matches in all WTA Tournaments are the best of three (3) sets with No-Ad scoring in the first two (2) sets and a 10-point match tie-break as the third set. The WTA has the right to authorize the use of alternative scoring systems at WTA Tournaments and to award appropriate ranking points.
- b. The organizing committee of each Grand Slam Tournament will decide which scoring system will be used at each Grand Slam.
- c. There will be no rest period before the final set except when the Extreme Weather Condition Rule is in effect. (See Section XVIII.B.7 - Extreme Weather Conditions and Lightning.)
- d. The ITF Rules of Tennis will apply in their entirety except where noted in these Rules.

**37. Seating – Minimum**

The minimum center court seating capacity is 750.

**38. Security and Credentialing Systems**

The WTA has considered Tournament security issues and has determined that the Tournaments and players are the appropriate parties to bear the responsibility for Tournament security. Each Tournament shall be responsible for providing on-site security for players, Tournament staff, officials, and spectators and shall, if requested, promptly provide the WTA with detailed information about security plans.

As part of each Tournament's security plan, a photo credentialing system must be established. Tournaments must include and take reasonable steps to enforce the following policy on all non-media persons issued credentials: No credentialed person may continually collect, disseminate, transmit, publish, or release from the grounds of the Tournament any match scores or related statistical data during match play (from the commencement of a match through its conclusion) for any commercial or gambling purposes. Such policy shall be printed on all Tournament credentials or otherwise notified to credentialed persons.

**APPENDIX E**  
**WTA 125 TOURNAMENT STANDARDS OF PERFORMANCE**

Use of video surveillance systems must comply with Appendix E, Section A.46.

Players shall cooperate with Tournament security measures.

**39. Stringing**

Each Tournament must provide quality racquet stringing services on-site from the day before the start of Qualifying until the completion of the Tournament. The stringer must be available on site each day matches are scheduled until thirty (30) minutes after the end of the last match. The stringing costs per racquet and the stringer's hours of availability must be approved by the WTA at least one (1) month prior to the Tournament.

At WTA/ATP combined events, the stringer must be available on site each day two (2) hours prior to the starting time of the first scheduled match. The recommended maximum fee per racquet is US\$20 (or €20) at combined events. If play has been scheduled at an approved alternate site during a combined event, then access to the stringing service must be provided at such alternate site from the start of play until play has been completed at that site.

**40. Television and Digital Media**

Tournaments must comply with the Television and Digital Media requirements set forth in Sections XVIII.E and F.

**41. Ticketing**

Tournaments must include and take reasonable steps to enforce the following policy on all ticket holders: No ticket holder may continually collect, disseminate, transmit, publish, or release from the grounds of the Tournament any match scores or related statistical data during match play (from the commencement of a match through its conclusion) for any commercial or gambling purposes. Such policy shall be printed on all Tournament tickets or otherwise notified to ticket holders prior to purchase. Tournaments should also have notices posted in the local language and in English at all tournament entrances, VIP hospitality areas, player areas, and throughout the Tournament grounds.

**42. Tournament Director**

The Tournament Director shall be approved in advance by the WTA and shall be responsible for the overall conduct and organization of the

**APPENDIX E**  
**WTA 125 TOURNAMENT STANDARDS OF PERFORMANCE**

Tournament and other such personnel as necessary for the proper conduct of a tennis tournament including, but not limited to, the Tournament Physician, Referee, Chief of Umpires, Chair Umpires, Line Umpires, and Ball Persons. New Tournament Directors that have not previously been approved by the WTA must attend a one (1) day orientation session at a WTA designated office or WTA Tournament. Each Tournament Director must complete the Tennis Integrity Protection Programme module prior to the start of the Tournament. Tournament Directors are prohibited from playing in their own Tournament.

**43. Towels and Sheets**

Each Tournament must provide an adequate supply of already washed (with antimicrobial soap and hot water), absorbent, bath-sized towels that will accommodate i) all locker room (shower) needs, ii) SS&M staff (PHCP, Tournament Physician, and Massage Therapist) and iii) on-court needs. Each Massage Therapist will require a minimum of twenty (20) sheets and twenty (20) towels per day.

**44. Towel Bins**

Tournaments must provide on-court player towel bins, the design and location of which is subject to Supervisor approval. The Chair Umpire must assign towel bins to players before each match, and players must use only their assigned towel bins to place towels during each match. Each player must handle her own towels and must not request towels from, or give her towels to, any ball person at any time before, during, or after a match.

a. Design

Towel bins must be clearly identifiable for each player/team. Tournaments may place branding on towel bins.

b. Location

For all match courts, eight (8) towel bins must be available with two (2) towel bins located in each corner of the court. Depending on the court configuration, the towel bins should:

- i. Be easily accessible and raised high enough that players do not need to bend down;
- ii. Be placed either against the side wall outside the extension of

**APPENDIX E**  
**WTA 125 TOURNAMENT STANDARDS OF PERFORMANCE**

the baseline or against the back wall outside the extension of the doubles sideline, whichever location is the shortest distance for the players;

- iii. Be located away from spectators and on-court personnel;
- iv. Be placed at least 20 cm/7.9 inches apart; and
- v. Not block scoreboards or court branding.

**45. Transport**

Transportation drivers must be highly experienced, preferably over 25 years old, have knowledge of the host city roads, conversant in English, and uniformly and appropriately dressed. Transportation drivers should work no more than 8 hours per day. Transportation drivers must not smoke or use mobile devices while transporting players and must follow traffic regulations and advise players to wear seatbelts.

Transportation desks must be set up at the Venue.

a. Airport Transportation

Unless otherwise agreed upon by the WTA, airport transportation must be provided to Qualifying and Main Draw players, as well as Player Support Team members when traveling with a player, beginning the day before the Qualifying Sign-In deadline (as long as 24-hour notice is given to the Tournament) until the morning following the final day of the Tournament.

Airport transportation must be provided to WTA staff, associates, and contractors working at the Tournament.

b. Transportation between Hotels and Tournament Site

Tournaments are required to provide transportation for players, credentialed guests, coaches, and WTA staff between the official hotel (and alternative hotel, if provided) and the Tournament site and practice facility on a regularly scheduled shuttle, beginning the day before the Qualifying Sign-In deadline. Transportation must be available up to one (1) hour after the last match is completed.

If private housing is provided, the Tournament has the responsibility to advise players of the transportation available, if any. The Supervisor

## **APPENDIX E**

### **WTA 125 TOURNAMENT STANDARDS OF PERFORMANCE**

also should be advised of any other available local transportation. It is recommended that all Tournaments arrange for a player discount with a local car rental agency.

#### **46. Video Cameras**

Closed-circuit television (“CCTV”) and video surveillance systems (including security drones) are used at Tournaments for general public security, crime prevention, and other specified purposes. As use of such systems collects and processes individuals’ personal and biographical data, a Tournament’s collection, use, and disclosure of surveillance footage (including captured audio) must (a) comply with all applicable laws and regulations and (b) be fair, transparent, and respect an individual’s right to privacy.

CCTV and video surveillance cameras must not be placed in private areas where there is a reasonable expectation of privacy, including (but not limited to): locker rooms, nursing rooms, bathrooms, and treatment rooms. In all other areas, Tournaments must assess whether the placement of CCTV and video surveillance cameras is appropriate in the circumstances, taking into account the reasonable expectations of individuals and the potential impact on their rights and freedoms.

If CCTV or video surveillance cameras are used in credential-restricted areas, including fitness and warm down areas, the cameras must be visible and signs must be placed prominently to inform individuals that they are in an area where a camera is in operation. Signs must be placed more prominently and frequently in areas where individuals are less likely to expect that they will be monitored. Signs in areas accessed by players must include the purpose of the camera’s use if other than for security.

Tournaments must make information available about the location of CCTV and video surveillance systems (including any use of security drones) in player areas and how the footage will be used and provide individuals a mechanism to raise complaints or concerns and view footage captured of them.

A Tournament’s disclosure of CCTV and video surveillance footage to third parties must be consistent with the purpose(s) communicated with the individuals. Tournaments may not publicly release the following types of CCTV and video surveillance footage without an individual’s consent: (a) footage captured in an area where an individual would reasonably expect privacy and cameras are not visible and/or signs placed; (b) footage that would reasonably be deemed to be extremely sensitive or inappropriate, and (c) footage that if released could reasonably place the player at a competitive disadvantage.

**APPENDIX E**  
**WTA 125 TOURNAMENT STANDARDS OF PERFORMANCE**

Tournaments must make CCTV and video surveillance footage available upon request to the WTA and ITIA for use in connection with Rules and Integrity Rules investigations and proceedings.

**47. Walkie-Talkies**

Each Tournament must provide one (1) walkie-talkie for each Supervisor, PHCP, Communications Manager (if on site), WTA IT Staff, Live Scoring vendor, Referee, Chief of Umpires, and Tournament Physician, and two (2) walkie-talkies for each match court. Each Tournament also must provide one (1) walkie-talkie to the Massage Therapists for their shared use. In addition, each Tournament must provide walkie-talkies, in accordance with the WTA Television Broadcast Standards requirements (see Section XVIII.F.4 - Tournament Facilities). It is requested that a private medical channel is provided for use by the PHCPs, Massage Therapists, and Tournament Physicians. Separate channels are required for:

- a. The collective use of the Supervisor(s), officiating staff, PHCPs, and Massage Therapists to ensure direct and private communication for on-court matters among them; and
- b. The use of the Electronic Review Official and the Chair Umpire to ensure a direct and private communication for on-court matters between them (each court with Electronic Review must have a different channel).

**48. WTA Office**

- a. Location and Security Requirement

The Supervisor shall be provided with a private and secure office with a desk from which the Supervisor can base him/herself in order to carry out his/her duties. Players and associated people conveniently should be able to access the Supervisor and WTA information in the WTA office. It is also a place for Officials and Tournament staff to meet, when necessary.

- b. Office Equipment/Communication and Installation Timing

Each Tournament must provide the Supervisor with a printer and a minimum of one (1) international telephone line in the WTA office and high speed internet connections operational by 9:00 a.m. tournament local time the day of Qualifying Sign-In. The Supervisor shall notify

**APPENDIX E**  
**WTA 125 TOURNAMENT STANDARDS OF PERFORMANCE**

the Tournament at least eight (8) weeks prior to the start of Qualifying of the exact number of telephone lines and internet connections needed. At a minimum, each Tournament must provide one (1) high speed internet connection for each staff permanently located in the WTA Office during the Tournament (Supervisors and Player Relations staff), wireless access is acceptable. The Tournament shall be responsible for the cost of installing the telephone lines and internet connections.

It is recommended that telephone number(s) be available at the time the Tournament Fact Sheet is published seven (7) weeks prior to each Tournament (one (1) week prior to the official entry deadline). Telephone numbers, however, must be available one (1) week prior to the Qualifying Sign-In day. A photocopy machine also should be available in the WTA office or in a nearby convenient location.

c. Office Furniture and Setup

The appropriate number of working positions must be prepared for each Supervisor and/or Player Relations representative working on site. The office should have adequate wall/table space or bulletin boards available for Tour information and must have a live score monitor. A locking drawer or a cabinet must also be provided for the Supervisor's use.

**49. WTA Coach Program**

Each Tournament must comply with and provide all Tournament-related benefits under the WTA Coach Program Rules available on PlayerZone, TournamentZone, and [www.wtatennis.com/wta-rules](http://www.wtatennis.com/wta-rules). For questions about the WTA Coach Program, please contact the WTA Coach Program Manager at [coach@wtatennis.com](mailto:coach@wtatennis.com).

**50. Breach of Tournament Standards of Performance**

a. General

The provisions of the Tournament Standards of Performance shall be strictly applied by the WTA. Each WTA Tournament must follow, abide by, and conform to all requirements set forth in the Tournament Standards of Performance unless otherwise approved in writing by the WTA.

Tournaments seeking an exemption from any of the Tournament Standards of Performance must request the exemption from the



**APPENDIX E**  
**WTA 125 TOURNAMENT STANDARDS OF PERFORMANCE**

WTA at least three (3) months in advance of the Tournament. Exemption requests must be sent in writing.

Breaches of the Tournament Standards of Performance and/or an apparent lack of ability to solve documented problems affecting the quality of the presentation of the Tournament shall result in a disciplinary penalty and/or loss or change in a Tournament's status as provided herein.

b. Violations/Procedures

i. Investigation of Alleged Violations

The WTA shall investigate any alleged violation of the Tournament Standards of Performance requirements.

ii. WTA Determination

The imposition of a warning, fine, or other penalty shall be determined by the WTA. Upon the completion of its investigation, the WTA shall determine the potential wrongfulness of the conduct of the Tournament involved and shall notify the Tournament of any violations and penalties. A copy of the WTA's decision shall be delivered to the Tournament.

Where a violation is capable of being cured in a timely manner, with timeliness being based on the circumstances, the WTA will provide the Tournament with the opportunity to cure a violation prior to issuing a determination.

iii. Possible Penalties

Violations of the Tournament Standards of Performance shall subject a Tournament to one (1) or more of the following: (a) a warning; (b) a fine; (c) being placed on "Probationary" status; (d) loss or change in membership status; (e) forfeiture of all sums, if any, paid to the WTA; and/or (f) any other reasonable penalties. In addition to the foregoing, when a Tournament or Tournament partner uses a Player Likeness in violation of Section VII.B.7.a, then the affected Player may request that such Tournament shall be precluded from using her likeness in any and all advertising the following year of the Tournament provided that such request is made at least six (6) months prior to the start of such Tournament.

**APPENDIX E**  
**WTA 125 TOURNAMENT STANDARDS OF PERFORMANCE**

Violations of the Tournament Standards of Performance shall be classified by the WTA by Tournament category and by Violation Level. Please see Appendix H for a chart detailing Violation Levels and corresponding fines. If a Tournament receives a warning in a Supervisor Report for a violation and that violation is not remedied the following year, then the Tournament will be fined according to the chart in Appendix H.

iv. Payment of Fines

All fines for violations of the Tournament Standards of Performance shall be paid by the Tournament to the WTA, to the attention of the Chief Operating Officer, within twenty-one (21) days after receipt of written notice thereof. Fines not paid within twenty-one (21) days may be deducted from Commercial Benefits or other payments due from the WTA to the Tournament.

All Tournament Standards of Performance fines shall be retained by the WTA, with the exception of those fines assessed against a Tournament due to a violation which directly affects the players (i.e., violations due to insufficient courts, hotel facilities, medical staff, or Section D.2 of the WTA Betting, Gambling and Fantasy Sponsorship Rules), which shall be split 50/50 between the WTA and the WTBA.

In addition to the foregoing, for fines assessed against a Tournament because the Tournament used a Player Likeness in violation of Section VII.B.7.a or Section D.3 of the WTA Betting, Gambling and Fantasy Sponsorship Rules, then the entirety of such fine shall go to the WTBA.

v. Board of Directors Decision on Recommended Loss of Membership

In the event that the WTA recommends that the penalty imposed on the Tournament should be the loss of the Tournament's membership, such recommendation shall be reviewed by the Board of Directors, prior to the imposition of the penalty and the Board of Directors may affirm, modify or reverse the WTA's recommendation.

vi. Subsequent Violations

Subsequent violations of the Tournament Standards of Performance by a Tournament previously placed on probation

**APPENDIX E**  
**WTA 125 TOURNAMENT STANDARDS OF PERFORMANCE**

may result in a revocation of its WTA membership in accordance with the procedures set forth in sub-Section v immediately above. In addition, fines double for violations of the same Issue (see Appendix H) in consecutive Tour Years.

c. Review and Appeal Process

i. Tournament Request for Appeal

After paying all fines as provided above, any Tournament sanctioned for a breach of the Tournament Standards of Performance may request a hearing before the Standards Committee, with the exception of appeals involving monetary penalties of \$50,000 or more or a loss or change in membership status, in which case the matter will be referred to the Board of Directors for a decision.

This petition shall be in writing and must be filed with the CEO within twenty-one (21) days after notice of the penalty is received by the Tournament from the WTA. Such petition shall state in detail the basis for such appeal.

ii. Hearing Procedures

The Tournament shall be advised of the date, time and place for the hearing of such appeal; however, attendance is not mandatory. In addition to submitting a written submission of the basis for its appeal, a Tournament may also request in writing to send a representative to the hearing to orally present its appeal.

On appeal, the Standards Committee or the Board of Directors may affirm, reverse, or modify the decisions of the WTA. The decision of the Standards Committee or the Board of Directors shall be final and non-appealable.

iii. Request for New Hearing

Notwithstanding Appendix E Section A.49.c.ii above, after the Standards Committee or Board of Directors renders a decision on a Tournament's breach of the Tournament Standards of Performance, the WTA or any applicable Tournament Support Personnel may submit a request to the WTA for the Standards Committee or Board of Directors, as applicable, to grant a new hearing ("New Hearing") of such breach because of the

**APPENDIX E**  
**WTA 125 TOURNAMENT STANDARDS OF PERFORMANCE**

discovery of new information that: (i) was not known to the Tournament at the time of the Code of Conduct and Standards of Performance Committee's or Board of Directors' original hearing on the breach; and (ii) is capable of causing the Standards Committee or Board of Directors, as applicable, to render a different decision on the breach ("New Information"). Such request must be submitted to the WTA no later than ninety (90) days after notice of the Committee's or Board of Directors' original decision unless the Committee or Board of Directors otherwise agrees.

The Standards Committee or Board of Directors, as applicable, has no obligation to grant a New Hearing and has sole, absolute discretion in determining whether a New Hearing request contains any New Information and whether to grant a New Hearing on a breach. The decision regarding a New Hearing by the Committee or Board of Directors, as applicable, is final and non-appealable. If the Standards Committee or Board of Directors, as applicable, grants a New Hearing, the provisions of this Appendix E Section A.49.c will apply to that hearing.



## APPENDIX F

### ROOF POLICY

#### General Conditions:

- WTA Tournaments played outdoors may have one (1) or more courts with a retractable roof, allowing play to continue or be resumed even when inclement weather affects the Tournament.
- Tournaments with retractable roofs shall remain primarily outdoor events. Wherever practicable, the conditions on courts with retractable roofs shall be the same as those on all other courts.
- When the roof on a court is open, the two (2) moveable halves shall be positioned as determined by the Supervisor based on the site's configuration.
- At combined events, the Supervisor, in consultation with the ATP supervisor, shall make all decisions concerning the closing, re-opening, and positioning of the roof.

#### Rain:

- In the event of rain falling prior to the scheduled start of play, the roof shall remain closed for the duration of the match.
- If the rain stops or the weather forecast is good, the roof may be opened after the match in progress is completed. Decisions on re-opening the roof will be made on a match-by-match basis depending upon current conditions and the weather forecast.
- If play commences with the roof closed, the roof shall remain closed for the remainder of such match. A decision may be made to open the roof for the following scheduled matches.
- If play commences with the roof open, a decision to close the roof will normally be made after play has stopped due to rain, although if other factors warrant the roof to be closed prior to play being stopped, the Supervisor shall make such decision.
- In general, the roof will not be closed because of a threat of rain.
- In the event high winds of a sufficient capacity to harm the retractable roof are forecasted with reasonable certainty, the roof may be closed prior to the start of the match. The reverse is applicable when the roof is closed and high winds or other conditions necessitate, for safety reasons, that the roof be reopened.

## **APPENDIX F**

### **ROOF POLICY**

- Changes to the order of play, including the completion of an unfinished match on a different court than the one on which it started, may be authorized in exceptional circumstances in the best interests of completing a Tournament on schedule.

#### Darkness:

- If the roof must be partially closed in order for the lights to work properly, then the roof must be partially closed prior to the start of the match. The Supervisor will determine the exact time of day after which the roof will be closed for this purpose.

#### Cold:

- In the event the temperature is below 50F/10C prior to the start of a match, in order to enhance the fan experience, the roof may be closed as directed by the Supervisor. Decisions on whether to close the roof for cold will be made on a match-by-match basis.

## APPENDIX G

### WTA PLAYER AND TOURNAMENT FINES

All fines will be deducted from player prize money at Tournaments to be determined by the WTA, in its sole discretion. †

Category	Fines
Main Draw Late Withdrawal (IV.A.3)	Based on ranking at the entry deadline and Tournament Category^ (See IV.A.3.b.ii for amounts)
Main Draw No Show (IV.A.3.c)	Fine 50% greater than the applicable Late Withdrawal fine.
Qualifying Late Withdrawal (IV.A.4)	\$500 \$250 at WTA 125 Tournaments
Qualifying No Show (IV.A.4.c)	\$600^ \$300 at WTA 125 Tournaments^
Failure to Submit a Withdrawal Statement (IV.A.1.c.ii)	Qualifying \$500 Main Draw \$1,000 Doubles \$1,000 \$250 for all players at WTA 125 Tournaments
Failure to Comply with On-Site Withdrawal Requirements (IV.A.2.b)	Based on ranking at the entry deadline and Tournament Category
Violation of ACES Program (VII.A)	Based on ranking at the entry deadline (See VII.A.6.c for amounts)
Violation of Marketing Activity Requirements (VII.B.2)	Based on ranking at the time of notification of the activity (See VII.B.2.c for amounts)
Violation of WTA Patch Rule (unless conflicting contract) (VII.C.8.d)	1st offense warning 2nd offense \$100 3rd offense \$500 4th offense up to \$25,000
Not Wearing the WTA Patch for duration of the match (after 5 warnings) (VII.C.8.d)	\$100
Violation in any televised match from QF on (VII.C.8.d)	up to \$50,000



## APPENDIX G

### WTA PLAYER AND TOURNAMENT FINES

Category	Players	Fines
Tennis Anti-Corruption Program	All Players	up to \$250,000 plus amounts received
Violation of AER or Player Development Requirements (X.C)	All Players	up to \$25,000
On Court Match Violations§ (XVII.D.4)	All Players	
Visible Obscenity		up to \$ 5,000
Audible Obscenity		up to \$ 5,000
Verbal Abuse		up to \$ 10,000
Physical Abuse		up to \$ 10,000
Ball Abuse		up to \$ 2,500
Racquet Abuse		up to \$ 2,500
Coaching & Coaches		up to \$ 5,000
Unsportsmanlike Conduct		up to \$ 10,000
Best Efforts		up to \$ 10,000
Leaving the Court		up to \$ 3,000
Failure to Complete a Match		up to \$ 5,000
Punctuality		
- 10 minutes late		\$ 250
- 15 minutes late		\$ 750
- Missed TV "walk-on" time		up to \$ 10,000
Dress & Equipment (VII.C)		
- Commercial Identification		**up to \$25,000
- Manufacturer's Logo		**up to \$25,000
- Other Tennis Events		up to \$ 5,000
- Unacceptable Attire		up to \$ 500
Dishonorable or Unprofessional Conduct (XVII.D.13)	All Players	up to \$ 10,000
Aggravated Behavior (XVII.D.13.b)	All Players	up to \$25,000 or prize money won, whichever is greater
Mandatory Physical Exam Violation	All Players	\$ 500
Exhibition/Non-WTA Event Rule Violation (XVII.E)***	1 - 10 11 - 20 21 - 35 36 - 50 Exemption WC	\$100,000 \$ 75,000 \$ 50,000 \$ 25,000 \$ 75,000

† If a discrepancy exists between this chart and the Rule language, the Rule language shall prevail.

^ The fine shall double with each subsequent offenses.

\* Top 10 Players who enter but are not accepted into a WTA 250 Tournament due to the Prize Money Policy, may withdraw before acceptance, without penalty.

§ Monetary fines do not apply for Code Violations received due to loss of physical conditioning or as a result of the medical treatment not being complete in the allocated time, unless it is interpreted by the Referee/Supervisor as gamesmanship.

\*\* For each offense.

\*\*\* Based on a player's WTA Singles Ranking or Singles Special Ranking, whichever is better at the Tournament's Singles Main Draw Entry Deadline, or her meeting the Exemption Wild Card criteria.

**APPENDIX G**  
**WTA PLAYER AND TOURNAMENT FINES**

**TOURNAMENT STANDARDS OF PERFORMANCE FINES**

Level 1 Violations	WTA 1000 Mandatory		WTA 500		WTA 250		WTA 125	
	Minor	Major	Minor	Major	Minor	Major	Minor	Major
Ball Persons	\$10,000	\$20,000	\$5,000	\$10,000	\$2,500	\$5,000	\$1,250	\$2,500
FitnessCenter								
Media Facilities								
Officials' Clothing								
Officiating								
On-Court Equipment								
On-Court Supplies								
Player Lounge								
Player Travel Documentation								
Tournament Personnel/ Player Services/ Welcome Desk								
Towels & Sheets								
Training Room								
Walkie-Talkies								
Web Filter								
WTA Office								
Other Level 1 Violations								

<b>Level 2 Violations</b>	<b>WTA 1000 Mandatory</b>		<b>WTA 500</b>		<b>WTA 250</b>		<b>WTA 125</b>	
<b>Issue</b>	<b>Minor</b>	<b>Major</b>	<b>Minor</b>	<b>Major</b>	<b>Minor</b>	<b>Major</b>	<b>Minor</b>	<b>Major</b>
Balls	\$15,000	\$30,000	\$7,500	\$15,000	\$3,750	\$7,500	\$1,875	\$3,750
Center Court Seating								
Court Signage								
Credentials/Tickets								
Seating								
Hotel								
Internet Communication								
Locker Rooms								
Physician								
Player Restaurant								
Prize Money								
Scoreboards/Video Screens								
Transport & Parking								
Other Level 2 Violations								
<b>Level 3 Violations</b>	<b>WTA 1000 Mandatory</b>		<b>WTA 500</b>		<b>WTA 250</b>		<b>WTA 125</b>	
<b>Issue</b>	<b>Minor</b>	<b>Major</b>	<b>Minor</b>	<b>Major</b>	<b>Minor</b>	<b>Major</b>	<b>Minor</b>	<b>Major</b>
Marketing	\$25,000	\$50,000	\$10,000	\$20,000	\$5,000	\$10,000	\$2,500	\$5,000
Match Court Specifications (including the Net)								
Number of Courts								
Practice Facilities								
Security								
Anti-Doping Facilities/Chaperones								
Other Level 3 Violations								
<b>Level 4 Violations</b>								
Live Scoring	Up to \$100,000							
Commercial Benefit Requirements								
Television								
Betting, Fantasy & Gambling Sponsorship Rules								

## APPENDIX H

### ON-COURT SIGNAGE

Court Host Locality  
Signage Option 1

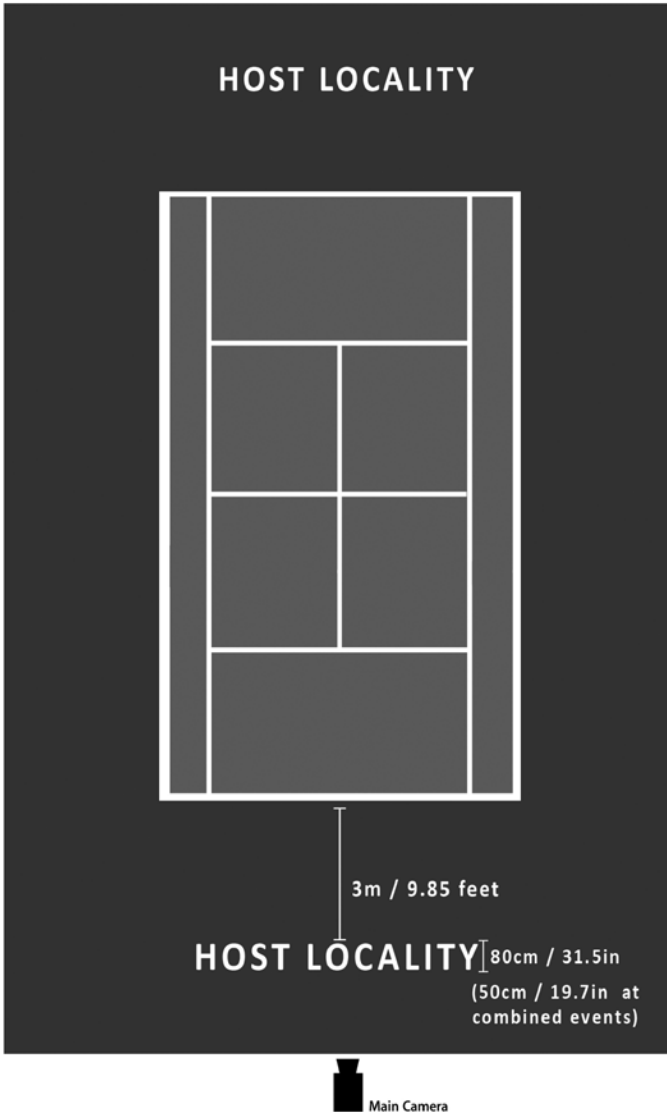

Please note that this diagram is not to scale.



## APPENDIX H ON-COURT SIGNAGE

### Court Host Locality Signage Option 2 - Hard, grass, or clay courts

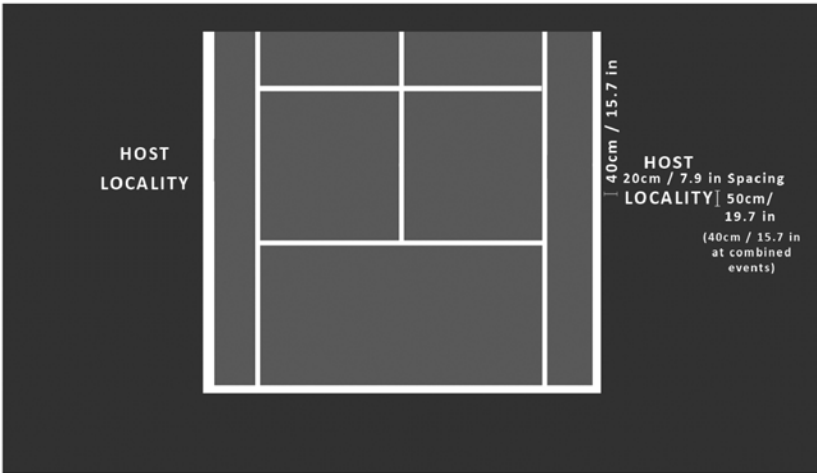
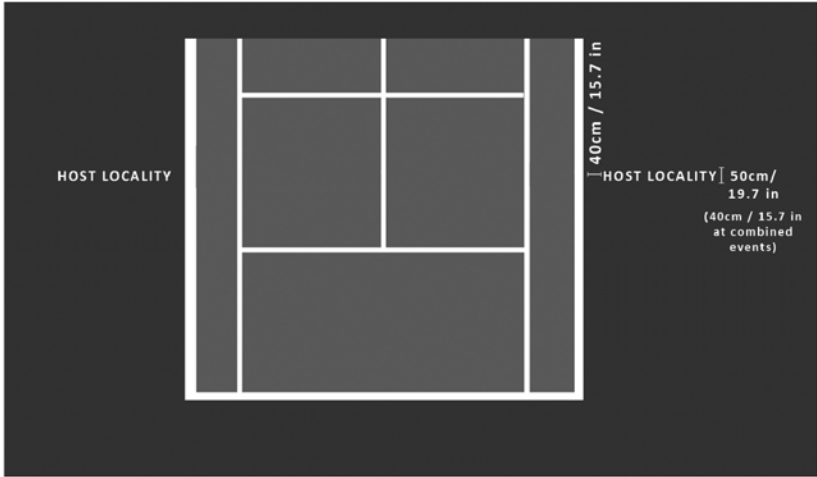

Please note that these diagrams are not to scale.

# APPENDIX H ON-COURT SIGNAGE

## WTA Logo - Court Surface

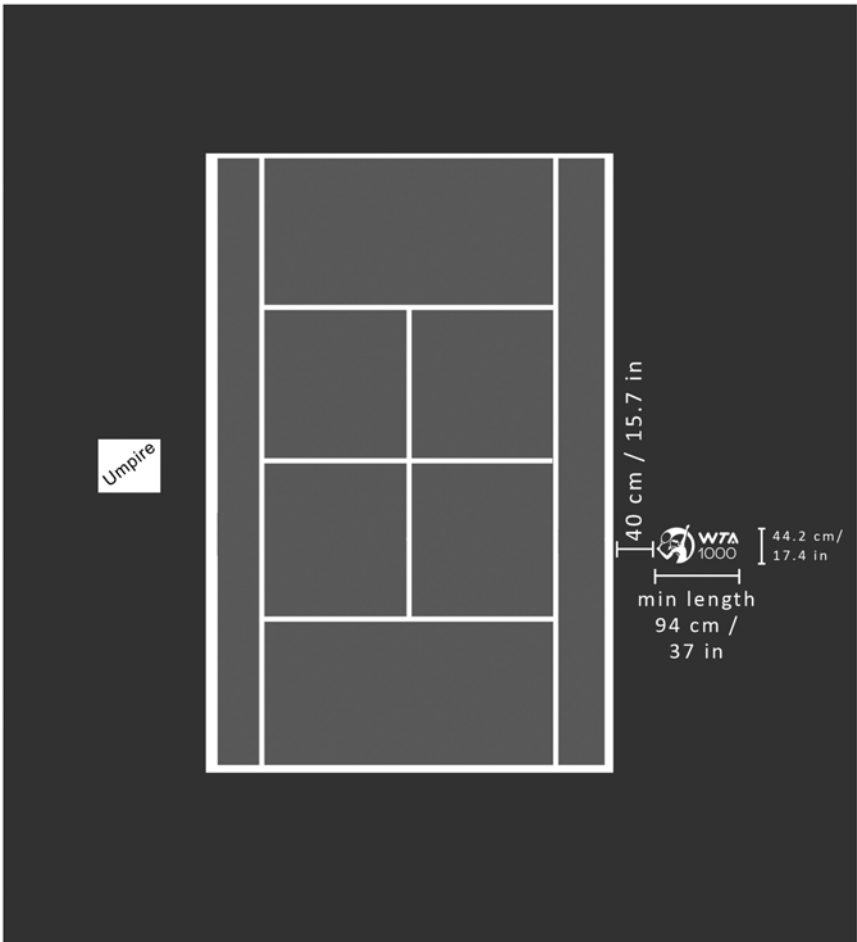

Please note that this diagram is not to scale.

## APPENDIX H ON-COURT SIGNAGE

### WTA Logo - Back Fence



Please note that these diagrams are not to scale.



# APPENDIX H ON-COURT SIGNAGE

Court Manufacturer

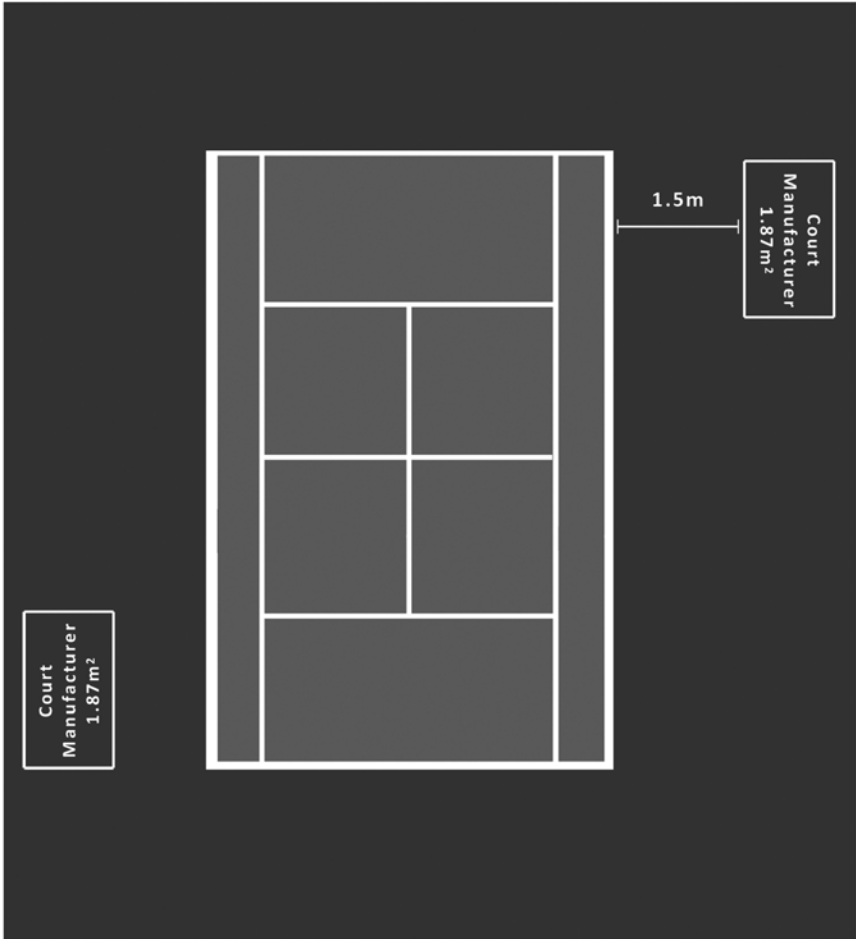

# APPENDIX I

## COURT AND LIGHT MEASUREMENTS

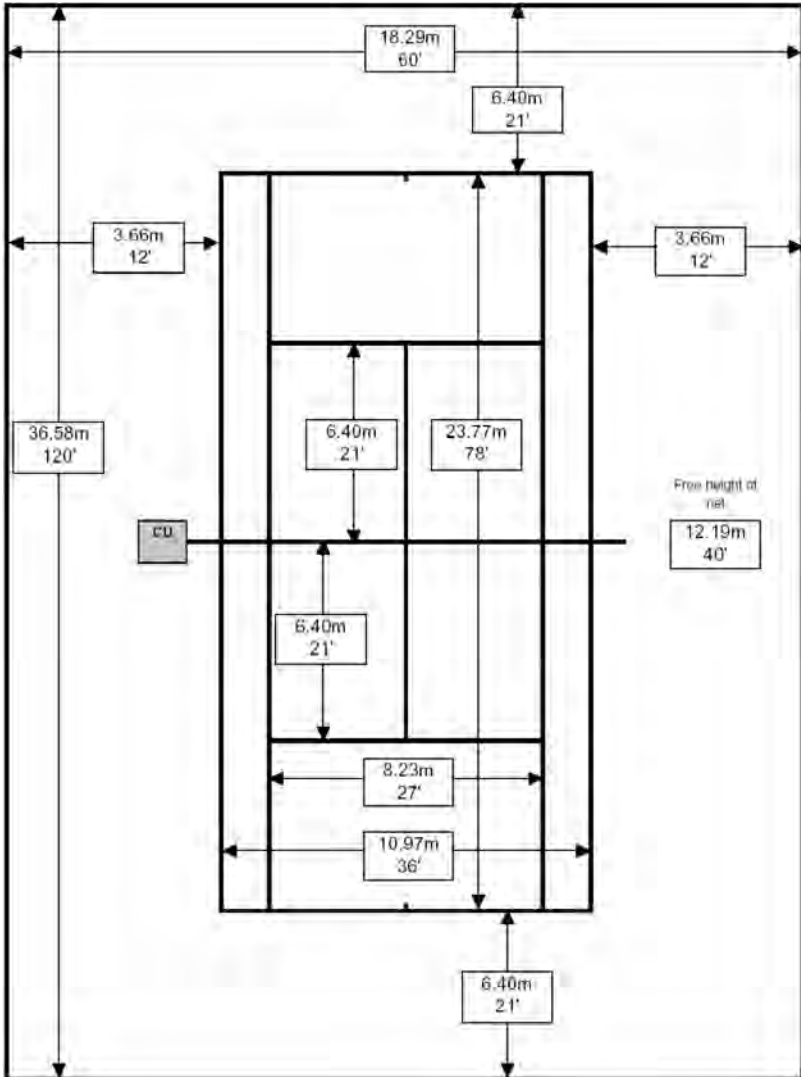

# APPENDIX I COURT AND LIGHT MEASUREMENTS

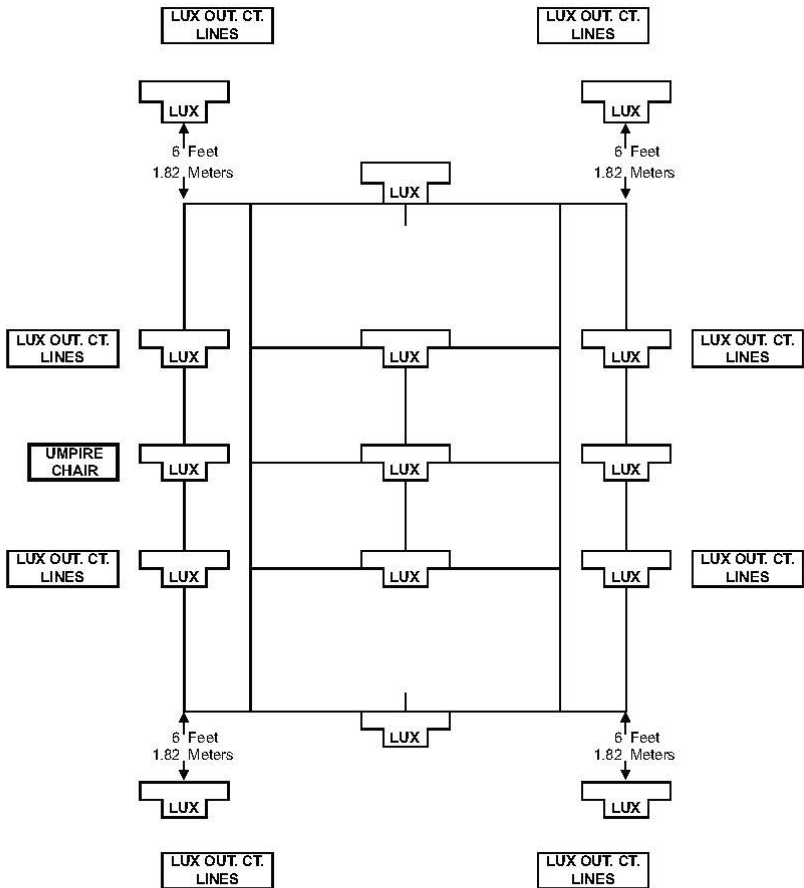

Readings  
Displayed in  
LUX

AVERAGE:

HIGH:

LOW:

RATIO:

Required Minimum Average:

1076

Required Maximum Ratio:

1.50

## APPENDIX J

### UNITED CUP RULES

The United Cup is a country vs country mixed team competition for eighteen (18) teams with a minimum of four (4) players (two (2) WTA players and two (2) ATP players) and a maximum of six (6) players (three (3) WTA players and three (3) ATP players) on each team.

#### A. Player Nationality

1. A player's nationality as of the entry date shall be used to determine team entry. All player nationality determinations are subject to WTA approval.
2. Change of Nationality
  - a. A player may only represent one (1) country in the United Cup during her career, unless:
    - i. The player changes her nationality in the WTA database; and
    - ii. Any of the following apply:
      - (a) The player competed under such nationality in the Billie Jean King Cup or Olympic Tennis Event;
      - (b) The player competed under such nationality in Professional Tennis tournaments during the Tour Year immediately preceding the United Cup;
      - (c) WTA determines the full circumstances of the player's situation demonstrate the player has a sufficient, genuine connection to the country that the player wishes to represent; or
      - (d) In exceptional circumstances, as determined by WTA.
  - b. All requests to change a player's nationality are subject to WTA approval.

#### B. Team Qualification

1. Entry
  - a. Players must enter the Tournament to be eligible.
  - b. The entry deadline is 5:00 p.m. Eastern time (New York, USA time) on October 17, 2023.

**APPENDIX J**  
**UNITED CUP RULES**

2. Acceptance

a. At the entry deadline

- i. Acceptance is determined using the WTA/ATP Singles Ranking or Singles Special Ranking/Protected Ranking of a country's highest-ranked singles player based on the rankings as of the Monday before the entry deadline.
- ii. The teams with the five (5) highest-ranked WTA players and five (5) highest-ranked ATP players to enter will be accepted as the first ten (10) teams. If players of the same nationality qualify in both WTA and ATP, the next-highest-ranked players will qualify their country until ten (10) teams are qualified (five (5) from WTA top-ranked players and five (5) from ATP top-ranked players).

If two (2) or more players' rankings are tied, then a player using her actual WTA Ranking receives priority over a player using her Special Ranking. If two (2) or more players' actual WTA Rankings are tied or Special Rankings are tied, the ranking (actual WTA Ranking or Special Ranking) of the next highest ranked player on each team will break the tie. If still tied, the next highest ranked player, and so on.

- iii. The next six (6) teams are determined using the highest combined ranking of the highest-ranked WTA player and highest-ranked ATP player from each team (other than players on the teams already accepted); provided, however, that if the host country does not qualify for acceptance, it will receive one (1) Wild Card and only five (5) teams will be accepted using combined rankings.

If two (2) or more teams are tied, the team with the highest ranked singles player (WTA or ATP) takes priority. If still tied, the team with the next highest ranked singles player (WTA or ATP) takes priority.

- b. On November 20, 2023 at 12:00 p.m. Eastern time, the remaining two (2) teams (one (1) based on a highest-ranked ATP player and one (1) based on a highest-ranked WTA player) will be accepted based on rankings as of that day; provided, however, that the teams must have entered by the entry deadline.

## APPENDIX J UNITED CUP RULES

### 3. Alternates

- a. The Alternate Team is the first team out of the final acceptance list.
- b. If needed, players may be granted a release from any other WTA Qualifying they are entered in during the period of the United Cup if released prior to the start of Qualifying of the WTA Tournament, pending WTA approval.
- c. The Alternate Team may be selected for participation until 10:00 a.m. local time in Perth/Sydney the day prior to the start of competition.

### C. Team Composition

1. Each team represents one (1) country and must have a minimum of two (2) WTA players, all of which must have a WTA Singles Ranking or Singles Special Ranking as of the Monday before the entry deadline.
  - a. Players 1-2 on each team are determined using a player's WTA Singles Ranking or Singles Special Ranking.
  - b. If two (2) or more players' rankings are tied, then the following player receives priority:
    - i. The player using her actual WTA Ranking over the player using her Special Ranking; then
    - ii. The player with the most total points from Grand Slams, WTA 1000 Mandatory Tournaments, and the WTA Finals; then
    - iii. The player with the fewest Tournaments played (counting all missed Grand Slams and WTA 1000 Mandatory Tournaments a player could have played as if she played them); then
    - iv. The player with the highest number of points from a single Tournament, then, if needed, the second highest points from a single Tournament, and so on; then
    - v. The player who wins a coin toss.
2. Teams may include a third WTA player.
  - a. Position 3 on each team is determined using the highest of a player's WTA Singles Ranking (up to 500), Singles Special Ranking (up to 500), WTA Doubles Ranking (up to 250), or Doubles Special Ranking (up to 250).

**APPENDIX J**  
**UNITED CUP RULES**

- b. If two (2) or more players' rankings are tied, then the following player receives priority:
  - i. The player using her actual WTA Ranking over the player using her Special Ranking; then
  - ii. If the best-of ranking is tied, the player with the highest WTA Singles Ranking (ties between singles rankings are broken according to B.1.b above).
3. Provided that only one (1) junior player may be included per gender per team, if a team does not have a third player who meets the criteria above, a junior player may be a team's third player if she:
  - a. Is under 18 years of age; provided, however, that she is subject to the Age Eligibility Rule\*;
  - b. Has entered; and
  - c. As of the Entry Deadline, has an ITF Junior World Ranking of 50 or better;

\*If a player subject to the Age Eligibility Rule is accepted into the United Cup, the Tournament counts toward the player's AER Tournament Allotment.
4. If a team includes a Top 20 WTA or ATP player but does not meet the qualification criteria for the WTA or ATP second player, the United Cup Steering Committee has discretion to determine such team's qualification.

**D. Withdrawals and Replacements**

A player's withdrawal from the United Cup is subject to all applicable withdrawal requirements and penalties in Section IV of the WTA Rules.

1. Late Withdrawals
  - a. Any withdrawal after 5:00 p.m. Eastern time on October 17, 2023 will be considered a Late Withdrawal.
  - b. Any player withdrawing after acceptance is not permitted to participate in any other Tennis Event during the United Cup Competition; provided, however, that a player accepted as the third player on a team may withdraw from the team to play another Tennis Event during the United Cup if she withdraws prior to the applicable entry deadline for such Tennis Event.

**APPENDIX J**  
**UNITED CUP RULES**

2. After Entry Deadline But Prior to 10am Local Time the Day Before Competition Starts

A withdrawing player may be replaced with another player who has entered in accordance with the below procedures. Only when a team number drops below two (2) may a team replace a withdrawing player with a player who has not entered. All player replacements are subject to WTA/ATP approval.

a. Number 1 Player Withdrawal

- i. If the highest ranked player on a team withdraws, the team remains in the competition provided that (i) the team has a minimum of two (2) WTA players with a WTA Singles Ranking, unless otherwise approved by the WTA/ATP, and (ii) one (1) team member (WTA or ATP) has a WTA/ATP Singles Ranking of 250 or better\*. This can include a replacement player. Number 1 and Number 2 Players (as defined below) are reclassified if necessary.
- ii. The next highest ranked singles player from the team's country as of the Monday before the entry deadline who has entered will be added to the team, unless otherwise approved by the WTA/ATP.
- iii. If the team's number drops below two (2) and no other players are entered from the team's country, the team may add a replacement player who has not entered provided that the above criteria for the team to remain in the competition is met.

\*If through the withdrawal of the Number 1 Player or the Number 1 and Number 2 Players, a team does not have at least one (1) player ranked 250 or better in singles, then the team may be withdrawn and replaced by an alternate team.

b. Number 2 Player Withdrawal

- i. If the second highest ranked player on a team withdraws, the next-highest-ranked singles player from the team's country as of the Monday before the entry deadline who has entered will be added to the team, unless otherwise approved by WTA/ATP. Such player may be (a) a player not already accepted into a Tournament in the same week; (b) a player who by approval of WTA/ATP may withdraw from Qualifying of a Tournament in the same week before the start of Qualifying without penalty; or (c) a player who by approval of WTA/ATP may withdraw from the



## **APPENDIX J**

### **UNITED CUP RULES**

Main Draw of a WTA 125 Tournament in the same week before the draw is made without penalty.

- ii. If the team's number drops below two (2) and no other players are entered from the team's country, the team may add a replacement player who has not entered.

#### **3. Withdrawal After Competition Starts**

- a. If the team number falls below two (2) WTA players, the Team Captain may nominate a replacement player during the competition provided that the player is not accepted into any draw for another Tournament in the same week.
- b. If a team only has one (1) player remaining from the WTA, the team may continue in the competition provided that the player has a WTA Singles Ranking, unless otherwise approved by WTA/ATP. The players must play singles and be available for mixed doubles.
- c. A team may replace a player after the competition has begun provided that the player is not violating WTA Rules by withdrawing from one Tournament to play another, or as approved by WTA/ATP. In no case may a player compete in two Tournaments held in the same week.
- d. In the event of a conduct default, the Supervisor may decide to remove the offending player(s) for the remainder of the Tie or Tournament.

#### **E. Competition Format**

##### **1. The Tie**

###### **a. Format**

A Tie consists of one (1) WTA singles match, one (1) ATP singles match, and one (1) mixed doubles match. The team that wins the most matches wins the Tie. Players are permitted to play both singles and doubles.

###### **i. Singles**

- (a) The singles players are the highest ranked WTA and ATP players (including Special Rankings) as of the Monday before the entry deadline, unless there is a medically supported substitution or otherwise approved by the Supervisor.

**APPENDIX J**  
**UNITED CUP RULES**

- (b) The highest-ranked singles players from each team (“Number 1 Players”) compete against each other. Positions are based upon the WTA Rankings (including Special Rankings) as of the Monday before the start of the competition. Changes may be allowed for medical conditions or for unforeseen circumstances if approved by the WTA/ATP Supervisors.
  - (c) If a player withdraws and changes the player positions on a team after the order of play is released but before the start of the first match, the order of play will be adjusted based upon the new team order (e.g., if the Number 1 Player withdraws, the next highest-ranked singles player becomes the Number 1 player.
  - (d) All singles matches are the best of three (3) sets.
- ii. Doubles
- (a) The mixed doubles team may be chosen from any players named to the team.
  - (b) A player who withdraws from singles is eligible to play mixed doubles in the same Tie.
  - (c) All doubles matches are the best of three (3) sets with No-Ad scoring in the first two (2) sets and a 10-point match tie-break as the third set.
  - (d) The doubles match must be played regardless of the results of the singles matches.\*

\*For the Final Tie, if the Tie is decided following the singles matches, then the mixed doubles match will not be played (unless mutually agreed by both teams). In such case, the prize money for the doubles win will be split evenly between the members of both teams.

b. Timing

- i. Each team Captain must submit in writing to the Supervisor the name of the team’s four (4) singles players and the mixed doubles team selected to compete by 3:00 p.m. local time the day prior to the scheduled Tie.
- ii. The Team Captain must notify the WTA/ATP Supervisor in writing of any change to the mixed doubles team within ten (10) minutes

**APPENDIX J**  
**UNITED CUP RULES**

of the conclusion of the second singles match. The Supervisor will notify the opposing Team Captain and all other relevant staff once both Team Captains have submitted their doubles teams.

- iii. The Team Captain must name the mixed doubles team one (1) hour before the start of the day's play if her or his team has no singles matches on that day.
- iv. If none of the players designated for the mixed doubles has competed in the last singles match, the mixed doubles shall be scheduled as "followed by" with the exact time determined by the Supervisor (fifteen (15) minutes is recommended). If one (1) or more of the doubles players competed in the last singles match, there shall be a maximum of twenty-five (25) minutes between the end of the last singles match and the start of the mixed doubles match.
- v. The Team Captain must submit in writing to the Supervisor the names of the four (4) singles players and the mixed doubles team to the Supervisor within fifteen (15) minutes after the completion of the second Semi-Final determining the teams for the Finals.
- vi. In the event of player changes in a match, the Supervisor may allow reasonable time adjustments in the schedule.

**2. Group Stage**

The group stage of the competition is a round robin format with six (6) groups of three (3) teams each. Each team plays both other teams in its group during round robin stage.

**a. Seeding**

- i. Seeding is based on the combined ranking (not including Special Rankings) of the top WTA player and top ATP player on each team as of the rankings the Monday before the entry deadline.
- ii. In the case of a tie, the team with the highest ranked singles player (WTA or ATP) becomes the higher seed. If teams are still tied, the team with the highest ranked second singles player becomes the higher seed.

**APPENDIX J**  
**UNITED CUP RULES**

- b. The Draw
- i. Group A consists of Seed 1 plus one (1) randomly selected team from seeding group 7-12 and one (1) randomly selected team from seeding group 13-18.
  - ii. Group B consists of Seed 2 plus one (1) randomly selected team from seeding group 7-12 and one (1) randomly selected team from seeding group 13-18.
  - iii. Group C consists of Seed 3 plus one (1) randomly selected team from seeding group 7-12 and one (1) randomly selected team from seeding group 13-18.
  - iv. Group D consists of Seed 4 plus one (1) randomly selected team from seeding group 7-12 and one (1) randomly selected team from seeding group 13-18.
  - v. Group E consists of Seed 5 plus one (1) randomly selected team from seeding group 7-12 and one (1) randomly selected team from seeding group 13-18.
  - vi. Group F consists of Seed 6 plus one (1) randomly selected team from seeding group 7-12 and one (1) randomly selected team from seeding group 13-18.
  - vii. Two (2) cities are assigned three (3) groups each, according to the following:
    - (a) Group A, Group C, and Group E
    - (b) Group B, Group D, and Group F
- c. Determination of Group Winners
- i. The first of the following methods that applies determines the group winners from the Group Stage:
    - (a) Greatest number of Ties won; then
    - (b) Greatest number of Ties played; then
    - (c) Head-to-head results if only two teams are tied; or

**APPENDIX J**  
**UNITED CUP RULES**

- (d) If three (3) teams are tied:
  - (i) The team with fewer total matches (singles and doubles) will be eliminated and the winner of the head-to-head matchup between the two (2) remaining teams advances; or if still tied,
  - (ii) The team with the most match wins (singles and doubles); or if still tied,
  - (iii) The team with the highest percentage of matches won; or if still tied,
  - (iv) The team with the highest percentage of sets won; or if still tied,
  - (v) The team with the highest percentage of games won; and
  - (vi) If (b), (c), (d), or (e) produces one superior team, then the tie is broken; or
  - (vii) If (b), (c), (d), or (e) produces one inferior team, then that team is eliminated and the winner of the head-to-head matchup between the two (2) remaining teams is the winner of the group.
  
- ii. In all tie-break situations, the following applies:
  - (a) A walkover counts as a Tie played in the winning team's results, but it does not count as a Tie played for the team causing the walkover;
  - (b) Unplayed singles or doubles matches are scored as completed for purposes of matches played;
  - (c) Defaulted and retired singles or doubles matches are scored as completed for purposes of matches played and count as a straight set win or loss; however, games won or lost in matches with a defaulting or retiring player are not counted for percentage of games won;
  - (d) Teams advancing from a Tie via a team walkover (i.e., no alternate) count as a Tie won, but it does not count toward total matches won, percentage of sets won, or percentage of games won;

**APPENDIX J**  
**UNITED CUP RULES**

- (e) Any team that withdraws from any round robin Tie after the first round robin Tie is not eligible for the Quarterfinals; and
- (f) The doubles match tie-break counts as a set won and a game won.

3. Quarterfinals

- a. The six (6) Group Winners advance to the Quarterfinals with the final two (2) spots awarded to the one (1) best runner up in each city. The Quarterfinals is a knock-out competition for a guaranteed spot in the Semi-Finals.
- b. Determination of Best Runner-Up
  - i. The first of the following methods that applies determines the best runner-up\*:
    - (a) Greatest number of Ties won; then
    - (b) Greatest number of Ties played; then
    - (c) In a tie between three (3) teams, the following applies:
      - (i) If the teams have the same number of wins, then the team having played fewer total matches (singles and doubles) will be eliminated; or if still tied,
      - (ii) The team with the most match wins (singles and doubles); or if still tied,
      - (iii) The team with the highest percentage of matches won; or if still tied,
      - (iv) The team with the highest percentage of sets won; or if still tied,
      - (v) The team with the highest percentage of games won; and
      - (vi) If (b), (c), or (d) produces one superior team, then the tie is broken.
  - ii. In all tie-break situations, the following applies:
    - (a) A walkover counts as a Tie played in the winning team's

## APPENDIX J UNITED CUP RULES

results, but it does not count as a Tie played for the team causing the walkover.

- (b) Unplayed matches are scored as completed for purposes of matches played;
- (c) Defaulted and retired singles or doubles matches are scored as completed for purposes of matches played and count as a straight set win or loss; however, games won or lost in matches with a defaulting or retiring player are not counted for percentage of games won;
- (d) Advancing from a Tie via a team walkover (i.e., no alternate) counts as a Tie won, but it does not count toward total matches won, percentage of sets won, or percentage of games won; and
- (e) Any team that withdraws from the Quarterfinals is not eligible for the Semi-Finals.
- (f) The doubles match tie-break counts as a set won and a game won.

### b. Draw

- i. The winner of Group 1 will play the best runner-up\* from the remaining groups from the city.
- ii. The winner of Group 3 will play the winner of Group 5\*.
- iii. The winner of Group 2 will play the best runner-up\* from the remaining groups from the city.
- iv. The winner of Group 4 will play the winner of Group 6\*.

\*If a runner-up team is from Group 1 or Group 2, it will swap positions with the winner of the lowest ranked group in its city to prevent two teams from the same group playing against each other before the Final of the competition.

### 4. Semi-Finals

The four (4) winners of the Quarterfinals play in a knock-out competition in the Semi-Finals.

**APPENDIX J**  
**UNITED CUP RULES**

**5. Finals**

The winner of each Semi-Final will play in a knock-out competition in the Finals.

**F. Team Captain**

**1. Designation of Team Captain**

a. The highest-ranked player (WTA or ATP) on each team at the time at which the team is accepted is the default Team Captain; however, each team can elect another player or person as Team Captain. The highest-ranked player has the authority on the Team Captain. If the highest-ranked player decides to appoint a Team Captain, the chosen person must be of the same nationality and one of the following: (i) a current or former WTA or ATP player; or (ii) a WTA or ATP coach; provided, however, that exceptions are subject to approval by the United Cup Steering Committee.

b. The Team Captain must be confirmed and submitted to the WTA or ATP, as applicable, no later than December 1.

**2. Duties of Team Captain**

a. Attend all team meetings;

b. Submit the team's lineup;

c. Act as official representative for the team; and

d. Be on-site for the duration of the team's participation in the competition.

The designated Team Captain may sit on court during matches, and coaching is permitted. However, only a player playing in a match can initiate challenges to line calls.

**G. Coaches**

1. Each player's personal coach may coach during her matches.

2. Coaches with multiple players may coach their players even if they are competing for different teams. If the coach has a player competing on each team during a match, then the coach may only be in the team box for one (1) country in that Tie.



**APPENDIX J  
UNITED CUP RULES**

3. A Team Captain may only sit on court and coach for the team she or he is captaining.

**H. Clothing**

1. All team members must dress in similar clothing that identifies them with the country they are representing.
2. Team clothing must be submitted to and approved by WTA and ATP in advance of the event.
3. Team Captains must wear Tournament provided clothing (polo shirt/jacket/hat) with the United Cup logo while on the team bench and performing all Captains' duties both on and off court. Captains with ongoing personal clothing sponsorships are permitted to wear a shirt other than the United Cup polo shirt provided that: (i) the shirt is in the team color or similar; (ii) the sponsor logos comply with WTA/ATP sizing and placement guidelines; and (iii) the WTA/ATP have approved the shirt in advance of the event.

**I. Prize Money**

Total prize money is \$10,000,000 (\$5,000,000 each to WTA players and ATP players). All prize money figures are in USD.

1. Participation Fee

<b>Ranking*</b>	<b>Number 1 Player</b>	<b>Number 2 Player</b>
1-10	\$200,000	\$200,000
11-20	\$100,000	\$100,000
21-30	\$60,000	\$50,000
31-50	\$40,000	\$30,000
51-100	\$30,000	\$20,000
101-250	\$25,000	\$15,000
251+	\$20,000	\$10,000

<b>Ranking*</b>	<b>Number 3 Player</b>
1-30	\$30,000
31-100	\$15,000
101-250	\$7,500
251+	\$6,000

\*Singles Ranking or Singles Special Ranking used for acceptance.

## APPENDIX J UNITED CUP RULES

### Notes

- Players may only receive a participation fee in one category (singles or mixed doubles, whichever was used for their acceptance).
- Participation fees for any team replacements following the October 17, 2023 entry deadline are based on the entry ranking team order and player ranking.
- Number 2 players receive 100% of the participation fee regardless of whether they compete in any of the Group Stage matches.
- Number 1 singles players receive 100% of the participation fee if they compete in all Group Stage singles matches. Number 1 players competing in less than all Group Stage singles matches receive pro-rata participation fees according to the schedule below.

<b>2024 Participation Fee – Group Stage Pro-Rata Schedule</b>			
Number 1 Players	Promotional Percentage	Per Singles Match Percentage	Doubles Match Percentage
		40%	30%

- Applies to Group Stage matches and Ties only
- Applies to all Number 1 Players including players using their Special Ranking
- Promotional Percentage = minimum participation fee

\*15% maximum for mixed doubles matches, regardless of whether a player plays one (1) or two (2) mixed doubles matches during the Group Stage. Players competing in singles and mixed doubles in a Tie receive the Promotional fee plus 30% per singles match. A Number 1 Player only playing two (2) mixed doubles matches during the Group Stage receives 40% Promotional + 15% total for both mixed doubles matches (55% overall). See examples in the table below.

Scenario	Group Tie 1		Group Tie 2		Fee Collected
	Singles	Doubles	Singles	Doubles	
A	X		X		100%
B	X			X	85%
C	X	X			70%
D	X				70%
E		X		X	55%
F		X			55%
G					40%

**APPENDIX J  
UNITED CUP RULES**

2. Per Individual Wins

Match Wins	Number 1 Player	Doubles Player
Final Win	\$251,000	\$47,255*
Semifinal Win	\$132,000	\$24,750*
Quarterfinal Win	\$69,500	\$13,000
Group Win	\$38,325	\$7,200

\*If a Tie is decided following the singles matches, the doubles match may not be played. In such case, the doubles win prize money will be split evenly among the members of both teams.

3. Per Team Wins

Team Wins	Prize Money per Player*
Final Win	\$23,155
Semifinal Win	\$13,650
Quarterfinal Win	\$8,025
Group Win	\$5,000

\*All players on a team earn the same prize money for a team win regardless of whether a player plays a match.

**J. WTA Ranking Points**

WTA ranking points at the United Cup are awarded for the singles competition only. No points are awarded if no matches of a Tie are played. The ranking points that a player earns at the United Cup may count on her ranking as one (1) of her other best six (6) results.

Match Wins	Opponent's Ranking*						
	1-10	11-20	21-30	31-50	51-100	101-250	251+**
Final Win	180	140	120	90	60	40	35
Semifinal Win	130	105	90	60	40	35	25
Quarterfinal Win	80	65	55	40	35	25	20
Group Win	55	45	40	35	25	20	15
Max Points^	500	400	345	260	185	140	110

\*Singles Ranking or Singles Special Ranking as of the Monday before the start of the competition.

\*\*If an individual match in a Tie is won by a walkover, points are awarded based upon the lowest ranking category (251+).

^A player who wins all five (5) matches receives 500 points. A player who wins four (4) of five (5) matches receives a minimum of 325 points or points per the table above, whichever is higher.

**APPENDIX J**  
**UNITED CUP RULES**

**K. Special Ranking**

The Special Ranking Rules and restrictions in Section VIII.C and the following apply to the United Cup:

- a. Special Rankings may be used for team entry, position in the singles lineup, and categories for ranking points;
- b. Special Rankings do not count for team seeding;
- c. If a player uses her Special Ranking for team entry, it will count toward her maximum Tournaments to use her Special Ranking; and
- d. A player may use her Special Ranking to participate in the United Cup only one (1) time per Special Ranking.

**L. Jurisdiction Governing the Competition**

1. The Competition is sanctioned and recognized by WTA Tour and ATP Tour, Inc.
2. All players who enter and compete in the competition agree to be subject to the Rules and Regulations of the WTA and ATP, including, but not limited to, the Code of Conduct, the Tennis Anti-Corruption Program, and the Tennis Anti-Doping Program.
3. The WTA/ATP Supervisors, in consultation with the WTA SVP, Competition & On-Site Operations and the ATP SVP, Rules & Competition, shall determine and resolve all questions not considered in these Rules and Regulations.



## APPENDIX K

### GLOSSARY

**ACES** - Media/sponsor/WTA-related activities at each Tournament.

**Additional Seed** - A player in the Main Draw who does not play another seeded player in the first-round of that draw because of her Special Ranking.

**Age** - For the purposes of the Age Eligibility Rule, a player's age is determined by her age as of the date of the start of a Tournament's singles Main Draw. For the purposes of the Years of Service Rule, a player's age is determined by her age as of January 1 of a Tour Year.

**Alternate** - Any player who has entered a Tournament but who has not been accepted into either the Main Draw or Qualifying Draw of that Tournament.

**Board of Directors** - The Board of Directors of the WTA, comprised of three (3) Player Board Representatives, three (3) Tournament Board Representatives, one (1) ITF Board Representative, and the CEO.

**Breach** - Violation of a rule.

**Bye** - Advances a player to the second round without playing a match, either because there are a designated number of byes assigned to seeded players from the outset, or because there are vacancies in the draw and no Alternates are available to fill the spots.

**Commitment Tournaments** - All Tournaments that a player must play if she is accepted, or would have been accepted if she had entered, into the Singles Main Draw at the Tournament's Entry Deadline.

**Committee** - The WTA Code of Conduct Committee, the body comprised of WTA staff members, Player Board Representatives, Tournament Board Representatives, and an ITF Board Representative, which shall hear appeals of Code of Conduct violations and fines and consider changes to the Code.

**Default** -The losing player is defaulted under the Code of Conduct after the match has been called.

**ELC System** - A WTA-approved electronic system for reviewing line calls and/or overrules.

**Exhibition/Non-WTA Event** - A tennis competition involving one (1) or more Players who compete in Professional Tennis tournaments whether or not the Player or Players receive remuneration for their participation in the event, which is not a part of the WTA or Women's ITF World Tennis Tour and is not recognized on the WTA or ITF Women's

## APPENDIX K GLOSSARY

calendars. These events include single-day, multiple-day, week-long, and seasonal team-oriented competitions, as well as charity events.

**Identification** - Any sort of identification associated with, or intended to be associated with, a commercial sponsor, an apparel manufacturer, or any other person or entity, regardless of the trademark registration status of the identification, and shall include any and all forms of writing.

**ITF Rules of Tennis** - The rules of tennis promulgated by the ITF, which can be found at [www.itftennis.com/en/about-us/governance/rules-and-regulations/](http://www.itftennis.com/en/about-us/governance/rules-and-regulations/).

**ITF World Tennis Tour W15+ Event** - A Women's ITF World Tennis Tour event with prize money between \$15,000 and \$100,000. Results from these events are eligible for inclusion on the WTA Rankings.

**ITIA** - International Tennis Integrity Agency.

**Long-Term Injury** - An absence from play in any form of women's Professional Tennis due to a Medical Condition for at least eight (8) consecutive weeks counting from the player's last Tournament played.

**Lucky Losers** - Players who are placed in the Main Draw to fill vacancies after they have been eliminated in the final Qualifying round or, if more Lucky Losers are required, in the previous Qualifying round(s).

**Manufacturer** - The entity that distributes, or offers for sale, tennis racquets, clothing, strings, or shoes.

**Medical Condition** - A medical illness or a musculoskeletal injury that warrants medical evaluation or medical treatment.

**Minimum Player Compensation (MPC)** - A Tournament's minimum gross publicized compensation paid to players.

**Modification of Play** - A ten (10) minute break allowed between the second and third sets when the Heat Stress Index (WBGT) meets or exceeds 30.1 degrees Celsius/86.2 degrees Fahrenheit or the Heat Index (Apparent Temperature) meets or exceeds 34.0 degrees Celsius/93.2 degrees Fahrenheit.

**Off Season** - Weeks 45-52.

**Official with International Certification** - An official who has successfully passed the ATP-ITF-WTA Joint Officiating Program school, proven by earning an international certification (Green, White, Bronze, Silver, or Gold).

**Out of Competition** - Not participating in any Tennis Event other than an Exhibition/

## APPENDIX K GLOSSARY

Non-WTA Event for which a player was granted a waiver or competing in any other organized sport.

**Out-of-Competition Period** - A period during which a player is Out of Competition for a minimum of twenty-six (26) weeks, which for a particular player is calculated using the last day of the last Tennis Event that she played and the date of her Return to Competition.

**Parental Start** - Adoption, surrogacy, or becoming the legal guardian of a person under the age of eighteen (18).

**Penalty** - Financial or disciplinary action taken against a WTA player or Tournament that fails to fulfill their professional obligations or violates a Rule.

**Performance Bye** - The type of bye awarded to a player based on her previous week's performance as determined by the WTA when approving the calendar and draw sizes.

**Player** - Any professional or amateur woman tennis player, whether a member of the WTA/WTBA or not, who applies to enter a Tournament.

**Player Support Team Member** - Any coach, trainer, manager, agent, medical, paramedical, family member, tournament guest, or other similar associate of any player.

**Prize Money Formula (PMF)** - The formula used to determine the Minimum Player Compensation a Tournament must pay to players.

**Point** - Unit of counting in the scoring of a game or contest.

**Pregnancy** - The medically-diagnosed condition of being pregnant.

**Professional Tennis** - For the purposes of the Age Eligibility Rule, any Tournament at which a player earns WTA Ranking points (singles or doubles) or, but for the operation of the WTA Rules or the player's violation of the WTA Rules, would have earned WTA ranking points. For the purposes of a Long-Term Injury, any form of women's professional tennis, including WTA Tournaments, Grand Slams, Billie Jean King Cup, Women's ITF World Tennis Tour events, and any Exhibition/Non-WTA Event.

**Qualified Singles Event** - The singles event of a Tournament in the week before a Special Exempt Tournament in accordance with the chart in Section V.A.1.a.vii.

**Qualifier** - Those players accepted into the Main Draw because of their success in the Qualifying competition.



## APPENDIX K GLOSSARY

**Race Year** - Tournaments starting the week before the previous year's WTA Finals through and including Tournaments two weeks before the current year's WTA Finals.

**Referee** - Any official so designated by a Tournament at which the Code is in effect and approved by the WTA.

**Related Geographic Area** - In a country which has multiple WTA Tournaments, Related Geographic Area is a radius of approximately 125 miles (200 km) from an original venue. For those countries with only one (1) WTA Tournament, the Related Geographic Area is the entire country.

**Retirement** - After a match has started, a player does not finish the match because of illness or injury.

**Sanctioned Entity** - any individual or entity on any sanctions lists administered by the United States Department of Treasury's Office of Foreign Assets Control, the United Kingdom HM Treasury's Office of Financial Sanctions Implementation, or the European Union's European External Action Service.

**Shot Clocks** - Electronic timing devices controlled directly by the Chair Umpire's tablet.

**Special Exempt Spot** - A singles Main Draw spot reserved for a singles player who is unable to compete in the Qualifying of a WTA Tournament in which she has been accepted because she is still competing in a Qualified Singles Event.

**Special Ranking** - A player's ranking as of the WTA Rankings published immediately after (i) the points of the last Tournament she played before her Out-of-Competition Period began have been added to the WTA Rankings or (iii) the last Tennis Event she played before her Out-of-Competition Period began.

**Special Ranking Application** - Required documentation that a player must submit to WTA Operations for approval of a Special Ranking.

**Special Ranking Period** - A player has fifty-two (52) weeks from the date of her Return to Competition to use her Special Ranking.

**Supervisor** - Any official so designated or approved by the WTA at any Tournament at which the Code is in effect.

**Suspension of Play** - Suspending play because the Heat Stress Index (WBGT) meets or exceeds 32.2 degrees Celsius/90.0 degrees Fahrenheit or the Heat Index (Apparent Temperature) meets or exceeds 40.1 degrees Celsius/104.2 degrees Fahrenheit.

**TACP** - The Tennis Anti-Corruption Program, which can be found at [itia.tennis/tacp/](http://itia.tennis/tacp/).

**TADP** - The ITF Tennis Anti-Doping Programme, which can be found at [itia.tennis/tadp/](http://itia.tennis/tadp/).

## APPENDIX K GLOSSARY

**Tennis Event** - Any WTA Tournament, Grand Slam, ITF (including World Tennis Tour and Billie Jean King Cup) event, Olympic or Olympic Qualification event, or Exhibition/ Non-WTA Event, regardless of whether ranking points are awarded.

**Top 10 Player** - A player whose WTA Singles Ranking is 1-10 at a Tournament's Main Draw Entry Deadline.

**Top 30 Player** - A player whose WTA Singles Ranking is 1-30 at a Tournament's Main Draw Entry Deadline.

**Tour Year** - A year commencing the day immediately following the final day of the WTA Finals and extending through the final day of the WTA Finals the following calendar year.

**Tournament** - Any singles or doubles tennis competition administered by the WTA or approved as a WTA Ranking event by the WTA.

**Tournament Director** - The person or persons designated by a Tournament and responsible for the overall organization and conduct of the Tournament and other personnel as necessary.

**Tournament Logo** - The official identity of the Tournament that includes the Tournament name.

**Tournament Owner** - A person who or entity that owns the right to organize, promote, and conduct a professional women's tennis tournament on the WTA in a specific geographic region.

**Tournament Support Personnel** - Any Tournament Director, Tournament Owner, Tournament operator, Tournament employee, or any designated agent of the Tournament.

**Waive** - To make an exception to a rule or policy or dismiss charges brought against a recognized body or constituent of the WTA.

**Walkover** - Match did not begin because a) losing player was ill or injured or b) losing player was subjected to penalties of the Code of Conduct before first serve of match was struck or otherwise not permitted by the WTA or Tournament official to play. This would not be used when a Lucky Loser is substituted.

**Wild Card** - Players chosen by the Tournament Director to fill designated spots in the draw.

**Withdrawal** - The written communication by a player after her acceptance into a Tournament that officially notifies the WTA that the player will not participate in the Tournament.

## APPENDIX K GLOSSARY

**Withdrawal Statement** - A statement provided at the time of a player's withdrawal that contains the reason for her withdrawal and a suitable, in WTA Communications Department's discretion, quotation that the WTA may release to the media and public.

**WTA 125** - Tournaments sanctioned and licensed by the WTA that offer hospitality to the players, in addition to minimum prize money of \$125,000, and are eligible for inclusion of their results on the WTA Rankings.

**WTA Logo** - The logo that includes the WTA name and the name of any Title/Premier/Presenting sponsor, if applicable.

**WTA Rankings** - The worldwide computer rankings for women's Professional Tennis.

**WTA Tournaments** - The Tournaments comprising the WTA.

**WTBA** - Women's Tennis Benefit Association.

**Year-End WTA Rankings** - The WTA Rankings produced immediately following the previous year's WTA Finals.

**Years of Service Player** - A player thirty-four (34) years of age or older as of January 1 of the current Tour Year.

## APPENDIX L

### ITF RULES OF TENNIS

This Appendix L is only an excerpt of the ITF Rules of Tennis. For the complete and current ITF Rules of Tennis, please visit [www.itftennis.com/en/about-us/governance/rules-and-regulations/](http://www.itftennis.com/en/about-us/governance/rules-and-regulations/).

### ITF RULES OF TENNIS

	Foreword
Rule 1	The Court
Rule 2	Permanent Fixtures
Rule 3	The Ball
Rule 4	The Racket
Rule 5	Score in a Game
Rule 6	Score in a Set
Rule 7	Score in a Match
Rule 8	Server & Receiver
Rule 9	Choice of Ends & Service
Rule 10	Change of Ends
Rule 11	Ball in Play
Rule 12	Ball Touches a Line
Rule 13	Ball Touches a Permanent Fixture
Rule 14	Order of Service
Rule 15	Order of Receiving in Doubles
Rule 16	The Service
Rule 17	Serving
Rule 18	Foot Fault
Rule 19	Service Fault
Rule 20	Second Service
Rule 21	When to Serve & Receive
Rule 22	The Let During a Service
Rule 23	The Let
Rule 24	Player Loses Point
Rule 25	A Good Return
Rule 26	Hindrance
Rule 27	Correcting Errors
Rule 28	Role of Court Officials
Rule 29	Continuous Play
Rule 30	Coaching
Rule 31	Player Analysis Technology
	Amendment to the Rules of Tennis
Appendix I	The Ball
	Classification of Court Surface Pace
Appendix II	The Racket
Appendix III	Player Analysis Technology

## **APPENDIX L**

### **ITF RULES OF TENNIS**

- Appendix IV Advertising
- Appendix V Alternative Procedures and Scoring Methods
- Appendix VI Role of Court Officials
- Appendix VIII Plan of the Court
- Appendix IX Suggestions on How to Mark a Court

*References to the International Tennis Federation or ITF shall hereafter mean ITF Limited.*

### **FOREWORD**

The International Tennis Federation (ITF) is the governing body of the game of tennis and its duties and responsibilities include protecting the integrity of the game through determination of the Rules of Tennis.

To assist the ITF in carrying out this responsibility, the ITF has appointed a Rules of Tennis Committee which continually monitors the game and its rules, and when considered necessary makes recommendations for changes to the Board of Directors of the ITF who in turn make recommendations to the Annual General Meeting of the ITF which is the ultimate authority for making any changes to the Rules of Tennis.

Appendix V lists approved alternative procedures and scoring methods. In addition, on its own behalf or on application by interested parties, certain variations to the rules may be approved by the ITF for trial purposes only at a limited number of tournaments or events and/or for a limited time period. Such variations are not included in the published rules and require a report to the ITF on the conclusion of the approved trial.

**Note:** *If there are any inconsistencies between the English version and Rules of Tennis translated into other languages, the English version shall prevail.*

## APPENDIX L ITF RULES OF TENNIS

### 1. THE COURT

The court shall be a rectangle, 78 feet (23.77 m) long and, for singles matches, 27 feet (8.23 m) wide. For doubles matches, the court shall be 36 feet (10.97 m) wide.

The court shall be divided across the middle by a net suspended by a cord or metal cable which shall pass over or be attached to two net posts at a height of 3½ feet (1.07 m). The net shall be fully extended so that it completely fills the space between the two net posts and it must be of sufficiently small mesh to ensure that a ball cannot pass through it. The height of the net shall be 3 feet (0.914 m) at the centre, where it shall be held down tightly by a strap. A band shall cover the cord or metal cable and the top of the net. The strap and band shall be completely white.

- The maximum diameter of the cord or metal cable shall be 1/3 inch (0.8 cm).
- The maximum width of the strap shall be 2 inches (5 cm).
- The band shall be between 2 inches (5 cm) and 2½ inches (6.35 cm) deep on each side.

For doubles matches, the centres of the net posts shall be 3 feet (0.914 m) outside the doubles court on each side.

For singles matches, if a singles net is used, the centres of the net posts shall be 3 feet (0.914 m) outside the singles court on each side. If a doubles net is used, then the net shall be supported, at a height of 3½ feet (1.07 m), by two singles sticks, the centres of which shall be 3 feet (0.914 m) outside the singles court on each side.

- The net posts shall not be more than 6 inches (15 cm) square or 6 inches (15 cm) in diameter.
- The singles sticks shall not be more than 3 inches (7.5 cm) square or 3 inches (7.5 cm) in diameter.
- The net posts and singles sticks shall not be more than 1 inch (2.5 cm) above the top of the net cord.

The lines at the ends of the court are called baselines and the lines at the sides of the court are called sidelines.

Two lines shall be drawn between the singles sidelines, 21 feet (6.40 m) from each side of the net, parallel with the net. These lines are called the

## **APPENDIX L**

### **ITF RULES OF TENNIS**

servicelines. On each side of the net, the area between the serviceline and the net shall be divided into two equal parts, the service courts, by the centre serviceline. The centre serviceline shall be drawn parallel with the singles sidelines and half way between them.

Each baseline shall be divided in half by a centre mark, 4 inches (10 cm) in length, which shall be drawn inside the court and parallel with the singles sidelines.

- The centre serviceline and centre mark shall be 2 inches (5 cm) wide.
- The other lines of the court shall be between 1 inch (2.5 cm) and 2 inches (5 cm) wide, except that the baselines may be up to 4 inches (10 cm) wide.

All court measurements shall be made to the outside of the lines and all lines of the court shall be of the same colour clearly contrasting with the colour of the surface.

No advertising is allowed on the court, net, strap, band, net posts or singles sticks except as provided in Appendix IV.

In addition to the court described above, the court designated as “Red” and the court designated as “Orange” in Appendix VII can be used for 10 and under tennis competition.

*Note: Guidelines for minimum distances between the baseline and backstops and between the sidelines and sidestops can be found in Appendix IX.*

## **2. PERMANENT FIXTURES**

The permanent fixtures of the court include the backstops and sidestops, the spectators, the stands and seats for spectators, all other fixtures around and above the court, the chair umpire, line umpires, net umpire and ball persons when in their recognised positions.

In a singles match played with a doubles net and singles sticks, the net posts and the part of the net outside the singles sticks are permanent fixtures and are not considered as net posts or part of the net.

## **3. THE BALL**

Balls, which are approved for play under the Rules of Tennis, must comply with the specifications in Appendix I.

## **APPENDIX L**

### **ITF RULES OF TENNIS**

The International Tennis Federation shall rule on the question of whether any ball or prototype complies with Appendix I or is otherwise approved, or not approved, for play. Such ruling may be taken on its own initiative, or upon application by any party with a bona fide interest therein, including any player, equipment manufacturer or National Association or members thereof. Such rulings and applications shall be made in accordance with the applicable Review and Hearing Procedures of the International Tennis Federation.

The event organisers must announce in advance of the event:

- a. The number of balls for play (2, 3, 4 or 6).
- b. The ball change policy, if any.

Ball changes, if any, can be made either:

- i. After an agreed odd number of games, in which case, the first ball change in the match shall take place two games earlier than for the rest of the match, to make allowance for the warm-up. A tie-break game counts as one game for the ball change. A ball change shall not take place at the beginning of a tie-break game. In this case, the ball change shall be delayed until the beginning of the second game of the next set; or
- ii. At the beginning of a set

If a ball gets broken during play, the point shall be replayed.

*Case 1: If a ball is soft at the end of a point, should the point be replayed?*

*Decision: If the ball is soft, not broken, the point shall not be replayed.*

Note: Any ball to be used in a tournament which is played under the Rules of Tennis, must be named on the official ITF list of approved balls issued by the International Tennis Federation.

#### **4. THE RACKET**

Rackets, which are approved for play under the Rules of Tennis, must comply with the specifications in Appendix II.

The International Tennis Federation shall rule on the question of whether any racket or prototype complies with Appendix II or is otherwise approved, or not approved, for play. Such ruling may be undertaken on its own initiative, or upon application by any party with a bona fide



## **APPENDIX L**

### **ITF RULES OF TENNIS**

interest therein, including any player, equipment manufacturer or National Association or members thereof. Such rulings and applications shall be made in accordance with the applicable Review and Hearing Procedures of the International Tennis Federation.

*Case 1: Is more than one set of strings allowed on the hitting surface of a racket?*

*Decision: No. The rule mentions a pattern (not patterns) of crossed strings. (See Appendix II)*

*Case 2: Is the stringing pattern of a racket considered to be generally uniform and flat if the strings are on more than one plane?*

*Decision: No.*

*Case 3: Can vibration damping devices be placed on the strings of a racket? If so, where can they be placed?*

*Decision: Yes, but these devices may only be placed outside the pattern of the crossed strings.*

*Case 4: During a point, a player accidentally breaks the strings. Can the player continue to play another point with this racket?*

*Decision: Yes, except where specifically prohibited by event organisers.*

*Case 5: Is a player allowed to use more than one racket at any time during play?*

*Decision: No.*

*Case 6: Can a battery that affects playing characteristics be incorporated into a racket?*

*Decision: No. A battery is prohibited because it is an energy source, as are solar cells and other similar devices.*

## **5. SCORE IN A GAME**

### **a. Standard game**

A standard game is scored as follows with the server's score being called first:

**APPENDIX L**  
**ITF RULES OF TENNIS**

No point	-	“Love”
First point	-	“15”
Second point	-	“30”
Third point	-	“40”
Fourth point	-	“Game”

except that if each player/team has won three points, the score is “Deuce”. After “Deuce”, the score is “Advantage” for the player/team who wins the next point. If that same player/team also wins the next point, that player/team wins the “Game”; if the opposing player/team wins the next point, the score is again “Deuce”. A player/team needs to win two consecutive points immediately after “Deuce” to win the “Game”.

b. Tie-break game

During a tie-break game, points are scored “Zero”, “1”, “2”, “3”, etc. The first player/team to win seven points wins the “Game” and “Set”, provided there is a margin of two points over the opponent(s). If necessary, the tie-break game shall continue until this margin is achieved.

The player whose turn it is to serve shall serve the first point of the tie-break game. The following two points shall be served by the opponent(s) (in doubles, the player of the opposing team due to serve next). After this, each player/team shall serve alternately for two consecutive points until the end of the tie-break game (in doubles, the rotation of service within each team shall continue in the same order as during that set).

The player/team whose turn it was to serve first in the tie-break game shall be the receiver in the first game of the following set.

Additional approved alternative scoring methods can be found in Appendix V.

**6. SCORE IN A SET**

There are different methods of scoring in a set. The two main methods are the “Advantage Set” and the “Tie-break Set”. Either method may be used provided that the one to be used is announced in advance of the event. If the “Tie-break Set” method is to be used, it must also be

## **APPENDIX L**

### **ITF RULES OF TENNIS**

announced whether the final set will be played as a “Tie-break Set” or an “Advantage Set”.

a. “Advantage Set”

The first player/team to win six games wins that “Set”, provided there is a margin of two games over the opponent(s). If necessary, the set shall continue until this margin is achieved.

b. “Tie-break Set”

The first player/team to win six games wins that “Set”, provided there is a margin of two games over the opponent(s). If the score reaches six games all, a tie-break game shall be played.

Additional approved alternative scoring methods can be found in Appendix V.

## **7. SCORE IN A MATCH**

A match can be played to the best of 3 sets (a player/team needs to win 2 sets to win the match) or to the best of 5 sets (a player/team needs to win 3 sets to win the match).

Additional approved alternative scoring methods can be found in Appendix V.

## **8. SERVER & RECEIVER**

The players/teams shall stand on opposite sides of the net. The server is the player who puts the ball into play for the first point. The receiver is the player who is ready to return the ball served by the server.

*Case 1: Is the receiver allowed to stand outside the lines of the court?*

*Decision: Yes. The receiver may take any position inside or outside the lines on the receiver’s side of the net.*

## **9. CHOICE OF ENDS & SERVICE**

The choice of ends and the choice to be server or receiver in the first game shall be decided by toss before the warm-up starts. The player/team who wins the toss may choose:

- a. To be server or receiver in the first game of the match, in which case the opponent(s) shall choose the end of the court for the first game

**APPENDIX L**  
**ITF RULES OF TENNIS**

of the match; or

- b. The end of the court for the first game of the match, in which case the opponent(s) shall choose to be server or receiver for the first game of the match; or
- c. To require the opponent(s) to make one of the above choices.

*Case 1: Do both players/teams have the right to new choices if the warm-up is stopped and the players leave the court?*

*Decision: Yes. The result of the original toss stands, but new choices may be made by both players/teams.*

**10. CHANGE OF ENDS**

The players shall change ends at the end of the first, third and every subsequent odd game of each set. The players shall also change ends at the end of each set unless the total number of games in that set is even, in which case the players change ends at the end of the first game of the next set.

During a tie-break game, players shall change ends after every six points.

Additional approved alternative procedures can be found in Appendix V.

**11. BALL IN PLAY**

Unless a fault or a let is called, the ball is in play from the moment the server hits the ball, and remains in play until the point is decided.

**12. BALL TOUCHES A LINE**

If a ball touches a line, it is regarded as touching the court bounded by that line.

**13. BALL TOUCHES A PERMANENT FIXTURE**

If the ball in play touches a permanent fixture after it has hit the correct court, the player who hit the ball wins the point. If the ball in play touches a permanent fixture before it hits the ground, the player who hit the ball loses the point.

**14. ORDER OF SERVICE**

At the end of each standard game, the receiver shall become the server

## **APPENDIX L**

### **ITF RULES OF TENNIS**

and the server shall become the receiver for the next game.

In doubles, the team due to serve in the first game of each set shall decide which player shall serve for that game. Similarly, before the second game starts, their opponents shall decide which player shall serve for that game. The partner of the player who served in the first game shall serve in the third game and the partner of the player who served in the second game shall serve in the fourth game. This rotation shall continue until the end of the set.

#### **15. ORDER OF RECEIVING IN DOUBLES**

The team which is due to receive in the first game of a set shall decide which player shall receive the first point in the game. Similarly, before the second game starts, their opponents shall decide which player shall receive the first point of that game. The player who was the receiver's partner for the first point of the game shall receive the second point and this rotation shall continue until the end of the game and the set.

After the receiver has returned the ball, either player in a team can hit the ball.

*Case 1: Is one member of a doubles team allowed to play alone against the opponents?*

*Decision: No.*

#### **16. THE SERVICE**

Immediately before starting the service motion, the server shall stand at rest with both feet behind (i.e. further from the net than) the baseline and within the imaginary extensions of the centre mark and the sideline.

The server shall then release the ball by hand in any direction and hit the ball with the racket before the ball hits the ground. The service motion is completed at the moment that the player's racket hits or misses the ball. A player who is able to use only one arm may use the racket for the release of the ball.

#### **17. SERVING**

When serving in a standard game, the server shall stand behind alternate halves of the court, starting from the right half of the court in every game.

In a tie-break game, the service shall be served from behind alternate halves of the court, with the first served from the right half of the court.

**APPENDIX L**  
**ITF RULES OF TENNIS**

The service shall pass over the net and hit the service court diagonally opposite, before the receiver returns it.

**18. FOOT FAULT**

During the service motion, the server shall not:

- a. Change position by walking or running, although slight movements of the feet are permitted; or
- b. Touch the baseline or the court with either foot; or
- c. Touch the area outside the imaginary extension of the sideline with either foot; or
- d. Touch the imaginary extension of the centre mark with either foot.

If the server breaks this rule it is a “Foot Fault”.

*Case 1: In a singles match, is the server allowed to serve standing behind the part of the baseline between the singles sideline and the doubles sideline?*

*Decision: No.*

*Case 2: Is the server allowed to have one or both feet off the ground?*

*Decision: Yes.*

**19. SERVICE FAULT**

The service is a fault if:

- a. The server breaks Rules 16, 17 or 18; or
- b. The server misses the ball when trying to hit it; or
- c. The ball served touches a permanent fixture, singles stick or net post before it hits the ground; or
- d. The ball served touches the server or server’s partner, or anything the server or server’s partner is wearing or carrying.

*Case 1: After tossing a ball to serve, the server decides not to hit it and catches it instead. Is this a fault?*

## **APPENDIX L**

### **ITF RULES OF TENNIS**

*Decision: No. A player, who tosses the ball and then decides not to hit it, is allowed to catch the ball with the hand or the racket, or to let the ball bounce.*

*Case 2: During a singles match played on a court with net posts and singles sticks, the ball served hits a singles stick and then hits the correct service court. Is this a fault?*

*Decision: Yes.*

## **20. SECOND SERVICE**

If the first service is a fault, the server shall serve again without delay from behind the same half of the court from which that fault was served, unless the service was from the wrong half.

## **21. WHEN TO SERVE & RECEIVE**

The server shall not serve until the receiver is ready. However, the receiver shall play to the reasonable pace of the server and shall be ready to receive within a reasonable time of the server being ready.

A receiver who attempts to return the service shall be considered as being ready. If it is demonstrated that the receiver is not ready, the service cannot be called a fault.

## **22. THE LET DURING A SERVICE**

The service is a let if:

- a. The ball served touches the net, strap or band, and is otherwise good; or, after touching the net, strap or band, touches the receiver or the receiver's partner or anything they wear or carry before hitting the ground; or
- b. The ball is served when the receiver is not ready.

In the case of a service let, that particular service shall not count, and the server shall serve again, but a service let does not cancel a previous fault.

Additional approved alternative procedures can be found in Appendix V.

## **23. THE LET**

In all cases when a let is called, except when a service let is called on a second service, the whole point shall be replayed.

**APPENDIX L**  
**ITF RULES OF TENNIS**

*Case 1: When the ball is in play, another ball rolls onto court. A let is called. The server had previously served a fault. Is the server now entitled to a first service or second service?*

*Decision: First service. The whole point must be replayed.*

**24. PLAYER LOSES POINT**

The point is lost if:

- a. The player serves two consecutive faults; or
- b. The player does not return the ball in play before it bounces twice consecutively; or
- c. The player returns the ball in play so that it hits the ground, or before it bounces, an object, outside the correct court; or
- d. The player returns the ball in play so that, before it bounces, it hits a permanent fixture; or
- e. The receiver returns the service before it bounces; or
- f. The player deliberately carries or catches the ball in play on the racket or deliberately touches it with the racket more than once; or
- g. The player or the racket, whether in the player's hand or not, or anything which the player is wearing or carrying touches the net, net posts/singles sticks, cord or metal cable, strap or band, or the opponent's court at any time while the ball is in play; or
- h. The player hits the ball before it has passed the net; or
- i. The ball in play touches the player or anything that the player is wearing or carrying, except the racket; or
- j. The ball in play touches the racket when the player is not holding it; or
- k. The player deliberately and materially changes the shape of the racket when the ball is in play; or
- l. In doubles, both players touch the ball when returning it.

*Case 1: After the server has served a first service, the racket falls out of the server's hand and touches the net before the ball has bounced. Is*



**APPENDIX L**  
**ITF RULES OF TENNIS**

*this a service fault, or does the server lose the point?*

*Decision: The server loses the point because the racket touches the net while the ball is in play.*

*Case 2: After the server has served a first service, the racket falls out of the server's hand and touches the net after the ball has bounced outside the correct service court. Is this a service fault, or does the server lose the point?*

*Decision: This is a service fault because when the racket touched the net the ball was no longer in play.*

*Case 3: In a doubles match, the receiver's partner touches the net before the ball that has been served touches the ground outside the correct service court. What is the correct decision?*

*Decision: The receiving team loses the point because the receiver's partner touched the net while the ball was in play.*

*Case 4: Does a player lose the point if an imaginary line in the extension of the net is crossed before or after hitting the ball?*

*Decision: The player does not lose the point in either case provided the player does not touch the opponent's court.*

*Case 5: Is a player allowed to jump over the net into the opponent's court while the ball is in play?*

*Decision: No. The player loses the point.*

*Case 6: A player throws the racket at the ball in play. Both the racket and the ball land in the court on the opponent's side of the net and the opponent(s) is unable to reach the ball. Which player wins the point?*

*Decision: The player who threw the racket at the ball loses the point.*

*Case 7: A ball that has just been served hits the receiver or in doubles the receiver's partner before it touches the ground. Which player wins the point?*

*Decision: The server wins the point, unless it is a service let.*

*Case 8: A player standing outside the court hits the ball or catches it before it bounces and claims the point because the ball was definitely going out of the correct court.*

**APPENDIX L**  
**ITF RULES OF TENNIS**

*Decision: The player loses the point, unless it is a good return, in which case the point continues.*

**25. A GOOD RETURN**

It is a good return if:

- a. The ball touches the net, net posts/singles sticks, cord or metal cable, strap or band, provided that it passes over any of them and hits the ground within the correct court; except as provided in Rule 2 and 24 (d); or
- b. After the ball in play has hit the ground within the correct court and has spun or been blown back over the net, the player reaches over the net and plays the ball into the correct court, provided that the player does not break Rule 24; or
- c. The ball is returned outside the net posts, either above or below the level of the top of the net, even though it touches the net posts, provided that it hits the ground in the correct court; except as provided in Rules 2 and 24 (d); or
- d. The ball passes under the net cord between the singles stick and the adjacent net post without touching either net, net cord or net post and hits the ground in the correct court, or
- e. The player's racket passes over the net after hitting the ball on the player's own side of the net and the ball hits the ground in the correct court; or
- f. The player hits the ball in play, which hits another ball lying in the correct court.

*Case 1: A player returns a ball which then hits a singles stick and hits the ground in the correct court. Is this a good return?*

*Decision: Yes. However, if the ball is served and hits the singles stick, it is a service fault.*

*Case 2: A ball in play hits another ball which is lying in the correct court. What is the correct decision?*

*Decision: Play continues. However, if it is not clear that the actual ball in play has been returned, a let should be called.*

**APPENDIX L**  
**ITF RULES OF TENNIS**

**26. HINDRANCE**

If a player is hindered in playing the point by a deliberate act of the opponent(s), the player shall win the point.

However, the point shall be replayed if a player is hindered in playing the point by either an unintentional act of the opponent(s), or something outside the player's own control (not including a permanent fixture).

*Case 1: Is an unintentional double hit a hindrance?*

*Decision: No. See also Rule 24 (f).*

*Case 2: A player claims to have stopped play because the player thought that the opponent(s) was being hindered. Is this a hindrance?*

*Decision: No, the player loses the point.*

*Case 3: A ball in play hits a bird flying over the court. Is this a hindrance?*

*Decision: Yes, the point shall be replayed.*

*Case 4: During a point, a ball or other object that was lying on the player's side of the net when the point started hinders the player. Is this a hindrance?*

*Decision: No.*

*Case 5: In doubles, where are the server's partner and receiver's partner allowed to stand?*

*Decision: The server's partner and the receiver's partner may take any position on their own side of the net, inside or outside the court. However, if a player is creating a hindrance to the opponent(s), the hindrance rule should be used.*

**27. CORRECTING ERRORS**

As a principle, when an error in respect of the Rules of Tennis is discovered, all points previously played shall stand. Errors so discovered shall be corrected as follows:

- a. During a standard game or a tie-break game, if a player serves from the wrong half of the court, this should be corrected as soon as the error is discovered and the server shall serve from the correct half of

**APPENDIX L**  
**ITF RULES OF TENNIS**

the court according to the score. A fault that was served before the error was discovered shall stand.

- b. During a standard game or a tie-break game, if the players are at the wrong ends of the court, the error should be corrected as soon as it is discovered and the server shall serve from the correct end of the court according to the score.
- c. If a player serves out of turn during a standard game, the player who was originally due to serve shall serve as soon as the error is discovered. However, if a game is completed before the error is discovered the order of service shall remain as altered. In this case, any ball change to be made after an agreed number of games should be made one game later than originally scheduled.

A fault that was served by the opponents(s) before the error was discovered shall not stand.

In doubles, if the partners of one team serve out of turn, a fault that was served before the error was discovered shall stand.

- d. If a player serves out of turn during a tie-break game and the error is discovered after an even number of points have been played, the error is corrected immediately. If the error is discovered after an odd number of points have been played, the order of service shall remain as altered.

A fault that was served by the opponent(s) before the error was discovered shall not stand.

In doubles, if the partners of one team serve out of turn, a fault that was served before the error was discovered shall stand.

- e. During a standard game or a tie-break game in doubles, if there is an error in the order of receiving, this shall remain as altered until the end of the game in which the error is discovered. For the next game in which they are the receivers in that set, the partners shall then resume the original order of receiving.
- f. If in error a tie-break game is started at 6 games all, when it was previously agreed that the set would be an "Advantage set", the error shall be corrected immediately if only one point has been played. If the error is discovered after the second point is in play, the set will continue as a "Tie-break set".

## **APPENDIX L**

### **ITF RULES OF TENNIS**

- g. If in error a standard game is started at 6 games all, when it was previously agreed that the set would be a “Tie-break set”, the error shall be corrected immediately if only one point has been played. If the error is discovered after the second point is in play, the set will continue as an “Advantage set” until the score reaches 8 games all (or a higher even number), when a tie-break game shall be played.
- h. If in error an “Advantage set” or “Tie-break set” is started, when it was previously agreed that the final set would be a match tie-break, the error shall be corrected immediately if only one point has been played. If the error is discovered after the second point is in play, the set will continue either until a player or team wins three games (and therefore the set) or until the score reaches 2 games all, when a match tie-break shall be played. However, if the error is discovered after the second point of the fifth game has started, the set will continue as a “Tie-break set”. (See Appendix V)
- i. If the balls are not changed in the correct sequence, the error shall be corrected when the player/team who should have served with new balls is next due to serve a new game. Thereafter the balls shall be changed so that the number of games between ball changes shall be that originally agreed. Balls should not be changed during a game.

## **28. ROLE OF COURT OFFICIALS**

For matches where officials are appointed, their roles and responsibilities can be found in Appendix VI.

## **29. CONTINUOUS PLAY**

As a principle, play should be continuous, from the time the match starts (when the first service of the match is put in play) until the match finishes.

- a. Between points, a maximum of twenty-five (25) seconds is allowed. When the players change ends at the end of a game, a maximum of ninety (90) seconds are allowed. However, after the first game of each set and during a tie-break game, play shall be continuous and the players shall change ends without a rest.

At the end of each set there shall be a set break of a maximum of one hundred and twenty (120) seconds.

The maximum time starts from the moment that one point finishes until the first service is struck for the next point.

Event organisers may apply for ITF approval to extend the ninety

## APPENDIX L ITF RULES OF TENNIS

(90) seconds allowed when the players change ends at the end of a game and the one hundred and twenty (120) seconds allowed at a set break.

- b. If, for reasons outside the player's control, clothing, footwear or necessary equipment (excluding the racket) is broken or needs to be replaced, the player may be allowed reasonable extra time to rectify the problem.
- c. No extra time shall be given to allow a player to recover condition. However, a player suffering from a treatable medical condition may be allowed one medical time-out of three minutes for the treatment of that medical condition. A limited number of toilet/change of attire breaks may also be allowed, if this is announced in advance of the event.
- d. Event organisers may allow a rest period of a maximum of ten (10) minutes if this is announced in advance of the event. This rest period can be taken after the 3rd set in a best of 5 sets match, or after the 2nd set in a best of 3 sets match.
- e. The warm-up time shall be a maximum of five (5) minutes, unless otherwise decided by the event organisers.

### 30. COACHING

Coaching is considered to be communication, advice or instruction of any kind and by any means to a player.

In team events where there is a team captain sitting on-court, the team captain may coach the player(s) during a set break and when the players change ends at the end of a game, but not when the players change ends after the first game of each set and not during a tie-break game.

In all other matches, coaching is not allowed.

*Case 1: Is a player allowed to be coached, if the coaching is given by signals in a discreet way?*

*Decision: No.*

*Case 2: Is a player allowed to receive coaching when play is suspended?*

*Decision: Yes.*

*Case 3: Is a player allowed to receive on-court coaching during a match?*

**APPENDIX L**  
**ITF RULES OF TENNIS**

*Decision: Sanctioning bodies may apply to the ITF to have on-court coaching allowed. In events where on-court coaching is allowed, designated coaches may enter the court and coach their players under procedures decided by the sanctioning body.*

**31. PLAYER ANALYSIS TECHNOLOGY**

Player analysis technology, that is approved for play under the Rules of Tennis, must comply with the specifications in Appendix III.

The International Tennis Federation shall rule on the question of whether any such equipment is approved, or not approved. Such ruling may be taken on its own initiative, or upon application by any party with a bona fide interest therein, including any player, equipment manufacturer or National Association or members thereof. Such rulings and applications shall be made in accordance with the applicable Review and Hearing Procedures of the International Tennis Federation.

**AMENDMENT TO THE RULES OF TENNIS**  
(Article 28 of the Constitution of ITF Ltd)

The official and decisive text to the Rules of Tennis shall be for ever in the English language and no alteration or interpretation of such Rules shall be made except at an Annual General Meeting of the Council, nor unless notice of the Resolution embodying such alterations shall have been received by the ITF in accordance with Article 17 and such Resolution or one having the like effect shall be carried by a majority of two-thirds of the votes recorded in respect of the same.

Any alteration so made shall take effect as from the first day of January following, unless the Meeting shall by the like majority decide otherwise.

The Board of Directors shall have power, however, to settle all urgent questions of interpretation subject to confirmation at the General Meeting next following.

This text shall not be altered at any time without the unanimous consent of a General Meeting of the Council.

**APPENDIX L  
ITF RULES OF TENNIS**

**APPENDIX I**

**THE BALL**

For all measurements in Appendix I, SI units shall take precedence.

- a. The ball shall have a uniform outer surface consisting of a fabric cover except for the Stage 3 (Red) foam ball. If there are any seams they shall be stitchless.
- b. The ball shall conform to one of the types specified in the table immediately below or in the table under paragraph (d).

	<b>Type 1 (Fast)</b>	<b>Type 2 (Medium)<sup>1</sup></b>	<b>Type 3 (Slow)<sup>2</sup></b>	<b>High Altitude<sup>3</sup></b>
<b>Weight (Mass)</b>	56.0-59.4 grams (1.975-2.095 ounces)	56.0-59.4 grams (1.975-2.095 ounces)	56.0-59.4 grams (1.975-2.095 ounces)	56.0-59.4 grams (1.975-2.095 ounces)
<b>Size</b>	6.54-6.86 cm (2.57-2.70 inches)	6.54-6.86 cm (2.57-2.70 inches)	7.00-7.30 cm (2.76-2.87 inches)	6.54-6.86 cm (2.57-2.70 inches)
<b>Rebound</b>	138-151 cm (54-60 inches)	135-147 cm (53-58 inches)	135-147 cm (53-58 inches)	122-135 cm (48-53 inches)
<b>Forward Deformation<sup>4</sup></b>	0.56-0.74 cm (0.220-0.291 inches)	0.56-0.74 cm (0.220-0.291 inches)	0.56-0.74 cm (0.220-0.291 inches)	0.56-0.74 cm (0.220-0.291 inches)
<b>Return Deformation<sup>4</sup></b>	0.74-1.08 cm (0.291-0.425 inches)	0.80-1.08 cm (0.315-0.425 inches)	0.80-1.08 cm (0.315-0.425 inches)	0.80-1.08 cm (0.315-0.425 inches)
<b>Colour</b>	white or yellow	white or yellow	white or yellow	white or yellow

Notes:

- 1 This ball type may be pressurised or pressureless. The pressureless ball shall have an internal pressure that is no greater than 7kPa (1 psi) and may be used for high altitude play above 1,219 m (4,000 feet) above sea level and shall have been acclimatised for 60 days or more at the altitude of the specific tournament.
- 2 This ball type is also recommended for high altitude play on any court surface type above 1,219 m (4,000 feet) above sea level.
- 3 This ball type is pressurised and is specified for high altitude play above 1,219 m (4,000 feet) above sea level only.
- 4 The deformation shall be the average of a single reading along each of three perpendicular axes. No two individual readings shall differ by more than 0.08 cm (0.031 inches).



**APPENDIX L**  
**ITF RULES OF TENNIS**

- c. In addition, all ball types specified under paragraph (b) shall conform to the requirements for durability as shown in the following table:

	<b><u>MASS (WEIGHT)</u></b>	<b><u>REBOUND</u></b>	<b><u>FORWARD DEFORMATION</u></b>	<b><u>RETURN DEFORMATION</u></b>
<b><u>MAXIMUM CHANGE<sup>1</sup></u></b>	0.4 grams (0.014 ounces)	4.0 cm (1.6 inches)	0.08 cm (0.031 inches)	0.10 cm (0.039 inches)

Notes:

- <sup>1</sup> The largest permissible change in the specified properties resulting from the durability test described in the current edition of *ITF Approved Tennis Balls & Classified Court Surfaces*. The durability test uses laboratory equipment to simulate the effects of nine games of play.
- d. Only the ball types specified in the ITF Rules of Tennis can be used in 10 and under tennis competition. See the complete rules for details.
- e. All tests for rebound, mass, size, deformation and durability shall be made in accordance with the Regulations described in the current edition of *ITF Approved Tennis Balls & Classified Court Surfaces*.

**CLASSIFICATION OF COURT PACE**

The ITF test method used for determining the pace of a court surface is ITF CS 01/02 (ITF Court Pace Rating) as described in the ITF publication entitled "ITF guide to test methods for tennis court surfaces".

Court surfaces which have an ITF Court Pace Rating of 0 to 29 shall be classified as being Category 1 (slow pace). Examples of court surface types which conform to this classification will include most clay courts and other types of unbound mineral surface.

Court surfaces which have an ITF Court Pace Rating of 30 to 34 shall be classified as being Category 2 (medium-slow pace), while court surfaces with an ITF Court Pace Rating of 35 to 39 shall be classified as being Category 3 (medium pace). Examples of court surface types which conform to this classification will include most acrylic coated surfaces plus some carpet surfaces.

Court surfaces with an ITF Court Pace Rating of 40 to 44 shall be classified as being Category 4 (medium-fast pace), while court surfaces which have an ITF Court Pace Rating of 45 or more shall be classified as being Category 5 (fast

## **APPENDIX L**

### **ITF RULES OF TENNIS**

pace). Examples of court surface types which conform to this classification will include most natural grass, artificial grass and some carpet surfaces.

*Case 1: Which ball type should be used on which court surface?*

*Decision: 3 different types of balls are approved for play under the Rules of Tennis, however:*

- a. *Ball Type 1 (fast speed) is intended for play on slow pace court surfaces*
- b. *Ball Type 2 (medium speed) is intended for play on medium-slow, medium and medium-fast pace court surfaces*
- c. *Ball Type 3 (slow speed) is intended for play on fast pace court surfaces*

*Note:*

In addition to the ball types specified under paragraph (b) above, the Stage 1 (Green) ball may be used for all levels of competitive play except for world ranking professional tennis events, Davis Cup and Billie Jean King Cup, the Olympic and Paralympic Tennis Events, World Tennis Tour Men's, Women's and Junior Tournaments and Team events sanctioned by the ITF and affiliated Regional Associations, ITF Senior Circuit and Team events and ITF Wheelchair Tennis Tour Circuit and Team events.

Each National Association shall have the right to decide which national competitive events should use the Stage 1 (Green) ball.

## **APPENDIX II**

### **THE RACKET**

For all measurements in Appendix II, SI units shall take precedence

- a. The racket shall consist of a frame and string(s). The frame shall consist of a handle and head, and may also include a throat. The head is defined as that part of the racket to which the string(s) connect. The handle is defined as that part of the racket connected to the head which is held by the player in normal use. The throat, where present, is that part of the racket that joins the handle to the head.
- b. The hitting surface, defined as the main area of the stringing pattern bordered by the points of entry of the strings into the head or points of contact of the strings with the head, whichever is the smaller, shall be flat and consist of a pattern of crossed strings, which shall

## **APPENDIX L**

### **ITF RULES OF TENNIS**

be alternately interlaced or bonded where they cross. The stringing pattern must be generally uniform and, in particular, not less dense in the centre than in any other area.

The racket shall be designed and strung such that the playing characteristics are identical on both faces.

- c. The racket shall not exceed 73.7 cm (29.0 inches) in overall length, and 31.7 cm (12.5 inches) in overall width. The hitting surface shall not exceed 39.4 cm (15.5 inches) in overall length, when measured parallel to the longitudinal axis of the handle, and 29.2 cm (11.5 inches) in overall width, when measured perpendicular to the longitudinal axis of the handle.
- d. The racket shall be free of any attached object, protrusion or device which makes it possible to change materially the shape of the racket, or its moment of inertia about any principal axis, or to change any physical property which may affect the performance of the racket during the playing of a point. Attached objects, protrusions and devices that are approved as Player Analysis Technology, or that are utilised to limit or prevent wear and tear or vibration or, for the frame only, to distribute weight, are permitted. All permissible objects, protrusions and devices must be reasonable in size and placement for their respective purpose(s).

No energy source that in any way could change or affect the playing characteristics of a racket may be built into or attached to a racket.

## **APPENDIX III**

### **PLAYER ANALYSIS TECHNOLOGY**

Player Analysis Technology is equipment that may perform any of the following functions with respect to player performance information:

- A. Recording
- B. Storing
- C. Transmission
- D. Analysis
- E. Communication to a player of any kind and by any means

Player Analysis Technology may record and/or store information during a match. Such information may only be accessed by a player in accordance with Rule 30.

**APPENDIX L  
ITF RULES OF TENNIS**

**APPENDIX IV**

**ADVERTISING**

1. Advertising is permitted on the net as long as it is placed on the part of the net that is within 3 feet (0.914 m) from the centre of the net posts and is produced in such a way that it does not interfere with the vision of the players or the playing conditions.

A mark (non-commercial) of the sanctioning body is permitted on the lower part of the net, minimum 20 inches (0.51 m) from the top of the net, as long as it is produced in such a way that it does not interfere with the vision of the players or the playing conditions.

2. Advertising and other marks or material placed at the back and sides of the court shall be permitted unless it interferes with the vision of the players or the playing conditions.
3. Advertising and other marks or material placed on the court surface outside the lines is permitted unless it interferes with the vision of the players or the playing conditions.
4. Notwithstanding paragraphs (1), (2) and (3) above, any advertising, marks or material placed on the net or placed at the back and sides of the court, or on the court surface outside the lines may not contain white or yellow or other light colours that may interfere with the vision of the players or the playing conditions.
5. Advertising and other marks or material are not permitted on the court surface inside the lines of the court.

**APPENDIX V**

**ALTERNATIVE PROCEDURES AND SCORING METHODS**

The alternatives listed in this Appendix V may be used.

**SCORE IN A GAME (RULE 5)**

**“No-Ad” SCORING METHOD**

A “No-Ad” game is scored as follows with the server’s score being called first:

No point	-	“Love”
First point	-	“15”

**APPENDIX L**  
**ITF RULES OF TENNIS**

Second point	-	“30”
Third point	-	“40”
Fourth point	-	“Game”

If both players/teams have won three points each, the score is “Deuce” and a deciding point shall be played. The receiver(s) shall choose whether to receive the service from the right half or the left half of the court. In doubles, the players of the receiving team cannot change positions to receive this deciding point. The player/team who wins the deciding point wins the “Game”.

In mixed doubles, the player of the same gender as the server shall receive the deciding point. The players of the receiving team cannot change positions to receive the deciding point.

**SCORE IN A SET (RULES 6 AND 7)**

**1. SHORT SETS**

The first player/team who wins four games wins that set, provided there is a margin of two games over the opponent(s). If the score reaches four games all, a tie-break game shall be played. Alternatively (at the discretion of the sanctioning body), if the score reaches three games all, a tie-break game shall be played.

**2. SHORT SET TIE-BREAK**

When playing Short Sets only, a Short Set tie-break may be used. The first player/team to win five points wins the “Game” and “Set”, with a deciding point if the score reaches four all. The order and number of serves shall be determined by the sanctioning body. Players/Teams will only change ends after the first four points have been played.

**3. MATCH TIE-BREAK (7 POINTS)**

When the score in a match is one set all, or two sets all in best of five sets matches, one tie-break game shall be played to decide the match. This tie-break game replaces the deciding final set.

The player/team who first wins seven points shall win this match tie-break and the match provided there is a margin of two points over the opponent(s).

**APPENDIX L**  
**ITF RULES OF TENNIS**

**4. MATCH TIE-BREAK (10 POINTS)**

When the score in a match is one set all, or two sets all in best of five sets matches, one tie-break game shall be played to decide the match. This tie-break game replaces the deciding final set.

The player/team who first wins ten points shall win this match tie-break and the match provided there is a margin of two points over the opponent(s).

**Note:** *When using the match tie-break to replace the final set:*

- *the original order of service continues. (Rules 5 and 14)*
- *in doubles, the order of serving and receiving within the team may be altered, as in the beginning of each set. (Rules 14 and 15)*
- *before the start of the match tie-break there shall be a 120 seconds set break.*
- *balls should not be changed before the start of the match tie-break even if a ball change is due.*

**CHANGE OF ENDS (RULE 10)**

During a tie-break game, players shall change ends after the first point and thereafter after every four points.

**THE LET DURING A SERVICE (RULE 22)**

**“NO LET” RULE**

This alternative is play without the service let in Rule 22a, whereby a serve that touches the net, strap or band is in play.

At the discretion of the sanctioning body, when playing doubles using Short Sets in combination with No-Ad scoring and the No-Let rule, either player on the receiving team is permitted to return a serve that touches the net, strap or band and lands within the correct service box.

**APPENDIX L**  
**ITF RULES OF TENNIS**

**APPENDIX VI**

**ROLE OF COURT OFFICIALS**

The referee is the final authority on all questions of tennis law and the referee's decision is final.

In matches where a chair umpire is assigned, the chair umpire is the final authority on all questions of fact during the match.

The players have the right to call the referee to court if they disagree with a chair umpire's interpretation of tennis law.

In matches where line umpires and net umpires are assigned, they make all calls (including foot-fault calls) relating to that line or net. The chair umpire has the right to overrule a line umpire or a net umpire if the chair umpire is sure that a clear mistake has been made. The chair umpire is responsible for calling any line (including foot-faults) or net where no line umpire or net umpire is assigned.

A line umpire who cannot make a call shall signal this immediately to the chair umpire who shall make a decision. If the line umpire cannot make a call, or if there is no line umpire, and the chair umpire cannot make a decision on a question of fact, the point shall be replayed.

In team events where the referee is sitting on-court, the referee is also the final authority on questions of fact.

Play may be stopped or suspended at any time the chair umpire decides it is necessary or appropriate.

The referee may also stop or suspend play in the case of darkness, weather or adverse court conditions. When play is suspended for darkness, this should be done at the end of a set, or after an even number of games have been played in the set in progress. After a suspension in play, the score and position of players on-court in the match shall stand when the match resumes.

The chair umpire or referee shall make decisions regarding continuous play and coaching in respect of any Code of Conduct that is approved and in operation.

*Case 1: The chair umpire awards the server a first service after an overrule, but the receiver argues that it should be a second service, since the server had already served a fault. Should the referee be called to court to give a decision?*

*Decision: Yes. The chair umpire makes the first decision about questions of tennis law (issues relating to the application of specific facts).*

**APPENDIX L**  
**ITF RULES OF TENNIS**

*However, if a player appeals the chair umpire's decision, then the referee shall be called to make the final decision.*

*Case 2: A ball is called out, but a player claims that the ball was good. May the referee be called to court to make a decision?*

*Decision: No. The chair umpire makes the final decision on questions of fact (issues relating to what actually happened during a specific incident).*

*Case 3: Is a chair umpire allowed to overrule a line umpire at the end of a point if, in the chair umpire's opinion, a clear mistake was made earlier in the point?*

*Decision: No. A chair umpire may only overrule a line umpire immediately after the clear mistake has been made.*

*Case 4: A line umpire calls a ball "Out" and then the player argues that the ball was good. Is the chair umpire allowed to overrule the line umpire?*

*Decision: No. A chair umpire must never overrule as the result of the protest or appeal by a player*

*Case 5: A line umpire calls a ball "Out". The chair umpire was unable to see clearly, but thought the ball was in. May the chair umpire overrule the line umpire?*

*Decision: No. The chair umpire may only overrule when sure that the line umpire made a clear mistake.*

*Case 6: Is a line umpire allowed to change the call after the chair umpire has announced the score?*

*Decision: Yes. If a line umpire realises a mistake, a correction should be made as soon as possible provided it is not as the result of a protest or appeal of a player.*

*Case 7: If a chair umpire or line umpire calls "Out" and then corrects the call to good, what is the correct decision?*

*Decision: The chair umpire must decide if the original "Out" call was a hindrance to either player. If it was a hindrance, the point shall be replayed. If it was not a hindrance, the player who hit the ball wins the point.*



**APPENDIX L**  
**ITF RULES OF TENNIS**

*Case 8: A ball is blown back over the net and the player correctly reaches over the net to try to play the ball. The opponent(s) hinders the player from doing this. What is the correct decision?*

*Decision: The chair umpire must decide if the hindrance was deliberate or unintentional and either awards the point to the hindered player or order the point to be replayed.*

**BALL MARK INSPECTION PROCEDURES**

1. Ball mark inspections can only be made on clay courts.
2. A ball mark inspection requested by a player (team) shall be allowed only if the chair umpire cannot determine the call with certainty from their chair on either a point-ending shot or when a player (team) stops playing the point during a rally (returns are permitted but then the player must immediately stop).
3. When the chair umpire has decided to make a ball mark inspection, they should go down from the chair and make the inspection themselves. If they do not know where the mark is, they can ask the line umpire for help in locating the mark, but then the chair umpire shall inspect it.
4. The original call or overrule will always stand if the line umpire and chair umpire cannot determine the location of the mark or if the mark is unreadable.
5. Once the chair umpire has identified and ruled on a ball mark, this decision is final and not appealable.
6. In clay court tennis the chair umpire should not be too quick to announce the score unless absolutely certain of the call. If in doubt, wait before calling the score to determine whether a ball mark inspection is necessary.
7. In doubles the appealing player must make their appeal in such a way that either play stops or the chair umpire stops play. If an appeal is made to the chair umpire then they must first determine that the correct appeal procedure was followed. If it was not correct or if it was late, then the chair umpire may determine that the opposing team was deliberately hindered.
8. If a player erases the ball mark before the chair umpire has made a final decision, they concede the call.
9. A player may not cross the net to check a ball mark without being subject to the Unsportsmanlike provision of the Code of Conduct.

**APPENDIX L**  
**ITF RULES OF TENNIS**

**ELECTRONIC REVIEW PROCEDURES**

At tournaments where an Electronic Review System is used, the following procedures should be followed for matches on courts where it is used.

1. A request for an Electronic Review of a line call or overrule by a player (team) shall be allowed only on either a point-ending shot or when a player (team) stops playing the point during a rally (returns are permitted but then the player must immediately stop).
2. The chair umpire should decide to use the Electronic Review when there is doubt about the accuracy of the line call or overrule. However, the chair umpire may refuse the Electronic Review if they believe that the player is making an unreasonable request or that it was not made in a timely manner.
3. In doubles the appealing player must make their appeal in such a way that either play stops or the chair umpire stops play. If an appeal is made to the chair umpire then they must first determine that the correct appeal procedure was followed. If it was not correct or if it was late, then the chair umpire may determine that the opposing team was deliberately hindered, in which case the appealing team loses the point.
4. The original call or overrule will always stand if the Electronic Review is unable, for whatever reason, to make a decision on that line call or overrule.
5. The chair umpire's final decision will be the outcome of the Electronic Review and is not appealable. If a manual choice is required for the system to review a particular ball impact, a review official approved by the referee shall decide which ball impact is reviewed.
6. Each player (team) is allowed three (3) unsuccessful appeals per set, plus one (1) additional appeal in the tie-break. For matches with advantage sets, players (teams) will start again with a maximum of three (3) unsuccessful appeals at 6 games all and every 12 games thereafter. For matches with match tie-break, the match tie-break counts as a new set and each player (team) starts with three (3) appeals. Players (teams) will have an unlimited number of successful appeals.



**APPENDIX L  
ITF RULES OF TENNIS**

**APPENDIX IX**

**SUGGESTIONS ON HOW TO MARK OUT A COURT  
Including Blended Lines**

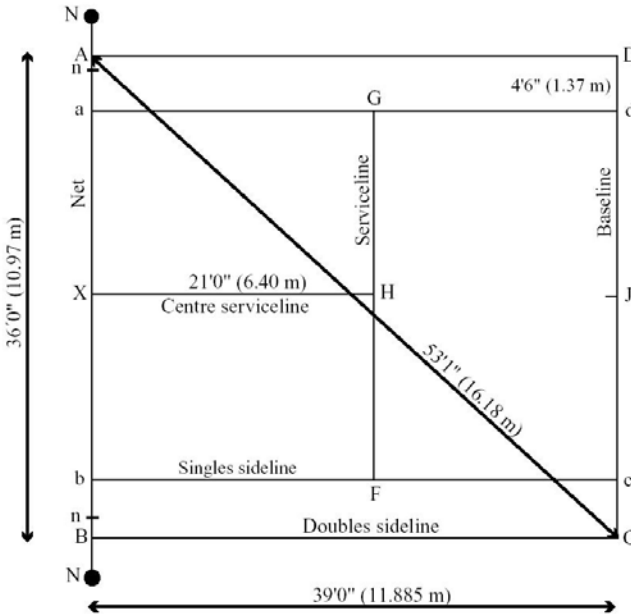

**Note:** All court measurements shall be made to the outside of the lines.

The following procedure is for the usual combined doubles and singles court. (See note at foot for a court for one purpose only.)

First select the position of the net; a straight line 42 feet (12.80 m) long. Mark the centre (X on the diagram above) and, measuring from there in each direction, mark:

- at 13'6" (4.11 m) the points a, b, where the net crosses the inner sidelines,
- at 16'6" (5.03 m) the positions of the singles sticks (n, n),
- at 18'0" (5.48 m) the points A, B, where the net crosses the outer sidelines,
- at 21'0" (6.40 m) the positions of the net posts (N, N), being the ends of the original 42'0" (12.80 m) line.

Insert pegs at A and B and attach to them the respective ends of two measuring tapes. On one, which will measure the diagonal of the half-court,

## APPENDIX L ITF RULES OF TENNIS

take a length 53'1" (16.18 m) and on the other (to measure the sideline) a length of 39'0" (11.89 m). Pull both taut so that at these distances they meet at a point C, which is one corner of the court. Reverse the measurements to find the other corner D. As a check on this operation it is advisable at this stage to verify the length of the line CD which, being the baseline, should be found to be 36'0" (10.97 m); and at the same time its centre J can be marked, and also the ends of the inner sidelines (c, d), 4'6" (1.37 m) from C and D.

The centreline and serviceline are now marked by means of the points F, H, G, which are measured 21'0" (6.40 m) from the net down the lines bc, XJ, ad, respectively.

Identical procedure the other side of the net completes the court.

If a singles court only is required, no lines are necessary outside the points a, b, c, d, but the court can be measured out as above. Alternatively, the corners of the baseline (c, d) can be found if preferred by pegging the two tapes at a and b instead of at A and B, and by then using lengths of 47'5" (14.46 m) and 39'0" (11.89 m). The net posts will be at n, n, and a 33'0" (10 m) singles net should be used.

When a combined doubles and singles court with a doubles net is used for singles, the net must be supported at the points n, n, to a height of 3 feet 6 inches (1.07 m) by means of two singles sticks, which shall be not more than 3 inches (7.5 cm) square or 3 inches (7.5 cm) in diameter. The centres of the singles sticks shall be 3 feet (.914 m) outside the singles court on each side.

To assist in the placing of these singles sticks it is desirable that the points n, n, should each be shown with a white dot when the court is marked.

When sanctioning bodies approve so called "Blended Lines" on courts the following guidelines must be followed:

Colour:

- Within the same colour family as the background playing surface.
- Lighter than the background playing surface.
- Limit on colour variation of +22 points on the L\* scale  
(Add 25% by volume of white paint to the background colour)

## APPENDIX L ITF RULES OF TENNIS

Pace:

- Within 5 CPR of the playing surface.

Dimensions:

- 1.0-1.5 cm narrower than the standard lines.

Marking:

- Terminate 8 cm from intersection with white playing lines.

**Note:**

*As a guide for international competitions, the recommended minimum distance between the baselines and the backstops should be 21 feet (6.40 m) and between the sidelines and the sidestops the recommended minimum distance should be 12 feet (3.66 m).*

*As a guide for recreational and Club play, the recommended minimum distance between the baselines and the backstops should be 18 feet (5.48 m) and between the sidelines and the sidestops the recommended minimum distance should be 10 feet (3.05 m).*

*As a guide, the recommended minimum height measured at the net from the court surface to the ceiling should be 29.6 feet (9.0 m).*



## APPENDIX M

### ANTI-DOPING CONTROL STATION

The Doping Control Station must be a dedicated facility for the exclusive use of the Doping Control team for the duration of the event.

Location: Near the locker room (but not with direct access).

Accommodation: A minimum of two (2) (and preferably three (3)) connected areas or rooms including a Sample Collection Room and a Waiting Room at a minimum, plus an Administration Room if possible, all of which should be air-conditioned or well ventilated. The Sample Collection Room should be directly connected to a toilet (for the sole use of Doping Control).

Security: If free-standing, a security guard should be posted to restrict admission to those with appropriate credentials. It must be lockable, with access restricted to the Doping Control team. The Doping Control Officer must be given charge of all keys to all rooms for the duration of testing.

Hygiene: The Doping Control Station should be cleaned every day at a time agreed with the Doping Control Officer.

Items to be supplied in the Doping Control Station (for all draw sizes):

<b>SAMPLE COLLECTION ROOM</b>	<b>WAITING ROOM</b>
1 toilet	Comfortable seating for at least 8 people
Desk and 4 chairs	Refrigerator with an adequate supply of individually sealed, non-caffeinated and non-alcoholic beverages
Table to display testing material	Table to display reading material
TV/court monitor (and also in the Administration Room if provided)	Various newspapers and magazines
Telephone (to be placed in Administration Room if provided)	TV/court monitor
Main electricity supply	Waste bin
Lockable refrigerator	
2 large waste bins	
Sink, with soap or hand-wash	
Paper towels	
Storage cupboard	



# APPENDIX M

## ANTI-DOPING CONTROL STATION

A suggested layout for a Doping Control Station is shown in the diagram below.

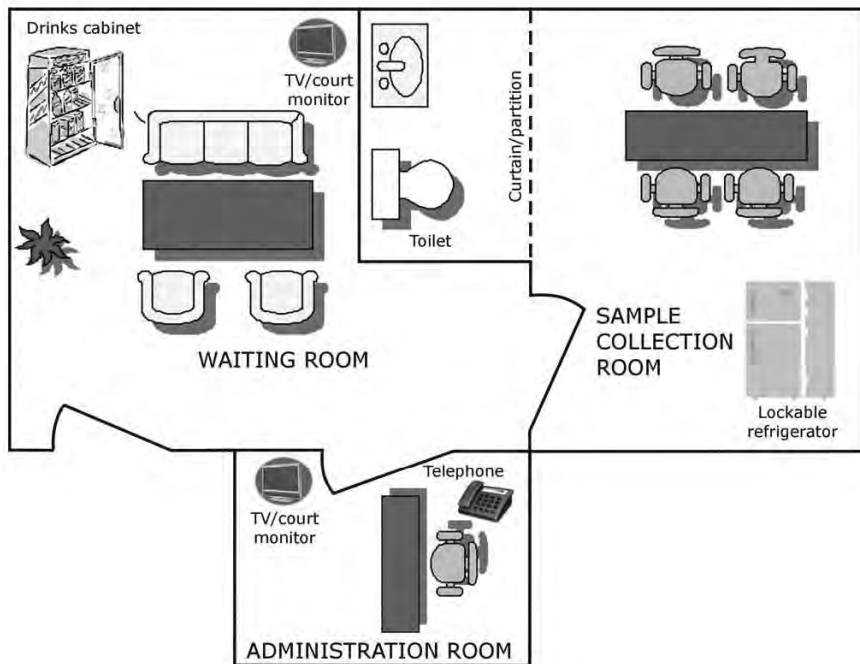

## INDEX

### A

- Abuse of Balls, 279
- Abuse of Racquet or Equipment, 279
- Acceptance, Ranking Tied, 33
- ACES Program, 103
  - Commitments, 103
  - Division/Usage of ACES, 103
  - Fines, 105, 109
  - Mandatory and Optional ACES, 106
  - Planning, 104
- Accounting Rules (Tournaments), 253
- Additional Wild Cards, 44
- Additional Seeds, 79, 156
- Administrative Fee, 15
- Administrative Error, 35, 74
- Age Eligibility Rule, 167
  - Event Participation, 168
  - Merited Increases, 173
  - Player Activity On-Site at Tournaments, 177
  - Summary, 176
  - Violations, 187
- Aggravated Behavior, 287
- Alternates, On-Site, 61, 67, 69
- Alternate Wild Card, 35, 43, 67
- Amateur (Prize Money), 163
- Animals, 303, 425
- Annual Player Form, 16
- Anti-Corruption Program, 7, 15, 274
- Anti-Doping Program, 7, 15, 274
  - Anti-Doping Control Station, 303, 547
- Application – New Tournament, 199
- Audible Obscenity, 279

## INDEX

### B

- Bags, 126
- Ball Persons, 304, 426
- Balls, 304, 426
- Banners, 227, 433
- Best Efforts, 282
- Betting, Fantasy & Gambling Sponsorship Rules, 305, 415, 428
- Biohazardous Materials, 367
- Bleeding, 367
- Board of Directors, 5, 405
- Booth (Electronic Review), 376
- Broadcast, 378
  - Host Broadcaster Responsibilities, 389
  - Match Start Times, 383
  - Number of Matches Per Tournament Category, 387
  - Standards, 387
- Byes, 62, 69, 70

### C

- Calendar, 199
- Cameras
  - CCTV, 343, 465
  - Television, 392
- Ceremonies, 108
- Chairs/Umbrellas, 305
- Chair Umpire, 275, 330
- Chaperones - Anti-Doping, 304
- Chief of Umpires, 329
- Choices - Player Entry, 20
- Clay Court Shoes, 138
- Clothing and Equipment, 120
  - Commercial Identifications, 120
  - Fines, 128
  - Footwear Requirements, 124
  - Identification on Players' Clothing and Equipment, 121
  - Manufacturer Identifications, 120

## INDEX

- WTA Patch Rule, 128
- Coaching, 281, 377
- Code of Conduct for Officials, 402
- Code of Conduct, 273
  - Applicability and Availability, 275
  - Definitions, 274
  - General Principles, 273
  - Rules and Penalties - Players, 277
    - Player On-Court and Off-Court Behavior, 278
- Commercial Benefits Payments - Tournaments, 271
- Commercial Benefits – WTA, 225
- Commercial Identifications (Clothing and Equipment), 120
- Commitment Tournaments, 9
- Communications - WTA Staff, 409
- Compression Shorts, 123
- Consecutive Withdrawals, 53
- Court Calls – Simultaneous, 366
- Courts, 306, 428
  - Manufacturer Signage, 308, 484
  - Measurements, 307, 485
  - Minimum Numbers, 307
  - Preparation, 311
  - Signage, 308, 479
  - Specifications, 306
  - Surface, 306
- Credentials/Tickets/Seating, 312, 340
- Currency (Prize Money), 202

## D

- Data Content Licensing, 324, 339, 389
- Defaults, 166, 285
- Defibrillator, 351
- Delay of Game, 132
- Discrimination, 6, 161, 201
- Doctor – Tournament Physician, 336, 355
- Doubles, 31, 69, 73, 233

## INDEX

- Acceptance – Tie-Breaking Procedure, 34
- Entry Deadlines, 19
- Openings in the Draw, 73
- Sign-In Deadline, 20
- Withdrawal – Prize Money, 52, 164
- Withdrawal – Ranking points, 145
- Withdrawal – Repairing, 31

### Draws, 61

- Byes, 76
- Composition, 61
- Ceremony, 75
- Doubles, 69
- Seeds, 77
- Main Draw Singles, 61
- Making a Draw, 75
- Openings in the Draw, 70
- Qualifying Singles, 67
- Sign-In Deadlines, 70

Drink – Recommended Sports Drink, 315, 352

Drink Containers, 126

Dress, 124

Dress Code, 120

## E

Electronic Review (ELC System), 373

Entries, 15

- Acceptance, 25

- Annual Player Form, 16

- Choices, 20

- Entry Deadlines, 18

- One Tournament Per Week, 20

- Ranking Eligibility, 17

- Second week of WTA 1000 Mandatory or Grand Slam, 22

- Playing Singles/Doubles in Different Tournaments, 23

Exchange Rates (Prize Money), 203

Excused Withdrawals, 50

## INDEX

Exhibition/Non-WTA Event Rule, 288  
Extreme Weather Conditions, 370

### F

Failure to Complete a Match, 283  
Fees (Tournament Fees), 266  
Final Dispute Resolution, 403  
    Arbitration, 403  
Fines, 475  
    ACES, 105, 109  
    Age Eligibility Rule Penalties, 187  
    Appeals, 273, 284, 289, 292  
    Player and Tournament Fine Chart, 475  
    Clothing and Equipment, 128  
    Late Withdrawals, 48, 49  
    Outstanding Fines, 17  
First Round Retirement, 58  
Fitness Center, 314  
Food and Beverage Selections, 314  
Freeze Deadline, 31

### G

Gambling, 335, 415  
Gender Participation Policy, 6  
Glossary, 505  
Grass Court Shoes, 124

### H

Hat, Headband, 126  
Heat Stress Index, 370  
Hindrance Rule, 133  
Host Locality Signage, 309, 479  
Hotel Rooms, 317  
    Players, 317  
    WTA Staff, 322

### I

Insurance (Tournament Requirements), 224  
International Media Rights Pool, 378

## INDEX

Match distribution – Rights and Obligations, 380  
Match Schedule, 383  
Overspill, 383  
Television Broadcast Standards, 387  
    Commentary Positions, 396  
World Feed, 380  
International Tennis Integrity Agency (ITIA), 15, 415  
Internet, 323  
ITF Rules of Tennis, 511  
    Plan of the Court, 542

### L

Laptop Computers, 334  
Late Withdrawal, 47, 49  
Laundry, 323  
Lease (Tournament Membership), 215  
Leaving the Court, 282  
LED Banners, 311  
Letter of Credit, 211, 266  
Lighting, 323, 486  
Lightning, 373  
Line Umpires, 332  
Live Scoring, 324  
Locker Room, 325  
Logo (WTA), 226  
Long-Term Injury, 140  
Lucky Losers, 62

### M

Main Draw, 61  
    Acceptance – Tie-breaking Procedure, 33  
    Alternates, 61  
    Entry Deadline, 19  
    Openings in the Draw, 70  
Manufacturer's Identifications (Clothing and Equipment), 120  
Marketing Fund, 266  
Massage Therapist, 352, 408

## INDEX

Media Facilities, 326  
Media Pool, 378  
Media/Sponsor/Public Relations, 111  
    Marketing Activity, 114  
    Player Responsibilities Upon Withdrawal or Retirement, 45  
Medical, 349  
    Mandatory Physical Examination, 349  
    Medical Procedures, 359  
        Extreme Weather Conditions, 370  
        Medical Time-Out, 363  
        Apparent Temperature Chart, 370  
    Tournament Physician, 336, 355  
    Player Treatment Area/Training Room, 337  
Minimum Player Compensation, 235  
Modification of Play, 371

## N

Nationality, 6  
Net, 327  
Net Post Signs, 228  
No Release Rule, 206  
No-Show Offense, 49, 50

## O

Office (WTA), 345  
Officials, 339  
    Chair Umpire, 330  
    Chief of Umpires, 329  
    Conditions, 335  
    Line Umpires, 332  
    Referee, 339  
    Review Official, 375  
On-Court Offenses, 278  
On-Court Supplies, 335  
One-on-One Interviews, 107  
Other Events, 127  
Ownership (Tournaments), 211



## INDEX

### P

- Parking, 232
- Patches (WTA), 128
- Pension Plan, 195
- Per Diem, 317
- Physical Abuse, 280
- Player Desk, 337
- Player Development Programs, 178
  - Elite Phase, 184
  - Introductory Phase, 180
  - Premier Phase, 186
  - Program Overview and Process, 178
  - Pro Path Phase, 178
  - Rookie Phase, 181
- Player Development - WTA staff, 410
- Player Group Licensing Rights (Likeness Rights), 116
- Player Lounge, 337
- Player Membership, 189
  - Insurance, 194
  - Member Responsibilities, 191
  - Membership Benefits, 190
  - Membership Qualifications, 189
    - Associate Membership, 189
    - Full Membership, 189
- Player Relations - WTA staff, 409
- Player Support Team, 274
- Point Penalty Schedule, 278
- Post-Match Media Activities, 112
- Postponement of First Round Qualifying Matches, 85
- Practice Balls, 305
- Practice Facilities, 338
- Preliminary Match, 74
- Pre-Match Interview, 111
- Pre-Tournament Media Availability, 106
- Primary Health Care Provider (PHCP), 408

## INDEX

- Primary Source of Income (Tournament PSI), 243
- Program Pages, 230
- Prize Money, 100, 161
  - Amateurism, 163
  - Breakdowns, 166
  - Withdrawals, Byes, Walkovers, and Defaults, 163
  - Qualifying Prize Money at WTA 125 Tournaments, 162
  - Wire Transfer Requirements, 161
- Prize Money Formula, 235
  - Minimum Player Compensation, 235
  - PMF Committee, 249
- Prize Money – Payment Currency, 202
- Prize Money Withdrawals, 51
- Punctuality, 283

## Q

- Qualifiers, 61
- Qualifying, 67
  - Acceptance – Tie-Breaking Procedure, 33
  - Entry Deadline, 19
  - Sign-In Deadline, 67
  - Openings in the Draw, 72

## R

- Race to the Finals Leaderboard, on-site, 232
- Rankings, 137
  - Withdrawals, Byes, Walkovers, and Defaults, 144
  - Eligibility, 137
  - Long-Term Injury, 140
  - Ranking Points Chart, 143
  - Special Ranking Rule, 148
  - Tie-Break Procedure, 147
- Referee, 328
- Retirements, 56
  - Requirements, 56
  - First Round, 56
- Return to Competition, 149

## INDEX

Review Official, 333, 375  
Roof Policy, 473

### S

Scheduling, 83  
    Change of Surface, 87  
    Interruptions and Breaks, 88  
    Late Start Request, 84  
    No Postponement of First Round Qualifying Matches, 85  
    Rescheduling of Finals, 86  
    Rescheduling of Matches, 86  
Scoreboards, 338  
Scoring system, 339  
Seating, 340  
Security, 340  
Security – Risk assessment, 200  
Seeds, 77  
    Additional Seeds, 79, 156  
    Seeding Procedure, 79  
    Withdrawal of a Seed, 80, 82  
Sexual Abuse, 283  
Sheets, 341  
Shirts, 121  
Shoes, 124  
Shot Clocks, 338  
Signage, 227  
    On-Court Signage, 228, 308, 479  
    WTA Name and Logo, 226  
Sign-In Deadlines, 70  
Site check, 200  
Skirts, 123  
Smoking, 312  
Special Exempt Spots, 65  
Special Ranking Rule, 148  
Spectator Movement, 311  
Sponsorship Restrictions, 119, 233

## INDEX

Staff (WTA), 407  
Standards of Performance, 303  
Stringing, 340  
Supervisor, 407  
Suspension of Play, 371

## T

TADP Return to Competition Special Ranking Rule, 160  
Tennis Anti-Corruption Program, 274  
Tickets, 231, 311, 340  
Toilet/Change of Attire Breaks, 131  
    Abuse of Rule, 132  
    Denial of a Player Request, 132  
    Number of Breaks Allowed, 131  
    Timing of Breaks, 131  
Top 10 Players, 26  
Top 10 Player Entry – WTA 250 Tournaments, 26  
Tournament Applications, 199  
    Application Fee, 200  
    Application for a New Tournament, 199  
    Membership Fee, 201  
    No Release Deadline, 206  
    Site Check, 200  
Tournament Director, 341  
Tournament Financial Obligations, 265  
    Financial Security Requirements, 266  
    Letter of Credit, 266  
    Tournament Financial Commitment, 266  
    Payment Schedule and Amount, 266  
Tournament Insurance Requirements, 224  
Tournament Ownership, 211  
    Membership Lease, 215  
    Request for Change, 219  
    Transfer, 211  
Tournament Release Request, 206  
Tournament Responsibilities/Benefits to WTA, 225

## INDEX

Awards Ceremony, 232  
Banners, 227  
Commercial Benefits, 225  
Hospitality, 231  
Net Post Signs, 228  
Press Area/Interview Room, 229  
Program pages, 230  
Race to the Finals Leaderboard, 232  
Seats/Tickets, 231  
Sponsor Product Category Exclusivities, 225  
WTA Signage, 226  
Tournament Standards of Performance, 303  
    WTA 125 Tournament Standards of Performance, 425  
Tournament Support Personnel, 275  
Towels and Sheets, 341  
Training Room, 350  
Transfer of Ownership – Tournament, 211  
Transport, 342  
Treatment table, 351  
TV Pool (see Media Pool), 378

## U

Uniforms – Chair Umpires, 331  
United Cup, 487  
Unsportsmanlike Conduct, 56, 282

## V

Verbal Abuse, 280  
Video Board/Screens, 338  
Visible Obscenity, 278  
Vomiting, 368

## W

Walkie-Talkies, 344  
Web filtering, 323  
Wild Cards, 35  
    Acceptance, 36

## INDEX

- Additional, 44
- Age Eligibility Rule, 167
- Charts, 38, 39, 40, 41
- Exceptions, 42
- Exemption Wild Card, 37
- Maximums, 41
- Nomination Deadlines, 36
- Replacement, 43
- WTA 125, 40
- Withdrawals, 45
  - Extraordinary Circumstances, 59
  - Excused Withdrawals, 50
  - Main Draw Late Withdrawal, 47
  - Main Draw No-Show Offense, 49
  - Prize Money Withdrawals, 51
  - Prohibition Against Playing Another Tournament, 56
  - Qualifying Late Withdrawals, 49
  - Qualifying No-Show Offense, 50
  - Retirements, 56
  - Withdrawal of Seeds, 80, 82
  - Withdrawal Statment, 45
- Writing Table Chair Umpire, 334
- WTA Calendar, 199
- WTA Finals, 91
- WTA Contact Information (Headquarters), 405
- WTA Office (On-Site), 345
- WTA Rankings, 137
- Years of Service Player, 10



WTATENNIS.COM