

USER MANUAL

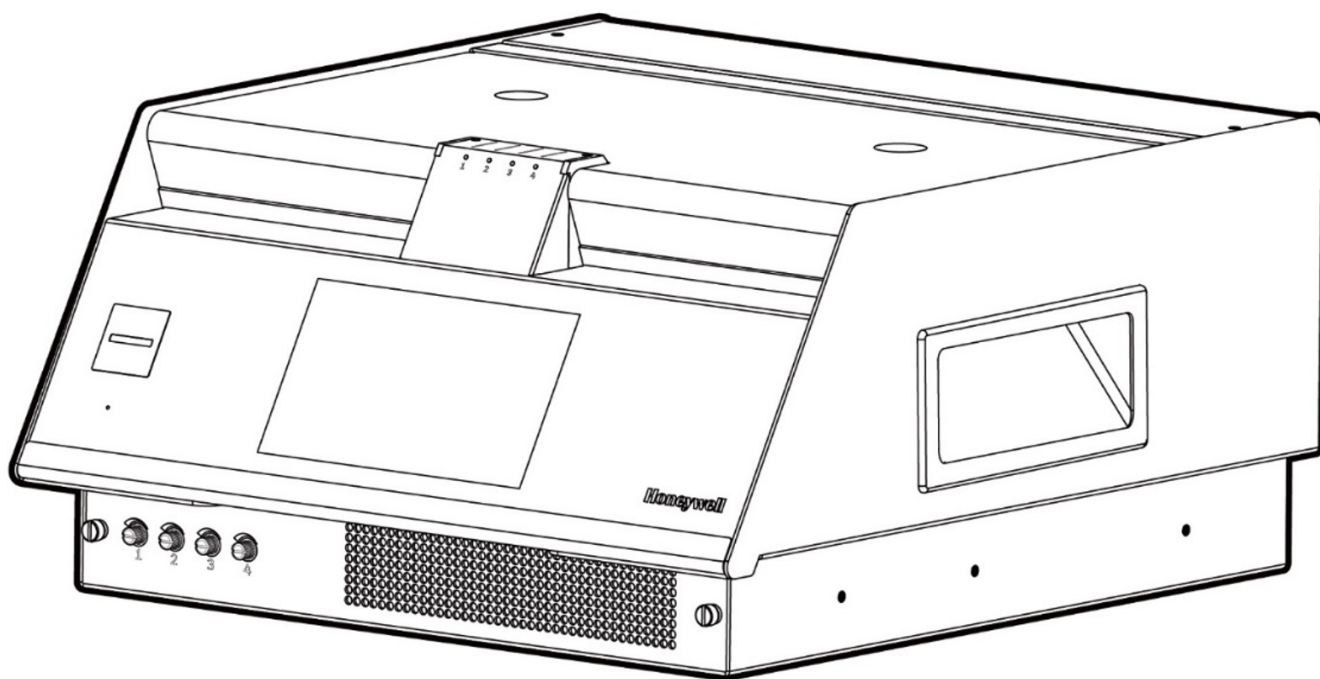

VC4™

4-Point Continuous Monitor

Honeywell

CONTENTS

Chapter 1 - Safety	7
1.1 Trademarks	7
1.2 General Safety	7
1.3 Continuous Monitor Symbols	8
1.4 Approvals	8
1.4.1 EMC Considerations	8
1.4.2 FCC Compliance Statement	9
1.4.3 NCC Compliance Statement	9
1.4.4 China RoHS	10
1.5 Cabling	10
1.6 Connectors	11
Chapter 2 - Introduction	12
2.1 System Overview	12
2.2 System Components	13
2.2.1 Overview	13
2.2.2 Back View	14
2.2.3 IO Panel	14
2.2.4 System Control Unit	15
2.2.5 Chemcassette™	15
2.3 Sampling System	16
2.4 Chemcassette™ Detection System	17
2.4.1 Detector Optics	17
2.4.2 Stain Pattern	17
2.4.3 Chemcassette™ Tapes	18
2.5 Vacuum Pump	19
2.6 Control Systems	19
2.7 Data Acquisition Computer	20
Chapter 3 - Installation	21
3.1 Installation Step 1: Surveying the Installation Site	21

3.1.1	Placement of the VC4™ system	21
3.1.2	Exposure to Dust and Humidity	22
3.1.3	Sample Transport Time	22
3.1.4	Monitor Dimensions	22
3.1.5	Sample Locations	22
3.1.6	Sample Line Particulate Filter Use	22
3.1.7	Installation Drawings	23
3.2	Installation Step 2: Optional Mounting Method	23
3.2.1	Rack Mounting	23
3.3	Installation Step 3: Installing Sample Lines	25
3.3.1	Sample Line Installation Requirements	25
3.3.2	Sample Line Connections	26
3.3.3	Installing Sample Line Particulate Filters	27
3.4	Installing the Pump Exhaust Line	27
3.4.1	Exhaust Line Installation Requirements	27
3.4.2	Exhaust Line Connection	27
3.5	Installation Step 5: Electrical Power	28
3.6	Installation Step 6: Data Acquisition System	28
3.7	Installation Step 7: Wiring Alarm Relays	29
3.7.1	Relay Contacts	29
3.7.2	Ratings	30
3.7.3	Wiring Guidelines	31
3.8	Installation Step 8: Wiring Current Loop (4-20 mA Output)	31
Chapter 4 - Device Operations		32
4.1	Getting Ready for the Start-up	32
4.2	Initial Startup	33
4.3	Power Up	33
4.4	Start Program	34
4.5	Create a Configuration Profile	35
4.5.1	Analyzer & Points	38
4.5.2	Service Due	41
4.5.3	Events	41

4.5.4	Set Timeout Values	44
4.5.5	Set Serial Comm	44
4.5.6	Set Database	45
4.5.7	Export/Import a Profile	45
4.6	Create a New User	47
4.7	Edit User Accounts	48
4.8	Set Login Timeout	49
4.9	Login and Logout	49
4.10	View Overview Status	52
4.11	View System Status	53
4.12	View Detailed Analyzer Information	54
4.13	View Detailed Point Data	56
4.14	Acknowledge Notifications	58
4.15	Maintain the Pump Close to Due Date	59
4.16	Turn a Pump On and Off	60
4.17	Turn the Monitoring Mode On and Off	61
4.18	Open the Optic Gate	61
4.19	Advance the Chemcassette™ Tape	62
4.20	View Optic Status	62
4.21	Adjust the Optic Block	63
4.22	Test Optic Block	66
4.23	Leak Checking Sample Lines	70
4.24	Adjust the Flow Rate	71
4.25	Sample Line Filter Replacement Counter	72
4.26	2mA Fault Operation	73
4.27	Calibrate Current Loop	74
4.28	Tune Current Loop	76
4.29	Set Relay State	77
4.30	View and Export the Events History Listed by Time	78
4.31	Export the Events History	79

4.32	View System Version Information	81
4.33	Fault/Alarm Test	83
4.33.1	Fault Test	83
4.33.2	Alarm Test	84
4.34	View Help File	84
4.35	Update an Analyzer Firmware	85
4.36	System Shutdown	89
Chapter 5 - Maintenance		90
5.1	Maintenance Schedule	90
5.2	Replace the Chemcassette™	90
5.3	Replace Pump	95
5.4	Replace Internal Filters	98
5.5	Orifice Inspection, Cleaning & Replacement	100
5.6	Clean the Optics	102
5.7	Clean the Touchscreen	103
Chapter 6 - Additional Information		104
6.1	Specifications	104
6.2	Detectable Gases	106
6.3	Maintenance Faults	110
6.4	Instrument Faults	113
6.5	Information Events	117
6.6	Manual Analyzer Override	120
6.7	Fix an Unresponsive VC4™ Touch Screen	121
6.8	Filter Compatibility	122
6.9	Replacement Parts & Consumables	124
6.10	Network Interfaces and Options	127
6.10.1	Modbus RTU	127
6.10.2	Modbus TCP	128
6.11	HMI PC Security Considerations	129
6.11.1	Connectivity	129

6.11.2	Internal Network	129
6.11.3	External Network	129
6.11.4	VC4™ HMI External Network Services	129
6.11.5	HTTPS Connections	130
6.11.6	External Network Security Considerations	130
6.12	Serial Communications and Options	131
6.12.1	Set Serial Communication	132
6.12.2	Serial Communications Protocol	132
6.13	Remote Alarm Reset Option	179
6.14	Warranty Statement	182
6.15	Contact Us	184

1 SAFETY

Read this information before you start using your device.

1.1 Trademarks

Brand or product names are trademarks of their respective owners. The following brand or product names are trademarks of Honeywell:

- VC4™
- Chemcassette™

1.2 General Safety







Follow all installation and operational instructions to ensure the safe and reliable operation of this unit. If this monitor is used in a manner not specified by Honeywell, the protection provided by the equipment could be impaired.



WARNING

RISK of damage to the equipment and electric shock. Do not connect or disconnect anything from the Power Distribution Unit (PDU) while energized.

1.3 Continuous Monitor Symbols

Symbol	Description
	Lifting instructions, low clearances, slipping/tripping hazards, minor corrosive dangers. Also used when defining personal protective equipment (gloves, dust masks, etc.)
	Personal injury risk: machinery hazards around guarded equipment, moving parts, crush/pinch hazards, flying debris, and arc flash hazards.
	The most dangerous or potentially lethal hazards: unguarded equipment, confined space entrances, and lockout labels.
	Caution: possibility of electric shock
	Caution: hot surface
	Protective conductor terminal (ground terminal)

1.4 Approvals

1.4.1 EMC Considerations

Your Honeywell continuous gas monitor has been designed to comply with Electromagnetic Compatibility (EMC) standards applicable at the time of its manufacturing. The design includes filtering, shielding and bypassing techniques. At the time of certification, simulated customer Input/ Output (I/O) schemes were tested.

All methods used in your equipment for emission suppression and reduction of susceptibility are interactive. Modifications to the monitor could result in increased emissions and higher vulnerability to other radiated fields.

Following the guidelines in this EMC Considerations section will ensure your monitor maintains the enhanced degree of EMC integrity. The guidelines listed apply only to I/O emissions and do not apply to A.C. and D.C. monitor power connections.

1.4.2 FCC Compliance Statement



CAUTION

RISK of radio interference. Changes or modifications not expressly approved could void your authority to use this equipment.

This equipment complies with Part 15 of the FCC rules. Operation is subject to the following two conditions: (1) This device may not cause harmful interference, and (2) This device must accept any interference received, including interference that may cause undesired operation.

This equipment has been tested and found to comply with the limits for a Class A digital device, pursuant to part 15 of the FCC Rules. These limits are designed to provide reasonable protection against harmful interference when the equipment is operated in a commercial environment. This equipment generates, uses, and can radiate radio frequency energy and, if not installed and used in accordance with the instruction manual, may cause harmful interference to radio communications. Operation of this equipment in a residential area is likely to cause harmful interference in which case the user will be required to correct the interference at his own expense.

To satisfy FCCRF exposure requirements, a separation distance of 20 cm or more should be maintained between the antenna of this device and persons during device operation. To ensure compliance, operations at closer than this distance is not recommended.

1.4.3 NCC Compliance Statement

Without permission granted by the NCC, any company, enterprise, or user is not allowed to change frequency, enhance transmitting power or alter original characteristic as well as performance to an approved low power radio-frequency devices. The low power radio-frequency devices shall not influence aircraft security and interfere legal communications; If found, the user shall cease operating immediately until no interference is achieved. The said legal communications means radio communications is operated in compliance with the Telecommunications Management Act. The low power radio-frequency devices must be susceptible with the interference from legal communications or ISM radio wave radiated devices.

1.4.4 China RoHS

产品中有害物质的名称及含量						
部件名称	有害物质					
	铅 (Pb)	汞 (Hg)	镉 (Cd)	六价铬 (Cr(VI))	多溴联苯 (PBB)	多溴二苯醚 (PBDE)
印刷电路板组件	×	○	○	○	○	○
线束及电镀连接组件	×	○	○	○	○	○
第三方电脑、显示器、键盘、光驱、开关、集成器、控制器	×	○	○	○	○	○
机械部件风扇, 马达, 福马轮	×	○	○	○	○	○
外壳	○	○	○	○	○	○
金属零件	○	○	○	○	○	○
紧固件	×	○	○	○	○	○
管路系统	○	○	○	○	○	○

本表格依据 SJ/T 11364 的规定编制

○：表示该有害物质在该部件所有均质材料中的含量均在 GB/T 26572 规定的限量要求以下。

×：表示该有害物质至少在该部件的某一均质材料中的含量超出 GB/T 26572 规定的限量要求。

1.5 Cabling

At the very minimum, all cables should include a braided shield. Ensure local electrical code requirements are met.

Braid	Must have a minimum 65% coverage
Foil	When used with braid, provides 100% coverage. Do not use foil alone. It has a tendency to break.
Stranded Pair	Provides the greatest surface area
Shield Termination	Continuation of the shield to the cabinet earth ground is most important. For discrete wire terminations, pigtailed to the cabinet (connector) ground should be extremely short (no greater than three inches). For multiconductor connector terminations, only 360° shells should be used.

Note: Honeywell product testing uses >65% braid with foil (around the bundle); twisted pair; stranded 24 AWG (minimum wiring for all qualification and certification testing.)

1.6 Connectors

All qualifications and certification of Honeywell products were achieved with high quality connectors, providing 360° shield coverage. These connectors generally had metal shells.

Failure to properly secure the connector to the equipment will result in high emission levels. Also, poorly constructed or improperly assembled connectors can be a high source of radiated noise and provide a path for external signals into the monitor.

To comply with global EMC requirements, all external cables need to be installed in either metal ducts or zipper tubes that have both ends connected to ground.

All Ethernet cables need to be shielded cables.

2 INTRODUCTION

2.1 System Overview

The Honeywell VC4™ system continuously monitors up to 4 remote locations for toxic gases. It responds to gases that exceed programmed levels by:

- Triggering alarms and opening event windows to warn operators of high concentrations
- Displaying the location, gas type and gas concentration
- Storing the alarm information in a database

The VC4™ system provides fast response to a wide range of gases. Each location may be up to 400 ft (122 m) from the VC4™ system. The system triggers relays for each individual point for two levels of gas concentrations.

The VC4™ system's flexibility allows it to be easily configured for tabletop use or rack mounting. The VC4™ system uses Honeywell patented Chemcassette™ technology for rapid, accurate gas detection. The system was designed for maximum uptime, so filters, Chemcassette™, and even the entire chassis can be replaced quickly and easily. The system powers up in the same state as when powered down.

Operation can be through an LCD touch screen or through a local area network (LAN). Chemcassette™ is a registered trademark of Honeywell.

2.2 System Components

The following photos illustrate the VC4™ system views, ports, connections, and controls.

2.2.1 Overview

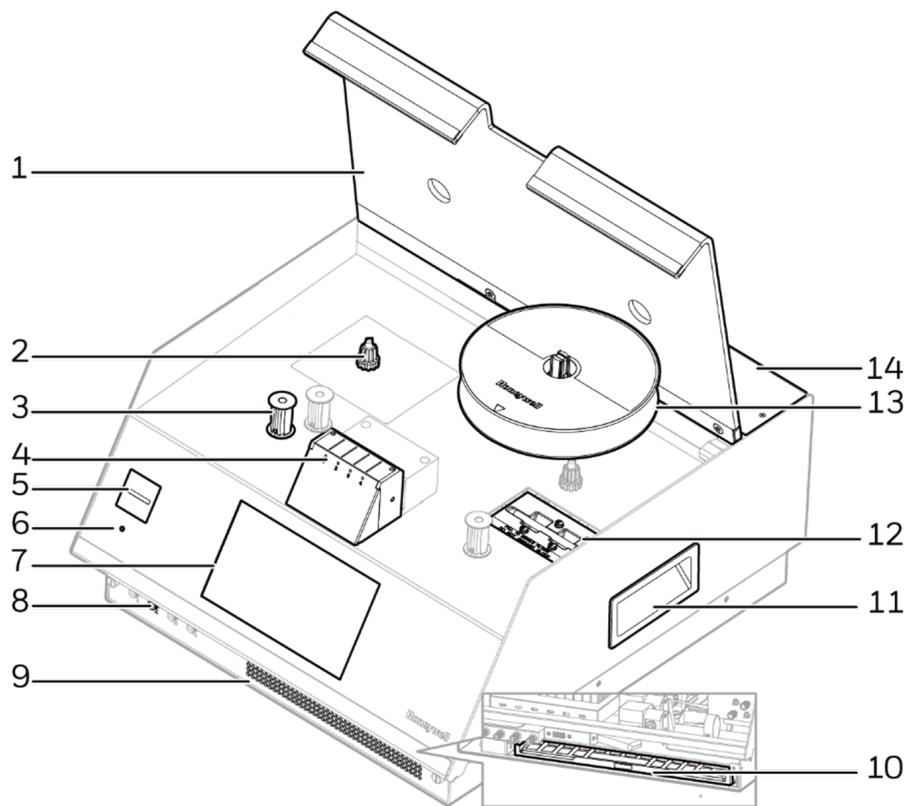

1. Cover of Chemcassette™	6. Alarm buzzer	11. Handle
2. Supply reel	7. HMI display	12. Filter block
3. Tape guide roller	8. Needle valve	13. Take-up reel
4. Optics block	9. Air filter	14. Cover of IO panel
5. Status LED	10. Keyboard	

2.2.2 Back View

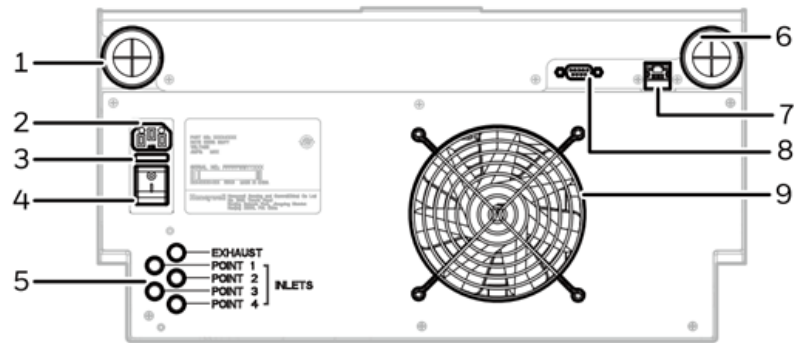

1. Alarm wire panel knockouts	4. Power switch	7. Ethernet port
2. Line power in	5. Sample inlets and exhaust	8. COM port
3. Fuse	6. Current loop knockout	9. Cooling fan

2.2.3 IO Panel

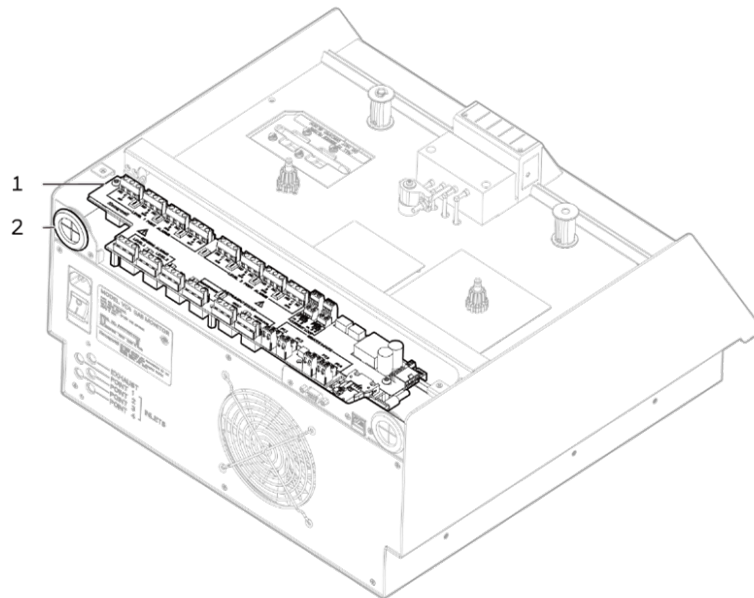

Note: Remove the cover of IO panel

1. IO panel (cover removed)	2. IO connection identification card
-----------------------------	--------------------------------------

2.2.4 System Control Unit

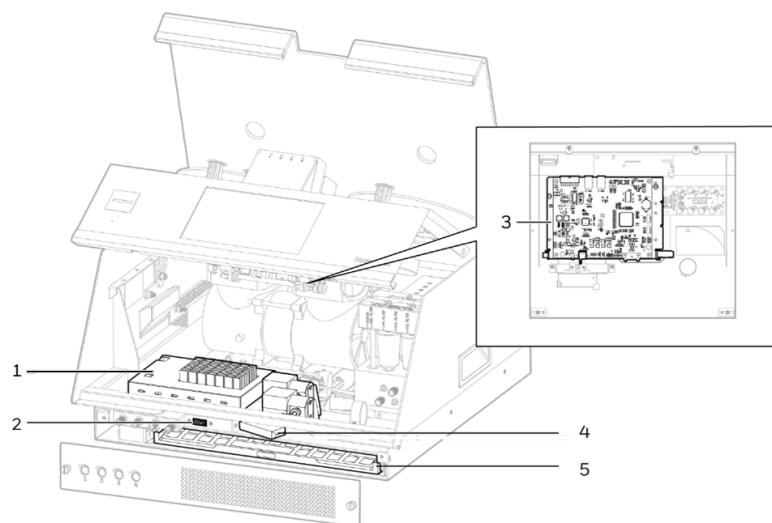

1. Single Board Computer	4. USB disk
2. USB port	5. Keyboard
3. Analyzer main board	

2.2.5 Chemcassette™

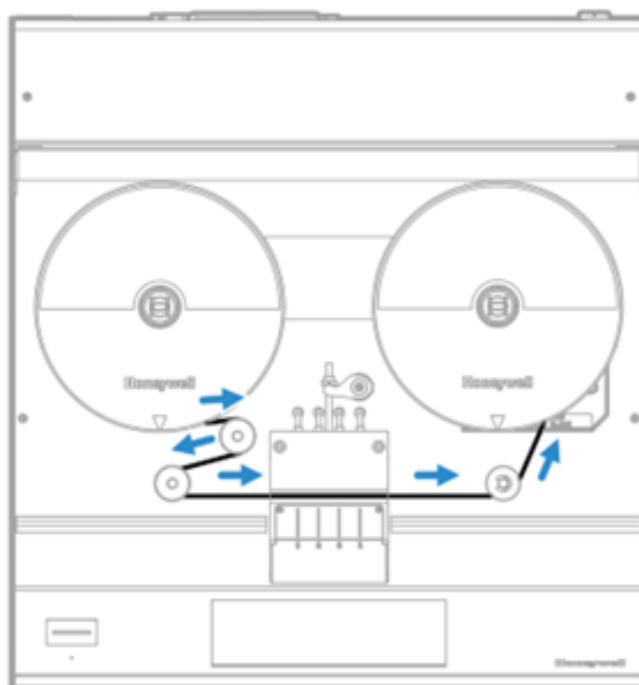

Chemcassette™ directional flow

2.3 Sampling System

The VC4™ is a monitoring center for sampling lines from sample locations. As they apply to the VC4™ system, the words point, line, and location require definition:

- A location is a place to be monitored
- Sample atmosphere runs from the location to the VC4™ system via a line
- Each of the 4 sample tubing connections on the VC4™ system corresponds to a point. The system draws air simultaneously from all locations. Two different types of flow are:
 - **Transport flow:** high-velocity, large-volume air movement through the lines
 - **Sample flow:** air admitted to the Chemcassette™ detection system

The high speed of transport flow allows rapid monitoring and response time when using long lines from monitored locations to the VC4™ system. A small portion of the transport flow (sample flow) is analyzed to determine concentration levels.

The complete sampling and monitoring system consists of the following components:

- Sample lines to all monitored locations
- Flow connections through quick-connect ports on back of unit
- Vacuum pump
- Manifolds, Orifices, Chemcassette™ and filters
- Flow controlling manual needle valve
- Exhaust port

There are 4 inlets, one for each monitored location. One exhaust port is also located at back of the VC4™ cabinet.

2.4 Chemcassette™ Detection System

The Chemcassette™ detection system is included on an analyzer plate on top of the VC4™. The Analyzer module is a self-contained, microprocessor-controlled analyzer. Sample lines and the vacuum source are connected to the Chemcassette™ via a single 5-tube connector to develop a better stain for better sensitivity and reliability.

The system powers up in the same state as when powered down. Data is stored in the module's memory until the data acquisition computer retrieves it.

The VC4™ Analyzer module use the Honeywell Chemcassette™ optical detection system. Analyzer module sample and detect a specific gas or family of gases.

The Analyzer module manages Chemcassette™ tape transport, provides optical detection of stain, directs sample flow through the Chemcassette™ to develop a better stain for better sensitivity and reliability, stores event data for retrieval by the data acquisition computer.

Components of the detection system include:

- Chemcassette™ detection tape
- Optics and electronics for the detection system
- Chemcassette™ tape transport mechanism
- Manual adjustment needle valve

2.4.1 Detector Optics

The heart of the Chemcassette™ module is an optical detection system that measures a stain that develops on the Chemcassette™ tape in the presence of a target gas.

2.4.2 Stain Pattern

The following chart shows the stain pattern of sample detection on the Chemcassette™ tape.

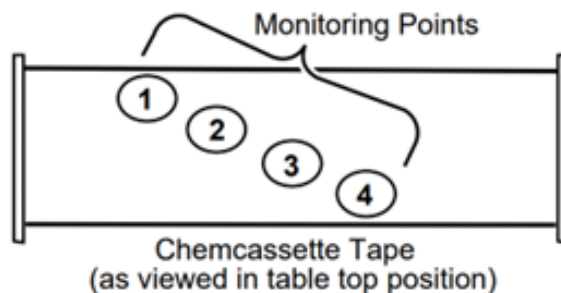

When monitoring a location, the system detects and measures a specific gas or a family of gases in the sample. The microprocessor in the analyzer module interprets the data and responds appropriately.

In the Closed Loop Optics (CLO) detection system, a reference detector monitors and controls the intensity of the LED.

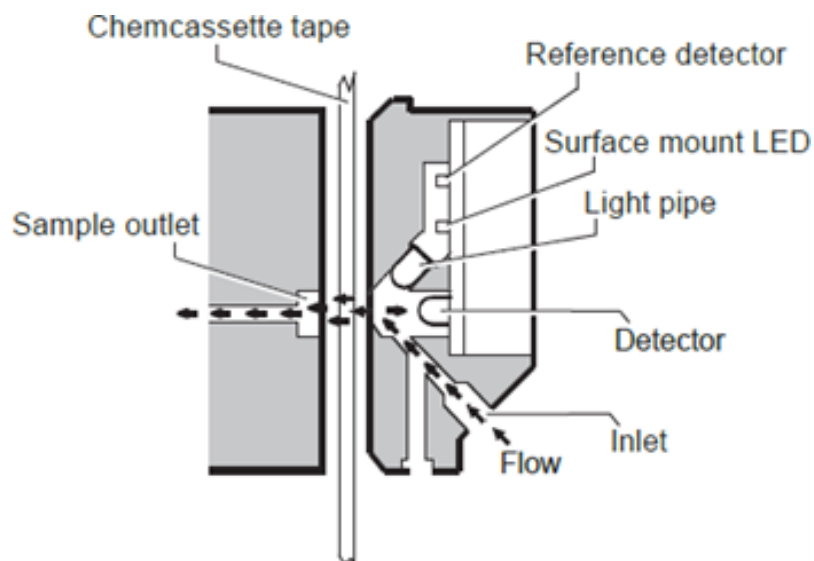

The microprocessor in the Chemcassette™ analyzer module interprets the stain. It then calculates and reports a precise concentration level to DAq PC or external system. Gas concentrations are reported in parts-per-million (ppm), parts-per-billion (ppb) or milligrams-per-cubic-meter (mg/m^3).

2.4.3 Chemcassette™ Tapes

Chemcassette™ tapes are tagged with a radio frequency identification (RFID) tag to automatically identify the following:

- Serial number
- Gas family/ tape type
- Revision level
- Expiration date of the tape
- Chemcassette™ leader parameters

The module uses a leader on the Chemcassette™ tape to allow calibration of the optics every time a new tape is installed. This feature can be bypassed.

2.5 Vacuum Pump

The pump provides a vacuum source for the transport and sample flow system. The pump exhaust connects to the manufacturing facility central toxic exhaust system.

Note: The exhaust line from the VC4™ should not exceed 50 feet.

The pump is located in the VC4™ system cabinet. The cooling fan circulates air over the pump.

The VC4™ system draws cooling air in through a filter mounted on the front panel of the cabinet.

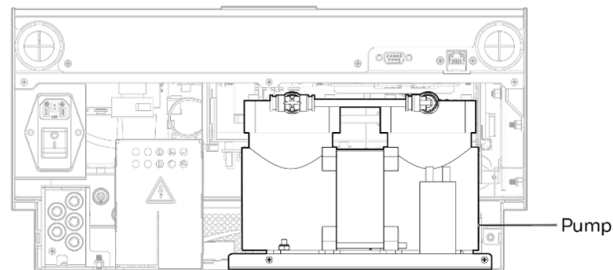

2.6 Control Systems

The VC4™ control system consists of a central data acquisition computer (DAq), and an analyzer module.

Following is a simplified block diagram of the communications path of the control system. The analyzer module is microprocessor controlled and contains non-volatile memory.

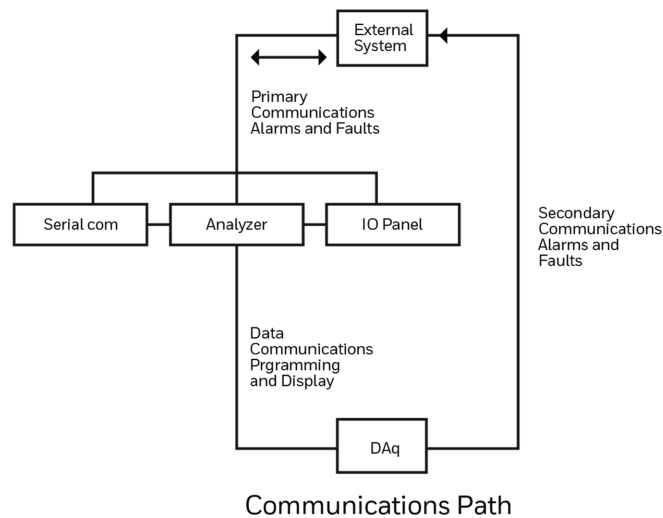

2.7 Data Acquisition Computer

The data acquisition computer (DAQ) is the central processor for the VC4™ system. It configures the analyzer, stores data and provides a network interface for data transfer to other computers.

System display and operator control is through an on-screen keyboard.

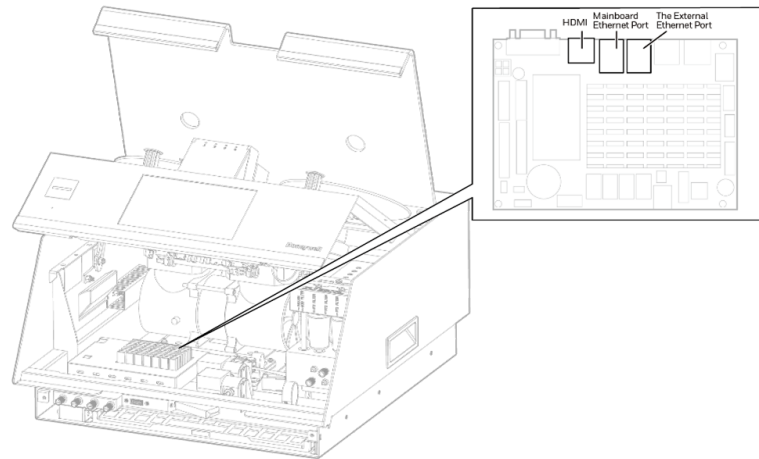

3 INSTALLATION

The installation procedure for the VC4™ system consists of eight steps:

1. Surveying the Installation Site
2. Optional Mounting Method
3. Installing Sample Lines / Filters
4. Installing Pump Exhaust Line
5. Electrical Power
6. Data Acquisition System
7. Wiring Alarm Relays
8. Wiring Current Loop (4-20 mA Output)

3.1 Installation Step 1: Surveying the Installation Site

A survey of the site helps you to make important decisions before installing your VC4™ system. Topics in this section are intended to assist you with appropriate placement of the VC4™ system and in determining if you have special filtering needs at the sampling location.

The site should:

- Be remote from the monitored location
- Have sufficient ventilation for cabinet cooling
- Have power available
- Be indoors in an area that is not subject to wide variations in temperature and humidity

Note: The recommended humidity is 20-80% RH and a temperature between 50°F to 104°F (10°C to 40°C).

3.1.1 Placement of the VC4™ system

Install the VC4™ system in an environmentally-protected site remote from the manufacturing or storage locations that it monitors.

You can place the VC4™ system away from sample locations with sample tubing up to 400ft. (122m) length.

3.1.2 Exposure to Dust and Humidity

Exposure to corrosive gases or materials, excess moisture, dust and other unusual environmental conditions could seriously hamper the unit's monitoring ability and could cause damage to it.

Allow room around the VC4™ system for ventilation and servicing.

3.1.3 Sample Transport Time

The shorter the sample line, the shorter the transport time. If monitoring a critical location, it may be desirable to place the monitor near that critical area to reduce sample transport time for that location.

3.1.4 Monitor Dimensions

Monitor dimensions are important factor in monitor placement. The basic tabletop, the dimensions are approximately 8.7 inches (22 cm) high. "Rack Mounting" on the facing page for required clearances and mounting dimension for the optional rack mount configurations. Monitor dimensions are important factors in instrument placement for the basic tabletop configuration. The VC4™ system is 17 inches (43 cm) wide and 17.9 inches (45 cm) in depth. Allow clearance above the monitor for installing sample lines.

The VC4™ system weighs about 51 pounds (23 kg).

3.1.5 Sample Locations

Before installing the VC4™ system, evaluate the sampling locations to determine the presence of excessive dust or moisture. An external filter must be used in all locations. Make sure you use the correct filter. Dust may be a result of construction as well as manufacturing activities. Moisture may result from rain entering a line at an outdoor sampling location or from condensation caused by temperature fluctuations. Water condensation in the sample lines could cause false alarms.

Note: Variables such as airflow, the molecular weight and temperature of the sample gas, and the physical conditions of the areas being monitored influence the placement of the sampling locations. You may need to consult your company's industrial hygienist or safety officer before installing sample lines to determine your company's policy related to sampling locations and monitoring of the desired sample gas.

3.1.6 Sample Line Particulate Filter Use

"Filter Compatibility" on page 122 for Specifications, to determine which filter type should be used at the location.

3.1.7 Installation Drawings

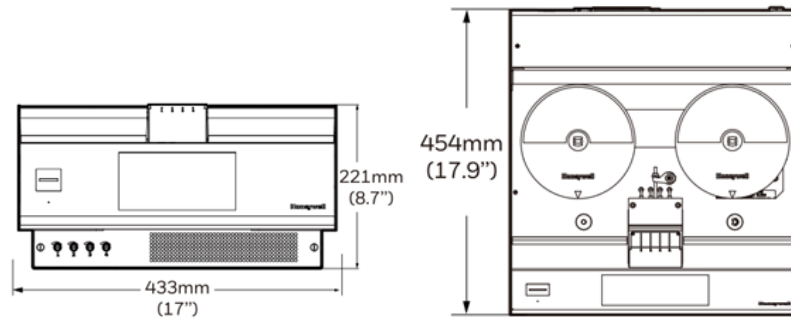

3.2 Installation Step 2: Optional Mounting Method

3.2.1 Rack Mounting

The VC4™ Rack Kit includes two custom slides™ and hardware for installation in a customer-supplied standard 19 inch rack.



CAUTION

RISK of equipment damage. Verify power is Off before disconnecting customer I/O board.

Follow these points when installing the rack mount:

1. Verify proper clearances and dimensions for instrument placement.

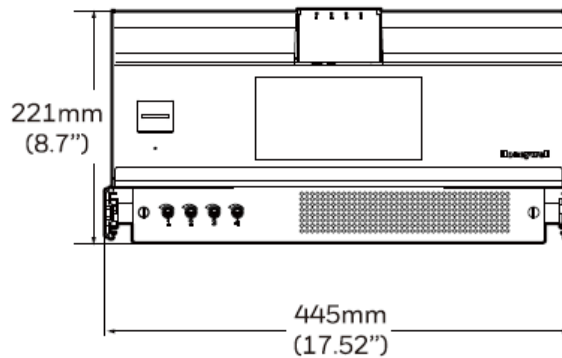

2. Allow 9.00 inch (23 cm) height between units for proper clearance.
3. Refer the figure for right side fastener locations. Left side installation is identical.

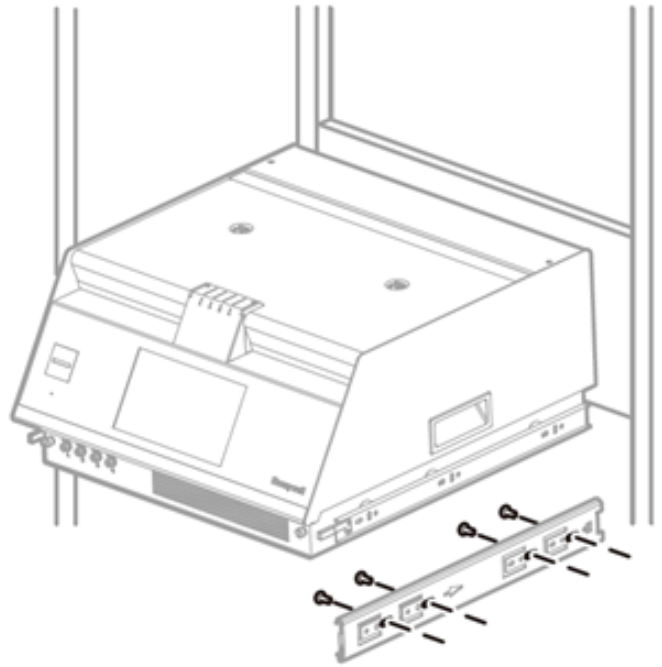

4. In the recessed position, make sure there is 3-1/4 inch (8.25 cm) clearance for the loop of slack cable as shown in Figure below.

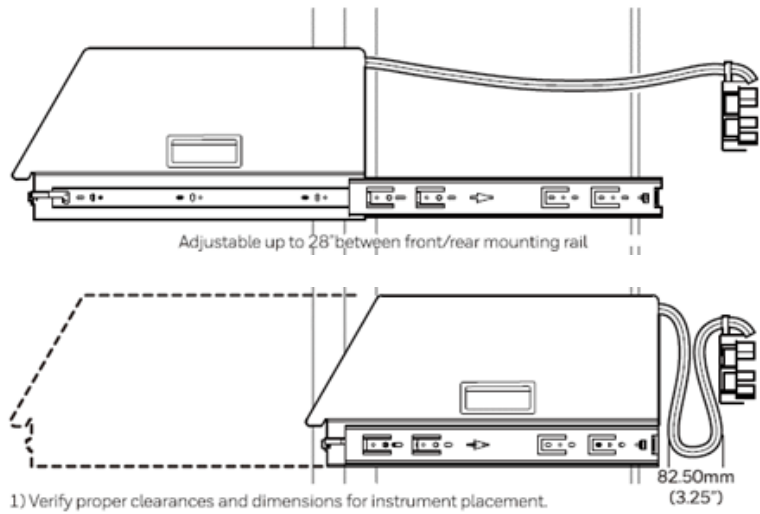

5. To slide out the device, press the lever.

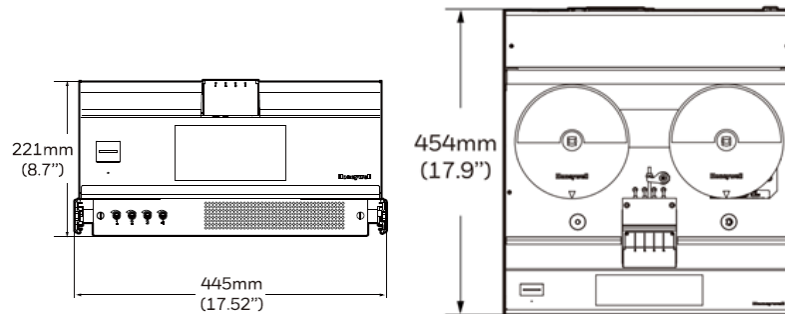

3.3 Installation Step 3: Installing Sample Lines

Use only FEP Teflon™ tubing to assure proper sample transport. Other types of tubing are not sufficiently inert. "Specifications" on page 104, for tube specifications. FEP tubing can be ordered from Honeywell.

Install sample lines from each location to the VC4™ system, allowing room to access the back panel. This procedure involves:

- Sample Line Installation Requirements
- Sample Line Connections
- Installing Sample Line Particulate Filters

Honeywell supplies FEP grade Teflon tubing with all new monitors. This tubing is manufactured to our own strict specifications and has been purged of all byproducts of the manufacturing process. On occasions, users have supplied their own FEP type tubing. Should you choose to use your own tubing, be advised that some brands of FEP tubing off-gas small amounts of HF, which can be detected on start up by Honeywell monitors configured for detecting mineral acids gases (HBr, HCl, HF, NF₃). Before enabling building alarm systems, make certain that:

1. You have installed the correct Chemcassette™, and
2. Your monitor reads zero.

1/4 in. (6.35 mm) O.D. x 0.190in. (4.83 mm) (Thin wall)

3.3.1 Sample Line Installation Requirements

Follow the general requirements listed below when installing sample lines.

- Sample lines should not exceed 400 ft. (122m) in length.
- Route all lines as direct as possible to improve transport time.
- Avoid running sample lines through areas of great temperature extremes, such as adjacent to steam or chiller lines.
- Sample lines should not be crimped, bent to less than a 12 in. (30.5 cm) radius, or placed in an area where weight could collapse the tubing. Sample lines should be easily accessible for periodic inspection.
- Where possible, leave as many bends exposed for periodic visual inspection of the line for kinked or damaged tubing.
- Check each sample line installation for seal integrity after completing installation of the VC4™ system. See Leak Checking Sample Lines, for the leak check procedure. Also use this procedure to detect leaking or severed tubing after events, such as construction, which may have affected the integrity of the tubing.
- Unused points require a filter. Filter kit 1295A0702 is recommended.
- If the VC4™ system is installed with a Chemcassette™ tape, the optics may need cleaning before activating a previously unused point(s).

3.3.2 Sample Line Connections

To prepare for installation of sample lines, remove the FEP Teflon tubing from the installation kit. The back of the unit includes 5 connections:

- 4 Sample Inlets (Point legend follows and is in proper sequence.)
- Exhaust Outlet (See Installing Pump Exhaust Line, for connection.)

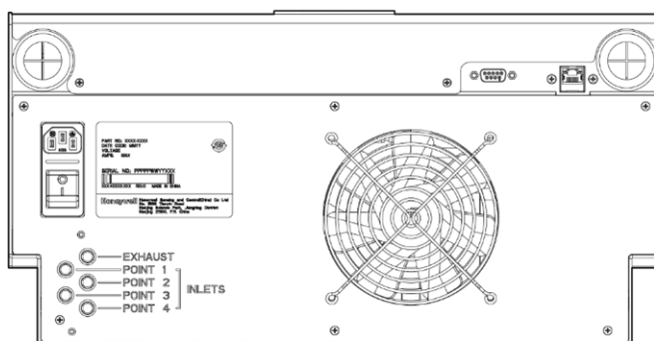

Note: Always perform a leak check after installing sample lines. "Leak Checking Sample Lines" on page 70 for the leak check procedure.

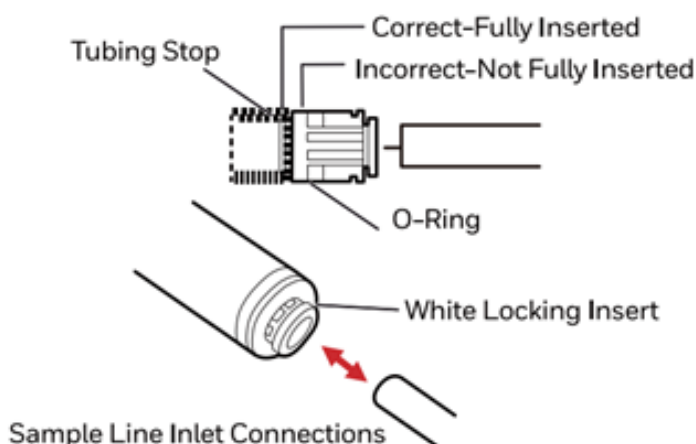

Each inlet has a quick connect/disconnect fitting with an internal O-ring and an external grab ring. To install a tube into a sample line inlet, insert the tube far enough into the fitting to ensure that the tube has passed through both the external grab ring and the internal O-ring and is firmly seated against the stop. The insertion depth for a correctly installed sampling line is 1/2in. to 5/8in. (12 mm -16 mm).



CAUTION

RISK of improper operation. Improper installation of the tube into the connector results in dilution of the sample. Make sure to install the tube properly in the connector.

3.3.3 Installing Sample Line Particulate Filters

Attach a sample line filter to the sampling end of the line for all locations.



CAUTION

RISK of improper operation. Excess amounts of dirt in the filters reduces the sample flow, raises sample vacuum and may affect concentration readings of the analyzer.

"Filter Compatibility" on page 122 to determine the proper filter type to use with each target gas.

3.4 Installing the Pump Exhaust Line

This section describes exhaust connections and installation. The VC4™ is equipped with a vacuum pump located in the VC4™ cabinet. The pump exhaust line connects to the manufacturing facility central toxic exhaust system.

3.4.1 Exhaust Line Installation Requirements

Follow the general requirements listed below when installing exhaust lines.

The length of the line should not exceed 50 ft. (15 m). If longer distances are required, contact Honeywell.

Do not crimp exhaust lines or place them in an area where weight could collapse the tubing or bend them to less than a 12 in. (30.5 cm) radius.

Where possible, leave as many bends exposed for periodic visual inspection of the line for kinked or damaged tubing.

Varying exhaust pressure can induce pump failure or flow faults.

3.4.2 Exhaust Line Connection

The instrument includes 50 ft. (15 m) of 0.190in. (4.83mm) I.D. x 1/4in. (6.35mm) O.D. Teflon or Polypropylene tubing. Insert the tubing into the exhaust port at the back of the unit.



CAUTION

RISK of injury. Leaks in the exhaust tubing connection can cause exposure to toxic gases from remote sample areas.

To ensure a leak-free installation:

- Use a polypropylene tube with outside diameter 1/4in. (6.35mm) +/- .005in. (0.127mm).
- Verify that the external surface of the tube is free of score marks and scratches that could compromise the O-ring seal used in the fitting over the insertion depth.
- Cut the tube end perpendicular to its length 0.062in (1.5mm) from its end.
- Insert the tube in the fitting to a depth of 1/2in. to 5/8in. (12 mm -16 mm).

With the system running, verify the leak integrity by plugging a sample point and monitor sample point flow via HMI point flow screen.

3.5 Installation Step 5: Electrical Power

The VC4™ system requires a dedicated AC power line. Configurations include:

- 110 VAC; 50 or 60 Hertz; 3 amp
- 220 VAC; 50 or 60 Hertz; 2 amp

Plug the line into a dedicated outlet having sufficient amperage capacity.

Line voltage should fluctuate no more than $\pm 10\%$

3.6 Installation Step 6: Data Acquisition System

The data acquisition computer or DAq is the main computer in the VC4™ system.

The VC4™ system can be connected to an external Ethernet network at the port shown.

Main computer and Keyboard



External Network Connection

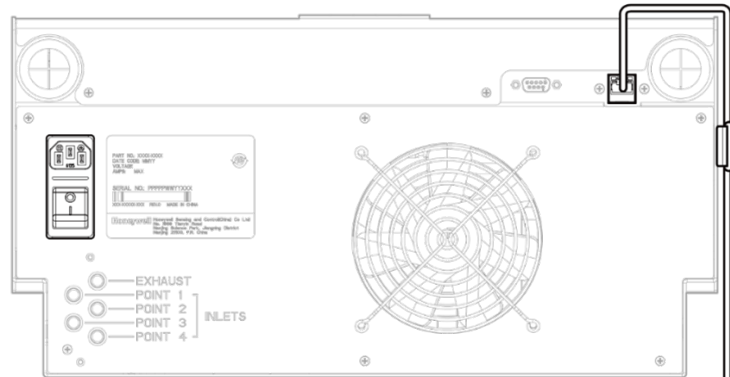

The ferrite is supplied with the VC4™ product, and it is in the accessory kit in the product package.

Note: To maintain EMC certification, the Ethernet cable should make 1 loop through the supplied ferrite cable clamp. The clamp should remain on the outside of the VC4™ enclosure.

3.7 Installation Step 7: Wiring Alarm Relays



WARNING

RISK of electric shock. Use caution when servicing fuses or terminal blocks. Power to contacts is supplied externally.

3.7.1 Relay Contacts

The VC4™ system has 14 form C, single-pole, double-throw relays that activate external alarm devices. Contacts are available for each circuit to accommodate installation of external devices.

The relay panel may be removed from the VC4™ chassis without disconnecting relay wiring. This allows you to replace the VC4™ system without having to reinstall the relay connections.

Each relay has three terminal contacts.

- Normally open
- Fused common
- Normally closed

The terminal blocks for the relay contacts are located on the relay panel. Relays include:

- Four Level 1 alarms (RY1, RY3, RY5, RY7)
- Four Level 2 alarms (RY9, RY11, RY13, RY14)
- One general Level 1 alarm (RY2)
- One general Level 2 alarm (RY4)
- One watch dog (power loss/CPU failure) relay (RY12)
- One maintenance fault relay (RY8)
- One instrument fault relay (RY10)
- One **Out of Monitoring** relay (RY6)

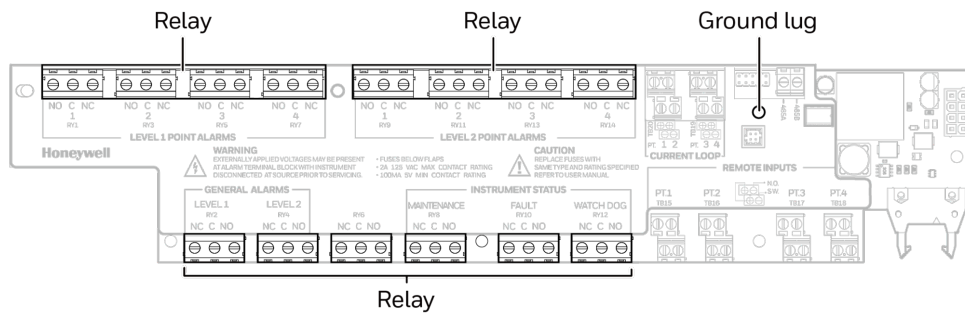

NOTE: Make sure that watch dog relays and instrument fault relays are wired in series to ensure that any fault will trigger a diagnostic alarm. This will ensure a fail-safe operation.

3.7.2 Ratings

To ensure reliable contact operation, the following limits must be observed:

- 0.1 to 2.0 amps
- @5-24 VDC or
- @5-120 VDC

CAUTION

RISK of improper operation. The alarm relay has a minimum load requirement of greater than 5V and 100 mA. For reliable relay operation, ensure the alarm circuit meets these requirements. The relay contacts are protected by metal oxide varistors rated for 120 VAC maximum operation.

3.7.3 Wiring Guidelines



CAUTION

RISK of improper operation. Failure to replace and retighten hardware after servicing can adversely affect instrument performance and EMC compliance. Make certain all fasteners are reinstalled and firmly tightened. This will ensure a proper ground.

To wire the alarm relays:

- Use shielded cable or conduit. "Specifications" on page 104 for additional cable information.
- Connect grounds to stud at lower left corner of the I/O panel.
- Use #8 hardware provided
- Use a single, solid or stranded wire (not exceeding 14 gauge) per terminal block connection
- Do not switch DC current with the relay contact unless you are using counter electromotive force (CEMF) protection such as a suppression diode
- Do not use the VC4™ system power supply for external alarm power

Note: Make sure all connections comply with applicable RFI/EMI standards.

3.8 Installation Step 8: Wiring Current Loop (4-20 mA Output)

Each current loop output produces a current which varies linearly from 4 to 20 mA as the concentration of gas varies from zero to full scale concentration. The gas concentration for 20 mA full scale defaults to the full scale of the gas.

Furthermore, the VC4™ system can be configured lower to reduce these output currents to 2 mA if certain faults occur. These outputs will drop to zero mA after a power failure.

The current loop connection points are located on the I/O Panel. The impedance range of the analog output is 100-800 ohms. "Specifications" on page 104 for wiring guidelines.

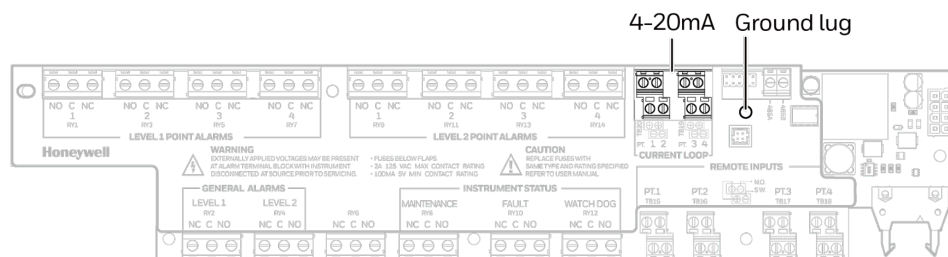

4 DEVICE OPERATIONS

Learn what you can do with your Honeywell VC4™ system Continuous Monitor.

4.1 Getting Ready for the Start-up

Learn the Honeywell VC4™ system start-up sequence and how to configure the analyzer module for specific gas locations.

Honeywell loads all software on the DAq at the factory. Please configure each point for the target gases at your facility.

Before you begin the start-up and configuration, gather the following information:

- The location to which each point is connected
- Target gas at each location
- Alarm levels

Ahead of the start-up sequence, make sure that the following installation steps are completed:

- Sample lines
- Exhaust line
- AC power connection
- Sample Line Dust Filters
- I/O Connection

4.2 Initial Startup

Use this section to turn on your VC4™ system and to configure the analyzer module for specific gas locations. There are eight parts to this startup procedure:

- Power Up
- Start Program
- Log in the HMI program
- Create a configuration profile
- Replace the Chemcassette™ Tape
- Leak Checking Sample Lines
- Adjust the Flow rate
- Adjust Supply Vacuum

4.3 Power Up

Use the rocker switch on the right rear of the unit, above the power cord, to turn on power to the VC4™ system.

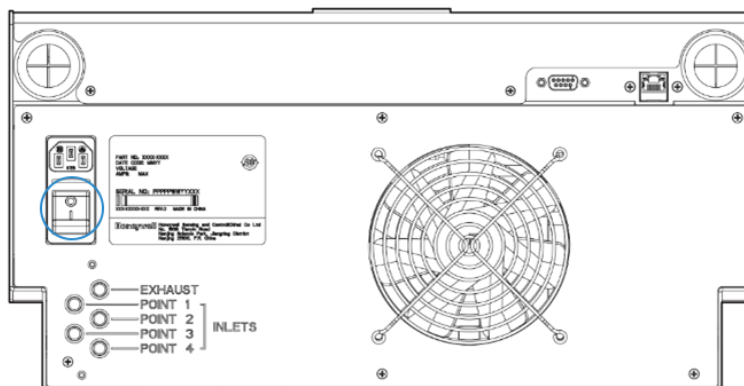

After the initial color sequence, the VC4™ LEDs show system status. The following chart matches status with LED signals.

Mon State	Alarm State	Fault State	time in milliseconds									
			500	400	100							
idle	0	none	black			green						
		maintenance instrument	amber		black	black						
	1	any	red		black	black						
		2	any	red		black	black					
monitoring	0	none	green			black						
		maintenance instrument	amber		green	green						
	1	any	red		green	green						
		2	any	red		green	green					
primary program invalid			amber	black	amber	black	amber	black	amber	black	amber	black
unpowered			black									

Beep Status,

- Level 1 alarms, Constant audio alarm tone
- Level 2 alarms, Beeping audio alarm tone
- Critical instrument faults impact gas monitoring, Beeping audio alarm tone

Note: Before the VC4™ system can begin monitoring, you must create a configuration profile.

4.4 Start Program

Upon power-up, the HMI PC automatically starts Ubuntu (Linux) and loads the VC4™ HMI program. After the startup sequence, the VC4™ HMI main screen opens as below. The start-up time may take several minutes, and the default user is Viewer (R3).

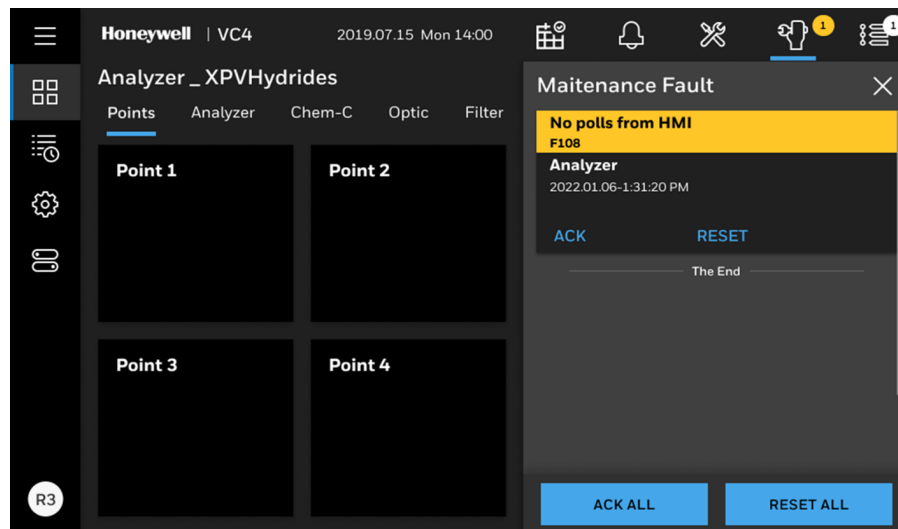

Note: Any time the VC4™ system is powered up, loss of communications may cause maintenance faults. "Acknowledge Notifications" on page 58 for instructions to clear faults.

Note: Use the System Manager->Region and time menu to change the time and date on your VC4™ system.

4.5 Create a Configuration Profile

The configuration profile stores all of the monitor settings in a single file on the hard drive. Configuration profiles include system level information, point settings and analyzer information.

1. From the main menu, go to **System Manager > Profile Manager**.

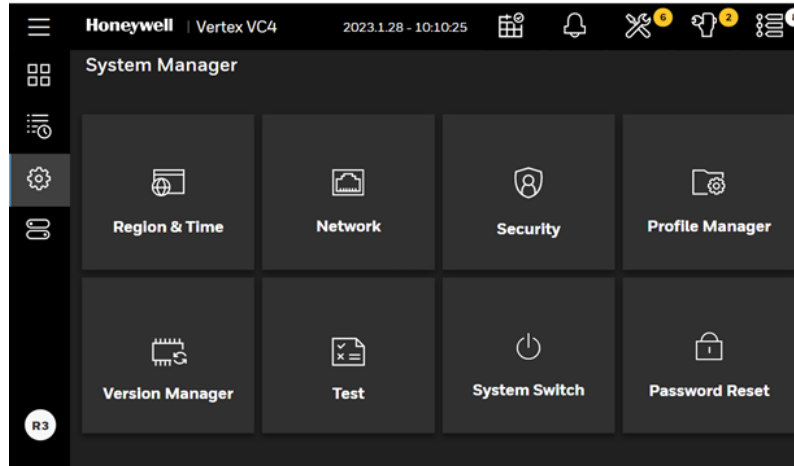

Then you'll see the following screen.

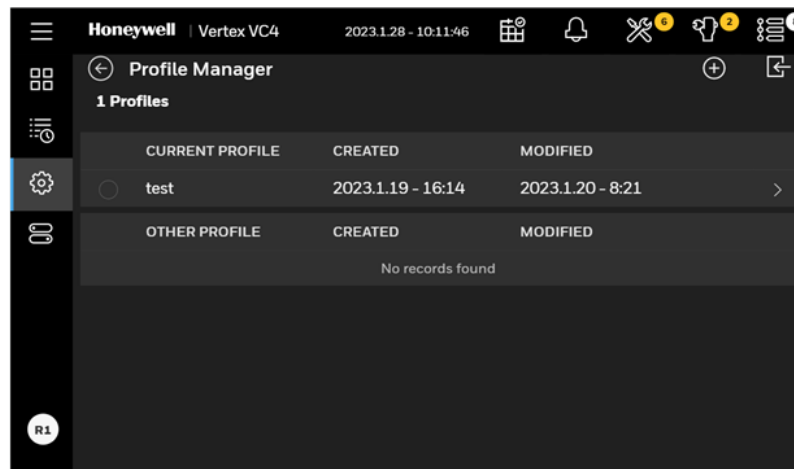

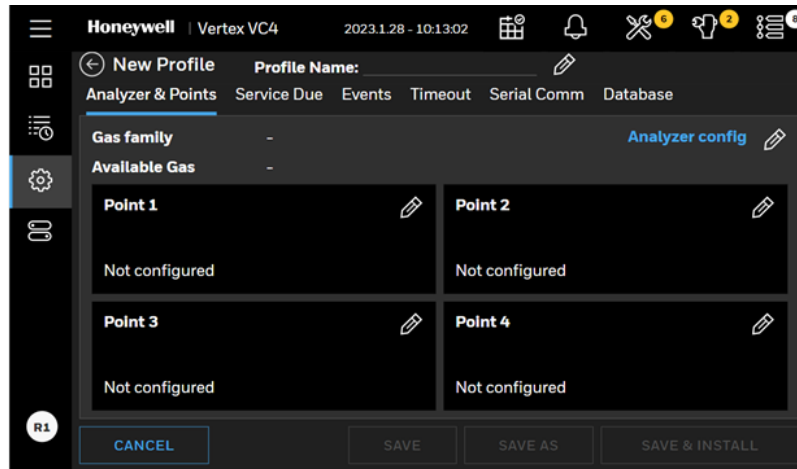

2. Tap the Add profile button .

- In the Add new profile page, enter a profile name, and then you can start to edit the profile.



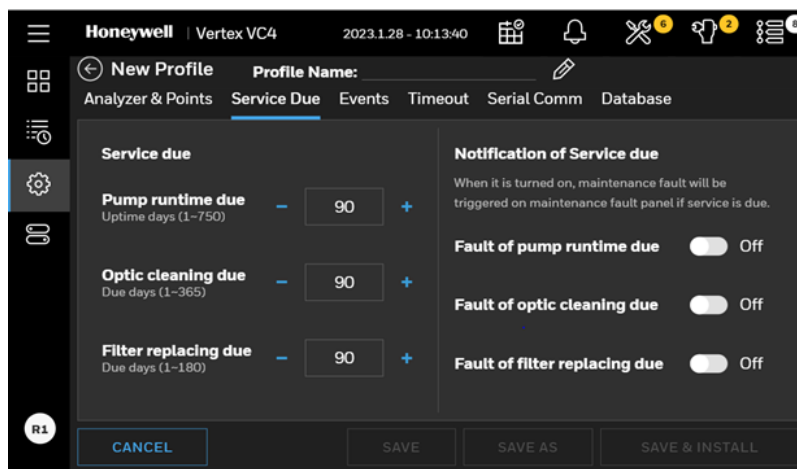
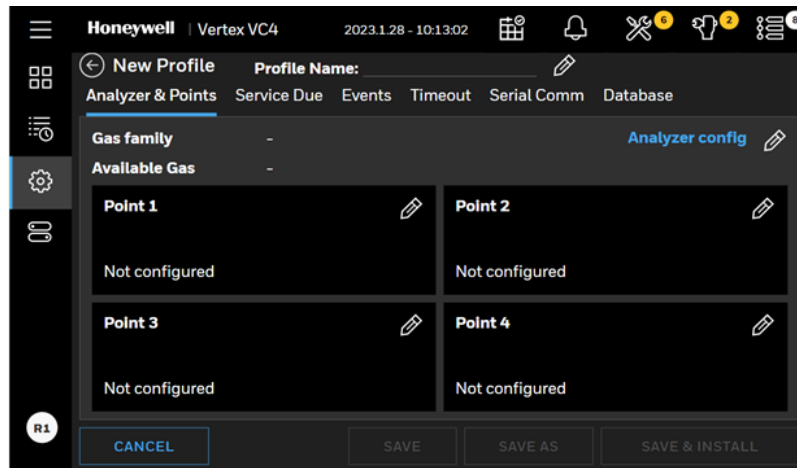

- You can edit or modify values such as: Configuration of Analyzer & Points and Notification of Service Due, Events, Timeout, Serial comm, Database through pressing the tabs to access the relative pages.

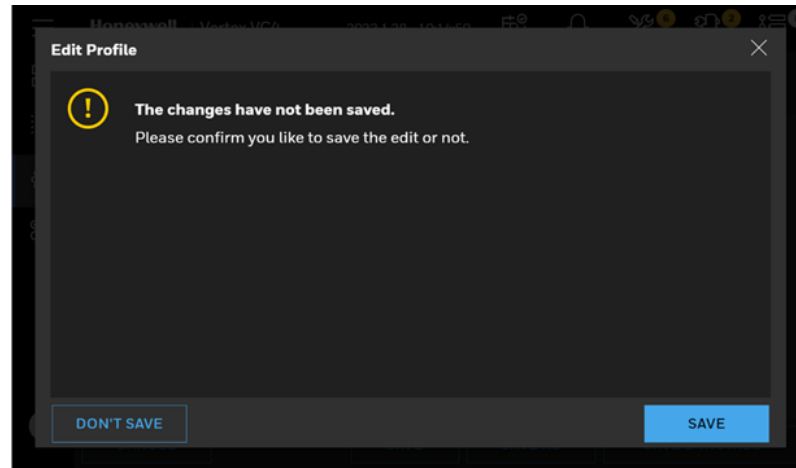

- After configuration is completed, tap **SAVE** button or tap back button  to complete the Creating Profile process.

6. When you tap the back button , there are several options for the profile you just edit, you can choose to **SAVE** or **DON'T SAVE** the profile.



7. Tap **SAVE & INSTALL** whether you want to install this new profile in the system. If you do not want to install this project, tap **SAVE AS** and enter a profile name.
8. To install another profile, you can select a profile in the list on the left side, and then tap the install button  to complete installation.

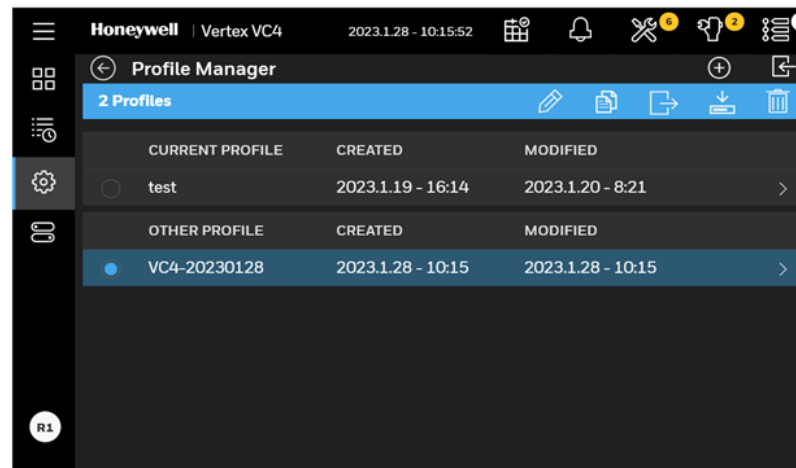

4.5.1 Analyzer & Points

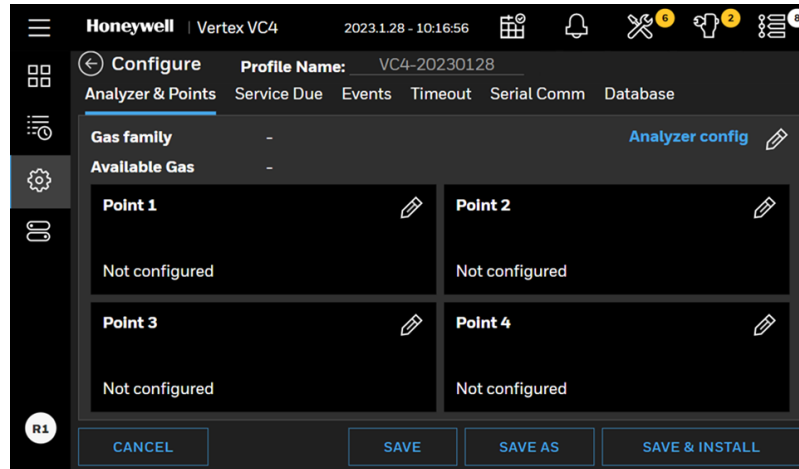

Tap on the Analyzer configure **EDIT**  button and activate the analyzer configuration, select the gas family.

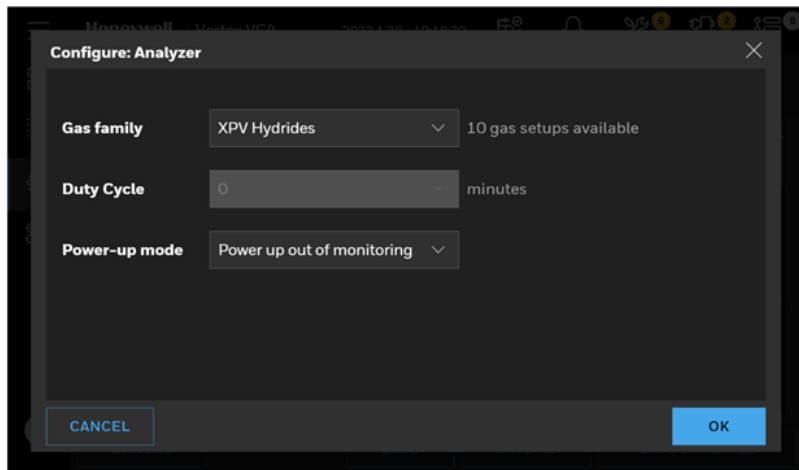

Duty Cycle

This function allows the user to extend the duration of the tape advance interval. This is useful in applications in which a background level of gas is expected in normal operation. This interval can be configured for up to fifteen minutes. When in monitor mode, if the detector reaches its maximum concentration for that window, it will not advance tape and stays at current window until the duty cycle expires.

Power-up mode

There are three options in power-up mode:

- **Power up in monitoring mode:** Analyzer will start monitoring mode after it powers up.
- **Power up out of monitoring mode (default):** Analyzer will stay at idle more after it powers up. An operator manually starts monitoring mode.
- **Power up in last state:** Analyzer remembers its last state and gets back to that state after it powers up.

Select the point to configure and tap on  the EDIT button.

Activate the selected point and select the Target Gas. If you want to apply same configurations to other points of the analyzer, tap on the **APPLY TO OTHERS** button.

Note: When making and saving a change to an item in the analyzer configuration, this also changes all items in the points to the default.

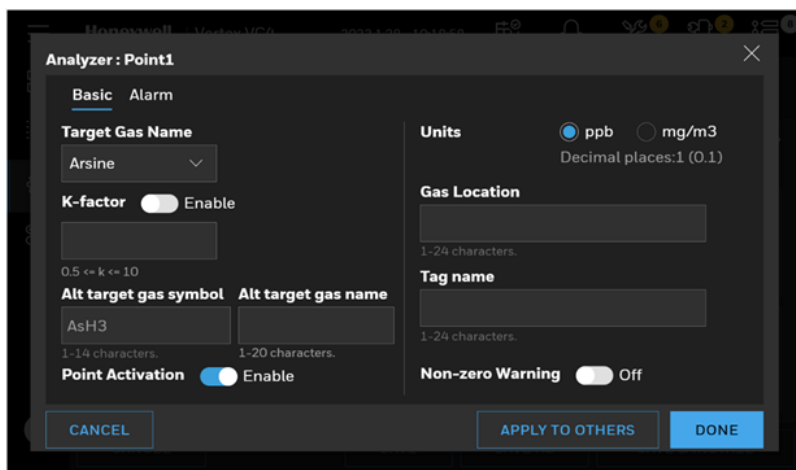

Units

Select to display concentrations in milligrams per cubic meter. If this option is not selected, VC4™ displays concentrations in parts-per-million (ppm) or parts-per-billion (ppb).

Select a target gas for the point and enter the gas location of the place where gas is sampled. A Tag Name can be set for the point also.

K-factor

K-factor is a feature that allows gases' cross-sensitivity to be employed to measure a different gas using gas calibrations of a selected gas. The detector's readings are modified by the known relationship between the two gases. For example, a 5ppm concentration of Gas A is seen by the detector as the same as a 5.8 ppm concentration of Gas B. The K-factor is 1.2 ($5.8 \div 5 = 1.16 = 1.2$ when rounded to one decimal place).

When k-factor is enabled, gas levels will be multiplied by k-factor automatically. Alarm levels should be checked again after enabling the k-factor.

Note: When mg/m³ is selected as a measurement unit, k-factor is not allowed to be ON.

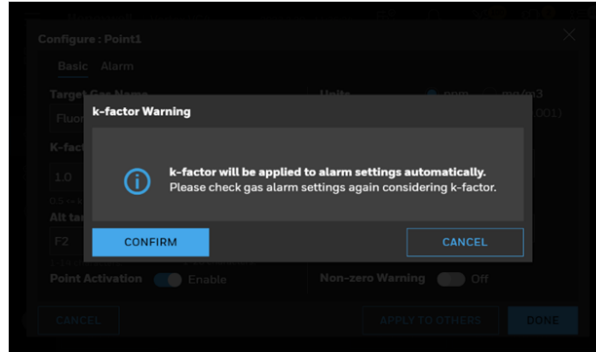

Non-Zero Warning

When this option is ON and non-zero gas concentration is detected, an informative event will be recorded and non-zero warning status will be reported to DAq. The point with non-zero warning will blink in green.

Alarm

Alarm levels can be selected from the preset or entered. When custom is selected, alarm levels are edited manually.

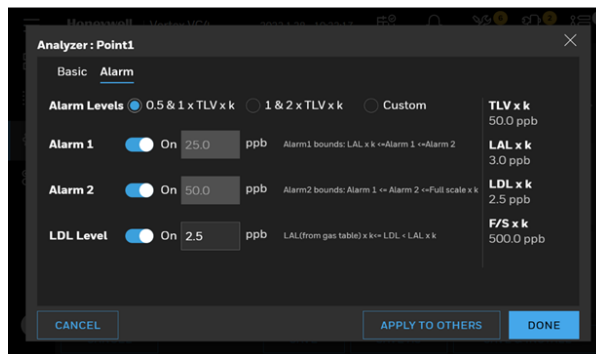

Copy Point Configurations

When multiple points are configured in same way, an operator can configure one point and copy it to other points to save time. Tap on the **APPLY TO OTHERS** button.

4.5.2 Service Due

Notification of service due is **ON**, the analyzer will generate a maintenance fault when the maintenance service is overdue. When this option is **OFF**, an informative event will be recorded instead.

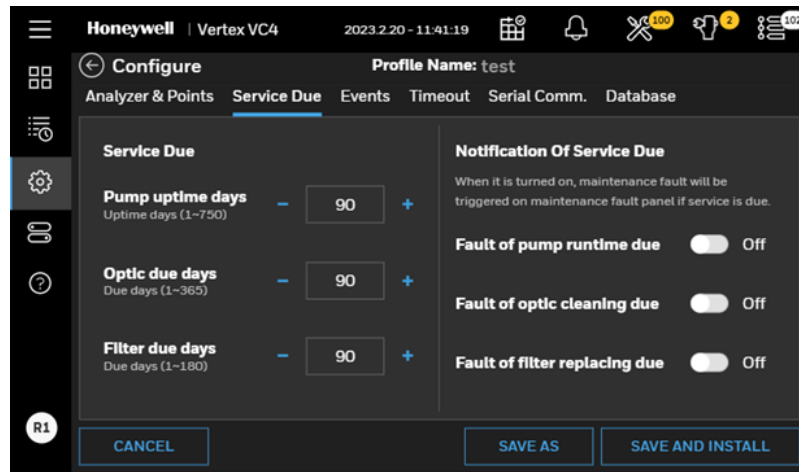

4.5.3 Events

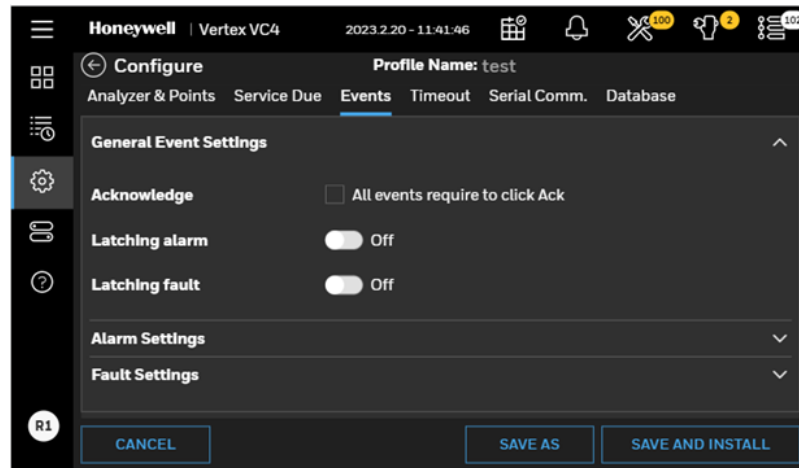

All events require to click Ack (default setting)

When selected, all gas alarms, and fault events will not be removed from the event list until an authorized user acknowledges the event.

Non-Latching Gas Alarm

A latching gas alarm activates when a gas concentration reaches a level 1 or level 2 alarm setting. The latching gas alarm remains until an authorized operator resets the alarm. Non-latching gas alarm events clear themselves as soon as the gas concentration drops below the alarm setting.

Non-Latching Fault

A latching fault activates when an analyzer detects faulty conditions. The latching fault remains until an authorized operator resets the fault. Non-latching fault events clear themselves as soon as the faulty conditions disappear.

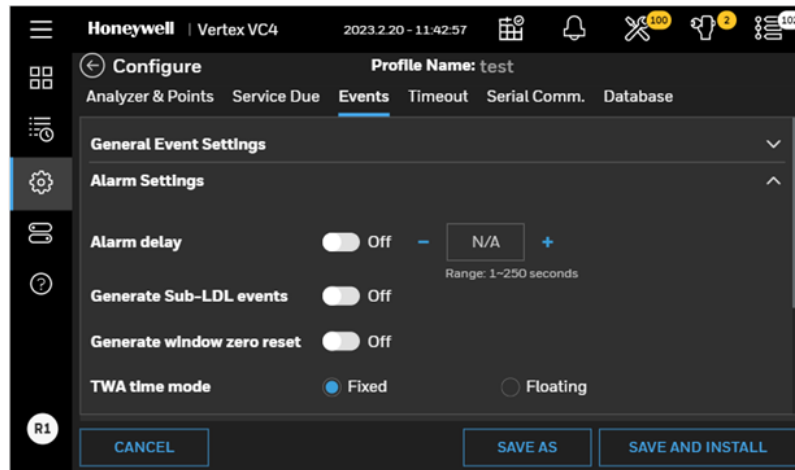

Alarm Delay

When Alarm delay is **ON**, a gas alarm will be reported when a gas concentration reaches a level 1 or level 2 alarm setting and stays for more than alarm delay time. If the gas concentration drops below the alarm setting in less than alarm delay time, the gas alarm event will not be reported. This option is to filter out flickering gas events.

Generate Sub-LDL Events

This is to record Optic signal exceed the Sub-LDL limits while gas concentration remains zero as an informative event.

1st TWA Time

Use to set times for the beginning and end of each 8-hour, Time Weighted Average (TWA) period. Use this option to associate the TWA periods with shifts or any other regular event. The system calculates and displays the TWA after each 8-hour TWA cycle.

The default setting is 04:00 indicating that the VC4™ system will run three successive TWA periods from 04:00 to 11:59, 12:00 to 19:59, 20:00 to 03:59. Remember, the VC4™ system uses a 24-hour clock. For example, to set the first TWA to 3:00 P.M., enter 15:00. The system automatically sets the beginning times of the second and third TWA periods at 8-hour intervals from the time entered for the first TWA period.

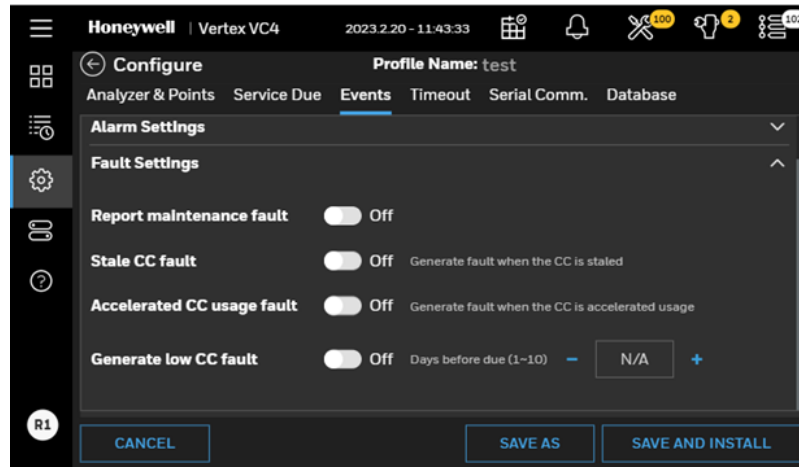

Report Maintenance Fault

Select **OFF** to disable maintenance faults. When this option is **OFF**, the Analyzers will not generate maintenance faults. Instead informative events will be recorded.

Stale CC Fault

When this option is **ON** and Chemcassette™ is nearing its expiration date, the maintenance fault will be generated.

Accelerated CC Usage Fault

When this option is **ON** and Chemcassette™ usage for up to 24 hours exceeds twice of the average daily usage, the maintenance fault will be generated.

Generate low CC Fault

VC4™ software tracks the amount of Chemcassette™ tape remaining on the supply reel and triggers a low tape event when remaining tape is less than Days Before Due. Choosing **OFF** disables the low tape event.

4.5.4 Set Timeout Values

Authorized users may temporarily disable points or inhibits alarms from activating and points from monitoring. A point or alarm that is disabled/inhibited longer than the timeout limit will cause a maintenance fault which will call attention to locations excluded from monitoring.

Select **ON** and enter a timeout up to displayed minutes or select **OFF** to disable the maintenance fault.

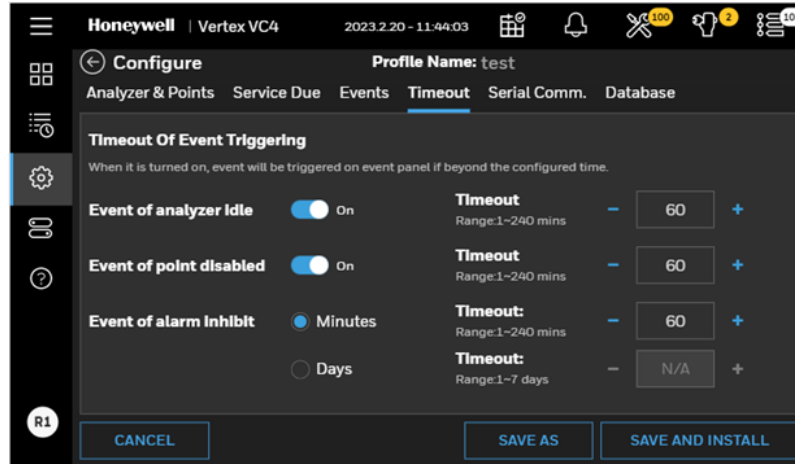

4.5.5 Set Serial Comm

The configuration of Modbus RTU can be configured in Serial Comm Settings.

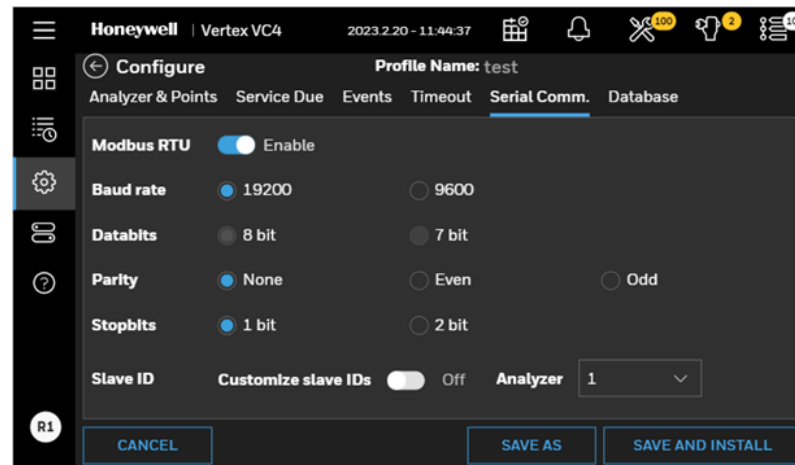

4.5.6 Set Database

The retention period of logged gas data and event records can be configured in Database Settings.

The default setting for the retention period of the logged gas data is 90 days.

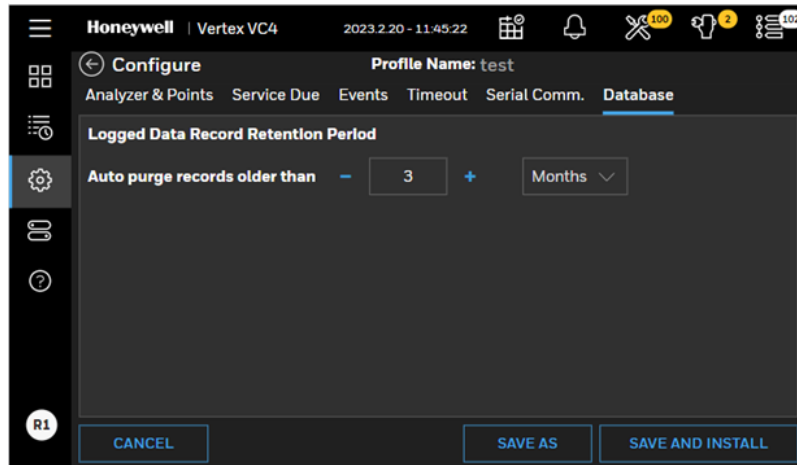

4.5.7 Export/Import a Profile

To export a profile, plug in USB flash drive in the DAq. Select the profile in the list and tap **EXPORT**  to export it to USB flash drive.

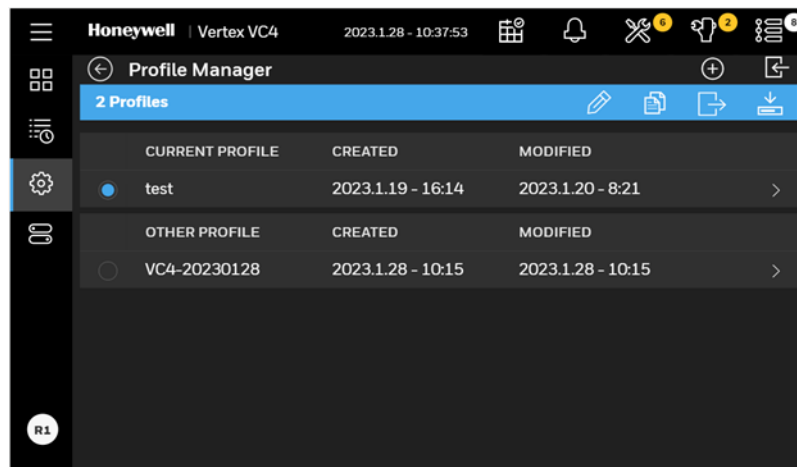

Select the location where the profile will be exported and tap **NEXT**.

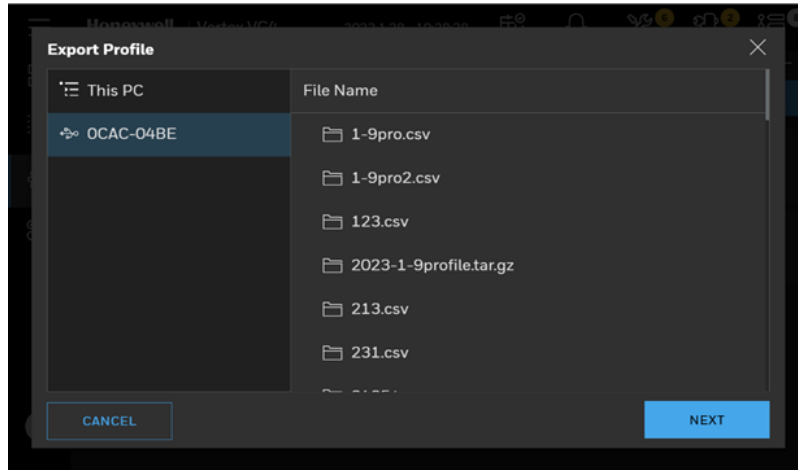

Enter a profile name and tap **EXPORT** and profile exporting will be completed.

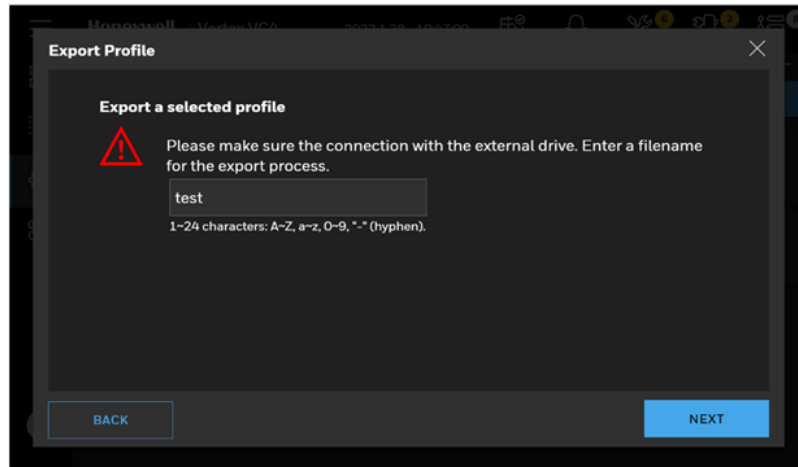

To import a profile from USB flash drive, tap  **IMPORT**.

Select the profile in the Import Profile window and tap **NEXT**.

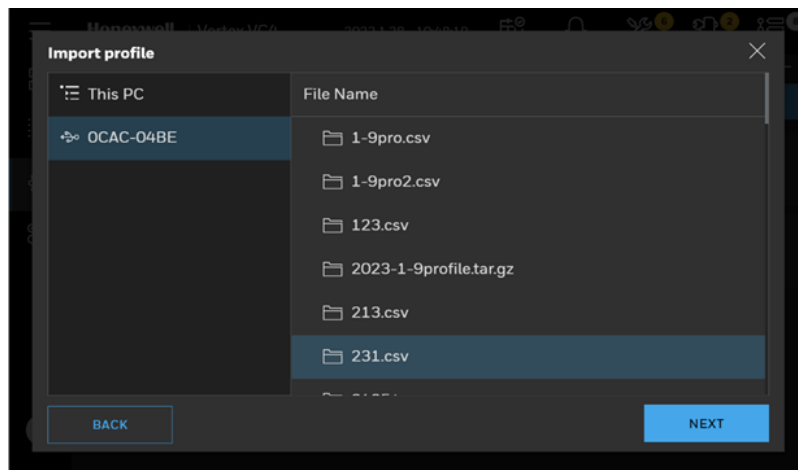



Selected profile will be imported and shown in the profile list of Profile Manager.

4.6 Create a New User

Administrator can add a new user and assign an appropriate role to the user account.

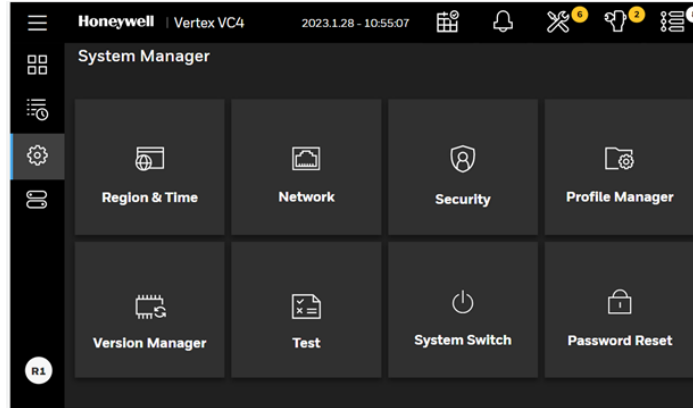
1. From the main menu, go to **System Manager > Security**



2. To add a new user, tap on the **ADD**  button.

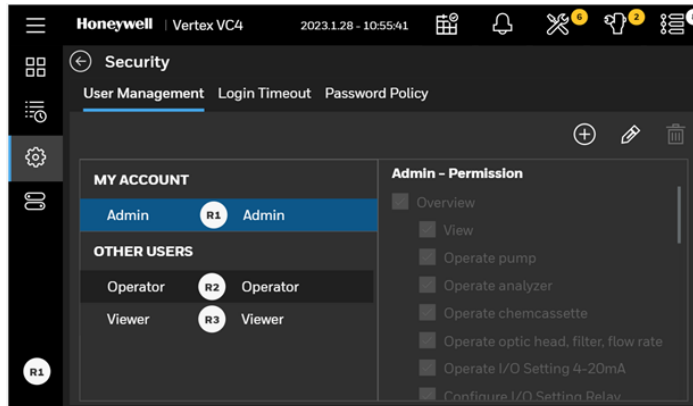

3. Type a username, password according to the password complexity and select an appropriate role to the user.

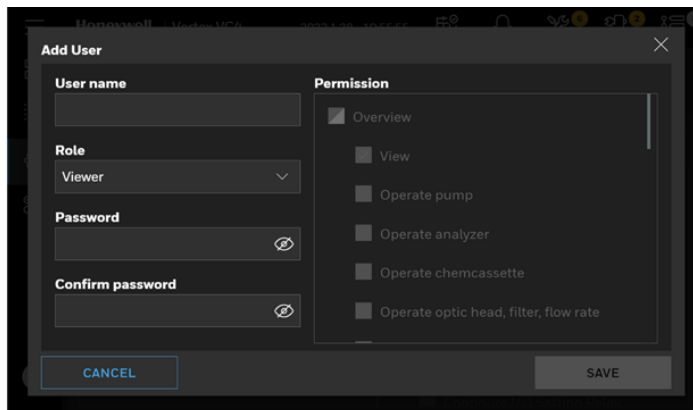

4.7 Edit User Accounts

Administrator can edit user counts and change the user role and password.

1. From the main menu, go to **System Manager > Security**

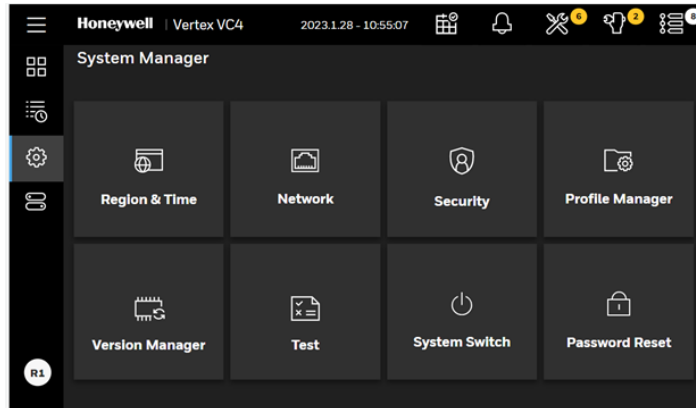

To edit users, select the target user in the list and tap on the **EDIT USERS**  button.

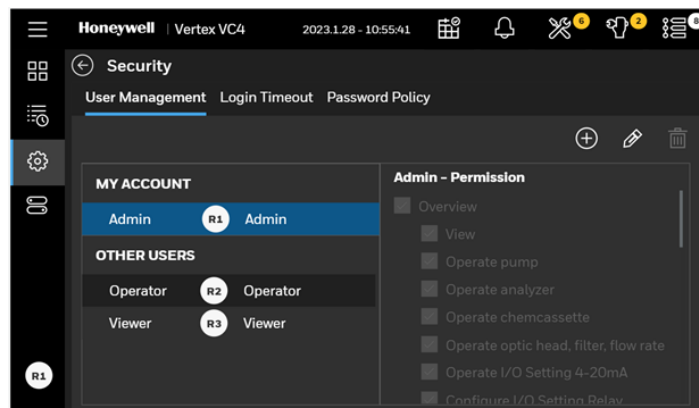

2. User role and password for the user can be changed by an administrator.

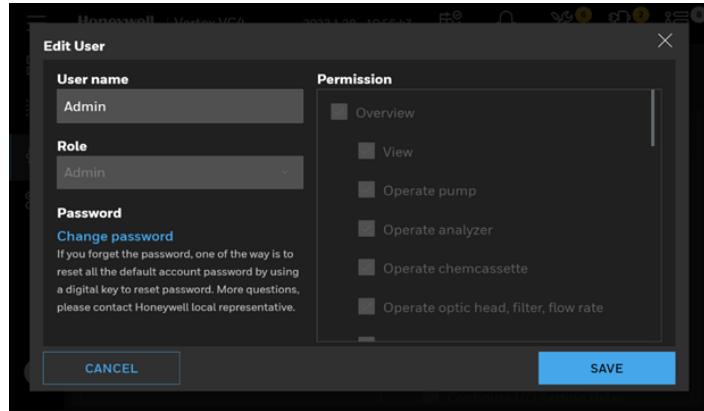

3. Alternatively, logged user can change one's password by tapping on the **Change password** button.

Note: The modified user password needs to log in again to take effect.

4.8 Set Login Timeout

Administrator can set login timeout to log out the account automatically, if there is no operation within the set time.

From the main menu, go to **System Manager > Security**

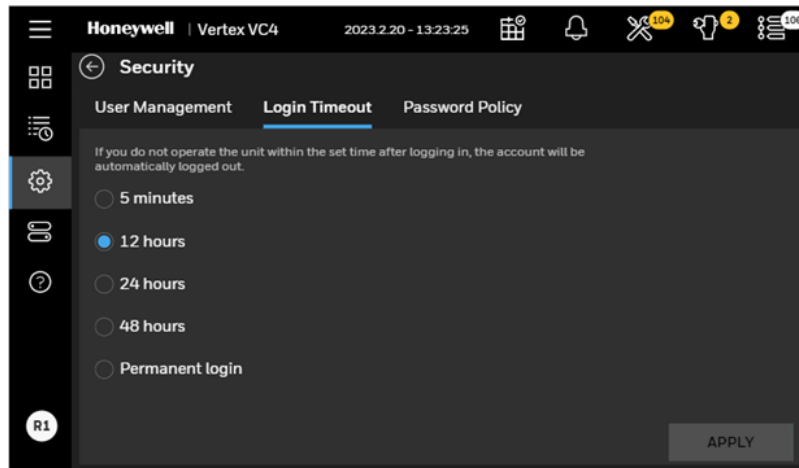

Note: The setting Timeout period needs to log in again to take effect.

4.9 Login and Logout

To protect the integrity of the system, the VC4™ system classifies the access levels as a viewer, an operator and an administrator. If you require access to a protected menu, you must log in under a user role with permission to use that menu. The VC4™ system administrator assigns a role to the user accounts. The role of the currently logged user is shown on the bottom of the main menu.

1. To log in, tap on the user role icon at the bottom of the main menu and select Log In.

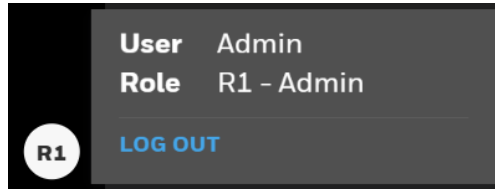

2. Enter your user ID and password in Log In screen and tap on the Log In button.

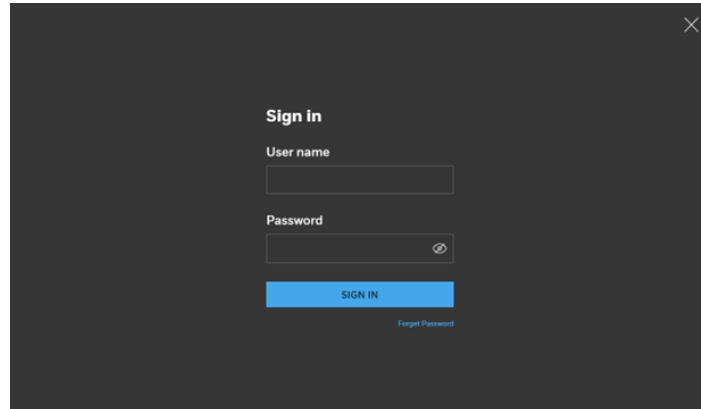

3. Once logged in, the system checks your role. As you use VC4™ system menus, only the pages to which you have access will be accessed. The pages associated with functions to which you are denied access will request you to switch to another user with an appropriate authority.

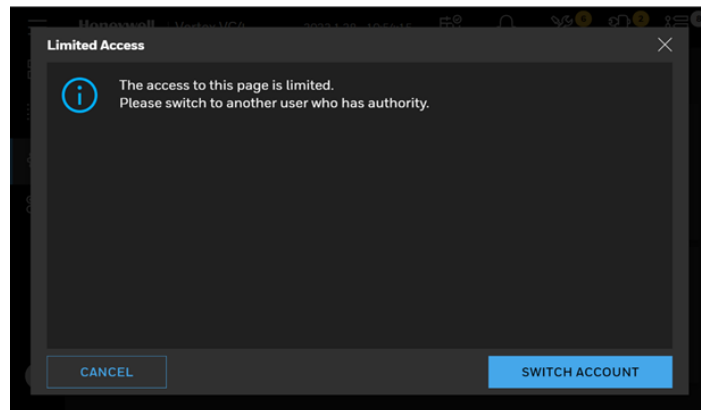

4. To log out tap on the user role icon at the bottom of the main menu and select Log Out.

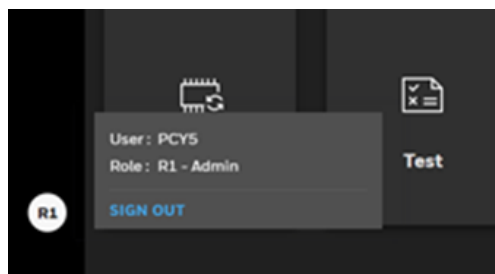

Note: Default user ID and password are Admin / Admin for an administrator role and Operator / Operator for an operator role.

Note: Upon initial installation and login, it is strongly recommended to change the password of the default users in accordance with the password complexity.

4.10 View Overview Status

View Overview status of the VC4™ system such as analyzer status, pump status and point status of up to 4 points.

1. In the left navigation panel, tap **OVERVIEW** .
2. Analyzer status is shown with gas family configured to the Analyzer.

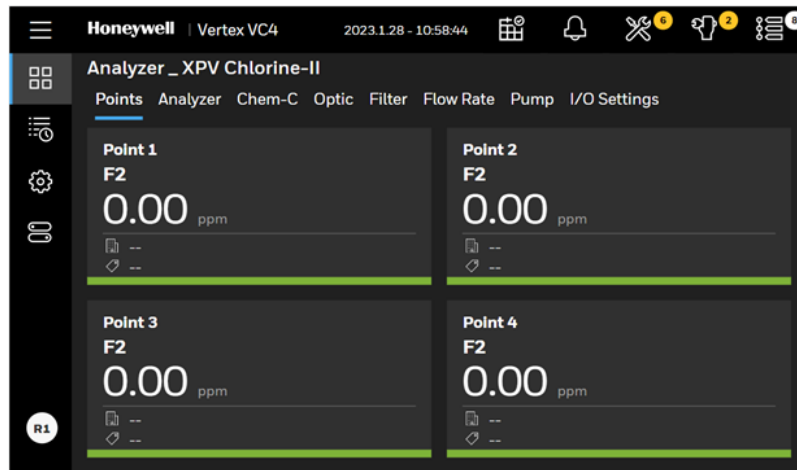

The point status are represented graphically as below depending on the status and configuration.

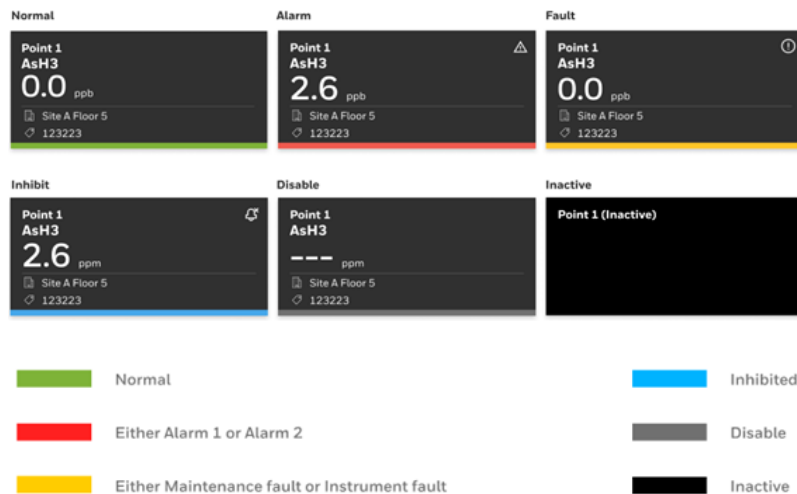

To view service due of the VC4™ system, tap  on the at the upper right of the Overview screen.

Service due will be shown graphically such as remaining CC tape life, remaining days to

Optic cleaning and remaining days to filter replacement.

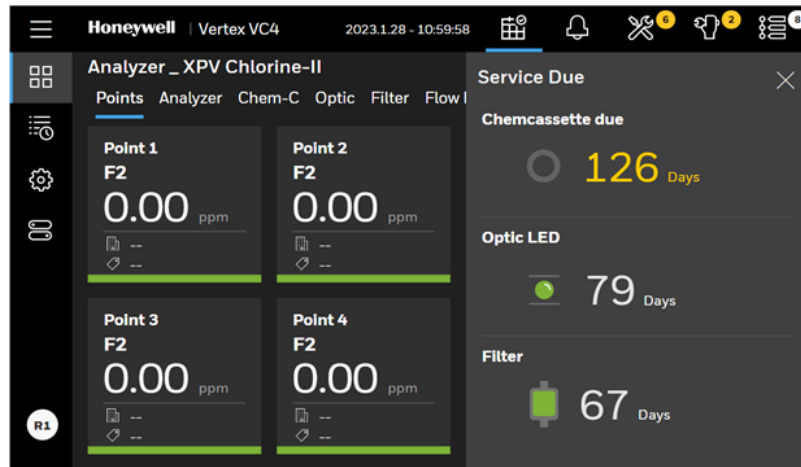

4.1.1 View System Status

Review status of 4 points, Chemcassette™ life, Optic block status, flow status, filter status, Pump status and I/O setting.

1. From the main menu, tap **OVERVIEW** .
2. Point status such as gas name, gas concentration, measurement unit, location tag and point status will be displayed. The graphical representations of the point status at the bottom of point status box are the same as the Overview screen.

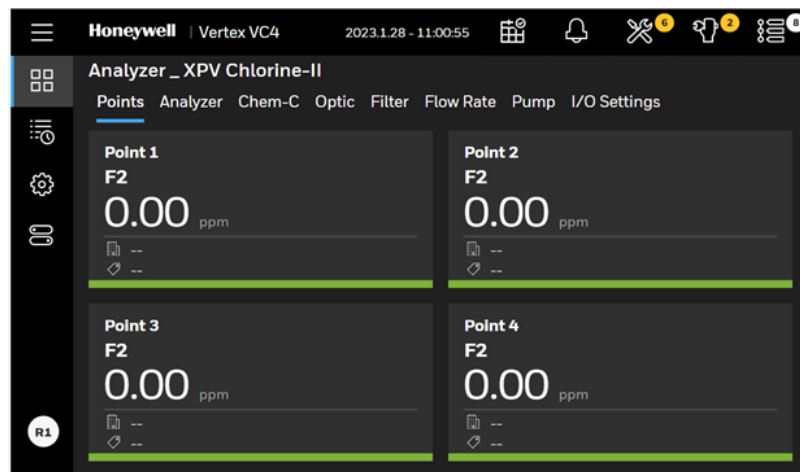

4.12 View Detailed Analyzer Information

1. In the left navigation panel, tap **OVERVIEW** .
2. Tap on the **Analyzer** button

The Analyzer Information window displays the Serial No. and the Profile ID.

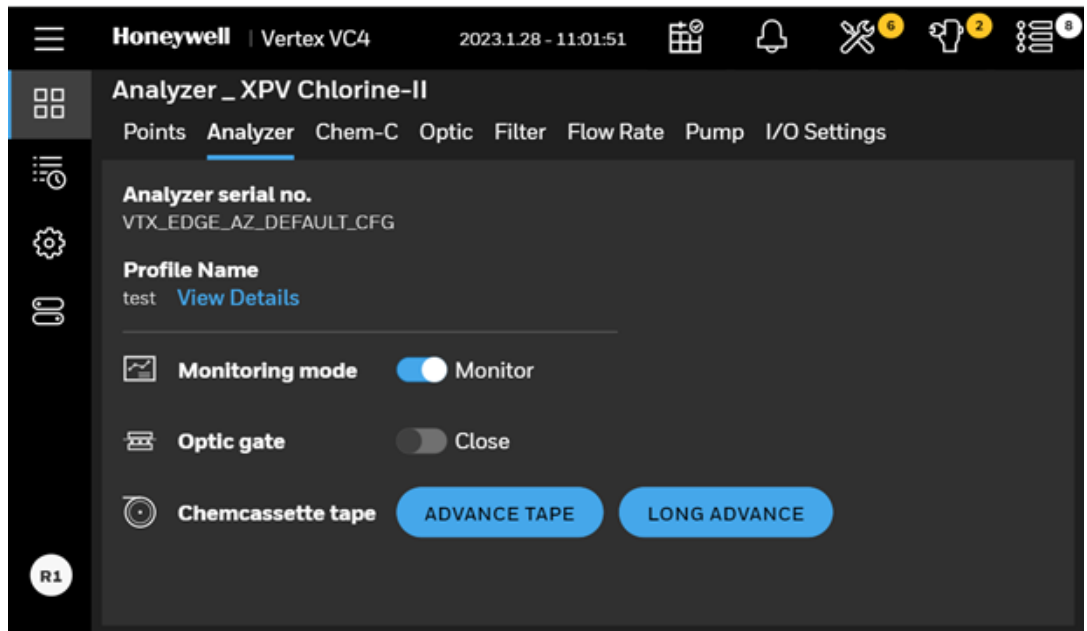

3. Tap View Details. The detailed info is displayed. Use the arrow button to expand or collapse the contents. Scroll downward to view the entire contents.

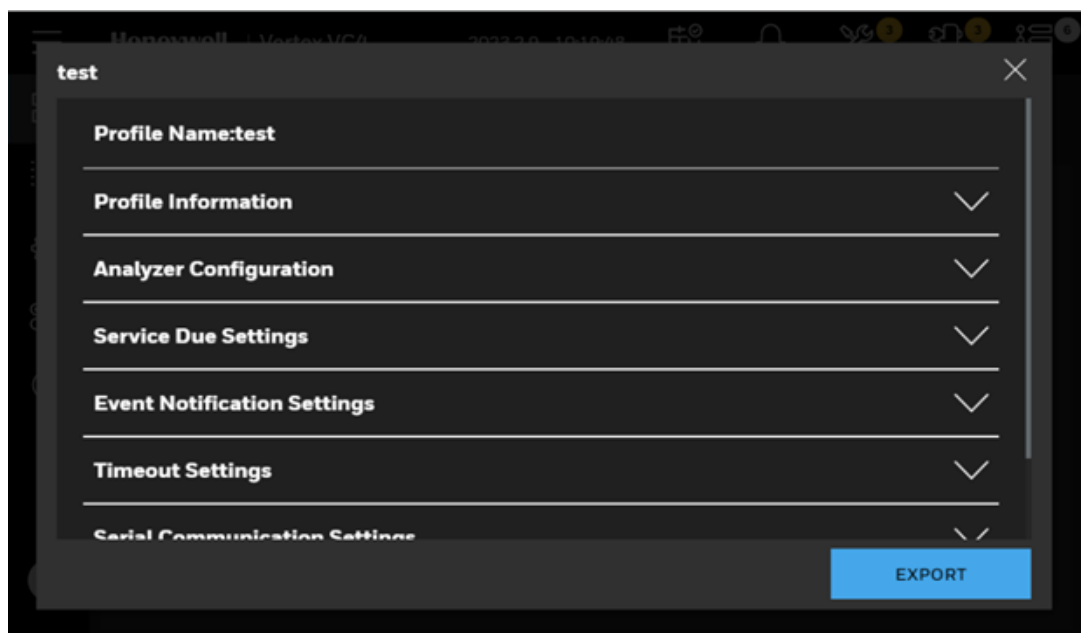

4. Optional Step to export the detailed profile information, tap **Export**.

Select a USB port to export the information, and then tap **NEXT**. In the File name field, enter a file name for the export process, and then tap **NEXT**. Follow the instruction to complete the process.

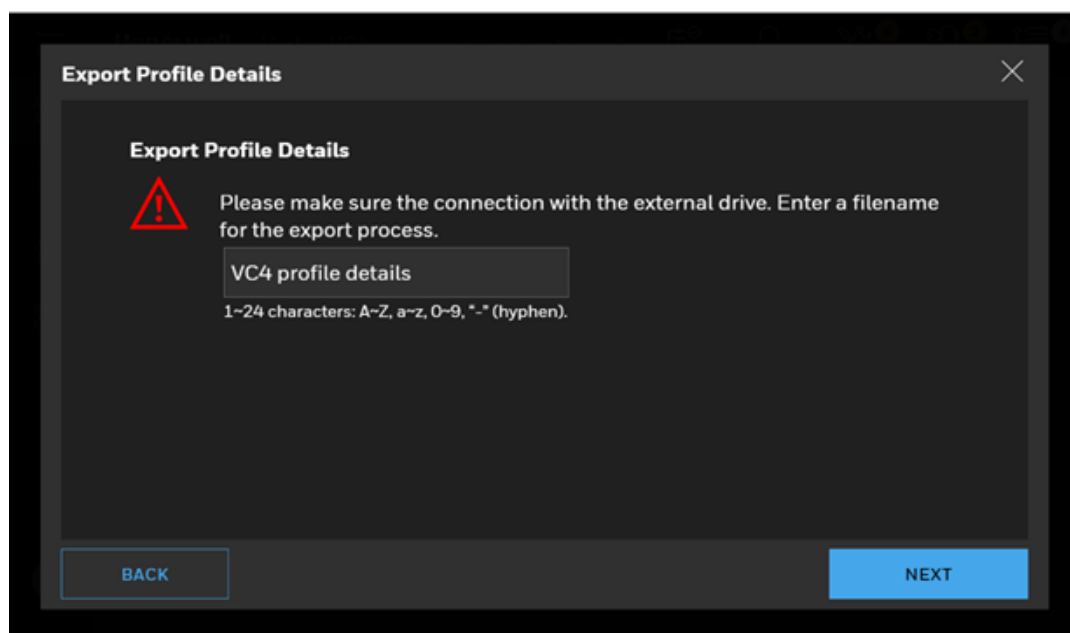
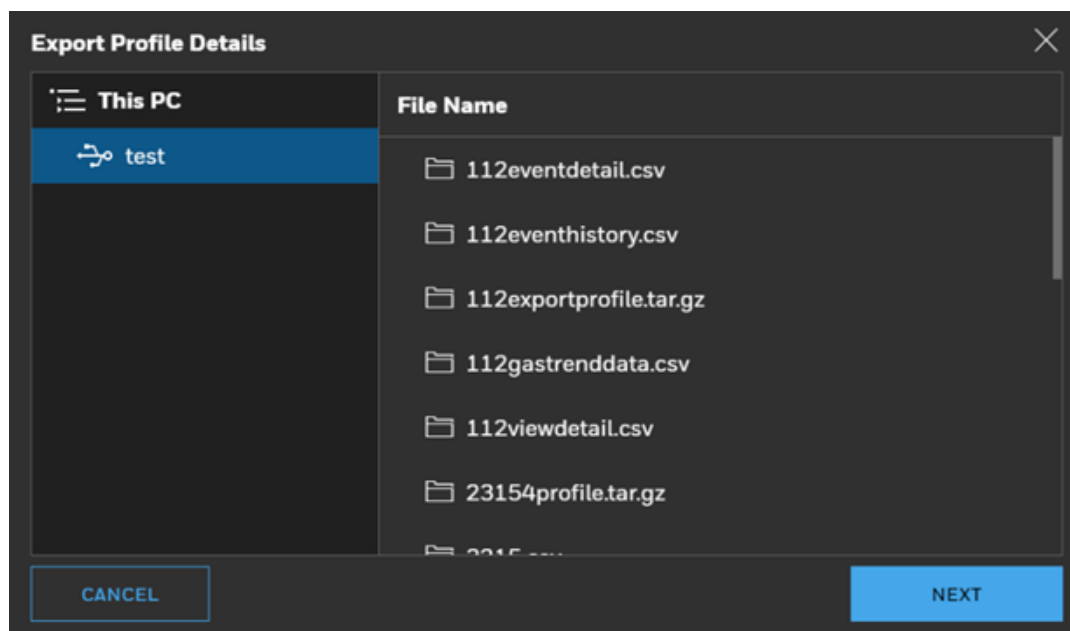

4.13 View Detailed Point Data

Review point status, alarm settings and trend chart of the selected point. The point status includes gas name, gas concentration, measurement unit and live chart of the point. In the Point Detailed Status screen, alarm settings and k-factor are displayed along with real time gas concentration.

1. From the main menu, tap **OVERVIEW**  .
2. Tap the selected Point.

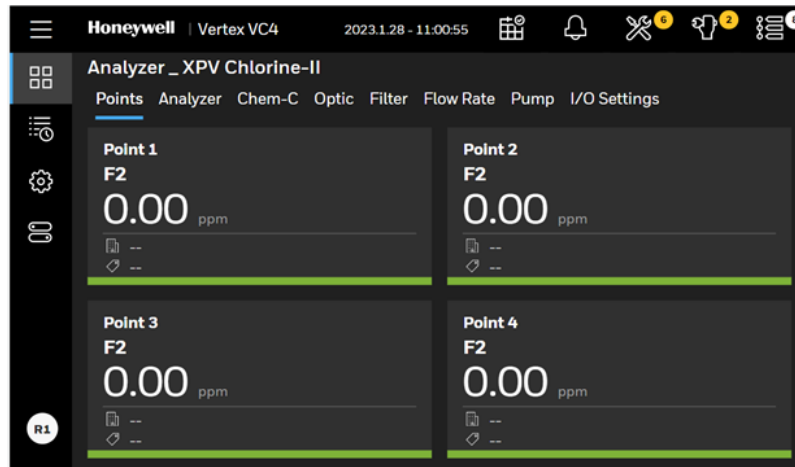

3. From the detailed point information screen, you can perform several operations such as:
 - Live chart.
 - Trend chart for all data.
 - Scroll left and right on the gas chart.
 - Tap on the chart to view the gas concentration value.
 - Adjust the range using the slider.
 - Change the time-line.
 - Export gas data of the trend chart.

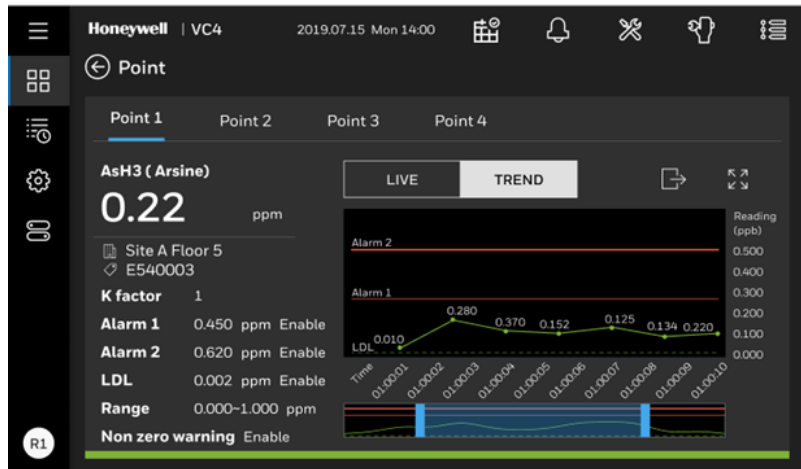
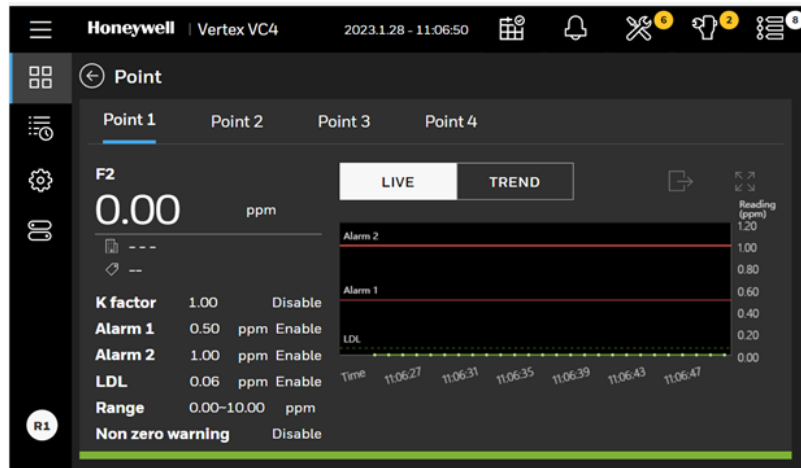

4. Tap the back button  to return to the Overview screen.



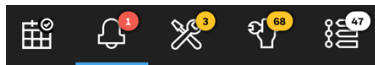

4.14 Acknowledge Notifications

Acknowledge and clear gas alarm, Instrument faults, and Maintenance faults notifications.

- From the upper right side of the main screen, tap on any of the notification icons of



to view notification details. The selected icon is highlighted with a blue underline. The number within the circles indicate the sum of events for each type of notification.

	Service Due
	Alarm
	Instrument Fault
	Maintenance Fault
	All Events

Note: If there is a new alarm or fault, the notification panel will expand automatically.

Note: The latest events are filtered first.

- Acknowledge or reset individual notifications by tapping on individual **ACK** or **RESET** button on each notification or acknowledge or reset all notifications from selected panel by tapping on **ACK ALL** or **RESET ALL** button. When the buttons are blue, they are active and can be tapping, when the color turn into dark grey, it means they already been acknowledged and the buttons are temporarily inactive, and the acknowledged event moves to the bottom of the list, and its color diminishes.

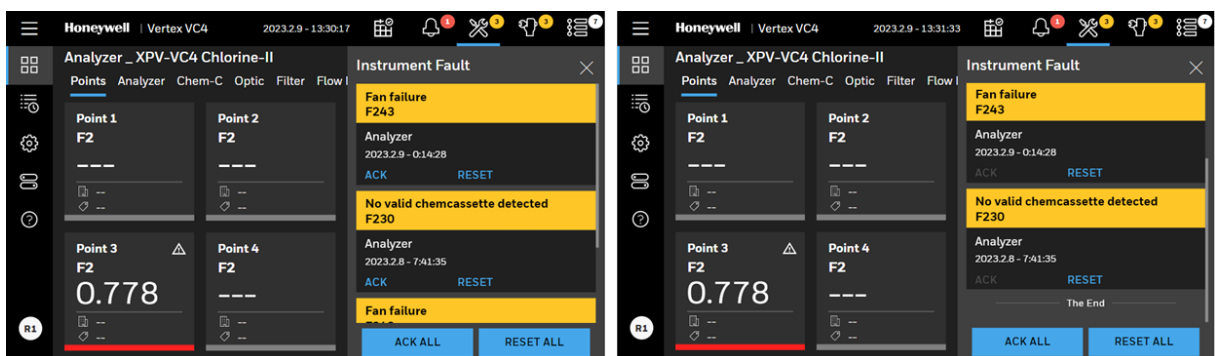

4.15 Maintain the Pump Close to Due Date

Service is required when pump uptime is reaching to the end. Normally, recommend to maintain the pump every 6 months.

1. In the Pump maintenance page, if runtime is due or there are some faults, the color of texts would turn into yellow, otherwise, when the pump status is good, the color is white. When pump runtime is due, contact the service people to maintain the pump.

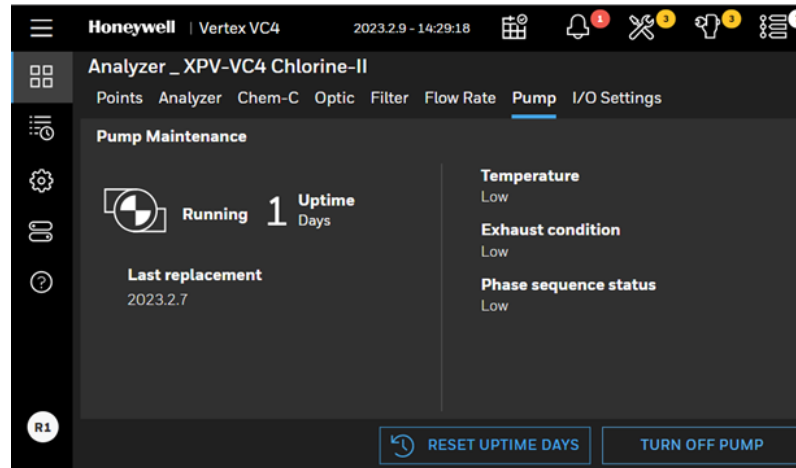

2. Optional step. When you want to reset the uptime of the pump, tap **RESET UPTIME DAYS** button, then the time will be reset as zero and initiate the count from the beginning.
3. Tap **CONFIRM** to reset the counted uptime days. The highlighted uptime resets to zero.

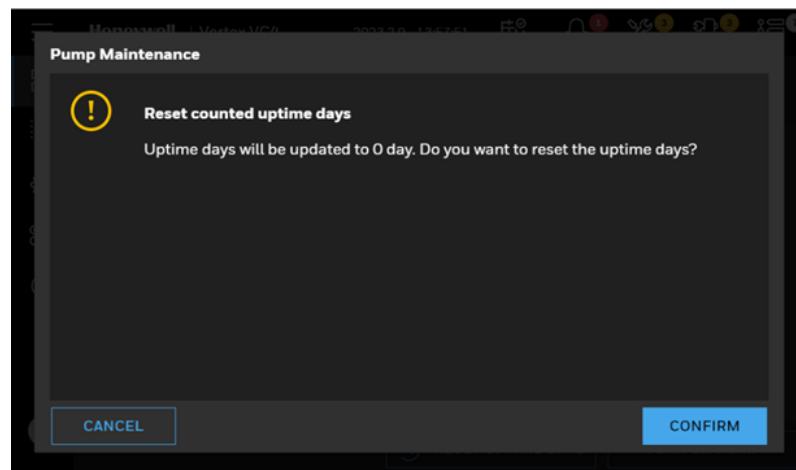

4. Optionally the temperature status in the pump module and high pressure status at exhaust line can be checked. When there is any issue in temperature and exhaust pressure, the text of Temperature and Exhaust tubing will be highlighted in yellow.

4.16 Turn a Pump On and Off

You can turn ON or OFF a pump when all the Analyzer is out of the monitor mode.

In the Pump Maintenance window, tap **TURN ON PUMP** or **TURN OFF PUMP** as needed.

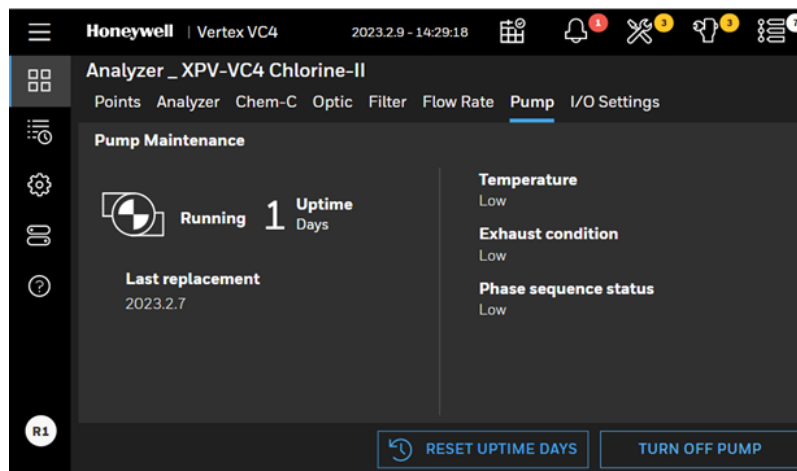
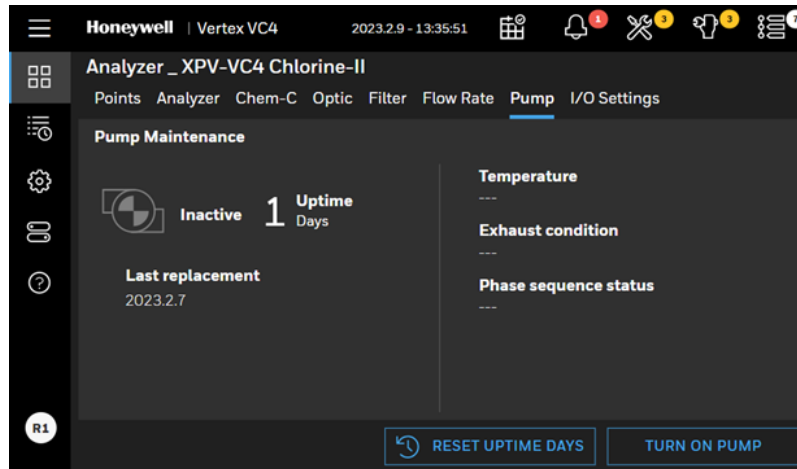

4.17 Turn the Monitoring Mode On and Off

1. In the left navigation panel, tap **OVERVIEW** .
2. Tap on the **Analyzer** button to enter to the analyzer detail page.
3. In below page, switch the toggle button of **Monitoring mode** can setup the analyzer either as **Monitor** or as **Idle**.

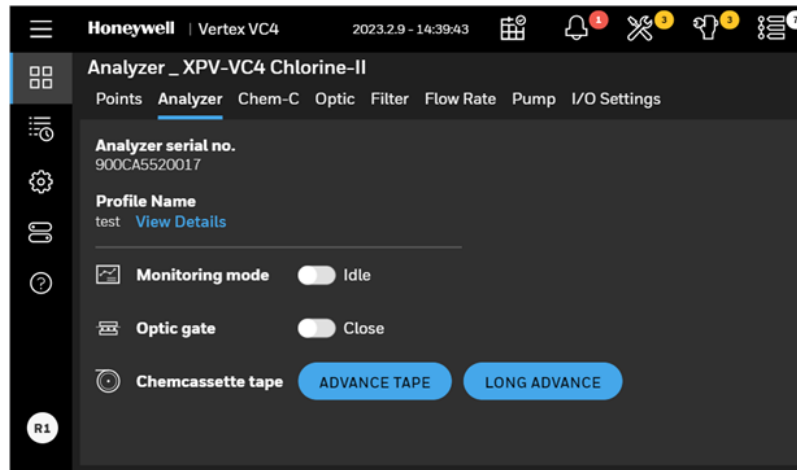

Note: The Optic gate is closed when Monitoring mode is on.

4.18 Open the Optic Gate

1. In the left navigation panel, tap **OVERVIEW** .
2. Tap on the **Analyzer** button to enter to the analyzer detail page.
3. In below page, switch the toggle button of Optic gate into Open.

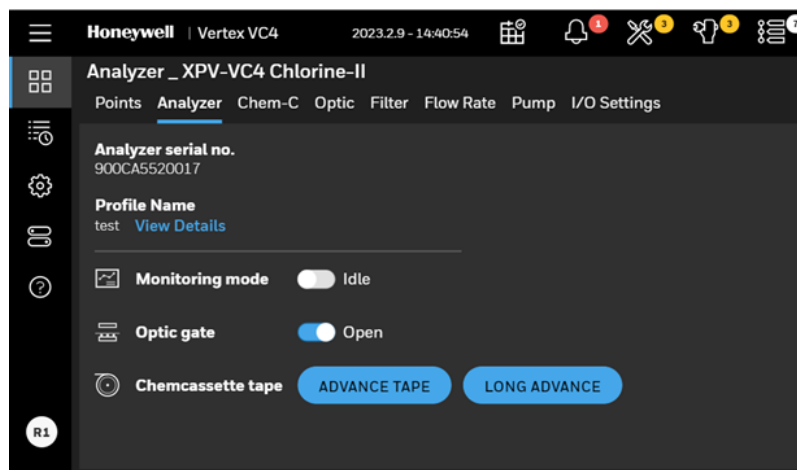

Note: The Optic gate is closed when Monitoring mode is on.

4.19 Advance the Chemcassette™ Tape

1. In the left navigation panel, tap **OVERVIEW** .
2. Tap on the **Analyzer** button to enter to the analyzer detail page.
3. In below page, tap **ADVANCE TAPE** button next to Advance tape. Or tap **LONG ADVANCE** button, Chemcassette™ tape will advance long distance.

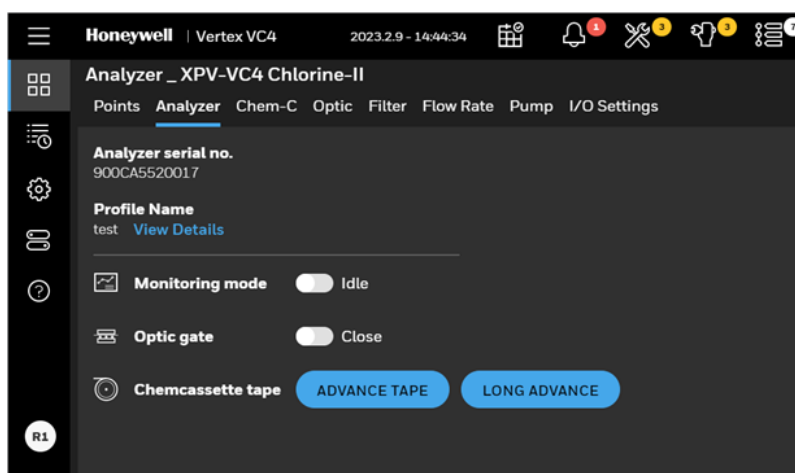

4.20 View Optic Status

View Optic status of the selected analyzer such as optic drive status, optic block status and optic cleaning due.

1. In the left navigation panel, tap **OVERVIEW** .
2. Tap on the **Optic** button to enter to the optic detail page.

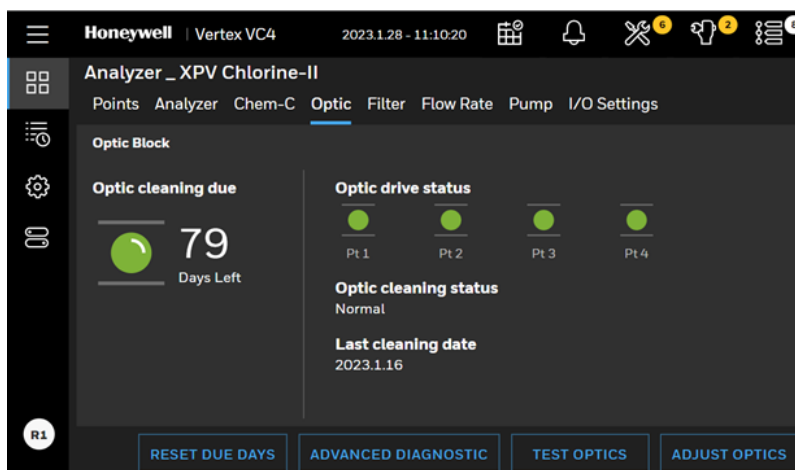

3. Tap **ADVANCED DIAGNOSTIC** to view LED drive and Optic value levels for 4 points and check whether the LED drive levels are within the recommended range.

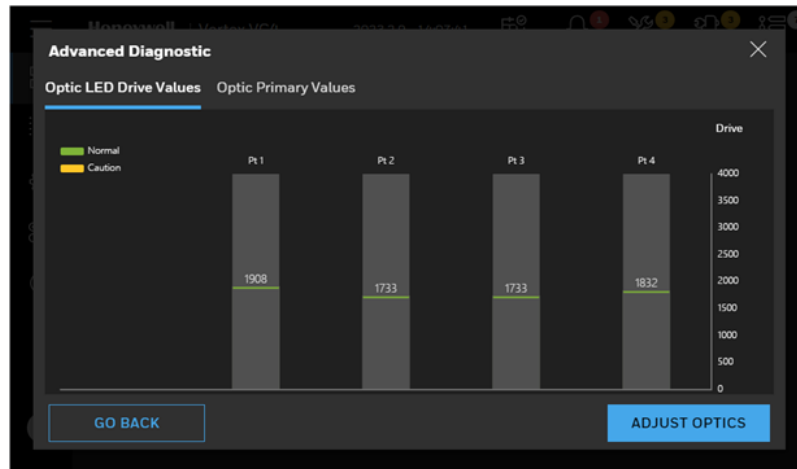

4.21 Adjust the Optic Block

1. In the left navigation panel, tap **OVERVIEW** .
2. Tap on the **Optic** button to enter to the optic detail page.
3. In the Optic Block page, tap **ADJUST OPTICS**, and then tap **CONFIRM**. Follow up on screen instructions and when **Next** button appear, tap **NEXT** button to continue.

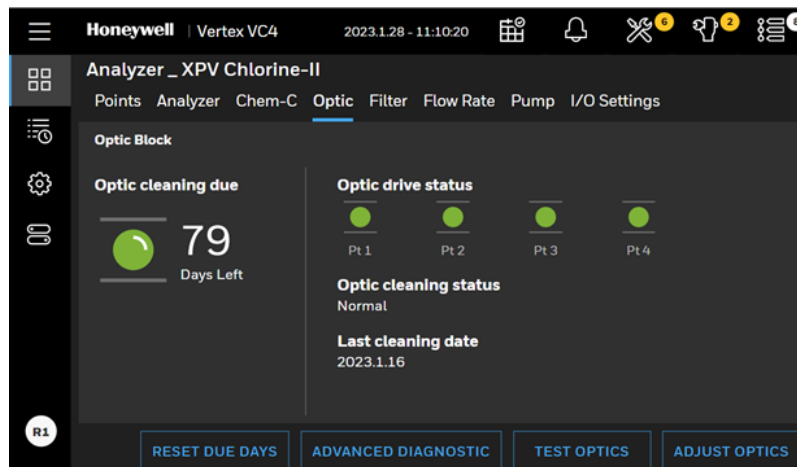

4. If the cleaning date has expired, there is maintenance fault reported. Clean the Optics block, and then Tap **ADJUST OPTICS** and follow onscreen instructions to complete the process. Tap the **RESET DUE DAYS** button to reset the due days.

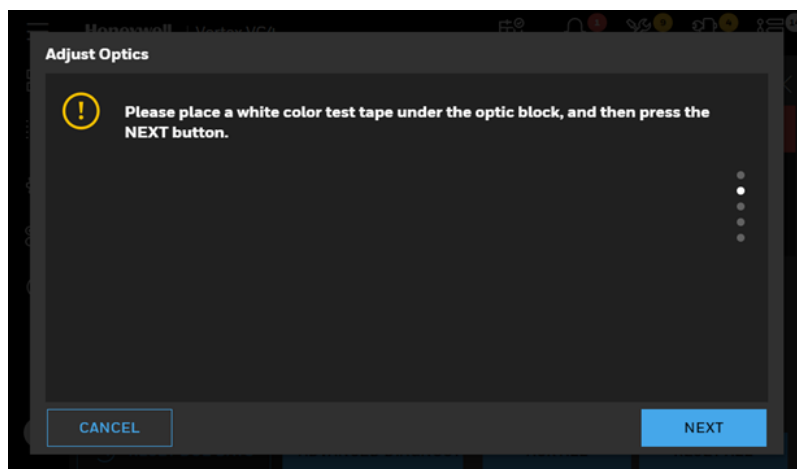
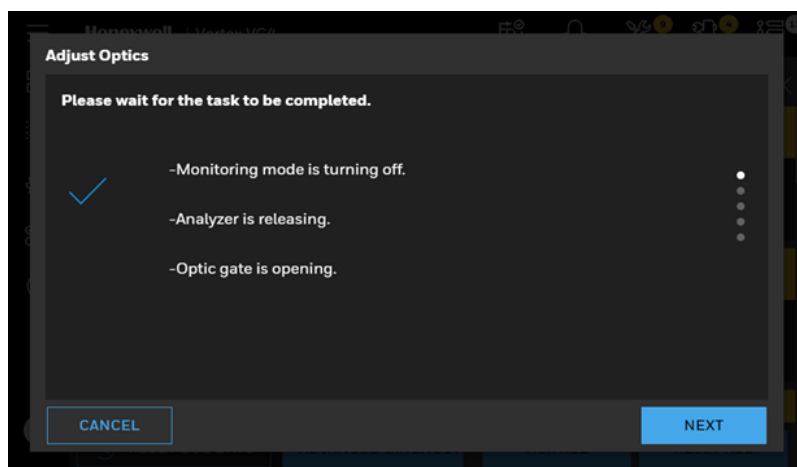
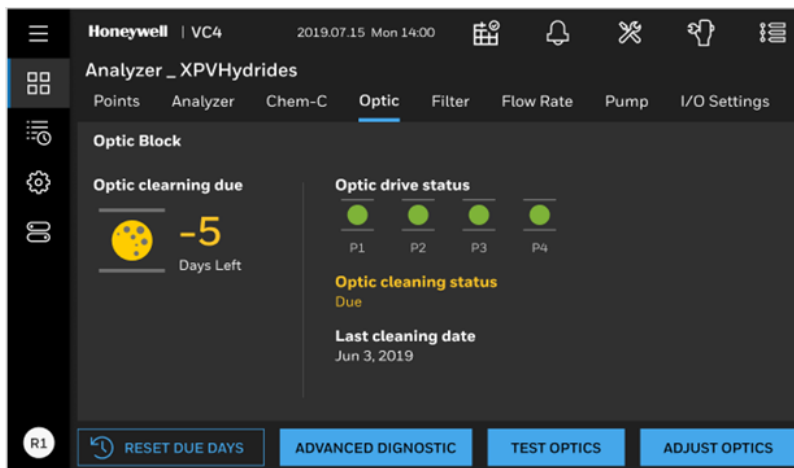

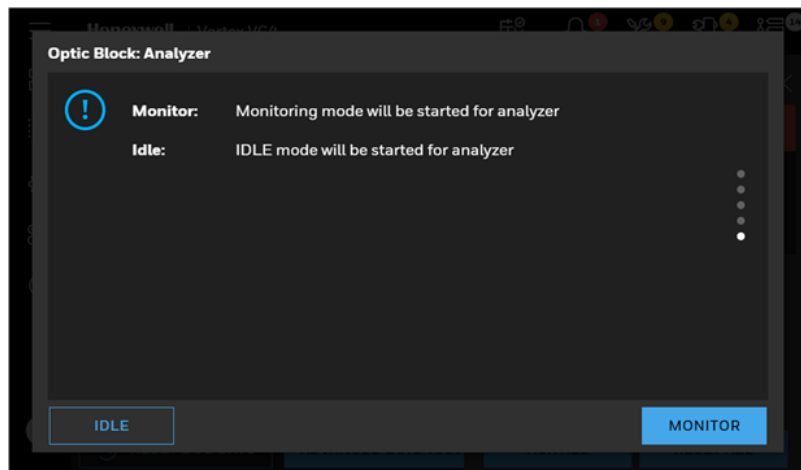
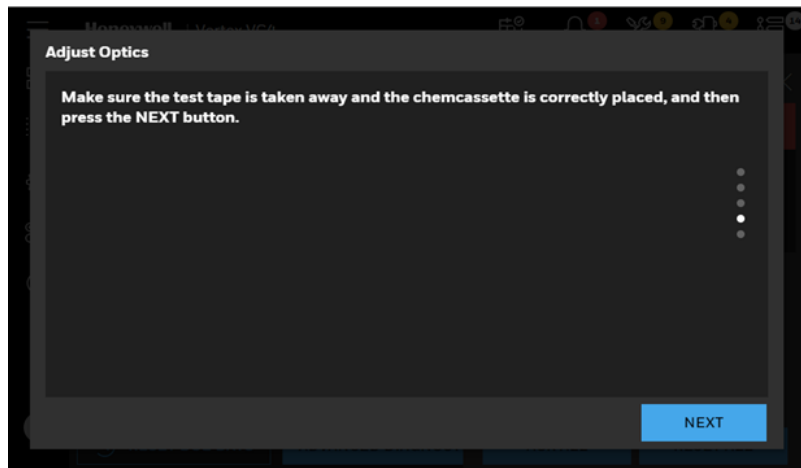
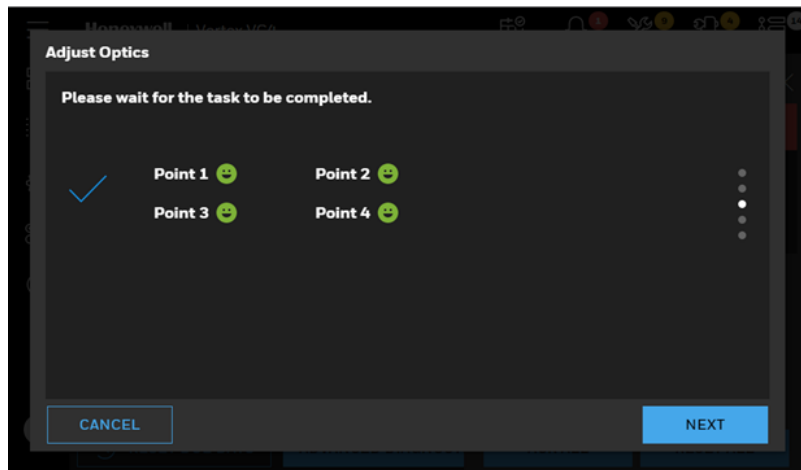

5. Optional Step. Tap the **RESET DUE DAYS** button to reset the configured Optic cleaning interval.

4.22 Test Optic Block

1. In the left navigation panel, tap **OVERVIEW** .
2. Tap on the **Optic** button to enter to the optic detail page.
3. In the Optic Block status screen, tap on the **TEST OPTICS** button.

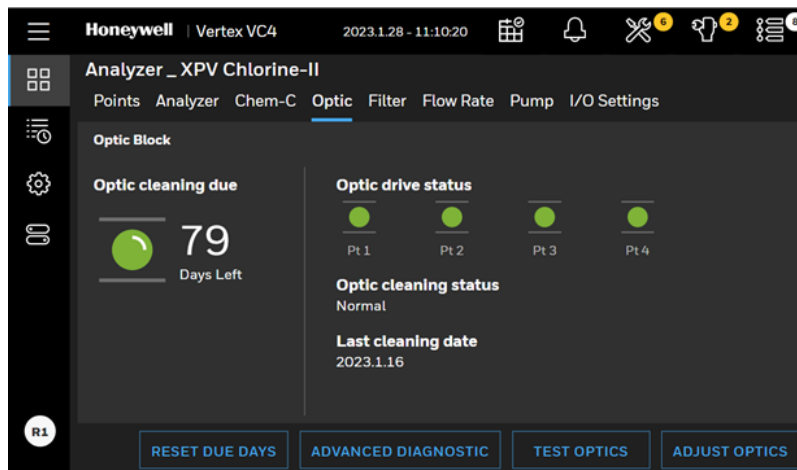

Prepare a tape leader and follow the instruction to test optic block. The whole process is manual operation.

When Optic block is tested with light gray tape and optic readings meet the criteria of color change, the alarm level 1 will be generated.

When Optic block is tested with dark gray tape and optic readings meet the criteria of color change, the alarm level 2 will be generated.

Note: While testing optic block, real gas alarms may be generated

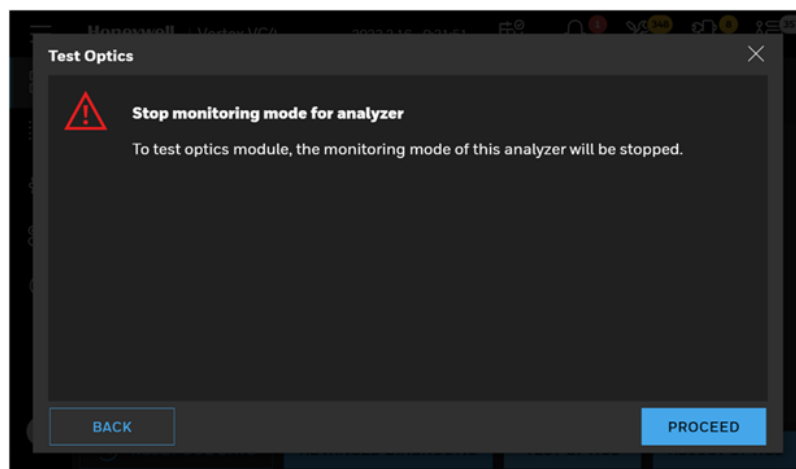

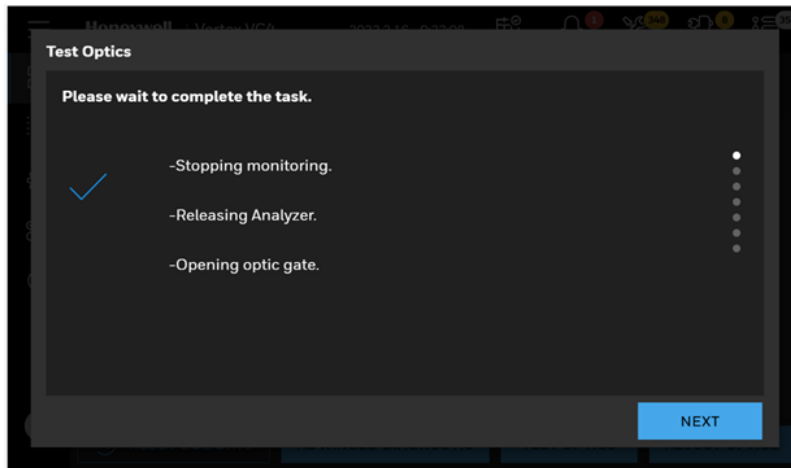

4. Insert the white tape leader to the Optic block carefully to make sure white tape leader is placed and well aligned Optic block and tap on the **NEXT** button.

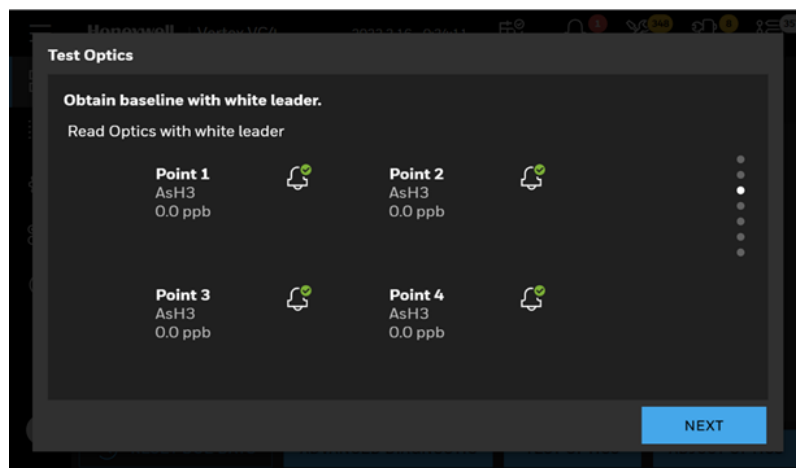
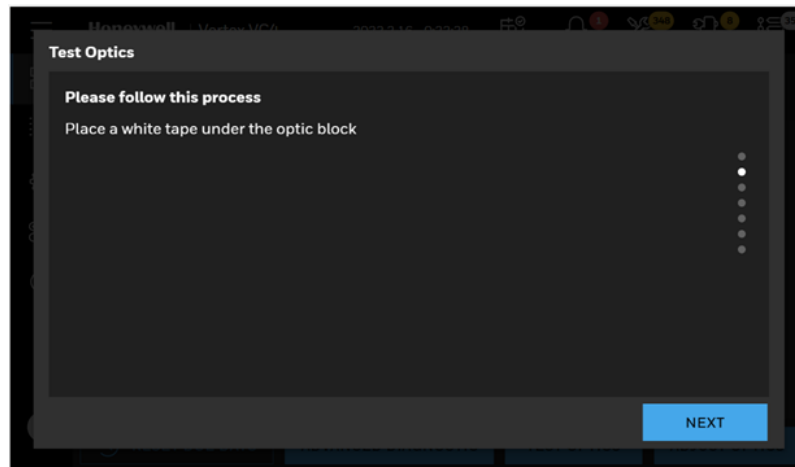

5. Insert the light gray tape leader to the Optic block carefully to make sure light gray tape leader is placed and well aligned Optic block and tap on the **NEXT** button.

6. If color change (stain development) is detected by Optic blocks, the Analyzer computes gas concentrations and generate a gas alarm1.

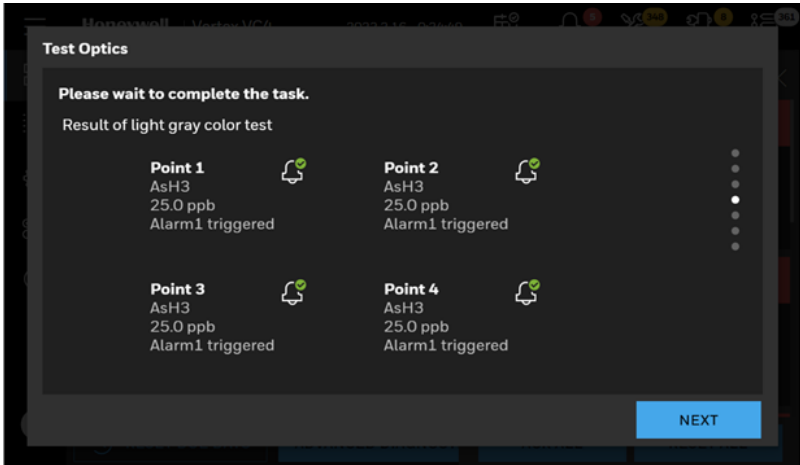

7. Insert the dark gray tape leader to the Optic block carefully to make sure dark gray tape leader is placed and well aligned Optic block and tap on the **NEXT** button.
8. If color change (stain development) is detected by Optic blocks, the Analyzer computes gas concentrations and generate a gas alarm2.

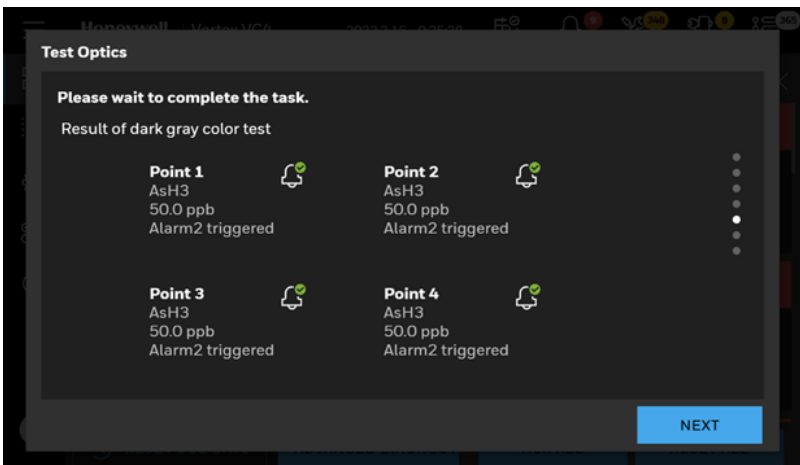

9. Take out the test leader, re-install the Chemcassette™ tape and tap on the **NEXT** button.

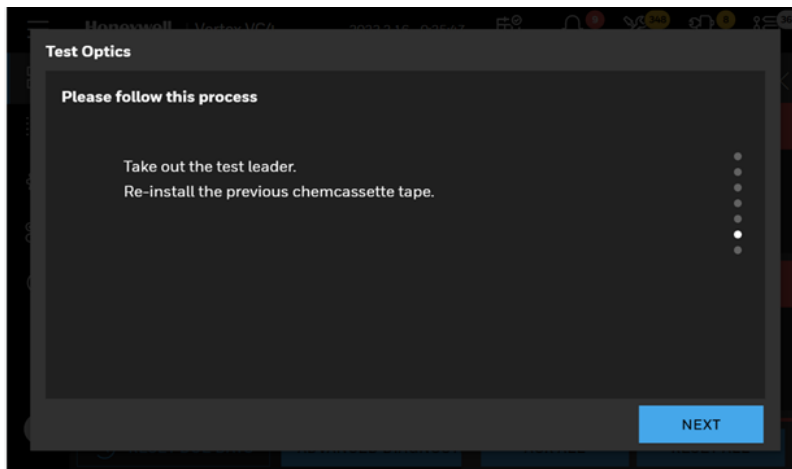

10. Choose a mode for this analyzer, **MONITOR** or **IDLE**.

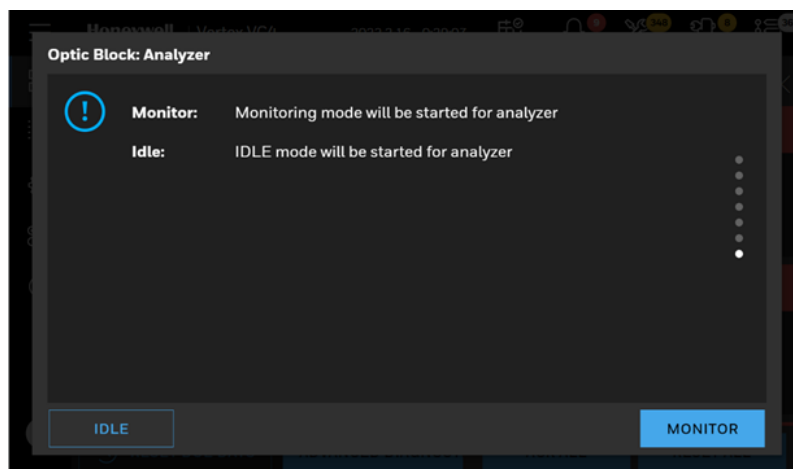

4.23 Leak Checking Sample Lines

Perform a leak check of the sample lines following installation and also whenever a line is changed or moved. The leak check procedure involves plugging the end of the sample line and verifying that there is no flow through the line. To perform a leak check:

1. Put the analyzer in idle mode.
2. Go to Overview and open Flow Rate screen.
3. Tap on the Adjust Flow button.
4. Securely plug the end of the sample line being tested.
5. Verify that the sample flow is less than 20cc, and that the Sample Pressure equals the Supply Vacuum within a tolerance of +/-0.5 inHg.
6. After testing all points, tap on the Stop Flow button.

Note: Tap on the Start Flow button on Flow Rate screen even if the pump is operating. Tapping on Start Flow turns on the solenoid valve to provide vacuum to the VC4™. A sample point failing to meet both the flow and vacuum conditions of step 6 indicates either a leak in the sample line or a faulty sample inlet connection. To troubleshoot the condition, disconnect the sample line at the inlet port at the back of the VC4™. Securely plug the inlet port and repeat the above leak check procedure.

If the sample point passes the test with the back port plugged, the leak is somewhere in the sample line and the line must be replaced. If the sample point fails the leak check procedure with the back inlet port plugged, contact Honeywell for assistance.

4.24 Adjust the Flow Rate

With the system vacuum level set, the unit is now ready to adjust flow for all the points.

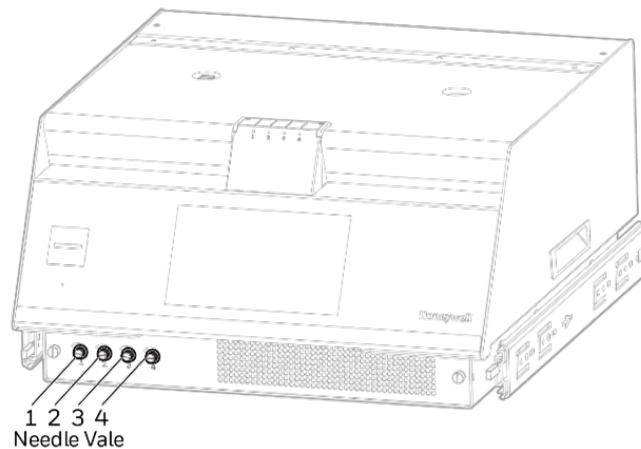

1. In the left navigation panel, tap **OVERVIEW** .
2. Tap on the Flow Rate button to enter the flow detail page.
3. Check the flow rate, and if there is any point marked in yellow, you must adjust the rate.

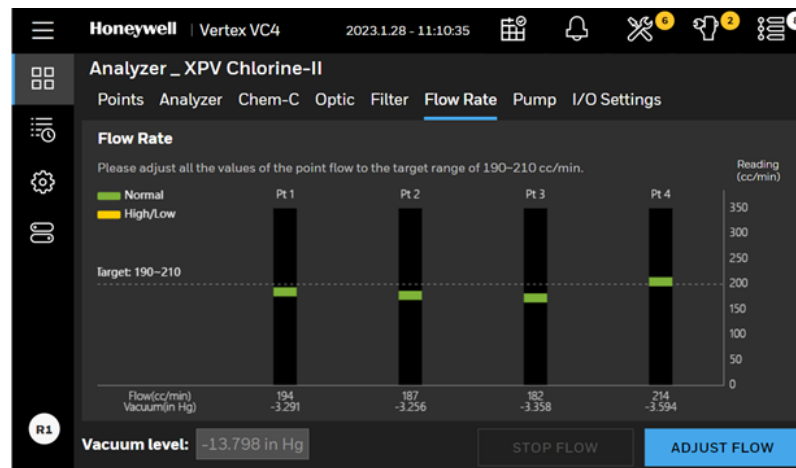

4. Click **ADJUST FLOW** and adjust the needle valve on the front panel while watching the flow rate on the graph.
5. Once the flow reaches the target flow rate of 200 ± 10 cc/min, the bar will change color to green.
6. Repeat for all points that are out of range.
7. Once complete, press **STOP FLOW**. This will stop for the flow, and the pump will turn off.

4.25 Sample Line Filter Replacement Counter

1. In the left navigation panel, tap **OVERVIEW** .
2. Tap on the **Flow Rate** button to enter the flow detail page.

Either the regular replacement window highlighted in green or the expired time window highlighted in yellow is displayed.

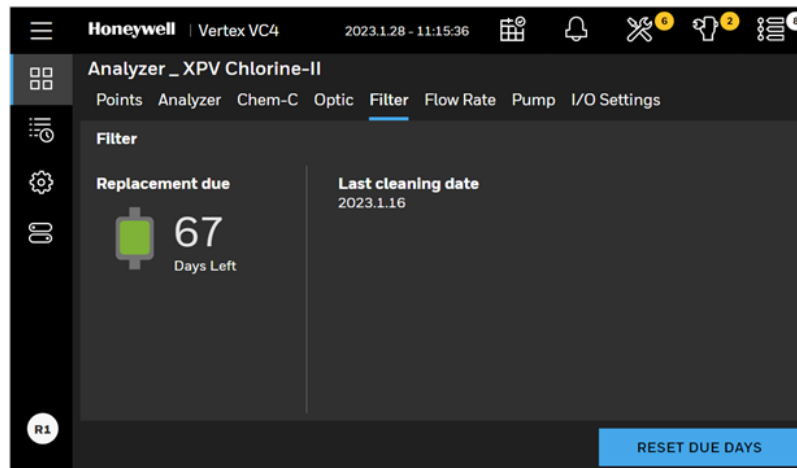

3. End of sample line filters should be replaced on a regular interval of 3 months.
4. Tap the **RESET UPTIME DAYS** button to reset the due days.

Note: This counter should be used with end of sample line filters only.

Note: Internal filters protecting the orifice should be inspected and cleaned on a regular interval of 6 months. "Orifice Inspection, Cleaning & Replacement" on page 100 for more information.

4.26 2mA Fault Operation

Use the 2 mA fault operation function to enable a 2 mA signal on the current loop that indicates when an instrument fault occurs. The VC4™ system differentiates between a power loss and a fault by dropping the signal to 0 mA after a power loss or CPU failure and 2 mA when an instrument fault occurs. When enabled, the fault operation function causes the calibrate current loop function from the Calibration Mode to include the 2 mA outputs as part of the VC4™ system's fault routine.

1. In the left navigation panel, tap **OVERVIEW** .
2. Tap on the **I/O Settings** button
3. Under 4~20mA tag, select **Enable 2mA Fault** and tap **APPLY** button to enable 2mA fault operation function.

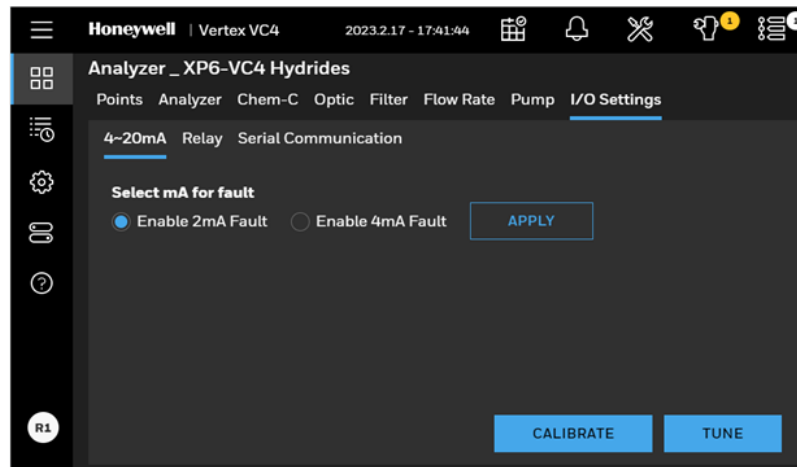

4.27 Calibrate Current Loop

The Calibrate Current Loop function calibrates the external analog devices connected to the module by generating a 2 mA to 20 mA analog signal from each individual point. If 2 mA fault indication is disabled, then the minimum current will change from 2 mA to 4 mA.

This function provides three signal Levels methods to calibrate connected devices.

- **Manually:** Toggling between 2 mA, 4 mA, and 20 mA signal levels
- **Ramp:** Automatically changing output signal levels beginning at 2 mA and going up to 20 mA
- **Step:** Step up the current loop from 4 mA to 20 mA in 1 mA increments

1. In the left navigation panel, tap **OVERVIEW** .
2. Tap on the **I/O Settings** button
3. Tap on the **CALIBRATE** button, the Stop monitoring screen will pop up asking a user to confirm it.
4. Select the Point to output
5. Select the Signal Levels methods
6. Select the **APPLY** button to enable the output.

Selecting the Signal Levels - Manually

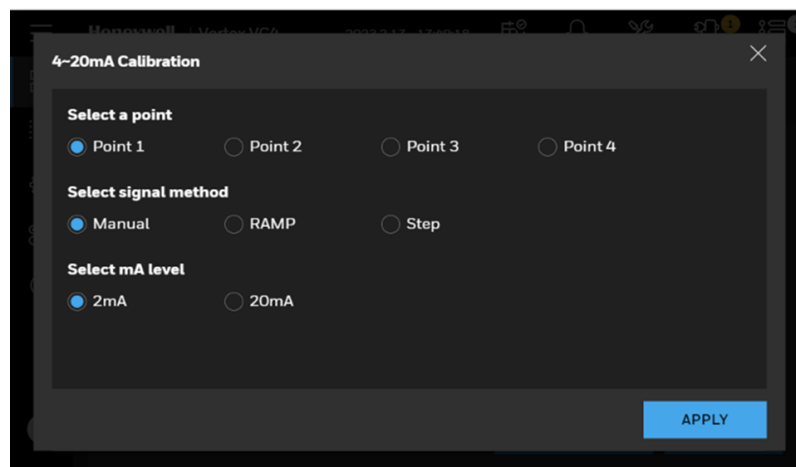

Selecting Signal Levels – Automatic Ramping

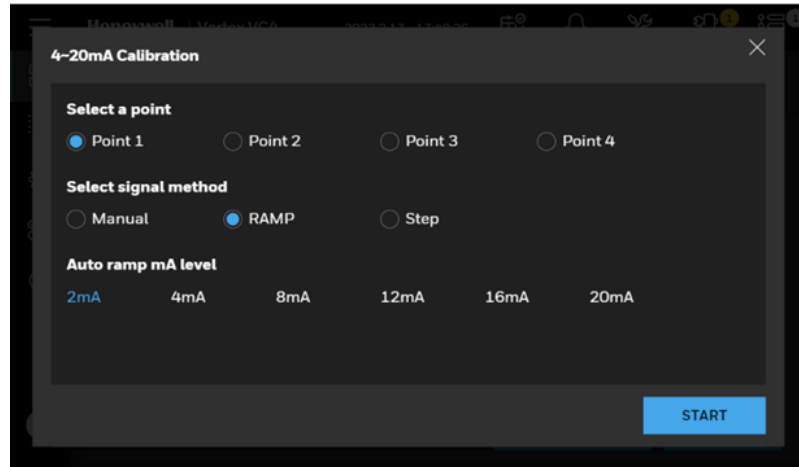

Selecting Signal Levels – Step

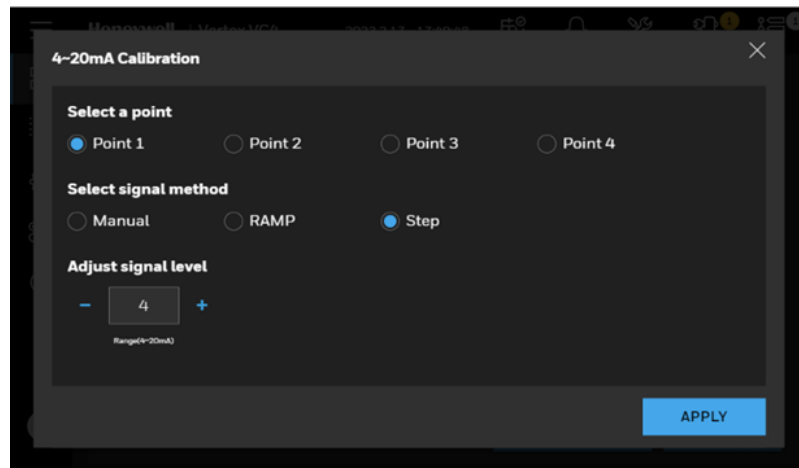

4.28 Tune Current Loop

The Tune Current Loop function allows you to adjust the VC4™ system's output level so that it is correlated from zero to full scale with a driven device (an instrument used to monitor 4-20 mA output).

This is necessary only if new current loop hardware has been field installed.

1. In the left navigation panel, tap **OVERVIEW**  .
2. Tap on the **I/O Settings** button
3. Tap on the **TUNE** button, the Stop monitoring screen will pop up asking a user to confirm it.

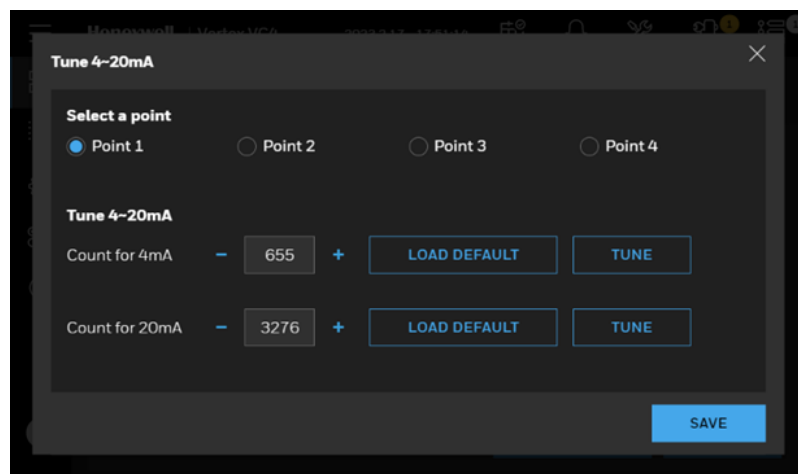

4. Select the Point to output
5. Change the DAC endpoint value corresponding to 4 mA by pressing '+' or '-' button
6. Tap **TUNE** button to enable the output
7. Similarly, operate to change the 20 mA DAC endpoint
8. Tap **SAVE** button to save 4 mA and 20 mA DAC endpoint value in system.
9. Optional, user can tap **LOAD DEFAULT** button to reload the default DAC endpoint value to adjust 4 mA or 20 mA output.

Note: This should not be performed without a known accurate external ammeter.

4.29 Set Relay State

Select the state of the relay contacts to either energized or de-energized. The default condition is de-energized for all relay contacts except the watchdog relay, which remains energized as a failsafe precaution in the event of power loss.

1. In the left navigation panel, tap **OVERVIEW** .
2. Tap on the **I/O Settings** button
3. Tap on the **Relay** button, select the Relay state as Energized or De-energized.
4. Tap on the **APPLY** button to validate the setting.

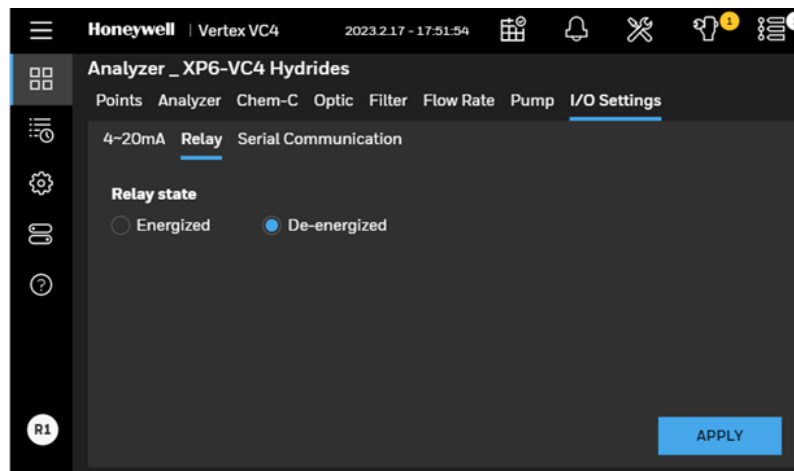



CAUTION

RISK of improper operation. Selecting the energized state changes all relay states, except the watchdog. If power is lost, energized relays change state if they are selected to be energized. Be sure that this will not initiate a false alarm condition in your facility.

4.30 View and Export the Events History Listed by Time

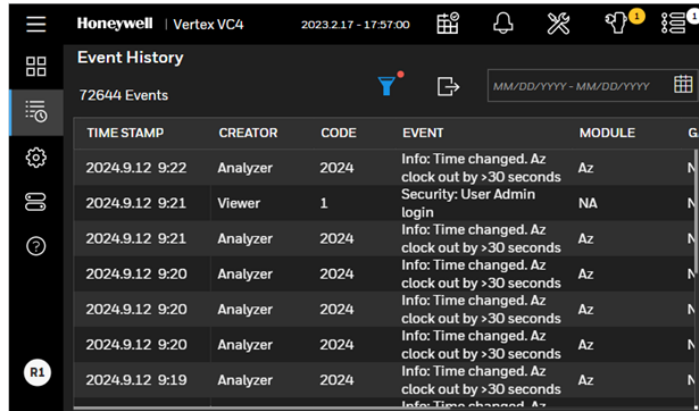
1. In the left navigation panel, tap Event History  .



2. Tap the filter  button, there are more filter types can be selected.

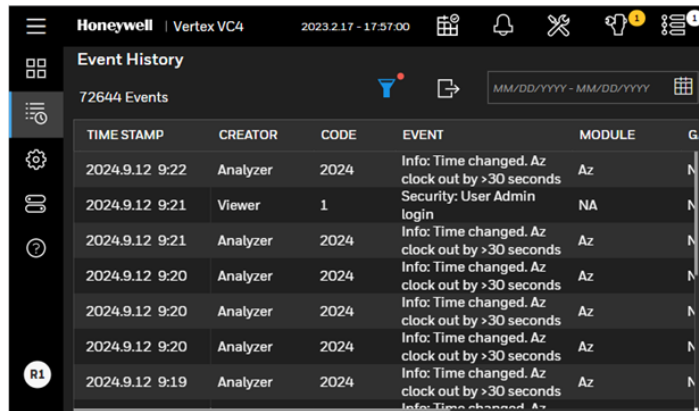

3. Tap the  button, you can filter the events by time range.

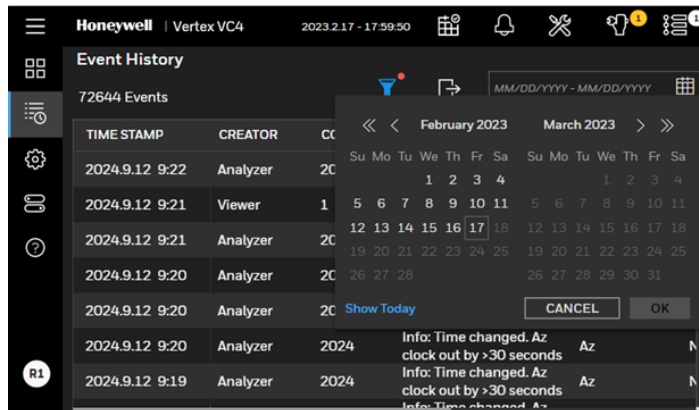

4.31 Export the Events History

1. Insert a USB flash drive to VC4™ HMI PC.

2. Tap the **Export** icon  to export the event histories to CSV file.

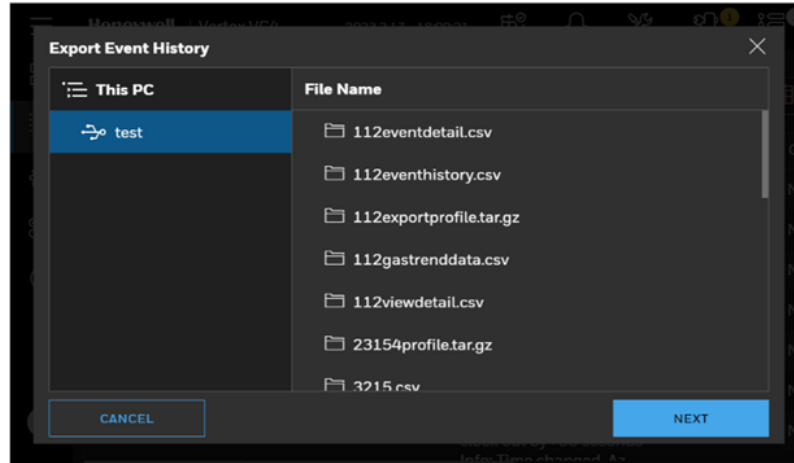

3. Export event history screen will pop up asking the user to enter a file name. Type a file name and touch **NEXT** button.

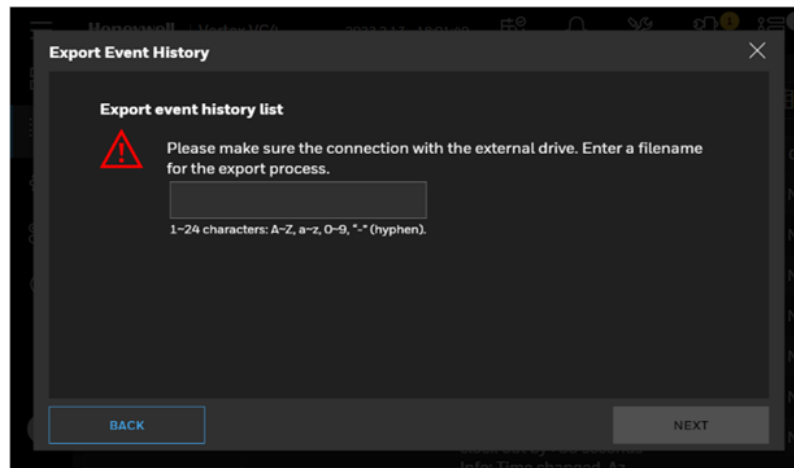

4. Select a USB drive to export the event histories and touch **NEXT** button. Once exporting is complete, the **Exporting is completed** screen will be shown as below. It may take several minutes depending on number of events to be exported.

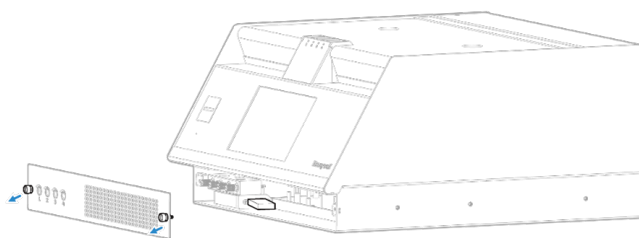
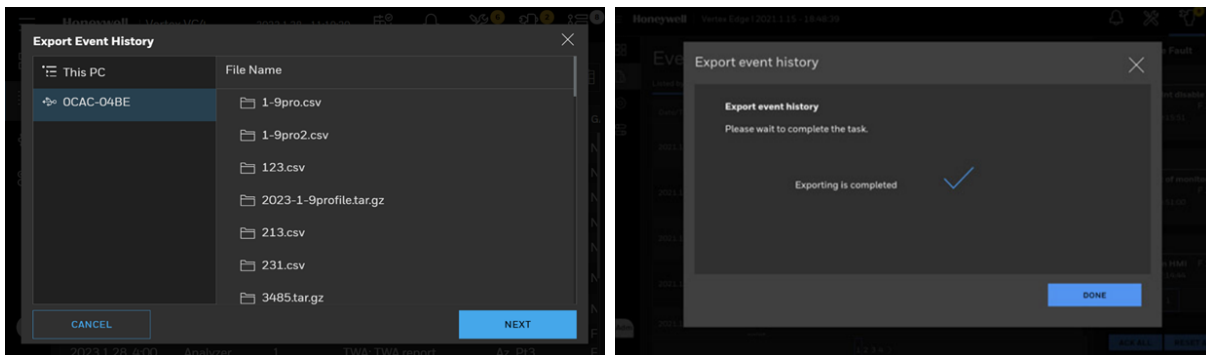

4.32 View System Version Information

Version Manager shows version information of VC4™ system components such as Analyzer, DAq and IO Panel. The version information includes FW version, HMI application version, part numbers, and serial numbers.

1. From the main menu, go to **System Manager > Version Manager**.

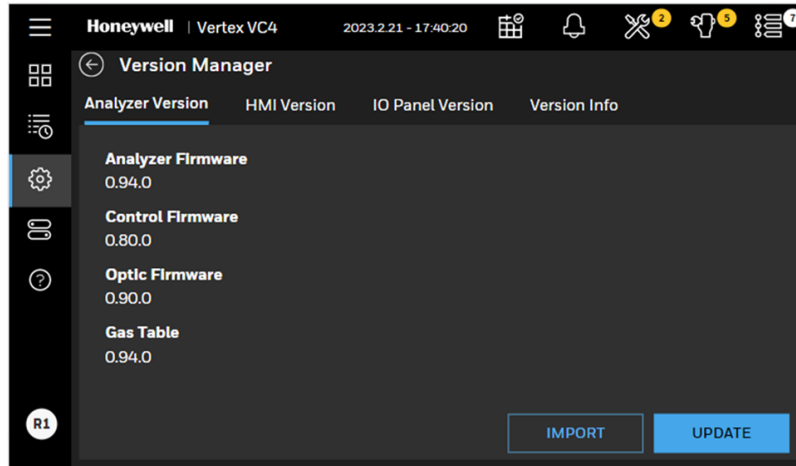

2. Tap on the **HMI Version** tab or **IO Panel** tab to view detailed version information of the system components.

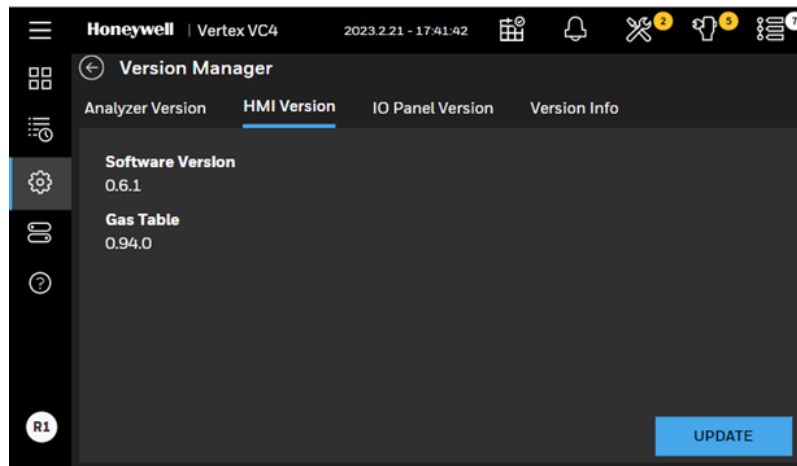

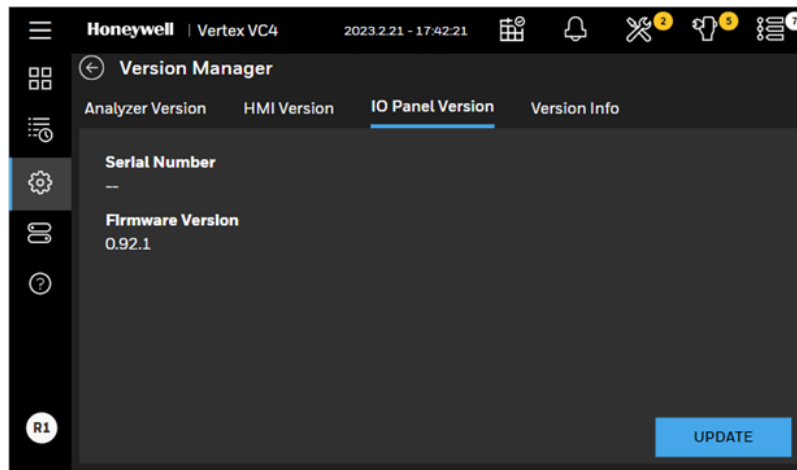

3. In Version Information tab, the summary of version information is shown and can be exported to a CSV file. Tap on the **EXPORT** button and enter file name to export a version.

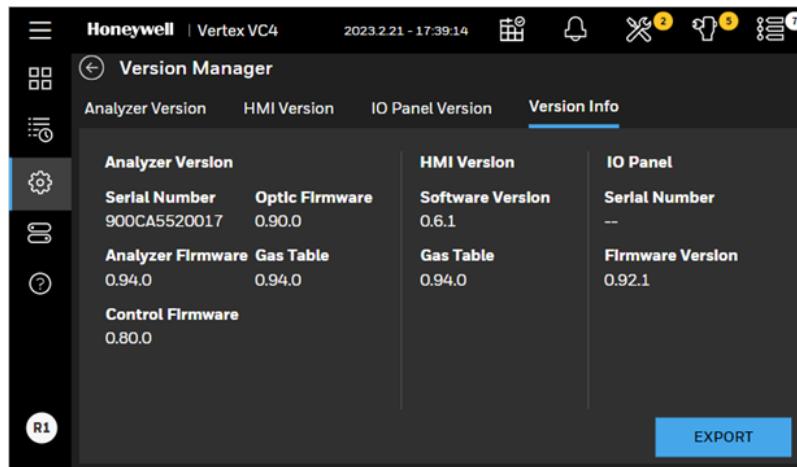

4.33 Fault/Alarm Test

VC4™ system can simulate Fault and Alarm to test system.

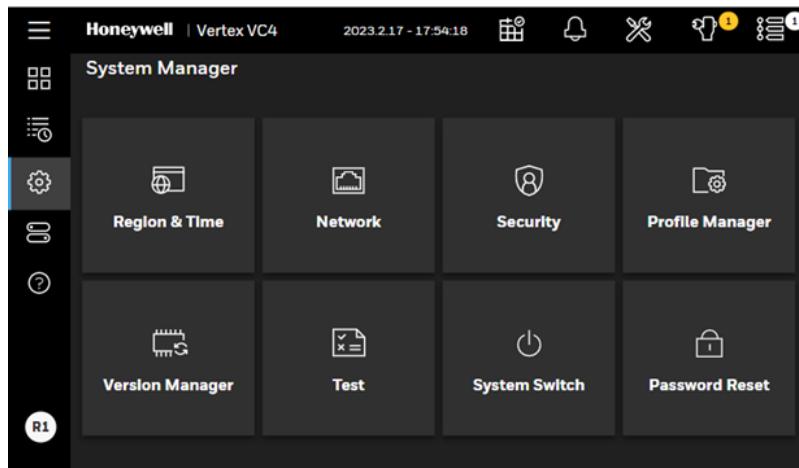

4.33.1 Fault Test

Use the Fault Test to simulate Maintenance Fault and Instrument Fault.

1. From the main menu, go to **System Manager** > **TEST**.
2. In **Fault Test** tab to select Fault Type, Maintenance Fault or Instrument Fault.
3. Tap on **Start Test** button to validate the fault test.

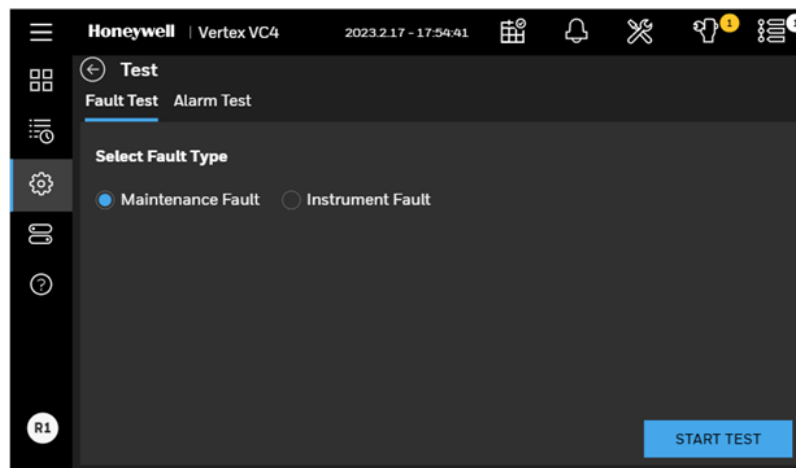

Note: The fault test simulates an actual fault condition and the VC4™ system activates fault relays. Notify appropriate personnel that you plan to conduct a fault test.

4.33.2 Alarm Test

Use the alarm test to simulate a gas concentration for any analyzer.

1. From the main menu, go to **System Manager > TEST**
2. In **Alarm Test** tab to select Point and Alarm Level
3. Tap on **Start Test** button to validate the Alarm test

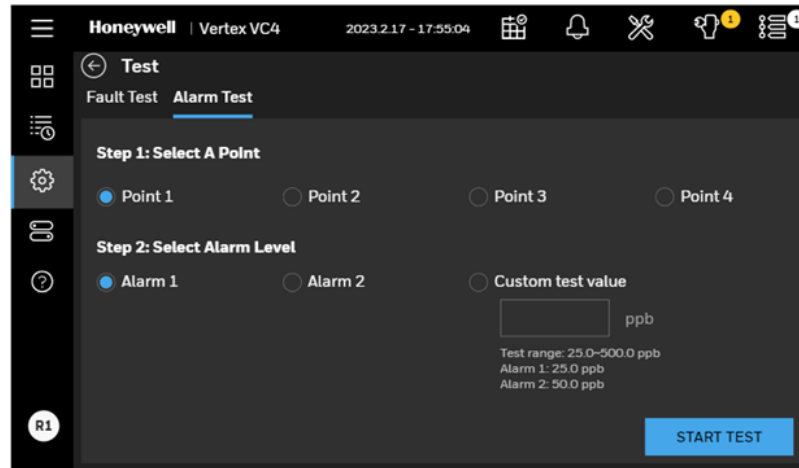

Note: The alarm test simulates an actual alarm condition and the VC4™ system activates all alarm relays. Notify appropriate personnel that you plan to conduct an alarm test.

4.34 View Help File

1. In the left navigation panel, tap  HELP.
2. Navigate the help using navigation panel on the top of help.

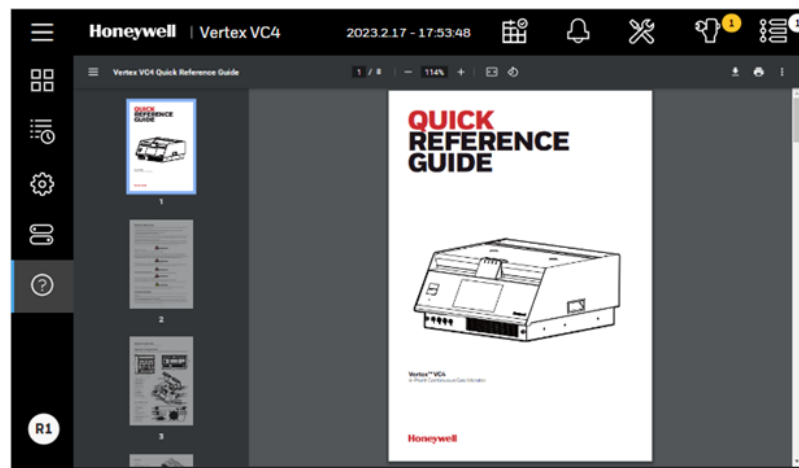

4.35 Update an Analyzer Firmware

To update an analyzer firmware, USB flash drive with an update file should be prepared. Please contact Honeywell to get the latest update software files.

1. From the main menu, go to **System Manager > Version Manager**
2. Insert the CD or USB flash drive to the VC4™ HMI PC.

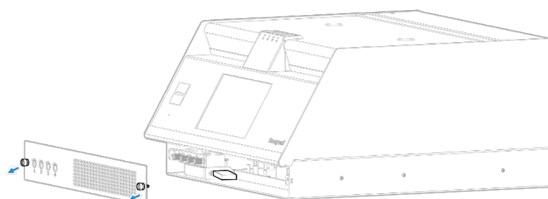

3. Tap on the **IMPORT** button to copy an update file from USB flash drive to HMI PC
4. Select an analyzer update file. If the selected update file is valid, HMI will import it successfully as below.

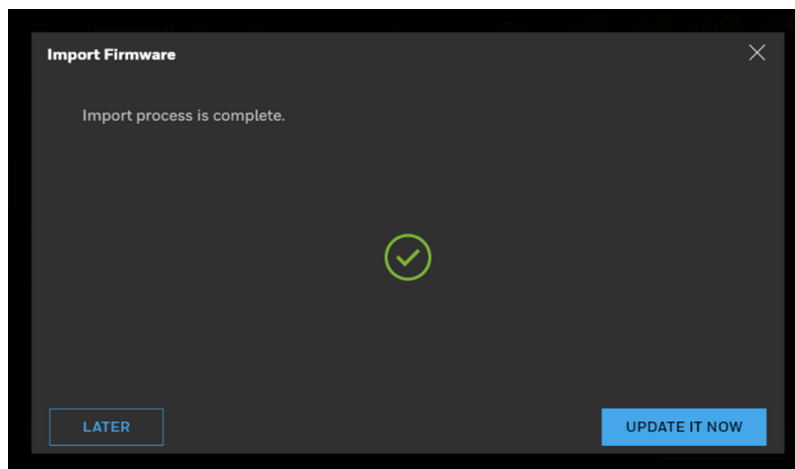

5. After importing the target update file, select the Analyzers to be updated and tap on **Update** button. A user will be asked to select the system type and a target firmware file in the list as below. The updatable firmware is as below:

- Analyzer firmware
- Control firmware
- Optic firmware

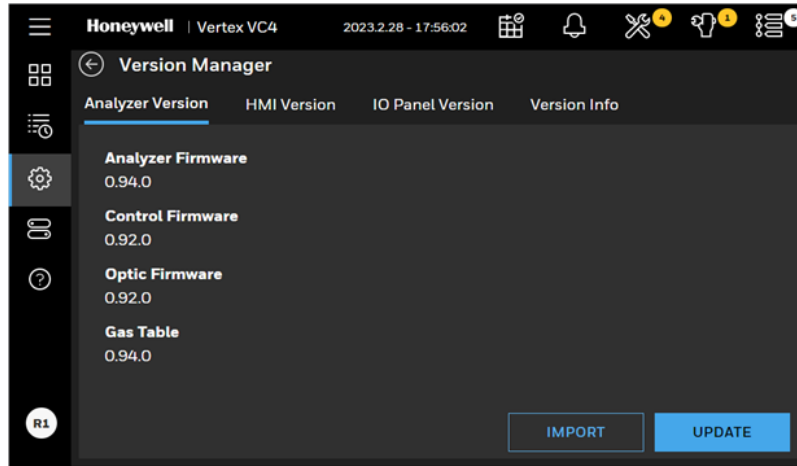

6. Tap on the **Next** button. Select the analyzers you are going to update firmware. Tap on the Next button, the Stop monitoring screen will pop up asking a user to confirm it.

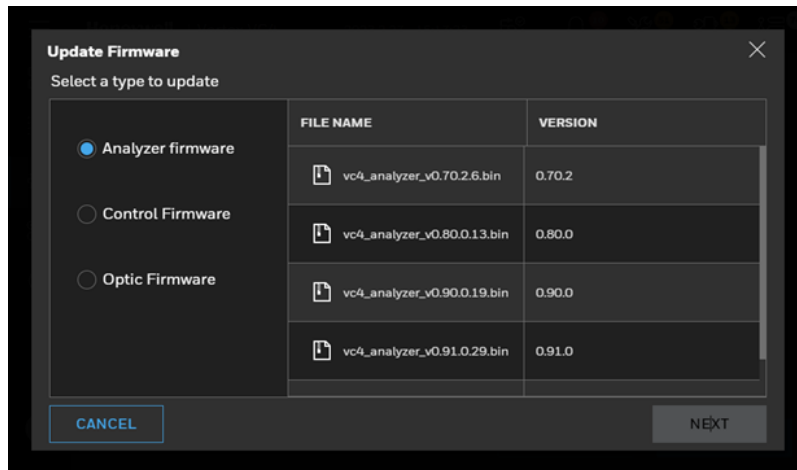

7. Tap on **CONFIRM** button and firmware update will be started. The firmware update progress has two steps. The first step is that the update file is being transferred to Analyzers, and the second step is that the Analyzers are updating the firmware. If there is any communication error or any issue in updating the firmware, the Error message page will be shown instead.

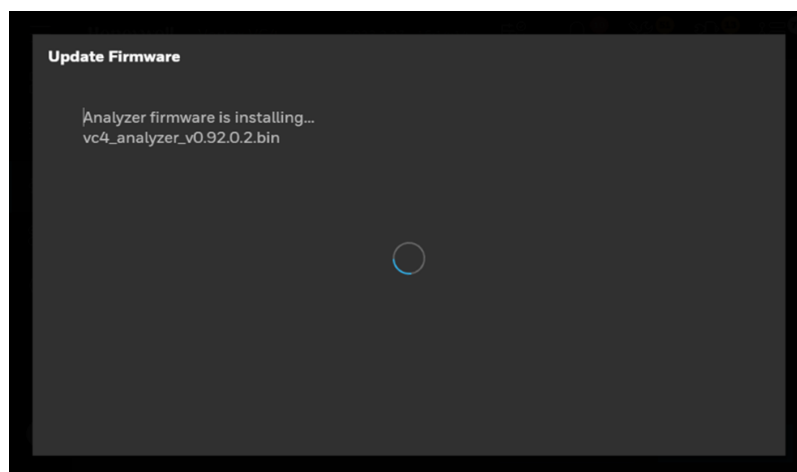
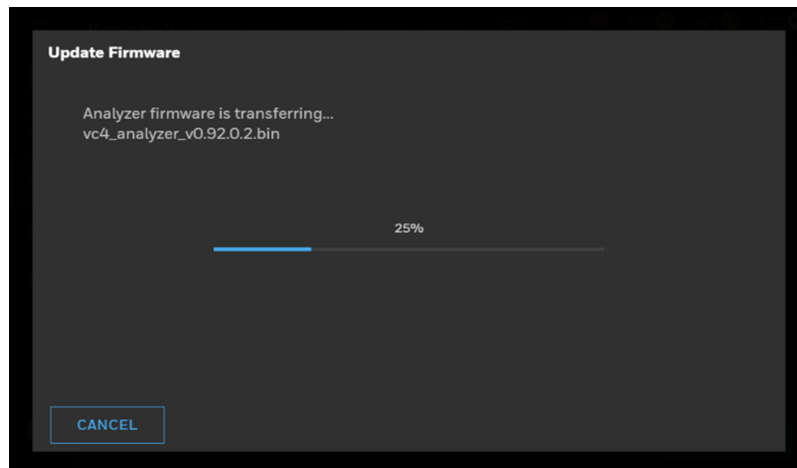
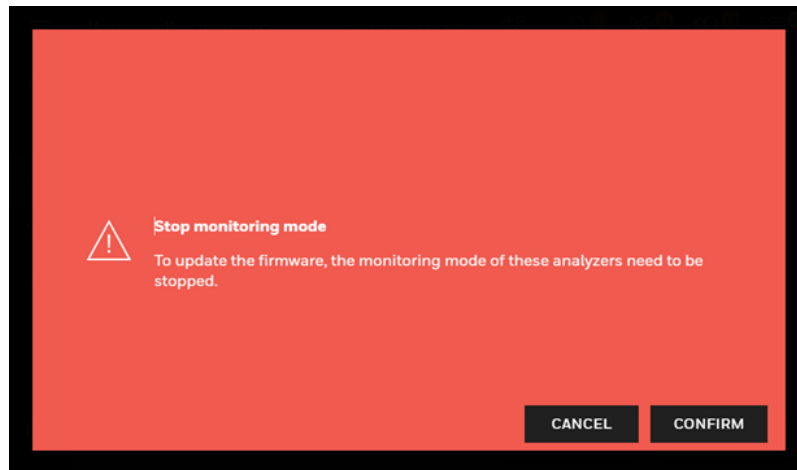

8. Tap on **Done** button when Firmware update is done with green tick and it moves back to Version Manager screen with updated version information.

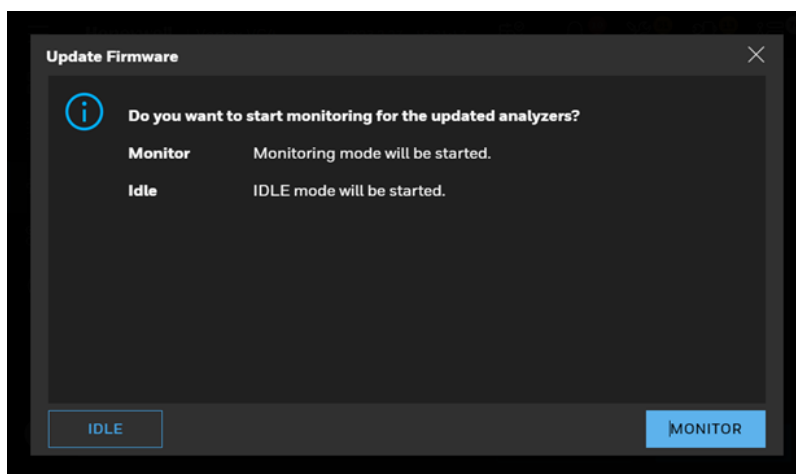
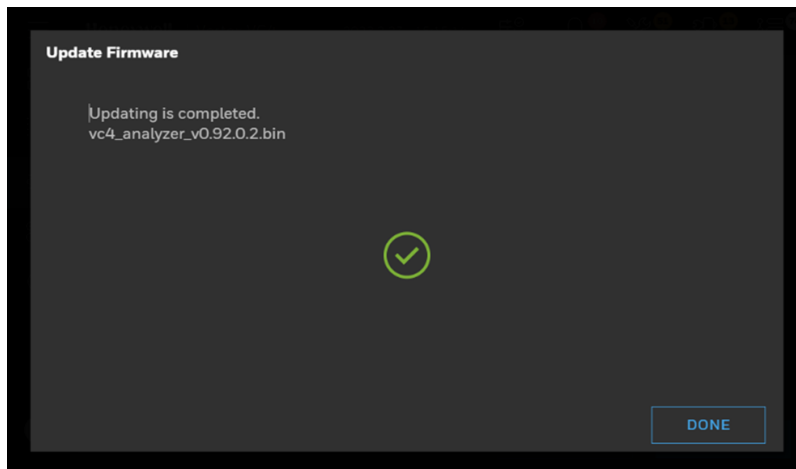

4.36 System Shutdown



CAUTION

RISK of improper operation. Failure to properly shut down the VC4™ system could result in system file corruption.

1. Go to Runtime Operation and stop monitoring mode.

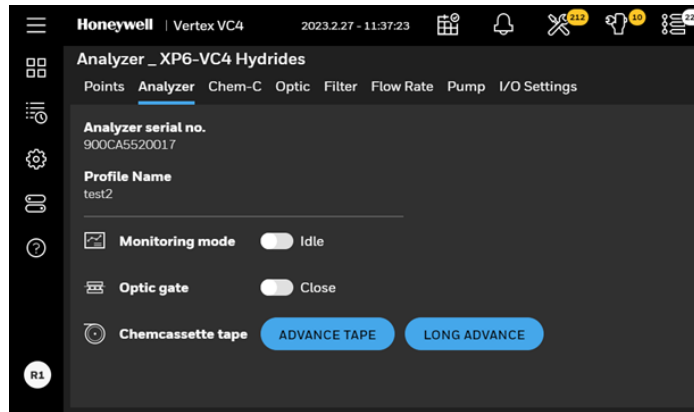

2. Go to **Settings** -> **System Switch** and touch System Shutdown Touch Proceed on the confirmation screen.

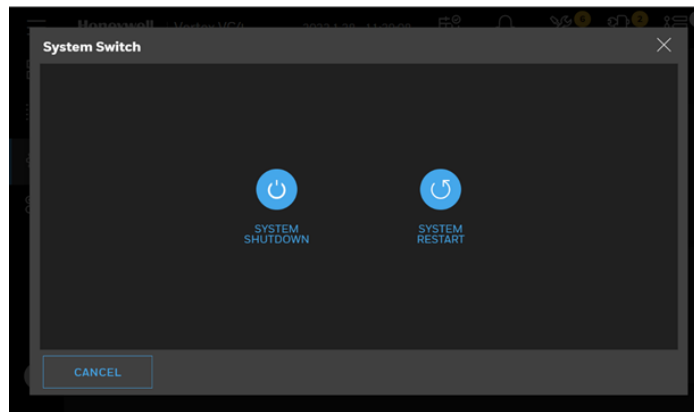

3. Once the HMI system is off, set the power switch to **Off**.

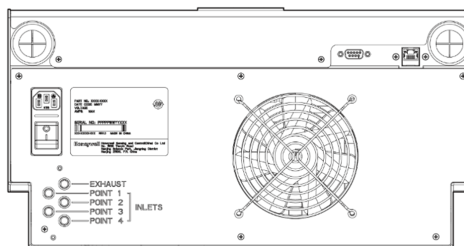

This section describes routine maintenance procedures.

5.1 Maintenance Schedule

Component	Frequency
Sample line filters (end of line)	3-6months
Pump diaphragm replacement	9-24 months operation per pump
Particulate Filters	3-6months
Acid Scrubber Filter	6 months
Optics Cleaning	1 year or as needed
System File Maintenance	1 year or as needed

5.2 Replace the Chemcassette™

Change the VC4™ Chemcassette™ tape for any of the following reasons:

- Scheduled end-of-tape service
- Low Chemcassette™ warning
- Chemcassette™ has expired
- End of Chemcassette™

1. In the left navigation panel, tap **OVERVIEW**  .
2. Tap on the **Chem-C** button to enter Chemcassette™ page.

3. In the Chemcassette® page, tap **REPLACE CHEMCASSETTE**.

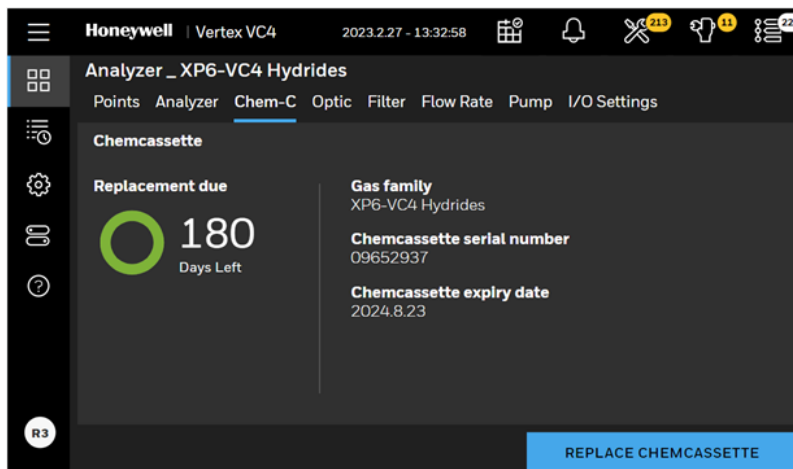

4. Stopping monitoring mode confirmation screen pops up. Tap **CONFIRM**.

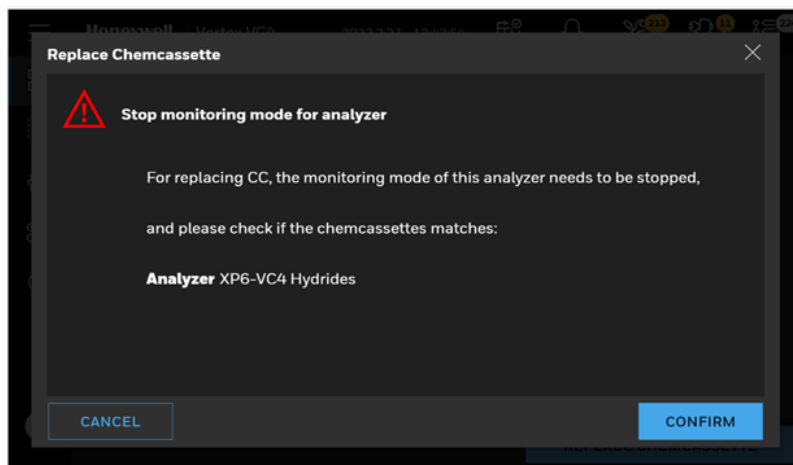

5. The tape replacement procedure gets started. The Analyzer is released, and the Optics gate opens.

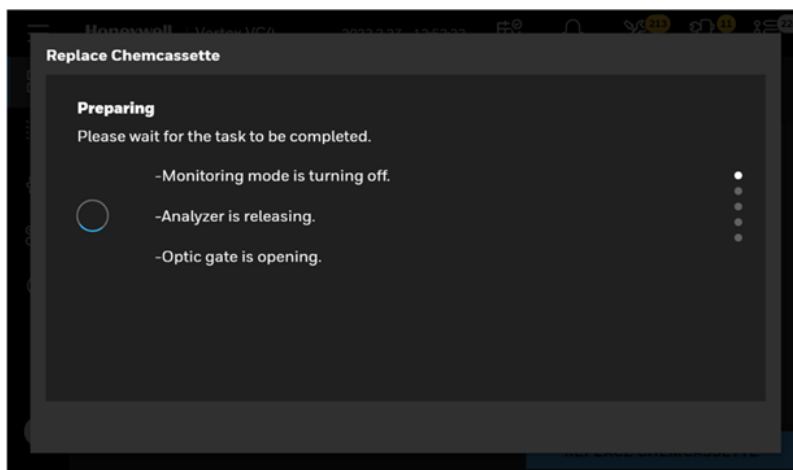

6. When you see this page, pull out the Analyzer and remove old Chemcassette™ tape.

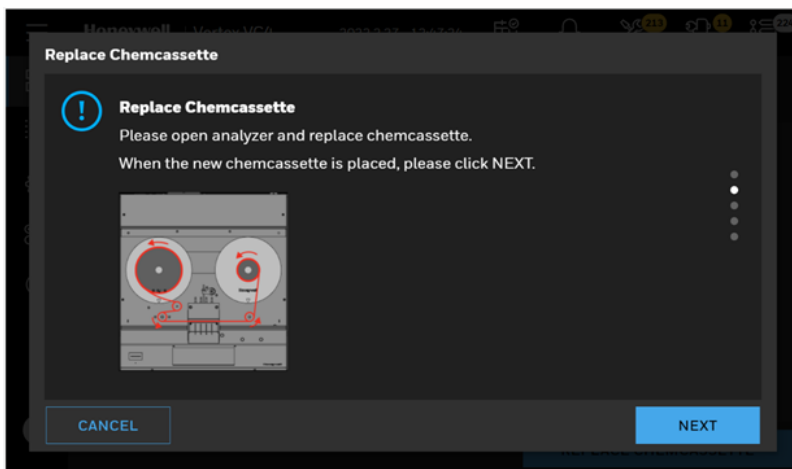

7. Route the Chemcassette™ tape through Optics blocks and guide rollers.

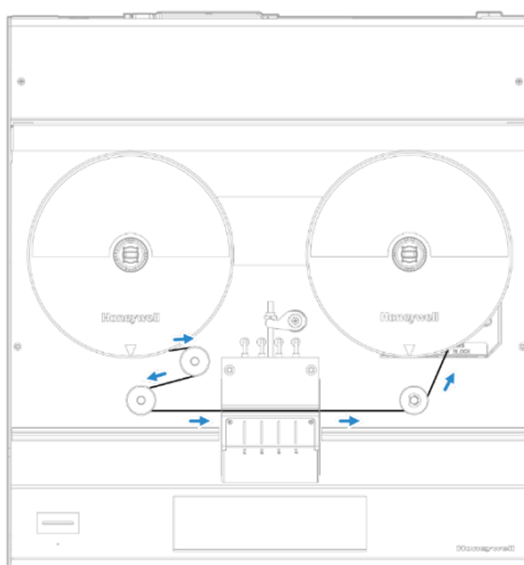

8. Install the leader tape into slot of the pick-up reel.

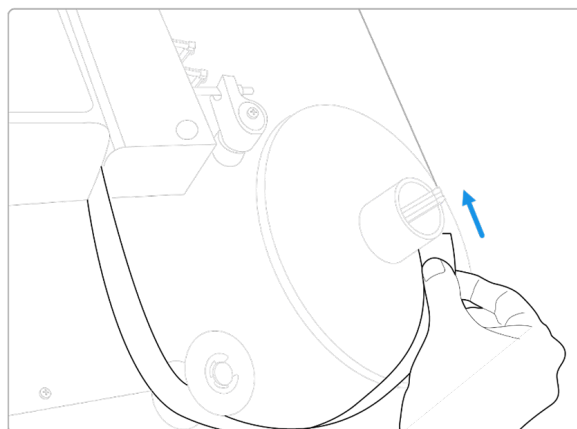

- When the Chemcassette™ leader is installed, adjust the leader tape by verifying the optics block should be placed between the two “ALIGN” marks on the tape leader. The alignment is essential to adjust and verify the Optics module before gas monitoring.

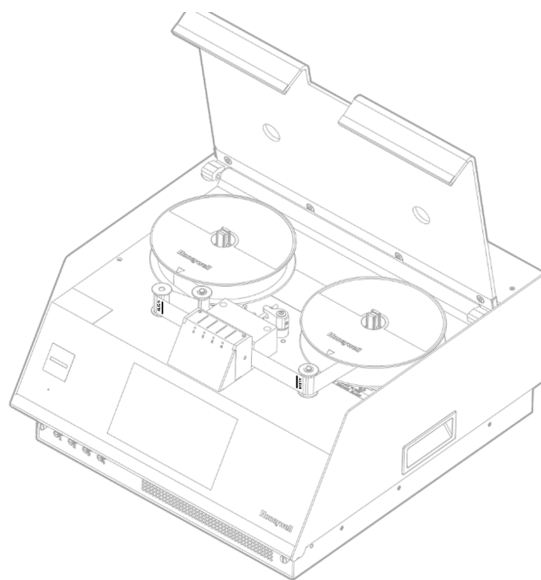

- When new Chemcassette™ is installed correctly, tap **NEXT**.
- The Analyzer reads the RFID tag on the Chemcassette™ tape and shows the tape information. Check the Chemcassette™ information and if no issue appears, tap **NEXT**.

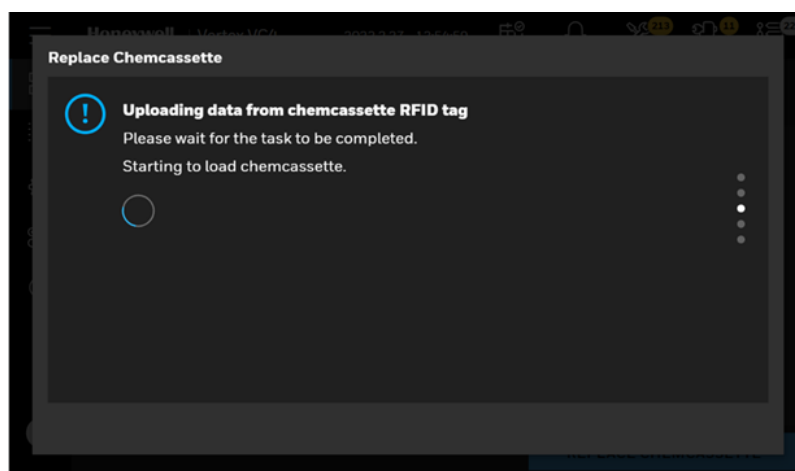

12. If the Chemcassette™ is a brand-new tape, the Optics module is adjusted and verified while advancing the Chemcassette™ tape automatically. The results of optics adjustment and verification are shown on the screen. If the tape is not brand new as below picture, Optics adjustment and verification steps will be skipped.

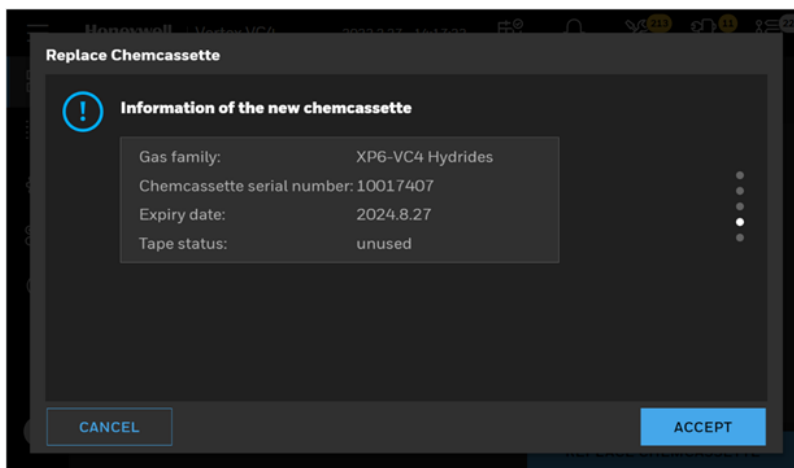

13. After completing the Optics adjustment/Verification, either turn the analyzer into monitoring or leave them as idle by tapping **MORNITOR** or **IDLE**.

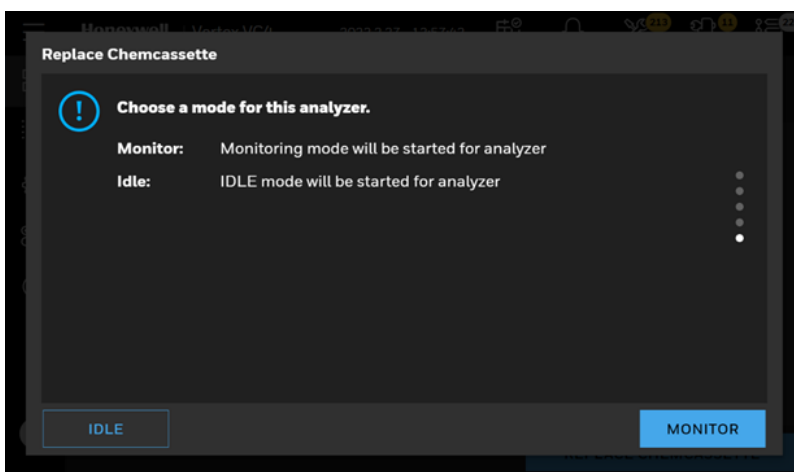

5.3 Replace Pump

The VC4™ system includes one vacuum pump. Please replace a defective pump with a new good one.

Note: You may replace a pump only when the system is power off. Do not replace an operating pump.



WARNING

RISK of electric shock. Turn pump off and disconnect power before servicing.

1. Power off VC4™ system and disconnect power/internet/digit cable and inlet/exhaust 1/4-inch tubes in backside of VC4™ system.
2. Push down the latch on both sides of VC4™ system's slide and pull out it from Rack. (if VC4™ system is set up in Rack).

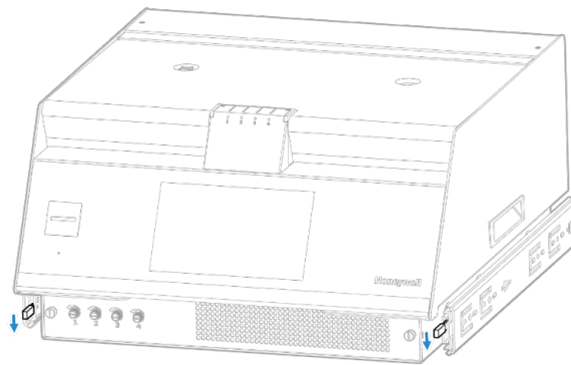

3. Open cover and chassis top to service position, disconnect pump power connect and barb fitting from pump's quick connector fitting.

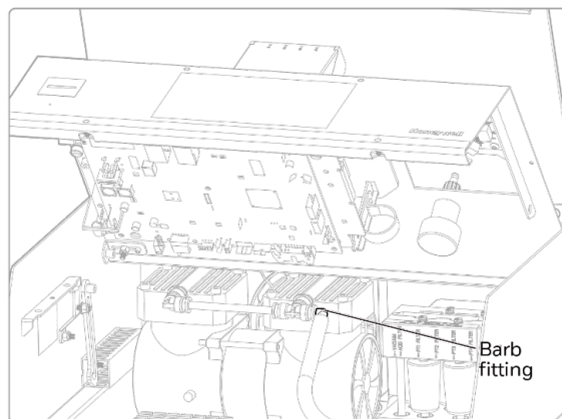

4. Unscrew six screws on rear cover of VC4™ system and disassemble rear cover.

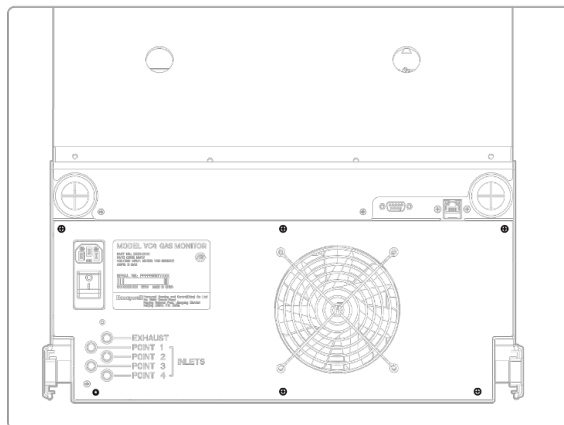

5. Loosen screw nut 1 and disassemble screw nut 2 and ground wire from screw bolt 2.

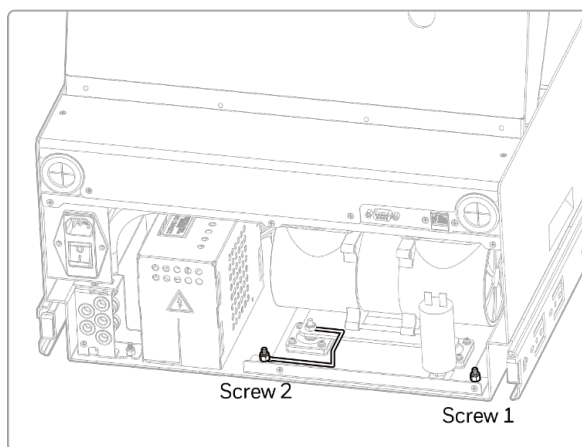

6. Disconnect tube from pump's quick connector fitting. Slide out pump assembly on proper location and then take out pump assembly.

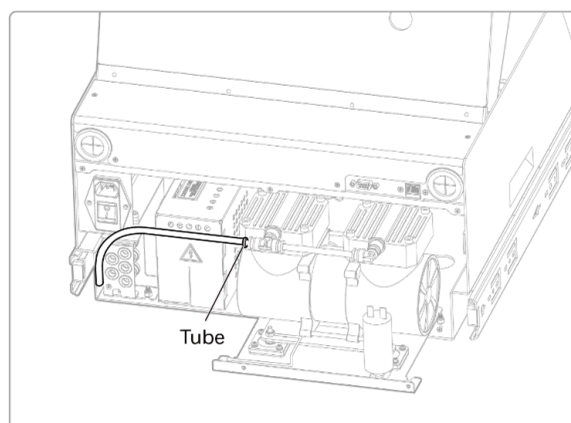

7. Unfasten 5 nuts (4 nuts for fixing pump, one for fixing capacitor), disassemble ground wire and capacitor and pump from bracket.

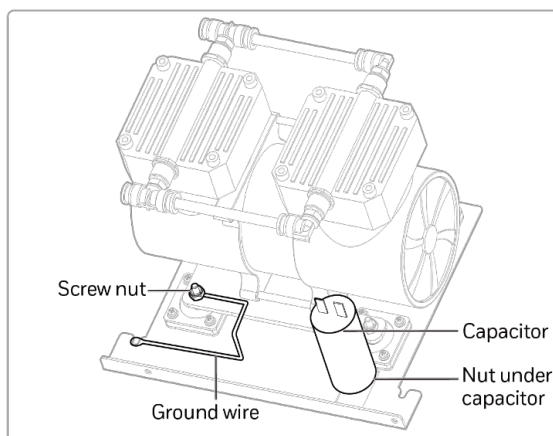

8. Reinstall new pump and capacitor into bracket and assemble ground wire and fasten 5 nuts.

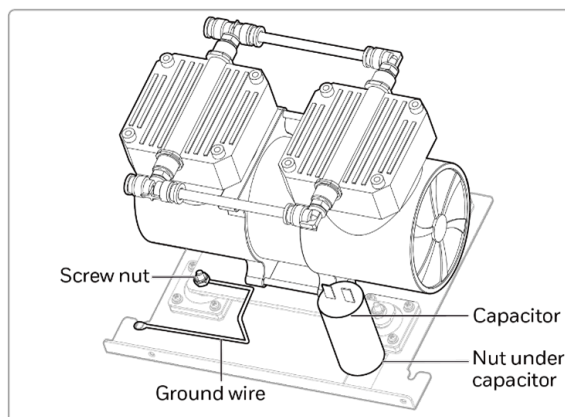

9. Repeat steps in reverse order to finish the pump replacement.

5.4 Replace Internal Filters

The VC4™ system will use one filter block. The filter block is keyed to fit only one way into the instrument.

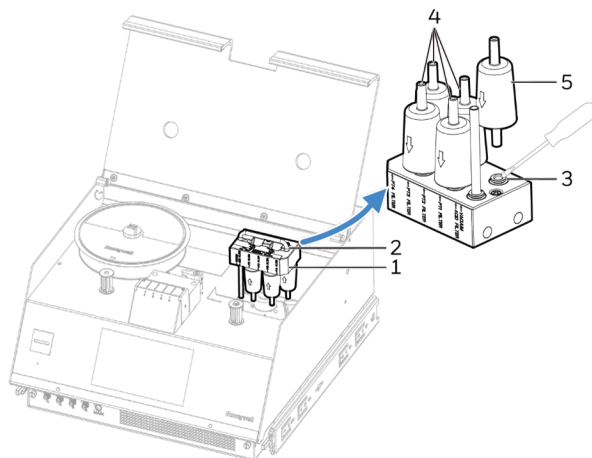

1. Filter block	3. Gray ring	5. Acid filter
2. Filter block handle	4. Particulate filters	

1. Open VC4™ cover to the servicing position.
2. Take away the right Chemcassette™ tape.
3. Grasp the filter block handle (2) and pull out.
4. The filters are attached with a quick disconnect connector. Remove the filter by pressing the gray ring (3) against the fitting and sliding the filter out of the fitting.
5. Install the new filters by fully inserting the fittings. Filters have an arrow on the filter body indicating the direction of flow. The arrows should point toward the filter block. Be sure to orient the filters correctly.
6. Reinstall the filter block (1).
7. Reinstall the Chemcassette™ tape and close VC4™ cover.

The positions of the filters in filter block.

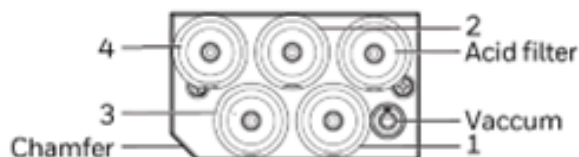

Fuse Replacement

The VC4™ is protected with a fuse located on the rear panel beneath the power cord.

To replace the AC line fuse,

1. Unplug the power cord.
2. With a slotted screwdriver, carefully pry the fuse cap outward.
3. Always replace fuses with the same type and style.
4. Replace the fuse cap.

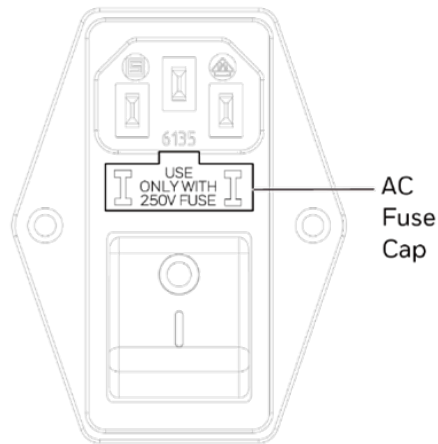

This section describes the AC line fuse. The following are acceptable fuse values:

Part Number	Voltage	Rating and Size	VC4™ Model
3012-4090-101	110VAC 50/60Hz	3.5A,5x20 mm	1904C-1000
3012-4095-101	220 VAC 50/60Hz	2.5A,5x20 mm	1904C-1002

A spare fuse is supplied with the VC4™ product, and it is in the accessory kit in the product package.

5.5 Orifice Inspection, Cleaning & Replacement

The orifice is protected by filter. In general, there is no need to replacement or cleaning. In the event that a particle or foreign object makes it past the end of sample line filter, the orifice is clogging and slowing down sample transport times, you may clean or replace orifice.

Note: This inspection should only take place on VC4™ system and it is out of monitor mode.

1. Open VC4™ system cover to the servicing position.

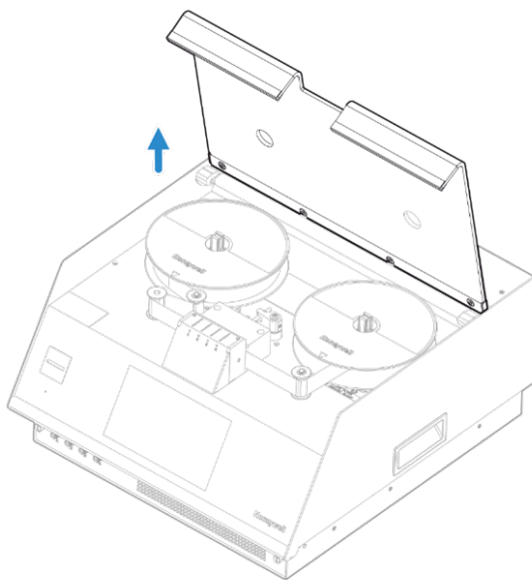

2. Take away the right Chemcassette™ tape.

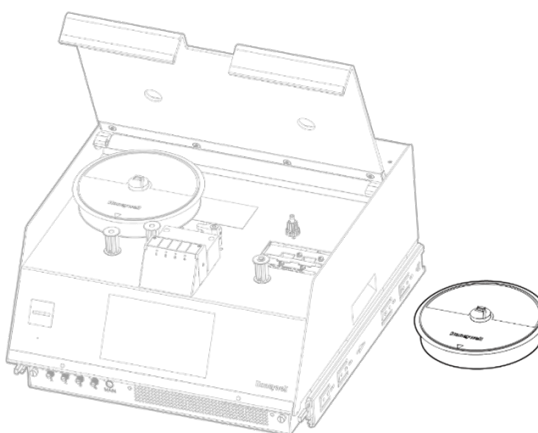

3. Use needle nose pliers to clamp orifice cartridge head and pull out it from the manifold.

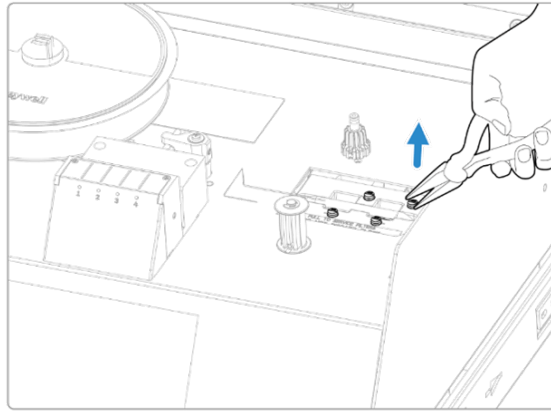

4. Once removed, cleaning the cartridge for any debris on the surface. (Check orifice on the end of cartridge)

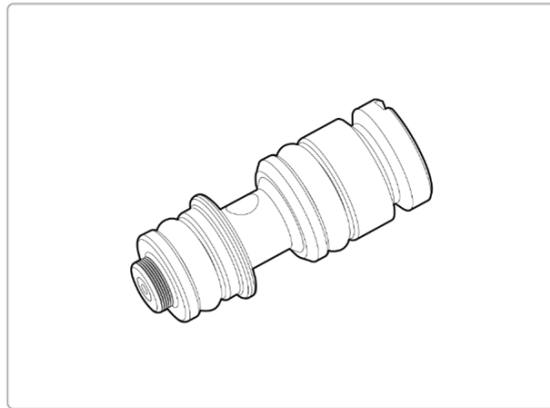

5. Replace the cleaned or new orifice into the cavity it came from, check that the orifice is fully installed into the manifold and Align the slot on the back side of the orifice to be horizontal.

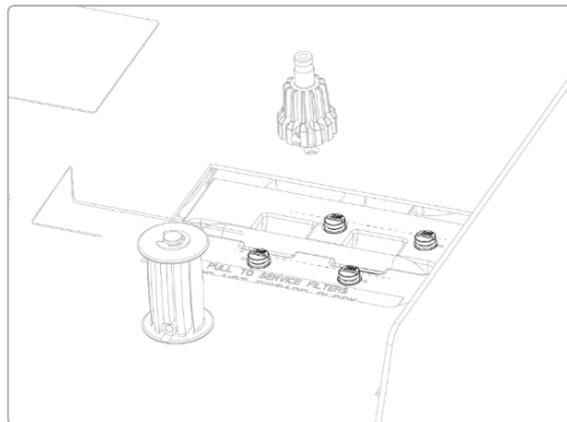

6. Repeat the process with the rest of the points.

5.6 Clean the Optics

Clean Chemcassette™ optics annually or whenever optics verification error occurs.

Compressed air is required or per the locations PM schedule.

1. Make sure the Analyzer is out of Monitor Mode.
2. Open the Optics Block Gate.
3. Remove the Chemcassette™ by releasing and pulling out the analyzer.
4. Open VC4™ system cover and chassis top to service position.
5. Remove tubing (shown in photo) one at the time and blow out with compressed air.

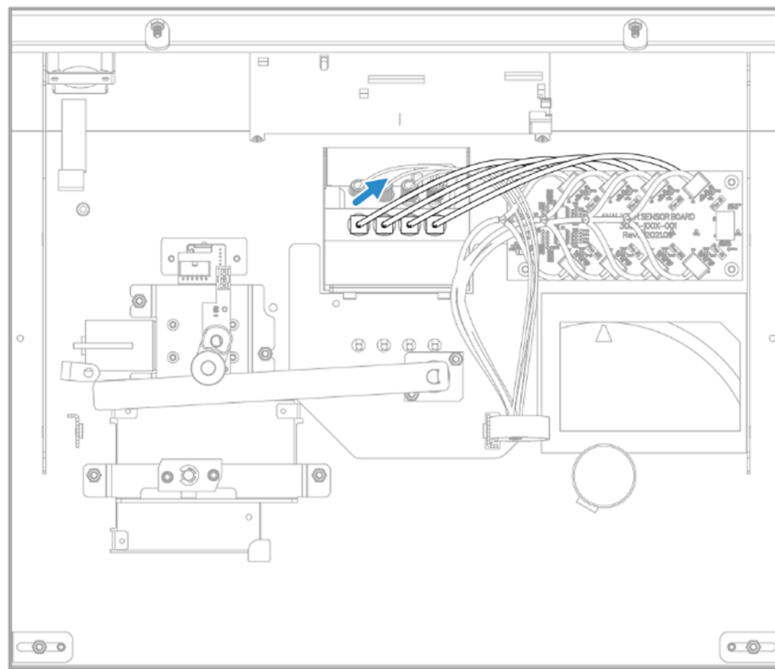

6. Re-secure side panel and reload the Chemcassette™.

Note: Remove and clean one port at a time to insure proper orientation of tubing. Do not remove the capillary tubing (microtubes). After cleaning the Optics, the cleaning counter should be reset to avoid unnecessary maintenance warning due to Optics cleaning due. ("Adjust the Optic Block" on page 63 for more information.)



CAUTION

RISK of equipment damage. Failure to replace and retighten hardware after service can adversely affect instrument performance and electromagnetic radiation C (EMC). Make certain all fasteners are reinstalled and firmly fastened.

5.7 Clean the Touchscreen

Clean the touch screen display with a lightly moistened towel. Do not spray cleaner directly onto the glass. Excess liquid will run down the screen and interfere with operation.

Reference your touch monitor manual for any additional information.

ADDITIONAL INFORMATION

Learn from about strategic information related to the Honeywell VC4™ system.

6.1 Specifications

Module	
Part No.	1904C-1000, 110V ± 10% VAC 50/60Hz 1904C-1002, 220V ± 10% VAC 50/60Hz
OVERALL SYSTEM DIMENSION	
Size	8.7“(H) x 17”(W) x 17.9“(D) (22 x 43 x 45cm) (Table mount) 8.7“(H) x 17.5”(W) x 17.9“(D) (22 x 45 x 45cm) (Rack mount)
Weight	≤ 23kg (51lbs)
POWER REQUIREMENTS	
Operating voltage	~3A @ 110VAC ~2A @ 230VAC
DISPLAY AND OUTPUTS	
Visual	7” wide screen monitor with capacitive touch interface
	Display gas reading, alarm & instrument status real-time base Provide real-time trend chart and gas event snapshot trend chart
	Event logging including maintenance/instrument fault and gas alarm Multiple searching option for the event
	LED indicator: Normal (Green), Alarm 1 (Red), Alarm 2 (Red), Fault (Yellow)
Local Alarm indication	Audible and visual
Fieldbus Outputs	TCP/IP and RTU Modbus
Serial Outputs (Optional)	RS232, RS422, and RS485

Relay Outputs	Relay contacts (500mA minimum) 2A @ 120VAC, form C contacts.
	Programmable low and high levels, maintenance, watch dog, energized or de-energized, latching or nonlatching
Current Loop Outputs (per Point)	4-20mA isolated (2-4mA range available for fault indicators)
SECURITY	
	Role-based access control Support HTTPS
CERTIFICATION AND SPECIFICATION	
	EN50270; UL/IEC/EN 61010; FCC, NCC for RFID
PERFORMANCE	
	Refer to product manual for complete gas list
Flow rate	2.8 LPM
Transport time	Less than 40 seconds up to 325ft with thin wall tube (0.190"ID)
Sample line tubing	1/4 in. (6.35 mm) O.D. x 0.190in. (4.83 mm) (Thin wall) Teflon tubing
Tubing length	Up to 400ft (120m) maximum
Exhaust line tubing	1/4 in. (6.35 mm) O.D. x 0.190in. (4.83 mm) (Thin wall) Teflon tubing or Polypropylene tubing
Exhaust length	Up to 50 ft. (15 m) maximum
OPERATING CONDITIONS	
Temperature	50°F to 140°F (10°C to 40°C)
Humidity	20-80% RH
Altitude	-1000 ft. (-305 m) to 6000 ft. (1829 m) above sea level
Pollution degree	2
WIRING REQUIREMENT	
Power	Singe phase power, Minimum 14 AWG
Outputs	Modbus TCP/IP: CAT5 shielded cable or equivalent (RJ45 connector)
	Modbus RTU: 2-wire stranded, shielded cable or equivalent (24-14 AWG)
	Serial outputs: DB9 connector
	Relay output: 24-14 AWG
	Current output: 24-14 AWG

6.2 Detectable Gases

VC4™ system Chemcassette™ analyzer are continuous monitoring instrument. The initial analysis period listed in the following table varies based on the programmed alarm levels. This period is valid only after the system pulls a new Chemcassette™ window. Increasing the programmed alarm levels will decrease the initial sample period.

For accurate detection, gas must be present at sufficient levels and durations. Typical response times are shown in this table at 2 TLV, which will vary in duration depending on the target gas and alarm level settings. For high concentrations (greater than full scale) a minimum of 4 seconds is required.

Family	CC Name (P/N)	Table	Gas Name	TLV	LAL	LDL	Default Alarm Level 1	Default Alarm Level 2	Range	Alarm Setting	Initial Analysis Period (second)	Time to 1TLV alarm @ 2TLV concentration, 10ft sample line
1	XP6-VC4 Hydrides (1904-9300)	1	Arsine XP6 (AsH ₃)	5 ppb	3 ppb	2.5 ppb	25 ppb	50 ppb	0-500 ppb	3-500 ppb	30	<24 sec (Alarm @ 50 ppb with 100 ppb AsH ₃ gas)
		2	Arsine XP6 (AsH ₃) Low Level	5 ppb	0.5 ppb	0.3 ppb	2.5 ppb	5 ppb	0-50 ppb	0.5-1.9 ppb 2-4.9 ppb 5-9.9 ppb 10-50 ppb	300 150 60 30	<60 sec
		3	Diborane XP6 (B ₂ H ₆)	100 ppb	15 ppb	10 ppb	50 ppb	100 ppb	0-1000 ppb	15-49 ppb 50-99 ppb 100-1000 ppb	60 45 30	<45 sec
		4	Germane XP6 (GeH ₄)	200 ppb	100 ppb	100 ppb	100 ppb	200 ppb	0-2000 ppb	100-149 ppb 150-199 ppb 200-2000 ppb	480 360 240	<200 sec
		5	Phosphine XP6 (PH ₃)	50 ppb	5 ppb	5 ppb	25 ppb	50 ppb	0-3000 ppb	5-3000 ppb	15	<30 sec (Alarm @ 50ppb with 100ppbPH ₃ gas)
		6	Silane XP6 (SiH ₄)	5 ppm	0.5 ppm	0.3 ppm	2.5 ppm	5 ppm	0-50 ppm	0.5-4.9 ppm 5-9.9 ppm 10-19.9 ppm 20-50 ppm	60 45 30 15	<35 sec
		7	Silane-M XP6 (SiH ₄ - M)	5 ppm	0.06 ppm	0.05 ppm	2.5 ppm	5.0 ppm	0.05-15 Ppm	0.05-2.49 ppm 2.5-4.99 ppm 5-9.99 ppm 10-15 ppm	180 60 45 30	<35 sec
		8	Hydrogen Sulfide XP6 (H ₂ S)	1 ppm	0.2 ppm	0.1 ppm	0.5 ppm	1 ppm	0-10 ppm	0.2-0.4 ppm 0.5 - 0.9 ppm 1-1.9 ppm 2-10 ppm	45 30 15 10	20 sec

Family	CC Name (P/N)	Table	Gas Name	TLV	LAL	LDL	Default Alarm Level 1	Default Alarm Level 2	Range	Alarm Setting	Initial Analysis Period (second)	Time to 1TLV alarm @ 2TLV concentration, 10ft sample line
		9	Hydrogen Sulfide XP6 (H ₂ S) Low Level	1 ppm	20 ppb	15 ppb	250 ppb	500 ppb	0-2000 ppb	20-99 ppb 100-199 ppb 200-399 ppb 400-2000 ppb	120 60 30 15	<20 sec (Alarm @ 500 ppb with 1000 ppb H ₂ S gas)
		10	Hydrogen Selenide XP6 (H ₂ Se)	50 ppb	8 ppb	6 ppb	25 ppb	50 ppb	0-500 ppb	8-49 ppb 50-99 ppb 100-500 ppb	180 120 60	<45 sec
2	XP4-VC4 Mineral Acids (1904-9310)	1	Boron Trifluoride XP4 (BF ₃)	0.1 ppm	0.05 ppm	0.04 ppm	0.05 ppm	0.1 ppm	0-10 ppm	0.05-0.99 ppm 1.0-10.0 ppm	45 30	<100 sec (Alarm @0.1ppm with 0.2ppm BF ₃ gas)
		2	Hydrogen Bromide XP4 (HBr)	2 ppm	0.3 ppm	0.2 ppm	1 ppm	2 ppm	0-20 ppm	0.3-1.9 ppm 2-20 ppm	45 30	<50 sec
		3	Hydrogen Bromide XP4 (HBr) Low Level	2 ppm	30 ppb	20 ppb	100 ppb	200 ppb	0-2000 ppb	30-99 ppb 100-399 ppb 400-2000 ppb	180 120 60	<200 sec (Alarm @ 200 ppb with 400 ppb HBr gas)
		4	Hydrogen Chloride XP4 (HCl)	2 ppm	0.2 ppm	0.2 ppm	1 ppm	2 ppm	0-20 ppm	0.2-0.9 ppm 1-3.9 ppm 4-20 ppm	60 30 20	<40 sec
		5	Hydrogen Chloride XP4 (HCl) Low Level	2 ppm	30 ppb	20 ppb	100 ppb	200 ppb	0-2000 ppb	30-199 ppb 200-399 ppb 400-2000 ppb	240 150 90	<135 sec (Alarm @ 200 ppb with 400 ppb HCl gas)
		6	Hydrogen Fluoride XP4 (HF)	0.5 ppm	0.4 ppm	0.4 ppm	1 ppm	2 ppm	0-20 ppm	0.4-0.9 ppm 1-3.9 ppm 4-20 ppm	240 90 60	<50 (Alarm @ 2ppm with 4ppmHF gas)
3	XP6-VC4 Ammonia (1904-9309)	1	Ammonia XP6 (NH ₃)	25 ppm	1.5 ppm	1.5 ppm	12.5 ppm	25 ppm	0-150 ppm	1.5 - 49.9 ppm 50 - 150 ppm	10 5	<25 sec
		2	Dimethylamine XP6 (DMA)	5.0 ppm	0.5 ppm	0.5 ppm	2.5 ppm	5.0 ppm	0-50.0 ppm	0.5-2.4 ppm 2.5-50.0 ppm	15 10	<30 sec

Family	CC Name (P/N)	Table	Gas Name	TLV	LAL	LDL	Default Alarm Level 1	Default Alarm Level 2	Range	Alarm Setting	Initial Analysis Period (second)	Time to 1TLV alarm @ 2TLV concentration, 10ft sample line
		3	Tetrakis Dimethylamino Titanium XP6 (TDMAT)	None Estimated	0.1 ppm	0.1 ppm	0.5 ppm	1.0 ppm	0-10 ppm	0.1-0.4 ppm 0.5-10.0 ppm	15 10	<30 sec (Alarm @1ppm with 2ppm TDMAT gas)
4	XP4-VC4 Phosgene (1904-9307)	1	Phosgene XP4 (COCl ₂)	100 ppb	10 ppb	7 ppb	50 ppb	100 ppb	0-1000 ppb	10-49 ppb 50-99 ppb 100-199 ppb 200-4000 ppb	60 45 30 15	<30 sec
		2	Phosgene XP4 (COCl ₂) High Range	100 ppb	10 ppb	7 ppb	50 ppb	100 ppb	0-4000 ppb	10-49 ppb 50-99 ppb 100-199 ppb 200-4000 ppb	60 45 30 15	<30 sec
5	XPV Chlorine-II (1904-0560)	1	Fluorine XP-Cl ₂ -II (F ₂)	0.1 ppm	0.06 ppm	0.06 ppm	0.5 ppm	1 ppm	0-10 ppm	0.06-1.99 ppm 2.0-3.90 ppm 4.0-10.0 ppm	90 60 30	<75 sec (Alarm @ 0.1ppm with 0.2 ppm F ₂ gas)
		2	Fluorine XP-Cl ₂ -II (F ₂) (Low Level)	0.1 ppm	0.05 ppm	0.03 ppm	0.05 ppm	0.1 ppm	0-1.0 ppm	0.05-0.199 ppm 0.2-1.0 ppm	120 60	<85 sec (Alarm @ 0.1ppm with 0.2ppm F ₂ gas)
		3	Chlorine XP-Cl ₂ -II (Cl ₂)	0.1 ppm	0.06 ppm	0.05 ppm	0.1 ppm	0.2 ppm	0-5 ppm	0.06-0.24 ppm 0.25-5.0 ppm	45 30	<40 sec (Alarm @ 0.1ppm with 0.2ppmCl ₂ gas) <20sec (Alarm @ 0.5ppm with 1.0ppmCl ₂ gas)
		4	Chlorine XP-Cl ₂ -II (Cl ₂) (Low Level)	0.1 ppm	0.03 ppm	0.007 ppm	0.05 ppm	0.1 ppm	0-1.0 ppm	0.03 - 0.099 ppm 0.1 - 0.199 ppm 0.2 -1.0 ppm	120 90 60	<110 sec (Alarm @ 0.1ppm with 0.2ppmCl ₂ gas)
6	Fluorine/Oxidizer (1904-0220)	1	Chlorine (Cl ₂)	0.1 ppm	0.05 ppm	0.04 ppm	0.05 ppm	0.1 ppm	0-5 ppm	0.05-0.24 ppm 0.25-0.49 ppm 0.5-5 ppm	45 30 15	<40 sec (Alarm @ 0.5ppm with 1ppm Cl ₂ gas)
		2	Fluorine (F ₂)	0.1 ppm	0.1 ppm	0.06 ppm	0.5 ppm	1 ppm	0-10 ppm	0.1-0.9 ppm 1.0-10 ppm	60 30	<80 sec (Alarm @ 0.1ppm with 0.2 ppmF ₂ gas)
		3	Nitrogen Dioxide (NO ₂)	0.2 ppm	0.1	0.1	0.1 ppm	0.2 ppm	0-30	0.1-8.9	240	<350 sec

Family	CC Name (P/N)	Table	Gas Name	TLV	LAL	LDL	Default Alarm Level 1	Default Alarm Level 2	Range	Alarm Setting	Initial Analysis Period (second)	Time to 1TLV alarm @ 2TLV concentration, 10ft sample line
					ppm	ppm			ppm	ppm 9-30 ppm	120	
		4	Chlorine Dioxide (ClO ₂)	100 ppb	50 ppb	50 ppb	100 ppb	200 ppb	0-1000 ppb	50-99 ppb 100-199 ppb 200-399 ppb 400-1000 ppb	300 240 120 60	<70 sec
7	Sulfur Dioxide (1904-0552)	1	Sulfur Dioxide (SO ₂)	250 ppb	30 ppb	25 ppb	125 ppb	250 ppb	0-2500 ppb	30-249 ppb 250-2500 ppb	60 30	<60 sec
8	Hydrogen Cyanide (1904-0222)	1	Hydrogen Cyanide (HCN)	4.7 ppm	1 ppm	0.5 ppm	2.3 ppm	4.7 ppm	0-30 ppm	1-9.9 ppm 10-19.9 ppm 20-30 ppm	30 20 15	<15 sec
9	XP4 Chlorine (1904- 9308)	1	Chlorine (Cl ₂)	0.1ppm	0.05 ppm	0.05 ppm	0.05 ppm	0.1 ppm	0-5 ppm	0.05-0.24 ppm 0.25-5.0 ppm	45 30	<53 sec
		2	Chlorine (Cl ₂) (Low Level)	100 ppb	30 ppb	7 ppb	50 ppb	100 ppb	0 - 2000 ppb	30 - 199 ppb 200 - 499 ppb 500 -2000 ppb	120 90 60	<65 sec
TLV - Threshold Limit Value – LAL - Lowest Alarm Level – LDL - Low Detection Limit												

6.3 Maintenance Faults

A maintenance fault indicates the VC4™ system requires attention but is continuing to monitor.

Event ID	Description	Possible Cause	Resolution
101	Flow is 70 cc/min less than nominal	Excessive point vacuum due to clog or kinked sample line	Check sample line and line filter
			Clean the sample line and replace filter
			Correct sample line issue
		Sample line too long or ID too small	Ensure sample line requirements are with specifications
		Poor gate seal	Check nut on the optic block
			Contact Honeywell Service
		Supply vacuum insufficient (less than 7"Hg)	Contact Honeywell Service
		Condensation	Check internal lines for moisture
		Chemcassette™ thickness variation	Advance the Chemcassette™
Adjust the needle valve to achieve 200cc/min			
Contact Honeywell Service			
102	Remaining Chemcassette™ is low	Less than preset reminder on the Chemcassette™	Replace the Chemcassette™
103	Analyzer out of monitor too long	Analyzer out of monitor	Reset all alarms and faults, and then return analyzer to Monitor Mode
		Out of Monitor time limit too short	Change time limit in Configuration Profile
104	Run time point disable time out	Alarms were manually bypassed	Restore point to alarm active mode
		Run Time Point Disable time limit too short	Change time limit in Configuration Profile
105	Sample pressures greater than ambient	Point pressure above atmospheric pressure while in idle	Review sample line location
		Pressure sensor Calibration error, Defective sensor	Confirm atmospheric conditions
106	Flow is 70 cc/min more than nominal	Chemcassette™ thickness variation	Contact Honeywell Service
			Adjust the needle valve to achieve 200cc/min
		Defective needle valve	Replace needle valve
107	Chemcassette™ expired	Chemcassette™ expiration date reached	Replace Chemcassette™
		Chemcassette™ installed past its expiration date	Replace Chemcassette™
108	No polls from HMI for 10 seconds	Communications to HMI PC interrupted longer than 10 seconds	Check Ethernet cable at rear of analyzer
			Check Ethernet hub connection and operation
			Check Ethernet connection to HMI PC
			Contact Honeywell Service
109	*Reserved		

Event ID	Description	Possible Cause	Resolution
110	Optics Block Dirty - Cleaning Required	Optic block dirty	Clean optics
			Contact Honeywell Service
		Optic block is aged	Replace optics block
		Tape leader installed improperly	Reload Chemcassette™ and recalibrate using leader
111	Sample Pressure High	End of line filter clogged	Replace end of line filter
		Sample line kinked	Isolate by disconnecting possible crimped sample line
		Too small ID and/or Maximum line length exceeded	Check sample tube ID and length
		Crimped tube in cable carrier	Identify crimps in tubing harness by checking pressure with analyzer closed vs. open
112	*Reserved		
113	Pump Over Temperature	Fan failure	Check fans in pump module
		Line voltage less than 99VAC or higher than 121VAC when high voltage(110VAC) is applied Line voltage less than 198VAC or higher than 242VAC when low voltage(220VAC) is applied	Verify main line voltage
		220VAC module is powered by 110VAC power supply. 110VAC module is powered by 220VAC power supply.	Check the VC4™ module part number and verify main line voltage
114	High Exhaust Pressure	Kinked exhaust	Check exhaust tubing for kinks or restrictions
		Exhaust tubing length exceeds 50ft. (15m.)	Reroute to reduce length
		Exhaust line restricted	Clean Exhaust line
			Replace Exhaust line
115	Power Supply failure	Power line disconnected	Check power line from power module to Analyzer
116	Optics Temperature Out of Range	Hot or Cold environment	Relocate VC4™
		Electronic problem	Replace optics block
		Cooling air failure	Replace fans
117	*Reserved		
118	Filter Timer Expired	Maintenance reminder, no malfunction	Change filter and reset timer
119	Optics Cleaning Timer Expired	Maintenance reminder, no malfunction	Clean the Optics and reset timer
120	Pump Maintenance Timer Expired	Maintenance reminder, no malfunction	Rebuild pump and reset timer
121	*Reserved for LIT option		
122	*Reserved for LIT option		
123	*Reserved for LIT option		
124	*Reserved for LIT option		
125	Possible debris in optics block	Debris in optics block	Clean optics block
126	Abnormal Optics reading detected	Compensated optic reading automatically. So no further action required. But too frequently happens, debris in the optic block.	Clean optics block
127	Accelerated Chemcassette™ Usage	Low level background gas below lower detectable limit	Locate source of background gas

Event ID	Description	Possible Cause	Resolution
128	Ethernet initialization failed	Failed load the driver, Electronic problem	Reboot the VC4™
			Contact Honeywell Service
129	File system of Analyzer is corrupted	File system corrupted	Contact Honeywell Service
130	*Reserved		
131	Unable To Log event data	File system corrupted	Contact Honeywell Service
132	Software version mismatched among Analyzers	New analyzer was installed into the VC4™ rack that contains a different software revision than the other analyzers	Upgrade analyzer Software
133	This Chemcassette™ is nearing its expiration date	Chemcassette™ not used too long	Replace Chemcassette™
134	Chemcassette™ Type Not Matched	Chemcassette™ with wrong gas family installed	Reinstall Configuration Profile
135	Analyzer configuration failed	Analyzer configuration failed	Reinstall Configuration Profile
136	Point configuration failed	Point configuration failed	Check alarm settings and reinstall Configuration Profile
137	Could not start monitoring	Instrument faults not cleared	Resolve the reported instrument faults and reset all faults
		Invalid RFID tag detected	Reinstall Configuration Profile or Replace Chemcassette™
		All points disabled	Reinstall Configuration Profile or enable runtime disabled points
		Invalid Analyzer/Point Configuration	Reinstall Configuration Profile
		LIT in progress	Wait until LIT test is complete and restart monitoring mode
		Tape Advance Failure	"Instrument Faults" on the next page for Fault 233
138	Analyzer RTC not set correctly	Low voltage of the coin battery	Replace the coin battery
		RTC failure on the analyzer board	Replace Analyzer
139	*Reserved		
140	*Reserved		
141	*Reserved		
142	*Reserved		
143	Pump current overload	Line voltage issue	Verify main line voltage
144	Temperature out of range	Fan failure Line voltage issue	Check fans in pump module Verify main line voltage

6.4 Instrument Faults

An instrument fault indicates a loss of monitoring on one or more points.

Event ID	Description	Possible Cause	Resolution
201	Chemcassette™ tape decolored	Improper Chemcassette™ storage	Confirm Chemcassette™ storage meeting temperature meets or exceeds the Chemcassette™ storage requirements
			Replace Chemcassette™
		Tape is too old	Confirm Expiration date will reach the tape length time line
			Replace Chemcassette™
202	End of Chemcassette™	End of Chemcassette™	Replace Chemcassette™
		Chemcassette™ broken	Rethread Chemcassette™
		Faulty tape encoder	Service analyzer
		Advance motor failure	Service analyzer
		Gate opening insufficient	Service analyzer
203	Failed writing hardware configuration	Non-volatile memory failure in analyzer CPU	Retry and reboot the Analyzer. Service or replace analyzer
204	Failed reading hardware configuration	Non-volatile memory failure in analyzer CPU	Retry and reboot the Analyzer. Service or replace analyzer
205	Gate motor times out	Gate position sensor not activated before timeout	Check motor operation using Maintenance, Analyzer Operations, Open Gate, or Close Gate
		Motor does not operate	Check motor connections to sensor interface PCB in analyzer
		Bad sensor or cable	Check sensor connection on PCB
			Contact Honeywell service
206	Gate motor driving failure	Gate position sensor not activated before timeout	Check motor operation using Maintenance, Analyzer Operations, Open Gate, or Close Gate
		Motor does not operate	Check motor connections to sensor interface PCB in analyzer
		Bad sensor or cable	Check sensor connection on PCB Contact Honeywell service
207	Optics signals are noisy	Poor grounding	Replace Analyzer, Contact Honeywell service
		Optics block cover loose	Retighten or reinstall as required
208	Optics counts very low <200	Optics LED not properly calibrated	Perform Load CC Operation to recalibrate
		Cable disconnected	Check cable
			Contact Honeywell service
		Optics board defective	Replace Analyzer, Contact Honeywell service
Analyzer CPU defective	Replace Analyzer, Contact Honeywell service		
209	Gas table file is bad or missing	No configuration loaded	Reinstall Configuration Profile
210	Optics drive unusually low	Optics LED not properly calibrated	Perform Load CC Operation to recalibrate
		Optics board defective	Replace Analyzer, Contact Honeywell service
		Analyzer CPU defective	Replace Analyzer, Contact Honeywell service

Event ID	Description	Possible Cause	Resolution
211	Optics drive unusually high	Optics LED not properly calibrated	Perform Load CC Operation to recalibrate
		LED degraded	Replace the optics block
		Optics board defective	Replace Analyzer, Contact Honeywell service
		Analyzer CPU defective	Replace Analyzer, Contact Honeywell service
212	Excess optics signal	Optics LED not properly calibrated	Perform Load CC Operation to recalibrate
		Optics board defective	Replace Analyzer, Contact Honeywell service
		Analyzer CPU defective	Replace Analyzer, Contact Honeywell service
213	*Reserved		
214	Loss of Flow	Improper flow setup	Adjust flow to 200cc
		Tape tracking problem	Reload Chemcassette™
		Condensation in system	Purge internal lines
		Clogged micro tube	Replace tube. Note: Calibration required, contact Service.
		Gate not fully closing	Gate adjustment loose, pivot binding
		Optics block loose	Tighten optics block fasteners
		Flow adjustment is unstable during adjusting	Replace needle valves
215	Failed to stop Analyzers monitoring mode	Queen Analyzer (first in the rack) failed to communicate with other Analyzers	Replace first Analyzer in the rack
		Analyzer hardware failure	Replace Analyzer, Contact Honeywell service
216	Point Pressure Out of range	Miscalibrated sensor board or defective transducer	Replace Analyzer
217	System Pressure Out of range	Miscalibrated sensor board or defective transducer	Replace Analyzer
218	Inadequate Analyzer Vacuum	Improper system pressure adjustment	Adjust system pressure to 10"Hg
219	Optics SW corrupted	Hardware failure	Replace Analyzer
220	Optics Internal SW errors	Cable issue	Confirm cable connections
		Hardware failure	Replace Analyzer, Contact Honeywell service
221	LED adjustment failed due to insufficient optical signal	Optic block dirty	Clean optics Contact Honeywell Analytics Service
		Optics LED not properly calibrated	Perform Load CC Operation to recalibrate
		LED degraded	Replace the optics block
		Optics board defective	Replace Analyzer, Contact Honeywell service
222	Q-Factor out of range	Chemcassette™ leader not tight or improperly positioned during white to light gray calibration	Reload Chemcassette™
		Bad RFID tag	Load new Chemcassette™
		Dirty optics block	Clean and recalibrate
		Bad optics PCB set	Service or replace analyzer

Event ID	Description	Possible Cause	Resolution
223	Failed reading dark gray leader	Chemcassette™ leader not tight or improperly positioned during white to light gray calibration	Reload Chemcassette™
		Bad RFID tag	Load new Chemcassette™
		Dirty optics block	Clean and recalibrate
		Bad optics PCB	Service or replace analyzer
224	Failed reading light gray leader	Chemcassette™ leader not tight or improperly positioned during light gray to dark gray calibration	Reload Chemcassette™
		Bad RFID tag	Load new Chemcassette™
		Dirty optics block	Clean and recalibrate
		Bad optics PCB	Service or replace analyzer
225	Optics blocks fail at SPI communication	Bad optics PCB	Replace Optics Block
			Service or replace analyzer
226	Optics reference photodiode out of range	Dirty Optics block	Clean optics Contact Honeywell Service.
		Hardware failure	Contact Honeywell Service
227	LED Drive not stable in Optics	Hardware failure	Contact Honeywell Service
228	Control module not responding to Analyzer	Hardware failure	Contact Honeywell Service
229	*Reserved		
230	No valid Chemcassette™ detected	Chemcassette™ changed without using Change Tape utility	Reload Chemcassette™
		Non-Honeywell tape installed	Unauthorized Tape installed
			Contact Honeywell Service
231	Chemcassette™ write failure	RFID Reader	Replace RIFD Board
			Replace Analyzer, Contact Honeywell service
232	Internal voltage error	Internal voltage hardware issue	Contact Honeywell Service
233	Tape advance failure	Encoder failure	Replace Encoder
		Cable issue	Check Encoder cabling
			Contact Honeywell Service
		Stepper Motor Failure	Replace Stepper Motor
		Cable issue	Check Stepper Motor cabling
Contact Honeywell Service			
234	Internal Comm failure	Hardware failure	Contact Honeywell Service
235	Abnormal Az current consumption is detected	Hardware failure	Contact Honeywell Service
236	Internal fault at control module	Hardware failure	Contact Honeywell Service
237	Internal fault at PDU module	Hardware failure	Contact Honeywell Service

Event ID	Description	Possible Cause	Resolution
238	Analyzer SW corrupted	Software installation failure	Re-install analyzer software
			Replace Analyzer, Contact Honeywell service
239	Internal SW fault at analyzer	Internal SW operation failed	Reboot the Analyzer. Contact Honeywell service
240	Pump failure	Line voltage issue Pump failure Circuit breaker tripped Leakage in system	Verify main line voltage Replace pump, Contact Honeywell service Contact Honeywell service Check tubing and fitting in system, Contact Honeywell service
241	IO panel not responding to Analyzer	Cable issue IO panel SW operation failed	Check IO panel cabling Reboot the IO panel module. Contact Honeywell service
242	Internal fault at IO panel module	IO panel SW operation failed	Reboot the IO panel module. Contact Honeywell service
243	FAN fail	Fan blade gets stuck Fan short circuit	Check fan blade, Contact Honeywell Analytics Service Replace fan, Contact Honeywell Analytics Service

6.5 Information Events

The VC4™ system enters informational and other non-fault events into the event history database. These do not require any action by the user.

Use the event history to check the status of the instrument.

Event ID	Description
2001	Analyzer Powered Up
2002	Detected sub LDL event
2003	First non-zero reading is detected for the window
2004	Windows Zero Reset
2005	Optics Auto Adjust Requested
2006	Optics Auto Adjust Success (LED Drive Adjusted)
2007	Accept new gas family
2008	Optics verification Started
2009	Optics verified Successfully
2010	Q-factors set
2011	Test Optics requested
2012	Started gas monitoring
2013	Stopped gas monitoring
2014	Inhibited point - run time
2015	Released the inhibited point
2016	Disabled a point - run time
2017	Enabled the disabled point - run time
2018	Inhibited point switches back to normal (times out)
2019	New hardware configuration stored
2020	Analyzer accepts new location
2021	Reset filter replacement counter
2022	Reset optics cleaning counter
2023	Reset pump maintenance counter
2024	Time changed. Az clock out by >30 seconds
2025	The analyzer rebooted by watchdog

Event ID	Description
2026	A new Chemcassette™ was installed
2027	Mon stopped for no enabled points
2028	Az Button Resets Alm&Flts
2029	Az Button - Starts Monitoring
2030	Az Button - Stops Monitoring
2031	Az Button Triggers to reset
2032	Reserved
2033	Extra window pull because of flow problems
2034	Analyzer Programmed Successfully
2035	Analyzer Program Failed
2036	Optics Programmed Successfully
2037	Optics Program Failed
2038	Ctrl Module Programmed Successfully
2039	Ctrl Module Program Failed
2040	Reserved
2041	Reserved
2042	Gas table updated
2043	Rejected gas table file
2044	Imported license file successfully
2045	Rejected license file
2046	Failed to verify update file
2047	Line integrity test characterized
2048	Line integrity test performed
2049	Reserved
2050	Alarm/Fault Reset Request
2051	Reset All Alarms and Faults
2052	Reset All Alarms and Faults – Modbus
2053	Az Configuration updated
2054	Point Configuration updated

Event ID	Description
2055	Reserved
2056	Reserved
2057	Reset Alarms and Faults - Remote Input
2058	Reset Alarms and Faults - Remote Serial
2059	IO Panel Programmed Successfully
2060	IO Panel Program Failed

6.6 Manual Analyzer Override

The VC4™ Analyzer is equipped with a Manual Override button in the event the communications to the VC4™ Data Acquisition (DAq) computer halts. This button activates only when the communications has completely ceased.

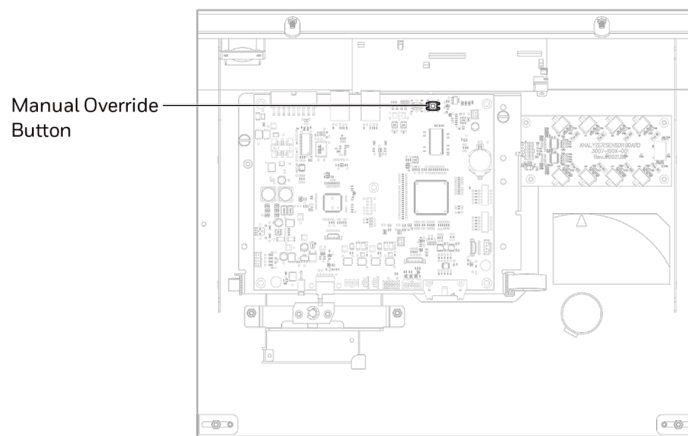

There are cases where the DAq appears to be “frozen” or “locked-up” (no response from the keyboard or any user invoked actions after a few moments) while in reality this is not the case. Events that could cause these symptoms include AC power surges or sags and improper shutdowns of the DAq that result in file corruption. As a result, future attempts to access these files can slow down the response of the DAq. To confirm a non-responsive DAq as opposed to frozen/locked- up, check the clock located in the upper right hand corner of the VC4™ HMI window. If the clock is still advancing, then the DAq CPU is not frozen/locked-up and your local Authorized Service Center needs to be contacted for assistance.

On occasions, there may be the need to install a new Chemcassette™ to continue monitoring your facility, or to reset alarms or faults. If the DAq is not responding, these tasks can be performed using the **Manual Override** button. An extra step may be required to “force” activation of the **Manual Override** button under the above mentioned conditions if the DAq computer is still communicating with the analyzer. The following instructions will instruct you on how to accomplish this task:

Note: Performing this task will generate Maintenance Fault F108 – No polls from HMI.

1. Open VC4™ cover and chassis top to service position.
2. Locate the Ethernet cable on the Analyzer and disconnect it.
3. Approximately 20 seconds after the Ethernet Cable has been disconnected, the Analyzer will recognize that it has lost communications with the DAq and activate the **Manual Override** button. The LED's on the front of the Analyzer will flash to show a Maintenance Fault per the LED status flash pattern.

To reset faults and alarms press and hold button for 1-3 seconds.

To Exit Monitor and Open Gate press and hold button for 10 seconds and above.

To restart monitoring mode, press and hold button for 4 to 9 seconds.

4. Reconnect the Ethernet Communications Cable and close VC4™ cover.

6.7 Fix an Unresponsive VC4™ Touch Screen

Completely resetting the computer can resolve many issues that cause a frozen/unresponsive screen. Follow these steps to perform a hard reset:

1. Remove any USB devices from the USB ports of the HMI PC if non-default USB devices were inserted. The USB connection from touch screen should remain.
2. Turn off the computer by pressing and holding the power button for a few seconds.

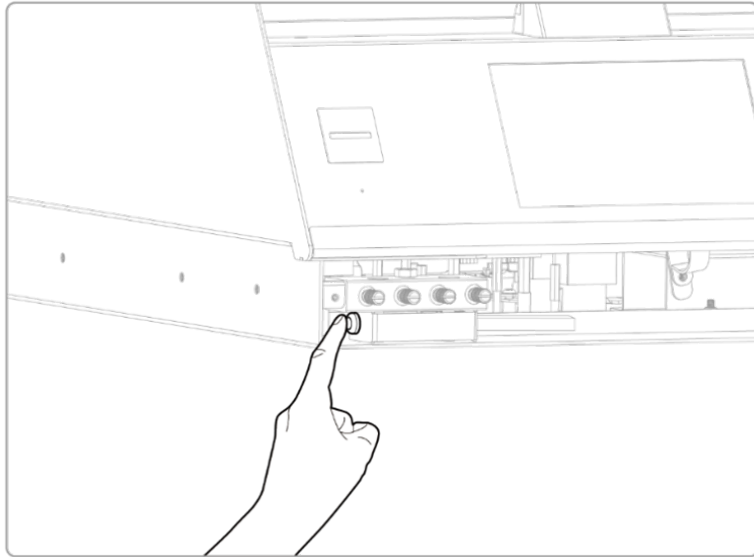

3. Turn on the PC by pressing the Power button.
4. Wait until HMI application starts up.
5. Check if touch screen is responsive and all connected analyzers are shown on Overview screen.

Note: When this occurs, the system will continue to monitor gas.

6.8 Filter Compatibility

When monitoring non-corrosive target gases, use filter type A, (P/N 780248), a sample line dust/ particulate filter.

For monitoring corrosive gases, such as chlorine (Cl₂), hydrogen fluoride (HF), hydrogen chloride (HCl), and hydrogen bromide (HBr), sample lines in a dusty environment or for outdoors, use filter type B, (P/N 1830-0055), or type C, (P/N 1991-0147) filter assembly for corrosive gases. The Teflon membrane particulate filter is designed to prevent dust and dirt greater than one micron from entering the sample line. Unlike standard particulate filters, it does not exhibit sample loss with corrosive monitoring.

The one micron Teflon membrane contained in the Filter B housing (P/N 0235-1096, 100 per pack) should be replaced every 30 days.

Filters have an arrow on the side of the filter pointing in the direction of airflow toward the VC4™ system. Replacement of filters is site dependent.

Filter A - P/N 780248 Filter B - P/N 1830-0055 Filter C - P/N 1991-0147

The following table shows sample filter requirements.

Symbol	Gas Name	Filter Type A	Filter Type B	Filter Type C
NH ₃	Ammonia		X	X
AsH ₃	Arsine	X		
AsH ₃	Arsine - Low Level	X		
BF ₃	Boron Trifluoride		X	X
CL ₂	Chlorine		X	X
B ₂ H ₆	Diborane	X		
DMA	Dimethylamine		X	X
F ₂	Fluorine		X	X
GeH ₄	Germane	X		
H ₂ S	Hydrogen Sulfide	X		
H ₂ S-LL	Hydrogen Sulfide - Low Level		X	X
HBr	Hydrogen Bromide		X	X
HBr-LL	Hydrogen Bromide - Low Level		X	X
HCl	Hydrogen Chloride		X	X
HCl	Hydrogen Chloride - Low Level		X	X
HCN	Hydrogen Cyanide	X		

Symbol	Gas Name	Filter Type A	Filter Type B	Filter Type C
HF	Hydrogen Fluoride		X	X
HF-LL	Hydrogen Fluoride - Low Level		X	X
H ₂ Se	Hydrogen Selenide	X		
NO ₂	Nitrogen Dioxide	X		
COCl ₂	Phosgene	X		
COCl ₂ / HL	Phosgene - High Range	X		
PH ₃	Phosphine	X		
SiH ₄	Silane	X		
SO ₂	Sulfur Dioxide		X	X
TDMAT	Tetrakis Dimethylamino Titanium		X	X

6.9 Replacement Parts & Consumables

Chemcassette™	P/N
XP6-VC4 AMINES /AMMONIA CHEMCASSETTE	1904-9309
XP6-VC4 HYDRIDES CHEMCASSETTE	1904-9300
XP4-VC4 MINERAL ACIDS CHEMCASSETTE	1904-9310
VC4 FLUORINE CHEMCASSETTE	1904-0220
XP4-VC4 PHOSGENE CHEMCASSETTE	1904-9307
VC4 Sulfur Dioxide CHEMCASSETTE	1904-0552
VC4 HYDROGEN CYANIDE CHEMCASSETTE	1904-0222
XP-VC4 CHLORINE-II CHEMCASSETTE	1904-0560
XP4-VC4 CHLORINE CHEMCASSETTE	1904-9308
XP6-VC4 AMINES /AMMONIA CHEMCASSETTE	1904-9309

End of Line Particulate Sample Filters	P/N
For non-corrosive gases	780248
For corrosive gases	1830-0055
Replacement membrane, for corrosives (pk/100)	0235-1072
For corrosive gases	1991-0147

Spare Part Number	P/N
1/4 FEP TUBING KIT (400 ft roll)	F15-1554-001
1/4 FEP TUBING KIT (1000 ft roll)	F15-1558-001
Equal Straight Connector KIT,1/4	F15-1282-001
Pump Diaphragm kit, 110AVC	F15-1268-001
Pump Diaphragm kit,220VAC	F15-1269-001
Pump Repair Kit, 60/50 Hz	F15-1270-001
Pump inlet tube kit	F15-1283-001
1/4 elbow fitting 1/8 NPT, KIT	F15-1284-001
1/4 TEE fitting 1/8 NPT, KIT	F15-1293-001

Spare Part Number	P/N
NEEDLE VALVE MODULE KIT,4P	F15-1272-001
NEEDLE VALVE KIT	3007-2408-001
OPTICS BLOCK MODULE KIT,4P	F15-1276-001
1/8B FITTING KIT	3007-2411-001
SOLENOID VALVE KIT, VC4	F15-1279-001
Orifice cartridge 0.026 kit	F15-1277-001
MANIFOLD MODULE KIT,4P	F15-1278-001
FILTER MANIFOLD MODULE KIT	F15-1280-001
THREADED RESISTOR KIT	F15-8638-001
ELBOW FITTING 1/4 TO 1/4 PLUG KIT	F15-0105-001
SV KIT, MICRO TUBE ASSY	F14-7039-001
SV KIT, ENCODER_ASSY, VC4	3011-8716-001
SV KIT, PCBA IO, VC4	3010-1545-001
KIT, CABLE ASSY, IO Extension, VC4	3011-2720-001
SV KIT, POWER MODULE,220V, VC4	3010-1551-001
SV KIT, POWER MODULE,110V, VC4	3010-1549-001
SV KIT, SLIDES, VC4	3010-1555-001
SV KIT, DUST FILTER, PK OF 2, VC4	3010-1557-001
SV KIT, WINDOW ASSY, VC4	3010-1559-001
SV KIT, STEPPING MOTOR ASSY	F14-7040-001
SV KIT, GATE MOTOR ASSY, VC4	3010-1560-001
SV KIT, BRAKE BLOCK ASSY	F14-7013-001
SV KIT, SPROCKET/W SCREW	F14-7002-001
SV KIT, TAPE_GUIDE/W SCREW	F14-7001-001
SV KIT, TAPE GUIDE SHAFT	F14-7032-001
SV KIT,4P TUBES SET, VC4	3010-1561-001
SV KIT, TUBE, OPB TO PRE, VC4	3010-1562-001
SV KIT, LED INDICATOR, VC4	3010-1563-001
PCBA, RFID, W/LABEL, VC4	3010-1564-001

Spare Part Number	P/N
SV KIT, HARNESS INTERCONNECTION, VC4	3010-1565-001
SV KIT, PCBA RS232, VC4	3010-1566-001
SV KIT, PCBA RS422, VC4	3010-1567-001
SV KIT, PCBA RS485, VC4	3010-2157-001
SV KIT, EMI Power Filter,110VAC, VC4	3009-0870-101
SV KIT, EMI Power Filter,220VAC, VC4	3009-0870-102
SV KIT, LCD Module,7 inch, HDMI, VC4	3009-0872-101
KIT, SBC, J1900, LAN, USB, HDMI, VC4	3009-0871-101
SV KIT, Fan,24VDC,0.18A, VC4	3009-0878-101
SV KIT, ANALYZER MAIN BOARD, VC4	F14-1116-101
SV KIT, ANALYZER SENSOR BOARD, VC4	F14-1115-101
SV KIT, SBC Reset Button, VC4	3010-1970-101
SV KIT, Fuse,3.5A,250VAC,5 X 20 MM, VC4	3012-4090-101
SV KIT, Fuse,2.5A,250VAC,5 X 20 MM, VC4	3012-4095-101

6.10 Network Interfaces and Options

6.10.1 Modbus RTU

- Enable or Disable
- Baud rate (User Selectable)
 - 9600 (Default)
 - 19200
- Data bits
 - 7 bits
 - 8 bits
- Parity (User Selectable)
 - None
 - Even (Default)
 - Odd
- Stop Bits
 - 2 (when Parity is set to None)
 - 1 (when Parity is set to Odd or Even)
- Slave ID option
 - Used for each Analyzer (Default 1-8 as shown)

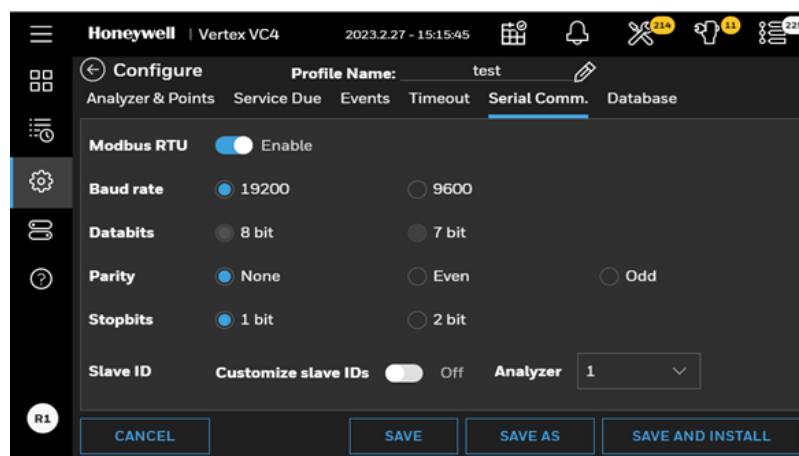

6.10.2 Modbus TCP

- IP Configuration
 - DHCP (Default)
 - Static IP: Static IP address, Gateway, DNS
- Modbus TCP/IP Enable or Disable
- Web interface on port 80
 - Enable
 - Disable (Default)
- Encrypted web interface on port 443
 - Enable
 - Disable (Default)

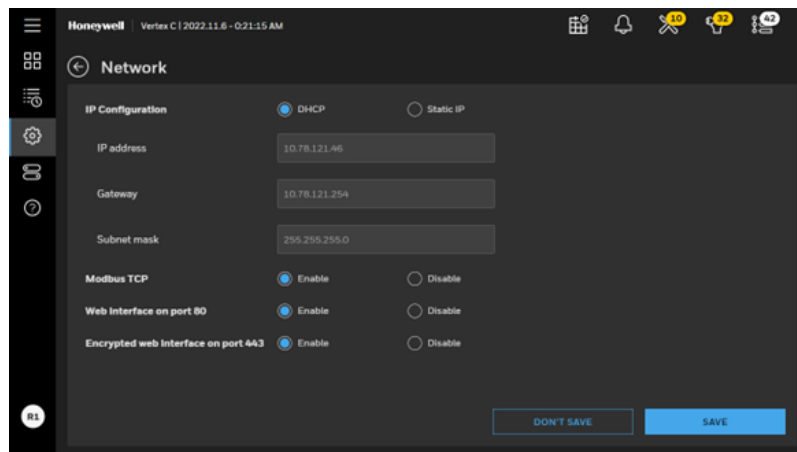

6.11 HMI PC Security Considerations

In general, we provide out-of-box application and install application to single computer so it's not necessary and not allowed to modify application yourself. Please contact Honeywell service team before any firmware/software updates.

In order to protect your data please lock HMI Rack to forbidden touching USB port without permission , keep the key properly.

6.11.1 Connectivity

The VC4™ HMI PC has two one-gigabit ethernet ports, one for connecting to the internal analyzer network, and one for connecting to an external network. The VC4™ HMI PC has no wireless connectivity.

6.11.2 Internal Network

The internal analyzer network is 192.168.254.0/24, and the HMI PC has the address 192.168.254.1 on this network. Only connect analyzers and the HMI PC to this internal network. Do not connect any other device.

6.11.3 External Network

The connection to the external network is not required but enables additional features, including remote web access and the Modbus TCP server. These services are enabled by default but can be disabled via the General > Network configuration page. The default configuration of the VC4™ HMI PC external network connection is via DHCP. However, if desired, a static configuration is possible via the General > Network configuration page. Care should be taken both in DHCP server configuration as well as in the static configuration that the network assigned to the external connection, and that does not overlap with the internal analyzer network.

6.11.4 VC4™ HMI External Network Services

Service	Port	Transport Protocol	Default Setting
HTTP	80	TCP	OFF
HTTPS	443	TCP	OFF
Modbus TCP	502	TCP	OFF

Note: Chrome browser of 93.0.xx or later version is strongly recommended to access to the HMI remotely.

Note: When the web interface is enabled/used, the encrypted interface on port 443 is strongly recommended since HTTP web service is not secure.

6.11.5 HTTPS Connections

When making a connection to the VC4™ HMI PC via HTTPS, it will be necessary to accept the certificate. A message like the one using Google Chrome will be shown:

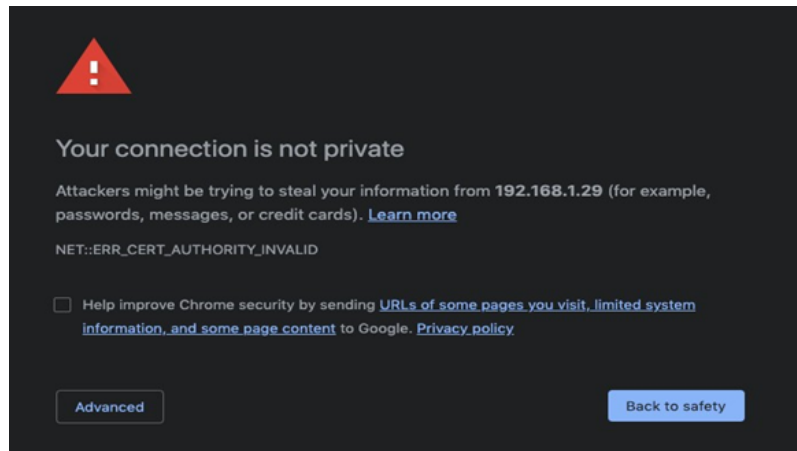

Tap on the Advanced button, and select “Proceed to <some IP> (unsafe).”

6.11.6 External Network Security Considerations

The VC4™ HMI PC is intended ONLY for connection to a private network – no connections from the internet should be allowed. All services not explicitly named above are disabled and filtered via the iptables rules. Access control is via users and roles defined in the security configuration. By default, anyone can view system state information, but elevated permissions are required for any configuration, control, or maintenance.

Note: Router with IPSec or Peer-to-Peer (P2P) Network is recommended to enhance security on Modbus TCP/IP communication.

6.12 Serial Communications and Options

The rear panels of the VC4™ monitor allows installation of serial interface port. These ports are designed to allow output to other devices, and two-way communication between the VC4™ system and another device.

There are three serial interfaces available for the VC4™ system, each designed for a specific communication application. The options are:

- RS-232 for remote bidirectional binary communication
- RS-422 for remote bidirectional binary communication
- RS-485 for remote multi-drop bidirectional binary communication via two-wire transmission

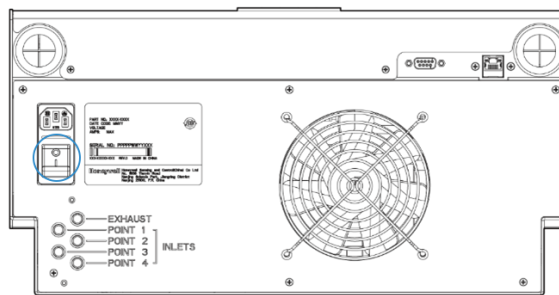

This port is a DB-9 female connector. This port is designed for bidirectional communications between the VC4™ system and your equipment. Signals present at the port conform to RS-232, RS-422, or RS-485 specifications. This is based on which interface option was installed in your VC4™ system. The pin-out specifications for each option are as follows.

RS-232	
Pin Number	Signal
2	Transmit
3	Receive
5	Ground

RS-422	
Pin Number	Signal
2	Receive +
3	Receive -
4	Transmit -
5	Transmit +

RS-485	
Pin Number	Signal
2	B (Transmit/Receive +)
3	A (Transmit/Receive -)
7	Signal Ground

6.12.1 Set Serial Communication

After the networking cabling has been connected to the slave, the slave must be configured to communicate. Configuration is performed with the following sequence:

1. In the left navigation panel, tap **OVERVIEW**.
2. Tap on the **I/O Settings** button
3. Tap on the **Serial Communication** button, protocol version, Baud rate and Address are selectable.

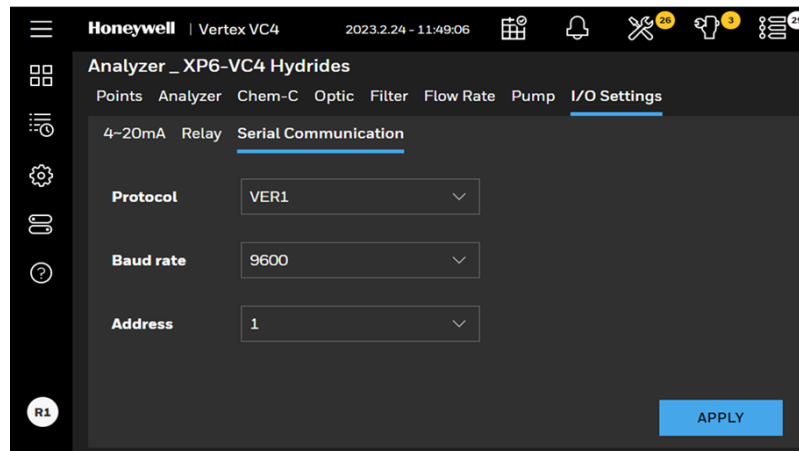

4. Tap on the **APPLY** button to validate the setting.

6.12.2 Serial Communications Protocol

Note: VC4™ compatible with CM4 communication protocol outputs.

Overview

The VC4™ serial communications protocol was designed and developed by Honeywell, and is proprietary information. This section of the manual will describe the setup and operation of the communication protocol.

Your VC4™ four-point continuous monitor is equipped with an optional serial remote device communication port. With this communication port, you can monitor the VC4™ system's operation with equipment from a remote location. It will also allow you to gather gas concentration data for analysis or reports.

The VC4™ monitor accepts commands and issues responses to any valid command it receives. The VC4™ monitor is always considered the **slave** device, and the remote equipment is the **master** device. The remote equipment can be a personal computer (PC), a programmable logic controller (PLC), or other device capable of RS-232, RS-422, or RS-485 serial communications. This configuration requires a **master** device. Therefore, one VC4™ monitor will not communicate directly with another VC4™\ monitor. However, one master can be used to communicate with more than one VC4™ monitor on a two-wire RS-485 bus.

The VC4™ monitor supports multiple baud rates. These user selectable rates are 1200, 2400, 4800, 9600, and 19,200. Additional port settings are 8-bit, 1 stop bit, and no parity.

The slave is identified by an address programmed into the VC4™ monitor (selectable 1-255). If more than one VC4™ monitor is used, each must have a unique address.

The equipment (master) is always at address 0. Each VC4™ monitor will respond to a signal directed to it from the equipment. To prevent a collision of messages, the master must avoid transmitting any information after a packet until the slave responds. Typically this occurs within 1000 milliseconds.

Communication Port

Access to the VC4™ protocol is through the COM port. This port is a DB-9 female connector. This port is designed for bidirectional communications between the VC4™ instrument and your equipment.

Signals present at the port conform to RS-232, RS-422, or RS-485 specifications. Again, this is based on which interface option was installed in your VC4™ instrument. The pin-out specifications for each option are as follows:

RS-232 (Part Number 874270)	
Pin Number	Signal
2	Transit
3	Receive
5	Ground

RS-422 (Part Number 874326)	
Pin Number	Signal
2	Receive +
3	Receive -
4	Transmit -
5	Transmit +

RS-485 (Part Number 874556)	
Pin Number	Signal
2	B (Transmit/Receive +)
3	A (Transmit/Receive -)
7	Signal Ground

The collection of the three bytes in our message (0x42, 0x41, 0x44) may be referred to as a packet, since these bytes are always associated with each other.

Just as all words are not the same length (number of letters), packets may also vary in length. One way to denote the size of the word is to put the number of letters you have in the word as the first number in your packet. Your data packet containing the word (or command) **BAD** will then become 0x03, 0x42, 0x41, 0x44.

Checksum (Check Character)

During transmission of the packet, an error could change the value of the data. Suppose in our example, for instance, the packet 0x03, 0x42, 0x41, 0x44 is actually 0x03, 0x42, 0x30, 0x44. How can you determine that the numbers you get are the same as the numbers sent? Using a check-character is a method of assigning a value to the packet to check if any bytes have been modified.

If all the data bytes are added together and this sum made into a byte, that byte could be called a check character, or more commonly referred to as a checksum. For the VC4™ instrument, the checksum is the negated sum of all the bytes in the packet. In our example, the packet is 0x03, 0x42, 0x41, 0x44, 0x36. For this packet, the sum modulo 0x100 of all the bytes added to the checksum must equal zero (0). Any other result indicates there is an error with the data.

The slave's data contained within the packet is interpreted in a somewhat different manner than our example. The data is composed of two sections, a command and one or more parameters. The command indicates what type of information is being transmitted in the packet. The parameters contain specific arguments or data values to be interpreted. Parameters for most VC4™ instrument's packet require at least four bytes for the Date and Time stamps. This information is important to provide a date and time reference for each communication from the instrument. You should ensure that the date and time have been set accurately in each VC4™ monitor.

Every packet sent by the VC4™ instrument also contains an address, a length, a command and its associated parameters, and a checksum. The VC4™ instrument assumes that the master's address is 0 (zero). You assign a unique address to each slave which communicates with the master.

ACK/NAK Handshake

Each slave (VC4™) uses a handshake scheme between itself and the master. The simplest response back from the instrument is called an ACK (an abbreviation for ACKnowledge). When the slave receives a command packet from the equipment, it will send back an ACK response if the command is received, but no additional data has been requested in the command.

If however, the checksum does not match, the slave will send a NAK (an abbreviation for Negative ACKnowledge). A NAK indicates that a data packet has been received, but the checksum did not match with the packet data. The master may send the request again. An example of an ACK packet is 0x40, 0x00, 0x05, 0x20, 0x9B (40 + 0 + 5 + 20 + 9B = 0x100).

Protocol Packet Definition

Packet Format

Two similar protocols are supported by VC4™ software. The original protocol with a minimum packet length of five bytes is included for compatibility with previous software. Additionally, a new protocol with a minimum packet length of six bytes is included for greater robustness. Examples of packets using both protocols are included at the end of this chapter.

The format of packets using original version 1 protocol is as follows:

start code	receiver address	length	command	data	checksum
------------	------------------	--------	---------	------	----------

The format of packets using the new version 2 protocol is similar:

start code	receiver address	transmitter address	length	command	data	checksum
------------	------------------	---------------------	--------	---------	------	----------

Start Code

Size: 1 byte. Always 0x40

Receiver Address

Size: 1 byte

For responses from slave to master, this is always 0.

For inquiries from master to slave, this must match the slave's address as set with menu function 3.3.1.

Transmitter Address

Size: 1 byte

For inquiries from master to slave, this is always 0.

For responses from slave to master, this will match the slave's address as set with menu function 3.3.1.

Length

Size: 1 byte

The length of the total packet from start code to checksum.

Command

Size: 1 byte

This is 0x28 to 0x69 as defined in the remainder of this book.

Data

Size: 0-250 byte(s)

This section varies according to the command chosen and is often empty.

Checksum

Size: 1 byte

The two's complement of the sum of all the previous bytes in the packet. This makes the sum of the entire packet a multiple of 0x100.

Generic Data Formats

Date Format

Size: 2 bytes

Year: (7 bits)

Month: (4 bits)

Day: (5 bits)

Year is based from 1980.

2005 would be $2005 - 1980 = 25$.

Time Format

Size: 2 bytes

Hours: (5 bits)

Minutes: (6 bits)

Seconds/2: (5 bits)

Date/Time Examples

Date: 1F 56 Oct. 22. 2005

Date: 1F 75 Nov. 21, 2005

Time: 13 C0 02:30:00

Time: 74 23 14:33:06

Time: 4C 09 09:32:18

Concentration Data Format Code

UOXXXXYY

U = 0 concentration of PPB

1 concentration of PPM

O = future use

XXX = future use

YYY = used for PPB/PPM (bit 7), and indicates where the decimal place is located:

000 = no decimal places

001 = 1 decimal place

010 = 2 decimal places

011 = 3 decimal places

For example, (HEX) 82 (1000 0010) represents PPM with 2 decimal places.

For a concentration value of 317:

Format Code	Interpretation
0000 0010 (02)	3.17 PPB
1000 0010 (82)	3.17 PPM
0000 0000 (00)	317 PPB

Protocol Command Definition

Status and Query Commands

These commands indicate the function and expected response format for each command. Command numbers are in hexadecimal. If a specific response is required, the response packet will have the same command code as the command packet sent to the slave. If no specific response packet is specified, a general ACK response is sent to acknowledge the command.

NOP - 0x28

This is used to test for communication between the master and the specified slave.

Command packet to instrument:

Command Code (0x28) - 1 byte

Get System Information - 0x30

This packet requests information about the slave system only and the software version currently in use.

Command packet to instrument:

Command Code (0x30) - 1 byte

Response packet from instrument:

Command Code (0x30) - 1 byte VC4™ Date - 2 bytes

VC4™ Time - 2 bytes

Serial # - 2 bytes, product code 851 is assumed.

Software Rev.

Major - 1 byte

Minor - 1 byte

VIP - 2 bytes - 0xFFFF as default

Prom Check Sums

MSB PROM - 2 bytes

LSB PROM - 2 bytes

Status - 1 byte

0x00 Read verified

0xff Error in reading

Software Rev. Examples (Major/Minor/VIP):

01/07/FFFF - Rev. 1.07

03/0C/FFFF - Rev. 3.12

03/0C/0066 - Rev. 3.12-102

04/12/017A - Rev 4.18-378

Get Unit Status - 0x31

This command requests the current condition or status of the slave. This command allows the master to inquire about the general operating condition of the system.

Command packet to instrument:

Command Code (0x31) - 1 byte

Response packet from instrument:

Command Code (0x31) - 1 byte

VC4™ Date - 2 bytes

VC4™ Time - 2 bytes

General Status - 2 bytes

bit 0: Current Operating mode

0 = Not monitoring

1 = Monitoring

bit 1: Keyboard Lockout state

0 = Disabled

1 = Enabled

bit 2: Key pad status

0 = unlock

1 = locked

bit 3: Chemcassette™ counter status

0 = Counter disabled

1 = Counter enabled

bit 4: 2mA Fault operation

0 = Feature disabled

1 = Feature enabled

bit 5: Point Lock-ON

0 = No Lock-ON

1 = Lock-ON

bits 6-7: Point Locked (Ignore if bit 5 is 0.)

00 = Point 1

01 = Point 2

10 = Point 3

11 = Point 4

bit 8: Date Format

0 = MM/DD/YY

1 = DD/MM/YY

bits 9-12: Points enable when No Lock on

0x01 = Point 1 enabled

0x02 = Point 2 enabled

0x04 = Point 3 enabled

0x08 = Point 4 enabled

bit 13: Relay state

0 = De-energized

1 = Energized

bit 14: Relay Latching state

0 = Non-latching

1 = Latching

bit 15: Alarm Simulation state

0 = Unit not in alarm simulation mode

1 = Unit in alarm simulation mode

New Events - 1 byte

bit 0: The alarm history contains an entry which has not been read via packet 0x36 or 0x47.

1 = a new entry exists

0 = no new entries

bit 1: The fault history contains an entry which has not been read via packet 0x3D

1 = a new entry exists

0 = no new entries

bits 2-7: undefined Concentration Summary - 1 byte

bits 0-1: concentration summary integer (CSI) for point 1

bits 2-3: CSI for point 2

bits 4-5: CSI for point 3

bits 6-7: CSI for point 4

The CSI expresses the concentration relative to the alarm levels according to the following enumeration:

- 0 0.0 == concentration
- 1 0.0 < concentration < AL1
- 2 AL1 <= concentration < AL2
- 3 AL2 <= concentration

Chemcassette™ windows remaining - 2 bytes

Chemcassette™ days remaining - 2 bytes

Internal Filter 2 bytes (days in use)

External Filter - 2 bytes (days in use)

Flow Rate Point 1 - 2 bytes (cc/Min)

Flow Rate Point 2 - 2 bytes

Flow Rate Point 3 - 2 bytes

Flow Rate Point 4 - 2 bytes

Optics Cal Status - 1 byte

bit 0: Optics have been calibrated

0 = Not Tested

1 = Tested

bits 1-4: Optics test results

0x01 = Passed optics 1

0x02 = Passed optics 2

0x04 = Passed optics 3

0x08 = Passed optics 4

bits 5-7: Undefined

Maintenance Status

- 0x01 = low flow point 1
- 0x02 = low flow point 2
- 0x04 = low flow point 3
- 0x08 = low flow point 4
- 0x10 = low Chemcassette™ tape
- 0x20 = Maint. Relay
- 0x40 = Instr. Fault Relay

Get Idle Time - 0x32

This command inquires about how long the unit can be left out of analysis before setting an Instrument Fault. Idle time is used to notify operators that the unit is not monitoring. An idle time of 0 disables this option.

Command packet to instrument:

Command Code (0x32) - 1 byte

Response packet from instrument:

Command Code (0x32) - 1 byte

VC4™ Date - 2 bytes

VC4™ Time - 2 bytes

Idle Time - 1 byte (0 disabled, 1-45 min)

Status - 1 byte

0x00 = No errors in reading

0xff = Error in reading

Get Date & Time - 0x33

This command retrieves the current date and time from the unit.

Command packet to instrument:

Command Code (0x33) - 1 byte

Response packet from instrument:

VC4™ Date - 2 bytes

VC4™ Time - 2 bytes

Status - 1 byte

0x00 = Date and Time READ

0xff = Read problem

Get Maintenance Dates - 0x34

This command queries the maintenance items.

Command packet to instrument:

Command Code (0x34) - 1 byte

Response packet from instrument:

Command Code (0x34) - 1 byte

VC4™ Date - 2 bytes

VC4™ Time - 2 bytes

Last Power Down Date - 2 bytes

Last Power Down Time - 2 bytes

Last Power Up Date - 2 bytes

Last Power Up Time - 2 bytes

Flow Balance Date - 2 bytes

Flow Balance Time - 2 bytes

Optics Calibration Date - 2 bytes

Optics Calibration Time - 2 bytes

Date Chemcassette™ Replaced - 2 bytes

Time Chemcassette™ Replaced - 2 bytes

Date Int. Filter Replaced - 2 bytes

Date Ext. Filter Replaced - 2 bytes

Status - 1 byte

0x00 = No errors

0xFF = Error

Get Point Configuration - 0x35

This command queries an individual point for its current configuration. Command packet to instrument:

Command Code (0x35) - 1 byte

Point Flag - 1 byte

bits 0-1: Point Number

00 = Point 1

01 = Point 2

10 = Point 3

11 = Point 4

bits 2-7: Undefined

Response packet from instrument:

Command Code (0x35) - 1 byte

VC4™ Date - 2 bytes

VC4™ Time - 2 bytes

Point Status Flag - 1 byte

bit 0: Point Enable/Disable bit

0 = Disabled

1 = Enabled

bits 1-2: Point locked status

00 = Normal (No point lock-on)

01 = Lock-on for this point

10 = Lock-on for another point

11 = Undefined

bits 3-7: Undefined

MDA Gas Abbr. - 6 bytes (not null terminated)

Gas Table number - 1 byte (0 is the first table)

Format Code - 1 byte

Alarm Level 1 - 2 bytes

Alarm Level 2 - 2 bytes

20 mA - 2 bytes

Full Scale - 2 bytes

Point ID - 20 bytes

Status - 1 byte

0x00 = Point read

0xff = Error

Get Alarm History - 0x36

This command queries the unit for any alarms. The unit saves only the 16 most recent alarms regardless of point. The alarms can all be on one point or there can be alarms from several points.

Command packet to instrument:

Command Code (0x36) - 1 byte

Response packet from instrument:

Command Code (0x36) - 1 byte

VC4™ Date - 2 bytes

VC4™ Time - 2 bytes
of Alarms - 1 byte
(alarm data, up to 16 possible)
VC4™ Date of Alarm - 2 bytes
VC4™ Time of Alarm - 2 bytes Gas Abbr. 6 bytes
Point # - 1 byte
 bits 0-1: Point #
 00 = Point 1
 01 = Point 2
 10 = Point 3
 11 = Point 4
 bits 2-7: Undefined
Format Code - 1 byte
Conc. - 2 bytes
Alarm Level - 1 byte
 bit 0: Alarm Level
 0 = Level 1
 1 = Level 2
 bits 1-5: Undefined
 bit 6: Previously Read
 0 = new (not previously read)
 1 = old (previously read)
 bit 7: Undefine

Get Current Point Status - 0x37

This command queries an individual point for its current status. Command packet to instrument:

Command Code (0x37) - 1 byte
Point # - 1 byte
 bits 0-1: Point #
 00 = Point 1
 01 = Point 2
 10 = Point 3
 11 = Point 4
 bits 2-7: Undefined

Response Packet from instrument:

Command Code (0x37) - 1 byte

VC4™ Date - 2 bytes

VC4™ Time - 2 bytes (If point is Disabled/Invalid/locked out, fill with zeroes)

MDA Gas Abbr. - 6 bytes (not null terminated)

Format Code - 1 byte

Flow Rate - 2 bytes (current flow)

TWA Start Date - 2 bytes

TWA Start Time - 2 bytes

TWA End Date - 2 bytes

TWA End Time - 2 bytes

TWA Conc. - 2 bytes

Last Conc. - 2 bytes (last reported conc.)

Alarm Status - 1 byte (0 none, 1 or 2 level) (Fill for all conditions) Status - 1 byte

0x00 = Data valid

0x01 = Point Disabled (no data filled)

0x02 = Point Locked Out (no data filled)

0x04 = No TWA calculated

0x08 = No concentration available

0x10 = Alarm Simulation mode active

0xff = Invalid data

Get TWA Time - 0x38

This command queries the three TWA output time in a 24-hour format. Each of the TWA times are eight hours apart.

Command packet to instrument:

Command Code (0x38) - 1 byte

Response packet from instrument:

Command Code (0x38) - 1 byte

VC4™ Date - 2 bytes

VC4™ Time - 2 bytes

TWA time 1 - 2 bytes

TWA time 2 - 2 bytes

TWA time 3 - 2 bytes

Status - 1 byte

0x00 = Time read 0xff = Error in reading

Get Display Cycle Time - 0x39

This command queries for the length (in seconds) that the concentration for each point is displayed while the unit is in the Monitoring mode.

Command packet to instrument:

Command Code (0x39) - 1 byte

Response packet from instrument:

Command Code (0x39) - 1 byte

VC4™ Date - 2 bytes

VC4™ Time - 2 bytes

Cycle Time - 1 byte

(valid 2-10 sec., default 4 sec.)

Status - 1 byte

0x00 = No error

0xff = Error

Get the Number of Gas Tables Available - 0x3A

This command allows you to query the unit for the number of loaded gas tables in the unit.

Command packet to instrument:

Command Code (0x3A) - 1 byte

Response packet:

Command Code (0x3A) - 1 byte

VC4™ Date - 2 bytes

VC4™ Time - 2 bytes

of Gas Tables - 1 byte (1-255)

Get Printer Setup - 0x3B

This command queries the unit for the printer configuration.

Command packet to instrument:

Command Code (0x3B) - 1 byte

Response packet from instrument:

Command Code (0x3B) - 1 byte

VC4™ Date - 2 bytes

VC4™ Time - 2 bytes

Setup Status - 1 byte

bit 0: Printer port enable/disable

0 = Disable

1 = Enable

bits 1-2: Printer report format

00 = Continuous

01 = Summary

10 = Compressed

11 = Invalid

bits 3-5: Printer baud rate

000 = 1200

001 = 2400

010 = 4800

011 = 9600

100 = 19200

bit 6: Printer hardware handshaking (flow control)

0 = Disabled

1 = Enabled

bit 7: Undefined

Get Gas Table Data - 0x3C

This command allows you to view individual gas tables that are contained within the system.

Command packet to instrument:

Command Code (0x3C) - 1 byte

Gas to table to retrieve - 1 byte (0-255)

Response packet from instrument:

Command Code (0x3C) - 1 byte

VC4™ Date - 2 bytes

VC4™ Time - 2 bytes

(filled with zeroes if error)

MDA Gas Abbr. - 6 bytes (not null terminated)

Full Scale - 2 bytes

TLV - 2 bytes

LAL - 2 bytes

LDL - 2 bytes

Format Code - 1 byte

Revision # - 1 byte (1-255) (always filled)

Status

0x00 = Read OK

0x01 = Invalid Gas # index

0xff = Bad read

Get Fault History - 0x3D

This command will query the unit for the latest fault(s). There can be as many as four and as few as zero faults. General system faults are indicated by bit 0 of the point status byte. If bit 0 is set to 1, bits 1-2 should be ignored. The point status byte is invalid for Fault 17 (Voltage Fail) and Fault 18 (Relay Fail).

Command packet to instrument:

Command Code (0x3D) - 1 byte

Response packet from instrument:

Command Code (0x3D) - 1 byte

VC4™ Date - 2 bytes

VC4™ Time - 2 bytes

of faults - 1 byte (0-4 maximum) (fault data, maximum of four possible)

Date of fault - 2 bytes

Time of fault - 2 bytes

Fault # -1 byte

Point Status -1 byte

bit 0: General fault bit

0 = point specific

1 = general

bits 1-2: Point # where fault occurred

(ignored if bit 0 is 1 and for Flts 17 and 18)

00 = Point 1

01 = Point 2

10 = Point 3

11 = Point 4

bits 3-5: Undefined

bit 6: Previously Read

0 = new (not previously read)

1 = old (previously read)

bit 7: Instrument Fault

0 = maintenance fault - the VC4™'s ability to monitor is not compromised.

1 = instrument fault - the VC4™'s ability to monitor is compromised.

Get K-Factor - 0x3E

This command will inquire about K-Factor settings for all points. An individual point is assigned with a K-Factor times 1000 (a K-Factor of 1.000 is sent as 1000). The K-Factor is used to change the sensitivity of a point in the range of 0.200-5.000. This adjustment is made after the calculation of concentration.

Command packet to instrument:

Command Code (0x3E) - 1 byte

Response packet from instrument:

Command Code (0x3E) - 1 byte

VC4™ Date - 2 bytes

VC4™ Time - 2 bytes

K-Factor (x 1000) Point 1 - 2 bytes

K-Factor (x 1000) Point 2 - 2 bytes

K-Factor (x 1000) Point 3 - 2 bytes

K-Factor (x 1000) Point 4 - 2 bytes

Status

0x00 = Point read

0xff = Read problem

Get Pump Limits - 0x43

This command returns the user's settings for pump limits.

Command Packet to slave:

Command Code (0x43) - 1 byte

Response from slave:

Command code (0x43) - 1 byte

VC4™ date 2 bytes

VC4™ time 2 bytes

High Limit - 2 bytes (defaults to 600)

Low Limit - 2 bytes (defaults to 400)

Status - 1 byte (always 0x00 as currently implemented)

Get Filter Life - 0x44

This command returns the user's settings for total filter lifetime. Lifetime is set by the user to indicate how often the filters should be changed. A maintenance fault will be issued when the filters are this old. The valid range is 30 to 365 days. Zero lifetime means a filter maintenance.

Command Packet to slave:

Command Code (0x44) - 1 byte

Response from slave:

Command code (0x44) - 1 byte

VC4™ date - 2 bytes

VC4™ time - 2 bytes

Internal filter life - 2 bytes

External filter life - 2 bytes

Status - 1 byte (always 0x00 as currently implemented)

Get Floating Status - 0x45

This packet returns general information about the slave. It combines the information of packet 0x37 (Get Point Status) and 0x31 (Get Unit Status). However, it reports the concentration in IEEE floating-point format instead of as a scaled integer. Since it provides information that would otherwise require five interrogations, this should permit faster polling of slaves on a multidrop RS-485 bus.

Command Packet to Slave:

Command Code (0x45) - 1 byte

Response from Slave:

Command code (0x45) - 1 byte

VC4™ date - 2 bytes

VC4™ time - 2 bytes

Status - 1 byte

0x01 - in monitor

0x02 - maintenance fault relay activated

0x04 - instrument fault relay activated

0x08 - (1 bit) undefined

0x10 - A new fault has occurred since the last time packet 0x3D (Get Fault History) was requested.

0x20 - A new alarm has occurred since the last time packet 0x36 (Get Alarm History) was requested.

0xC0 - (2 bits) undefined

(The 7 byte Point Structure repeats 4 times)

Concentration - 4 byte floating point

Number in PPM

Flow - 2 byte integer in CC/min

Point status - 1 byte

0x01 - point disabled in config

0x02 - point disabled now (It may have become disabled because of a fault.)

0x04 - point locked out

0x08 - low flow

0x30 - (2 bits) concentration summary integer. The meaning of this field is as follows:

00: 0.0 == Concentration

01: 0.0 < Concentration < AL1

10: AL1 <= Concentration < AL2

11: AL2 <= Concentration

0xC0 - (2 bits) current alarm level

00: no alarm

01: alarm level 1 active

10: alarm level 2 active

(End of Point Structure)

Total size is 34 bytes

Example

The following example is an illustration of the above packet using serial communication protocol version 2. The address of the slave is 42 (0x2A). Point 1 is in a level 2 alarm, but the gas concentration has decreased below AL2 and AL1 to 42.2 ppb. The other three points are reading zero concentration. The instrument fault relay is activated and point 4 is disabled because of loss of flow. Both the Fault History and the Alarm History have new entries which have not been read yet. Point 3 is configured to be disabled via menu function 3.1. All four flows are near the norm of 180 cc/min except for point 4, which is 139 cc/min.

Master:	40 2A 00 06 45 4B;			inquiry
Slave:	40 00 2A 27 45	23 64 66	DA;	header, date/time
	3D;			unit status byte
	3D 2C E2 19	00 BB	90;	point 1 data
	00 00 00 00	00 BD	00;	point 2 data
	00 00 00 00	00 C4	03;	point 3 data
	00 00 00 00	00 8B	0A;	point 4 data
	5E;			checksum

Get One Alarm - 0x47

This packet returns the oldest unread entry from the alarm history. It duplicates the functionality of packet 0x36 in a form that some masters may find more convenient. Note that this packet causes an alarm to be marked as read in the same way as packet 36. If no unread entries exist in the history, the response packet will contain zeros in the alarm date field.

Command packet to slave:

Command Code (0x47) - 1 byte

Response packet from slave:

Command Code (0x47) - 1 byte

VC4™ Date - 2 bytes

VC4™ Time - 2 bytes

Alarm Date - 2 bytes

Alarm Time - 2 bytes

Gas abbreviation - 6 bytes (not null terminat'd)

Point number - 1 byte

bits 0-1 point number

bits 2-7 undefined

Concentration - 4 bytes (in IEEE floating point format)

Alarm Level - 1 byte

bit 0: alarm level

0= level 1

1= level 2

bits 1-7: undefined

Configuration and Directive Commands

These are the commands and responses that the VC4™ system will support for remote control and configuration.

Set K-Factor - 0x50

This command configures the manual K-Factor for a specific point. An individual point is given a K-Factor times 1000. The K-Factor is used to change the sensitivity of a point in the range of 0.200-5.000.

Command packet to instrument:

Command Code (0x50) - 1 byte

Point # - 1 byte

bit 0-1: Point to set K-Factor

00 = Point 1

01 = Point 2

10 = Point 3

11 = Point 4

bits 2-7: Undefined

K-Factor (x 1000) value - 2 bytes (200-5000)

Response packet from instrument:

Command Code (0x50) - 1 byte

VC4™ Date - 2 bytes

VC4™ Time - 2 bytes

Status - 1 byte

0x00 = Point configured and verified

0x01 = Factor <0.200

0x02 = Factor >5.000

0xff = Save problem, K-Factor unchanged

Reset Fault or Alarm - 0x51

This command allows a remote reset of any faults or alarm conditions.

Command packet to instrument:

Command Code (0x51) - 1 byte

Flag - 1 byte

bits 0-4: Reset selection

0x01 = Point 1 alarms

0x02 = Point 2 alarms

0x04 = Point 3 alarms

0x08 = Point 4 alarms

0x10 = Faults

Response packet from instrument:

Command Code (0x51) - 1 byte

VC4™ Date - 2 bytes

VC4™ Time - 2 bytes

Status - 1 byte

0x00 = Alarms reset

0xff = Error

Set Key-Code - 0x52

This command allows you to reconfigure the keypad lock-out and key code. The keypad can be disabled, preventing unauthorized user intervention by enabling the keypad lockout (bit 0). This configures the keypad and a new key code.

The old key code must match the code currently programmed into the VC4™ monitor for this command to succeed in changing the code.

Command packet to instrument:

Command Code (0x51) - 1 byte

Keypad Status - 1 byte

bit 0: Keypad lock-out function

0 = Disable

1 = Enable

bits 1-7: Undefined

Old Key code - 2 bytes (valid 0000 - 9999)

New Key code - 2 bytes (valid 0000-9999)

Response packet from instrument:

Command Code (0x51) - 1 byte

VC4™ Date - 2 bytes

VC4™ Time - 2 bytes

Status -1 byte

0x00 = Saved and verified

0x01 = Key code invalid

0xff = Error, not saved

Lock Keyboard - 0x53

This command allows you to lock out the keyboard. The keyboard can be disabled, preventing unauthorized user intervention by enabling the keypad lock out and sending a valid key code.

This allows only persons with the key code to operate the keypad.

Command packet to instrument:

Command Code (0x53) - 1 byte

Keypad Status -1 byte

bit 0: Lock or unlock keypad

0 = Unlocked

1 = Locked

bits 1-7: Undefined

Key code - 2 bytes (valid 0000 - 9999)

Response packet from instrument:

Command Code (0x53) - 1 byte

VC4™ Date - 2 bytes

VC4™ Time - 2 bytes

Status -1 byte

0x00 = Saved and verified

0x01 = Key code invalid

0xff = Error, not saved

Set 2mA Fault Operation - 0x54

This command configures the unit for an output option of 2 milliamperes rather than the default 4 milliamperes.

Command packet to instrument:

Command Code (0x54) - 1 byte

Enable/Disable - 1 byte

0 = Feature disabled

1 = Feature enabled

Response packet from instrument:

Command Code (0x54) - 1 byte

VC4™ Date - 2 bytes

VC4™ Time - 2 bytes

Status - 1 byte

0x00 = Feature programmed

0xff = Error occurred

Start New Cycle - 0x55

This command allows you to toggle the unit into and out of the Monitor mode.

Command packet to instrument:

Command Code (0x55) - 1 byte

State - 1 byte

bit 0: Take/put into analysis

0 = Take out of Monitor mode

1 = Put in Monitor or pull window

bits 1-7: Undefined

Response packet from instrument:

Command Code (0x55) - 1 byte

VC4™ Date - 2 bytes

VC4™ Time - 2 bytes

Status - 1 byte

0x00 = Request Executed

0xff = Error

Program Chemcassette™ Counter - 0x56

This command enables/disables the Chemcassette™ counter. When enabled, the system will provide a fault when there is approximately 24 hours of Chemcassette™ remaining.

Command packet to instrument:

Command Code (0x56) - 1 byte

Enable/disable - 1 byte

bit 0: Enable/disable the Chemcassette™ counter

0 = Disable

1 = Enable

bits 1-7: Undefined

Response packet from instrument:

Command Code (0x56) - 1 byte

VC4™ Date - 2 bytes

VC4™ Time - 2 bytes

Return Status - 1 byte

0x00 = Counter is enable/disable

0x01 = No windows left

0x02 = Maintenance status exists (Low Chemcassette™)

0xff = Error in programming counter

Set Printer Configuration - 0x57

This command configures the printer for output.

Command packet to instrument:

Command Code (0x57) - 1 byte

Setup Status - 1 byte

bit 0: Printer port enable/disable

bits 1-2: Printer Report format

00 = Continuous (prints all conc. for each pt)

01 = Summary (prints alarms, faults, and TWA only)

10 = Compressed (prints conc. > LDL)

11 = Invalid

bits 3-5: Printer baud rate

000 = 1200

001 = 2400

010 = 4800

011 = 9600

100 = 19200

bit 6: printer hardware handshaking (flow control)

0 = Disabled

1 = Enabled

bit 7: Undefined

Response packet from instrument:

Command Code (0x57) - 1 byte

VC4™ Date - 2 bytes

VC4™ Time - 2 bytes

Status Flag - 1 byte

0x00 = Printer programmed

0x01 = Invalid report format

0xff = Printer programming error

Set Point Enable/Disable – 0x58

This command enables or disables points on the VC4™ monitor.

Command packet to instrument:

Command Code (0x58) - 1 byte

Point enable mask - 1 byte

bits 0-3: Point selection

0x01 = Point 1 enable

0x02 = Point 2 enable

0x04 = Point 3 enable

0x08 = point 4 enable

bits 4-7: Undefined

Response packet from instrument:

Command Code (0x58) - 1 byte

VC4™ Date - 2 bytes

VC4™ Time - 2 bytes

Status - 1 byte

0x00 = Point enable updated and verified

0xff = Error, not saved

Set Point Configuration - 0x59

This command configures an individual point. The point can be configured even if it is disabled.

Command packet to instrument:

Command Code (0x59) - 1 byte

Point to be configured - 1 byte

bits 0-1: Point #

00 = Point 1

01 = Point 2

10 = Point 3

11 = Point 4

Gas Table # - 1 byte (0 = first table)

Alarm Level 1 - 2 bytes

Alarm Level 2 - 2 bytes

20 mA Full Scale - 2 bytes

Point ID - 20 bytes

Response packet from instrument:

Command Code (0x59) - 1 byte

VC4™ Date - 2 bytes

VC4™ Time - 2 bytes

Status - 1 byte

0x00 = Point configured and verified

0x01 = Gas error

0x02 = Alarm 1 Err (L1 < LAL or L1 > FS)

0x04 = Alarm 2 Error (L2 < L1 or L2 > FS)

0x08 = 20 mA Error (< LAL or > FS)

0xff = Save problem

Set TWA Time - 0x5A

This command configures the TWA time output. You need to enter only the initial TWA output time. The other two time factors are calculated automatically.

Command packet to instrument:

Command Code (0x5A) - 1 byte

TWA Time - 2 bytes

Command Code (0x5A) - 1 byte

VC4™ Date -2 bytes

VC4™ Time - 2 bytes

Status - 1 byte

0x00 = Value saved and verified

0x02 = Minutes Invalid

0xff = Not saved

Set Display Time - 0x5B

This command configures the length in seconds Cycle that the concentration for each point is displayed while in the Monitor mode.

Command packet to instrument:

Command Code (0x5B) - 1 byte

Cycle time - 1 byte (valid 2-10 sec)

Response packet from instrument:

Command Code (0x5B) - 1 byte

VC4™ Date - 2 bytes

VC4™ Time - 2 bytes

Status - 1 byte

0x00 = Value saved and verified

0x01 = Value < 2 seconds

0x02 = Value > 10 seconds

0xff = Not saved

Set Idle Time - 0x5C

This command configures how long the unit can be left out of analysis before setting an Instrument fault. Idle time allows you to exit the Monitoring mode without causing an Instrument fault (if the idle time is > 0). You simply set the idle time to an appropriate idle (non-monitoring) time. If the idle time has expired and the unit is not in the Monitoring mode, an instrument fault will be issued. An idle time setting of 0 disables this option.

Command packet to instrument:

Command Code (0x5C) - 1 byte

Idle Time - 1 byte (0 disabled, 1-45 mins)

Response packet from instrument:

Command Code (0x5C) - 1 byte

VC4™ Date - 2 bytes

VC4™ Time - 2 bytes

Status - 1 byte

0x00 = Value saved and verified

0x01 = Value > 45

0xff = Not saved

Set Date Format - 0x5D

This command changes the current date format on the display and printer outputs only. It does not change the date format for communication.

Command packet to instrument:

Command Code (0x5D) - 1 byte

Format Flag - 1 byte

bit 0: Date format

0 = MM/DD/YY

1 = DD/MM/YY

Response packet from instrument:

Command Code (0x5D) - 1 byte

VC4™ Date - 2 bytes

VC4™ Time - 2 bytes

Status - 1 byte

0x00 = Format changed

0xff = Error

Set Date and Time - 0x5E

This command allows you to configure the unit to a new time and date. Use this feature to synchronize the time and date between the remote equipment and multiple VC4™ monitors.

Command packet to instrument:

Command Code (0x5E) - 1 byte

New Date - 2 bytes

New Time - 2 bytes

Response packet from instrument:

Command Code (0x5E) - 1 byte

VC4™ Date - 2 bytes

VC4™ Time - 2 bytes

Status - 1 byte

0x00 = Date and time configured and verified

0x01 = Month bad

0x02 = Day bad

0x04 = Year bad

0x10 = Hour bad

0x20 = Minutes bad

0x40 = Seconds bad

0xff = Save problem

Set Relay State - 0x5F

This command allows you to configure the relay states. The relays are normally de-energized, and can be configured to operate in the energized fail-safe condition. When the relays are latched, they are cleared by operator intervention. Non-latching relays are cleared automatically once the concentration decreases below the alarm level threshold, or the fault is corrected without operator intervention.

Command packet to instrument:

Command Code (0x5F) - 1 byte

Relay Flags - 1 byte

bit 0: Relay state

0 = De-energized

1 = Energized

bit 1: Relay latching state

0 = Non-latching

1 = Latching

bits 2-7: Undefined

Response packet from instrument:

Command Code (0x5F) - 1 byte

VC4™ Date - 2 bytes

VC4™ Time - 2 bytes

Status - 1 byte

0x00 = relays state set

0xff = Error, relays state not changed

End Point Lock-on - 0x60

This command unlocks the unit from a single point lock-on to all other points that are enabled. When this command is issued, a new TWA start for all points.

Command packet to instrument:

Command Code (0x60) - 1 byte

Response packet from instrument:

Command Code (0x60) - 1 byte

VC4™ Date: - 2 bytes

VC4™ Time - 2 bytes

Status - 1 byte

0x00 = Points unlocked

0xff = Error

Start Point Lock-on - 0x61

This command locks the unit to one specific point. When this command is issued, all other points are disabled and locked-on point continues to monitor for concentration and TWA.

Command packet to instrument:

Command Code (0x61) - 1 byte

Point Lock - 1 byte

bits 0-1: point to lock on

00 = Point 1

01 = Point 2

10 = Point 3

11 = Point 4

Response packet from instrument:

Command Code (0x61) - 1 byte

VC4™ Date - 2 bytes

VC4™ Time - 2 bytes

Status - 1 byte

0x00 = Point locked

0x01 = Selected point not enabled

0xff = Error

Save Current Configuration - 0x62

This command saves a backup copy of the current configuration to nonvolatile memory in the VC4™ monitor. This configuration can be restored using the Restore Configuration command.

Command packet to instrument:

Command Code (0x62) - 1 byte

Response packet from instrument:

Command Code (0x62) - 1 byte

VC4™ Date - 2 bytes

VC4™ Time - 2 bytes

Status - 1 byte

0x00 = Configuration saved

0xff = Error

Restore Configuration - 0x63

This command restores a configuration that was previously saved to nonvolatile memory in the CM4 monitor.

Command packet to instrument:

Command Code (0x63) - 1 byte

Response packet from instrument:

Command Code (0x63) - 1 byte

VC4™ Date - 2 bytes

VC4™ Time - 2 bytes

Status - 1 byte

0x00 = Configuration restored

0xff = Error, configuration unchanged

Set Duty Cycle - 0x65

This command allows a master to set the minimum window time and the monitor relay response bits on a slave. Please see packet 0x69, GetDutyCycle for a discussion of these parameters.

Command packet to slave:

Command code (0x65) - 1 byte

Bits permitting monitor relay action during duty cycle - 1 byte

bit 0 point1

bit 1 point2

bit 2 point3

bit 3 point4

bits 4-7 unused (ignored by slave)

Minimum window time (seconds) - 2 bytes

Response from slave:

Command code (0x65) - byte

VC4™ date 2 bytes

VC4™ time 2 bytes

Status - 1 byte

0x00 packet accepted

0x01 time >900 seconds, unacceptable

0x02 time < 0 seconds, unacceptable

0xFF slave in monitor, unable to accept changes

Set Filter - 0x66

This command allows a master to set the lifetime of a filter. See packet 44 for a discussion of these parameters. The valid range of lifetimes is 30 to 365 days. The system maintains the number of days remaining as a constant if the lifetime changes.

Command packet to instrument:

Command code (0x66) - 1 byte

Internal filter lifetime (days) - 2 bytes

External filter lifetimes (days) - 2 bytes

Response from instrument:

Command code (0x66) - 1 byte

VC4™ date - 2 bytes

VC4™ time - 2 bytes

Status - 1 byte

0x00 = packet accepted

0x01 = internal filter lifetime unacceptable

0x02 = external filter lifetime unacceptable

0xFF = slave in monitor, unable to accept changes

Get Duty Cycle - 0x69

This command allows the master to find out the minimum window time and the monitor relay action during duty cycle bits on a slave.

The minimum window time (or duty cycle) defaults to zero seconds. But it may be set larger to conserve tape in installations that have some concentration of gas for long periods of time. The tape will not advance until the minimum window time has accumulated even if the tape is saturated. During periods when the tape is saturated but prevented from advancing, the VC4™ will continue to report the most recent concentration reading. Unfortunately it will not be able to detect any changes in concentration during this period because the tape is saturated.

By default, the monitor relay (RY6) will energize when monitoring is temporarily suspended because of tape saturation. However this reaction can be inhibited for individual points. The **monitor relay action during duty cycle** bits default to TRUE but can be set to FALSE via either the keypad or serial packet 0x65, Set Duty Cycle.

Command Packet to slave:

Command code (0x69) - 1 byte

Response from slave:

Command code (0x69) - 1 byte

VC4™ date 2 bytes

VC4™ time 2 bytes

Bits permitting monitor relay action during Duty cycle - 1 byte

bit 0 point1

bit 1 point2

bit 2 point3

bit 3 point4

bits 4-7 unused (always 0)

Min window time (seconds) - 2 byte

Status - 1 byte (always 0x00)

Operation

VC4™ Instrument Power-up

Upon power-up, the VC4™ instrument conducts a self-diagnostic procedure to check its memory, hardware, and voltages. After the self-diagnostics, the instrument automatically begins monitoring, and the COM port (if enabled) is activated.

Commands

Your VC4™ instrument will accept and process commands sent to it from your equipment.

Responses

The VC4™ instrument will send a return communication for any message it receives at its address. Included in most response packets from the VC4™ instrument are date and time stamps.

Example Packets

The following section contains examples of packets from a master to a slave and the slave's responses. Protocol version 2 is used. The address of the slave is 1. All numbers are in hexadecimal.

Master	40 01 00 06 28 91
Slave	40 00 01 06 20 99

Master	40 01 00 06 31 88
Slave	40 00 01 20 31 24 A6 47 31 5E C1 02 00 00 00 00
	00 FF FF FF FF 00 B9 00 A5 00 A4 00 CD 00 00 40

Master	40 01 00 06 35 84
Slave	40 00 01 30 35 24 A6 47 33 01 4E 48 33 2D 49 49
	00 81 00 FA 01 F4 02 EE 02 EE 50 54 31 2D 43 4D
	34 2D 38 35 31 2D 30 30 30 36 20 20 20 20 00 39

Master	40 01 00 06 37 82
Slave	40 00 01 21 37 24 A6 47 35 4E 48 33 2D 49 49 81
	00 B9 24 A6 47 10 24 A6 47 35 00 00 00 00 00 00
	F8

Master	40 01 00 06 3C 7D
Slave	40 00 01 1B 3C 24 A6 47 39 4E 48 33 2D 49 49 02
	EE 00 FA 00 1E 00 1E 81 04 00 EB

Master	40 01 00 06 3D 7C
Slave	40 00 01 1D 3D 24 A6 47 3A 03 24 A6 46 E2 09 81
	24 A6 46 CF 09 81 24 A5 81 17 09 81 47

Master	40 01 00 06 45 74
Slave	40 00 01 27 45 24 A6 47 45 09 00 00 00 00 00 BA
	00 00 00 00 00 00 A6 00 00 00 00 00 00 A3 00 00
	00 00 00 00 CC 00 25
Master	40 01 00 09 50 00 03 E8 7B
Slave	40 00 01 0B 50 24 A6 47 6A 00 E9

Master	40 01 00 07 51 1F 48
Slave	40 00 01 0B 51 24 A6 47 50 00 02

Master	40 01 00 07 55 00 63
Slave	40 00 01 0B 55 24 A6 47 60 00 EE

Master	40 01 00 22 59 00 00 00 FA 01 F4 02 EE 50 4F 49
	4E 54 5F 49 44 5F 53 54 52 49 4E 47 5F 00 00 00
	00 5A
Slave	40 00 01 0B 59 24 A6 48 30 00 19

The following section contains examples of packets from a master to a slave and the slave's responses. Protocol version 1 is used.

Master	40 01 05 28 92
Slave	40 00 05 20 9B

Master	40 01 05 30 8A
Slave	40 00 14 30 22 A6 43 C8 00 06 02 05 FF FF 37 AB 71
	A5 00 A6

Master	40 01 05 31 89
Slave	40 00 1F 31 22 A6 43 CB 5E CA FF FF 0C 1C 00 20 00
	2A 00 2A 00 00 00 00 00 00 00 00 1F 00 B9

Master	40 01 05 32 88
Slave	40 00 0B 32 22 A6 43 FA 2D 00 51

Master	40 01 05 33 87
Slave	40 00 0A 33 22 A6 43 E9 00 8F

Master	40 01 05 34 86
Slave	40 00 22 34 22 A6 43 D8 22 A5 6A 7B 22 A5 6A 7D 22
	A6 41 78 22 A6 41 89 22 A6 41 4E 22 A6 22 A6 00 33
Master	40 01 06 35 00 84
Slave	40 00 2F 35 22 A6 43 FD 01 4E 48 33 2D 49 49 00 81
	00 FA 01 F4 02 EE 02 EE 50 54 31 2D 43 4D 34 2D 38 35 31 2D
	30 30 30 36 20 20 20 20 00 77

Master	40 01 05 36 84
Slave	40 00 64 36 22 A6 43 E0 06 22 A5 6A E8 4E 48 33 2D
	49 49 03 81 02 EE 01 22 A5 6A CA 4E 48 33 2D 49 49 03 81 02
	EE 01 22 A5 6A 06 4E 48 33 2D 49 49 02 81 02 EE 01 22 A5 6A
	06 4E 48 33 2D 49 49 01 81 02 EE 01 22 A5 69 F2 4E 48 33 2D
	49 49 02 81 02 EE 01 22 A5 69 F2 4E 48 33 2D 49 49 01 81 02
	EE 01 87

Master	40 01 06 37 00 82
Slave	40 00 20 37 22 A6 43 E5 4E 48 33 2D 49 49 81 00 00
	22 A6 00 F9 22 A6 41 06 00 00 00 00 00 00 A0

Master	40 01 05 38 82
Slave	40 00 10 38 22 A6 44 03 00 00 40 00 80 00 00 A9

Master	40 01 05 39 81
Slave	40 00 0B 39 22 A6 44 06 04 00 66

Master	40 01 05 3B 7F
Slave	40 00 0A 3B 22 A6 44 09 1D 49

Master	40 01 05 3D 7D
Slave	40 00 22 3D 22 A6 43 ED 04 22 A5 6A 9D 1B 02 22 A5
	69 DD 05 01 22 A5 69 BC 05 01 22 A5 69 B1 05 01 8E

Master	40 01 05 3E 7C
Slave	40 00 12 3E 22 A6 44 0C 03 E8 03 E8 03 E8 03 E8 00
	AC

Master	40 01 05 43 77
Slave	40 00 0E 43 22 A6 43 F1 01 F4 01 90 00 ED

Master	40 01 05 44 76
Slave	40 00 0E 44 22 A6 43 F4 00 2A 00 2A 00 1B

Master	40 01 08 50 00 04 57 0C
Slave	40 00 0A 50 22 A6 44 85 00 D5

Master	40 01 06 51 1F 49
Slave	40 00 0A 51 22 A6 44 17 00 42

Master	40 01 0A 52 01 04 57 00 00 07
Slave	40 00 0A 52 22 A6 44 8E 00 CA

Master	40 01 08 53 00 04 57 09
Slave	40 00 0A 53 22 A6 44 20 00 37

Master	40 01 06 54 01 64
Slave	40 00 0A 54 22 A6 44 93 00 C3
Master	40 01 06 55 01 63
Slave	40 00 0A 55 22 A6 44 25 00 30

Master	40 01 06 56 01 62
Slave	40 00 0A 56 22 A6 44 97 00 BD

Master	40 01 06 57 1B 47
Slave	40 00 0A 57 22 A6 44 A1 00 B2

Master	40 01 06 58 0D 54
Slave	40 00 0A 58 22 A6 44 A7 00 AB

Master	40 01 07 5A 09 60 F5
Slave	40 00 0A 5A 22 A6 44 AD 00 A3
Master	40 01 06 5B 02 5C
Slave	40 00 0A 5B 22 A6 44 B1 00 9E

Master	40 01 06 5C 2C 31
Slave	40 00 0A 5C 22 A6 44 B8 00 96

Master	40 01 06 5D 00 5C
Slave	40 00 0A 5D 22 A6 44 BC 00 91

Master	40 01 09 5E 22 A6 44 67 E5
Slave	40 00 0A 5E 22 A6 44 35 00 17

Master	40 01 06 5F 02 58
Slave	40 00 0A 5F 22 A6 44 C4 00 87

Master	40 01 05 60 5A
Slave	40 00 0A 60 22 A6 44 76 00 D4

Master	40 01 06 61 00 58
Slave	40 00 0A 61 22 A6 44 72 00 D7

Master	40 01 08 65 0F 00 64 DF
Slave	40 00 0A 65 22 A6 44 CB 00 7A

Master	40 01 05 69 51
Slave	40 00 0D 69 22 A6 44 11 0F 00 00 00 1E

Serial Device Applications

The serial interface is designed for unidirectional communication from a VC4™ monitor to a single printer or other remote device. It is possible, therefore, that the application for this interface requires connection to a remote device other than the printer options described in this appendix.



CAUTION

RISK of improper operation. Cabling used between the VC4™ monitor and the external device must be shielded and properly grounded to maintain reliable operation and control RF emissions and susceptibility.

For these applications, note the pin-out configuration in each of the diagrams.

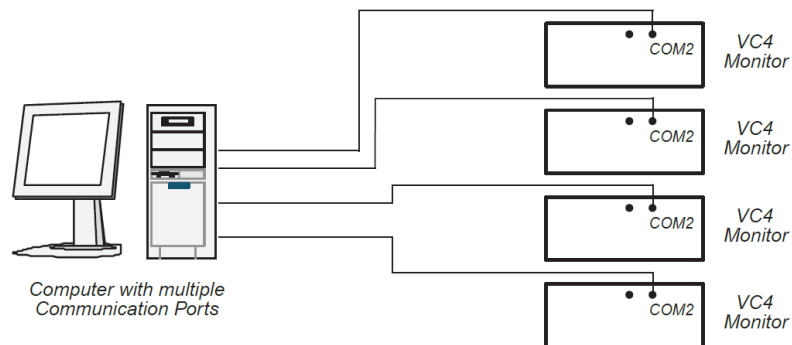

Multiple VC4™ monitors and a single computer

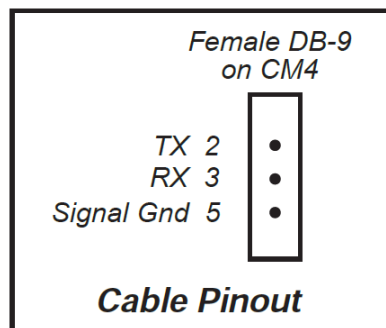

Serial Interface, Multiple VC4™'s, Single Computer, Unidirectional Communications

Interface	RS-232 P/N 874022-R Rear Panel Mount
Computer Port	Customer-supplied RS-232C; check user device for compatibility before ordering.
Cable	User-supplied. Refer to diagram for pin-out configuration.
Protocol	Customer-written per information in "Serial Communications Protocol" on page 132
Note	Maximum range: 50 Ft.

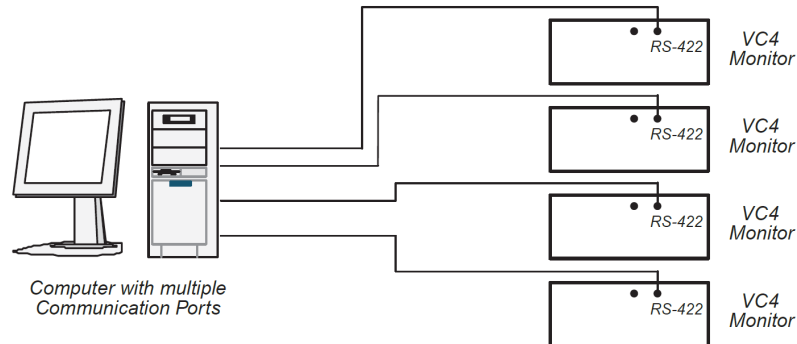

**Multiple VC4™ monitors and a single computer
Bi-Directional Communication up to 4000 ft distance**

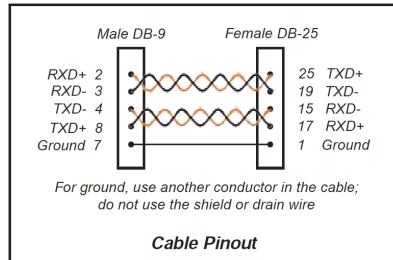

Bidirectional Communication, Single Computer, Multiple VC4™'s up to 4000 ft distance.

Interface	RS-232 P/N 874024-R Rear Panel Mount
Computer Port	Customer-supplied; check user device for compatibility before ordering.
Cable	User-supplied. Refer to diagram for pin-out configuration.
Protocol	Customer-written per information in "Serial Communications Protocol" on page 132
Note	Maximum range: 4000 Ft.

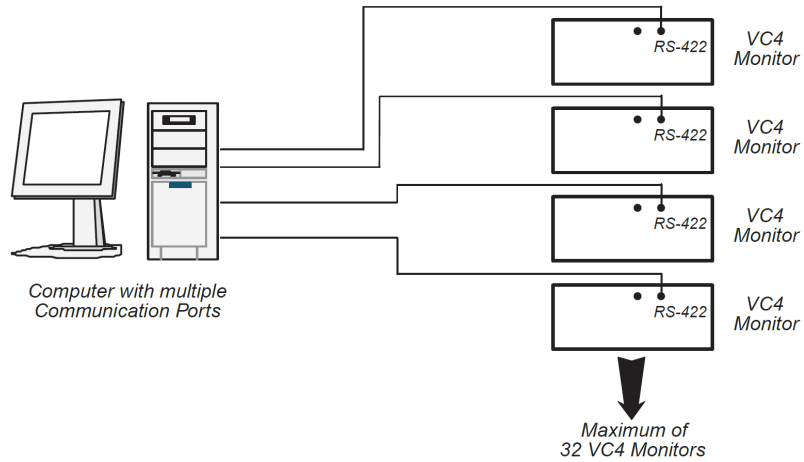

Multiple VC4™ monitors and a single computer

Bi-Directional Communication over a 2-wire system

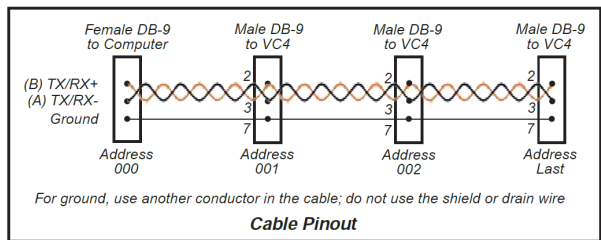

Bidirectional Communication, Single Computer, Multiple VC4™'s over a two-wire system.

Interface	RS-232 P/N 874327-R Rear Panel Mount
Computer Port	Customer-supplied; check user device for compatibility before ordering.
Cable	User-supplied. Refer to diagram for pinout configuration. Drop distance between the VC4™ and the daisy-chain cable should be as short as possible (less than three feet).
Protocol	Customer-written per information in "Serial Communications Protocol" on page 132
Note	Refer to the computer port documentation for specific pinout information for the computer's RS485 interface. RS485 ports are limited to 32 nodes due to drive-level limitations. The number of nodes per port can be extended up to 255 by use of RS485 repeaters.

Impedance Matching

The communication interfaces in the first and last units in the daisy-chain configuration must have matching impedance. This is true whether the computer is at the end of the daisy chain or within the daisy chain. Check the computer's interface to determine the impedance termination resistor's value and how to install/set. The illustrations below show two daisy chain schemes, the first with the computer on the end of the daisy chain, and the second with the computer within the daisy chain. The impedance termination resistors on all interfaces between the first and last units are removed.

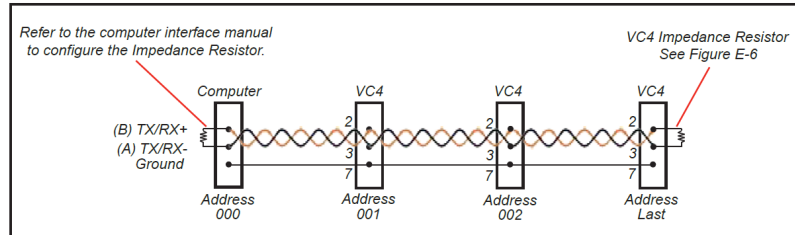

Configuration showing Computer at one end of a Daisy-Chain

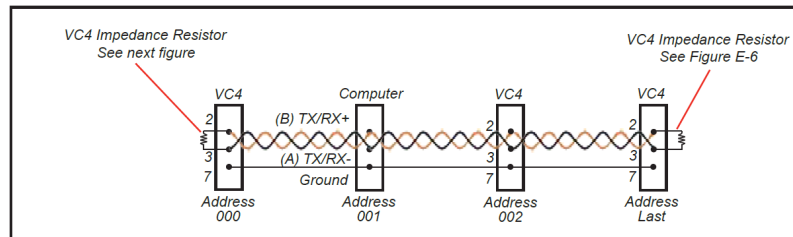

Configuration showing Computer in the middle of a Daisy-Chain

The VC4™ unit's impedance termination resistor is located on the RS-485 interface as shown below. The resistor plugs into sockets on the interface board for easy removal or insertion; there is no soldering required.

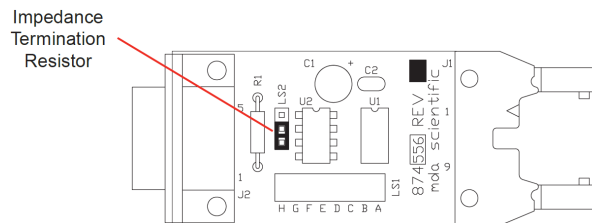

VC4™ RS-485 Interface Board Impedance Resistor Location.

Glossary

The following terms are used in this manual:

Byte: A byte is a collection of 8 bits (or pieces) of information used in the communication process. A byte refers to these 8 bits as a single entity. Each bit has a value of either 0 or 1.

Communication: The act or process of passing digital information between two points.

Data: Information that is transferred between the equipment and the VC4™ monitor. Data refers to the information contained within a packet (see Packet). This information may be gas concentration, date, or other information.

Equipment: This term is used to refer to the master device which is used to communicate with the VC4™ monitor(s). The equipment can be a personal computer (PC) or other device capable of performing the digital communications described in this protocol.

Handshake: The process of acknowledging a communication has been received. The VC4™ monitor uses ACK/NAK responses.

Hexadecimal: A type of numbering system with a base of 16. In this numerical system, numbers 10 through 15 are represented by the letters A through F respectively. The shortened version of the word hexadecimal is generally “Hex,” as in “Hex 42.” “0x” is the notation used in this manual for hexadecimal (e.g. 0x42).

Instrument: This term is used to refer to the VC4™ four-point continuous monitor.

Master: Another computer which communicates with slaves using the VC4™ protocol.

Packet: A block of information that is passed between the instrument and the equipment. A packet is made from many bytes of information.

Protocol: The manner in which data is transferred and the format used for the transfer. VC4™ protocol refers to the packets of transferred data the VC4™ instrument recognizes.

Slave: The MDA Scientific VC4™ gas monitor. A network may have several slaves.

Time-Out: The maximum amount of time allowed between the time the last byte of a packet is sent from the “master” device to the time the “slave” device responds. The time-out period for this protocol is one second.

6.13 Remote Alarm Reset Option

The remote alarm reset option provides the ability to reset the VC4™ system alarm conditions for any individual point from a remote location. There are two ways to connect the remote reset circuit:

- using an external 24V DC power supply
- using the VC4™ unit's internal 24V DC system

External wiring, power supply, and switches are user-supplied items. The following information will describe the two types of alarm reset circuits, wiring, and recommendations for installing an alarm reset system.

How it Works

The remote alarm reset option works similar to the reset button on the VC4™ system. However, the remote option will allow resetting an alarm from individual points, while the reset button on the VC4™ system resets all alarms from all points at once. An additional advantage to the remote reset option is it can be located away from the VC4™ system. In an alarm condition, momentarily pressing (0.250 seconds minimum) the remote reset button will reset the individual point's alarm. This will also reset all fault indications on the instrument.

Wiring Considerations



WARNING

RISK of electric shock. Removal of the cover over the Input/Output Module may expose hazardous voltages that are still present with power removed from the VC4™ system. Ensure all wiring installation is performed by qualified personnel following all national and local electrical codes.

A major consideration in any remote application is the reduction of electrical interferences such as RFI or other electrical noise. Follow the guidelines below when choosing the wire and routing path for your remote reset switch location.

1. External wires should be either shielded twisted pair or individually shielded wires and should be rated at 600V for isolation. The remote alarm reset contacts draw approximately 25 mA/pt (100 mA for all four points). The loop resistance (wire and switch contact resistance) should be 2000 ohms per point maximum.
2. Do not run the alarm circuit wiring in the same conduit with wiring for inductive loads such as motor controls or AC loads and lines.
3. Use switches designed for low current applications, with normally open, momentary close contacts.

- The back panel of the VC4™ system has been designed to allow low voltage wiring to exit from the unit from the right side (as you view the back panel) while higher voltage and AC wiring exits on the left. Keeping this wiring protocol reduces the risk of electrical noise causing interference to your alarm circuit. The remote inputs are located at the lower right of the relay panel as shown below.

Using an External Power Supply

The recommended method of wiring the remote alarm reset circuit is using an external (user-supplied) 24 VDC power supply. Using the external power supply provides a very efficient method of powering the alarm reset circuit, and reduces the risk of electrical interference within the VC4™ system.

A schematic of the circuit using External Power Supply.

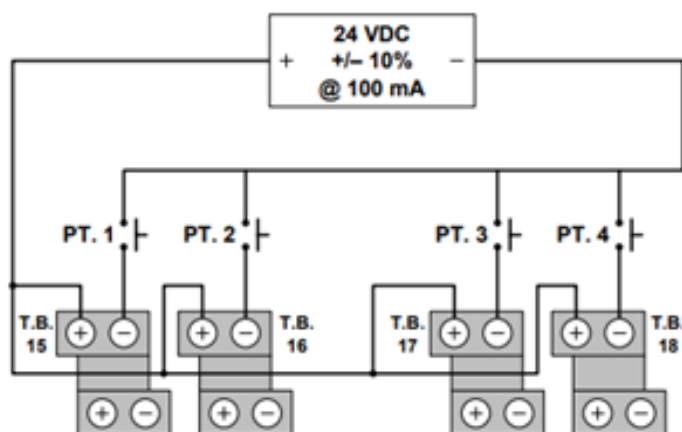

Using the VC4™ system's Internal Power Supply

Another method of installing the remote alarm reset circuit utilizes the 24 VDC supply available from the VC4™ system. While this method is usable for many applications, there are limitations to consider.

CAUTION

RISK of electric shock. To ensure the VC4™ system operates correctly, avoid EMI and RFI coupling circuits to the unit. Follow these guidelines when wiring external circuits:

- Do not connect the negative side of the remote reset terminal to building ground.
- Do not install wiring in the same conduit with any other circuitry.
- If properly grounded conduit is not used, a twisted pair shielded cable with the proper shield grounding techniques utilized must be used

A schematic of the circuit using the VC4™ system's internal 24 VDC power supply.

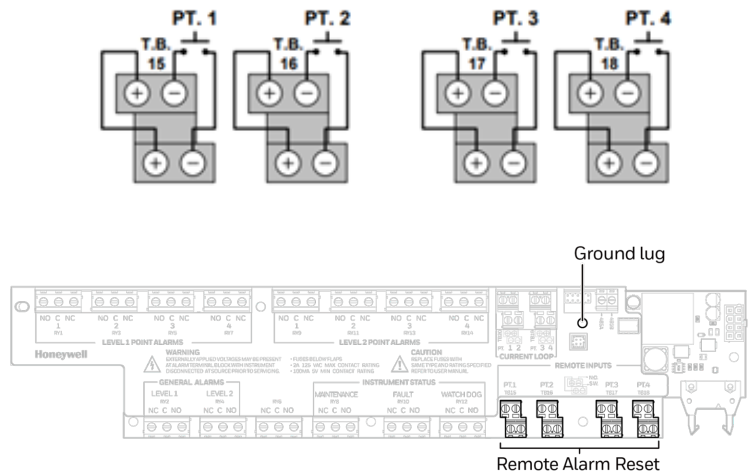

6.14 Warranty Statement

All products are warranted by Honeywell (herein referred to as 'Honeywell') to be free from defects in material or workmanship under normal use and service for a period of twelve (12) months after start-up or eighteen (18) months after shipment.

Honeywell limited warranty only extends to the sale of new and unused products to the original buyer if the products were purchased from Honeywell or from a Honeywell distributor, dealer or representative. When, in the opinion of Honeywell, a warranty claim is valid, Honeywell will repair or replace the defective product free of charge and send it or any replacement back to the buyer. A warranty claim will only be accepted if a proof of purchase is submitted and all conditions contained within this Warranty are met.

Conditions

The obligations set forth in this warranty are conditional on:

- a. proper storage, installation, calibration, use, maintenance and C with the product manual instructions and any other applicable recommendations of Honeywell; and
- b. the buyer promptly notifying Honeywell of any defect and, if required, promptly making the product available for correction. No goods shall be returned to Honeywell until receipt by the buyer of shipping instructions from Honeywell.

Warranty Return Process:

When the buyer wishes to return a product under warranty, the buyer must obtain a Service Order Number from Honeywell and if practical return the product clearly marked with the Service Order Number and a full description of the fault at buyer's expense. If no description of the fault is provided, Honeywell reserves the right to charge an investigation fee. If the product is found to be of "no fault", Honeywell reserves the right to charge an investigation fee and return same product to buyer after the investigation fee and transport cost are reimbursed in full. The investigation fee in both cases will not exceed \$320. In the case of a fixed installation or where it is not practical to return the product, the buyer must submit a written claim to Honeywell's Service Department. A service engineer will attend on site on a day rate basis. Where a valid warranty claim is identified, the faulty product will be repaired or replaced free of charge but in all cases the day rate charge will apply. If, in the course of investigation Honeywell determines that recalibration of the instrument is required, Honeywell will recalibrate the instrument and calibration charges will apply. In no event shall Honeywell's liability exceed the original purchase price paid by the buyer for the product.

Exclusions:

Excluded from any warranty claim is any product, which in Honeywell's opinion, has been misused, altered, neglected or damaged by accident or abnormal conditions of operation, handling or use, defects attributable to improper installation including but not limited to: Physical damage, warping to the main PCB as a result of crushing, component or board damage at a point of impact or as a result of dropping of the unit from above the stated certification height, fluid ingress as a result of submergence beyond the I.P. rating specification, poisoning or inhibition of sensor, any damage or defects attributable to repair of

the product by any person other than an authorized dealer or Honeywell's affiliate within the Honeywell group or installation of unapproved parts on the product. Excluded are consumable items such as dry-cell batteries, filters and fuses or routine replacement parts due to the normal wear and tear of the product. After the effective date this warranty supersedes all existing warranty statements and Honeywell makes no other warranty expressed or implied except as stated above.

6.15 Contact Us

Americas

Honeywell
405 Barclay Boulevard
Lincolnshire, Illinois
60069, USA
is.gas.techsupport@honeywell.com
Tel: +1 847 955 8200
Toll free: +1 800 538 0363

Honeywell

Building #1, 555 Huanke Road
Zhangjiang Hi-Tech
Park Pudong New Area Shanghai, China
Tel: 021-80386800

Honeywell (Beijing) RAE Systems (Beijing) Inc

A1 Building, C&W Industry Zone, No.14
Jiu Xianqiao
Road, Chaoyang District, Beijing
Tel: 010-56696000

Honeywell

6F-2, No.8, Ziqiang S. Road, Chupei City
30264,
Taiwan
Tel: +886-2-29569986

Technical Services

North America:
is.gas.techsupport@honeywell.com
Greater China: gaschina@honeywell.com
Taiwan: analytics.tw@honeywell.com
Europe, Middle East and Africa:
ha.emea.service@
honeywell.com
America: ha.us.service@honeywell.com
www.honeywell.com



Europe, Middle East, and Africa Life Safety Distribution AG

Javastrasse 2
8604 Hegnau Switzerland
Tel: +41 (0)44 943 4300
gasdetection@honeywell.com

India

Honeywell India Pvt. Ltd.
Unitech Trade Center, Sector - 43,
Block - C, Sushant Lok - 1,
Gurgaon - 122002, Haryana, India
Tel : +91 124 4971930

Asia Pacific

Honeywell Asia Pacific
#508, Kolon Science Valley (I)
187-10 Guro-Dong, Guro-Gu
Seoul, 152-050 Korea
Tel: +82 (0)2 6909 0300

Middle East, Africa

Life Safety Distributor AG
Javastrasse 2
8604 Hegnau
Switzerland
Tel: +41(0)44 943 4300

User Manual 3013-2582-001

Language: English

Revision B

@ 2023 Tuesday, October 10, 2023

CoE CDMX