

National Aeronautics and Space Administration



James Webb Space Telescope

# Webb Telescope Fun Pad

*PACKED WITH THINGS TO DO!*

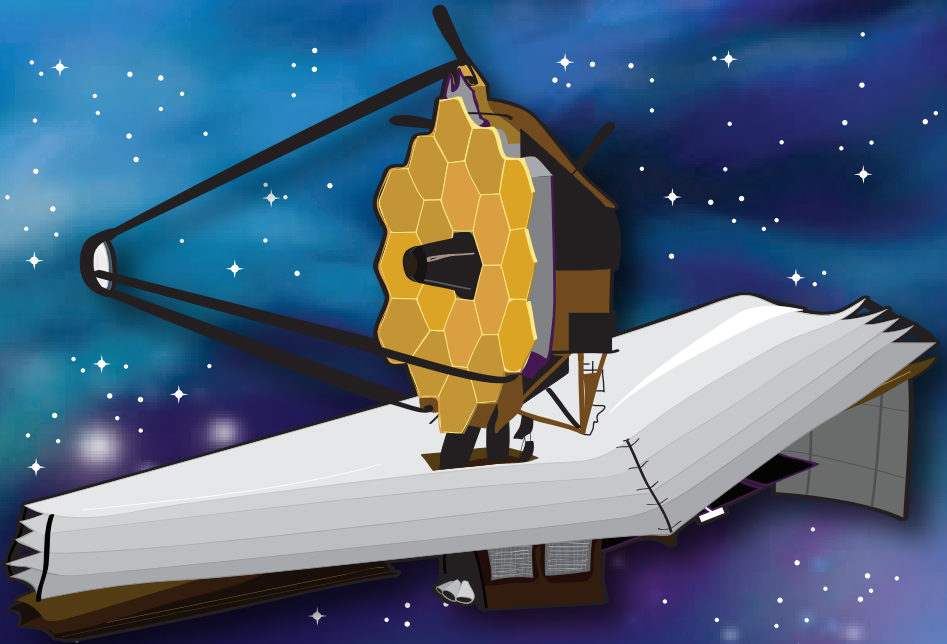

[www.nasa.gov](http://www.nasa.gov)

## **Introduction**

This Fun Pad is designed for grades K-4 and is divided into sections:

- Pages 1-12: Contains general information about the James Webb Space Telescope.
- Pages 13-27: Contains activities for students in grades K-2.
- Pages 28-46: Contains more challenging activities and is best suited for students in grades three and four.
- This Fun Pad is best completed with adult guidance.

## **Education Standards**

AAAS Benchmarks: Project 2061

12. Habits of Mind

D. Communication Skills

By the end of the 2nd grade, students should be able to:

- Describe and compare real-world objects in terms of number, shape, texture, size, weight, color, and motion.
- Draw pictures that portray some features of the thing being described.
- Interpret pictures, drawings, and videos of the real-world objects and events.

By the end of the 5th grade, students should be able to:

- Interpret written descriptions of real-world objects and events.

## **Common Core Standards for English Language Arts**

Reading: Informational Text, Kindergarten

With prompting and support, describe the relationship between illustrations and the text in which they appear (e.g., what person, thing, or idea in the text and illustration depicts). (CCSS.ELA-Literacy.RI.1.10)

Reading: Informational Text, Grade 1

With prompting and support, read informational texts appropriately complex for grade 1. (CCSS.ELA-Literacy.RI.2.10)

Reading: Informational Text, Grades 2-3

By the end of the year, read and comprehend informational texts, including history/social studies, science, and technical text, in the grades 2-3 text complexity band proficiently, with scaffolding as needed at the high end of the range. (CCSS.ELA-Literacy.RI.3.10)

Reading: Informational Text, Grades 4

By the end of the year, read and comprehend informational texts, including history/social studies, science, and technical text, in the grades 2-3 text complexity band proficiently, with scaffolding as needed at the high end of the range. (CCSS.ELA-Literacy.RI.4.10)

# WEBB TELESCOPE

*Mission logo*



This is the Webb telescope mission patch. The National Aeronautics and Space Administration (NASA), the European Space Agency (ESA), and the Canadian Space Agency (CSA) are working together to create and build this new telescope.

# JAMES WEBB

*A man and his telescope*



The Webb telescope was named after the person who was the head of NASA in the 1960s. Though he is most commonly linked to the Apollo Moon Program, James Webb was the one who thought NASA should be doing more science. Because he inspired NASA's successful science program, it is only fitting that the next generation space telescope bears his name.



# HUBBLE IN SPACE

*Connect the dots to see Hubble*

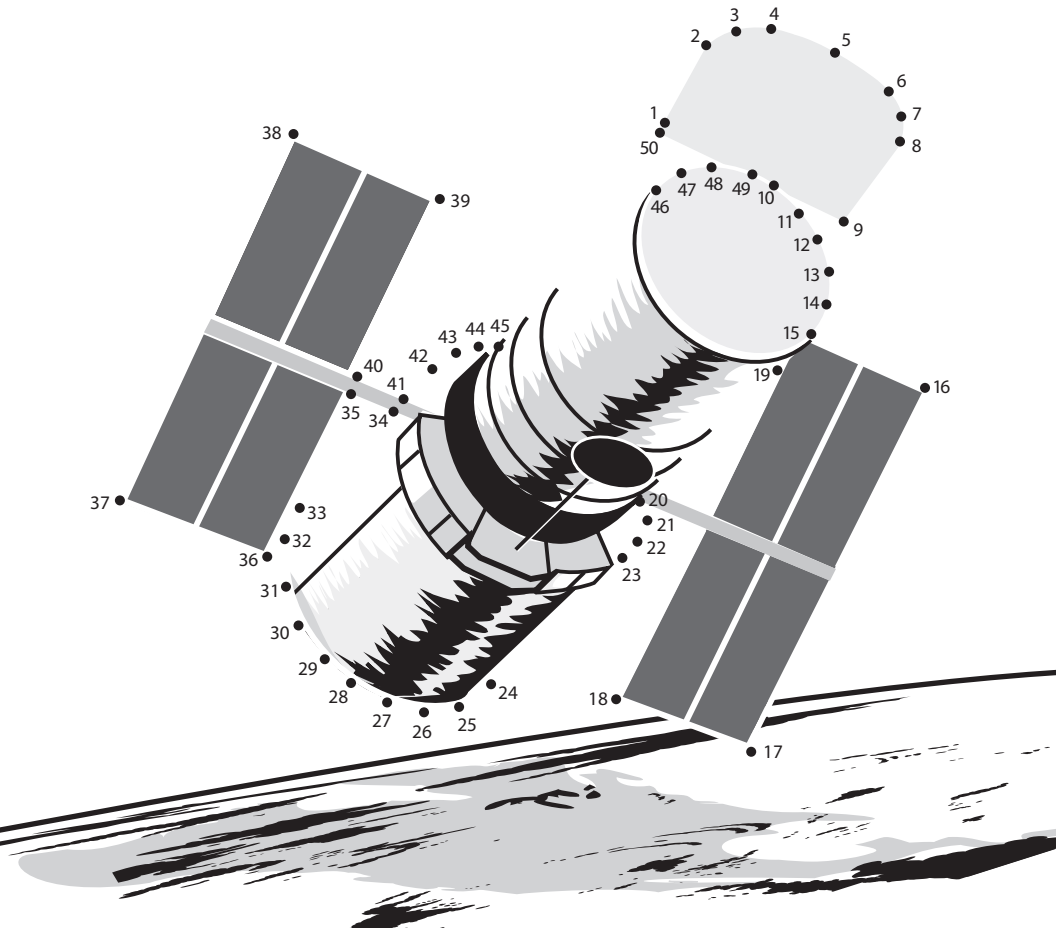

The Hubble Space Telescope was launched into space in 1990. After more than 20 years and a few upgrades, Hubble keeps sending back beautiful images and helping scientists to learn about the universe. The Webb telescope will be the “big brother” to Hubble and scientists expect great discoveries and wonderful images from the Webb telescope.

# LEARN ABOUT WEBB TELESCOPE

## *Fun facts*

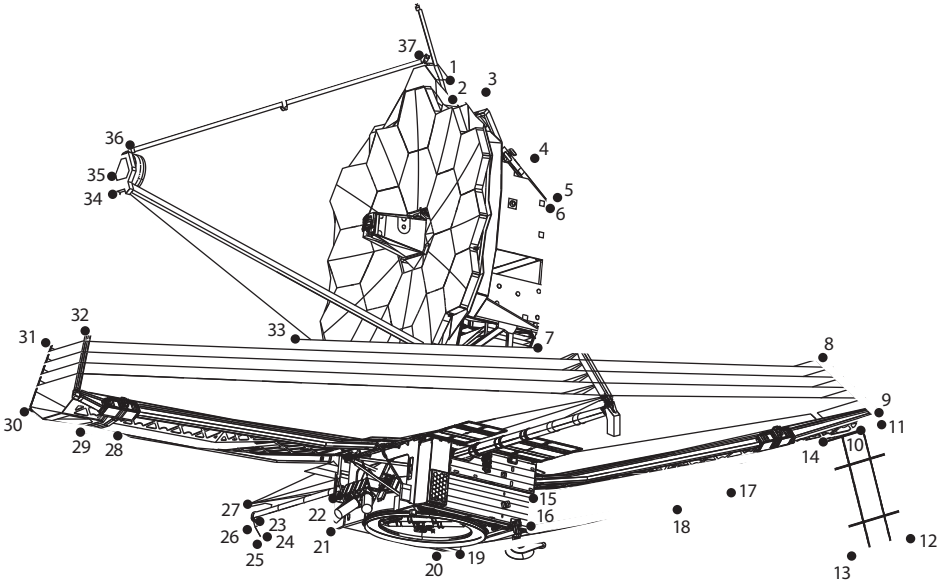

The Webb telescope will have the largest mirror ever placed in space, so large that for it to fit in the rocket, it will have to be folded like origami. The five layer sunshield, the size of a tennis court, will protect the telescope from the light and heat of the Sun, Earth, and Moon. The sunshield adds protection to the telescope that is equivalent to SPF 1,000,000. Webb will be such a powerful telescope that it will be able to see a penny from 24 miles away.

The Webb will be a giant leap forward in our quest to understand the universe and our origins. The Webb will examine every phase of cosmic history: from the bright glows after the Big Bang to the formation of galaxies, stars, and planets to the evolution of our own solar system.

# MIRROR... MIRROR

*Count and write in the number of segments in the Webb mirror*

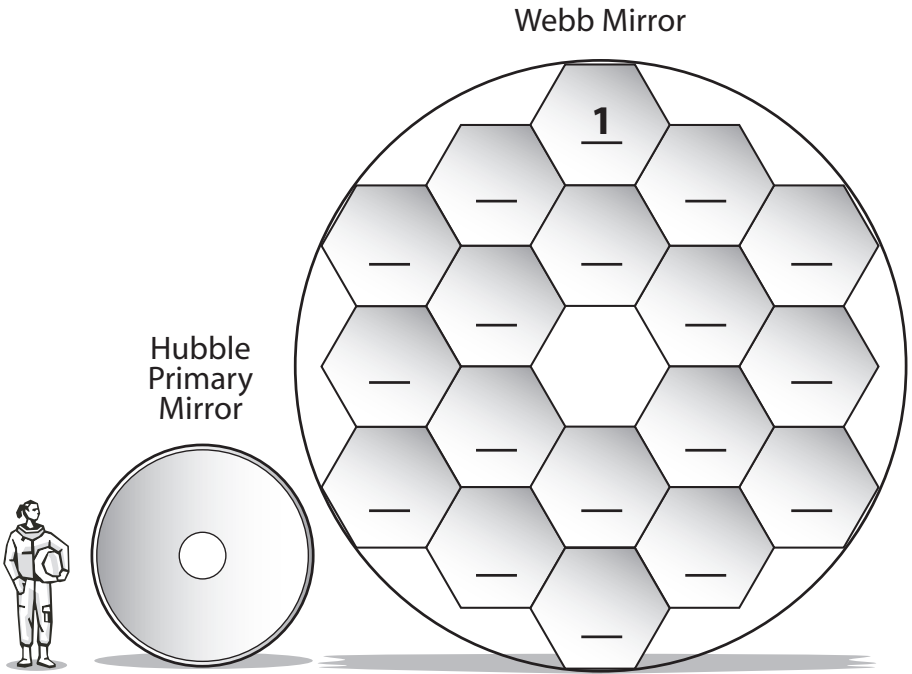

The Webb mirror is very large and will collect 7 times more light than Hubble's mirror. However, a large, solid mirror (like Hubble's) would be too heavy to launch into space, Webb's is made up of 18 mirror segments that will act as one. The mirror segments will be folded up and put inside the rocket for launch.

# A NEW IDEA TO SEE BETTER

*How microshutters work*



One of the science instruments on the Webb telescope has a new way of looking at faint, far away galaxies. It uses something called microshutters. To get an idea of how this works, think about how you would make something far away look clearer—just squint! By squinting, your eyelashes block out the light closest to you. This is very similar to how microshutters work.

# READY TO LAUNCH

*Find out how Webb folds up and fits into the launch rocket nose cone*

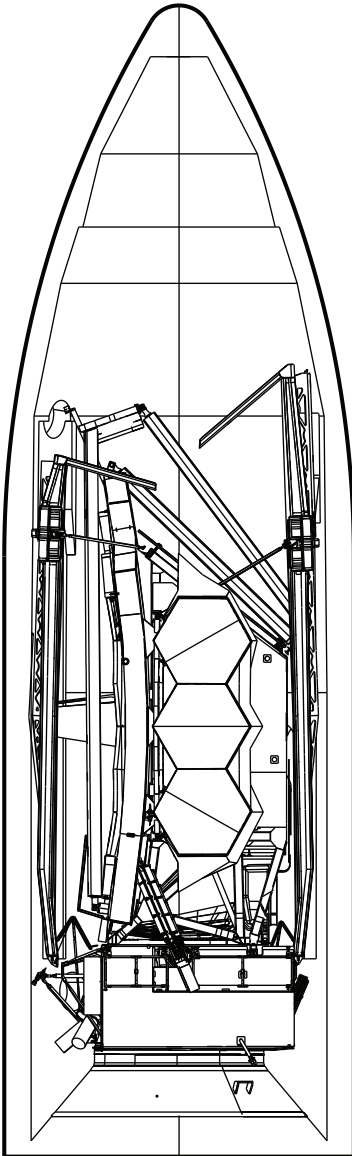

The Webb telescope is as wide as a tennis court and as tall as a 3-story building.

It is too big to fit into a rocket, so Webb will be folded up like origami and tucked inside the nose of the rocket.

Once in space, the telescope will open like a transformer.

# WEBB TELESCOPE IN SPACE

*How far away will it be?*

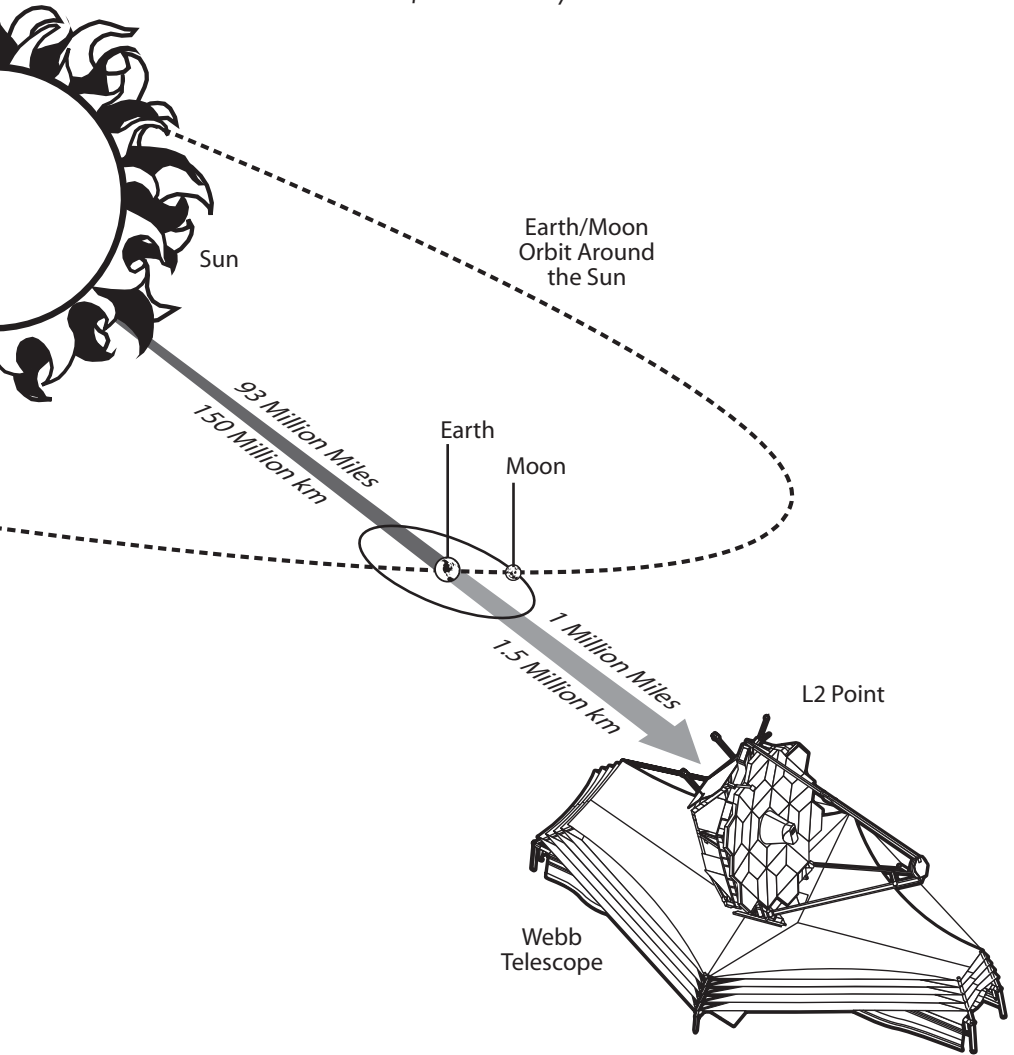

The Webb telescope will live 1 million miles from Earth. This is nearly 4 times the distance between the Earth and the Moon.

# DOWNLOADING DATA

*How does the information get to us?*

There are three stages in getting the data from Webb to the ground:

- 1** The Webb gathers the data
- 2** The Webb sends the data down to ground stations on Earth
- 3** The data is sent to the Science Center

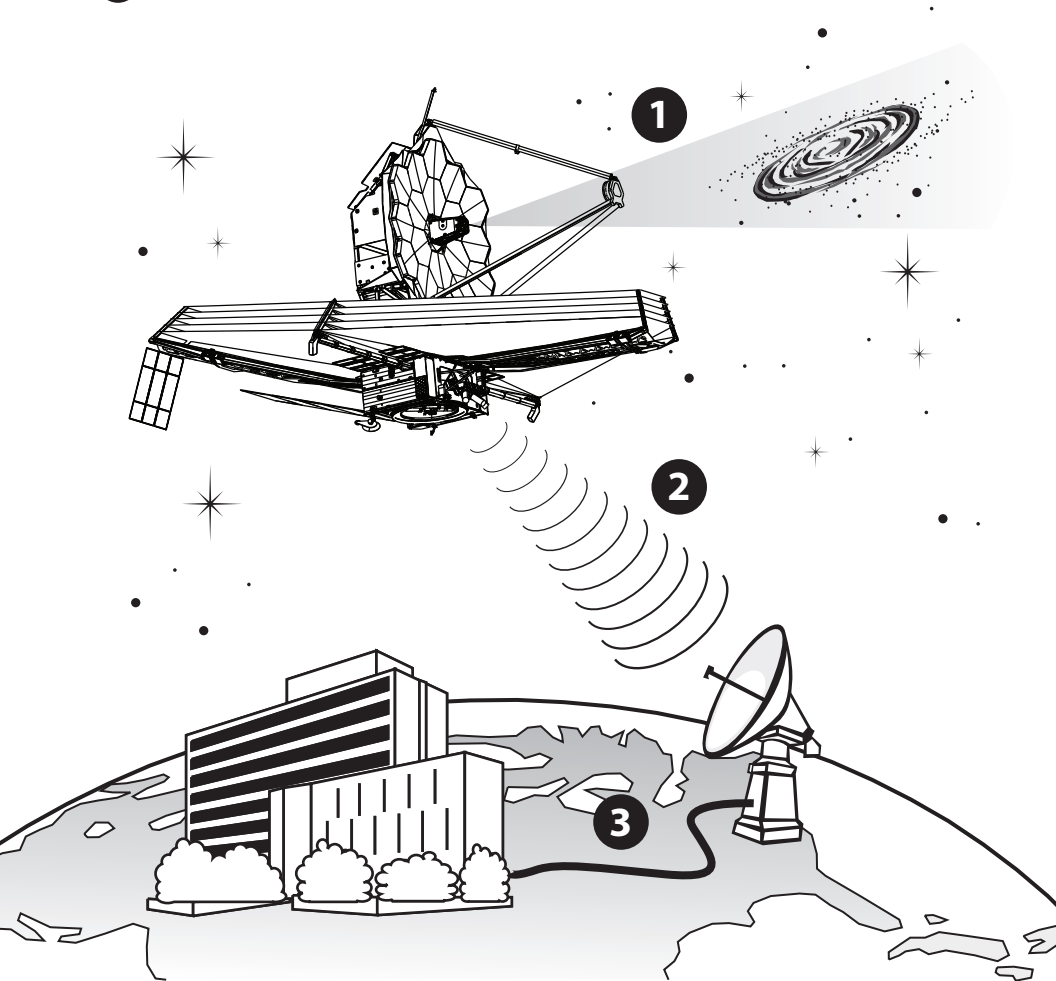

# INFRARED IMAGING

*How Webb will see objects in space*

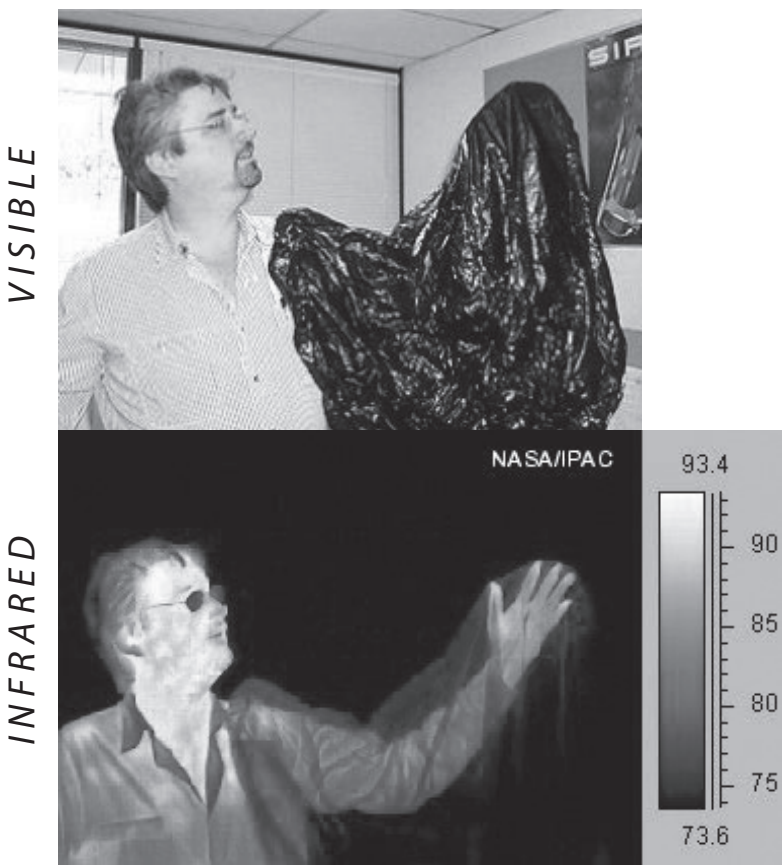

Infrared light can be seen through some materials that visible light cannot. Notice that in the visible light image, you cannot see the man's hand in the black bag. With an infrared camera, however, we can detect the heat from the man's arm and hand and thus "see" through the bag. Similarly, Webb can detect the infrared light from young stars hidden in clouds and dust.



# SEEING IN A NEW LIGHT

## *Infrared facts*

Can you tell what animals are in these pictures?

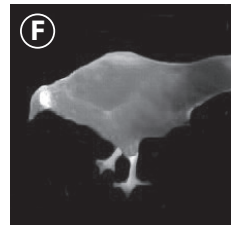
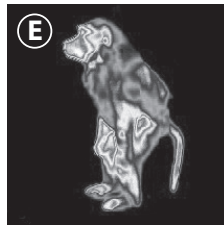
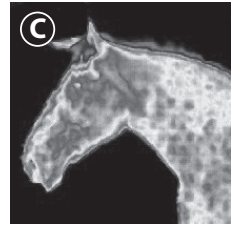
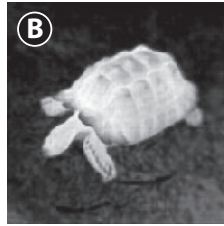
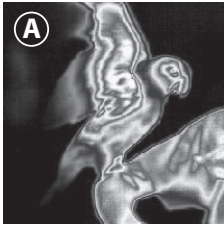

A. \_\_\_\_\_

D. \_\_\_\_\_

B. \_\_\_\_\_

E. \_\_\_\_\_

C. \_\_\_\_\_

F. \_\_\_\_\_

To make infrared pictures like the ones above, we can use special cameras that sense heat. Many things besides people and animals give off infrared light — the Earth, Sun, and far away things like stars and galaxies do also!

# MAKE A MATCH

*Draw a line between the matching pictures and words*

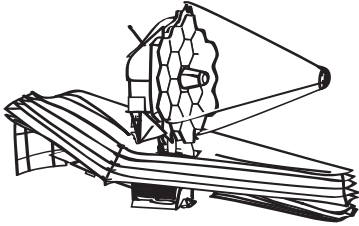

Hubble  
Telescope



Galaxy



Webb  
Telescope

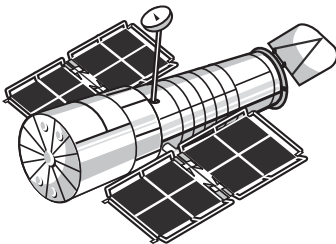

Earth

# DRAW A FACE ON THE STAR

*Make it sad, mad, or glad!*

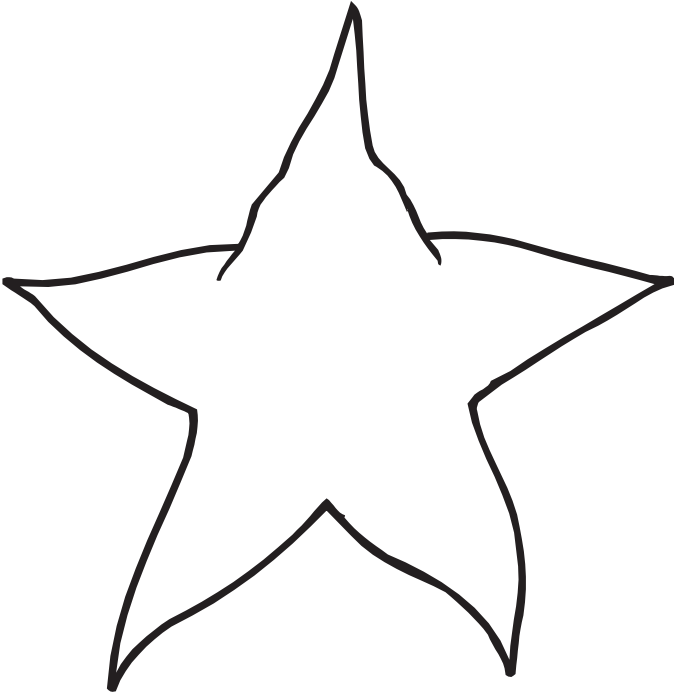

**SAD**



**MAD**



**GLAD**

# LOOKING DIFFERENT

*Circle the one that is not the same*

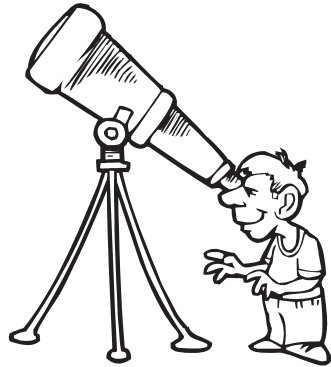
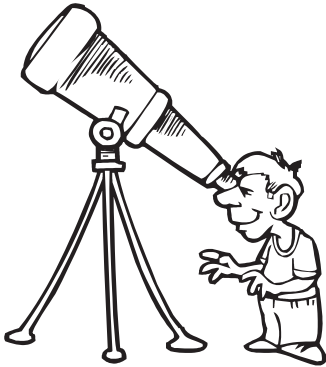
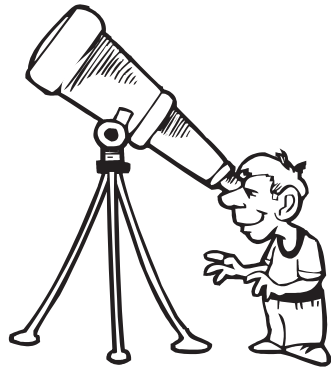
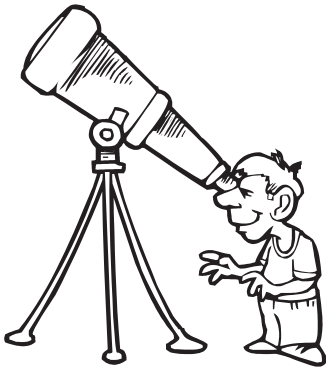
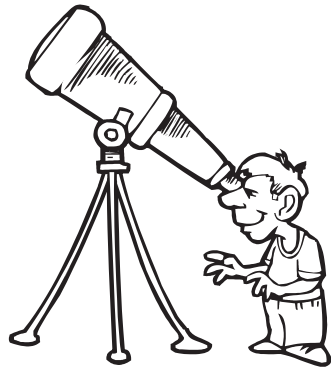
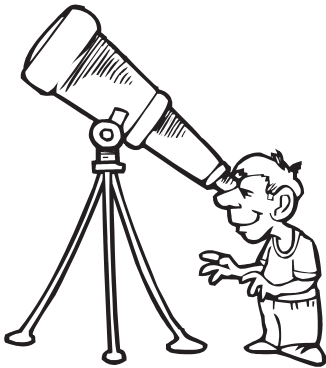

# COLOR THE WEBB TELESCOPE

*Make this a work of art and space*

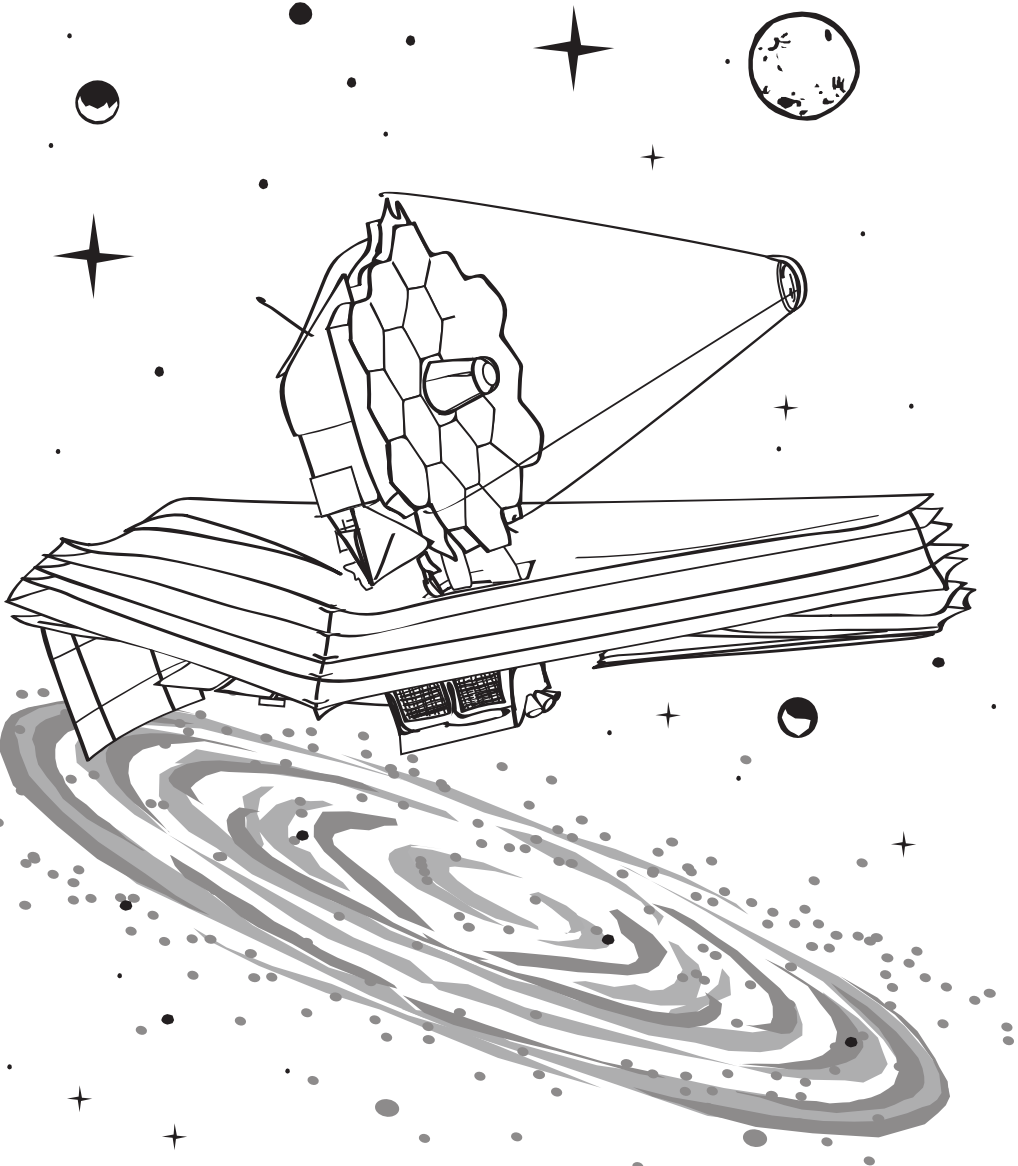

# MIX AND MATCH

*Draw a line from the shape to its shadow*

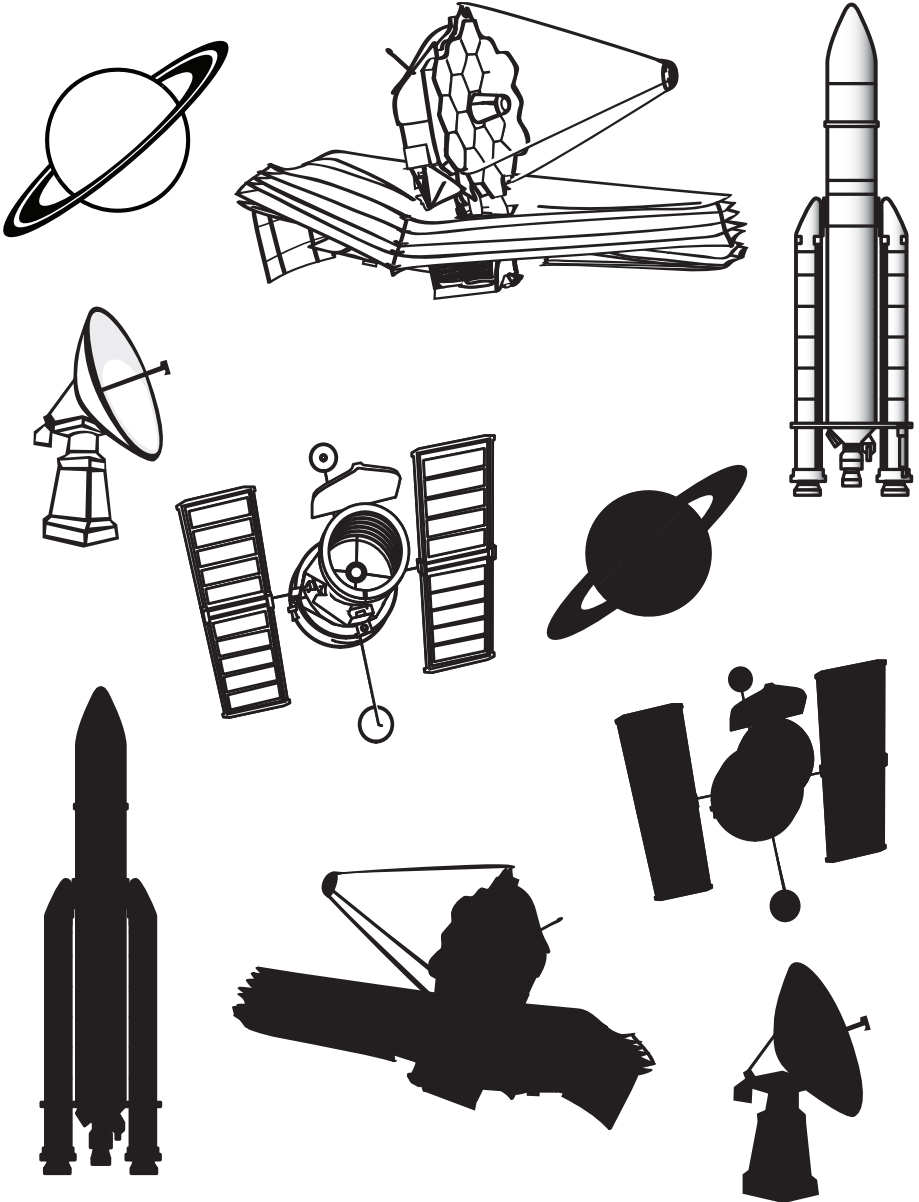

# MOON DOGGIE

Color-by-number space dog

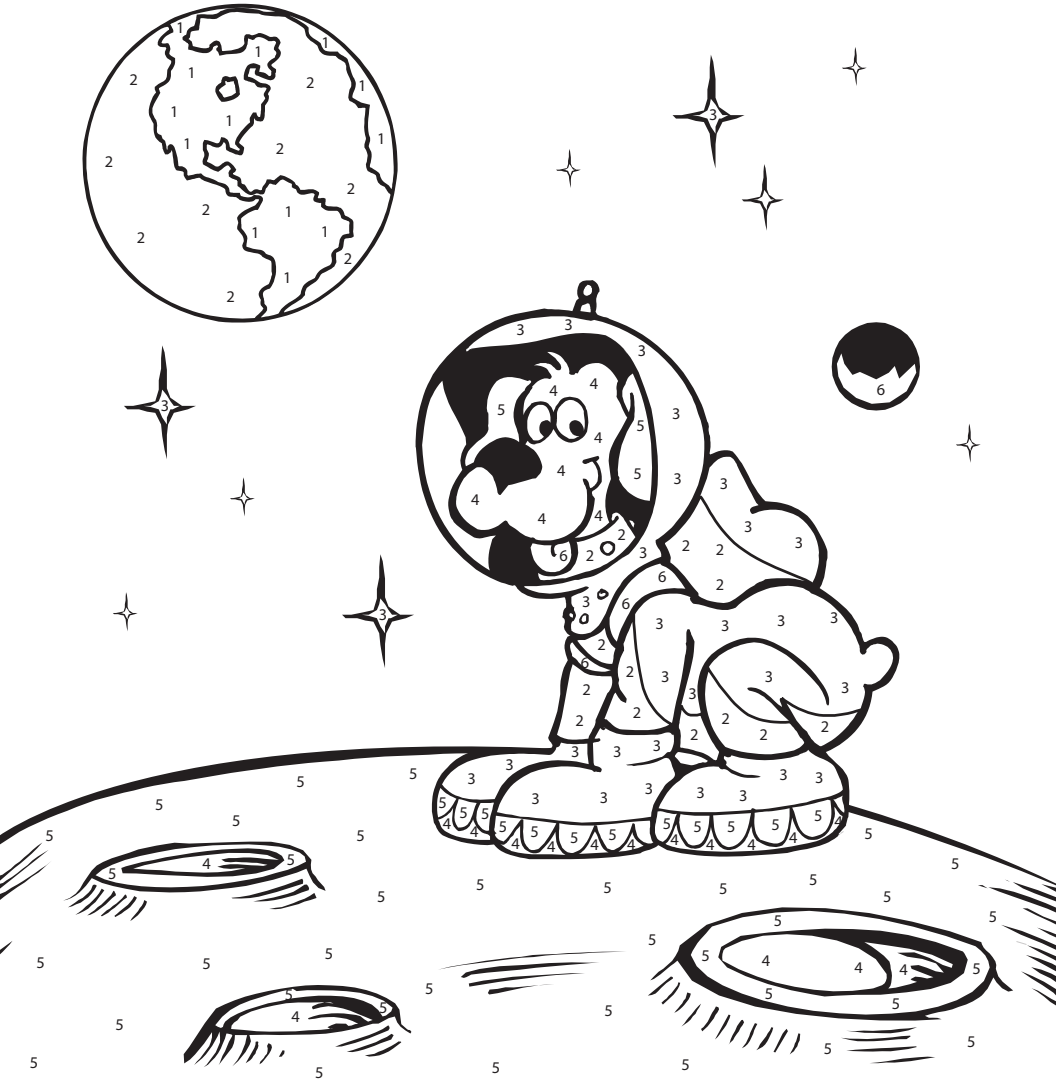

- |                |           |
|----------------|-----------|
| 1 - Green      | 4 - Brown |
| 2 - Blue       | 5 - Tan   |
| 3 - Light Blue | 6 - Red   |

# IS IT FREEZING IN SPACE?

*Connect the dots to see a cold spot*



The snowman's temperature is around 27° Fahrenheit (-3° Celcius).  
The Webb telescope has to stay at -400° F (-240° C) below zero.



# WHAT COMES NEXT?

Draw the picture that comes next in each row

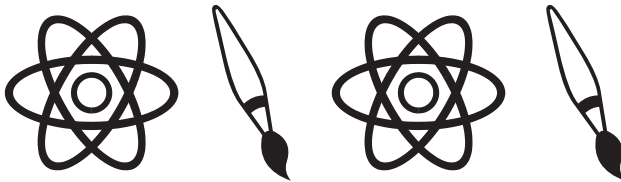
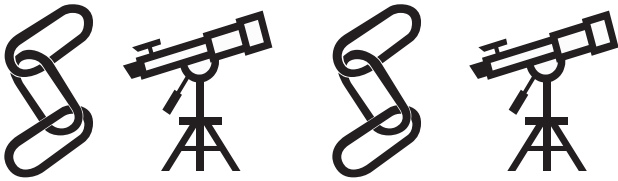

# DRAWING THE LINE

*Draw a line between the pictures and the words that match*

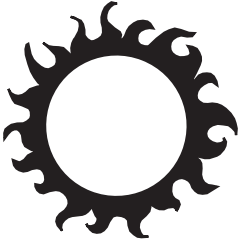

Webb  
Telescope

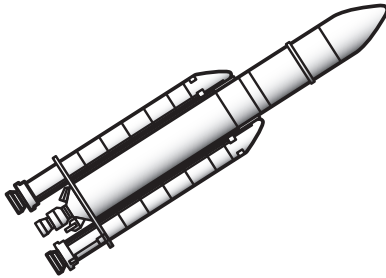

Sun



Rocket

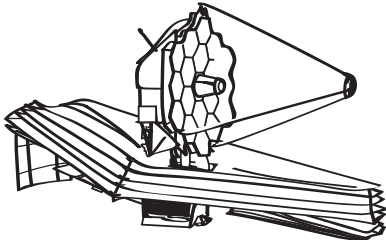

Hexagon

# RHYME TIME

What other words rhyme with STAR?



-----

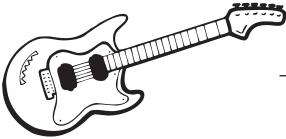

-----



-----



-----

# ASTRONAUT COLOR BY NUMBER

*Help the astronaut place the flag*

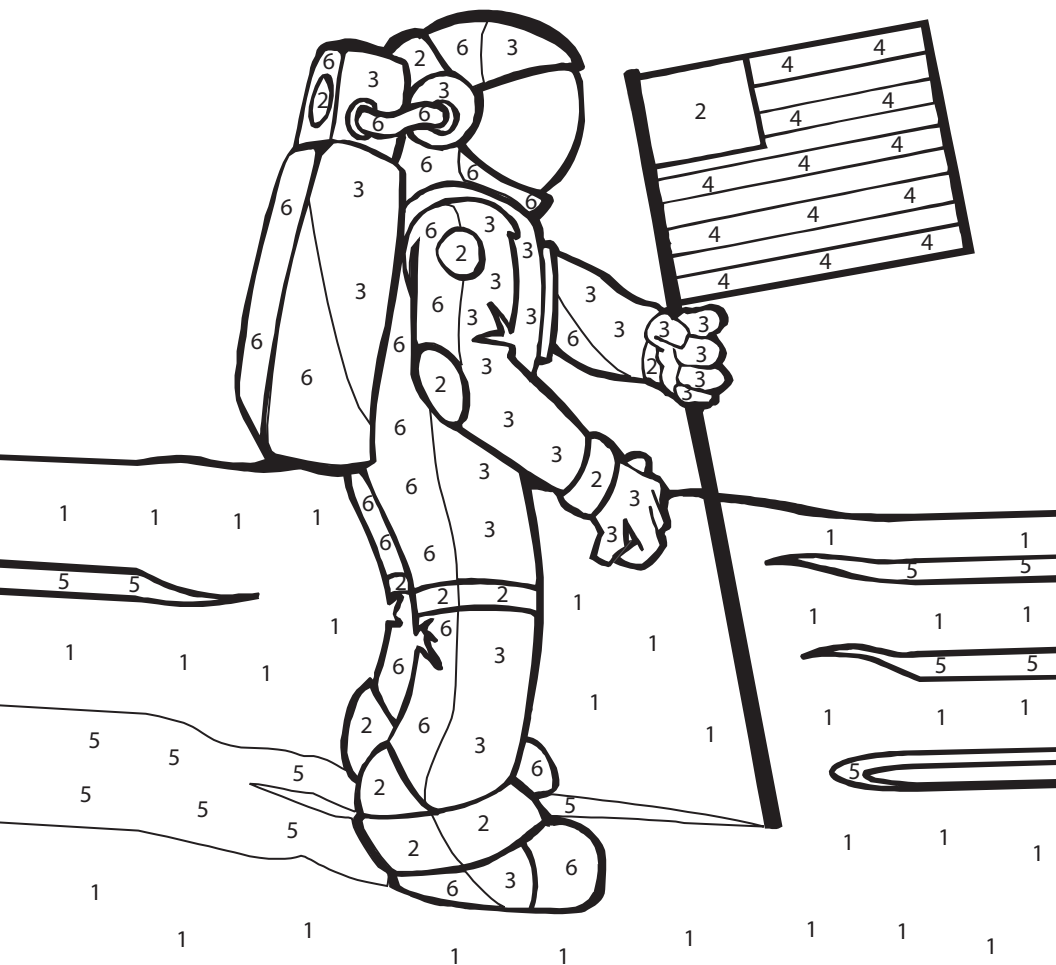

- |          |          |               |
|----------|----------|---------------|
| 1 - Tan  | 3 - Gray | 5 - Brown     |
| 2 - Blue | 4 - Red  | 6 - Dark Gray |

# ONE MORE WORD

*What word replaces the question mark?*

Webb [?]

Hubble Space [?]

Ultraviolet [?]

Optical [?]

Radio [?]

X-ray [?]



# DRAWING LESSON

*Draw your own space telescope*

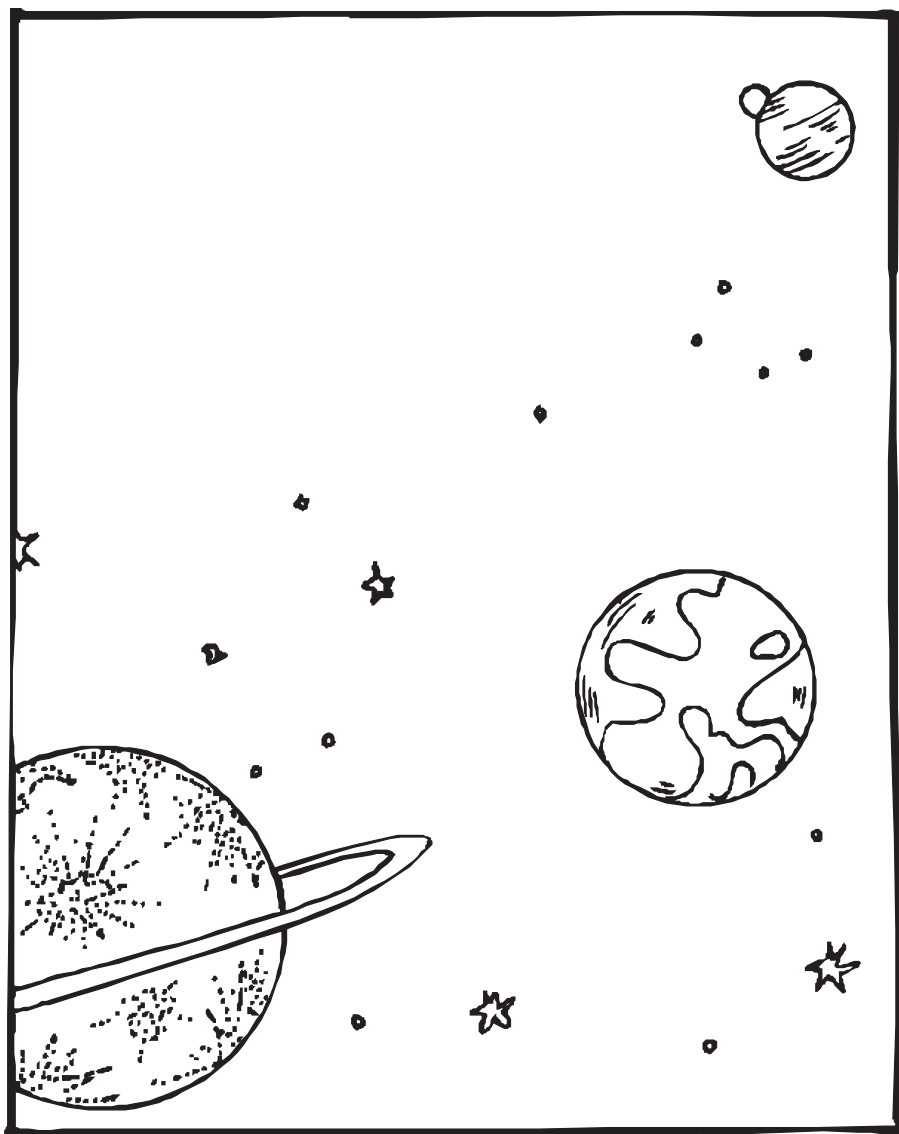

# SPACE STUFF

Unscramble the letters to spell space words

XLAYGA

-----

HRATE

-----

NTEPAL

-----

NUHALC

-----

UNS

-----

RSTA

-----

UDLCO

-----

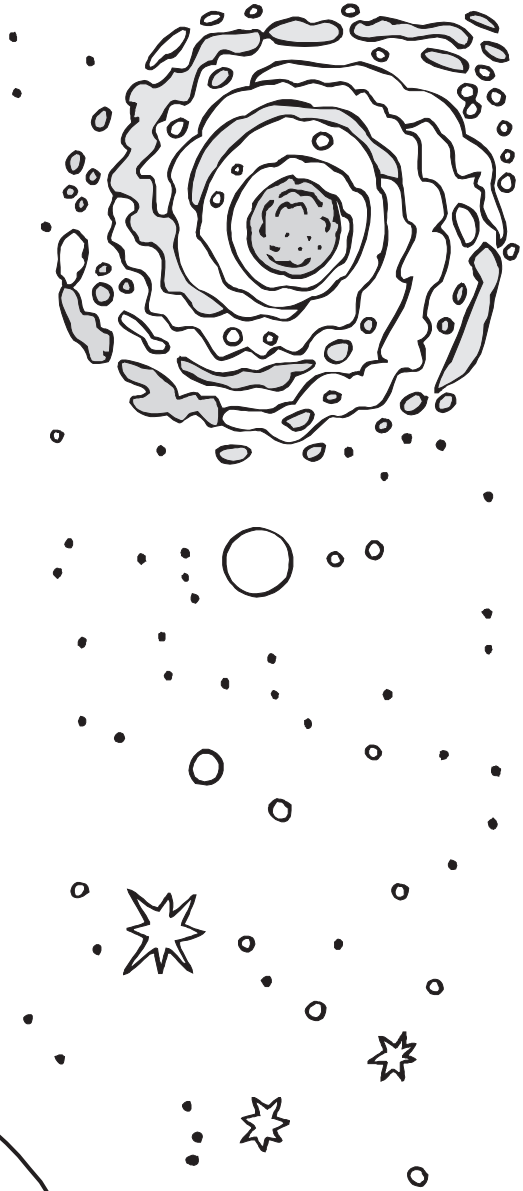

Galaxy, Earth, Planet, Launch, Sun, Star, Cloud

# ORDER UP!

*Alphabetize these space-related words*

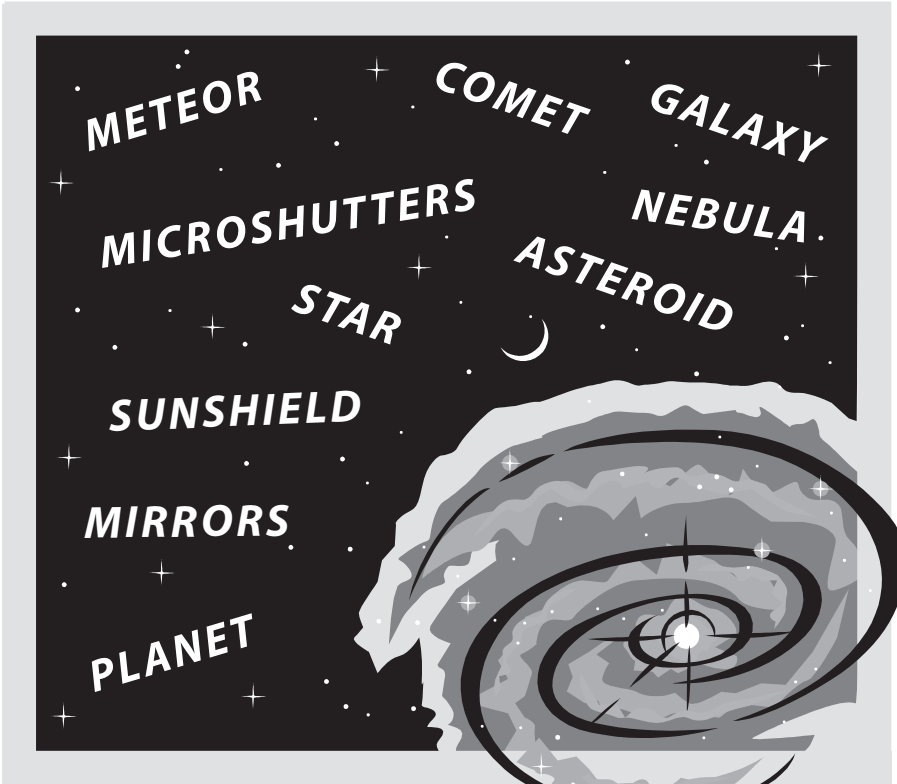

1. \_\_\_\_\_

6. \_\_\_\_\_

2. \_\_\_\_\_

7. \_\_\_\_\_

3. \_\_\_\_\_

8. \_\_\_\_\_

4. \_\_\_\_\_

9. \_\_\_\_\_

5. \_\_\_\_\_

10. \_\_\_\_\_

Asteroid, Comet, Galaxy, Meteor, Microshutters, Mirrors, Nebula, Planet, Star, Sunshield



# A STRONG ELEMENT

*How many words can you spell using the letters in BERYLLIUM?*

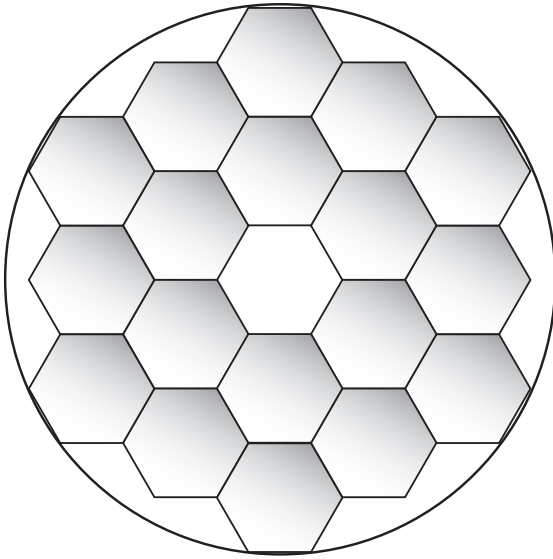

1. \_\_\_\_\_

6. \_\_\_\_\_

2. \_\_\_\_\_

7. \_\_\_\_\_

3. \_\_\_\_\_

8. \_\_\_\_\_

4. \_\_\_\_\_

9. \_\_\_\_\_

5. \_\_\_\_\_

10. \_\_\_\_\_

Beryllium is a steel grey, strong, light-weight metal that is used to make the Webb's mirrors and optics.

# THE PLANETS AROUND US

*Name the planets in our Solar System*

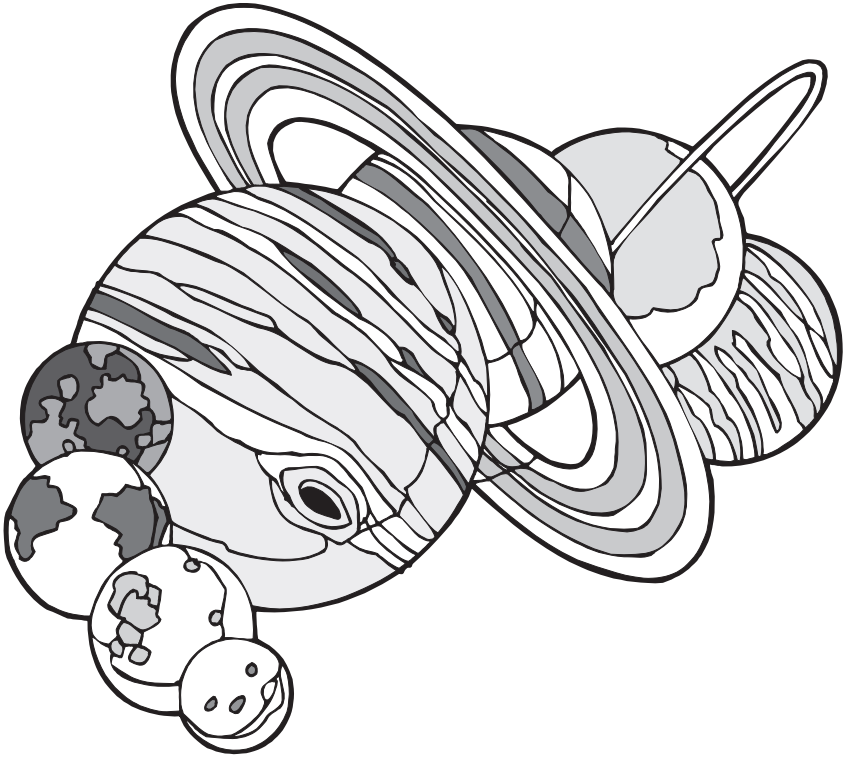

M \_\_\_\_\_

J \_\_\_\_\_

V \_\_\_\_\_

S \_\_\_\_\_

E \_\_\_\_\_

U \_\_\_\_\_

M \_\_\_\_\_

N \_\_\_\_\_

*HINT: My Very Educated Mother Just Served Us Noodles*

Mercury, Venus, Earth, Mars, Jupiter, Saturn, Uranus, Neptune

# FIND SOME SHADE

How many times can you find the word "sunshade"?

S	U	A	S	U	S		
U	N	H	U	E	S		
N	S	A	N	E	A		
S	U	N	S	H	A	D	E
H	N	A	H	S	N	U	S
A	S	H	A	U			
D	H	A	D	A			
E	A	A	E	H			
S	D	N	S				
U	E	A	E				
N	U	A	E				

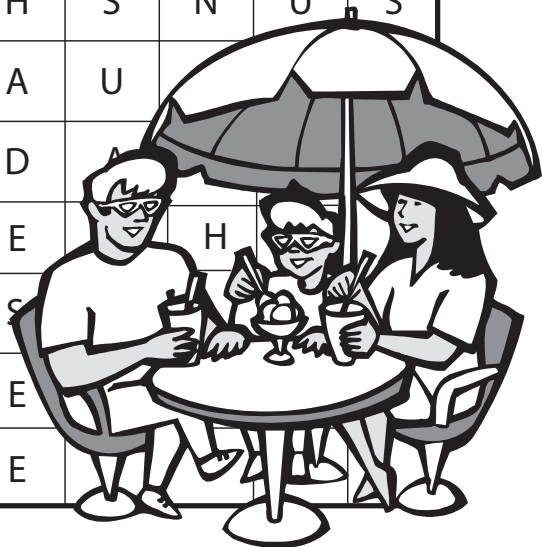
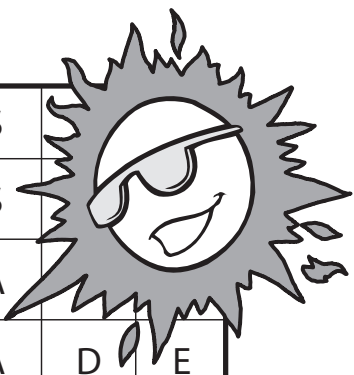

The large sunshield (sunshade) will protect the Webb telescope from getting hot by direct sunlight, allowing it to cool down to a temperature  $-400^{\circ}$  below zero Fahrenheit (or  $-240^{\circ}$  Celcius).

# CROSSWORDS

Answer the clues to fill in the word

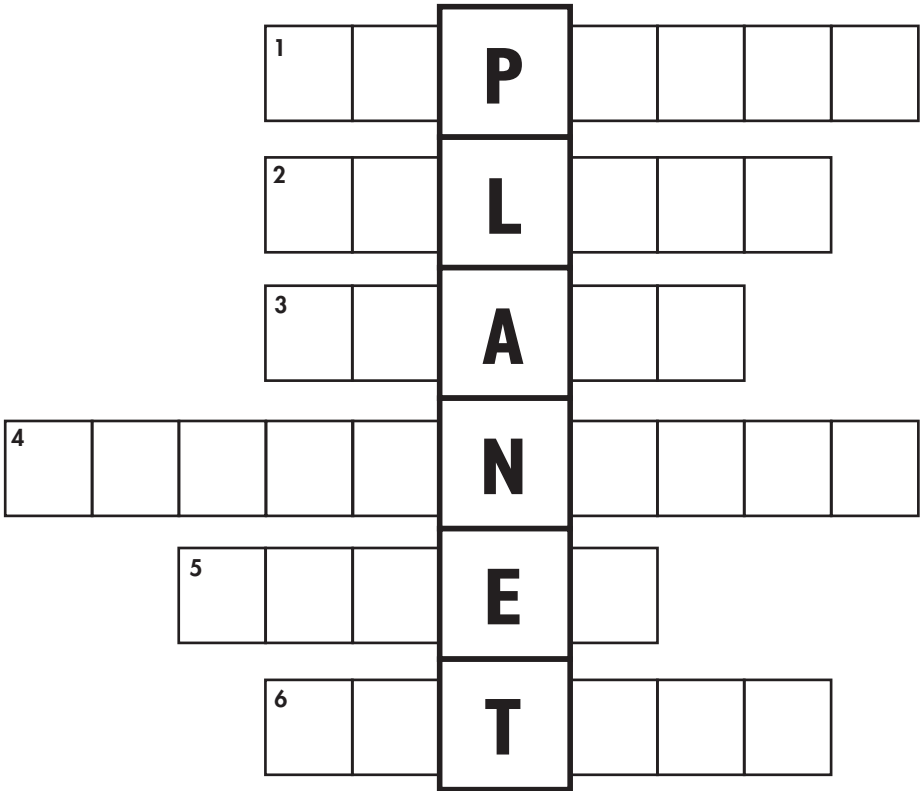

## CLUES:

1. The fifth planet from the Sun, the largest and most massive in the solar system
2. Our solar system is in the Milky Way \_\_\_\_\_
3. Celestial bodies that are seen as points of light in the night sky
4. A scientist who studies planets, stars, and galaxies
5. A small extraterrestrial body that is a frozen mass that travels around the Sun
6. Any small solid extraterrestrial bodies that hits the Earth's atmosphere

# LOOK FOR WEBB TELESCOPE WORDS

*Search and find*

D	E	R	A	R	F	N	I
D	J	D	L	E	I	H	S
O	E	W	A	V	E	T	G
B	E	T	S	K	Y	R	A
S	P	E	C	T	R	A	L
E	O	T	A	T	L	E	A
R	C	E	N	U	S	T	X
V	S	L	B	E	N	H	Y
A	U	E	N	D	E	G	H
T	N	S	C	A	F	I	C
O	O	C	T	A	M	L	N
R	D	O	L	A	P	O	U
Y	N	P	G	<b>N</b>	<b>A</b>	<b>S</b>	<b>A</b>
E	N	E	R	G	Y	E	L

---

EARTH  
ENERGY  
GALAXY  
HEAT  
IMAGE

INFRARED  
LAUNCH  
LIGHT  
✓NASA

NEBULA  
OBSERVATORY  
SCAN  
SCOPE

SENSOR  
SHIELD  
SKY  
SPACE

SPECTRAL  
SUN  
TELESCOPE  
WAVE

# COMPARE THE SIZE

*Hubble or Webb: Which is bigger?*

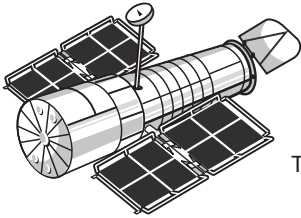

Hubble  
Space  
Telescope

The Hubble Space Telescope is about the size of a large tractor trailer truck.

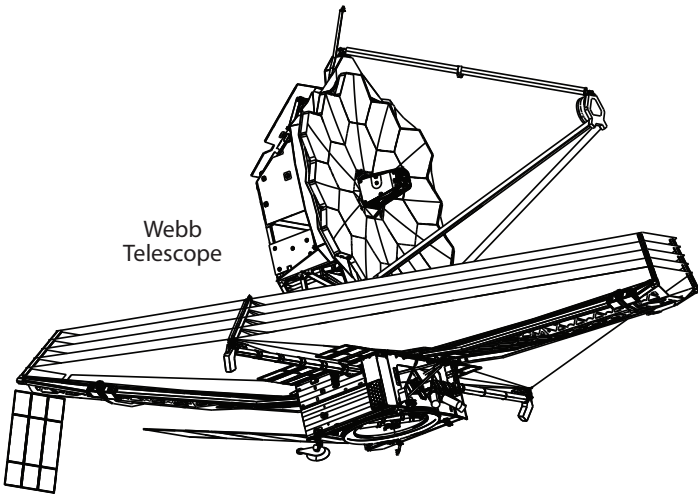
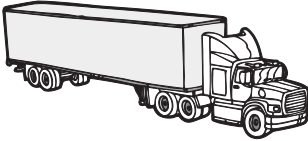

Webb  
Telescope

The Webb telescope's sunshield is almost as big as a Boeing 737 airplane!

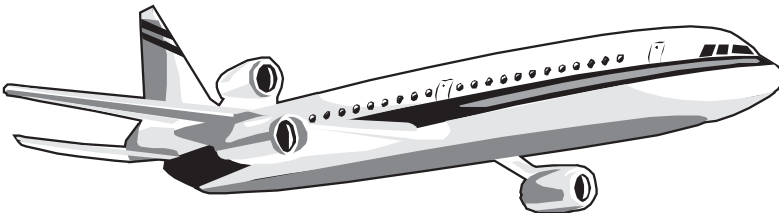

Webb Telescope

# CROSSWORDS

*Answer the clues to fill in the word*

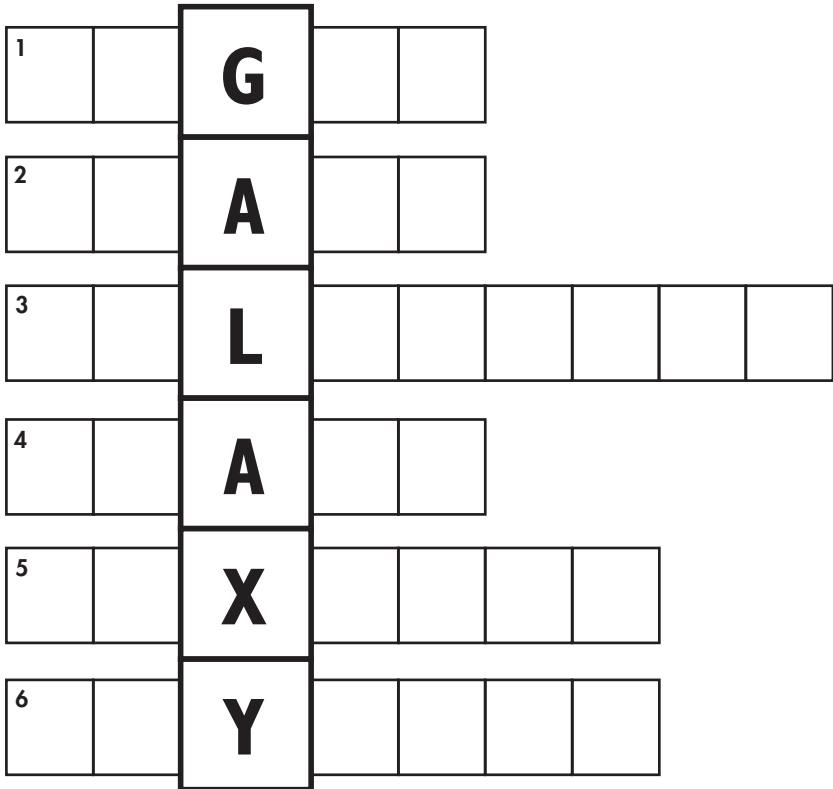

## CLUES:

1. What the Sun, a lamp, or a beacon gives off
2. The Webb telescope will be launched into outer \_\_\_\_\_
3. Webb \_\_\_\_\_ or Hubble Space \_\_\_\_\_
4. Heavenly bodies that look like points of light in the sky
5. The shape of Webb's eighteen mirrors
6. Equipment that is launched on board the Shuttle or rockets for a mission in space

# WAY OUT OF HERE

*Get Webb to the launch pad*

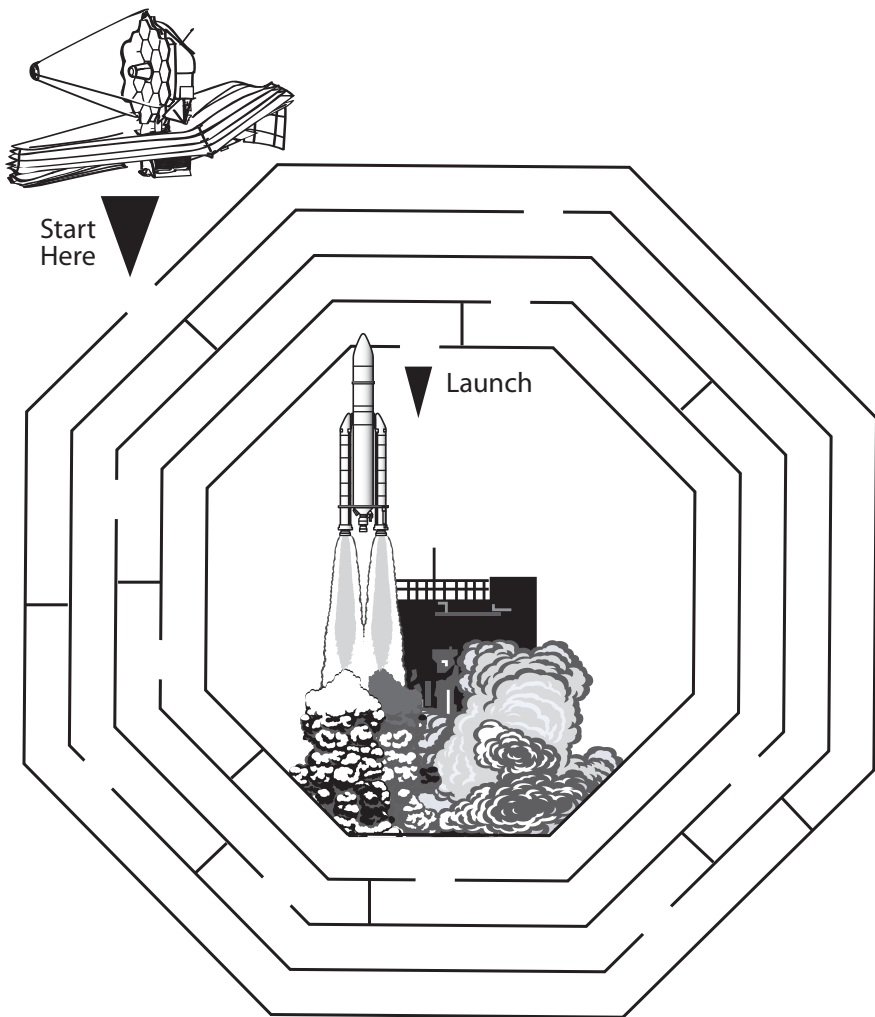

The Webb telescope will be launched on an Ariane-5 rocket in South America.



# SEARCHING FOR WORDS

*Circle the Webb telescope words*

C	A	M	E	R	A	L	Y
P	N	I	R	O	I	K	E
A	S	C	O	R	S	N	P
Y	A	R	R	A	C	R	G
L	C	O	R	T	I	A	P
O	O	S	I	S	T	O	Y
A	S	H	M	A	P	R	M
D	M	U	D	R	O	B	O
E	O	T	<b>N</b>	C	R	I	N
L	S	T	K	<b>A</b>	L	T	O
B	B	E	W	G	<b>S</b>	I	R
B	T	R	A	W	N	<b>A</b>	T
U	E	S	J	D	E	M	S
H	T	E	N	A	L	P	A

✓ NASA  
ARRAY  
ASTRONOMY  
CAMERA  
COSMOS

DATA  
GAS  
HUBBLE  
LENS  
MICROSHUTTERS







MIRROR  
ORBIT  
OPTICS  
PAYLOAD  
PLANET

PRISM  
RING  
ROCKET  
SKY

STAR  
SUN  
WEBB

# WEBB HAS EIGHTEEN...

Find the answer by writing the first letter of each object in the box beside the picture

Moon, Ice Cream, Rabbit, Rocket, Ring, Saturn = MIRRORS

# SPACE COUNTING

*How many times can you find the word "space"?*



S	P	A	C	E	C	E	S
P	P	C	A	E	S	P	C
A	E	A	S	E	A	S	S
C	S	C	C	C	P	P	E
E	C	A	E	A	A	A	C
P	P	C	A	P	A	E	A
S	E	A	P	S	E	P	P
S	P	A	C	E	C	E	S

# DIFFERENT EARTHLINGS

*Find and circle 8 different things*

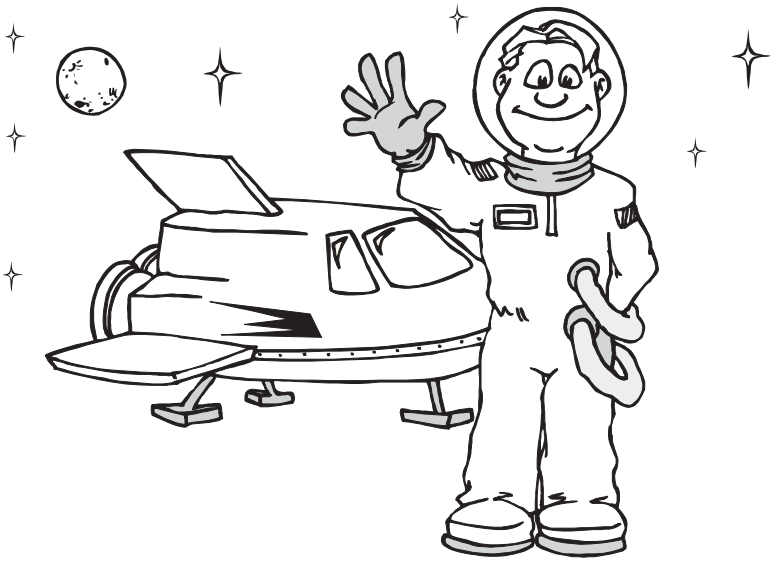

# MAZE CRAZE

*Help light get from the galaxy  
to the Webb telescope*

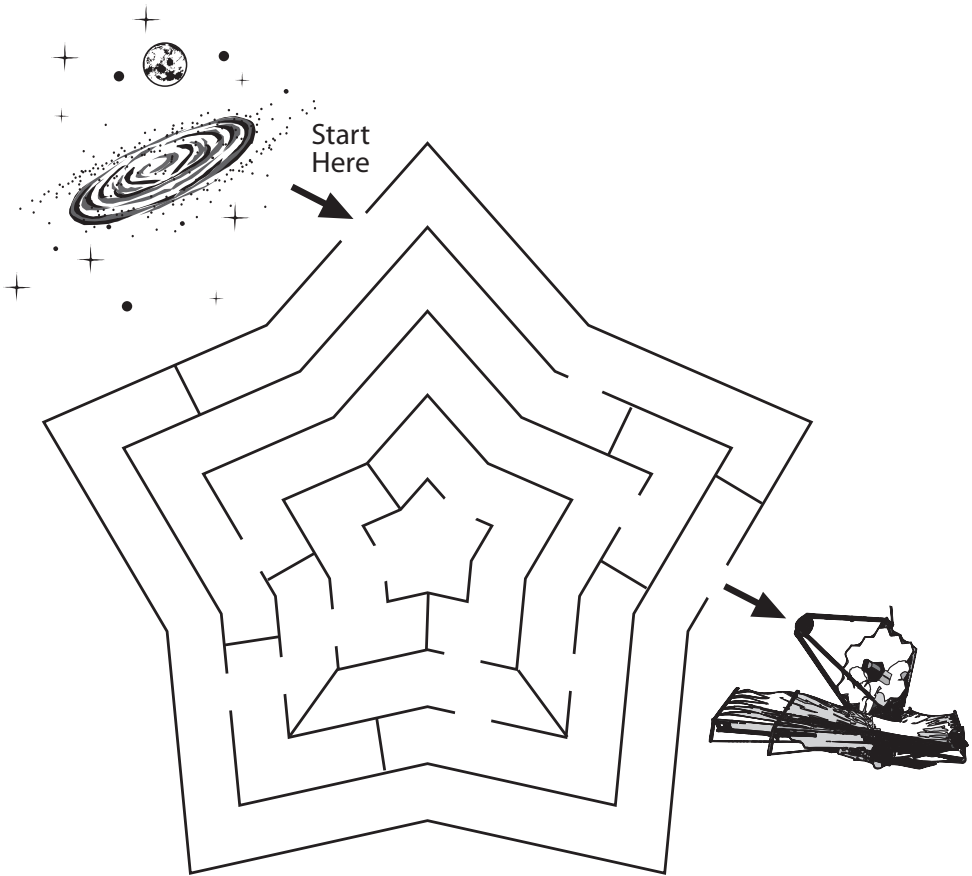

The Webb telescope will be a million miles from Earth, which means that it will be much farther away from us than the Moon! Webb needs to stay cool so it can see faint, far away galaxies. The place where Webb will be will let the telescope use its large sunshield to block out infrared light from the Sun, Earth, and Moon.

# WEBB TELESCOPE PARTS

Use the code to name the parts of the spacecraft

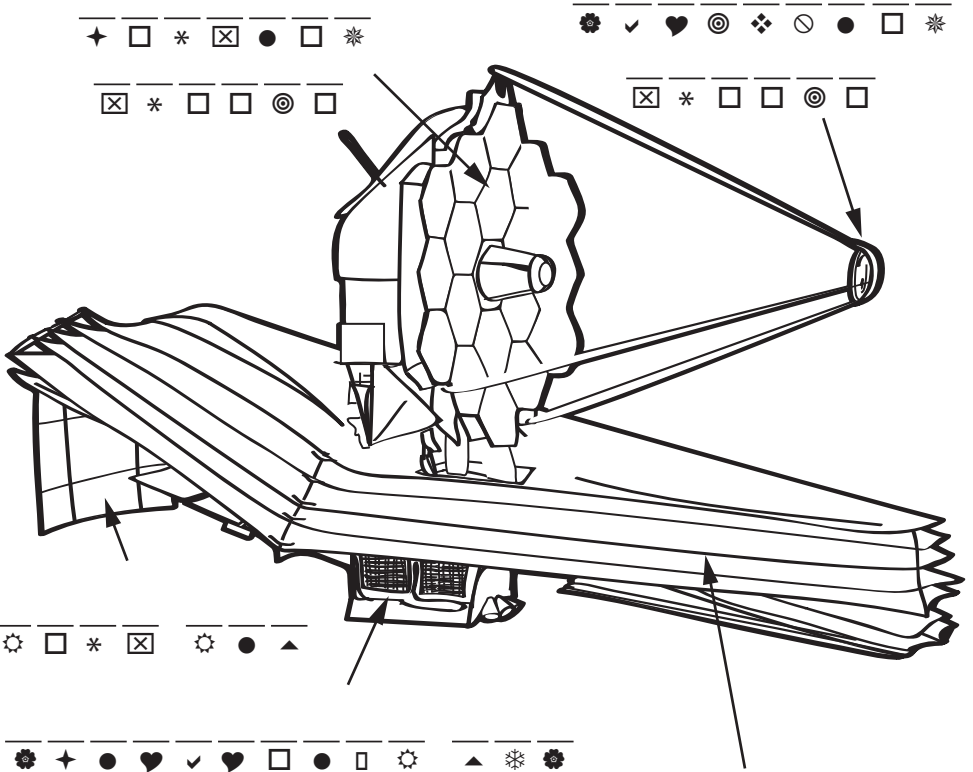

✦ □ \* ☒ ● □ \*

⚙️ ✓ ♥️ 🎯 ❖ 🚫 ● □ \*

☒ \* □ □ 🎯 □

☒ \* □ □ 🎯 □

⚙️ □ \* ☒ ⚙️ ● ▲

⚙️ ✦ ● ♥️ ✓ ♥️ □ ● ▭ ⚙️ ▲ ❄️ ⚙️

⚙️ ❄️ ❖ ⚙️ ▶️ \* ✓ 😊 🚫

- |        |        |        |       |        |       |
|--------|--------|--------|-------|--------|-------|
| A = ●  | F = □  | K = ☹️ | O = 🎯 | S = ⚙️ | W = 🌠 |
| B = ▲  | G = 👁️ | L = 😊  | P = ✦ | T = ⚙️ | X = 📞 |
| C = ♥️ | H = ▶️ | M = ☒  | Q = 😊 | U = ❄️ | Y = * |
| D = 🚫  | I = *  | N = ❖  | R = □ | V = ○  | Z = ▼ |
| E = ✓  | J =    |        |       |        |       |

Primary Mirror, Secondary Mirror, Trim Tab, Spacecraft Bus, Sunshield

# COUNT THEM UP

*How many objects can you find?*

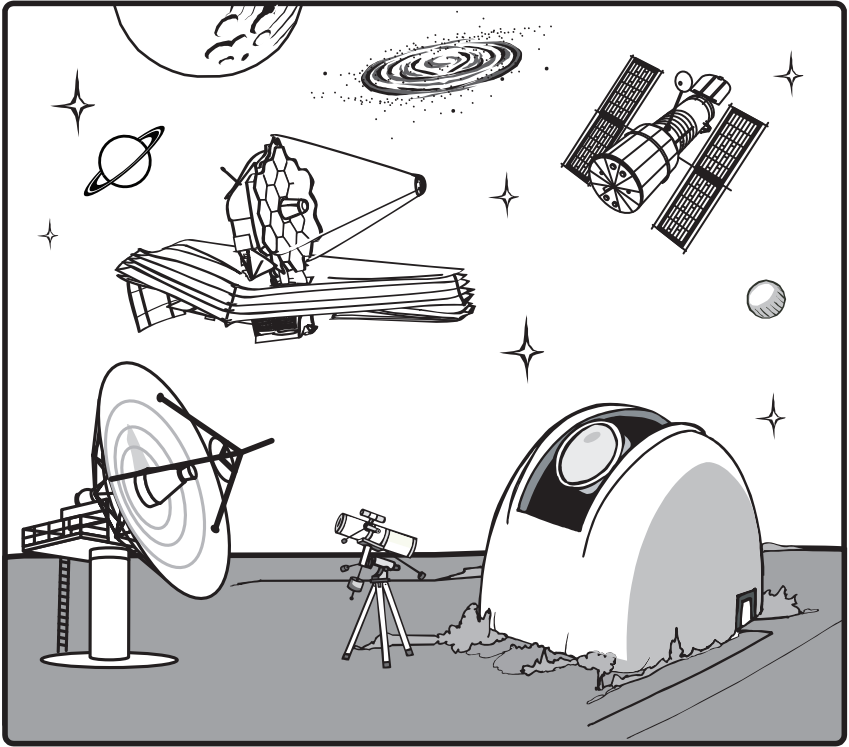

How many telescopes? \_\_\_\_\_

How many stars? \_\_\_\_\_

How many galaxies? \_\_\_\_\_

How many planets? \_\_\_\_\_

How many radar antenna? \_\_\_\_\_

4 Telescopes, 6 Stars, 1 Galaxy, 3 Planets, 1 Radar Antenna

# IDENTICAL WEBB

*Circle the two telescopes that are the same*

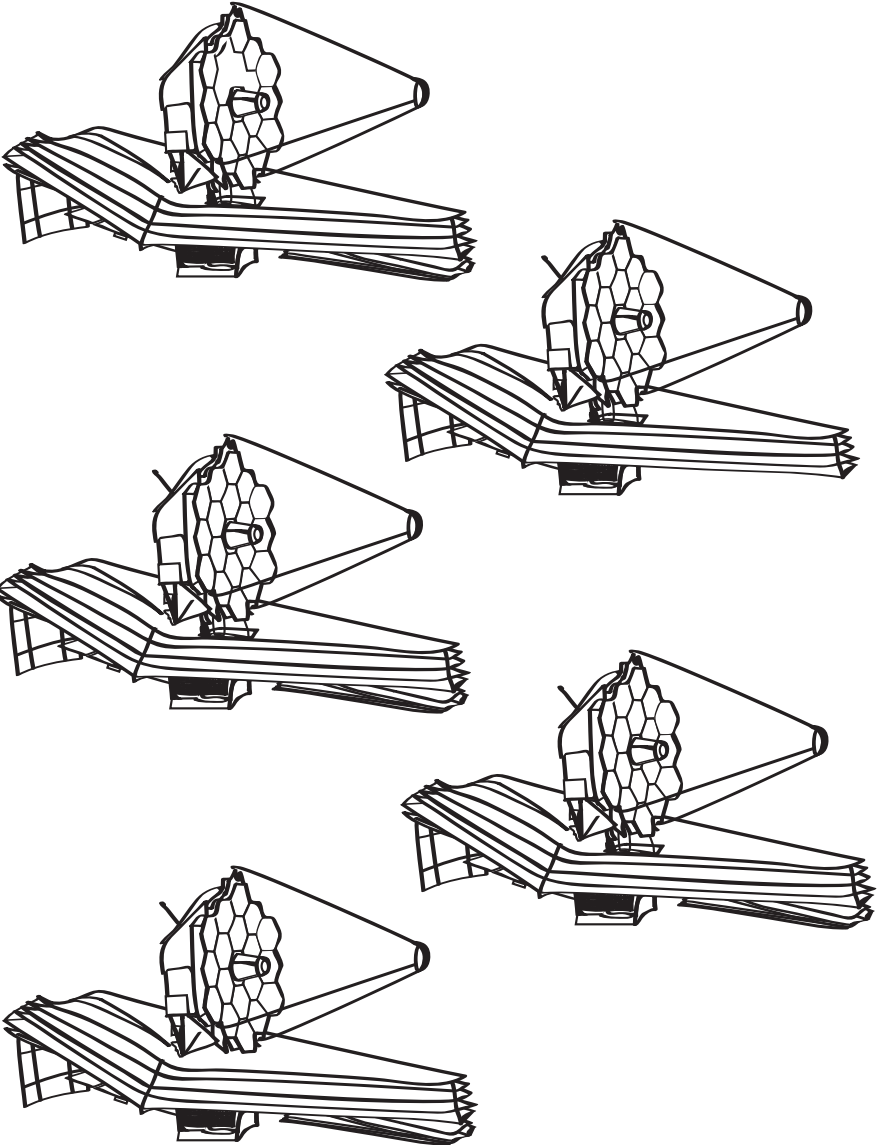



# SCRAMBLE TIME

Trace over the dashed lines and unscramble the words to name the spacecraft



LEUBHB  
CEPSA  
LETPOESCE

-----  
-----  
-----

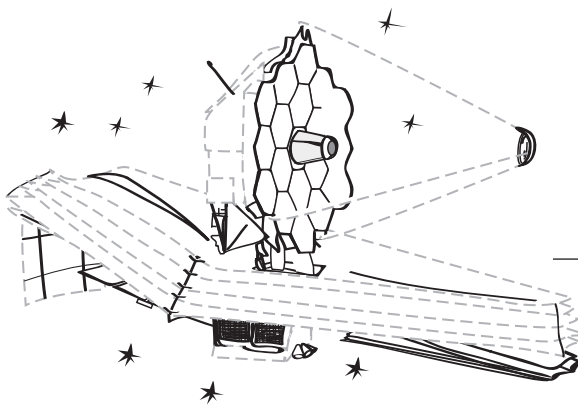

BEWB  
POCLEETSE

-----  
-----

# HOW DID WE GET HERE?

*From the first light in the universe to the birth of planets and the origins of life*



The launch of the Webb telescope will be a giant step in the human quest to understand our place in the universe. With the largest telescope mirror ever placed in space, the Webb telescope will examine every phase of our history: from wisps of gas condensing into the first stars and galaxies after the Big Bang, to the formation of solar systems capable of supporting life on planets like Earth, and to the evolution of our own Solar System.

**EXPLORE  
MORE**

For more information on NASA  
and the Webb Telescope, visit  
these web sites:

*<http://nasa.gov/stem>*

*<http://science.nasa.gov>*

*<http://www.nasa.gov/webb>*

*<http://www.nasa.gov/hubble>*

*<http://www.stsci.edu/jwst/>*



James Webb Space Telescope

# Webb Telescope Fun Pad

*PACKED WITH THINGS TO DO!*

