

Origami

## **SOLVINGE**

Storlek: 800x300x350 mm (DxBxH)

Material: 27 ark A4-papper



Den här produkten är designad av Trunk Cultural & Creative Co., LTD.

---

©2022 Sony Interactive Entertainment Europe. Utvecklat av Guerrilla.

Horizon Forbidden West är ett varumärke som tillhör Sony Interactive Entertainment LLC.



Verktyg: Sax/brytbladskniv, linjal, lim, präglingspenna (rekommenderas)

## Rekommenderat papper

Den officiella färdiga produkten är tryckt på papper med en vikt på ungefär 235 g/m<sup>2</sup>.

Skriv ut på A4-papper med en vikt på minst 160 till 180 g/m<sup>2</sup>.

När du skriver ut, välj att skriva ut dubbelsidigt i färg och vända längs långsidan.

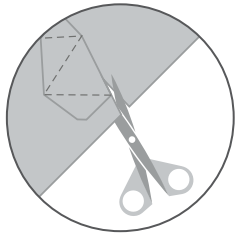

1. Klipp eller skär längs de heldragna linjerna.

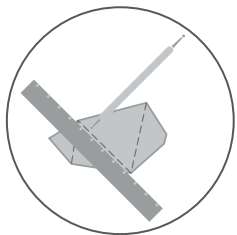

2. Använd en präglingspenna (eller baksidan på en brytbladskniv) för att vika längs de streckade linjerna.

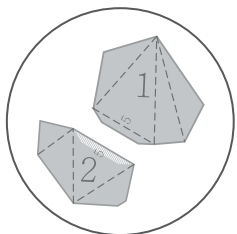

3. Klistra eller sätt ihop delarna i nummerordning (stora siffror) och matcha sedan de små siffrorna och klistra ihop flärparna (du behöver inte följa sifferordningen).

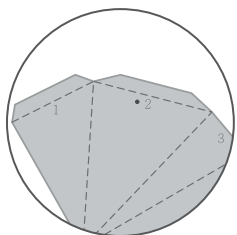

4. Börja klistra från flärparna som är markerade med "." för att underlätta följande steg.

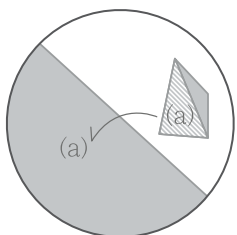

5. När du har satt ihop extradelarna matchar du siffrorna på dem mot motsvarande siffror på huvudkroppen och klistrar fast eller sätter ihop dem.

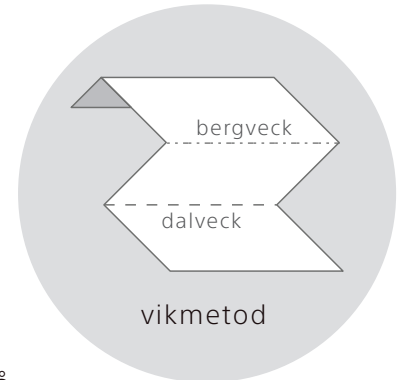



' R = right side  
' L = left side

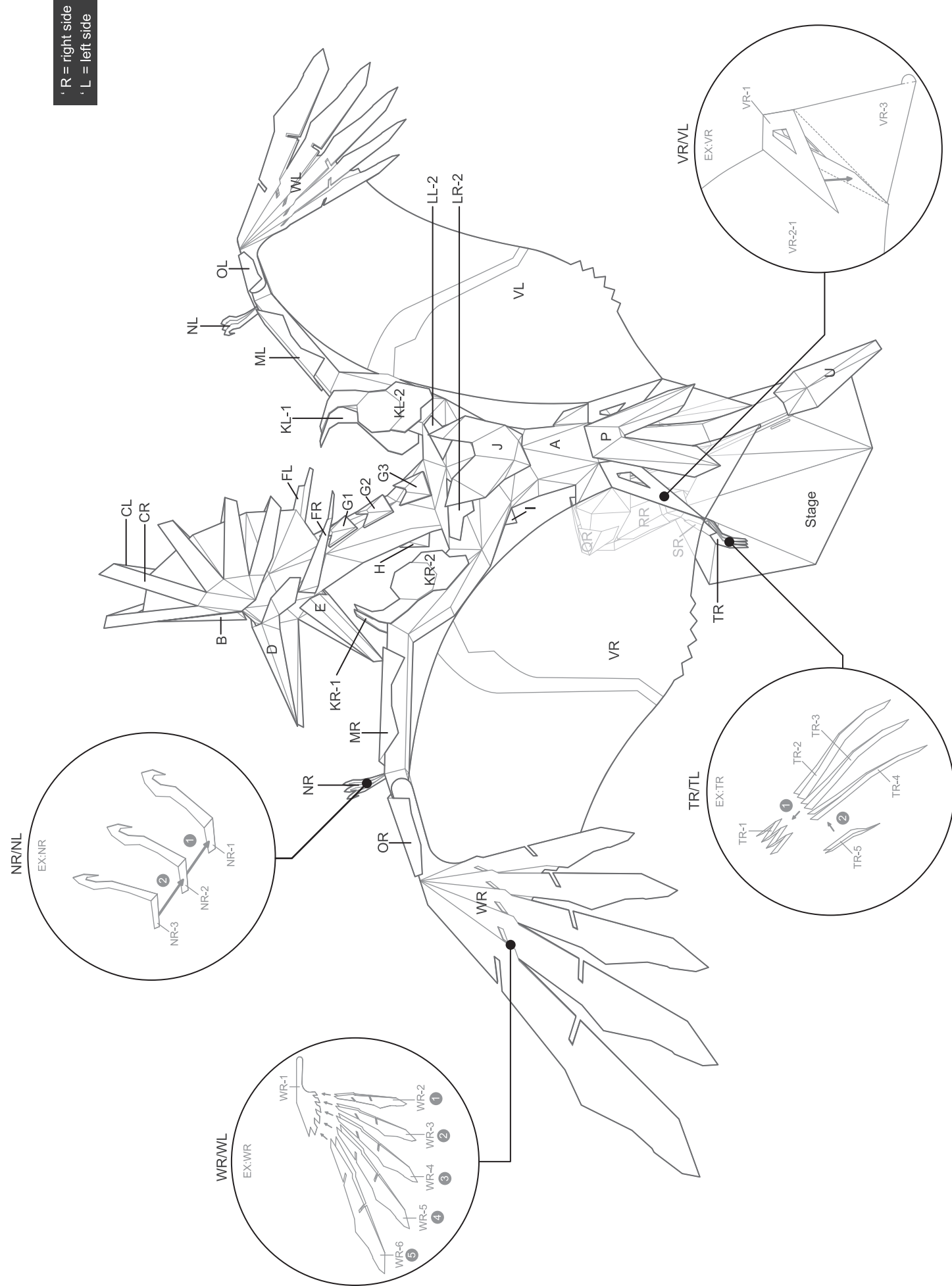



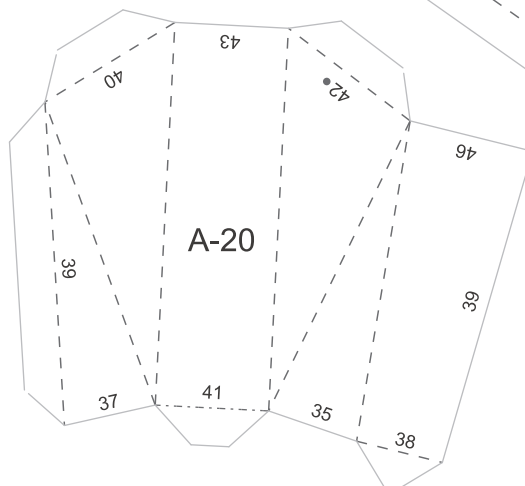
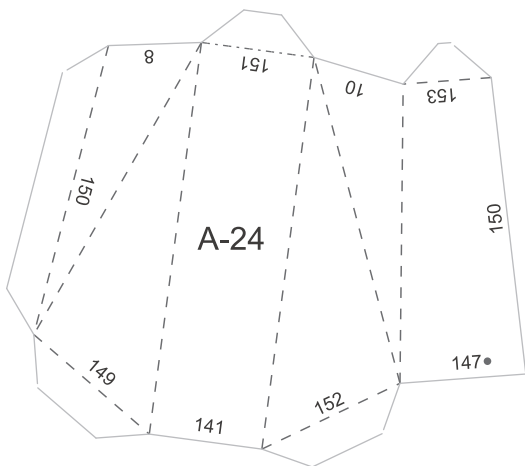
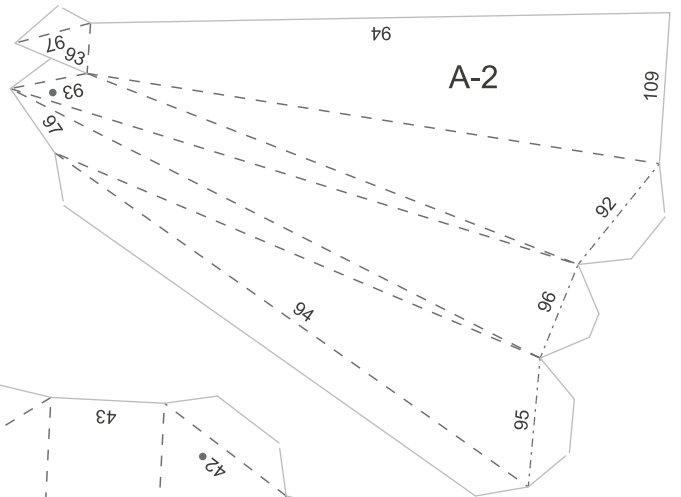
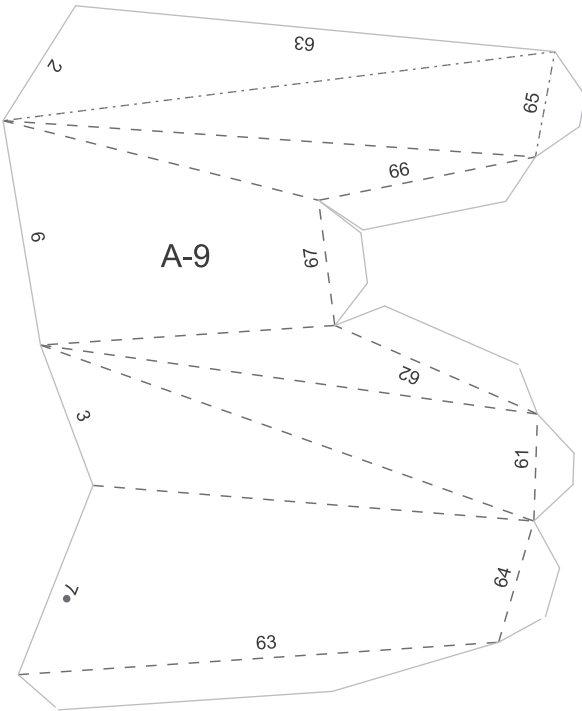
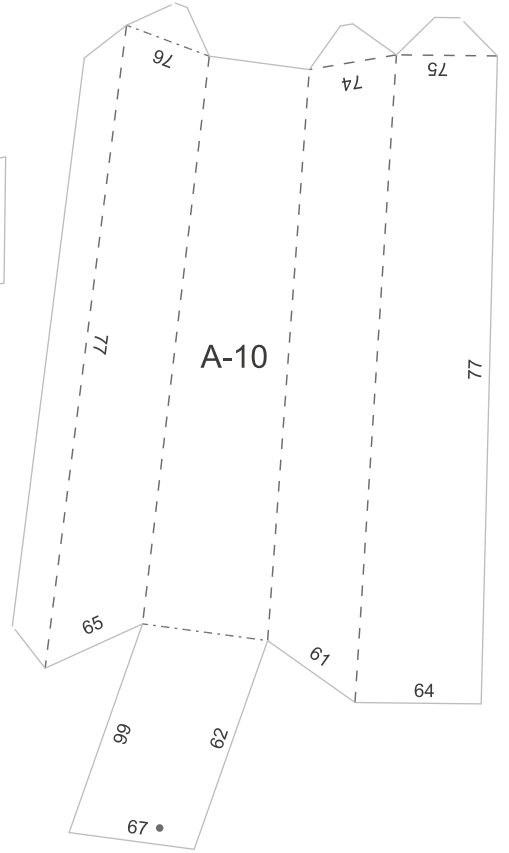
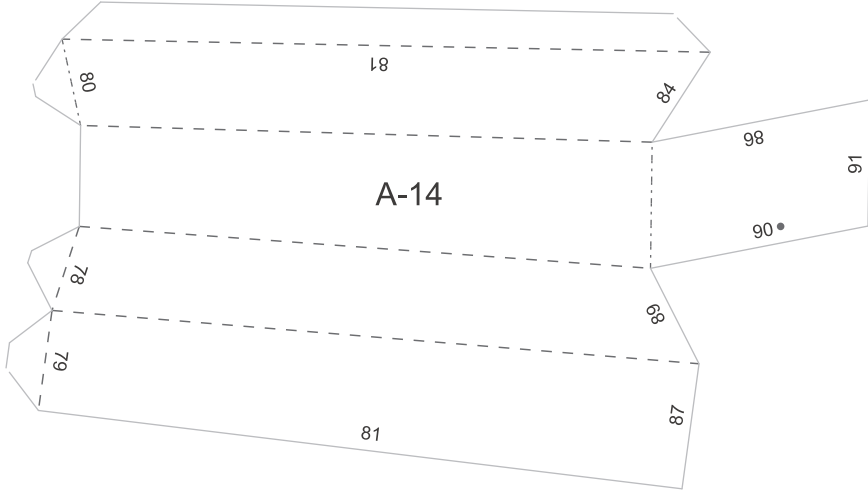
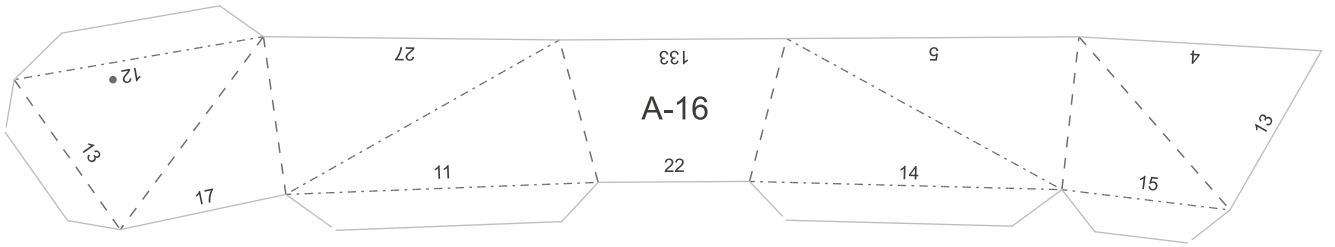

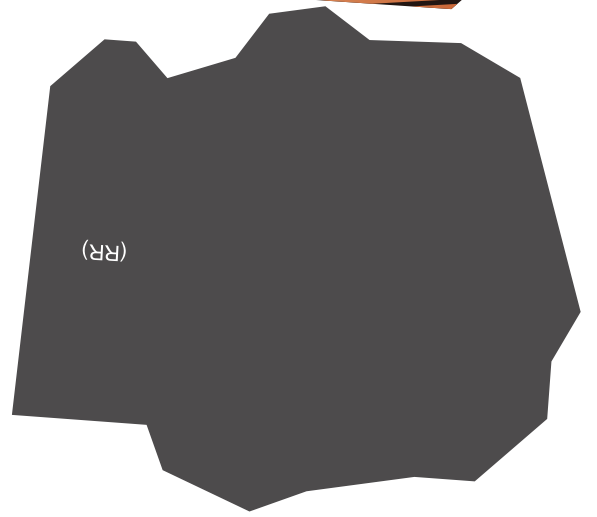
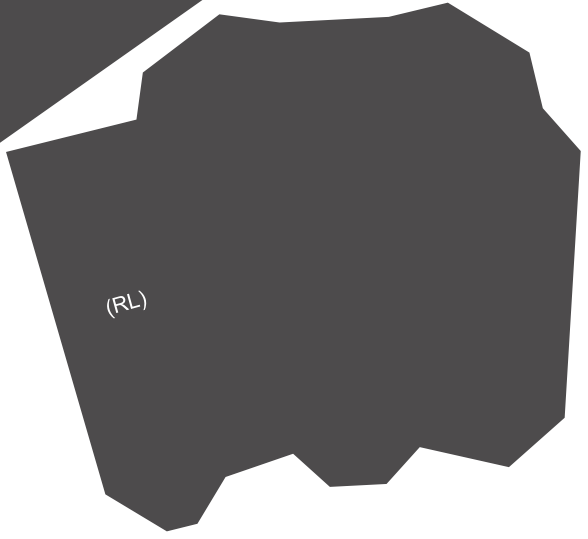
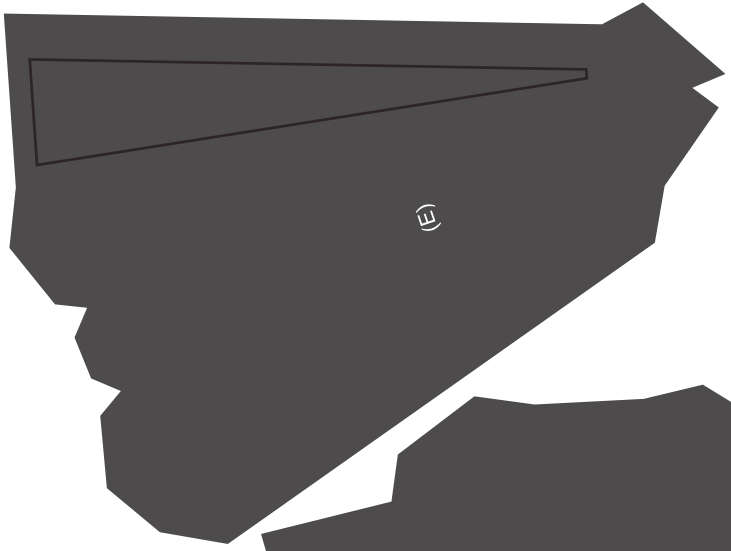
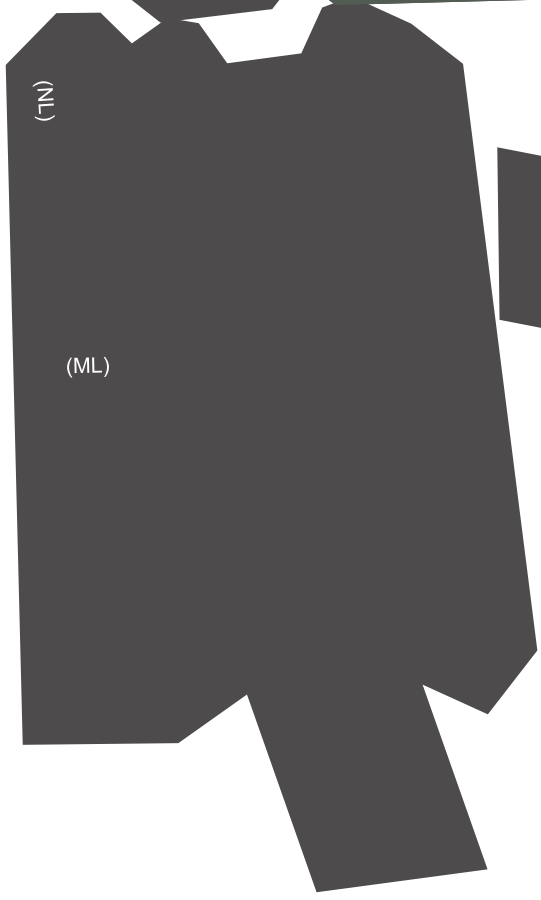
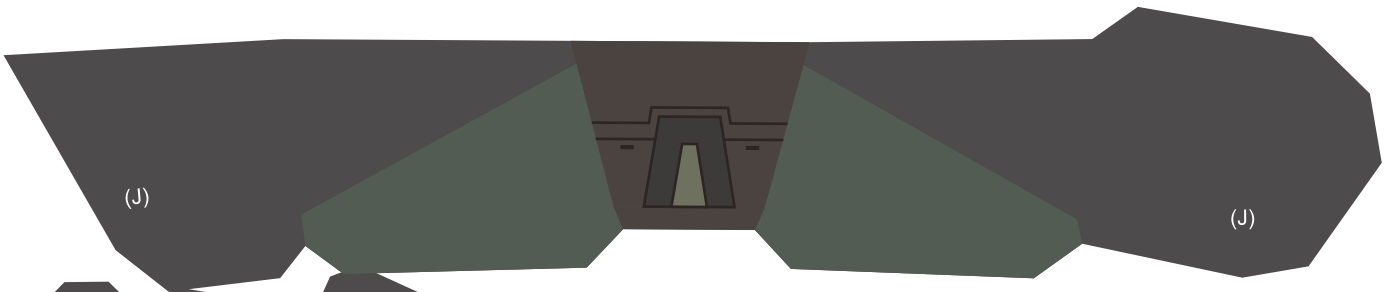





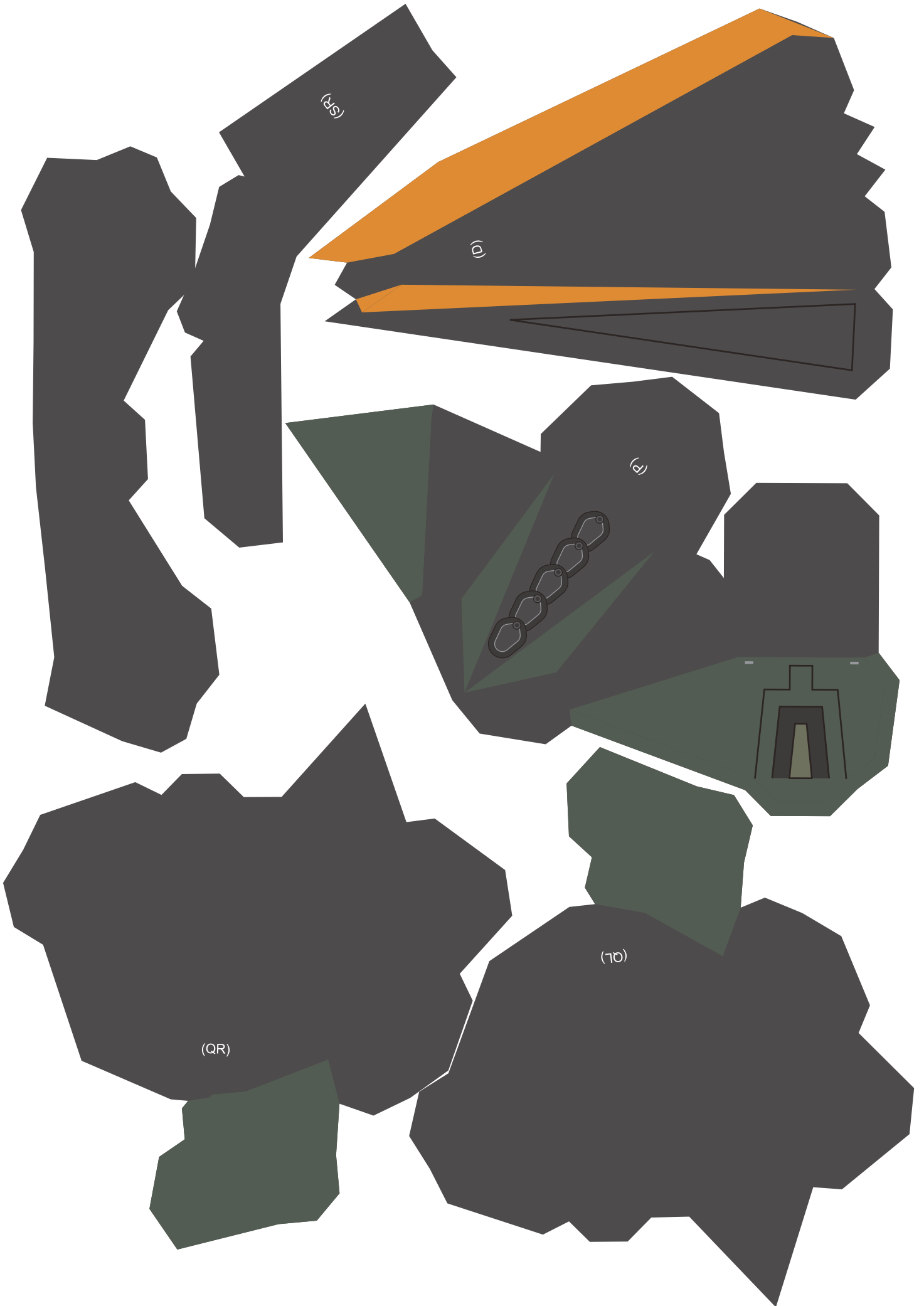

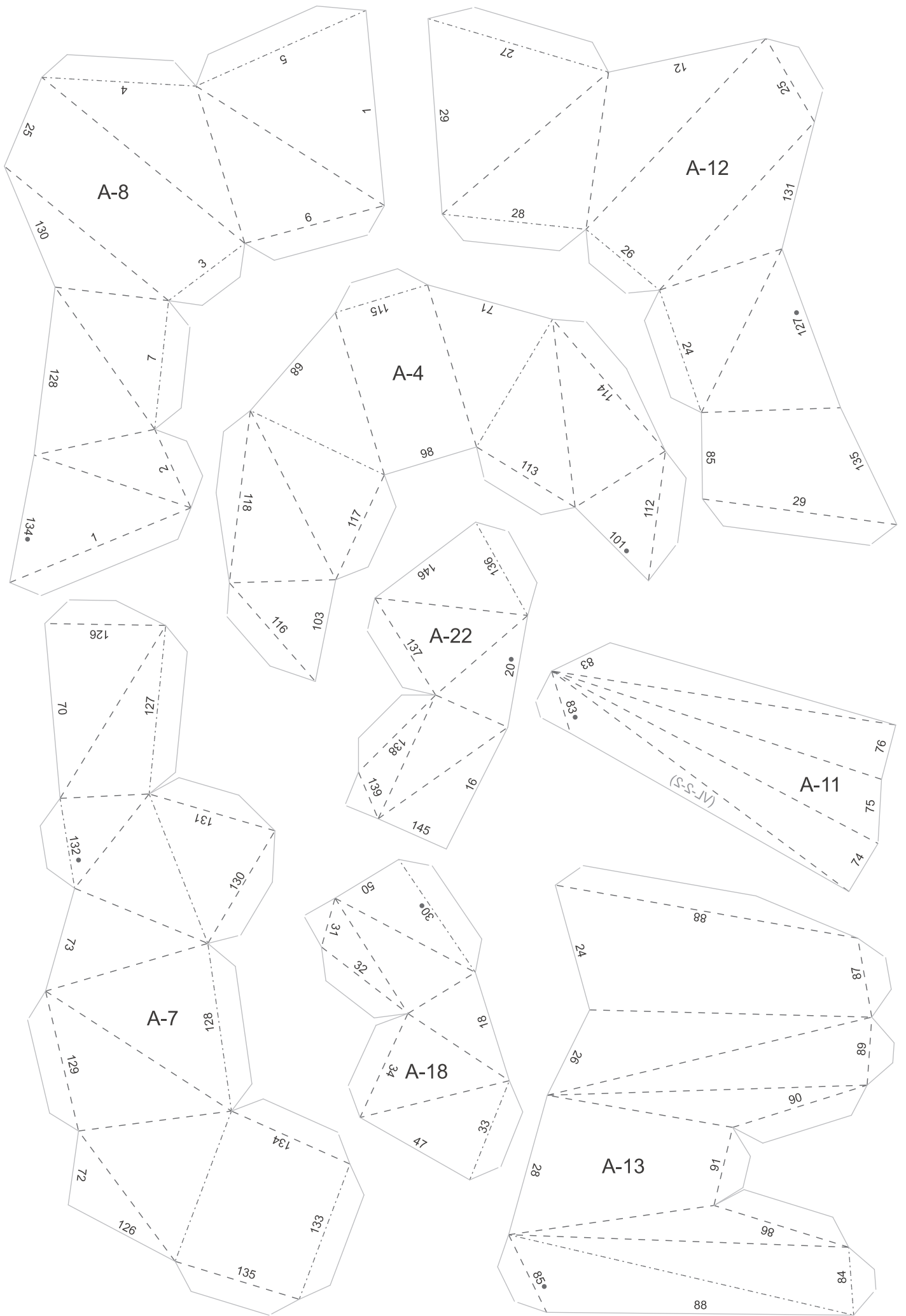

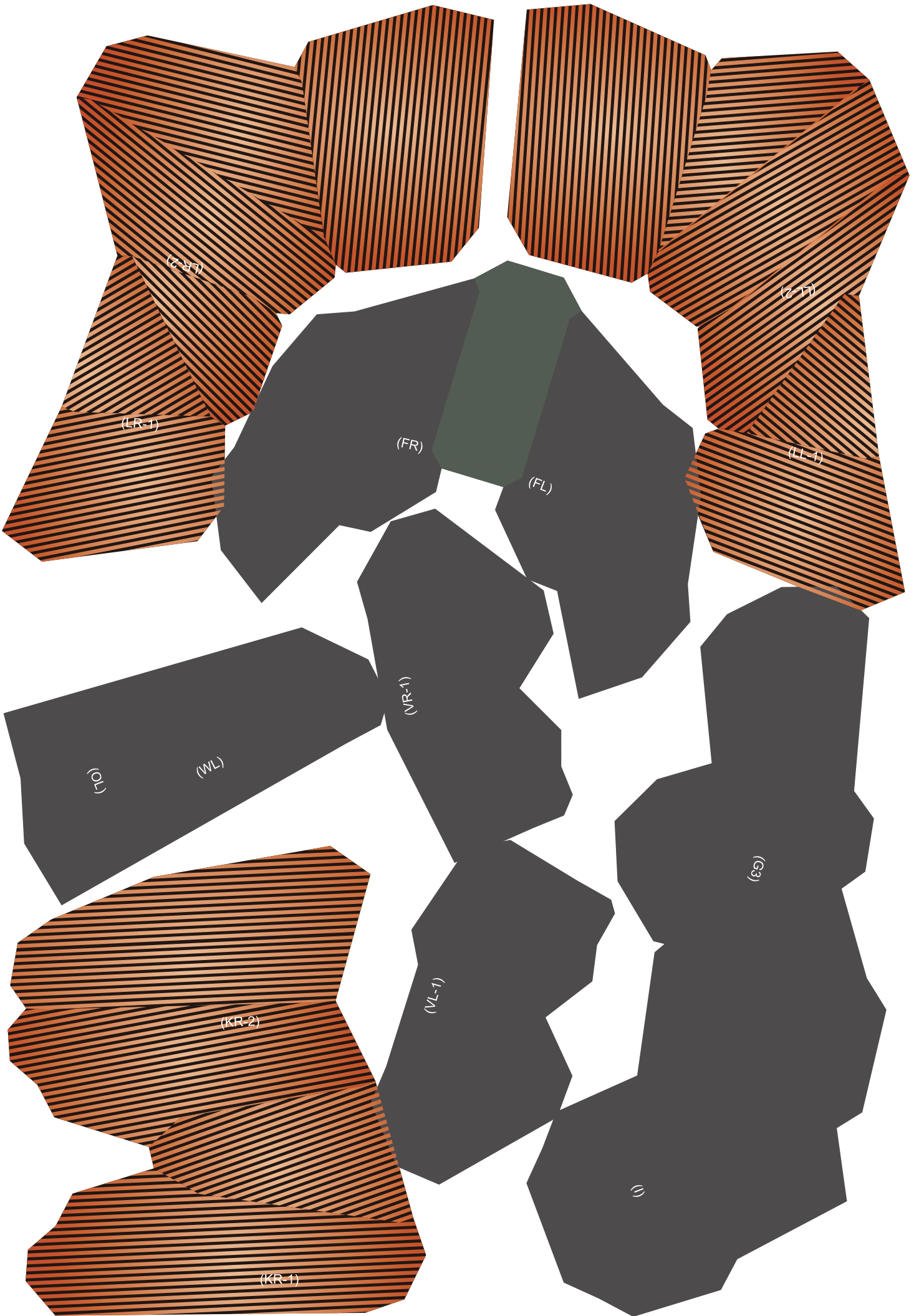

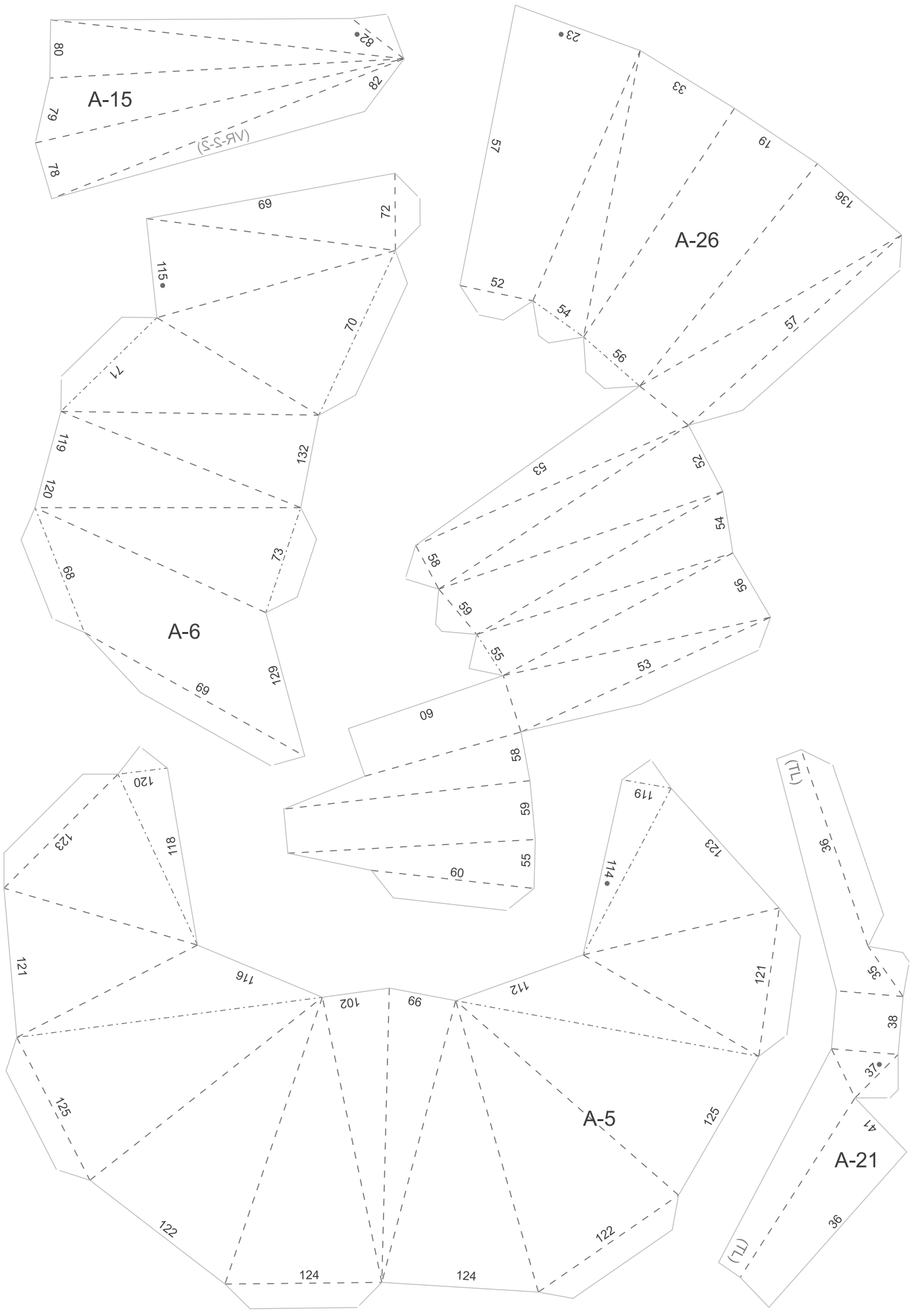

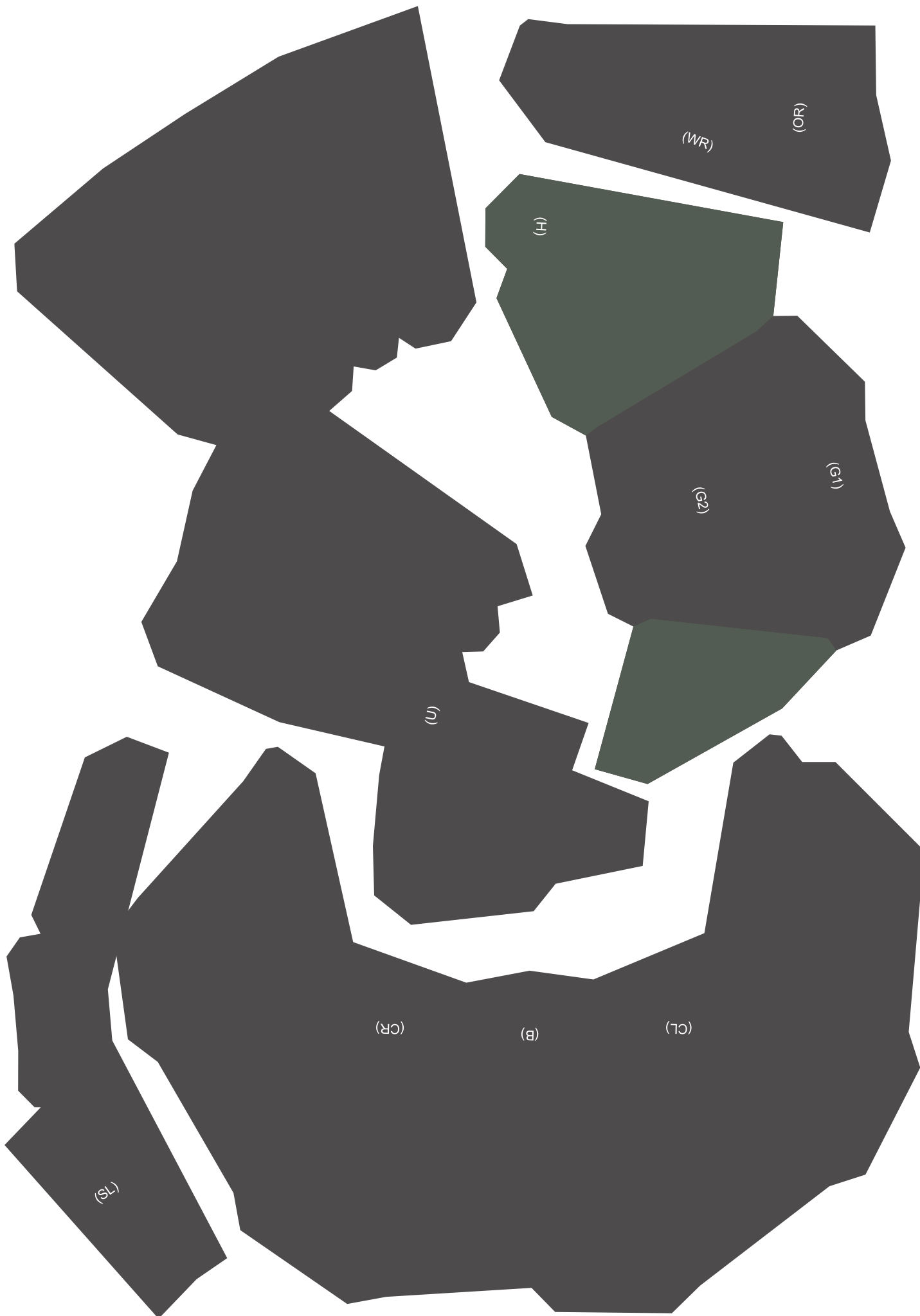

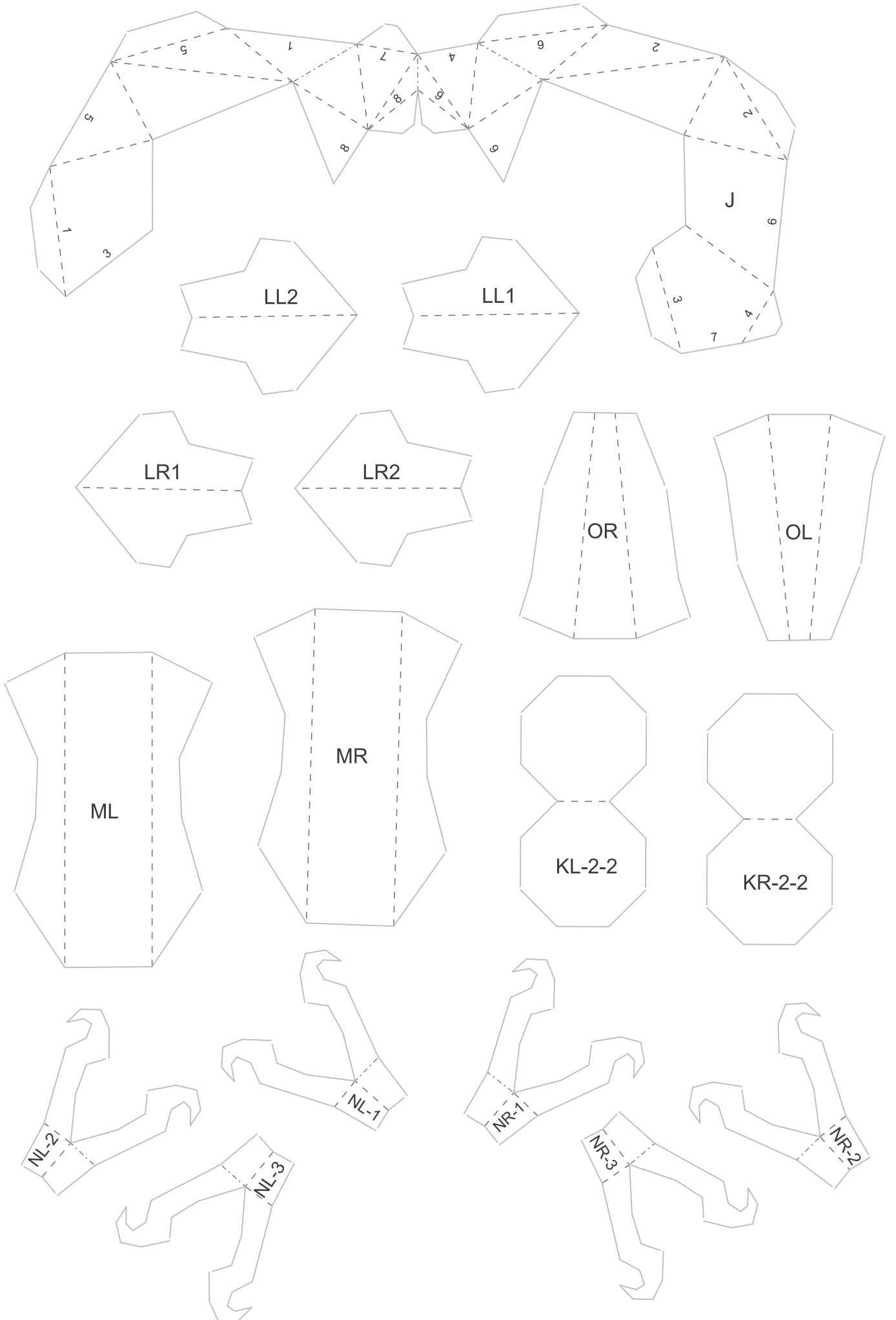

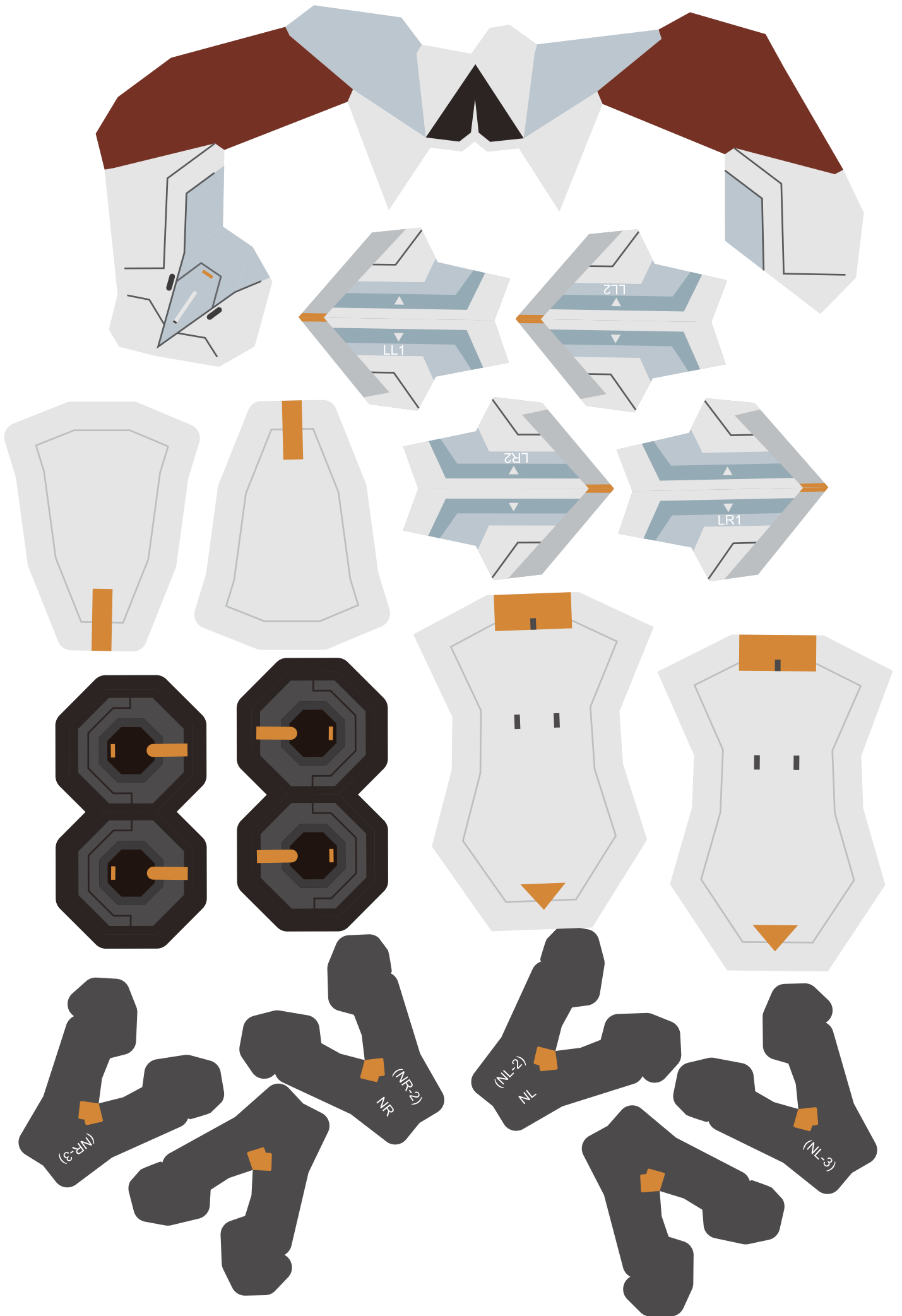



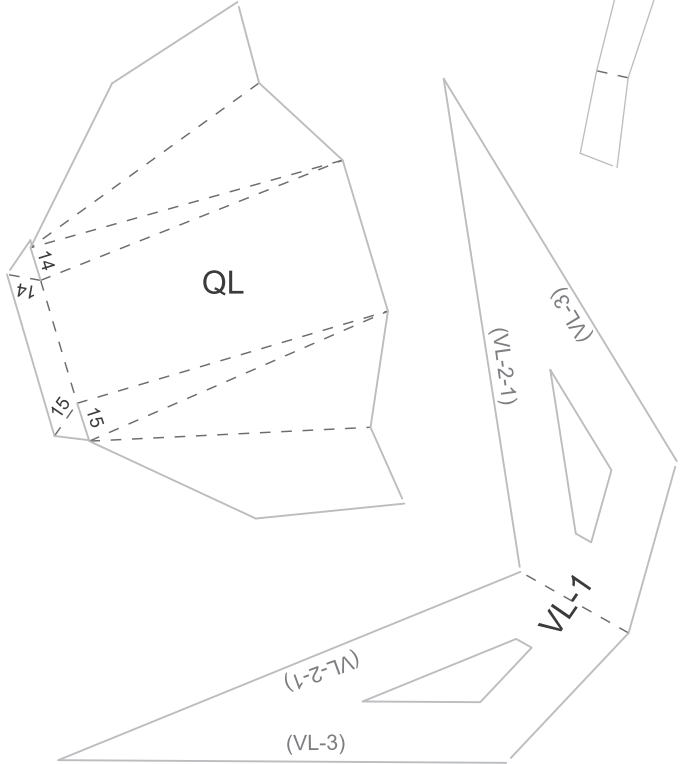
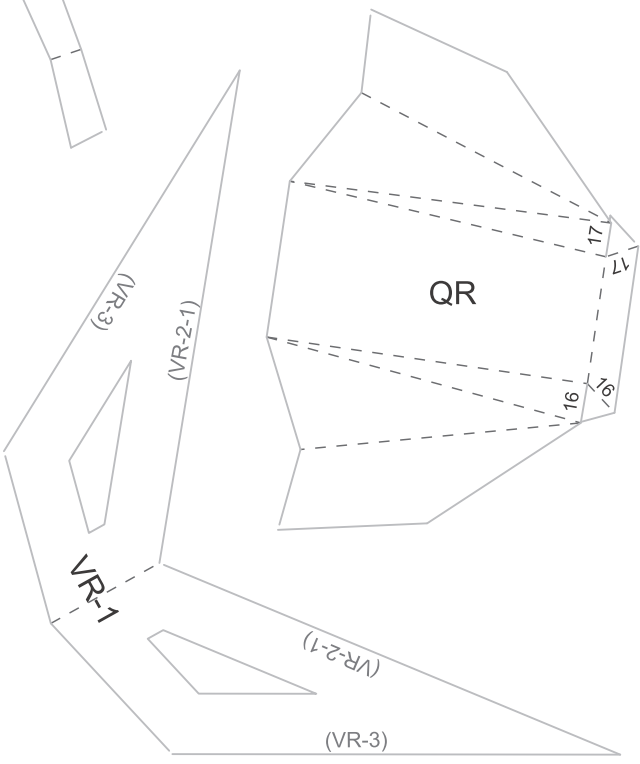
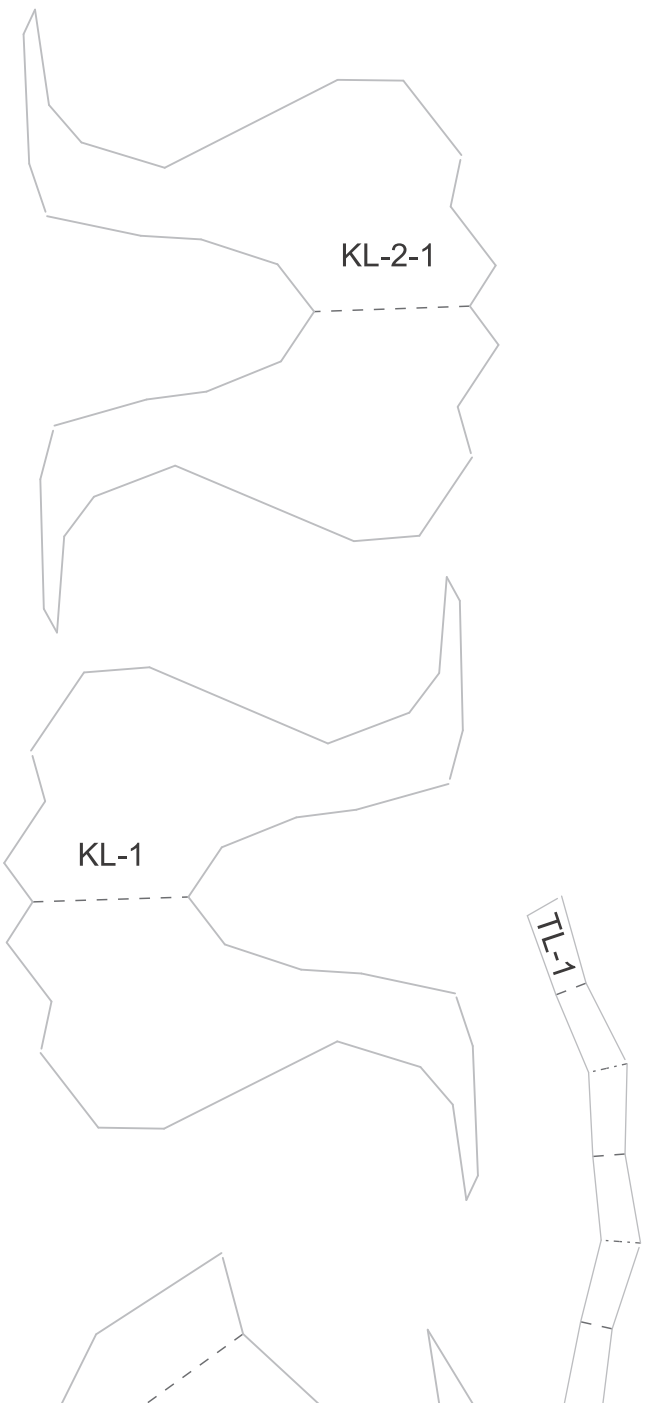
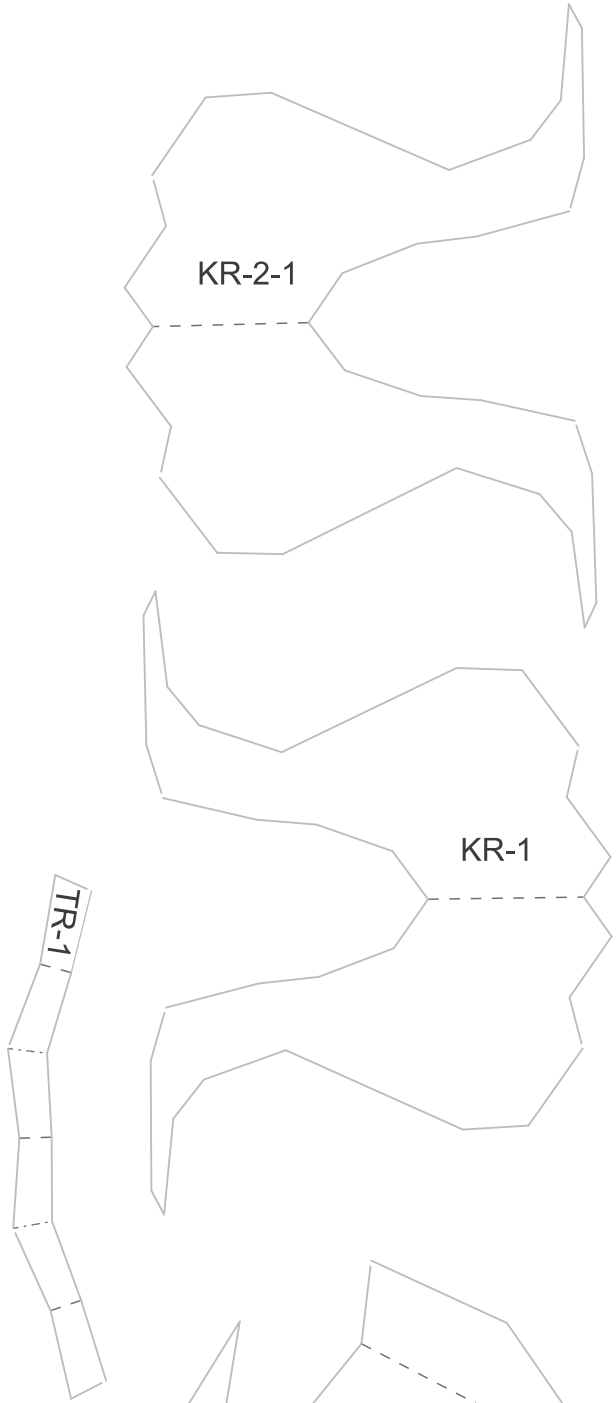



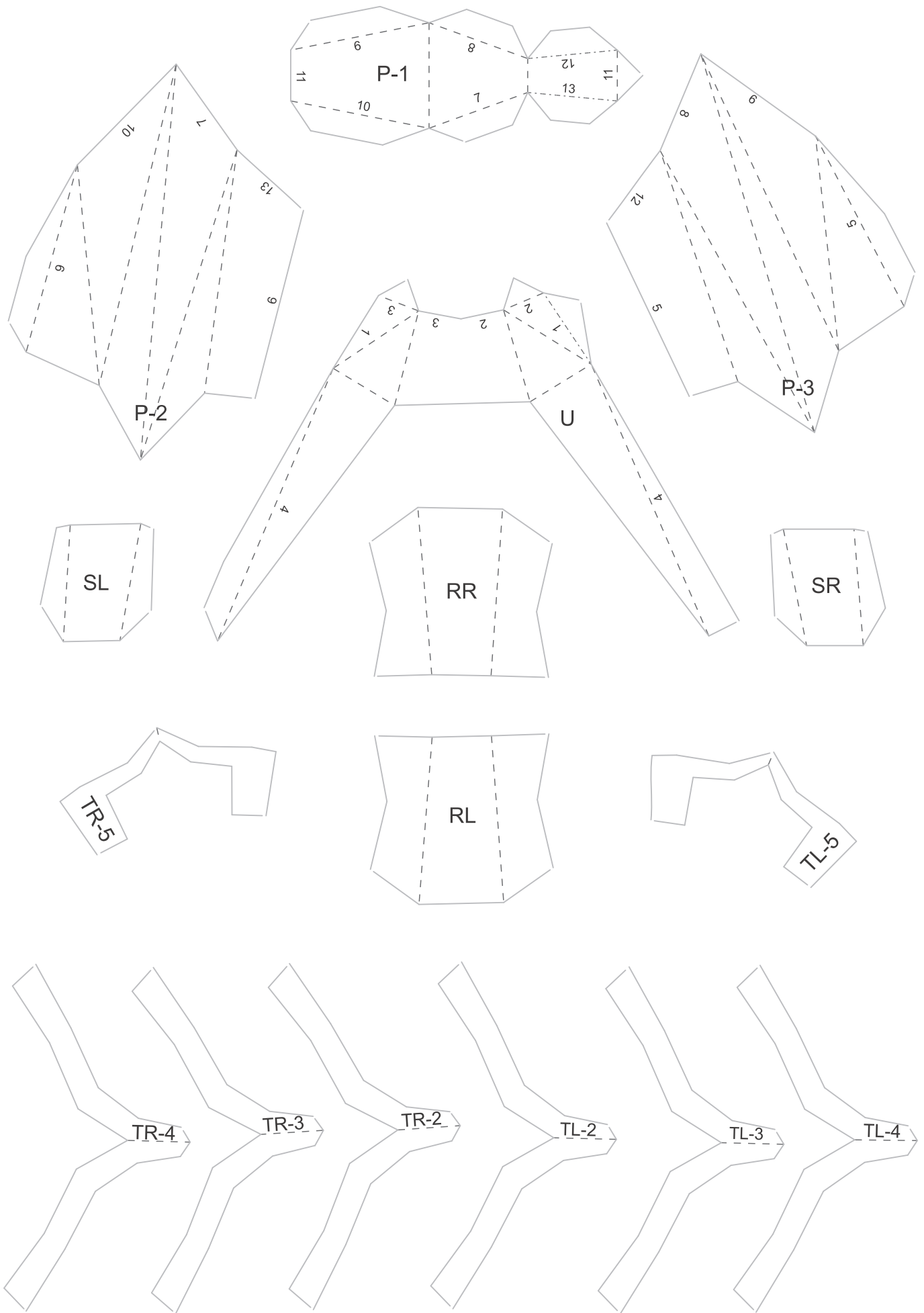



(TR-5)

(TL-5)

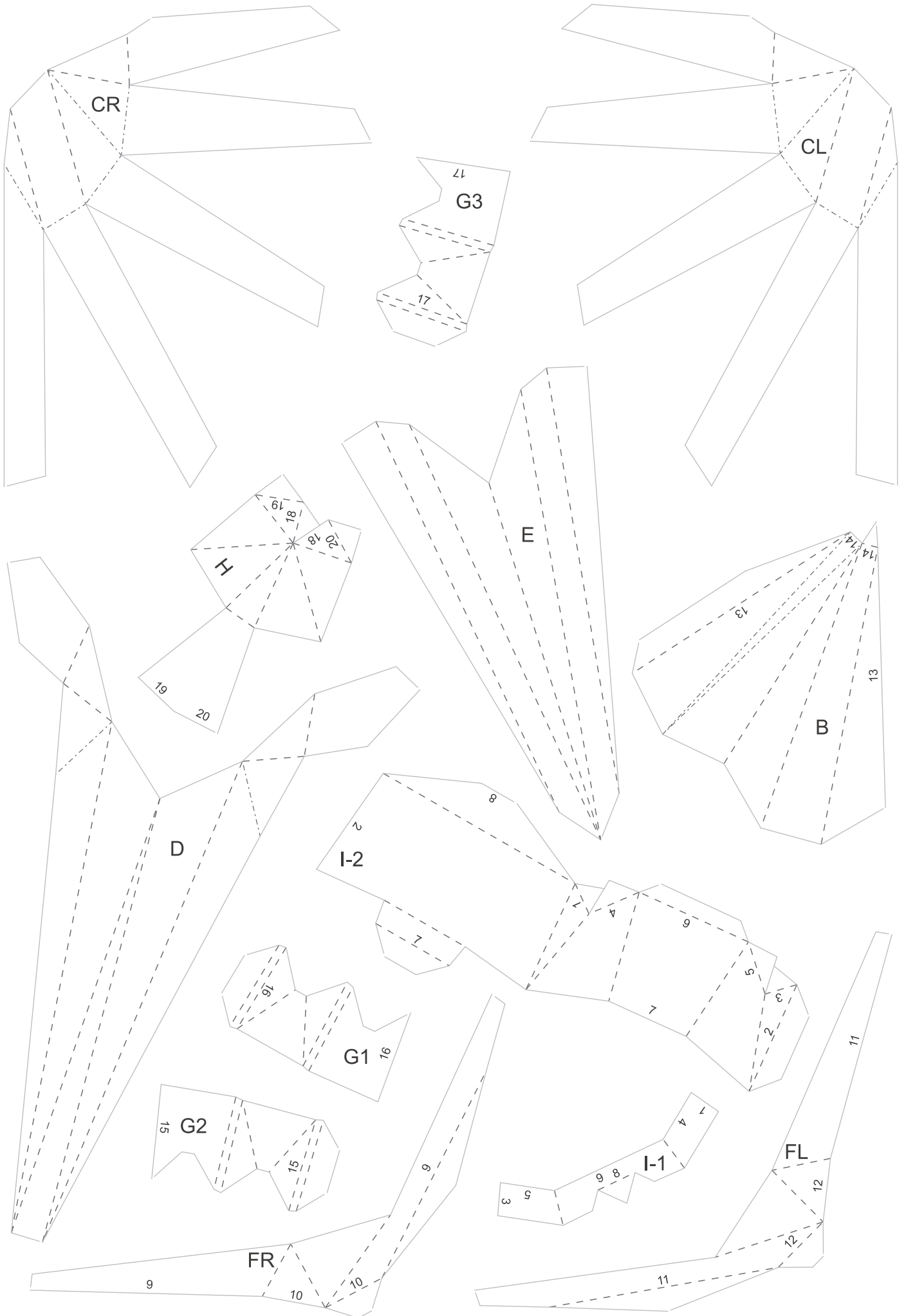



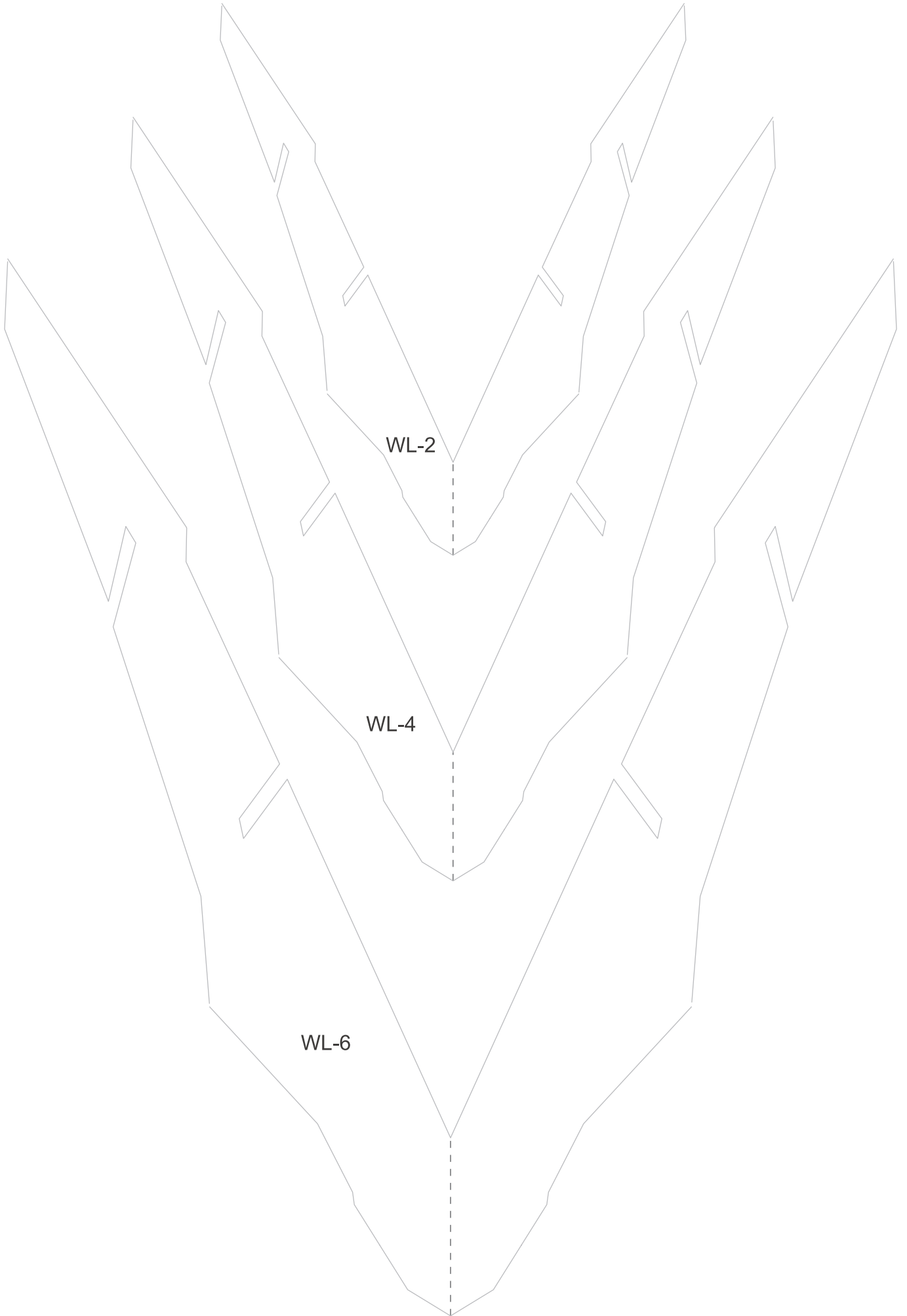

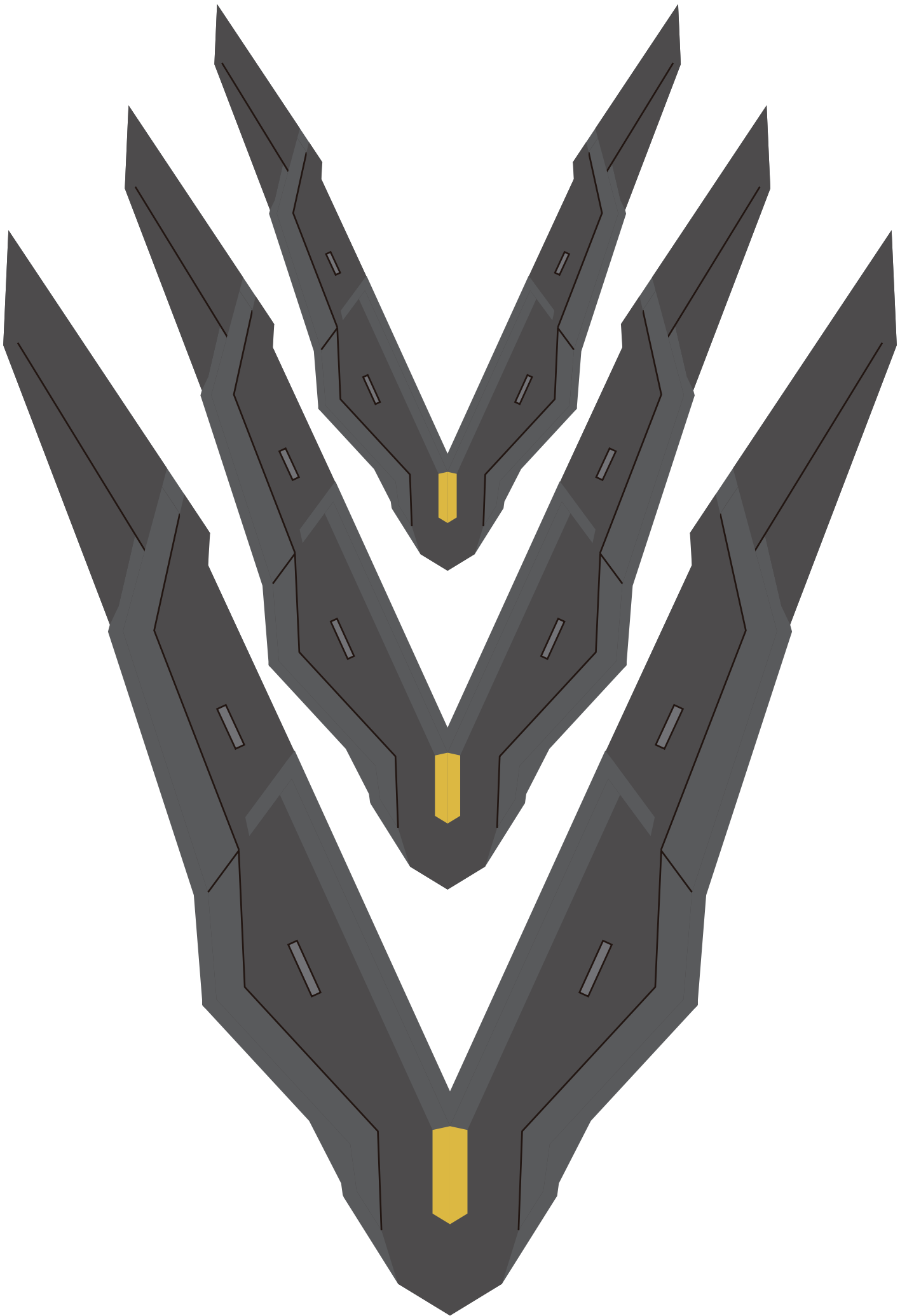



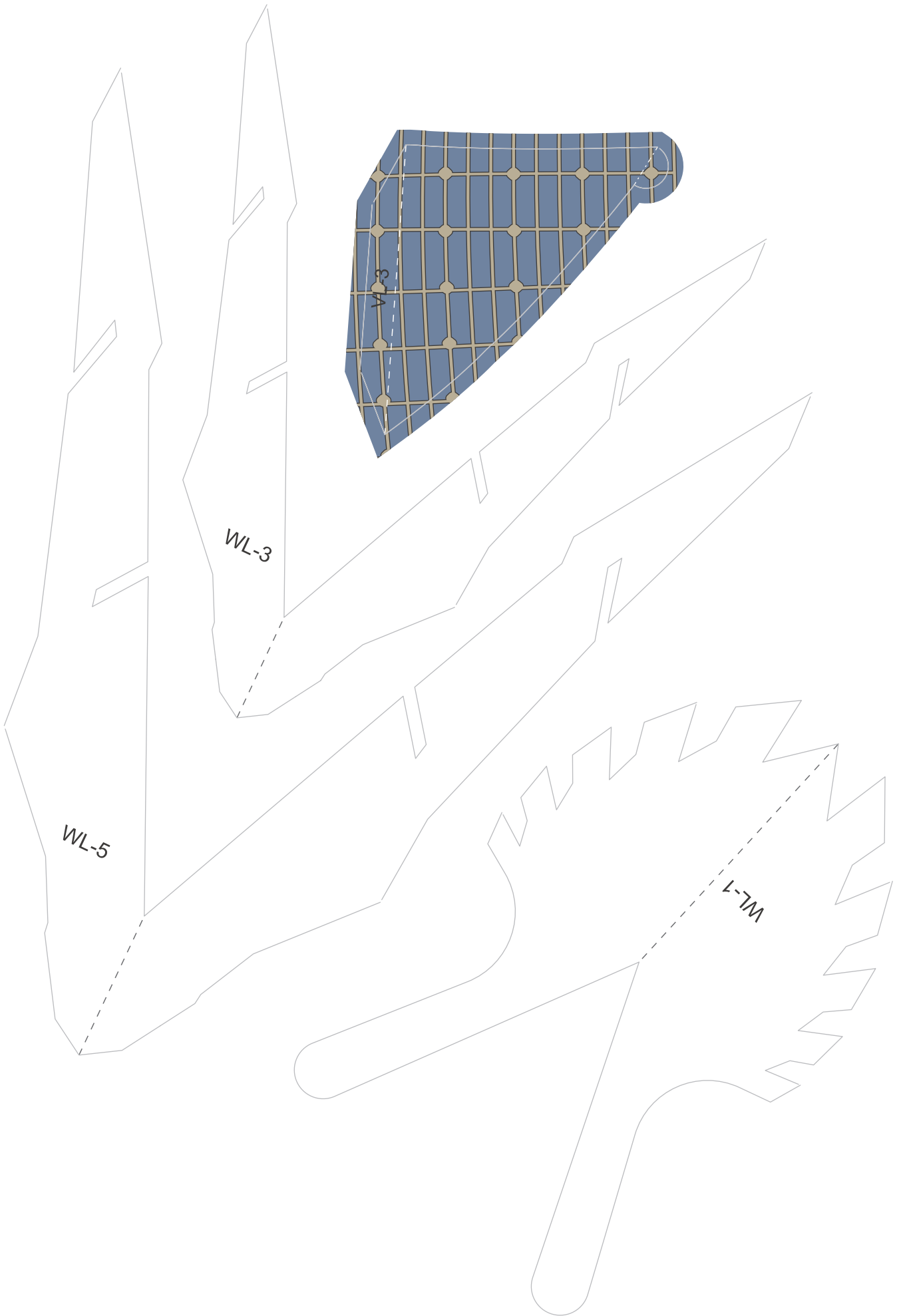

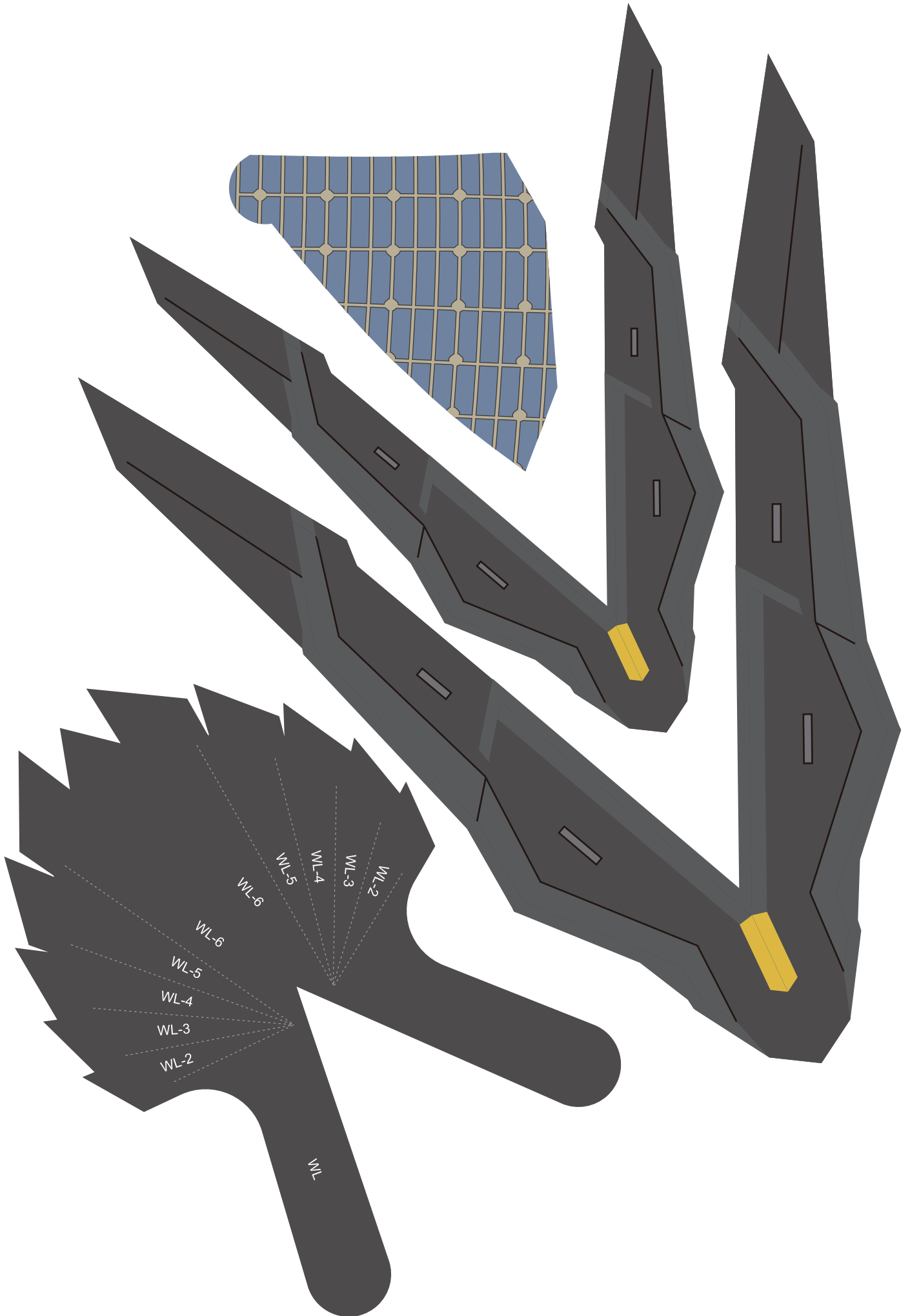

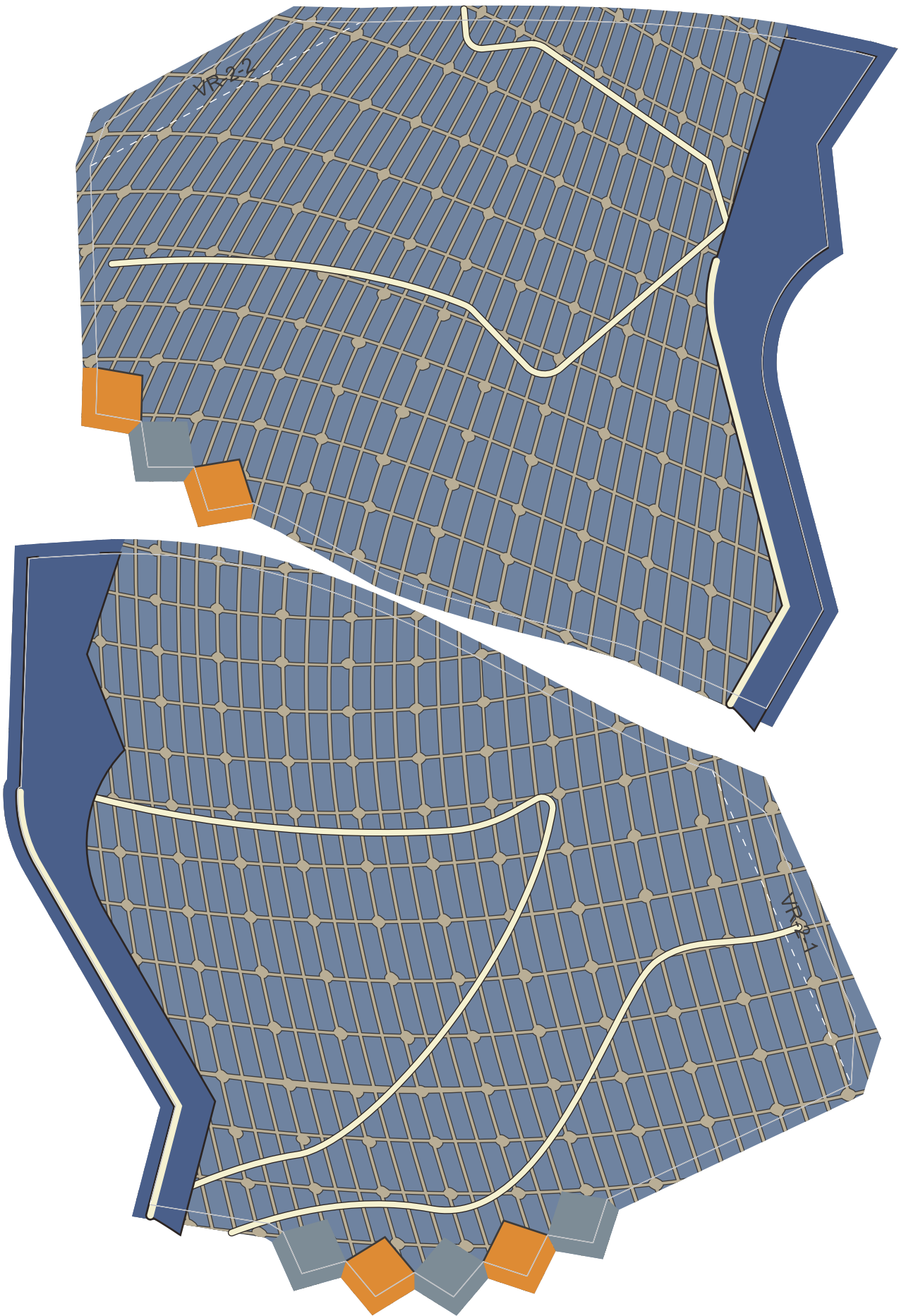

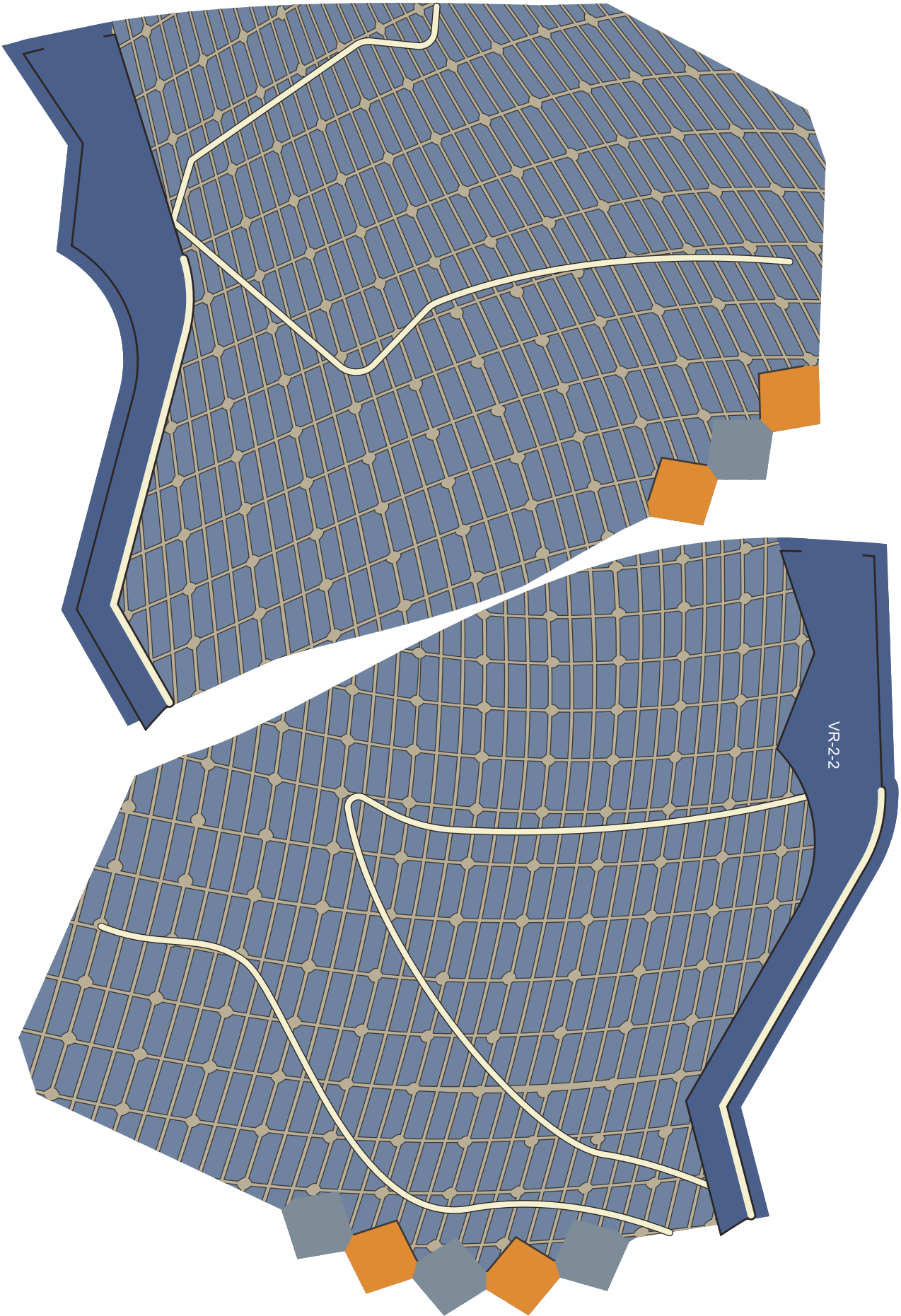

VR-2-2

