

# The High Altitude Student Platform (HASP)

HASP, a collaborative venture of the NASA Balloon Program Office and Louisiana Space Consortium at Louisiana State University, provides a launch platform for a total of 12 student research payloads and is launched yearly in August/September from the NASA balloon launch facility at Fort Sumner, New Mexico. The Columbia Scientific Balloon Facility (CSBF) provides launch services and support. The project has a rich history spanning 14 years of successful missions providing undergraduate and graduate students with real-world science and engineering project development experience. HASP was conceived to provide students with flight opportunities on an intermediate platform between those available with small latex sounding balloons and Earth orbiting satellites. HASP has a support vehicle, based upon flight proven hardware and software designs that uses an 11 million cubic foot, thin film polyethylene, helium filled balloon to carry multiple student built payloads to altitudes of ~120,000 feet (~36km) at an ascent rate of 1000 feet per minute, for durations up to 20 hours.

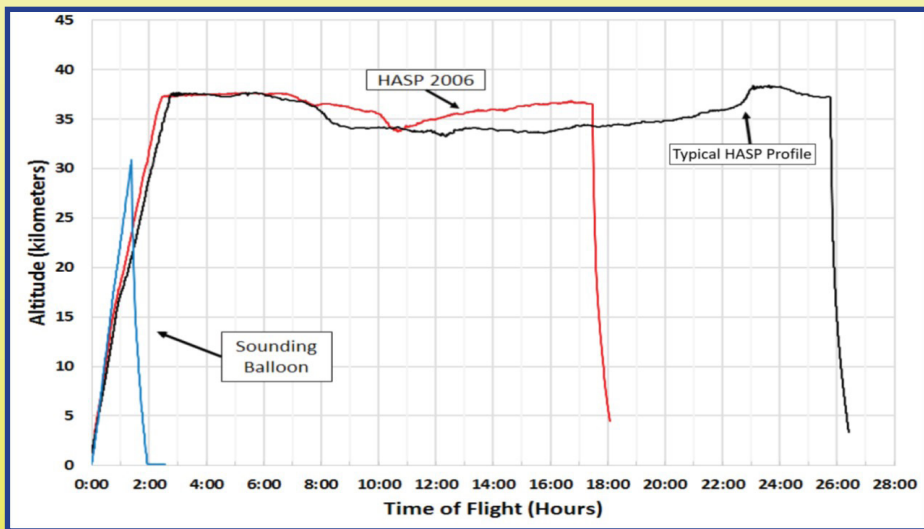

A typical altitude vs. time flight profile for HASP compared to that of a sounding balloon flight

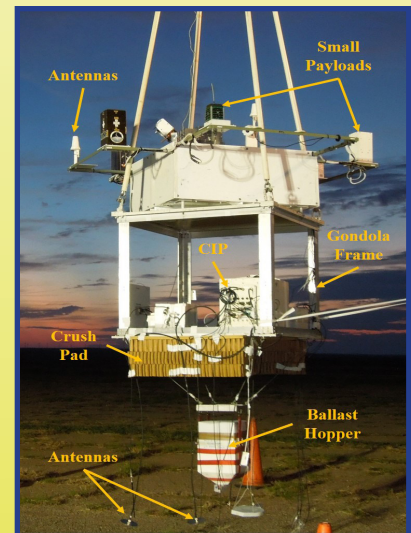

The HASP payload as configured for a typical flight (CIP: Consolidated Instrument Package)

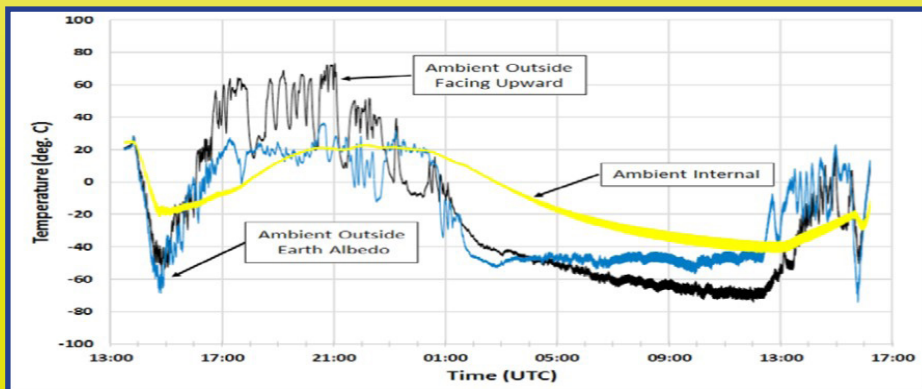

Characteristic temperatures outside HASP during flight

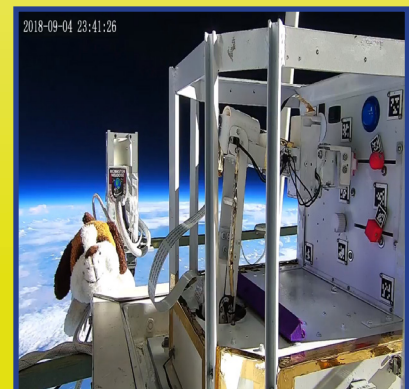

HASP at altitude

# HASP Configuration and System Description

The platform is currently designed to support eight small payloads of ~3 kg weight and four large payloads of ~20 kg weight (i.e. 12 experiment “seats”). A standard interface is provided for each student payload that includes power, serial telemetry, discrete commands and analog output. HASP will archive student payload data on-board as well as telemeter the stream to the ground for real-time access.

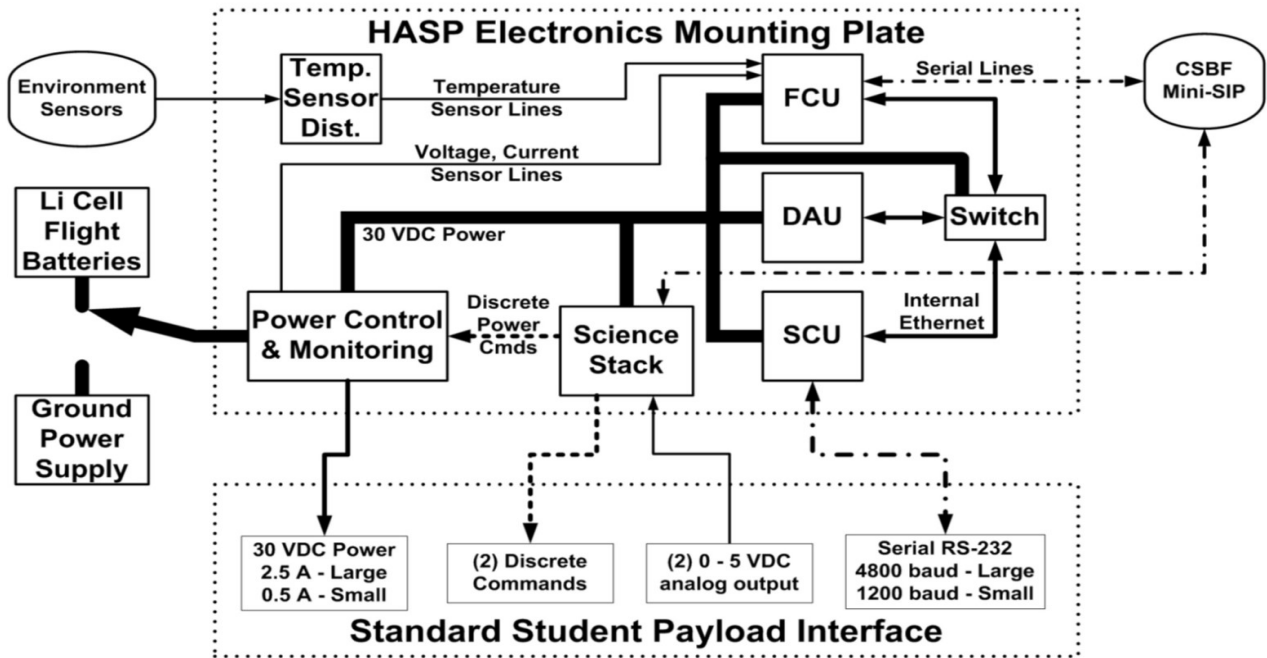

HASP flight electronics system and student payload interface

The four large payload positions are on the top of the central structure while the eight small payloads are mounted on fiberglass outrigger booms. The small payloads may be mounted for nadir pointing. The core structure of the platform is a welded aluminum gondola frame with dimensions of 112 cm long, 91.5 cm wide, 51 cm tall. For flight, HASP is attached to a frame which provides support for the CSBF vehicle control equipment and attach points for suspension cables, crush pads and the ballast hopper.

The HASP command and control subsystem provides the means for receiving and processing uplinked commands, acquiring and archiving the payload data, downlinking status information and controlling the student payloads. There are three primary modules in the subsystem; the Flight Control Unit (FCU) which manages communications, the Serial Control Unit (SCU) which provides a serial communication link to each of the individual student payloads, and the Data Archive Unit (DAU), recording inflight data. The primary power source for HASP is 11 cell lithium battery packs, eight of which will supply ~29 to 32 Volts for ~270 Ahr @ +20°C.

Specifications for the mechanical, electrical and data interface between HASP and a student payload are provided in the latest version of the document “HASP – Student Payload Interface Manual” which can be obtained from the Participant Information page <http://laspaces.lsu.edu/hasp/Participantinfo.php> or the Technical Documents page <http://laspaces.lsu.edu/hasp/Documentation.php> of the HASP website.



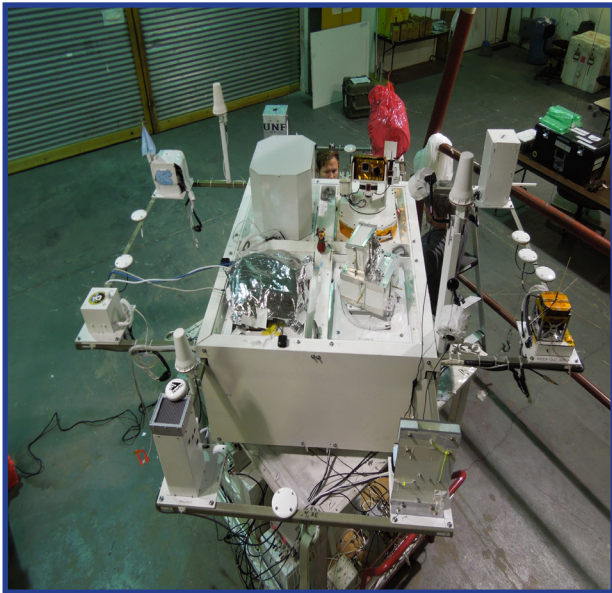

Top view of HASP showing a collection of small and large payloads



2019 HASP Student Participants

## HASP Flight History

Since 2006, HASP has flown 134 student-built payloads engaging close to 1452 undergraduate and graduate students from 47 universities, colleges, and minority serving institutions located across 22 continental U.S. states plus Puerto Rico, Canada, Belgium, and United Kingdom with a total float time of more than 188 hours. The figure below shows the geographical distribution of these student teams.

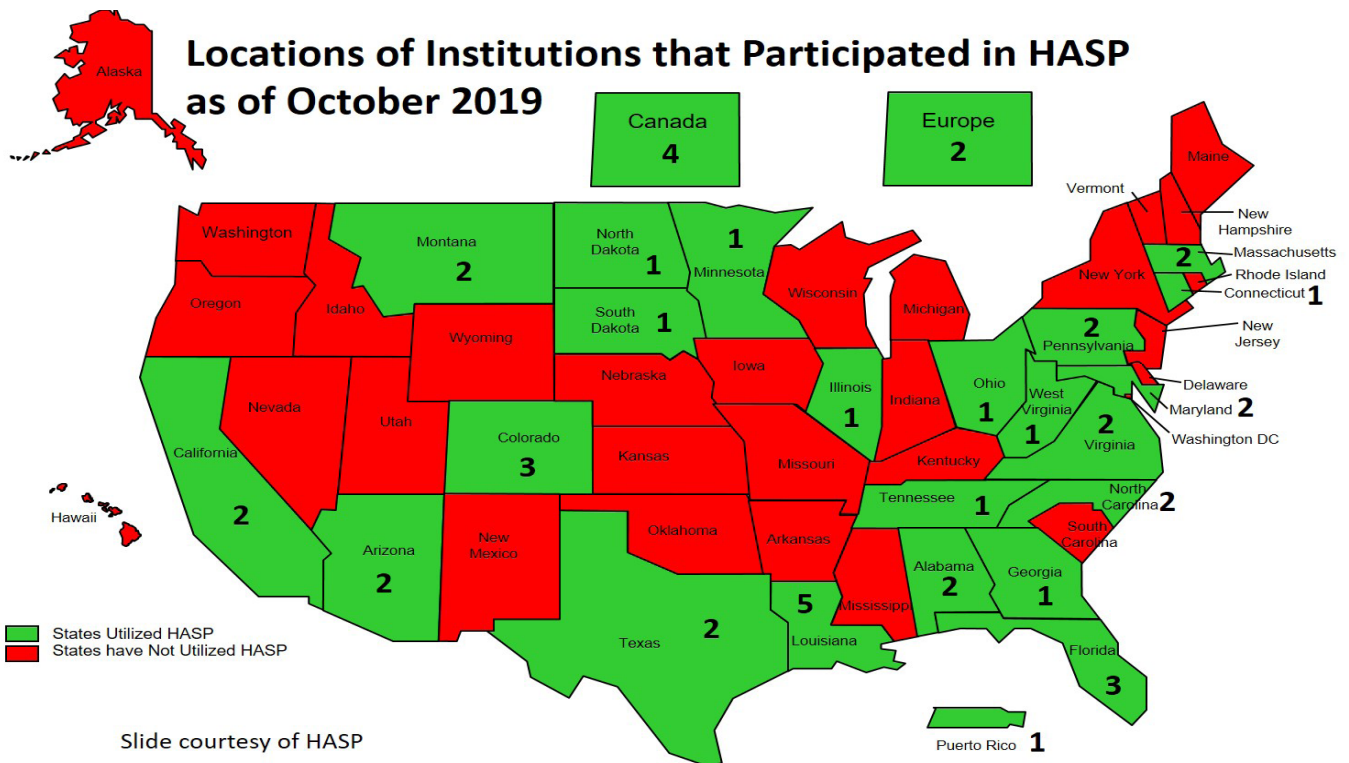

Geographic distribution of institutions which have flown payloads on HASP, shown in green



## HASP Highlights

- ▶ The High Altitude Student Platform supports advanced student-built payloads
  - Regular schedule of launches once per year
  - Provides high altitude (~36 km) and reasonable duration (~15 to 20 hours)
  - Flight tests student-built satellites
  - Flies payloads too heavy for sounding balloons
- ▶ Existing flight designs and experience minimize cost of development and operation
  - Flight proven hardware and software
  - Use time-tested CSBF balloon vehicle hardware
  - Capitalize on decades of CSBF experience with flight operations
- ▶ Could be easily adapted for LDB (~15 – 30 days) flights
- ▶ Could become a major part of aerospace workforce development



HASP payload undergoing compatibility testing

## Participation and Application Process

Students from all universities are invited to apply for a HASP flight opportunity. Flight opportunities on HASP are offered annually. Application details and other resources can be found at the HASP website (<http://laspace.lsu.edu/hasp/>). The application deadlines change slightly from year to year. However, the general guidelines given below should be observed unless stated otherwise for upcoming years.

The completed application should be submitted electronically on or around December 15 by 11:59 pm (Central Time) to the Louisiana Space Consortium at [laspace@lsu.edu](mailto:laspace@lsu.edu). The deadline will be preceded by an informational Q&A teleconference on or around November 15; selections of candidate payloads will be made by mid-January. Student teams must provide their own funds for payload development and travel to integration and flight operations.

**HASP provides undergraduate and graduate students with real-world science and engineering project development experience.**

For more information on HASP, please contact Dr. T. Gregory Guzik by email at ([Tgguzik@lsu.edu](mailto:Tgguzik@lsu.edu)), or by mail to: Louisiana Space Consortium, 364 Nicholson Hall / Tower Drive, Department of Physics & Astronomy, Louisiana State University, Baton Rouge, LA 70803-4001

HASP support is provided by the Louisiana Space Consortium (LaSPACE) which is part of the National Space Grant College and Fellowship Program. The NASA Balloon Program Office, the Columbia Scientific Balloon Facility and LaSPACE have, currently, committed to supporting one flight of HASP per year, supporting one flight of HASP per year.

