

June 2024

Introduction to Sona Comstar

Corporate, Technology & Product Overview



SONA COMSTAR



Mission, Vision, and Values

Our Mission

Be leaders in the technology we invest in and give our customers an edge over the rest, while designing and building products that enable the future of mobility

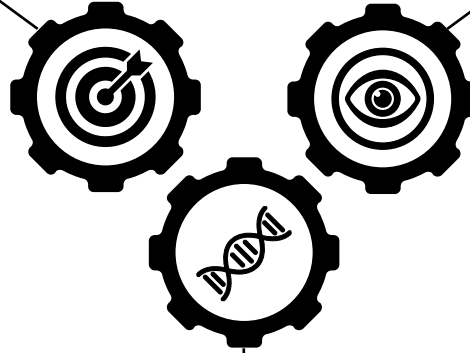

Our Vision

To become the world's most respected and valuable mobility technology company for our customers, employees and shareholders

Our Values



Integrity

Always do the right thing.
No matter what the cost.
No matter if anyone is looking

Build **better** products



Vitality

Build better products –
more economically



Frugality

Build better and more
economical products –
faster



Agility

Our Journey

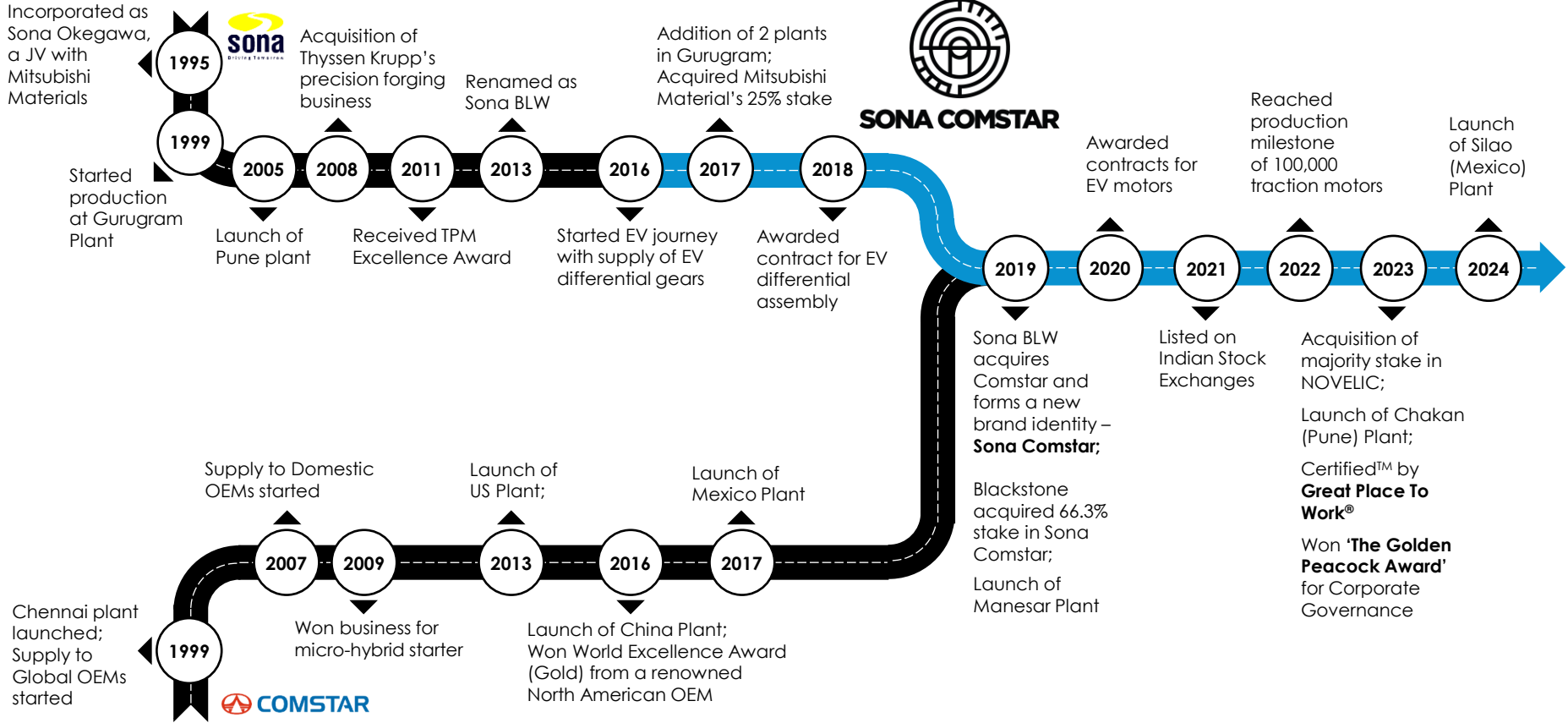

Business Overview



Headquartered in
Gurugram, India



4,674 Employees¹



3 Business Verticals



Driveline Business



Motor Business



Sensors & Software
Business



10 Manufacturing Facilities



3 Engineering Capability
Centres



5 Countries
India, USA, China, Mexico, Serbia



FY24 Revenue:
₹31,848 million
(~\$380 million)



29% Revenue Share
from BEV³

54 EV Programs across
30 customers¹



Top 9% in Sustainalytics
ESG (Core) Risk Rating

45% Revenue share from
BEV as a target for 2026



4 R&D Centres

415 R&D Manpower¹

25% of total on-roll
workforce in R&D¹



131 Software
Engineers in R&D¹

67 Patents²
(Granted: 34, Applied: 33)



Leading Industry Certifications

ISO 9001, ISO 14001,
ISO 50001, ISO 45001,
IATF 16949, TPM, ENMS,
ASES, VQE

1. As of Mar 31, 2024; 2. As of May 31, 2024, 3. For FY24

Our Products

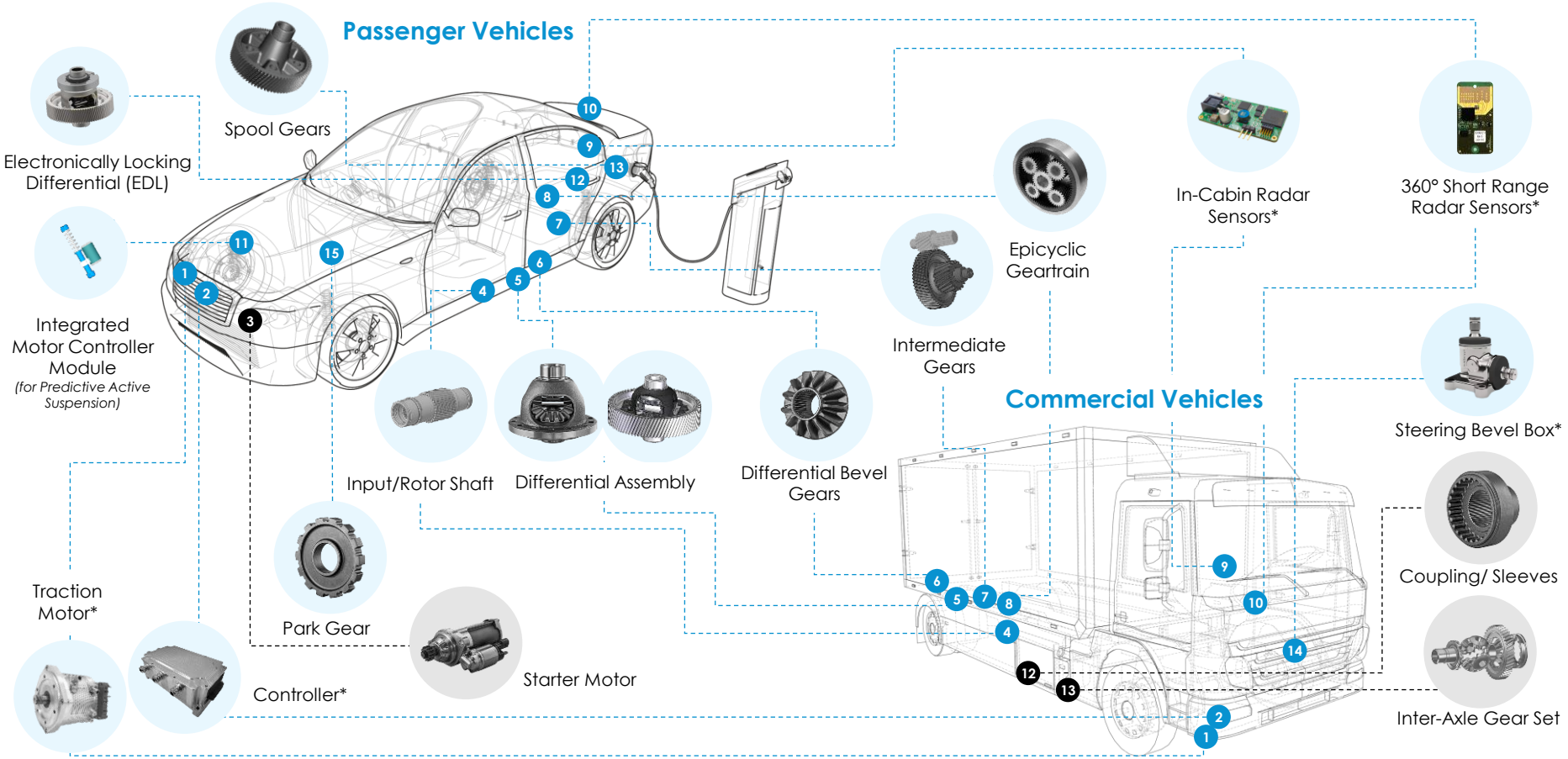

*Product under development

Our Products

Buses

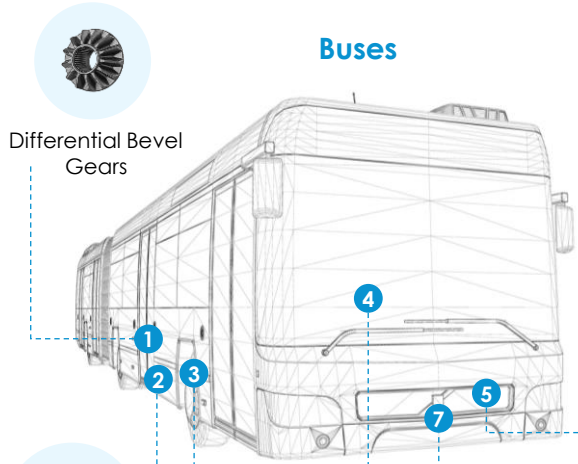

Differential Bevel Gears



Controller*



Traction Motor*



Steering Bevel Box*

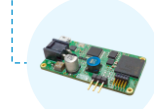

In-Cabin RADAR Sensors*



360° Short Range Radar Sensors*



In-Cabin Radar Sensors*

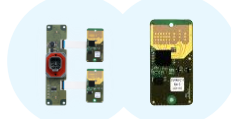

360° Short Range Radar Sensors*

Light Commercial Vehicles /3-Wheeler (Cargo)

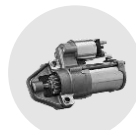
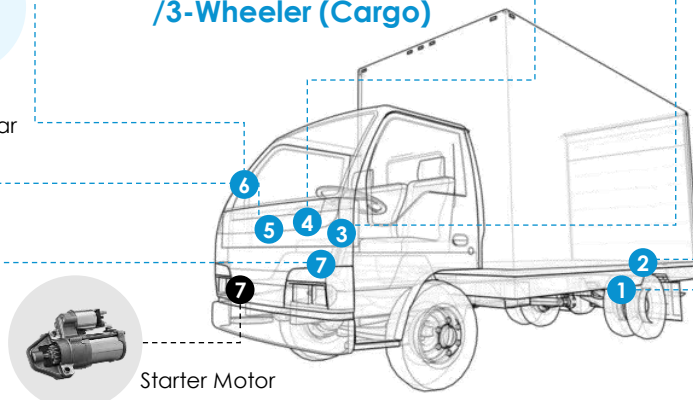

Starter Motor

Off Highway Vehicles

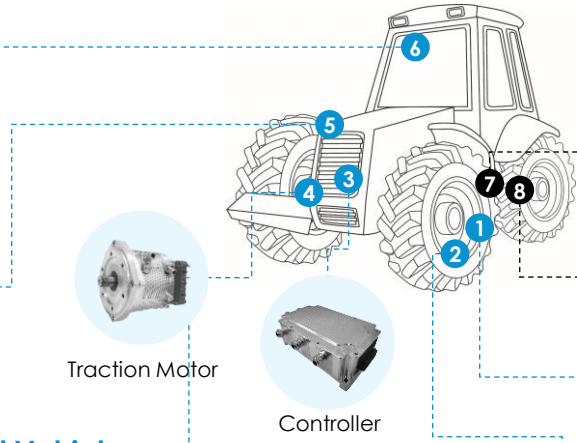

Traction Motor



Controller



Spiral Bevel Gears

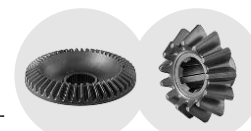

Portal Axle Gears



Differential Assembly



Differential Bevel Gears

*Product under development

Our Products

Electric 2-Wheelers

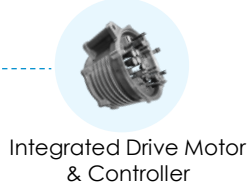
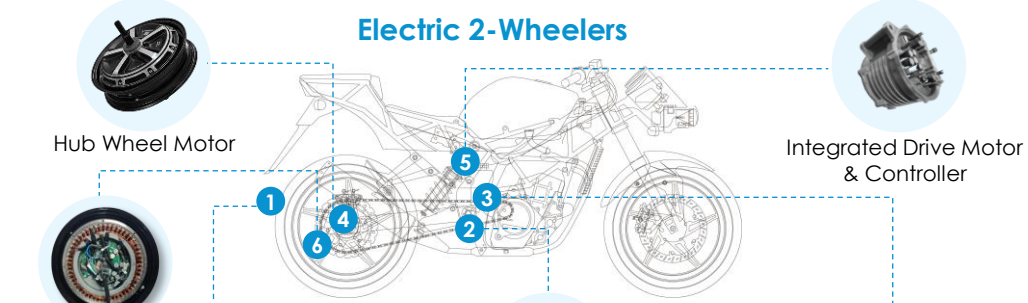

Electric 3-Wheelers

360° Short Range Radar Sensors*

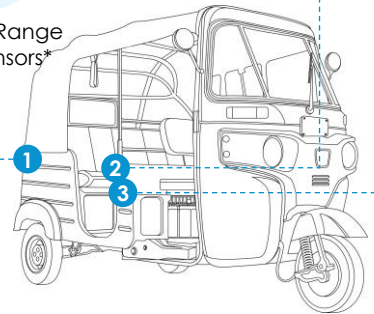

Industrial Automation, AGVs & Robots

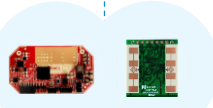
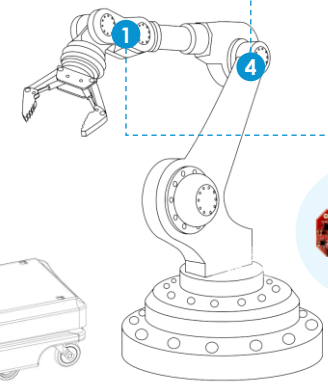
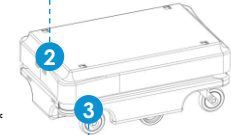
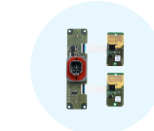
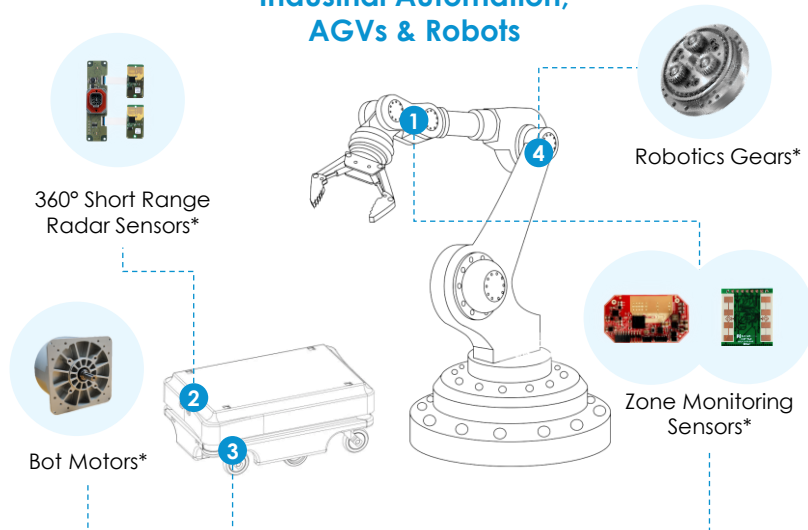

Building Automation

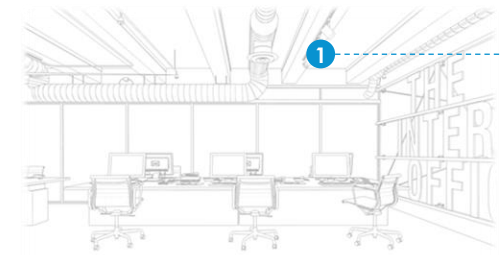

*Product under development

Our Engineering, Research & Development Services



E2E Radar + Perception Solutions

- Radar sensors for people detection
- Radar sensors for autonomy
- Hyper_risc Radar DSP accelerator
- Hyper_gate high-speed logger



Software for Mobility

- Software-defined vehicles competence
- ADAS perception services
- Powertrain services
- Body control services
- Automotive android design services
- Sensor fusion

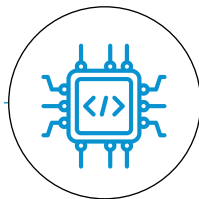

E2E Embedded Systems

- Full-scale Electronics & Software engineering
- Medical / Industrial /IoT engineering
- Mechatronics & Mechanical engineering

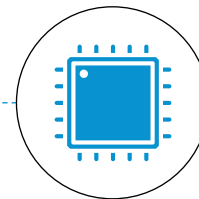

Semiconductor Solutions

- Analog / mmWave IC design
- Digital IC / RISC-V
- Firmware design & testing
- Reference designs
- Analog & digital IPs

Global Footprint

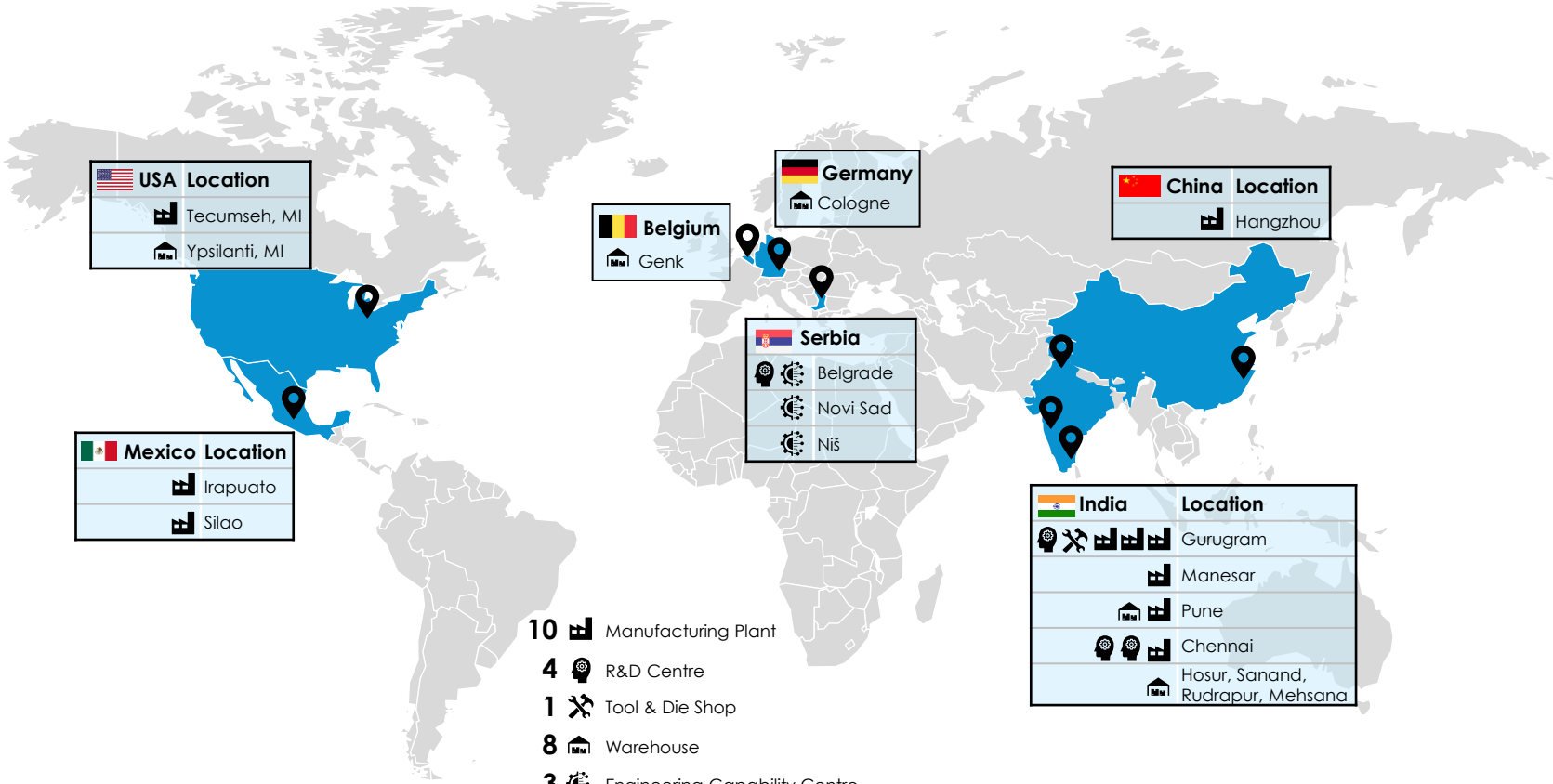

Diversified Revenue

Breakup of FY24 Revenues

By Powertrain

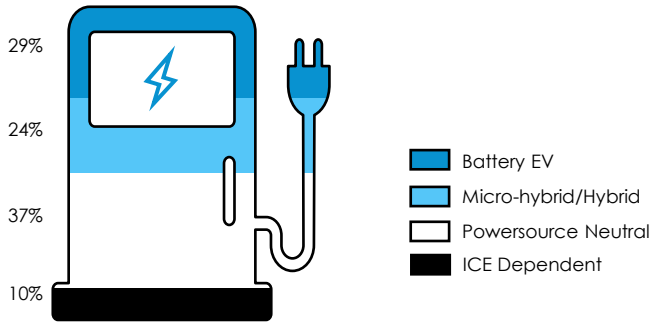

By Geography

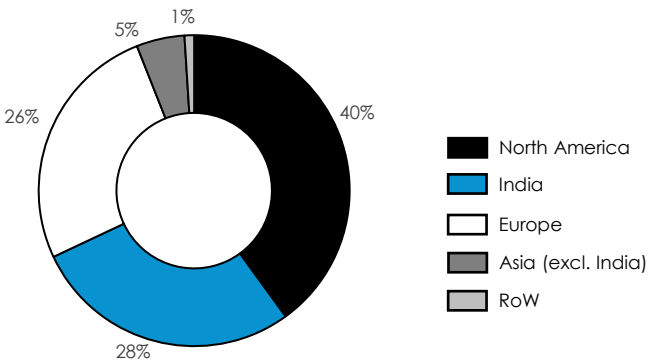

By Product

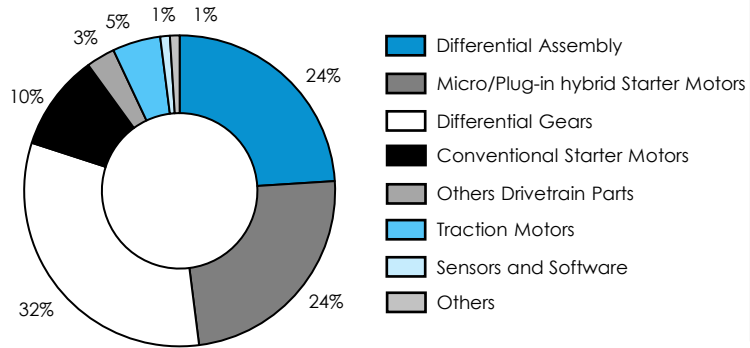

By Vehicle Segment

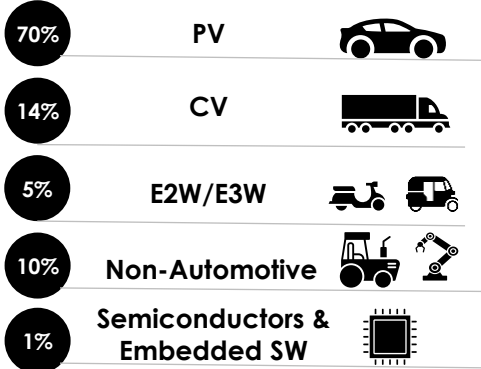

Amongst the Leaders in All Our Product Lines

With significant production volumes¹ since inception...

 **404 Mn**
differential gears

 **37 Mn**
starter motors

 **6.1 Mn**
differential assemblies

 **323 k**
traction motors

...and leading market shares in our products...

Global Market Share²

 **Differential Gears**  **8.1%**

 **Starter Motors**  **4.2%**

Indian Market Share in Differential Gears³

 **55-60%**
Passenger Vehicles

 **80-90%**
Commercial Vehicles

 **75-85%**
Tractors

... we are supplying to most of the major global OEMs

 **7** out of top 10 global PV OEMs^{4a}

 **3** out of top 10 global CV OEMs^{4b}

 **7** out of top 10 global tractor OEMs^{4b}

 **4** out of top 10 global EV OEMs^{4c}

 **3** out of top 10 Indian E-2 Wheeler OEMs^{4d}

1. As of Mar 31, 2024, since inception; 2. In CY23 as per Ricardo Report; 3. As per CRISIL Report; 4. a) BoFA Global Automobiles Report; b) Ricardo Report; c) EV-Volumes; d) Vahan Database; Company Analysis

Our Technology Roadmap for E.P.I.C. Mobility

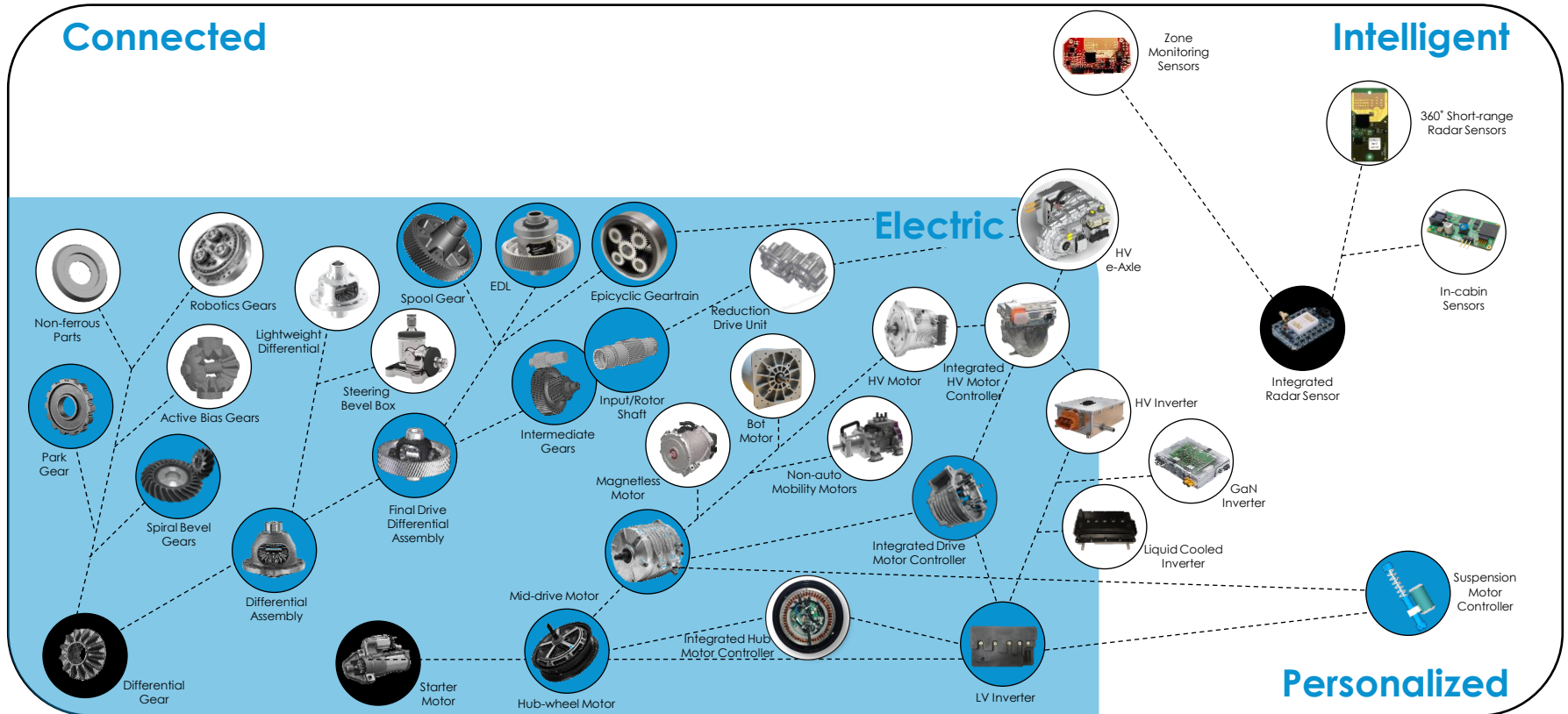

Note: The product images shown are for illustration purposes only and may not be an exact representation of the products

Electrification: Our Approach to Market

Driveline Solutions

Core Strength:
High Torque, High Power Density

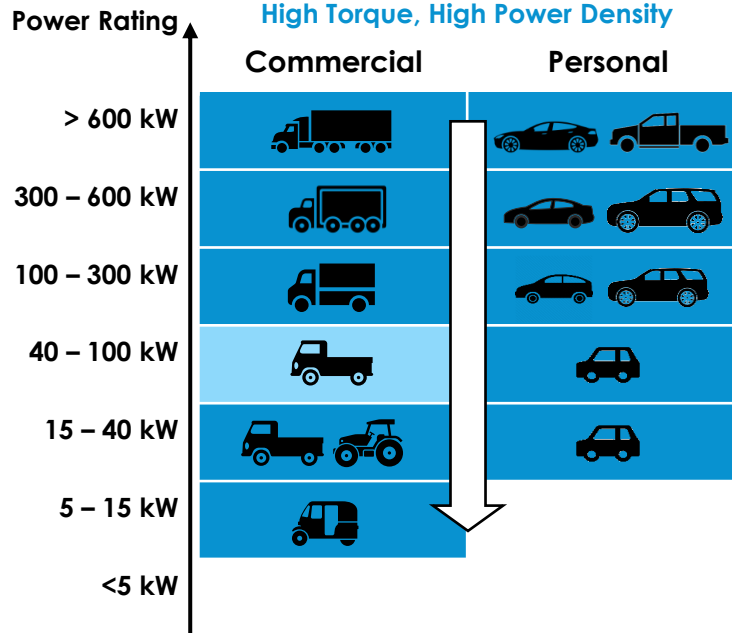

In serial production or in orderbook

To be added between CY24-25

EV Products



Motor Solutions

Core Strength:
Low Voltage, High Power Density

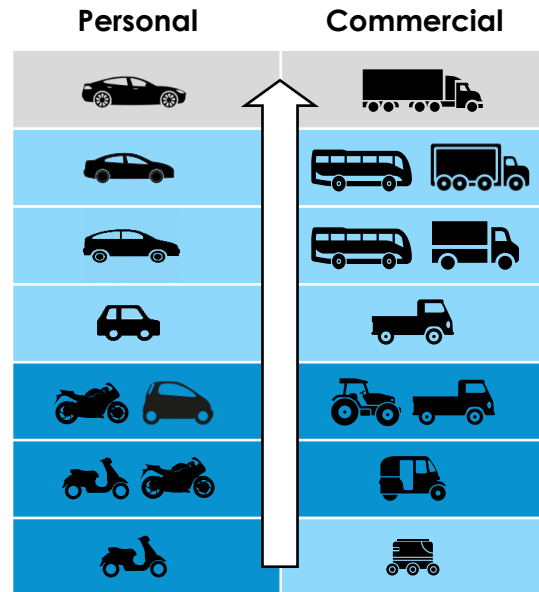

R&D Infrastructure and Strength

Well-equipped to meet the growing demand for lighter and high-power density components and solutions across the globe

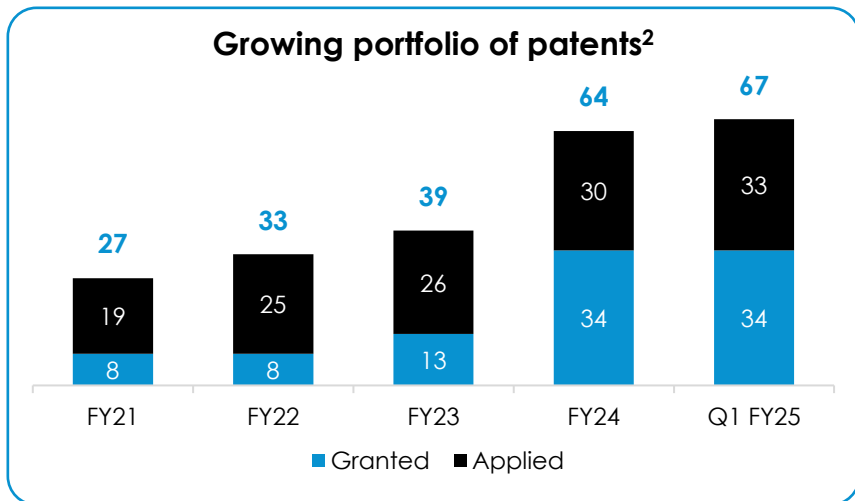

1. As of Mar 31, 2024, 2. As of May 31, 2024

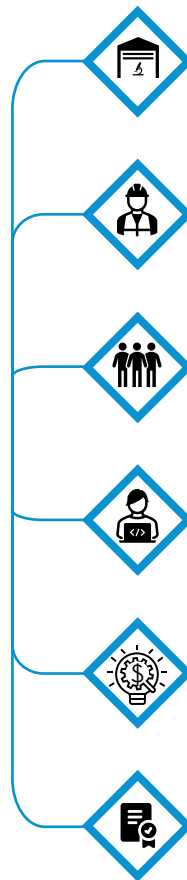

4
R&D Centers

415
R&D Manpower Strength¹

25%
of Total On-roll Workforce¹

131
Software Engineers¹

3.0%
of Revenue Spent on R&D
in the Last 5 Years¹

67
Patents²
(Granted: 34, Applied: 33)

ESG Highlights



14.3 Low Risk



Top 9%

Out of 16,421 global companies¹



We have published our second sustainability report in December 2023

[Click on the image to read the report](#)



- 10% improvement in emissions intensity in FY24 from FY22
- 15% improvement in water intensity in FY24 from FY22
- Setting up a total solar group captive capacity of 21.35 MWp across Maharashtra, Haryana, and Tamilnadu



- Great Place to Work Certified in Jan 2023 and recertified in Jan 2024 with a higher rating
- Driving incubation of 11 startups innovating for sustainability in partnership with IIT Delhi and IIM Ahmedabad
- Improved the female participation in the total workforce from 3% to 6%



- Golden Peacock Award won in 2023 for excellence in corporate governance
- 5 independent directors and 2 women directors out of 8 board members
- Promoter holds the position of a non-executive chairman

¹. As of Mar 31, 2024

Thank You

SONA COMSTAR

Sona Enclave, Village Begumpur Khatola
Sector 35, Post Box No. 90
Gurugram 122004 Haryana, India

+91 124 476 8200
+91 124 410 4639
enquiry@sonacomstar.com

Follow us on

