



A Water Education Program for  
School Enrichment and 4-H Leaders



# Authors

Ronald A. Howard Jr.  
Professor and Extension 4-H and Youth Development Specialist  
The Texas A&M University System  
and  
Lisa Whittlesey  
Extension Program Specialist-Horticultural Sciences  
The Texas A&M University System

# Acknowledgments

The development of this curriculum has involved the cooperation and support of many individuals, agencies and organizations. Financial support was provided by the Texas Water Resources Institute, the Association of Texas Soil and Water Conservation Districts Public Information and Education Committee, and Texas Cooperative Extension. Special thanks to Tricia Davis for her willingness to coordinate the coalition, Clyde Gottschalk for his unflinching dedication to seeing the project through to completion, and Gail Chandler for consistency and diligence in meeting with the committee and providing much needed information and support. Many others contributed to the developmental process, and the authors extend their thanks and appreciation on behalf of the Texas 4-H Program and the youth of Texas.

Principal support for the project came from the following sources (listed alphabetically):

**Natural Resources Conservation Service (USDA)**  
**South Plains Underground Water Conservation District**  
**Texas Cooperative Extension**  
**Texas Alliance of Groundwater Districts**  
**Texas Association of Soil and Water Conservation Districts**  
**Texas Education Agency**  
**Texas Natural Resources Conservation Commission**  
**Texas State Soil and Water Conservation Board**  
**Texas Water Development Board**  
**Texas Water Resources Institute (Texas A&M University System)**



Reviewers and field testers included many teachers, most of whom remained anonymous, as well as professionals in several agencies. Special thanks are extended to Clyde Gottschalk (TASWCD), Amy Howard (6<sup>th</sup> grade science teacher), Gene Lindemann (NRCS—Texas), John Sweeten (TAES), and to the aquatic science teachers in the Rio Grande Valley who critiqued the program through their participation in a training workshop. The authors regret that all of those who provided written or verbal comment on the draft version of the text cannot be acknowledged here. Your service was vital to completion of the guide.

Permission to use content or illustrations was provided by:

Cornell Cooperative Extension: *Pond and Stream Safari* (4-H Leader's Guide 147-L-24) by Karen Edelstein, and the *Sportfishing and Aquatic Education Manual* (SAREP) edited by Bruce Matthews  
Georgia Cooperative Extension: *Investigation H<sub>2</sub>O*  
Texas Water Development Board: Watershed and Aquifer Maps

Original artwork was provided by of Chris Holle of Temple, Texas, with funding support from the Texas Association of Soil and Water Conservation Districts through the Educational Committee. Ron Howard developed computer graphics in support of the content as well. Funding for this publication was provided by the Texas Water Resources Institute.

---

Cherie LeBlanc, Typesetting and design  
Gale Norman, Editor  
Agricultural Communications, Texas Cooperative Extension

# Contents

<b>Acknowledgments</b> .....	i
<b>Contents</b> .....	ii
<b>Foreword</b> .....	iv
<b>Texas Essential Knowledge and Skills</b> .....	v
<b>References</b> .....	viii
<b>Agencies to Contact for More Information</b> .....	ix
<b>Lesson 1 Water in Our Daily Lives</b> .....	1
Fact Sheet 1.1, Cycles .....	7
Activity 1.1, Calculating Average Water Costs .....	9
<b>Lesson 2 Water: A Look Inside the Drop</b> .....	11
Activity 2.1, Opposites Attract .....	15
Activity 2.2, How Much Can It Take? .....	17
Record Sheet 2.2, How Much Can It Take? .....	19
Activity 2.3, Sink or Swim .....	21
<b>Lesson 3 Water: State It Like It Is</b> .....	25
Activity 3.1, Camouflage Water .....	31
Activity 3.2, Liquid Layers .....	33
Activity 3.3, Carrot Float .....	35
Activity 3.4, Funny Funnel .....	37
Activity 3.5, Break Out .....	39
Activity 3.6, Hold in the Heat .....	41
Activity 3.7, Pressure Points .....	43
<b>Lesson 4 The Water Cycle</b> .....	45
Fact Sheet 4.1, Recycled .....	51
Activity 4.1, Any Way You Slice It .....	53
Activity 4.2, Around and Around We Go .....	55
Record Sheet 4.2, Around and Around We Go .....	57
Activity 4.3, See How it Runs .....	59
Record Sheet 4.3, See How it Runs .....	61
Activity 4.4, A Groundwater Drink .....	63
Activity 4.5, Cloud Maker .....	65
Activity 4.6, What Goes Up . . . Must Come Down .....	67
Activity 4.7, Hydrologic Puzzle .....	69
Record Sheet 4.7, Hydrologic Puzzle .....	71
Activity 4.8, Living in a Bubble World .....	73
Activity 4.9, Water Bingo .....	75
<b>Lesson 5 Amazing Aquifers</b> .....	85
Activity 5.1, Abracadabra Aquifer .....	89
Record Sheet 5.1, Abracadabra Aquifer .....	91
Activity 5.2, Sandwiched Between .....	93
<b>Lesson 6 The Fabulous Duo: Watersheds and Wetlands</b> .....	95
Activity 6.1, Lone Star Watersheds .....	105
Activity 6.1, Answer Key Lone Star Watersheds .....	107
Activity 6.2, Watershed Come Alive .....	109
Record Sheet 6.2, Watershed Come Alive .....	111
Activity 6.3, Wetland Mobile .....	113
Activity 6.4, Wetlands: Nature’s Clean Machine .....	115

Record Sheet 6.5, What's in Your Neighborhood? .....	117
Activity 6.6, Fun with Water in Our Landscape Crossword Puzzle .....	119
Activity 6.6, Answer Key Fun with Water in Our Landscape Crossword Puzzle .....	121
<b>Lesson 7 Water and Soil</b> .....	123
Activity 7.1, 1,2,3 — Sand, Silt, Clay and Me .....	131
Activity 7.2, Watch It Run! .....	133
Activity 7.3, Splish, Splash .....	135
Activity 7.4, Bare or Covered? .....	137
Activity 7.5, Slip Sliding Away .....	139
<b>Lesson 8 Water and Plants</b> .....	141
Activity 8.1, Trap It In .....	147
Activity 8.2, Plant Straws .....	149
Activity 8.3, Fruits are Full of It .....	151
Record Sheet 8.3, Fruits are Full of It .....	153
<b>Lesson 9 Water and Animal Life</b> .....	155
Activity 9.1, How Watery Are You? .....	165
Record Sheet 9.1, How Watery Are You? Handout 1 .....	167
Record Sheet 9.1, How Watery Are You? Handout 2 .....	169
Activity 9.2, Wet and Dry .....	171
Record Sheet 9.2, Wet and Dry .....	173
<b>Lesson 10 Aquatic Ecosystems</b> .....	175
Activity 10.1, Water Creatures .....	185
Fact Sheet 10.1, Quick Reference Guide to Aquatic Invertebrates .....	187
Activity 10.2, Currents and Eddies .....	189
Activity 10.3, Food Webs .....	191
Activity 10.4, Playing the Game of Life .....	193
<b>Lesson 11 Water and Pollution</b> .....	195
Activity 11.1, Pollution, Pollution, Everywhere! .....	205
Record Sheet 11.1, Pollution, Pollution, Everywhere! .....	207
Activity 11.2, Pollution at Its Source! .....	211
Activity 11.3, Landfill Ooze .....	213
Record Sheet 11.3, Landfill Ooze Observation and Evaluation Form .....	215
Activity 11.4, Let's Give It a Measure . . . pH! .....	217
Activity 11.5, The Lone Drop .....	219
Activity 11.6, Water Detective .....	223
Record Sheet 11.6, Water Detective .....	225
Activity 11.7, Bottle 'Em Up .....	227
Record Sheet 11.7, Bottle 'Em Up .....	229
Activity 11.8, Pollution — Solution! .....	231
Record Sheet 11.8, Pollution — Solution! .....	233
<b>Lesson 12 Wise Water Use</b> .....	235
Fact Sheet 12.1, Water Efficient Home Guide .....	243
Record Sheet 12.1, Water Wise Scorecard .....	245
Record Sheet 12.2, Splish, Splash, Should I Take a Bath? .....	247
Record Sheet 12.3, Meter Reader .....	249
Record Sheet 12.4, Water We Do Now? .....	251
<b>Glossary</b> .....	253

# Foreword

Water is the mainstay of life, and all living things need water to survive. People require a plentiful supply of clean water to support and maintain our homes, farms and factories, and to provide for the living things that enrich our lives and supply us with our needs. Because it is used so frequently and for so many purposes, water is often taken for granted. Yet this natural resource is neither unlimited nor forever safe from pollution and must be conserved and protected.

Children are the key to conserving and protecting water. *Investigating Water* provides lesson plans and activities to help fourth grade students and 4-H youths discover and appreciate this precious fluid. These teaching materials are designed to increase student knowledge of water and understanding of its importance while reinforcing skills learned in many other areas. These lesson plans have been designed with the climate, aquifers, water use patterns, and needs of Texas in mind. The concept for this material was based upon an effective program, *Investigation H<sub>2</sub>O*, developed by the Cooperative Extension Service at the University of Georgia.

Educators, both classroom teachers and volunteer youth leaders, play a vital role in introducing young people to the wonders of water. Thank you for your participation in this project! We look forward to working with you to educate the young people of Texas about this critically important resource.

Each of the 12 lessons in this manual is divided into the following sections: Objectives, Materials/Equipment, Vocabulary, Lesson Requirements, Lesson Overview, Lesson Background, Applications, Summary Activity, For Further Thought, and Sharing or Exhibit Suggestions.

The *Objectives* briefly summarize what participants will do or learn during the course of the lesson.

*Materials/Equipment* lists the basic needs for conducting the lesson

*Vocabulary* is a list of vocabulary words introduced in the lesson. As each word is used for the first time in the Background Material or Applications sections, the word is printed in **bold type**. As the instructor, you may wish to provide the vocabulary words as a handout for the participants to use in taking notes.

The section on *Lesson Requirements* lists the time required to complete the lesson and the best time and location for conducting the lesson.

The *Lesson Overview* is the suggested format for presenting the lesson material. Use your own words to cover the points in the outline. As the instructor, you may wish to provide the overview as a handout for the participants to use in taking notes.

*Lesson Background* is a resource for your use in developing the material to present in each lesson. It is not intended for use as a narrative or lecture notes. It is reference material that follows the format of the *Lesson Overview*. Read it and other resource material, if you wish, before presenting the lesson.

The section on *Applications* has numerous activities and suggestions for presenting information to the participants. Action words are written in CAPITAL letters as prompts for action by the instructor or the participants.

Additional activities and experiments are included in *For Further Thought*.

The *Summary Activity* can be used as a final review of the lesson.

*Sharing or Exhibit Suggestions* lists projects and activities for individual participation and exploration.

Lessons usually are followed by several activities and record sheets that will be helpful in presenting the material and in reaching the lesson objectives.

# Texas Essential Knowledge and Skills

Because this curriculum is designed primarily for fourth-grade-level school enrichment and for use by 4-H volunteers in a club setting, we have listed those TEKS directly addressed in the activities. Others may be incorporated by teachers who wish to extend the lesson. Please do not feel limited by our suggestions of those TEKS that are identified. The TEKS are listed in a condensed table associating them with each of the activities. Teachers at other grade levels may wish to use these examples as a foundation for their own planning. For application to the TEKS knowledge and skills and objectives, refer to the Web site at [www.tea.state.tx.us/teks/ti](http://www.tea.state.tx.us/teks/ti).

## Texas Essential Knowledge and Skills

Learning Experience	Curriculum Area	Knowledge and Skills	Objectives
Opposites Attract	English Language Arts Mathematics Science	4.4; 4.5; 4.13 4.8; 4.15; 4.16 4.2; 4.3; 4.7	A; A-F; F A; A; A,B A-E; A,C; A,B
How Much Can It Take?	English Language Arts Mathematics Science	4.4; 4.5; 4.9; 4.13; 4.21 4.11; 4.14; 4.15 4.1; 4.2; 4.4; 4.7; 4.10	A; B-F; B; A,G,H; F B; A-D; A,B A; A-D; A,B; B; A
Sink or Swim	English Language Arts Science	4.1; 4.5 4.2; 4.3; 4.7	A,B; B,E,F A,B,C; C; B
Camouflage Water	English Language Arts Mathematics Science	4.3; 4.5; 4.6; 4.9; 4.13 4.11; 4.14; 4.15; 4.16 4.1; 4.2; 4.4; 4.7	A; E; C; A,B,D,E; A A; A; A,B; A,B A; A-E; A; B
Liquid Layers	English Language Arts Mathematics Science	4.1; 4.5; 4.6; 4.9; 4.15; 4.16; 4.18 4.11; 4.14; 4.15; 4.16 4.2; 4.6; 4.7	A-C; D-F; C; A-E; A,B; A-C; A-F A,B; A-C; A,B; A,B A-E; A; B
Carrot Float	English Language Arts Mathematics Science	4.4; 4.5; 4.13 4.11; 4.14; 4.15; 4.16 4.2; 4.6; 4.7	A; A,D-F; A A,B; A-D; A,B; A,B A-E; C; A,B; B; A
Funny Funnel	English Language Arts Mathematics Science	4.1; 4.2; 4.5; 4.9; 4.17; 4.18 4.15; 4.16 4.1; 4.2; 4.3; 4.7; 4.10	A-C,D; A,B,D-F; A-E; A-D; A-F A,B; A,B A,B; A-D; A-C; A,B; A,B
Break Out	English Language Arts Mathematics Science	4.1; 4.4; 4.5 4.11; 4.14; 4.15; 4.16 4.2; 4.3; 4.4; 4.6; 4.7	A-C; A; B,F A,B; A-D; A,B; A,B A-E; A-C; A,B; A; A,B
Hold in the Heat	English Language Arts Mathematics Science	4.1; 4.4; 4.5 4.11; 4.14; 4.15; 4.16 4.2; 4.3; 4.4; 4.6; 4.7	A-C; A; B,F A,B; A-D; A,B; A,B A-E; A-C; A,B; A; A,B
Pressure Points	English Language Arts Mathematics Science	4.1; 4.4; 4.5 4.11; 4.14; 4.15; 4.16 4.2; 4.3; 4.4; 4.5; 4.7	A-C; A; B,F A,B; A-D; A,B; A,B A-E; A-C; A,B; A; A,B
Recycled	English Language Arts Science	4.10; 4.11; 4.12 4.2; 4.3; 4.6; 4.7; 4.10	A-I; A-D; B-D, F,G,I,J B-E; A-C; A,B; A; A
Any Way You Slice It	Mathematics Science	4.2; 4.10; 4.14 4.3	A,C; A; A,C C
Around and Around We Go	English Language Arts Science	4.6; 4.9; 4.13 4.3; 4.5; 4.6; 4.7; 4.10; 4.11	A-C; A-E; A-H A,C; A,B; A; A; B,C
See How It Runs	English Language Arts Science Social Studies	4.6; 4.7; 4.15 4.10 4.6; 4.7; 4.8; 4.9	A-C; A-D; A,C A A; B; A-C; A
A Groundwater Drink	English Language Arts Science	4.1; 4.4; 4.10 4.2; 4.3	A-C; A; A,F-H,K A-C; A-C

<b>Learning Experience</b>	<b>Curriculum Area</b>	<b>Knowledge and Skills</b>	<b>Objectives</b>
Cloud Maker	English Language Arts Science	4.1; 4.2; 4.4 4.2; 4.6; 4.7	A-C; D; A A-D; A; A,B
What Goes Up . . . Must Come Down	English Language Arts Mathematics Science	4.1; 4.2 4.11; 4.12; 4.14; 4.15 4.1; 4.2; 4.3; 4.4; 4.6; 4.7	A-C; A,D A,B; A; A-D; A,B A,B; A,E; A-C; A,B; A; A,B
Hydrologic Puzzle	English Language Arts Science	4.6; 4.7; 4.8; 4.9; 4.10 4.5; 4.7; 4.11	A-C; A-D; C; A-E; A-C A; A; A-C
Living in a Bubble World	Science	4.1; 4.2; 4.5; 4.8; 4.11	A,B; A-E; A,B; A,B; C
Water Bingo	English Language Arts Science	4.1; 4.6; 4.9 4.6	A,B; A; A,E A,B
Abracadabra Aquifer	English Language Arts Science Social Studies	4.6 4.2; 4.3 4.6; 4.7; 4.8	A,C B; C A,B; A; A-C
Sandwiched Between	English Language Arts Mathematics Science	4.5; 4.7 4.11; 4.12 4.3	E; A-D A,B; A A,C
Lone Star Watersheds	Social Studies	4.6; 4.7; 4.8; 4.9	A,B; A; A-C; A
Watershed Come Alive	English Language Arts Mathematics Science Social Studies	4.1; 4.2; 4.5; 4.7 4.2; 4.3; 4.8; 4.12; 4.14 4.1; 4.3; 4.4 4.6; 4.7	A-C; A,D; A,D-F; A-F A-D; A,B; A-C; A; A-D A; A-E; A,B A; B
Wetland Mobile	English Language Arts Science	4.1; 4.5; 4.25 4.3; 4.5; 4.8	A-C; A-F; A C; A,B; A,B
Wetlands: Nature's Clean Machine	English Language Arts Mathematics Science	4.7; 4.10 4.11; 4.12; 4.15 4.2; 4.3; 4.4; 4.10	A-F; A-F,K A,B; A; A,B A-E; C; A,B; A,B
What's in Your Neighborhood?	English Language Arts Mathematics Social Studies	4.10; 4.17; 4.18 4.1; 4.2; 4.3; 4.4; 4.5; 4.6; 4.15 4.6; 4.7; 4.22; 4.23	A,B; A-D; A-G A,B; A-D; A,B; A-E; A,B; A-C; A,B A; B; A-C,F; B-D
Fun with Water in Our Landscape Crossword Puzzle	English Language Arts	4.7; 4.9; 4.17	A-F; A-E; A-C
1,2,3 - Sand, Silt, Clay and Me	English Language Arts Mathematics Science	4.7; 4.9; 4.16; 4.17; 4.18 4.2; 4.11; 4.12; 4.14; 4.15 4.2; 4.4; 4.11	A-F; A-E; A,B; A-D; A-G A-D; A,B; A; A-D; A,B A-E; A,B; A
Watch It Run!	Mathematics Science	4.11; 4.12; 4.15 4.3; 4.4; 4.10; 4.11	A,B; A; A,B A,C; A,B; A; A
Splish, Splash	English Language Arts Mathematics Science	4.10 4.11; 4.12 4.2; 4.4; 4.10; 4.11	A-D A,B; A A-C; A,B; A,B; A
Bare or Covered?	English Language Arts Mathematics Science	4.4 4.11; 4.12 4.2; 4.3; 4.4; 4.10; 4.11	A A,B; A A-C; C; A,B; A,B; A
Slip Sliding Away	English Language Arts Mathematics Science	4.7 4.11; 4.12; 4.13; 4.14 4.2; 4.4; 4.10; 4.11	A-F A,B; A; A-C; A-D A-E; A,B; A,B; A
Trap It In	Mathematics Science	4.4; 4.5; 4.6; 4.7; 4.11; 4.12; 4.14 4.2; 4.4; 4.8; 4.10	A-E; A,B; A-C; A; A,B; A; A-D A-E; A,B; A,B; A
Plant Straws	Science	4.2; 4.6; 4.8; 4.10	A-E; A-C; A,B; A



<b>Learning Experience</b>	<b>Curriculum Area</b>	<b>Knowledge and Skills</b>	<b>Objectives</b>
Fruits are Full of It	Mathematics Science	4.3; 4.4; 4.6; 4.11; 4.12; 4.15 4.1; 4.2; 4.4; 4.7; 4.10	A,B; A-E; A-C; A; A; A,B A,B; A-E; A,B; A,B; A
How Watery Are You?	Mathematics Science	4.3; 4.4; 4.5; 4.6; 4.11; 4.14 4.4; 4.7	A,B; A-E; A,B; A-C; A; A A; B
Wet and Dry	English Language Arts Mathematics Science	4.7; 4.9 4.3; 4.7; 4.12; 4.15 4.1; 4.2; 4.4; 4.6; 4.7; 4.10	A-E; A,B,E A,B; A; A; A,B A,B; A-E; A,B; A,B; A
Water Creatures	English Language Arts Science	4.1; 4.2; 4.5 4.1; 4.2; 4.4; 4.5; 4.8	A-C; A-D; A,B,D-F A,B; A-C; A,B; A,B; A-C
Currents and Eddies	Science	4.2; 4.3; 4.4; 4.7; 4.10	A-E; A,B,C,D; A; B; A
Food Webs	English Language Arts Science	4.5 4.2; 4.3; 4.4; 4.5; 4.8	A-F A-E; A,C,D; A; A,B; A,B
Playing the Game of Life	English Language Arts Science Social Studies	4.5 4.3; 4.5; 4.11 4.22; 4.23; 4.24	A-F A,C,D; A; C A-F; B,E; A,B
Pollution, Pollution, Everywhere!	English Language Arts Mathematics Science Social Studies	4.2; 4.5 4.11; 4.12; 4.12 4.1; 4.2; 4.3; 4.4; 4.6; 4.10 4.9; 4.22; 4.23; 4.24	A-D; A-F A,B; A; A,B A,B; A-E; A,C,D; A,B; A; A A; A-F; B-E; A,B
Pollution at Its Source!	English Language Arts Mathematics Science Social Studies	4.1; 4.2 4.2; 4.11; 4.12 4.1; 4.2; 4.3; 4.4; 4.6; 4.10; 4.11 4.5; 4.9; 4.22; 4.23; 4.24	A-C; A,C,D A,B; B; A A,B; A-E; C; A; A; A; A A; A-F; B-E; A,B
Landfill Ooze	English Language Arts Mathematics Science Social Studies	4.1; 4.2; 4.6; 4.15 4.11; 4.12; 4.14; 4.15; 4.16 4.1; 4.2; 4.3; 4.4; 4.5; 4.10 4.5; 4.22; 4.23; 4.24	A-C; A-D; A-C; A,C,F A,B; A; A-D; A,B; A,B A,B; A-E; A,C,D; A,B; A A; A-F; B,D,E; A,B
Let's Give It a Measure . . . pH!	Mathematics Science	4.11; 4.12; 4.14 4.1; 4.2; 4.3; 4.6; 4.10	A,B; A; A-D A,B; A-E; A,C,D; A; A
The Lone Drop	Mathematics Science	4.1; 4.2; 4.6; 4.11; 4.15 4.1; 4.2; 4.4	A,B; A,C,D; C; A,B; A,B A,B; A-E; A
Water Detective	English Language Arts Science Social Studies	4.1; 4.2; 4.5; 4.15; 4.16; 4.17; 4.18 4.3 4.23; 4.24	A-C; A-D; A,B,D-F; A-F; A,B; A-D; A-G A-D B-E; A,B
Bottle'Em Up!	English Language Arts Science	4.1; 4.2; 4.4; 4.5 4.1; 4.2	A-C; A-D; A; A,B,C-F A,B; A-E
Pollution - Solution!	English Language Arts Social Studies	4.2 4.5	A-D A
Water Wise Scorecard	English Language Arts	4.7	A-F
Splish, Splash, Should I Take A Bath?	English Language Arts Mathematics Science Social Studies	4.7 4.3; 4.4; 4.6; 4.11; 4.12 4.1; 4.2; 4.4 4.24	A-F A,B; A-E; A,B; B; A; A-D A,B; A; A,B A,B
Meter Reader	English Language Arts Mathematics Science	4.7; 4.9; 4.10 4.1; 4.11; 4.12 4.2; 4.4	A-F; E; A-C,K A,B; B; A B,C; A
Water We Do Now?	English Language Arts Social Studies	4.15; 4.16; 4.17; 4.18; 4.19 4.24	A-F; A,B; A-D; A-G; A-H A,B

## References

- Investigation H<sub>2</sub>O*, Cooperative Extension Service, The University of Georgia College of Agricultural and Environmental Sciences, 1993.
- Oh, Give Me a Home!*, "Creative Learning Activities/ Water Quality/Nonpoint Source Pollution," Mississippi Soil and Water Conservation Commission.
- Water Sourcebook*, "A Series of Classroom Activities for Grades 3-5," U.S. Environmental Protection Agency, Tennessee Valley Authority - Environmental Education Section, May 1994.
- Indiana's Water Riches*, "A Water Quality Curriculum - Taking A Closer Look At Water," Purdue University Cooperative Extension Service 4-H Youth Department.
- A Guide to Environmental Education*, St. Joseph County Soil and Water Conservation District, South Bend, Indiana.
- Critical Issue: Water*, "You Can Make A Difference," Water Resources Education Kit, Cornell Cooperative Extension Association of Nassau County.
- Acid Rain: A Student's First Sourcebook*, United States Environmental Protection Agency, Office of Environmental Processes and Effects Research, Washington, DC., July 1990.
- Aquatic Resources Education Curriculum*, American Fishing Tackle Manufacturers Association, Barrington, Illinois, 1987.
- Wetlands Fact Sheets*, United States Environmental Protection Agency, Office of Water, Office of Wetlands, Oceans and Watersheds, February 1995.
- Teaching Soil and Water Conservation*, "A Classroom and Field Guide," United States Department of Agriculture, Soil Conservation Service, February 1992.
- 4-H Sportfishing and Aquatic Resource Education Program*, New York State Department of Environmental Conservation, New York State Sea Grant and Cornell Cooperative Extension, September 1989.
- 200 Goopy, Slippery, Slimy, Weird and Fun Experiments*, Janice VanCleave, John Wiley & Sons, Inc., 1993.
- 45 Suggested Environmental Education Lesson Plans*, United States Department of Agriculture, Soil Conservation Service.
- Water Quality and Conservation*, "Training/Resource Manual for County Extension Agents," by Water Quality and Conservation Initiative Teams, Texas Cooperative Extension, Texas A&M University System, College Station, Texas.
- Engineering Field Handbook*, United States Department of Agriculture, Soil Conservation Service [Natural Resources Conservation Service], Landover, Maryland, 1992.
- Harmony: A Partnership with a Healthy Land*, United States Department of Agriculture, Natural Resources Conservation Service, U.S. Government Printing Office, 1995.
- The Water Cycle: Nature's Recycling System*, U.S. Department of Agriculture, Soil Conservation Service & Water Environment Federation, October 1993.
- Ecosystems, A Natural Mix*, University of Illinois at Urbana-Champaign, College of Agriculture, Illinois Cooperative Extension Service.
- Water Education - Grades K-6*, Donald R. Daugs and C. Earl Israelsen, International Office for Water Education, January 1992.
- Working with Wetlands*, United States Department of Agriculture, Soil Conservation Service (Natural Resources Conservation Service), Agriculture Information Bulletin Number 672.
- EnviroScope*, JT & A, Tucson, Arizona, 1992.
- Drinking Water and Health*, Ann V. Beard and Dymple C. Cooksey, Texas Cooperative Extension, Texas A&M University System, publication B-1655.
- Compendium of Educational Materials on the Water Environment*, Alliance for Environmental Education, Inc., 51 Main Street, P.O. Box 368, The Plains, VA 22171, 1992.

## **Agencies to Contact for More Information**

You can find them listed in your local telephone book under U.S., State or County Agencies

**Natural Resources Conservation Service**

**Texas Cooperative Extension**

**Texas Education Agency - Environmental Education**

**Texas Engineering Extension Service**

**Texas Natural Resources Conservation Commission**

**Texas State Soil and Water Conservation Board**

**Texas Water Development Board**

**Texas Water Resources Institute**

**U.S. Fish and Wildlife Service**

**U.S. Forest Service**

### **Texas 4-H Youth Development**

The State 4-H Office, 7607 Eastmark Drive, Suite 101, College Station, TX 77843-2473

Telephone: (409) 845-1214 Fax: (409) 845-6495 Internet: r-howard1@tamu.edu





# Water in Our Daily Lives

*Every living thing on earth requires water to survive*

## Objectives

1. Identify ways people use water.
2. Identify functions of water in plants and animals.
3. Identify and discuss obvious and hidden uses of water in daily living.
4. Identify local water supply sources.
5. Calculate average water costs and compare them with selected Texas cities.
6. Have fun while learning.

## Materials/Equipment

chalkboard, overhead or similar display surface  
writing materials  
drawing/writing materials for students  
globe or map

## Vocabulary

average	component	extraction	potable
brainstorm	conclusion	hygiene	resource
chemical	distribution	lubricant	solvent
commerce	excretory	manufacture	speculate

## Lesson Requirements

**Best Time:** Any time of year, at or near the beginning of the lesson sequence

**Best Location:** Any safe setting where young people can work in small groups

**Time Required:** Approximately 15 to 30 minutes, depending upon the level of interaction desired

## Lesson Background

### I. Water Usage

Water, one of the most common compounds on earth, covers more than three-fourths of the earth's surface. This natural **resource** is so common that people sometimes take it for granted. However, it is the foundation of life on earth and is vital to everything that people do.

#### People use water

People directly use water in a number of obvious ways. We drink it to replenish bodily fluids (the human body is about 80 percent water). We cook with it and we use it for the purposes of **hygiene**; we bathe in it, wash our clothes, clean our living space, and use it as an aid in sanitation. People also use water for recreation and in commercial transportation.

## Lesson Overview

- I. Water Usage
  - A. People use water
    1. Directly
    2. Indirectly
  - B. Water and living things
  - C. Water use patterns
    1. Individual/personal
    2. Recreation
    3. Manufacturing
  - D. Hidden water needs
- II. Water Supply and Wastewater
  - A. Sources
  - B. Treatment
  - C. Distribution
  - D. Wastewater
  - E. Costs
- III. Water - Common but Vital

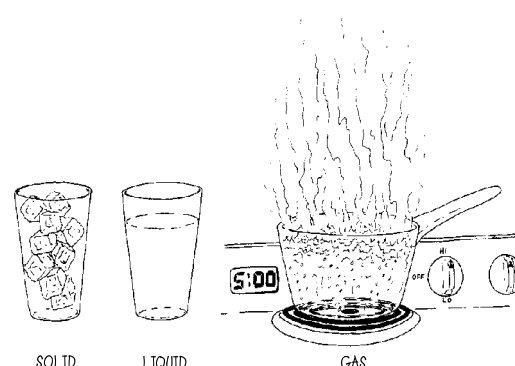

## Applications

In small groups, have students **BRAINSTORM** about ways people use water. ASK leading questions that involve agricultural, manufacturing, household, **commerce** and other uses of water.

Indirectly, people use even more water. All of the foods people and other animals eat depend upon water. Water, in some form, is used to generate most of our electrical power and is often used to heat and cool buildings. Water is one of the most commonly used materials in manufacturing most products.

### **Water and living things**

Water is the universal **solvent** (Lesson 2) for the **chemicals** that are necessary for the growth and maintenance of the human body.

Water is the primary **component** of the fluids that carry materials to and from cells. Oxygen, dissolved in the watery fluid of the body, is carried to cells so they can release energy to permit growth and cell replication. Carbon dioxide and nitrogen-containing compounds are carried away from the cells as waste. Water also is the primary means of eliminating wastes, through the **excretory** system, from the bodies of living things. Water is required for the exchange of gases when breathing. It also serves as a major component of the **lubricants** in the joints of the body. If these functions are not provided, living things soon die.

### **Water use patterns**

Most of us are aware of a portion of our personal daily water use. We can account for the water we drink directly or in other beverages. We know that we use water in the bathroom for washing, brushing teeth, flushing toilets and taking showers or baths. Other individual or personal uses might be less obvious: water is used in cooking foods and water is contained in foods we eat. Other uses include water used in keeping our clothes clean, washing dishes, watering lawns and gardens, and washing cars or bicycles.

Water also is often a focal point for recreational activities. Water-based sports, including fishing, diving, swimming, wading, surfing, boating of all types and sail boarding, are enjoyed by many people. Water is critical to many other sports as well. Hunting, wildlife viewing and photography, hiking, backpacking and camping all require water in some form. Field sports are played on prescription turf or lawns that require water. Water also is used in the production of raw materials and the manufacturing process of the equipment used in sports.

It is very easy to overlook the water used in the **manufacture** of products, from paper to automobiles, that we use every day. Inclusive daily water use (water used for all purposes) in the United States has been estimated at approximately 2,000 gallons per person per day. That means we use approximately 355 billion gallons of water each day or nearly 130 trillion gallons each year. That's enough water to cover 10,000 football fields to a depth of almost 400 feet; or cover 6,200 square miles to a depth of 1 foot; or lower the depth of Lake Ontario by almost 1 foot; or fill almost 2,364 million 55-gallon drums. Usually, we use this vast amount of water without thinking about it. However, taking water for granted does not lessen its importance to our lives.

The human body is about 80 percent water. Have participants **SPECULATE** on the functions that water has in their bodies. Lead them to the **CONCLUSION** that water is the main component of our bodies and those of other living things.

Ask participants to **ESTIMATE** the total amount of water they use in a single day. Then, gradually **EXTEND** the range of activities in the estimate to include household cleaning, washing clothes, watering plants, water used in growing foods, and water required to manufacture products or obtain raw materials. **EMPHASIZE** the importance of water to our way of life.

Have participants **LIST** some ways that water is important in recreational activities. **ENCOURAGE** them to think beyond the obvious answers. Working in small groups is a good way to encourage discussion.

**STATE** that a single automobile requires about 100,000 gallons of water in its manufacture. Ask students to **SPECULATE** on some of the ways water is used in the manufacturing process.

## Hidden water needs

Water is a vital part of many processes and activities. Water is used to extract and/or transport natural resources such as ores and chemicals. Hot water or steam is used to melt sulfur deposits so sulfur can be piped to the earth's surface as a liquid. Some ores are transported from mines to refining sites as a slurry of crushed rock and mineral in water. Fossil fuel **extraction** and refining use large quantities of water. Oil drilling, for example, uses a "drill mud" to ease the progress of rotary bits into the oil-bearing rock. Renewable resources use water in production and require water in processing. Logs are sprayed with water to prevent loss of wood from drying and cracking (checking) while stacked at the mill before sawing or slicing into veneer. Wood pulp is suspended in water before it is made into paper. Even the capture, cleaning and processing of fish for consumption require large amounts of water.

Manufacturing processes use large amounts of water in cleaning and washing. Water is used as a coolant or as a carrier for heat. It generates energy through steam production or by spinning turbines of electrical generators or in water powered equipment.

## II. Water Supply and Wastewater

The ability to supply water for domestic use is a major concern for cities and towns across the nation. It also is an important concern for rural residents with individual water supplies.

### Sources

In the United States, domestic water comes from many sources. A very small amount is desalinated sea water or saltwater from underground sources. Most of the domestic water supplies in this country come from surface water sources (rivers, lakes or impounded reservoirs) or from subsurface water (aquifers). Some of that water is close to the surface and quickly replenished. Some of it is in deep aquifers. The high rate at which we are using aquifer water amounts to "mining fossil water."

### Treatment

Regardless of the source, almost all of the municipal water in this country must be treated in some way before it is distributed to consumers. It may be settled, filtered, chlorinated, desalinated, or otherwise treated to meet standards for **potable** (drinkable) water. Surface waters often require more treatment than do supplies from underground aquifers. Most water taken from private wells is brought into the home with little or no treatment, although it may be "softened" before use.

### Distribution

To **distribute** water to consumers, some major cities bring water from considerable distances through large pipelines or surface aqueducts. Water is treated and then distributed through a network of pipes to homes, factories and businesses. Private water supplies bring the water from the well or spring into a pressurized storage tank or elevated storage tank before piping it to the water service system in the home.

## Wastewater

Used water is classified as either “gray water” or “black water.” Sewage is “black water,” and all other household-use water is “gray water.” All wastewater must be handled carefully. Private homes in rural areas often use septic tanks and leach fields to treat wastewater. Bacteria digest the waste, leaving solids that must be removed periodically and nutrient-rich effluent water that is distributed through the leach field. Wastewater treatment plants use a similar approach on a much larger scale. Wastewater is treated at several different levels. Primary treatment removes most solids and reduces bacterial loads but leaves dissolved nutrients in the water. Secondary and tertiary treatments further treat the water, sometimes leaving it in purer form at the completion of treatment than the water taken from the original water supply source.

## Costs

Monthly water bills to consumers reflect the availability of and processing costs for source water and the sewage discharge and costs for waste treatment. The accompanying table shows some **average** monthly charges for water and sewer service in 1994 for the cities of Austin, Dallas, El Paso and Houston. Water and sewage costs for users of private well water include the costs of drilling wells and operating pumps.

## III. Water - Common but Vital

Water is among earth’s most common substances. It covers most of the earth’s surface, sometimes to a depth of more than a mile. It exists as a colorless gas in the atmosphere. It caps the poles with ice and occurs in the snows of winter. Liquid water fills brooks, streams, rivers, lakes, ponds, estuaries, seas and oceans. Almost everywhere we look, we can find water and that property makes it easy to take for granted. But water is absolutely essential to life as we know it on earth.

## For Further Thought

1. Analyze how water is used to produce any common object or product, like a tablet, desk, chair or pencil. Consider all the sources of material and processes required to produce the raw materials, process them, package them, ship them and market them. Add all the water needed to produce the equipment at each step and the water needed by the people or other animals involved in the process. Challenge participants to think about the object deeply and systematically to produce a water flowchart for the product. Finally, estimate or research water needs for similar operations and calculate the water needed. Compare that to the estimate of 2,000 gallons per person per day. Consider the anticipated life span of the object and the cost in water over that life span as well. Ask, what will happen to the product when it is no longer useful? How will that affect the water needs and quality of the area?

Have participants MAP the sources and dispositions of their household water to the best of their abilities. DISCUSS the costs of bringing water to and removing it from the home. ASK where the water goes after it is used in the house. Have participants CALCULATE average water and sewer costs for their locality and COMPARE them with the values listed below. Use Activity 1.1, *Calculating Average Water Costs*.

Average Sewer and Water Costs for Selected Cities

	Austin	Dallas	El Paso	Houston
Sewer:	\$25.23	\$17.28	\$ 8.18	\$18.13
Water:	\$17.84	\$ 9.62	\$ 5.89	\$18.34

Use a globe or world map to ESTIMATE the proportion of the earth’s surface covered by water. NOTE the existence of water in three forms, depending upon the conditions. Lead into the next session by STRESSING the importance of water to all living things.

## Summary Activity

Have participants write a brief essay on what they have learned in this lesson and the importance of water in their lives. Keep these essays for use at the end of the program.



2. Take a field trip to a municipal water treatment plant or a waste water treatment plant. Have participants outline the processes required to make water ready for use and processes for handling effluent collected through the sewage system. Ask participants to trace the water from its source to its ultimate destination and cite possible uses of water along the way.

## **Sharing or Exhibit Suggestions**

1. Generate science fair exhibits, conservation exhibits or reports.
2. Design class or club projects to make communities aware of water use, the importance of water, or water saving processes. Consider using one or more of the ideas presented in the Water Wise teacher's packet available through the Texas Water Development Board.
3. Conduct family water use inventories and discuss ways to reduce excessive uses of water in their daily lives.
4. Develop a class or club presentation that can be shared with other classes or clubs in the area.
5. Design individual presentations or activities to share with others.



# Cycles

In *A Sand County Almanac*, Aldo Leopold reflects on the journeys of a molecule of element X through the prairie ecosystem. His essay provides a small example of the importance of biogeologic cycles in providing the building blocks of life.

The water cycle is one example of the many cycles occurring on earth. It has two major components: physical and biological. The purely physical part of the water cycle greatly overshadows the biological one, particularly if transpiration and evaporation are considered physical processes that take place in living things.

The biological side of the water cycle includes the splitting of water and the combination of hydrogen with carbon dioxide to form simple carbohydrates with oxygen as a waste product. The energy of the sun is stored in the chemical bonds of the carbohydrates. When they are metabolized (a sort of “burning” of the carbohydrate fuel by the body), the initial products are re-formed, producing carbon dioxide and water. While the biological component of the water cycle involves much less water than the physical one, it is equally important in the water cycle.

All elements on earth exist in limited amounts. Some, like silica or aluminum, are extremely abundant at the earth’s surface. Others exist in very limited supplies. A wide array of cycles must interact to provide plants and animals with the elements and compounds they need to survive and flourish. The complex systems of native flora (plants) and fauna (animals) treat the chemical building blocks of life they capture very conservatively. That is, the chemicals are passed around, cycled through the living things and the local nonliving environment rather quickly. This keeps the biologically important chemicals available.

Thus, calcium, carbon, nitrogen, phosphorus or potassium cycles might be very local for well-adapted communities of living things. Simplifying those systems or eliminating them altogether can result in losing in a matter of days to weeks the materials that have been cycled through the complex system for thousands of years. If the chemicals escape capture by other living systems, they may travel into deep sea sediments or other inaccessible areas for extended periods of time. Replacement of the lost materials can become a serious challenge either to the system or to humans who use the soils to produce crops or livestock. Their options are to wait for natural processes to replace the lost materials (often an extremely slow process) or to add materials to the soil from other sources (fertilizers).

Understanding that matter cycles and energy flows is fundamental to understanding the economics of life and living things. These concepts are at the core of understanding ecology and the environment. Adding the concepts of tolerance, the law of the minimum or limiting factors, and carrying capacity increases insight into how living systems operate and what our limitations are in trying to develop simplified systems to serve the functions of very complex ones.



## Calculating Average Water Costs



The population in some areas of the United States has increased so much that water demand currently exceeds water supply.

Contacts with the local municipality could produce average monthly cost figures for water and sewer services in your community, but the exercise can be more personal if the participating young people collect the data on their own homes or apartments. Have participants collect water and sewer bills for the previous year (or as many months as they can find) and calculate a household average by adding the bills and dividing by the number of months included. Each person should have a total amount spent, a number of months included, and an average per month. Once these data are collected for each individual household, the data can be pooled to determine the average water and sewer costs for the club or class. This can be accomplished by several methods.

### **For participants using municipal water and sewage services:**

1. The total costs for all members of the class may be divided by the total number of months represented by all of the households combined to obtain a monthly average cost.
2. Alternatively, the monthly average costs may be added for all participants and divided by the number of entries. These two methods may produce slightly different answers because of rounding error or variation in the times of year included in each average cost calculation. An individual who has costs only for the summer, for example, may have an “annual average” somewhat higher than one who has costs for the entire year. (You may want to have participants discuss reasons why this might be so.) They should be fairly close to an overall average cost per household, however.

### **For participants with rural water or sewage management systems:**

1. If possible, determine the cost of the well and sewage system and divide by the estimated life expectancy of those systems. These vary by location and use rate, but local contractors may be able to provide a reasonable estimate.
2. Add any treatment costs like water softeners, filtration systems, or the regular need to have septic systems pumped to remove solids.
3. Add electricity costs for pumping.
4. Divide the total costs (1, 2 and 3) by the number of years that the system is expected to operate without replacement.
5. Use this figure as the average annual cost for water and sewer services.
6. Divide by 12 to get a monthly cost for comparison with the table of values given.





# Water: A Look Inside the Drop

## Objectives

1. Identify the composition and shape of a water molecule.
2. Construct a model of a water molecule.
3. Dissolve various substances in water.
4. List positive and negative effects of water as a solvent.
5. Describe solvents, solute and saturation.
6. Identify hydrophilic and hydrophobic substances.
7. Hypothesize why substances are hydrophilic or hydrophobic.
8. Have fun while learning.

## Materials/Equipment

See individual activities.

toothpicks  
waxpaper  
water  
construction paper  
glue

## Vocabulary

atom	dissolve	hydrophobic	pollutant
cohesion	element	leach	saturation
compound	hydrogen	molecule	solute
concentration	hydrophilic	oxygen	

## Lesson Requirements

**Best Time:** Any time of the year, but near the beginning of the water lesson sequence

**Best Location:** Any safe setting where water is available and young people can work in small groups

**Time Required:** Approximately 60 to 75 minutes (depending upon activities used)

## Lesson Background

### I. What is Water?

#### Basic requirement of living things

Water is essential for all life. Where there is no water at all, there is no life; therefore, water is one of the most important substances on earth.

#### Physical properties

Water is a colorless, odorless, tasteless substance. It is a liquid at normal temperatures and pressures. It becomes a solid (ice) at temperatures below 0 degrees C (32 degrees F). It becomes an invisible gas at temperatures above 100 degrees C (212 degrees F).

## Lesson Overview

- I. What is Water?
  - A. Basic requirement of living things
  - B. Physical properties
    1. Colorless
    2. Odorless
    3. Tasteless
    4. Liquid
    5. Solid
    6. Gas
- II. Structure and Qualities of Water
  - A. Structure of molecules
  - B. Cohesion of water
  - C. Water as a solvent
    1. "Universal solvent"
    2. Solute
    3. Hydrophilic
    4. Hydrophobic
  - D. Importance of solvent qualities
  - E. Negative effects of solvent qualities

## Applications

DISCUSS the importance of water to all living things.

## II. Structure and Qualities of Water

### Structure of molecules

To begin to understand water, we must become familiar with the structure of water. The smallest physical particles of **elements**, like **oxygen** and **hydrogen**, are called **atoms**. Water is a **compound**, a substance made up of two or more elements. Each **molecule** (the smallest particle of a compound) of water is composed of one oxygen atom bonded to two hydrogen atoms. Because of their bonding angles (the hydrogen atoms are attached at an angle of 105 degrees to each other), hydrogen and oxygen combine to form a molecule that is similar in appearance to a narrow “Mickey Mouse” head. The larger oxygen atom corresponds to the head and the smaller hydrogen atoms correspond to the ears.

### Cohesion of water

The structure of the molecule results in a polar or charged molecule. The hydrogen end of the molecule has a small positive charge and the oxygen end has a small negative charge. The polarity of the molecule causes water molecules to arrange themselves in an orderly fashion because each molecule is strongly attracted to the one closest to it. The attraction the molecules have for each other results in a powerful **cohesion** between them. This cohesion also is called surface tension. This is why raindrops are actually spheres; it is the resistance of the air when they fall that pulls the trailing edge into a “tail.” Cohesion is the reason water “beads” on waxed surfaces. The polar nature of water molecules is a vital factor in water’s ability to **dissolve** many other compounds. It also contributes to the ability of water to wet, or adhere to, some surfaces. The attraction of water molecules for each other is similar to the way oppositely charged ends of bar magnets are attracted to each other, or the way a magnet can support a network of paper clips.

### Water as a solvent

In its pure form, water is an excellent solvent. It has the capability to dissolve many other substances. In fact, water has been called the “universal solvent” because of its unique ability to dissolve so many other substances. Material dissolved in a solvent is called a **solute** and the resulting material is a solution. Thus, when sugar is stirred into water, the water is the solvent and sugar is the solute. If you are adding sugar to water, the **concentration** of sugar can increase until the solution becomes saturated. **Saturation** refers to the condition in which no more of a solute will dissolve in a solvent.

Substances that dissolve easily in water are called **hydrophilic** or “water-loving.” In contrast, substances that do not mix well with water are called **hydrophobic** or “water-fearing.”

### Importance of solvent qualities

The ability of water to dissolve many substances is one of its most important positive features. It allows dissolved gases, like oxygen and carbon dioxide, to be carried to and from living tissues. It allows chemical building blocks of living things to come together in solution so the necessary reactions can take place. It carries away

BRAINSTORM about some of the physical properties of water. USE leading questions to extract the obvious properties of water. ENCOURAGE students to share their observations about water, e.g. ice floats, water seems to climb the surface of a clean glass, water vapor in breath condenses at cool temperatures.

To explain cohesion and surface tension, allow participants to use toothpicks to play with water droplets on waxed paper. EMPHASIZE the rounded shapes of the droplets and the reason for that shape (water is more attracted to itself than to the air or the hydrophobic wax coating on the paper).

Use Activity 2.1 *Opposites Attract* to ILLUSTRATE that the two positive ends of magnets repel each other while a positive end and a negative end are strongly attracted to each other. NOTE that the same effect takes place in the polar molecules of water. Use one of the magnets to capture a string of paper clips. EXPLAIN that water molecules are attracted to each other and connected in a similar fashion.

Have participants make paper models of water molecules and construct a chain of those molecules. Glue the molecules together to REINFORCE the concept of cohesion among the molecules.

Identify and DEFINE “solvent” and “solute.” BRAINSTORM about some of the substances that can be dissolved in water. HYPOTHESIZE whether or not the volume of water will change when a small amount of solute is dissolved in it. DESIGN a test of that hypothesis.

Using Activity 2.2 *How Much Can It Take?*, have small groups EXPERIMENT with the solubility of several different substances in water. Have the groups COMPARE their results and DISCUSS reasons for differences in solubility.

Have participants EVALUATE the saturation points of water for several substances by slowly adding potential solutes to solutions until some remain undissolved. ASK why there are differences in the saturation points (type of chemical bonds, formation of ions [charged particles], size of the molecules, polarity of molecules). DO NOT overwhelm participants with information, but use these things to REINFORCE their speculative answers.



waste products like ammonia and urea. Its ability to act as a solvent also allows us to use it as a cleaning product for our bodies, homes and housewares.

### Negative effects of solvent qualities

This same quality can result in negative impacts as well. Water can **leach** nutrients from the soil, carrying them into waterways and eventually to the sea. It can dissolve minerals like calcium, magnesium or other salts, which then make the water unfit for consumption or make the water “hard.” “Hard” water contains a fairly high concentration of dissolved minerals. These dissolved minerals interfere with the wetting action of soaps and detergents, making it more difficult to produce a lather for washing. Minerals also react with cleaning products to produce a residue that is difficult to remove. Finally, minerals can accumulate as deposits in water heaters or other appliances, which shortens their life spans or makes them less efficient in operation. Water’s ability to dissolve and carry materials can also contribute to the spread of **pollutants** that can be harmful to wildlife and people. In some areas this is the result of natural processes, but most cases of water pollution are the result of human error or lack of foresight in handling potentially harmful materials.

## For Further Thought

1. Conduct a simple experiment to test the solubility of sugar in water. Dissolve as much sugar as possible in cold water, then bring it to a boil and add more sugar to make a syrup. Follow any recipe found on a flavoring box to make a useable syrup. Many of those recipes call for the addition of a small amount of corn syrup to the sugar water solution. This acts as a stabilizer and reduces the rate of “sugaring” or formation of sugar crystals. Two major conclusions should be evident from this experiment. First, the solid (sugar) dissolves much more readily in hot or boiling water than it does in cold water because hot water allows a greater amount of sugar to be held in solution. The second conclusion is that the boiling point of the sugar water changes as syrup is produced. In fact, the boiling point of syrup is several degrees greater than that of water at the same elevation and pressure. If possible, conclude the experiment by providing each child with a sample of the syrup they have made or by using it in a meal they prepare.
2. A second experiment tests the change in the boiling or melting/freezing points of water as solutes are added to it. Does the freezing point of water rise or fall under the same conditions? Personal experience helps here, too. Salted water has a slightly higher boiling point than “pure” water; salt raises the cooking temperature. The temperature of boiling syrup is much higher than the temperature of boiling water at the same elevation. The boiling point continues to rise with the concentration of solutes in the water. Freezing points are decreased in a similar fashion. If young people have ever made homemade ice cream, they know that a considerable amount of rock salt is added to the ice surrounding the ice cream container. This lowers the temperature

DISSECT the words “hydrophilic” and “hydrophobic,” explaining the Greek roots that form the words. “Hydro” comes from the Greek word for water. “Philic” comes from the Greek word for brotherly love, “philos,” and “phobic” comes from the Greek “phobia,” meaning fear. Lead participants to CONCLUDE that the literal meanings of these words are “water-loving” and “water-fearing,” respectively. Use *Sink or Swim* (Activity 2.3) to DEMONSTRATE hydrophilic and hydrophobic substances. IDENTIFY other hydrophilic and hydrophobic substances. NOTE that soaps and detergents are wetting agents.

Lead participants to EXPLORE some important roles of water’s solvent qualities to them and their lives.

Have participants LIST some potentially negative impacts of water as a solvent. ENCOURAGE them to think beyond the obvious answers. Working in small groups is a good way to encourage discussion.

## Summary Activity

Ask participants to outline the structure and physical qualities of water. Note that water is found on the earth in three primary states – liquid, gas and solid, depending upon the conditions.

of the solution surrounding the container enough to freeze the sugary ice cream. Either phenomenon can be tested easily with a thermometer while preparing either ice cream or a hard candy.

3. Compare the boiling point and freezing point of water at your location with those that are quoted for standard conditions - sea level or 1 atmosphere of air pressure. Simply bring water to a boil and observe the thermometer reading as it is boiling. At elevations significantly above sea level, the boiling point will be depressed slightly. At high elevations, the boiling point may be depressed enough to demand longer cooking times for foods that are boiled or steamed. Freezing points tend to rise with increased elevation. A cooperative group of young people from across a region could construct a map of their state or region showing the boiling and freezing points of water. The directly observed readings are not “wrong” because they disagree with the standard. They are more accurate for their location and conditions than the idealized conditions that produce the “constants” listed in most references.
4. Demonstrate that cold water holds more dissolved gases than warm water by observing aquatic life. Fish and other aquatic organisms that demand very high oxygen levels are much more common in cool or cold water than they are in warm water. Fish kills are more common in the summer than during the winter, even though algae are photosynthesizing and adding oxygen to the water. Decay organisms use some of the oxygen, but the warmer water also has a much lower capacity for dissolved oxygen than it does when it is cold. Gases are less soluble in water as the temperature increases, while solids are more soluble with increased water temperature.

## Sharing or Exhibit Suggestions

1. Using the ideas developed by the group, construct a poster or collage showing the properties of water and display it in an appropriate location.
2. Make a chain or sheet of “water molecules” showing how solute molecules can be held in the spaces between the water molecules. Use it in a demonstration or illustrated talk to share your knowledge with others.
3. Develop a table showing solubilities of various household substances in water. (Caution! Do NOT use caustic materials, strong acids or strong bases - like lye or drain cleaner. They may react violently with water with dangerous results.) Share your findings with others in your group.
4. Prepare a talk or demonstration on an important property of water and present it in an appropriate setting.

# Opposites Attract



Three-fourths of the earth's surface is covered by water.

## Materials/Equipment

two small bar magnets      two colors of construction paper  
 scissors                      tape or glue  
 colored yarn

**Time Required:** 10 to 15 minutes

## Procedure

1. Identify the north and south poles of the small bar magnets. Have a participant try to press the two magnets together with the same poles next to each other. Note that they repel each other quite strongly and considerable force is needed to hold them close. Then attempt to press the north end of one magnet to the south end of the other. Have the participants describe what happens and lead them to conclude that opposites attract.

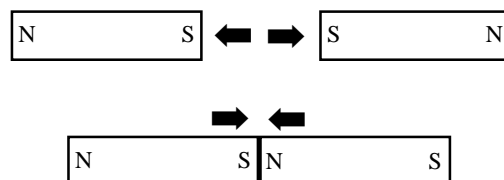

2. Have each participant cut one large circle from colored paper to represent an oxygen molecule and cut two smaller circles from another color of paper to represent hydrogen molecules. Using glue or tape, construct "water molecules" by placing the two "hydrogen" atoms on one end of the "oxygen" atom at an angle of approximately 100 degrees (actually 105 degrees). This results in a silhouette similar to the familiar "Mickey Mouse" head with ears. After participants have made their water molecules, they can attach them together with the "hydrogen" ends associated with the "oxygen" ends of other molecules to form either a chain or a sheet. The cohesiveness of water comes from the weak electronic attractions between the polar molecules.

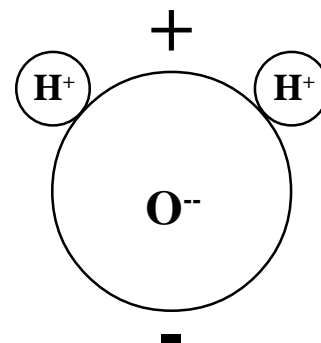

## Extension

When materials dissolve in water, the polar molecules orient themselves to place the appropriately charged ends of water molecules close to the molecules of the solute that is being dissolved. With table salt, for example, the positively charged sodium ( $\text{Na}^+$ ) ion is surrounded by the negatively charged ends (oxygen) of water molecules, while the negatively charged chloride ( $\text{Cl}^-$ ) ion is surrounded by the positively charged ends (hydrogen) of water molecules. This places the solute in a matrix of water molecules, keeping it in solution. When nonpolar or neutral molecules are encountered (like oils or other hydrocarbons), they do not mix with the water because of their lack of charge and relative lack of electromagnetic activity.



## How Much Can It Take?



When something is dissolved in water, that material is held in the spaces between the water molecules. As a result, the volume of the water does not change!

### Equipment/Materials

five cups of water  
clear plastic or glass cups or beakers  
table salt  
granulated sugar  
baking soda  
cocoa (not chocolate drink mix)  
cooking oil  
plastic spoons  
Student Record Sheet 2.2: “How Much Can It Take?”

**Time Required:** 20 minutes plus setup and cleanup time

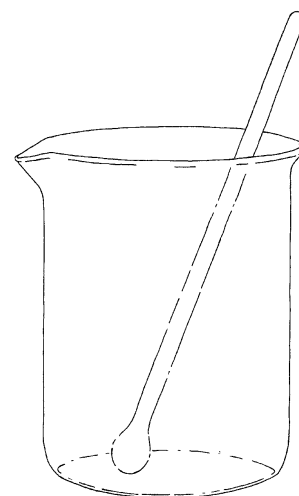

### Procedure:

1. Label each cup (1 to 5 or by naming the material being tested) and measure equal amounts of water into each cup.
2. Using a measuring spoon or a plastic spoon and leveling the sugar on each spoonful, add sugar to Cup 1 while stirring constantly until the sugar no longer dissolves. Note: If the water seems cloudy, the material has not yet dissolved completely. Continue stirring until each spoonful is completely dissolved (the water is clear) or the sugar remains on the bottom of the cup. Record the number of spoonfuls of sugar added until the water could not dissolve any more sugar.
3. Have each participant estimate the amount of each of the other materials that will dissolve in water and record those estimates on his or her record sheet. You may wish to state that an estimate or guess is known as a hypothesis. (They will probably hypothesize that the other materials will behave like the sugar, and the water will dissolve similar amounts. This is a null hypothesis; it states that there is no difference between the solubility of sugar and the solubility of the other materials.)
4. Use the same technique used in step 2 above, and repeat the procedure with table salt in Cup 2, adding 1 spoonful at a time until the salt no longer dissolves. Record the number of spoonfuls of salt dissolved in the water along with any other observations made during the test.
5. Repeat this procedure with baking soda in Cup 3.
6. Repeat the procedure with cocoa in Cup 4.
7. Repeat the procedure with cooking oil in Cup 5.
8. Have the participants compare the results with their hypotheses recorded on their record sheets. Ask them to discuss the differences they observed and to discuss some possible reasons for those differences.
9. Lead them to conclude that the sugar and salt are very soluble in water, baking soda is moderately soluble, cocoa is slightly soluble and cooking oil is essentially nonsoluble. Use the instructor information and other background material.
10. Challenge participants to think. Ask if the solubility would change if the water were heated to boiling or chilled. Based on their own experiences, they should be able to predict that water will hold more solute as its temperature increases (e.g. cocoa dissolves much more readily in hot water than in cold water).

**Instructor Information:** At room temperature, a cup of water should dissolve approximately 5 to 7 teaspoons of sugar or table salt. Baking soda is less soluble. Real cocoa dissolves poorly in water at room temperature. Watch for cocoa to drop out of suspension to form a siltlike layer on the bottom of the container. Cooking oil may form a

temporary suspension of tiny globules (like those seen in vinegar and oil salad dressings when shaken) if it is stirred vigorously, but the oil should form its own layer on top of the water very quickly. Cooking oil is a fat with hydrophobic molecules that are much more attracted to each other than to water molecules. Because oil is lighter than water, it forms a separate layer on the surface of the water. Cocoa contains small amounts of cocoa butter, a fat found in the cocoa bean. As a result, it is slightly hydrophobic, although it is slightly soluble in water at room temperature. To make cocoa, water or milk is heated to get the chocolate into solution. Moderately soluble sodium bicarbonate (baking soda) dissolves more slowly and to lower concentrations than do the very soluble table salt and sugar. The structure of these two solutes makes them very hydrophilic.

Pure water does not exist in nature. It dissolves gases from the air almost as quickly as it condenses from a gas itself, and its ability to dissolve many other substances results in most natural water being a solution of the atmosphere, soils and vegetation in its watershed. Dissolved minerals in water give it its “taste,” and its solvent nature is very important to life on earth. Discuss some of the ways that water as a solvent is useful to us, from the ability to brew tea to the action of carrying nutrients to the cells in our bodies.

# How Much Can It Take?



? Do you know when a solvent is the solution?

Name: \_\_\_\_\_

1. How many spoonfuls of sugar dissolved in Cup 1? \_\_\_\_\_
2. When no more sugar will dissolve in the water the solution is \_\_\_\_\_.
3. Before testing the other materials, predict if each one will dissolve more, the same, or less than the sugar did in water. Circle your prediction.

table salt      more      less      same

baking soda    more      less      same

cocoa            more      less      same

cooking oil     more      less      same

4. Repeat the experiment for Cups 2, 3, 4, 5. Record the number of spoonfuls dissolved and your observations below:

Amount Dissolved (spoonfuls)	Observations
---------------------------------	--------------

Cup 2 - table salt

Cup 3 - baking soda

Cup 4 - cocoa

Cup 5 - cooking oil

5. How did your predictions compare to the actual results? (Use back if needed)

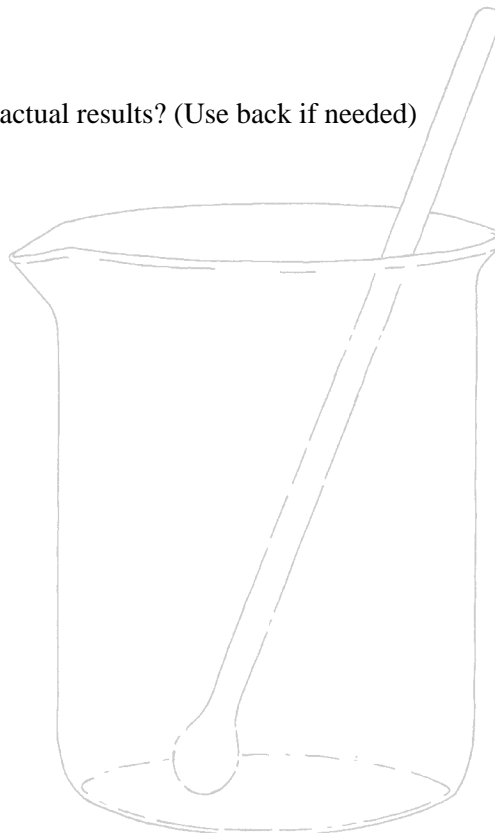

**Answer:** *When your problem is how to clean up any water soluble material, water is the solvent, the solution to the problem!*





## Sink or Swim



It takes about 1,400 gallons of water to produce a meal of a burger, fries and a soft drink.

### Equipment/Materials

liquid dish washing soap      waxed paper  
scissors                              two bowls  
water

**Time Required:** 15 minutes

### Procedure

1. Using the pattern provided as a guide, cut out two duck shapes from waxed paper.
2. Fill both bowls with water taken from the same source.
3. Add 4 to 5 drops of soap or detergent to the water in one of the bowls.
4. Carefully place a “duck” on the surface of the water in each bowl.
5. Record your observations and speculate on the reasons for them.

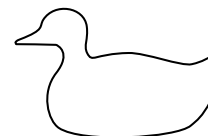

### Expected Result

The “duck” placed on the plain water should continue to float on the surface. The “duck” placed on the surface of the soap or detergent solution should sink.

### Anticipated Conclusion

The waxed paper duck is coated with paraffin, a hydrophobic hydrocarbon. As a result, the surface tension of the water remains unbroken and the waxed paper duck is supported on the surface of the water by the surface tension. Addition of the soap or detergent reduces the surface tension and the mutual attraction of water molecules for one another, making the water “wetter.” The reduced surface tension allows the water to wet the surface of the waxed paper, causing it to sink.

### Discussion

Have participants discuss the uses of soaps and detergents in other areas. Note that these products, known as surfactants, are able to decrease the surface tension of water, which causes the water to wet surfaces that would normally be hydrophobic. As a result, surfactants are useful in many situations. They can be used to remove greasy dirt and stains by attracting water molecules that wash the dirt away.

Ducks float because their body feathers are coated with an oil that makes them very hydrophobic. The oily feathers repel water, causing ducks to be supported by the surface tension of the water and displacement. If a duck were treated with a detergent or an organic solvent that removes the oil, the duck would sink. What might happen if a bottle of detergent were dumped into a duck pond? If the concentration were high enough, the ducks would sink. For this and many other reasons, it is not a good idea to wash clothes, dishes or ourselves in a lake or stream while camping.



## Duck Patterns for Cut Outs

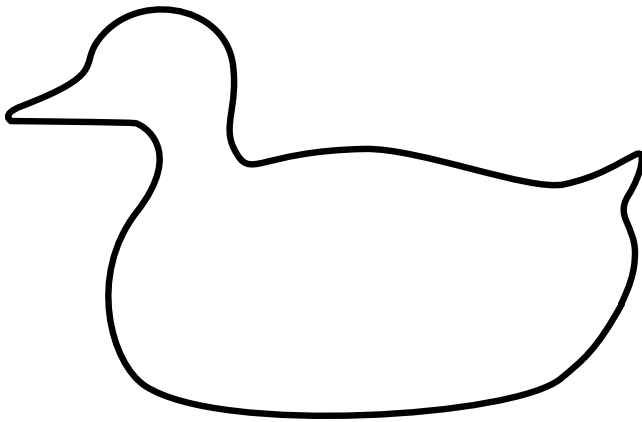
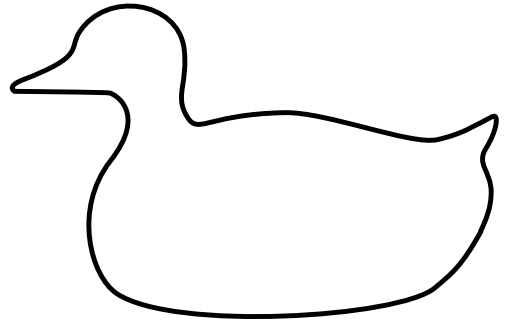
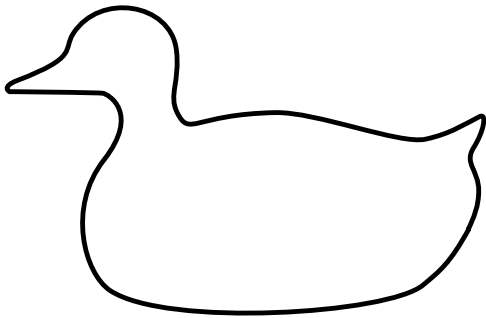
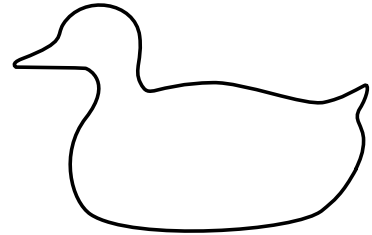
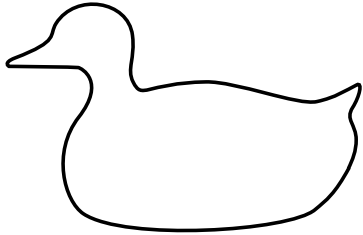





# Water: State It Like It Is

## Objectives

1. Identify the three states of water: liquid, solid and gas.
2. Define density and specific gravity.
3. Evaluate densities of many liquids compared to water.
4. Recognize the effect of water pressure on humans.
5. Define surface tension.
6. Have fun while learning.

## Materials/Equipment

See individual activities.

glass or cup  
water  
ice cube  
thermometer  
hot plate to boil water

## Vocabulary

absorb	density	meniscus	specific gravity
adsorb	evaporation	miscible	specific heat
calorie	gas	pressure	surface tension
condensation	liquid	solid	

## Lesson Requirements

**Best Time:** Any time, but with both Lesson 1 and Lesson 2

**Best Location:** Classroom setting where young people can work in small groups

**Time Required:** Approximately 60 minutes, variable with activities used

## Lesson Background

### I. Properties of Water

Water is one of our most important natural resources. Water is very dynamic and has many physical properties, some of which we normally do not consider. It occurs in three different states of matter, changes density with temperature, retains heat, has mass and exerts pressure, and maintains surface tension. Some properties, such as specific density and volume increase as it approaches freezing, make it unique.

### II. States of Matter

#### Mass

Liquids, like other types of matter, differ in mass and weight. Mass multiplied by the acceleration of gravity yields a weight. Since we

## Lesson Overview

- I. Properties of Water
- II. States of Matter
  - A. Mass
  - B. Density
- III. Physical States of Water
  - A. Liquid
  - B. Solid
  - C. Gas
- IV. Specific Heat of Water
- V. Water Pressure
  - A. Pressure
  - B. Buoyancy

are on earth and the acceleration of gravity is approximately the same over the entire earth, we often equate mass with weight. A liter of water on earth has a mass of about 1 kilogram. On the moon, with its lower gravity, the liter of water would feel much lighter, but its mass would remain the same. Its weight would be only about one-fifth as much, however, because the acceleration of gravity on the moon is only about one-fifth that on earth.

### Density

**Density** describes how heavy something is compared to how much of it there is; density is weight (or mass) per unit volume. In metric terms this might be expressed as grams per cubic centimeter or grams per milliliter. In English units, the density might be expressed in pounds per gallon, pounds per cubic foot, or a similar measure.

Water has a density of approximately 1 gram per cubic centimeter or 1 gram per milliliter, with a maximum density occurring at about 4 degrees C. The density of water is used as the standard for **specific gravity**, a measure of the relative density of a substance to that of water. Things that are more dense than water sink, while those that are less dense float.

## III. Physical States of Water

### Liquid

In nature, water is found as **liquid**, **solid** and **gas**. The most common form of water is as a liquid. A liquid is an amorphous (shapeless) substance without a crystal structure. Water, like most other liquids, changes its shape to fit the boundaries of solid containers or other boundaries like the banks of streams or lakes or the shore of a sea. Liquid water does not compress, so the water at the bottom of a column has about the same mass or density as water at the top of the column. Liquid water pours or flows with the force of gravity, fits into containers, dissolves many other substances, mixes with many other liquids, and is absorbed by some materials.

Liquid water wets many surfaces, allowing it to be used to wash those surfaces. Water behaves as both a solvent, dissolving many substances and carrying them as a solution, and as a physical force, moving solid objects from place to place by the force of its own motion.

Water molecules also tend to stick to each other very tightly. The adhesion between water molecules tends to give water a characteristic shape. Rain drops are somewhat globular with a trailing point. If water is placed in a glass tube or cylinder, it wets the sides slightly, but pulls into a crescent shape in the center of the tube. This **meniscus** is the result of the water's **surface tension**. Insects, like water striders or whirligig beetles, and plants, like duckweed, take advantage of water's surface tension to remain on the surface and travel on a surface that, to them, is as firm as a grassy lawn is to us.

## Applications

ASK participants if water has weight. DEFINE density (weight per unit volume). If desired, lead them to CALCULATE the density of water. (Calculating volume in milliliters or cubic centimeters and mass in grams yields results that can be compared with the listed density of pure water - 0.99707 g/cm<sup>3</sup> at 25°C or 0.99995 g/cm<sup>3</sup> at 4°C.) *Liquid Layers* (Activity 3.2), *Carrot Float* (Activity 3.3) and *Funny Funnel* (Activity 3.4) can be used to demonstrate density. As time permits, allow participants to EXPERIMENT with other liquids to determine their densities relative to water. NOTE that water is the standard used for specific gravities of solids and liquids.

Ask participants to LIST the three states of matter or the three states in which water is commonly found. Use leading questions if necessary to HELP them reach the conclusion of gas, liquid and solid. *Camouflage Water* (Activity 3.1) may be a useful tool in this exercise.

EMPHASIZE that liquid water is the most common state for water under normal conditions of temperature and pressure.

Lead participants to DISCUSS some of the characteristics they have observed for liquid water.

BRAINSTORM about some other characteristics of water. LIST the characteristics for use as a reference during the remainder of the discussion. Lead participants to RECALL the experiments in Activity 2.2 *How Much Can It Take?* DEMONSTRATE the mixing of **miscible** liquids like alcohol and water or water and liquid detergent. If desired, NOTE that the distinction between solvent and solute loses much of its meaning with liquids.

DIFFERENTIATE between **absorb** (taking the liquid into the structure of the absorbing material) and **adsorb** (wetting the surface of a material without penetrating into the material). NOTE that absorption involves the entire volume of a substance, while adsorption is a surface process.

## Solid

Water freezes to form ice (solid water) at 0 degrees C or 32 degrees F under normal atmospheric pressure. As water turns to ice, the molecules of water move much more slowly and form crystals. Water forms six-sided crystals of nearly infinite variety, and the formation of crystals causes solid ice to take up more space than liquid water. In fact, ice is only about 90 percent as heavy as water because it expands as it freezes. Ice is less dense than water, which is at its most dense at 4 degrees C or 37 degrees F. As a result, ice floats! If this were not so, ice would sink to the bottoms of rivers and lakes and they would freeze solid. It is also why icebergs are so dangerous to ships. Only the tip of the ice (about 10 percent) shows above the surface of the water. Nine times as much ice floats under the surface of the water. At the freezing/melting point, water can transform between states of matter. If heat is being absorbed, ice melts to form a liquid. If heat is being lost, liquid water freezes to become ice.

Solid water has a shape, although it can be many shapes, like cubes, flat plates, irregular ice bergs, or columnar shapes like Popsicles. Ice is hard, transparent and brittle. It can be broken into irregular pieces when struck. Solid ice, without impurities or tiny gas bubbles as inclusions, is clear and colorless. It continues to expand as it gets colder than the freezing point. Sounds of booming and crackling may be heard as frozen water surfaces of ponds and lakes crack as the ice expands and grows in thickness during very cold weather.

## Gas

**Evaporation** is the process that transforms liquid water into gaseous water (water vapor). **Sublimation** is the process that transforms solid ice into water vapor. These processes can take place at any temperature, but evaporation becomes more rapid as temperatures increase.

The act of evaporation is clearly visible at water's boiling point, 100 degrees C or 212 degrees F, under standard atmospheric pressure at sea level. At the boiling point, gaseous water escapes from the liquid as bubbles form and pop. When the gaseous water hits the cooler air, some of it may condense into visible clouds of steam. As a liquid reaches the boiling point, molecules of the liquid gain more and more energy. Some molecules gain enough energy to escape from the liquid as a gas. Because that energy is lost from the liquid, the liquid remains at a constant temperature while it boils. No matter how rapidly the liquid boils, that temperature remains constant.

Water vapor is a colorless, odorless, tasteless gas. It is easy to see the process of evaporation at normal temperatures and during our normal activities. Simply observe puddles drying, rain drying from sidewalks, or sweat drying from skin or clothing. The "drying" is simply evaporation, a critical step in the water cycle.

NOTE that the freezing/melting point of water/ice is 0 degrees C or 32 degrees F. Pure water makes a transition between the liquid and solid states at that temperature. [**Challenge: determine if adding something to water changes its freezing/melting point, e.g. table salt or sugar.**]

Drop an ice cube into a glass of water and OBSERVE what it does. Lead participants to CONCLUDE that ice floats. Ask participants to STATE why they think ice forms on the surface of water. REINFORCE the fact that water becomes less dense as it cools below 4 degrees C (about 37 degrees F). Use Activity 3.5 *Break Out* to illustrate the expansion of ice as it freezes and continues to chill. Ask participants to THINK about the importance of this for living things in cold climates.

Lead participants to LIST some of the characteristics of water in its solid form.

DEFINE evaporation and sublimation as the processes of liquid and solid water changing to a gaseous form. Have participants SPECULATE on factors that could increase evaporation or sublimation (air movement, heat, bright light, decreased air pressure). **Condensation** of gas to liquid can be demonstrated using a glass or metal container filled with ice. Water from the air (gas) condenses onto the outer surface of the cold container. On cold days, a similar effect could be demonstrated by blowing out one's breath in a warm room, then again outside. The cloud of condensed moisture shows that gaseous water is present.

Use a thermometer to MEASURE the temperature of boiling water over a period of time. NOTE that air pressure changes the boiling point, but the boiling point remains constant no matter how long the water boils. NOTE that American Indians used wooden or bark containers to boil foods. Ask the participants to EXPLAIN how that would be possible without burning the vessel.

Ask participants to DESCRIBE gaseous water (water vapor). NOTE that gaseous water is colorless and odorless - as hard to see as air. When it condenses, we can see the tiny particles of liquid as steam or clouds of breath on a cold day .

## IV. Specific Heat of Water

Water is used as the standard for determining **specific heat**, which is the ratio of the amount of heat needed to raise the temperature of a mass 1 degree compared to that required to raise the temperature of an equal mass of water 1 degree. Specific heat is measured in the calories required to raise the temperature of 1 gram of a substance 1 degree C. A **calorie** is the amount of heat needed to raise the temperature of 1 cubic centimeter (1 ml) of water by 1 degree Celsius.

Very few substances have a higher heat capacity, or specific heat, than water. That means a relatively large amount of heat energy is absorbed or given up in order to change the temperature of the water. As a result of water's high heat capacity, large bodies of water, like lakes and oceans, moderate the climate of the land nearby. They act as heat reservoirs; they heat more slowly as the air and land temperatures warm and they cool more slowly than the air or land. Plants and animals that live in the water face less severe temperature extremes than do those that live on the land where they are exposed to the air.

## V. Water Pressure

### Pressure

Because water has mass and is not compressible, it exerts **pressure**. Pressure is described in terms of force per unit area, where force is the mass times the acceleration of gravity. Pressure is commonly measured in pounds per square foot or per square inch in English units or ergs per square centimeter in metric units.

In a liquid, the pressure is determined by the density of the fluid and the height of the column of fluid. Water weighs 1 gram per cubic centimeter or 62.4 pounds per cubic foot. Therefore, a column of water 1 foot high would exert a pressure of 62.4 pounds per square foot of surface. If the column of water or depth were 2 feet high, the pressure would double to 124.8 pounds per square foot. At a depth of 1,000 feet, the pressure would be 62,400 pounds per square foot!

As depth increases, the pressure increases proportionally. The great pressures encountered become a critical consideration for scuba divers, deep-diving whales and seals, deep sea fishes or mollusks, and builders of submarines. Water pressure is distributed equally in all directions, so at any given depth the pressure is equal in all directions. Water pressure is independent of the shape or the total volume of the container (even if that container is the Pacific Ocean's shores). Depth and density are the only two factors that contribute to water pressure under these conditions.

### Buoyancy

Water also provides buoyancy. Water supports an object submerged in it with a force equal to the volume of water displaced. This principle (Archimedes' principle) allows ships to be constructed of steel or even concrete. If the weight of the vessel and its contents is lighter than the volume of water displaced, the ship will float.

ASK why climates are less severe near large bodies of water or coastal areas. LEAD participants to conclude that water tempers weather changes because of its high heat capacity.

Use Activity 3.6 *Hold in the Heat* to evaluate water's ability to hold in heat.

DEFINE pressure as a weight or force per unit area. ASK participants if they have ever seen a floor with tiny dents in it. RELATE their observations to the pressure exerted by ladies' high heels. NOTE that concentrating their weight on the tiny area of a heel creates tremendous pressure; the much larger heels on men's shoes seldom dent the floor, although the average man is much heavier than the average woman. Water exerts pressure in proportion to the mass of water or the height of the water column. As one descends in depth, the pressure exerted by water goes up, until it is powerful enough to crush even the hulls of submarines! CONSIDER inviting a scuba diver to visit your group and explain how pressure impacts the sport.

Use Activity 3.7 *Pressure Points* to illustrate how the height of a column of water above a point determines the pressure exerted by the water at that point.



Plants and animals living in the water are supported at least in part by the buoyancy of the water. Whales, for example, cannot support their great weight on land, but in the sea they are swift and agile — able to have much lighter bones than would be needed if they were land animals.

## For Further Thought

1. Study some of the ways animals cope with the pressures of extreme depths. Some whales dive to depths more than 3,000 meters (about 10,000 feet). They allow their lungs to collapse as they dive or dive with empty lungs, staying under for long periods of time as they forage for squid and other prey. Deep-diving seals also are adapted to cope with the pressures of the depths. Nearly any book about marine mammals will contain some interesting things about how these animals cope with pressure.
2. Examine how water can provide a less demanding environment for living things. Consider its ability to support objects in proportion to the volume of water displaced, its ability to maintain relatively constant temperatures, and similar factors. These things have a cost, however. A beached whale cannot breathe properly because it is too heavy to support itself.
3. The story of Archimedes is an excellent and easily remembered story of scientific discovery. Challenged with determining the composition of a crown without destroying the crown, he is alleged to have been pondering the problem in the bath. He thought about the displacement of the water by his body and the buoyancy of the water. He is said to have emerged from the bath running through the streets yelling “eureka!” [I have found it!], but forgetting to stop long enough to put on his clothes. Consider how displacement of water, the weight of the crown in air, and the volume of the crown could have allowed him to determine the composition of the metals in the crown.

## Sharing or Exhibit Activities

1. Develop a series of activities to demonstrate the physical states and properties of water.
2. Use a suitable medium to show the characteristics of water and to illustrate its physical states.
3. Explain how the physical characteristics of water are important to life on earth.
4. Use simple experiments to demonstrate Archimedes’ principle, e.g. comparing displacement of water by various materials and the specific gravity of those materials.
5. Prepare a report on deep-diving marine mammals or deep sea fishes and share it with the group. Be sure to include adaptations that enable them to live at great depths while coping with the pressure of the water around them.

## Summary Activity

After participants have had a chance to explore the various experiments associated with this level, ask them to outline a set of characteristics of water in its various states.



## Camouflage Water



Did you know that only 1 percent of the earth's water is in a usable form for humans?

### Equipment/Materials

glass	hot plate
ice	paper
pencil	Pyrex container
rubber bands	thermometer
water	

**Time Required:** 15 minutes

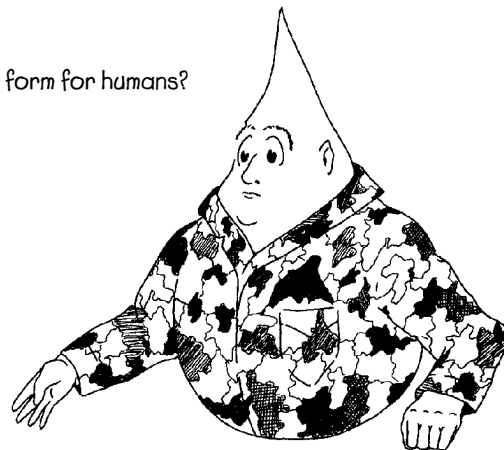

### Procedure

1. Place an ice cube and a glass of water on the table. Have participants observe them and describe what they see. Discuss the properties of solid and liquid water both from these observations and their previous experience.
2. Place some ice cubes in the Pyrex container and place the container on the hot plate. Heat it until the water comes to a boil. Ask the participants to observe and describe what they see. Ask the participants to name the three states of matter observed in this experiment. Emphasize that the water vapor that forms the steam when the water is boiling is actually a gas.
3. Once the water reaches a boil, place a thermometer in the boiling water. Wait a few seconds for it to stabilize before reading and recording the temperature. Continue recording the temperature in 2-minute intervals at least three times (more may be used if you desire). Ask participants to think about why the temperature remains constant (except for minor errors in reading the thermometer) as long as the water is boiling.

***Water molecules that exceed the boiling point carry away heat as they are converted to water vapor, so the water cannot rise above the boiling point unless it is placed under pressure.***

4. Look up the boiling point of water under standard conditions (212 degrees F or 100 degrees C). Did your water boil at that temperature? Note that the boiling point of water is lower as the air pressure decreases (as with increasing altitude). The standard conditions are at nominal sea level. Would something need to cook for more or less time at 10,000 feet in the Rocky Mountains?
5. Emphasize that water is found on the earth's surface in all three states and that each state of matter has its own set of physical properties.



## Liquid Layers



It takes about 50 gallons of water to wash a load of clothes.

One of the physical properties of any substance is density, a measure of its mass or weight per unit volume. If liquids do not mix or mix slowly, layers form according to density with the heaviest layer on the bottom and the lightest on the top of the column. This activity allows participants to observe differences in density and to discuss those differences.

### Equipment/Materials

clear glass jar, jug or glass or graduated cylinder

water*	molasses
postal scale	cooking oil
small measuring cups	paper clip
cork	raisin
piece of candle	aluminum foil

\* amounts from a few milliliters to a cup as required by the container

### Procedure

1. Have participants guess which of the liquids is the most dense.
2. Carefully measure equal amounts of each one and weigh on a postal scale or similar device. Note that the volume is the same for each one, so the weight is a good estimate of its density.
3. Have the participants predict which of the substances will be on the bottom, in the middle and on top of the column when they are all added to one container.
4. Gently pour each liquid into the container. Although it may not be necessary with these three liquids, you may want to pour the liquids over the bowl of a spoon to break up the force of the fall and to keep them from mixing too much.
5. Observe the liquid layers as they form. Determine which of the liquids is on the bottom [*molasses, a dense sugar solution*]. Is it the most dense of the three? [*Yes*] Why would it form the bottom layer?

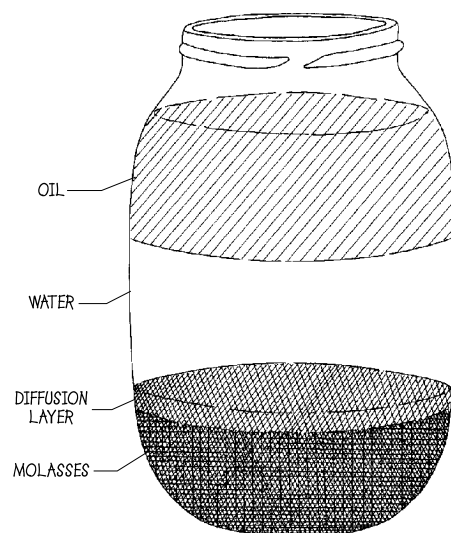

***Molasses is the most dense of the three liquids used in this experiment, therefore it sinks to the bottom of the container and forms the bottom layer.***

6. Repeat the discussion with the other two layers that are formed. Which liquid is the most dense? Which liquid is the lightest? If the liquids stand for very long, participants may notice a narrow zone of mixing (in still containers that are not disturbed). This is the result of the molasses dissolving in the water.

***The sugar solution gradually will become completely dissolved in the water through the process of diffusion. The cloudy or slightly colored band in the container is a diffusion layer.***

7. Participants may wish to experiment with a variety of objects to see which layers may or may not support them. Bits of cork, candle wax, strips of aluminum foil, raisins, paper clips, a small bit of eraser or similar objects may be used. What does their position in the column say about their density?

***They will sort in the column by relative density or by other characteristics, like their hydrophilic or hydrophobic structure.***

8. Why do the materials tend to be either at the top or at the bottom of any given liquid layer instead of remaining suspended in the middle of a layer?

*Most of them are likely to lie in the interfaces between the layers because they are more dense than the upper liquid but less dense than the lower one. Nearly none of them will remain in suspension within a single liquid layer.*

9. Why do oil slicks form on the surface of the ocean when oil spills occur?

*Most petroleum products that are carried by tankers are lighter (less dense) than water.*

10. Why are tar balls found at the bottom of the ocean and on beaches after a marine oil spill?

*Lighter parts of the oil evaporate, leaving only the denser parts of the crude oil. Those parts of the crude oil form tar balls that sink and are carried inshore by currents and tidal action, washing up on beaches at high tide.*

## Carrot Float



Did you know that salt water is more dense than fresh water?  
That's why it's easier to float in the ocean.

### Equipment/Materials

plastic bowls (2) per work group  
carrot sticks or disks (2) per work group  
table salt  
water

**Time Required:** 5 minutes



### Procedure

This activity can be done either as a demonstration or as a group experiment.

1. Fill each of the plastic bowls with approximately the same amount of warm tap water.
2. Add a carrot stick to each bowl. Observe and record what happens.

*The carrot pieces should sink to the bottom of the bowls.*

3. Begin adding salt and stirring it into the water in one of the bowls. Continue to do so until the carrot floats.  
Hint: It is helpful if the water is very warm. The salt dissolves more readily.
4. What does the added salt do to the density of the water?

*Since the weight or mass of the salt is added to the weight or mass of the water, it increases the density of the water.*

5. Why does the carrot float in the salt water and sink in the fresh water?

*The concentrated salt water is more dense than the carrot (which has only a small amount of dissolved salts) while the fresh water is less dense than the carrot!*





## Funny Funnel



Did you know that the average American citizen uses approximately 2,000 gallons of water per day?

Water density changes with changing temperatures. This activity demonstrates how differences in temperature can cause water to separate into layers of differing density until the temperatures and densities match.

### Equipment/Materials

empty clear plastic soft drink bottle	cold water
scissors or sharp knife	ice (if needed to chill water)
measuring cup	hot water
spoon	heat source if required
green or any other dark food coloring	

**Time Required:** 5 minutes

### Procedure

1. Cut across the soft drink bottle to make top and bottom halves.
2. Fill the bottom half of the bottle a little over half full using very cold water. Very cold water is vital to the demonstration. Use ice to chill the water if necessary, but remove the ice before going to the next part of the demonstration.
3. Invert the top of the bottle to make a funnel and insert it firmly into the bottom half.
4. Fill the measuring cup with very warm (hot) water and add enough food coloring to make the hot water dark green (or another deep color).
5. Gradually pour the warm, colored water into the funnel, and observe the container for several minutes. Record your observations on what happens to the colored water.
6. If desired, the apparatus can be checked periodically to see how the color spreads through the water.
7. Lead participants in a discussion of the things they have observed, using questions to lead them to valid conclusions about the relative densities of the cold and hot water.

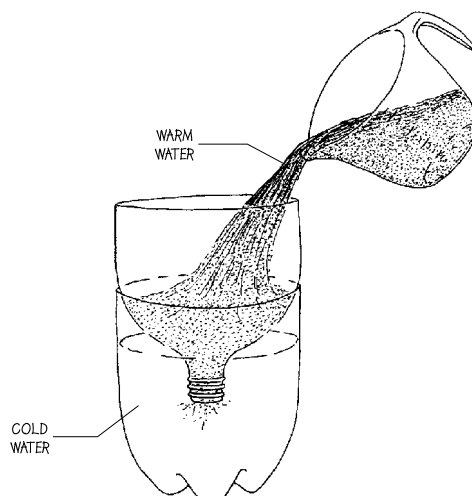

### Analysis

Water becomes more dense as it cools until it reaches a maximum density at about 37 degrees F or 4 degrees C. As water cools beyond that point, it becomes less dense. The molecules of water are more densely packed in cold water than they are in warmer or freezing water. In a sense, there is more water in a given volume of cold water than there is in warm water. Because the cold water is more dense than the warm, colored water, it remains on the bottom of the container. Any warm water that moves out of the funnel rises toward the surface, perhaps even forming a colored layer at the top. As the temperature difference decreases, the densities become similar and the color mixes more completely with the entire volume in the container. Eventually the green dye will be dispersed more or less evenly throughout the container.

## Challenge

How do the things observed in this demonstration relate to water in deep lakes or oceans?

*These bodies of water often are stratified into layers because of temperature differences. The edges of currents, like the Gulf Stream, are often defined by masses of water with different densities. The most dense water would lie under the less dense layers, often with little mixing taking place.*

Do you think the water at the bottom of the ocean is more or less dense than surface water?

*Under most conditions, the deeper water would have a higher density than the surface water. Under cold conditions, the entire water column can mix together to have a nearly even temperature from top to bottom.*

When might the water have the same density at the surface and at the bottom?

*This could occur any time the conditions are favorable to allow surface waters to be the same temperature, about 37 degrees F or 4 degrees C, as the deeper waters.*

## Break Out



In 1956, a scientist measured the tip of an iceberg that was 208 miles long and 62 miles wide!

One of the unique properties of water is the fact that its maximum density occurs before its freezing/melting point. As a result, ice expands as it freezes, taking up more space than very cold water does. This activity demonstrates how water expands and the fact that ice is lighter than liquid water. It also shows the power of freezing water in breaking out of its container (the same power that cracks rocks to produce future soil particles).

### Equipment/Materials

small plastic bottles (e.g. soft drink bottles)  
aluminum foil or plastic wrap  
freezer  
water container  
large rubber bands

### Procedure

1. Fill several matched plastic bottles completely full of lukewarm (room temperature) water.
2. Place a cap of a piece of aluminum foil or plastic wrap over each one. The covering may be secured with a rubber band if desired.
3. Place one or more bottles in a freezer and allow enough time for the contents to freeze completely. (Try an expanded approach if you have the capability of measuring 500 ml of liquid accurately. Place one or more additional bottles in a refrigerator and allow them to chill to as near 37 degrees F or 4 degrees C as possible. Leave one or more bottles at or near room temperature to act as controls. The differences in volume that can be expected are on the order of 1 ml!)
4. After the water in the freezer has completely frozen, remove the bottles and have the participants study them carefully and record their observations. (If the expanded approach is used, assist them in carefully measuring the volume of water in the control bottles and the chilled bottles using a graduated cylinder. Remember that the difference between 4 degrees C and 25 degrees C will only be about 1 ml for a 12- to 16-fluid-ounce bottle, so it will be difficult to measure.)
5. Discuss the observations that were made, using questions where necessary to focus on the change in density with changing temperature and the resulting change in volume. Be prepared to comment on the reason for having a bulge of ice above the rim of the container or for any bulged or split bottles.

***The open top was the only noncontained part and the easiest place for the water to go as it froze. If the top were sealed completely by ice before the body finished freezing, the bottle may have bulged or even split from the pressure.***

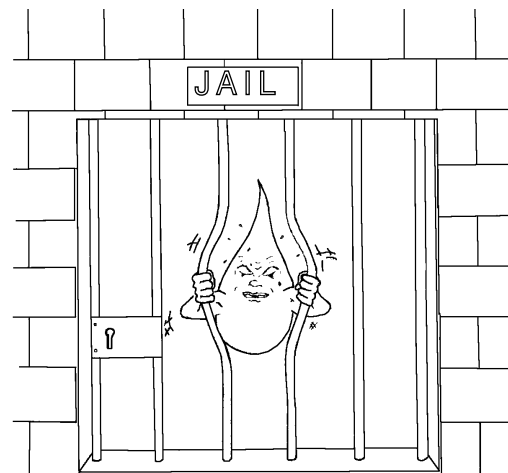





# The Water Cycle

## Objectives

1. Define the hydrologic cycle.
2. Explore and discuss the distribution of water on the earth.
3. Identify the components of the hydrologic cycle.
4. Construct a hydrologic cycle model.
5. List factors that can affect the hydrologic cycle.
6. Have fun while learning.

## Materials/Equipment

See individual activities.

## Vocabulary

drizzle	hydrologic	runoff	vernal pond
evapotranspiration	infiltration	sleet	water table
groundwater	mist	sublimation	
hail	precipitation	topography	
humidity	rain	transpiration	

## Lesson Requirements

Best Time: Any time of the year

Best Location: Any safe setting where water is available and young people can work in small groups

Time Required: Approximately 3 to 4 hours, depending upon the learning activities selected

## Lesson Background

### I. Introduction to the Water Cycle

Water is a form of matter, so it cannot be created or destroyed under normal circumstances. As a result, the water you drink today may have been in the iceberg that crushed the hull of the Titanic. Before that, the water may have been drunk by a *Tyrannosaurus rex*.

#### Hydrologic cycle

Water is an outstanding example of the cycling of materials. Some water is broken down and re-formed, but most of it simply changes its form and location through the hydrologic cycle. This cycling process was discovered by Edmund Halley (discoverer of Halley's Comet) in the late 1600s.

## Lesson Overview

- I. Introduction to the Water Cycle
  - A. Hydrologic cycle
  - B. Characteristics of water cycle
  - C. Distribution of water
- II. Components of the Hydrologic Cycle
  - A. Precipitation
    1. Water that falls from sky
    2. Forms of Precipitation
      - a. Liquid
      - b. Solid
    3. Gaseous form - condensed water vapor
  - B. Runoff water
    1. Water running off earth's surfaces
    2. Collection and storage sites
  - C. Stored surface waters
    1. Long-term storage
    2. Temporary storage
  - D. Infiltration
  - E. Groundwater
  - F. Evapotranspiration and respiration
    1. Evaporation
      - a. Influences on evaporation rate
      - b. Sublimation - solid to gas
    2. Transpiration
  - G. Condensation
- III. Factors Affecting the Hydrologic Cycle

## Applications

READ the poem "Recycled" to stimulate discussion of water and how it is reused over and over again.

## Characteristics of water cycle

The Latin roots of these words show us its meaning. “Hydro” means water. “Logia” means “science of,” and “cycle” implies a never-ending circle. Simply stated, the hydrologic cycle is the endless process whereby water is circulated from the sea or land to the atmosphere and back again. Some water moves very quickly through this cycle. Some moves very slowly, even pausing for thousands of years in deep groundwater reserves. The amount of water circulating through the hydrologic cycle remains constant, but its form changes from liquid to solid or gas and back.

This recycling process has kept a balanced and fairly constant quantity of fresh water available on earth for nearly 3.5 billion years. A glimpse at how water is distributed on the earth soon makes this a very comforting thought.

## Distribution of water

Three-fourths of the earth’s surface is covered with water. However, 97 percent of all of the earth’s water is saltwater, while only a mere 3 percent is fresh water. Of this 3 percent, two-thirds of it is locked up as ice in glaciers and polar ice caps. Hence, only 1 percent of the earth’s water is in a usable form. Thank Goodness for the hydrologic cycle!

## II. Components of the hydrologic cycle

### Precipitation

Although the hydrologic cycle is continuous and doesn’t really have a beginning, a convenient place to start studying it is with precipitation. **Precipitation** is water that falls from the sky. It may take either the liquid or the solid forms of water. **Rain** is precipitation in the form of liquid water drops. A very light rain is known as a **drizzle**. **Mist** is composed of water droplets that are so small they remain suspended in air or fall very slowly to the ground. Fog is a very fine mist that remains suspended in the air. In structure, it is very similar to clouds.

Solid precipitation comes in three forms. Rain that freezes on its way to the surface is known as **sleet**, while **hail** grows to greater size as it is alternately driven upward and downward in the atmosphere by the powerful air currents found in thunderstorms. **Snow** takes many forms, but all of them are based upon ice crystals.

Although it is not a form of precipitation, gaseous forms of water may condense to have a similar effect. Dew and frost are familiar forms of condensed water, and in some parts of the world, tiny ice crystals, known as hoar frost, may form in the air and cause it to sparkle.

### Runoff water

Once precipitation falls to the earth, several things can happen. If it hits the ground more rapidly than it can soak into the soil or hits surfaces that are impermeable, it becomes runoff. Runoff is water that flows off of surfaces into streams and rivers, ponds, and lakes, swamps and marshes, impoundments, or oceans and seas.

INTRODUCE “hydrologic cycle” by breaking down the words into their Latin roots.

ILLUSTRATE the amount, type and distribution of surface water on the earth using Activity 4.1 *Any Way You Slice It!* as a visual model.

DISTRIBUTE Record Sheet 4.2 *Around and Around We Go* to each participant. Have them FILL IN each part of the hydrologic cycle as it is discussed.

DEFINE “precipitation” or LEAD participants to construct a working definition. Challenge small groups to BRAINSTORM about types of precipitation they can identify. ADD types that the groups may have missed.

Ask participants to DEFINE “runoff water” and to IDENTIFY as many types of runoff water they can, including those found in and around their communities. Using Activity 4.3 *See How It Runs*, LEAD participants in identifying and labeling the major rivers of Texas.

## Stored surface waters

A tremendous amount of water is stored as surface water, ultimately ending up as salt water. Polar ice caps, glaciers, and some montane snow fields are good examples of long-term storage of precipitation. Temporary forms of storage include puddles, standing ditches, and temporary pools or wetlands. Those that form only in the spring are known as **vernal ponds** or vernal wetlands.

## Infiltration

**Infiltration** is the process of water moving into the soil, while percolation is the process of water moving through the soil. Once water enters the soil, it may be absorbed by plant roots, moved to the surface by capillary action, or incorporated into the **groundwater**.

## Groundwater

Groundwater is water located under the earth's surface below the water line known as the water table. The water table is the uppermost level to which the groundwater rises. In some areas it may be extremely shallow, while in others it may be deep under ground.

## Evapotranspiration and respiration

Some water is returned to the atmosphere by the process of **evapotranspiration**. This is a term that refers to two separate processes that are often linked together, the processes of evaporation and transpiration. It is defined as the process in which water from soils and plants is returned to the atmosphere.

Evaporation takes place when liquid water becomes water vapor. Evaporation can take place from any moist surface, including soil, water, skin surfaces, and the respiratory tissues of animals. Many factors influence the rate of evaporation. Temperature, air movement, amount of solar energy, altitude, and even relative **humidity** influence evaporation rates.

A closely related process, **sublimation**, takes place when solid water goes directly to water vapor without becoming a liquid first. Any source of energy can cause water to become gaseous and return to the atmosphere. The two most common ones are wind and sunlight.

Water may also be returned to the atmosphere in huge volumes via **transpiration**, defined as the movement of water from plant pores into the atmosphere. Transpiration provides adequate pressure for plants to draw water and nutrients into the leaves, the food factories of the plants.

Animals contribute water to the atmosphere through direct evaporation from moist membranes and through respiration. Exhaled air is saturated with water vapor, while inhaled air generally contains less water vapor. On a molecular level, the process of cellular respiration produces water and carbon dioxide as end products of "burning" carbohydrates for energy.

EMPHASIZE that all rivers, streams and ponds eventually flow toward salt water. If desired, NOTE that Great Sal Lake, the Salton Sea and the Dead Sea are examples of salt water that is unable to reach the ocean.

Lead participants to IDENTIFY stored surface water types and locations. NOTE that oceans and seas store the vast majority of surface water as salt water.

Lead participants to CONCLUDE that polar ice caps, glaciers and some mountain snowfields are solid, long-term freshwater storage, while puddles and temporary vernal (spring) pools and wetlands provide temporary freshwater storage.

Ask participants to CONSIDER what happens to water that does not run off the surface of the earth. NOTE that this movement into the soil is called infiltration. LEAD them to consider what can happen to water infiltrated into the soil.

EMPHASIZE that groundwater is an end result for some infiltrated water. Use Activity 4.4 *A Groundwater Drink* to visually ILLUSTRATE groundwater and the corresponding water table.

ASK what would happen to water in a cup if it were left in the sunshine for a day. EMPHASIZE that the water would evaporate into the air, becoming water vapor. Lead participants to DISCUSS factors that influence evaporation rates.

NOTE that water moving through plants is essential for photosynthesis (making food) and that water vapor is released to the air through pores (stomates or stomata) as part of the water transport process. EMPHASIZE that evapotranspiration includes both evaporation ( and sublimation) and transpiration.

## Condensation

After returning to the atmosphere in the form of vapor, water can condense from its gaseous state to form a liquid. Condensation takes place when cooling of the earth or air reduces the ability of the air to hold water vapor. Water vapor always condenses onto a solid such as surfaces of plants or the soil or tiny dust particles or salt crystals in the air. When the air cools, water vapor can form tiny water or ice particles to form clouds or fog. Note that fog is simply a cloud at ground level. Each cloud is composed of billions of tiny water droplets. These droplets collect on the particles in the atmosphere until they become too heavy and fall to the earth as drops of rain. This is precipitation and thus, the hydrologic cycle continues. If saturated air comes in contact with cold solids on the surface, the water may condense as dew or form a solid (frost). This, too, represents returning liquid water to the earth's surface for recycling in the hydrologic cycle.

## III. Factors Affecting the Hydrologic Cycle

Numerous factors, among them climate, weather, geography and topography, affect how water travels through the hydrologic cycle.

Higher temperatures tend to speed up the hydrologic cycle. Thus, water is cycled faster near the equator than it is in polar regions. The lower pressures found at higher altitudes also increase the evaporation rate. Mountain ranges tend to force warm air higher, causing it to cool and produce clouds and precipitation. The area on the downwind side of mountain ranges tend to be much drier, however, because the water has been deposited on the upwind slopes. Good examples are the high deserts found between mountain ranges in the American West and the great grasslands of the central plains downwind of the Rocky Mountains.

Soil type and soil moisture, slope, ground cover or vegetation types and manmade structures also affect the hydrologic cycle. Clay or densely packed soils, for example, allow for little infiltration, but sandy, loose soils allow more water to seep in or infiltrate. The slope of the land also influences infiltration and runoff rates. Steep slopes tend to have higher runoff rates and lower infiltration rates than do flat or gently sloping land. The amount of water held in the soil is an obvious influence on the ability of soil to hold more. Saturated soils produce more runoff than do dry soils under similar conditions. In addition, when rain or snow melt takes place faster than it can infiltrate, the excess water runs off to surface water. Ground cover and heavy vegetation protect the soil and absorb moisture, thus reducing runoff. Buildings and paved areas, like parking lots and roads, allow very little, if any, infiltration; so they contribute to increased runoff. Water held in groundwater, snowfields and glaciers moves relatively slowly in the cycle.

Regardless of the rate of movement through the cycle, all of these processes are important in the constant renewal of water—earth's most vital resource.

ASK participants why water forms on the outside of a glass containing ice or a cold liquid that is allowed to stand in a warm area for some time or why they can see their breath outside on a cold day but not when the air is warm. NOTE that both these things are the result of condensation. Lead them to EXPLORE and DISCUSS other examples of condensation they have observed. USE Activity 4.5 Cloud Maker to further enhance and emphasize condensation.

SUMMARIZE the components of the hydrologic cycle using Activity 4.6 *What Goes Up...Must Come Down* as a demonstration. For further reinforcement, consider using Activity 4.7 *Hydrologic Puzzle* and worksheet.

Lead participants to HYPOTHESIZE about factors that might affect the hydrologic cycle. LEAD them to include the factors outlined here and any others they might be able to grasp.

Ask participants to CONSIDER how the steepness and orientation of a slope could affect the water cycle on those slopes.

NOTE that vegetation delays the flow of water off the land and provides for greater infiltration. Increasing the number of layers of vegetation or the density of the vegetation tends to increase the influence of plants on infiltration and slowing runoff.

Have participants CONSIDER how human development might alter water cycles. Be careful NOT to CONVEY an antihuman attitude in presenting these notions.



## For Further Thought

1. Encourage participants to think about other cycles they can observe in nature. Seasonal changes (the changing of the earth's position toward the sun as the year progresses); changes in the cycle of lunar phases; the process of leafing out, growth, senescence and loss of leaves on deciduous trees; and nearly all geochemical cycles are good examples.
2. Discuss the influence of natural phenomena on our weather, e.g. La Niña or El Niño conditions and their influence on rainfall patterns and amounts or the influence of volcanic dust in the air on air temperatures and resulting weather patterns.
3. Challenge young people to consider the water cycle impacts of:
  - a. Removing 80 percent of the ground cover from a site,
  - b. Putting roads and parking lots over large areas of sandy, gravelly or karst soils,
  - c. Establishing small wetlands along watersheds,
  - d. Building water recharge basins in urban areas,
  - e. Transferring water from one watershed to another to meet human demand.

## Sharing or Exhibit Suggestions

1. Make a poster, model or diorama of the water cycle and use it to demonstrate how the cycle works.
2. Write a story of a single molecule of water, showing its journeys through the water cycle, including use by plants and animals. Make the story as simple or as complex and complete as you wish. Tell the story to someone you know.
3. Discuss the main ideas in Verne Rockcastle's poem, "Recycled" (Fact sheet 4.10. Share the poem with someone you know.
4. Use topographic maps (maps showing changes in elevation) to outline the watersheds of rivers or streams in your area. Remember, water flows downhill. Consider building a relief map of your watershed using cardboard and clay or plaster to shape the landscape.

## Summary Activity

Construct a terrarium using Activity 4.8 *Living in a Bubble World* as a foundation. Reinforce the notion that we are all part of the hydrologic cycle. Use Activity 4.9 *Water Bingo* to review some of the terms introduced in this and other lessons.



## Recycled!<sup>1</sup>

The glass of water your about to drink  
Deserves a second thought, I think.  
For Avogadro, oceans and those you follow  
Are all involved in every swallow.

The mollecles of water in a single glass  
In number, at least five times, outclass  
The glasses of water in stream and sea,  
Or wherever else that water can be.

The water in you is between and betwixt,  
And having traversed is thoroughly mixed,  
So someone quenching a future thirst  
Could easily drink what you drank first!

The water you are about to taste  
No doubt represents a bit of the waste  
From prehistoric beast and bird -  
A notion you may find absurd.

The fountain spraying in the park  
Could well spout bits from Joan of Arc,  
or Adam, Eve, and all their kin;  
You'd be surprised where our drink has been!

Just think! The water you cannot retain  
Will some day hence return as rain,  
Or be beheld as the purest dew.  
Though long ago it passed through you!

Verne N. Rockcastle<sup>2</sup>

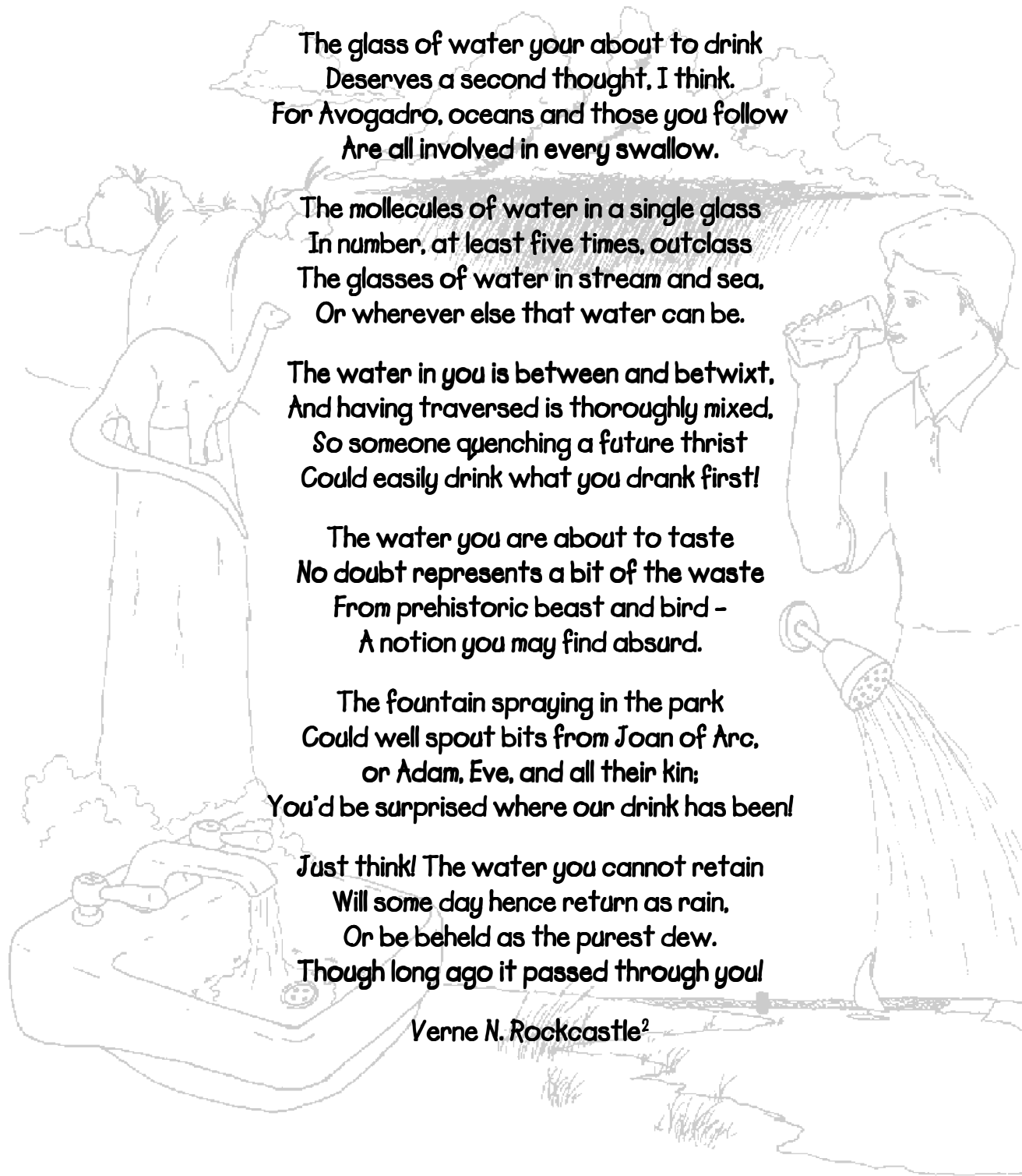

<sup>1</sup>Water Resources Education Kit, 4-H Youth Development, College of Agriculture and Life Sciences, Cornell University, Ithaca, NY

<sup>2</sup>Professor Emeritus, Outdoor Education, College of Agriculture and Life Sciences, Cornell University



## Any Way You Slice It



If all the water in the oceans were divided among all the people on earth, each person would have enough to fill 80 Olympic-sized swimming pools!

### Materials/Equipment

knife                      apple  
paper                      pencil

**Time Required:** 10 to 15 minutes

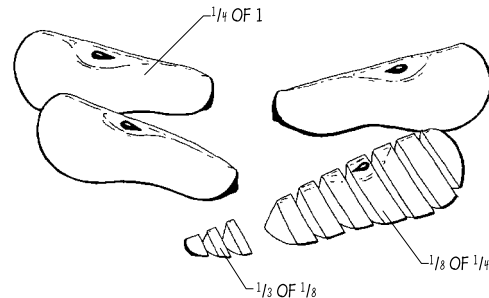

### Procedure

1. Cut the apple into four equal sections.
2. What percent of the earth's surface is water?

***Approximately 75 percent***

3. How many apple slices represent the water on the earth?

***3 slices***

4. What percent of the earth's water is salt water or ocean?

***97 percent***

5. How much of the apple would represent the fresh water?

***3 percent***

6. Cut one of the three "water" slices into eight equal-sized pieces. Each piece now represents about 3 percent of the total, approximating the amount of fresh water on the earth's surface. Set all but one of the pieces aside.

***Note that one of the eight pieces presents approximately 3 percent of the total represented by the three pieces.***

7. How much of the fresh surface water on earth is in glaciers and the polar ice caps?

***2 percent of the total water or about 67 percent of the fresh water***

8. Cut one of the eight small pieces into thirds. Each of these pieces will represent 1 percent. Set two of the pieces aside to represent these stored but unavailable water supplies.

9. How much of the water on the earth is actually available for us to use as fresh water?

***One (1) percent of the total water - approximately the amount indicated by the last remaining piece of the apple.***

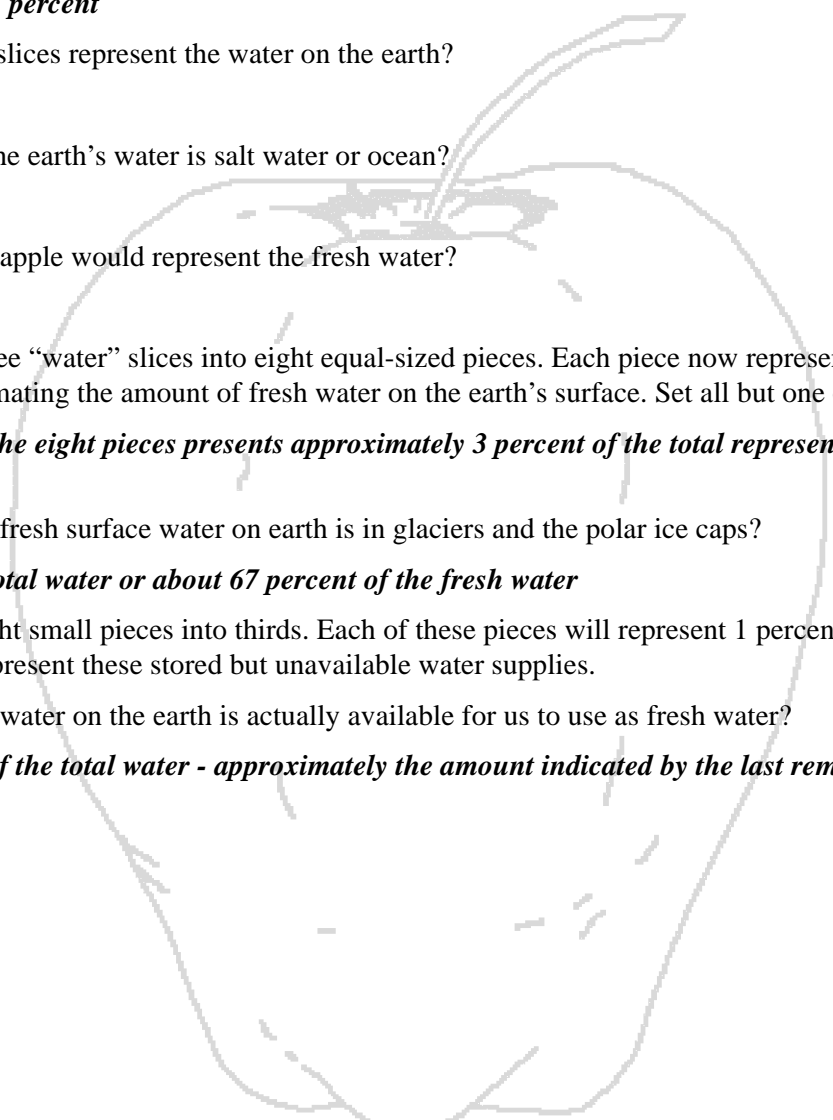



## Around and Around We Go



One mature oak tree may transpire 100 to 1,000 gallons of water each day during its growing season, or about 6,000 to 60,000 gallons each year!

### Word Bank

condensation  
evaporation

precipitation  
respiration

transpiration

**Directions:** Label the water cycle diagram with the words from the Word Bank, showing whether the water is moving into the atmosphere, being deposited on the surface or entering the groundwater. Discuss how the cycle works and the history of the water we are using today

### Water Cycle Diagram

This diagram contains the basic elements of the water cycle. Condensation takes place on the surface (dew, frost) or in the clouds as gaseous water becomes liquid or solid water. Evaporation takes place from any moist surface, including moist ground, surface water, and plant or animal tissues. Groundwater includes any water below the surface of the ground. It may become surface water by way of springs, seeps or artesian aquifers. Infiltration is the process that allows surface water to enter the groundwater through the pores between soil particles. Precipitation is the process of condensed water in the atmosphere falling to the earth's surface as rain, snow, sleet or hail. Respiration forms water as a by-product of metabolism. Oxygen from the air combines with hydrogen from the carbohydrates consumed as food to form water and carbon dioxide. When plant photosynthesize (produce carbohydrates by capturing energy from light) they split water molecules, combining the hydrogen atoms with carbon dioxide to produce carbohydrates and releasing oxygen as a by-product. Runoff is precipitation in excess of what can infiltrate into the soil. It runs off into surface waters. Transpiration is the water given off by a plant through its stomata (stomates). These are holes in the leaves that allow water drawn from the ground through the plant's vascular system to escape into the atmosphere. Plants also respire, producing smaller amounts of water through that process. Both the physical and biological sides of the water cycle are important contributors to the process.

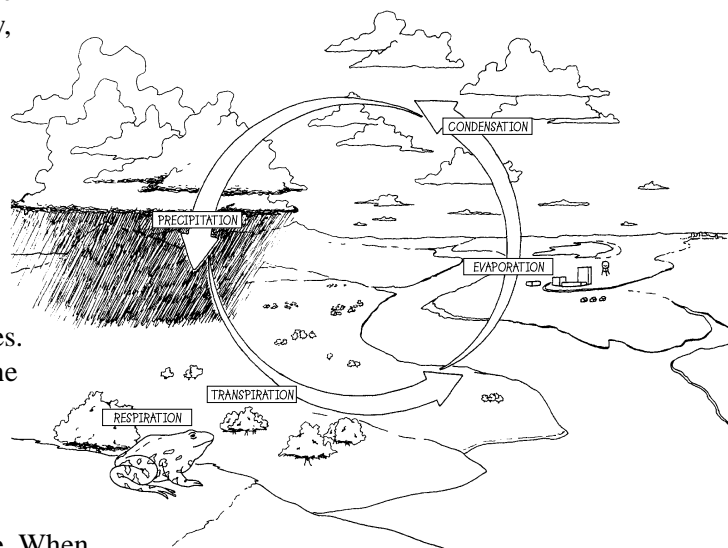





# Around and Around We Go



One mature oak tree may transpire 100 to 1,000 gallons of water each day during its growing season, or about 6,000 to 60,000 gallons each year!

## Word Bank

condensation  
evaporation

precipitation  
respiration

transpiration

**Directions:** Label the water cycle diagram with the words from the Word Bank, showing whether the water is moving into the atmosphere, being deposited on the surface or entering the groundwater. Discuss how the cycle works and the history of the water we are using today

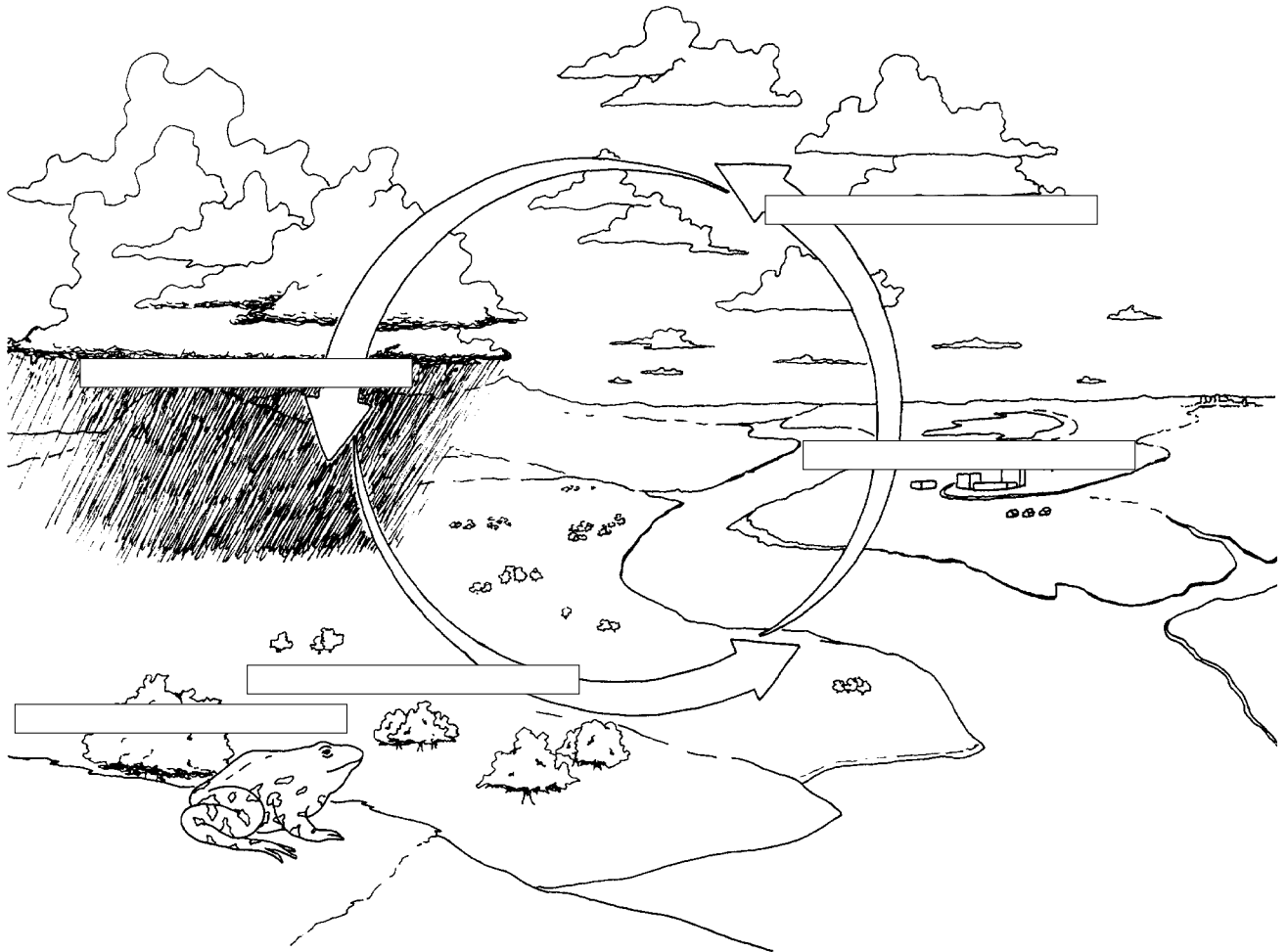



## See How It Runs



Texas has thousands of miles of rivers and streams, but only Caddo Lake, among all our large lakes, is a natural one.

### Directions

1. Label the 15 major rivers listed below on a Texas map.
2. Use a Texas highway map to help you correctly locate all of these rivers.
3. Find the surface river closest to your hometown.

*Use a watershed map to locate the watershed in which your school is located. Note that some maps may reference more than one river system.*

4. What surface waters in your area feed into this river?

*All surface waters drain into the rivers forming the watersheds, but they may go through many routes to get there. Encourage the students to think about the destinations of drainage ditches, storm sewers, creeks, runoff from lawns or parking lots, and similar sources as part of the watershed.*

5. Where does the water from all of the Texas rivers go?

*Texas rivers drain into the Gulf of Mexico with their waters eventually reaching the Atlantic Ocean by way of the Gulf Stream. Tremendous amounts of water are lost to evaporation or evapotranspiration along their courses.*

### Major Rivers of Texas

Brazos  
 Canadian  
 Colorado  
 Guadalupe  
 Lavaca  
 Medina  
 Neches  
 Nueces  
 Red  
 Rio Grande  
 Sabine  
 San Antonio  
 San Jacinto  
 San Marcos  
 Sulphur  
 Trinity

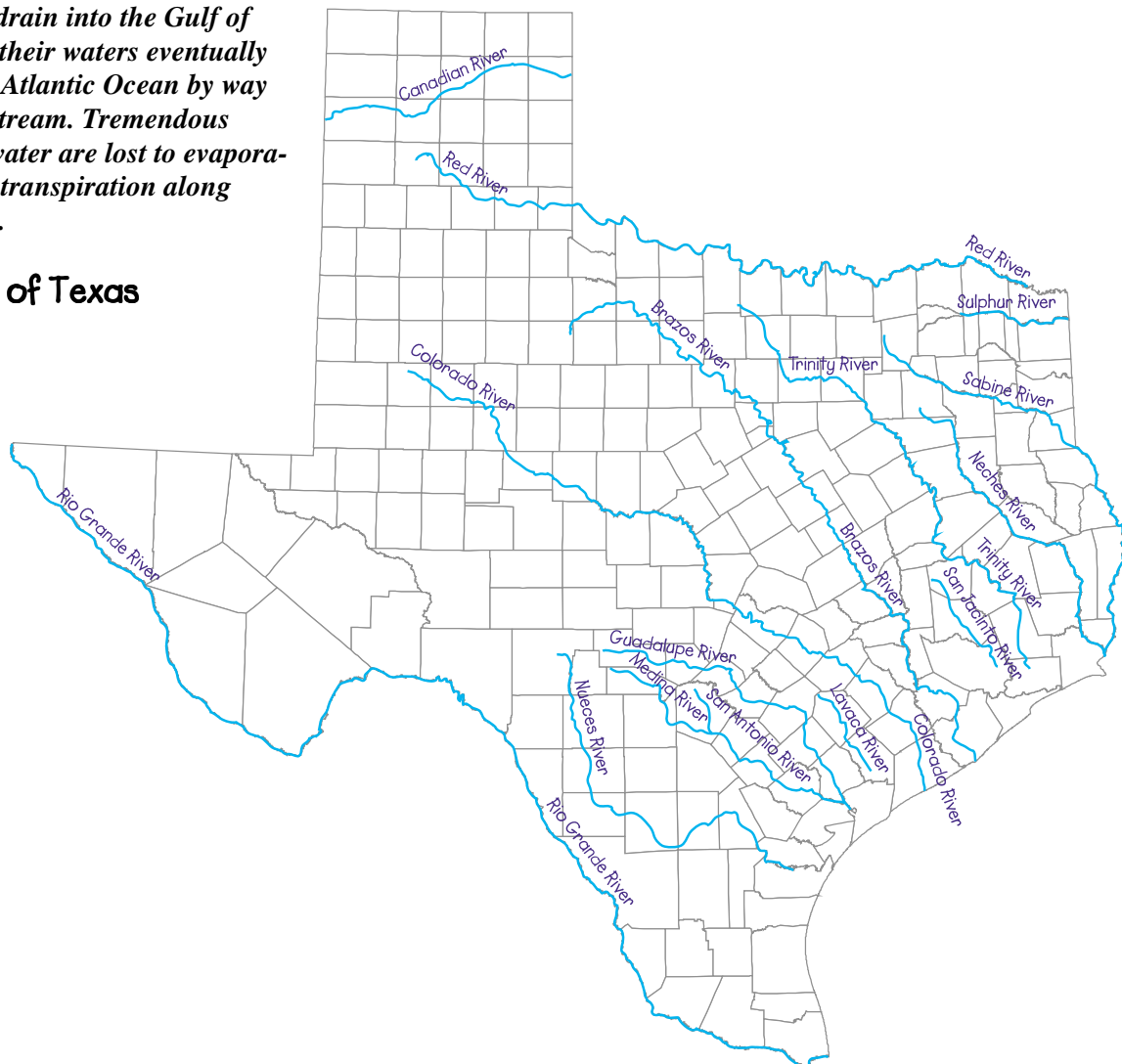







## A Groundwater Drink



Removal of groundwater in some areas, like Houston, has caused the earth to subside (sink) enough to cause cracks in buildings and roadways.

### Materials/Equipment

Crushed ice (rocks and soil)  
approximately 3 ounces of cola (groundwater)  
clear plastic straw (pump)  
clear plastic cup or glass

### Procedures

1. Fill the cup or glass with crushed ice, noting that this simulates the rocks and soil.
2. Ask participants to observe carefully as you slowly pour the cola into the ice-filled glass or cup.
3. Ask the participants to describe what happens.

*The cola drips or runs down through the ice until most of it ends up in the bottom of the glass or cup. Note that the ice in the bottom of the cup is flooded by cola (saturated zone). All the spaces among the ice chunks are filled with cola. Higher in the glass, some cola may cling to the ice or the sides of the glass, but the spaces among the ice chunks are filled with air (unsaturated zone). The water table is the top of the saturated zone.*

4. Put a clear straw into the glass and observe what happens.

*The cola fills the straw to a point even with or slightly above the water table*

5. Sip enough cola through the straw to lower the level of the cola slightly. Ask the participants to describe what happens.

*The level of the cola drops as it flows through the spaces in the ice so its surface remains relatively level, but lower, in the glass.*

6. Pause and allow the cola to fall to a relatively level “water table” before taking another sip.

*The level of the cola in the straw falls to the level of the water table. Note that wells work the same way on a larger scale. As water is withdrawn from the saturated zone at the well head, water flows through the saturated zone keeping the water table relatively level. If adequate recharge is taking place, the water table may remain fairly constant. If water is being removed faster than it can be replenished, the water table will drop. In that case, water is being “mined” from the aquifer.*

**Extension:** To show subsidence of the ground level, float a bit of ice cream or whipped topping on the ice to simulate soil. Allow room for the ice to settle after some cola has been removed from the glass. As “water” is removed, the “soil” surface will settle lower in the glass.





## Cloud Maker



A dairy cow must drink 3536 gallons of water to produce 12 gallons of milk.

### Materials/Equipment

Clear, empty glass  
freezer

### Procedure

1. Put a dry, empty, clear glass into the freezer, leaving it in place for a least 15 minutes.
2. Remove the glass from the freezer with an insulated mitt and breathe gently into it.
3. Ask participants what produced the cloud, and lead them to conclude that it is formed by water vapor in the warm breath coming in contact with the cold glass surfaces.
4. Ask them if this is similar to the way clouds form in the sky? If necessary remind them that temperatures at higher altitudes can be considerable below zero ( on either scale) even when the surface temperatures are uncomfortably warm.

### Alternative:

A less demanding approach works well during cold weather. Have the participants breathe normally in a warm room to see if they can observe water vapor in their breath. Then move outside in a relatively still area. Have the participants breathe again, observing the puffs of condensation formed as they do so. Follow the same logic to the conclusion that the saturated air at body temperature contains more water vapor than the colder air can hold. The excess condenses to form the cloudlike plumes of visible “breath.”



## What Goes Up . . . Must Come Down



If the 355 billion gallons of water used in the United States every day were placed in gallon jugs and set side by side, the line would reach to the moon and back 70 times!

### Equipment/Materials

hot plate or other heat source	water
tea kettle (long spout best)	ice
baking pans or cookie sheets (2)*	boards (2)**
concrete block (2)***	

\* pans with a raised rim are necessary for this experiment

\*\* boards must be wide enough to span the pans

\*\*\* similar supports may be used

**Time Required:** 10 to 15 minutes

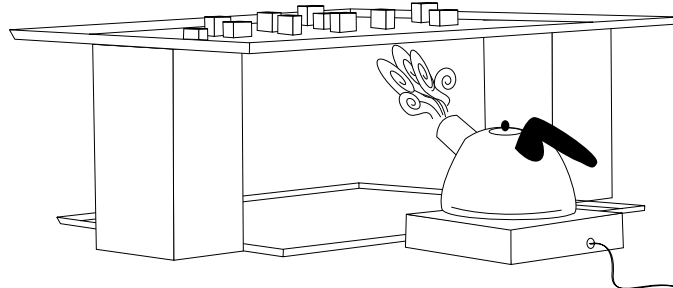

### Procedure

1. Place a rimmed cookie sheet or baking pan beside the heat source.
2. Set two or more blocks or other spacers beside the cookie sheet or baking pan to support a second rimmed sheet or pan above the level of the spout on the tea kettle. [If wooden or other combustible spacers are used, be sure to place them far enough from the heat source to avoid problems.] Set the spacers so they will provide solid support yet allow circulation under the upper pan or sheet.
3. Fill the tea kettle with water and place it on the hot plate or heat source with its spout directed toward the bottom of the top pan or cookie sheet.
4. As the kettle is coming to a boil, place at least 10 to 12 ice cubes or a similar amount of ice on the top cookie sheet or in the top pan. [Have additional ice on hand to replace the ice as it melts.]
5. Have the participants observe the formation of condensation from the steam as it strikes the cooled area of the upper pan, forms droplets and falls as “rain” into the lower pan.
6. Continue by returning the water collected in the lower pan to the tea kettle, completing the water cycle.
7. Ask the participants to discuss the following questions and others you might wish to add.

- a. Which part of the cycle is like a lake?

*The reservoir of the tea kettle and the lower pan both could be considered “lakes.”*

- b. Which part of the cycle is like the sun?

*The heat source provides the energy to change water from the liquid to gaseous state.*

- c. Which part of the cycle is like the rain?

*The droplets that form on the upper pan and fall to the lower one could be considered like rain.*

- d. Which part of this cycle represents the upper atmosphere?

*The cooling effect of the upper atmosphere is represented by the ice in the upper pan.*

- e. Why do you end up with less water than you started with?

*The condensation process is not completely efficient, and some of the water is lost by wetting the surfaces of the pans and kettle.*

f. Do you think that this happens in the actual water cycle?

*Yes and no—the answer depends upon the point of view taken by the responding participant and the time scale being used. Water can be delayed in cycling by many factors, like being tied up in the tissues of plants or animals, becoming part of an underground aquifer, or being bound by soil particles. On the other hand, any water on the surface of the earth is subject to evaporation and any water taken up by plants is subject to transpiration as well as evaporation. Water is even broken down in photosynthesis and re-formed in the metabolism of foods by plants and animals. The cycle, however, remains intact, just as the water that is not recovered in this experiment becomes part of the gaseous water in the atmosphere and remains in the cycle. We just failed to recover it completely in the illustration of the cycle.*

## Hydrologic Puzzle



If all the groundwater were pumped to the earth's surface, it would cover the earth to a depth of about 10 feet!

### Materials

Record sheet 4.7 (1 per participant)

pencil (1 per participant)

**Time Required:** 15 to 20 minutes

**Instruct the participants to fill in the blanks on the record sheet using words from the Word Bank.**

1. The water cycle is also known as the **hydrologic** cycle.
2. Water falling from the sky as **rain, snow, sleet** and **hail** is called **precipitation**.
3. Loss of water from the soil, surface water or moist surfaces is called **evaporation**.
4. **Evapotranspiration** includes evaporation from the soil and transpiration by plants.
5. Water that fails to infiltrate but runs into surface waters like lakes, streams, rivers, ponds and oceans is called **runoff**.
6. **Streams, rivers, ponds, lakes** and **oceans** are all bodies of water that collect runoff.
7. **Clouds** are formed by **condensation** of water vapor.
8. Water found under the earth's surface is called **groundwater**.
9. Movement of water into soil is called **infiltration**.
10. All the water on earth's surface is constantly being **recycled**.

### Word Bank

clouds	hail	ponds	runoff
condensation	hydrologic	precipitation	sleet
evaporation	infiltration	rain	snow
evapotranspiration	lakes	recycled	streams
groundwater	oceans	rivers	



## Hydrologic Puzzle



If all the groundwater were pumped to the earth's surface, it would cover the earth to a depth of about 10 feet!

**Instruct the participants to fill in the blanks on the record sheet using words from the Word Bank.**

### Word Bank

clouds	hail	ponds	runoff
condensation	hydrologic	precipitation	sleet
evaporation	infiltration	rain	snow
evapotranspiration	lakes	recycled	streams
groundwater	oceans	rivers	

1. The water cycle is also known as the \_\_\_\_\_ cycle.
2. Water falling from the sky as \_\_\_\_\_, \_\_\_\_\_, \_\_\_\_\_, and \_\_\_\_\_ is called \_\_\_\_\_.
3. Loss of water from the soil, surface water or moist surfaces is called \_\_\_\_\_.
4. \_\_\_\_\_ includes evaporation from the soil and transpiration by plants.
5. Water that fails to infiltrate but runs into surface waters like lakes, streams, rivers, ponds and oceans is called \_\_\_\_\_.
6. \_\_\_\_\_, \_\_\_\_\_, \_\_\_\_\_, \_\_\_\_\_ and \_\_\_\_\_ are all bodies of water that collect runoff.
7. \_\_\_\_\_ are formed by \_\_\_\_\_ of water vapor.
8. Water found under the earth's surface is called \_\_\_\_\_.
9. Movement of water into soil is called \_\_\_\_\_.
10. All the water on earth's surface is constantly being \_\_\_\_\_.





## Living in a Bubble World



During a rainstorm, a Saguaro cactus can absorb a ton or more of water!

### Equipment/Material

1 large glass container with lid for each participant or group  
gravel  
potting soil  
terrarium plants (e.g., English ivy, holly fern, Boston fern, maidenhair fern, asparagus fern, wandering jew, pothos ivy...)

**Time required:** 20 to 25 minutes

### Procedure

1. Cover the bottom of each glass container with a 1-inch layer of gravel for drainage.
2. Add a 3-inch layer of potting soil on top of the gravel.
3. Select several plants to put in your terrarium. Be sure to space them far enough apart that they will not crowd each other.
4. Make holes in potting soil deep enough to cover plant roots. Gently pat soil around the roots and base of the plant.
5. Water the plants lightly and put the cover on the container.
6. Put the terrarium in a sunny location and watch the hydrologic cycle in action!
7. Small amounts of water (1 to 2 teaspoons) may need to be added about every 6 weeks depending on the tightness of the jar cover.

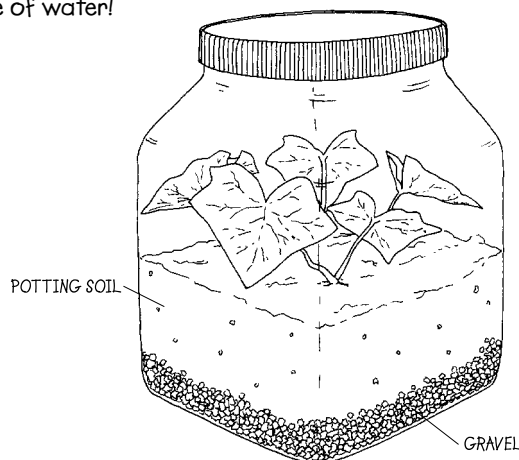



# Water Bingo



Growing on ear of corn requires about 25 gallons of water!

## Equipment and Materials

bingo card for each student  
beans or other markers

## Procedure

1. Using the word list (add others if you wish), construct a number of bingo cards with a central free space (free drop) and words in an array five wide and five down.\*
2. Construct a set of definition cards, defining each one of the words used on the bingo cards.  
*(You may wish to use the glossary for help.)*
3. Pass out one or more bingo cards to each member of the group or class.
4. Shuffle the stack of definition cards.
5. Call out definitions as they surface in the deck of definition cards.
6. As participants recognize a word on their cards, have them mark that word using a bean or similar marker.
7. When a person gets five words across, down or on a diagonal they may call “bingo” and have their score card verified.
8. Continue the game as long as interest remains high and you feel reinforcement of learning is taking place.

\* Cards can be composed using a square, 5x5 table with the central square being a free space. Select a word list and rearrange the words on the cards to make randomized, but similar cards that create “fair” card sets. All words used should have been defined and used prior to this exercise. Your word selection governs difficulty or ease of the exercise. You may choose to use the following bingo cards.

## Word List

absorb	evapotranspiration	mist	snow
adsorb	extraction	molecule	solid
aquatic	fog	photosynthesis	solute
aquifer	food web	pollution	solvent
artesian	fossil water	pollution	specific gravity
clay	gas	pond	specific heat
cloud	gray water	potable	steam
cohesion	groundwater	precipitation	stomates
compass	hail	pressure	stream
compound	humidity	rain	sublimation
concentration	hydrologic	recharge	surface tension
condensation	hydrophilic	recycled	topography
confined	hydrophobic	river	transpiration
cycle	infiltration	runoff	unconfined
density	leach	sand	vernal pond
dissolve	liquid	saturation	water
drizzle	meniscus	silt	water cycle
evaporation	miscible	sleet	wetland



Water Bingo Card				
runoff	surface tension	cloud	hydrologic	precipitation
pond	wetland	condensation	infiltration	leach
groundwater	stream		gray water	lake
recycled	snow	solvent	rain	river
transpiration	sleet	saturation	evapo-transpiration	hail

Water Bingo Card				
hail	surface tension	pond	transpiration	snow
runoff	wetland	lake	infiltration	meniscus
groundwater	stream		topography	condensation
evapo-transpiration	precipitation	recycled	rain	river
hydrologic	sleet	saturation	solvent	cloud





Water Bingo Card				
adsorb	cycle	meniscus	density	sleet
molecule	runoff	topography	polar	vernal pond
leach	fog		fossil water	solvent
potable	surface tension	saturation	cloud	gas
groundwater	dissolve	humidity	condensation	transpiration

Water Bingo Card				
absorb	saturation	fog	sublimation	condensation
miscible	adsorb	gas	density	pressure
potable	precipitation		infiltration	hydrophilic
solid	drizzle	gray water	cohesion	specific heat
evapo-transpiration	hydrologic	solute	surface tension	compound





Water Bingo Card				
water cycle	wetland	humidity	cohesion	evaporation
river	mist	steam	condensation	saturation
confined	gray water		absorb	solid
artesian	cloud	dissolve	water table	surface tension
gas	adsorb	compound	specific gravity	precipitation

Water Bingo Card				
hail	confined	cloud	groundwater	precipitation
surface water	runoff	surface tension	infiltration	hydrologic
specific heat	recycled		condensation	lake
sublimation	solute	drizzle	wetland	gray water
meniscus	leach	saturation	miscible	rain



## Water Bingo Card

## Water Bingo Card





# Amazing Aquifers

In the United States, approximately half of the water used is drawn from groundwater sources, and that equals approximately 82 billion gallons of groundwater each day!

## Objectives

1. Describe the characteristics of an aquifer.
2. Construct a model illustrating confined and unconfined aquifers.
3. Locate and identify the major aquifers of Texas.
4. Describe the differences between an artesian well and a spring.
5. Have fun while learning.

## Materials/Equipment

See individual activities.  
Writing materials

## Vocabulary

aquifer	impermeable	thermal
artesian well	percolate	
geothermal	spring	

## Lesson Requirements

**Best Time:** Any time of the year

**Best Location:** Any safe setting where water is available and young people can work in small groups

**Time Required:** Approximately 45 minutes, depending upon activities selected

## Lesson Background

### I. Aquifer – Water Carrier

In the study of the water cycle, we learned that precipitation falls from the sky and lands on the earth’s surface. Some of the water runs off into surface sources, but some of the precipitation **percolates** down through the soil, pulled by gravity.

#### Formation

This water moves through the pore spaces surrounding soil particles until it reaches an **impermeable** layer such as rock or a layer of clay. Water begins to collect above this layer, filling the pore spaces and saturating the area. This saturated, water holding area is called an **aquifer**.

#### Definition

The Latin meaning for *aqua* is water and *ferre* means to carry. Therefore, an aquifer literally means “to carry water.” Ninety-seven (97) percent of the world’s supply of fresh water is retained in such water-bearing formations.

## Lesson Overview

- I. Aquifer – Water Carrier
  - A. Formation
  - B. Definition
  - C. Water table
- II. Nine Major Aquifers in Texas
- III. Types of Aquifers
  - A. Confined aquifers
  - B. Unconfined aquifers
- IV. Uses of Aquifer Water
- V. Springs
  - A. Cave formations
  - B. Thermal/geothermal

## Applications

WRITE the word “aquifer” and ask students to define it. To enhance learning, break down the word into its Latin roots.

## Water Table

The upper level of an aquifer is the water table. The level of the water table can fluctuate depending upon seasonal changes, precipitation amounts, and the amount of water extracted from the aquifer. Excessive pumping can reduce the level significantly.

The water table generally slopes in the same direction as the surface of the land. It is often difficult to identify the boundaries and volume of an aquifer. In fact, most aquifers are actually series of interconnected aquifers rather than one large aquifer.

## II. Nine Major Aquifers in Texas

There are many aquifers found in Texas. The nine largest are the Ogallala, Gulf Coast, Edwards, Carrizo-Wilcox, Trinity, Edwards-Trinity, Seymour, Hueco-Mesilla Bolson and Cenozoic Pecos Alluvium. Of these aquifers, the Ogallala is the largest. It reaches all the way from the Panhandle of Texas into Canada. It is estimated that this aquifer is more than 2 million years old and holds about 650 trillion gallons. This aquifer is vital for crop irrigation in the midwest portion of the United States.

## III. Types of Aquifers

### Confined aquifers

The two major types of aquifers are confined aquifers and unconfined aquifers. A confined aquifer is a water supply that is sandwiched between two impermeable layers. The water is trapped between the two layers of rock, similar to the way peanut butter is trapped between two slices of bread in a peanut butter sandwich. The source of water to recharge a confined aquifer is often some distance away

Water in a confined aquifer is under pressure. Sometimes the pressure is so great that when a well is drilled, the pressure pushes the water above the water table and the water comes to the surface without being pumped. This is called an **artesian well**. This type of well is prevalent in areas with confined aquifers

### Unconfined aquifers

Unconfined aquifers usually have an impermeable layer or one of lower permeability under it but not above it. This permits the water table to rise or drop as the level of the water changes. The recharge area for an unconfined aquifer is local, not wide spread. This is the most common type of aquifer.

## IV. Uses of Aquifer Water

Water derived from aquifers is critical for agricultural, industrial, and municipal purposes. Many aquifers are becoming depleted rapidly because withdrawal rates exceed their recharge rates. Such excessive withdrawals are called “mining” of an aquifer. Where that process takes place in an ancient aquifer like the Ogallala, it may be termed “mining fossil water.”

REFER to Activity 4.4 *A Groundwater Drink* to illustrate groundwater and its corresponding water table.

USE Activity 5.1 *Abracadabra Aquifer* and have students label the nine major aquifers of Texas. ASK which aquifer is in your geographic location. EMPHASIZE to students that these are only the major aquifers of Texas. There are also many smaller aquifers. EXPLAIN that some aquifers are very large. The Ogallala holds up to 650 trillion gallons of water. Have students WRITE 650 trillion gallons. ESTIMATE how many gallon jugs would fit into your classroom. CALCULATE how many times you would have to fill your classroom with gallon jugs to equal 650 trillion gallons.

INTRODUCE the terms “confined” and “unconfined” as they apply to aquifers. USE Activity 5.2 *Sandwiched Between* to visually demonstrate the differences between confined and unconfined aquifers and to introduce artesian wells.

Have students BRAINSTORM to develop a list of all the many users of our aquifers. EMPHASIZE that aquifers can be depleted from excess use and pumping.

## V. Springs

Have you ever been in the woods and seen water bubbling up from the ground? This is called a **spring**. Springs occur where a saturated area intersects the surface of the ground. This may result in a slow seep or a large flow of water.

### Cave formations

Springs occurring in locations underlain by limestone may contribute to the formation of caverns.

As the groundwater moves along cracks in the limestone a chemical reaction occurs that wears away small pieces of the rock. (Remember, water exposed to air is slightly acidic. It reacts with the calcium carbonate [a base] in the limestone and dissolves it.) Over time, cracks may enlarge enough to form a cave or cavern or even extensive cave systems. In some areas, the underground rock dissolves and sinkholes develop on the surface when the supporting rock collapses.

### Thermal/geothermal

Springs and wells that bring warm or hot water to the earth's surface are called **thermal** or **geothermal** springs. These springs can be found in parts of the western United States where volcanic activity still occurs. These springs are hot because of masses of molten rock that have come near the surface of the earth. One of the largest groupings of thermal springs and geysers can be found in Wyoming in Yellowstone National Park.

## For Further Thought

1. Challenge participants to discuss the similarities and differences between springs, geysers and artesian wells. [Geysers develop over areas of thermal activity, where water becomes heated to the point of producing steam and is forcibly ejected from an opening by steam pressure. Artesian wells result from confined aquifers where the pressure on the aquifer forces water upward through the piping above the level of the aquifer. If it is adequate, the pressure will force water to flow from the aquifer to the surface. Springs are simply locations where an aquifer meets the surface of the soil.]
2. Investigate place names in Texas that indicate the locations of wells or springs. Try to determine how many of those historic wells or springs are still producing water. What reasons could exist for any changes? [Note that Texas has been losing springs and other water sources for quite some time, indicating that the water table has lowered in many areas. On the other hand, good land management in some areas has restored spring flows in locations where springs have not flowed in over 50 years.]
3. Consider a visit to a local water treatment facility to see how water is handled there before being made available for domestic or industrial use.

DEFINE "spring." IDENTIFY any springs located in your area. Perhaps schedule a visit to the spring area or cave formations. EMPHASIZE to students that not all springs yield cold water. DESCRIBE thermal/geothermal springs. Use an encyclopedia to show pictures of these types of springs found in Yellowstone National Park.

## Summary Activity

Lead participants in discussing the water resources found where they live—rivers and streams, standing water in lakes and man-made impoundments or ponds, and underground water resources. Identify these water sources and discuss the source of local drinking water. If possible, consider a field trip to a local water treatment facility to learn how water is treated before it is piped to users in the area.

## Sharing or Exhibit Suggestions

1. Make a diagram or working model of an aquifer to explain how it functions.
2. Research the condition of a selected aquifer and discuss whether or not storage volume is increasing, decreasing or being maintained. Write a report or make a poster showing the condition of the aquifer and some of the challenges or benefits that might be faced because of changes taking place in the aquifer.
3. Make a poster or other exhibit of terms associated with aquifers and explain their meanings for others. Consider leaving the poster with a teacher or leader who can use it as an aid to teach other groups about aquifers.
4. Set up one or more of the experiments in this section as a demonstration for another club or class and teach others what you have learned in this lesson.



# Abracadabra Aquifer

## Equipment/Materials

Record Sheet 5.1 for each student

**Directions:** Have students complete the following.

1. Label the nine major aquifers in Texas.
2. Which aquifer is closest to your home?
3. Which is the largest aquifer in Texas?

### *Ogallala*

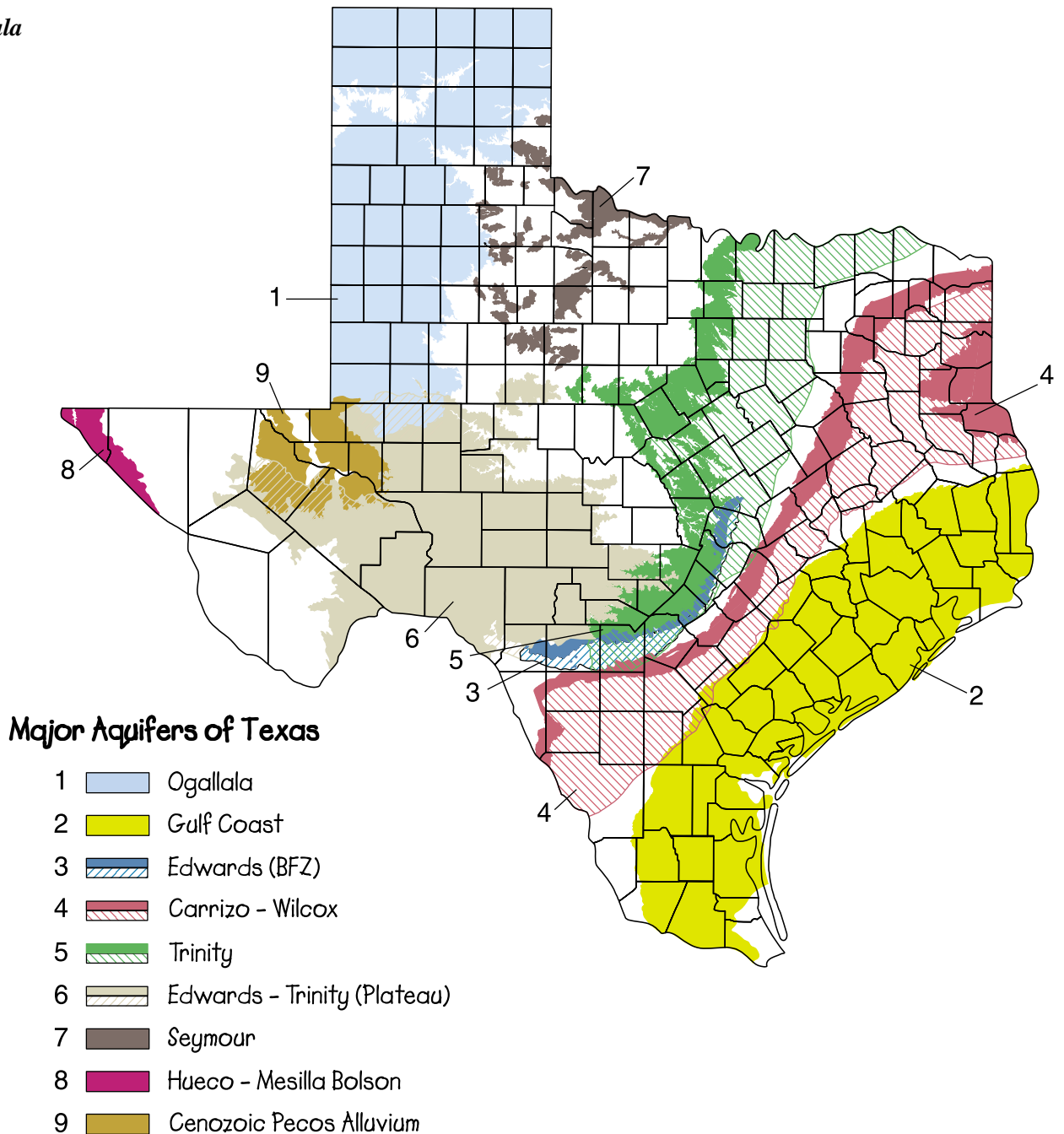



# Abracadabra Aquifer

**Directions:** Complete the following.







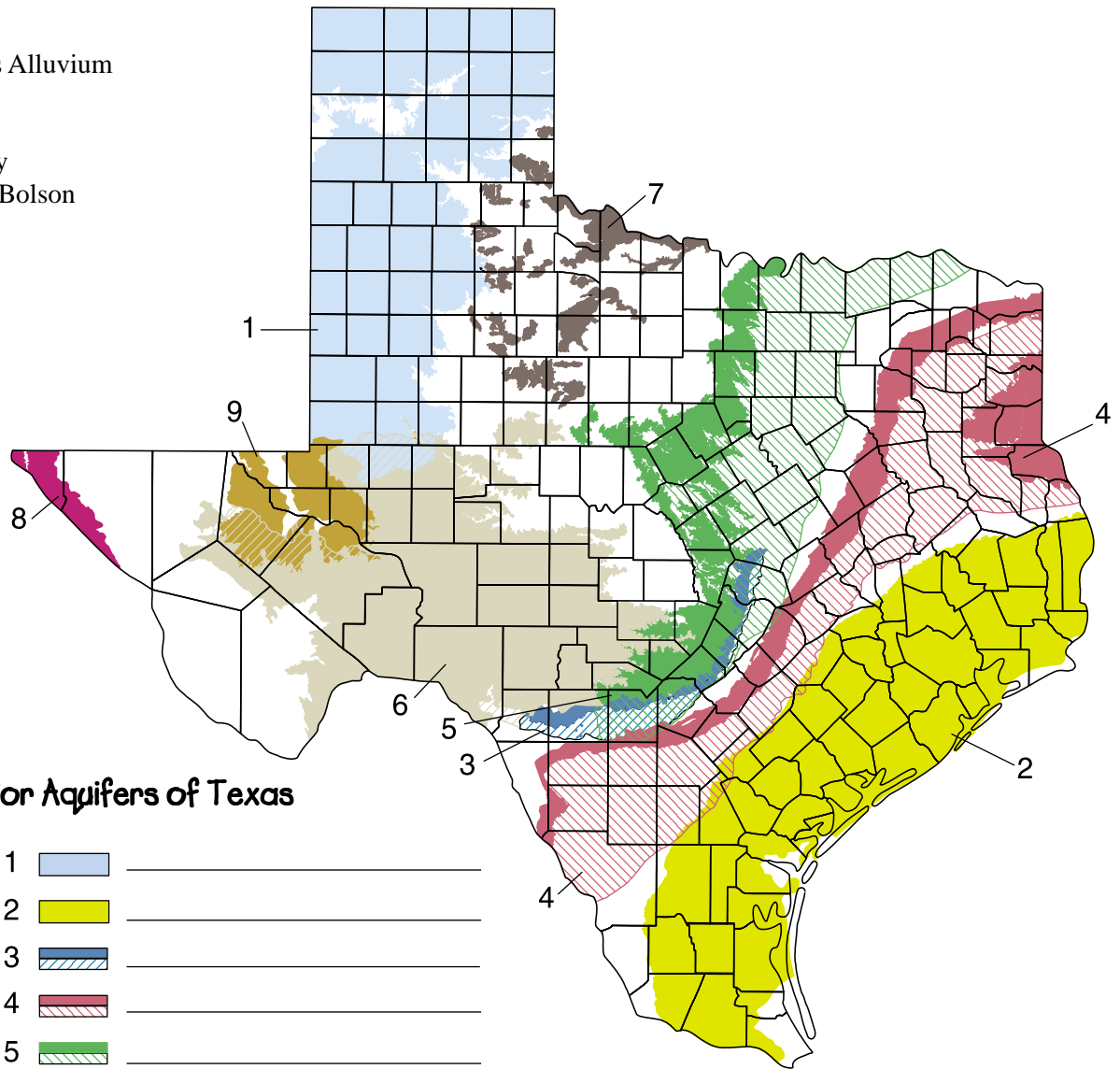

1. Label the nine major aquifers in Texas.
2. Which aquifer is closest to your home?
  
3. Which is the largest aquifer in Texas?

## Major Aquifers of Texas

- Carrizo-Wilcox
- Cenozoic Pecos Alluvium
- Gulf Coast
- Edwards
- Edwards-Trinity
- Hueco-Mesilla Bolson
- Ogallala
- Seymour
- Trinity



### Major Aquifers of Texas

- |   |                                                                                     |       |
|---|-------------------------------------------------------------------------------------|-------|
| 1 |  | _____ |
| 2 |  | _____ |
| 3 |  | _____ |
| 4 |  | _____ |
| 5 |  | _____ |
| 6 |  | _____ |
| 7 |  | _____ |
| 8 |  | _____ |
| 9 |  | _____ |



# Sandwiched Between



Some places, like deserts, get less than an inch of water a year; others, like tropical rain forests, may get more than 400 inches of rainfall a year.

## Equipment/Materials

- |                         |                     |
|-------------------------|---------------------|
| large, clear glass bowl | clean washed sand*  |
| modeling clay           | aquarium gravel*    |
| pump from spray bottle  | blue food coloring  |
| measuring cup           | water               |
| plastic cup             | clear plastic straw |

\* light colors, like white or pale brown, make the water easier to see

## Procedure

- Put about 2 inches of sand in the bottom of the glass bowl.  
Explain that the bottom of the bowl represents an impermeable layer (one that water cannot pass through) in this aquifer model. The sand represents an aquifer because water can fill the spaces between the sand grains.
- Fill the measuring cup with water and add 2 to 3 drops of blue food coloring. Pour enough water into the sand to saturate it. This represents groundwater in an aquifer.
- Put a layer of modeling clay or play-clay over the top of the sand. Since the clay is impermeable to water, the aquifer is trapped between two impermeable layers. This represents a confined aquifer.
- Pour 2 or more inches of aquarium gravel on top of the clay, and pour some of the tinted water into the gravel layer, partially filling the gravel layer with water. Point out that the water table is the top level of the water in the aquifer. This model represents an unconfined aquifer because water is not trapped between two impermeable layers.
- Put the spray bottle pump into the unconfined aquifer and pump the water into a small plastic cup. Explain that this is how a well works when it pumps water from an aquifer. Ask participants to observe what happens to the water table as water is pumped from the aquifer. Discuss how the aquifer could be replenished.
- Insert a clear straw into the confined aquifer along the edge of the bowl so it can be seen. Note that the pressure in the model is not great enough to cause the water to flow from the straw, but that deep, confined aquifers may be under extreme pressure. Explain the concept of an artesian well, where water under pressure in a confined aquifer can rise to the surface without the need for pumping.

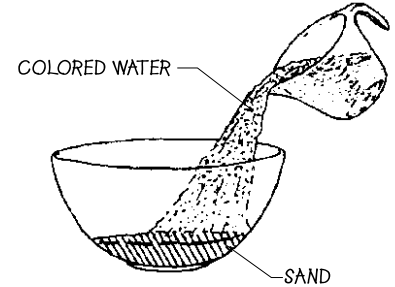

CONFINED AQUIFER

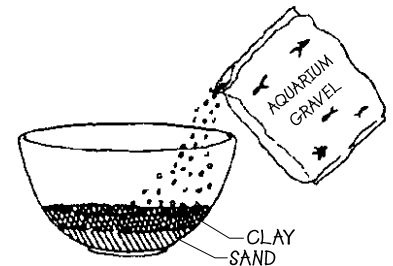

UNCONFINED AQUIFER

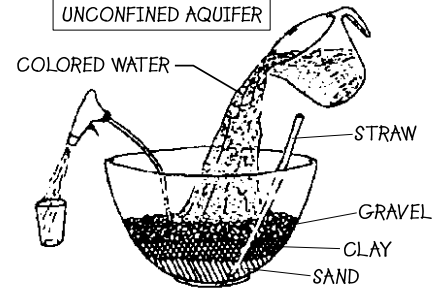





# The Fabulous Duo: Watersheds and Wetlands

America's wetlands are habitat for more than 5,000 species of plants

## Objectives

1. Define watershed.
2. Map a small watershed.
3. Calculate the area of a watershed.
4. Identify the major watersheds of Texas.
5. Describe the major types of wetlands.
6. Recognize the many vital functions of wetlands.
7. Identify cooperative wetland management efforts among land-owners, agencies and the public.
8. Have fun while learning.

## Materials/Equipment

See individual activities.  
Writing materials

## Vocabulary

accumulate	casual water	harmful	recharge
adversely	deposit	meander	rivulet
aesthetic	detritus	mitigation	seasonal
aquaculture	ephemeral	obligate	sediment
basin	erosion	persistent	water
beneficial	extirpated	playa	watershed
brackish	gradient	pulpwood	wetlands

## Lesson Requirements

**Best Time:** Any time, but it is easier to observe watershed areas during wet seasons

**Best Location:** See individual activities

**Time Required:** About 30 to 45 minutes, more depending upon activities selected. Mapping a watershed may add 1 to 2 hours.

## Lesson Background

### I. Introduction to Watersheds

Certainly all precipitation that falls from the sky does not end up as groundwater. Think about the roof of your house. When it rains or snows, the precipitation is collected by the roof. It runs down over the shingles to fall on the ground or into the rain gutters and down spouts before being discharged on the soil in the yard. Rain falling on one side of the roof tends to run off that side of the house, and in heavy rains, some water may collect in puddles or run off as small **rivulets**. Like the roof of your house, the landscape around you collects rainfall, snow, sleet and other precipitation. If the precipitation does not infiltrate into the soil, it runs across the slope

## Lesson Overview

- I. Introduction to Watersheds
  - A. Basin
  - B. Size of watersheds
  - C. Erosion and watersheds
  - D. Texas watersheds
- II. Importance of Watersheds to People
  - A. Adverse effects
  - B. Contamination
- III. Wetlands
  - A. Vital components of watersheds
  - B. Common elements of wetlands
  - C. Types of wetlands
- IV. Functions of Wetlands
  - A. Flood storage
  - B. Commercial production
  - C. Habitat for plants and animals
  - D. Recreation
  - E. Maintaining water quality
- V. Wetland Management
  - A. Loss of wetlands
  - B. Value
  - C. Management processes
  - D. Influences

## Applications

DEFINE "watershed" for students. Have them interlock their fingers with their palms upward and press their thumbs along their index fingers. NOTE that their hands demonstrate the border between two watersheds and the folds in their hands simulate watercourses within those watersheds.

of the land as sheets or rivulets, joining larger and larger bodies of water until it reaches the sea.

## Basin

The land and water courses that it travels to reach a given body of water compose the **watershed** for that body of water. All the land area contributing runoff is included, and the watershed is a **basin** that guides the runoff into a specific river system. Your yard may have a low spot that forms puddles when it rains. The part of the yard that provides the water for the puddle is the watershed for the puddle.

## Size of watersheds

Watersheds vary in size from very tiny ones, like the watershed of the puddle, to extremely large ones like the watershed for the Amazon River. Small watersheds merge to form larger ones until the watershed empties into its final destination. Even tiny trickles and underground flows are moving toward the sea under the influence of gravity. The potential energy created by the pull of gravity on the water becomes kinetic (moving) energy as the water drops toward sea level.

The small stream near your home or school, even if it only has water at certain times of the year, carries the water from its small watershed to a larger stream or river. Other tributary streams and rivers join it to form a major river. The Mississippi River, for example, drains a watershed of about 1,243,000 square miles. This large watershed is made up of thousands of smaller ones that drain most of the land between the Appalachian Mountains on the east and the Rocky Mountains on the west.

Other major watersheds include the Great Lakes-St. Lawrence River watershed that covers 21,250 miles with a drainage area of 565,000 square miles and 24 percent of the earth's surface fresh water (this ties with Russia's Lake Baikal); the 1,210-mile Columbia River drainage; and the Colorado River with its 1,400 miles of river, 240,000-square-mile drainage basin, and the spectacular Grand Canyon. The Rio Grande has an 1,800-mile course and a drainage of 248,000 square miles. Other major Texas River basins include the 870-mile-long Brazos River with its 45,000-square-mile basin; the 1,018-mile-long Red Rover with its 66,000-square-mile drainage that mixes with the Mississippi River at flood stage to form the Atchafalya Basin in Louisiana; and the Trinity River with its 18,000-square-mile drainage over a course of some 360 miles.

## Erosion and watersheds

Watersheds are marked by erosion. As water moves over them, the highlands are worn down and the rivers change courses as their sediment and water loads modify their flows. As they drop toward the sea, most rivers have less gradient, the change in elevation per unit of distance; and they tend to meander (change direction) more.

In some areas, erosion can be rapidly and extremely destructive of the land by moving soil particles or even boulders downstream. In others, the changes are more gradual, but dramatic. The Grand

Have students BRAINSTORM to identify some of the larger watersheds in the United States. FOL-LOW UP with data on the size of several of the larger ones and CHALLENGE them to identify some of the Texas watersheds.

ASK students to identify a major Texas watershed. EXPAND to the major watershed if necessary (e.g. the Devils River drainage is part of the Rio Grande River system).

ASK if anyone can identify some characteristics of watersheds and the erosion that may be found in them. NOTE that stream channels need not be considered destructive although they may involve considerable loss of soil or changes in the location of the channels.



Canyon of the Colorado River is an excellent example of erosion. During a period of thousands of years, the river cut a canyon more than a mile deep through the rock of the riverbed. The Palo Duro Canyon of Texas is another excellent example of the spectacular results of gradual erosion on the landscape.

### **Texas watersheds**

Texas has 15 major river basin watersheds plus several coastal or lowland watersheds. The major river basins in the state include the Canadian, Red, Sulphur, Cypress, Sabine, Neches, Trinity, San Jacinto, Brazos, Colorado, Lavaca, Guadalupe, San Antonio, Nueces and Rio Grande rivers. Intermediate watersheds along the coast and in the South Texas Coastal Bend include the Neches-Trinity, Trinity-San Jacinto, San Jacinto-Brazos, Brazos-Colorado, Colorado-Lavaca, Lavaca-Guadalupe, San Antonio-Nueces, and Nueces-Rio Grande watersheds. Each of these is composed of many smaller watersheds.

## **II. Importance of Watersheds to People**

Watersheds are important to people as well as to other living things. People depend upon watersheds for their water supply, recreation, food and fiber, industrial uses and beauty. They also depend upon the watersheds for the ecological benefits to themselves and the other living things they support. All of these things are influenced by both the **beneficial** or **harmful** things that take place in the watershed.

### **Adverse effects**

The things that occur in a tiny watershed in the backyard affect larger watersheds downstream. Those influences **accumulate** (add up) to impact water sources for people and animals, contaminant loads, flow rates and volumes and other factors that can have a major impact on all of us.

Excessive runoff on unprotected land can increase erosion, stripping topsoil from the land and making farms less productive. Too many soil particles in the water can impact fish and other aquatic organisms **adversely**, and may even kill them. When eroded soil is deposited in reservoirs, their storage capacities are reduced and their useful lifespans are shortened. This can reduce their ability to reduce damage from flooding. Flooding can damage homes, businesses, property, highways and utilities. It can destroy crops, livestock and woodlands. It can also cause the loss of human life as well as the lives of many other animals. Preserving and protecting our watersheds can help us avoid serious problems. However, that protection must take place in the tiny watersheds at the headwaters in order to have an impact downstream.

### **Contamination**

Some contamination of watersheds is from natural sources. The upper reaches of the Brazos and Red Rivers, for example, are quite salty because of natural salt deposits in their watersheds. Other types of contamination come from human-induced sources. Sewage, industrial wastes, acid precipitation, agricultural chemicals and

DISTRIBUTE Activity 6.1 *Lone Star Watersheds*. Have students IDENTIFY the major watersheds in Texas. Consider inviting locate representatives from the Soil and Water Conservation District or the Natural Resources Conservation Service to discuss local watersheds and how they feed into larger watershed systems.

SELECT a site with a visible drainage pattern. USE Activity 6.2 *Watershed Come Alive* to assist in mapping and calculating the size of an actual watershed.

wastes, and toxic materials from homes and lawns all contribute to the pollution or contaminant load in watersheds. Control of these, too, requires care at the source in all the tiny upstream watersheds.

### III. Wetlands

#### Vital components of watersheds

**Wetlands** are among the vital components of watersheds. Wetlands can be defined in many ways. The ecological definition of wetlands is very broad, including both areas that are periodically or permanently covered with fresh or salt water and areas where the soil is saturated with water seasonally or all the time. In both cases, availability of water is high, and some elements of terrestrial and aquatic habitats are combined.

Examples of inundated or flooded wetlands include marshes, swamps, oxbow lakes, playas, vernal ponds, and tidal marshes. These areas usually have emergent or floating plants at least seasonally.

Wetlands based on saturated soils may include fens, moors, wet meadows, solid bogs, seasonal sloughs and vernal pools (after they “dry up”). Many of these wetlands are only wet seasonally.

A legal or regulatory definition of wetlands has been developed for consistency and to protect farmers and ranchers from arbitrary interpretations or actions. The Natural Resources Conservation Service (NRCS) is the United States Department of Agriculture (USDA) agency responsible for developing that definition and for assisting agriculturalists with the interpretation. The definition states that the soil must be inundated or saturated with water at a frequency and duration adequate to support predominantly hydrophytic (adapted for growing in saturated soil conditions) plants under normal conditions. By listing these plants for each region of the country and providing technical services, the agency can assist farmers and ranchers in complying with the regulations. The regulations do not apply to constructed wetland areas (like marshy stock tanks), seasonally flooded croplands (like rice farms) or to temporary puddles in low spots after a rain, even though these areas may serve some wetland functions for plants and animals in the area.

#### Common elements of wetlands

Several common elements can be seen in the varying definitions of wetlands. First, wetlands are based on standing water or saturated soils either seasonally or more or less permanently. Second, under normal conditions they can support plants that are adapted to saturated soils or growing in standing water. Finally, they are wet under “normal” conditions. These wetlands can be natural or constructed. To most people, wetlands are simply places that combine features of aquatic and terrestrial habitats. They are located in most counties in essentially every state, where land and water meet. Some wetlands are **persistent**, lasting all year. Others are **seasonal** or **ephemeral**, lasting for a season or so or perhaps for only a relatively short time. Vernal pools may last for the spring and early summer. **Ephemeral** or **casual water** may become

DEFINE “wetland” and NOTE that there are many definitions depending upon the point of view of the persons using them. Lead youths to CONCLUDE that the term can be applied in many ways and that understanding which definition is being used is important.

CHALLENGE participants to identify some types of habitats they would call wetlands. Once some valid ones are identified, ask them to IDENTIFY some characteristics that are common to the wetlands they identified.

*[Fens and moors are areas with at least seasonally saturated soils, often with standing water during parts of the year. They often have plants adapted to both acidic conditions and wet or saturated soils. They are much more common at higher latitudes. Most bogs in Texas are likely to form where clays or other relatively impermeable soils collect water and create conditions similar to norther glacial bogs.]*

NOTE that being a wetland ecologically does not necessarily mean it is a wetland by legal definition. Rice fields, for example, are agricultural fields that are seasonally inundated with water to produce the crop (and often to attract wintering waterfowl). They serve a wetland function but are not considered wetlands under agricultural regulations.

EMPHASIZE that some wetlands can be found almost anywhere. Local Soil and Water Conservation District personnel or Natural Resource Conservation Service representatives can assist in providing information and showing local topographical maps illustrating local watersheds and wetlands. Have students IDENTIFY some of the types of wetlands that are located in Texas.

established after heavy rains or periods of high runoff, lasting a matter of days to weeks. Where wetland values or wetland regulations are being discussed, it is vitally important that everyone involved uses a common definition to avoid confusion and confrontation.

### Types of wetlands

Many types of wetlands can be identified. Coastal marine wetlands are located along quiet shorelines of bays or inlets. Normally they feature some type of vegetation, like grasses or mangroves, and are covered with water for at least part of the day. Tidal wetlands include salt marshes, some of the most productive habitats on earth, and **brackish** marshes and swamps. These have deeper channels or pools interspersed with drier areas covered with salt-tolerant vegetation.

Freshwater wetlands include marshes with mostly herbaceous vegetation, swamps with mostly woody vegetation, bogs where aquatic plants and acid-tolerant plants gradually fill in a water-holding site, shallow lakes and ponds or bays, prairie potholes that may be dry for part of the year, playas that are similar to prairie potholes but found in drier parts of the country, beaver ponds, and meadows, and spring seeps. These wetlands are critical habitat for many animals. Over 50 percent of North America's ducks breed on prairie potholes, in spite of the fact that they may go dry during the late summer and early fall. **Playas** are vital feeding and roosting sites for waterfowl and shorebirds during the winter months and the spring and fall migrations. Some wetlands are very stable. Others may change depth and character with the seasons and weather patterns. Sometimes wetland managers manipulate water level in wetlands to achieve certain desired effects.

Constructed wetlands include vegetated ponds and stock tanks, diked marshes and swamps, green tree reservoirs, catchment basins, check dams and agricultural wetlands. Some of them are created in an attempt to re-establish wetlands where they were destroyed by earlier human activity. Some are attempts to capture and hold water in dry areas for wildlife or livestock. Others are seasonally flooded to attract waterfowl, to grow crops, or for aquaculture purposes. The later types are not regulated wetlands, but they provide wetland benefits as a by-product of their intended use. All wetlands, natural or constructed, play vital roles in ecosystems and may be among the most valuable types of landscapes on earth.

## IV. Functions of Wetlands

Wetlands have many functions. They provide habitat for fish and aquatic invertebrates like mussels, shrimp and crayfish. They provide spawning sites and nursery areas where developing young can find protection from predators and abundant food for rapid growth. They provide forage and feeding areas for many species. Wetlands productivity in higher plants, algae, and microscopic phytoplankton, as well as the abundant **detritus** or decaying organic material (living things and their products), forms the foundation for many aquatic food webs.

LEAD participants to identify various types of wetlands they have observed.

USE Activity 6.3 *Wetland Mobile* to construct a mobile illustrating some of the many functions of wetlands. USE small groups with each group having a different function as a theme to develop a part of the class mobile. Let each group PRESENT their mobile segment and their ideas about wetland functions as they add their segment to the class mobile.

## Flood storage

Wetlands act as storage areas for water during flood conditions, slowing the water and reducing the impact of floods. During peak runoff, rivers and streams overflow into floodplains and associated wetlands. These wetlands can be compared to giant sponges, soaking up the overflow of a river or stream. As the flow of the water is reduced passing through the wetland, the rate of flow in the stream channel is reduced. This allows the watershed to release its excess water more slowly, reducing the frequency and severity of floods. Strong evidence exists relating the loss of wetlands to increased incidence and severity of flooding in major watersheds.

## Commercial production

Wetlands have a vital role in food production as well as flood control and groundwater recharge. They provide nursery areas for fish and other food animals. Most of our major game and inshore commercial fishes depend upon wetlands for some stage of their life cycle. While **aquaculture**, the “farming” of aquatic food animals like catfish, tilapia, redfish, shrimp and crayfish, is providing substantial amounts of protein for human consumption, natural wetlands and wild stocks provide important commercial harvests. The atchafalya Swamp of Louisiana provides thousands of pounds of crayfish for commercial markets every year.

Some forms of farming create seasonal wetlands as a by-product. Rice is usually grown where it can be flooded during parts of the growing season. Collection of wild rice from some wetland areas provides a food that is prized by many people. In addition to the food production that takes place in these areas, many wetlands produce an abundance of furbearing animals like muskrat, beaver, mink, otter and nutria. In addition to their valuable pelts, muskrat and beaver are excellent food sources.

Forested wetlands are important sources of some types of wood products, like cypress lumber. Wetland areas can also produce fuel wood or **pulpwood**, as well as lumber from other wetland-loving trees. Some species, like black ash, are used for special purposes like the construction of baskets or snowshoe frames.

## Habitat for plants and animals

Nearly all wetlands provide forage for wild game animals that are harvested and eaten. Some species require wetlands in their development and are hunted there. Ducks and geese are excellent examples. Other species may use wetlands either regularly or seasonally. For example, pheasants commonly use cattail stands or similar wetland vegetation for winter cover.

Some wetlands are important in the production of forage or grazing for domestic livestock. Wet meadows usually have greener or darker vegetation than the surrounding areas because of the abundance of water. Like other wetlands, they can help control flooding and support unique communities of plants and animals.

Haying has been a seasonal use of some wet meadows for centuries. The wetland is not disturbed during the early part of the growing season, when the land is too wet to work and many wetland species

USE Record Sheet 6.4 *What's in Your Neighborhood?* to illustrate the land uses in Texas. ENCOURAGE students to think about how these uses affect watersheds and wetlands.

If these items are not covered in the mobile development process, LEAD participants to discover some of the functions of wetlands they many not have considered originally. EMPHASIZE the values of wetlands that are easily overlooked and note that some scientists have concluded that wetlands are worth \$15,000 or more per acre in benefits to people and our ecosystem.

are raising their young. However when the meadow becomes drier and the wetland grasses have matured, hay is harvested from these areas. Haying grazing of these areas with responsible management can be very beneficial to a healthy wetland. Haying and grazing can open up feeding areas and the droppings of cattle can enrich the soil to produce more food for shorebirds. However, excessive trampling of the soil can make it impermeable and turn it into a lake. Mormon Lake near Flagstaff, Arizona, was a wet meadow until compaction of the soil by grazing cattle made the soil impermeable and created a lake.

Wetlands are wonderlands for those who love plants and wildlife. America's wetlands support approximately 5,000 species of vascular plants. About one-third of all species of birds, nearly all species of amphibians (at least 190 species), many reptiles (like turtles, water snakes and alligators), and many semiaquatic or wetland-loving mammals can be found in wetlands. All species of ducks and geese require wetlands. Nearly all wading birds, like herons and egrets, and shorebirds (like sandpipers, avocets, stilts, plovers and snipes) require wetlands for nesting and feeding. Rails, gallinules, gulls, terns, cormorants, loons and similar species are wetland birds. Many other types of birds—blackbirds, marsh and sedge wrens, purple martins, swallows, ospreys, and harriers (marsh hawks)—use wetlands for nesting and feeding. Wetlands are preferred roosting areas for many perching birds during migration, as they take advantage of the moderating effect of the water on air temperatures.

Semiaquatic mammals, like beaver, muskrat, nutria, mink and otter, use wetlands extensively. Many lesser known animals also use the wetlands. Moles, water rats, water shrews and several species of mice use the wetlands for foraging and as secure nest sites. Many bats use wetlands as foraging sites when insects are hatching. While they are not **obligate** wetland animals, mammals like moose, black bear, raccoon, gray fox, white-tailed deer, bobcat and many more use wetlands as feeding, loafing or refuge areas.

### **Recreation**

Wetlands are extremely valuable for recreation and **aesthetic** enjoyment. They are home to flowers like iris, sweet flag, swamp rose, marsh mallow, pitcher plant, cattail, and blue-eyed grass. The feast for the eyes is extended by the shrubs, like bayberry, and grasses, like cordgrass, that occupy wetlands. These wetland plants plus the encounters with wetland animals, make a rich landscape that refreshes the spirit and communicates natural order to those who invest in learning about wetlands. The beauty of these natural landscapes makes them invaluable to many people. For those interested in outdoor recreation, wetlands support hunting, fishing, swimming, boating and canoeing, camping, outdoor photography, nature study, birding, and much, much more.

### **Maintaining water quality**

Wetlands also play a vital role in maintaining water quality. They are effective in removing sediment from water. Relatively slow flow rates and the stems and roots of aquatic plants permit sedi-

Ask participants to **DISCUSS** some of the uses they might make of wetlands for recreation or simply for viewing nature.

**CONSTRUCT** a model wetland using Activity 6.4 *Wetlands - Nature's Clean Machine*. **ENCOURAGE** students to think about how natural or constructed wetlands can help control pollution.

ments to drop out of suspension, allowing the wetland to gain soil (accretion). These soil deposits are amended by the addition of detritus either carried into the wetland or produced there. The result is a rich soil that may one day support a grassland or forest. At the same time, the cleaner, clearer water discharged by the wetland contributes to improved water quality downstream.

Wetlands also play a significant role in the reduction of contaminants in the water. Some contaminants are taken up and used by the plants themselves. Organic materials are often captured in this manner, turning from pollutant to fertilizer for plant growth. Some contaminants and pathogens adhere to suspended soil particles (clays particularly) and become bound in the sediments when those particles are deposited. The organic material in the soil attracts some materials strongly, either binding it or allowing it to be decomposed by microbes in the soil. Even some persistent toxic materials can be broken down in this manner. Although sewage treatment lagoons must be impermeable, constructed wetlands are frequently used as finishing or “polishing” treatments for discharged water. The actions of plankton and plants in the wetland reduce the nutrient load in the water while increasing the amount of primary food production in the wetland. This increases both animal foods and water quality.

Wetlands also contribute to enhancing water supplies. Retaining water for slow release to streams maintains in-stream flows during periods of low rainfall. In addition, water can infiltrate into the soil under the wetlands. Both natural and constructed wetlands can contribute to groundwater recharge while filtering out contaminants. Urban recharge basins are examples of constructed wetlands that serve multiple functions while contributing to infiltration of collected runoff.

## **V. Wetland Management**

### **Loss of wetlands**

According to the U.S. Fish and Wildlife Service, the United States has lost more than half of the 200 million acres of wetlands that were present when European settlement of North America began. Vast amounts of those losses can be attributed to agriculture, as farmers drained wetlands to plant crops. Growth of urban areas, highways, buildings and parking lots also has been a significant factor in wetland loss.

### **Value**

These habitats were considered worthless before their role in the environment was understood. As that role became more fully understood, realization of the value of wetlands has grown (though we still have a long way to go). Careful management following increased awareness can maintain and enhance these valuable resources for present and future generations.

### **Management procedures**

Wetland management began with awareness of their value and importance. Some recognized those values early and took personal

CONSIDER inviting someone from a Soil and Water Conservation District office, Texas Parks and Wildlife Department, the Natural Resources Conservation Service, or some other knowledgeable person to discuss wetland management with the group.

responsibility to protect wetlands under their control. Others labored to provide legal protection, including ways to reduce the loss rate and requirements for mitigation when wetlands were destroyed. In order to build a pad for an oil well in a Texas salt marsh, a company may be required to establish a wetland of greater area on another site before the construction permit is released.

Spoils dredged from shipping channels or harbors may be used to construct shallow water wetlands on other sites. In other cases, wetland management may mean dredging some of the sediment from the wetland to increase its water holding capacity and prolong its life as a wetland. Water control structures and dikes may be added to allow managers to manipulate the water levels or to bar salt water from entering freshwater marshes. Water may be pumped into or from wetlands to maintain levels that are optimum for the objectives of the manager. Wildlife damage to dikes, dams and vegetation may be controlled in a variety of ways, including hunting and trapping to maintain a balance between vegetation and the animals that eat it. The vegetation in wetlands may be managed by removing exotic plants, establishing native plants where they have been **extirpated** (completely destroyed), or enhancing growth of preferred food plants. Areas around wetlands may be protected to maintain the vegetation, vital to many wildlife species, at the edge of the wetland.

### **Influences**

All of these things require that the land manager determine the potentials for the site, weigh the costs and benefits, factor in the desires and wishes of the landowner, consider all legal issues, and determine a best course of action. Wetland management is an art and a science that requires a wide array of knowledge and skills. One overriding factor influences it, however—the behavior of the individual people who live upstream in the watershed. The best efforts of the best managers in the world are useless if individuals are not committed to clean water, sound soil management, responsible uses of chemicals, and personal responsibility for their actions.

## **For Further Thought**

1. Compile a list of all benefits and costs that might be associated with a wetland, including those things that are important to you and your family, e.g. a place to watch birds or have a picnic. Ask yourself how much those benefits are worth and try to determine what it would take for you to give them up. Compare that to the value of other uses that would eliminate your benefits. Draw some conclusions and discuss them with a friend or family member.
2. Look at a watershed near your home. Outline any apparent problems. See if you can think of any ways to reduce or eliminate those problems. How many people might need to be involved to protect the entire watershed? How could you do anything to improve it on your own?

Distribute Activity 6.6 *Fun with Water in Our Landscape* crossword puzzle as a review of Lessons 5 and 6.

### **Summary Activity**

Use the activities in this lesson to form an image of the local watershed and any wetlands that may exist in the local area. Consider inviting someone responsible for watershed or wetland management to come to the group and discuss the challenges they face, any problems that are being confronted, and the benefits derived from the wetlands or the watershed.

## Sharing or Exhibit Suggestions

1. Make a watershed relief map as outlined in the lesson. Show any problems or challenges you can see on the map and offer suggestions on ways to relieve them. Use the map to explain topography to others who may not understand it yet.
2. Make a poster display of wetland benefits and costs. Display it and use it as a teaching tool to enlighten others about wetlands and their importance to aquifers, wildlife and water management.
3. Use any of the activities in this lesson as a teaching tool for others.
4. Make a poster showing the status of wetlands in North America now and in 1700. Discuss the loss of wetlands and ways that we can restore or maintain them.
5. Interview people who have a vested interest in wetlands and summarize their comments in a poster display for others.
6. Consider a storm drain labeling campaign to increase awareness of their connection to watersheds and wetlands as well as the need to avoid using them as disposal sites for toxic or noxious materials. Be sure to get permission before doing so.



# Lone Star Watersheds

Identify the locations of the 23 watersheds or river basins on the map.

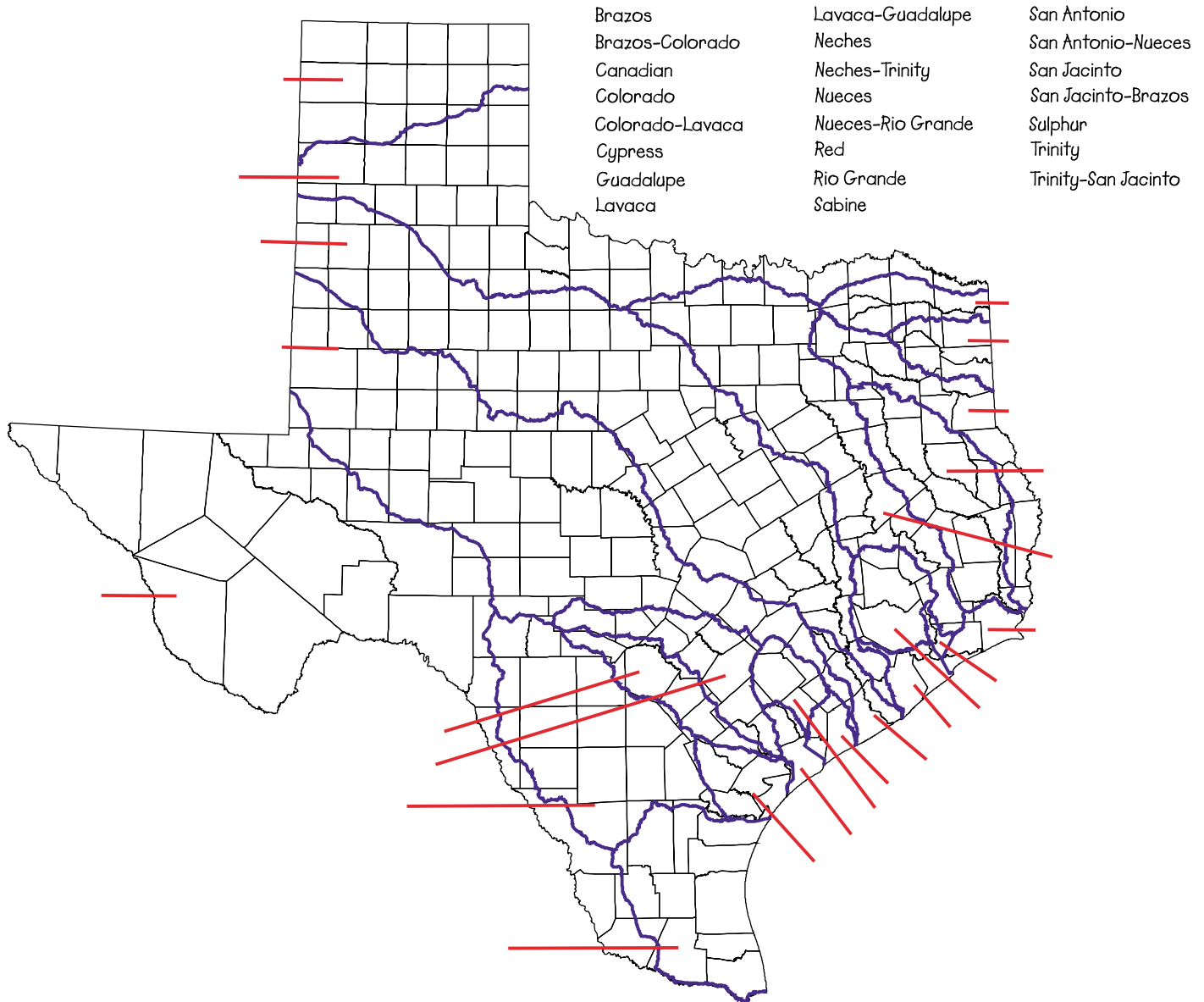



## Lone Star Watersheds

Identify the locations of the 23 watersheds or river basins on the map.

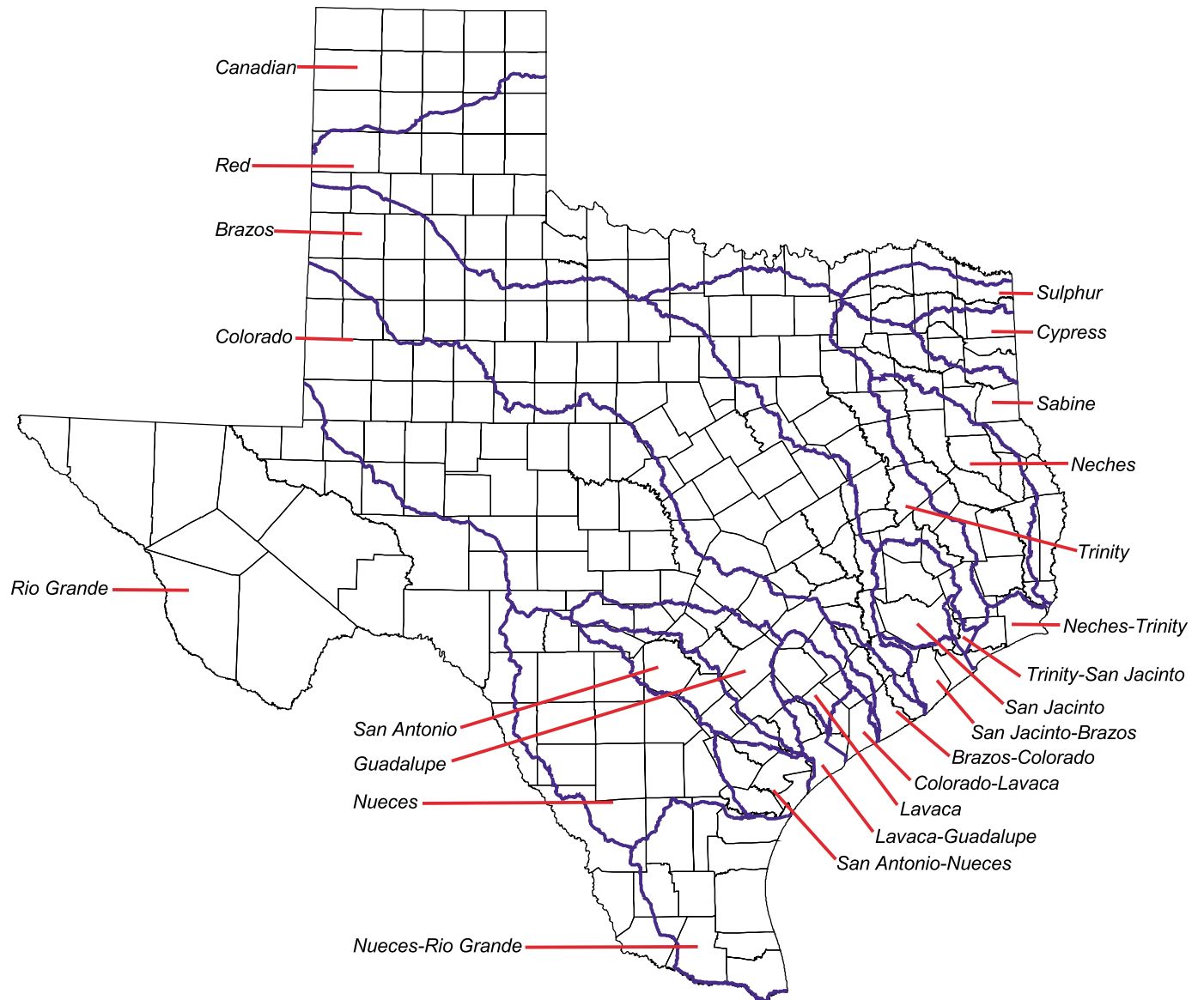



## Watershed Come Alive



Americans dump 16 tons of sewage into surface waters every minute

This exercise allows participants to map a small watershed, giving them options to calculate its area or construct a topographic map of the area. A relatively small amount of equipment is required, and a wide array of analytical, mathematical and manual skills are involved. Although the exercise seems a bit complicated, it is relatively easy to complete with a minimum of equipment. Its benefits far outweigh the costs, and measurable areas can frequently be found very close at hand.

### Equipment/Materials

stakes/markers (several per small group)  
tall control stake  
100-foot or 30-meter measuring tapes (2)  
graph paper (1/10 inch grid best)  
ruler (clear decimal ruler preferred)  
Record Sheet 6.2

hammer  
meter stick(s) or yard sticks  
50-foot or 15-meter measuring tapes (2)  
twine/string  
orienting compass

line level(s)  
pens/pencils  
clipboards  
protractor

**Time Required:** 45 minutes or longer

### Procedure

1. Select a site that has visible slope and drainage patterns, like a small hollow draining a playground or playing field, or a field edge that shows clear drainage patterns. The presence of obvious ridges is helpful and makes the exercise clearer to the participants. You may predetermine the locations of stakes or wait until the participants come to the site and let them determine the stake locations. **Hint: Decide on a contour interval for the map. On flat areas, differences of 5 cm or 2 inches might make sense, while on steep areas, intervals on 1 foot or even 1 meter might be best.**
2. Before the field exercise, review the watershed concept, stressing the capture and channeling of water. Lead them to conclude that high points or ridges represent breaks between tiny watersheds or even between major ones. Note that this exercise maps and measures a very small part of a larger watershed. **Use the hand example in Applications of desired.**
3. Move to the site and let participants decide on a low point (it will be checked later), setting a tall control stake at that point. **Using a control stake that is premarked with the selected contour interval makes the measuring process much easier for the participants and provides a more accurate map. Be sure the stake is driven into the ground until the indicator mark for the first interval is level with the soil surface.**
4. Divide the participants into smaller groups (three to five works well). Each group can be given a segment of the watershed, a contour interval, or a task (e.g. taking compass bearings, adjusting the line on the control stake, determining when the line is level, measuring distances from the control stake to the contour stake, plotting the points on graph paper, etc.). Stakes should be located so they are on a selected contour level with enough points to permit drawing a contour map of the watershed. **Hint: You may want to use 5- or 10-degree segments of the circle around the stake for simplicity in mapping.** Every mapped point should include the contour interval, the distance from the control stake and the direction from the control stake to the mapped point. **Suggestion: You may want to lead the group in determining the information they will need to accomplish the mapping once their field data collection is completed.** Ideally the watershed should be mapped to its perimeter. But that is not essential for participants to understand the process or produce a valid map.

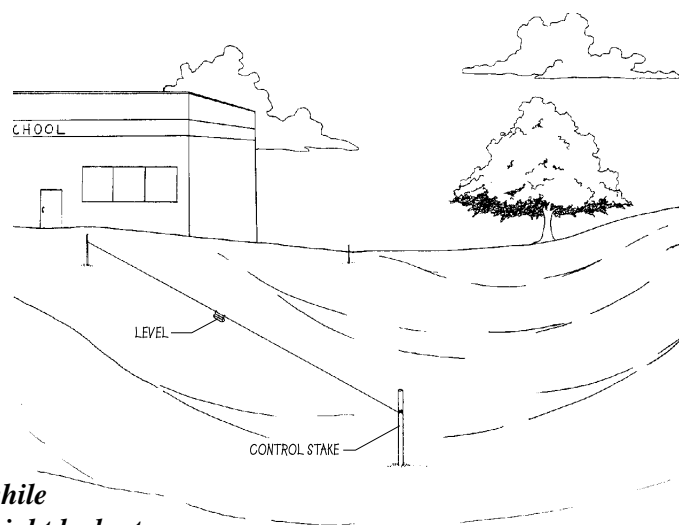

5. The location of each stake should be checked by compass bearing and with a line level to make sure it is on the proper interval. *Hint: Critical thinking may be stimulated by challenging them to determine if using a level is important to obtaining accurate measurements or if other means could be used to make sure the contours are being followed. Remember to reward critical thinking and to correct any proposed methods that will not accomplish the task with positive reinforcement of the thought process involved. Creating a huge paper compass rose on preselected intervals might make the measurements more accurate and easier.*
6. The distance and direction to each contour stake should be measured carefully. If the ridge line can be identified, the height of the ridge line from the control stake should be recorded and distances measured as well. *Data Collection Hint: Like most other data collection processes, at least three estimates of the distance and direction should be recorded and an average used for each data point.*
7. Once all the measurements have been taken, the stakes may be removed. The remainder of this exercise can be completed in a comfortable site with writing surfaces.
8. Pool all the measurements taken at the site.
9. Have participants lay out a piece of paper large enough to mark from the control point to the edges of the watershed. Lay out faint north-south and east-west lines that cross at the point indicating the control stake. These lines need not be in the center of the paper, but north should be at the top of the map by convention. *Hint: North is oriented to the top of the map as a standard practice. Students may need some help deciding where to put the control point.*
10. Use a protractor or compass rose to locate each point by determining the direction and the distance to the point from the control point. With a compass rose, place the 0/360 line on the north line. With a protractor, place the center mark on the protractor on the north or south line and calculate the position for the mark. *Hint: Note that convention places North at 0 or 360 degrees, East at 90 degrees, South at 180 degrees and West at 270 degrees. Some students may find it difficult to visualize the problems, but a little help and superimposing the 360 degree units and the 180 degree units of the protractor should enable them to get their points in the proper locations. A small mark at the edge of the protractor or rose should be adequate to allow alignment of the ruler from the origin to the endpoint.*
11. Using a scale that will fit the map on the paper and make it readable, lay out the contour points. If English units are used, a 1 inch = 10 feet scale is recommended. A clear decimal ruler and graph paper with 10 grid lines to the inch make layout fairly simple. *Hint: Remind the students to measure on the azimuth line rather than simply counting squares!*
12. Have the participants connect each set of contour points at each contour level, interpolating between points to create a scaled contour map of their watershed.
13. If desired, have the participants calculate the area of the watershed they mapped. *Hint: A good estimate can be obtained simply by counting the squares (and estimating parts of the squares) included in the mapped area. A more challenging technique, but one that lays some foundation for calculus at an early age, is to treat all the sampled areas as triangles. The areas of each of the triangles can then be calculated using the formula,  $\text{area} = \frac{1}{2} \text{base} \times \text{height}$ . Adding all the triangles together yields an estimate of the total area for the watershed studied. Critical thinking can be encouraged by asking if the estimate would improve if many more, smaller triangles were used (to fit the shape of the watershed better). Lead them to conclude that as the number of triangles increases, the error at the margins decreases, yielding a better approximation of the area (a foundation principle of calculus).*
14. The topography of the watershed also can be shown for those who are more spatially oriented by transferring the contour lines to layers of cardboard or similar material. These can be stacked using a common origin and North-South or East-West line to form a relief map of the area. If desired, the contour mode can be covered with a thin layer of modeling clay or papier-maché to mold a model of the watershed. The model can be an excellent teaching device to look at the influences of slope and runoff rates.
15. A similar model can be made from USGS 7½ minute topographic maps of your area. Once the watershed in question is located on the map, the participants can explore the area noting things like oil or gas leaked into parking areas, trash, signs of erosion, grassy areas, wooded areas, etc. Explore this in a discussion of the influence that area has on the watershed as a whole, on us as individuals, and on our downstream neighbors.

# Watershed Come Alive

Name \_\_\_\_\_ Date \_\_\_\_\_

Record you data below:

1. Describe the location of the watershed
  
  
  
  
  
  
  
  
  
  
2. What are the measurements from the control stake to the ridge stakes?

Stake Number	Direction (°)	Distance	Elevation

3. Draw a map of the watershed using the data collected.
4. Calculate the area of the watershed. (*Hint: Length x width = area of a rectangle; 1/2 base x height = area of a triangle*)





## Wetland Mobile

### Equipment/Materials

Poster board                      yarn  
construction paper              old magazines  
glue                                      markers  
tape      scissors

**Time Required:** 45-55 minutes

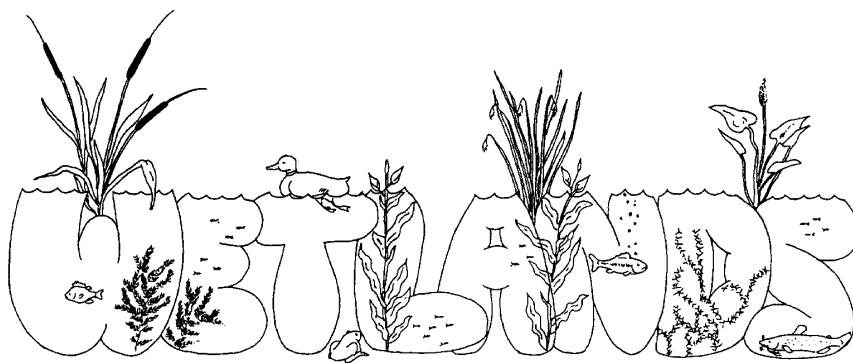

### Procedure

1. Write the word WETLANDS in large bubble letters on a poster board. Cut out and attach yarn to the top of the word. This will be the top part of the mobile
2. Divide the participants into smaller groups and assign each on a function of wetlands.

fish/shellfish habitat	flood storage	food production
plant habitat	animal habitat	aesthetics
recreation	sediment control	water supply/improvement
3. Have the group members write the function they have been assigned on a piece of construction paper, then draw, color, or cut and glue pictures around that function label to illustrate the importance of wetlands.
4. Ask each group to share their ideas in a brief presentation to the larger body, then have each of them add their creation to the mobile.
5. Hang the mobile in a prominent location as a reminder of the many functions of wetlands in our environment.
6. If time and resources permit, encourage each participant to make a mobile to take home.

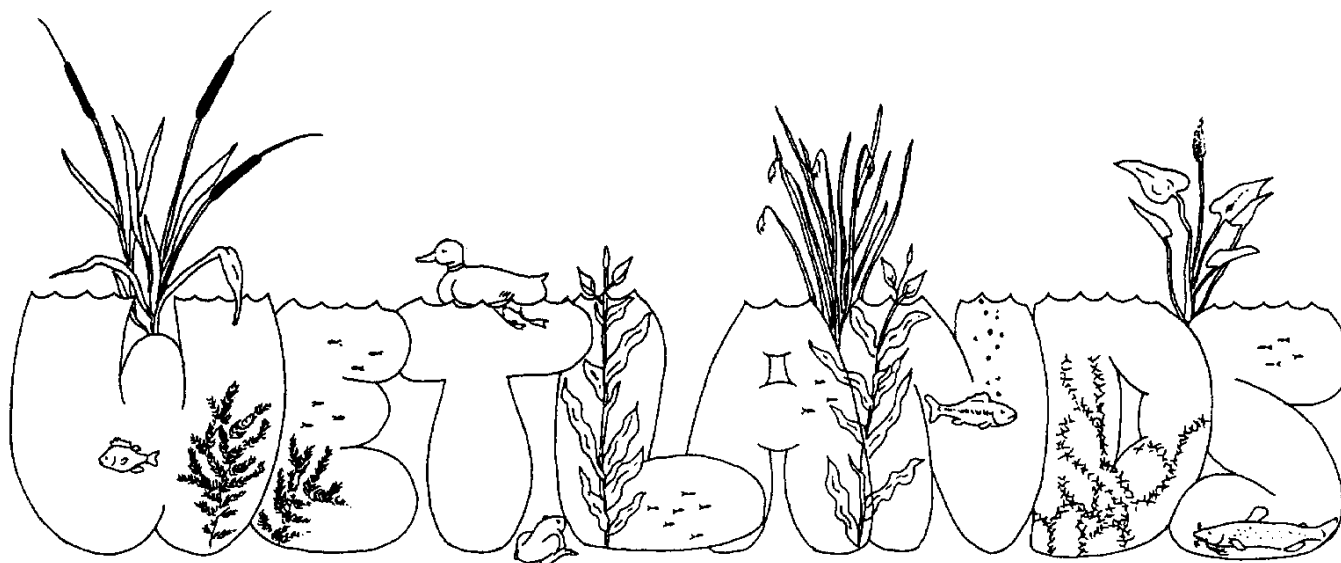



## Wetlands: Nature's Clean Machine



The state of Minnesota has more wetlands than any other state and about 9 percent of the national total.

### Equipment/Materials

modeling clay	shallow baking pan
floral foam (wet type)	watering can with sprinkler head
tap water	soil

### Procedure

1. Spread modeling clay in one end of a baking pan, sloping it gently toward the opposite end of the pan. Press the clay firmly along the sides of the pan to form a sealed edge that will not allow water to flow around it. The modeling clay represents the land, and the empty part of the pan represents a body of water.
2. Fill the watering can with tap water and pour water over the "land." Note how rapidly the water runs off into the "lake" in the other end of the pan.
3. Empty the water from the pan and add a "wetland" by placing a piece of floral foam along the edge between the "land" and the "water," making sure that it fills the space between the sides of the pan completely.
4. Pour water over the "land" again, trying to pour it at about the same rate as you did the first time. Did you notice any differences between the two experiments? Why did these differences occur? This demonstrates how wetlands assist in flood and erosion control by holding water and releasing it slowly.
5. Drain the water from the pan.
6. Stir 4 to 6 tablespoons of soil into 2 cups of water to make the water muddy. Pour about half of the muddy water over the "land." Compare the water that enters the "water body" in the pan with the muddy water that remains. Which one is muddier? Why do you think this difference occurs? This is an example of the way a wetland "filters" water. The slower

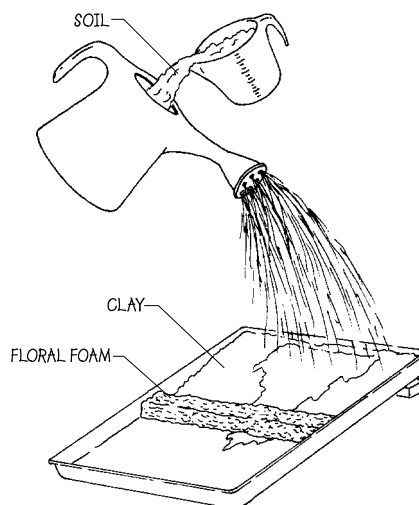
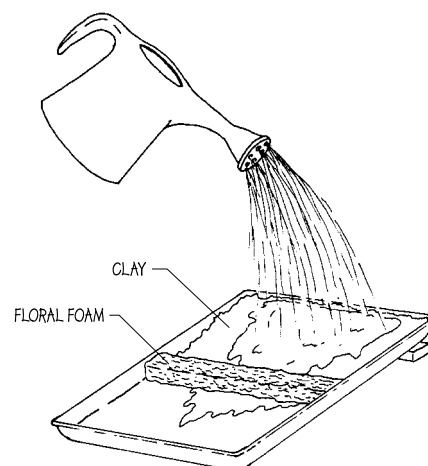
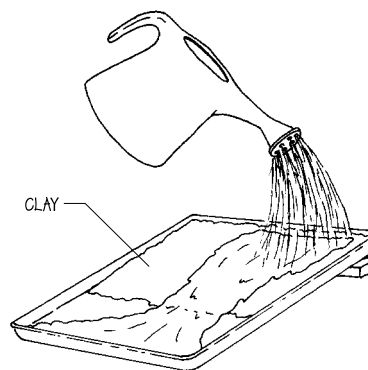



## What's in Your Neighborhood?



Improvements in agricultural practices and changes in wetland regulations resulted in fewer wetland losses from agricultural activities than from other types of activities between 1982 to 1992.

### Earth Cover of Non-Federal Lands in Thousands of Acres

Location	Crops	Grasses Herbs	Trees	Shrubs	Barren	Artificial	Water	Total
<b>Texas</b>	26,913.1	75,550.5	21,527.8	18,420.6	17,036.9	4,222.8	3,882.0	167,553.7
<b>U.S.</b>	315,069.8	530,879.3	409,512.3	82,808.8	96,869.7	46,428.4	50,454.6	1,532,022.7

### Land Cover/Use on Non-Federal Lands in Thousands of Acres

Location	Cropland	Pasture	Range	Forest	Minor Use	Total
<b>Texas</b>	28,261.4	16,709.8	94,155.2	9,960.1	6,396.2	155,456.0
<b>U.S.</b>	382,317.1	125,926.7	398,948.6	394,957.6	88,623.9	1,390,773.9

### What do you think?

1. How do the many different land uses in your area affect watersheds and wetlands?
2. What impact does agriculture have on watersheds and wetlands in Texas?
3. What role does urban development have on watersheds and wetlands in Texas?
4. What can you do to educate others about watersheds and wetlands and their importance to people?

<sup>1</sup>Extracted from the Natural Resources Conservation Service (USDA) Natural Resources Inventory



# Fun with Water In Our Landscape Crossword Puzzle



Did you know that it takes 100,000 gallons of water to make an automobile?

## Across

1. \_\_\_\_\_ springs develop in areas where magma is cooled near the earth's surface.
2. A \_\_\_\_\_ aquifer is found between two impermeable layers.
3. Wetlands can help to prevent a \_\_\_\_\_ during heavy rains.
4. \_\_\_\_\_ zones are areas where confined aquifers receive more water.
5. An \_\_\_\_\_ well is a result of drilling into a confined aquifer.
6. A \_\_\_\_\_ includes all the land area contributing runoff to a body of water.
7. Clay is an example of an \_\_\_\_\_ layer.
8. Man-made or \_\_\_\_\_ wetlands can be beneficial in controlling pollution.
9. Wetlands provide spawning habitat and nursery areas for many types of \_\_\_\_\_.
10. \_\_\_\_\_ occur where a saturated area intersects the ground and can result in a slow seep or large flow of water.

## Down

11. An \_\_\_\_\_ is a saturated water holding area.
12. Boating, fishing, and hunting are some different types of \_\_\_\_\_ activities that take place in wetland areas.
13. \_\_\_\_\_ are important "in-between" places located between water sources and dry land.
14. The \_\_\_\_\_ is the uppermost level of an aquifer.
15. Wetlands can help prevent the loss of soil by \_\_\_\_\_.

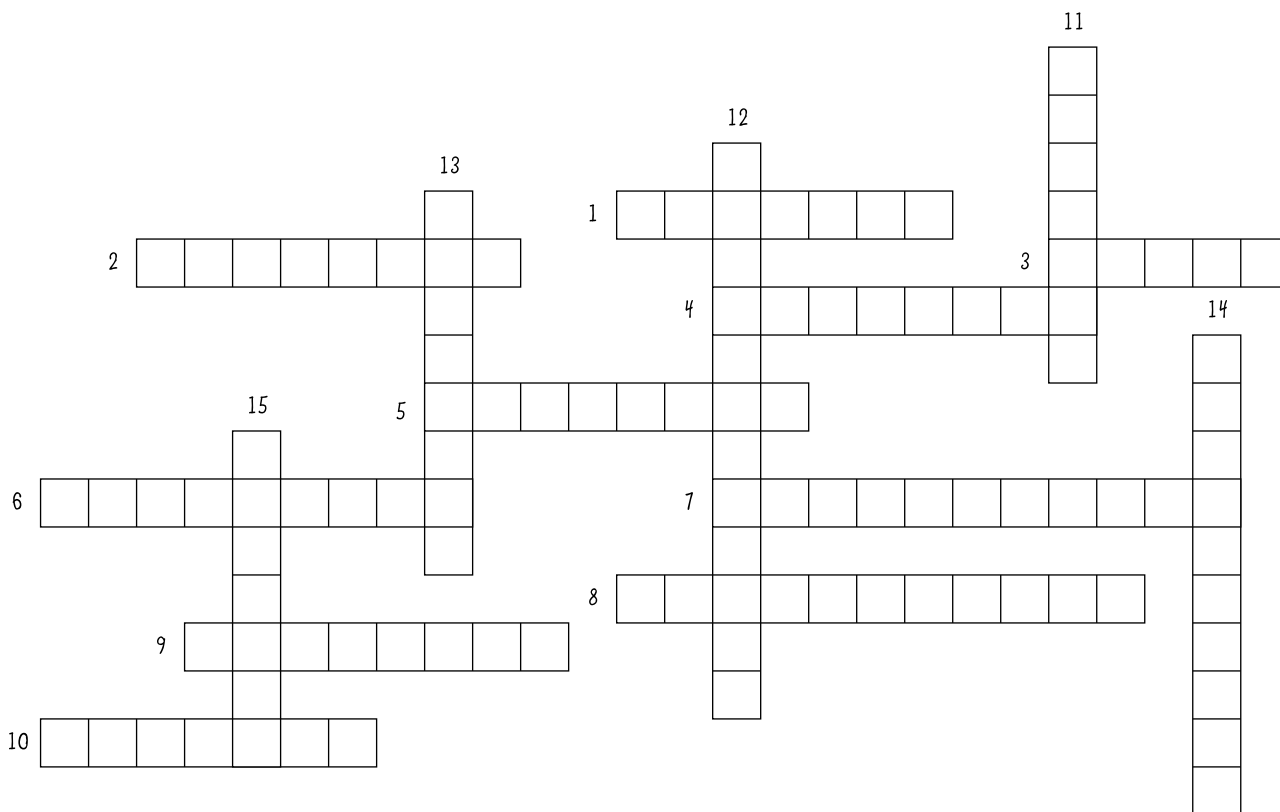





## Fun with Water In Our Landscape Crossword Puzzle



Did you know that it takes 100,000 gallons of water to make an automobile?

### Across

1. **THERMAL** springs develop in areas where magma is cooled near the earth's surface.
2. A **CONFINED** aquifer is found between two impermeable layers.
3. Wetlands can help to prevent a **FLOOD** during heavy rains.
4. **RECHARGE** zones are areas where confined aquifers receive more water.
5. An **ARTESIAN** well is a result of drilling into a confined aquifer.
6. A **WATERSHED** includes all the land area contributing runoff to a body of water.
7. Clay is an example of an **IMPERMEABLE** layer.
8. Man-made or **CONSTRUCTED** wetlands can be beneficial in controlling pollution.
9. Wetlands provide spawning habitat and nursery areas for many types of **WILDLIFE**.
10. **SPRINGS** occur where a saturated area intersects the ground and can result in a slow seep or large flow of water.

### Down

11. An **AQUIFER** is a saturated water holding area.
12. Boating, fishing, and hunting are some different types of **RECREATIONAL** activities that take place in wetland areas.
13. **WETLANDS** are important "in-between" places located between water sources and dry land.
14. The **WATER TABLE** is the uppermost level of an aquifer.
15. Wetlands can help prevent the loss of soil by **EROSION**.

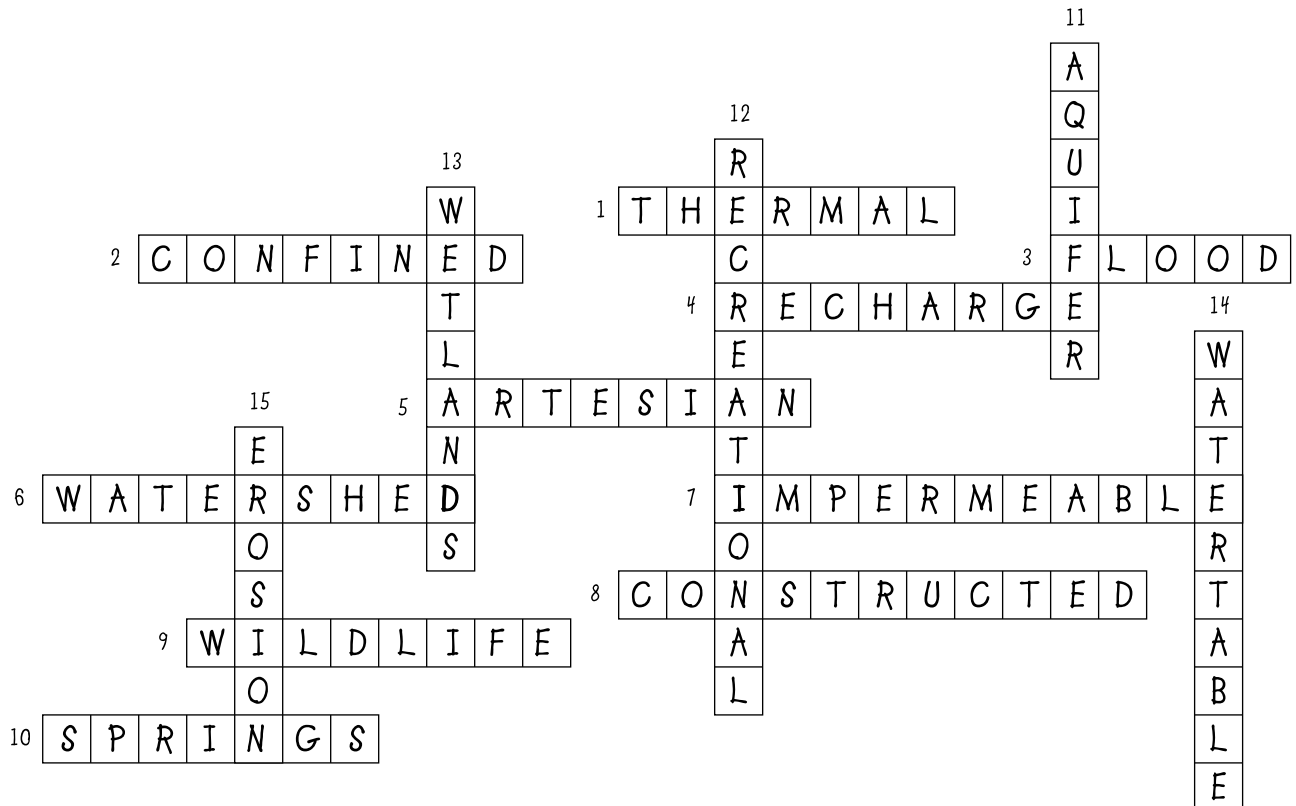





# Water and Soil

## Objectives

1. Identify the components of soil.
2. Describe differences between sand, silt and clay.
3. Compare water holding capacity in different soils.
4. Identify sheet, rill and gully erosion.
5. Demonstrate how vegetation decreases erosion.
6. Demonstrate farm and ranch management practices that decrease erosion.
7. Have fun while learning.

## Materials/Equipment

Small amount of soil in a bag or other clear container  
 Small amounts of dry sand (salt, sugar), silt (flour) and clay (modeling clay)  
 See individual activities.

## Vocabulary

aeration	gully erosion	sand	subsoil
buffering capacity	mineral	sheet erosion	terrace
clay	organic	silt	texture
contour	parent material	sloughing	topsoil
dredge	particle	soil structure	
erosion	rill erosion	splash erosion	

## Lesson Requirements

**Best Time:** Any time of the year

**Best Location:** See individual activities

**Time Required:** 20 minutes to 2 hours depending upon activities selected

## Lesson Background

### I. Soil Formation

To those who study the soil, dirt and soil are not the same. Dirt is soil or other contaminating materials that are out of place. Soil is the weathered, upper layer of the earth's crust—the part that allows plants to grow and animals to find food.

Soil is a mixture of minerals, organic material, air and water. It contains a wide array of animals, fungi, bacteria, and other living things that make it behave like a living organism. All land organisms and many aquatic ones are dependent upon the soil, just as people and their societies are. Soil is one of the primary components governing the food chains of living things.

## Lesson Overview

- I. Soil Formation
- II. Soil Composition
  - A. Mineral material
  - B. Organic matter
  - C. Water and air
- III. Texture
- IV. Soil Layers
- V. Erosion
- VI. Sediment
  - A. Particles carried by water
  - B. Impact of sedimentation
  - C. Erosion and sediment control
- VII. Importance of Soil and Water

## Applications

SHOW participants a small plastic bag or clear container of soil. ASK them what it is, and use their responses to define soil and differentiate it from “dirt.”

ASK participants if they have ever thought about the soil and how it got here. DESCRIBE the process of soil formation briefly from the rock in the earth's mantle to productive surface soils in your area.

If desired, USE locally available information (Soil and Water Conservation district offices, Natural Resource Conservation Commission offices) for the rate of soil development and the depth of topsoil in the area and have participants calculate the time required for that soil to develop.

The soil that covers our ground today is the product of millions of years of soil building. It could take 500 years or more to produce a millimeter of soil (about the thickness of a dime); and even where soil building takes place rapidly, like in huge marshes, it could take 1,000 years to produce up to 30 centimeters of soil.

When large glaciers moved over the land thousands of years ago, they ground rocks together, rubbing off rock **particles** of all sizes. Most soils developed from rock material that was moved by ice, water or wind or by the weathering of rocks by climatic conditions and by chemical reactions with air, water, plants and animals. Plant and animal life played important roles in soil formation by adding organic matter to the soil, aiding in weathering, and by mixing soil layers to alter **soil structure**.

## II. Soil Composition

Soil is composed of four major elements: **mineral** material, **organic** material, air and water. The mineral material is derived from the **parent material** (rock) from which the soil developed. Mineral material commonly makes up about 45 percent of soil.

### Mineral material

Mineral soils are classified by the size of the particles. **Sand** is the largest of the particles. Some sands look like tiny rocks, others are much finer. All of them have a somewhat gritty or rough surfaced feel when rubbed between the fingers. Sand tends to drain easily, allowing water to pass through it with relative ease. Unless it is saturated with water, it has the greatest amount of air space; and it holds water and nutrients relatively poorly. Under dry conditions sandy soils can become droughty very quickly.

**Clay** is on the other end of the mineral spectrum—the smallest of the soil particles. Clay has the greatest water holding capacity of all soil types, but much of the water adheres to the particles and is unavailable for use by plants. Its water holding ability and small size minimize the amount of air in clay soils, and it tends to allow water to pass through only slowly, if at all. Moist clay feels slippery and can be formed into a ribbon when wet.

**Silt** is intermediate between clay and sand in particle size. It holds water much better than sand, but less tightly than clay. It has more air space than clay and less than sand, and it holds soil nutrients better than sand as well. When it is dry, silt has a flourlike or talcum powderlike feel.

### Organic matter

The organic matter in soil is made up of the decomposed remains of plants and animals. The amount of organic material in the soil varies with the soil type, climate and land use. Forest and prairie soils may accumulate large amounts of organic material, while tropical rain forests have very little organic material in their soils. *[Note that one of the reasons tropical rain forest soils are so low in organic material is that organic matter is rapidly incorporated into growing trees and other vegetation almost as fast as it accumulates!]*

SHOW students a recipe for a cake. NOTE that several ingredients are needed to make a cake. Use the analogy to INTRODUCE the notion that soil is composed of several ingredients as well. NOTE that the physical structure of soil depends upon the mixture and arrangement of primary soil particles into secondary particles or peds. The structure influences the availability of water and air in the soil. Adding living things increases the complexity of the soil “cake.”

Sand particles can be used to ILLUSTRATE the feel of sand. Granulated sugar or table salt provide a similar feel or texture.

Potter’s clay or modeling clay can be used to give participants the feel of clay particles and to ALLOW them to form ribbons to personally observe that characteristic of clay.

Flour is an excellent substitute for silt in learning the texture of silt particles either dry or wet.

INTRODUCE “organic matter,” noting that it applies to materials derived from living things. LEAD participants in brainstorming some possible sources of organic matter. CHALLENGE them to make a list of the positive influences of organic matter on soil.

Organic material increases the soil tilth, a measure of its structure. It improves the water holding capacity because the organic material tends to act as a sponge for water, it decreases or slows runoff, it increases water availability for plants, and it helps aerate soils.

**Aeration** is the amount of air available in the soil. Organic material provides many nutrients for plant growth as well.

### **Water and air**

Water and air are present in varying quantities in the soil, filling the spaces among the soil particles and coating the particles. A soil's ability to hold water is called its water holding capacity. Different soil textures have different water holding capacities. Clay normally has a greater capacity than silt, and silt has a greater capacity than sand. While the amounts of water and air differ with soil type and environmental conditions, both of them average about 25 percent of the soil volume in prime topsoil.

## **III. Texture**

Soil **texture** is determined by the relative amounts of sand, silt and clay in the soil. The texture of the soil influences the availability of water to plants and the types of plants that can grow on any site.

Soil texture also influences the ability of the soil to hold water, the infiltration rate of water into all soil layers or groundwater, and the moisture retention of the soil.

In some parts of Texas, changes in soil texture can account for radical changes in the vegetation types observed. In East Texas, for example, clay cells in the soil create bog-like conditions with standing water in an otherwise dry, sandy soil covered with pine trees.

From an agricultural point of view, texture also affects the ease of working the soil and the efficiency of fertilizer use. An ideal agricultural soil has about 45 percent mineral soil particles, 25 percent air, 25 percent water and 5 percent organic material

## **IV. Soil Layers**

Mature soils have three primary layers: the **topsoil**, **subsoil** and parent material. Topsoil is the uppermost layer and the layer that is most important for plant growth. It may be divided into several horizons or layers by its characteristics. The subsoil contains less organic material and more particles of the parent material. Parent material is the basic rock from which the soils are being produced.

Soil may be produced by weathering and mixing with organic matter. Since soil is exposed to the elements, it also is susceptible to wind or water erosion, often at rates faster than its rate of replacement. That results in depletion of the soil on some sites, but enrichment of the soil where fertile topsoil is deposited. An example is the Nile Delta of Egypt, for thousands of years a dependable and rich agricultural soil. It was refreshed annually by the flooding of the Nile River, with deposits of new topsoil coming from upstream. After construction of the Aswan Dam, that fertile

USE Activity 7.1 *1, 2, 3 - Sand, Silt, Clay and Me* to introduce the particles of sand, silt and clay and their roles in soil texture. Local Soil and Water Conservation Districts can illustrate these components to students and can show models of soil horizons for the local area.

USE Activity 7.2 *Watch It Run!* to demonstrate how soil texture can affect a soil's ability to hold water. INTRODUCE "water holding capacity," and encourage participants to think about how soil texture could affect soil erosion and runoff.

Participants can dig a pit in a suitable location to determine the different layers in the soil, or you can have samples of the local soil showing layers from the parent material to topsoil. Employees of the Natural Resources Conservation Service, Soil and Water Conservation Districts, Natural Resources Conservation Commission or local agricultural universities may have samples that could be used in support of this section. Soil maps available from these sources also may be used to help determine the types of soils present and their characteristics.

soil was deposited at the bottom of the lake and other means of maintaining fertility had to be used. In 1992, Texas lost an estimated 326,000,000 tons of topsoil to wind and water erosion! Much of that erosion could have been prevented by better land management practices.

## V. Erosion

Water **erosion** can be classified into three basic types. **Splash erosion** is the result of mobilizing soil particles through the impact of water droplets on bare soil. As the drop hits and parts of it bounce upward, soil particles are ejected into the water and carried with it.

**Sheet erosion** involves removal of a uniform layer of soil by runoff water. Another process that may contribute to erosion or result in increased erosion is soil **sloughing** or sliding down a slope. This occurs because the saturated top layer loses its hold on layers underlying it and slides down the slope as a mass. Large slides have the potential to cause great damage and can have serious impacts on a region.

**Rill or gully erosion** occurs when water running off a watershed creates channels in the soil. Rills are often small, irregular or fingerlike channels forming on mini-watersheds or areas with minimal slope. Pouring water on exposed soil that has a bit of slope will create rills easily.

Gullies are similar to rills, but with much greater magnitude. Both the amounts of water and the amounts of soil removed are greater in gully erosion. Sometimes, when water volumes are large enough or slopes are steep enough, these gullies are deep and cut down to the parent material. On a large scale, major rivers have created spectacular geographic features after centuries of erosion. The Palo Duro Canyon on the Red River is an example known to most Texans.

## VI. Sediment

### Particles carried by water

Sediment is simply soil particles that are carried by water. When the force of the water exceeds the pull of gravity and other forces that keep soil particles in place, the particles are mobilized and enter the water as suspended solids. Then, when the pull of gravity exceeds the forces exerted by the water on soil particles, they are deposited and become sediment. Coarse sands drop out of suspension sooner than fine sands. Silts are deposited as sediment when the forces of water are reduced still more. Because of their small size, clay particles may remain in suspension for some time.

### Impact of sedimentation

Sediments carried by streams affect fish and wildlife resources as well as people. Sediments can cover vital spawning habitat for fish. In some cases, the suspended soil particles can damage the gills of aquatic animals and even kill them. Sediments can bury aquatic

USE Activity 7.3 *Splash, Splash* to illustrate splash erosion and its role on soil erosion.

NOTE that in sheet erosion water uniformly scrapes away a layer of soil.

Lead participants to OBSERVE construction sites or other sloped land after a moderate rain for examples of rill erosion. NOTE that the rills may meander on gentle slopes but point directly down the slope on sharper slopes. Highway overpasses or similar areas are excellent places to view rill erosion.

Stream or ditch channels in urban areas, areas below highway culverts, or well-defined watersheds on sharply sloped land are excellent places to VIEW gully erosion. Dry stream beds in deserts or other dry areas often take on the characteristics of gully erosion after rains. NOTE that the main difference between these types of water erosion is the size of the objects that can be moved during the erosion events. Gullies may move boulders or dig through layers of clay, while rills, sheet erosion and splash erosion can move only smaller particles of soil.

Sloughing of saturated soils after long periods of heavy rains, mud slides, or similar conditions also contribute to erosion. Upper layers of soil saturated with water may start to slide down the slope when gravity overcomes the friction and adhesion holding the soil in place. In some areas, the impacts of such circumstances can be very serious.

plants or, while still suspended in water, block light from reaching submerged plants and cause them to die.

Sediments fill in reservoirs and reduce their storage capacity for water. Most Texas reservoirs have lost from about 1 percent to over 30 percent of their storage capacity in the past 30 years. Under drought conditions, the reduced capacity of reservoirs means more water is lost to evaporation in relation to the volume stored and less water is available to meet the varied needs.

Suspended particles must be filtered from the water before water can be processed for domestic use. This results in higher water bills and the need for more elaborate water treatment facilities. Sediments deposited in harbors and shipping channels decrease their depth, which requires that they be **dredged** to maintain their usefulness. In addition, the sediments dredged from those sources, known as dredge spoils, must be deposited somewhere. In the past, they were often placed in wetlands, destroying those valuable habitats. While they may be applied to land now, they can cause problems because of heavy metals or other toxic materials contained in them.

The financial cost of sediment removal amounts to millions of dollars annually, but the ecological cost may be even higher. That cost includes both the loss of valuable soils from upland habitats because of erosion and the damage to aquatic habitats when soils are deposited in them as sediment.

### **Erosion and sediment control**

If erosion and sedimentation are such serious problems, what can be done to prevent them? Some of the answers are almost too simple to believe. Maintaining plant cover on the soil is one of the most beneficial things that can be done. Native plant communities are best at holding soil in place, but even well managed crops or rangeland do the job effectively. The aerial parts of the plants intercept precipitation and winds, reducing the impact of water droplets on the soil and reducing wind velocity tremendously. This cushioning effect helps to prevent soil particles from mobilizing. The root systems of the plants form a netlike structure that holds soil particles in place and resists the force of water on the soil. Plants, along with organic material in the soil, increase the rate of infiltration into the soil and reduce runoff rates, decreasing water velocity and volume and reducing soil loss.

Farm management practices also impact soil erosion and resulting sediments. Minimizing exposure of bare soil to wind and rain helps. Minimum till, ridge till and no-till agriculture minimize disturbance of the soil and keep plant residues and soil holding cover on the ground. Other practices help as well. **Terracing**, a process of making many flat areas from a sloping plot of ground, increases infiltration and reduces runoff. **Contour** farming, plowing and planting around (on the contour) rather than up and down slopes, is helpful on gentle slopes. Installation of grass waterways to convey runoff water from agricultural fields while acting as soil filters is helpful. Leaving crop residues on the ground to protect the surface

PLACE a small amount of soil in a test tube or vial. ADD water to fill half to three-quarters of the container. COVER the end of the container and SHAKE it vigorously for about a minute, then SET IT ASIDE standing upright in a place where it will not be disturbed. OBSERVE the process of sedimentation as the soil particles are deposited. NOTE that the sandy soil is deposited on the bottom with a layer of finer silt on top of that and very fine clays being last to drop out of suspension.

Encourage participants to LIST ways that sediment or suspended soil particles could be costly to the environment or to people. Encourage them to THINK broadly, but STRESS the impacts of deposited sediments on habitat, reservoir and lake capacity, and filling in of channels and harbors.

USE Activity 7.4 *Bare or Covered?* and Activity 7.5 *Slip Sliding Away* to demonstrate how plant cover and contour farming can control soil erosion. Divide the participants into small groups, representing farmers (types of farming in your area), ranchers, building contractors, highway construction contractors, or others. Ask them to brainstorm about ways their groups might control soil erosion.

from wind and rainfall also benefits the farmer by reducing erosion. Leaving uncultivated or specially planted buffer strips along waterways, planting windbreaks and maintaining or establishing wetlands are all ways to minimize erosion and sedimentation.

Livestock producers can do their part to control erosion by practicing sound range management. Establishing a grazing rotation to maintain at least a minimum amount of vegetative cover at all times, avoiding over-stocking of ranges with livestock, and managing range plants to maintain ground cover all promote good soil management. Using proper stocking rates benefits the rancher by maintaining palatable plants and adequate ground cover while permitting optimum weight gain in his or her stock. Fencing livestock out of wetlands to minimize soil compaction and to maintain the wetland is also sound practice. In short, controlling erosion is not only good for the general population and the streams and rivers of the state, it is also good for farmers and ranchers.

## VII. Importance of Soil and Water

Why is soil important to the water quality in Texas? A healthy soil both filters and stores water for wetlands, streams, rivers and lakes. It is the first layer of filtering between the surface and the groundwater supply. It impacts the condition and quantity of surface water and it provides for the slow release of water into the atmosphere through healthy plants. As water percolates through the soil in the watershed and into the water table, the soil filters out many impurities by binding them to soil particles such as clays or organic materials. Living things in the soil, such as fungi and bacteria, also act as decomposers for many contaminants and prevent them from reaching water supplies. The **buffering capacity** of the soil also aids in maintaining the pH (a measure of acidity) balance of the water as it percolates toward the groundwater. The soil, water and climate forge ecosystems. All the plants and animals so important to us are dependent upon them. Our soils are critical to water quality and to us.

### For Further Thought

1. What happens to soil that is eroded by water? Where does that soil go, and what are the effects on other systems? How might wetlands impact that soil loss?
2. Why might erosion have a serious impact on water supplies? Might it affect those getting water from groundwater supplies differently than those who use surface water from reservoirs?
3. How might aquatic animals and plants be affected by soil erosion by either wind or water? What impact might sediment have on those animals and plants? What might happen to the fertilizer applied to soil that is washed into waterways?
4. Are the costs of soil erosion greater than the loss of fertility and soil to the landowner? Justify your response.

### Summary Activity

Use photographs or illustrations from books to show participants a variety of erosion types and conservation practices designed to combat that erosion. Ask them to relate those situations to the land management practiced in your area and to discuss the reasons for the land management practices they observe.



## Sharing and Exhibit Suggestions

1. Use any of the activities from this lesson to demonstrate soil loss and conservation. Demonstrate the impacts of both good and poor land management practices.
2. Prepare a poster showing the impacts of sediment on aquatic habitat and the plants and animals living there. Show how good land management can result in cleaner water, lakes that last longer, and a more stable water supply, as well as better fishing and aquatic recreation.
3. Make a profile of local soils by digging a pit (with permission) and collecting samples for each visible layer in the soil. Draw a scale model of the soil pit and put small samples of the soil from each layer on the poster opposite the layer it represents.
4. Make a poster or collection of photographs showing good and poor land management practices with captions that interpret the practices.
5. Collect soil samples from several areas in your vicinity. Label them so you can tell where each sample was obtained. Shake them in water and allow them to settle so the various sizes of particles in the soil are defined. Interpret what you find with a poster and the samples.



## 1.2.3 – Sand, Silt, Clay and Me



Between 1982 and 1992, 6 million acres of prime farmland in the United States were converted to some other use. This area represented in football fields would circle the earth 14 times if laid end to end.

### Equipment/Materials

beach ball or basketball	softball or baseball
marble or BB	sand*
potter's clay or modeling clay	flour
soil samples from local area	water
clear, sealable containers**	test tube rack

\* granulated sugar or table salt may be used if desired

\*\* glass canning jars with lids, plastic jars, screw top vials, test tubes

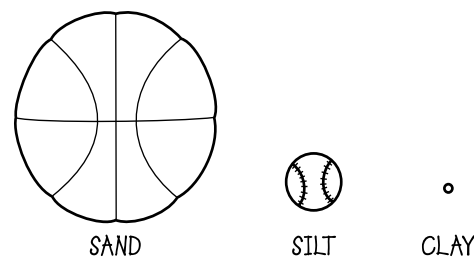

### Procedure

1. Collect (or assign participants to collect) soil samples from several areas in your community. Try to get samples from a variety of sites, including cultivated fields or gardens, roadsides, stream banks or areas under dense plant cover (woodlands, grasslands, etc.).
2. Use the combination of balls to create an analogy with the different sizes of soil particles — beach ball or basketball represents sand, softball or baseball represents silt, and marble or BB represents clay. Explain that this approximates the way the soil particles relate to each other in size.
3. Have participants guess which particles have the most space between them. Lead them to conclude that space between particles increases with particle size.
4. Encourage students to think about why sandy soils drain faster but dry much more quickly than soils that are high in clay.
5. Allow participants to feel the textures of the sand (or its mimics), flour and clay. Emphasize the gritty feel of sand, the floury feel of dry silt and the slick feel of clay. Note that moist clay can be squeezed between the fingers to form a ribbon of soil.
6. Have participants feel the soil samples provided, recording their guesses about the relative amounts of sand, silt and clay in each sample. Stress the characteristics they have just learned. Note that the proportion of clay in the soil is directly related to the length of the ribbon that can be formed with the soil sample.
7. Divide the group into pairs or groups of three. Provide each group with a small soil sample (enough to fill the container being used about an eighth to a third full). Have each group place the sample into a container and cover it completely (filling the container about half full) with water. Seal the container and shake it vigorously to thoroughly mix the soil with the water, then place it upright and allow the soil to settle.
8. Have the participants observe the soil as it drops out of suspension. The coarser particles will settle out first (almost immediately) followed by silt then clay. Finally the lighter organic material will settle on top of the clay layer. Some organic matter may be light enough to float on the surface of the water, and some clays may remain in suspension for a considerable length of time.
9. If desired, measure the relative thicknesses of the layers, and compare these observed values with the estimates made by feeling the soil. Remind the participants that use of this technique improves with practice.
10. Compare the proportions of sand, silt, clay and organic material among the samples. Lead participants to consider possible reasons for any differences they observe.
11. Encourage them to consider and discuss the types of soils from their samples that would be best for plant growth.



## Watch It Run!



One earthworm can process 36 tons of soil in a year!

### Equipment/Materials

two 1-liter plastic soda bottles  
 two 1-quart canning jars  
 two 5-inch-square pieces of cheesecloth  
 dry soil, about 2 cups\*  
 watch, stop watch or electronic timer  
 \* gather the soil from your community

water  
 clear measuring cup  
 two stout rubber bands  
 dry sand - about 2 cups

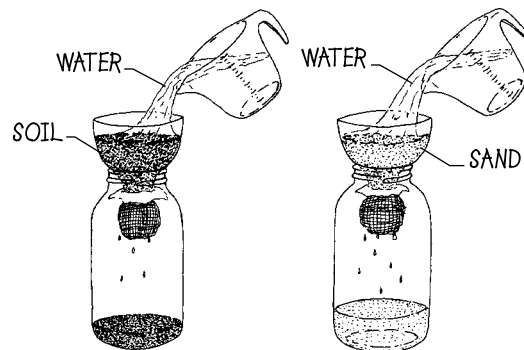

**Time Required:** 10 minutes

### Procedure

1. Make a funnel from the top portion of each empty soda bottle by cutting off the bottom.
2. Fold the cheesecloth and cover the small end of the soda bottle funnel with it, securing it with the rubber band. Invert the funnel into the canning jar or other container with the small end down. The funnel should not rest on the bottom of the container.
3. Put about 2 cups of dry soil from your community into one of the funnels. Several samples could be used if desired. Spread the soil in a thin layer and allow it to dry for at least 1 or 2 days before doing this activity!
4. Put an equal amount of dry sand into the other funnel. Like the other sample, this one should be completely air dry.
5. While one participant times the process from the beginning, pour a measured amount of water (about 1 pint or 2 cups) into the first funnel; and record the following information.

Elapsed time for first drop to reach the container \_\_\_\_\_

Elapsed time until water stops flowing or dripping into the container \_\_\_\_\_

Original amount of water added \_\_\_\_\_

Amount of water collected in the receiving container \_\_\_\_\_

Amount of water retained by the soil \_\_\_\_\_

6. Using the same techniques and amounts of material, repeat the process for the other funnel(s), recording the same data.

Elapsed time for first drop to reach the container \_\_\_\_\_

Elapsed time until water stops flowing or dripping into the container \_\_\_\_\_

Original amount of water added \_\_\_\_\_

Amount of water collected in the receiving container \_\_\_\_\_

Amount of water retained by the soil \_\_\_\_\_

7. Lead participants to compare the water holding capacities of the samples and to consider how the texture of the soil affects its water holding capacity.
8. Using the relative amounts of soil that are carried into the receptacles by the water flowing through the funnels, compare the influence of soil texture on soil erosion. Remember, the cheesecloth may act as a selective filter to some degree, allowing only smaller soil particles through, if it is tightly woven.



## Splish, Splash



Vegetable crops use an average of 650,000 gallons of water per acre

### Equipment/Materials

two 1-quart canning jars with perforated lids	water
ice pick or awl	duct tape
1 to 2 cups of soil	flat pan
1/2 cup grass clippings or other mulch	watering can
two white poster boards	

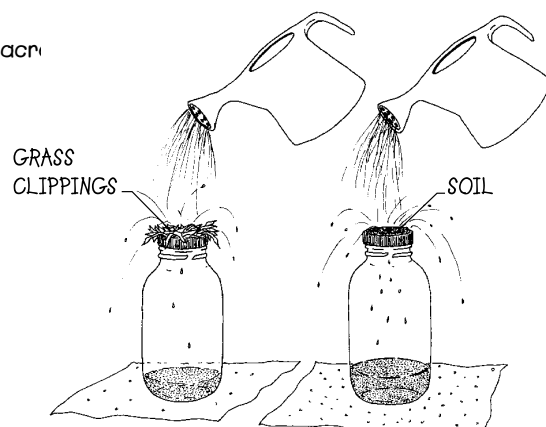

### Procedure

1. Use an ice pick or awl to make the same number of holes in the lids of each canning jar. Keep the holes in approximately the same locations.
2. Hold the rings so the lip that is normally on the top of the jar is down. Place the lids in the rings with the sharp ends of the holes down and tape them to the top of each jar with the ring up as a collar.
3. Fill each ring with the same amount and type of soil.
4. Add a thin layer (about a half inch) of grass clippings on top of the soil in one lid.
5. Place each jar in the center of a piece of white poster board. If this activity cannot be done outside, you may want to place a pan under the poster board to catch any stray water.
6. Hold the watering can about 3 feet above each lid and dump the same amount of “rain” on each one. Ideally you should measure the water into the can and dump the entire amount for a good comparison.
7. Observe the amounts of soil visible on each of the poster board pieces. Which jar suffered the most splash erosion (soil carried into the air by impacting water droplets)?
8. Measure the amount of water that was captured in each jar. Which one allowed more water to leach through the soil into the jar (represents deeper soil layers)?
9. Discuss the amount of soil that could be lost during rains through splash erosion.





## Bare or Covered?



A comparison of 1982 and 1992 soil losses shows 900 million tons more soil was lost in 1982 than in 1992. This is enough top soil to fill a convoy of dump trucks, placed 95 across and stretching from Los Angeles to New York.

### Equipment/Materials

two paint roller pans  
8 cups of water  
two bricks  
water

soil to fill each pan  
3 cups of leaves, twigs, grass clippings, or mulch  
two cookie sheets with sides

### Procedure

1. Fill each of the paint roller pans to the top with soil.
2. Put a 1/2-inch to 1-inch layer of leaves, twigs, grass clipping, or mulch on top of the soil in one of the pans.
3. Put a cookie sheet at the end of each paint roller pan to catch the water runoff.
4. Pour 2 cups of water over each of the pans allowing the water to flow downhill and collect in the cookie sheet. Which water runoff is cleaner? Which pan allowed the water to run off faster?
5. Put a brick under each of the paint roller pans to increase the slope. Repeat Step 4.
6. Do you think that vegetation helps control soil erosion?
7. Do you think that vegetation growing on soil improves water quality in our rivers and streams?
8. Do you think that plants with roots growing in the soil would reduce soil erosion?

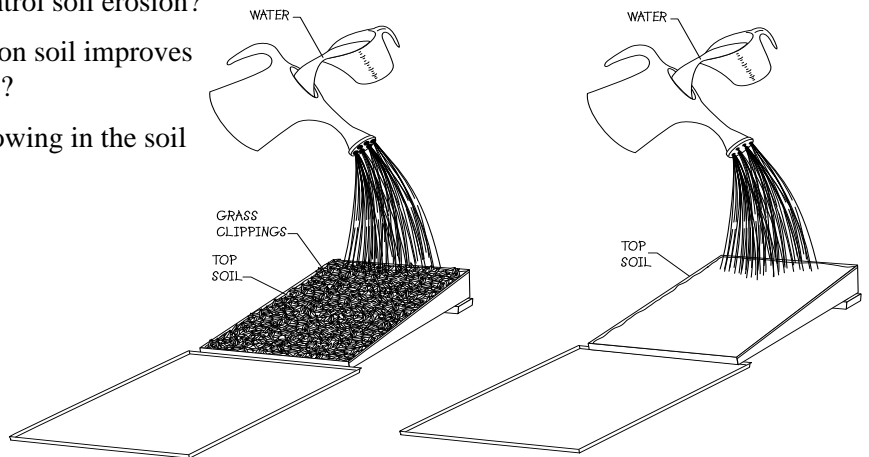
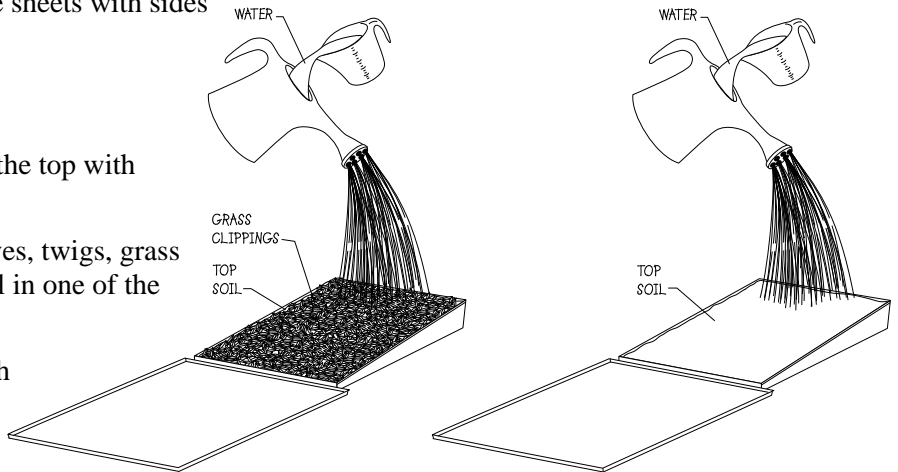



## Slip Sliding Away



Your local soil and water conservation district can give you tips for preventing soil erosion from your home.

### Materials/Equipment

two watering cans with shower heads      two catch pans  
two paint roller trays                      six bricks  
water (at least 8 cups per can)          ruler  
topsoil (enough to fill trays)            measuring cup

### Procedure

1. Fill each of the trays with soil, level with the top surface of the tray.
2. Stack two bricks in the back and one in the front so that the tray has a slope. Put the catch pan on the end to catch the excess water as it drains over the field.
3. Using the ruler, make a series of rows in one tray that run the length of the roller tray.
4. Using the ruler, make a series of rows in the other tray that run across the slope.
5. Hold the watering can 30 inches above each of the trays and allow it to rain.
6. How much soil was eroded from the pan with furrows lengthwise along the slope?
7. What pattern did the soil loss take?
8. How much soil was eroded from the pan with the furrows across the slope?
9. What pattern did the soil loss take?
10. If these results were extended to farms, which farming practice would result in the most soil loss, contour plowing or plowing up and down slopes?
11. Does contour plowing on farmland help to control soil erosion?
12. Will contour plowing work on slopes that are even steeper than the ones we tested?

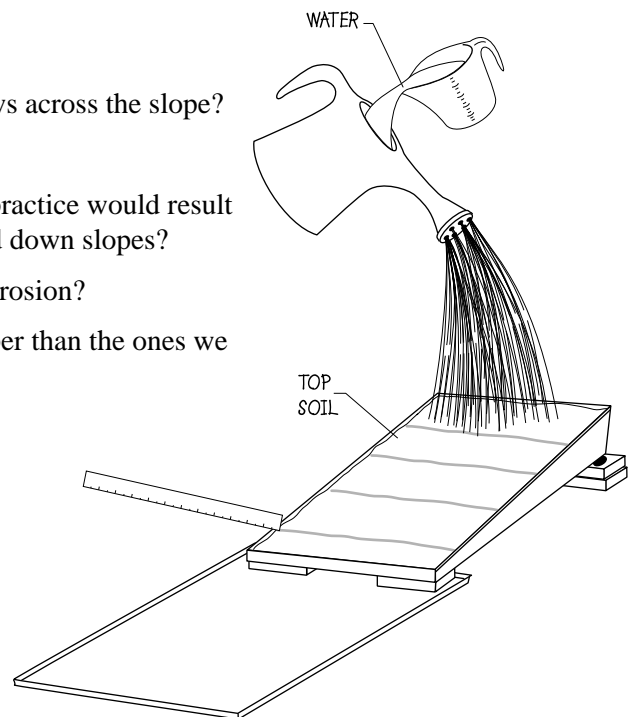
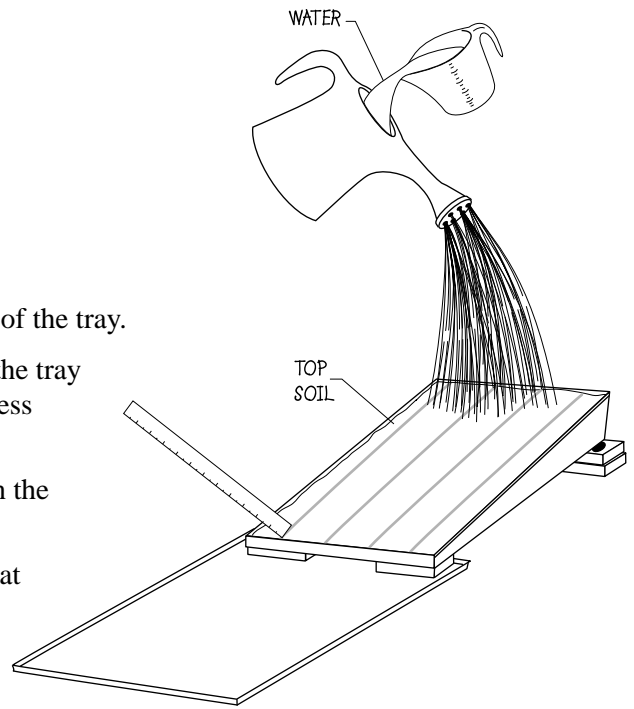





# Water and Plants

## Objectives

1. Identify how plants influence the water cycle.
2. Identify vascular tissues and their functions in the plant.
3. Calculate the volume of water transpired from a large tree using a sample.
4. Calculate the amount and **percentage** of water in a variety of fruits.
5. List how plants help the environment.
6. Have fun while learning.

## Materials/Equipment

See individual activities.

## Vocabulary

carbohydrate	photosynthesis	stomates (stomata)
chlorophyll	proportion	vascular
percentage	sample	xylem
phloem	siltation	

## Lesson Requirements

**Best Time:** Any time of the year

**Best Location:** Any safe setting where water is available and young people can work in small groups

**Time Required:** 30 minutes, additional time required to collect data on activity sheets

## Lesson Background

### I. Plants and Their Role in the Water Cycle

Plants play a major role in the water cycle because they modify the amount of water held by the soil and the atmosphere. The root systems of plants extract water from the soil as they help hold the topsoil in place and reduce soil erosion. The above-ground portions of plants return water to the air through transpiration. Plants act as living filters by trapping particulate pollutants from the air as well as dissolved or suspended pollutants in the water. By slowing the movement of water, plants reduce suspended solids in the water, retard runoff and reduce the impact of flooding.

Like people, plants modify their environments. They shade the surface of the land, which cools the soil, and add water to the air. Both of these actions influence and are influenced by the water cycle. Plants also reduce heating and cooling costs for homeowners through their influences on local climate and home sites.

## Lesson Overview

- I. Plants and Their Role in the Water Cycle
- II. Plant Structures and Function
  - A. Xylem
  - B. Phloem
- III. Photosynthesis
- IV. Environmental Influences of Plants
  - A. Reduce pollution
  - B. Modify climate
  - C. Reduce flooding
- V. Plants in Our Lives

## Applications

SHOW students pictures of plants in the landscape and home. Have students BRAINSTORM about how plants are important to us and how they play a role in the water cycle.

## II. Plant Structure and Function

Like other living things, plants have many parts that work together to allow the plant to survive, grow and reproduce. They must produce food and “burn” that fuel for the energy required to survive. Producing food requires water and carbon dioxide and produces oxygen as a by-product. Using the sugar fuel to produce energy consumes oxygen and produces carbon dioxide and water. Since these products must be obtained from or released to the environment, plants need transport systems for both liquids and gases.

### Xylem

Plants have a **vascular** system similar to our system of veins and arteries. That system links all parts of the plant, from the tips of the roots to the leaves at the top. Water taken in by the roots (root hairs) is transported through the **xylem** to the leaves where it is used in making food (simple sugars) or expelled to the air as water vapor through transpiration.

Transpiration occurs through tiny pores in the leaves called **stomates** or stomata. Under some conditions plants may even expel liquid water droplets from their stomates. In woody plants, like trees and shrubs, xylem is the wood. It provides support for the plant as well as a water transport system. Only newly formed xylem cells are living. Most of the transport system is made up of dead cells that act like hollow straws. Xylem cells vary in size with the growth rate of the plant; they are larger when growing conditions are favorable and smaller when they are less favorable. As a result, most woody plants have annual or seasonal rings of xylem, sometimes called water rings or growth rings. These rings can be used to tell both how old the plant is and what type of growing conditions it encountered in any given year. The number of complete rings from the center of the tree to the edge tells its age. The width of the rings indicates the growth rate during that year or growing season. Nonwoody plants, like grasses, have bundles of xylem and phloem scattered throughout the inner parts of the plant.

Movement through the xylem is the result of two pressures. One of these is called root pressure. It is the result of water being absorbed by the roots into the plant tissue. The addition of water at the bottom of the plant increases the pressure to make water move upward in the xylem tubes. The other pressure is the result of evaporation of water from the leaves by the process of transpiration. As the water evaporates, it creates a slightly reduced pressure and pulls the water in the xylem tubes upward, much like the way we draw in water through a straw.

Plants transpire much like humans perspire. We have tiny pores in our skin that release sweat, which evaporates, allowing the body to cool itself. Plants have pores in their leaves called stomates or stomata that allow gas exchange with the atmosphere. Thus, they act in a fashion similar to our lungs in both gas exchange and water vapor release. Transpiration keeps water flowing through the plant and cools both the plant and the atmosphere in the process. Plants actually are natural air conditioners.

INTRODUCE the terms stomates, xylem, and phloem. USE a cut piece of wood to show the rings of xylem tissue.

Use Activity 8.2 *Plant Straws* to ILLUSTRATE how xylem pulls the water up through the plant. ENCOURAGE students to think about the characteristics of water that allow it to be pulled up the plant. Activity 8.1 *Trap It In* illustrates how transpiration occurs through the stomates in the leaves. Plants are composed of large volumes of water. Activity 8.3 *Fruits are Full of It* illustrates how much water is in fruit. EXPAND this activity to include other fruits, vegetables or plants. Encourage students to GUESS how much water is in each item before drying.

## Phloem

The other type of vascular tissue in plants is **phloem**. It is a very thin layer of living cells found just under the bark of woody plants. Phloem distributes food as a sugar solution to all parts of the plant. Unlike xylem, where flow through the tubes is essentially one way from the roots to the leaves, flow through phloem can be in either direction.

## III. Photosynthesis

People and other animals have to eat, but most plants produce their own food. Have you ever wondered how plants make food? They capture some of the energy in light in chemical bonds of simple sugars that can be used as food or fuel for their life processes. The process is called **photosynthesis**. Literally, photosynthesis means to put together (synthesis) with light (photo). The process is like the one you might use to bake brownies in an oven. You put together several ingredients—flour, sugar, flavorings, egg and milk—and bake them in the oven until they are done. The recipe for photosynthesis is fairly simple.

carbon dioxide + water + (chlorophyll + sunlight) = simple sugar + oxygen

Carbon dioxide is a gas found in the atmosphere. It is a by-product of respiration (the burning of sugar fuels by cells). All plants and animals produce carbon dioxide (CO<sub>2</sub>) and water when they respire. Plants absorb CO<sub>2</sub> into the cells in their leaves after it is taken in through the stomates. Water is brought to those cells through the xylem from the roots to the leaves. **Chlorophyll** is a green pigment found in plants. Carbon dioxide and water are the ingredients in the “brownie mix.” To make the simple sugars, however, sunlight and chlorophyll combine to act as the oven. Chlorophyll absorbs sunlight and stores the energy from the sunlight in “excited” electrons. When those electrons drop back to their normal state, they release energy that can be used to split water molecules. The hydrogen from the water combines with CO<sub>2</sub> to form a simple sugar. Simple sugars are synthesized by the plant to make **carbohydrates**, such as complex sugars containing 6 or 12 carbon atoms, starches or cellulose. Complex sugars and starches are stored as chemical energy for later use by the plant, and animals take advantage of that storage when they eat plants. Oxygen (from the water) is a by-product of photosynthesis that is discharged to the air.

When the carbohydrates are used as fuel by plants or animals, they are broken down into CO<sub>2</sub> and water. During active photosynthesis, plants produce much more oxygen than they consume. People and other animals consume oxygen and return CO<sub>2</sub> and water to the atmosphere. As the basic producers of food from the sun, plants are extremely important to all living things as well as being important in the water cycle.

## IV. Environmental Influences of Plants

### Reduce pollution

Did you know that plants actually help reduce pollution? Plants can help remove some air pollutants by absorbing them through the pores in the leaf surface. Other pollutants are filtered by leaves,

SHOW students the typical ingredients for making brownies. CORRELATE how a plant makes food in photosynthesis to how brownies are made. REFER to the background material for more detailed explanations.

NOTE that electrons in chlorophyll are excited when struck by light and store energy absorbed from the light waves. As they drop back to their normal state, they release energy that is used to make simple sugars from carbon dioxide and water.

NOTE that the complex sugars, starches and cellulose in plants are all built by the plant from simple sugars.

STRESS the fact that water is split by the chemical energy during photosynthesis and re-formed during respiration.

stems and twigs and are then washed to the ground by rainfall. Healthy forest or prairie soils can act like a blotter, trapping particles of pollutants and binding them to soil particles so they cannot move through the ecosystem. Many soil microorganisms break down some types of pollutants into less harmful or less persistent compounds. Thus trees and other plants help clean the air and the water.

### Modify climate

Trees are cool—literally. Trees and other plants intercept light, cooling the soil and cooling the air in shaded places. A shady, green landscape filled with trees can be 10 degrees to 20 degrees F cooler than surrounding areas with concrete and paving. During cold weather, trees and shrubs can reduce the wind velocity around homes and keep them warmer. Both of these situations result in savings in utility costs through lowered air conditioning or heating costs. Plants also add moisture to the air through transpiration.

### Reduce flooding

Plants have a pronounced impact on flooding, erosion and **siltation**. They have a strong influence on keeping soil in place by slowing and reducing impact of water droplets on the soil, allowing more time for infiltration. By slowing the water on impact and by acting as multiple barriers to flow, plants slow the entry of water into streams, reducing the potential for floods. Even when streams rise outside their banks, plants reduce flow rates and reduce erosion to some degree. Plant roots help control erosion by forming a network that holds soil in place. When flood waters enter wetlands, plants trap sediments and reduce the load of suspended soil that enters streams, rivers and lakes.

## V. Plants in Our Lives

Plants are vital parts of our lives. They provide food for humans and other creatures. They renew the oxygen supply in the air. They reduce pollution, help control floods, keep soil in place and contribute to the water cycle. Finally, they add beauty to the landscape and richness to our lives.

## For Further Thought

1. Do all the leaves on a tree or shrub produce the same amount of water through transpiration and respiration? How might that question be answered?
2. What kinds of factors might change the transpiration rate within a single plant?
3. How could a sampling scheme be designed to test for differences? How does sample selection impact the accuracy of estimates made from samples?
4. Would different types of plants react differently in the dye experiment? Why or why not? Could we see the same phenomenon by cutting across the stem and looking at the vascular tissue? Would a corn stem look different from the stem of a bean plant or a small branch from a tree or shrub?

Encourage students to **THINK** about how plants can absorb pollutants.

**BRAINSTORM** and list the ways that plants can modify climate and save energy.

Refer to Lessons 6 and 7 for activities to illustrate how plant materials reduce flooding.

## Summary Activity

Use the results of the activities in this lesson to have participants draw conclusions about water in plants and how water moves through the vascular systems of the plants. In addition, discuss the reasons for the processes used. Why use a **sample** branch rather than enclosing an entire tree or bush in a plastic bag to observe transpiration? Why use different dyes and why were the dyes distributed in the flower as observed? How much water was in each of the fruits when they were fresh and when they were air dried?



5. Is there any moisture left in air dried fruit or wood? What might happen if air dried fruit or wood were placed in a warm oven or in completely dry air (air with a desiccant that removes all water vapor)?
6. Why has drying been used as a way to preserve food, and how does that work?
7. Why do dried fruits differ in appearance from fresh fruits from which they have been formed?
8. Why would added heat, like smoking or drying in an oven or drying something in a solar dryer, decrease the time required to reach a given level of water loss?
9. How can plants reduce the sediment load in flood waters? [Hint: think of water velocity and the creation of eddies on the downstream side of the plants.]

## Sharing or Exhibit Suggestions

1. Construct a “plant” poster showing how the plant uses water and how that water is transported, used and eliminated from the plant. Include the processes involving water and interpret those processes.
2. Develop a demonstration using the experiments in this chapter or create your own activities to show how plants function. Arrange the demonstrations in stages with results from start to finish. Or, take pictures or make diagrams that show the process and display the results.
3. Perform experiments on various plant samples, determining the **proportions** of the plant mass made up of water. Speculate on the reasons that the water content might vary among various types of tissues.
4. Make a poster or diorama that depicts the results of one or more experiments with water and plants.
5. Develop a presentation on the role of plants in flood control, erosion control or environmental enhancement (cooling, warming, increasing air moisture, etc.). Use a variety of sources and take personal measurements to determine if those impacts can be verified by observation. Present your findings in a pleasing way to an audience of your choice.



## Trap It In



On a hot summer day, a willow tree can use and lose more than 5,000 gallons of water!

### Equipment/Materials

tree or shrub                      plastic bag  
string or tape                      small pebble  
measuring cup/spoons or graduated cylinder

### Procedure

1. Place a plastic bag around a small branch of a tree, making sure to surround to seven leaves.
2. Place a small pebble in the bag.
3. Secure the bag tightly to the stem, trying to make an air-tight seal; and leave it in place for 24 hours.
4. Record the number of leaves in the bag.
5. Remove the bag carefully, taking care not to lose any of the collected water. Pour the water into a suitable container to measure the amount (measuring cup/spoon or graduated cylinder).
6. Record the amount of water transpired by the leaves in the 24-hour period.
7. Estimate the number of leaves on the entire tree or shrub.
8. Assuming that each leaf transpires about an equal amount of water, calculate how much water the tree or shrub transpired in the 24-hour period.

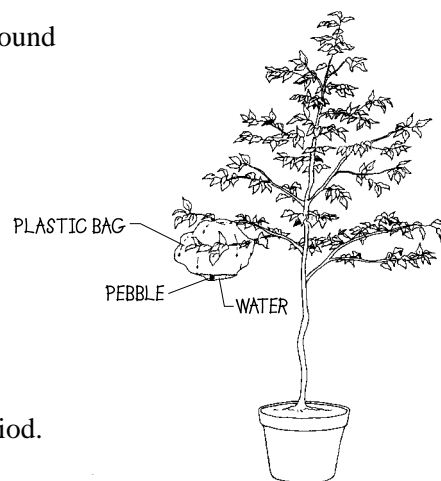



## Plant Straws



One acre of trees produces enough oxygen for 18 people every day!

### Equipment/Materials

white carnation                      glass or other small glass container  
water                                    paring knife  
red and blue food coloring (others as you wish)

### Procedures

1. Fill the glass or other container with about 1 cup of warm water.
2. Add 6 drops of red food coloring to the water and stir.
3. Using a sharp knife, cut approximately 1 inch off the bottom of the carnation stem.
4. Place the carnation in the glass of colored water, just as you would put any flower in a vase.
5. Leave the flower in the colored water for several hours. Keep it in an easily observed place.
6. Describe what happened to the color of the flower.

***The flower became tinted with the dye.***

7. Explain why the change took place.

***As the plant drew water from the dyed supply, the vascular tissues of the plant supplied water and food coloring to the flower itself, resulting in the flower changing colors.***

8. Repeat the experiment, but split the lower part of the flower stem and place each half in differently colored water. Hint: Choose colors that will be visually pleasing.
9. Observe and explain the differences in the second experiment.

***The vascular tissues of the plant are similar to tubes, and the tissues serve different parts of the flower. As a result, the parts of the flower served by each colored water supply will be colored by the dye in that water supply.***

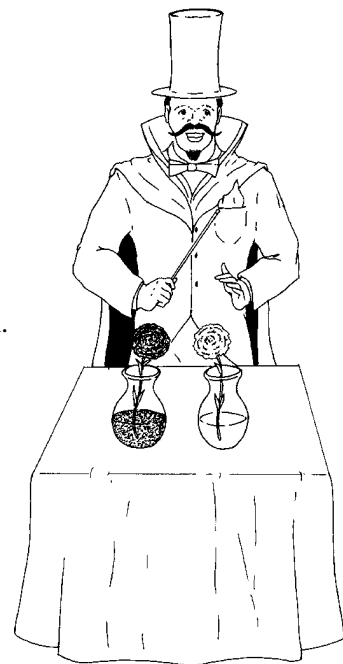



## Fruits Are Full of It



Did you know that a watermelon, including rinds and seeds, is approximately 93 percent water?

### Equipment/Materials

knife	apple
postal scales, digital scales or triple beam balance	several grapes
three glass pie plates	lemon
labels or tape	marker



### Procedure

1. Cut a fresh apple into quarters and weigh each quarter.
2. Separate and label each quarter. Record the weight for each one on the data sheet.
3. Repeat these steps for the lemon and four split grapes.
4. Place each fruit on an individual pie plate, keeping the pieces separate and labeled.
5. Place the pie plates in a sunny, airy spot to allow the fruit to dry. A food dehydrator may be used if it is available. A warm oven with the door open may be used in wet, cold weather. Dehydration times will be much shorter and will require measurements at approximately 2-hour intervals.
6. Allow the fruit to dry for 12 hours.
7. Weigh each piece of fruit and record the weight on the data table.
8. Allow the fruit to dry another 12 hours, weigh it again, and record results in the data table.
9. Allow the fruit to dry for 3 more days, weigh it again, and record the results in the data table.
10. Calculate the water loss for each of the pieces in each observation period.
11. Using this information, calculate how much water would be in a whole apple, whole lemon or whole cluster of grapes.
12. Calculate the percentage of each fruit that is represented by water.

For more advanced students or to increase critical thinking skills, try slicing the sections to various thicknesses. Thinner slices will dehydrate more quickly and completely than thicker ones. Challenge the young people to determine why there are differences in the water loss rates. Note that the thinner slices have greater surface area for their volume, thus exposing more of their tissues to the drying air and providing a greater evaporative surface. Ask them to think of ways this surface-to-volume relationship might impact stored water, evaporation of surface waters or similar situations. Lead them to conclude that equal volumes of water stored in deep and shallow lakes will have very different evaporation losses if other conditions are similar. Have them try to devise an experiment to test their hypothesis, like putting equal amounts of water in a flat pan and in a graduated cylinder or tall glass and noting the loss rates over specified time periods.





# Fruits Are Full of It

## Fruit Dehydration Data Table

Fruit		Weights				Water loss
		Original	12 hours	24 hours	4 days	
Apple	1	_____	_____	_____	_____	_____
	2	_____	_____	_____	_____	_____
	3	_____	_____	_____	_____	_____
	4	_____	_____	_____	_____	_____
Lemon	1	_____	_____	_____	_____	_____
	2	_____	_____	_____	_____	_____
	3	_____	_____	_____	_____	_____
	4	_____	_____	_____	_____	_____
Grape	1	_____	_____	_____	_____	_____
	2	_____	_____	_____	_____	_____
	3	_____	_____	_____	_____	_____
	4	_____	_____	_____	_____	_____

Apple

Water loss in 12 hours \_\_\_\_\_

Water loss in 24 hours \_\_\_\_\_

Water loss in 4 days \_\_\_\_\_

Percent water in apple \_\_\_\_\_

Lemon

Water loss in 12 hours \_\_\_\_\_

Water loss in 24 hours \_\_\_\_\_

Water loss in 4 days \_\_\_\_\_

Percent water in lemon \_\_\_\_\_

Grape

Water loss in 12 hours \_\_\_\_\_

Water loss in 24 hours \_\_\_\_\_

Water loss in 4 days \_\_\_\_\_

Percent water in grape \_\_\_\_\_





# Water and Animal Life

## Objectives

1. List some uses of water in the body.
2. Calculate the amount of water in a human body.
3. Describe why good water quality is critical to everyone.
4. Identify organisms that live in and around water.
5. Have fun while learning.

## Vocabulary

ammonia	filter	radiate
dehydration	metabolism	salivary
digestive	nitrogenous	thirsty
enzyme	osmosis	urea
fetus	perspiration	uric acid

## Materials/Equipment

Small saltine crackers (one per participant)  
See individual activities.

## Lesson Requirements

**Best Time:** Any time of year

**Best Location:** Any safe setting where young people can work in small groups

**Time Required:** 45 to 60 minutes

## Lesson Background

### I. People and Water

Human beings are watery animals adapted to living in environments where water is readily available. Even people who live in deserts require large amounts of water for survival, and the lack of availability of fresh water limits human habitation of any area.

#### Percentage of water in humans

The proportion of a person's body weight represented by water varies with age. Embryos may be as much as 98 percent water by weight, while infants are about 75 percent water and adults are about 50 to 60 percent water. Thus, a 10-pound infant has a water content of about  $7\frac{1}{2}$  pounds, while a huge football lineman weighing 360 pounds may contain from 180 to 215 pounds of water. Either one would have problems with water losses of about 10 percent of their body weight. For the baby, that is only about a pint. For the lineman, that represents over 4 gallons! The human body is relatively inefficient at conserving water and intolerant of even moderate **dehydration**, so an adequate supply of fresh, clean water is essential to our health and well-being.

## Lesson Overview

- I. People and Water
  - A. Percentage of water in humans
  - B. Mechanics of water loss
  - C. Need varies with conditions
- II. Water's Importance to Animals
  - A. Metabolism
  - B. Movement
  - C. Growth
  - D. Reproduction
  - E. Adaptation
- III. Specializations in Water Uses
  - A. Osmotic balance
  - B. Temperature regulation
- IV. Comparison of People to Desert Animals

## Applications

Have participants **CALCULATE** the amount of water in their bodies by using Activity 9.1 *How Watery Are You?* If desired, challenge the group to figure out how much water is in the body of a huge football lineman (360 pounds) and/or in a 10-pound infant. Have each person compare these values to their own water volume.

**NOTE** that water losses of 10 to 12 percent of body weight can become life threatening. If desired have participants calculate how much water that represents for them, the lineman, and the baby. [A net loss of only about a pint of water is serious for a baby, while the 360-pound lineman must lose more than 4 gallons to reach the same stage of dehydration!]

## Mechanics of water loss

People lose water every time they take a breath. The inspired air has some moisture in it (even in deserts it may be around 10 to 20 percent); but the exhaled air is completely saturated with water. With each breath we have a net loss of water. Respiratory water loss can be significant—up to a quart per hour—even in cold weather, so constant fluid replacement is important.

We lose more water in processing metabolic wastes. As proteins are metabolized, the body produces **ammonia**, a toxic compound. Mammals convert ammonia to **urea**, a less toxic material that can be eliminated in a watery liquid called urine. Although the kidney is designed to recover the vast majority of the water it **filters**, it operates to maintain a balance in the dissolved salts found in tissue fluids like blood. When water is readily available, the urine is relatively dilute. When the body needs to conserve water, the urine becomes more concentrated. Even though the large intestine recovers the majority of the water from the organic material in the **digestive** tract, small amounts of water are lost when these wastes are eliminated.

Temperature regulation also consumes large amounts of water. Even though the average body temperature for people is about 98.6 degrees F, our comfort zone is significantly lower than that. As the temperature rises above the thermal neutral zone (comfort zone), we use active means to eliminate excess heat and keep the body temperature stable. Humans do that through **perspiration** or sweating. Glands in the skin release slightly salty water onto the surface of the skin. As the water evaporates, the skin is cooled, and the body eliminates excess heat. A person exposed to the sun during the summer in one of our Southwestern deserts can lose as much as 1.4 percent of body weight each hour through sweating and respiration. Under those conditions, a critical water loss of 10 to 12 percent of the body weight could take place quickly, in as few as 7 to 8 hours, and lead to heat stroke and death. Shelter and fluid replacement are critical to survival under these desert conditions.

## Need varies with conditions

The fact that water requirements change with the conditions being encountered is clear. Both high and low temperatures increase water requirements beyond those with temperatures around the thermal neutral zone, and the more extreme those temperatures, the greater the increase in water demand. Physical activity increases **metabolism** and produces excess heat that must be eliminated, even when the external temperatures are cool to cold. Although metabolic activity produces some water, it requires more to eliminate the heat and the metabolic wastes produced. Diet can affect the need for water, too. Carbohydrates require relatively little water in digestion and metabolism, while protein metabolism demands more water. Some foods, like fresh fruits and vegetables, contain a significant amount of water and help to replenish the body's supply. In addition, illness or injury can increase the need for water, either because tissue repair is taking place or because symptoms or conditions related to the illness increase water loss

ASK participants if they have ever seen their breath on a cold day. NOTE that exhaled air is saturated with water. If the air around us is not saturated (100 percent relative humidity), we have a net loss of water with each breath.

Have the group ESTIMATE how long it would take for a person to become critically dehydrated if they were not replacing fluids under the conditions of 1.4 percent of body weight lost each hour for a total of 10 to 12 percent. [*Less than 10 hours!*]

Ask participants to DISCUSS factors they think contribute to differences in water use or demand. Use leading questions to get beyond simple notions of higher temperatures and increased physical exertion. Simple experiments could be used to demonstrate the effect of physical activity.

NOTE that moist foods replace some water directly and that use of carbohydrates for fuel creates some metabolic water. Protein metabolism, however, produces nitrogenous wastes that require water to remove them.

NOTE that very cold air is dry; and hot, dry air can increase efficiency of evaporative cooling. Humidity influences water balance at all temperatures. Respiratory water loss depends upon the difference between the saturated exhaled air and the humidity of the inspired (ambient) air.

rates. Finally, age has an influence on water needs and dehydration tolerance. Younger people have greater water composition and more reserves than older people.

Under “normal” conditions every human needs to replace approximately 1½ to 2 quarts of bodily water each day. That’s about six to eight 8-ounce glasses daily. Thirst is a sensation that triggers us to seek fluids, but it usually does not signal that a need exists until the need has become relatively serious. Therefore, people should drink water frequently whether or not they feel **thirsty**. Under hot, dry conditions a person may need to replace up to 1 or 1½ quarts each hour!

## II. Water’s Importance to Animals

All living things share some common life processes—metabolism or energy exchange, movement, growth, reproduction and adaptation. These processes depend upon a balanced mixture of salts dissolved in water. The mixtures in the tissue fluids of both animal and plant cells are similar to dilute sea water. The tissue fluid is comprised of about 0.7 to 0.9 percent sodium chloride with a lesser amount of potassium chloride, calcium chloride and sodium bicarbonate, as well as other dissolved solids. The relative concentrations of the various salts is critically important, and living things have developed many mechanisms for maintaining that balance.

Fresh water is defined as any body of water containing 5 parts per thousand (ppm or ‰) or less of these salts. In contrast, the waters of open oceans are much more salty, about 30 ppm. Some salt water has a much higher concentration and has very limited animal or plant life. Mammals, such as humans, maintain a salt concentration of about 9 ppm, and freshwater aquatic animals have a salt concentration of about 7 ppm.

### Metabolism

All processes linked to metabolism, from food production to the actions required to gather and transport the food, involve the use of water. Digestion takes place in a watery mix of ground food particles, digestive **enzymes** and coliform bacteria. The actions of digestive enzymes can be demonstrated by chewing a cracker. Saltines go from a bland, salty taste to a sweet taste as they are chewed. This is the result of the actions of an enzyme, **salivary amylase**, in human saliva.

Transportation of digested nutrients from the intestines to the cells of the body takes place through the blood stream. This water bath for the tissues also carries the oxygen needed for cellular respiration and carries away carbon dioxide and nitrogenous wastes, the waste products of metabolism. Cellular metabolism, the biochemistry of life, takes place in a watery environment; and the waste products are carried to the liver (for detoxification), the kidneys for elimination of **nitrogenous** waste, and to the lungs for elimination of gaseous wastes. [Note that fecal material is not metabolic waste, but undigested organic matter and bacteria. Although the digestive tract is inside the body, its contents are actually “outside the body” since they are separated from the internal tissues by the walls of the

ASK participants why an ill person might require greater water intake.

EMPHASIZE that water loss is almost constant, increasing with activity, sweating, deep or rapid breathing, and other factors. NOTE that a person needs about 1½ to 2 quarts of water daily under cool, moist conditions to remain healthy. Under hot, dry conditions a person may need to replace up to 1 or 1½ quarts each hour to prevent dehydration. ENCOURAGE participants to drink often (before they think they are thirsty) and enough to satisfy them and remain healthy.

REINFORCE the fact that water is required to produce all foods and that transporting it requires water in some form as well.

ASK participants what happens to food after they put it in their mouths. GIVE each a small cracker. ASK if the cracker changed taste as they chewed it. *[An enzyme called salivary amylase is in saliva. It starts turning the starches in the cracker into sugars, so the chewed mixture becomes sweeter as it is partially digested in the mouth.]* LEAD them to include the grinding process (chewing) and the processing of food by digestive enzymes. Some may know that intestinal bacteria are important in processing some types of food as well.

ASK the group how digested foods, like glucose, get from the intestinal tract to the cells in the body. NOTE that blood serves as a transport medium for the food, oxygen that is required for respiration (burning the food for energy), and removal of metabolic wastes.

NOTE that the extraction of energy from food in cells takes place in a watery medium that allows very complex chemical reactions to take place to fuel cellular processes.

ASK group members how the waste products of metabolism are eliminated. BE PREPARED to field responses about fecal material (undigested materials and bacteria from the intestines - not metabolic wastes). *[Carbon dioxide and nitrogenous wastes from processing proteins (urea in humans) are transported to other organs for removal by the blood. Carbon dioxide is eliminated through the lungs. Urea is concentrated by the kidney and eliminated through the urine. Other by-products, including some toxic materials, are transported to the liver and detoxified (broken down) there. You may want to note that both the kidneys and the liver work harder than the heart, functioning continuously while the heart rests about half the time.]*

intestines. The intestinal tract can be considered a tube that runs through the body from the mouth to the anus, containing cells that aid in digestion and absorption of food and water.]

### **Movement**

Movement requires at least muscles and nerves in complex animals. In humans and “higher” animals it involves some skeletal structures as well. Both muscles and nerves depend upon tiny electrical impulses along cell membranes to function. These electrical impulses are made possible by differences in chemical balance inside and outside the cells. This is known as polarization. When the polarity of the cell membrane breaks down (depolarizes), a wave of stimulus moves over the membrane. All of that activity requires an aqueous solution in order to occur. Propagation of impulses, contraction of muscles, lubrication of joints, and support are all functions of the water in our bodies.

### **Growth**

Growth requires accumulation of chemical building blocks and energy to assemble those building blocks into new cells and tissues. Usually that accumulation is called “good nutrition.” Nutrition depends upon a good, balanced and available food supply. Water is required at every step, from fixing sunlight to produce energy-storing chemical bonds to transporting digested food to the cells that need it. Because water is essential to produce, transport, digest and metabolize food, it is also essential for growth and development

### **Reproduction**

Water plays a vital role in reproduction for all animals. Water protects and carries gametes, the cells that unite to form new individuals. Some animals, like most fish and amphibians (frogs and salamanders), deposit their gametes in the water, using external fertilization. The “eggs” are dependent upon water to keep them from drying and to protect them from temperature shock and other types of damage. Others, like insects, reptiles, mammals and birds, fertilize the eggs before they are deposited. Reptiles and birds protect the growing **fetus** in a shell containing food for the embryo and a watery sac that protects it and provides water during its growth. During pregnancy, mammals protect their young in a water-filled sac as well. Mammals have an additional link between water and reproduction. They feed their young on milk, a nutrient-rich watery liquid produced by the mother.

### **Adaptation**

Adaptation is the process of passing on learned or genetic traits that enable succeeding generations to cope with their environment more successfully. Genetic traits require that the adult animals survive at least long enough to reproduce. Learned traits demand that the adults live long enough to teach their offspring to use the same solutions they have learned on their own or through exposure to other animals. Survival is a necessary precursor to adaptation. Water is essential to survival.

ASK group members if they have ever pricked themselves with a thorn or touched something too hot to hold. What happened when they did so? The reflex movement resulted from a complex interaction between the nervous system, the muscles, and the skeleton. Differences in chemical concentrations inside and outside the cells result in an electrical potential across the cell membrane. When that electrical charge breaks down, an impulse is sent along the nerve to the muscle. The same process causes the muscle to contract, pulling parts of the skeleton closer together by bending joints one way or another. Watery solutions **lubricate** the joints and provide additional support during movement.

NOTE that only those animals that survive to reproduce are able to pass on any adaptations enabled by their genes. Water is involved in all life stages and all life processes for animals.

Have participants BRAINSTORM ways that water is used by humans and other animals. If necessary USE leading questions to get at some of the important roles water plays in their lives. For more advanced groups addressing specifics may be helpful to expand learning.

### III. Specializations in Water Use

Water is used in similar ways by all animals, but specialized or unique uses of water also occur. Usually the unique uses of water are specific adaptations or specializations based upon those common uses.

#### Osmotic balance

Osmoregulation, the maintenance of osmotic balance, is the process of maintaining balanced salt concentrations in the body. It is common to nearly all animals. Living membranes are semipermeable; they restrict movement of some things while allowing others to pass through freely. The movement of water across semipermeable membranes from areas of higher concentration of water to areas of lower concentration is called **osmosis**. Thus, water flows from areas of lower salt concentration (greater proportions of water) to areas of higher salt concentration (lesser proportions of water). Salt concentration of animals approximates 7 to 9 parts per thousand (‰). Since fresh water has salt concentrations of only about 5 parts per thousand or less, freshwater animals must eliminate excess water while conserving salts. Conversely, since open oceans average about 30 parts per thousand, saltwater animals must excrete salts to maintain water balance.

Water enters freshwater animals ( freshwater fishes, amphibians and insects) passively, by osmosis through the gills, skin or digestive tracts. They retain their salt balance by producing lots of urine that is nearly pure water. They excrete most of their nitrogenous wastes as ammonia through their gills or skin. Their kidneys are excellent salt conservation organs.

Saltwater animals (saltwater fishes, crustaceans, sea birds, and marine mammals) constantly lose water to the sea around them. They actively drink seawater and excrete highly concentrated urine (having kidneys that are well adapted to recover water) or make use of specialized glands to eliminate salts. Some fishes, like striped bass and salmon, are able to switch between these modes.

Terrestrial animals must locate water sources. Most of them drink standing water, lap dew or other condensation or eat foods with high water content. Others may use behavioral adaptations to increase their water supply, like storing dry seeds underground to increase their water content in the higher humidity of a burrow. Some others, like kangaroo rats or pocket mice, live almost entirely on metabolic water—water produced by breaking down foods to yield energy. These species concentrate their metabolic wastes, producing less toxic substances like urea or **uric acid**.

Mammals, amphibians and some reptiles normally produce urea and eliminate it in watery urine. Sharks also produce urea, but they store it in their tissues to balance the salt concentration of the water. Birds and other reptiles handle nitrogenous wastes by producing uric acid, a much more concentrated substance. This is the white material in bird droppings. Doing so reduces their water demand. All of these species have kidneys adapted to extract most of the water and concentrate salts in the excretory tract.

NOTE that water moves across living membranes from areas of lower salt concentration to areas of higher salt concentration through osmosis. RE-MIND them that most animals have a salt concentration of about 7 to 9 ‰; salt concentration of fresh water is 5 ‰ or less, and ocean water is about 30 ‰. LEAD them to conclude that freshwater animals tend to have excess water to eliminate, while saltwater (and terrestrial) animals must conserve water and eliminate concentrated salts and wastes.

NOTE that the problems faced by terrestrial or saltwater animals are opposite those faced by freshwater animals. ASK participants if they would expect a tuna to drink water. [*They ingest water and excrete salts almost constantly.*] NOTE some of the other solutions to the problem of finding water in dry places.

ASK participants if they have ever seen a bird dropping? The white part of the dropping is uric acid, an extremely concentrated and nearly dry form of nitrogenous waste. Mammals cannot use uric acid because the crystals are needle shaped and would damage their tissues. Urea is less toxic than ammonia and less concentrated than uric acid. It requires more water for elimination.

## Temperature regulation

Osmotic balance is related to temperature balance in animals that use evaporative cooling. Temperature can be regulated behaviorally. Animals can seek shade or bask in the sun. They can swim in shallow or deeper water, at a preferred temperature, or go deeper in a burrow or some other shelter on land. They can time their daily or seasonal activities to coincide with the most favorable times for those activities. Animals like woodchucks or marmots hibernate in the winter, avoiding the coldest parts of the year when food availability is poor. Others, like the tiny pygmy mouse found in Texas, aestivate. They avoid heat stress by going underground and becoming torpid (deep sleep with slowed metabolic processes) during hot, dry spells. Nearly all animals use behavioral thermal regulation to some degree, even if it is simply adjusting the degree of exposure of their bodies to sunlight, cold winds or other factors.

Both poikilothermic (cold-blooded) and homeothermic (warm-blooded) animals use behavioral means to regulate their temperatures. Very large poikilotherms (like tuna, large sharks, pythons, crocodiles, alligators and Komodo dragons) are able to maintain body temperatures above the ambient temperature (the temperature of the water or air around them) through heat produced by muscle contractions and metabolic activity. (Most biologists agree that dinosaurs were able to behave in a similar manner to actively increase body temperature.) These animals may seek surroundings that have a temperature within their comfort range, seek shade or shelter, or bask in the sun to increase body temperature.

Active temperature regulation involves the use of evaporative cooling in most cases. In humans, sweating is the predominant evaporative cooling process. Specialized glands in the skin release a slightly salty fluid that evaporates off the skin and cools its surface. We also use radiant cooling. When people get hot, they may get flushed (the skin may redden somewhat). This is the result of blood vessels near the skin dilating (opening up to larger diameter). When air temperatures are lower than the body temperature, radiant cooling can help disperse heat from the body core. When air temperatures are cold, the skin may look paler because the blood vessels are constricted to conserve heat. These processes are used to maintain a fairly constant temperature in the internal part of the body.

Some animals sweat, but others cannot. Many of them cool their skin by wallowing in moist soil, mud or water. Animals that cannot sweat, like pigs, must have access to wallowing sites if temperatures become too high. Many other animals wallow as part of their temperature regulation process.

Panting is another means of evaporative cooling. The dog is a common example of an animal that pants. Dogs have no sweat glands, but they can evaporate water from their mouths and noses to lower their temperatures. Like sweating, panting requires both considerable water and considerable energy. People also pant

REVIEW the concept of poikilothermic (“cold-blooded”) and homeothermic (“warm-blooded”) animals. NOTE that very large poikilotherms (like tuna, large sharks, pythons, and big lizards) may maintain body temperatures above the ambient temperature through muscle contractions and metabolic activity.



when they are hot, particularly after strenuous physical activity; but that is clearly a secondary method of regulating body temperature for people.

Other animals use a sort of vascular (blood vessel) radiator to cool all or parts of their bodies. Jackrabbits, for example, have extremely large ears. The ears have abundant blood vessels and very thin tissue. When the animal is hot and the air temperature is below that of the blood, the rabbit can raise its ears and flare them slightly to allow the air to cool the blood flowing through the ears. The same mechanisms could heat the animal if the temperatures are higher than the temperature of the blood. The ears are held tightly to the body when the animal is too cold or too hot under conditions where its “ear radiators” cannot help.

Some animals adapted to hot deserts or savannahs combine passive and active heat regulation. Large animals, like oryx, elephants or camels, allow their body temperatures to rise slowly during the day, then **radiate** the heat back to the atmosphere at night when temperatures are lower. Many of these animals have developed internal vascular radiators (called *retes* or *retia*) in their noses that expose the blood to evaporative cooling while allowing the animal to recover most of the water required to accomplish that cooling. These animals may keep only certain parts of their bodies, like the brain, cool while allowing other tissues to bear the heat burden.

#### IV. Comparison of People to Desert Animals

Humans exploit almost every part of our planet, but we are adapted to moist conditions. Our ability to regulate water use is poor compared to desert-adapted animals. We use evaporative cooling to keep our body temperatures nearly constant. We are unable to tolerate even moderate dehydration; losses of 10 to 12 percent of our body weight are extremely dangerous. Our survival depends on the availability of free water (water in its liquid state) to replace fluid losses. Even under relatively mild conditions, people are able to live only about 4 to 5 days without water, and under severe conditions dehydration can become life threatening in only a few hours.

In contrast, desert-adapted animals make extremely efficient use of the water that is available to them. Many of them, in fact, need no free water at all. Some desert rodents may not drink during their adult lives, getting all the water they need from metabolic water and water in their food, even if their diet consists primarily of dry seeds. Some, like pocket mice and kangaroo rats, store dry seeds in burrows so the seeds will absorb water from the soil to increase water intake. Others may be active only at night when relative humidity is higher and temperatures are lower. Still others get their moisture from dew or moist foods. All of them are extremely efficient at recovering water from their digestive and excretory tracts.

ASK the members to compare how they regulate their temperature on hot days or when they are very active to the way a dog handles the problem. NOTE that panting and sweating are both evaporative cooling processes. REFER to Activity 9.2 *Wet and Dry* to demonstrate evaporative cooling. Wallowing by pigs and other animals is also evaporative cooling. NOTE that the large ears of jackrabbits are used as radiators, exposing their blood vessels to cooler air to reduce body temperature under hot conditions.

NOTE that large desert or savannah animals like elephants, oryx, or camels allow their body temperatures to rise during the day and radiate the heat back to the atmosphere at night, saving tremendous amounts of water and energy. Some desert animals even have a radiator of sorts in their noses, cooling their brain and recovering water from their breath.

Larger animals may store water in tissues, extracting fluids from some tissues to support vital functions. This allows them to tolerate much higher levels of dehydration. Camels, for example, selectively extract water from “nonessential” tissues, like bone or muscle, to maintain their blood fluid. They can tolerate dehydration as high as 25 percent of their body weight without apparent ill effects and rehydrate quickly when water is available. Individual camels dehydrated by 25 percent of their body weight have been observed to drink more than 28 gallons of water in only 10 minutes, restoring their tissue reserves. A human being suffering less than half that loss would suffer a series of events leading to heat stroke and death. The blood would become so viscous (thick and syruplike) that it would not move through the circulatory system, but would simply slosh back and forth with the beating of the heart. Temperatures would spike rapidly, followed by heat stroke, loss of consciousness and death.

Humans and most livestock are adapted to relatively moist conditions. People often attempt to modify existing environments to create those needed for our survival and comfort. Water is among the most basic of the requirements we have for survival, and it is required constantly. Most livestock is similarly adapted. Native animals are adapted either to get their water from food or to travel to water sources as needed. Some of their adaptations may seem odd to human observers, but solving the problem of having enough water (but not too much) is the key. Without adequate water, no living things survive.

## For Further Thought

1. Have participants search for information on various animals adapted to different environments, suggest the water balance/osmotic balance or temperature regulation problems they might face, and explore adaptations that permit them to solve those challenges.
2. Pose a situation with environmental conditions that would stress a hypothetical animal and have the participants suggest mechanisms that would be helpful in meeting those challenges. Follow up with a critical review of all suggestions by the group. Note that all discussion should be about the ideas, not about the persons coming up with them. Further, all suggestions should be recorded even if they appear to be unworkable at the surface. The group should behave as design engineers with the ability to accomplish the notions they put forward.

REMINDE members that water loss on a hot summer day could be more than a quart per hour, with critical water loss taking less than one day under some circumstances. Even under cool conditions, most people could not survive more than a few days without water. ENCOURAGE them to think about why people might survive only 5 days or less without water.

DISCUSS the fact that some desert rodents may not drink during their adult lives, getting all the water they need from metabolic water and water in their food.

STATE that camels can tolerate dehydration of two or three times the level people are able to tolerate. EXPLAIN rehydration and compare camels to humans.

## Summary Activity

Conduct any of the following activities and lead a group discussion about implications for participants or other living things, or have participants observe a wild or domestic animal to determine how it obtains water, how it cools itself under heat stress, and any behavioral heating/cooling mechanisms they can see.

OR

Hold a water and animals quiz bowl or baseball game where teams establish a “batting order” and the “batter” gets a question that is graded from a single to a home run on the basis of its difficulty. (Alternatively you may wish to allow the “batters” to select a difficulty level.) Wrong answers should be outs, but should have the right answer given. Good answers advance the runners as they would in baseball. The teams play as many “innings” as you and they decide.

## Sharing or Exhibit Suggestions

1. Prepare a poster, exhibit or illustrated talk on the use of water by a selected animal species. Display or present your exhibit or talk to an appropriate audience.
2. Prepare an exhibit or talk about a native species that is adapted to arid (dry) conditions and present that exhibit or talk to an appropriate audience.
3. Observe a dog, cat or bird and an aquarium fish. Outline their similarities and differences with respect to water availability, osmotic balance, nitrogenous waste removal, temperature regulation and any other items of interest. Use the outline to describe the challenges met by those species in survival. Share your findings with someone.
4. Do your own thing. Investigate a question you might have about water use by animals and present your findings to others, either one-on-one or in a group setting.



## How Watery Are You?



The average adult consumes and excretes about  $2\frac{1}{2}$  to 3 quarts of water each day.

### Equipment/Materials

bathroom scale or similar weighing device	pencil
10 to 12 empty gallon jugs	paper
Choice of Record Sheets 9.1	water

### Procedure

*The procedure outlined below is for the most simple approach to the mathematical problem. More advanced students may apply algebraic relationships, fractions or decimal equivalents. Select one of the two Record Sheets that fits your students.*

1. Have each student in the class weigh himself or herself.
2. Multiply the weight by 2.
3. Divide this answer by 3. This will tell how many pounds of water are in each student's body.
4. A quart of water weighs 2 pounds, so divide your last answer by 2.
5. Four quarts are in a gallon, so divide again by 4.
6. This will tell you how many gallons of water are in student's body.
7. Have each student fill up gallon jugs with water to represent the amount of water in their body.
8. Have students calculate how many pounds of their body is not water. Have students calculate this number as a percent of their body weight.





# How Watery Are You?

## Handout 1



A fluid loss of more than 10 percent of body weight can be fatal in a young child. For a 10-pound infant, that is only 1 pound!

How can you find out how much water is in your body? If the average person in your age group has a mass of water equal to about  $\frac{2}{3}$  (66.66... percent) of his or her body weight, the volume and mass of water can be calculated fairly easily. Let's find out!

1. Weigh yourself on the scale provided and record the weight: \_\_\_\_\_ pounds
  
2. Multiply your weight by 2: \_\_\_\_\_ pounds x 2 = \_\_\_\_\_ pounds
  
3. Divide the product from step 2 by 3: \_\_\_\_\_ ÷ 3 = \_\_\_\_\_ pounds  
(This tells you how many pounds of water are in your body!)
  
4. Each quart of water weighs approximately 2 pounds (2.08 pounds). The number of quarts of water can be found by dividing the answer from step 3 by 2:  
\_\_\_\_\_ pounds ÷ 2 pounds per quart = \_\_\_\_\_ quarts
  
5. To determine the number of US gallons that makes, divide that answer by the number of quarts per gallon (4):  
\_\_\_\_\_ quarts ÷ 4 quarts per gallon = \_\_\_\_\_ gallons
  
6. Determine the weight of your body that is not represented by water. (Hint: Subtract the weight that is water from your weight.)  
\_\_\_\_\_ pounds (step 1) - \_\_\_\_\_ pounds (step 3) = \_\_\_\_\_ pounds
  
7. Calculate the percentage of your body that is not water by dividing the answer from step 6 by your total weight and multiplying by 100.  
\_\_\_\_\_ pounds ÷ \_\_\_\_\_ pounds = \_\_\_\_\_ x 100 = \_\_\_\_\_ %.
  
8. If each person should drink about six to eight glasses (8 fluid ounces each) of water daily, how many quarts of water should you drink each day? (There are 32 fluid ounces in a quart.)
  - a. 6 x 8 fl.oz. = \_\_\_\_\_ fl.oz.      b. 8 x 8 fl. oz. = \_\_\_\_\_ fl. oz.
  - \_\_\_\_\_ or \_\_\_\_\_ fl.oz. ÷ 32 fl.oz. per quart = \_\_\_\_\_ or \_\_\_\_\_ quarts
  - \_\_\_\_\_ or \_\_\_\_\_ quarts x 2 pounds per quart = \_\_\_\_\_ or \_\_\_\_\_ pounds





# How Watery Are You?

## Handout 2



A fluid loss of more than 10 percent of body weight can be fatal in a young child. For a 10-pound infant, that is only one pound!

How can you find out about how much water is in your body? If the average person in your age group has a mass of water equal to about 66.66... percent of his or her body weight, the volume and mass of water can be calculated fairly easily. Let's find out!

1. Weigh yourself on the scale provided and record the weight: \_\_\_\_\_ pounds
2. Multiply your weight by 0.6666...: \_\_\_\_\_ pounds x 0.6666 = \_\_\_\_\_ pounds  
(This tells you how many pounds of water are in your body!)
3. Since each quart of water weighs approximately 2.08 pounds, the number of quarts of water can be found by dividing the answer from 2 by 2.08:  
\_\_\_\_\_ pounds ÷ 2.08 pounds/quart = \_\_\_\_\_ quarts
4. The number of US gallons can be determined by dividing the number of quarts by the number of quarts per gallon (4):  
\_\_\_\_\_ quarts ÷ 4 quarts/gallon = \_\_\_\_\_ gallons
5. Determine the weight of your body not represented by water by subtracting the water weight from the total weight  
\_\_\_\_\_ pounds (total) - \_\_\_\_\_ pounds (water) = \_\_\_\_\_ pounds (not water)
6. Calculate the weight of your body not represented by water by multiplying total weight by the percentage of your body not represented by water (100 - 66.66...).  
\_\_\_\_\_ pounds x \_\_\_\_\_ = \_\_\_\_\_ pounds (not water)
7. Were these amounts exactly the same? Why not?  
(This small difference comes from rounding error. It gets smaller as the decimal is carried to more places.)
8. The recommended daily intake of water is at least 1½ to 2 quarts. A quart contains 32 fluid ounces (16 fl. oz. in a pint). How many 8-fl. oz. glasses of water are required to reach the recommended amount?



## Wet and Dry



People can lose as much as 1.4 percent of their body weight in water every hour they are exposed to the sun in a hot Southwestern desert!

This exercise demonstrates the effect of evaporative cooling while using a direct method of measuring relative humidity.

### Equipment/Materials

thermometers (two)\*      string or two rubber bands  
cotton T-shirt material      water  
small container      note paper and pencil

\* sling psychrometer is excellent if available

### Procedure

1. Select a pair of alcohol or mercury thermometers (or a sling psychrometer) with accurate, easy-to-read scales (Celsius thermometers preferred).
2. Wrap the bulb of one of the thermometers with one or two layers of light cotton material and secure it in place with a couple of rubber bands or string. This will be the wet bulb thermometer.
3. Set a small amount of lukewarm water in the shade and allow it to reach air temperature.
4. Set the thermometers in the same area and allow them to reach air temperature.
5. Have group members record the temperatures of the two thermometers.

***They should be the same temperature.***

6. Apply a few drops of water to the cotton wicking on the prepared thermometer or the “wet bulb” of the sling psychrometer.
7. Move the thermometers rapidly through the air for a minute or two, being careful not to hit them or lose your grip on them. With the sling psychrometer, simply swing it in circles rapidly with wrist motion.
8. Immediately read the temperatures of the two thermometers.

***The wet bulb should read lower than the dry bulb.***

9. Record the temperatures on a data sheet.
10. Ask the group why the wet thermometer had a lower temperature than the dry one.

***As the thermometers were whirled through the air, the water on the wicking material evaporated, lowering the temperature of the thermometer’s bulb and causing it to read a lower temperature.***

11. Calculate the difference between the wet bulb and the dry bulb thermometers.
12. If desired, use the following table to determine the relative humidity of the air.



# Table of Dry Bulb Temperature, Wet Bulb Temperature, and Relative Humidity

Td = dry bulb temperature, Tw= wet bulb temperature, Td-Tw= difference between wet and dry bulb readings

Td	-----Td-Tw-----																														
Td	0.5	1.0	1.5	2.0	2.5	3.0	3.5	4.0	4.5	5.0	5.5	6.0	7.0	8.0	8.5	9.0	9.5	10.0	10.5	11.0	11.5	12.0	12.5	13.0	13.5	14.0	14.5	15.0	15.5	16.0	14.5
-10	84	67	57	35	25																										
-9	85	69	54	39	24	9																									
-8	86	71	57	43	29	15																									
-7	87	73	60	46	34	20	8																								
-6	88	74	62	49	38	25	13																								
-5	88	76	64	52	41	29	18	7																							
-4	89	77	66	55	44	33	23	12																							
-3	89	78	68	57	47	37	27	17	8																						
-2	90	79	70	60	50	40	31	22	12																						
-1	90	81	71	62	53	43	35	26	17	8																					
0	91	81	73	64	55	46	38	29	21	13	5																				
1	92	83	74	66	58	49	42	33	25	17	10																				
2	92	84	76	68	60	52	44	37	29	22	14	7																			
3	92	84	77	70	62	55	48	40	33	26	19	12	5																		
4	92	85	78	71	64	57	50	43	36	29	22	16	9																		
5	92	86	78	72	66	58	52	45	39	33	26	20	13	7																	
6	93	86	80	73	66	60	54	48	41	35	29	24	17	11	5																
7	94	87	80	74	68	62	56	50	44	38	32	26	21	15	10																
8	94	87	81	75	69	63	57	51	46	40	35	29	24	19	14	8															
9	94	88	82	76	70	64	59	53	48	42	37	32	27	22	17	12	7														
10	94	88	82	77	71	66	60	55	50	44	39	34	29	24	20	15	10	6													
11	94	89	83	78	72	67	61	56	51	46	41	36	32	27	22	18	13	9	5												
12	94	89	84	78	73	68	63	58	53	48	43	39	34	29	25	21	16	12	8												
13	94	89	86	79	74	69	64	59	54	50	45	41	36	32	28	23	19	15	11	7											
14	95	90	85	79	75	70	65	60	56	51	47	42	38	34	30	26	22	18	14	10	6										
15	95	90	85	80	75	71	66	61	57	53	48	44	40	36	32	27	24	20	16	13	9	6									
16	95	90	85	81	76	71	67	63	58	54	50	46	42	38	34	30	26	23	19	15	12	8									
17	95	90	86	81	76	72	68	64	60	55	51	47	43	40	36	32	28	25	21	18	14	11	8								
18	95	91	86	82	77	73	69	65	61	57	53	49	45	41	38	34	30	27	23	20	17	14	10	7							
19	95	91	87	82	78	74	70	65	62	58	54	50	46	43	39	36	32	29	26	22	19	16	13	10	7						
20	96	91	87	83	78	74	70	66	63	59	55	51	48	44	41	37	34	31	28	24	21	18	15	12	9	6					
21	96	91	87	83	79	75	71	67	64	60	56	53	49	46	42	39	36	32	29	26	23	20	17	14	12	9	6				
22	96	92	87	83	80	76	72	68	64	61	57	54	50	47	44	40	37	34	31	28	25	22	19	17	14	11	8	6			
23	96	92	88	84	80	76	72	69	65	62	58	55	52	48	45	42	39	36	33	30	27	24	21	19	16	13	11	8	6		
24	96	92	88	84	80	77	73	69	66	62	59	56	53	49	46	43	40	37	34	31	29	26	23	20	18	15	13	10	8	5	
25	96	92	88	84	80	77	74	70	67	63	60	57	54	50	47	44	41	39	36	33	30	28	25	22	20	17	15	12	10	8	
26	96	92	88	85	81	78	74	71	67	64	61	58	54	51	49	46	43	40	37	34	32	29	26	24	21	19	17	14	12	10	5
27	96	92	89	85	82	78	75	71	68	65	62	58	56	52	50	47	44	41	38	36	33	31	28	26	23	21	18	16	14	12	7
28	96	93	89	85	82	78	75	72	69	65	62	59	56	53	51	48	45	42	40	37	34	32	29	27	25	22	20	18	16	13	9
29	96	93	89	85	82	79	76	72	69	66	63	60	57	54	52	49	46	43	41	38	36	33	31	28	26	24	22	19	17	15	11
30	96	93	89	85	83	79	76	73	70	67	64	61	58	55	52	50	47	44	42	39	37	35	32	30	28	25	23	21	19	17	13
31	96	93	90	86	83	80	77	73	70	67	64	61	59	56	53	51	48	45	43	40	38	36	33	31	29	27	25	22	20	18	14
32	96	93	90	86	83	80	77	74	71	68	65	62	60	57	54	51	49	46	44	41	39	37	35	32	30	28	26	24	22	20	16
33	97	93	90	87	83	80	77	74	71	68	66	63	60	57	55	52	50	47	45	42	40	38	36	33	31	29	27	25	23	21	17
34	97	93	90	87	84	81	78	75	72	69	66	63	61	58	56	53	51	48	46	43	41	39	37	35	32	30	28	26	24	23	18
35	97	94	90	87	84	81	78	75	72	69	67	64	61	59	56	54	51	49	47	44	42	40	38	36	34	32	30	28	26	24	20
36	97	94	90	87	84	81	78	75	73	70	67	64	62	59	57	54	52	50	48	45	43	41	39	37	35	33	31	29	27	25	21
37	97	94	91	87	84	82	79	76	73	70	68	65	63	60	58	55	53	51	48	46	44	42	40	38	36	34	32	30	28	26	23
38	97	94	91	88	84	82	79	77	74	71	68	66	63	61	58	56	54	51	49	47	45	43	41	39	37	35	33	31	29	27	24
39	97	94	91	88	85	82	79	77	74	71	69	66	64	61	59	57	54	52	50	48	46	43	42	39	38	36	34	32	30	28	25
40	97	94	91	88	85	82	80	77	74	72	69	67	64	62	59	57	54	53	51	48	46	43	42	40	38	36	35	33	31	29	26

Read relative humidity from the scale.  
All data are in Celsius degrees.

## Wet and Dry



### Record the following:

Dry Bulb Temperature \_\_\_\_\_ °C      Wet Bulb Temperature \_\_\_\_\_ °C

Difference (Dry - Wet) \_\_\_\_\_ °C      Relative Humidity \_\_\_\_\_ %

1. How did the water evaporating from the dampened thermometer affect the temperature of that thermometer?
2. Why does the temperature difference reflect the relative humidity or the amount of water in the air?
3. How cool would it feel to a person on a 30°C day if he or she were saturated with perspiration and the relative humidity was at 50 percent?
4. Why do you think that would be so?
5. Would evaporative cooling be more effective in the desert with a relative humidity of 15 percent or near the coast with a relative humidity of 90 percent? Why?

# Table of Dry Bulb Temperature, Wet Bulb Temperature, and Relative Humidity

Td = dry bulb temperature, Tw = wet bulb temperature, Td - Tw = difference between wet and dry bulb readings

Td	-----Td-Tw-----																																
	0.5	1.0	1.5	2.0	2.5	3.0	3.5	4.0	4.5	5.0	5.5	6.0	7.0	8.0	8.5	9.0	9.5	10.0	10.5	11.0	11.5	12.0	12.5	13.0	13.5	14.0	14.5	15.0	15.5	16.0	14.5		
-10	84	67	57	35	25																												
-9	85	69	54	39	24	9																											
-8	86	71	57	43	29	15																											
-7	87	73	60	46	34	20	8																										
-6	88	74	62	49	38	25	13																										
-5	88	76	64	52	41	29	18	7																									
-4	89	77	66	55	44	33	23	12																									
-3	89	78	68	57	47	37	27	17	8																								
-2	90	79	70	60	50	40	31	22	12																								
-1	90	81	71	62	53	43	35	26	17	8																							
0	91	81	73	64	55	46	38	29	21	13	5																						
1	92	83	74	66	58	49	42	33	25	17	10																						
2	92	84	76	68	60	52	44	37	29	22	14	7																					
3	92	84	77	70	62	55	48	40	33	26	19	12	5																				
4	92	85	78	71	64	57	50	43	36	29	22	16	9																				
5	92	86	78	72	66	58	52	45	39	33	26	20	13	7																			
6	93	86	80	73	66	60	54	48	41	35	29	24	17	11	5																		
7	94	87	80	74	68	62	56	50	44	38	32	26	21	15	10																		
8	94	87	81	75	69	63	57	51	46	40	35	29	24	19	14	8																	
9	94	88	82	76	70	64	59	53	48	42	37	32	27	22	17	12	7																
10	94	88	82	77	71	66	60	55	50	44	39	34	29	24	20	15	10	6															
11	94	89	83	78	72	67	61	56	51	46	41	36	32	27	22	18	13	9	5														
12	94	89	84	78	73	68	63	58	53	48	43	39	34	29	25	21	16	12	8														
13	94	89	86	79	74	69	64	59	54	50	45	41	36	32	28	23	19	15	11	7													
14	95	90	85	79	75	70	65	60	56	51	47	42	38	34	30	26	22	18	14	10	6												
15	95	90	85	80	75	71	66	61	57	53	48	44	40	36	32	27	24	20	16	13	9	6											
16	95	90	85	81	76	71	67	63	58	54	50	46	42	38	34	30	26	23	19	15	12	8											
17	95	90	86	81	76	72	68	64	60	55	51	47	43	40	36	32	28	25	21	18	14	11	8										
18	95	91	86	82	77	73	69	65	61	57	53	49	45	41	38	34	30	27	23	20	17	14	10	7									
19	95	91	87	82	78	74	70	65	62	58	54	50	46	43	39	36	32	29	26	22	19	16	13	10	7								
20	96	91	87	83	78	74	70	66	63	59	55	51	48	44	41	37	34	31	28	24	21	18	15	12	9	6							
21	96	91	87	83	79	75	71	67	64	60	56	53	49	46	42	39	36	32	29	26	23	20	17	14	12	9	6						
22	96	92	87	83	80	76	72	68	64	61	57	54	50	47	44	40	37	34	31	28	25	22	19	17	14	11	8	6					
23	96	92	88	84	80	76	72	69	65	62	58	55	52	48	45	42	39	36	33	30	27	24	21	19	16	13	11	8	6				
24	96	92	88	84	80	77	73	69	66	62	59	56	53	49	46	43	40	37	34	31	29	26	23	20	18	15	13	10	8	5			
25	96	92	88	84	80	77	74	70	67	63	60	57	54	50	47	44	41	39	36	33	30	28	25	22	20	17	15	12	10	8			
26	96	92	88	85	81	78	74	71	67	64	61	58	54	51	49	46	43	40	37	34	32	29	26	24	21	19	17	14	12	10	5		
27	96	92	89	85	82	78	75	71	68	65	62	58	56	52	50	47	44	41	38	36	33	31	28	26	23	21	18	16	14	12	7		
28	96	93	89	85	82	78	75	72	69	65	62	59	56	53	51	48	45	42	40	37	34	32	29	27	25	22	20	18	16	13	9		
29	96	93	89	85	82	79	76	72	69	66	63	60	57	54	52	49	46	43	41	38	36	33	31	28	26	24	22	19	17	15	11		
30	96	93	89	85	83	79	76	73	70	67	64	61	58	55	52	50	47	44	42	39	37	35	32	30	28	25	23	21	19	17	13		
31	96	93	90	86	83	80	77	73	70	67	64	61	59	56	53	51	48	45	43	40	38	36	33	31	29	27	25	22	20	18	14		
32	96	93	90	86	83	80	77	74	71	68	65	62	60	57	54	51	49	46	44	41	39	37	35	32	30	28	26	24	22	20	16		
33	97	93	90	87	83	80	77	74	71	68	66	63	60	57	55	52	50	47	45	42	40	38	36	33	31	29	27	25	23	21	17		
34	97	93	90	87	84	81	78	75	72	69	66	63	61	58	56	53	51	48	46	43	41	39	37	35	32	30	28	26	24	23	18		
35	97	94	90	87	84	81	78	75	72	69	67	64	61	59	56	54	51	49	47	44	42	40	38	36	34	32	30	28	26	24	20		
36	97	94	90	87	84	81	78	75	73	70	67	64	62	59	57	54	52	50	48	45	43	41	39	37	35	33	31	29	27	25	21		
37	97	94	91	87	84	82	79	76	73	70	68	65	63	60	58	55	53	51	48	46	44	42	40	38	36	34	32	30	28	26	23		
38	97	94	91	88	84	82	79	77	74	71	68	66	63	61	58	56	54	51	49	47	45	43	41	39	37	35	33	31	29	27	24		
39	97	94	91	88	85	82	79	77	74	71	69	66	64	61	59	57	54	52	50	48	46	43	42	39	38	36	34	32	30	28	25		
40	97	94	91	88	85	82	80	77	74	72	69	67	64	62	59	57	54	53	51	48	46	43	42	40	38	36	35	33	31	29	26		

Read relative humidity from the scale.  
All data are in Celsius degrees.



# Aquatic Ecosystems

## Objectives

1. Identify the main components of food webs.
2. Identify major elements in aquatic habitat structure.
3. Describe how water quality affects aquatic habitat.
4. Identify organisms that live in and around water.
5. Explore adaptations of aquatic organisms.
6. Have fun while learning.

## Materials/Equipment

See individual activities.

## Lesson Requirements

**Best Time:** Any time of year, but more aquatic life is evident in spring, summer, and early fall.

**Best Location:** Any safe setting where young people can work in small groups. Optional field trip site of a pond, stream, stock tank or other place where aquatic life can be observed.

**Time Required:** 30 minutes, 1 to 1½ hours needed for Activity 10.1 *Water Creatures*

## Vocabulary

benthic	eutrophication	streamlined
bioaccumulation	herbivores	substrate
camouflage	inferior	superior
carnivores	laminar	surface film
consumers	nymphs	terminal
decomposes	omnivores	thermal
ecosystem	pelagic	trophic
eddy	producers	
emergent	riffle	

## Resources

Consider inviting a representative from your local Soil and Water Conservation District, Texas Cooperative Extension, the Natural Resources Conservation Service, the Texas Natural Resources Conservation Commission, or Texas Parks and Wildlife to assist in this lesson and the recommended field trip. Other local expertise may be available through youth groups or other teachers. Ask the representative to lead a discussion on the importance of water quality to aquatic life and to humans. The field trip option included (Activity 10.1 *Water Creatures*) provides an exciting and powerful reinforcement for this lesson. It may be used either before the lesson or as a summary activity. Local professionals or experts, along with the guide and the recommended references, provide

## Lesson Overview

- I. Aquatic Habitats
  - A. Types of water bodies
  - B. Water flow
  - C. Substrate
  - D. Water organisms
    1. Bottom dwellers
    2. Midlevel dwellers
    3. Surface and shallow water dwellers
- II. Water Quality Factors
  - A. Temperature
  - B. Dissolved oxygen
  - C. Clarity or turbidity
  - D. Water chemistry
  - E. Nutrient sources
- III. Food Webs and Food Chains
  - A. Interactions of organisms
    1. Producers
    2. Consumers
    3. Decomposers
  - B. Role of Water

support for collecting and identifying aquatic organisms, understanding their habitats, adaptations, and places in local food webs.

## Lesson Background

### I. Aquatic Habitats

Aquatic organisms are adapted to a wide variety of habitats. Many factors are involved in defining aquatic habitat, including the type of water body, the presence or absence and amount of water flow, portion of the water body used by an organism, water quality and sources of nutrients in the system.

#### Types of Water bodies

The type of water body includes its persistence, from ephemeral to permanent. Ephemeral water bodies exist for a limited period of time, usually measured in days, weeks or seasons. They may be small, like periodic puddles or pools in rocky depressions, or large, like the seasonal flood waters of great river basins. Periodic puddles may support animals like fairy shrimp or fast growing tadpoles (like those of spadefoot toads). Vernal pools or flooded rice fields may support many other animals or slower growing life stages of certain animals or plants. Permanent water exists in many forms: wetlands like marshes and swamps, ponds, lakes, streams and rivers, estuaries and lagoons, coastal or inshore saltwater environments, and open oceans or seas. Each of these has characteristics that allow an array of organisms to occupy them.

#### Water flow

The combination of water flow and **substrate** (bottom character) is strongly interrelated and it impacts the types of plants and animals found in any given place. Still waters (lentic habitats) are more likely to have mud, silt or sand bottoms, providing habitat for stillwater species, burrowing animals, **emergent** vegetation, and organisms that use surface tension to exploit the water's surface. Moving waters (lotic habitats) show variable influences of the currents. Pools in streams or rivers represent a transition between still water and the more swiftly moving water of **riffles** or rapids. Bays and estuarine habitats are similar to pools in rivers or to lakes with major currents, while river mouths and inlets are often much like rivers during tide changes. (Lagoons, like the lower Laguna Madre on the Texas coast, may have very low flow and very high salinity.) Species living in rapids or riffle habitats must be adapted to cope with the movement of the water, but they benefit from food being carried past them and from higher oxygen levels because turbulence mixes air into the water. These species may be adapted to find shelter among the coarser bottom materials, to cling to the substrate, or to swim against strong currents. Plunge pools represent a mixture of adaptations, because they have both pool and riffle characteristics of relatively low flow rates, but highly oxygenated water.

All of these habitats have species that are found primarily on the bottom with the cover and shelter it provides (**benthic** species) and species that range throughout the water column (**pelagic** species).

### Applications

Ask participants to NAME factors that affect aquatic plants and animals.

Lead participants to DEFINE types of water bodies used by living things and to SPECULATE on how the type of water body affects the types of plants and animals living there and their life cycles.



Even pelagic species, however, take advantage of any eddy or break in the current to reduce their energy use. They may use areas with strong turbulence as feeding stations, capturing prey that is swept to them. In strong currents, they frequently hold on or near the bottom where current flows are lightest. Water tends to behave as though it is flowing in smooth layers or sheets, with each layer sliding over the one beneath it. This phenomenon is known as **laminar** flow, and the slowest currents (as well as small eddies) are found near the bottom.

### **Substrate**

Water flow tends to dictate the type of substrate or bottom material within the range made available by the soils and geology of the area. Thus, tiny particles of soil, like clay or silt, are very likely to be swept away by swift currents, while sand, gravel, large rocks or boulders are likely to require successively stronger currents to move them. Under extreme conditions, house-sized boulders can be carried downstream for miles. Normally, however, they do not move very much once they are deposited. Where bedrock is relatively close to the surface, river or stream bottoms may be scoured to the bedrock level by heavy flows. Normally, one would expect to find larger rocks in rapids, riffles, or at the heads of pools and finer material would be common in the middle sections of pools. As the current picks up speed at the tail (downstream end) of pools, the substrate material tends to become coarser (sand, gravel or smaller stones) once again. In watersheds where deep soils are common and gradients (the amount it descends for any given length of flow) in streams are gentle to moderate, bottoms tend to be composed of smaller pieces of parent material and deposited soil.

### **Water organisms**

Location in the water body also affects the types of plants or animals that might be found. Benthic organisms (those that live on the bottom) include rooted plants or animals adapted to clamber over and around the substrate, to burrow into the bottom sediments, or to fasten themselves to the substrate in some fashion. Many species of mayflies and stoneflies are excellent clamberers, as are riffle beetle larvae and water pennies. Some mayflies and other organisms (mussels, for example) burrow into bottom sediments for protection. Many species of caddisflies build tubes of sand grains, pebbles or vegetation, either attached to rocks or as mobile homes. Some free-living caddisflies build nets to capture drifting prey. Midge or fly larvae may attach themselves to rock surfaces with silk strands or use clasping organs. In slower sections or still waters, damselfly or dragonfly naiads or **nymphs** can be found on the bottom or on vegetation. Fishes that spend most of their time on or near the bottom are often flattened from top to bottom (like flounder) or equipped with an **inferior** (below the end of the head) mouth that makes feeding on the bottom easier. This development can be seen in suckers, carp, sturgeon and similar fishes. Bottom dwellers often show **camouflage** or cryptic coloration and patterns, which conceals them from either predator or prey. In fact, flounders are much better at matching their background than are chameleons.

ASK participants if they have ever observed the flow of water around a rock or some other obstacle (or use Activity 10.2 *Currents and Eddies*). LEAD them to describe the flow pattern, and to conclude that the obstacles create sheltered areas where animals and plants can avoid most currents while getting the benefit of higher oxygen levels and current-borne foods [*For more advanced participants, consider introducing the concept of laminar flow, the appearance of water moving in smooth layers with the slowest ones at the bottom and progressively faster current toward the top of the water column.*]

CHALLENGE participants to consider how soil types in the watershed could affect the bottom materials found in water bodies. REFER to earlier activities to show how current speed or strength influences the types of material that are moved or allowed to deposit on the bottom. Lead the young people to CONCLUDE that current speed and watershed characteristics strongly affect the substrate types available. NOTE that the bottom characteristics strongly influence the types of plants and animals found in any location.

Midwater levels are occupied by plants and animals adapted to an open water or pelagic existence. Tiny plants and animals—plankton—move up and down in the water column on a daily cycle but generally drift with prevailing currents. Pelagic fishes, like white bass, travel in schools pursuing schooling prey in open waters. Counter shading (dark on the back and lighter on the sides and belly) and silvery appearance are common in pelagic fishes. Most pelagic species have a **terminal** mouth (one located on the front of the head). The active swimmers tend to be very **streamlined** in shape, reducing their energy expense of moving swiftly through the water. Saltwater species like tuna and billfish are outstanding examples of this feature.

Organisms that live on or near the surface have another set of adaptations. Some, like water striders, whirligig beetles, mosquito larvae, duckweed and water hyacinth, float on the **surface film**. The waterstrider and whirligig beetle skate or surf on the film, capturing prey on the surface of the water. They are usually found in calm waters where the surface is relatively smooth. Mosquito larvae and pupae have breathing tubes that reach the surface and allow them to breathe air while floating just beneath the surface. Like the other species mentioned here, they do best in still waters. Duckweed (*Lemna*, *Spirodela*, or *Wolffia*) and water hyacinth are true floating plants with root systems that trail in the water beneath them. In rich, calm waters duckweed can make the surface look like a bright pea soup. Hyacinths can clog waterways, particularly where nutrient levels are high during warm periods of the year. These beautiful, but noxious, plants have invaded much of the southern United States by hitching rides on currents and boats.

In shallow waters, emergent plants may be very common. Some emergents grow best when partially submerged all the time. Cattails, reeds, pondweed, pickerel weed and water lilies are examples. Others, like some grasses (rice, reed canary grass), sedges, buttonbush or water-tolerant trees like willow or water oak, tolerate being submerged or flooded for part of the year. These plants often form a special habitat for animals that prefer dense cover or for semi-aquatic animals like frogs, muskrat, nutria, beaver, mink or otter.

Other plants may occur down to the limits of light penetration in the water. Algae and submerged aquatic plants are common in many slow or still waters. Although some algae form floating mats, they need not emerge from the water to reproduce. The rooted flowering plants, often erroneously called “moss” or “grass” by anglers and boaters, set flowers and seeds after they have grown to the surface. Many of them also reproduce by having broken pieces take root when they locate suitable habitat.

Shallow waters are home to a wide variety of predators and prey. Many of them display vertical bars or streaks or spotted or netlike patterns that help conceal them in vegetated waters. These animals are usually ambush predators, waiting until a suitable prey comes close enough to be captured by a sudden rush or strike. Bass and other sunfish, pickerel, gar, water scorpions, dragonfly and damselfly nymphs, and crustaceans like scuds and crayfish are common

Lead the group to CONSIDER some adaptations of bottom dwelling organisms, e.g., flattened bodies (like flounder or some mayfly nymphs), mouths on the bottom of the head (like suckers, carp or freshwater drum), use shelter (like burrowing mayfly nymphs or crayfish), or camouflaged body coloration.

CONSIDER some of the adaptations of pelagic organisms, like reflective sides, counter-shading (being dark on the back and lighter on the sides and belly), streamlined body shape, strong swimming or drifting ability, terminal mouths (mouth at end of head).

CITE local examples, like those listed. Lead young people to IDENTIFY some of the adaptations that allow these plants and animals to use the surface film of the water. NOTE that the floating vegetation extracts its nutrients from the water, mosquito larvae and pupae have a breathing tube that reaches the surface, and water striders and whirligig beetles are able to “skate” on the surface film as they forage.

ENCOURAGE participants to identify emergent vegetation they have observed, including both plants that tolerate “wet feet” and those that are able to survive year round with portions of the plant under water.

NOTE that the complex algae need not emerge from the surface, but that most rooted aquatic plants develop flowers and seeds once they have grown to the surface. These plants often are referred to erroneously as “moss” or “grass” by anglers or boaters.

NOTE that many fish and insects live in shallow or near surface waters in the cover of plant growth. These animals are often camouflaged to blend in with vertically arranged patterns of plant stems. They frequently act as ambush predators, waiting until prey comes close enough to be captured with a sudden lunge.

in shallow waters. Many juvenile fishes, tadpoles, salamander larvae and other larval animals live in shallow waters.

The surface film provides a banquet table for specialized predators like mosquito fish and water striders. The mosquito fish has a superior mouth (above the end of the head) that allows it to feed on the surface easily. The archer fish, an Asian species, actually cruises along just under the water's surface until prey is located. It shoots a stream of water to knock the prey into the water, then takes it from the surface.

## II. Water Quality Factors

Water quality has a powerful impact on the structure of aquatic communities. Temperature and temperature change, oxygen availability, water clarity and water chemistry are all important factors in water quality.

### Temperature

All plants and animals are adapted to a range of temperatures. Within their range of tolerance, they are most efficient within a smaller range of preferred temperatures. Since most aquatic organisms are poikilothermic (cold-blooded), their body processes change rates as the temperature of the water changes. In most cases, the rates decrease if the temperature is either above or below an optimum range. Adapted to water, where temperature changes are relatively slow, many aquatic animals are shocked by sudden changes in temperature. This **thermal shock** can stun or kill the animals affected. In addition to thermal shock, some species, particularly those adapted to cool or cold water, may be killed by temperatures above their tolerance range. Many trout, for example, cannot stand temperatures above approximately 70 degrees F.

### Dissolved oxygen

Temperature is one of the factors that determines the amount of dissolved oxygen available in the water. As water warms, its ability to hold oxygen decreases. Decreased oxygen availability and increased oxygen demand by organisms often result in oxygen depletion. Many sensitive species, including most fish, die when dissolved oxygen levels plummet. Biological oxygen demand (BOD) is a measure of the oxygen needed to decompose organic material in the water. It is frequently measured as an indicator of water quality. When oxygen demand is high, it can contribute to reduction of oxygen in the water for other living things, resulting in death of fish or other organisms. Wind is also a factor in oxygen availability. Turbulence on the surface mixes oxygen into the surface waters through wave action. Fish kills or total kills of all living things can occur when high water temperature, low light penetration, minimal surface mixing and high oxygen demand are combined. At the end of a heavy algal bloom on a warm, still summer day, summer kills can be serious problems in ponds. These fish die-offs can be reduced significantly by aerating ponds or by creating man-made turbulence by simply pumping water out and allowing it to fall back into the pond.

NOTE that most aquatic organisms are adapted to a moderate range of temperatures and to relatively slow changes in temperature. Rapid temperature change can result in thermal shock, which stuns or kills animals.

REMIND young people about the relationship between water temperature and the amount of dissolved oxygen. NOTE that high water temperatures, low light penetration, and high oxygen demand may severely deplete oxygen supplies.

## Clarity or turbidity

Clear waters have fewer nutrients in them than do waters that are cloudy with suspended plankton. Increases in nutrient availability allow plankton to reproduce at a higher rate. Since these species are often the foundations of food webs in lakes or ponds, these blooms produce pulses of growth and reproduction in the animals that depend on them for food. Excessive amounts of plankton in deep lakes can result in increasing oxygen demand in cooler deep layers of the lake, even to the point of depleting those deep layers of oxygen and killing fish and other organisms dependent upon those cooler waters. Other suspended solids, like clay, silt or sand particles, block the penetration of light into the water and they can interfere with body functions in plants or animals, causing productivity to decrease sharply. Organisms differ in their tolerance for turbidity, just as they do for temperature or other factors. Black crappies, for example, require relatively clear water, but white crappies are much more tolerant of turbidity.

## Water chemistry

Water chemistry strongly influences the communities that can be present. The hardness of the water, its buffering capacity (the ability to resist changes in alkalinity or acidity), the pH (measure of acidity or alkalinity), and the presence of toxic materials are all important. In general, aquatic systems are most productive in a range from slightly acid to slightly basic conditions. Most aquatic organisms tolerate a range of acidity from mildly basic to moderately acidic, but even short pulses exceeding those limits of tolerance can be fatal to fish and other aquatic life. The most common problems are associated with acid precipitation. The acid precipitation tends to mobilize aluminum in the soils. The aluminum tends to interfere with the functioning of gill tissue on aquatic animals, causing them to die. In highly acidified waters, the availability of calcium and other chemicals may be affected, resulting in the loss of other species. Acidified lakes are often beautiful, with crystal clear water; but they have extremely limited life or no life at all.

Toxic substances can occur naturally as the result of human activities or some type of natural phenomena, e.g., volcanic activity. Some waters are relatively high in mercury or other heavy metals because the soils in the area have relatively high concentrations of those substances. Acid precipitation or other factors may mobilize the metals, but their presence is natural. In other cases, toxic materials can be the result of industrial wastes, burning of fossil fuels, agricultural practices, improper disposal or use of household or garden products, mining wastes, landfill leachates or other factors. Sensitivity to toxic materials differs among groups of living things. A chemical may kill insect larvae without harming fish or it may kill certain species of fishes and mollusks yet have a minor impact on insects. Some products kill plants with little impact on fishes. Some kill fishes with little impact on other kinds of organisms.

One of the major problems with toxic materials is their misuse. Dose rates that may be quite safe for land application can have disastrous effects if they get into the water. Thanks to legislation

Ask participants to PROPOSE things that could make water turbid (less clear). CHALLENGE them to think about the relationship of nutrient availability and turbidity caused by plankton. If other water quality factors are adequate, will clear water or water cloudy with plankton be more productive? [*Since plankton provides a food source, the cloudy water should produce more animal life or more rapid growth than the clear water.*] NOTE that other suspended solids (like clay, silt or sand particles) can damage gills on aquatic animals.

NOTE that most aquatic organisms tolerate a range of acidity from mildly basic to moderately acidic, but that even short pulses that exceed these limits may be fatal to fish or other aquatic things.

MENTION toxic materials and the fact that sensitivity to them varies with the organisms involved. Some things that do not affect plants may kill fish or insect larvae while others may kill plants without significant effects on animals.

and responsibility, industrial and agricultural contributions to these problems have been reduced significantly in recent years. But improper disposal or use of household products, paints, cleaning agents, solvents, fertilizers and pesticides remains a major problem. Every person can contribute to reducing that problem.

### **Nutrient sources**

The nature of the nutrient source for any system also affects its structure. In relatively rich waters with minimal current, plankton and aquatic plants contribute most of the base of any food web or food pyramid. In headwaters streams or rivers, however, most of the nutrient base comes from terrestrial plants and animals in the form of detritus—decaying organic matter. Dead leaves, decaying wood and similar items are the staff of life for these systems.

## **III. Food Webs and Food Chains**

### **Interactions of organisms**

Living things are found in communities of interacting organisms. One of the most fundamental interactions—energy flow—unites organisms into food webs. A general principle states that greater numbers of links and alternative links create more stable and robust food webs. The simplest food web is a chain linking only a single species at each level. It is easy to see how that system could become unstable if one of the links were lost.

Food webs consist of **producers**, **consumers** and **decomposers**. Producers can manufacture organic foods from air, water and sunlight or by breaking down the chemical bonds in inorganic compounds. The vast majority of producers use photosynthesis to fix sunlight as organic food. Consumers cannot manufacture their own food, but they gather it by eating producers or by eating other consumers. Decomposers break down the leftovers for their remaining energy and return the chemical building blocks to the system.

Consumers are often categorized into **trophic** orders or levels removed from the producer (trophic refers to energy and energy transfer). **Herbivores** or primary consumers live primarily on plants. These animals may graze or browse on vegetation, or they may use plants in more specialized ways. For example, granivores feed primarily on seeds and frugivores eat mostly fruits. All of them are primary consumers and may be lumped as herbivores, even though one may eat wood and another may eat only tender shoots of young plants. Secondary consumers eat primary consumers. They are also known as **carnivores** or meat eaters. Some consumers, known as **omnivores**, eat both plants and animals. Others may feed higher or at several levels on the trophic pyramid. The hawk that eats small insectivorous birds is a tertiary or quaternary consumer, depending upon the types of insects the other bird is eating.

Since some energy is required to maintain life, the total amount of energy available decreases at each succeeding trophic level. As a result, there are fewer top carnivores, those organisms at the top of a food web, than there are herbivores in food webs. In an aquatic system, phytoplankton could be eaten by a zooplankton. Zooplankton could be eaten by an insect, which is eaten by a shad, which is

eaten by a crappie, which is eaten by a striped bass, which is eaten by a hungry angler. In this case, the striped bass is the top carnivore in the aquatic system, but the angler is eating higher on the trophic scale than the bass. The energy stored by millions of individual phytoplankters was funneled through hundreds of thousands of zooplankters to tens of thousands of insects, to thousands of shad to hundreds of crappies to tens of bass and to a single human. It flowed from the sun to the human through this living chain or web. Unused portions, wastes, and the decaying bodies of the plants and animals at all levels were decomposed by fungi, specialized insects and bacteria and the chemical building blocks were returned to the system and reused.

Some toxic chemicals, like methyl mercury, polychlorinated biphenols (PCB), dioxin, or DDT or DDE, that may exist at undetectable levels in the water can accumulate in a food web. These substances are usually fat-soluble materials that may concentrate in potentially dangerous levels in some species of fish or in fish-eating birds. The process, known as bioaccumulation, has resulted in many advisories about eating some types of fishes in various parts of the country, including Texas. Bioaccumulation also defies the notion that “dilution is the solution to water pollution,” since biological systems can concentrate some of the things we have tried to disperse. Keeping potentially toxic substances out of our water is vitally important to everyone.

### Role of water

Since the entire food web or trophic pyramid is made up of living things, water is vital to food webs at all levels. It is one of the basic building blocks that the system cannot do without. As a result, the quality of the water is critical to the functioning of any food web. Water quality can be affected by the quantity of water available at any given time. Floods may alter aquatic habitats, cover them with silt, kill fish with suspended solids, or create new wetlands. Flooding is critical to the health of some aquatic habitats, like the Achafalya Basin in Louisiana’s bayou country. It also replenishes the nutrients in oxbow lakes. Drought may reduce water quality by allowing waters to warm, or by simply eliminating aquatic habitat as ponds, lakes and streams dry. Pollution in the form of excessive nutrient enrichment, toxic chemicals, thermal pollution, or suspended solids can damage entire systems or result in one system being replaced by another through **eutrophication** (over-enrichment of lakes resulting in excessive production and oxygen depletion in deeper waters). Habitat alteration by humans, other animals (e.g., beavers), geological activity, forest fire or other factors can destroy, enhance or replace entire systems. As in other types of wildlife conservation, one of the greatest challenges to fishery management is loss of good quality habitat through change in water quality, quantity or flow rates.

The changes brought about by habitat alteration can be both positive and negative. A bottom release reservoir, like Canyon Lake near New Braunfels, can create a cold water fishery where none existed. Creation of a reservoir with stockings of exotic fish (like striped bass) can create a new fishery as well, but it will replace the

Ask participants to **DISCUSS** the sources of food aquatic animals may have. Be sure to **INCLUDE** tiny organisms suspended in the water (plankton), rooted or floating aquatic plants, and plant and animal materials from terrestrial habitats (detritus and terrestrial animals).

Ask participants to **IDENTIFY** members of each of these groups. **USE** Activity 10.3 *Food Webs* to illustrate the interaction among these levels of food webs. **NOTE** that the energy in living things flows through the system and must be replenished constantly, but the chemical building blocks (like water) are cycled and reused.

**REINFORCE** the importance of water for all living things and life processes. If time permits and you desire, **USE** Activity 10.4 *Playing the Game of Life* as an exercise to demonstrate the importance of basic resources like water to living things.

Lead participants to **IDENTIFY** some things that could affect water quality for aquatic organisms. **NOTE** that both natural conditions and human (or other animal—e.g., beavers building dams on small streams) activities can alter water quality.

Use “what if” statements to **REINFORCE** the importance of good water quality to wildlife and humans. What if we added fertilizer to a pond or lake? *Up to a certain point, it could be beneficial to aquatic life and to people using the resource, but beyond that point it degrades the quality of the water and restricts the organisms that may live in it. At low levels it can cause faster growth of plants and animals, but at higher levels it may increase turbidity and water temperature and result in decreased oxygen and light levels, leading to the loss of many of the organisms that lived there previously.* What if a flood scoured the bottom of a rocky stream down to bed rock leaving only a few channels for cover? What if someone failed to read the label on an insecticide they used to control fire ants in their backyard and dumped the left-over poison into their storm sewer where it is carried to a tiny stream and into a river feeding a favorite fishing lake?

flowing water environment with a still or slack water habitat. Darters, stoneflies and other stream-adapted animals will be lost as others find a place to live. These changes take place as species adapted to a given habitat and way of living are replaced by others better adapted to the new habitat and way of living. Specialists in the new environment will be more successful than generalists in all environments. The keys lie in the requirements for each species, its demand for materials that exist in minimum supply, its ability to tolerate other factors that exist in maximum amounts, and the range of tolerances each species exhibits. As the environment changes, changes in the **aquatic ecosystems**, trophic structure, and human uses and values associated with the aquatic ecosystems also change.

Humans use available information, desires and capabilities to determine the uses of aquatic resources. Frequently those decisions pit one use against another. In the past, the importance of the resource to wildlife or hidden values was frequently overlooked, sometimes with very damaging results. In a semiarid state, like most of Texas, conflicts over water uses can occur, particularly under drought conditions. What constitutes just and reasonable use? Who has a right to the flow in a river? How are the citizens of the state to make these decisions? Each generation must be equipped from a base of knowledge and wisdom to answer these questions.

## For Further Thought

1. Pick a set of environmental conditions in an aquatic system, e.g., cold, rapidly flowing water tumbling over a rocky substrate or warm, still water with silt bottom and emergent vegetation, and design a group of organisms to live under those conditions. Consider real organisms that live in such systems and use them for clues to important adaptations if desired. Critique the designs. Compare and contrast them with real animals living in such places.
2. Consider a numbers game where a human needs 400 big fish to survive for a year, each fish needs 1,000 small fish each year for 5 years to become large enough to be captured, each small fish needs 10 little fish daily, each little fish needs 50 crustaceans daily, each crustacean eats 35 zooplankton items each day, and each zooplankter requires three phytoplankters daily. Diagram the numbers required to support the single human.

	1 human
h x 400	400 big fish
bf x 1000 x 5	2,000,000 smaller fish
sf x 10 x 365	7,300,000,000 little fish
lf x 50 x 365	133,225,000,000,000 crustaceans
c x 35 x 365	1,701,948,375,000,000,000 zooplankters
z x 35 x 365	1,863,633,470,625,000,000,000 phytoplankters

Alternatively, to simplify the problem, you may want to manipulate the numbers so the products of the daily needs by days become multiples of 10, 100 or 1000.

## Summary Activity

1. Take a field trip to a local pond, stream, lake or other body of water. Try to observe or capture some of the animals found at different levels in the water. Discuss their adaptations for their life in the water. Consider using some of the recommended references to assist you with identification and interesting points of natural history. For introductory purposes, the *Golden Guide to Pond Life* is an excellent reference.
2. Use yarn and cards to construct a human food web. Label the cards as plants, plant eaters, secondary consumers, up to top carnivores. Include some omnivores and some that are very specialized (perhaps eating only one type of food). Give each player a card and allow the players to connect, using yarn, with any other "species" that could be connected directly to them in an energy transfer. Removing any given player breaks all of those bonds, and the yarn should be removed. Note that losing a top carnivore does less than does losing a group of producers.

3. Consider a problem in bioaccumulation where the water contains undetectable amounts of a fat-soluble substance, and zooplankton contains the same substance at 0.01 parts per billion. If only 10 percent of the substance at any level is transferred to the next trophic level in the example above, what would the concentration be in the big fish? In this example, the accumulation would result in having approximately 45,549 parts per billion or 45.549 parts per million in the single fish. If the human consumed 400 fish and retained 10 percent of the total load, he or she would have a tissue contamination of 1,821.96 parts per million.
4. Contact your conservation, fish and game, wildlife and fisheries department, or your state department of health to see if there are any advisories on eating fish in your state or in your area. Discuss those advisories and the sources of the chemicals involved.
5. Consider establishing an aquarium in your club or class room to provide observation opportunities for aquatic animals. Allow time for observation, recording and sharing to enhance learning.

## **Sharing and Exhibit Suggestions**

1. Create a poster or other exhibit of a simple aquatic food web, showing illustrations of the plants and animals involved. Consider multiple webs based upon aquatic plants, plankton or detritus.
2. Research the life cycle of an insect with an aquatic larval stage. Create a poster or other display showing that life cycle and the adaptations of the insect in its various stages of development. Share the poster with others interested in aquatic life.
3. Collect small samples of sediment from various water bodies, including wetlands, still waters and flowing waters with various flow rates. Dry the sediment samples and display them with estimates of the water flow rates observed.
4. Do your own thing. Decide on a question or concept you wish to interpret. Collect materials to make a display or exhibit based upon that question or concept, and share your exhibit or display with others interested in water and aquatic life.



## Water Creatures



Plants and animals living in different types of water bodies and at different depths in the water have various adaptations that help them survive.

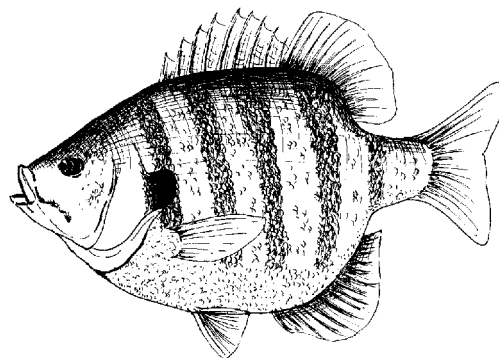

### Equipment/Materials

Aquarium dip net or kitchen strainer	minnow seine
plastic containers*	minnow bucket
eye dropper	magnifying glasses
soft forceps	turkey baster
wire screen	reference material
pen or pencil	white enamel pans or plastic bowls
*peanut butter jars will do	paper or small notebooks

### Reference Material

*Golden Guide to Pond Life*  
*Pond and Stream Safari*  
*Leading a Field Trip*  
*TNRCC Guide to Aquatic Insects*

### Procedure

1. Preview the field trip site to determine any hazards and some of the potential organisms that might be encountered. Local Soil and Water Conservation District personnel, Texas Parks and Wildlife Fisheries personnel or TNRCC staff members can help locate sites and/or assist with this activity. They can identify other resources, expertise and educational materials as well.
2. Take participants on a field trip to study the organisms they can find in a pond, stock tank, river, or small stream. Be sure they are prepared to get wet and muddy and that you have adequate help to supervise the group.
3. Group participants in teams of three to four for collecting samples. Stress the importance of safety around the water and staying together as a group.
4. Give each group some sampling equipment and containers for organisms they capture. Encourage them to visit a variety of habitats (rocky areas, sand, gravel, weedy areas, mud bottomed areas, emergent vegetation) and to record their observations in each one.
5. Encourage participants to make observations of other animal signs like tracks, droppings, evidence of feeding, mussel shells, or shed exoskeletons of insects, as well as other organisms from tiny flying insects to snakes, turtles, birds and raccoons that might be in the area.
6. After 15 to 20 minutes, gather the groups to share their findings and identify the organisms they located. Use the aquatic organism guide sheet or another reference to assist in identifying the organisms. Compare and contrast the different habitat types and the organisms that were found in them. Lead the participants to speculate on why the organisms were found in those particular habitats. Count the ones that were common to all areas and those that were unique to only one as well as the total that were collected or observed.



7. Use an eye dropper, turkey baster, soft forceps or a fine-meshed dip net to move single specimens into smaller containers for easier observation. Release the other individuals as quickly as possible to avoid mortality under the crowded conditions.
8. If time permits let teams of participants drag a small seine through several habitat types to see what types of fish and other large organisms might be found.
9. Lead the group to speculate on the adaptations these animals have for life in their particular habitats and the reasons they think the variety of organisms are living in that body of water.
10. Challenge them to continue studying these habitats and to become involved with water quality assessment by monitoring the animals and organisms.

## Quick Reference Guide to Aquatic Invertebrates<sup>1</sup>

Aquatic Invertebrate	Distinguishing Characteristics	Where Found	Respiratory Adaptations	Food	Specializations
<b>Intolerant of Pollution</b>					
stonefly nymph	Two tails, two sets of wing pads, axillary gills	well-oxygenated, running water, most abundant in cold water	gills on thorax, also through body surface, does "push-ups" to increase water flow	predators and herbivores	streamlined body for clambering over and under rocks, requires high oxygen level
mayfly nymph	three tails (sometimes two) one set of wing pads, abdominal gills	well-oxygenated water, greater variety in cool and cold waters	via abdominal gills (various shapes)	herbivore or scavenger	requires high to medium oxygen levels, shape adaptations vary with substrates used, adults very short-lived ( <i>ephemera</i> - <i>Ephemeroptera</i> )
caddisfly larvae	soft body, most species build cases or nets, mothlike flight	both running and standing water, usually cool or cold	exchanges gases through moist body surfaces	filter feeder, herbivore or predator	many species build cases of pebbles or sand grains, twigs or other vegetation
water penny (larvae)	round, flat, disklike body	cold running water	gills on underside of body	herbivore, grazes on algae	flattened body resists currents well
<b>Somewhat Tolerant of Pollution</b>					
predaceous diving beetle (larvae)	up to 6 cm long, robust jaws	quiet freshwater areas	through body surface	voracious predator	special channels in jaws to direct body fluids of prey into oral opening
whirligig beetle (adult)	shiny black, often seen in groups, spinning movement on water	surfaces of quiet waters	atmospheric oxygen taken in through spiracles	predator or scavenger	two pairs of eyes to see above and below the water's surface, locates objects on water surface by vibrations, secretes white protective fluid to deter predators
black fly (larvae)	hooks on abdomen to hold onto rocks, maggotlike body with "combs"	primarily cold, well-oxygenated, running water	through body surface	filter feeder	anchors to rock surfaces with silk, requires moderate to high oxygen levels
dragonfly nymph	stout body, grasping jaws	still or slow-moving water	through interior, cloacal gills	predator	hides in vegetation or detritus, jet propulsion by forcing water from cloaca
damselfly nymph	slender body, side to side swimming motions, three leaf-like gills at end of abdomen	still or slow moving water	three, terminal (taillike) gills shaped like feathers or leaves	predator	hides among vegetation or detritus, swims by lashing body from side to side
dobsonfly (hellgrammite), alderfly or fishfly larvae	large head, thorax without wing pads, elongated body, abdominal gills	hellgrammites in flowing water or riffles; alderflies in silty areas	abdominal gills; some fishflies have breathing tubes	predators	powerful jaws, can swallow prey without chewing

Aquatic Invertebrate	Distinguishing Characteristics	Where Found	Respiratory Adaptations	Food	Specializations
water strider (adult)	skates on water surface	ponds, lake edges or still pools	atmospheric oxygen	predator	water repellent "feet" enable the insect to stay on the water's surface
water boatman (adult)	long swimming "hairs" on legs	lakes, ponds or still areas in streams	atmospheric oxygen, carries bubble of air under water	omnivore, herbivore or predator	long "hairs" on oarlike swimming legs, swims upright
backswimmer (adult)	light colored underside, swims on back, oarlike legs	lakes, ponds or still areas in streams	atmospheric oxygen, carries bubble of air under water	predator	swims on back, streamlined shape, long oarlike swimming legs
cranefly larva	cylindrical, maggotlike body, often has lobes on rear end of abdomen	bottom and edges of streams and ponds	atmospheric oxygen through spiracles on rear end of body	active predator, herbivore or omnivore	species that eat decaying matter have gut bacteria to digest cellulose, some larvae as large as 6 cm or more in length
mosquito larva	tiny, wriggling, cylindrical bodies near water surface	still waters	atmospheric oxygen through a breathing tube	scavenger, feeds on microorganisms	swims or dives when disturbed
aquatic sowbug	flattened body (top to bottom), seven pairs of legs	shallow fresh water, among rocks and detritus	through body surface	scavenger or omnivore	male clasps female under it during mating, female sheds half of exoskeleton to form egg case for developing eggs
scuds	body flattened side to side, swims on side	bottom of lakes, ponds or streams in sediment or among vegetation	through gills under body surface	scavenger or omnivore	male carries female on its back during mating; female sheds half of her exoskeleton and this becomes an egg case for fertilized eggs
crayfish	small "lobster," five pairs of legs, first pair robust claws	rocky, muddy or weedy areas in fresh water, mud tubes to water table	gills under carapace	omnivore	backs away defensively when disturbed, may swim backwards quickly using tail, females carry developing eggs under tail
Tolerant of Pollution					
midge larva	small, cylindrical body, sometimes blood red	bottom sediments of lakes, ponds or streams	through body surface	predator, herbivore or omnivore	blood chemistry that absorbs more oxygen under oxygen-poor conditions
rat-tailed maggot (mouse grub)	cylindrical body, elongated taillike breathing tube	cool to warm water with low oxygen levels	atmospheric oxygen through breathing tube	scavenger, eats decaying matter and sewage	can survive very low oxygen levels in the water fatal to most invertebrates
tubifex worm	segmented body, builds vertical tube from which one end protrudes	polluted or oxygen-poor waters	through body surface, but can tolerate water with nearly no oxygen	scavenger, eats decaying matter and sewage	can survive very low oxygen levels fatal to most invertebrates

## Currents and Eddies



Water is a powerful mover of objects. Even relatively small streams can move boulders larger than houses during flood conditions!

### Equipment/Materials

fine soil	rocks
sand	bits of cork or foam
pebbles or fine gravel	water source

**Time Required:** 20 minutes to more than an hour, depending upon set up used and level of discussion

### Preparation

Lay out a “stream bed” in a parking lot gutter or a similar location on the school grounds. Place large rocks (or bricks) in the middle and along the edge of the “stream” to create changes in both flow and direction. Test the flow to see that it changes direction and has a variety of flow rates. On the downstream end, build a low dam to slow the water before it runs off. Mix small rocks, fine gravel or pebbles, sand and finely divided soil near the “headwaters” of your stream, using enough material to show deposition downstream.

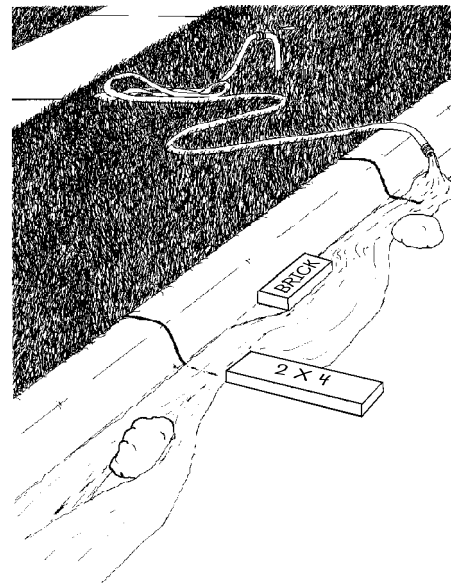

### Procedure

1. Have participants study the flow of water in a curbside gutter and record their observations.
2. Create an artificial stream bed in the gutter using bricks, clay or rocks. Be sure that the stream meanders somewhat and that it has variations in current speed.
3. Lay some obstructions in the mid current area of the “stream.”
4. Place a mixture of rocks, fine gravel, sand and silty soil near the water source.
5. Allow the water to run with enough volume to move the materials deposited, but not so much that it simply flushes them through the entire bed.
6. Have participants observe the flow rates and directions in the “stream” and record their observations. If desired, launch small bits of cork, balsa or sawdust to see where the flow takes it and how fast the surface water is moving in various places along the course.
7. Shut off the water and let the stream dry.
8. Note where materials are deposited and what materials are being deposited along the course of the stream.
9. Have participants compare their notes on flow rate and direction to see if they can explain why deposits are formed where they are observed.
10. Discuss the reasons for the directions and force of the current flows observed.
11. Have participants hypothesize how various materials would be affected by the flow and where they might be deposited.
12. Challenge them to consider how streams are formed, why they tend to meander, and where they would expect to find boulders, freestone bottoms, gravel, sand or mud.



## Food Webs<sup>1</sup>



Some animals, like kangaroo rats and pocket mice, get all the water they need from their food or through the production of metabolic water. They do not drink as adults!

### Materials/Equipment

cards (5x7) marking pens  
yarn or engineer's flagging\* paper punch  
safety pins sharp knife or scissors  
\*yellow, green, red, purple, brown, and gray or white if showing the type of relationship is desired

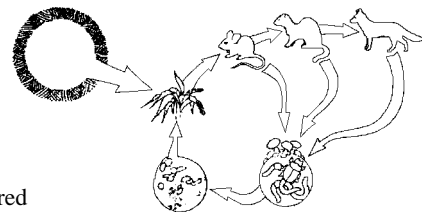

**Time Required:** 15 minutes or longer

### Preparation

For younger youths prepare a set of identification cards that shows or names primary producers (plants), primary consumers (plant eaters), secondary consumers (plant-eater eaters), higher order consumers, omnivores and decomposers. Cards may be color coded to the type of organism being depicted, and names or pictures should be large enough for all participants to read or see. (One color scheme is to use yellow for producers, green for primary consumers, red for secondary consumers, purple for higher order consumers, brown for omnivores, gray or white for decomposers.) One or two assistants are extremely helpful in working with the web.

### Procedure

1. Construct a simple food chain by having one plant, one plant eater, one predator and one decomposer and connecting them with yarn, cord or engineer's tape.
2. Ask what would happen if one of the organisms disappeared.

***If one level of the food chain drops out, any organisms higher on that chain would also disappear because they have no energy (food) source.***

3. Construct a parallel food chain with at least two plants and two plant eaters (perhaps adding an omnivore), and ask what would happen if one of the plants or plant eaters dropped out of the chain.

***The alternative food sources would be used more, but the others would survive because they had alternative energy sources.***

4. Hand out the rest of the identification cards and have the group stand in a circle facing inward.
5. With the assistants in the center of the circle, have the your people identify relationships (who eats whom) in their "community." As each relationship is identified, stretch a string showing the type of relationship between the two individuals. Note that more than one link can be made to any "organism" by others.
6. Continue making connections that are legitimate, asking leading questions to develop relationships if necessary.
7. Note that some individuals have many connections while others have very few. Ask the group to think about which connections are more stable, simple one-to-one connections or complex links among many organisms.

***In general, stability increases with increasing numbers of connections in a food web.***

<sup>1</sup>Illustrations of food chains and food webs extracted from *Understanding Northeastern Birds of Prey* (IB 175, Cornell Cooperative Extension, New York State College of Agriculture and Life Sciences, by Bonney, Kelley, Decker and Howard.

8. Begin asking “what if” questions about losing members of the group. Break the connections to an individual and see what types of changes take place at other sites in the web. Be prepared to discuss the types and significance of each type of relationship, letting the participants take the lead but keeping them realistic.
9. Parts of the circle that would be lost if another element were removed should either drop their strings and step back from the circle (this reinforces the point that losing important features of the web of life creates a mess that is hard to straighten up) or drop their strings and sit down.
10. Compare the impact of removing basic elements (soil, water, sun) to removing a higher order consumer. Note that the web is much more sensitive to disturbance at its base level than at higher levels.
11. Conclude by noting that the web constructed is a simple, graphic illustration of the complexity of interactions among living things and their environment. The real relationships in even simple communities are much more complex.

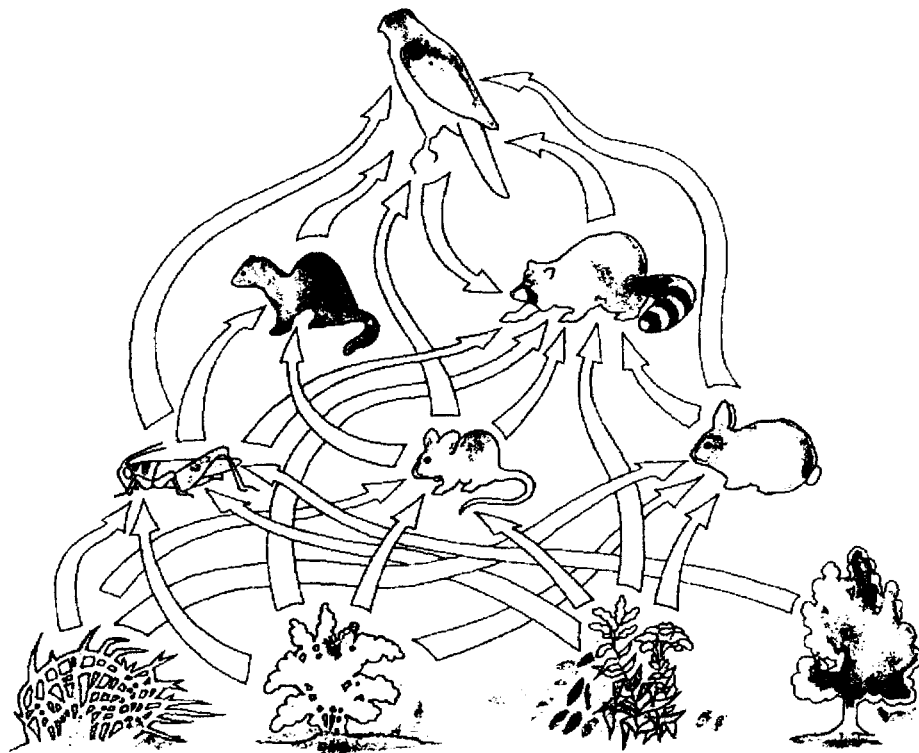



## Playing the Game of Life



Did you know that the ancient Greeks thought the basic building blocks of life were earth, air, fire and water - not too different from our own if the sun is substituted for the fire.

### Materials/Equipment

construction paper\* trading cards (enough for 10 to 12 per participant)  
base colors: orange, white, yellow, blue, brown, green  
additional colors helpful (any you wish to use)  
small rubber bands

\*light card stock is more durable for extended use

**Time Required:** 15 to 45 minutes, depending upon discussion included

### Preparation

1. Lay out cutting patterns on construction paper or card stock to yield approximately 12 trading cards slightly larger than a business card from each sheet.
2. Cut out a supply of trading cards from orange, white, yellow, blue, brown and green stock in a ration of approximately 1:1:1:2:3:5.
3. With younger groups, have enough of the rare cards to allow each participant to have a “winning hand,” but you may restrict them as desired to minimize the number of “survivors.”
4. Cut out additional cards of other colors as desired and in varying levels of abundance.

### Playing the Game

1. Pass out a more or less random selection of about 10 to 13 cards to each person. (You may let them select an assortment on their own, but this takes about 10 minutes longer than simply passing out rubber-banded packets.)
2. Make sure each packet contains at least one orange card or several green ones.
3. Put any leftover cards away to prevent participants from returning to the stockpile to alter their hands.
4. Explain that the orange cards represent gold, the green ones represent money, and the others are all resources that will be defined later.
5. Explain that the object of the game is to accumulate wealth. They may trade among themselves in any fashion, making up their own standards of exchange.
6. Allow 5 to 10 minutes of trading time; wander through the group as needed to encourage trading.
7. About half way through the trading time ask if they are absolutely sure they are satisfied with their trades and encourage them to continue.
8. With time limit warnings becoming more frequent toward the end of the period, call a halt at the “close of trading.”
9. Have each participant sit down and assess the results of their efforts.
10. Ask each group member who has a white card to hold it high so it can be seen.

11. Explain that the white card represents air. Only one white card is necessary, and extra white cards have no value—air is a common resource. You have it or you do not. (This offers abundant opportunity to discuss air pollution, greenhouse effects, etc., but avoid the temptation at this point.)
12. Have all the youngsters without white cards move to another part of the room or area. Without air, they have not survived and have become losers in the game of life.
13. Next, ask each of the “survivors” to hold up a yellow card. This card represents sunlight, our basic energy source, and one is all that is needed. Extra yellow cards have no value and those without yellow cards join the deceased group.
14. Now, ask the survivors to hold up a brown card. This represents soil, an advantage resource where having extra cards allows the holder to do other things beyond surviving. Those without a brown card join the dead group.
15. Next, ask the survivors to show a blue card. The blue cards represent water, another advantage resource. The water beyond that required for survival may be used for agricultural, industrial or recreational purposes. Those without a blue card join the dead group.
16. Under normal circumstances, very few (if any) of the young people survive. Most interpret “wealth” to be money, precious metals, and similar things, but fail to include the basic requirements for life in their assessment.
17. If there are survivors at the end of the game, count only the cards representing real resources e.g., fossil fuels, metals, wood products, precious stones, glass...) as wealth. Note that money is only a symbol that is an agreed-upon medium of exchange.
18. The activity should consume about 10 to 20 minutes to this point. Use the next few minutes to reinforce the relative importance of things necessary for survival (like water) and things normally associated with wealth. Be prepared to cope with some serious issues, particularly with middle school or older youth.

# Water and Pollution

## Objectives

1. Identify major types and sources of pollution
2. Construct a model demonstrating how different pollutants affect water.
3. Demonstrate how pollutants can get into groundwater.
4. Identify how landfill sites can be made to prevent pollution of groundwater.
5. Evaluate pH of various household items and hypothesize how pH affects water.
6. Demonstrate parts per million.
7. Interview community leaders about local water quality issues.
8. Identify differences between various bottled waters.
9. List environmentally friendly alternatives for common household products.
10. Have fun while learning.

## Materials/Equipment

See individual activities.

## Vocabulary

acid precipitation	fertilizers	nonpoint	pollution
bacteria	gray water	pathogens	
coliform	landfill	point source	

## Lesson Requirements

**Best Time:** Any time of the year

**Best Location:** Any safe setting where water is available and young people can work in small groups

**Time Required:** Approximately 1 hour, varies with activities selected

**Introductory Activity:** [Note: This activity must be set up at least 1 week before the lesson is offered to allow time for observation and drawing conclusions.] Ask participants to list some major types of pollution. Summarize their statements or use leading questions to derive the four major categories of pollutants—nutrient enrichment, toxic materials, pathogens and thermal pollution. Use Activity 11.1 *Pollution, Pollution, Everywhere!* to illustrate some pollution effects. Have students keep a record of their observations on their student record sheet.

## Lesson Background

### I. Definition of Pollution

Water **pollution** is defined in several different ways. To most biologists, it is the contamination of water with chemicals, organic

## Lesson Overview

- I. Definition of Pollution
- II. Primary Types of Pollution
  - A. Nutrient enrichment
    1. Fertilizers
    2. Organic wastes and sewage
    3. Impacts of nutrient enrichment
  - B. Toxic materials
  - C. Pathogens
  - D. Thermal pollution
  - E. Sedimentation
- III. Sources of Pollution
  - A. Point source pollution
  - B. Nonpoint source pollution
- IV. Regulations Regarding Water
  - A. Public water supplies
  - B. Private water supplies
- V. Bottled Water
  - A. Distilled/demineralized water
  - B. Spring water
  - C. Mineral water
- VI. Make Water Quality a Personal Issue

materials, **pathogens** or heat. To environmental engineers or regulatory agencies, it is the addition of harmful or objectionable materials in quantities sufficient to adversely affect the usefulness or quality of the water. Regardless of the definition, water pollution reduces the quality of the water, both as a resource for human use and for living things adapted to the water. Pollution places aquatic communities under stress, and can even eliminate entire communities of plants, animals and microorganisms. Pollution also poses a challenge for users of the water, demanding additional treatment before the water can be used for human consumption, agriculture or industrial processes. Because all living things need fresh, clean water, pollution affects us all.

## II. Primary Types of Pollution

Pollution comes from a variety of sources. Ecologists classify **pollutants** in several categories: nutrient enrichment, toxic materials, pathogens and thermal pollution. While light sediment loads are common elements of most flowing waters and seldom considered a pollutant by biologists, enhanced sediment loads resulting from agricultural, urban or other erosion and runoff have powerful impacts on water quality for all purposes. Impacts on aquatic organisms can be severe.

### Nutrient enrichment

A National Science Foundation panel referred to this type of pollutant as “resources out of place.” Nutrient enrichment can come from a wide variety of sources. One major source of these pollutants is **fertilizers** used in agriculture or home lawns and gardens. Where excessive amounts are applied or rains wash the nutrients into water courses, fertilizers can pollute water.

A very significant source of nutrient enrichment is effluent from sewage treatment plants. While the practice of releasing untreated sewage into waterways has been reduced substantially, some releases still occur when septic systems or sewage treatment facilities do not operate properly. Even sewage that has undergone secondary treatment is nutrient rich. If the quantity of effluent is sufficient, it will result in changes in the types, diversity and communities of organisms in the vicinity of and downstream from outflows. Tertiary treatment is designed to remove fine particulate matter and most nitrates and phosphates from the treated water before discharging it. Some treatment plants “polish” effluent by cycling it through constructed wetlands to remove even more of the nutrients before releasing the water. Treatment to this level, however, is relatively rare and quite expensive.

A relatively minor source of nutrient enrichment today was once a very important source. Organic wastes and chemically enriched wastes from processing cheeses, paper, meat, poultry or fish had devastating impacts on the waters near their outfalls. Now these wastewaters are normally treated to defined water quality standards before release. In fact, some processing plants use sensitive fish or other demanding aquatic organisms as bio-indicators in their effluents. As a result, water is returned to the source at higher quality

### Applications

SHOW participants a glass of water colored with red food coloring. ASK them if they would like to drink this water if it came out of their faucet. EXPLAIN that pollution affects everyone and that we all want and need fresh, clean water. Have students BRAINSTORM and LIST some of the things that can cause pollution in our water supply.

NOTE that these pollutants are really “resources out of place” that often result in greatly increased oxygen demand and the elimination of sensitive species as well as eutrophication—over-production and aging of waterways. USE Activity 11.2 *Pollution at Its Source* as an example of different types of pollutants.

STRESS that environmental protection regulations and voluntary actions by industry have greatly reduced this source of organic enrichment in surface waters, although some problems continue to occur, most often from municipal runoff during storms or from leaking sewage systems.

NOTE that too much of a good thing can be fatal to aquatic systems when enrichment reduces oxygen production while oxygen demand by decomposers increases. Lowered oxygen levels in the water result in fish kills and loss of other aquatic organisms.

than when it is extracted for use in the manufacturing process. The primary impact of organic wastes is the high demand for oxygen as the organic material decays. Because oxygen levels in water are much lower than those in the air, many species of animals and plants are eliminated and others that are able to tolerate the more inhospitable environment are favored.

The primary pollutants of concern in aquatic systems are phosphates and nitrates. Phosphates tend to be limiting in freshwater systems, so the addition of small amounts of phosphates can increase the productivity of those systems. Greater enrichment tends to produce algal or phytoplankton blooms. The increased productivity can reduce light penetration into the water, cause a “rain” of dead organic material into deeper waters and greatly increase the biological oxygen demand. Decreased oxygen levels in the deeper waters tend to mobilize phosphates that are captured in the bottom sediments, thus enhancing the problem.

**Gray water**, the water used in washing dishes or clothes, has been a major source of phosphate pollutants. Phosphate-containing washing compounds were excellent at cleaning clothes and dishes, but their side effect on water was substantial. In the late 1960s and early 1970s, phosphate enrichment in Lake Erie had eutrophied the lake to the point where its “death” was predicted. Elimination of phosphate detergents from the Lake Erie watershed nearly eliminated the problem in less than 10 years. As a result, most current detergents and laundry products are made without phosphorus compounds. Nitrates from fertilizers and other sources are the primary limiting factor in saltwater systems. Addition of nitrates to saltwater communities tends to have similar impacts to those described by phosphates in fresh water.

### **Toxic materials**

Toxic substances may occur naturally in some waters. Traces of selenium, lead, mercury or similar compounds may be present in the water as products of the watershed. Many other toxic substances were deliberate or accidental introductions by human activity. Petrochemicals, pesticides, industrial solvents, radioactive wastes or their decomposition products can enter waterways as runoff from land application, through improper disposal or handling, or as airborne traces that eventually reach the water through precipitation or runoff. Inadequately constructed landfills can be a source of toxic materials as can remnants of past human activities, like abandoned mines or mineral wastes. Some toxic substances (mostly fat-soluble materials) can accumulate through aquatic food chains. Some toxic contaminants may take hundreds to thousands of years to decompose. Others break down rather quickly through the action of organisms in the water or soil, exposure to sunlight, or other chemical actions.

**Acid precipitation** is a dramatic example of pollution from toxic materials. In its natural form, rainwater is slightly acidic, with a pH of 5.6 to 5.7. When water and CO<sub>2</sub> combine, carbonic acid is formed. Acidified precipitation with a pH below 5.0 is common in some areas where the burning of fossil fuels is prevalent. The burning of fossil fuel (coal) for heat releases 70 to 90 percent of

ENCOURAGE group members to consider toxic materials in their homes that might pollute the water if improperly discarded or used.

STATE that Americans produce an average of about 5 pounds of waste per person per day (much of that is industrial waste used to support us) and much of that waste winds up in landfills. ASK group members how they could reduce the amount of waste being produced in their homes and community. (Remember the Reduce, Reuse, Recycle options.) Use Activity 11.3 *Landfill Ooze* to illustrate how a landfill is created. The activity will demonstrate the difference between lined and unlined landfills.

REVIEW the components of the water cycle, noting how the water cycle interacts with acidifying chemicals to produce acid precipitation. INTRODUCE pH by noting that it measures how acidic or basic a substance is. NOTE that the pH scale runs from 14 (extremely basic) to 1 (extremely acidic) with a pH of 7 being neutral. USE Activity 11.4 *Let's Give it a Measure . . . pH!* to introduce the concept. EMPHASIZE that the pH scale is a logarithmic (exponential) scale, so a pH of 2 is not twice as acidic as pH of 4, but 100 times more acidic. A pH of 1.4 recorded for rain in one storm in West Virginia was 15,800 times more acidic than normal rain with a pH of 5.7!

EMPHASIZE that some natural sources of acidifying chemicals occur (like volcanos), but that most of them come from burning fossil fuels, particularly those high in sulfur. REMIND participants that water in the air dissolves the acidifying chemicals like CO<sub>2</sub>, SO<sub>2</sub> and NO<sub>x</sub> to produce mild to strong acids.

DEFINE buffering as the ability of the soil or water to resist changes in its pH when either acids or bases are added. Limestone-based soils are very well buffered against acids, but granite-based soils are relatively poorly buffered. Much of the area most severely affected by acid rain is on thin, granitic soils that are naturally “sour” or slightly acidic.

NOTE that buildings, monuments, bridges, and similar structures deteriorate much more rapidly under the influence of acid precipitation. Limestone or marble structures are particularly vulnerable because they react chemically with the acids in the rain, snow, mist or fog.

acidifying compounds found in the air. Sulfur dioxide (SO<sub>2</sub>) combined with water yields sulfuric acid. Nitrogen oxides (NO<sub>x</sub>) yield nitric acid. The lowest recorded pH level in rainwater was 1.4.

The impact of acid precipitation in well-buffered soils has been found to be low to moderate. On poorly buffered soils, the impact can be moderate to high.

Acid rain can damage man-made buildings, monuments and structures. It can severely damage aquatic life because there is little naturally occurring acidic water. Wildlife adaptations to acidified water are rare; fish and many insects are sensitive to acidified water. Acid rain can result in lifeless lakes and streams.

### Pathogens

Pathogens are biological “toxic substances,” the organisms that cause disease or illness in other living things. Bacteria, viruses, simple fungi, and many protozoans (one-celled animals) can enter the water from a wide variety of sources. For humans, one of the most significant sources of pathogens in the water is improper or inadequate wastewater treatment. Naturally occurring organisms, like *Giardia* or *Amoeba*, can cause severe problems in humans who drink contaminated water. Other diseases transmissible to humans may be endemic (always present) in some waters or carried by animals that use or live in the water. Water contaminated with pathogens is more costly to treat for human consumption; and other human uses, like swimming or fishing, are often limited.

### Thermal pollution

Thermal pollution is the result of returning water used to cool equipment or electric generation plants to the water source at above-normal temperatures. Because the heated water differs from cooler water in many characteristics, the effect of adding “waste heat” to water can be significant. In some areas, the heated water is used to heat homes or grow warmwater fish before being returned to the watercourse at near normal temperatures.

### Sedimentation

Sedimentation is listed as the number one pollutant by the Environmental Protection Agency. The cost of sediment in our waterways affects all of us, either directly or indirectly, as local, state and federal agencies cope with managing sediment. While some rivers or lakes are naturally “stained” or “silty,” many once clear watercourses carry heavy burdens of sediment today because of human activities in the watershed. Sediment fills reservoirs, reducing their lifespans and water-holding capacities. It also alters the structure of the bottom, replacing rock, gravel or sand with mud. It reduces light penetration in the water, decreasing plant life and productivity. It covers spawning sites, reducing fish productivity, and in severe cases may kill fish by damaging their gills. While some sedimentation results from natural causes (e.g., glacial melt, wind erosion of desert soils, fires or volcanic activity), sources attributable to human activities (e.g., construction, road construction, logging,

NOTE that many lakes in northeastern North America, downwind from major cities, industry and power plants, are severely affected by acid rain. In addition to upsetting ionic (salt) balance in the fishes and reducing availability of such important chemicals as calcium, acid precipitation mobilizes aluminum from the soil. Aluminum is extremely damaging to the gill tissues of fishes and many insects. Where snow melt provides a major flush of water, acidified snow may cause the water to reach lethal acid levels seasonally, even if animals could survive it during other seasons.

NOTE that many diseases, from simple infective bacteria like *Streptococcus* to epidemic diseases like cholera or hepatitis or flu-like diseases like tularemia, can be held in the water or sediments. ASK if anyone knows someone who has been infected with *Giardia* or *Amoeba*, both of which produce severe diarrhea, or if they have ever had “swimmer’s itch,” a skin inflammation caused by a parasite. STRESS that water can be contaminated with pathogens.

In some cases, adding heat to a water system could be beneficial to its productivity; but too much added heat can eliminate entire communities of cold- or cool-water species and replace them with species better adapted to warm waters. NOTE that most power plants use some sort of cooling lake or tower to aid in dissipating waste heat, although interest in using deep water, cold lakes remains.

farming, ranching or urban development) are more common and often more severe in impact. Little can be done about the naturally occurring sedimentation, but use of best management practices can drastically reduce human-caused sedimentation and its effects on water sources.

### III. Sources of Pollution

Pollution can come from either **point sources** or **nonpoint** sources.

#### Point source pollution

Point sources are relatively easy to define. They can be linked to a specific place or event, like an outflow pipe or an overturned tank car. Landfill sites that are leaching materials into the ground or water, industrial outflows, stacks or dumps, some feedlots or confined livestock facilities, chemical spills or overflows, failing septic systems, leaking sewer lines, leaking fuel storage tanks, construction sites, and volcanic eruptions are all point sources. An individual agricultural field or lawn might be a point source under some conditions, as would sewage treatment effluent where only primary or secondary treatment is applied. If a specific source and location can be identified, the pollution is considered a point source. Many point sources have been eliminated either by people exercising personal or corporate responsibility or through environmental legislation and enforcement.

#### Nonpoint source pollution

Nonpoint sources are much more difficult to define because the pollution comes from a broader area or a wide variety of sources. Soil erosion, as a general process across a region, can result in nonpoint source pollution by moving agricultural chemicals, including fertilizers, crop residues and biocides, into the water. Runoff from roads, city streets, buildings and parking lots contributes to nonpoint source pollution by carrying rubber particles, petrochemicals, leachates from asphalt, salts and other materials into the water. Chemical pollution can come from unknown sources, including naturally occurring materials like metal salts, and from contaminants like PCBs (polychlorinated biphenyls) and tetraethyl lead (formerly a gasoline additive) that are transported and deposited from the air. Runoff from managed forests, including pesticides, adjuvants (things to make biocides more effective), and motor fuels and oils, can comprise a nonpoint source of pollution. Among the most substantial and most difficult to manage nonpoint sources of pollution are the biocides, fertilizers and petrochemicals used around homes and gardens by both rural and urban households. Many of these sources are the result of failure by the users to read, understand or follow label directions or of simple carelessness or improper disposal of these products. Too many times, homeowners use the “if a little is good, more will be better” approach to using chemicals around the home.

Have participants LIST some types of pollutants and their sources. Then DIRECT them to assign each one to either a point source or a nonpoint source. EMPHASIZE the need to identify specific sources, locations or events for point sources. NOTE that the nonpoint sources are much more difficult to locate or identify specifically. USE Activity 11.2 *Pollution At Its Source!* as an aid in visualizing how pollutants can contaminate surface water and groundwater.

## IV. Regulations Regarding Water

As people learn about pollution, many begin to wonder if any of our water is really safe to drink.

### Public water supplies

Regardless of whether they come from surface or groundwater sources, municipal water supplies are subject to a variety of federal and state regulations, including required testing for some types of pollutants. Most public water supplies are tested for the presence of **coliform** bacteria as an indicator of the presence of potential pathogens. Supplies also are tested for additional pollutants (like heavy metals), hardness (dissolved minerals), salinity and some additional factors. Each monitoring step is performed on a routine basis using standardized biological or chemical tests. These tests are designed to maintain water quality and to ensure users that the water is safe.

### Private water supplies

Private water supplies most often are not covered by these regulations. Water testing may be required before a home can be sold, but routine water testing is neither required or necessary under most conditions. Wise homeowners may have their water tested for bacteria (indicative of contamination from septic systems). Where conditions merit, screening for additional chemicals, like nitrites or pesticides, may be wise. If agricultural chemicals are used or livestock are confined near the well location, the homeowner may want to test for those chemicals or by-products, including nitrates and nitrites, in the water. Randomized testing of private water supplies in several states has shown that the vast majority of private water supplies are safe. Where problems have been found, researchers usually have been able to identify specific sources for the contaminants, like mixing herbicides near the well head. In some situations, particularly on very porous soils (sand or karst limestone), entire bodies of groundwater have been contaminated. These situations have been rare, but wise people should check the water supply before buying a home. Water supply quality varies with the region and with sanitation and the type of water source being used; but it is good to excellent in most areas unless a specific problem has occurred. Local civil engineers, testing lab staff, Extension staff, Soil and Water Conservation District staff, or others may be able to provide specific information that applies to your community. Note that going beyond basics in testing private water supplies can become very expensive and that sampling procedures must be followed very carefully for valid results.

## V. Bottled Water

Some people are concerned enough about local water quality that they use bottled water for drinking or other purposes, and many grocery stores sell bottled water. Water that is offered for sale in bottled form must meet the same basic standards as municipal water. In fact, a significant amount of bottled drinking water is taken from municipal water supplies.

CONSIDER inviting a local civil engineer, water department official, or water testing lab staff member to talk about how water is tested and treated. INVITE a county Extension agent or District Soil and Water Conservation employee to discuss water quality and assist in collecting water samples to be tested. Use Activity 11.5 *The Lone Drop* to demonstrate the meaning of parts per million. Encourage participants to use Activity 11.6 *Water Detective* to investigate the water they drink and to record the facts they can determine about it.



### **Distilled/demineralized water**

There are several different types of bottled water. Distilled water is usually produced by condensing water from steam. It may be further processed by deionizing (e.g., removing chloride ions that were carried over with the steam in distillation), and it closely approaches the odorless, flavorless liquid described for pure water. Demineralized water is usually produced by using an ion-exchange process or reverse osmosis. People who require restricted diets, particularly those who must limit sodium intake, may use distilled or demineralized water for drinking. People who would like to avoid having their steam irons fill with boiler scale (mineral deposits) or produce stains on their clothing frequently use distilled water in their irons. Where water has a high mineral or salt content, using distilled water to water house plants will prolong their lives significantly. Distilled water is also used in scientific laboratories for mixing reagents and as a final wash for glassware or instruments.

### **Spring water**

Spring water comes from underground aquifers or flowing springs. Its mineral and gas content contributes to its flavor, which many people prefer. Commercially available spring water must come from approved and monitored sources and testing is required. Spring water contains minerals that are leached from the rock strata of the aquifer. Unmonitored springs may be contaminated, either because the groundwater from which the spring flows is contaminated or because of some chemical or organic misuse near the spring head or in the recharge zone of the aquifer.

### **Mineral water**

Mineral water also comes from springs or underground sources, but it must contain a minimum of 500 ppm (parts per million) of dissolved minerals to be labeled as mineral water. Some mineral waters are also sparkling waters or seltzers. Although a few springs worldwide are naturally carbonated, most of these sparkling waters are manufactured by adding carbon dioxide to the water at the time of bottling. Some sparkling waters have sweeteners or flavorings added to create flavored drinks or tonic waters.

## **VI. Make Water Quality a Personal Issue**

The key to a safe and high quality water supply is personal involvement coupled with personal responsibility. Every citizen has the responsibility to stay informed on local water quality issues that can affect watersheds and aquifers across the nation and the world. We may not be able to do much about water quality in Kazakhstan, but we can do something personally about water quality at home.

We can also become actively involved with issues impacting water quality, like waste management and zoning or land use issues. We can be involved in issues concerning water quality problems resulting from industrial or other activities, and the means of reconciling water quality and employment opportunities. Personal involvement in recycling programs and encouraging family and

ASK the group if any of them have used bottled water in their homes. Use Activity 11.7 *Bottle 'Em Up* to illustrate the many types of bottled water. Let them TASTE each one and evaluate them on the data sheet. Encourage them to CONSIDER similarities and differences between the bottled waters and tap water. DISCUSS these observations.

ENCOURAGE students to take water quality personally. Every individual can make a difference in water quality today and in the future. Use Activity 11.8 *Pollution-SOLUTION!* to propose alternatives for some common household products. Use some of these in your classroom and home.

friends to be involved can reduce the potential for water quality problems in future years. As individuals we can reduce our use of toxic materials by using them only when they are needed and by following label instructions carefully when they are used. We can be sure to dispose of these materials and their containers properly and also dispose of waste oil at appropriate recovery sites.

We can contact local officials, visit and understand local water and wastewater treatment sites, and study issues involving water and water quality. We can also select products that reduce the burden on water and aquatic systems, choosing ones that make sense in our particular situation. While we need not feel guilty about taking a shower or bath, wearing clean clothes or keeping fleas off our pets, we can select the ways we do so and the products that we use to minimize environmental impacts. The little things we do make a big impact on the long-term quality of our water in Texas and in the world.

## For Further Thought

Try to trace water through its cycle and include the impact of humans and human use. Consider the source of water, the processing and use of water in local homes and industry, wastewater treatment and disposal, and the mechanics of getting the water supply recharged. Ask where there are potential problems and how these problems can be avoided, reduced or eliminated. Consider some ways that you might be able to change public attitudes about water or water issues.

## Sharing or Exhibit Suggestions

1. Prepare a poster or similar exhibit showing examples of various types of pollution. Use the poster to educate others about the types of pollution and their incidence in your area.
2. Set up one of the demonstrations or experiments from this lesson with an interested group of people and lead them through the procedures to draw conclusions from it. Attempt to motivate them for additional activity in the area of water, pollution or water quality.
3. Visit a local municipal water management facility and discuss the source of the water, the treatment that is needed before it is ready for use, and issues of the future. Ask if there is anything you can do as an individual to address those issues. Summarize your findings in a report or some type of display, and share it with interested persons.
4. Visit a wastewater treatment facility to observe the processing of that wastewater. Ask the management if there are any issues concerning wastewater or requirements for the effluents that are causing concerns for the future. Share your findings in an appropriate manner.

## Summary Activity

The level of interest and resources govern potential *summary activities* that may be conducted. A few examples follow. A visit to a water treatment plant or a wastewater treatment plant (or both) would do an excellent job of involving participants in local water issues. Staff from a municipal water or sewer authority might be willing to come and share their views on local issues with water quality and availability. Finally, the group may take direct interest and action on a water quality issue in the community.

5. Request permission to stencil storm drains in your community with a conservation message, e.g., Gulf of Mexico Watershed—Treat it with Care. Recruit some friends to assist you and your group in accomplishing the task to increase public awareness that storm drains are not appropriate disposal sites for unwanted materials like oil, toxic chemicals, etc.
6. Visit a solid waste disposal site and the agency or company that manages it. Ask about the regulations that must be followed, the structure of the landfill, and the way any toxic or hazardous wastes are handled. Ask about the lifespan of the landfill and the use of the land after the landfill is closed. Share your findings with other interested persons in an appropriate manner.



## Pollution, Pollution, Everywhere!



The average American produces 5 pounds of solid waste and refuse each day.

### Equipment/Materials

five 1-liter plastic soft drink bottles\*

measuring cup

labels

masking tape

kitchen waste (1/4 cup)\*\*

\* clear with tops cut off

\*\* avoid meat or fat

pond or stream (2 1/2 gallons)

distilled water (5 cups)

liquid detergent (2 teaspoons)\*\*\*

vinegar (1/4 cup)

liquid bleach (1/4 cup)\*\*\*\*

\*\*\* phosphate-based for best results

\*\*\*\* chlorine or hypochlorite bleach is best

**Time Required:** Approximately 2 hours over the course of a week

### Procedures:

1. Pour approximately 1/2 gallon of pond water into each of the five plastic soft drink bottles. Try to have an equal amount of water in each of the containers.
2. Prepare five labels and attach them to each container. A suggested labeling scheme is:  
#1 = control, #2 = nutrient, #3 = toxic, #4 = bacteria, #5 = acidic.
3. Add 1 cup of distilled water to the control container (#1).
4. Add 1 cup of distilled water and 2 teaspoons of phosphate-based liquid detergent to the nutrient container (#2).
5. Add 1 cup of distilled water and 1/4 cup of liquid bleach to the toxic container (#3). Be careful not to splash the bleach on the skin or clothing.
6. Add 1 cup of distilled water and 1/4 cup of kitchen waste to the bacteria container (#4). Fruit or vegetable trimmings work great. The more finely they are chopped or ground, the more rapidly they will decompose.
7. Add 1 cup of distilled water and 1/4 cup of household vinegar to the acidic container (#5).
8. Have participants set the containers on a table near a window. Encourage them to record their observations each day. In the beginning, it may be helpful to share observations to encourage all participants to record their observations (including color, turbidity, odors, color changes, presence of gas bubbles, or observations of living things) more completely. The record sheet provided may encourage careful observation.
9. Challenge participants to speculate or hypothesize what will happen in each container and to record their personal hypotheses.
10. Common observations are as follows:  
**Control**—no change to a slight algal bloom  
**Nutrient**—Extensive growth of algae  
**Toxic**—no visual change to clarification of the water and loss of living things visible in the water, chemical smell that may dissipate during observation  
**Bacteria**—increased turbidity, gas bubbles common, may form mats of decaying material, foul odors (methane or sulfur smell)  
**Acid**—no change to slight clearing of the water, loss of some aquatic life
11. Encourage participants to explain why they got the results they did. Ask them why the containers were treated in a similar fashion and placed in the same general location during this experiment. Encourage them to explain the differences that they observed between the containers. Ask them to draw implications for similar types of pollutants in larger bodies of water.

*Algae, plankton, bacteria and protozoans were present in the pond water collected for the experiment. Growth and multiplication of some small organisms should have occurred in the control container. The phosphates in the liquid detergent should have provided fertilizer for the algae, initiating an algal bloom (it will occur rapidly once it gets started). The organic waste in the “bacteria” container should have produced a bacterial bloom (decomposers) that would have consumed the oxygen in the water, killing other organisms while releasing decay gases like methane and sulfur dioxide. The bleach should have killed all or nearly all the organisms in the water, allowing it to clear slightly. If the acid treatment is great enough, similar outcomes would have taken place in the acidified container as well.*

# Pollution, Pollution, Everywhere!

1. Briefly state what you think will happen in each of the containers.

Control \_\_\_\_\_

Nutrient \_\_\_\_\_

Toxic \_\_\_\_\_

Bacteria \_\_\_\_\_

Acid \_\_\_\_\_

2. Observe each container at least once daily for 7 days and record any changes you observe.

**Control:**

Initial \_\_\_\_\_

\_\_\_\_\_

Day 1 \_\_\_\_\_

\_\_\_\_\_

Day 2 \_\_\_\_\_

\_\_\_\_\_

Day 3 \_\_\_\_\_

\_\_\_\_\_

Day 4 \_\_\_\_\_

\_\_\_\_\_

Day 5 \_\_\_\_\_

\_\_\_\_\_

Day 6 \_\_\_\_\_

\_\_\_\_\_

Day 7 \_\_\_\_\_

\_\_\_\_\_

Conclusions \_\_\_\_\_

\_\_\_\_\_

**Nutrient:**

Initial \_\_\_\_\_

\_\_\_\_\_

Day 1 \_\_\_\_\_

\_\_\_\_\_

Day 2 \_\_\_\_\_

\_\_\_\_\_

Day 3 \_\_\_\_\_

\_\_\_\_\_

Day 4 \_\_\_\_\_

\_\_\_\_\_

Day 5 \_\_\_\_\_

\_\_\_\_\_

Day 6 \_\_\_\_\_

\_\_\_\_\_

Day 7 \_\_\_\_\_

\_\_\_\_\_

Conclusions \_\_\_\_\_

\_\_\_\_\_

**Toxic:**

Initial \_\_\_\_\_

\_\_\_\_\_

Day 1 \_\_\_\_\_

\_\_\_\_\_

Day 2 \_\_\_\_\_

\_\_\_\_\_

Day 3 \_\_\_\_\_

\_\_\_\_\_



Polution, Polution, Everywhere!—continued

Day 4 \_\_\_\_\_

\_\_\_\_\_

Day 5 \_\_\_\_\_

\_\_\_\_\_

Day 6 \_\_\_\_\_

\_\_\_\_\_

Day 7 \_\_\_\_\_

\_\_\_\_\_

Conclusions \_\_\_\_\_

\_\_\_\_\_

**Bacteria:**

Initial \_\_\_\_\_

\_\_\_\_\_

Day 1 \_\_\_\_\_

\_\_\_\_\_

Day 2 \_\_\_\_\_

\_\_\_\_\_

Day 3 \_\_\_\_\_

\_\_\_\_\_

Day 4 \_\_\_\_\_

\_\_\_\_\_

Day 5 \_\_\_\_\_

\_\_\_\_\_

Day 6 \_\_\_\_\_

\_\_\_\_\_

Day 7 \_\_\_\_\_

\_\_\_\_\_

Conclusions \_\_\_\_\_

\_\_\_\_\_

**Acid:**

Initial \_\_\_\_\_

\_\_\_\_\_

Day 1 \_\_\_\_\_

\_\_\_\_\_

Day 2 \_\_\_\_\_

\_\_\_\_\_

Day 3 \_\_\_\_\_

\_\_\_\_\_

Day 4 \_\_\_\_\_

\_\_\_\_\_

Day 5 \_\_\_\_\_

\_\_\_\_\_

Day 6 \_\_\_\_\_

\_\_\_\_\_

Day 7 \_\_\_\_\_

\_\_\_\_\_

Conclusions \_\_\_\_\_

\_\_\_\_\_

3. Did the results observed differ from your original hypothesized outcomes? If so, why?

Control:

Nutrient:

Bacteria:

Toxic:

Acid:

4. List some examples of pollutants that could occur in water sources.

Nutrient

Bacteria

Toxic

Acid

## Pollution At Its Source!



Your county Extension agent can help you conduct a test of your water!

### Equipment/Materials

small glass	aquarium sand
water	turkey baster
red food coloring	measuring spoons

**Time Required:** Up to 45 minutes depending upon size of aquarium

### Preparation

1. Fill the aquarium three-fourths full with sand.
2. Slowly pour water into the aquarium until it is about halfway up the container. Ask the group members to name what the upper level of the water is called. ***water table***
3. Make a small pit to simulate a pond on one end of the aquarium by moving the sand.
4. Add five drops of food coloring on the sandy ground surface near the edge of the pond.
5. Add 1 teaspoon of water to the ground surface.
5. Address questions 1 through 4 in the observation and analysis section.
7. After the first round of observation and analysis, use the turkey baster to draw some of the water from the aquifer (not the pond). Review the content of lesson 5 if necessary for information about aquifers.
8. Address the remaining observations and analysis questions.

### Observation and Analysis

1. Observe the model for movement of the food coloring (pollutant).
2. Did the food coloring reach the pond? ***yes***
3. Is the food coloring an example of point source or nonpoint source pollution? ***point source***
4. What are some examples of point source pollution? (Try to make the samples as applicable to the local community as possible. See text for some assistance.) ***chemical spills, leaking landfills, some feedlots, filling stations, wastewater treatment plants***
5. Is the water from the aquifer contaminated? ***??***
6. Are most contaminants as easily observed as the dyes used in this demonstration? ***NO!***
7. How could someone tell if the groundwater had been polluted? ***Have the water tested.***





# Landfill Ooze



The first known regulation against throwing waste in the streets and the establishment of dumps for refuse took place about 500 B.C. in Greece.

## Equipment/Materials

- |                                                 |                               |
|-------------------------------------------------|-------------------------------|
| two 1- to 3-liter plastic soft drink containers | soil                          |
| 44-in. x 4-in. piece of cheesecloth             | pea gravel or aquarium gravel |
| rubber bands                                    | household waste               |
| two plastic kitchen trash bags                  | water                         |
| clear plastic wrap                              |                               |

**Time Required:** Approximately 15 minutes to construct the models; minutes daily for a week in observation, variable time for evaluation; discussion

## Procedure

1. Cut across the plastic soft drink containers, dividing them into approximately equal sizes.
2. Put a piece of cheesecloth over the narrow end of one of the funnels and anchor it in place with a rubber band.
3. Invert the funnel into the bottom of the container, seating it firmly in place
4. Place approximately 1/2 cup of pea gravel or aquarium gravel in the funnel as a base.
5. Add about 1 inch of soil on top of the gravel.
6. Place about 1 inch of household waste in a layer over the soil. Avoid fats and meat scraps. They become rancid quickly and produce extremely foul decay odors.
7. Alternate layers of soil and household waste until the funnel is full, ending with a layer of soil on the top. As the “landfill” is being built, encourage participants to consider why people cover landfills with soil.  
*To combat odors, rodents, flies, etc.*
8. This model represents an unlined landfill.
9. Repeat this process, but place two layers of plastic bag material inside the second funnel after the cheesecloth has been secured in place. This model represents a lined landfill.
10. Select a warm, well-lighted area and place the models on tables that have been covered with plastic and newspaper to prevent damage from any leaks or spills.
11. Water each landfill model with approximately 1/2 cup of water daily during the observation period. Do not over-fill the funnels.
12. At the end of the observation period, prick the bottom of the liner with a stiff piece of wire shoved down through the landfill model and observe any changes in the treated container.

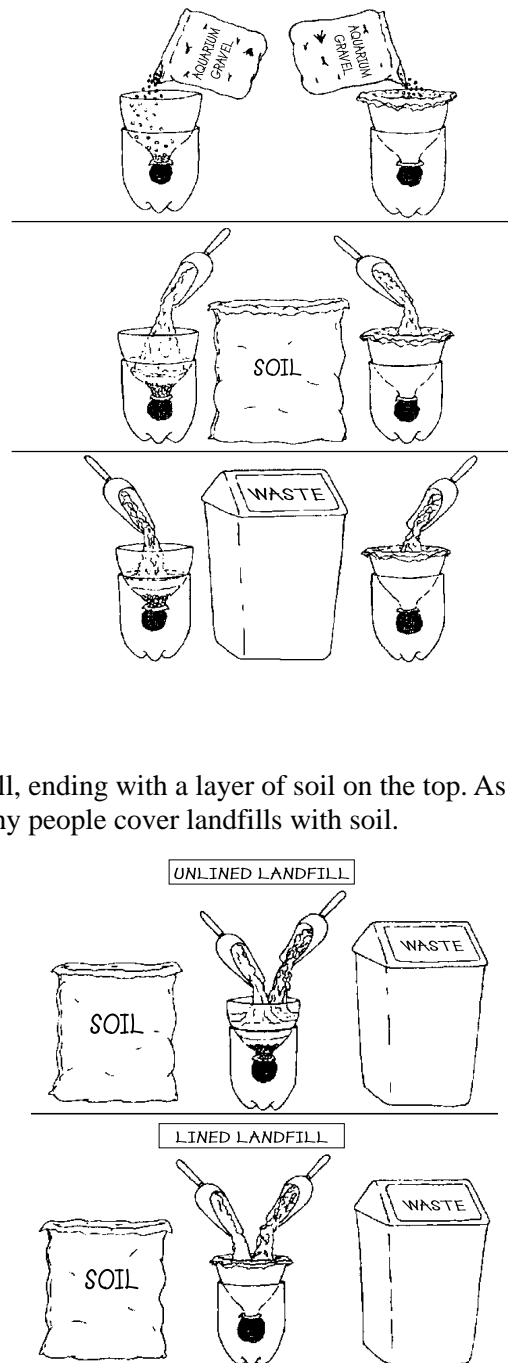

## **Observation and Discussion**

1. Have the participants observe each of the models for a few minutes each day and record their observations. Emphasize the use of all senses (except perhaps taste and touch) in recording observations.
2. Lead them in discussing their observations and conclusions.
3. Challenge them to consider what the leachate from the landfills represents.
4. Consider possible differences between the lined and unlined landfill models with respect to smell, appearance, and amounts of leachate or overflow experienced.

# Landfill Ooze Observation and Evaluation Form



The first known regulation against throwing waste in the streets and establishment of dumps for refuse took place about 500 B.C. in Greece.

1. Briefly describe the models, recording your observations on a daily basis for at least a week. Skip days when the group does not meet.

Day 1: \_\_\_\_\_

\_\_\_\_\_

Day 2: \_\_\_\_\_

\_\_\_\_\_

Day 3: \_\_\_\_\_

\_\_\_\_\_

Day 4: \_\_\_\_\_

\_\_\_\_\_

Day 5: \_\_\_\_\_

\_\_\_\_\_

Day 6: \_\_\_\_\_

\_\_\_\_\_

Day 7: \_\_\_\_\_

\_\_\_\_\_

2. Do you think that a leachate forms in real landfills as it has in the model?

3. How can people protect groundwater from landfill leachates?

4. Did the addition of a liner help control the leachate?
  
5. Did the lined model produce a leachate that moved into the lower container (groundwater)?
  
6. Did the landfill models differ in odor, decomposition rate or other factors you could observe?
  
7. What happened when the liner was damaged?
  
8. Could this become a problem in real landfills?
  
9. How could we reduce the problems associated with landfills in our landscape?
  
10. Do you have any other observations you would like to add?



## Let's Give It a Measure . . . pH!



Given enough time, acid rain breaks down stone, metal, paint, concrete and many other materials exposed to the weather

### Equipment/Materials

distilled water	vinegar
household ammonia	other household materials as desired*
three small plastic cups	plastic spoons or stirring sticks
measuring cups/spoons**	eye dropper
masking tape	markers or wax pencil
pH paper and color chart or garden soil pH testing kit***	

\* Consider using tiny amounts of dish washing soap, orange or lemon juice, tomato juice, antacid tablets, hand soap or lye soap, baking soda, baking powder, soft drinks, tap water, rain water, fruits, vegetables....

\*\* Precision in measuring is not essential, but may make handling easier.

\*\*\* Red cabbage juice can be used as an indicator for acids and bases, but will not indicate the pH range. pH paper is available in many scientific supply catalogs, in many teacher supply stores, and in some craft or department stores.

**Time Required:** 10 minutes to much longer depending upon the materials selected

### Procedure

1. Label the three plastic cups as follows:

- #1 = water
- #2 = vinegar
- #3 = ammonia

2. Pour  $\frac{1}{2}$  cup distilled water into each of the three cups.

3. Add  $\frac{1}{2}$  teaspoon of white vinegar to cup #2 and stir.

4. Add  $\frac{1}{2}$  teaspoon of ammonia to cup #3 and stir with a clean spoon.

5. Put a clean strip of pH paper into each of the three cups and leave for about 2 seconds. Immediately compare the strip to the color chart.

6. Is the water in cup #1 an acid or a base?

*Pure distilled water (in a vacuum) is neutral, with a pH of 7. Water that is exposed to the air soon becomes saturated with carbon dioxide, forming carbonic acid (a weak acid). As a result water in air usually has a pH of about 5.6 to 5.7. Boiling the water reduces the amount of dissolved gas and lowers the pH temporarily. A buffered solution can be prepared by adding tiny amounts of baking soda until the solution reaches a pH of 7.*

7. Is the vinegar solution in cup #2 an acid or a base?

*Vinegar is dilute acetic acid.*

8. Is ammonia an acid or a base?

*Ammonia is a base.*

9. Test other common household items to measure pH and record your observations. Would you have predicted these results from other experiences?

10. Do pH levels in water affect plant and animal growth?

*The lesson provides no real basis for determining an answer to this question, but the answer is YES! The level of the effect varies with the pH level and the tolerance of the organisms involved. Most living things cannot exist when pH level is extreme.*

11. Can a lake that is too acidic be neutralized?

*The only evidence of such an action in this experiment would have come from the creation of a buffered system to take the water to a pH of 7. In reality, the answer is both yes and no. It is chemically possible to neutralize or reduce the acidity in acidified lakes, but the pH of the water and the volume of the water may make that action economically prohibitive or practically impossible. The most common treatment of moderately acidified lakes is to add crushed limestone as a buffering agent.*

12. What are some things that can affect the pH of water?

*Pollutants in the air (particularly  $SO_2$  and  $NO_x$ ), soil chemistry, plant extracts (e.g., sphagnum), chemical inputs and many other things can affect the pH of water. Since water is such a great solvent, its pH can be altered by many things.*

## The Lone Drop



One aspirin tablet in 86 gallons of water makes 1 part per million!

Municipal water supplies are commonly tested for many chemicals and bacteria. Modern equipment like flame spectrometers can detect some pollutants in amounts as small as a part per billion (ppb) or a part per trillion. Many pollutants reach “actionable” levels at one or more parts per million (ppm).

This activity creates graphic examples of how diluted one part per million, one part per billion and one part per trillion are. Note that some contaminants (like dioxin) have actionable levels as low as one part per trillion. *Instructors please note: two dilution demonstrations are provided for your use. The first one requires a substantial amount of equipment and large volumes of water. The second requires very little equipment and provides a graphic comparison of dilution against a neutral background. For most classes, the second demonstration is both easier and more graphic. To grasp the concept of comparative volume, however, the comparison of a BB or some other item you have measured to the size of a room is vital.*

**Time Required:** 15 minutes to an hour, depending on the activities selected

### Equipment/Materials

eye droppers (at least two)	1/8 teaspoon
20-gallon aquarium	yardstick
gallon jug, marked to volume	tape measure (50 to 100 feet)
measuring cup (glass, 16-ounce)	white foam egg carton
tablespoon	water
teaspoon	dark food coloring
1/4 teaspoon	BB or BB-sized bead

### Dilution Demonstration 1

1. Fill the aquarium with 13 gallons, 3 1/2 cups, 1 Tbsp, 1 3/8 tsp, and six drops of water.\*
2. Add one drop of dark food coloring and allow to mix thoroughly with the solution. This is one part per million (1 ppm) of dye.
3. Assuming that the container and the water put into it were clean, do you think the water would be safe to drink with this 1 ppm of pollutant in it?

\* All of these activities and calculations are easier if metric measures are used. A single drop from an eye dropper is assumed to be approximately 1/20 cubic centimeter (cc) or milliliter (ml). A dilution rate of 1 ppm requires 50 liters of water. One can get from liters to cubic meters (m<sup>3</sup>) by multiplying by 0.001. More advanced students can figure out the conversion by multiplying 0.01 m x 0.01 m x 0.01m x 1000 (the number of ml in one liter) to get the same conversion factor.

### Dilution Demonstration 2

1. Add 10 drops of dye to one cell in a white foam egg carton.
2. Draw 1 drop of dye from that cell and place it in the second cell of the carton. With a clean eye dropper add 9 drops of water to that cell and mix thoroughly. Clean and dry the “dye” eyedropper completely. Mark the top edge of the cell showing that the dye is in a 1:10 or 10 percent solution.

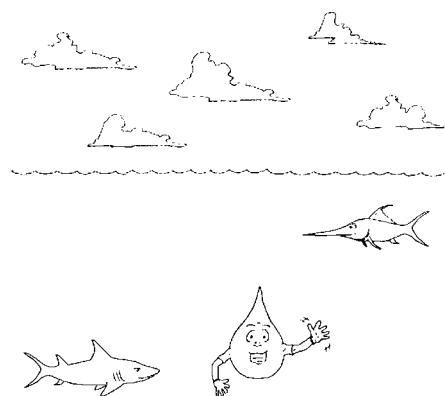

3. With a clean eye dropper, remove 1 drop of the solution from the 1:10 cell and add it to the next cell. Use the other eye dropper to add 9 drops of water to that cell and mix completely. Label this cell as a 1:100 or 1 percent solution.
4. Clean and dry the eye dropper and transfer one drop of the 1:100 solution to the fourth cell in the container. Using the other eye dropper, add 9 drops of water to the solution and mix completely. Label this cell as a 1:1,000 or 0.1 percent solution.
5. Continue in this fashion, transferring one drop of the previous solution with a clean, dry eye dropper and adding 9 drops of water to the current cell. At each transfer add one zero to the end of the large number or one decimal place to the percentage to indicate the strength of the solution. A summary of the concentration in each cell is listed here.

Cell Number	Concentration	Percentage
1	1:1	100
2	1:10	10
3	1:100	1
4	1:1,000	0.1
5	1:10,000	0.01
6	1:100,000	0.001
7	1:1,000,000	0.0001
8	1:10,000,000	0.00001
9	1:100,000,000	0.000001
10	1:1,000,000,000	0.0000001
11	1:10,000,000,000	0.00000001
12	1:100,000,000,000	0.000000001
13	1:1,000,000,000,000	0.0000000001

Note that by eliminating the 1:1 or 100 percent dye solution, a series that includes dilutions of 1:10 (10 percent) to 1 part per billion can be contained in a single egg carton.

6. Have the participants compare the dye color in the water through the series.
7. Ask them to determine which cell contains such dilution that the water seems to contain no dye at all. Use their observations to illustrate that some pollutants can be present in water even though we cannot detect them with human senses.

## Volume Demonstration

1. Show participants a BB or the plastic head of a dressmaker's pin.

*The approximate volume of a standard 0.177 BB is 0.02903475 inches<sup>3</sup> or 0.000001680251 feet<sup>3</sup>, assuming that the BB is a perfect sphere. The volume of a sphere is calculated as  $4\pi r^3/3$ .)*

2. How much water would need to be added to this amount of material to dilute it to one part per million?

*This can be found by multiplying the calculated volume by 1,000,000 (at this level, the difference between 999,999 and 1,000,000 is insignificant and the calculations are much easier). This results in a volume of 29,034.75 inches<sup>3</sup> or 1.68 feet<sup>3</sup>. Since each gallon of water occupies a volume of 231 inches<sup>3</sup>, a BB in 12.569 gallons of water is approximately 1 part per million.*

3. Refer to the dilution experiments and have participants calculate how many cubic inches of water would be required to dilute the single drop of pollutant to one part per million, given that the volume required is approximately 13.2 gallons. *Note that they can check the volume by measuring the inside width, depth and length of the tank and multiplying those dimensions, although accuracy in measuring these dimensions is critical to their answer. In the other experiment, they could measure a given number of drops (20 to 100) and multiply through the dilutions to get a similar answer.*

*Multiplying 13.2 gallons times 231 cubic inches per gallon yields an answer of 3,049.2 cubic inches or 1.76 cubic feet (cubic inches divided by 1,728). [Note that the calculated amount added was 13.208602 gallons if*

*each measurement was exactly right and no liquid was spilled or left in the measuring containers. Thus the precisely calculated amount was 3,051.1871 cubic inches. The differences are due to rounding error.]*

4. Challenge the group to determine the amount of space required to get to dilutions of one part per billion and one part per trillion.

*One part per billion requires that one drop be diluted with 3,051,187 in<sup>3</sup> or 1,765.7333 ft<sup>3</sup> of water. One part per trillion would require that the drop be diluted by 3,051,187,100 in<sup>3</sup> or 1,765,733.3 ft<sup>3</sup> of water.*

5. If desired, have the students compare the volume (length x width x height) of a classroom, assembly hall or cafeteria with the volume of the BB to find a space that comes close to those dimensions. Try to locate rooms or buildings that would approximate these volumes. *Note that a 30- x 30-foot room with a 12-foot ceiling holds about 1,080 ft<sup>3</sup> of space, a 40- x 30- x 10-foot room would hold about 12,000 ft<sup>3</sup> and a 40- x 30- x 12-foot room would hold about 14,400 ft<sup>3</sup>.*

*If the volume of a BB is approximately 0.02903475 in<sup>3</sup> or 0.000001680251 ft<sup>3</sup>, a space of about 29,034.8 in<sup>3</sup> or 1.7 ft<sup>3</sup> represents one part per million, while a volume of 13,442.011 ft<sup>3</sup> (23,227,794 in<sup>3</sup>) would represent one part per billion and a volume of 13,442,011 ft<sup>3</sup> (23,227,794,000 in<sup>3</sup>) would represent one part per trillion. [Note that comparisons with classrooms, auditoriums, or football stadiums might be instructive. One part per billion represents about 1,680.25 ft<sup>3</sup> of classroom with 8-foot ceilings, for example.]*

6. Note that some pollutants are considered to be dangerous at dilution rates of one part per trillion or less, and stress that biological amplification or bioaccumulation of pollutants can concentrate pollutants that cannot be detected in water to levels of 50 to 100 parts per million!
7. Ask why these factors could be important to people?

*They are important because we, too, can accumulate these materials and we may eat the organisms that concentrate them, which results in damaging levels being ingested.*

## **Follow Up Activity**

Contact local water treatment personnel, district soil and water conservation personnel, Texas Natural Resources Conservation Commission staff, or the county Extension agent for more information on water testing and pollution.



## Water Detective

\* Allow at least a week from the time of assignment to discussion to permit adequate research.

### Equipment/Materials

individual record sheets  
chalkboard and chalk or newsprint pad and markers

**Time Required:** 15 to 20 minutes of discussion time\*

This exercise allows participants to research the sources, treatment and use of water in their homes and communities. Notify officials who might be contacted about the potential deluge of questions from children who are trying to get information directly from local sources. Use information from the discussion period in a manner that is meaningful to the group.



1. What is the source of the water used in your home?

***Municipal or other public water supplies come from underground aquifers using wells, artesian wells or springs, or from rivers, lakes and reservoirs. Private water supplies come primarily from wells or cisterns. Try to get specific sources, e.g., the Bosque River, Lake Brownwood, water wells on Reservation Road. Push beyond treatment plant sites.***

2. Is the water treated in some way? How much water is treated daily?

***In private sources, water is most commonly untreated, but it may be treated to reduce hardness or some other chemicals. Public water supplies may be filtered, flocculated, chlorinated, fluoridated, desalinated, or treated in some other fashion.***

3. Is the water used in your home tested? How and for what types of materials?

***Most home water supplies are not tested except when wells are first drilled or when homes are sold. Public water supplies are tested to conform to certain standards; usually they are tested for coliform bacteria and hardness, as well as some contaminants. In other cases, they may be tested for a much wider variety of chemicals. Your local water treatment staff could inform you about the treatments in your community.***

4. What minerals are found in your water, and how much of each one is present in your drinking water?

***This is highly variable and may be unknown for private water supplies. It should be well documented for public water supplies.***

5. Is anything added to your drinking water? What and how much is added?

***The most common additives are chlorine and fluorides, but water softeners add some salts while removing others. Hypochlorite bleach may be used as a disinfectant in some private supplies.***

6. Is your household water filtered? How and why is that done?

***Filtration is highly variable and may be seasonal in some public water supplies.***

7. Have there been any problems with your water supply? What kinds and when did they take place?

***Examples include waterline breaks, filtration plant failures, floods, lowered water levels in wells, and similar items.***

8. How is the public notified of a water emergency?

*This will vary with water source, type of problem and area affected.*

9. What can you do to keep water clean?

*Accept any reasonable contribution here. Note some of the suggestions in the text.*

10. What careers are available for people interested in water quality and the environment?

*A long list could be constructed, e.g., well driller, plumber, civil engineer, microbiologist, watershed manager, municipal water supply technician, pipe fitter, reservoir manager, water chemist, test lab technician.*



## Water Detective

How much do you know about the water that you drink every day? How much is used in your home for sanitation, dish washing, cooking, taking baths, washing clothes and other uses? What is the source of all that water? You can be a water detective. Use resources in your community to find answers to these questions.

1. What is the source of the water used in your home?
2. Is the water treated in some way? How much water is treated daily?
3. Is the water used in your home tested? How and for what types of materials?
4. What minerals are found in your water, and how much of each one is present in your drinking water?
5. Is anything added to your drinking water? What and how much is added?
6. Is your household water filtered? How and why is that done?
7. Have there been any problems with your water supply? What kinds and when did they take place?
8. How is the public notified of a water emergency?
9. What can you do to keep water clean?
10. What careers are available for people interested in water quality and the environment?

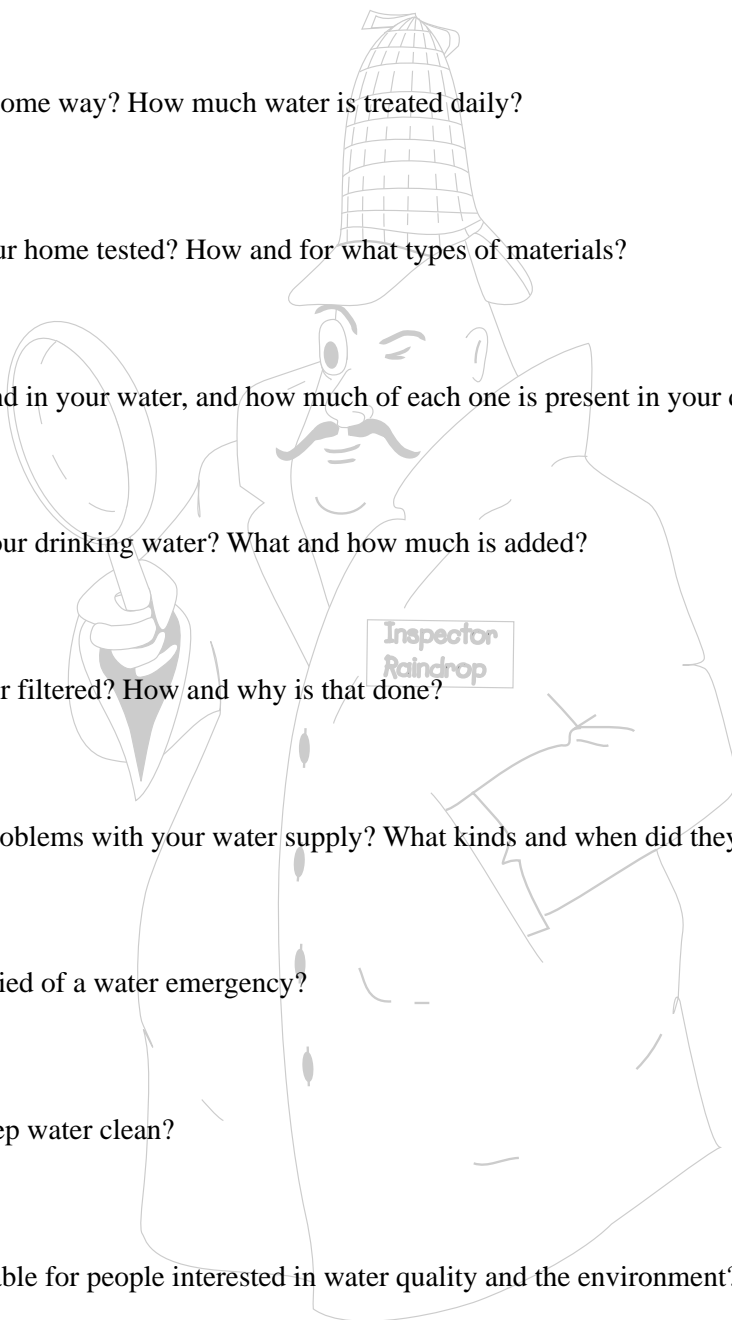



## Bottle 'Em Up



Did you know some bottled water comes from municipal water systems?

This exercise is a blind taste test to see if all types of bottled water are the same and to determine participant preferences.

### Equipment/Materials

survey sheet for each participant  
pen or pencil for each participant  
small paper cups (six per participant)  
small pitchers or decanters (six identical)  
tap water  
distilled water  
bottled drinking water  
spring water  
mineral water  
seltzer water

**Time Required:** Approximately 20 minutes

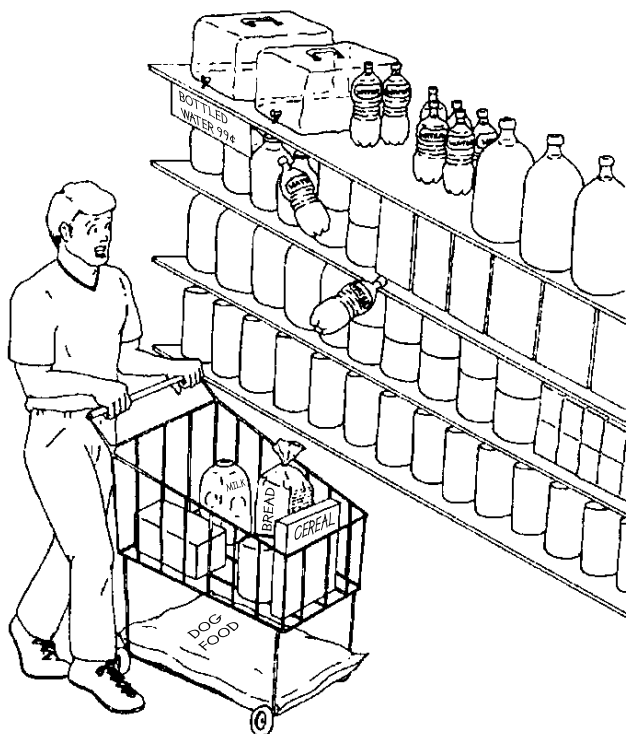

### Procedure

1. Refrigerate the sample waters to chill them thoroughly.
2. Set up a sampling table by filling each decanter or pitcher with one of the samples and labeling it with a number. (Record the number and the type of water included in a suitable place.)
3. Place a stack of small paper cups (bathroom cups or tiny condiment cups are large enough) at each sampling station.
4. Have the participants sample each of the bottled water samples and record their observations on taste as well as their likes and dislikes next to the number of the sample. (An assistant at each of the sites might be helpful to prevent spills and other accidents.)

### Discussion and Analysis

1. Have participants discuss their observations on each of the samples using the numbers listed with the samples.
2. Ask them to rank the samples from best to worst in flavor and to rank them in order of their preference.
3. Provide them with the list of products by numbers, so they can fill in the product name next to their observations.
4. Lead a discussion on the reasons for the differences in taste among the samples.
5. Ask how the bottled water samples compared to the tap water sample. Where does the tap water rank in comparison to the other types of water available?
6. Review the types of water and their definitions.



## "Bottle 'Em Up"

**Directions:** Taste small samples of each of the six types of water provided and record your observations and preferences below. Rank the samples by taste and preference. After the samples have been ranked, look at the content label and list the content of each sample to assist in the discussion.

**Example:**

Sample A ( tap water ) good flavor, slight chlorine taste and slight mustiness, ranked #4 in flavor and

#3 in preference by me, surface water from lake

Sample 1 ( )

Sample 2 ( )

Sample 3 ( )

Sample 4 ( )

Sample 5 ( )

Sample 6 ( )



# Pollution - Solution !



Many pollutants are odorless, tasteless and colorless and some of them cannot even be detected in the water!

## Equipment/Materials

individual record sheets  
pens/pencils

**Time Required:** 15 to 30 minutes depending upon discussion process

## Procedure

1. Supply a student record sheet to each member of the group, and challenge members to find some less damaging means to replace each of the items on the list.
2. Have them share their ideas with each other. Encourage them to think broadly about the issue of environmental “friendliness” in balance with human welfare and quality of life.
3. Provide some workable alternatives as listed here, and be prepared to accept others that work without increasing pollution over the amounts in the alternative method.
4. Encourage members to work with other family members in making “water-wise” decisions about products used in the household.

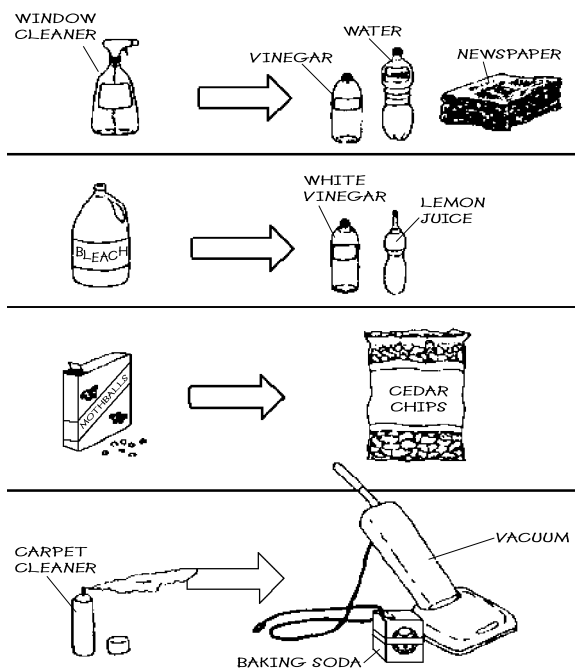

## Household Product

## Water-wise Substitute

laundry detergent

choose one without phosphates  
use mildest form needed

general cleanser

wash with baking soda

carpet cleaner

sprinkle baking soda on carpet, then vacuum

chlorine bleach

nonchlorine bleach  
lemon juice  
white vinegar

furniture polish

lemon oil  
carnauba oil/wax  
beeswax

insecticide

spray plants with soapy water  
remove insects by hand  
use beneficial insects (e.g., lady bugs or lacewings)  
interplant with insect-repelling plants  
use natural controls like *Bascillus thuringiensis*

mothballs

use cedar chips

window cleaner

use 2 Tbsp vinegar in 1 quart of water  
rub newspaper on glass





## Pollution - Solution !



Many pollutants are odorless, tasteless and colorless and some of them cannot even be detected in the water!

There are many hazardous products found in our households that can be harmful to our water supply. Can you think of any alternatives that could be used for the following household products?

<b>Household Product</b>	<b>Water-wise Substitute</b>
--------------------------	------------------------------

laundry detergent	
-------------------	--

general cleanser	
------------------	--

carpet cleaner	
----------------	--

chlorine bleach	
-----------------	--

furniture polish	
------------------	--

insecticide	
-------------	--

mothballs	
-----------	--

window cleaner	
----------------	--





# Water Wise Use

## Objectives

1. Identify ways that water is wasted in the home.
2. List the principles of Xeriscape™ landscaping.\*
3. Locate and read the water meter at home.
4. List ways that water can be conserved in the home.
5. Have fun while learning.

## Materials/Equipment

See individual activities.

## Lesson Requirements

**Best Time:** Any time of the year

**Best Location:** Any safe setting where young people can work in small groups

**Time Required:** Approximately 45 minutes, longer to evaluate some of the learning activities

## Vocabulary

agriculture	industrial	sanitation
arid	irrigation	xeric
bacterial	mesic	Xeriscapes™
domestic	objectionable	
engineering	per capita	
hydric	petrochemicals	

## Lesson Background

### I. Per Capita Water Use

#### Estimates vary

Estimates of **per capita** water use in the United States vary, but most agree that the average American uses 38 to 80 gallons of water daily in and around the home. Drinking and cooking account for about 5 percent of that use. **Sanitation** (bathing and flushing of organic wastes) uses about 45 percent of that total, and cleaning clothing or dishes accounts for nearly 50 percent. In some parts of the country, lawn or garden **irrigation** increases total consumption tremendously. Other uses of water include application of pesticides or liquid fertilizers; washing vehicles; home maintenance; cleaning sidewalks, driveways, windows or siding; or using it for amenities such as swimming or wading pools, bird baths or fountains. People have an affinity for **hydric** or wet environments, even if they live in deserts.

\* Xeriscape™ is trademarked by the City of Boulder, Colorado.

## Lesson Overview

- I. Per Capita Water Use
  - A. Estimates vary
    1. Domestic water use
    2. Overall water use
  - B. Impact on resources
    1. Depletion of aquifers
    2. Increased contamination rates
- II. Why We Use So Much Water
  - A. Critical to life
    1. Usefulness
    2. Plentiful
    3. Value to manufacturing
    4. Requirement in agriculture
- III. Water Conservation in the House
  - A. Personal conservation
  - B. Toilets
  - C. Bathing
  - D. Laundry/dishes
  - E. Other
- IV. Conserving Water in the Landscape
  - A. Landscape use of water
  - B. Xeriscape™ landscaping
  - C. Efficient watering
- V. Working on the Bottom Line
  - A. Direct savings
  - B. Indirect savings
- VI. A Most Precious Resource

## Application

NOTE the per capita use of water. Ask group members how and where they use water in their homes. Give each one a *Water Wise Scorecard* (Record Sheet 12.1) and have them COMPARE their use with the models presented. LEAD them in brainstorming ways people use large quantities of water without realizing they are doing so.

LIST the breakdown of water usage inside the home. Have students BRAINSTORM to list ways they could decrease the amount of water they use. ALLOW group members to take home and to complete Record Sheet 12.2 *Splish, Splash, Should I Take a Bath?* [This could be done before the lesson and repeated when the lesson is completed.]

Our researcher estimated per capita water consumption for the United States at 1,567.5 gallons per person per day. In that estimate, **domestic** water use accounted for 4 percent or 62.5 gallons/person/day. **Industrial** uses consumed 48 percent of the total or 752.4 gallons/person/day. Those uses included processing, use as a coolant, cleaning, and use as a solvent in chemical processes. **Agriculture** used 43 percent of the total or about 674 gallons/person/day. The vast majority of that total was used for irrigation, but watering livestock and sanitation also consumed large quantities. Other uses accounted for the remaining 5 percent or about 78.6 gallons/person/day. These numbers are reasonable as a national average, but they are somewhat high for cooler, moister areas and quite low for hotter, drier regions of the country.

### Impact on resources

Water use exceeds the recharge capacities of many aquifers. One estimate places recharge rates for most aquifers at one-half to two-thirds the rate of withdrawal, which results in depletion of the aquifer. In addition to impacts on the future usefulness of those aquifers, excessive withdrawal reduces flows to springs, which harms aquatic life.

Withdrawal also increases the potential for contamination of the aquifer. Estimates for aquifer contamination vary with population and other factors. It is possible that 1 percent of the aquifers in the United States are seriously contaminated, primarily in areas where population levels are high. Evidence from one state suggests that about 13 percent of the groundwater contamination is from landfill leachates and between 30 and 40 percent is from **petrochemicals**. Contamination and excessive withdrawal create long range problems for future generations as well as periodic or persistent short-term problems for current users.

## II. Why We Use So Much Water

### Critical to life

The main reason we use so much water is that it is both critically important to us and ideally suited to our purposes. A ready supply of water allows us to keep our bodies, clothing, dishes and homes clean. It permits us to remove bodily wastes in an effective manner that helps control disease organisms or surface water contamination. It lets us grow lush lawns and landscapes, even when the weather is dry and hot. Sometimes we act as though the supply were unlimited. The water flows every time we turn the handle on the faucet, and water bills or electricity bills for pumping the water from our wells are relatively small. In addition, major portions of the population have shifted from colder, wetter climates to hotter, drier parts of the nation, moving the water demand with them. Finally, we seem to demand solutions to problems even when the real problem is one of having too many of us in too small an area. Thus major cities may deplete aquifers or demand substantial portions of the flow from massive watersheds simply to meet demands of growing populations. **Engineering** solutions to water supply problems are common, particularly where surface waters are

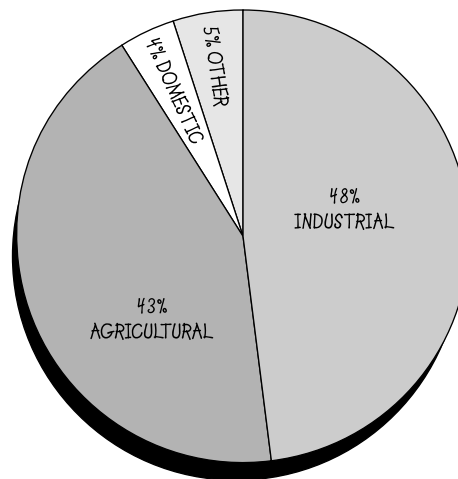

NOTE that overall water use is much higher than the amount used in and around the home. CHALLENGE participants to list some of the ways water is used every day in support of our lives and lifestyles. [While this focuses on consumption of water, recreational or aesthetic uses of water may be mentioned and are valid in most cases.]

Lead group members to DISCUSS the relative amounts of water used in various activities and the impact of local climate and weather conditions on the use of water at home and in agriculture.

ASK how removing water from an aquifer at a rate faster than its recharge compares with mining minerals. LEAD the respondents to discuss the possible impacts of depletion of aquifers in both short-term and long-term time periods.

used for public water supplies, but their impacts on aquatic organisms have been significant.

The use of water in manufacturing has grown with industrial production, but industrial users have made tremendous strides in water treatment. Some major polluters of past years actually return water of higher quality than they remove. Other manufacturers are treating and reusing wastewater, reducing demand on aquifers or public sources.

Use of water in agriculture has become more widespread in **arid** regions, but efficiency has grown as better means of applying the water to crops have been developed. Large amounts of water must be allowed to run off some irrigated lands to prevent their becoming saturated with salts, either from the soil or from the water source. In other situations, additional water is added in an attempt to leach the salts from the surface layers of the soil to depths beyond the root zone of the crops.

### Valuing water

Water is vitally important to us—one of the basic requirements of life. Although legislation and research have produced great advances in water use efficiency by industry and agriculture, changes in domestic water use are usually left to individuals. Continuing attention to wise, conservative water use is a key to a healthy environment and an adequate supply of fresh, clean water.

## III. Water Conservation in the Home

Each of us can review personal water use in an effort to use water more wisely and to reduce demand on wells or municipal water supplies. A look inside our homes and at our water use patterns can give us some ideas that will help.

### Personal conservation

The water we drink every day is essential to our welfare, and cooking and drinking water averages only about 5 percent of what is used at home. Although this is a small percentage, there are some things we can do to reduce water use in this area. For example, keeping chilled water in the refrigerator rather than waiting for the water from the tap to cool reduces the amount of water withdrawn from the source and the amount that enters the septic or wastewater treatment systems. Taking only what is needed and turning off the tap while drinking also reduce the use of water. Water used in cooking vegetables can be used as a stock in cooking other vegetables or soups if it can be used quickly or handled in a way that eliminates **bacterial** contamination or **objectionable** combinations of flavors and odors.

### Toilets

Almost half (45 percent) of the water used in American homes is used to flush toilets, which sends organic wastes into the septic or wastewater treatment systems. Bacterial and chemical treatments assist in returning purified water to surface sources when those systems are working well. In addition, treatment decreases the potential for groundwater contamination, disease transmission, and

NOTE that many uses of water are vital to the survival, health and well-being of people. Every person must have a certain amount of water to maintain those functions. ASK if cutting back on functions like cleanliness or sanitation makes sense. PUSH the notion further to discuss whether having beautiful lawns, flowers, fountains, and similar aesthetic items is sufficiently important to support the use of water.

ASK participants if they have ever been in a situation where there was a water shortage. Experiences might include dry land camping for extended periods, living under severe water rationing, or similar situations. ASK them to describe how they got water and how that water was used. NOTE that most of us never experience a want for water. Lead them to DISCUSS the cost of water service, population growth, population movement to hotter, drier parts of the country and similar factors as they affect water use and demand. [*For more advanced groups, consider discussion of engineering solutions to water problems and their impacts on other resources and the landscape.*]

Ask participants to RECALL some water uses in manufacturing or processing all sorts of products, including electrical energy, steel, fossil fuels, textiles, foods and drugs. NOTE that water treatment and reuse is becoming more common in industry, and that the contribution of industry to water pollution has been declining.

ASK the group members to discuss why water is important to agriculture. NOTE that irrigation is the biggest user of water in agriculture (about 70 percent), particularly in warmer, drier parts of the country where high value agricultural products are grown for fresh consumption. *If desired, more advanced youths may want to CONSIDER possible salinization of the soil and the need for letting water run off to carry away salts. What happens to the salts being carried away?*

CHALLENGE young people to summarize the reasons for our heavy use of water every day and the importance of conserving water for its many, vital uses by people and other living things, both now and in the future.

other problems associated with more primitive waste management systems. The use of flush toilets is unlikely to stop, but tremendous amounts of water could be saved if more efficient toilets were used.

A simple way to conserve water is to reduce the volume of water used at each flush while maintaining toilet efficiency. If each member of a family of four flushed the toilet six times each day, a one-half gallon reduction in the amount of water used in each flush would result in a savings of 4,380 gallons of water each year. If the toilet were flushed an average of 10 times per day by each family member, the savings would grow to about 7,300 gallons.

This reduction in volume can be accomplished in several ways: place a water-filled jug in the tank; add a couple of sealed bricks to the tank to reduce volume; change the location of the float; build a tank dam; or weight the flapper to cause it to close sooner. If efforts to reduce flush volume result in needing to flush the toilet several times, these “water conservation efforts” can result in inefficient, increased water use. Using one flush of adequate water volume is more conservative than using several smaller flushes—and it is more convenient, too. Newer toilets are designed for greater water efficiency.

Under extreme conditions, water could be conserved by flushing the toilet only after several uses or when solid wastes are present. This may result in odor problems, alterations of indoor air quality, or possible disease transmission problems. Toilets are not garbage disposals, and they should not be used to dispose of wastepaper like facial tissues, gum wrappers, or other items that could go into the trash or be recycled.

## Bathing

About half the water used in our homes is used in washing laundry and dishes and in bathing. Every inch of water used in a bath represents about 4½ gallons of water. Reducing the amount of water used in a bath reduces the amount of water consumed. Short showers (less than 5 minutes) and water-saving shower heads decrease the amount of water consumed even more. A quick shower can use about 15 gallons less water than an average bath. Small children can be bathed together, reducing both the amount of water and the amount of energy used to heat water for separate baths. A more extreme, but effective, method of reducing water use is to use enough water to wet the hair and body, lather thoroughly with the water turned off, then turn the water back on to rinse. Using this method, a shower can be taken with as little as 1 or 2 gallons of water. Keeping faucets functioning properly, turning water off when it is not immediately in use, and similar actions can further reduce water use.

## Laundry/dishes

Every household generates plenty of dirty clothes and dirty dishes. Huge amounts of water are required for cleaning them. Adjusting the water level to the size of a load of laundry or waiting until a full load is ready for cleaning before running the washer will keep the water required to a minimum. Items that demand special care can be washed in a sink and rinsed in a small amount of clean water

Even though domestic water use is only 4 percent of the total use, direct involvement with water conservation is possible for every young person and adult participating. DISTRIBUTE Fact Sheet 12.1 *Water Efficient Home Guide* as a reference and challenge for saving water. REVIEW some of the potential ways of reducing water use at home. [This discussion may be taken in parts or categories or it can be a generalized discussion with categorization during or after the open discussion.]

Have participants CALCULATE the reduction in water use possible by reducing the tank volume on the toilet by either ½ gallon or a gallon per flush. For easy calculation, consider that each member of the family flushes the toilet(s) 10 times daily, 365 days each year.

Examples:

$$3 \text{ persons} \times 10 \text{ flushes/day} \times 1 \text{ gallon/flush} \times 365 \text{ days/year} = 10,950 \text{ gallons/year}$$

$$4 \text{ persons} \times 10 \text{ flushes/day} \times 0.5 \text{ gallon/flush} \times 365 \text{ days/year} = 7,300 \text{ gallons/year}$$

REVIEW the results of Record Sheet 12.2 *Splish, Splash, Should I Take a Bath?* ASK if anyone has ever used a camping shower (1 to 2 gallons of water in a plastic bag with a spray head attached). If so, NOTE that two people can take showers with about 3 gallons of water if they wet their bodies, lather with the water off, and rinse quickly. ASK how that principle could be used at home.

rather than being machine laundered separately. Clothing needs to be washed only when it is dirty, not merely as a means of eliminating wrinkles. Some clothing can be worn several times before laundering is needed.

Washing dishes by hand and rinsing them in standing hot water consumes less water than using a dishwasher. Dishwashers generate high water temperatures that combat bacteria better, but they waste water unless they are run with a full load of dishes.

### Other

Lots of simple things can be done to reduce water use in the home. Water can be turned off while brushing teeth, then run briefly to rinse the sink. Holding some water in the sink for washing or shaving uses less water than allowing the water to run throughout the process. Each time you use water, stop to consider whether it is necessary for the water to be flowing. If not, shut it off or catch some in a basin or sink for the use desired. For example, the car could be washed using a bucket and/or a pistol grip hose rather than using a continuous stream of water. A broom could be used to sweep the driveway or sidewalk, rather than using the water hose to spray debris off its surface. Think it over. There are lots of ways to save some water and perhaps prevent a water emergency.

## IV. Conserving Water in the Landscape

### Landscape use of water

Some estimates show about 60 to 70 percent of domestic water use is devoted to watering the outside landscape. Careful selection of landscape materials, including ground covers, can greatly reduce water use. The traditional use of grasses and other landscape materials with high demand for water is one alternative, but grasses adapted to **mesic** (moist) environments may demand an inch or more of water each week.

### Xeriscape™ landscaping

In dry (**xeric**) environments, careful and creative selection of plants and ground covers adapted to dry conditions can greatly reduce water demands. These types of landscape, known as **Xeriscapes™**, make creative use of several factors to achieve more efficient water use. This starts with a good landscape design and plan. Use of soil preparation and amendments can increase drainage, absorption of water and the water-holding capacity of the soil. Selection of trees, shrubs, flowering plants and grasses adapted to the area and its normal rainfall greatly reduces the amount of supplemental watering required. Turfgrasses demand huge amounts of water. Reducing turf areas to a practical level aids in water conservation. In addition, watering plants only when the water is needed encourages deep root growth and produces a healthier and more drought-tolerant landscape.

### Efficient watering

More effective watering processes also help. Watering during the middle of the day results in higher water losses through evaporation. Watering early in the day makes the water available to the

CHALLENGE the young people to expand on the listings here with workable, safe and responsible ways to conserve domestic water use. ENCOURAGE them to share the Fact Sheet 12.1 *Water Efficient Home Guide* with their parents and to become leaders in making water use more efficient.

COMPARE mesic or moist environments to xeric or dry environments. NOTE that the plants differ in many ways (adaptations) to survive under these conditions. Ask participants to DISCUSS how using plants adapted to dry areas could improve water use and efficiency in landscaping.

If possible, INVITE an Extension agent or local landscaper to discuss the use of Xeriscape™ techniques in your area (if merited). In wetter areas, consider comparison between local conditions and those where drought and heat resistance are vital unless considerable water is supplied.

plants with a minimum of water loss. Similar principles can be applied to providing water for gardens. Using drip or trickle irrigation systems as opposed to spray, and using irrigation only when necessary, will produce productive gardens with minimal water demand. Gauging rainfall and measuring water applied to the landscape and garden can maximize water use efficiency.

## V. Working on the Bottom Line

Wise water use saves money too!

### Direct savings

Reducing water use results in smaller water and sewage bills or reduced energy costs for pumping water. Using less hot water also reduces household energy costs, saving money on gas or electricity. These direct savings are easy to see, either by studying utility bills or by reading meters before and after implementing some savings techniques.

### Indirect savings

The conservation approach also produces indirect savings by reducing demand on municipal wells or water sources, reducing costs for water treatment, reducing the size of wastewater treatment facilities and the cost of wastewater treatment, and reducing the cost of the infrastructure needed to support distribution systems for water and wastewater. It also reduces the impact of water withdrawals from lakes, rivers and reservoirs, maintains recharge rates in aquifers, and produces higher quality environmental benefits like increased productivity of coastal fisheries, more abundant and higher quality water-based recreation, and much more. The fact is that conserving water makes good sense for everyone!

## VI. A Most Precious Resource

It is clear that water is one of the foundations of life. Water is critical to our survival, our quality of life, environmental health, manufacturing, the growth of our food supply and more. Although water is recycled by natural processes, conservation of fresh water in aquifers and in surface sources is critical. Fresh water is in very limited supply, and the human population puts tremendous strain on that supply in some regions. Even where water is abundant, conservation of this resource demands attention and care by all people.

As with other societal changes, increased concern and conservation of freshwater resources is most likely to come about through young people who learn about the resources and work together to conserve them. This doesn't mean that we do foolish or ridiculous things in the name of water conservation, but it should mean that we treat our water resources with the care and respect required to maintain and enhance their value in our lives. Conservation and care will allow future generations to enjoy the many benefits and uses of water, including being able to take a life-sustaining drink of cool, clear, clean water.

VISIT a residential site and locate the water meter. USE Record Sheet 12.3 *Meter Reader* to help young people read the water meter. ENCOURAGE the students to read their water meters each month to see if their home use of water is changing and if their conservation efforts are having a positive effect.

INVITE representatives from local utility (water and sewer) services to discuss ways of reducing water use or electricity use. Ask them specifically to ADDRESS savings in indirect costs to the consumer when overall water use is reduced.

GIVE each participant a contract (*Water We Do Now*, Record Sheet 12.4) and encourage them to set some water conservation goals and test their impacts (see Record Sheet 12.3 *Meter Reader* for ideas).

NOTE that some might consider air or sunlight the MOST precious resource, but all the basic resources must be present for life to exist!

LEAD participants to summarize the vital importance of water to life on earth.

Lead the group to REVIEW the water cycle and the importance of conserving freshwater supplies.

DISCUSS the mechanics of change in societal behaviors, and ENCOURAGE the participants to think toward the future as well as immediate needs when reviewing options for themselves and their society at any level.



## For Further Thought

An abundant supply of high quality water is a vital element in the quality of life for people. Although water is seldom an issue with people until there is a crisis, all of us can do much more to ensure an adequate supply of good quality water for ourselves and other living things. Water conservation, planned reuse of water, and many other means can be part of the solution. Helping others see that water is important and that even little things affect both its quality and quantity is an important element in responsible citizenship. Even children can do something about water—first by learning about it, second by sharing what they have learned, third by being aware of ways they can contribute directly and acting on those opportunities, and finally by helping others understand the issues involved. What can YOU do?

## Sharing or Exhibit Suggestions

Share what you have learned in this series of lessons with your family and friends. Help them to understand the importance of water to living things, human society, and our welfare and quality of life. Share some of your findings with them or help them in doing the things you have done in the course of this program.

## Summary Activity

Challenge each participant to conduct a water audit at home and suggest some practical ways to reduce water use. For example, they could install a shower head that delivers less water, repair any leaking faucets, check the pattern of their sprinklers and the amount of water delivered to various sites on the lawn and then adjust the watering regime accordingly.



## Water Efficient Home Guide

Following are some suggestions for conserving water in your household. Use them as a guide for developing your own water-saving ideas.

### Bathing and Personal Care.

- Bathe small children together.
- Relax with exercises or a massage instead of a shower.
- As you wait for shower water to heat up, collect cold water in a bucket for plants.
- Fill sink to shave and dip razor as needed.
- Turn the shower off while you shampoo your hair.
- Limit your showers to 5 minutes or less.
- Reduce the amount of bath water used in the tub.
- Install water-saving shower heads.

### Laundry

- Adjust the water level in the machine according to load size.
- Wash clothes only when you have a full load.
- Avoid buying garments that must be washed separately or require special laundry care.
- Check water hoses for leaks.
- Wash clothes only when they are dirty, not to remove wrinkles.

### Cooking/Drinking

- Cook food in as little water as possible
- Save water left after cooking vegetables for soups, stews or cooking other vegetables.
- Use the correct size pan for the amount of food; large pans use more water.
- Use the dishwasher only for full loads.
- Limit the use of the garbage disposal—compost instead!
- Rinse hand-washed dishes in a sink of water rather than under running water.
- Keep drinking water in the refrigerator so you don't have to run tap water to get it cold.

### Household Cleaning

- Use a broom to clean sidewalks/driveways.
- Vacuum rugs regularly so you will not have to shampoo as often.
- Wash windows outdoors and automobiles with a bucket of soapy water. Rinse quickly with a hose using a high-pressure, low-volume pistol grip handle.
- Wash the car on the lawn to irrigate it.

### Lawn and Garden

- Plan and develop a good landscape to conserve water.
- Use mulch (leaves, lawn clippings, bark or straw) around plants to reduce evaporation.
- Select plants adapted to the area.
- Use drip or trickle irrigation.
- Water early in the morning or late in the evening to reduce evaporation loss.
- Check irrigation equipment for leaks.



## Water Wise Scorecard



Reducing the volume of water per flush by just  $\frac{1}{2}$  gallon could save about 10,000 gallons of water annually for a family of four.

**Take this simple water conservation test. Read the following questions and answer:**

**always                      most of the time                      sometimes                      never**

1. Do you leave the water running when you brush your teeth?
2. Do you use the toilet to get rid of trash instead of putting it in the trash can or recycling it?
3. Do you take a bath instead of a shower?
4. Do your showers exceed 5 minutes in length?
5. Do you run the washing machine before you have a full load of laundry?
6. Do you run the dishwasher before it's completely full?
7. Do you leave the water running while you wash your car or dog?
8. Do you get the sidewalk or street wet while you are watering your lawn?
9. Do you allow your faucets to drip?
10. Do you allow the water to run while you are washing your hands?

Give a numerical score to each of your answers using the values listed below. Total the numerical values to get your water watching score.

always = 1  
most of the time = 2  
sometimes = 3  
never = 4

If your total score is:

- 34-40 points - You are a super water server!
- 27-33 points - You are doing a good job.
- 10-26 points - You could do a better job of conserving water in your home.



# Splish, Splash, Should I Take a Bath?



A shower without a water-saving shower head may use more than 5 gallons of water per minute.

## Equipment/Materials

ruler                      paper                      pencil or pen

## Procedure

1. Fill the bathtub as you would if you were going to take a bath. Use a ruler to measure the depth of the water in four places the length of the tub, and record those measurements. Remember to hold the ruler vertically when taking the measurements. Record your measurements here.

Depth \_\_\_\_\_, \_\_\_\_\_, \_\_\_\_\_, \_\_\_\_\_ inches

2. Add all of the measurements together and divide by the number of measurements you took. This gives you an average depth for the water in the tub. **Hint: It is easier if all the measurements are converted to decimals before doing the math.** Record the average depth here.

Average depth \_\_\_\_\_ inches

3. Since every inch of water in a bathtub represents approximately 4½ gallons of water, multiply the average depth of water by 4.5 to get an estimate of the amount of water you use to take a bath. Record that below.

I use \_\_\_\_\_ gallons of water when I take a bath.

4. Drain the water from the tub.

5. Close the drain and take a shower.

6. Measure the depth of the water in the tub as you did before and calculate the amount of water used in your shower. Record that value below.

Depth \_\_\_\_\_ inches

Average depth \_\_\_\_\_ inches      Water used for shower \_\_\_\_\_ gallons

7. Was showering or bathing the more efficient way to wash? \_\_\_\_\_

8. How could you reduce the amount of water required for either a bath or a shower? List some things you think might help.

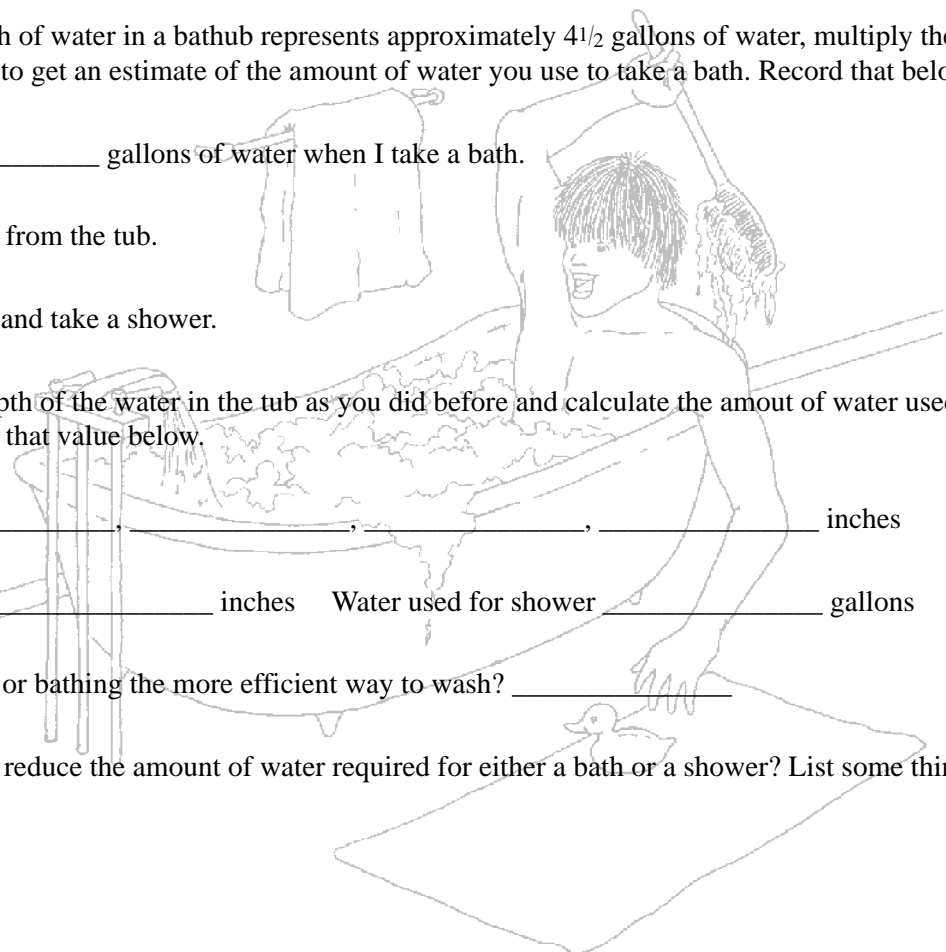







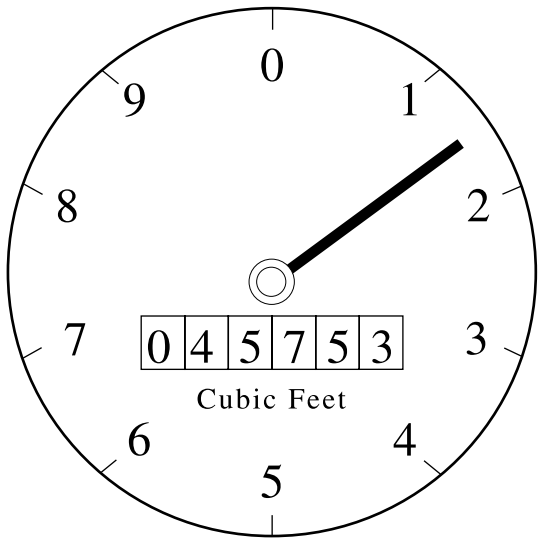

## How to Read a Single-dial Water Meter

Single-dial meters are read like an automobile's odometer. As each counter returns to the zero reading, the next counter moves up a unit. The major difference between an odometer and the single-dial water meter is that the last digit of the reading is read by the position of the needle dial on the gauge. The illustrated meter reads 457,531 gallons. If the previous reading had been 9,987,745, the amount of water consumed during the measurement period would have been 469,786 cubic feet. Like the six-dial meters, single dial meters are read in either cubic feet or gallons. You can convert either type to the other with the information on the previous page ( $10,457,531 - 9,087,745 = 469,786$  gallons used).

## How to Read a Six-dial Water Meter

Each dial is marked with a number indicating the order of magnitude being recorded. Read the dial with the highest order of magnitude first (in this case 100,000) and continue reading them in decreasing orders of magnitude until the last dial is read. The dials rotate clockwise, and the number the pointer points to or past is the one recorded. Thus, if the needle points between two numbers, record the lower number. Continue to read the dials in succession. When the last dial is read, you have the meter reading. In the example given, the meter reads in gallons and the reading is 47,631 gallons. If the previous reading had been 935,631 gallons, the amount of water consumed would have been 112,000 gallons for the period measured ( $1,047,631 - 935,631 = 112,000$  gallons used).

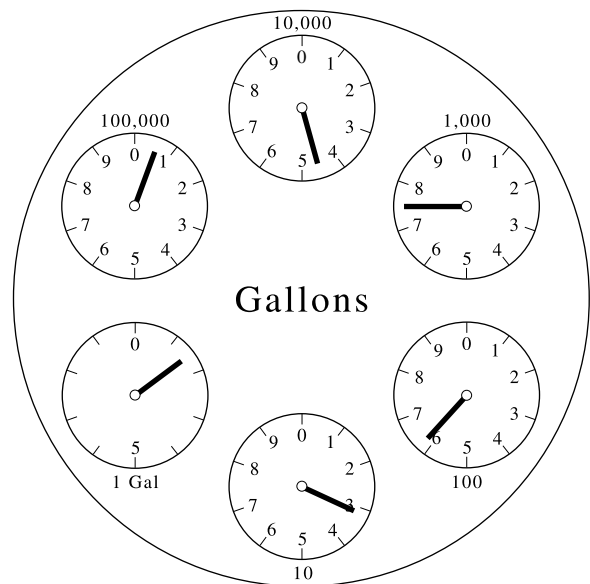



## Water We Do Now? Water Wise Contract

*I, \_\_\_\_\_, promise to do my best to protect and conserve water during the next month. As part of this contract with the environment I will try to practice the following things:*

1. \_\_\_\_\_
2. \_\_\_\_\_
3. \_\_\_\_\_
4. \_\_\_\_\_
5. \_\_\_\_\_
6. \_\_\_\_\_
7. \_\_\_\_\_
8. \_\_\_\_\_
9. \_\_\_\_\_
10. \_\_\_\_\_

Duly signed and witnessed before me this day, \_\_\_\_\_ .

Justice H. Two Oh *H. Two Oh, Esq.*

*Signed* \_\_\_\_\_, *faithful wise water user*

*Witnessed* \_\_\_\_\_, *guide and mentor*





# Glossary

absorb	to take a substance into the structure of another; e.g., plant roots <i>absorb</i> water
accretion	deposition of material through sedimentation; e.g., coastal marshes grow through <i>accretion</i> of sediments carried by flood waters
accumulate	increase, gather or build up
acid	any chemical compound with a pH less than 7; e.g., vinegar is a weak <i>acid</i>
acid precipitation	precipitation with a pH less than 5.6, the slightly acid state of normal moisture in the air
actionable level	concentration or level at which a specific pollutant or contaminant falls under the jurisdiction of a governmental body; e.g., the concentration of PCBs in fish
adsorb	to hold a substance on the surface of another; e.g., clay particles <i>adsorb</i> water, holding it tightly to the surface of the clay particle
adversely	in a negative fashion
aeration	adding air or oxygen, usually to accelerate decomposition or to prevent fish kills
aerobic	respiratory pathways requiring the presence of adequate oxygen, or conditions which permit oxygen-requiring organisms to live and reproduce (normal end products of aerobic respiration are carbon dioxide and water); most plants, animals and microbes require aerobic conditions for survival; see also <b>anaerobic</b>
aesthetic	pertaining to appreciation, beauty, sensory appreciation or similar values
agriculture	culture of plants or animals for consumption by humans, other animals, or use in manufacturing processes
algae	single-cell or multicellular plants without differentiated vascular tissue and primarily adapted to living in water
ammonia	a compound composed of nitrogen and hydrogen (NH <sub>3</sub> ), toxic to most organisms if in adequate concentrations; the normal nitrogenous waste of bony fishes
anaerobic	respiratory pathways that do not require the presence of oxygen or conditions that will not permit oxygen-requiring organisms to live and reproduce (end products of anaerobic respiration include chemicals such as hydrogen sulfide and methane); see <b>obligate anaerobe</b>
aquaculture	growing food fishes, mollusks, crustaceans or other animals as an agricultural enterprise, often in confinement or created ponds or wetlands, but including some open systems
aquatic	associated with or living in the water
aquifer	a water-bearing geological feature
arid	dry
artesian well	a well or natural opening into a confined aquifer with adequate pressure to raise the level of the water above the water table in the confined aquifer; see <b>potentiometric surface</b>
atom	the smallest indivisible particle of a chemical element; a hydrogen atom contains a nucleus with a single proton (+) orbited by a single electron (-)
autotroph	producer, organism able to manufacture chemical energy from sunlight or other chemical sources without requiring other organisms; see also <b>heterotroph</b>
average	a measure of the central tendency of a set found by dividing the total for all observations by the number of observations, also known as the mean; the average of 6, 4, 6, 6, 4, 5, 4 is 5 or 35/7

bacteria	any of a large group of organisms in the Kingdom Monera, primarily microscopic and without defined nuclei in their cells, mostly <b>beneficial</b> , but may be <b>pathogens</b> as well
bacterial	pertaining to bacteria or their actions in the body or other environments
basin	a watershed
beneficial	helpful to human endeavor or to the functioning of ecosystems
benthic	living on or near the bottom of a body of water
bioaccumulation	concentration of some material (often pollutants) through biological processes; e.g., fat soluble pollutants like polychlorinated biphenyls (PCBs) <i>bioaccumulate</i> as larger organisms consume smaller ones, reaching high concentrations in the fat of predatory fish even when nearly undetectable in the water itself
biochemical	the chemistry of living things, or the chemicals involved in that process, mostly involved in the storage or use of energy or the synthesis of organic materials
biogeochemical	the combination of biological and geological processes involved in the cycling and reuse of chemical building blocks of living things
biological	having to do with living things
black water	untreated sewage
boiling point	temperature at which a liquid becomes a gas, approximately 100 degrees C for water at standard pressure (sea level)
bonding angle	angle at which an atom attaches to another in the formation of a molecule (hydrogen atoms bond to each other at an angle of 105 degrees in forming a water molecule)
brainstorm	a group process technique that encourages rapid accumulation of many ideas without discussion or evaluation until after all the ideas have been collected
brackish	water with a salinity between that of freshwater and the waters of the open sea
buffer	chemicals with the ability to maintain or dampen changes in acidity or alkalinity
buffering capacity	the degree to which a system is able to maintain its pH balance in spite of additions of acids or bases to the system
calorie	unit of heat required to raise the temperature of 1 cubic centimeter of water by 1 degree Celsius (note that 1cc equals 1 milliliter and 1 gram of water as well)
camouflage	patterns designed to blend into the background or to disrupt the shape of an object
capillary action	tendency of water to move upward through porous materials toward the surface by the combination of adhesion to internal surfaces and the partial vacuum created by evaporation from the surface
carbohydrate	the primary chemical energy storage units for plants; chemical combinations of carbon (C), hydrogen (H) and oxygen (O) that produce sugars and starches as well as the closely related cellulose of plant tissues
carnivore	1) eaters of flesh such as insect-eating birds, fish-eating bears or meat-eating foxes; 2) members of the mammal order carnivora (cats, dogs, raccoons, weasels and their relatives)
casual water	water that temporarily inundates a local site as the result of immediate conditions, such as puddles that form after rains but dry or infiltrate into the soil quickly
chemical	elements and their compounds and mixtures that form matter; e.g., water is a chemical compound written in chemical symbolism as H <sub>2</sub> O, where each molecule of water is composed of one atom of oxygen (O) and two atoms of hydrogen (H); table salt is a chemical symbolized as NaCl where each molecule is composed of one atom each of sodium (Na) and chlorine (Cl)
chemical bond	energy stored in the forces that hold chemical compounds together

chlorophyll	the green pigment in plant cells that is essential to photosynthesis
clay	the smallest soil particle, having a slippery feel, a strong attraction for water and the ability to be formed into a ribbon when moist
cloud	condensed water vapor in the atmosphere
cohesion	an attractive force between molecules of the same structure; water molecules exhibit strong cohesive forces because they are polar, positive on one end and negative on the other
coliform	having to do with the digestive tract; e.g., <i>Escherichia coli</i> is a common coliform bacteria found in the lower digestive tracts of many animals, including humans
commerce	economic activity, trade and business
compass	a magnetic device that orients itself toward earth's magnetic field and enables a person to determine the direction of an object or location
component	any thing that is part of a system or structure
compound	a combination of two or more atoms to form a substance different from the component materials; e.g., sodium and chlorine, a heavy metal and a poisonous gas, combine to form sodium chloride (table salt), an essential part of our tissue fluids
concentration	1) a measure of the amount of solute in a solvent; 2) the process of reducing the amount of solvent to increase the relative amount of solute in a solution; 3) the ability to focus one's mind on a problem, process or circumstance
conclusion	reasoned outcome of a logical process, the result of analytical consideration of alternative explanations of observations
condensation	the process of forming a liquid from a gas
confined	held within boundaries or barriers; e.g., water in an aquifer held between impermeable layers
constructed wetland	wetlands formed by purposeful human action
consumer	1) end user of a product; 2) biologically, any heterotrophic organism
contour	pattern or line formed at the same elevation above a standard, such as sea level
contour plowing	plowing on contour lines when crossing sloping ground
control	1) to govern or regulate; 2) a comparison experiment in which all things are the same except for the experimental treatment
current	movement of liquid or gaseous materials, the force of that movement
cycle	a process that uses a substance and returns it to its original form through physical and chemical processes; all biologically important chemicals on earth are cycled through various organisms before being made available for reuse by the ecosystem
decomposer	organisms that break down dead organic material to use the remnant energy it contains
dehydration	loss or removal of water from tissues
density	the mass of a substance per unit of volume; see <b>concentration</b>
deposit	to place or leave material, material left as a result of deposition; e.g., suspended solids may become deposits as water flow decreases, allowing them to drop from suspension
deposition	the process of forming deposits
desert	environments where organisms are adapted to dry conditions and can survive with low and intermittent rainfall; both hot and cool deserts are found in North America
deterioration	breaking down or losing structure or structural integrity

detoxify	breaking down toxic materials to yield nontoxic products
detritus	decaying organic matter
diffusion	physical process of movement from areas of greater concentration to areas of lesser concentration
digestion	the process of breaking down complex food items into simpler forms that can be used by the body
digestive	relating to digestion; e.g., <i>digestive</i> enzymes are those enzymes involved in digestion
dissolve	the process of holding molecules or ions of a solute among the molecules of a solvent
distilled	heated above the boiling point and recondensed as a means of purification
distribution	arrangement and interspersions of items
domestic	related to use in the home
dredge	1) device used to remove materials from the bottom of water courses; 2) the process of removing materials from the bottom of water courses such as channels, rivers, bays, etc.
drizzle	a light, misty, and often persistent rain
ecology	the study of living things “at home” in their environment and the relationships within those environments
ecosystem	defined system of coexistent organisms and substrates
eddy	reversal of flow within a current, often with reduced flow rates
effluent	liquid materials discharged into the water from an identifiable point such as a sewage treatment plant, paper mill, slaughter house, or factory
element	chemical composed of atoms of only one type such as hydrogen or oxygen
emergent	partially submerged but with parts above the surface; e.g., cattails usually are <i>emergent</i> plants
engineering	art and science of designing structures and processes to achieve desired objectives
enzyme	biochemicals that break down or synthesize compounds useful to organisms
ephemeral	lasting only for a short time
erosion	removal of soil by water, wind or other factors
estimate	an approximation based upon defined criteria
eutrophication	excessive productivity in bodies of water, often referred to as “aging” in lakes
evaporation	transformation of liquids into gases; adding heat energy to liquid water increases <i>evaporation</i> by changing the liquid into water vapor, a gas
evapotranspiration	the combined processes of evaporation and transpiration through plants
excretion	elimination of nitrogenous wastes and excess water
excretory	referring to excretion
extirpated	locally exterminated or locally extinct
extraction	the process of removing a substance (e.g., water) from its place of origin (e.g., an <b>aquifer</b> )
fauna	term referring to all animal life
fecal	associated with feces or excrement
fertilizer	plant nutrients supplied to increase plant productivity or growth
fetus	unborn organism beyond the embryo stage



filter	device or process that selectively removes particles according to size or other characteristics
flood	inundation of terrestrial habitats by waters escaping the confines of water courses
flora	term referring to all plant life
fog	condensed water vapor at or near the surface of the earth
food web	an attempt to show the energy relationships among living things, including decomposers
forage	1) vegetative materials consumed by herbivores; 2) search for food
fossil water	water that entered an aquifer thousands of years ago, often in aquifers that recharge very slowly; e.g., many scientists consider the Ogallala aquifer to be composed of <i>fossil water</i>
freezing point	temperature at which a liquid transforms into a solid, approximately 0 degrees C for pure water at sea level (this is the same temperature as the <b>melting point</b> )
gas	the most highly dispersed form of a substance; e.g., water vapor
geothermal	heat derived from the molten portions of the earth's crust
gradient	1) amount of drop in elevation per unit of horizontal distance; 2) measurable or discernible change in density or other characteristics (such as salinity, temperature, color) between or among extremes of those characteristics
gray water	the wastewater coming from households after being used for washing clothing or dishes, or similar purposes
groundwater	water found under the surface of the ground
gully erosion	erosion by water resulting in the formation of gullies with removal of considerable soil
habitat	the environment in which an organism lives
hail	precipitation in the form of ice balls formed by repeatedly rising and falling in severe thunder storms, usually shows concentric rings of ice and may reach the size of softballs
harmful	able to cause damage, disease, loss of vigor or reduction in ability
head	1) source of a spring or other water flow; 2) surface portion of a well; 3) amount of pressure exerted by water; e.g., the distance from the top of a dam to an outlet at its base
headwaters	upper reaches of a watershed, river or stream
herbivore	an animal that feeds on primary producers, particularly green plants; e.g., cows are <i>herbivores</i>
heterotroph	organism that derives nutrition from external sources such as other organisms; a consumer
humidity	a measure of the amount of water vapor in the air
hydration	1) adding water; 2) restoring water losses to tissues
hydric	environments that are saturated with water at least seasonally; e.g., marshes are <i>hydric</i> environments and wet meadows may have <i>hydric</i> soils
hydrogen	the lightest element on the periodic chart of elements, having a single proton and a single electron in its most common form, designated <b>H</b> as its chemical symbol
hydrologic	having to do with water
hydrophilic	water loving, being strongly attracted to water or easily dissociated in water
hydrophobic	water hating, nonpolar molecules that do not mix well with water
hygiene	cleanliness adequate to maintain health and vigor
hypothesis	a potential explanation for an observation, generally subject to being tested against alternatives and a null <i>hypothesis</i>

immiscible	incapable of forming a solution, generally of two liquids; e.g., oil and water are <i>immiscible</i>
impermeable	incapable of being penetrated; clay may form a layer that is <i>impermeable</i> to water
indispensable	essential, required, or necessary
industrial	used in a manufacturing process
inferior	biologically, inferior means “under” or “below;” e.g., a sucker has an <i>inferior</i> mouth, that is, on the underside of its head
infiltration	the process by which precipitation enters groundwater
interstices	spaces between cells, particles or other structures
irrigation	process of applying water to crops to supplement rainfall and to generate greater production
insoluble	incapable of being dissolved in a given solvent
interface	a meeting of surfaces; e.g., the zone where two immiscible liquids meet is their <i>interface</i>
karst	irregular, broken or cavernous limestone formations, often with streams, caves and sinkholes
lake	relatively large body of standing water with relatively little current, either natural or reservoirs held back by dams
laminar	in, as, or appearing to be layers
laminar flow	flow in which the liquid or gas appears to move as layers having different velocities
landfill	engineered site for the disposal and burial of refuse and garbage
leach	to place in solution and carry with the liquid to another site
leachate	a solution of water and other materials after the water has passed through organic debris
leaching	the process of dissolving the soluble materials from organic or inorganic deposits (landfill sites) as water passes through those deposits
liquid	a state of matter in which the material conforms to the shape of containers yet is otherwise amorphous (without its own shape); water is normally liquid at room temperature
lubricant	a substance that reduces friction; e.g., watery synovial fluid is a <i>lubricant</i> in mammal joints
lubricate	to reduce friction with a substance; see <b>lubricant</b>
manufacture	the process of producing useful objects or materials from raw materials using human ingenuity and energy
mass	the force exerted by an object divided by the acceleration of gravity (this is an absolute measure that does not change with gravity); e.g., the mass of an object on the earth or on the moon is the same, but the weight (a measure of force) changes with the gravitational pull of those bodies; in practice, the standard for mass is a cylinder of platinum-iridium that defines the kilogram
meander	curving back and forth within a flood plain; generally meanders are more common in lower gradient streams and rivers or “older” water courses
melting point	temperature at which solids become liquid, approximately 0 degrees C for pure water at sea level; see <b>freezing point</b>
meniscus	the curved upper edge of a water column held in a container because of the cohesion or surface tension of the water
mesic	moist regions with moderate rainfall are known as <i>mesic</i> environments
metabolic water	water produced in the process of metabolizing carbohydrates

metabolism	the processes involved in producing materials and energy to sustain life from nutrients and energy sources
mineral	inorganic chemicals, often used to mean ores or other items useful in manufacturing processes
mineral soil	soil that is without organic materials or amendments
miscible	able to mix with; water and alcohol are completely <i>miscible</i> , but oil and water are <b>immiscible</b>
mist	very fine, cloudlike precipitation that may adhere to all surfaces without appearing to fall on the surfaces
mitigation	a process of offsetting ecological damage by producing ecological benefits, often at a different site
molecule	the smallest identifiable unit of a chemical compound; e.g., a single molecule of water is composed of one oxygen atom and two hydrogen atoms
nitrate	nitrogen-oxygen ions that provide a ready source of the nutrient nitrogen to plants, often a limiting factor in marine ecosystems
nitrogenous	pertaining to compounds containing nitrogen, most often used in conjunction with organic wastes containing ammonia, urea or uric acid
nonpoint source	a source of pollution that cannot be identified to a specific site but may be assigned to an area or a broadly applied practice
noxious	offensive, foul, distasteful or objectionable
null hypothesis	a hypothesis stating that no changes will take place as a result of the experimental or observational activity
nursery area	a habitat in which young organisms may develop, often associated with sheltered areas having high nutrient levels and escape cover
nutrient	any metabolized substance required by an organism to carry out its life processes
nymph	an immature stage of insects undergoing incomplete metamorphosis, like mayflies, dragonflies, damselflies or stone flies; commonly used for any immature aquatic insects
objectionable	conditions that are disagreeable to an observer; foul odors may be deemed <i>objectionable</i> by users of a wetland where anaerobic decomposition is taking place
obligate	necessary and required; human beings are <i>obligate</i> air-breathing animals
obligate anaerobe	an organism that requires the absence of oxygen or extremely low oxygen levels for its survival
omnivore	deriving nutrition from multiple trophic levels, eating plants and animals; e.g., raccoons, bears, pigs and people are all <i>omnivores</i>
organic	chemically, carbon-bearing; biologically, part of or derived from an organism or its decomposition products
organism	living thing, currently divided into five kingdoms by most biologists—monera, protista, fungi, plantae and animalia
osmosis	the movement of water across a semipermeable membrane from a region of greater concentration (of water) to a region of lesser concentration
oxbow	lake formed when a meander or bend in a river or stream is cut off from the main stream
oxygen	element composed of eight protons, eight neutrons and eight electrons (atomic mass 16, atomic number 8) and designated <b>O</b> in chemical shorthand; a colorless, odorless gas
pH	negative log of the hydrogen ion concentration; a measure of acidity on a scale of 0 to 14 with 7 being neutral and the pH of pure water in a vacuum (values less than 7 are acidic, those greater than 7 are basic)

ppb	parts per billion, one part per billion parts either by weight or by volume
ppc	parts per centum, most frequently written as percent or %
ppm	parts per mille (=thousand) or parts per thousand, often written ‰, sometimes used to mean parts per million, although this is confusing
ppt	parts per trillion, one part per trillion parts either by weight or volume
parent material	underlying rock from which soil develops
particle	a differentiable unit or piece, generally relatively small
parts per million	one part in one million parts either by weight or by volume
pathogen	disease-causing organism, usually viruses, bacteria or protozoans
ped	a structural unit of soil formed from the basic units of sand, silt and clay
pelagic	organisms that use the open waters, moving throughout the water column in search of food
per capita	literally per head, some rate per person; e.g., the national debt is \$20,000 <i>per capita</i>
percentage	parts per 100, a special type of proportion, often expressed as %
percolate	to have liquid run through the interstices of a solid, generally assisted by gravity
permeable	capable of being penetrated; e.g., sand is extremely <i>permeable</i> to water
persistent	remaining in existence over a relatively long period of time
perspiration	the process of producing sweat for evaporative cooling
petrochemical	chemicals derived from fossil fuels, particularly oil or natural gas
phloem	vascular tissue in higher plants that distributes sugars and starches to all plant tissues
phosphate	phosphorus-oxygen ions that provide a readily available source of the nutrient phosphorus to plants, often a limiting factor in freshwater productivity
photosynthesis	process by which plants use light energy to synthesize simple sugars, source of nearly all biological energy
plankter	an individual planktonic organism; plankters may be either plants (phytoplankter) or animals (zooplankter)
plankton	small plants (phytoplankton) and animals (zooplankton) suspended in a body of water and unable to maintain their position in the water independent of the water's movements; the foundation of most freshwater, brackish and saltwater food webs
playa	an undrained basin in an arid region that sometimes becomes a lake as the result of runoff water
point	a single locus, location or site; a projecting object, as a point of land
point source	an identifiable source of a pollutant
polar	having different characteristics on opposite ends; e.g., water is a <i>polar</i> compound with each molecule having a slight negative charge on one end and a slight positive charge on the other
pollutant	anything added to air or water that reduces its utility to living things
pollution	contaminants in the air or water from either human-caused or other sources
pool	slower moving and often deeper portions of flowing waters, often intermingled with riffles or rapids
pond	a water-holding basin often without an outlet and designed to capture the runoff of a small watershed; often used as a synonym for small lakes in some regions of the country

potable	water that is suitable for drinking or cooking purposes
potentiometric surface	the level above the water table to which water will rise in an artesian well; if it exceeds the depth to the water table, the artesian well will flow
precipitation	liquid or frozen water—rain, snow, sleet, hail, drizzle or mist—that is returned to the earth by gravity
pressure	a measure of the force exerted on an object; e.g., the mass of water over a given point exerts a force that is equal in all directions at that point and proportional to the depth of the water
producer	an organism capable of forming its own food or energy by breaking down chemical bonds or using light, carbon dioxide and water in the presence of chlorophyll to produce simple sugars
proportion	an amount or volume of a substance relative to the same measure of another substance or substances with which it is mixed
protozoa	microscopic to barely macroscopic organisms, both autotrophic and heterotrophic, primarily single celled, but including some colonial species
pulpwood	wood that is intended to be broken down into cellulose fibers for the production of paper and related products; generally sold by mass or by cords ( 4 x 4 x 8-foot units)
radiate	1) to produce radiant energy (light); 2) to emerge in a pattern around a central point
rain	liquid water falling as precipitation
rapids	swiftly flowing, turbulent portions of rivers or other flowing waters
recharge	the process through which aquifers take in water to increase or maintain their supply
recreation	restoration or refreshment of spirits, strength, or resiliency through nonwork activity
recycled	returned to some earlier state and used to make new products; could include items that are reused in their current form as well
resource	anything that may be used
respiration	the process of gas exchange (breathing); oxidation of materials within the cells for the production of energy; the energy lost from a trophic level as heat or entropy
riffle	shallower and swifter portions of streams or rivers, intermingled in most cases with pools
rill erosion	formation of shallow water channels through the erosion of soil (looks like gully erosion on a smaller scale)
river	an open watercourse connecting a watershed to the sea or some other terminal destination
rivulet	a small stream or brook, similar to a river but on a smaller scale
runoff	water that does not infiltrate into the soil from precipitation
salivary	related to, contained in or producing saliva; e.g., <i>salivary</i> amylase is a digestive enzyme found in human saliva that begins turning starches into sugars
sample	a portion of a population examined as an example of that population; a selected portion or part
sand	the biggest and coarsest of the soil particles that is not considered rock; has a gritty consistency, allows easy infiltration and tends to dry quickly with much air in the soil
sanitation	the process of keeping things clean; disposing of wastes in a manner that prevents disease or accumulation of filth; prevention of disease or illness by keeping things clean
saturated zone	that region of an aquifer where the spaces among the solids are filled with water
saturation	the point at which no more of a solute can be held by the solvent

seasonal	available or persisting for a limited time period associated with a particular season of the year
sediment	solid materials dropped out of suspension
sediment load	suspended particulate matter carried by moving waters
sheet erosion	removal of a layer of soil over a relatively broad area by erosive forces
silt	intermediate sized soil particles; powdery to the touch (like flour); intermediate between sand and clay in characteristics
siltation	deposition of silt in slower portions of water courses such as reservoirs
sinkhole	a collapsed hollow, often in regions underlain with limestone caves or caverns
sleet	solid precipitation that falls as “frozen rain,” generally small in size and associated with cold temperatures at or near the ground
sloughing	down slope slumping of sheets of soil or other materials; literally shedding
snow	solid precipitation in the form of hexagonal (six-sided) ice crystals
soil	the weathered surface layers of the earth’s crust, with or without mixtures of organic material
soil structure	the arrangement of primary soil particles into compound units or clusters having characteristics differing from primary soil particles
solid	the state of a substance in which it has defined shape and crystal structure
solubility	the degree to which one substance may be dissolved in another
solute	any material that is dissolved in a solvent
solvent	any material that is capable of dissolving a solute
specific gravity	the mass (weight) of a substance divided by the mass of an equal volume of water
specific heat	the ratio of the amount of heat required to raise the temperature of a given mass by 1 degree Celsius to the amount of heat required to raise the temperature of an equal mass of water by 1 degree Celsius
speculate	to think about possible explanations for a circumstance or phenomenon
splash erosion	removal of soil or mobilization of soil by the forces created by the impact of water droplets on the soil surface
spoil	dredged solid materials, usually deposited in piles, banks or similar structures
spring	a point or area in which an aquifer discharges to the surface or another body of water
spring head	the point of discharge for a spring
steam	hot, gaseous water; generally evidenced by the condensation of the water vapor into a cloudlike form once it hits the cooler air; e.g., breath condensing on a cold day or the steam cloud emerging from a teapot
stomates	openings in leaves and some stems that are controlled to govern the amount of transpiration water loss from plants; also <b>stomata</b>
stratified	divided into layers; in some deep lakes the separation of a warmer upper layer from a colder lower layer by an intermediate layer shows rapid change in temperature with depth
stream	a tributary of a river, draining a smaller portion of the watershed
streamlined	aerodynamically or hydrodynamically shaped, often broadly rounded on the leading edge or end and coming to a point on the trailing edge; designed to reduce drag
sublimation	the process in which a substance can be transformed from a solid to a gas without first becoming a liquid; e.g., snow or ice can sublime to become water vapor at temperatures well below the freezing point

subsidence	subsiding or “sinking” of soil as water is removed from an underlying aquifer; extreme cases may result in <b>sinkholes</b> particularly in <b>karst</b> formations
subsoil	the soil layer underlying the topsoil or that soil that is normally plowed; the B or C horizons of a soil profile
substrate	the surface or medium in which or on which an organism grows
superior	1) better than; 2) biologically, on top of; e.g., topminnows have a <i>superior</i> mouth, on the top, front of their heads
surface film	the surface created by the surface tension of a liquid
surface tension	a measure of the cohesive forces among the molecules on the surface of a liquid
surfactant	a surface acting material; a detergent acts to reduce the surface tension of a liquid, making it “wetter”
terminal	at the end; biologically, at the end of; e.g., most predatory fish have a <i>terminal</i> mouth, one located at the leading edge of the head
terrace	one or more relatively level areas separated by ridges or banks; a method of reducing slope and erosion on sloping agricultural lands; to create level areas
terrestrial	pertaining to or living on land
texture	the relative proportions of primary soil particles in a soil mass such as the proportions of sand, silt and clay in the soil
thermal	pertaining to heat or the energy state of matter
thermal shock	syndrome causing stunning or death of aquatic animals subjected to rapid changes in temperature
thirst	physical sensation of requiring fluid intake
thirsty	feeling thirst
tilth	the physical condition of a soil with respect to its value for growing a particular type of plant or group of plants
topography	the relief (ridges and valleys) of a site, often indicated by lines drawn at equal elevations or contours
topsoil	1) a presumed fertile soil, usually rich in organic material, used to top dress lawns or similar areas; 2) the surface soil that can be plowed under ordinary circumstances; 3) the original or present, dark surface layer of the soil, from a fraction of an inch to several feet in depth
transpiration	the process in which water is evaporated from leaf surfaces, creating a partial vacuum within the vascular tissues of plants and aiding in moving water upward to the leaves
trophic	related to energy and energy transfer among living things
trophic level	position within a biological hierarchy of energy use from producers to primary consumers, secondary consumers, and so forth to decomposers
unconfined	an aquifer that is not bounded by impermeable layers
unsaturated zone	that portion of an aquifer in which the interstices (spaces) between particles are not filled with water
universal solvent	water is considered a universal solvent because it dissolves so many chemicals
urea	a moderately concentrated form of nitrogenous waste common to mammals
uric acid	a highly concentrated form of nitrogenous waste common to birds and some other organisms
vascular	having to do with the circulation of liquids

vascular tissue	tissue designed to carry fluids—the xylem and phloem of plants, the blood vessels of vertebrates, or the open circulatory systems of insects
vernal pond	a pond or pool that exists in the spring and early summer but dries later in the year
volume	a measure of the space occupied by something, generally expressed in cubic (length x height x width) dimensions or similar measures (cubic feet, gallons, quarts, cubic centimeters [cc], milliliters [ml]; a cubic centimeter is equal to a milliliter and a cc or ml of water has a mass of approximately 1 gram)
water	a compound of one oxygen and two hydrogen atoms; the foundation of living things
water cycle	the chemical and physical processes by which water is transformed into an atmospheric gas and deposited as precipitation or condensation on surface objects
water table	the interface between the saturated and unsaturated portions of an aquifer
watershed	the area from which a body of water collects runoff
weather	a combination of physical factors including temperature, atmospheric pressure, relative humidity, wind direction and force, cloud cover, precipitation and related factors at a specific time and place
well head	the point at which a well intersects the surface of the ground
wetland	area with saturated soils, usually containing emergent vegetation; e.g., swamps, marshes and tidal flats are all wetlands, as are vernal pools
wetting agent	any substance that reduces surface tension of a liquid; e.g., soap or detergent acts as a <i>wetting agent</i> when added to water; see <b>surfactant</b>
wildlife	variously defined, but generally inclusive of all species of free-ranging, native or naturalized animals
xeric	dry or arid
Xeriscape™	adaptive landscaping that minimizes the demand for supplementary water in arid or xeric regions, usually through use of locally adapted, native plants
xylem	plant vascular tissue carrying water and nutrients from the roots to the leaves





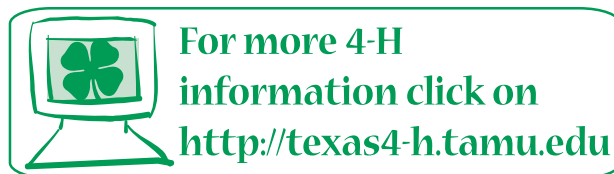

For sale only at \$XXX per copy

**Texas A&M AgriLife Extension Service**

*AgriLifeExtension.tamu.edu*

More Extension publications can be found at *AgriLifeBookstore.org*

Educational programs of the Texas A&M AgriLife Extension Service are open to all people without regard to race, color, sex, disability, religion, age, or national origin.

---

The Texas A&M University System, U.S. Department of Agriculture, and the County Commissioners Courts of Texas Cooperating.

Produced by Texas A&M AgriLife Communications