

TIMEX

**iConnect Active+ M08Y**

[USER GUIDE](#) ..... 1

**08Y095000 5.11.22**

Register your product at <https://www.timex.com/product-registration.html>

Register your product at <https://www.timex.ca/product-registration.html>

# iConnect Active+



M08Y

## User manual

Please read the manual before use.

The information in this document won't be modified or extended in accordance with any notice.

## 1. Product Overview

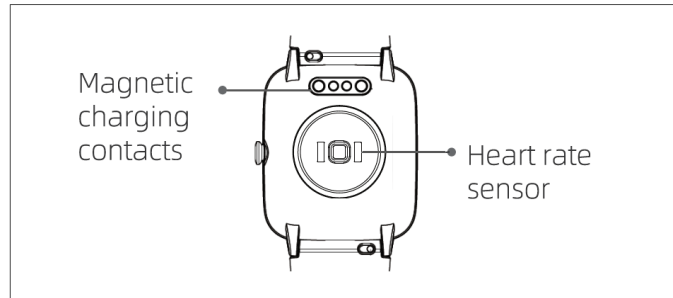
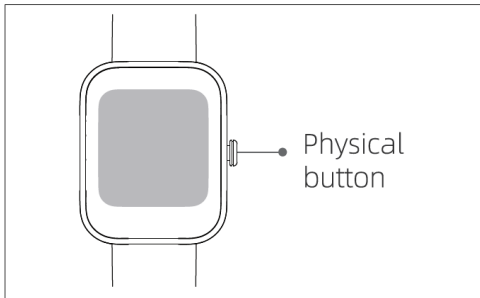

Physical button operation:

Single press

- To return.
- To wake up the screen when it is off.

Press and hold

- To turn on the watch when the watch is off.

## 2. Charging the watch

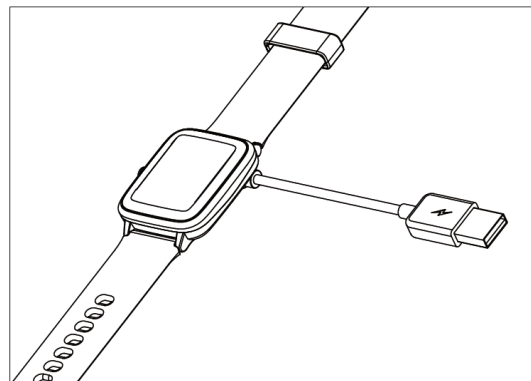
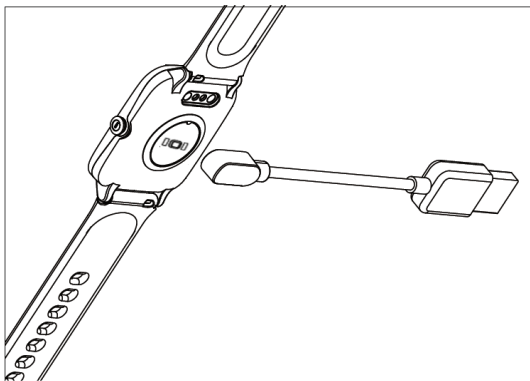

Connect the

USB connector end of the charging cable to a DC 5V power source.

Connect the other end of the charging cable to the magnetic charging contact of the watch.

Charge the watch for at least 3 hours to ensure fully charged before use.

Note: Remove the charging cable from any power source when the watch is not charging. Only the bundled charging cable should be used for charging the watch.

## 3. Turning on the watch

- Press and hold the physical button to turn on the watch
- The watch will automatically turn on once the watch is being charged.

## 4. Turning off the watch

Go to Settings -> Shutdown -> Press the tick icon.

## 5. App download and pairing

- 1) Download and install the **iConnect Next by Timex** App from Google Play Store, Apple Store.



- 2) Register a user account by using a valid email address. Verification by entering a code sent to the email address is required.
- 3) After registration, it is required to enter some personal information, such as gender, date of birth, etc.
- 4) Ensure the watch is fully charged and turned on before pairing with the App.

5) Follow the steps shown in the App to search the watch.

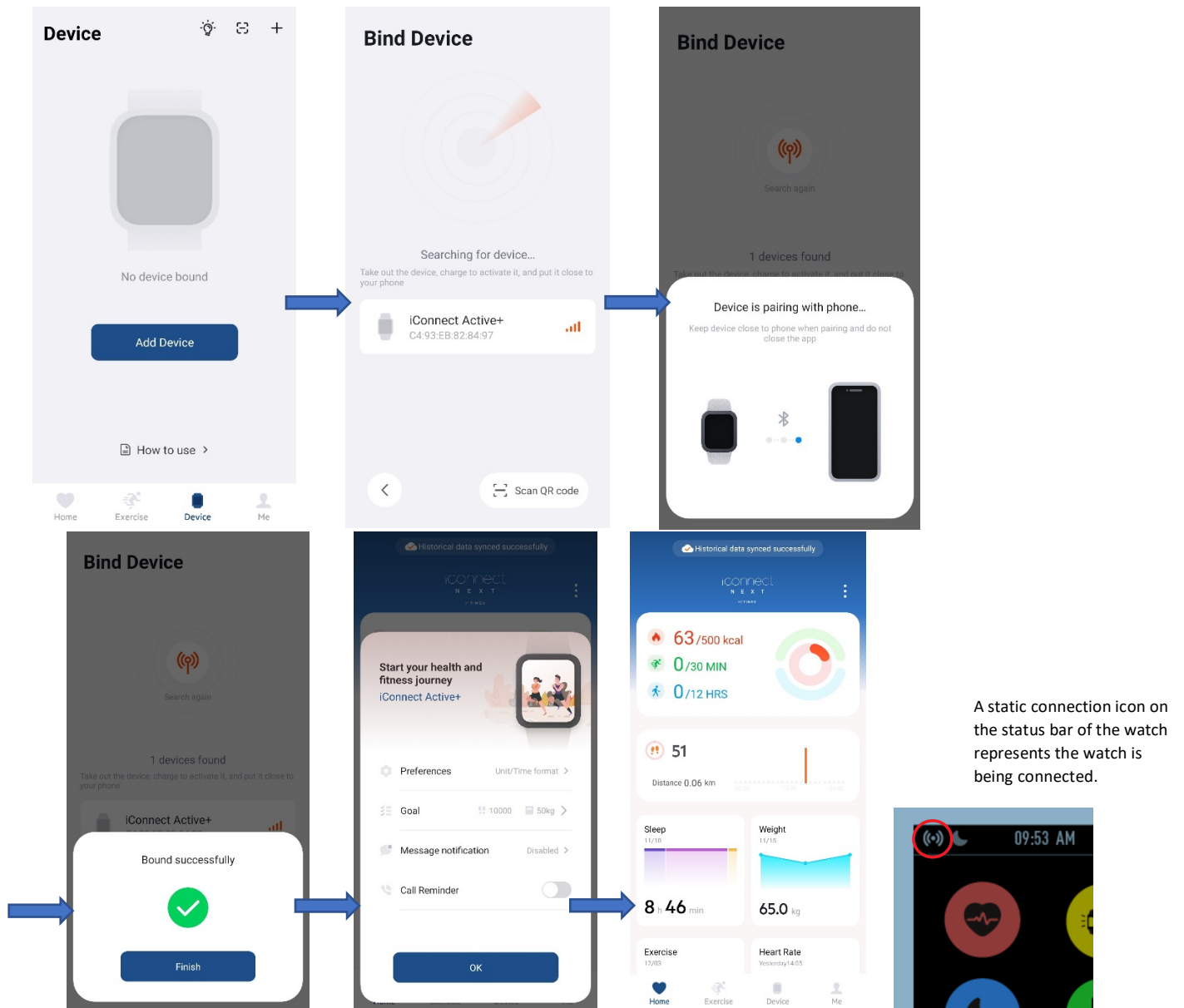

## 6. Basic operations

In TOD screen:

Swipe up – Display activity data, such as step count, HR, etc., and sport mode.



Swipe down – List out the message notifications.

Swipe right – Show up the status bar and feature shortcuts.

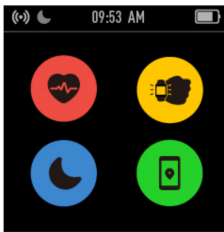

Swipe left – Enter the feature menu of the watch.

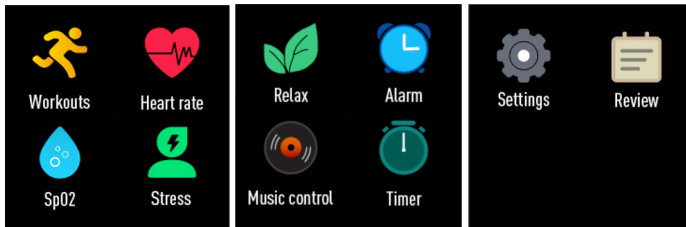

Press the physical button – Toggle the screen on and off.

## 7. Feature list

### 7.1. Workout

Various sport modes can be chosen for different sports training:

Outdoor Run, Indoor Run, Outdoor Walk, Indoor Walk, Hiking, Outdoor Cycle, Indoor Cycle, Cricket, Yoga, Rower, Elliptical, Other.

Set the goal of calories, time or distance (for some modes only) for the respective mode if required.

Press the triangle icon at the bottom right corner on the related setting screen, or simply press “START NOW” to start sport mode.

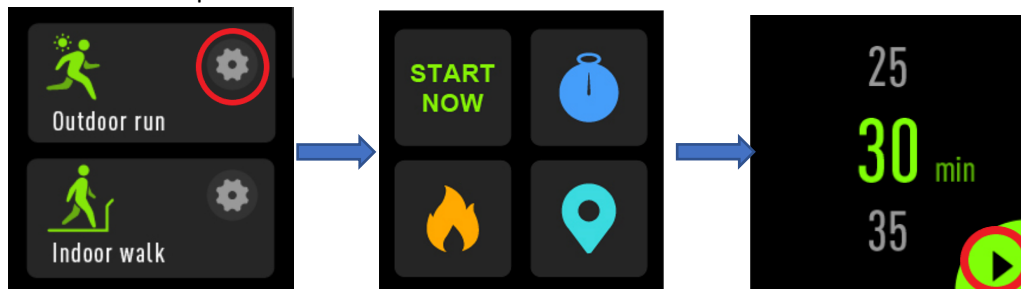

After starting any of the sport modes, press the button to toggle pausing and resuming the training or press and hold the button to quit the current training.

Note: iConnect Active+ is not recommended for any indoor or outdoor water sport.

### 7.2. Heart rate

After entering the heart rate measurement page, the watch will start the heart rate measurement immediately.

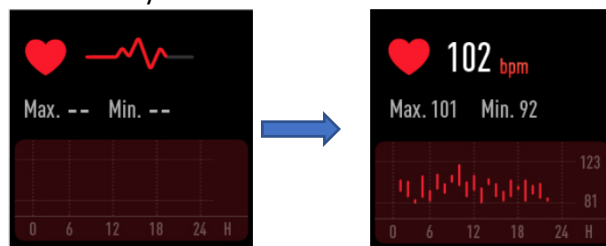

Note: Please wear the watch properly to ensure accurate heart rate measurement.

### 7.3. Blood oxygen

After entering the SPO2 measurement page, the watch will start the blood oxygen measurement immediately.

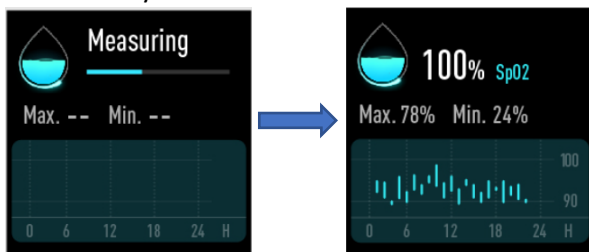

Note: The max. and min. reading will not be refreshed immediately during blood oxygen measurement. The max. and min. value can be refreshed by switching to menu and back to blood oxygen page.

### 7.4. Stress

After entering the Stress measurement page, the watch will start the stress measurement immediately.

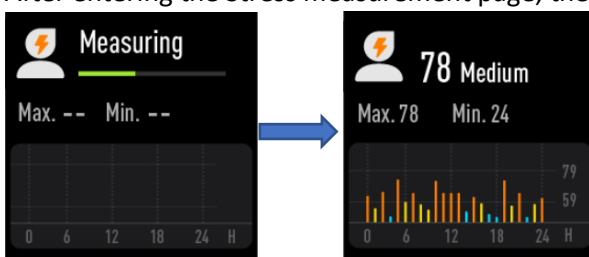

### 7.5. Relax

This mode regulates user's breathing frequency to help user relaxing. After entering the Relax page, choose the breath guiding duration, 1 min or 2 mins, and then press the triangle icon to start.

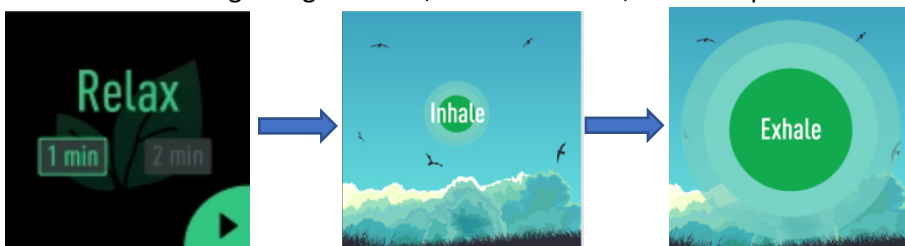

### 7.6. Alarm

Add alarm by using the iConnect Next by Timex App. After the alarm is set by the App, the alarm will be shown on the Alarm page of the watch. The alarm can be disabled or activated by tapping the related alarm in the page. Grayed icon represents the respective alarm is disabled.

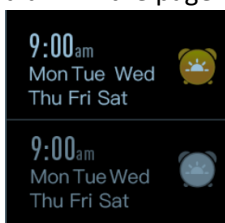

### 7.7. Music control

Music control has to be activated in the App before being able to control playing the music in the connected phone by the watch. Under this feature, the watch can play and pause the currently played music as well as choose the next or previous music.

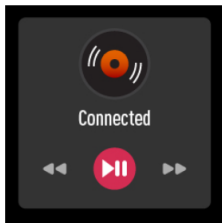

## 7.8. Timer

The watch can act as a stopwatch or count-down timer. After choosing the desired mode, just tap on the triangle icon at the bottom right corner of the screen to start counting. During counting, the timer can be paused tapping the pause icon at the bottom right corner. User can resume counting by tapping the triangle icon at the bottom right corner or stop and reset counting by tapping the square icon at the bottom left corner.



For timer function, maximum countdown time is 120min 59sec. After starting the countdown, the down-counting time is displayed as format HH:MM:SS.

## 7.9. Setting

There are four subpages inside Setting: Watchfaces, Brightness, About and Shutdown.

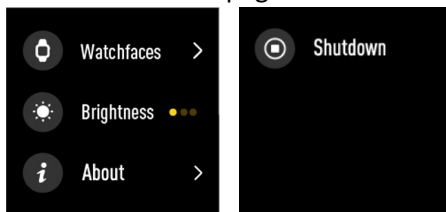

### 7.9.1. Watchfaces

Drag the screen up and down in this page to choose desired dial face in TOD screen. There are three build-in dial face on the watch. One optional dial face is available for downloading from the App to the watch.

### 7.9.2. Brightness

Tapping the word "Brightness" in Setting page to adjust the brightness of the screen. There are three brightness level can be set.

### 7.9.3. About

Tap on the word "About" to show the firmware version and BT address of the watch.

### 7.9.4. Shutdown

Tap on the word "Shutdown" and then tap on the tick icon to power off the watch.

## 7.10. Workout Record

List down the records of workout mode training.



## 7.11. Find Phone

Find Phone feature can be enabled and disabled through the iConnect Next by Timex App. Enable such feature before attempt finding the paired phone.

After connecting the watch to the App, swipe the screen to right in TOD to enter the shortcut page. Tap on the phone icon on the right bottom to trigger finding the connected mobile phone. The phone icon turns green and the phone should vibrate with media sound accordingly. Tap on the phone icon again to make it gray and the phone should stop vibrating and playing sound.

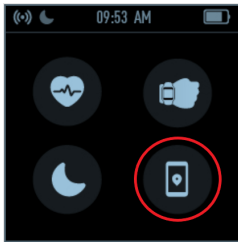

## 7.12. Do Not Disturb (DND) mode

After connecting the watch to the App, swipe the screen to right in TOD to enter the shortcut page. Tap on the moon icon on the left bottom to make it blue and enable the DND mode. The DND mode can be disabled by tapping on the moon icon again and turning it gray. Please ensure the time period is set for the DND mode in the App before enabling it.

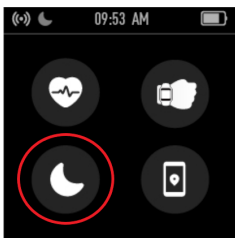

## 8. iConnect Next by Timex App operations

### 8.1. Home

#### 8.1.1. Fitness

Tap on the activity data area in Home page to enter Fitness page and display the summary of activity including the calories burned, the total workout time and total walking time. Tap on the horizontal bar of those three types of data to display respective detailed statistics.



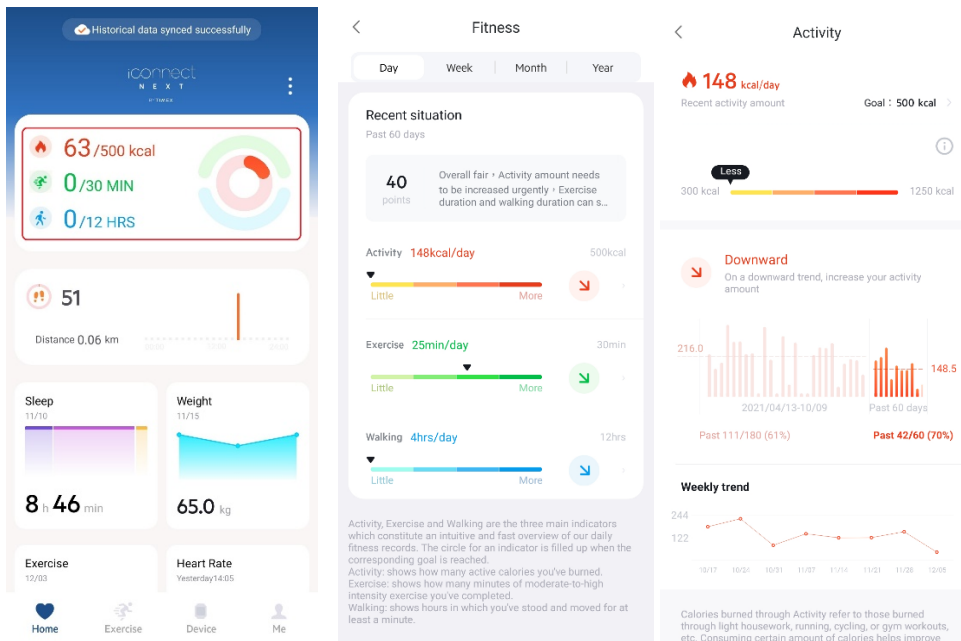

### 8.1.2. Step

Tap on the step counting area in Home page to display the step count details and records.

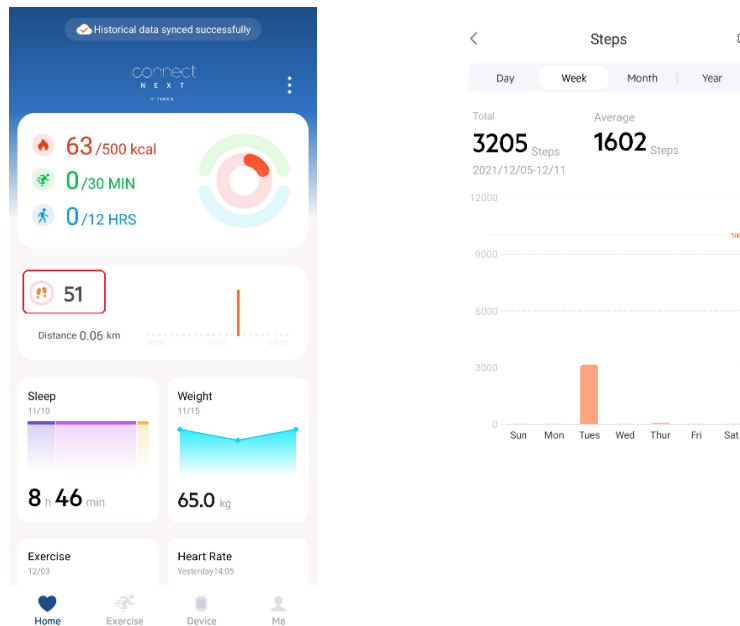

### 8.1.3. Distance

Tap on the distance area in Home page to display the distance details and records.

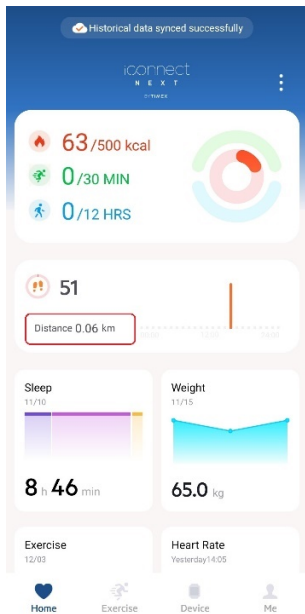

### 8.1.4. Training record

Tap on the Training record widget to check the training records obtained through the App and the training record synchronized with the watch.

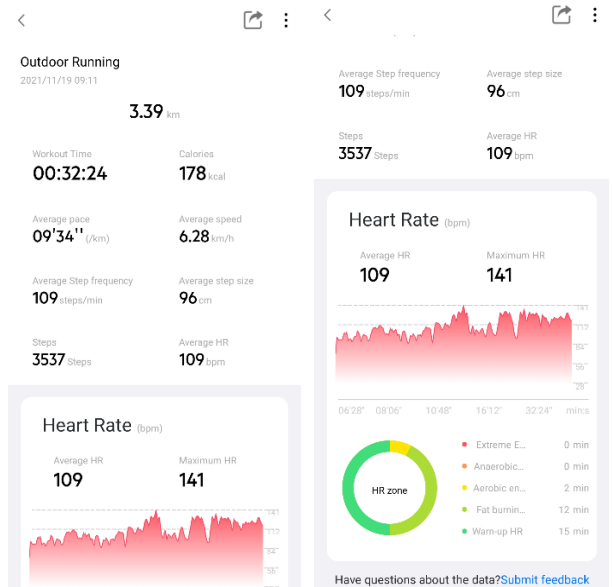
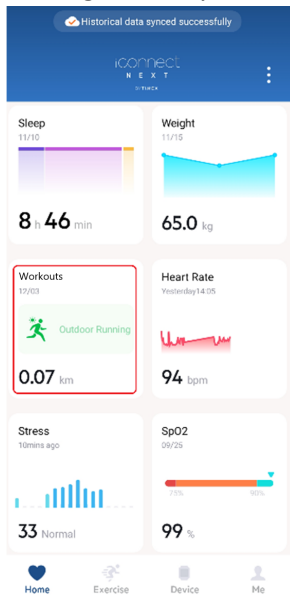

### 8.1.5. Sleep

Tap on the Sleep widget to check the details of sleep monitoring records.

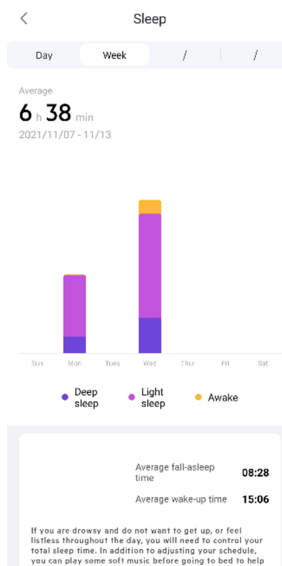
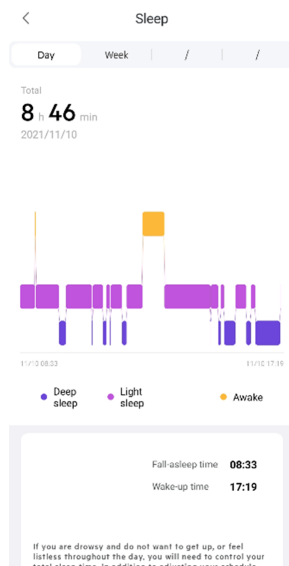

### 8.1.6. HR

Tap on the HR widget to check the heart rate measurement records and details.

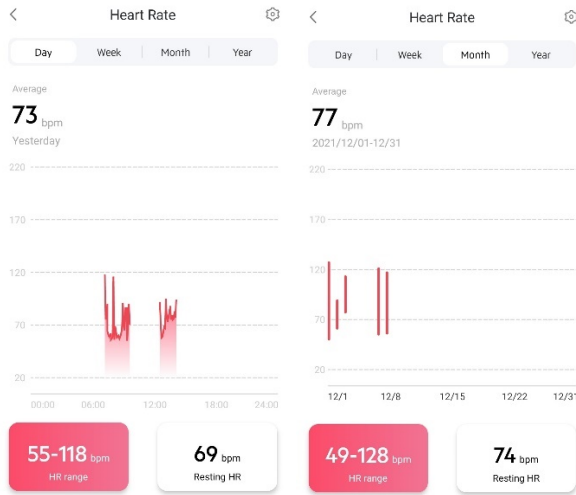
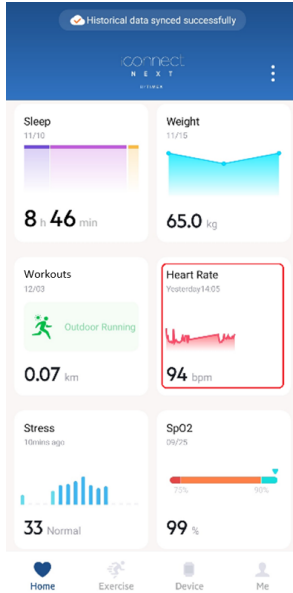

### 8.1.7. Stress

Tap on the Stress widget to check the stress measurement records and details.

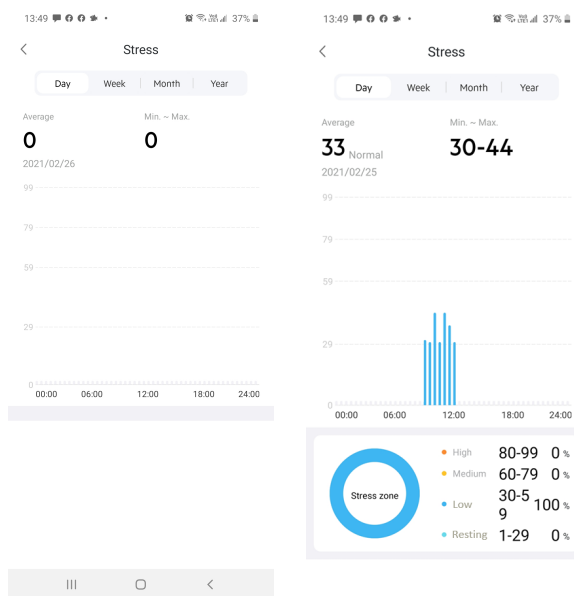
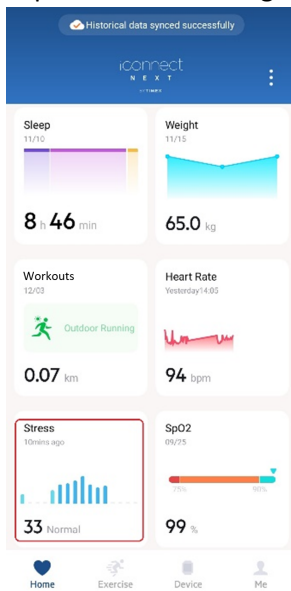

### 8.1.8. SPO2

Tap on the SPO2 widget to check the blood oxygen concentration measurement records and details.

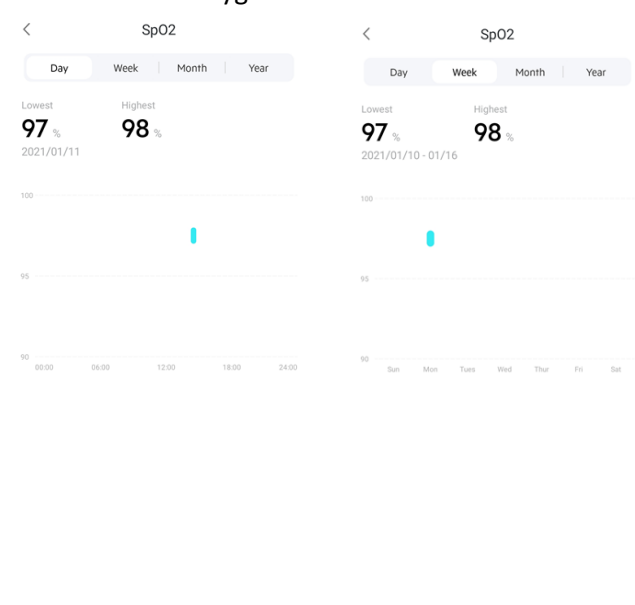

### 8.1.9. Weight

Tap on the Weight widget to input the weight of current date and check the recorded weight data.

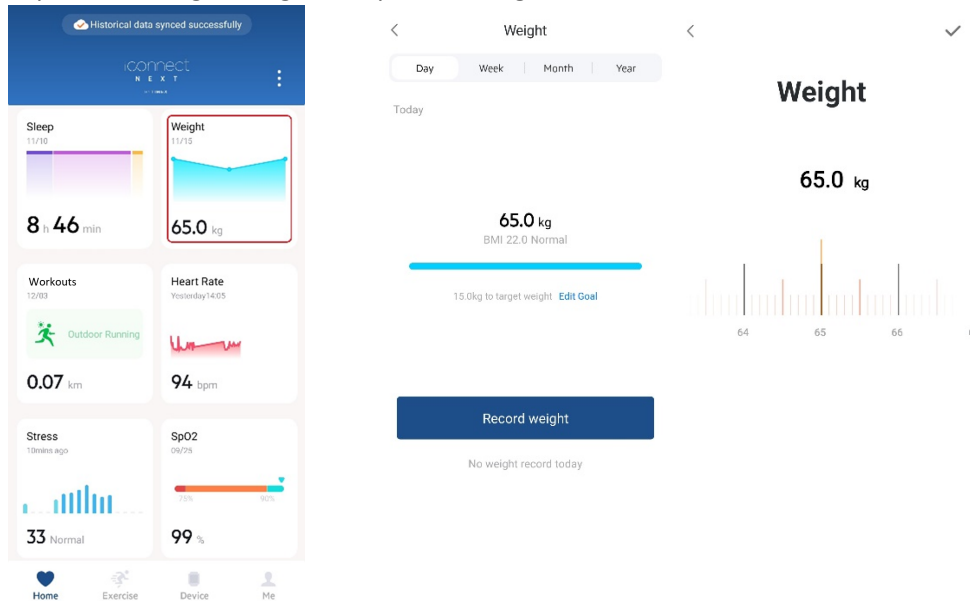

## 8.2. Workouts

The Workout mode of the app allows the user to record a workout from the phone, where for outdoor workouts the phone's GPS will be used to record the course. For all App-based workouts, if the watch is connected to the app the app will record heart rate data from the watch for the workout.

### 8.2.1. Add Device

User can add the watch by tapping "Add Device" and going through the steps in Section 5 if the watch is not connected.

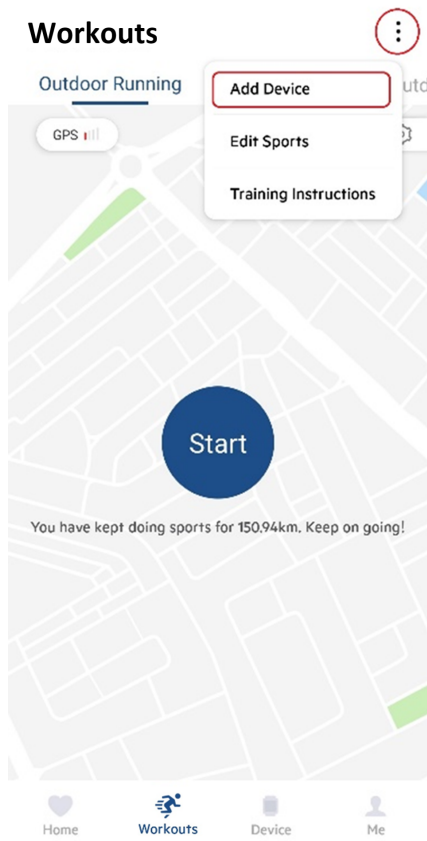

### 8.2.2. Edit Sports

User can add or remove the training modes shown in the Training page. There are six modes, Outdoor Running, Outdoor Walking, Outdoor Biking, Hiking, Indoor running and Indoor walking, can be chosen. Those training modes are independent to the training/sport modes on the watch.

### 8.2.3. Training Setup

User can enter the training setup page by tapping the gear icon.

The Training Objective is to set the specific goal of training, such as distance, calories, steps, time duration.

The Sound alerts defines the sound reminder frequency in training mode.

The HR zone displays the HR zone definition.

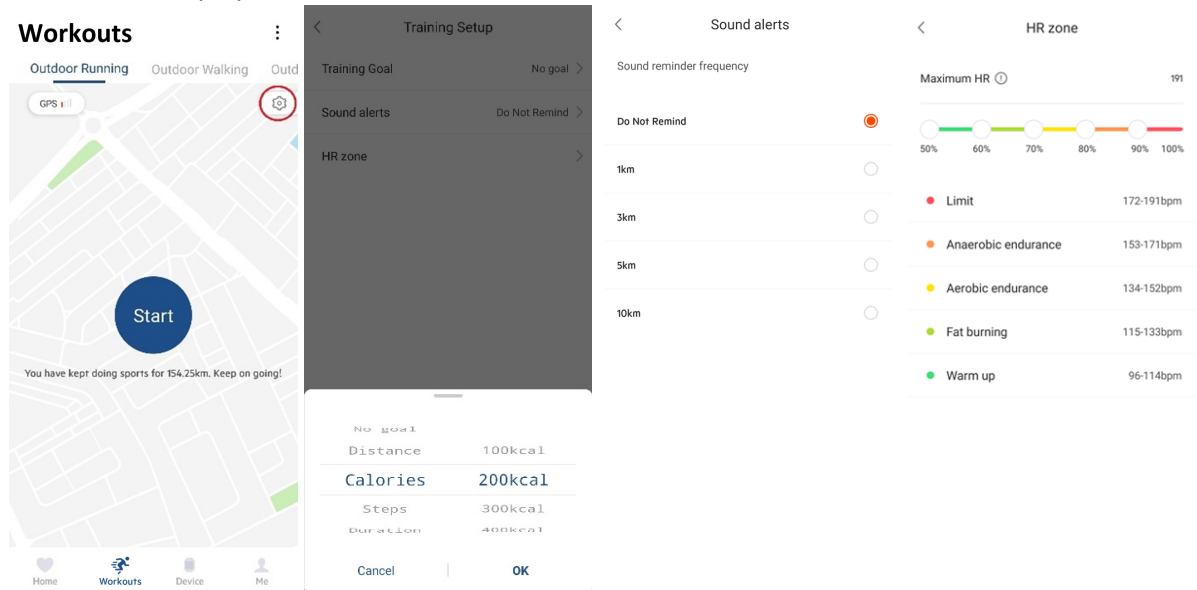

### 8.2.4. Training mode

After completing the training setup, choose the training mode and tap on the “Start” to start the training. After the training is started, tap on the pause icon to pause the training and then tap on the triangle icon to resume or tap on the square icon to stop the training. The recorded training can be checked in the “Training Record” in section 8.1.6.

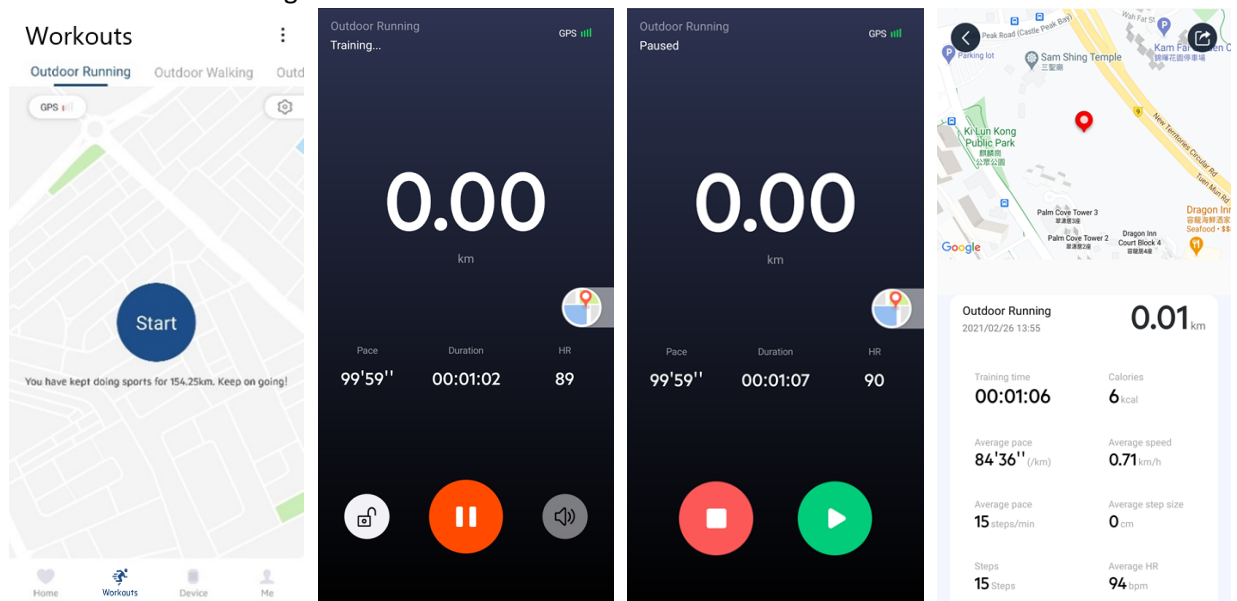

## 8.3. Device

The Device section of the app allows the user to pair a watch or to change settings for the watch.

### 8.3.1. Add Device

Add the watch by going through the steps mentioned in Section 5.

### 8.3.2. Device Information

Once the watch is connected with the App successfully, the icon and BT name of the watch will be displayed. The approximated battery level percentage, connecting status and the firmware version of the watch will also be shown under the BT name. Tap on the watch icon to enter the detailed information page.

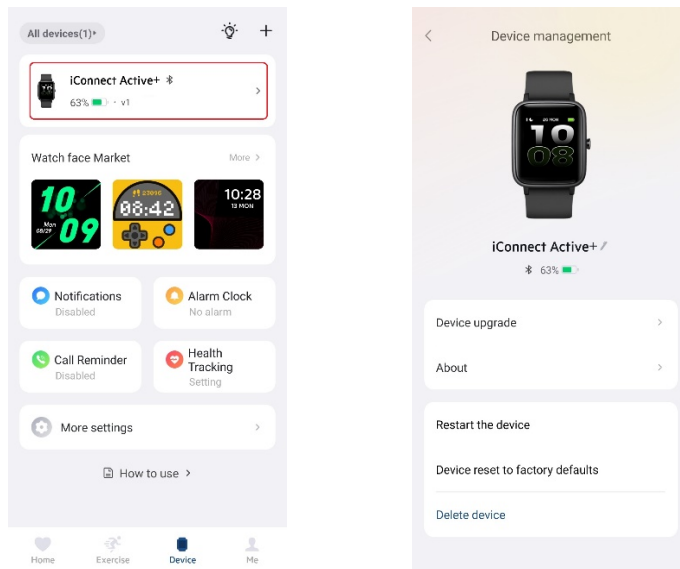

### 8.3.2.1. Watch face Market

Apart from the three build-in watch face, iConnect Active+ also supports watch face pushed from the App. There are a number of predefined watch face from the App. Users can also create their own watch face by using favorite picture located in the phone as the watch face wallpaper.

#### 8.3.2.1.1. Downloadable watch face

Tap on the “More” next to the “New arrivals” to check all downloadable watch faces predefined in the App. Tap on the desired watch face and tap on the “Add and install” button to download and install the watch face to the watch. The watch face will be set as the current watch face once downloaded and installed on the watch successfully.

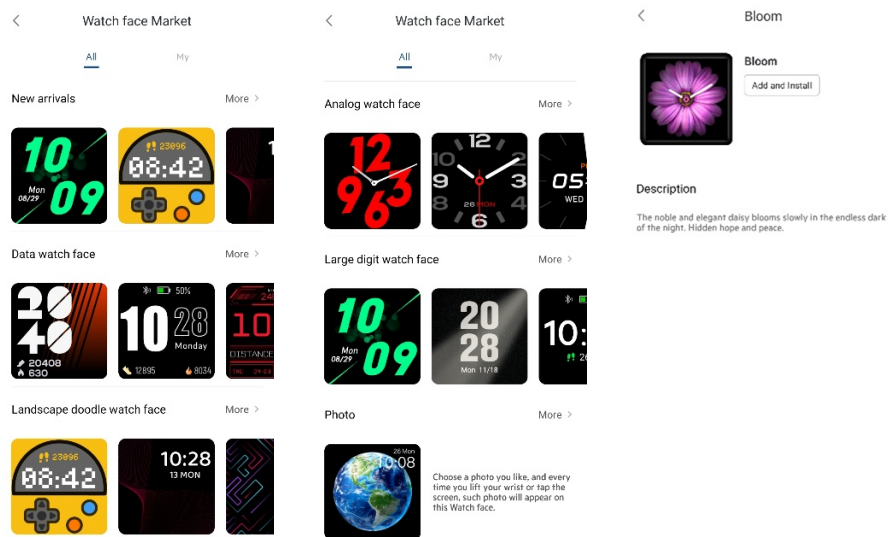

#### 8.3.2.1.2. Wallpaper watch face

To create and install self-defined wallpaper watch face, tap on the “More” next to the “Photo” and choose “Album” or “Camera” to import the favorite picture from the phone. Then tap on “Add and install” to button to download and install the watch face to the watch. The watch face will be set as the current watch face once downloaded and installed on the watch successfully.

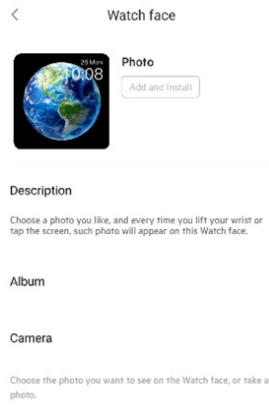

### **8.3.2.2. Health Tracking**

#### **8.3.2.2.1. HR monitoring**

The continuous automatic HR measurement on the watch can be enabled or disabled by toggling the button.

#### **8.3.2.2.2. Stress monitoring**

Pressure monitoring can be disabled or disabled by toggling the button.

#### **8.3.2.2.3. Walk-around Reminder**

Sedentary reminder can be enabled or disabled by toggling the button. The starting time, ending time, target steps per hour and repeat cycle of the sedentary reminder can also be adjusted in this page.

#### **8.3.2.2.4. Menstrual cycle**

Menstrual cycle reminder can be activated by toggling the button. The detailed setting of the menstrual cycle can also be adjusted in this page.

### **8.3.2.3. Alarm Clock**

Alarm clock can be added by tapping on “+ Add Alarm” and defining the alarm details. Ensure the set alarm is activated by toggling the button on the right side to green color. User can set the snoozing time and frequency by tapping the gear icon at the top right corner of the page.

### **8.3.2.4. Call Reminder**

Call reminder can be activated by toggling the button. Please note that no call reminder will be received if the Do Not Disturb mode is activated.

### **8.3.2.5. Notifications**

Message notification can be enabled by toggling the button next to “Allow notification” to green. Message notification for various App can be enabled or disabled individually in this page.

### **8.3.2.6. Device Settings**

#### **8.3.2.6.1. Do Not Disturb mode**

The time period of Do Not Disturb mode can be defined and enabled individually.

#### **8.3.2.6.2. Auto exercise recognition**

iConnect Active+ supports automatic identification of walking or running status even no training mode is initiated. Such feature can be enabled in this page.

#### **8.3.2.6.3. Find my phone**

The watch can trigger vibration on the phone by tapping the “Find phone” icon on the watch when this feature is activated.

**8.3.2.6.4. Music Control**

The watch can be used to control playing music on the phone when this feature is activated.

**8.3.2.6.5. Lilt wrist turn on screen**

Screen on by wrist turning can be activated.

**8.3.2.6.6. Auto-brightness at night**

Automatic screen brightness at night time can activated in this option. The night time period can also be defined.

**8.3.2.6.7. Training Mode**

The workout modes displayed on the watch can be chosen in this mode.

**8.3.2.6.8. Device language**

The UI language of the watch can be chosen under this option. If “Follow system” is chosen, the UI language of the watch will follow the UI language of the phone if available.

**8.3.3. Device upgrade**

OTA firmware upgrade is supported. User can upgrade the firmware of the watch if a newer version is available.

**8.3.4. About**

Display the details of the watch, such as firmware version and BT address, etc.

**8.3.5. Restart the watch**

The watch will be restarted when confirmed in this option.

**8.3.6. Reset the watch to factory default**

The watch will be reset to factory default when confirmed in this option. All the data on the watch will be erased after reset.

**8.3.7. Delete the watch**

The watch will be unpaired and all synchronized data on the phone will be erased once confirmed.

**8.4. Me**

The Me section of the app lets the user edit his/her profile, shows the user’s accomplishments, displays the user’s weekly health report, lets the user change account related settings and lets the user choose to upload data to Apple Health or Google Fit.

**8.4.1. My profile**

Under My page, tap on the region showing the nickname of user account to enter My profile page. Profile details including picture, nickname, gender, birthday, height, weight, email address and region can be modified.



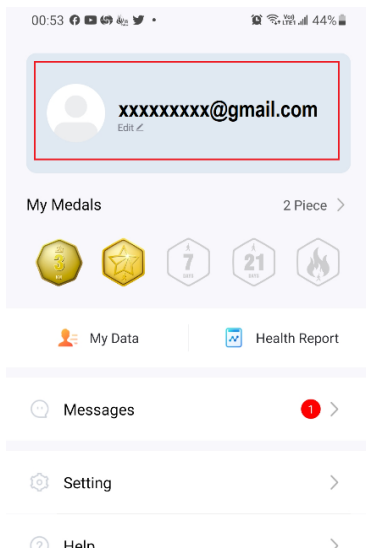

### 8.4.2. My Medals

Medal will be awarded if user achieve specific activity or training target.

### 8.4.3. My Data

A summary of activity data and training record can be checked in this page. Those data should match with those displayed in Home page if available.

### 8.4.4. Health Report

Allow access to weekly report on the tracked activity.

### 8.4.5. Messages

Any messages from the App to user, such as weekly activity report, is displayed in this page.

### 8.4.6. Setting

#### 8.4.6.1. My Objectives

User can define the goal of step count and weight.

#### 8.4.6.2. Data synchronization

User can manually synchronize the App with the connected watch by tapping the “Manual Sync” button.

#### 8.4.6.3. Time format

User can choose the time format shown in the App to be 12 hours or 24 hours.

#### 8.4.6.4. Unit

User can choose Metric or Imperial (British system) for the unit shown in the App.

#### 8.4.6.5. Week start time

User can define the first day of a week for the App.

#### 8.4.6.6. Map Engine

Google Map or Amap can be chosen as the default Map Engine used by the App.

#### 8.4.6.7. Privacy and Security

User can choose whether different information or data should be synchronized to the cloud system of the App.

#### 8.4.6.8. Data sharing and authorization

Data sharing to Strava and Goolge Fit can be activated in this page.

#### 8.4.6.9. Modify email

User can change the linked email address of registered account in this page. Re-acquiring verification code is required to complete the change process.

#### 8.4.6.10. Change password

User can change the password of the registered account here.

#### 8.4.6.11. Clear Cache

Manually clear the cache memory of the App.

#### 8.4.6.12. Logout

Logout current registered account. Please note that all synchronized data will not be available in the App once logout.

**8.4.6.13. Cancel Account**

Remove current registered account. Please note that all the data of the registered account will be removed permanently.

**8.4.7. Device problems and suggestions**

User is welcome to report on any problem to App server through this page.

**8.4.8. Check for update**

Check for any update on the App

**8.4.9. About**

Show the App version, Privacy Policy and User Agreement.

## 9. Compliances

### ISED Regulatory Compliance

This device contains licence-exempt transmitter(s)/receiver(s) that comply with Innovation, Science and Economic Development Canada's licence-exempt RSS(s). Operation is subject to the following two conditions: (1) This device may not cause interference. (2) This device must accept any interference, including interference that may cause undesired operation of the device.

L'émetteur exempt de licence contenu dans le présent appareil est conforme aux CNR d'Innovation, Sciences et Développement économique Canada applicables aux appareils radio exempts de licence. L'exploitation est autorisée aux deux conditions suivantes : (1) L'appareil ne doit pas produire de brouillage; (2) L'appareil doit accepter tout brouillage radioélectrique subi, même si le brouillage est susceptible d'en compromettre le fonctionnement.

### RF Exposure Compliance

This equipment complies with IC RSS-102 radiation exposure limits set forth for an uncontrolled environment. This transmitter must not be co-located or operating in conjunction with any other antenna or transmitter.

Cet équipement est conforme aux limites d'exposition aux radiations IC CNR-102 établies pour un environnement non contrôlé. Cet émetteur ne doit pas être situé ou fonctionner conjointement avec une autre antenne ou un autre émetteur.

### CAN ICES-3 (B)/NMB-3(B)

Environmentally friendly disposal



Old electrical appliances must not be disposed of together with the residual waste, but have to be disposed of separately. The disposal at the communal collecting point via private persons is for free. The owner of old appliances is responsible to bring the appliances to these collecting points or to similar collection points. With this little personal effort, you contribute to recycle valuable raw materials and the treatment of toxic substances.

### CAUTION

- Risk of explosion if the battery is replaced by an incorrect type
- disposal of a battery into fire or a hot oven, or mechanically crushing or cutting of a battery, that can result in an explosion ;
- leaving a battery in an extremely high temperature surrounding environment that can result in an explosion or the leakage of flammable liquid or gas ;
- a battery subjected to extremely low air pressure that may result in an explosion or the leakage of flammable liquid or gas.

## 10. Disclaimer

Salt water, chlorinated water, and sunlight exposure and some other certain conditions may effect the color of the strap and case over time.

## **IP68 Water Resistance**

The watch is rated IP68 for dust and water resistance. The watch is resistant to submersion in fresh water up to a maximum depth of 1.5 meters for up to 30 minutes. Care should be taken to avoid over exposure to moisture and excessive submersion in water.

## **Other Safety and Precaution Notices**

### **Bluetooth® Wireless Technology**

Bluetooth devices communicate without wires, using built-in radio transceivers that operate on a globally available radio frequency to ensure worldwide compatibility. The device can communicate with other Bluetooth devices (e.g. BT headsets) within a range of approximately 10 meters (33 feet).

### **Recycle**

Always return your used electronic products, batteries, and packaging materials to dedicated collection points.

### **Battery and Charger Info**

Your device has an internal, non-removable, rechargeable battery. Do not attempt to open the back cover or remove the battery, as you may damage the device. To replace the battery, take the device to the nearest authorized service facility.

### **Aircraft, Hospitals**

**CAUTION:** The device's Bluetooth radio must be switched to OFF in airplanes, hospitals or other public locations where handheld wireless and other electronic devices are prohibited.

### **Driving Precautions**

Responsible, safe driving is your responsibility when operating a vehicle. Using a mobile device or accessory for messaging while driving may cause distraction and could result in death or injury to you or others. Using a mobile device or accessory may be prohibited or restricted in certain areas; always obey the laws and regulations on the use of these products.

While driving, NEVER:

- Read messages
- Review on-screen data
- Perform any other functions that divert your attention from driving

### **Medical Devices**

Operation of radio transmitting equipment, including wireless phones, may interfere with the function of inadequately shielded medical devices. Consult a physician or the medical device's manufacturer to determine if it is adequately shielded from external radio energy.

To avoid potential interference, manufacturers of implanted medical devices recommend a minimum separation of 6 inches (15.3 centimeters) between a wireless device and the medical device. Persons who have such devices should:

- Always keep the wireless device more than 6 inches (15.3 centimeters) from the medical device.
- Not carry the wireless device in a breast pocket.
- Turn the wireless device off if there is any reason to suspect that interference is taking place.
- Follow the manufacturer directions for the implanted medical device.

If you have any questions about using your wireless device with an implanted medical device, consult your health care provider.

## **Timex International Warranty**

[www.timex.com/Warranty](http://www.timex.com/Warranty) or [www.timex.ca/Warranty](http://www.timex.ca/Warranty)

## **FCC Notice (U.S.)**

This device complies with Part 15 of the FCC Rules. Operation is subject to the following two conditions: (1) this device may not cause harmful interference; and (2) this device must accept any interference received, including interference that may cause undesired operation.

Warning: Changes or modifications to this unit not expressly approved by the party responsible for compliance could void the user's authority to operate the equipment.

Note: This equipment has been tested and found to comply with the limits for a Class B digital device, pursuant to Part 15 of the FCC Rules. These limits are designed to provide reasonable protection against harmful interference in a residential installation. This equipment generates, uses, and can radiate radio frequency energy and, if not installed and used in accordance with the instructions, may cause harmful interference to radio communications. However, there is no guarantee that interference will not occur in a particular installation. If this equipment does cause harmful interference to radio or television reception, which can be determined by turning the equipment off and on, the user is encouraged to try to correct the interference by one or more of the following measures:

- Reorient or relocate the receiving antenna.
- Increase the separation between the equipment and receiver.
- Connect the equipment into an outlet on a circuit different from that to which the receiver is connected.
- Consult the dealer or an experienced radio TV technician for help.

## **FCC Notice (Canada)**

Avertissement de la FCC (États-Unis) / Avertissement d'IC (Canada) Cet appareil est conforme à l'Article 15 de la Réglementation de la FCC. L'utilisation est soumise aux deux conditions suivantes : (1) cet appareil ne peut pas causer d'interférence nuisible ; et (2) cet appareil doit accepter toute interférence reçue, y compris toute interférence qui peut entraîner l'utilisation indésirable. Avertissement : Les modifications de cet appareil qui n'ont pas été expressément approuvées par la partie responsable de la conformité pourrait annuler l'autorité d'utiliser l'équipement. Remarque : Cet équipement a été testé et déclaré conforme aux limites pour appareils numériques de classe B, selon l'Article 15 de la Réglementation de la FCC. Ces limites visent à fournir une protection raisonnable contre les interférences dans une installation résidentielle. Cet équipement produit, utilise et peut émettre de l'énergie radio électrique et, s'il n'est pas installé et utilisé conformément aux présentes instructions, peut causer des interférences nuisibles aux communications radio. Cependant, il se peut que des interférences se produisent dans une installation particulière. Si cet appareil cause des interférences nuisibles à la réception des signaux de radio ou de télévision, ce qui peut être déterminé en allumant et éteignant l'appareil, on encourage l'utilisateur d'essayer de corriger ces interférences par l'un des moyens suivants : — Réorienter ou repositionner l'antenne de réception. — Augmenter la distance entre l'équipement et le récepteur. — Brancher l'équipement sur un circuit différent de

celui du récepteur. — Contacter votre revendeur ou un technicien radio/TV qualifié pour obtenir de l'aide. Cet appareil numérique de classe B est conforme à l'ICES-003 (Canada). Cet appareil est conforme aux norme(s) RSS d'Industrie Canada pour les appareils exempts de licence. L'utilisation est soumise aux deux conditions suivantes : (1) cet appareil ne peut pas causer d'interférence nuisible, et (2) cet appareil doit accepter toute interférence reçue, y compris toute interférence qui peut entraîner l'utilisation indésirable. 30 Déclaration de conformité Nom du fabricant : Timex Group USA, Inc. Adresse du fabricant : 555 Christian Road Middlebury, CT 06762 États-Unis d'Amérique déclare que le produit suivant : Nom du produit : iConnect Active par Timex® Numéros de modèle : M08Y est conforme aux législations harmonisées pertinentes de l'Union européenne. La présente déclarati

### **DECLARATION OF CONFORMITY**

**Manufacturers Name:** Timex Group USA, Inc.

**Manufacturers Address:** 555 Christian Road  
Middlebury, CT 06762  
United States of America

declares that the product:

**Product Name:** TIMEX® iConnect Active+®

**Model Numbers:** M08Y

is in conformity with the relevant EU harmonized legislations. This declaration is issued under the sole responsibility of the manufacturer and conforms to the following:

#### **EU RED Directive 2014/53/EU**

Standards:

EN 300 328

EN 301 489-1

EN 301 489-17

EN 50663

EN 62368-1

#### **Electromagnetic Compatibility (EMC) – Radio Frequency (RF)**

Standards

FCC 47 CFR Part 15, Subpart C

RSS 247

ICES 103

AS/NZS 4268

AS/NZ CISPR 32



Agent: \_\_\_\_\_

Sam Everett

Manager QA & Regulatory

Date: 6-May-2022, Middlebury, Connecticut, U.S.A.

©2022 Timex Group USA, Inc. TIMEX and ICONNECT are trademarks of Timex Group in the USA.