

A·D·O[®]

PRODUCTS YOU NEED. SERVICE WE DELIVER.



INSULATION AND BUILDING ACCESSORIES CATALOG

VOLUME 21



PRODUCTS YOU NEED. SERVICE WE DELIVER.

INSULATION AND BUILDING ACCESSORIES CATALOG

FIND US ONLINE @ WWW.ADOPRODUCTS.COM

TO PLACE AN ORDER

You may conveniently order by phone, fax or email.
Most orders received before 12:00 pm CST will be shipped the same day.



By Phone: Call 1-800-666-8191

Monday-Friday 7:00 am - 5:00 pm CST

By Fax:

Send fax to 1-888-641-3904

By Email:

Send your order to sales@adoproducts.com

ADO RETURN POLICY

ADO will accept returns based on the following conditions:

If the return is a result of an error made by ADO, a carrier, or vendor of ADO, we will gladly replace the item and credit all shipping charges and restock fees. All products that are to be returned MUST have a Return Authorization (RMA) number assigned. To receive an RMA number, please call your ADO Account Manager at 800-666-8191. All returns must be securely packed in the original packaging, received in resalable condition, and returned within 60 days of original shipment. Returns are subject to a 15% restock fee and return freight charges. No returns will be accepted on Special Order or Clearance items.

ADO VENTS

FOAM

SAFETY

MASKS

SANITIZATION

CAULK

TAPE

FILM & NETTING

BLOWING

EXTRAS

SCHEMATICS

PAGES 4-6

PAGES 7-21

PAGES 22-27

PAGES 28-31

PAGES 32-33

PAGES 34-37

PAGES 38-40

PAGES 41-48

PAGES 49-59

PAGES 60-68

PAGES 69-76

ALPHABETICAL INDEX

3M Papr Air System23	Durovent Baffle.....5	Magnum Refill.....10	Schematics, Staplers.....71
3M Respirators & Filter Cartridges.....28	Dynasolve CU-621	Manus-Bond.....37	Schematics, Stilts.....69-70
Allegro Air System.....26	Eco Seal Plus61	Masks, 3M.....28	Sheathing Tape.....38
Anchor, Washers, Caps, Adhesive.....67	Eye Protection27 & 31	Masks, Moldex30	Silicone Caulk.....35
Attic Access Covers64	Fabric45	Membrane41	Sill Seal61
Attic Baffles5	Facings.....42-43	Moisture Meters.....55	Soudal Foam.....7
Attic Rulers.....55	Fireblock, Firestop34	Moldex Cartridges31	Spray Adhesive.....37
Attic Vents4	First Aid Kit.....27	Moldex Full & Half-Face Resp.....30	Spray Sock & Goggles27
Backer Rod61	Foam.....7	Netting.....44	Staples46
Baffles5	Foam Saws & Accessories18	Non-Woven Fabric.....45	Staplers47
Batt Knives62	Foil Tape.....38	Nozzle, Dry Spray.....53	Stilts68
Batt Supports.....66	Gloves20 & 48	Nozzle, Wet Spray.....54	Stud Scrubbers55
Blowing Hose49	Graco, Reactor.....15	Olfa Knife.....63	Supplied Air Systems.....23-26
Blowing Machines56	Graco, Sanitization32	Plugs52	Tape38
Bullard Air Systems.....25	Graco, Fusion Sprayer.....15	Pneumatic Staplers.....47	Tennessee Chill Box.....24
Butyl Tape.....38	Graco, Heated Hoses.....17	Poly.....41	The Shoot.....6
Can Light Covers.....65	Graco, Schematics.....72-75	Powerblanket Drum Heaters.....17	Tiger Teeth.....66
Cardboard Baffle6	Graphite Powder55	Protective Wear22	Tool Pouches & Belts.....63
Caulk.....35	Great Stuff Foam.....12	Provent.....4	Turbo Cutz.....19
Caulk Guns, Warm Bag.....36	Hammer Tackers47	ProVent Baffle.....5	Two Component Foam.....9
Chem Trend.....21	HandiFoam.....8	Pumps/Motor54	Utility Knives63
Chutes.....4	Hard Hats.....31	Python Sidewinder Sleeve17	Vacuum Bags60
Connectors & Reducers53	Holes Saws & Bits50	Radiant Barrier.....42	Vacuum Hoses49
Curry Combs.....18	Hose Reels.....53	Radon Adhesive37	Vacuums.....59
Cylinder Warming Wrap.....18	Hoses.....49	Rafter Vents.....4	Versi-Foam.....11
Dessicant Cartridge.....17	Husky Plastic Sheeting41	Recessed Light Cover65	Vintool62
Disinfectant, Concrobiom.....33	Insul-Hold.....67	Release, Chem Trend21	Vinyl Foam Sealant Tape 3M.....40
Disinfectant, Shockwave.....33	Intumescent Coating.....16	Respirators, 3M.....28	Visqueen.....41
Dow Foam.....12	Knives, Batt, Utility.....62-63	Safety Glasses.....31	Wall Scrubbers55
Dow Two Component Foam.....13	Knives, Foam.....19	Sanitization32	Washers67
Dow Refill Kits14	Lamtec Facing43	Schematics.....69-76	Windblock4
Duct Sealant.....37	Latex & Vinyl Gloves.....20	Schematics, 3M.....76	Work Gloves.....48
Duct Tape.....39	Lightening Rods.....66	Schematics, Graco.....72-75	





INTRODUCING THE NEW PRODUCTS OF ADO

DESICCANT CARTRIDGES
SEE PAGE 17



TURBOCUTZ
FOAM REMOVAL TOOL
SEE PAGE 19



NO-BURN AND FIRESHELL
INTUMESCENT COATINGS
SEE PAGE 16

TITEBOND® RADON SEALANT
SEE PAGE 37



CHEMTREND® CLEANERS
SEE PAGE 21

TENNESSEE CHILL BOX™ KITS
SEE PAGE 24



ALLEGRO AIR BAG 12
SEE PAGE 26

NEW!

INTRODUCING THE NEW PRODUCTS OF ADO

GRACO SPRAYERS
SEE PAGE 15



POWERBLANKET®
HEATER WRAPS
SEE PAGE 16

BULLARD® PUMPS,
RESPIRATORS & MASKS
SEE PAGE 25

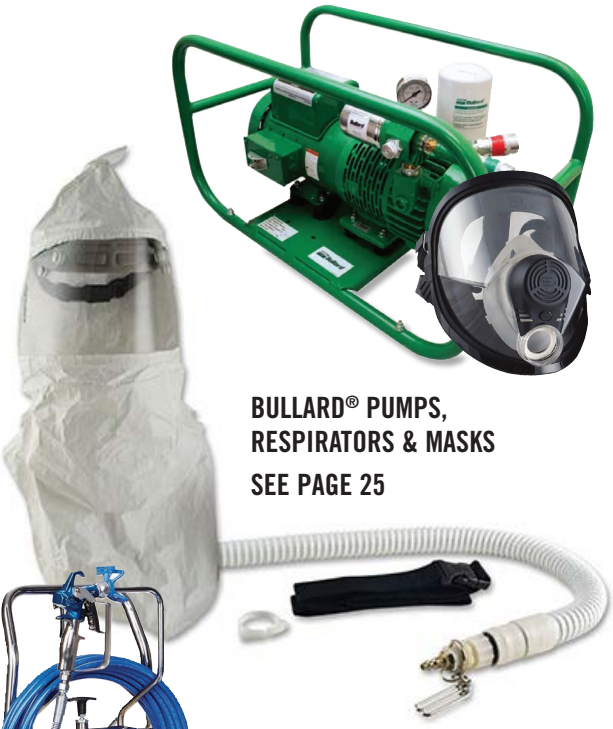

ECOSEAL PLUS™
ELASTOMERIC SEALANT
SEE PAGE 61



CERTAINTIED SMART MEMBRAIN™
SEE PAGE 41



SANITIZATION PRODUCTS
SEE PAGE 33



DUROVENT®



(A) DUROVENT®

The **Number ONE** selling vent in the industry! The polystyrene material provides a lightweight water resistant air channel. Ideal for high volume new construction or lower cost re-insulation.

- Economical way to meet energy code requirements for air flow
- Multiple lengths and perforated center line to fit all applications
- Wide nailing flange and center strut allows for easy installation

KEY	SKU	DESCRIPTION	PACKAGING	MIN QTY
A	DV2200	Durovent—22" x 48"	50/bag, 1000/pallet	1000
	UDV2248	Durovent w/UPC code—22" x 48"	70/carton, 840/pallet	70
	DV2272	Durovent—22" x 72"	50/bundle, 1000/pallet	1000

NOTE: Product color may differ by shipping location.

A

proVent®

(B-C) PROVENT®

Ideal for premium construction and for difficult applications like re-insulation. proVent may be installed prior to the soffit panel installation without fear of blow-out.

- Made with Pro Grade tear-resistant high-impact polystyrene
- Rigid vent construction eliminates breakage during re-insulation
- Full joist coverage for maximum air flow

KEY	SKU	DESCRIPTION	PACKAGING	MIN QTY
B	PV1148B	proVent—11" x 48"	3000/bulk pallet	3000
	UPV1448050	proVent w/ UPC code—14" x 48"	100/carton, 1500/pallet	100
	PV1448B	proVent—14" x 48"	2250/bulk pallet	2250
	PV1448D	proVent—29" x 48"	1500/bulk pallet	1500
	UPV2248050	proVent w/ UPC code—22" x 48"	100/carton, 1000/pallet	100
C	PV2248B	proVent—22" x 48"	1500/bulk pallet	1500

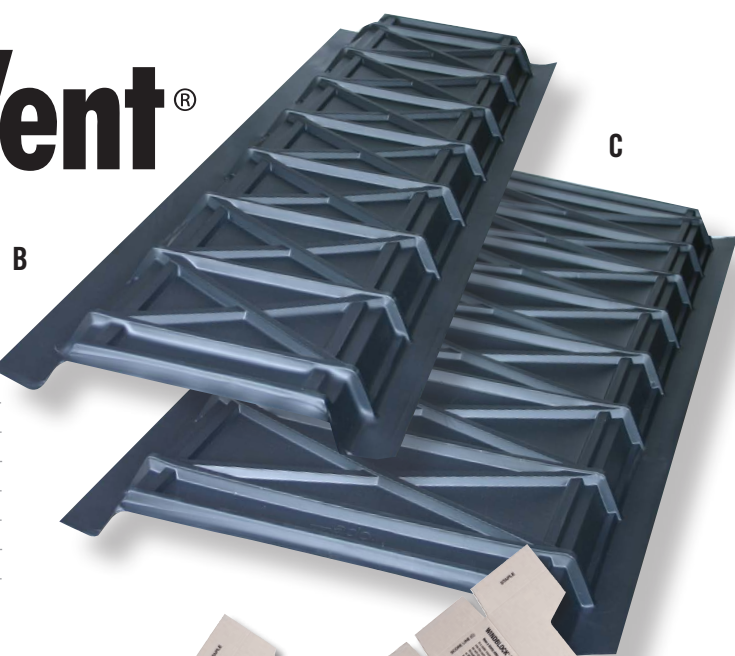

B

C

(D) WINDBLOCK®

Provides the best moisture and air infiltration seal between the rafter vent and wall top plate. Works with Durovent and proVent to provide a moisture impervious vent and block system.

- **Now scored for 16" and 24" O.C.**
- Install with rafter vents to maximize attic ventilation performance
- Secures vent in place thus eliminating blow-out during construction
- Blocks moisture from exterior and acts as an insulation stop
- Meets energy code requirements for air infiltration
- Provides a moisture and air infiltration seal between the rafter vent and top of the wall
- Prevents wind driven moisture and cold air infiltration between the rafter vent and the top of the wall
- Reduces energy loss at the attic perimeter
- Effective for use in new and retrofit applications
- Constructed of waterproof and durable polyboard

KEY	SKU	DESCRIPTION	PACKAGING	MIN QTY
D	WB2000	Windblock with UPC Code	200/carton	200

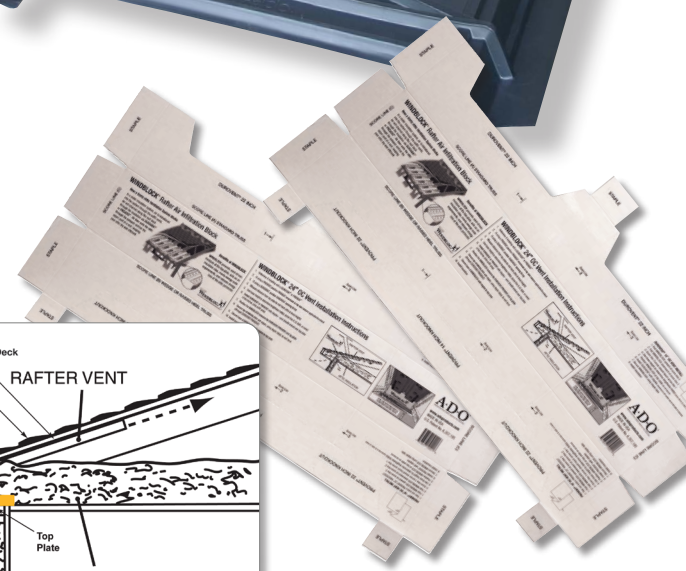

D

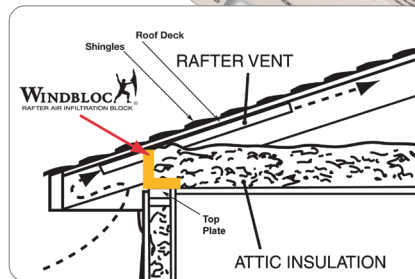

PATENT PENDING

WINDBLOC®
RAFTER AIR INFILTRATION BLOCK

DUROVENT[®] BAFFLE

(A) DUROVENT BAFFLE[®]

The most economical way to ventilate your roof and block out the wind and rain! A water resistant baffle is incorporated into the **Number ONE** selling vent in the industry allowing for a one-step rafter vent and baffle installation.

- One-step installation
- Easy positioning and stapling
- Allows for wide range of heel heights

KEY	SKU	DESCRIPTION	PACKAGING	MIN QTY
A	DVB152346	Durovent Baffle—23.5" x 46"	50/bag, 1000/pallet	1000
	UDVB152346	Durovent Baffle—23.5" x 46"	70/carton, 840/pallet	70



proVent[®] BAFFLE

The Versatile Baffle for the Insulation Professional.

- Withstands heat and pressure of spray foam
- Versatile design adapts to varying heel heights
- Attaches to the truss, as well as the roof deck
- Will not absorb moisture or grow mold
- Made from high-impact polystyrene
- Spans the entire width of the bay – 16" or 24" O.C.

KEY	SKU	DESCRIPTION	PACKAGING	MIN QTY
	PVB1541	proVent Baffle—14.5" x 41"	50/bundle, 1500/pallet	50
B	PVB1548	proVent Baffle—14.5" x 48"	50/bundle, 1500/pallet	50
	PVB2341	proVent Baffle—22.5" x 41"	50/bundle, 1000/pallet	50
C	PVB2348	proVent Baffle—22.5" x 48"	50/bundle, 1000/pallet	50

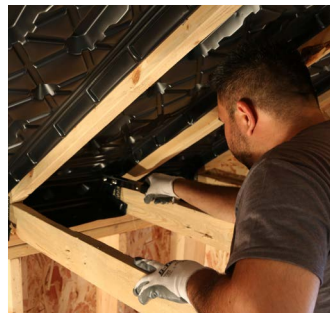
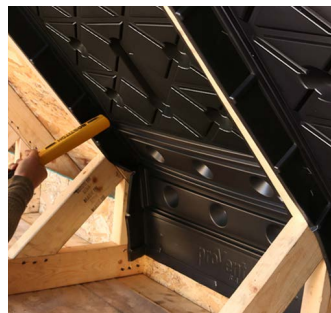
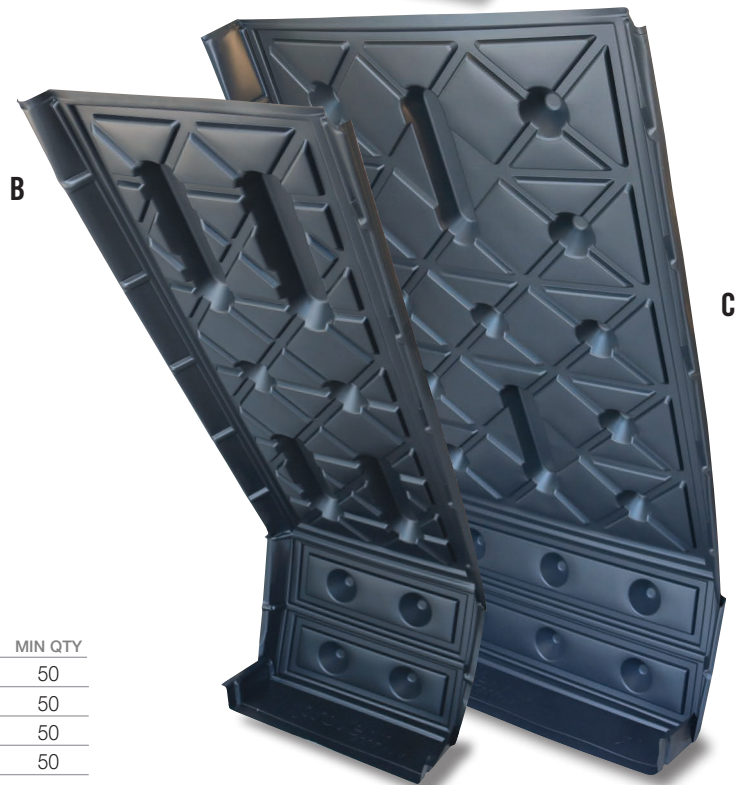

HOW A STATIC ATTIC VENTILATION SYSTEM WORKS

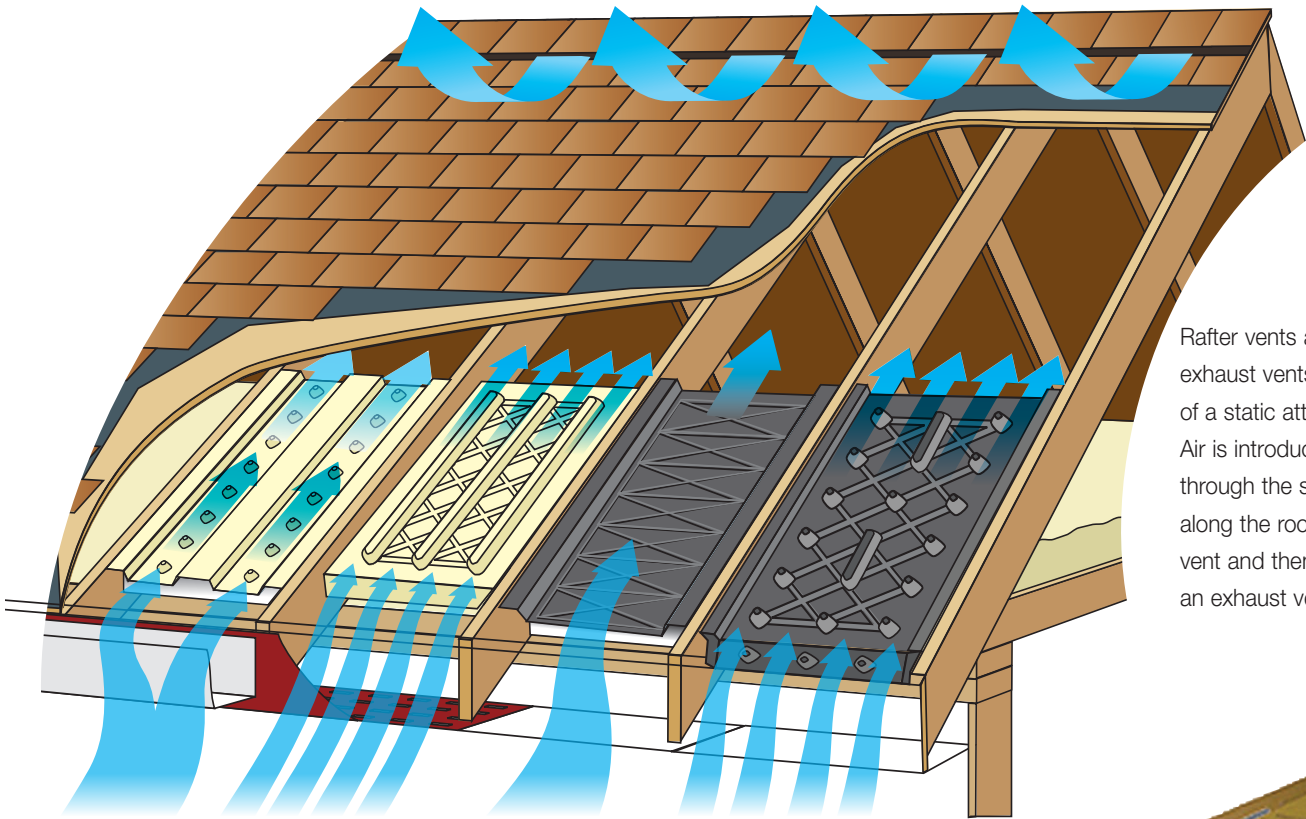

Rafter vents along with soffit and exhaust vents are the components of a static attic ventilation system. Air is introduced into the system through the soffit vents, channeled along the roof deck through a rafter vent and then is expelled through an exhaust vent.

(A) THE SHOOT™

The Shoot™ is a patented, effective way to insulate open framed areas in new construction applications of residential and commercial buildings, as well as room additions and remodeling projects. The Shoot™ has been researched and developed to be the perfect tool for the spray foam industry, spray-on systems and blow-in blanket systems. It is 6' in length and manufactured to fit 16" and 24" O.C. openings. With several scored edges, it can also fit odd sized openings.

KEY	SKU	DESCRIPTION	MIN QTY
A	SH016	The Shoot, 16" X 72", 50/bundle, 500/pallet	50
	SH024	The Shoot, 24" X 72", 50/bundle, 500/pallet	50



A



B

Unique rise height!

(B) CARDBOARD BAFFLES

Cardboard provides an economical vent that is easily installed. The baffle is incorporated into the vent providing a wind barrier to the exterior and an interior block for blowing in attic insulation. Flexible material for installing on all joist sizes.

- Vent incorporates a 6-9" tail that provides a full cavity block
- Stores flat and is easy to transport and handle

KEY	SKU	DESCRIPTION	OC	FLUE LENGTH	PACKAGING	MIN QTY
B	CBCOMBO	Cardboard Baffle, 16" & 24" x 23"	16"/24"	17"	50/bdl, 1200/pallet	50
	CB1623	Cardboard Baffle, 16" x 29"	16"	23"	50/bdl, 1200/pallet	50
	CB2423	Cardboard Baffle, 24" x 29"	24"	23"	50/bdl, 1000/pallet	50
	CB2433	Cardboard Baffle, 24" x 39"	24"	33"	50/bdl, 600/pallet	50
	CB2444	Cardboard Baffle, 16"/24" x 50"	16"/24"	44"	50/bdl, 600/pallet	50
	CB2444MC2	Cardboard Baffle, 16"/24" x 50" Michelman Coated—2 Sides	16"/24"	44"	50/bdl, 600/pallet	50

SOUDAL

FOAM

(A) SOUDAL WINDOW & DOOR GUN FOAM

Low-pressure formula eliminates windows and doors from bowing. Flame spread 15 and smoke developed 35. UL classified. Soudal Window & Door Foam meets AAMA (American Architectural Manufacturers Association) test specifications for low-pressure window and door sealant foams (AAMA 812-04).

KEY	SKU	DESCRIPTION	CANS/CASE	CASES/PALLET
A	116889	Soudal Window/Door Foam—24 oz Can	12	54

(B) SOUDAL FIREBLOCK GUN FOAM

Soudal Fireblock gun foam is a one-component, self expanding, ready to use, fire block, polyurethane orange-colored foam. It contains CFC-free propellants, which are completely harmless to the ozone layer. See ICC-ES Report #ESR-3118.

KEY	SKU	DESCRIPTION	CANS/CASE	CASES/PALLET
B	120919	Soudal Fireblock Foam—24 oz Can	12	54

(C) SOUDAL ALL SEASON GUN FOAM

Soudal All Season Gun Foam is a "top of the line," one-component moisture curing polyurethane foam developed especially to perform under difficult freezing temperature conditions or in hot conditions where traditional PU foams fail to extrude and cure. The foam will extrude at ambient temperatures as low as -13°F and as high as 120°F with a can temperature of minimum 41°F and maximum 95°F respectively. Cans should be stored at temperatures between 41° and 77°F. AAMA Compliant.

KEY	SKU	DESCRIPTION	CANS/CASE	CASES/PALLET
C	455800	Soudal All Season Gun Foam—24 oz Can	12	54

(D) SOUDAL SOUDAFOAM FLEX GUN FOAM

Soudal Soudafoam Flex is a one-component, moisture curing polyurethane foam developed to be flexible with minimal pressure and unique elastic recovery. Foam extrudes and cures in extreme temperatures from -13°F to 120°F with can temperatures between 41°F and 95°F and will not bend or bow window and door frames.

KEY	SKU	DESCRIPTION	CANS/CASE	CASES/PALLET
D	457800	Soudafoam Flex, PU Can Foam—24 oz Can	12	54

(H) SOUDAL CLEANER FOR FOAM GUNS

Environmentally safe agent specially formulated to dissolve non-cured and fresh polyurethane foams from can valves, dispensing equipment, foam guns and clothing. Contains no CFC's.

KEY	SKU	DESCRIPTION	MIN QTY	CANS/CASE
H	113433	Soudal Cleaner—12 oz Can	can	12

(I) SOUDAL FOAM GUN REPLACEMENT TIPS

Replaceable plastic extension tips for the Soudal Compact Gun (109953). Each tip is 3" long with a diameter of 3/16". Soudal foam gun tips allow the installer to get into tight areas as well as protect the tip of the gun, extending the overall life of the gun.

KEY	SKU	DESCRIPTION	MIN QTY
I	PETSFG	PU Foam, Plastic Extension Tip Straw	each

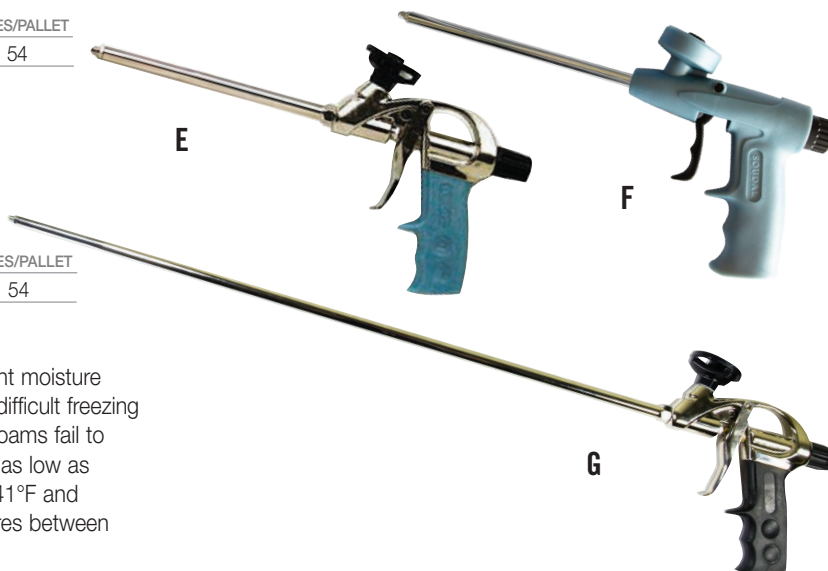

(E-G) GUNS FOR SOUDAL FOAM

These guns are recommended for use with Soudal foam products.

KEY	SKU	DESCRIPTION	MIN QTY
E	103266	Soudal Designer Gun	each
F	109953	Soudal Compact Gun	each
G	122129	Soudal 24" Long Barrel Gun	each





(A) HANDIFOAM® EXTREME POLYURETHANE FOAM

Formulated to work in extreme climates where ambient moisture/humidity is not always present. Tack-free within 10 minutes and meets ASTM E-84 Class 1 for caulk and sealants. Handi-Foam® Extreme is the perfect choice for sealing needs in extreme climates.

KEY	SKU	DESCRIPTION	CANS/CASE	CASES/PALLET
A	P30120	HandiFoam Extreme Gun Foam—24 oz Can	12	48

(B) HANDIFOAM® FIREBLOCK POLYURETHANE FOAM

Designed to seal, fill, bond and stop air infiltration. HandiFoam is more effective than traditional fireblock materials at blocking flames and smoke. Recognizable orange color allowing inspectors to easily identify the use of an approved fireblock product. Passes ICC-ES evaluation for use as a fireblock.

KEY	SKU	DESCRIPTION	CANS/CASE	CASES/PALLET
B	P30181	HandiFoam Fireblock—24 oz Can	12	48

(C) HANDIFOAM® WINDOW AND DOOR POLYURETHANE FOAM

Multiple purpose, UL classified, one-component polyurethane foam designed specifically for window and door installation and retro-fit applications. Low-pressure formulation will not bow windows or door frames. Meets AAMA (American Architectural Manufacturers Association) test specifications for low-pressure window and door sealant foams.

KEY	SKU	DESCRIPTION	CANS/CASE	CASES/PALLET
C	P30272	HandiFoam Window & Door Foam—24 oz Can	12	48

(D) HANDIFOAM® POLYURETHANE STRAW FOAM

May be used to seal, fill, bond, and stop air infiltration. Designed to seal and fill small cracks, gaps, and voids.

KEY	SKU	DESCRIPTION	CANS/CASE	CASES/PALLET
D	P30107	HandiFoam Straw Foam Sealant—24 oz Can	12	48

(E) HANDIFOAM® BLACK SEALANT

One-component polyurethane foam (OCF) sealant specifically designed black in color, making it ideal for applications where product appearance may be a factor. HandiFoam Black Sealant utilizes a (HC) propellant. May be used to fill gaps and cracks in pond and waterfall design, landscaping, RV undercarriages, crack and hole repair in trees, as well as to seal gaps and penetrations in the building envelope. Fish and plant safe.

KEY	SKU	DESCRIPTION	CANS/CASE	CASES/PALLET
E	P30053	HandiFoam Black Sealant—12 oz Can	12	75

(F) HANDIFOAM® CLEANER

Handi-Cleaner is a multi-purpose cleaning agent used to dissolve uncured or fresh polyurethane foam and adhesive, formulated without the use of any ozone-depleting materials.

KEY	SKU	DESCRIPTION	MIN QTY	CANS/CASE
F	P10083	HandiFoam Cleaner—12 oz Can	can	12

(G-J) APPLICATOR GUNS FOR HANDIFOAM®

Use with HandiFoam and Fast Foam one-component foam products.

- Reusable
- Adjustable output
- Metal barrel

KEY	SKU	DESCRIPTION	MIN QTY
G	F61033	Foam Gun, Handi-Tool, HT330	each
H	F61055	Foam Gun, Handi-Tool, HT550	each
I	F61077	Foam Gun, Steel Handi-Tool, HT770	each
J	F61020	Foam Gun, 22" Steel Handi-Tool	each

FEATURES	HT330	HT550	HT770
BASKET	Teflon Coated	Teflon Coated	Teflon Coated
SEALING BALL	Steel	Teflon	Teflon
NEEDLE SEALING	Steel	Teflon	Teflon
BARREL	Stainless	Stainless	Teflon Coated Aluminum
OUTLET NOZZLE	Barbed Copper	Barbed Copper	Teflon Coated Barbed Copper
BODY	Plastic	Chrome Plated Aluminum	Teflon Coated Aluminum
TRIGGER	Aluminum	Aluminum	Teflon Coated Steel

(K) EXTENSION TIPS

Fits Handi-Tool gun models F61033 and F61055.

KEY	SKU	DESCRIPTION	QTY	MIN QTY
K	E54300	Plastic Extension Tip— 5 tips/pack	pack	1 pk





A

(A) HANDIFOAM® LOW-PRESSURE CHANNEL FILL

High-flow technology is an industry first low-pressure polyurethane foam category that takes traditional pour-in-place polyurethane foam and adds the ability to completely fill difficult and intricate voids, making impossible applications possible. Handi-Flow Channel Fill is a stable, chemically-cured foam that will not settle, shrink or post-expand over time—providing quality assurance that the cavity is and will remain completely filled.

KEY	SKU	DESCRIPTION	MIN QTY	KITS/PALLET
A	P50001	HandiFoam Channel Fill—15 cu ft.	each	26
	P50002	HandiFoam Channel Fill—44 cu ft.	each	9

HANDIFOAM® LOW DENSITY LOW-PRESSURE SPRAY POLYURETHANE FOAM

HandiFoam® Low Density low-pressure, spray polyurethane foam is an open cell, chemically-cured, two-component system used to fill and insulate large voids and surfaces. HandiFoam® Low Density is great for sound deadening and reducing noise volume. Ideal for patch and repair or touch-up work of currently insulated buildings where a low density foam is installed.

KEY	SKU	DESCRIPTION	MIN QTY	KITS/PALLET
	P10692	II-250 HandiFoam Low Density Spray Foam	each	26
	P10694	II-450 HandiFoam Low Density Spray Foam	each	26
	P10770	II-1350 HandiFoam Low Density Spray Foam	each	9*

*18 A&B boxes total

(D) TANK FOAM SEALANT

Multiple purpose, UL classified one-component polyurethane foam designed for the professional user. Dispensed through a flexible hose with a valve controlled dispensing nozzle. Optimal application temperature is between 65-100° F (18-38° C), and may be used between 40-115° F (5-46° C). Dries tack-free within 10 minutes or less depending on moisture and temperature conditions. Cuttable within one hour and fully cures in 12-24 hours. Flame spread 25 and smoke developed 50. UL classified file #R13919 Caulking and Sealants. ASTM E-84 (12.5%).



KEY	SKU	DESCRIPTION	MIN QTY	KITS/PALLET
D	HANDI16HF0	Foam Tank HandiFoam —16 lb Tank Kit	each	40
	F62180	160/260 Hose Assembly (Hose, Valve, Nozzle)	pack	1 pk



B



C

(B-C) CLASS 1

HandiFoam® E84 Class 1 Spray Foam is a low-pressure foam system that utilizes a non-flammable blowing agent. Handi-Foam E84 Class 1 Spray Foam has been specifically formulated for flame retardancy and conforms to the requirements of ASTM E84 as a “Class 1(A)” system (flame spread of 25 or less, smoke development of 450 or less). The foam helps to lower heating and cooling costs by drastically reducing energy consumption.

KEY	SKU	DESCRIPTION	MIN QTY	KITS/PALLET
B	HANDI205C1	2-Comp, HandiFoam, 205 bd ft, Class 1	each	26
C	HANDI605C1	2-Comp, HandiFoam, 605 bd ft, Class 1	each	9
	HANDI205C1HFO	PU Foam, HFO Blend, 2-Comp, HandiFoam, 205 bd ft, Class 1	each	26
	HANDI605C1HFO	PU Foam, HFO Blend, 2-Comp, HandiFoam, 605 bd ft, Class 1	each	9



D

HANDIFOAM® SPRAY POLYURETHANE FOAM (SPF)

HandiFoam's refillable foam systems are chemically-cured, two-component spray and pour-in-place polyurethane foam systems, packaged in low-pressure refillable cylinders.

These systems are designed for larger applications, assembly line filling or any unique application that requires a balance between quality and affordability. Refillable foam systems are available in a variety of sizes and formulations to meet application and market requirements.

The refillable foam systems dispensing equipment utilizes the same patented Handi-Gun® as our disposable foam kits, providing accurate and precise dispensing. The addition of the Magnum Heated System® provides improved temperature control and extended reach for increased flexibility.

(A) HANDIFOAM® E-84 CLASS 1 REFILL SYSTEMS

HandiFoam® E84 Class 1 Spray Foam Refill Systems are low-pressure foam systems that utilize a non-flammable blowing agent. HandiFoam E84 Class 1 Spray Foam has been specifically formulated for flame retardancy and conforms to the requirements of ASTM E84 as a "Class 1(A)" system (flame spread of 25 or less, smoke development of 450 or less). The foam helps to lower heating and cooling costs, drastically reducing energy consumption.

KEY	SKU	DESCRIPTION	QTY	MIN QTY
A	P22090	2-Comp Refill for 1/2" Plumbing 17 Gal, Class 1, 1980 bd ft	each	1 kit
	P22290	2-Comp Refill for 1/2" Plumbing 27 Gal, Class 1, 3120 bd ft	each	1 kit
	P22490	2-Comp Refill for 1/2" Plumbing 60 Gal, Class 1, 6840 bd ft	each	1 kit
	P22890	2-Comp Refill for 1/2" Plumbing 100 Gal, Class 1, 11400 bd ft	each	1 kit

**Hose assembly sold separately*

HANDIFOAM® ACCESSORIES

(B-E) 2-COMPONENT FOAM ACCESSORIES

KEY	SKU	DESCRIPTION	QTY	MIN QTY
B	F66170	2-Comp HandiFoam, Cone Tip Temperature Warning Nozzle	each	1
C	F66190	2-Comp HandiFoam, Fan Tip Temperature Warning Nozzle	each	1
D	F66210	2-Comp HandiFoam Gun & 15' Hose	each	1
E	F65275	Magnum Heated Hose Starter Kit Starter Kit Includes: F65005: Nitrogen Regulator F65090: 6' Nitrogen Hose F65100: 6' Nitrogen Hose F66171: Cone Nozzle (25 pack) F66191: Fan Nozzle (25 pack) F65301: Refill Tank Pressure Gauge	each	1 kit
F	F66220	10" Handi-Gun Assembly for Refill Kits	each	1
	F66265	150' (45m) Magnum HD Heated Hose Assembly		1
	F66181	Handi-Gun Trigger Stop Metering Clip	3/pack	1 pk



D



E



B

C

"When the Nozzle
URNS BLUE
Stop Your Crew."™

*New Temperature
Warning Technology!*

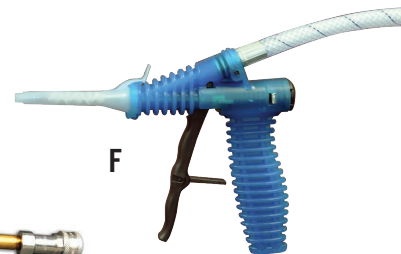

F



A



(A) VERSI-FOAM®

Versi-Foam® is a portable and disposable low-pressure spray foam insulation system. It is ideal for insulating, air sealing, sound dampening, condensation control, caulking, and void filling. Versi-Foam® applies to commercial and residential construction, plant and facility maintenance, HVAC equipment, roofing repair, marine flotation and insulation, pool and spa insulation, stage/film props, special effects, insulation used within trucks, trailers, buses, RV's, and much more.

- Two-component closed cell spray foam kits
 - Patented U-Control dispensing gun provides complete control over how much foam is dispensed
 - Excellent air seal
 - High R-value per inch
 - Energy efficient
 - Portable and disposable
 - Tack-free to touch in 30-40 seconds
- Kits include:**
- U-Control dispensing gun
 - Two hoses
 - 10 mixing nozzles
 - 3 fan tips
 - 1 pair of nitrile gloves
 - 1 packet of petroleum jelly
 - 1 wrench

KEY	SKU	DESCRIPTION	MIN QTY	KITS/PALLET
A	VF200	Versi-Foam, PU Foam, 2-Comp, 200 bd ft	each	30
	VF200C1	Versi-Foam, PU Foam, 2-Comp, 200 bd ft, Class 1(A)	each	30
	VF600	Versi-Foam, PU Foam, 2-Comp, 600 bd ft	each	12
	VF600C1	Versi-Foam, PU Foam, 2-Comp, 600 bd ft, Class 1(A)	each	12
	VF60030	Versi-Foam, PU Foam, 30' Hose, 2-Comp, 600 bd ft	each	12

(E) VERSI-FOAM® REPLACEMENT HOSES

Versi-Foam® offers replacement hoses for all of their two-component foam kits. The 10' hose and gun assembly kits are for the VF200 and VF200C1 kits only. The 15' and 30' hose and gun assembly kits can be added to the VF600, VF600C1 and VF60030. Assembly kits include two hoses.

KEY	SKU	DESCRIPTION	MIN QTY
E	VFH10	10' Gun/hose Assembly for VF200 and VF200C1 only	each
	VFH15	15' Gun/hose Assembly for VF600, VF600C1 and VF60030 Only	each
	VFH30	30' Gun/hose Assembly for VF600, VF600C1, and VF60030 Only	each

(B-D) VERSI-FOAM® REPLACEMENT NOZZLES AND FAN TIPS

Versi-Foam® offers replacement nozzles and fan tips to replace ones that have either been lost or broken. Class 1(A) kits require the use of nozzles designed with an extended mixing chamber to allow for the foams to completely mix. The fan tips can be added to either the standard nozzle or the Class 1(A) nozzle.

KEY	SKU	DESCRIPTION	MIN QTY
B	VFNOZ	Versi-Foam® Nozzle for VF200, VF600, and VF60030 (Standard Only)	each
C	VFNOZC1	Versi-Foam® Nozzle for VF200C1 and VF600C1 (Class 1(A) Only)	each
D	VFFANT	Versi-Foam® Fan Tip Spray Nozzle Attachment for VFNOZ and VFNOZC1 Fan-Shaped Pattern	each

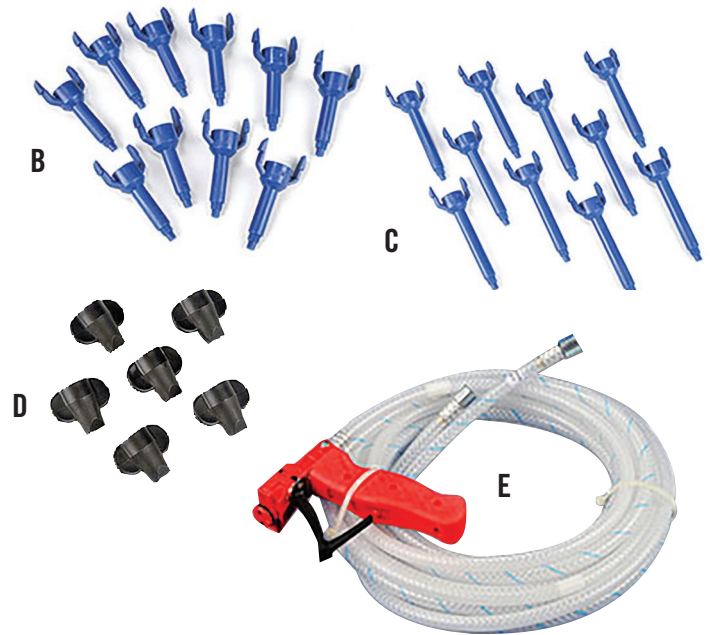



A



B



C



D



(A) GREAT STUFF™ PRO WINDOW & DOOR GUN FOAM

Minimal expansion, one-component, low-pressure formulation and flexible polyurethane foam sealant. Great Stuff Pro Window & Door foam sealant is exclusively formulated to air-seal the gap between a window or door frame and its rough opening. It expands only enough to generate an effective seal, and makes window and door systems more energy efficient. Proven not to bow windows or doors. Conforms to ASTM and AAMA standards. UL classified—flame spread 10 and smoke developed 20.

KEY	SKU	DESCRIPTION	CANS/CASE	CASES/PALLET
A	FOAMWD	Great Stuff Pro Window & Door—20 oz Can	12	64

(B) GREAT STUFF™ PRO GAPS & CRACKS GUN FOAM

Minimal expansion, one-component foam, recognized as an alternative fireblock penetration sealant. Evaluated by the International Code Council's Evaluation Service, Inc. for use in residential construction. Great Stuff Pro Gaps & Cracks is tinted orange to be more recognizable to building code officials. UL classified—flame spread 15 and smoke developed 20.

KEY	SKU	DESCRIPTION	CANS/CASE	CASES/PALLET
B	FOAMGC26	Great Stuff Pro Gaps & Cracks—30 oz Can	12	64

(C) ENERFOAM GUN FOAM

Premium grade minimal expansion foam with a working temperature range of 25°–120° F. Trimmable in 20 minutes. This closed cell foam is paintable and waterproof. UL classified—flame spread 15 and smoke developed 20.

KEY	SKU	DESCRIPTION	CANS/CASES	CASES/PALLET
C	ENER4226	Enerfoam—30 oz Can	12	64

(D) GREAT STUFF™ PRO CLEANER FOR FOAM GUNS

KEY	SKU	DESCRIPTION	MIN QTY	CANS/CASE
G	ENERCLEAN	Great Stuff Pro Cleaner—12 oz Can	can	12



(E-G) GUNS FOR DOW FOAM

Recommended for use with Enerfoam and Great Stuff Pro foam. Note: ENER13, ENER14, and ENERGUN are not recommended for use with other manufacturers' foams.

KEY	SKU	DESCRIPTION	MIN QTY
E	ENER13	Pro 13 foam gun – Includes tapered tips	each
F	ENER14	Pro 14 foam gun – Includes tapered tips	each
G	ENERGUN	Pageris Pro 15 foam gun	each



(H-I) GREAT STUFF™ DRYWALL GASKET DISPENSING GUN

Designed specifically for Great Stuff Pro™ Gasket, the blue-handled dispensing gun – colored to match the cans – allows for precise application of the foam. The gun is restartable, reusable and can be easily cleaned using a garden hose and the included cleanout adapter.

KEY	SKU	DESCRIPTION	MIN QTY
H	DGASKGUN	Dow Drywall Gasket Foam Gun with Cleaning Tool	each
I	DGASKCT	Cleaning Tool Hose Attachment for Dispensing Gun	each

(J) DOW GREAT STUFF™ GASKET FOAM

Designed to form a gasket-in-place foam where it is applied to the interior face of framing lumber, especially top and bottom plates, inside and outside corners and around rough openings. Effective at blocking air leaks past the top plate into the attic and through the bottom plate and the rim joist. Flexible and easily compressible.

- Rapid installation from an aerosol can on a Pro gun —no power tools needed
- Water-based and water clean-up before cure
- Seals over rough framing features, joist hangers, strapping, etc

KEY	SKU	DESCRIPTION	CANS/CASE
J	DGASK	Dow Drywall Gasket Foam—18oz	12



(A-C) TWO-COMPONENT SPRAY FOAM – DOW FROTH-PAK™

Two-component polyurethane spray foam that comes in portable kits. Ideal as an insulator and air-sealant, Froth-Pak bonds to most construction materials including lumber, plywood, particle board, foam board, masonry, metals, drywall, concrete and foam panels. Flame spread of 25 or less. Smoke development of 450 or less. It can be used to fill cavities, wall and floor penetrations, cracks and expansion joints. Includes 15' hose.

KEY	SKU	DESCRIPTION	MIN QTY
A	FROTH12	Froth-Pak Two-Component Kit—12 bd ft	144
B	FROTH180	Froth-Pak Two-Component Kit—200 bd ft †	1
C	FROTH600N	Froth-Pak Two-Component Kit—620 bd ft †	1

† Hazmat shipping charges may apply



(D-G) DOW FROTH-PAK™ ACCESSORIES

KEY	SKU	DESCRIPTION	MIN QTY
D	GHA15	Froth-Pak Gun & Hose Assembly, 15 ft Hose	each
	GHA30	Froth-Pak Gun & Hose Assembly, 30 ft Hose	each
E	FANTIP	(259215) Fan Spray Tip, Gray back, 6-7 lbs/min.	each
F	CONETIP	(259218) Cone Spray Tip, Gray back, 6-7 lbs/min.	each
G	259220	Pour Nozzle – Black back	each
	FANTIPM	Fan Spray Tip, White back, 4 lbs/min.	each
	CONETIPM	Cone Spray Tip, White back, 4 lbs/min.	each



(H-I) CLASS 1 TWO-COMPONENT SPRAY FOAM – DOW FROTH-PAK™

Multi-purpose two-component polyurethane froth foam specifically formulated for flame retardancy. It conforms to the requirements of ASTM E-84 as a “Class 1” system (flame spread of 25 or less, smoke development of 400 or less), and is designed to insulate, fill and seal various size voids, deaden sound or reduce vibration.

KEY	SKU	DESCRIPTION	MIN QTY
H	FROTH200C1	PU Foam, 2-Comp, Froth-Pak 210 bd ft (1.75 PCF) Class 1 †	each
I	FROTH600NC1	PU Foam 2-Comp, Froth Pak A & B, 650 bd ft Kit (1.75 PCF), Class 1 †	each

† Hazmat shipping charges may apply



DOW® TWO-COMPONENT FOAM REFILL SYSTEMS



Standard hoses and gun shown.

(A) TWO-COMPONENT SPRAY FOAM – REFILLABLE SYSTEMS

With 17-120 gallon capacities, you'll always have enough foam to complete the entire project. Save money with refillable canisters.

KEY	SKU	DESCRIPTION	MIN QTY
A	341167	Froth-Pak 17 Gal. A - ISO Refill	each
	345347	Froth-Pak 17 Gal. B - POLYOL Refill	each
	11042106	Froth-Pak 27 Gal. A - ISO Refill	each
	11042107	Froth-Pak 27 Gal. B - POLYOL Refill	each
B	341165	Froth-Pak 60 Gal. A - ISO Refill	each
	345344	Froth-Pak 60 Gal. B - POLYOL Refill	each
C	341168	Froth-Pak 120 Gal. A - ISO Refill	each
	345346	Froth-Pak 120 Gal. B - POLYOL Refill	each

TWO-COMPONENT SPRAY FOAM – REFILLABLE SYSTEMS - CLASS A

KEY	SKU	DESCRIPTION	MIN QTY
A	340334	Froth-Pak 17 Gal. A - ISO Refill	each
	340321	Froth-Pak 17 Gal. B - Class A POLYOL Refill	each
	11042108	Froth-Pak 27 Gal. A - ISO Refill	each
	11042109	Froth-Pak 27 Gal. B - Class A POLYOL Refill	each
B	340337	Froth-Pak 60 Gal. A - ISO Refill	each
	340323	Froth-Pak 60 Gal. B - Class A POLYOL Refill	each
C	340336	Froth-Pak 120 Gal. A - ISO Refill	each
	340322	Froth-Pak 120 Gal. B - Class A POLYOL Refill	each

FROTH-PAK™ REFILL ACCESSORIES

SKU	DESCRIPTION	MIN QTY
158336	Dispenser (gun)	each
158403	30' GHA Kit – Includes Dispenser, Valves, Hose, Wrench	each
238107	Regulator Kit - Requires 7.5' Hoses (#158420, below)	each
158428	On/Off Valve, Chemical (tank to hose)	each
158432	In-line On/Off Valve (hose to dispenser)	each
158420	7.5' Hose (use for chemical and/or nitrogen, single hose)	each
158421	15' Hose (buy in pairs for both A & B sides of chemicals)	each
158422	30' Hose (buy in pairs for both A & B sides of chemicals)	each
259202	Couplings – ACC Fitting 8 JIC (connects hoses)	each
216151	Replacement Tank Filter	each
328507	Arctic Pak Wrap Heated Hose System (controller assembly 150' hose)	each
328508	Arctic Pak Wrap and Controller Assembly (without hoses)	each
328509	Arctic Pak Wrap Controller Only	each
334489	Arctic Pak Replacement Hose Set (A & B side 150' hoses)	each
259207	Calibration Nozzle – Gray Back	each
FANTIP	(259215) Fan Spray Tip, Gray Back, 6-7 lbs/min.	each
CONETIP	(259218) Cone Spray Tip, Gray Back, 6-7 lbs/min.	each
259207M	Calibration Nozzle – White Back	each
FANTIPM	Fan Spray Tip, White Back, 4 lbs/min.	each
CONETIPM	Cone Spray Tip, White Back, 4 lbs/min.	each
259220	Pour Nozzle – Black Back	each
368846	Base Starter Kit, Froth Pak Refill	each
Contains: (1) – 158403 30' GHA Kit		
(1) – 238107 Regulator Kit		
(2) – 158420 7.5' Hose		
(2) – 216151 Replacement Tank Filter		

NEW!



(A) GRACO REACTOR E-20 PROPORTIONER PACKAGE

Equipped with material data and system diagnostics, the Reactor E-20 proportioner provides total control for spraying foam insulation. Advanced features provide longer equipment life, more uptime for your spray day, and the overall Graco reliability and durability you've come to expect. For low-to-medium output foam insulation applications—applies up to 20 lb (9 kg) per minute.

- Powerful hybrid heaters for better temperature control
- Circulation valves with longer-lasting seals
- Longer-lasting modular heater control boards that minimize downtime
- Hose heat transformer that doesn't require tap settings
- Easy to maneuver
- Digital heat and pressure controls

KEY	SKU	DESCRIPTION	MIN QTY
A	GRFH9034	Graco, Reactor E-20 Proportioner, 230v, 3-ph	each
	GR17H153	Graco, Reactor H-50 Elite Proportioner	each

A



B4
FUSION PC

(B) GRACO FUSION PC SPRAYER

The revolutionary Fusion ProConnect gun is the only gun available that features an easy-to-use disposable replacement cartridge that enables contractors to complete a perfect rebuild in seconds—maximizing uptime and minimizing spare parts inventory.

KEY	SKU	DESCRIPTION	MIN QTY
B	GR25P588	Graco, Complete PC Spray Gun, Rnd. -01*	each
	GR25P589	Graco, Complete PC Spray Gun, Rnd. -02*	each

*See Sprayer Schematics on Pages 72-75.

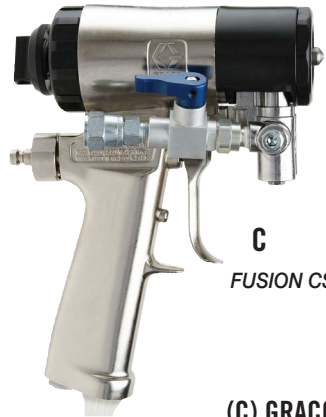

C
FUSION CS

(C) GRACO FUSION CS SPRAYER

Flexible for foam and polyurea applications, the Fusion ClearShot is the first ever liquid-purge gun. It utilizes a disposable ClearShot cartridge to clear material and keep the mix chamber clear, saving you valuable time each day you spray.

KEY	SKU	DESCRIPTION	MIN QTY
C	GR256490	Graco, Complete CS Spray Gun*	each



D
FUSION AP

(D) GRACO FUSION AP SPRAYER

The Fusion Air Purge is Graco's most popular plural-component gun for both polyurethane foam and polyurea applications. Its exceedingly simple air-blast tip technology ensures less maintenance and minimal downtime.

KEY	SKU	DESCRIPTION	MIN QTY
D	GR246101	Graco, Complete AP Spray Gun, Rnd. -01*	each



(A) FIRESHELL THERMAL BARRIER INTUMESCENT COATING

FIRESHELL® (F10E) is a proprietary non-flammable, intumescent (expands up to 2000%) interior coating that provides oxygen starvation to fire. It is a non-toxic, water-based, drain safe, no fuming GREEN product.

FIRESHELL® passes full scale room corner over foam NFPA 286 and E84 class A certified. It is a waterbased one-part coating system that comes white but can be tinted different colors. This coating can be latex or oil based topcoated.

- For walls, foam, attics, crawl spaces
- Open cell or closed cell insulation foam
- Bio foams

APPROVALS

- Meets NFPA 285 multi story fire resistance over sprayfoam for ACM aluminum/sprayfoam commercial wall assemblies
- The first coating to pass NFPA 286 over foam
- Water-based, 1-part, non-flammable, intumescent coating for interior use
- E84 Cl 'A' verified
- Meets green standards and lead paint requirements
- Meets EPA certification for ultra low VOC coating

KEY	SKU	DESCRIPTION	PAISLS/PALLET
	FSF10EG	NFPA 286 Thermal Barrier Intumescent Coating – Color: Gray	36
A	FSF10EWH	NFPA 286 Thermal Barrier Intumescent Coating – Color: White	36



A



B

C

(B-C) NO-BURN AND NO-BURN PLUS THB

No-Burn® Plus and No-Burn® Plus ThB are water-based thin film intumescent coatings when exposed to high temperatures and flame, intumesces creating a char-barrier protecting treated substrates from fire. Limits flame spread and smoke developed, providing intumescent protection when applied and where lapped or butted lumber and sheeting edges are joined together.

KEY	SKU	DESCRIPTION	MIN QTY
B	NOBURNP	No-Burn Plus Intumescent Coating, Engineered Wood, Spray Foam Only, 5 Gallon Pail—White	each
C	NOBURNPTHB	No-Burn Plus ThB Intumescent Coating, Spray Foam Only, 5 Gallon Pail—Grey	each



E

D

(D-E) DC315

DC315 is an intumescent coating for Spray Polyurethane Foam (SPF) and provides an alternative 15 or 20 minute thermal barrier. Tested and compliant in the USA by ICC-ES, and Canada by CCMC. DC315 is the most tested and approved alternative thermal barrier on the market today!

KEY	SKU	DESCRIPTION	MIN QTY
D	DC315	Intumescent Coating, 5 Gallon Pail—Ice Grey	each
E	DC315W	Intumescent Coating, 5 Gallon Pail—White	each
	DC315DRUM	Intumescent Coating, 55 Gallon Drum—Ice Grey	each
	DC315DRUMW	Intumescent Coating, 55 Gallon Drum—White	each

(A-B) GRACO HEATED HOSES

Graco's heated hoses are designed specifically for use with Reactor Equipment. Hoses are a key component to the total system, making it important to achieve accurate and uniform heating for the best application possible.

- Provides 10-times* the flex life compared to previous flat copper heating element
- Backwards compatible with existing Reactor heated hoses



KEY	SKU	DESCRIPTION	MIN QTY
A	GR24Y240	Heated Hose, 50ft, Xtreme Wrap, RTD Cable	each
	GR256549	Heated Hose, 50ft, Scuff Guard, No Cable	each
B	GR246678	Heated Hose, 50ft, Scuff Guard, FTS Cable	each
	GR246679	Graco, Heated Hose, HTD, 3500PSI, 3/8 w/ Scfgrd	each

* Testing based on 1/4 in. 2000 psi (6.35 mm and 138 bar) heated hose

GRACO PARTS AND REPAIR KITS

Contact us for easy to use drawings and parts lists. Our staff will help you find the parts you need for Graco guns, tips, hoses, transfer pumps and more. See *Sprayer Schematics* on Pages 72-75.



(C) SIDEWINDER SLEEVE AND ACCESSORIES

Your spray foam hose takes a lot of abuse, but installing the new SIDEWINDER SLEEVE is the “go-to” solution for protection from heavy abrasion, cold & wet weather, and other extreme environments. Sidewinder SPF Sleeve incorporates the most advanced insulation and abrasion-resistant materials to enhance sprayability and provide higher yields when pushing foam. Available for your hose and whip in both insulated and non-insulated products.

KEY	SKU	DESCRIPTION	MIN QTY
C	SW2175	Insulated Sleeve—50' with Radiant Liner and End Straps	each
	SW2176	Insulated Coupler Guard—3' with Radiant Liner and Straps	each
	SW2413	Whip Hose Cover—7' with End Straps	each
	SW2895	Kit, 210' SPF Rig—Non Insulated	each



NEW!

(D) DESICCANT CARTRIDGE

This disposable Desiccant Cartridge dries displacement air entering storage drums to -100° F dewpoint, preventing water vapor's condensation and resulting contamination. The indicator window turns from blue to pink when the cartridge is exhausted. When used with the drum adapter, these cartridges provide economical and versatile means for preventing moisture contamination in drums, totes, and small tanks.

KEY	SKU	DESCRIPTION	MIN QTY
D	DR40451	Desiccant Cartridge	each



NEW!

(E) POWERBLANKET DRUM HEATER WRAPS

Drum heaters are one of the most popular lines of Powerblanket products. The innovative design has changed the conventional method of heating materials by providing targeted and evenly distributed heat to the surface of the drum, thus eliminating hot and cold spots. Works on steel and poly drums.

- Full-Coverage—provides an insulated, full-wrap design
- Protect—preserve expensive materials without overheating or burning

KEY	SKU	DESCRIPTION	MIN QTY
	PBL55F	PowerBlanket Light Duty, 55-Gallon Drum Wrap	each
E	PBH55RR	PowerBlanket Industrial Duty, 55-Gallon Preset Internal Thermostat of 100°F	each
	PBH55PRO	PowerBlanket Industrial Duty, Preset Internal Thermostat of 145°F	each

* Product Temperatures may vary depending on boundary conditions



E



(A) 2-GALLON PAIL AND SPRAY FOAM CYLINDER WARMING WRAP

Pail warmer will warm a two gallon can or a 200 Bd Ft foam kit cylinder. Made from heavy duty nylon CPAI 84 which creates a heat retaining flexible barrier. Insulated with closed cell polypropylene with an enclosed heating element. Plugs into a 120V AC or 12V DC inverter using a heavy duty industrial cord. Voltage: 120 VAC - 80 Watts.

- Velcro closure and elastic top

KEY	SKU	DESCRIPTION	MIN QTY
A	PWW	Wrap—2-Gallon Warmer 8" High x 29" Long	each



(B) 5-GALLON SPRAY FOAM CYLINDER WARMING WRAP

This pail warmer will warm a five gallon can or a 620 Bd Ft foam kit cylinder. It is made from heavy duty nylon CPAI 84 which creates a heat retaining flexible barrier. It is insulated with closed cell polypropylene with an enclosed heating element. It plugs into a 120V AC or 12V DC inverter using a heavy duty industrial cord.

- Convenient cord storage pouch on the front
- Velcro closure and adjustable cinch straps for a snug fit

KEY	SKU	DESCRIPTION	MIN QTY
B	CWW	Wrap—5-Gallon Warmer 11.5" High x 41" Long	each

Cylinder wrap sold separately.

(C) 25' FOAM HOSE WARMING WRAP

To be used with 2-component kit hoses. Cylinder wrap is not included.

KEY	SKU	DESCRIPTION	MIN QTY
C	FHW	Warming Wrap—25' Foam Hose	each



(D) CURRY COMBS

The curry combs come in a set, one 4" and one 5". These are great tools for scraping/planing 1/2 lb and 2 lb foam from studs as well as foam that is protruding beyond a finished surface.

KEY	SKU	DESCRIPTION	MIN QTY
D	MAC605	Curry Combs, 4" and 5" Set	pack



(E) DENTAL PICKS

Dental picks are a great way to clean your spray foam guns as well as your other foam equipment. Made of stainless steel. Sold in packs of 6.

KEY	SKU	DESCRIPTION	MIN QTY
E	MAC604	Spray Foam Dental Picks, 6/pk	pack



(F) WALL SCRAPER

The Wall Scraper offers more flexibility when it comes to removing excess 1/2 lb or 2 lb spray foam from wall studs and ceiling joists.

KEY	SKU	DESCRIPTION	MIN QTY
F	MAC603	Wall Scraper, 17"	each



(G) FOAMZALLV18

The FOAMZALLV18 Milwaukee® brand M18 FUEL™ SAWZALL® Reciprocating Saw is the fastest saw in its class, offering up to 2X more runtime, 30% faster cutting, and 5X longer tool life of competitive saws. POWERSTATE™ brushless motor provides cutting power that has only been associated with corded tools. The M18™ REDLITHIUM™ XC4.0 Extended Capacity Battery Pack delivers up to 2X runtime and provides more work per charge and more work over the life of the pack than competitive batteries. Comes with (1) M18 FUEL™ SAWZALL® Reciprocating Saw, (2) M18™ REDLITHIUM™ XC 4.0 Extended Capacity Battery Pack, M18™ & M12™ Multi-Voltage Charger and Carrying Case.

KEY	SKU	DESCRIPTION	MIN QTY
G	FOAMZALLV18	Foam Saw, Foamzall, Battery Powered, 18Vdc	each

(A-B) FOAMZALL

Includes the toughest Milwaukee® brand heavy-duty orbital Sawzall® around, which has a custom coupling to secure a serrated blade intended for trimming 1/2 lb or 2 lb foam. 13 amp, 120 Vac saw has a 1-1/4" stroke and can provide up to 3,000 strokes/minute. Includes a variable control trigger for complete control over the speed of the saw and orbital or straight reciprocating cut options. Includes carry case. 24" and 36" 1/2 lb blades and 30" 2lb blades available.

KEY	SKU	DESCRIPTION	MIN QTY
A	FOAMZALL	Foam Saw, Foamzall, 13 Amp Corded	each
	FOAMZALL15	Foam Saw, Foamzall, 15 Amp Corded	each
B	FZBLADE24	Foam Saw Blade, Foamzall, 24"	each
	FZBLADE	Foam Saw Blade, Foamzall, 36"	each
	FZBLADE2LB	Foam Saw Blade for 2 lb foam, Foamzall, 30"	each

FZBLADE2LB not pictured - blade is white

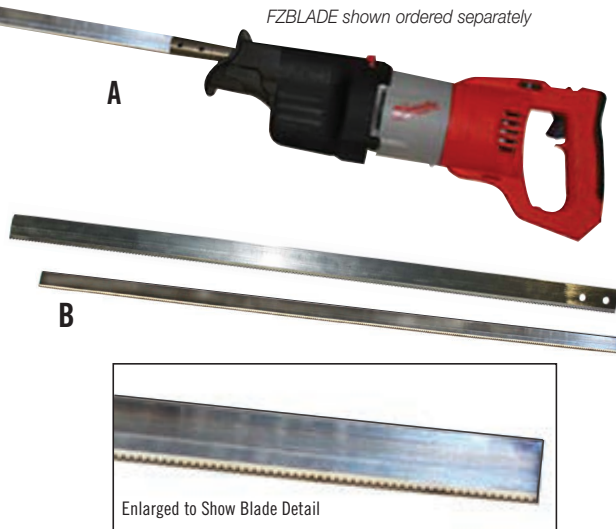

FZBLADE shown ordered separately

(C) SUPER SHEAR FOAM SAW

The Super Shear V3 foam saw has a 1-1/8 inch stroke. Longer stroke allows you to cut at a slower rpm (which reduces vibration) but still get excellent cutting speed. 11 amps.

- 1-1/8 inch stroke
- Absolutely maintenance free
- Stokes per minute: 0-2800
- Weight: 8.5 pounds
- Blade Mount: 2 screws
- Trim walls up to 10 feet tall

KEY	SKU	DESCRIPTION	MIN QTY
C	SUPERSHEARV3	Foam Saw, Super Shear V3, 12 Amp Corded	each
	SSBLADEC	Foam Saw Blade, Super Shear, Closed Cell 18"	each
	SSBLADEO	Foam Saw Blade, Super Shear, Open Cell 27"	each

BLADE shown ordered separately

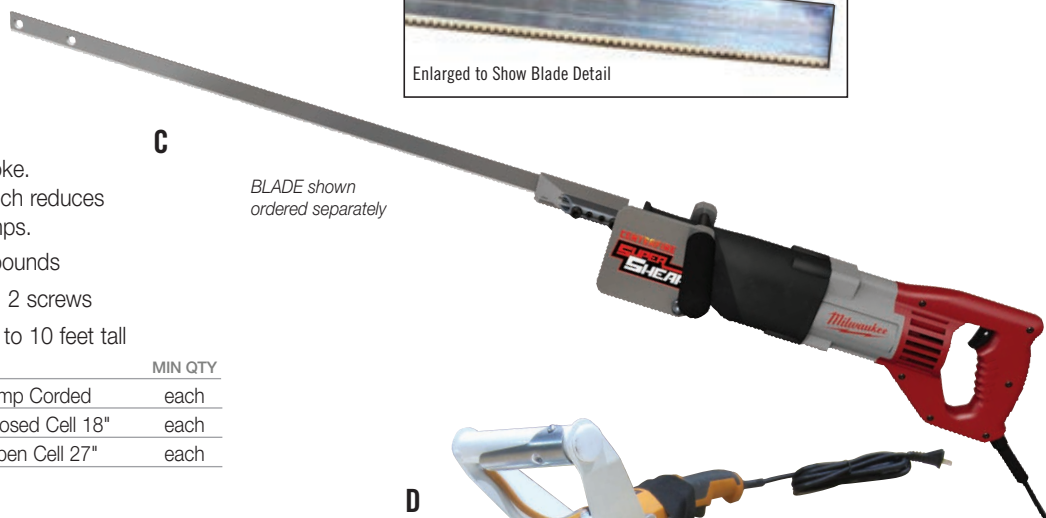

(D) TURBOCUTZ

TurboCutz Foam Removal Tool effectively removes open & closed cell foam efficiently with minimal discard waste. Works on 16"- 24" on-center construction. The scarfed foam is sized to allow for quick pick-up and no dust.

KEY	SKU	DESCRIPTION	MIN QTY
D	TURBOCUTZ	Scarving Tool for OC and CC SPF	each



(E-G) FOAM SAW ISO KNIVES, BLADES AND HANDLES

Both the 36" and 18" ISO Knives are designed for 1/2 lb spray foam removal. Designed with high impact resistant handles specially shaped to reduce the risk of the user's hands accidentally sliding forward across the blade in the event of a sudden stop while cutting.

KEY	SKU	DESCRIPTION	MIN QTY
E	MAC601	Foam Saw, 36" ISO Knives, 3/pk	pack
	MAC601ABLADE	Foam Saw Blade, 36" ISO Blades, 3/pk	pack
F	MAC601BHANDLE	Foam Saw Handle, ISO Style, 7", Fits 36" and 18" Foam Saws	each
G	MAC602	Foam Saw, 18" ISO Knives, 3/pk	pack
	MAC602ABLADE	Foam Saw Blade, 18" ISO Blades, 3/pk	pack

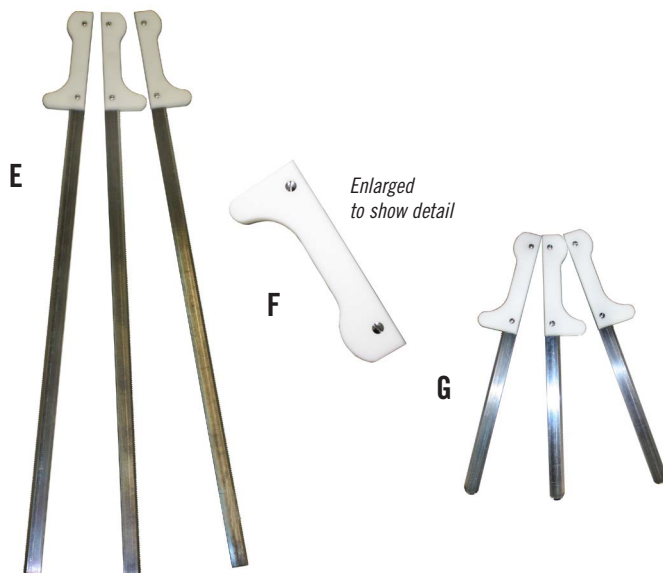

Enlarged to show detail

FOAM ACCESSORIES



A

(A) VINYL-GUARD GLOVES

Economical and comfortable USDA accepted, latex-free, consistent quality, sensitive touch beaded cuff, 4 mil.

KEY	SKU	DESCRIPTION	MIN QTY
A	650820	Gloves, Vinyl-Guard Powder—Large	100/box



B

(B) DERMA-LITE GLOVES

Nitrile gloves—superior puncture and abrasion resistance. Latex-free, consistent quality, textured grip with a beaded cuff. Ambidextrous gloves. 5 mil.

KEY	SKU	DESCRIPTION	MIN QTY
B	6608	Gloves, Nitrile-Lightly Powdered—Large	100/box
	6609XL	Gloves, Nitrile-Lightly Powdered—X-Large	100/box



C

(C) NITRILE DERMA-MAX

Powder-free exam grade gloves. 8 mil with a 12" length for added protection. Latex free with a textured grip. 50 gloves/box.

KEY	SKU	DESCRIPTION	MIN QTY
C	660940XL	Gloves, Nitrile-Powder Free, 8 mil, 12" Length—XL	50/box



D

(D) HUSKY CONTRACTOR CLEAN-UP BAGS

HUSKY 42 Gallon Clean-up Bags are ideal for all your tough clean-up jobs. Featuring a tear and puncture-resistant design, it includes true tie flaps and 1-by-1 dispensing for easy use. 42-gallon capacity is strong enough for contractor, commercial or home use.

KEY	SKU	DESCRIPTION	MIN QTY
D	HCB423	Husky Contractor Clean-up Bags, 32.75" x 45.12", 3-mil, Black, 42 Gal, 32 Bags	box



E

(E) SCOTT® RAGS IN A BOX

Designed for professionals doing hands-on work, these soft, absorbent, durable towels perform like a cloth. They're also low lint, making them ideal for thousands of projects. 10" x 12". Pop-up box. White.

KEY	SKU	DESCRIPTION	MIN QTY
E	LSR260	Scott®Rags In A Box, 200 Towels/box	box



F

G

(F-G) BARRICADE CAUTION AND DANGER TAPE

An economical disposable marking solution manufactured for exceptional durability and resistance to the elements.

KEY	SKU	DESCRIPTION	ROLLS/CASE
F	CAUTIONTAPE	2-mil Barricade Tape—3" x 1000'	8
G	DANGERTAPE	Red Danger Tape—3" x 300'	8



(A-B) DYNASOLVE CU-6 URETHANE CLEANING SOLVENT

Recommended for both flushing and cleaning, especially in applications in which liquid isocyanates are present either prior to cleaning or will be introduced after cleaning (such as in a mixing tank). Non-chlorinated, non-flammable, non-carcinogenic, and non-ozone depleting. Replaces and improves on the performance of commodity solvents such as methylene chloride, acetone, methyl ethyl ketone (MEK), and 1,1,1-trichloroethane. Can be used for extended periods, tolerate high resin loadings, and will reduce disposal costs. It is also recyclable via vacuum distillation.

KEY	SKU	DESCRIPTION	MIN QTY
A	DYNACU61G	Dynasolve Gun Cleaner/Solvent, Low VOC, 1 Gallon	each
B	DYNACU65G	Dynasolve Gun Cleaner/Solvent, Low VOC, 5 Gallon	each

(C) CHEM TREND INSULATION RELEASE

An effective barrier coat to keep overspray of PU foam insulation from adhering to items; spray equipment, tub and shower stalls and other non-porous surfaces. DO NOT apply to personal protective equipment.

KEY	SKU	DESCRIPTION	MIN QTY
C	PIRS1025	Chem Trend Insulation Release—10.25 oz. Aerosol Can	can

(D) CHEM TREND SPRAY FOAM REMOVER

Spray/apply to remove foam in any overspray areas where foam is not needed or was not intended to be applied.

KEY	SKU	DESCRIPTION	MIN QTY
D	CTSFR1G	Chem Trend Spray Foam Remover, 1 Gallon	1 gal
	CTSFR5G	Chem Trend Spray Foam Remover, 5 Gallon	5 gal

(E-F) CHEM TREND SPRAY FOAM FLUSH PRODUCTS

Products are meant for cleaning/flushing of spray equipment and guns.

KEY	SKU	DESCRIPTION	MIN QTY
	CTSFF15G	Chem Trend Spray Foam Flush 1—Blue Tint	5 gal
E	CTSFF35G	Chem Trend Spray Foam Flush 3—Aggressive Cleaner	1 gal
F	CTSFF25G	Chem Trend Spray Foam Flush 2—Mild Cleaner	5 gal



PROTECTIVE WEAR



Style A

Style B



C



D



E

F



G



(A-B) TYVEK® COVERALL SUITS

Spun bonded olefin fabric made from high density polyethylene fibers that offer excellent protection and strength.

STYLE	SKU	DESCRIPTION	MIN QTY
A	CVLTVKELG	Tyvek Suit - Lg Non-Hooded, 25/cs	25
	CVLTVKEXL	Tyvek Suit - XL Non-Hooded, 25/cs	25
	CVLTVKE3XL	Tyvek Suit - 3XL Non-Hooded, 25/cs	25
	CVLTVKE5XL	Tyvek Suit - 5XL Non-Hooded, 25/cs	25
B	CVLTVKHELG	Tyvek Hooded Suit - Lg, 25/cs	25
	CVLTVKHELXL	Tyvek Hooded Suit - XL, 25/cs	25
	CVLTVKHE2XL	Tyvek Hooded Suit - 2XL, 25/cs	25
	CVLTVKHE3XL	Tyvek Hooded Suit - 3XL, 25/cs	25
	CVLTVKHE4XL	Tyvek Hooded Suit - 4XL, 25/cs	25

Note: Please consult your Account Manager for information on sizing Tyvek® coverall suits.

(B) MICROMAX NS SUITS

Features high MVTR (Moisture Vapor Transmission Rate) and protection from dry particulates and light liquid splash. Comes with elastic wrists and ankles.

STYLE	SKU	DESCRIPTION	MIN QTY
B	CTL428LG	MicroMax NS Hooded Suit - LG	25
	CTL428XL	MicroMax NS Hooded Suit - XL	25
	CTL4282XL	MicroMax NS Hooded Suit - 2XL	25
	CTL4283XL	MicroMax NS Hooded Suit - 3XL	25
	CTL4284XL	MicroMax NS Hooded Suit - 4XL	25

(C) SMS SUIT W/BOOTIES

Spun bonded polypropylene fabric.

STYLE	SKU	DESCRIPTION	MIN QTY
C	CVLSMSHXL	SMS Hooded Suit - XL, 25/cs	25

(D) PROSHIELD 10 SMS W/HOOD

DuPont™ ProShield® 10 disposable garments are designed for workers in a range of industries for nonhazardous dry particle and light liquid splash applications. Garments constructed of SMS fabric are strong and durable, yet offer outstanding comfort, breathability, softness, and wearability. SMS is lightweight and resistant to tears and punctures.

STYLE	SKU	DESCRIPTION	MIN QTY
D	CVLSMSHEXLB	ProShield SMS Hooded Suit XL, 25/pack	pack
	CVLSMSHE2XLB	ProShield SMS Hooded Suit 2XL, 25/pack	pack

(E) PROTECTIVE SHOE COVERS

KEY	SKU	DESCRIPTION	MIN QTY
E	SCTVKSRSRL	Tyvek® NS Shoe Cover - Large, 200/cs	200
	SCKGXL	Tyvek® Alternative Shoe Cover - XL, 300/cs	300

(F) PROTECTIVE BOOT COVERS

KEY	SKU	DESCRIPTION	MIN QTY
F	BCTVKSRL	Tyvek® NS Boot Cover - L, 200/cs	200
	BCKGL	Tyvek® Alternative Boot Cover - L, 200/cs	200

(G) PROTECTIVE SLEEVES

Protective sleeves cover the arms from the end of a short sleeve shirt to the wrist. Just enough protection to keep debris off of the arms without enclosing the installer in a complete suit.

KEY	SKU	DESCRIPTION	MIN QTY
G	AGTVKIL	Tyvek® 18" Sleeve (Large) - 200/cs	200
	AGKGL	Tyvek® Alternative 18" Sleeve (Large) - 200/cs	200



(A) 3M HOOD ASSEMBLY, COLLAR, PREMIUM HEAD SUSPENSION FOR PAPR SYSTEM

The 3M Hood Assembly S-655 consists of a S-950 Premium Head Suspension and a S-605 Hood. Approved for use with certain 3M Powered Air Purifying and Supplied Air Respirator Systems.

KEY	SKU	DESCRIPTION	MIN QTY
A	3MS655	3M Hood Assembly, Collar, Premium Head Suspension	each
	3MS922	3M Lense Cover Peel-Offs (3M S-655 Hood)	40/pk
	3MS60510	3M Replacement Hood with Inner Collar	each

A



(B) 3M VERSAFLO BELT MOUNTED ASSEMBLY FOR PAPR SYSTEM

The TR-613N assembly includes motor/blower (TR-602N), standard battery (TR-630), length adjusting breathing tube (BT-30), high durability belt (TR-626), airflow indicator (TR-971). Headtops, filters, cartridges and battery charger sold separately.

KEY	SKU	DESCRIPTION	MIN QTY
B	3MTR613N	3M Versaflo Belt-Mounted PAPR Assembly	each

B



(C) 3M BREATHING TUBE FOR VERSAFLO PAPR SYSTEM

This breathing tube is used on 3M Versaflo PAPR Systems and is adjustable in length.

KEY	SKU	DESCRIPTION	MIN QTY
C	3MBT30	3M Breathing Tube	each

C

(D-E) 3M VERSAFLO ORGANIC VAPOR/HIGH EFFICIENCY CARTRIDGE & FILTER

The TR-6510N filter is a combination High Efficiency (HE) particulate filter and Organic Vapor (OV) cartridge for use with TR-600 series PAPRs. 3M recommends the use of the TR-6500FC filter cover to help protect the filter from physical damage (sold separately).

KEY	SKU	DESCRIPTION	MIN QTY
D	3MTR6510N	3M Organic Vapor/High Efficiency Cartridge	each
E	3MTR6500FC	3M PAPR Filter Cover	each

D

E



(F-G) 3M VERSAFLO SINGLE STATION BATTERY CHARGER

The TR-641N Battery Charger Kit is a complete single station battery charger for TR-600 Series PAPRs. It consists of a TR-640 Cradle and a TR-941 Power Supply.

KEY	SKU	DESCRIPTION	MIN QTY
F	3MTR641N	3M Versaflo Single Station Battery Charger Kit	each
G	3MTR630	PAPR Standard Battery	each

F

G



YEAR ROUND AIR CONDITIONED RESPIRATOR FOR A COMFORTABLE WORKPLACE

NEW!



(A-B) TENNESSEE CHILL BOX™

The Tennessee Chill Box 8000 (CB8000) is an Air-Conditioned Respirator, Fresh Air Supply System, which provides comfortable, safe breathing air for industry users who require a fresh air supply system, with the advantages of air-conditioned air.

It can maximize productivity and eliminate the possibility of heatstroke, heat exhaustion, dehydration, nausea, and cramps for your workers. The Chill Box 8000 offers 40% more cooling capacity than the original CB 5000. Up to two (2) hoses may be used, and up to 200' each with our standard kits. Comes equipped with an exterior manifold to allow for the use of multi-air lines, (single or double lines). Unit is sealed and maintenance free (with the exception of a removable, washable filter).

- 110 Volt 15/Amp electric requirement
- Unit measures 23-1/2"H x 15" D x 19-1/2" W — 76 lb unit
- Provides 97 CFM's at the exterior manifold

STYLE	SKU	DESCRIPTION	MIN QTY
A	TCBNCB8000M	Chill Box System with 2 Masks / 200' Hose	kit
B	TCBNCB8000H	Chill Box System with 2 Hoods / 200' Hose	kit
C	TCBCBH100	100' Air Supply Hose	each
	TCBCBH50	50' Air Supply Hose	each
	TCBCBBT	Breathing Tube for Hood	each
	TCBCBBTM	Breathing Tube for Mask	each
	TCBCBHD	Hood with Headband	each



(A-B) SPECTRUM CONTINUOUS FLOW RESPIRATOR MASK

The Spectrum Continuous Flow Supplied Air Respirator is compatible with economical low-pressure air sources such as Bullard Free-Air® pumps or with conventional breathing air compressors or cylinders. Spectrum meets ANSI/ISEA Z87.1+ 2010 Impact Face Protection and OSHA Assigned Protection Factor (APF) of 1,000.

STYLE	SKU	DESCRIPTION	MIN QTY
A	BCC20SYS2M	SAR Free Air (2)20TIC (2)20BT	kit
	BSPECLSYS2M	SAR Free Air SPECCFML	kit
B	BPASPECML	PAPR Spectrum Full Facepiece Md / Lg	each
	BSPECCFML	SAR Spectrum Full Facepiece Md / Lg Cont.	each
	BSPEC35L	SAR Comp Air SPECCFML SPECBT F35	each
	BSPEC40L	SAR Comp Air SPECCFML SPECBT F40	each
	BCC20TIC35	SAR Free Air 20TIC 20BT F35	each



(C) AIRFLOW BREATHING TUBE ASSEMBLY KIT

This breathing tube assembly controls the flow of air into the respirator.

STYLE	SKU	DESCRIPTION	MIN QTY
C	BV30	SAR Comp Air CC20 / RT Brth Tube Hd Clmp	each

(D) BULLARD® SAFETY HOOD LENS COVER

STYLE	SKU	DESCRIPTION	MIN QTY
D	BLC	SAR/PAPR Spectrum Mylar Lens Cover—Clear, 25/pkg	pkg



(E) BULLARD® CALIBRATION KIT

For use with Bullard® Clean Air Box Series Systems. Includes 34L CO gas cylinder, 34L zero air cylinder, regulator with tubing, and connector fitting. Manufactured in an ISO 9002 Registered facility.

STYLE	SKU	DESCRIPTION	MIN QTY
E	BCABCK	SAR Air Filt CAB Calibration Kit 34L	each
	B41AF	SAR Air Filt 41 Series Filter Cartridge	each
	B15921	Free-Air Pump Service Kit EDP10	each
	B23611	Free-Air Pump Inlet Filter	each
	B244852	Free-Air Pump Outlet Filter Jar	each
	B263552	Free-Air Pump Outlet Filter Assembly O-Ring	each
	BICEOF	Free-Air Pump ICE Pump Inline Filter 90 Mic	each
	BS17101	Free-Air Pump Outlet Filter Carbofine	each
	BICESK11	Free-Air Pump ICE Pmp Serv Kit ICEPUMP11	each



(F) BULLARD® FREE-AIR® PUMP

Supplies air for two hood-style or three half or full face mask airline respirators. When placed in a clean air environment, Bullard Free-Air® pumps offer a low-cost means of supplying clean, breathable air to respirator wearers working in contaminated environments up to 300 feet away from the pump. They are easy to operate and maintain. Free-Air pumps do not require temperature alarms, CO monitors or airline filters, so they can be a cost-effective alternative to compressed air.

STYLE	SKU	DESCRIPTION	MIN QTY
F	BEDP16TE	Free-Air Pump Electric Driven 2 QD	each



(G) BULLARD® BREATHING AIR HOSE

For use with breathing air compressors and have 3/8" I.D. Starter hose has 1/4" female coupler and 1/4" male fitting. Air supply hose for use with free-air ambient pumps has 1/2" I.D. hose.

STYLE	SKU	DESCRIPTION	MIN QTY
G	B4696100	SAR Comp Air Sup Hose V10 3/8" ID Start Ind.	each
	BV20100ST	SAR Free Air Sup Hose V20 1/2" ID Start Ind.	each



A



B

C

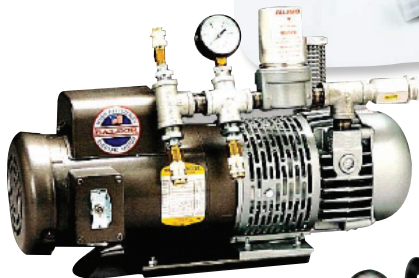

D

E



F/G



H

(A) ALLEGRO FULL MASK CONTINUOUS FLOW SUPPLIED AIR RESPIRATOR

For SAR System. Made of silicone rubber for durability and will hold its shape even in extreme heat and cold. Double sealing flange provides an improved face-to-mask seal and a deep chin pocket provides a better, more comfortable fit. Replaceable polycarbonate lens offers a wider, distortion-free viewing area with an anti-fog, anti-scratch coating. Comes with OBAC quick connects. NIOSH approved.

KEY	SKU	DESCRIPTION	MIN QTY
A	9901	Full Face Respirator – Low-Pressure	each
	9902	Full Face Respirator – High-Pressure	each
	990125	Lens Cover Peel Offs (for 9901), Full Face Mask	25/pk
	2025	Full Face Respirator Storage Bag	each
	990109L	Replacement Lens for 9901 Full Face Respirator	each
	9920-01A	Breathing Tube Assembly for 9901 Full Face Respirator	each

(B) LOW FLOW ADAPTER FOR SAR SYSTEM

For use as a low-pressure supplied air respirator, the Low-Pressure Flow Adapter allows the hood to connect to an ambient air pump, or any low-pressure air source. Low profile, lightweight, plastic threaded fitting offers quick connect design with belt and clip assembly. Requires an air supply pressure range of 2 to 40 psi.

KEY	SKU	DESCRIPTION	MIN QTY
B	991011	Low Flow Adapter for SAR System	each

(C) TYVEK® HOOD ASSEMBLY WITH SUSPENSION FOR SAR SYSTEM

Designed with one piece construction breathing tube and head suspension integrated with hood assembly. Fully disposable, eliminating need for decontamination. Flexible and splash resistant multi-layer sound dampening breathing tube ideal for workers with beards or glasses. Designed to connect to Adjustable Flow Control Valve, Personal Air Cooler or Air Temperature Controller.

KEY	SKU	DESCRIPTION	MIN QTY
C	991120	Tyvek Hood w/suspension for SAR System – Replacement	each
	991003	Ratchet Hood Suspension for the 991120 Tyvek Hood	each
	991025	Lens Cover Peel-Offs (991120 Hood)	10/pk

(D) ALLEGRO AMBIENT AIR PUMP FOR SAR SYSTEM

The easiest way to meet your needs for portable air sources for up to three respirator users or two hood users.

KEY	SKU	DESCRIPTION	MIN QTY
D	9832	Ambient Air Pump, 1500 (0-20cfm) with OBAC Fittings	each

(E) ALLEGRO AMBIENT AIR PUMP – MODEL A-75

Portable & lightweight air source for one hood user. Solid performance in multiple applications.

KEY	SKU	DESCRIPTION	MIN QTY
E	9821	Ambient Air Pump, Model A-75 3/4 hp Motor	each
	970001	Ambient Air Pump Filter, Model A-750 Inlet Filter Element	each
	972002	Ambient Air Pump Filter, Model A-750 Exhaust Filter	each

(F-G) RESPIRATOR AIR HOSE FOR SAR SYSTEM

KEY	SKU	DESCRIPTION	MIN QTY
F	9100100	Respirator Air Hose Extension – 100' Low-Pressure	each
	910050	Respirator Air Hose Extension – 50' Low-Pressure	each
G	9101-100B	Respirator Air Hose Extension – 100' High-Pressure	each

(H) ALLEGRO AIR BAG 12

12" metal blower system with ducting built into a heavy duty polyester bag for an all-in-one unit for ease of operation. Designed with zippered ends that allow blower use without removing blower from the bag. Zipper openings allow for plug/cord inlet and outlet.

KEY	SKU	DESCRIPTION	MIN QTY
H	A953512	Allegro Air Bag, 12 Ventilation Blower System	each
	NPKIT220	Spill Kit in High-Vis Bag, Absorbs up to 9 Gallons	each
	NPKIT336	HazMat Spill Kit in 30-Gallon Overpack	each

(A-C) SPRAY SOCK

One-size-fits-all painters spray sock fits snugly around head and neck to protect against dirt, dust, and overspray. Available in cotton and lycra.

KEY	SKU	DESCRIPTION	MIN QTY
A	1410	Allegro, Spray Sock, 12/pack	pack
B	6810LN	Painters Spray Sock, Cotton Blend, 12/pack	pack
C	6910	Painters Spray Sock Deluxe, Lycra—Black	each



(D-E) GOGGLES & LENS COVERS

A030 - Advanz Goggles contain 30 frame advances. Disposable with anti-fog lens, fits over eye glasses.

C045 - Advanz Lens Cover fits over all brands of full-face respirators and contains 36 frame advances.

KEY	SKU	DESCRIPTION	MIN QTY	QTY/CASE
D	C045	Goggles, Lens Cover—Clear	each	24
E	A030	Goggles, Disposable Anti-Fog	each	24

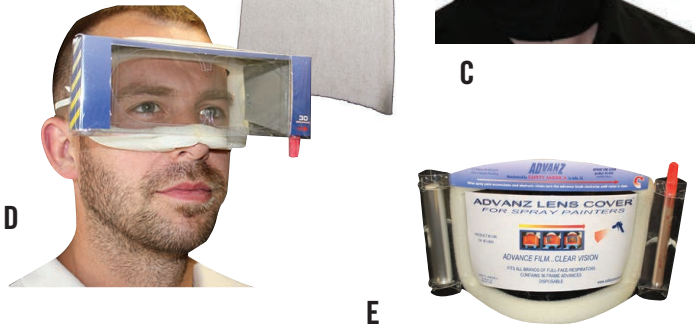

(F-G) GOGGLES & LENS COVERS

5110 - Anti-fog coating on interior lens, 99.9% UV protection, vents prevent liquid from getting into eyes, curved lens and anti-splash design. Meets ANSI Z87.1.

5111 - Package of 10. Protect the lens on your goggles with these easy-to-use peel-off lens covers. Covers protect lens against paint and chemical overspray.

KEY	SKU	DESCRIPTION	MIN QTY	QTY/CASE
F	5110	Goggles, Overspray	each	1 each
G	5111	Goggles, Peel-off Lens Covers	1 pack	10/pk



(H-I) GOGGLES & LENS COVERS

5106 - Anti-splash, special vents prevent liquid from getting into eyes, impact resistant polycarbonate lens sportstyle design flexible PVC construction, anti-fog coating on lens, wide elastic headstrap, 99.9% UV protection. Peel-off lens covers (510610) available. Meets current ANSI Z87.1 2003 Standard.

510610 - Keep overspray off your lens, use peel-off lens covers on your goggles. Comes in a package of 10 peel-offs.

KEY	SKU	DESCRIPTION	MIN QTY	QTY/CASE
H	5106	Goggles, Deluxe Overspray	each	1 each
I	510610	Goggles, Deluxe Peel-off Lens Covers	1 pack	10/pk



(J) EYE WASH

KEY	SKU	DESCRIPTION	MIN QTY
J	7006PK	Eye Wash—4 oz Bottles	each

(K) FIRST AID KIT

25 person, 113 piece kit designed for contractors. The steel case contains 17 key first aid products including bandages, gauze pads, compresses, eye care products, ointment, wipes, tape, scissors and tweezers. This kit meets OSHA and ANSI requirements.

KEY	SKU	DESCRIPTION	MIN QTY
K	FA223	First Aid Kit—25-Person	each



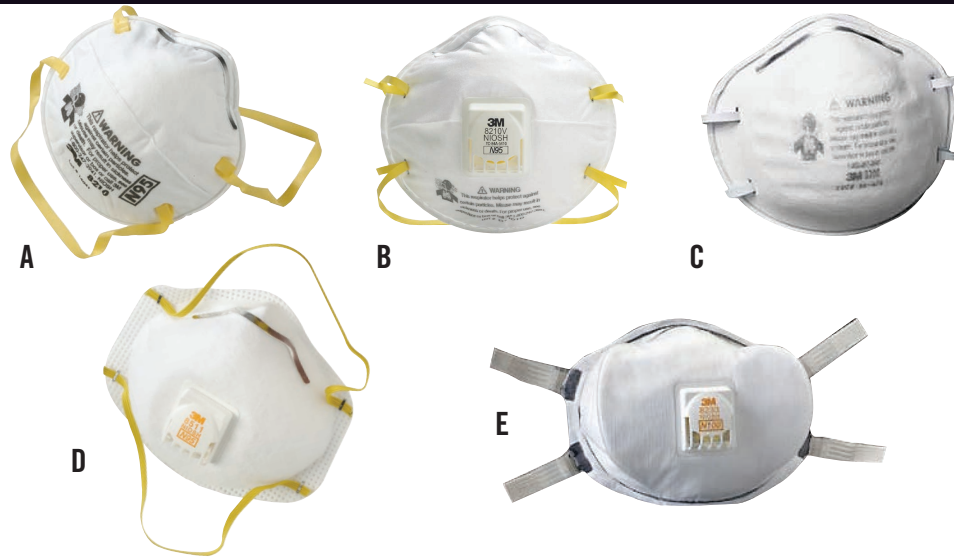

MASKS AND RESPIRATORS

Using a variety of patented technologies and features that enable them to filter a broad range of particles, these 3M disposable masks are NIOSH certified to have a filter efficiency of 95% or greater against particulates free of oil. The patented filter media uses advanced electrostatically charged micro fibers to help make breathing easier and cooler for advanced comfort. 3M masks are lightweight for more comfort and increased wear time on the job.



F



G



H



I



J



K

(A-B) 3M 8210 N95 RESPIRATOR, 2-STRAP

KEY	SKU	DESCRIPTION	QTY/BOX	BOXES/CASE	CASES/PALLET	MIN QTY
A	3M8210	3M N95 Respirator, 2 Straps	20	8	40	1 case
B	3M8210V	3M N95 Respirator with Valve, 2 Straps	10	8	40	1 case

(C) 3M 8200 N95 LIGHT DUTY RESPIRATOR, 2-STRAP

KEY	SKU	DESCRIPTION	QTY/BOX	BOXES/CASE	CASES/PALLET	MIN QTY
C	3M8200	3M L.D. N95 Respirator	20	8	40	1 case

(D) 3M 8511 N95 RESPIRATOR WITH EXHALATION VALVE, 2-STRAP

KEY	SKU	DESCRIPTION	QTY/BOX	BOXES/CASE	CASES/PALLET	MIN QTY
D	3M8511	3M N95 Respirator with Valve, 2 Straps	10	8	35	1 case

(E) 3M 8233 N100 RESPIRATOR

KEY	SKU	DESCRIPTION	BOXES/CASE	CASES/PALLET	MIN QTY
E	3M8233	3M N100 Respirator	20	32	1 case

(F-G) 3M FILTER DISKS

NIOSH approved filter disks provide at least 95% filtration efficiency against solid and liquid aerosols including oils. NIOSH 42 CFR 84.

KEY	SKU	DESCRIPTION	MIN QTY
F	3M2071	3M P95 Filter Disk	1 pair
G	3M2091	3M P100 Filter Disk	1 pair

(H-K) 3M HALF- & FULL- FACE REPLACEMENT CARTRIDGES & FILTERS

KEY	SKU	DESCRIPTION	MIN QTY
H	3M501	3M 501 Half Face Respirator Filter Retainer	each
I	3M5P71	3M 5P71 Half Face Respirator Particulate Filter	each
J	3M6001	3M 6001 Half Face Respirator Organic Vapor Cartridge	1 pair
K	3M60921	3M Cartridge/Filter, Organic Vapor/P100	1 pair



(A) 3M HALF-FACE RESPIRATORS, 6000 SERIES

The 6000 series half-face respirator provides reusable, economical protection. Facepiece is made from soft, lightweight thermoplastic elastomer which offers unsurpassed comfort and maximum versatility with an easy to adjust standard head strap. Compatible P95 rated particle filters are simple to remove and replace, with a built in set and twist feature, which eliminates the need for a filter holder.

KEY	SKU	DESCRIPTION	MIN QTY
A	3M6100	3M Half-Faced Respirator—Small	each
	3M6200	3M Half-Faced Respirator—Medium	each
	3M6300	3M Half-Faced Respirator—Large	each

Refer to schematics on page 76.

(B) 3M FULL-FACE RESPIRATORS, 6000 SERIES

KEY	SKU	DESCRIPTION	MIN QTY
B	3M6800	3M Full-Mask Facepiece—Medium	each
	3M6900	3M Full-Mask Facepiece—Large	each

Refer to schematics on page 76.

(C) 3M LENS ASSEMBLY, 6000 SERIES FULL FACEPIECE

Use as a replacement part on 3M Full Facepieces 6000 Series

KEY	SKU	DESCRIPTION	MIN QTY
C	3M6898	3M Lens Assembly, 6000 Series Full Facepiece	each

(D-M) 3M HALF- & FULL-FACE REPLACEMENT PARTS

KEY	SKU	DESCRIPTION	MIN QTY
D	3M6885	3M Lens Cover Peel-Offs (6000 Series)	100/pk
E	3M6884	3M Center Port Adapter Full Facepiece	each
F	3M6880	3M Side Caps Full Facepiece	each
G	3M7890	3M Plugs Full Facepiece (Mouth)	each
H	3M6897	3M Head Harness, 6000 Series Full Facepiece	each
I	3M6864	3M Center Adapter Assembly, 6000 Series	each
J	3M6894	3M Nose Cup Assembly, 6000 Series	each
K	3M6893	3M Inhalation Valve, 6000 Series (Diskside)	each
L	3M6895	3M Inhalation Gasket, 6000 Series (Outside)	each
M	3M6896	3M Center Adaptor Gasket, 6000 Series Full Facepiece (Mouth)	each



MOLDEX RESPIRATORS

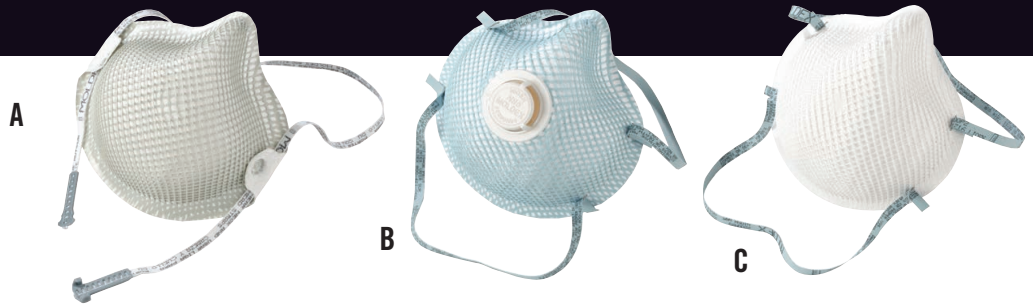

MOLDEX® DISPOSABLE AND REUSABLE RESPIRATORS

Breathe easy with a Moldex disposable particulate respirator. They're NIOSH certified to have a filter efficiency of 95% or greater against particulates free of oil. That's some clean air. Enjoy a contoured nose bridge and a soft foam nose cushion for comfortable seal—without a metal nose band. The exclusive Dura-Mesh® shell protects the filter media so it stays clean longer. It's built to resist collapsing in hot and humid conditions so the respirator holds its shape longer. Bottom line—fewer respirators are used = you save money.



(A) MOLDEX 2600 N95 RESPIRATOR, HANDYSTRAP®

- HandyStrap® with buckle allows mask to hang down around neck when not in use
- Stretch cloth strap feels cool and comfortable against the skin
- Softspun® lining for added comfort and durability

KEY	SKU	DESCRIPTION	QTY/BOX	BOXES/CASE	MIN QTY
A	MM2600	Moldex N95 Respirator w/HandyStrap	15	12	1 case



(B) MOLDEX 2300 N95 RESPIRATORS WITH EXHALE VALVE, 2-STRAP

- Exhale valve reduces hot air build-up and keeps workers cooler
- Naturally contoured facepiece with foam nose cushion relieves pressure points
- Softspun® lining gives added comfort and durability

KEY	SKU	DESCRIPTION	QTY/BOX	BOXES/CASE	MIN QTY
B	MM2300	Moldex N95 Respirator with Valve, 2 Straps	10	10	1 case

(C) MOLDEX 2200 N95 RESPIRATOR, 2-STRAP

- Naturally contoured facepiece relieves pressure points
- Softspun® lining gives added comfort and durability

KEY	SKU	DESCRIPTION	QTY/BOX	BOXES/CASE	MIN QTY
C	MM2200	Moldex N95 Respirator, 2 Straps	20	12	1 case

(D) MOLDEX HALF-FACE PROTECTION 7000 SERIES

PVC-Free®. Sleek and light-weight design for modern, high-tech look and increased worker acceptance. Extra-wide sealing area provides all-day comfort. Fits well under welding helmets and with safety glasses. Mask drops down for convenient storage around the neck or locks down for custom fit.

KEY	SKU	DESCRIPTION	MIN QTY
D	MM7001	Moldex Half-Face, 7000 Series—Small	each
	MM7002	Moldex Half-Face, 7000 Series—Medium	each
	MM7003	Moldex Half-Face, 7000 Series—Large	each

(E-F) MOLDEX FULL-FACE PROTECTION 9000 SERIES

Cost effective, high tech, streamlined design for exceptional worker acceptance. Exclusive over-molded lens offers greater field of vision. Lighter weight for superior all-day comfort. Fewer parts means less cost and easy maintenance. Tear-away lens protector included. Meets ANSI Z87+ for high-impact requirements. Filter sold separately.



KEY	SKU	DESCRIPTION	MIN QTY
E	MM9002	Moldex Full-Face, 9000 Series—Medium	each
	MM9003	Moldex Full-Face, 9000 Series—Large	each
F	MM0093	Lenze Cover Peel-Offs (9000 Series)	15/pk



(A-G) MOLDEX HALF- & FULL- FACE REPLACEMENT FILTERS & CARTRIDGES (7000 & 9000 SERIES)

KEY	SKU	DESCRIPTION	MIN QTY
A	MM7020	Moldex Pre-Filter Retainer 1 Pair per Bag	1 pair
B	MM7920	Moldex Filter Disk Piggyback Adapter, 7000/9000 Series	each
C	MM7990	Moldex 7000/9000 Series P100 Cartridge	1 pair
D	MM7100	Moldex 7100 Respirators Organic Vapor PVC Free	1 pair
E	MM7140	Moldex 7000/9000 Series Stacked Cartridge/Filter	1 pair
F	MM7940	Moldex P100 Particulate Filter Disk, 1 Pair per Bag	1 pair
G	MM8910	Moldex N95 Filter Disk, 5 Pairs per Bag	1 bag

(H) SAFETY GLASSES

High-impact polycarbonate lenses, anti-fog coating, 99.9% UV protection, wrap-around design, non-slip temples, scratch resistant lenses, non-slip rubber nose piece. Meets current ANSI Z87.1 2003 standard. Yellow, clear or smoke mirror lens.

KEY	SKU	DESCRIPTION	MIN QTY
H	5400205	Safety Glasses, Diamondback—Yellow	each
	5400200	Safety Glasses, Diamondback—Clear	each
	5400203	Safety Glasses, Diamondback—Smoke Mirror	each



(I-K) SINGLE LENS DESIGN SAFETY GLASSES

High-impact polycarbonate lenses, 99.9% UV protection, single lens design, scratch-resistant lightweight wrap-around lens. Meets current ANSI Z87.1+ standard.

KEY	SKU	DESCRIPTION	MIN QTY
I	5330	SAS Safety Glasses, NSX Turbo—Clear Lens	each
J	5331	SAS Safety Glasses, NSX Turbo—Smoke Lens	each
K	5332	SAS Safety Glasses, NSX Turbo—Yellow Lens	each



(L) EYE WEAR CLEANING WIPES FOR MASKS AND GLASSES

Perfect for cleaning eyewear or computer screens, these 100 individually wrapped pre-moistened wipes feature anti-fog, anti-static, silicone-free cleaning. Excellent on glass or polycarbonate lenses, the large 5" x 8" wipes are stored in a wall-mounted cardboard dispenser. Dimensions: 4-3/4" w x 9" h x 2-5/8" d.

KEY	SKU	DESCRIPTION	MIN QTY	QTY/BOX
L	0350	Eyewear Cleaning Wipes	box	100



(M) HARD HATS

Nylon suspension with adjustable head cradle. Complies with ANSI Z89.1, Class G, E and C.

KEY	SKU	DESCRIPTION	MIN QTY	QTY/CASE
M	716001	Hard Hat, White	each	12
	716045	Hard Hat, with Ratchet—White	each	12





(A) SANISPRAY HP 10 CORDED HANDHELD SPRAYER

The Graco SaniSpray HP 10 is the ultimate portable household disinfectant sprayer solution that is uniquely built with the highest-grade materials that are compatible with disinfectants, sanitizers and deodorizers. For household use only.

KEY	SKU	DESCRIPTION	MIN QTY
A	GR25R789	SaniSpray HP 10 – Corded Handheld Sprayer	each

(B) SANISPRAY HP 20 CORDED HANDHELD SPRAYER

The Graco SaniSpray HP 20 Corded is the ultimate portable disinfectant sprayer solution that delivers maximum productivity on smaller disinfecting jobs. Uniquely built with the highest-grade materials that are compatible with disinfectants, sanitizers and deodorizers.

Spray up to 20 oz per minute. Designed to deliver consistent edge-to-edge coverage, without heavy drips and runs, so that you can achieve specified disinfectant dwell times on smaller jobs like bathrooms, kitchens and more.

15-inch spray extension to minimize contact with materials.

KEY	SKU	DESCRIPTION	MIN QTY
B	GR25R790	SaniSpray HP 20 – Corded Handheld Sprayer	each

(C) SANISPRAY HP 20 CORDLESS HANDHELD SPRAYER

The Graco SaniSpray HP 20 Cordless is the ultimate portable disinfectant sprayer solution that delivers maximum productivity on smaller disinfecting jobs. Uniquely built with the highest-grade materials that are compatible with disinfectants, sanitizers and deodorizers.

Spray up to 20 oz per minute. Designed to deliver consistent edge-to-edge coverage, without heavy drips and runs, so that you can achieve specified disinfectant dwell times on smaller jobs like bathrooms, kitchens and more. Perfect for areas that require maximum portability.

KEY	SKU	DESCRIPTION	MIN QTY
C	GR25R791	SaniSpray HP 20 – Cordless Handheld Sprayer	each



NEW!



(A) SANISPRAY HP 130 2-GUN CART (AKA HI-BOY)

Graco SaniSpray HP 130 is the ideal disinfectant sprayer solution that delivers maximum, 2-gun productivity on large disinfecting jobs. Uniquely built with the highest-grade materials that are compatible with disinfectants, sanitizers and deodorizers. Designed to deliver consistent edge-to-edge coverage, without heavy drips and runs, so that you can achieve specified disinfectant dwell times on larger jobs like apartment complexes, warehouses, heavy commercial buildings, hospitals, stadiums and more.

KEY	SKU	DESCRIPTION	MIN QTY
A	GR25R793	SaniSpray HP 130 - Hi-Boy Sprayer	each

(B) SANISPRAY HP 65 PORTABLE HOPPER SPRAYER

The Graco SaniSpray HP 65 is the ideal disinfectant sprayer solution that delivers maximum productivity on midsized disinfecting jobs. Uniquely built with the highest-grade materials that are compatible with disinfectants, sanitizers and deodorizers.

Spray 3X faster than SaniSpray HP 20. Designed to deliver consistent edge-to-edge coverage, without heavy drips and runs, so that you can achieve specified disinfectant dwell times on midsize jobs like small office spaces, residential homes & apartments, light commercial buildings, vehicles and more.

KEY	SKU	DESCRIPTION	MIN QTY
B	GR25R792	SaniSpray HP 65 - Portable Hopper Sprayer	each

(C-D) FIBERLOCK SHOCKWAVE RTU - DISINFECTANT, SANITIZER AND CLEANER

ShockWave RTU is an EPA-registered, quaternary ammonium chloride cleaner, disinfectant, and sanitizer designed for use on various surfaces subject to microbial contamination. It's the only ready-to-use disinfectant that kills 120 organisms! A one-step disinfectant spray that works in the presence of 5% organic load. For use on tables, counters, toilet seats, telephones, door knobs and similar hard nonporous inanimate environmental surfaces in hospitals, food processing areas, homes, restaurants, hotels, motels, gas stations, health clubs and spas. Controls cross contamination from treated inanimate environmental surfaces.

KEY	SKU	DESCRIPTION	MIN QTY
C	83161	Fiberlock Shockwave, 1 Gallon	each
D	83165	Fiberlock Shockwave, 5 Gallon	each

(E) CONCROBIUM® BROAD SPECTRUM DISINFECTANT II

A professional-grade, botanically-derived spray disinfectant, cleaner, virucide, bactericide, tuberculocide and fungicide. Non-flammable formula is made from a proprietary blend of plant extracts and essential oils and is suitable for use in most environments. Safe for use in areas where contact with people, pets or food is likely, such as restaurants, veterinary facilities or offices.

- Included on the EPA List N Disinfectants (EPA#34810-25) for use against SARS-CoV-2 (COVID-19)
- Minimum surface wet-time of 10 minutes, per CDC cleaning guidelines
- Spray-applied or applied with a spray bottle, mop or towel
- There are no PPE requirements when using this product, but a face covering and gloves are recommended when disinfecting surfaces

KEY	SKU	DESCRIPTION	MIN QTY
	626001	Concrobium Broad Spectrum Disinfectant Pro, 1 Gal	each
E	364107	Concrobium Broad Spectrum Disinfectant Pro, 5 Gal	each
	626055	Concrobium Broad Spectrum Disinfectant Pro, 55 Gal	each



FIRE MORTAR, DRAFTSTOP, AND FIRESTOP CAULK



(A) BOSS® 139 FIRE MORTAR

Low-cost, non-combustible fireplace mortar that passes ASTM E-136 and has been tested to 3000°F. Can also be used in residential firestop applications where the building code calls for a non-combustible material.

- Ideal for sealing fireplaces and wood burning stoves

KEY	SKU	DESCRIPTION	TUBES/CASE	CASES/PALLET
A	CLK139	Boss 139 Fire Mortar—Black	12	108

(B) BOSS® 136 FIREBLOCK DRAFTSTOP SEALANT

Fire rated sealant and non-combustible filler caulking. Used in the annular space around wires, pipes, ducts, vents, cable lines and other penetrations to the building envelope. Applicable standards include: UBC page 1-387, 1997 edition, CABO section 602.7 item 4, 1995 edition, BOCA (NBC) 704.4.1.1 1996 and ASTM E-136.

KEY	SKU	DESCRIPTION	TUBES/CASE	CASES/PALLET
B	CLK136	Boss 136 Firestop/Draft Sealant	12	108

(C) BOSS® 816 INTUMESCENT FIRESTOP SEALANT

Non-sag, water-based sealant and smoke seal that is easy to apply and clean up. Prevents the spread of toxic gases, water, smoke and fire through joint openings. Meets ASTM E-814 (UL 1479), standard test method for fire tests of through-penetration firestops. Conforms to BOCA National Building Code (1996), CABO one and two family dwelling code (1995), Uniform Building Code (1997). See UL Fire Resistance Directory for a list of systems established for Boss 816.

KEY	SKU	DESCRIPTION	TUBES/CASE	CASES/PALLET
C	CLK816	Boss 816 Intumescent	12	108

(D) FIRE SEAL FS136

Tested to meet and exceed ASTM-E136 and ASTM-E814 standards for fireblocking/firestopping single-family residential construction. Fire Seal possesses superior adhesion and freeze-thaw characteristics and is the contractors' #1 choice for fireblocking non-rated wood-frame construction. Fire Seal will not shrink, crack, or crumble upon cure. Fire Seal creates an air-tight barrier to prevent passage of flames, smoke, and toxic gases from spreading area to area within concealed spaces.

KEY	SKU	DESCRIPTION	TUBES/CASE	CASES/PALLET
D	CLKFS136	Fire Seal 136 Fireblock 10.3 oz Tube	12	120

FIRESTOP EXPANDING FOAM

(E) BOSS 81324 FIRESTOP EXPANDING FOAM

A true firestopping foam that is UL Classified and has passed the strict UL 1479 and ASTM E-814 tests. UL systems for cables, conduit and metallic pipes available. Prevents spread of fire, smoke and toxic gases up to a 2-hour fire rating. Ideal for use in hotels, prisons, hospitals, condominiums, single and multi-family homes.



KEY	SKU	DESCRIPTION	CANS/CASE	CASES/PALLET
E	BOSS81324	Boss 81324 Expanding Firestop Foam	12	80



(A) BOSS® 355 LATEX CAULK

7-Year general purpose latex caulk designed for interior use. For use around windows, door frames, baseboards, or any joint or gap where a weather-tight seal is required. Adheres well to wood, masonry, brick, and plaster.

KEY	SKU	DESCRIPTION	TUBES/CASE	CASES/PALLET
A	CLK355	Boss 355 7-year Caulk	24	60

(B) BOSS® 357 ACRYLIC PAINTER'S CAULK

20-Year acrylic latex caulk designed for both interior and exterior use. Adheres well to wood, masonry, brick, and plaster. Available in white.

KEY	SKU	DESCRIPTION	TUBES/CASE	CASES/PALLET
B	CLK15	Boss 357 20-year Caulk	12	108

(C) BOSS® 360 SEALANT SILICONIZED PAINTER'S CAULK

35-Year siliconized latex caulk designed for both interior and exterior use. Forms a tough, resilient bond to most building material surfaces. It has excellent resistance to water, weathering, and cures to produce a flexible seal that is non-yellowing and paintable. Available in white.

KEY	SKU	DESCRIPTION	TUBES/CASE	CASES/PALLET
C	CLK25	Boss 360 35-year Caulk	12	108

(D) BOSS 363 ACRYLIC LATEX CAULK WITH SILICONE

50-Year acrylic latex caulk with silicone that is designed for both interior and exterior use. Forms a tough, resilient bond to most building material surfaces. It has excellent resistance to water, weathering, and cures to produce a flexible seal that is non-yellowing and paintable.

KEY	SKU	DESCRIPTION	TUBES/CASE	CASES/PALLET
D	CLK4501	Boss 363 50-year Caulk—White	12	108
	CLK4500	Boss 363 50-year Caulk—Clear	12	108

(E) BOSS® 365 75-YEAR 100% ACRYLIC ELASTOMERIC LATEX WITH SILICONE

Boss 365 100% Acrylic Elastomeric Adhesive/Sealant with Silicone is mildew resistant, rust inhibited and paintable. Can be used for both interior and exterior applications such as crown molding, chair rails, baseboards and all exterior trim. Cures to a tough, flexible seal that is non-yellowing.

- Specifically formulated for high joint movement
- Smooth, creamy consistency makes it easy to tool

KEY	SKU	DESCRIPTION	TUBES/CASE	CASES/PALLET
E	CLK36501	Boss 365, Elastomeric—White	12	108

(F) BOSS® 380 CONTRACTORS SILICONE SEALANT

100% Silicone caulk provides a weather and waterproof seal, with ozone, UV & radiation and extreme temperature protection. Suitable for your general construction applications. Fills and seals gaps around windows, doors, vents, fixtures and lights.

KEY	SKU	DESCRIPTION	TUBES/CASE	CASES/PALLET
F	CLKSI00	Boss 380 Sealant—Clear	12	108
	CLKSI01	Boss 380 Sealant—White	12	108

(G) BOSS® 125 MULTI-SEAL CONSTRUCTION SEALANT

Formulated to offer outstanding primerless adhesion to most common building materials including vinyl, aluminum, steel, concrete, wood and glass. It can be applied and tooled under most weather conditions. This sealant is paintable with most latex base paints.

KEY	SKU	DESCRIPTION	TUBES/CASE	CASES/PALLET
G	CLK12503	Boss 125 Sealant—Grey	12	108
	CLK12515	Boss 125 Sealant—Bronze Medium	12	108
	CLK12520	Boss 125 Sealant—Bronze Special	12	108
	CLK12501	Boss 125 Sealant—White	12	108
	CLK12502	Boss 125 Sealant—Black	12	108
	CLK12518	Boss 125 Sealant—Stone	12	108
	CLK12519	Boss 125 Sealant—Translucent	12	108

CAULKING AND ACCESSORIES

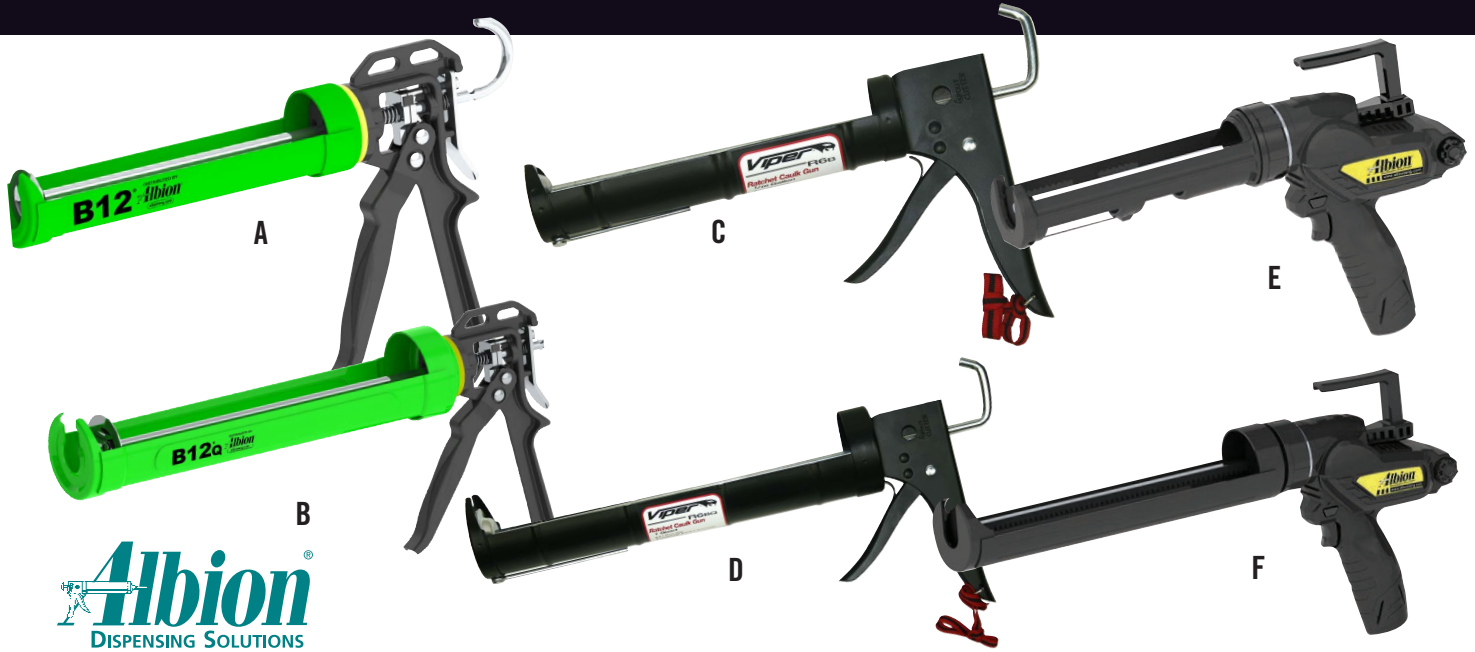

(A-B) ALBION® B-LINE CARTRIDGE GUNS, 12:1 DRIVE

Engineered with the professional in mind. Features Albion's Double-Gripping Plate technology for double the life of the tool and adjustable wear compensation device for no-loss trigger motion.

- 12:1 thrust ratio
- Smooth action
- Comfortable grip
- Ladder hook pull
- Cartridge puncture tool

KEY	SKU	DESCRIPTION	MIN QTY	QTY/CASE
A	AB12	Pint Cartridge Gun	each	12
B	AB12Q	Quart Cartridge Gun	each	6

(C-D) ALBION® VIPER CARTRIDGE GUNS, 6:1 DRIVE

State-of-the-art design make these tools value leaders. The convenient built-in spout cutter and puncture tool make for simple operation.

- 6:1 Thrust Ratio
- Ratchet Caulk Gun
- Ladder hook pull
- Cartridge puncture tool

KEY	SKU	DESCRIPTION	MIN QTY	QTY/CASE
C	AR6B	Pint Cartridge Gun	each	24
D	AR6BQ	Quart Cartridge Gun	each	24

(E-F) ALBION® ELECTRIC CAULK GUNS

Electric Cartridge Gun has 400 lbs of dispensing force. Variable speed trigger with max speed dial and auto reverse for no-drip.

- Lightweight
- Lithium ion battery
- Fast 30-minute recharge
- Includes 12V Li-Io battery & charger
- Ladder hook pull
- Battery fuel gauge

KEY	SKU	DESCRIPTION	MIN QTY
E	AE12	Electric Pint Cartridge Gun, 12V	each
F	AE12Q	Electric Quart Cartridge Gun, 12V	each

(G) CAULK WARMING BAG

This bag is designed to keep your caulk warm in cold weather.

- Heavy duty waterproof nylon construction
- Low energy consumption
- Plugs into 120 VAC or 12 VDC Inverter SKU #75WI*
- Retains heat when unplugged

KEY	SKU	DESCRIPTION	MIN QTY
G	CWB	Caulk Warming Bag	each

*Power Inverter sold separately. See SKU 75WI.

(H) CAULK WARMER BAG SAVER SLEEVES

Caulk Warmer Bag Saver Sleeves help to keep the inside of the bag clean and retains heat when item is out of the warmer. Simply slide over your caulk tube or caulk gun to keep the inside of your caulk warmer clean.

KEY	SKU	DESCRIPTION	MIN QTY
H	BSS	Caulk Warmer Bag Saver Sleeves—Pkg of 25	pack

The Caulk Warmer® holds 12 standard size caulk tubes, or 7 quart size tubes, or 12 sausage size tubes, or 7 cans of foam.



(I) 12 VDC 100 WATT INVERTER FOR CAULK AND CYLINDER WARMER

Provides overload protection, over voltage protection and over temperature protection. Additional uses include digital cameras, mobile phones, and notebook computers. The Power Inverter is the solution to using electricity in your automobile.

- Convert DC to AC
- Continuous power 100W—maximum power of 140W

KEY	SKU	DESCRIPTION	MIN QTY
I	75WI	12 VDC 100 Watt Inverter	each



(A-B) SPRAY ADHESIVES

Fast tacking and high bond strength product for a wide variety of substrates. Capable of handling virtually any light or heavy duty job. VOC compliant, fast drying, high strength web spray.

KEY	SKU	DESCRIPTION	CANS/CASE	CASES/PALLET
A	SA5017	Intertape Spray Adhesive, 17 oz Cans	12	105
B	SA635	BOSS Spray Adhesive, 12 oz Cans	12	105



(C) WATER-BASED DUCT SEALANT

A fiber reinforced, water-based, premium quality, UL Listed, high velocity duct sealant for commercial and residential supply and return air duct use. Used for sealing joints, seams, and duct wall penetrations on metal air duct; for sealing connections on flexible duct or fiberglass duct board, and is recommended up to 15 inches water column pressure.

- LEED qualified, ZERO VOC's
- Non-flammable
- 2-Year shelf life

KEY	SKU	DESCRIPTION	MIN QTY
C	DP1030G	Duct Sealant, 1 Gallon—Gray	each
	DP1030W	Duct Sealant, 1 Gallon—White	each

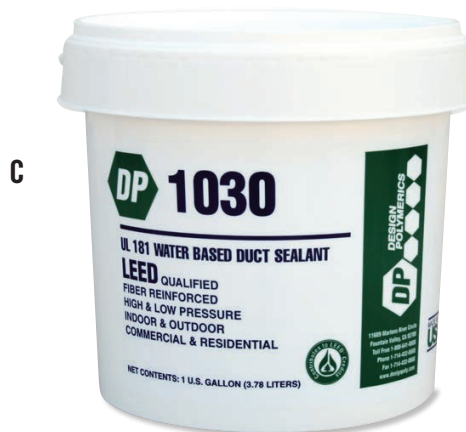

(D) TITEBOND® RADON SEALANT

Titebond® Radon Sealant is specifically designed to reduce the entry of radon. Use on foundation cracks, joints and penetrations, around foundation coatings normally used for damp proofing, and membranes surrounding the foundation. It is an extremely flexible and durable product which allows for extension and compression of at least 25%.

- No mixing or primer required
- VOC compliant in all 50 states
- Application Range 40°F to 120°F
- Joint Movement Capability ± 25%

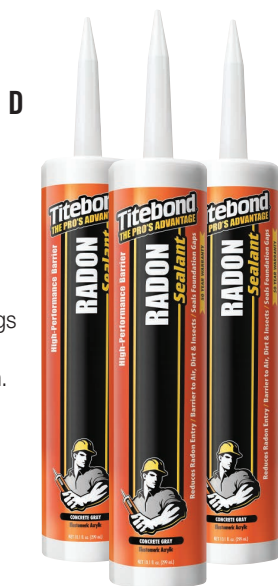

KEY	SKU	DESCRIPTION	TUBES/CASE	CASES/PALLET
D	3251	Titebond radon Sealant, 10.1 oz—Gray	12	108



(E) MANUS-BOND 50-AC ACOUSTICAL SEALANT

Non-drying butyl, synthetic rubber-based sealant for reducing sound and vapor transmission in partition systems. It remains flexible for a long-lasting, resilient, and acoustical seal. Conforms to CAN/CGSB 19.211 M87.



KEY	SKU	DESCRIPTION	TUBES/CASE	CASES/PALLET
E	C52A01	Manus-Bond, 28 oz Tube—White	12	32
	C52A02	Manus-Bond, 28 oz Tube—Black	12	32

3M ASJ (ALL SERVICE JACKET) TAPE UL CLASSIFIED

3M #105 ASJ insulation tape is used for seam sealing and patching of ASJ-faced mechanical insulation systems, providing a matching appearance and vapor retarder integrity.

- Service temperatures of 0° F to 150° F (-18° C to 66° C)
- Application range of 10° F to 120° F (-12° C to 49° C)

SKU	DESCRIPTION	ROLLS/CASE	CASES/PALLET
105ASJ3	3" x 50 yd	16	27



ECHO TAPE DOUBLE COATED/SSL POLYESTER TAPE CARRIER UL CLASSIFIED

Echo Tape #250 double coated/SSL (Self-Seal Lap) tape is used to seal vapor retarder or facing overlap seams on mechanical and other types of insulation.

It can be used to apply patches or to hang vapor retarders or facings on structural members.

- Service temperatures of 0° F to 150° F (-12° C to 66° C)
- Application range of -10° F to 120° F (-23° C to 49° C)

SKU	DESCRIPTION	ROLLS/CASE	CASES/PALLET
ETDC155	1.5" x 60 yd	36	27



3M 1.5 MIL ALUMINUM FOIL TAPE UL CLASSIFIED

3M #118 foil tape is used for seam sealing and patching of FSK-faced duct wrap insulation, board insulation and other insulation applications where FSK or foil facing is used.

- Service temperatures of -25° F to 250° F (-32° C to 121° C)
- Application range of 10° F to 120° F (-12° C to 49° C)

SKU	DESCRIPTION	ROLLS/CASE	CASES/PALLET
118FOIL2	2" x 50 yd	24	36
118FOIL3	3" x 50 yd	16	36



3M 2 MIL ALUMINUM FOIL TAPE UL CLASSIFIED

3M #120 foil tape is used for seam sealing and patching of foil and FSK-faced duct wrap and board insulation and other insulation applications where FSK or foil facing is used.

- Service temperatures of -25° F to 250° F (-32° C to 121° C)
- Application range of 10° F to 120° F (-12° C to 49° C)

SKU	DESCRIPTION	ROLLS/CASE	CASES/PALLET
120FOIL2	2" x 50 yd	24	36
120FOIL3	3" x 50 yd	16	36
120FOIL4	4" x 50 yd	12	36



RAVEN BUTYL SEAL TAPE

Butyl seal is a double-sided aggressive reinforced butyl rubber tape used to join panels of polyethylene and polypropylene together by overlapping the edges and applying Butyl Seal in between. It is also used to adhere to concrete walls and footings when properly prepared. Butyl Seal is non-hardening and flexible.

SKU	DESCRIPTION	ROLLS/CASE	CASES/PALLET
TP2BR	Tape, Raven Butyl Seal, 2" x 50'	12	20



3M VINYL FOAM SEALANT TAPE

3M Vinyl Foam Tape was designed to provide both a quick fix and long-lasting solution in applications that require vapor sealing and gap covering. Composed of a closed-cell vinyl foam coated with a pressure-sensitive acrylic adhesive. 3M vinyl foam sealant tape is grey in color; density—10 lb. per cubic foot.

SKU	DESCRIPTION	ROLLS/CASE
TVFS1714	3M Vinyl Foam Sealant Tape (3/8" x 1/4") x 50'	32

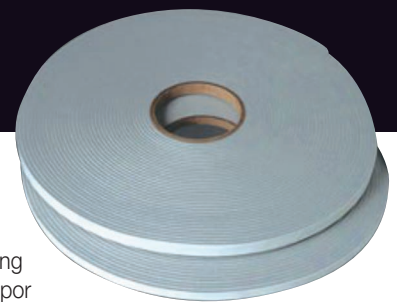

ECHO TAPE FSK (FOIL-SCRIM-KRAFT) TAPE UL CLASSIFIED

Echo Tape #110 FSK tape is used for seam sealing and patching of FSK-faced duct wrap insulation and other insulation applications where FSK facing is used; provides a matching appearance and vapor retarder integrity.

- Service temperatures of 0° F to 150° F (-18° C to 66° C)
- Application range of 10° F to 120° F (-12° C to 49° C)

SKU	DESCRIPTION	ROLLS/CASE	CASES/PALLET
ETFSK2	2" x 50 yd	24	48
ETFSK3	3" x 50 yd	16	48
ETFSK4	4" x 50 yd	12	48



RAVEN PSK (POLY-SCRIM-KRAFT) TAPE VR-10 TYPE UL CLASSIFIED

Raven #282 VR-10 PSK tape is used for seam sealing and patching of VR-10 faced metal building insulation and other insulation applications where VR-10 facing is used. VR-10 has a white film outer surface.

- Can also be used on Lamtec WMP-VR facing.
- Service temperatures of 0° F to 150° F (-18° C to 66° C)
- Application range of 10° F to 120° F (-12° C to 49° C)

SKU	DESCRIPTION	ROLLS/CASE	CASES/PALLET
TVB4	4" x 50 yd	12	27



ECHO TAPE WMP-VR TAPE

Echo Tape WMP-VR tapes are 3-way reinforced polypropylene film/scrim/kraft facing tapes, combined with a high performance cold weather solvent acrylic adhesive. They feature an easy release silicone treated liner and offer a superior quick stick at normal operating temperatures as well as great performance at low temperatures.

SKU	DESCRIPTION	ROLLS/CASE	CASES/PALLET
ETWMP10	Tape, 3" x 50 yd	16	27
ETWMP10B	Tape, 3" x 50 yd—Black	16	27
ETWMPVR	Tape, Poly Facing WMPVR, 3" x 50 yd—White	16	48
ETWMPVRB	Tape, Poly Facing WMPVR, 3" x 50 yd—Black	16	48



GREY BUTYL TAPE

Backerless butyl tape which remains pliable and will not cure. Perfect for seaming reinforced poly.

SKU	DESCRIPTION	ROLLS/CASE	CASES/PALLET
MBTAPEG	Gray Butyl Tape 1/32" x 1 1/2" x 30 yd	16	16



3M VENTURE FOIL TAPE

UL classified, 2 mil with high tack adhesive. Superior conformability for sealing insulation and foil-faced sheathing.



SKU	DESCRIPTION	ROLLS/CASE	CASES/PALLET
TF250C	2" x 50 yd	24	36
TF350C	3" x 50 yd	16	36

3M VENTURE FSK TAPE

6.5 mil tape is foil and fiberglass, scrim laminate designed for sealing scrim faced duct insulation. Used where extra strength beyond regular foil tape is needed.

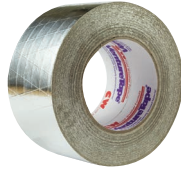

SKU	DESCRIPTION	ROLLS/CASE	CASES/PALLET
TK250	2" x 50 yd	24	36
TK350C	3" x 50 yd	16	27
TK450	4" x 50 yd	12	27

INTERTAPE BLACK DUCT TAPE

Versatile duct tape works well for vapor sealing, sheet metal ductwork and general purpose heavy duty service.



SKU	DESCRIPTION	ROLLS/CASE	CASES/PALLET
TD15B	Intertape Duct, 2" x 60 yd—Black	24	27

INTERTAPE UTILITY GRADE DUCT TAPE

Utility grade 8 mil poly-coated cloth-backed tape with a very aggressive adhesive. Has good conformability and is water resistant.



SKU	DESCRIPTION	ROLLS/CASE	CASES/PALLET
TD15	Intertape 8 mil—1-7/8" x 60 yd	24	27

INTERTAPE CONTRACTOR GRADE DUCT TAPE

Contractor grade 11 mil all-purpose duct tape with a natural rubber adhesive, aggressively bonds to almost any surface. Water resistant. Choose TD36 when high performance counts. UL723 rated, meets HUD and BOCA codes.



SKU	DESCRIPTION	ROLLS/CASE	CASES/PALLET
TD36	11 mil—1-7/8" x 60 yd	24	27

INTERTAPE ALL-PURPOSE RED DUCT TAPE

All-purpose 9 mil with a natural rubber adhesive and with excellent adhesive properties. Water resistant. Used for color coding, critical location marking or a variety of repair projects.



SKU	DESCRIPTION	ROLLS/CASE	CASES/PALLET
TD20R	9 mil—1-7/8" x 60 yd	24	27

INTERTAPE BLUE PAINTERS TAPE

High quality with a special adhesive that can cleanly be removed even from glass that has been left in direct sunlight for up to 14 days. Excellent UV resistance, conformability and tensile strength.



SKU	DESCRIPTION	ROLLS/CASE	CASES/PALLET
TPT75	Blue Painters Tape—2" x 60 yd	24	48

INTERTAPE UTILITY GRADE MASKING TAPE

5.1 mil for non-critical securing and bundling applications. A very comfortable backing with an aggressive adhesive.



SKU	DESCRIPTION	ROLLS/CASE	CASES/PALLET
TM513	5.1 mil—1-7/8" x 60 yd	24	48

3M VENTURE POLYMER FILM PRESSURE SENSITIVE TAPE

2.5 mil self-wound polymer film is designed to meet the stringent requirements of the Underwriters Laboratories standards UL181. The standards and the application are as follows: UL 181B, Closure Systems for Use with Flexible Air Ducts and Air Connectors; used to seal closures in flex duct and to seal flex duct vapor retarders to duct board. Use - UL 181BFX tape. Tape is for 181B applications only, and is not to be used for 181A applications.



SKU	DESCRIPTION	ROLLS/CASE	CASES/PALLET
360POLY3SIL	3" x 120 yd	16	27

3M VENTURE PSK (POLY-SCRIM-KRAFT) TAPE UL CLASSIFIED

This tape is used for seam sealing and patching of PSK faced metal building insulation and other insulation applications where PSK facing is used. PSK has a white film outer surface.

- Can be used on Lamtec WMP-10 and WMP-30 facing.
- Service temperatures of 0° F to 150° F (-18° C to 66° C)
- Application range of 10° F to 120° F (-12° C to 49° C)



SKU	DESCRIPTION	ROLLS/CASE	CASES/PALLET
280WHTPSK3	3" x 50 yd	16	27

3M ASJ (ALL SERVICE JACKET) TAPE UL CLASSIFIED

3M #105 ASJ insulation tape is used for seam sealing and patching of ASJ-faced mechanical insulation systems, providing a matching appearance and vapor retarder integrity.

- Service temperatures of 0° F to 150° F (-18° C to 66° C)
- Application range of 10° F to 120° F (-12° C to 49° C)

SKU	DESCRIPTION	ROLLS/CASE	CASES/PALLET
105ASJ3	3" x 50 yd	16	27



ECHO TAPE DOUBLE COATED/SSL POLYESTER TAPE CARRIER UL CLASSIFIED

Echo Tape #250 double coated/SSL (Self-Seal Lap) tape is used to seal vapor retarder or facing overlap seams on mechanical and other types of insulation.

It can be used to apply patches or to hang vapor retarders or facings on structural members.

- Service temperatures of 0° F to 150° F (-12° C to 66° C)
- Application range of -10° F to 120° F (-23° C to 49° C)

SKU	DESCRIPTION	ROLLS/CASE	CASES/PALLET
ETDC155	1.5" x 60 yd	36	27



3M 1.5 MIL ALUMINUM FOIL TAPE UL CLASSIFIED

3M #118 foil tape is used for seam sealing and patching of FSK-faced duct wrap insulation, board insulation and other insulation applications where FSK or foil facing is used.

- Service temperatures of -25° F to 250° F (-32° C to 121° C)
- Application range of 10° F to 120° F (-12° C to 49° C)

SKU	DESCRIPTION	ROLLS/CASE	CASES/PALLET
118FOIL2	2" x 50 yd	24	36
118FOIL3	3" x 50 yd	16	36

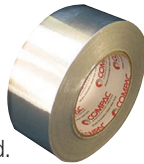

3M 2 MIL ALUMINUM FOIL TAPE UL CLASSIFIED

3M #120 foil tape is used for seam sealing and patching of foil and FSK-faced duct wrap and board insulation and other insulation applications where FSK or foil facing is used.

- Service temperatures of -25° F to 250° F (-32° C to 121° C)
- Application range of 10° F to 120° F (-12° C to 49° C)

SKU	DESCRIPTION	ROLLS/CASE	CASES/PALLET
120FOIL2	2" x 50 yd	24	36
120FOIL3	3" x 50 yd	16	36
120FOIL4	4" x 50 yd	12	36



RAVEN BUTYL SEAL TAPE

Butyl seal is a double-sided aggressive reinforced butyl rubber tape used to join panels of polyethylene and polypropylene together by overlapping the edges and applying Butyl Seal in between. It is also used to adhere to concrete walls and footings when properly prepared. Butyl Seal is non-hardening and flexible.

SKU	DESCRIPTION	ROLLS/CASE	CASES/PALLET
TP2BR	Tape, Raven Butyl Seal, 2" x 50'	12	20



3M VINYL FOAM SEALANT TAPE

3M Vinyl Foam Tape was designed to provide both a quick fix and long-lasting solution in applications that require vapor sealing and gap covering. Composed of a closed-cell vinyl foam coated with a pressure-sensitive acrylic adhesive. 3M vinyl foam sealant tape is grey in color; density—10 lb. per cubic foot.

SKU	DESCRIPTION	ROLLS/CASE
TVFS1714	3M Vinyl Foam Sealant Tape (3/8" x 1/4") x 50'	32

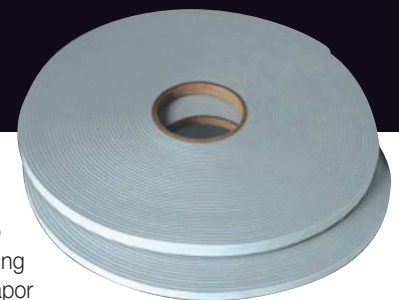

ECHO TAPE FSK (FOIL-SCRIM-KRAFT) TAPE UL CLASSIFIED

Echo Tape #110 FSK tape is used for seam sealing and patching of FSK-faced duct wrap insulation and other insulation applications where FSK facing is used; provides a matching appearance and vapor retarder integrity.

- Service temperatures of 0° F to 150° F (-18° C to 66° C)
- Application range of 10° F to 120° F (-12° C to 49° C)

SKU	DESCRIPTION	ROLLS/CASE	CASES/PALLET
ETFSK2	2" x 50 yd	24	48
ETFSK3	3" x 50 yd	16	48
ETFSK4	4" x 50 yd	12	48



RAVEN PSK (POLY-SCRIM-KRAFT) TAPE VR-10 TYPE UL CLASSIFIED

Raven #282 VR-10 PSK tape is used for seam sealing and patching of VR-10 faced metal building insulation and other insulation applications where VR-10 facing is used. VR-10 has a white film outer surface.

- Can also be used on Lamtec WMP-VR facing.
- Service temperatures of 0° F to 150° F (-18° C to 66° C)
- Application range of 10° F to 120° F (-12° C to 49° C)

SKU	DESCRIPTION	ROLLS/CASE	CASES/PALLET
TVB4	4" x 50 yd	12	27



ECHO TAPE WMP-VR TAPE

Echo Tape WMP-VR tapes are 3-way reinforced polypropylene film/scrim/kraft facing tapes, combined with a high performance cold weather solvent acrylic adhesive. They feature an easy release silicone treated liner and offer a superior quick stick at normal operating temperatures as well as great performance at low temperatures.

SKU	DESCRIPTION	ROLLS/CASE	CASES/PALLET
ETWMP10	Tape, 4" x 50 yd	16	27
ETWMP10B	Tape, 4" x 50 yd—Black	16	27
ETWMPVR	Tape, Poly Facing WMPVR, 3" x 50 yd—White	16	48
ETWMPVRB	Tape, Poly Facing WMPVR, 3" x 50 yd—Black	16	48



GREY BUTYL TAPE

Backerless butyl tape which remains pliable and will not cure. Perfect for seaming reinforced poly.

SKU	DESCRIPTION	ROLLS/CASE	CASES/PALLET
MBTAPEG	Gray Butyl Tape 1/32" x 1 1/2" x 30 yd	16	16





CERTAINTEED SMART MEMBRAIN™

Continuous Air Barrier & Smart Vapor Retarder. Dynamic performance and permeance rating compared to traditional kraft insulation or polyethylene sheeting.

KEY	SKU	DESCRIPTION	MIN QTY
	CTVR84	CertainTeed 8'4" x 100' Vapor Barrier	1 roll
	CTVR94	CertainTeed 9'4" x 100' Vapor Barrier	1 roll
	CTVR104	CertainTeed 10'4" x 100' Vapor Barrier	1 roll
	CTVR124	CertainTeed 12'4" x 100' Vapor Barrier	1 roll



WIDTH	SKU NUMBER	DIMENSIONS	THICKNESS	COLOR
4'2"	UP4220	4'2" x 200'	2 mil	Clear
8'	UP8030	8' x 100'	3 mil	Clear
8'	UP8040	8' x 100'	4 mil	Clear
8'	UP8060	8' x 100'	6 mil	Clear
8'	UP8060B	8' x 100'	6 mil	Black
8'4"	UP8415	8'4" x 200'	1.5 mil	Clear
8'4"	UP8420	8'4" x 200'	2 mil	Clear
8'4"	UP8440	8'4" x 100'	4 mil	Clear
8'4"	UP8440F	8'4" x 100'	4 mil	Flame
8'4"	UP8460	8'4" x 100'	6 mil	Clear
9'	UP9007	9' x 400'	.7 mil	Clear
9'	UP9040	9' x 100'	4 mil	Clear
9'	UP9060	9' x 100'	6 mil	Clear
9'4"	UP9440	9'4" x 100'	4 mil	Clear
9'4"	UP9440F	9'4" x 100'	4 mil	Flame
9'4"	UP9460	9'4" x 100'	6 mil	Clear
10'	UP1020	10' x 100'	2 mil	Clear
10'	UP1030	10' x 100'	3 mil	Clear
10'	UP1040	10' x 100'	4 mil	Clear
10'	UP1040B	10' x 100'	4 mil	Black
10'	UP1060	10' x 100'	6 mil	Clear
10'	UP1060B	10' x 100'	6 mil	Black
10'4"	UP10440	10'4" x 100'	4 mil	Clear

WIDTH	SKU NUMBER	DIMENSIONS	THICKNESS	COLOR
12'	UP1207	12' x 400'	.7 mil	Clear
12'	UP12003	12' x 400'	.3 mil	Clear
12'	UP1201	12' x 400'	1 mil	Clear
12'	UP1215	12' x 200'	1.5 mil	Clear
12'	UP1220	12' x 200'	2 mil	Clear
12'	UP1240	12' x 100'	4 mil	Clear
12'	UP1240B	12' x 100'	4 mil	Black
12'	UP1260	12' x 100'	6 mil	Clear
12'	UP1260B	12' x 100'	6 mil	Black
12'	UP1260F	12' x 100'	6 mil	Flame
12'4"	UP12440	12'4" x 100'	4 mil	Clear
16'	UP1640	16' x 100'	4 mil	Clear
16'	UP1660	16' x 100'	6 mil	Clear
16'	UP1660B	16' x 100'	6 mil	Black
20'	UP2015	20' x 200'	1.5 mil	Clear
20'	UP2040	20' x 100'	4 mil	Clear
20'	UP2060	20' x 100'	6 mil	Clear
20'	UP2060B	20' x 100'	6 mil	Black
20'	UP2060W	20' x 100'	6 mil	White
20'	UP2010	20' x 100'	10 mil	Clear
20'	UP2010B	20' x 100'	10 mil	Black
24'	UP2460	24' x 100'	6 mil	Clear



CALL 800-666-8191

SPECIAL ORDER CONSTRUCTION FILM/POLY

We've got your next project covered—with some of the best construction film available. ADO offers a complete line of poly films available in many sizes, colors and styles.

RADIANT BARRIERS

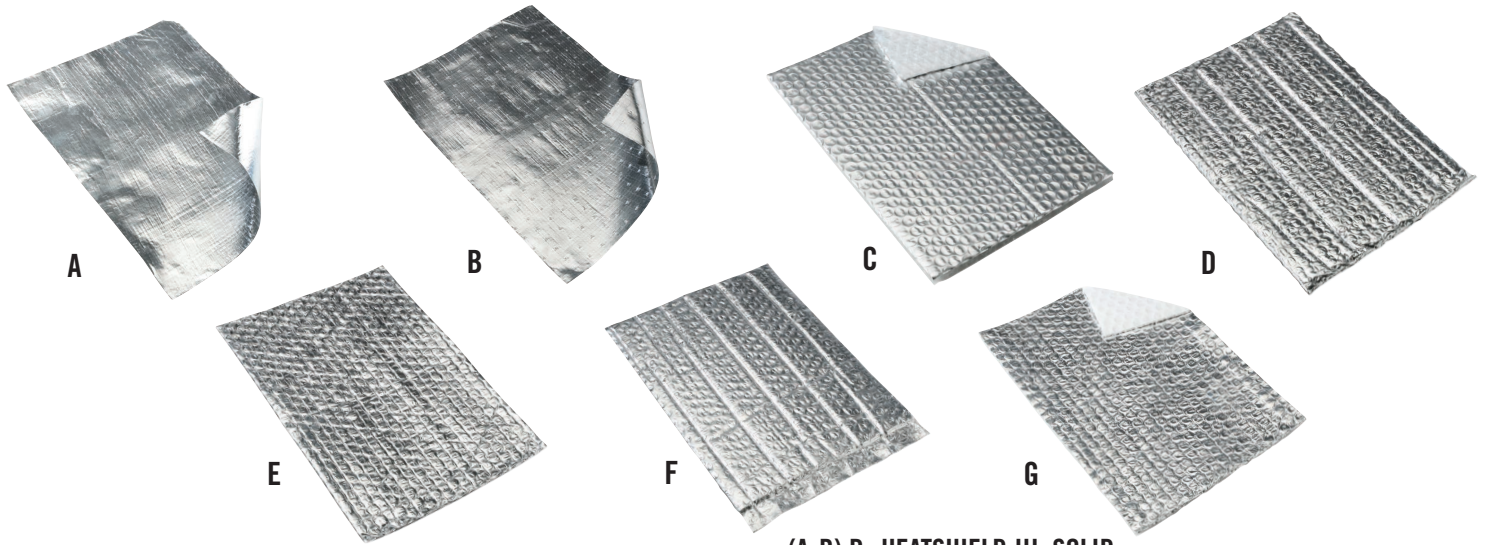

REFLECTIVE PRODUCTS

R+HEATSHIELD - RADIANT BARRIERS:

R+Heatshield is perfect over attic insulation (use perforated type), under rafters and over crawl spaces. It works as a complete insulation for metal and post-frame buildings, garages and garage doors. The solid type is ideal wherever a vapor and air infiltration barrier is needed. Perfectly safe to use, requiring no special breathing or handling precautions.

TUFF-STUFF - CONCRETE INSULATION:

High-strength insulating moisture barrier for use below heated concrete floors.

ASTRO-SHIELD - REFLECTIVE INSULATION:

Insulation material ideal for retrofit or new construction applications in commercial, industrial and agricultural pre-engineered metal and post-frame buildings. Its unique composite design consists of polyethylene air bubble pockets sandwiched between thin layers of reflective film. In many applications, Astro-Shield is more effective than 3" to 6" of conventional mass fiber insulation.

- Keeps buildings warmer in winter and cooler in summer
- Non-carcinogenic
- Lightweight material is thin, pliable and easy to install, and has little or no affect on building design loads
- Compact design works well in limited spaces—easy to ship/store
- Tough surfaces are wear and puncture resistant and can be pressure washed
- Water resistant, nonpermeable surfaces keep moisture out
- Solid surface wind barrier absolutely stops air infiltration, adding to the energy efficiency of any building
- Class1; Class A fire rating and low smoke spread



(A-B) R+HEATSHIELD III, SOLID OR PERFORATED - RADIANT BARRIERS - Foil/HD Scrim/Foil

KEY	SKU	DESCRIPTION	MIN QTY
A	AFM1SIII	R+Heatshield III, Solid—4' x 250'	1 roll
B	AFM5III	R+Heatshield III, Perforated—4' x 125'	1 roll

(C) TUFF-STUFF - CONCRETE INSULATION - PET/Foil/Clear Bubble/Clear Bubble

KEY	SKU	DESCRIPTION	MIN QTY
C	AFPTS4125	Tuff Stuff—4' x 125'	1 roll
	AFPTS6125	Tuff Stuff—6' x 125'	1 roll

(D) ASTRO-SHIELD II - REFLECTIVE INSULATION - Foil/Bubble/Bubble/Foil

KEY	SKU	DESCRIPTION	MIN QTY
D	AFA9	Astro-Shield II—4' x 125'	1 roll
	AFA	Astro-Shield II—6' x 125'	1 roll
	AFAL	Astro-Shield II—16" x 125'	1 roll

(E) ASTRO-E - REFLECTIVE INSULATION - Foil/Bubble/Foil

KEY	SKU	DESCRIPTION	MIN QTY
E	AFE5	Astro-E—4' x 125'	1 roll
	AFE	Astro-E—6' x 125'	1 roll

(F) ASTRO-TAB/ASTRO-PEAL & SEAL - REFLECTIVE INSULATION - Foil/Bubble/Bubble/Foil

KEY	SKU	DESCRIPTION	MATERIAL	MIN QTY
F	AFA9PS	Astro-Peel & Seal—4' x 125'	3/4" Release Tape one Side	1 roll
	AFAPS	Astro-Peel & Seal—6' x 125'	3/4" Release Tape one Side	1 roll

(G) ASTRO-WHITE - REFLECTIVE INSULATION

For ceilings in agricultural and commercial buildings including metal structures. For use as condensation barrier in heated or unheated commercial buildings, as radiant barrier in unheated commercial buildings, or as "white" facing for ceiling applications in commercial buildings. An excellent alternative to white vinyl-faced fiberglass batts.

KEY	SKU	DESCRIPTION	MATERIAL	MIN QTY
G	AFU1E5	Astro-White I—4' x 125'	Single Bubble	1 roll
	AFU1E	Astro-White I—6' x 125'	Single Bubble	1 roll
	AFUXX4125	Astro-White II—4' x 125'	Double Bubble	1 roll
	AFUXX6125	Astro-White II—6' x 125'	Double Bubble	1 roll

LAMTEC®

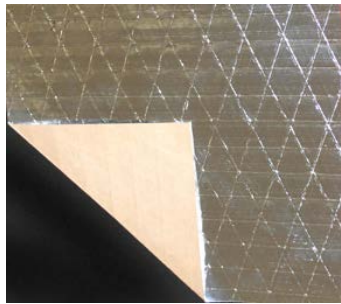
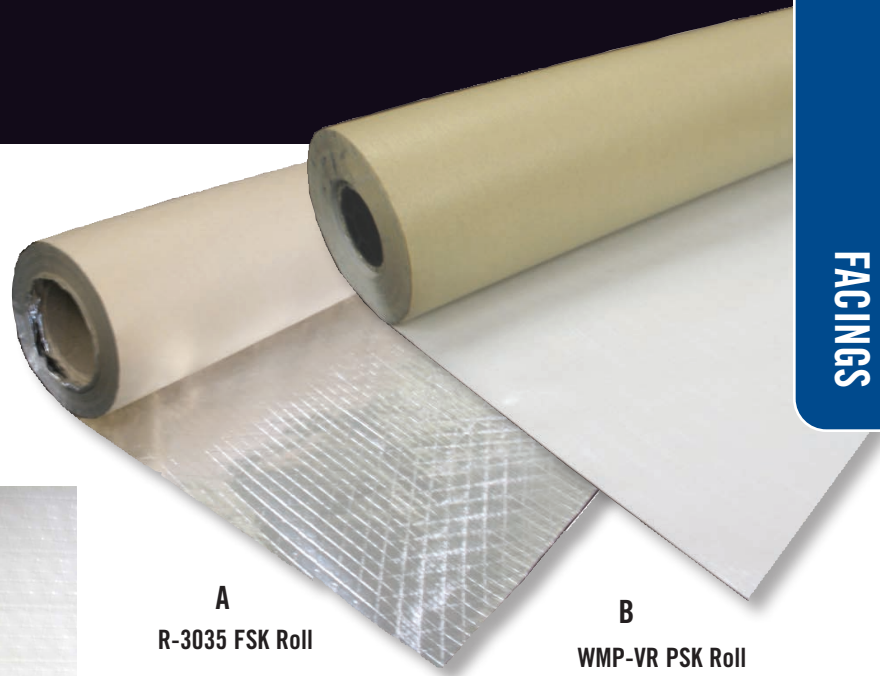

R-3035 FSK Folded

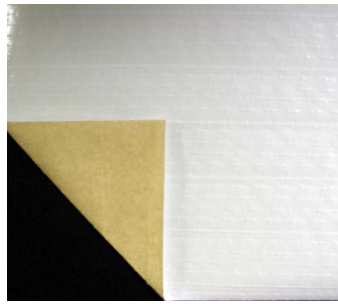

WMP - VR PSK Folded

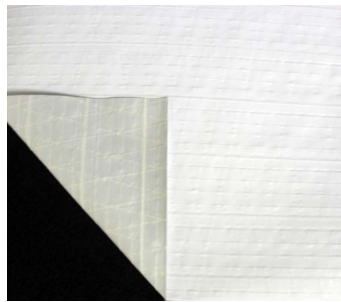

WMP-10 PSK Folded

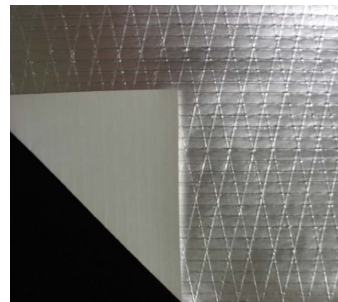

30-J ASJ Folded

(A) FSK FACING R-3035

Lamtec R-3035 FSK (Foil-Scrim-Kraft) product is most commonly used as a facing for duct wrap insulation, but has many other insulation applications where a general use vapor retarder is needed. It is also a good choice for radiant barrier applications because of its extremely low emissivity. Permeance Test Method ASTM E 96, Procedure A - 0.02 perms.

KEY	SKU	DESCRIPTION	ROLLS/PALLET
A	R3035FSK50300	R-3035 FSK 50" x 300' Roll	49
	R3035FSK50600	R-3035 FSK 50" x 600' Roll	36
	R3035FSK54300	R-3035 FSK 54" x 300' Roll	49
	R3035FSK54600	R-3035 FSK 54" x 600' Roll	36

(B) PSK FACING WMP-VR

Lamtec WMP-VR is a PSK (White polypropylene film, fiberglass & polyester scrim, 11# natural kraft) vapor retarder, or facing, primarily used for metal or pre-engineered buildings. It is a very cost effective metal building facing that has excellent installed appearance. The white film side is installed toward the interior of the building. Permeance Test Method ASTM E 96, Procedure A - 0.09 perms.

KEY	SKU	DESCRIPTION	ROLLS/PALLET
B	WMPVR54300	WMP-VR PSK 54" x 300' Roll	49
	WMPVR54600	WMP-VR PSK 54" x 600' Roll	36
	WMPVR54600P	WMP-VR PSK 54" x 600' Perforated Roll	36
	WMPVR54600B	WMP-VR PSK 54" x 600' Roll—Black	39
	WMPVR66600B	WMP-VR PSK 66" x 600' Roll—Black	28

A
R-3035 FSK Roll

B
WMP-VR PSK Roll

(C) PSK FACING WMP-10

Lamtec WMP-10 is a PSK (White polypropylene film, metallization, fiberglass and polyester scrim, 14# white kraft) used in applications as a vapor retarder or facing. It is a cost effective metal building facing that has excellent installed appearance. The white film side is installed toward the interior of the building. Permeance Test Method ASTM E 96, Procedure A - 0.02 perms.

KEY	SKU	DESCRIPTION	ROLLS/PALLET
C	WMP10255300	WMP-10 PSK 25.5" x 300' Roll	48
	WMP1033300	WMP-10 PSK 33" x 300' Roll	48
	WMP1054300	WMP-10 PSK 54" x 300' Roll	36
	WMP1054300B	WMP-10 PSK 54" x 300' Roll—Black	36
	WMP1066300	WMP-10 PSK 66" x 300' Roll	49

FSK VAPOR RETARDER LAMTEC R3050 (NOT SHOWN)

Lamtec R-3050 (Foil-Scrim-Kraft) product is primarily used as the facing or outer covering for fiberglass duct board, and in various insulation applications where a strong, abuse-resistant FSK vapor retarder or facing is needed. Permeance Test Method ASTM E 96, Procedure A - 0.02 perms.

KEY	SKU	DESCRIPTION	ROLLS/PALLET
	R3050FSK48300	VR R3050 FSK 48" x 300' Roll	49

PSK FACING WMP-50 (NOT SHOWN)

Lamtec WMP-VR is a PSK (White polypropylene film, fiberglass & polyester scrim, 11# natural kraft) vapor retarder, or facing, primarily used for metal or pre-engineered buildings. It is a very cost effective metal building facing that has excellent installed appearance. The white film side is installed toward the interior of the building. Permeance Test Method ASTM E 96, Procedure A - 0.09 perms.

KEY	SKU	DESCRIPTION	ROLLS/PALLET
	WMP5054300	WMP-50 PSK 54" x 300' Roll	49
	WMP5054300B	WMP-50 PSK 54" x 300' Roll—Black	49
	WMP5090300	WMP-50 VR PSKP 90" x 300' Roll	28
	WMP5066300	WMP-50 VR PSKP 66" x 300' Roll	28

(D) ASJ 30-J

Lamtec 30-J ASJ (All Service Jacket) is an aluminum foil/scrim/high intensity white kraft paper product used primarily for pipe and equipment (mechanical) insulation applications as a vapor retarder or facing. It is typically used with the white paper side exposed. Permeance Test Method ASTM E 96, Procedure A - 0.02 perms.

KEY	SKU	DESCRIPTION	ROLLS/PALLET
D	30JASJ48300	30J ASJ 48" x 300' Roll	49

NETTING AND FABRIC

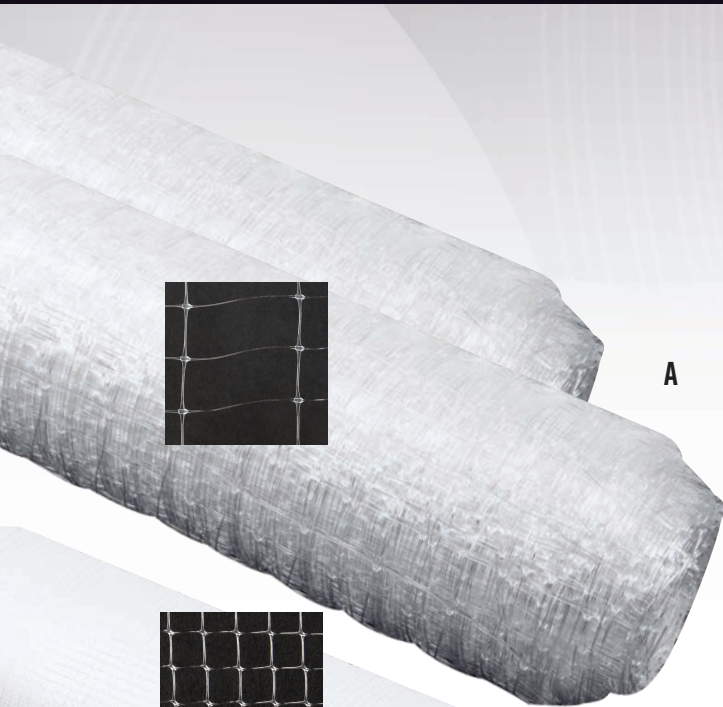

A

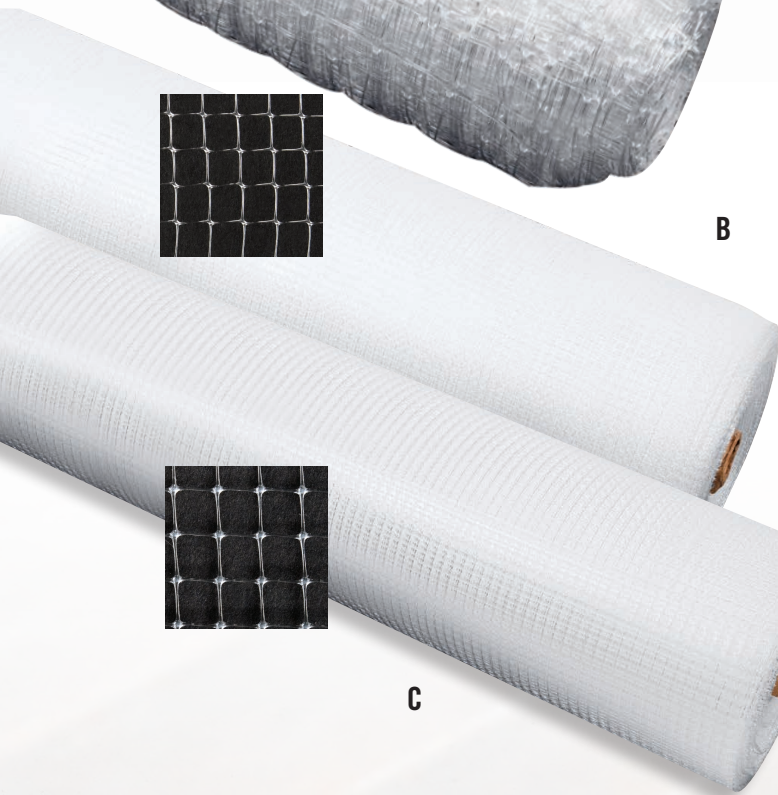

B

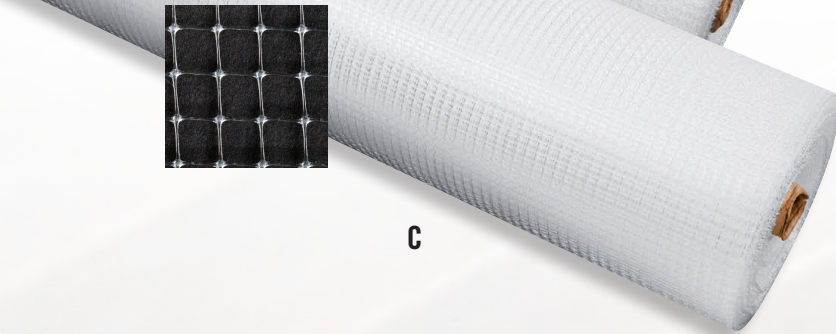

C



(A) ECONOMY 1" X 2" MESH

A great replacement for wire batt hangers!

KEY	SKU	DESCRIPTION	MIN QTY	ROLLS/CASE	CASES/PALLET
A	NT1250	4' x 250'	1 Roll	20	4

(B) LIGHT DUTY 1/6" MESH

Works well for walls when installing cellulose or fiberglass, as a backer to hold wet spray, and as a temporary face before installing drywall.

KEY	SKU	DESCRIPTION	MIN QTY	ROLLS/CASE	CASES/PALLET
B	NT6250	4' x 250'	1 Roll	16	4
	NT6125	8' x 125'	1 Roll	16	4
	NT62502	2' x 250'	1 Roll	32	4

(C) MEDIUM DUTY 1/4" MESH

A heavier choice where greater strength is required and for fireproofing spray applications.

KEY	SKU	DESCRIPTION	MIN QTY	ROLLS/CASE	CASES/PALLET
C	NT4250	4' x 250'	1 Roll	9	4
	NT4125	8' x 125'	1 Roll	9	4
	NT111	111" x 250'	1 Roll	4	8
	NT120	120" x 250'	1 Roll	4	8



A

(A) ADO PRO PAC

ADO Pro Pac fabric is ideal for knee walls, sound walls and many other applications. Keep your job site dust levels down to a minimum. Our best value, high quality non-woven netting is made of 100% polypropylene point bonded material. Rolls are folded for greater convenience when moving quickly through the job site installation. ADO Pro Pac is not the preferred fabric for wet/damp spray installations - See line (D) ADO Pro Web SKUs for this application.

KEY	SKU	DESCRIPTION	MIN QTY	ROLLS/BAG	ROLLS/PALLET
A	ICPP50	Pro Pac, 4' 2" x 750'	1 roll	1	12
	ICPP100	Pro Pac, 8' 4" x 750', Folded	1 roll	1	12
	ICPP110	Pro Pac, 9' 2" x 750', Folded	1 roll	1	12
	ICPP110375	Pro Pac, 9' 2" x 375', Folded	1 roll	1	12
	ICPP122	Pro Pac, 10' 2" x 375', Folded	1 roll	1	12

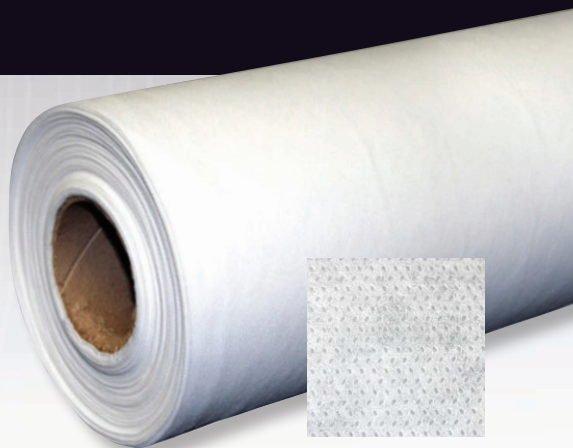

(B) ADO FLO WALL

ADO Flo Wall (Basis weight 1.66 oz per sq yard) fabric is ideal for knee walls, ceilings, sound walls and many other applications. Keep your job site dust free. Made of 100% polyester.

KEY	SKU	DESCRIPTION	MIN QTY	ROLLS/BAG	ROLLS/PALLET
B	FW4375	Flo Wall, 4' x 375'	1 roll	1	12
	FW8750	Flo Wall, 8' x 750' Folded	1 roll	1	12
	FW9375	Flo Wall, 9' x 375' Folded	1 roll	1	12
	FW9750	Flo Wall, 9' x 750' Folded	1 roll	1	12
	FW10375	Flo Wall, 10' x 375' Folded	1 roll	1	12

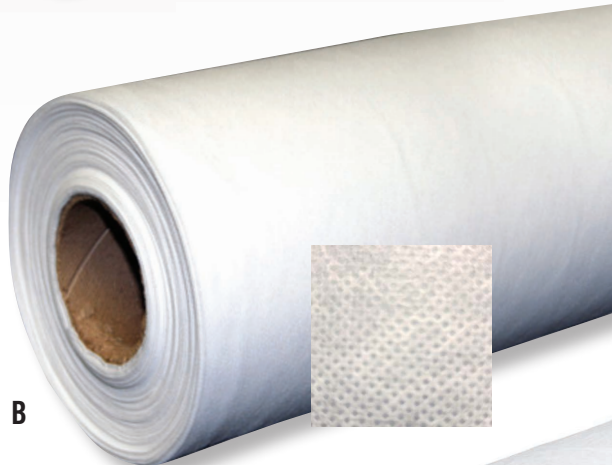

(C) ADO PRO WALL 50 PLUS

ADO Pro Wall 50 (Basis Weight 1.5 oz per sq yard) fabric is ideal for knee walls, ceilings, sound walls and many other applications. Keep your job site dust free. ADO Pro Wall 50 passes ASTM E84. Made from 100% polyester which has a low propensity for mold growth versus polypropylene.

KEY	SKU	DESCRIPTION	MIN QTY	ROLLS/BAG	ROLLS/PALLET
C	PW504375	Pro Wall 50 Plus, 4' x 375'	1 roll	1	18
	PW508375	Pro Wall 50 Plus, 8' x 375'	1 roll	1	12
	PW509375	Pro Wall 50 Plus, 9' x 375'	1 roll	1	12
	PW508750	Pro Wall 50 Plus, 8' x 750', Folded	1 roll	1	12
	PW509750	Pro Wall 50 Plus, 9' x 750', Folded	1 roll	1	12
	PW5010375	Pro Wall 50 Plus, 10' x 375', Folded	1 roll	1	12

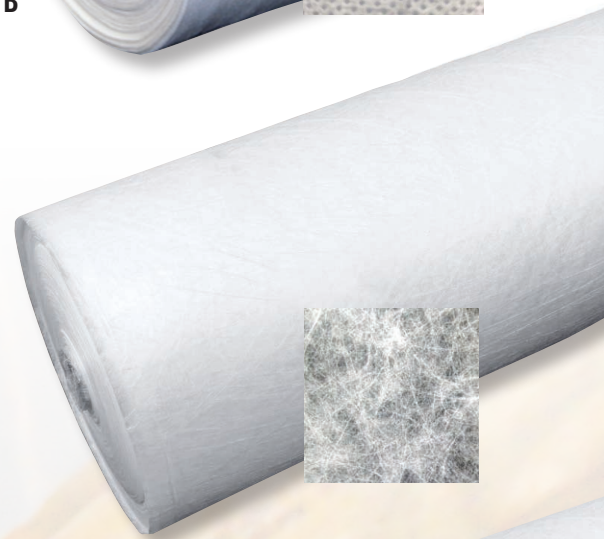

(D) ADO PRO WEB

Our premium grade non-woven netting made of 100% polypropylene. The 8', 9' and 10' rolls are folded. Ideal for wet/damp spray installations.

KEY	SKU	DESCRIPTION	MIN QTY	ROLLS/BAG	ROLLS/PALLET
D	IW4375	Pro Web, 4' x 375'	1 roll	1	30
	IW4500F	Pro Web, 4' x 1500'	1 roll	1	12
	IW8375F	Pro Web, 8' x 375', Folded	1 roll	1	12
	IW8200F	Pro Web, 8' x 750', Folded	1 roll	1	12
	IW9375F	Pro Web, 9' x 375', Folded	1 roll	1	12
	IW9200F	Pro Web, 9' x 750', Folded	1 roll	1	12
	IW1000F	Pro Web, 10' x 375', Folded	1 roll	1	12

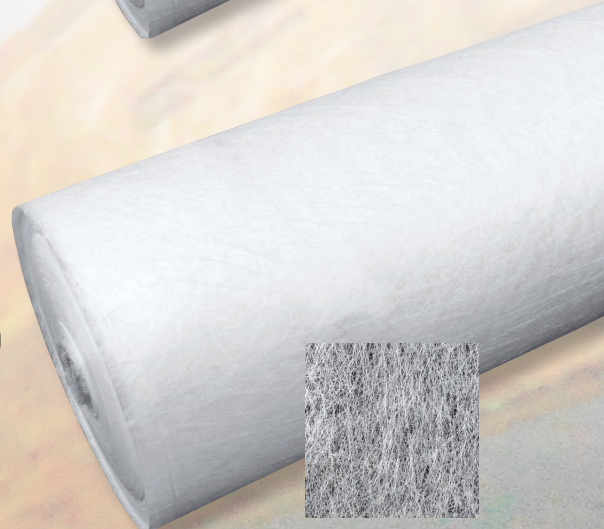

STAPLES



CONTRACTOR GRADE GALVANIZED STAPLES

Consistent quality that prevents jamming or breakage (no chicklets). Our staples are engineered to fit B&C Eagle, Fasco, Josef Kihlberg, Bostitch, Duo-Fast, Rapid, Arrow, and Prebena staplers.

SKU	DESCRIPTION	LEG LGTH	CROWN	FITS TACKER/STAPLER	QTY/BOX	BX/CASE	CASES/PALLET
B1950	STCR261906	1/4"	1/2"	HTH306	5M	50	48
B2000	STCR261908	5/16"	1/2"	HTH306	5M	50	48
B5000	STCR261910	3/8"	1/2"	HTH306	5M	50	30
B2250	STCR501906	1/4"	7/16"	HTH308, HTPC2K	5M	20	48
B2500	STCR501910	3/8"	7/16"	HTH308, HTPC2K	5M	20	48
D3575	DF5008	1/4"	1/2"	HT550CL, F1A50, BCED	5M	20	64
D3000	DF5010	5/16"	1/2"	HT550CL, F1A50, BCED	5M	20	64
J6000	No. 7	1/4"	3/8"	JK670, F1A7C, BCEJ670	10M	20	48
J6225	No. 7	5/16"	3/8"	JK670, F1A7C, BCEJ670	10M	20	48
K7000	No. 8	5/16"	1/2"	JK680, F1A80, BCEK680	10M	20	48
K7250	No. 8	1/2"	1/2"	JK680, F1A80, BCEK680	6M	20	60
R4575	RA19	1/4"	3/8"	HTA19	5M	50	48
RA1026	RA11	1/4"	3/8"	HTA11, T-50, F1A11, HTPF9, BCERA, R311	5M	20	64
RA1008	RA11	5/16"	3/8"	HTA11, T-50, F1A11, HTPF9, BCERA, R311	5M	20	64
RA1010	RA11	3/8"	3/8"	HTA11, T-50, F1A11, HTPF9, BCERA, R311	5M	20	64
A1650		1/2"		T-50, F1A11, BCERA	5M	20	64



(A) GENUINE BOSTITCH® STAPLES

High quality, light duty PowerCrown™ galvanized staples, with blunt chisel-point.

KEY	SKU	DESCRIPTION	FITS TACKER/STAPLER	BOXES/CASE	CASES/PALLET
A	B2000G	Bostitch STCR261908	HTH306	20	112

5/16", 5M/Box

(B) GENUINE DUO-FAST® STAPLES – 5000 SERIES

Wide crown fine wire staples are high quality, chisel-point. Galvanized.

KEY	SKU	DESCRIPTION	FITS TACKER/STAPLER	BOXES/CASE	CASES/PALLET
B	D3000G	Duo-Fast DF5010	HT550CL	20	36
	5008CDF	Duo-Fast DF5010	HT550CL	20	36

1/4", 5M/Box

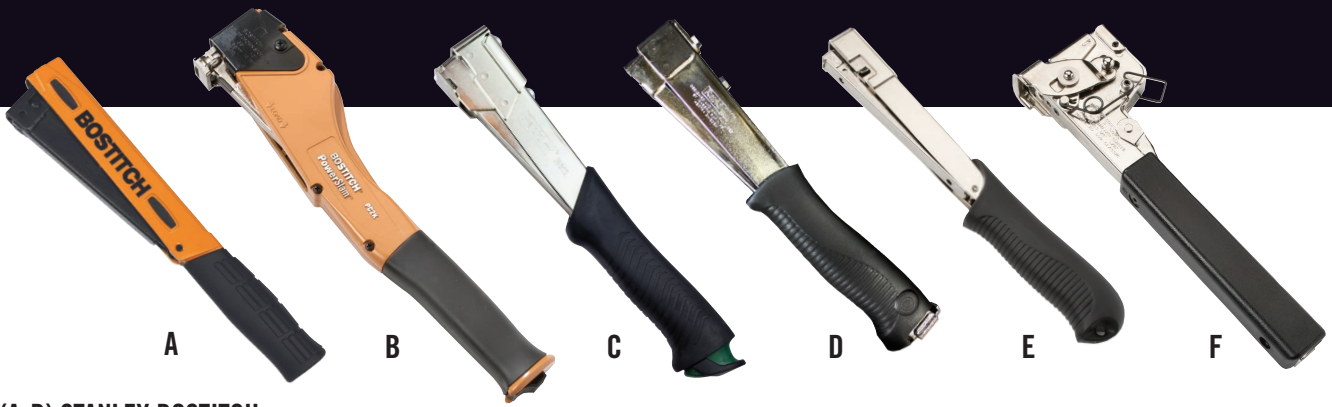

(A-B) STANLEY BOSTITCH

The H30-6 and the H30-8 PowerCrown™ staplers feature a compact, powerful design and quick-load magazines. The H30-6 uses thinner fine wire staples and the H30-8 uses thicker medium wire staples. The H30-6 can be fitted with 1/4", 5/16" or 3/8" staples; the H30-8 with 1/4" or 3/8" staples; and the PC2K with 1/4" or 3/8" staples.

KEY	SKU	DESCRIPTION	MIN QTY	TACKERS/CASE
A	HTH306	Bostitch H30-6	each	6
	HTH308	Bostitch H30-8	each	6
B	HTPC2K	Bostitch PC2K	each	4

Refer to schematics on page 71.

(C-E) RAPID

- R311 – Simple and reliable bottom-loading for staples between 1/4" to 1/2" with reversible driver blade
- A-11 – Easy-to-load and operate All-steel construction, and can be fitted with 1/4", 5/16" or 3/8" staples
- A-19 – Smaller, disposable version offering the most economical tacker/staple combination on the market and can be fitted with 1/4" staples

KEY	SKU	DESCRIPTION	MIN QTY	TACKERS/CASE
C	R311	Rapid R311	each	10
D	HTA11	Rapid A-11	each	10
E	HTA19	Rapid A-19	each	10

(F) DUO-FAST®

The HT-550 Classic features durable construction and two-strip staple capacity. Can be fitted with 1/4" or 5/16" staples.

KEY	SKU	DESCRIPTION	MIN QTY	TACKERS/CASE
F	HT550CL	Duo-Fast HT-550 Classic	each	5

Refer to schematics on page 71.



(G) AIR HOSES

Contractor's Choice reinforced polyurethane air hose. Lightweight—only 3.69 lbs for a 100' hose. Tough reinforced polyurethane—250 psi. Won't kink, twist or crush—flexible down to -40°F. Sold as pre-made assemblies with reusable fittings. Couplers, connectors, reusable ends for mending sold separately.

KEY	SKU	DESCRIPTION	MIN QTY
G	PUR14X50	Air Hose with Reusable Ends—1/4" x 50'††	each
	PUR38X50	Air Hose with Reusable Ends—3/8" x 50'††	each

†† Note: 1/4" and 3/8" hoses have 1/4" male NPT hose ends.



(H) B&C EAGLE HT 550H

Heavy Duty 5000 Series Hammer Tacker that works with 1/2" crown 5000 series 1/4" to 3/8" staples. The B&C Eagle HT 550H features a quick loading magazine and a comfortable rubber grip. Magazine is designed to fit two sleeves of our D3575 or D3000 staples.

KEY	SKU	DESCRIPTION	MIN QTY	TACKERS/CASE
H	ADOHT550H	B&C Eagle HT 550	each	10

(I-J) B&C EAGLE AND JOSEF KIHLEBERG

Lightweight Pneumatic tools designed for applying netting and roofing felt. Up to 1700 staples per minute. Easily adjusts to operator preferences. Double-length magazine provides large load capacity. **Note: All B&C Eagle and Josef Kihlberg pneumatic staplers will need a Milton plug, male—1/4".**

KEY	SKU	DESCRIPTION	STAPLES USED:	MIN QTY
I	BCEJ670	Stapler, Pneumatic Auto-Fire, J Series	J6000, J6225	each
	BCEK680	Stapler, Pneumatic Auto-Fire (80 series) K Series	K7000, K7250	each
BCED	Stapler, Pneumatic Auto-Fire, D Series	D3575, D3000, D3000G	each	
BCERA	Stapler, Pneumatic Auto-Fire, RA Series	RA1026, RA1008, RA1010, A1650	each	
J	JK670	Josef Kihlberg JK670L, Auto-Fire	J6000, J6225	each
	JK680	Josef Kihlberg JK680L, Auto-Fire	K7000, K7250	each



(K) PNEUMATIC TOOL ACCESSORIES

KEY	SKU	DESCRIPTION	MIN QTY
K	ATOIL8	Tool Tool Oil—8 oz Bottle	each



A

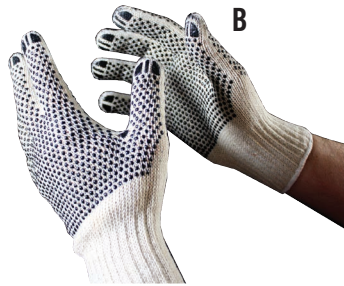

B



C



D



E



F



G

(A) G-TEK GLOVES

These easy-grip gloves are perfect for the insulation industry. Constructed of woven nylon, the nitrile coated palm and fingers will allow you to pick up the smallest of items without having to remove your gloves.

KEY	SKU	DESCRIPTION	MIN QTY
A	G225M	Nylon Gloves, Nitrile Dipped—Medium	1 pair
	G225L	Nylon Gloves, Nitrile Dipped—Large	1 pair
	G225XL	Nylon Gloves, Nitrile Dipped—X-Large	1 pair

(B) DOUBLE-DOT FINGERNAILS™ GLOVES

Seamless cotton/polyester gloves with two-sided PVC dots.

KEY	SKU	DESCRIPTION	MIN QTY
B	G2DDL	Gloves, FingerNails™ Double Dot—Large	1 pair

(C) LEATHER PALM WORK GLOVES

Leather palm work glove constructed of heavy side split cowhide.

KEY	SKU	DESCRIPTION	MIN QTY
C	6706529	Gloves, Split Palm Leather	1 pair

(D) LATEX PALM COAT GLOVES

String knit glove with a blue latex palm. Coated palm offers abrasion resistance and increased grip. Uncoated back allows the hand to breathe.

KEY	SKU	DESCRIPTION	MIN QTY
D	G122L	Gloves, String Knit, Blue Latex Palm Coat—Large	1 pair

(E) BROWN JERSEY GLOVES

Strong, comfortable hand protection, 8 oz. brown cotton jersey knit. Ideal for general purpose applications.

KEY	SKU	DESCRIPTION	MIN QTY
E	6706563	Gloves, Brown Jersey, Mens	1 pair

(F) PRO IMPACT BLACK “HIGH PERFORMANCE” GLOVES

Synthetic leather palm for secure grip, silicone strips on fingertips for handling small tools and parts, padded palms. Perfect for use with pneumatic tools. Velcro® closure.

KEY	SKU	DESCRIPTION	MIN QTY
F	6713	Gloves, Pro Impact Black—Large	1 pair
	6714	Gloves, Pro Impact Black—X-Large	1 pair

(G) HEADLAMPS

Includes three LEDs and a xenon bulb in the same reflector. Three-position lighting lets you select the best combination of lights for the task at hand. Powered by 3 "AAA" alkaline batteries (included). 300 mA xenon bi-pin bulb, plus three 100,000-hour life LEDs. 18 lumens typical (xenon); 24 lumens typical (3 LEDs). Weighs 4.64 oz.

KEY	SKU	DESCRIPTION	MIN QTY
G	61050	Headlamp, 3 LED with Xenon Bulb—Black	each



(A) MARK II HOSE

The industry standard. Lightweight polyethylene hose features abrasion-resistant crown and translucent ribbed walls for easy monitoring of material flow. Durable and economical. Interior walls are designed to fluff material.

KEY	SKU	DESCRIPTION	MIN QTY
A	MK1550	Mark II Clear Hose—1-1/2" x 50'	each
	MK2050	Mark II Clear Hose—2" x 50'	each
	MK2510	Mark II Clear Hose—2-1/2" x 10'	each
	MK2550	Mark II Clear Hose—2-1/2" x 50'	each
	MK3050	Mark II Clear Hose—3" x 50'	each
	MK3550	Mark II Clear Hose—3-1/2" x 50'	each
	MK4050	Mark II Clear Hose—4" x 50'	each

NOTE: Measurements are the inside diameter of the hose.

(B) MARK E-2 HOSE

A perfect lightweight hose that combines the wire reinforced strength of the Urethane Flexible style hoses, constructed out of Polyethylene material like the industry standard Mark II style hoses. The clear E-2 style hose with a spring steel wire helix provides efficient flow characteristics and is abrasion resistant. The maximum negative pressure rating for vacuuming applications far exceeds the ratings of the Mark II style hose and is equivalent to that of the Urethane Flexible style hoses.

KEY	SKU	DESCRIPTION	MIN QTY
B	MK6025W	Clear E-2 Flex Hose—6" x 25'	each

NOTE: Measurements are the inside diameter of the hose.

(E) WALL TUBING

Available in winter grades. Wall tubing attaches to the tip of a reducing nozzle, allowing the hose to be fed into a wall cavity and then pulled out as the wall cavity fills up with insulation.

KEY	SKU	DESCRIPTION	MIN QTY
E	WT100	1" ID, 1-1/4" OD, Winter Style	per foot
	WT125	1-1/4" ID, 1-1/2" OD, Winter Style	per foot
	WT150	1-1/2" ID, 2" OD, Winter Style	per foot
	WT200	2" ID, 2-1/2" OD, Winter Style	per foot

(C) URETHANE FLEX HOSE

Very lightweight clear polyurethane hose reinforced with a spring steel wire helix that provides excellent flexibility. The smooth bore offers a combination of efficient flow characteristics and abrasion resistance. Moisture resistant, temperature range -65° F to 200° F.

KEY	SKU	DESCRIPTION	MIN QTY
C	FT2050	Clear Urethane Flex Hose—2" x 50'	each
	FT2550	Clear Urethane Flex Hose—2-1/2" x 50'	each
	FT3050	Clear Urethane Flex Hose—3" x 50'	each
	FT3550	Clear Urethane Flex Hose—3-1/2" x 50'	each
	FT4050	Clear Urethane Flex Hose—4" x 50'	each
	FT6025	Clear Urethane Flex Hose—6" x 25'	each

NOTE: Measurements are the inside diameter of the hose.

(D) FLEX TUBE HOSES

Medium weight clear co-extruded elastomer with a rigid green external polypropylene helix. Spiral co-extruded engineered construction with environmentally friendly PVC. Ultra smooth interior assures efficient airflow. Good chemical and abrasion resistance. Helix acts as a wearstrip.

KEY	SKU	DESCRIPTION	MIN QTY
D	MKFT4050	Hose, Flex-Tube EF 4" x 50' Clear with Green Helix	each
	MKFT6025	Hose, Flex-Tube EF 6" x 25' Clear with Green Helix	each



HOLE SAWS AND BITS

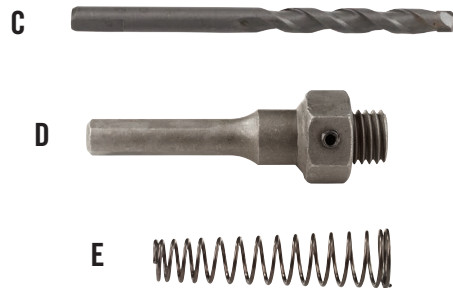
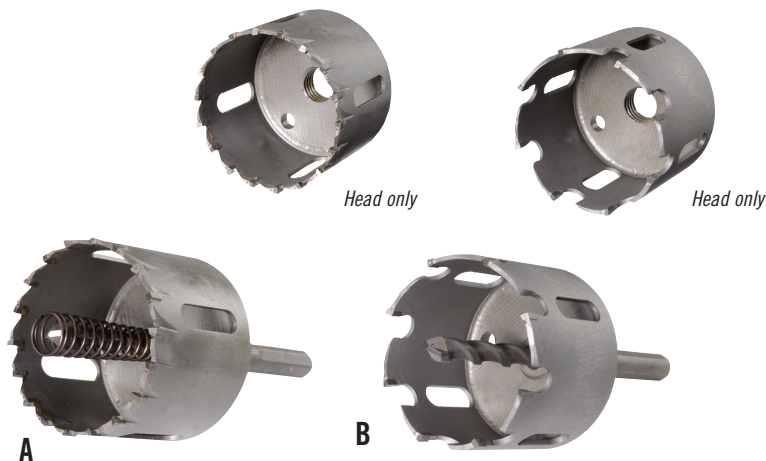

RELTON TOOTH HOLE SAWS

Ideal for cutting holes to install fiberglass, cellulose and other injected insulation. Carbide tips are brazed to the hole saw body with special high-temperature silver solder. Elongated slots allow easy plug removal. Consistently cut round holes are easily patched with wood or plastic plugs. Complete saws include cutter head, shank and carbide pilot.

(A) RELTON CARBIDE-TOOTH STUCCO HOLE SAWS

Stucco saw cuts stucco, mesh, asbestos or aluminum siding.

KEY	SKU	DESCRIPTION	MIN QTY
A	RSS100	Relton Carbide-tipped Stucco Saw—1"	each
	RSS113	Relton Carbide-tipped Stucco Saw—1-1/8"	each
	RSS125	Relton Carbide-tipped Stucco Saw—1-1/4"	each
	RSS150	Relton Carbide-tipped Stucco Saw—1-1/2"	each
	RSS200	Relton Carbide-tipped Stucco Saw—2"	each
	RSS213	Relton Carbide-tipped Stucco Saw—2-1/8"	each
	RSS250	Relton Carbide-tipped Stucco Saw—2-1/2"	each
	RSS300	Relton Carbide-tipped Stucco Saw—3"	each
	RSB200	Relton Carbide-tipped Stucco Saw—2" Head Only	each
	RSB250	Relton Carbide-tipped Stucco Saw—2-1/2" Head Only	each

(B) RELTON STEEL-TOOTH WOOD HOLE SAWS

Wood saw works best in any type wood, including particle board.

KEY	SKU	DESCRIPTION	MIN QTY
B	RWS100	Relton Carbide-tipped Wood Saw—1"	each
	RWS113	Relton Carbide-tipped Wood Saw—1-1/8"	each
	RWS125	Relton Carbide-tipped Wood Saw—1-1/4"	each
	RWS150	Relton Carbide-tipped Wood Saw—1-1/2"	each
	RWS200	Relton Carbide-tipped Wood Saw—2"	each
	RWS213	Relton Carbide-tipped Wood Saw—2-1/8"	each
	RWS250	Relton Carbide-tipped Wood Saw—2-1/2"	each
	RWS300	Relton Carbide-tipped Wood Saw—3"	each
	RWB250	Relton Carbide-tipped Wood Saw—2-1/2" Head Only	each
	RWB300	Relton Carbide-tipped Wood Saw—3" Head Only	each

(C-E) RELTON HOLE SAW REPLACEMENT PARTS

KEY	SKU	DESCRIPTION	MIN QTY
C	RSP025	Relton Pilot (for less than 2")—1/4" Carbide	each
	RSP142	Relton Pilot (for less than 2")—1/4" Steel	each
	RSP038	Relton Pilot (for 2" and more)—3/8" Carbide	each
	RSP382	Relton Pilot (for 2" and more)—3/8" Steel	each
D	RES100	Relton Shank—1/4"	each
	RES200	Relton Shank—3/8"	each
E	RES042	Relton Ejector Spring (for less than 2")	each
	RES062	Relton Ejector Spring (for 2" and more)	each

ASBESTOS CUTTER

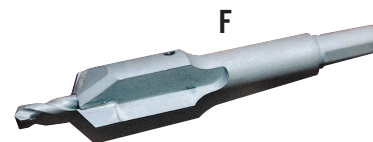

(F) ASBESTOS CUTTER BIT

Rugged bits, best for asbestos siding. Built to be sharpened repeatedly. Comes with carbide pilot.

KEY	SKU	DESCRIPTION	MIN QTY
F	AB100	1" Asbestos Bit with Carbide Pilot	each



(G-H) HOLE SAW REPLACEMENT PARTS

KEY	SKU	DESCRIPTION	MIN QTY
G	PBC475	Pilot Bit—4-3/4" Carbide-tipped	each
	PBHS313	Pilot Bit—3-1/8" Hole Saw, High-speed Steel	each
	MHS38	Hole Saw Mandrel—3/8"	each
H	MHS12	Hole Saw Mandrel—1/2"	each



WOOD BORING SYSTEM

One-piece construction bits with cutter blades welded to shanks. They are self-feeding with one replaceable pilot screw that fits all sizes, eliminating the need to match parts. The black oxide finish is rust resistant. The easy to use, fast cutting bits won't separate when backing out, and they're easy to sharpen with only two cutters.

(A) SELF-FEED WOOD BITS

Automatic-feed wood bits feature outside diameter threads and replaceable lead screws.

KEY	SKU	DESCRIPTION	MIN QTY
A	SFWB1	Bit—1" Self-feed, Wood	each
	SFWB125	Bit—1-1/4" Self-feed, Wood	each
	SFWB150	Bit—1-1/2" Self-feed, Wood	each
	SFWB2	Bit—2" Self-feed, Wood	each
	SFWB2125	Bit—2-1/8" Self-feed, Wood	each
	SFWB256	Bit—2-9/16" Self-feed, Wood	each

(B-C) WOOD BIT REPLACEMENT PARTS

KEY	SKU	DESCRIPTION	MIN QTY
B	RSFK18	Replacement Kit, Self-feed 1/8"	each
C	ESFB6	Extension, 6", 7/16" Shank (3/pk)	each
	ESFB12	Extension, 12", 7/16" Shank	each



HOLE SAWS

Long-lasting bi-metal hole saws. Arbor, standard and carbide-tipped pilots sold separately.

(D) BI-METAL HOLE SAWS

Bi-metal construction with a high-speed steel cutting edge. Vari-Tooth design creates sharper tooth tips for faster, freer cutting. Cutting depth is 1-1/2". Positive rake tooth creates a more aggressive cutting action than conventional tooth styles.

KEY	SKU	DESCRIPTION	MIN QTY
D	BHS1	Bi-metal Hole Saw—1"	each
	BHS1125	Bi-metal Hole Saw—1-1/8"	each
	BHS125	Bi-metal Hole Saw—1-1/4"	each
	BHS150	Bi-metal Hole Saw—1-1/2"	each
	BHS2	Bi-metal Hole Saw—2"	each
	BHS206	Bi-metal Hole Saw—2-1/16"	each
	BHS2125	Bi-metal Hole Saw—2-1/8"	each
	BHS250	Bi-metal Hole Saw—2-1/2"	each
	BHS256	Bi-metal Hole Saw—2-9/16"	each
	BHS3	Bi-metal Hole Saw—3"	each

(E-K) BI-METAL HOLE SAW PARTS

KEY	SKU	DESCRIPTION	MIN QTY
E	PBHS313	High Speed Steel Pilot Bit, 3-1/8"	each
F	PBC475	Carbide-Tipped Pilot Bit, 4-3/4"	each
G	MHS12	Quick Change Mandrel, 1/2" Shank	each
H	MHS38	Quick Change Mandrel, 3/8" Shank	each
I	MHS916	Standard Mandrel, 3/8" Shank Fits Hole Saws 9/16" to 6", 3/8" Shank	each
J	AHS916	Quick Change Adaptor, Fits Hole Saws 9/16" to 1-3/16"	each
K	AHS125	Quick Change Adaptor, Fits Hole Saws 1-1/4" to 6"	each



BOSCH



A

(A) LONG NOSE PLASTIC PLUGS

Exceptional design. With a 5/8" shank and heavy gripping teeth, this plug will hold in both single and multiple layers of siding. Extra wide cap has a tapered edge for obscured vision on siding. Textured surface for easy painting.

KEY	SKU	DESCRIPTION	QTY/BAG
A	LS100B	Long Nose Plastic—1"	500
	LS125B	Long Nose Plastic—1-1/4"	250
	LS150B	Long Nose Plastic—1-1/2"	250
	LS200B	Long Nose Plastic—2"	250

Measurements are the diameter of the threads and not the cap of the plug.



B

(B) REGULAR PLASTIC PLUGS

Paintable matte finish with a 3/8" shank and two clips on each side for a firm grip in aluminum, vinyl and steel siding.

KEY	SKU	DESCRIPTION	QTY/BAG
B	SP100B	Regular Plastic—1"	500
	SP125B	Regular Plastic—1-1/4"	250
	SP150B	Regular Plastic—1-1/2"	250
	SP200B	Regular Plastic—2"	250
	SP213BLB	Regular Plastic, Black—2-1/8"	250
	SP250B	Regular Plastic—2-1/2"	250
	SP300BL	Regular Plastic, Black—3"	100

Measurements are the diameter of the threads and not the cap of the plug.



C

(C) FOAM (STYROFOAM) PLUGS

Styrofoam plugs are used for holes in drywall and are recessed to accept spackling compound. They absorb little moisture, thus require fewer layers of spackling for a smooth finish.

KEY	SKU	DESCRIPTION	QTY/BAG
C	FP100B	Foam—1"	1000
	FP150B	Foam—1-1/2"	1000
	FP200B	Foam—2"	1000
	FP213B	Foam—2-1/8"	1000
	FP250B	Foam—2-1/2"	750
	FP256B	Foam—2-9/16"	750
	FP279B	Foam—2-5/8"	750
	FP300B	Foam—3"	500



D

(D) PINE WOOD PLUGS

Unlike other plugs, which are completely tapered, these wood plugs are slightly tapered over only 7/8 of the total thickness for easy insertion. The top 1/8 is the full diameter measurement for a tight, even fit. Made from kiln-dried lumber and produced on specially designed equipment for consistent high quality.

KEY	SKU	DESCRIPTION	QTY/BAG
D	WP100B	Pine—1"	250
	WP125B	Pine—1-1/4"	175
	WP150B	Pine—1-1/2"	125
	WP200B	Pine—2"	250
	WP201B	Pine, std—2" †	250
	WP213B	Pine—2-1/8"	250
	WP225B	Pine—2-1/4"	225
	WP250B	Pine—2-1/2"	175
	WP256B	Pine—2-9/16"	175
	WP300B	Pine—3"	125

† For use with Milwaukee hole saws.

(A-B) HOSE REELS

All hose reels have heavy duty bearings. The large hose reel stands upright and the extra large hose reel is to be wall mounted.

- X-Large reel holds: 150' of 4" hose, or 200' of 3-1/2" hose
- Large reel holds: 150' of 3" hose, 200' of 2-1/2" hose, or 250' of 2" hose

KEY	SKU	DESCRIPTION	MIN QTY
A	HR300	Large, 36" L x 23" W x 39" H	each
B	HR350	X-Large, 44" Dia x 28" W	each

(C) STEEL CONNECTORS

Provide durable, secure links between hose sections. Inside extensions are long enough to safely attach clamps for secure fits.

KEY	SKU	DESCRIPTION	MIN QTY
C	SC200	Steel Connector—2"	each
	SC250	Steel Connector—2-1/2"	each
	SC300	Steel Connector—3"	each
	SC349	Steel Connector—3-1/2"	each
	SC400	Steel Connector—4"	each
	SC600	Steel Connector—6"	each

(D) STEEL REDUCERS

KEY	SKU	DESCRIPTION	MIN QTY
D	RC252	Steel Reducer—2-1/2" to 2"	each
	RC320	Steel Reducer—3" to 2"	each
	RC325	Steel Reducer—3" to 2-1/2"	each
	RC352	Steel Reducer—3-1/2" to 2-1/2"	each
	RC353	Steel Reducer—3-1/2" to 3"	each
	RC430	Steel Reducer—4" to 3"	each
	RC435	Steel Reducer—4" to 3-1/2"	each
	RC640	Steel Reducer—6" to 4"	each

(E) HOSE CLAMPS

Steel clamps with worm drive adjust to fit 2", 2-1/2", 3", 3-1/2", 4" or 6" connectors, reducers or nozzles.

KEY	SKU	DESCRIPTION	MIN QTY
E	CL100	Hose Clamp—2" to 3"	each
	CL400	Hose Clamp—4"	each
	CL600	Hose Clamp—6"	each



(F) INTEC SWIVEL CONNECTORS

Swivel hose connectors can be used for blowing or vacuum applications. They provide the installer freedom and agility to move around by reducing tangles and kinks in the hose.

KEY	SKU	DESCRIPTION	MIN QTY
F	J52053	3" Straight Swivel Hose Connector	each
	J52058	4" Straight Swivel Hose Connector	each
	J52054	6" Straight Swivel Hose Connector	each

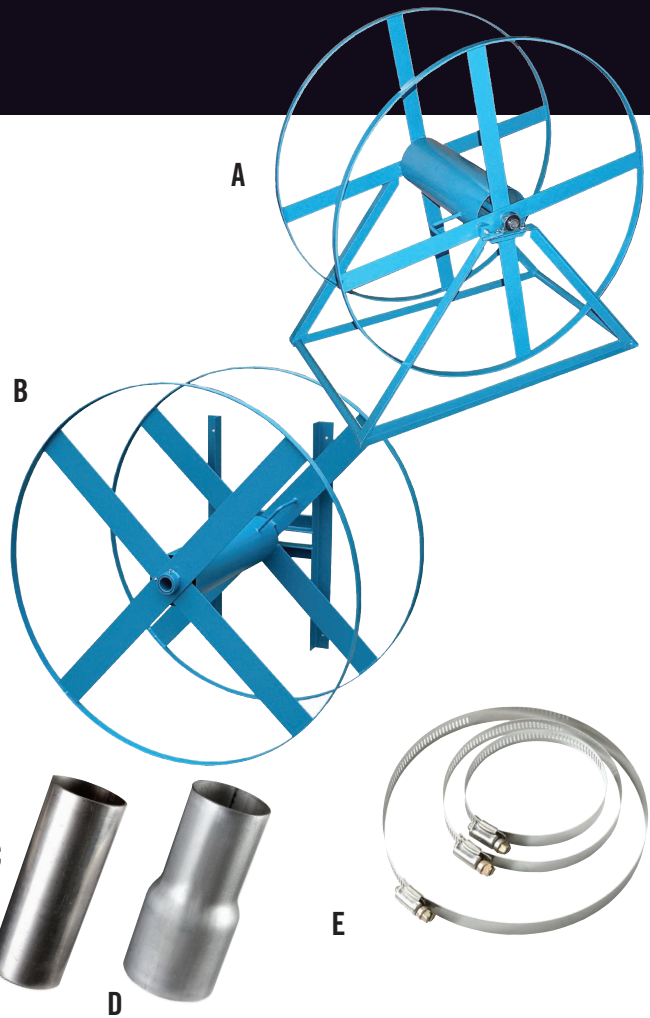

DRY-SPRAY NOZZLES

(G-K) DRY-SPRAY NOZZLES

We offer a wide variety of sizes and types of steel nozzles.

KEY	SKU	DESCRIPTION	MIN QTY
G	RN210	Steel Reducing Nozzle—2" to 1"	each
	RN214	Steel Reducing Nozzle—2" to 1-1/4" (not shown)	each
	RN215	Steel Reducing Nozzle—2" to 1-1/2" (not shown)	each
H	BR211	Plastic Reducing Nozzle—2" to 1" or 1-1/2"	each
I	BN2625	Brick Reducing Nozzle—2" to 5/8"	each
J	DS201	Directional Swivel Nozzle—2"	each
	DS251	Directional Swivel Nozzle—2-1/2"	each
	DS252	Directional Swivel Reducer—2-1/2" to 2"	each
K	DS200	Directional Nozzle—2"	each
	DS250	Directional Nozzle—2-1/2"	each

PUMPS, MOTORS AND NOZZLES

(A) MP-20 PUMP AND MOTOR

High quality, double belt-driven pump with 1 HP TEFC motor offers easy, reliable operation. Ideal for the entry level contractor as well as the professional contractor. Maximum flow: 5.7 gpm. Maximum pressure: 180 psi. Maximum speed: 650 rpm.

KEY	SKU	DESCRIPTION	MIN QTY
A	WS120	MP-20 Pump and Motor	each

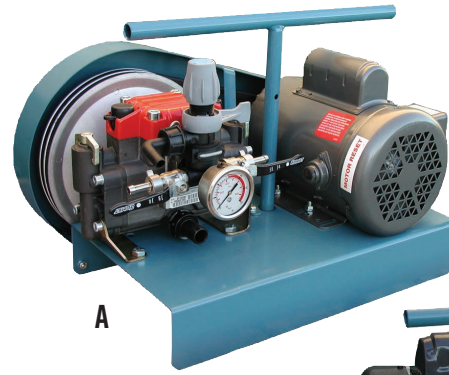

(B) M-3 PUMP AND MOTOR

Economical direct-drive, self-priming, triple diaphragm pump with a 1 HP TEFC motor. Ideal for the entry level contractor as well as the professional contractor. Maximum flow: 3 gpm. Maximum pressure: 300 psi. Maximum speed: 1,725 rpm.

KEY	SKU	DESCRIPTION	MIN QTY
B	WS030	M-3 Pump and Motor	each



(C) WATER HOSE

KEY	SKU	DESCRIPTION	MIN QTY
C	WH50	Water Hose, 3/8" X 50' (300 psi max)	each
	WH100	Water Hose, 3/8" X 100' (300 psi max)	each
	WH150	Water Hose, 3/8" X 150' (300 psi max)	each
	WH200	Water Hose, 3/8" X 200' (300 psi max)	each



(D) KRENDL 2-JET WET-SPRAY WALL CAVITY NOZZLES

Wide oval discharge allows for maximum flow of coarse, wet, recycled fibers without plugging. Rigid attachment of spray tip body to internally machined head eliminates misalignment and nuisance pressure tubing leaks caused by frequent accidental impacts. Quick-connect tips sold separately—QD202, #2502 standard.

KEY	SKU	DESCRIPTION	MIN QTY
D	WS202W	Krendl 2-jet Nozzle—2"	each
	WS252W	Krendl 2-jet Nozzle—2-1/2"	each
	WS320W	Krendl 2-jet Nozzle—3"	each

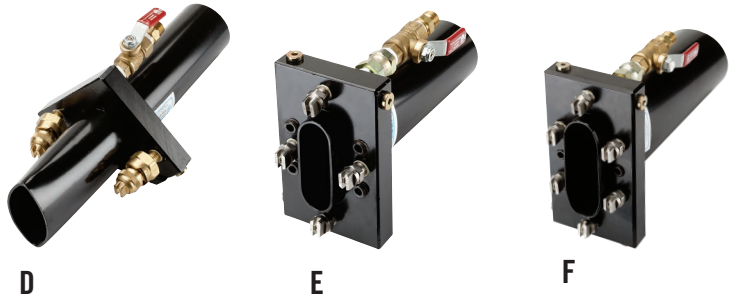

NOTE: Please consult your Insulation Account Manager for additional specifics on wet spray nozzle tips. Requirements vary by insulation manufacturer.

(E-F) KRENDL 4-JET AND 6-JET WET-SPRAY COMMERCIAL NOZZLES

Narrow, flat orifice increases dispersing, velocity and impact of fiber. This will maintain a flat, smooth flowing spray pattern which will fully encapsulate the fibers. Stainless steel, screw-in style tips #4002 standard, sold separately.

KEY	SKU	DESCRIPTION	MIN QTY
E	WS204C	Krendl 4-jet Commercial Nozzle—2"	each
	WS254C	Krendl 4-jet Commercial Nozzle—2-1/2"	each
F	WS256C	Krendl 6-jet Commercial Nozzle—2-1/2"	each

KRENDL WET-SPRAY TIPS—BRASS QUICK-CONNECT

SKU	DESCRIPTION	MIN QTY
QD200	Base Adapter	each
QD201	#2501	each
QD215	#25015	each
QD202	#2502	each
QD203	#2503	each
QD401	#4001	each
QD415	#40015	each
QD402	#4002	each

KRENDL WET-SPRAY TIPS—STAINLESS STEEL SCREW-IN

SKU	DESCRIPTION	MIN QTY
WS301	#1501	each
WS303	#4001	each
WS302	#40015	each
WS300	#4002	each
WS304	#4008	each



Krendl Wet-Spray Tips
Base adapter



Krendl Wet-Spray Tips
Brass Quick-Connect



Krendl Wet-Spray Tips
Stainless Steel Screw-In

(A) GRAPHITE POWDER

Reduces static electricity and friction. Occasionally blend one or two cans with cellulose and run through the blower and hose.

KEY	SKU	DESCRIPTION	MIN QTY	QTY/CASE
A	PG430	Graphite Powder—16 oz can	1 can	12

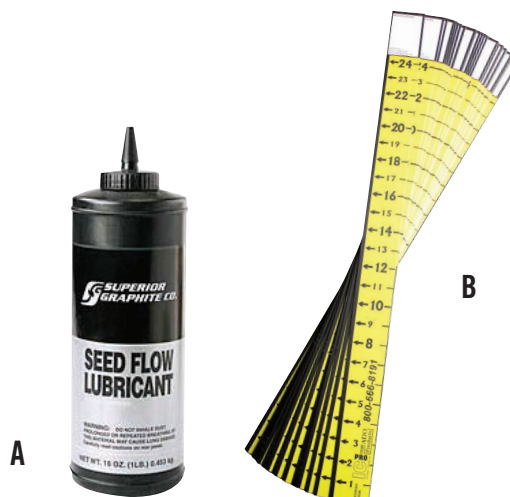

(B) ATTIC R-VALUE RULERS

Highly visible attic rulers are printed on one side and measure up to 24" of insulation.

KEY	SKU	DESCRIPTION	QTY/BOX
B	RT240N	24" R-Value Rulers	225

(C-E) KRENDL STUD SCRUBBERS

120Vac, 1/8 HP TEFC motor, belt-driven rubber rollers with tensioners. Used to remove excess spray-on insulation between wall studs, allowing for easy installation of drywall. The 27" wide scrubber is for use on 24" OC, the 18" width for 16" OC. Works well in closets or congested areas.

KEY	SKU	DESCRIPTION	MIN QTY
C	KS160	Krendl Stud Scrubber—18"	each
	KS240	Krendl Stud Scrubber—27"	each
D	KS160V	Krendl Stud Scrubber, Vertical—18"	each
	KS240V	Krendl Stud Scrubber, Vertical—27"	each
	KS290V	Krendl Stud Scrubber, Vertical—18" w/30" Extension	each
	KS300V	Krendl Stud Scrubber, Vertical—27" w/30" Extension	each
E	KS290	Krendl Stud Scrubber—18" w/30" Extension	each
	KS300	Krendl Stud Scrubber—27" w/30" Extension	each



KRENDL STUD SCRUBBER PARTS

SKU	DESCRIPTION	MIN QTY
KS161	18" Roller Assembly	each
KS241	27" Roller Assembly	each
KS242	28" Belting (2 per set)	each
KS243	17" Belting (2 per set)	each
KS245	Scrubber Motor	each
KS247	13" V-belt	each
KS251	70" V-belt for 30' Extension	each

BLOWING MACHINES

A



(A) KRENDL 425 BLOWING MACHINE

The Krendl 425 is designed for low maintenance, rugged performance, and portability. Provides large hopper capacity with user friendly controls.

Specifications:

- Light weight machine: 220 lbs
- User friendly electric panel
- Hopper capacity: 7 Cubic ft.
- 2.5" Outlet
- Power requirements:
Single input: 15 AMP, 120 volt/60hz
Double input: 15/15 AMP, 120 volt/60hz
- Output: Fiberglass: 200 lbs/hour (8 AMP Blower),
480 lbs/hour (14 AMP Blower)
Cellulose: 1100 lbs/hour (8 AMP Blower)
1400 lbs/hour (14 AMP Blower)

• Power cords not included

KEY	SKU	DESCRIPTION	WEIGHT (LBS)
A	KM425	Blowing Machine, Krendl 425, Single Input, 8 AMP Blower	220
A	KM425D	Blowing Machine, Krendl 425, Double Input, 14 AMP Blower	220

(B) KRENDL 475 BLOWING MACHINE

The Krendl 475 is an economical machine for the professional contractor. Designed for low maintenance and high production, the 475 provides a large easy loading hopper while offering simple rugged performance.

Specifications:

- Double 14 Amp / 2-stage blowers
- Clear acrylic safety guard for easy inspection
- LED start and stop buttons and Digital voltmeter
- Dual variable blower controls
- 3" Outlet
- Semi pneumatic run flat treaded tire
- Hopper capacity: 14 Cubic ft.
- Power requirements:
Double input: 15/15 AMPs each, 120 volt/60hz
- Output: Fiberglass: 700 lbs/hour
Cellulose: 2100 lbs/hour

• Power cords not included

KEY	SKU	DESCRIPTION	WEIGHT (LBS)
B	KM475	Blowing Machine, Krendl 475, Double Input	355



B

(C) KRENDL 575 BLOWING MACHINE

The Krendl 575 provides the highest production in its class for all brands of cellulose and fiberglass. Designed with the professional contractor in mind, the 575 will outperform and outlast the competition.

Specifications:

- Lightest machine in its class
- User-friendly electronic dashboard
- Double 14 Amp / 2-stage blowers
- Clear acrylic safety guard for easy inspection
- LED start and stop buttons
- Dual variable blower controls
- Digital voltmeter
- Semi-pneumatic run flat treaded tires
- Hopper capacity: 14 Cubic ft.
- 3" Outlet
- Power requirements:
Double input: 30/15 AMPs each, 120 volt/60hz
Single input: 30 AMP, 240 volt/60hz
- Output: Fiberglass: 800-1000 lbs/hour
Cellulose: 2600-2800 lbs/hour

• Power cords not included

KEY	SKU	DESCRIPTION	WEIGHT (LBS)
C	KM575D	Blowing Machine, Krendl 575, Double Input	380
C	KM575S	Blowing Machine, Krendl 575, Single Input	380

POWER CORDS

Twist plug heavy duty all weathered extension cords for use with Krendl Blowing machines.

MACHINE	50' CORD OPTION	100' CORD OPTION
325	(1) of EXTCORD-A	(1) of EXTCORD-B
425 SI	(1) of EXTCORD-A	(1) of EXTCORD-B
425 DI	(2) of EXTCORD-A	(2) of EXTCORD-B
475 DI	(2) of EXTCORD-A	(2) of EXTCORD-B
575 DI	(1) of EXTCORD-A & (1) EXTCORD-L	(1) of EXTCORD-B & (1) EXTCORD-M
575, FG1100 1300, 2300 SI	(1) of EXTCORD-G	(1) of EXTCORD-H
FG1100, 1300 2300 DI	(1) of EXTCORD-C & (1) EXTCORD-D	(1) of EXTCORD-E & (1) EXTCORD-F
2300-4BLR	(1) of EXTCORD-I	(1) of EXTCORD-J

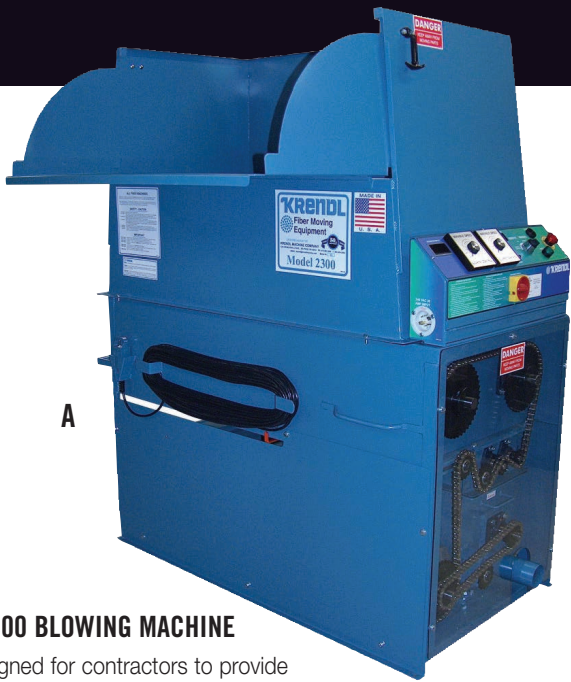

A

(A) KRENDL 2300 BLOWING MACHINE

Specifically designed for contractors to provide a smaller footprint while capable of blowing all brands of cellulose and fiberglass.

Specifications:

- User-friendly electronic dashboard
- 2 HP direct drive motor/reducer
- Hopper capacity: 40 Cubic ft.
- Power requirements:
Double input: 30/20 AMPs each, 120 volt/60hz
Single input: 30 AMP, 240 volt/60hz
- Output: Fiberglass: 1000 lbs/hour
Cellulose: 3000 lbs/hour
- Double blower system
- Slide Out Airlock system
- Clear acrylic safety guard allows for easy inspection
- Built in tool holder
- 3" Outlet

• Power cords not included

KEY	SKU	DESCRIPTION	WEIGHT (LBS)
A	KM2300D	Blowing Machine, Krendl 2300, Double Input	846
A	KM2300S	Blowing Machine, Krendl 2300, Single Input	846

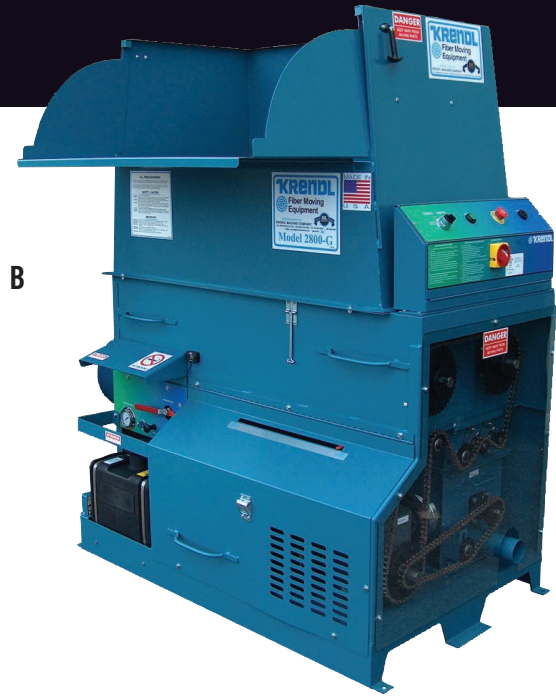

B

(B) KRENDL 2800-G BLOWING MACHINE

Specifically designed for contractors to provide a smaller footprint while capable of blowing all brands of cellulose and fiberglass.

Specifications:

- Removable all steel airlock allows quick access for maintenance
- 18 HP Briggs & Stratton V-Twin gas engine w/positive pressure lubrication system
- User-friendly 12V DC electric dashboard
- 5 gallon fuel tank
- Clear acrylic safety guard allows for easy inspection
- 3" Outlet
- Hopper capacity: 40 Cubic ft.
- Output: Fiberglass: 2100 lbs/hour
Cellulose: 3600 lbs/hour

• Power cords not included

KEY	SKU	DESCRIPTION	WEIGHT (LBS)
B	KM2800G	Blowing Machine, Krendl 2800-G, Gas Powered	1224



C

(C) KRENDL 4000-G-A

Maximize your production with your 4000-G-A all fiber machine. Designed for low maintenance and high production, the 4000-G-A with its additional agitation provides a large, easy loading hopper with adaptable fold-down folding door while offering simple rugged performance. Durable powder coat finish.

Specifications:

- Removable all steel airlock allows quick access for maintenance
- User-friendly 12 VDC electric dashboard
- Control panel with engine controls, pressure gauge and air bleed off
- 4.75 gallon fuel tank w/emergency shut off
- Hopper capacity: 62 Cubic ft.
- Positive Displacement Blower
- 4" Outlet
- Output: Fiberglass: 2200 lbs/hour
Cellulose: 4800 lbs/hour

• Power cords not included

KEY	SKU	DESCRIPTION	WEIGHT (LBS)
C	KM4000GA	Blowing Machine, Krendl 4000-G-A, Gas Powered	1684

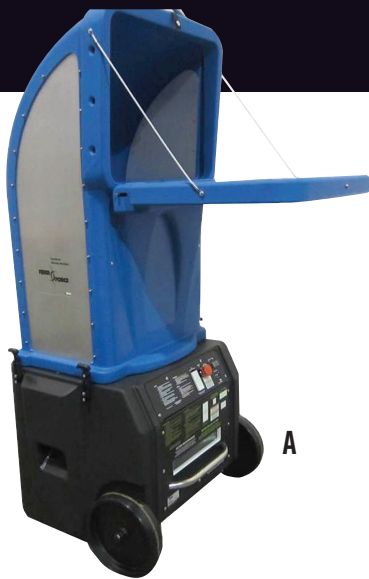

A



B



C

(A) FIBERFORCE TALL HOPPER W/ACCESSORIES

The ultimate machine for portability provides installers a compact machine with a detachable hopper for ease of transporting. Wireless remote, 1-15 amp circuit for complete operation.

Specifications:

- Hose - 2-1/2" x 50' (included)
- Wireless remote (range) - 250' (included)
- Gear motor - .38 HP @ 82 RPM
- Gear motor torque - 296 in/lb
- Blower (single stage) - 145 cfm / 2.8 psi
- Electrical - 115 VAC @ 14 amps 1610 Watts
- Power cord, type SJO (twist lock) - 14/3 x 50' (included)
- 2.5" Outlet
- Output:
Cellulose: 1,050 lbs per hr
Fiberglass: 400 lbs per hr
Results vary by manufacturer

KEY	SKU	DESCRIPTION	WEIGHT (LBS)
A	FFHOPPER	FiberForce Tall Hopper w/Accessories	220

(B) FORCE/2 HIGH POWER NEXT GENERATION

The ultimate machine for portability provides installers a compact machine with a detachable hopper for ease of transporting. Wireless remote, 1-15 amp circuit for complete operation.

Specifications:

- Dimensions - 30.25"D x 44.75"H
- Remote Cord - 18/4 x 100'
- Optional Wireless remote - Up to 250'
- Hopper Capacity - 9 cu. ft.
- Optional Hopper Ext - 13 cu. ft.
- Transmission - Custom, Direct drive
- Airlock - 12" Steel
- Blower: 115 VAC - 15 amp input, 2-stage generates over 6 psi at sea level
- Agitator motor: 1-1/2 HP 115 VAC - 15 amp input
- 3" Outlet
- Output:
Cellulose: 2,400 lbs per hr
Fiberglass: 700 lbs per hr
Rockwool: 2,100 lbs per hr
Results vary by manufacturer

• Power cords not included

KEY	SKU	DESCRIPTION	WEIGHT (LBS)
B	F257HDA	Force/2 - Requires 2 Straight Blade Power Cords	350
	F257HDW	Force/2 Next Generation Wireless - Requires 2 Straight Blade Power Cords	350

POWER CORDS – STRAIGHT BLADE

Straight blade, heavy duty, all-weather power cords for use with Intec blowing machines.

KEY	SKU	DESCRIPTION	MIN QTY
	PWRCD100SB	100' 12/3 - works with F257HD, F257HDW, TFHP3W and TFHPMAX	each
	PWRCD50SB	50' 12/3 - works with F257HD, F257HDW, TFHP3W and TFHPMAX.	each

(C) INTEC TURBO FORCE HP3 WIRELESS

The TURBO FORCE provides users with production rates similar to truck mount systems, with the performance and precision of an Intec portable system. These units have it all for the demanding professional. Large 17 cubic foot hopper & large loading platform, dual agitation for aggressive feed and conditioning, impressive production with best-in-class wall fill rates, and Intec Quick-Access design features - including revolutionary tilt-back design—to keep your uptime at a maximum.

Specifications:

- 3" Outlet
- Electrical: 115 VAC
3 - 15 amp circuits with hP3
2 - 15 amp & 1-20 amp circuit with hP MAX
- Industrial Wireless Remote with 250' operating range
- TFHP3 Output:
Cellulose: 2,475 lbs per hr
Fiberglass: 900 lbs per hr
Rockwool: 2,460 lbs per hr
Results vary by manufacturer
- TFHP MAX Output:
Cellulose: 3,200 lbs per hr
Fiberglass: 1,200 lbs per hr
Rockwool: 3,150 lbs per hr
Results vary by manufacturer
- Agitator motor: TURBO FORCE & hP3: 1/2 HP, 115 VAC, 7.1 amp
TURBO FORCE hP MAX: 3/4 HP, 115 VAC, 9.5 amp
- Airlock motor: TURBO FORCE & hP3: 1/2 HP, 115 VAC, 7.1 amp
TURBO FORCE hP MAX: 1 HP, 115 VAC, 7.8 amp

• Power cords not included

KEY	SKU	DESCRIPTION	WEIGHT (LBS)
C	TFHP3W	HP3 Wireless - Requires 3 Straight Blade Power Cords	390
	TFHPMAX	HP3 Max Wireless - Requires 2 Straight Blade Power Cords and 1 Twist Lock Power Cord	570

POWER CORDS – TWIST LOCK

Twist lock, heavy duty, all-weather power cords for use with Intec blowing machines.

KEY	SKU	DESCRIPTION	MIN QTY
	PWRCD100TL	100' 12/3 - Works with the TFHPMAX	each
	PWRCD50TL	50' 12/3 - Works with the TFHPMAX	each



(A) VORTEC BEAST VACUUM

Engineered for high productivity. Powered by a 21HP Honda GX660 V-Twin engine. A patented impeller moves high volumes of air and insulation. Highly portable design. The shroud is made of long-lasting, double-thick abrasive resistant steel at wear areas. 6" inlet and outlet with safety flaps covering both. Dispersion inlet allows for smoother and more consistent suction from the vacuum.

KEY SKU	DESCRIPTION	WEIGHT (LBS)
A IVBEAST	Intec Vortec BEAST High-Powered Vacuum—Electric Start	422
IVBEAST8	Intec Vortec BEAST 8" Inlet High-Powered Vacuum—Electric Start	422

(B) VORTEC CANNON VACUUM

Engineered for high value generation. Powered by a 13HP Vanguard V-Twin engine. A patented impeller moves high volumes of air and insulation. Highly portable design. The shroud is made of long-lasting, double-thick abrasive resistant steel at wear areas. 6" inlet and outlet with safety flaps covering both. Dispersion inlet allows for smoother and more consistent suction from the vacuum.

KEY SKU	DESCRIPTION	WEIGHT (LBS)
B IVCANNON	Intec Vortec CANNON Vacuum—Electric Start	361

(C) VORTEC VACSHIELD

By preventing foreign materials from entering the vacuum, both personal safety and the life expectancy of the vacuum are extended. Air sealed door provides easy access for cleaning and prevents any air leakage so vacuum can maintain its power.

KEY SKU	DESCRIPTION	WEIGHT (LBS)
C IVSHIELD	Vortec VACSHIELD, 6" Inlet and Outlet	28

(D) WOLVERINE WV300HD VACUUM

- 14 HP Kohler OHV with 12Vdc electric start and battery (includes a 2-year warranty on the Kohler engine)
- 4" Inlet and outlet tubes
- Heavy duty impeller

KEY SKU	DESCRIPTION	WEIGHT (LBS)
D WV300HD	Wolverine—14 HP, HD Impeller, 4"	250
WV300HD6	Wolverine—14 HP, HD Impeller, 6"	250

WOLVERINE PARTS

SKU	DESCRIPTION	MIN QTY
WV10001	Vacuum Part, Wolverine Impeller	each
WVAF	Vacuum Part, Air Filter	each

VORTEC PARTS

SKU	DESCRIPTION	MIN QTY
WVAF	Vacuum Part, Filter	each
WVHG	Vacuum Part, Gasket	each



VACUUMS

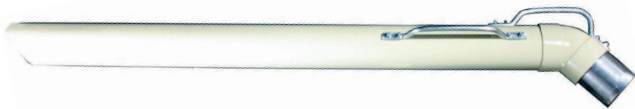

(A) KRENDL KV180 VACUUM

- 18 HP Briggs & Stratton gas engine, electric start
- 6" inlet and outlet tubes
- 18" steel fan, production of 7000 lbs/hour

KEY SKU	DESCRIPTION	WEIGHT (LBS)
A KV180	Krendl—18 HP, 6"	240

(B) KRENDL KV230 VACUUM

- 23 HP Briggs & Stratton gas engine
- Belt driven
- 6" inlet and outlet tubes
- 18" steel fan, production of 9000 lbs/hour

KEY SKU	DESCRIPTION	WEIGHT (LBS)
B KV230	Krendl—23 HP, 6"	331

(C) KRENDL VACUUM DEFENDER

Designed to remove potentially damaging debris before it comes in contact with the vacuum fan blades. Innovative design reduces wear and tear—prolonging the life of your vacuum.

- 6" Inlet and outlet tubes
- Reducer kit available

KEY SKU	DESCRIPTION	WEIGHT (LBS)
C KVDEFENDER	Krendl Vacuum Defender	60

KRENDL VACUUM DEFENDER REDUCER KIT

Includes: 6" to 4" reducer; 4" clamp; 6" clamp; 6" connector hose

KEY SKU	DESCRIPTION	MIN QTY
KV180KIT	Krendl Reducer Kit	each

(D) KRENDL IMPELLER

KEY SKU	DESCRIPTION	MIN QTY
D KV102	Vacuum Part, 18 & 23 HP Krendl Impeller	each

COMPLETE VACUUM ACCESSORY KITS

SKU	DESCRIPTION
WVAKN	4" Inlet/Outlet complete package includes:
	3 (MK4050) Mark II Clear Hose—4" x 50'
	2 (SC400) Steel Connector—4"
	6 (CL400) Hose Clamp—4"
	1 (WV101) 48" Suction Tube Attachment
	1 (450TB049) Vacuum Bags (5 bags)
WVAK6N	6" Inlet/Outlet complete package includes:
	6 (FT6025) Urethane Flex Hose—6" x 25'
	5 (SC600) Steel Connector—6"
	12 (CL600) Hose Clamp—6"
	1 (WV101) 48" Suction Tube Attachment
	1 (450TB049) Vacuum Bags (5 bags)
	1 (RC640) Steel Reducer—6" to 4"

(E-G) VACUUM BAGS AND SUCTION TUBE

KEY	SKU	DESCRIPTION	CASES/PALLET	MIN QTY
E	WV101	48" Suction Tube Attachment		each
F	450TB049	Vacuum Bags—75 cu ft., 55 GSM (5 bags/case)		1 case
G	IVAGBAGST	Vacuum Bags "Standard"—72 GSM (10 bags/case)	64	1 case
	IVACBAGGR	Vacuum Bags "Green"—80 GSM (10 bags/case)	64	1 case



(A) CONTRACTOR GRADE DRYWALL GASKET

Conformable 3/16" thick polyethylene flexible foam gasket strip (better known as sill seal). Drywall Gasket can reduce air infiltration between framing and drywall, helping to close the gaps on energy leaks. Unroll and staple to face of top and bottom plates of unfinished wall. Then apply around window and door openings before installing drywall. Larger widths for use with sealing sill plates.

KEY	SKU	DESCRIPTION	MIN QTY
A	SS2050	Drywall Gasket Sill Seal—2" x 50'	roll
	SS3550	Sill Seal—3-1/2" x 50'	roll
	SS5550	Sill Seal—5-1/2" x 50'	roll
	SS7550	Sill Seal—7-1/2" x 50'	roll

(B) 3M VINYL FOAM SEALANT TAPE

A specially formulated pressure-sensitive adhesive system applied to a very flexible, closed cell vinyl foam. The vinyl foam tape is grey in color and has a density of 10 lb. per cubic foot.

KEY	SKU	DESCRIPTION	ROLLS/CASE
B	TVFS1714	3M Vinyl Foam Sealant Tape (3/8" x 1/4") x 50'	32

(C) DOW GREAT STUFF™ GASKET FOAM

Designed to form a gasket-in-place foam where it is applied to the interior face of framing lumber, especially top and bottom plates, inside and outside corners and around rough openings. Effective at blocking air leaks past the top plate into the attic and through the bottom plate and the rim joist. Flexible and easily compressible.

- Water-based and water clean-up before cure
- Seals over rough framing features, joist hangers, strapping, etc

KEY	SKU	DESCRIPTION	CANS/CASE
C	DGASK	Dow Drywall Gasket Foam—18oz	12

See gasket foam dispensing guns on page 12.

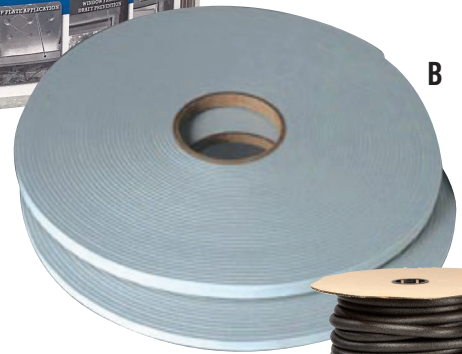
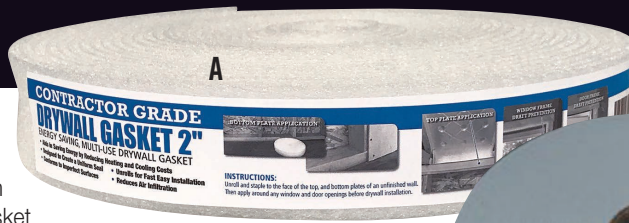

(D) MILE HIGH FOAM® BACKER ROD

Continuous lengths of flexible, round, closed cell polyethylene. Backer rod serves as a backing for elastomeric and other applied caulking sealants, controlling the depth and amount of sealant required. Black in color. All 8 sizes are shipped in an 18" x 18" x 30" box.

KEY	SKU	DESCRIPTION	ROLLS/BOX
D	BR025	Backer Rod—1/4" x 6400'	1
	BR038	Backer Rod—3/8" x 3600'	1
	BR050	Backer Rod—1/2" x 2500'	1
	BR063	Backer Rod—5/8" x 1550'	1
	BR075	Backer Rod—3/4" x 1100'	1
	BR088	Backer Rod—7/8" x 850'	1
	BR100	Backer Rod—1" x 550'	1
	BR125	Backer Rod—1-1/4" x 400'	1

(E) GRACO ULTRA MAX 795 AIRLESS SPRAYER

The Ultra Max II 795 Standard Series electric airless sprayer has a 2.2 hp brushless DC motor to handle multiple guns and includes the industry-proven Chromex pump with 2X life, SmartControl 4.0, BlueLink Job & Sprayer Management System, the lightweight and easy-to-use Contractor PC gun and more.

KEY	SKU	DESCRIPTION	QTY
E	GR17E579	Ultra Max II 795 Standard Series Airless Sprayer	each

(F) ECOSEAL PLUS™ ELASTOMERIC SEALANT

ECOSEAL Plus™ with Gasket Pro Technology is a fast-drying, water-based elastomeric spray that seals penetrations and joints in the building envelope, as well as provides a gasket between studs and drywall. Dries to a flexible but tough film and has great bond strength with low odor and zero V.O.C. Should be used with Knauf EcoBatt® Insulation or blowing insulation. Meets or exceeds all state and federal VOC requirements for architectural sealants; VOC: 0

KEY	SKU	DESCRIPTION	PAILS/PALLET
F	K498620	Knauf ECOSEAL Plus Gasket Pro	36





(A-C) WOOD HANDLE BATT KNIFE

General purpose professional cutting tool. 1" wide high carbon steel blade. Precision machine-ground cutting edge. With smooth wooden handle, this product won't get hung up on the insulation.

KEY	SKU	DESCRIPTION	MIN QTY
A	60450	Batt Knife with Wood Handle—4"	each
B	60630	Batt Knife with Wood Handle—6"	each
C	60780	Batt Knife with Wood Handle—8"	each

(D-E) BLACK DRAGON BATT KNIFE

General purpose professional cutting tool. 1" wide high carbon steel blade. Precision machine-ground cutting edge. Ergonomically engineered soft grip handles for positive grip and more powerful cutting. Designed with finger stops for maximum leverage and added safety. No-roll handle shape. Textured grip resists sliding in your hand or on inclined surfaces. LIFETIME GUARANTEE that blade will not separate from handle.

KEY	SKU	DESCRIPTION	MIN QTY
D	60110	Black Dragon Batt Knife—6"	each
E	60115	Black Dragon Batt Knife—8"	each

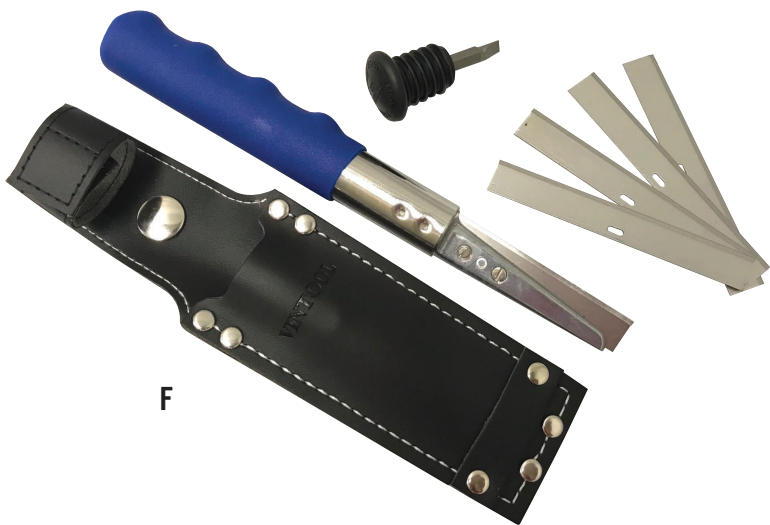

(F) VINTOOL BATT KNIFE

Designed by an insulation contractor to be "The Best on the Market." It has a 4" replaceable cutting blade with a soft grip handle. Blade is seated in utensil with set screws. The end of the handle has a small screw driver mounted in it for convenience when changing blades. Extra blades can be stored inside the handle. Comes with 5 blades and a leather sheath that will fit most belts.

KEY	SKU	DESCRIPTION	MIN QTY
F	VT400	Vintool Batt Knife with Leather Sheath—4"	each



(G) BLADES FOR VINTOOL BATT KNIFE

With the storage compartment in the handle of the Vintool you can load an entire tube for quick and easy change outs. USA made.

KEY	SKU	DESCRIPTION	MIN QTY
G	VTBLADE	Vintool Blades—4" (10/tube)	1 tube



(H) LEATHER BATT KNIFE SHEATH

Custom-made and designed to accommodate both 6" and 8" batt knives. It can be used for Black Dragon or wood handle knives. With riveted stress points, this rigid accessory leaves no part of the blade exposed, thus preventing accidental injuries.

KEY	SKU	DESCRIPTION	MIN QTY
H	56500	Leather Batt Knife Sheath—8" x 2"	each

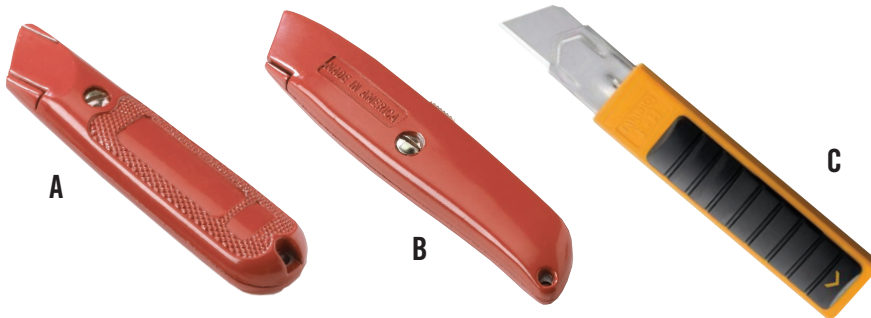

(A) FIXED BLADE UTILITY KNIFE

Stays in one fixed position with blade extended. All metal heavy duty handle with blade storage. USA made—high quality.

KEY	SKU	DESCRIPTION	MIN QTY
A	UKFB	Utility Knife, Fixed Blade	each

(B) RETRACTABLE BLADE UTILITY KNIFE

Retracts for safety and convenience. All metal heavy duty handle with blade storage. USA made—high quality.

KEY	SKU	DESCRIPTION	MIN QTY
B	UKRB	Utility Knife, Retractable Blade	each

(C) OLFA XHD CUTTER KNIFE

Extra heavy duty sure grip cutter features a ratchet wheel blade lock to prevent slipping and a rubber grip insert for positive handle control. Knife body is GUARANTEED FOREVER.

KEY	SKU	DESCRIPTION	MIN QTY
C	UKH1	OLFA XHD Cutter with Rubber Grip Insert	each

(D) UTILITY KNIFE BLADES

USA made of the finest quality steel. In boxes of 100 blades, they come wrapped in five-blade packages for safety and convenience.

KEY	SKU	DESCRIPTION	MIN QTY
D	UB100	Utility Blades, Standard Size, 5/pkg , 20 pkg/box	1 box

(E) OLFA XHD RETRACTABLE BLADES

Extra heavy duty snap-off replacement blades. Each blade is produced using OLFA's precise multi-step production process for amazing sharpness and superior edge retention. Easily handles cutting through difficult materials. Seven cutting edges per blade strip. 20-pack features 140 cutting edges.

KEY	SKU	DESCRIPTION	MIN QTY
E	UB20B	OLFA XHD Blades (20/pkg)	1 pkg

(F) LEATHER BELT

Adjusts up to a 46" waist and is 2" wide.

KEY	SKU	DESCRIPTION	MIN QTY
F	LB100	Leather Belt	each

(G) INSULATOR'S 2-POCKET LEATHER TOOL POUCH

Leather pouch with divider inside and utility knife holder on the front.

KEY	SKU	DESCRIPTION	MIN QTY
G	TP102	Tool Pouch, 2-Pocket Insulator's Pouch	each



A



(A) DRAFTMASTER ATTIC STAIRWAY INSULATORS

The Draftmaster Attic Stairway Insulator insulates and seals the drop down attic stairway. Offers R-Value of 15, reflects 96% of radiant heat. They offer a no-trip opening and easy open zipper. The seams are double stitched for extra support increasing the product's lifespan. Installs in 5 minutes or less. Draftmasters utilize radiant foil on both sides of the insulator, not just one side. 10-year warranty.

KEY	SKU	DESCRIPTION	MIN QTY
A	AI542416	Draftmaster Attic Stairway Insulator, 54" x 24" x 16"	each
	AI542616	Draftmaster Attic Stairway Insulator, 54" x 26" x 16"	each
	AI5422	Draftmaster Attic Stairway Insulator, 54" x 22" x 12"	each
	AI5426	Draftmaster Attic Stairway Insulator, 54" x 26" x 12"	each
	AI5430	Draftmaster Attic Stairway Insulator, 54" x 30" x 12"	each
	AI6030	Draftmaster Attic Stairway Insulator, 60" x 30" x 15"	each

(B) PULL DOWN LADDER JACKET WITH POCKET

This easy-to-install insulator closes the insulation gap created by attic stair access. The insulator is comprised of durable, highly reflective foil. There is no assembly required. The lightweight design provides comfort for your home year-round. The insulator is available with a patented insulation chamber that provides high thermal value over the attic stairway/ladder entrance.

- Tested for ASTM C518 and is rated up to R58
- Very durable – comes with SCRIM protection
- 99.8% aluminum material
- Class "A" fire rated
- Class 1 vapor retardant

B

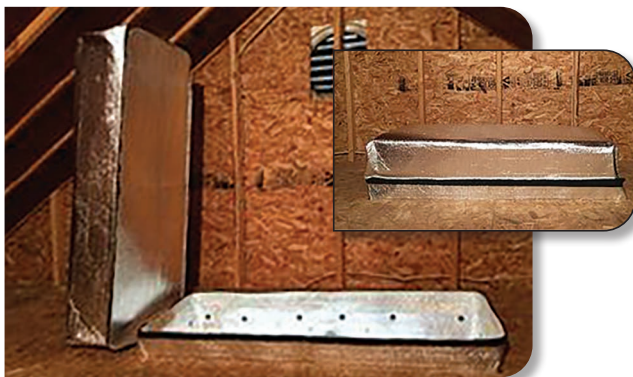

KEY	SKU	DESCRIPTION	MIN QTY
B	SES542210P	54" x 22" x 10" Pocket Attic Stairway Jacket	each
	SES542610P	54" x 26" x 10" Pocket Attic Stairway Jacket	each
	SES543016P	54" x 30" x 16" Pocket Attic Stairway Jacket	each

For horizontal installation—designed to seal pull-down stair openings.

KEY	SKU	DESCRIPTION	MIN QTY
	SESKWP	48" x 24" x 3" Pocket Knee Wall Jacket	each

For vertical installation—designed to seal knee wall doors.

C

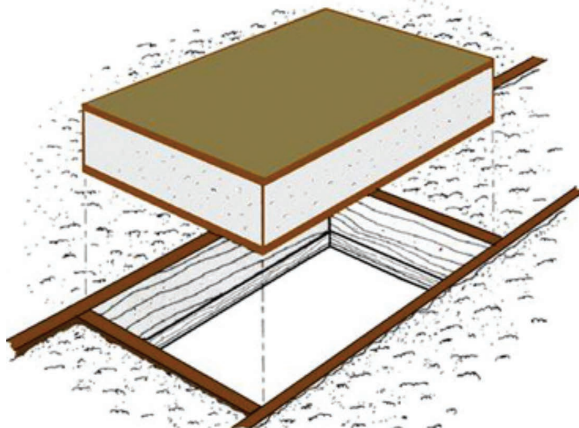

(C) INSUL-DOOR

The Insul-Door is a perfect replacement for old plywood attic doors. Packing carton reverses to make a dam around the hole to keep the insulation in the attic. Shipped 24" x 32" x 8" thick, cut to size. R30 R-Value.

KEY	SKU	DESCRIPTION	MIN QTY
C	IDR30	24" W x 32" L x 8" Thick—R30	each

(A) TENMAT RECESSED LIGHT COVERS

Made out of a fire-resistant mineral wool that exhibits excellent thermal insulating properties. Compatible with sprayed foam insulation, low-density foam, blown-in insulation and lay-in insulation. Can be used with IC-rated and non-IC-rated lights.



KEY	SKU	DESCRIPTION	MIN QTY
A	FF130E	15"L x 14"W x 9"H	each
	FF135	16-1/2" Diameter x 11"H	each

(B) INSUL-SHIELD

Your best protection against fire caused by heat build-up from insulating over or too close to non-IC-rated recessed lights, or other heat-producing fixtures. 14" x 24' roll makes about six to eight shields.

- Lightweight 30-gauge aluminum material
- Safe for use with cellulose, fiberglass and rockwool insulation



KEY	SKU	DESCRIPTION	MIN QTY	ROLLS/CARTON
B	IS1424	14" H x 24' L Roll	1 roll	12

(C) POLY RECESSED LIGHT COVER

A great way to get an airtight seal over IC-rated recessed lights for new or retrofit applications. Not to be used on non-IC-rated lights.

- Made of an extra heavy grade of polyethylene film
- Pre-formed to fit over most light cans

KEY	SKU	DESCRIPTION	MIN QTY
C	SVB18	12"W x 18"L x 8"H	each

(D) THE INSUL-LITE® PRO PLUS RECESSED LIGHT COVER

Fire retardant cover designed to allow the installer to insulate safely and effectively around recessed lights. When installed, the Insul-Lite® allows insulation to be placed as close to the light or heat producing fixture as possible without the risk of fire. Use solid covers for IC-rated lights only.

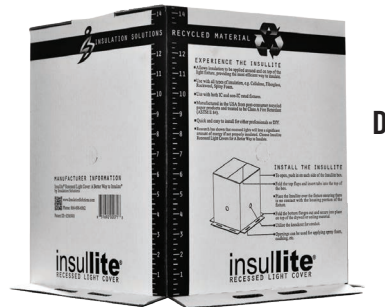

KEY	SKU	DESCRIPTION	MIN QTY
D	IL10S	10" x 10" x 12", 25/pack	each
	IL12S	12-1/2" x 12-1/2" x 14", 25/pack	each

(E) SUPERIOR F2 FACING

Superior F-2 radiant insulation is composed of aluminum foil laminated with flame retardant adhesive to both sides of 100 lb Kraft paper.

KEY	SKU	DESCRIPTION	MIN QTY
E	CANLIGHTF2255	100 lb Kraft Paper Roll 25-1/2" x 118'	each

(F-G) CANCOVERIT™ RECESSED LIGHT COVER

CanCoverit™ is essential to ensure maximum comfort and building envelope performance. CanCoverit™ even helps protect and maximize LED bulb life. Use on non-IC-rated recessed lights, IC recessed lights, LED inserts, bathroom exchange fans, speakers and more! Eliminates drafts, maximizes building insulation, protects against pests and moisture, and reduces load on HVAC systems. Unique design controls airflow and stops thermal conductance, providing the optimum protection needed to fully insulate for all climates. CanCoverit™ Universal Series has pop-out vents to allow installation on a wide range of fixtures, designed for safe use with Non-IC recessed lights. CanCoverit™ Low Profile series is air-tight with a shorter height specifically designed for IC-rated fixtures. Both CanCoverit™ series ship flat, pop open and install in seconds!



KEY	SKU	DESCRIPTION	MIN QTY
F	CANCOVERU	Universal Cover—14" x 14" x 22"H	each
G	CANCOVERLP	Low Profile Cover—14" x 14" x 12"H	each

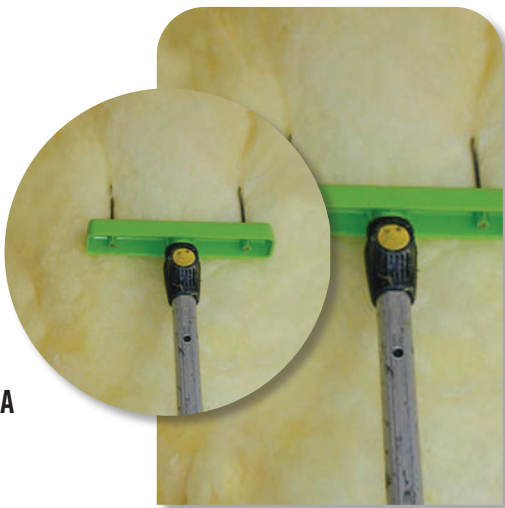

A

B



D



E

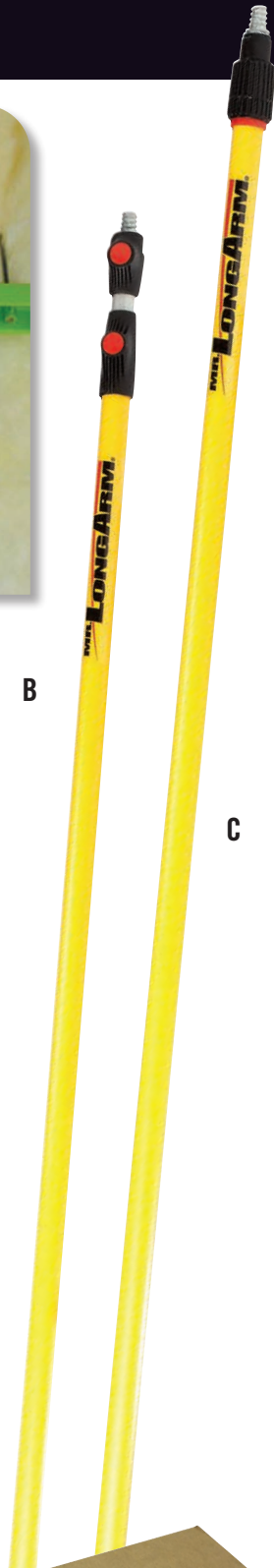

(A) THE INSTALLER

The batt installer screws onto the tip of the BI7710 and BI6512 extension poles, allowing for easy installation of pressure-fit batt insulation and wire batt supports in both overhead and wall installations. Sold in pairs only.

KEY	SKU	DESCRIPTION	MIN QTY
A	BI102	The Installer, Batt Installation Tool	pair

(B) SMART-LOK® EXTENSION POLES

Quickly change roller frames or other tools with the push of a button for Quick-on/Quick-off action.

- Heavy-duty composite fiberglass handle
- Patented locking device

KEY	SKU	DESCRIPTION	MIN QTY
B	BI7710	Smart-Lok Extension Pole—5' to 9'	each

(C) TWIST LOCK® EXTENSION POLES

Combination smooth composite fiberglass handle and aluminum tube for balance. Die cast metal 3/4" (2 cm) threaded end and heavy duty chuck and collet locking device.

KEY	SKU	DESCRIPTION	MIN QTY
C	BI6512	Twist Lock Extension Pole—6' to 12'	each

(D) PRO WALL STRAPPING MATERIAL

This material is ideal for supporting fiberglass batts and is a true economic alternative to duct strapping. Made from 100% polyester so there is a low propensity for mold growth.

KEY	SKU	DESCRIPTION	MIN QTY
D	PW402250	ADO Pro Wall—2" x 250'	roll

(E) WIRE BATT SUPPORTS

(also known as tiger teeth, wire stays and lightning rods)

Fastest, most economical method of installing roll and batt type insulation. Made of high tensile wire with angle cut to dig into wood. When installing batt supports space them 12" to 16" apart.

- Spring wire supports install with a twist of the wrist
- Holds permanently in floors, walls and ceilings

KEY	SKU	DESCRIPTION	QTY/BOX
E	BS120	Wire Batt Supports—12"	500
	BS160	Wire Batt Supports—16"	500
	BS170	Wire Batt Supports—17"	500
	BS180	Wire Batt Supports—18"	500
	BS190	Wire Batt Supports—19"	500
	BS200	Wire Batt Supports—20"	500
	BS230	Wire Batt Supports—23"	500
	BS240	Wire Batt Supports—24"	500
	BS250	Wire Batt Supports—25"	500
	BS260	Wire Batt Supports—26"	500
	BS280	Wire Batt Supports—28"	500

(A) INSUL-HOLD

Unique design simplifies installation. Insulation is impaled on the 2-1/2" arrow prongs which are on 8" centers. Use with either 16" or 24" OC. Product is .025 to .028 thick and 1" wide. It is cold rolled and hot dipped galvanized with a dry finish.

- Holds rigid or batt insulation
- Doubles as reinforcement strapping

KEY	SKU	DESCRIPTION	MIN QTY
A	IH660	Insul-Hold—100' Roll	1 Roll



(B) STANDARD INSULATION ANCHORS

Glued in place and used to support rigid board and batt type insulation on wall and ceiling applications. The anchors incorporate a 12-gauge spindle (nail) and a 2" x 2" square perforated base made of low carbon steel, galvanized coating.

KEY	SKU	DESCRIPTION	QTY/CARTON
B	IS016	Anchors—1-5/8"	1000
	IS020	Anchors—2"	1000
	IS025	Anchors—2-1/2"	1000
	IS0351	Anchors—3-1/2" Standard	500
	IS045	Anchors—4-1/2"	500
	IS055	Anchors—5-1/2"	500
	IS065	Anchors—6-1/2"	500
	IS0851	Anchors—8-1/2"	250
	IS0951	Anchors—9-1/2"	250
	IS1051	Anchors—10-1/2"	250
	IS1151	Anchors—11-1/2"	250
	IS1251	Anchors—12-1/2"	250
	IS1451	Anchors—14-1/2"	250

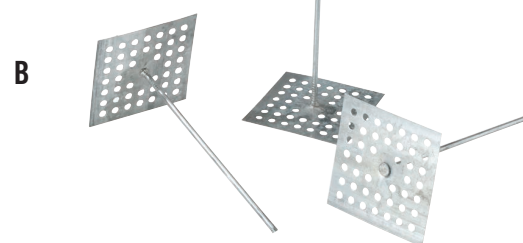

(C) ANCHOR ADHESIVE

High-strength, heavy-bodied, neoprene rubber adhesive. Specifically formulated for adhering insulation anchors. Coverage is one gallon of adhesive for every 500-1,000 hangers. Cannot be sold in California.

KEY	SKU	DESCRIPTION	MIN QTY
C	IS101	Anchor Adhesive—Gallon	each

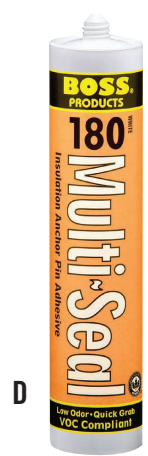

(D) BOSS® 180 MULTI-SEAL INSULATION ANCHOR ADHESIVE

California VOC compliant. Use for rigid board & fibrous, semi-rigid board insulation masonry walls, ducts & metal buildings. Adheres to paint & galvanized surfaces and can be used with nylon & metal-based pins. Provides an immediate grab and high bond strength, making insulation ready to be hung the next day. Low odor, VOC compliant. Each tube can cover approximately 200 pins.

KEY	SKU	DESCRIPTION	TUBES/CASE	CASES/PALLET
D	CLK180	Boss 180—White	12	108

(E-G) SELF-LOCKING WASHERS

Round and square washers are mild steel, galvanized coating. The dome caps are aluminum material with a stainless steel insert.

KEY	SKU	DESCRIPTION	QTY/CARTON
E	IS014	Washers, Round Self-locking—1-1/2"	1000
F	IS015	Washers, Square Self-locking—1-1/2"	1000
G	IS013	Washers, Dome Caps—7/8" dia	1000
	IS013W	Washers, Dome Caps—7/8" dia White	1000



STILTS

(A-B) SUR-PRO SUR-STILTS AND SUR-PRO QUADLOCK SINGLE-SIDED

Top-of-the-line adjustable height stilts. Spring tension (individually adjustable for natural leg movement) gives exactly the right “feel.” Telescoping legs slide smoothly for quick and easy adjustment without tools. Strap and shoe adapters included. Available in aluminum or magnesium—magnesium components offer enhanced durability and save 2 lbs. in weight per pair of stilts. The new Quadlock design incorporates an improved heel strap system, side pole key locks, double wingbolts, and an interlock system all adding to the safety and overall comfort of the stilts (not available in the 15"-23" sizes).

KEY	SKU	DESCRIPTION	MIN QTY
A	SS1523AP	Sur-Pro Sur-Stilts—15" - 23"	1 pair
	SPI1830AP	Sur-Pro Quadlock—18" - 30"	1 pair
	SPI2440AP	Sur-Pro Quadlock—24" - 40"	1 pair
B	SS1523MP	Sur-Pro Sur-Stilts Magnesium—15" - 23"	1 pair
	SPI1830MP	Sur-Pro Quadlock Magnesium—18" - 30"	1 pair
	SPI2440MP	Sur-Pro Quadlock Magnesium—24" - 40"	1 pair

Refer to schematics on page 69-70.

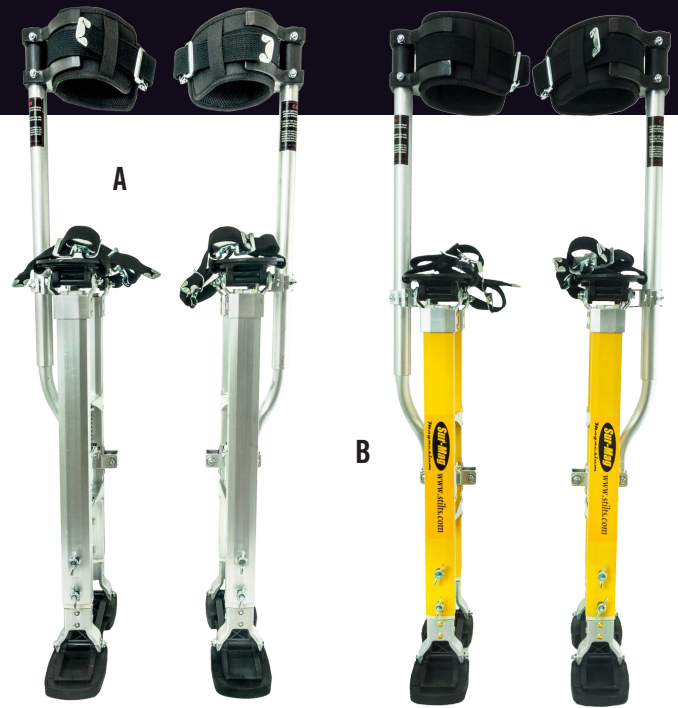

(C-D) SUR-PRO SUR-STILTS AND SUR-PRO QUADLOCK DOUBLE-SIDED

The next generation of stilts! Double-sided Sur-Stilts surpass the capabilities of traditional stilts by providing:

- Better balance and safety
- Less fatigue
- More productivity

Available in aluminum or magnesium—magnesium components offer enhanced durability and save 2 lbs in weight per pair of stilts. The new Quadlock design incorporates an improved heel strap system, side pole key locks, double wingbolts, and an interlock system all adding to the safety and overall comfort of the stilts (not available in the 15"-23" sizes).

KEY	SKU	DESCRIPTION	MIN QTY
C	SPII1830AP	Double-Sided Sur-Pro Quadlock—18" - 30"	1 pair
	SPII2440AP	Double-Sided Sur-Pro Quadlock—24" - 40"	1 pair
D	S21523MP	Double-Sided Sur-Pro Sur-Stilts, Magnesium—15" - 23"	1 pair
	SPII1830MP	Double-Sided Sur-Pro, Quadlock Magnesium—18" - 30"	1 pair
	SPII2440MP	Double-Sided Sur-Pro, Quadlock Magnesium—24" - 40"	1 pair

SUR-PRO STILTS REPLACEMENT KITS

SKU	DESCRIPTION	MIN QTY
SS1001	Sur-Pro Hardware Kit (SS & S2)	each
SS1002BK	Sur-Pro Strap Kit (SS only)	each
SS1002V	Sur-Pro Velcro Kit (SS only)	each
SS1003R	Sur-Pro Rubber Floor Plate with Sole (SS & S2)	each
SS1004	Sur-Pro Spring Kit (SS & S2)	each
SS1005P	Sur-Pro Plastic Leg Band Kit (new SS)	each
SS1005PF	Sur-Pro Wrap-around L.B.K. (new SS)	each
SS1006	Sur-Pro Clamp Kit (SS only)	each
SS1007	Sur-Pro Plastic Sleeve Kit (SS & S2)	each
SS1008	Sur-Pro Wing Bolt Kit (SS & S2)	each
SS1009	Sur-Pro Heel Bracket Kit (SS & S2)	each
SS1010R	Sur-Pro Right Leg Band Kit (S2 only)	each
SS1010L	Sur-Pro Strap Kit (S2 only)	each
SS1011	Sur-Pro Strap Kit (S2 only)	each

Refer to schematics on page 69-70.



SUR-PRO SUR-STILTS PARTS LISTING

SKU NUMBER	DESCRIPTION
H101PF	Replacement wraparound leg band for single sided Sur-Pro stilts
H104BK	Replacement leg band strap for single sided Sur-Pro stilts, Dimensions: 1 1/2" width, 10 1/2" length
H105	Replacement leg pole upper strut for single sided Sur-Stilts
H108W	Replacement adjustable toe strap with buckle, screws and washers for all Sur-Pro stilts Strap Dimensions: 1" width, 17" length
H109	Replacement nylon foot plate for all Sur-Pro stilts
H110W	Replacement adjustable heel bracket aluminum with screws for all Sur-Pro stilts
H12315AP(MP)	Replacement leg pole lower strut for 15"-23"
H1231824AP(MP)	Replacement leg pole lower strut for 18"-30" and 24"-40"
H124W	Replacement bolt with washers and locknut Dimensions: 1 1/2" in length
H126R	Replacement rubber floor plate for all Sur-Pro stilts
H127W	Replacement bolt with washers and locknut Dimensions: 3" in length
HP12930AP(MP)	Replacement side pole clamp for single sided Sur-Pro stilts
H131S	Replacement metal clamp bracket for all Sur-Pro stilts
H132W	Replacement bolt with washers and locknut Dimensions: 1 3/4" in length
H134W	Replacement bolt with washers and locknut Dimensions: 2" in length
H142	Replacement wing bolt for all Sur-Pro stilts
H145	Replacement spring for all Sur-Pro stilts
H151W15AP(MP)	Replacement inner extension tube 15"-23" with upward and downward nylon sleeves
H151W18AP(MP)	Replacement inner extension tube 18"-30" with upward and downward nylon sleeves
H151W24AP(MP)	Replacement inner extension tube 24"-40" with upward and downward nylon sleeves
H164BK	Replacement leg band strap for double sided Sur-Pro stilts Dimensions: 1 1/2" width, 10 1/2" length
H165W15AP(MP)	Replacement side pole with end cap and side pole holder for 15"-23" double sided Sur-Stilt stilts
H165W18AP(MP)	Replacement side pole with end cap and side pole holder for 18"-30" double sided Sur-Stilt stilts
H165W24AP(MP)	Replacement side pole with end cap and side pole holder for 24"-40" double sided Sur-Stilt stilts
H173	Replacement leg band laces for double sided Sur-Pro stilts (count 2)
HP107FW	Replacement adjustable wide arch strap with buckle, screws and washers for all Sur-Pro stilts Strap Dimensions: 1 1/2" width, 23" length
HP107W	Replacement adjustable arch strap with buckle, screws and washers for all Sur-Pro stilts Strap Dimensions: 1" width, 23" length

SUR-STILTS SINGLE-SIDED PARTS SCHEMATIC

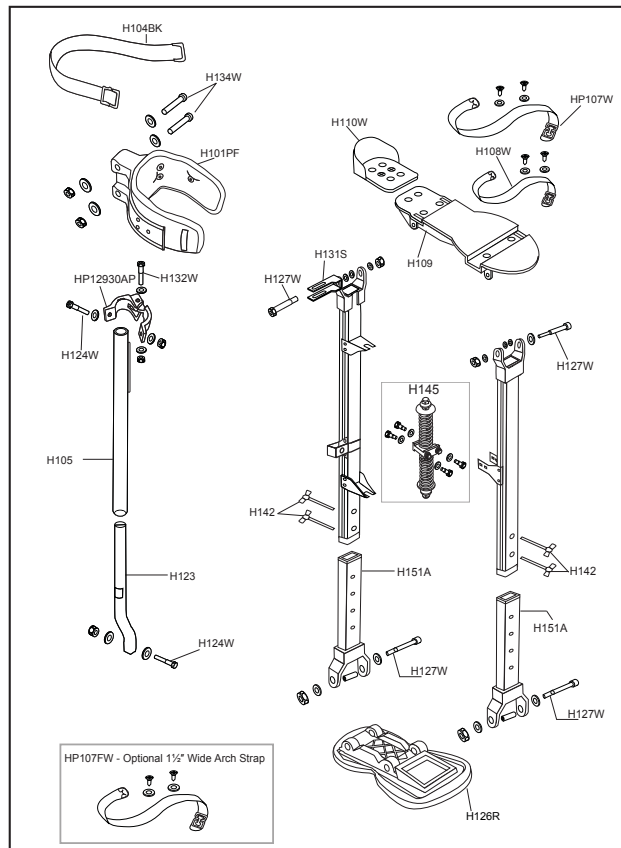

SUR-STILTS DOUBLE-SIDED PARTS SCHEMATIC

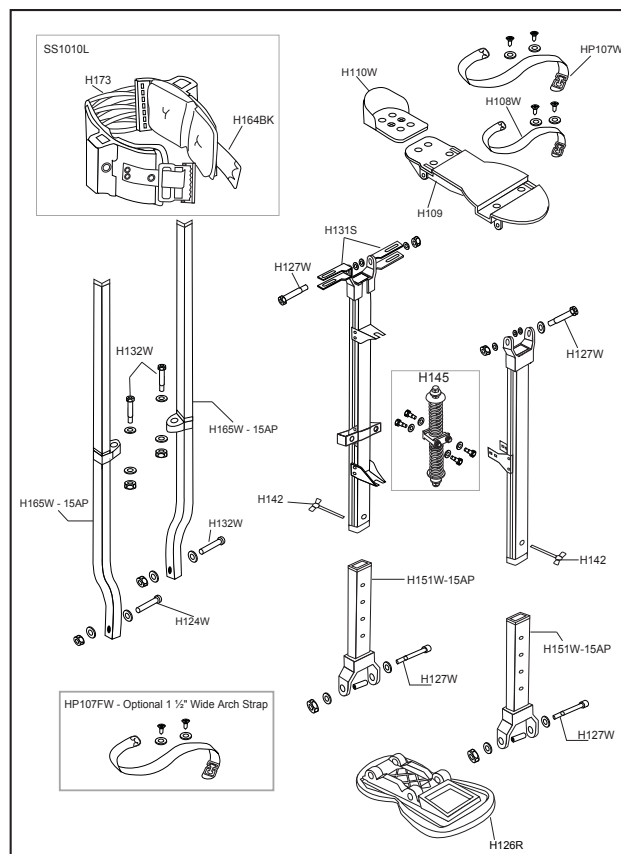

For a complete breakdown and parts list, please call or email us with your request.

QUADLOCK SINGLE-SIDED PARTS SCHEMATIC

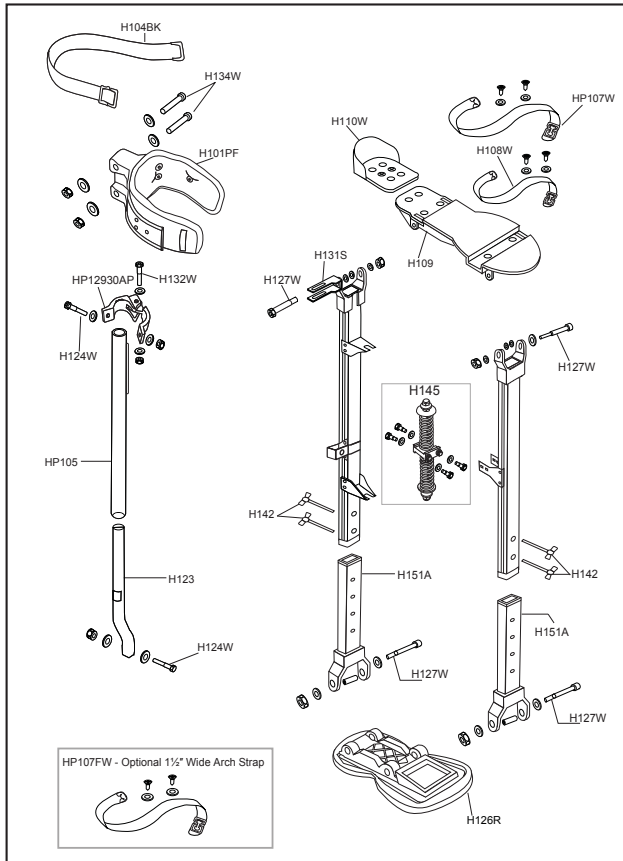

QUADLOCK DOUBLE-SIDED PARTS SCHEMATIC

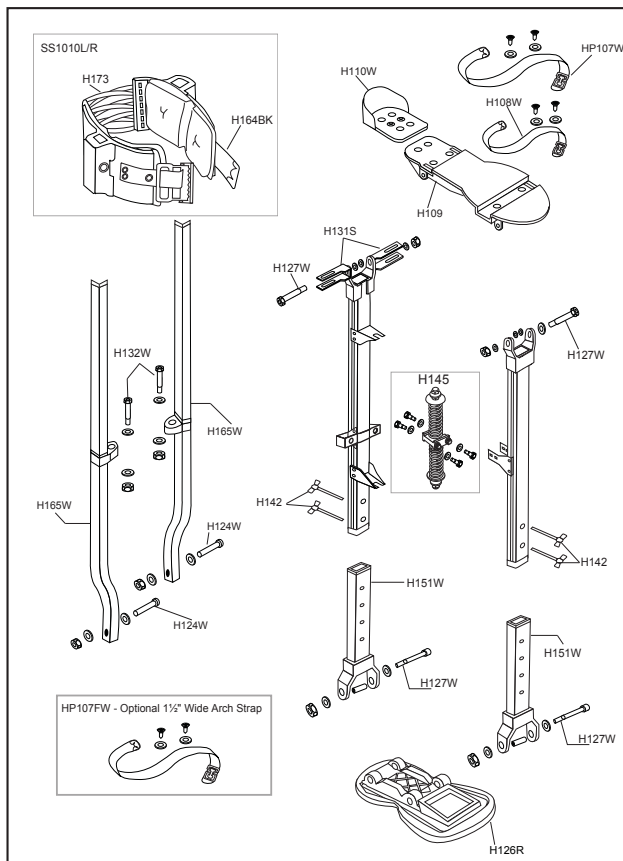

SUR-PRO QUADLOCK PARTS LISTING

SKU NUMBER	DESCRIPTION
H101PF	Replacement wraparound leg band for single sided Sur-Pro stilts
H104BK	Replacement leg band strap for single sided Sur-Pro stilts, Dimensions: 1 1/2" width, 10 1/2" length
HP105	Replacement leg pole upper strut for single sided Quadlock stilts
H108W	Replacement adjustable toe strap with buckle, screws and washers for all Sur-Pro stilts Strap Dimensions: 1" width, 17" length
H109	Replacement nylon foot plate for all Sur-Pro stilts
H110W	Replacement adjustable heel bracket aluminum with screws for all Sur-Pro stilts
H12315AP(MP)	Replacement leg pole lower strut for 15"-23"
H1231824AP(MP)	Replacement leg pole lower strut for 18"-30" and 24"-40"
H124W	Replacement bolt with washers and locknut Dimensions: 1 1/2" in length
H126R	Replacement rubber floor plate for all Sur-Pro stilts
H127W	Replacement bolt with washers and locknut Dimensions: 3" in length
HP12930AP(MP)	Replacement side pole clamp for single sided Sur-Pro stilts
H131S	Replacement metal clamp bracket for all Sur-Pro stilts
H132W	Replacement bolt with washers and locknut Dimensions: 1 3/4" in length
H134W	Replacement bolt with washers and locknut Dimensions: 2" in length
H142	Replacement wing bolt for all Sur-Pro stilts
H145	Replacement spring for all Sur-Pro stilts
H151W15AP(MP)	Replacement inner extension tube 15"-23" with upward and downward nylon sleeves
H151W18AP(MP)	Replacement inner extension tube 18"-30" with upward and downward nylon sleeves
H151W24AP(MP)	Replacement inner extension tube 24"-40" with upward and downward nylon sleeves
H164BK	Replacement leg band strap for double sided Sur-Pro stilts Dimensions: 1 1/2" width, 10 1/2" length
H165W15AP(MP)	Replacement side pole with end cap and side pole holder for 15"-23" double sided Sur-Stilt stilts
H165W18AP(MP)	Replacement side pole with end cap and side pole holder for 18"-30" double sided Sur-Stilt stilts
H165W24AP(MP)	Replacement side pole with end cap and side pole holder for 24"-40" double sided Sur-Stilt stilts
H173	Replacement leg band laces for double sided Sur-Pro stilts (count 2)
HP107FW	Replacement adjustable wide arch strap with buckle, screws and washers for all Sur-Pro stilts Strap Dimensions: 1 1/2" width, 23" length
HP107W	Replacement adjustable arch strap with buckle, screws and washers for all Sur-Pro stilts Strap Dimensions: 1" width, 23" length



DUO-FAST FT-550 CLASSIC – PARTS SCHEMATIC

KEY	SKU	DESCRIPTION
2	HTP5507A	Hammer Cap
3	HTP5509	Channel Block
4	HTPHT335	Pusher Bar
5	HTPHT336	Handle Lid
6	HTPHT382	Lever Assembly
7	HTPHT341	Front Jaw
8	HTPHT3991	Plunger Cam
9	HTPHT4102	Grip
10	HTP3151	Plunger Body
11	HTP7053C	Driver Blade
12	HTP7066	Spring
13	HTP3032	Screw
14	HTPHT1035	Feeder Spring Stud
15	HTP724	Nut
16	HTP727	Plunger Spring
18	HTP3011	Cam Pin
19	HTP730	Roll Pin
20	HTPHT3031	Grip Screw
22	HTP746	Handle Lid Stud
23	HTP747	Handle Lid Stud Washer
24	HTPHT1012	Jaw Pin
25	HTP3091	Trip Lever Bushing
26	HTPHT1011	Trip Pin
27	HTPHT1071	Trip Knob
28	HTP770A	Stud Pin
29	HTPHT3092	Knob
	HTP794	Stud & Bracket Assembly
31	HTPOR0076N	Jaw Pin O-ring
	HTPXH10848	Safety Label
	HTPXH10856	Model Label
34	HTPXK1150	Feeder Spring Complete
35	HTPHT3041	Split Ring

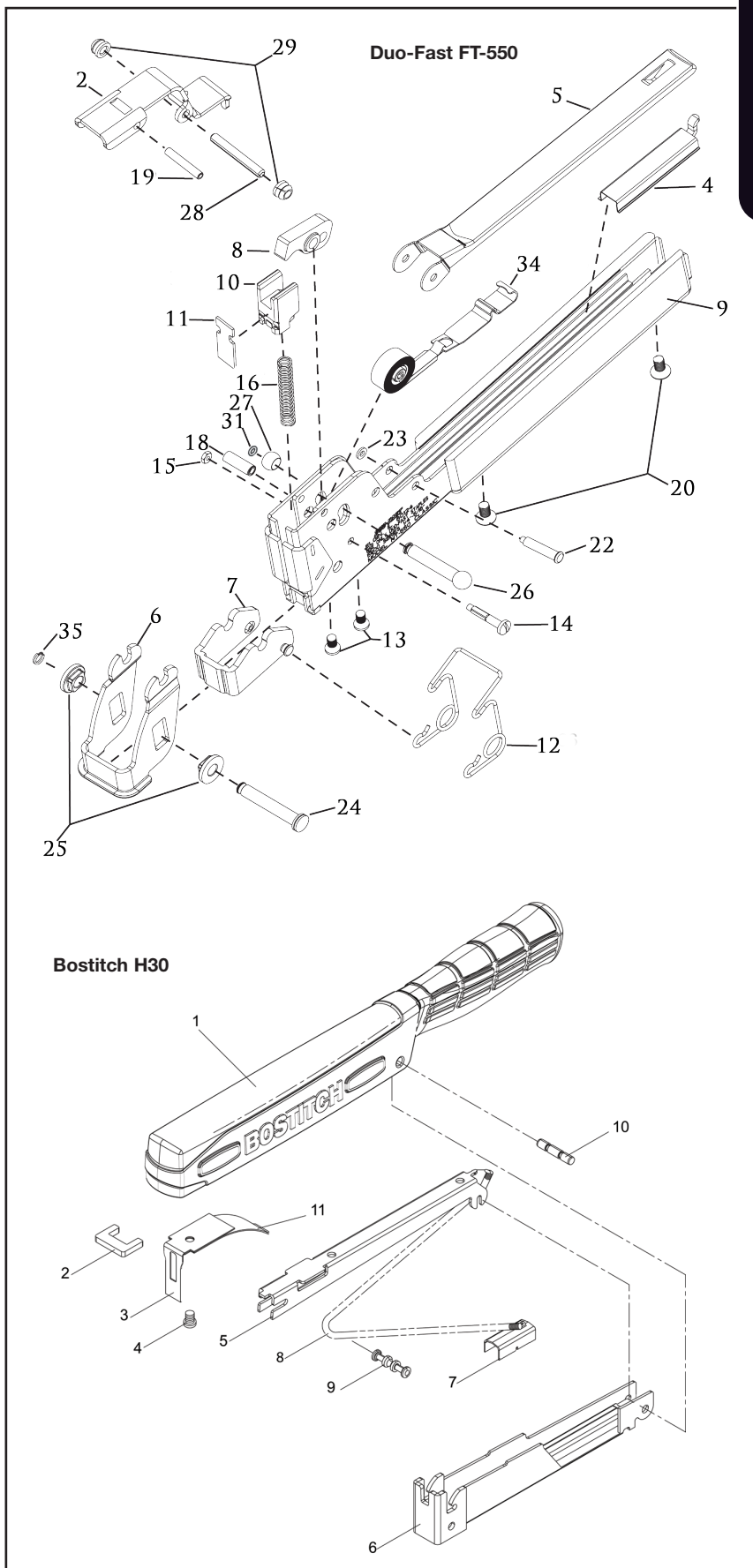

BOSTITCH H30-6/H30-8 – PARTS SCHEMATIC

KEY	SKU	DESCRIPTION
1	HTP177844	Frame-Grip-Pad Assembly
2	HTP30603	Bumper
3	HTP30624	HTH306, Driver
3	HTP30619	HTH308, Driver
4	HTPUA3806	#10-24 x 3/8 Screw
5	HTP30605	Top Guide
6	HTP30606	HTH306, Magazine Sssembly
6	HTP30616	HTH308, Magazine Assembly
7	HTP177846	Pusher
8	HTP30608	Pusher Spring
9	HTP30609	Roller
10	HTP30610	Pivot Pin
11	HTP30615	Return Spring

FUSION AP FLUID HOUSING SPRAYER SCHEMATICS

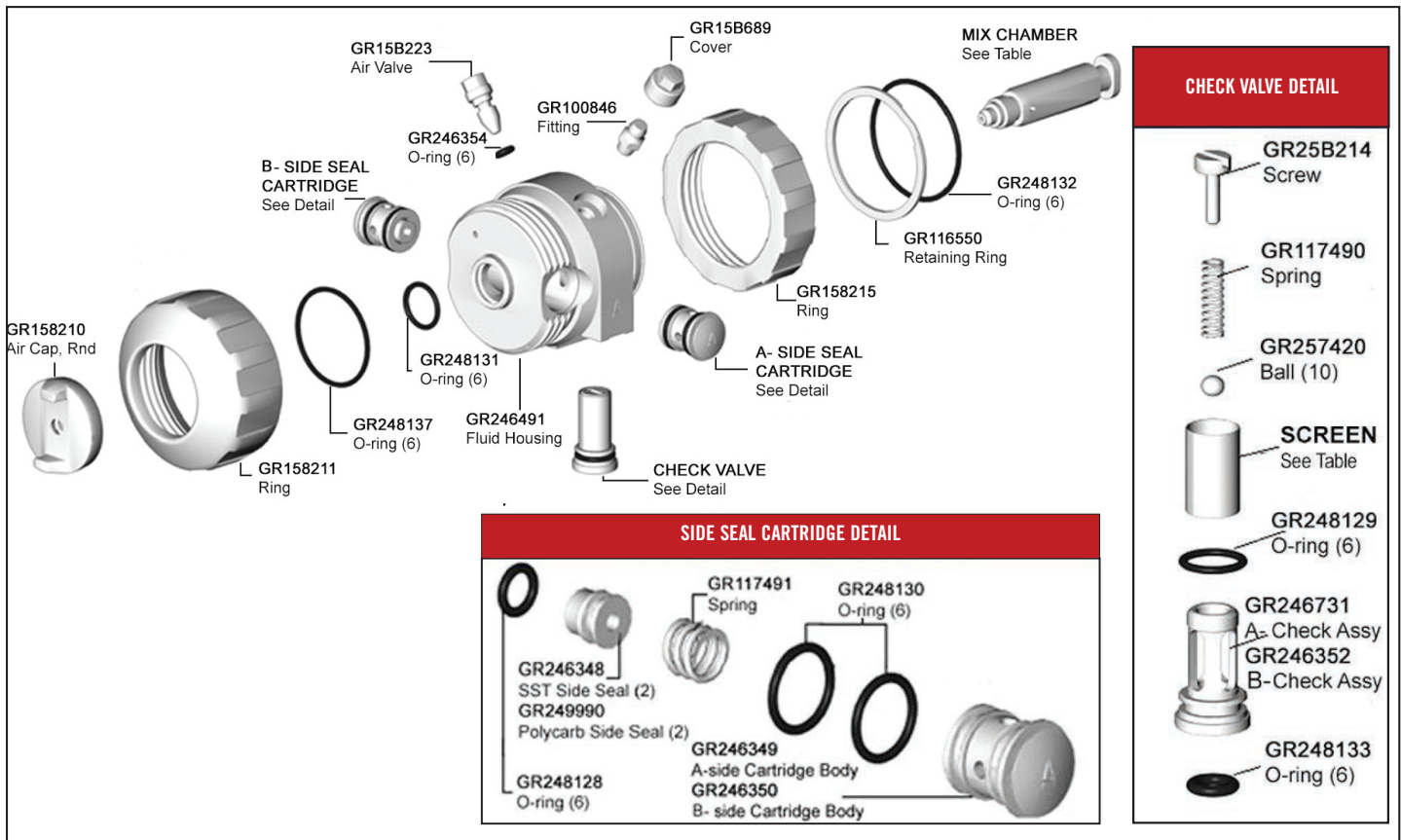

FUSION AP SPRAY GUN BULK PACKAGES

SKU NUMBER	DESCRIPTION
GR246348	Side Seal, SST (pkg 2)
GR277299	Side Seal, SST (pkg 50)
GR246354	O-ring Bulk, Air Valve (pkg 6)
GR246357	Filter Screen, 40 Mesh (pkg 10)
GR246358	Filter Screen, 60 Mesh (pkg 10)
GR246359	Filter Screen, 80 Mesh (pkg 10)
GR248128	O-ring Bulk, Side Seal Cartridge (pkg 6)
GR248129	O-ring Bulk, Check Valve (pkg 6)
GR25M247	O-ring Bulk, Check Valve (pkg 50)
GR248130	O-ring Bulk, Side Seal Cartridge (pkg 6)
GR25M242	O-ring Bulk, Side Seal Cartridge (pkg 50)
GR248131	O-ring Bulk, Fluid Housing (pkg 6)
GR25M243	O-ring Bulk, Fluid Housing (pkg 50)
GR248132	O-ring Bulk, Ring (pkg 6)
GR248133	O-ring Bulk, Check Valve (pkg 6)
GR248137	O-ring Bulk, Fluid Housing (pkg 6)
GR25M244	O-ring Bulk, Fluid Housing (pkg 50)
GR248135	O-ring Bulk, Piston (pkg 6)
GR25M245	O-ring Bulk, Piston (pkg 50)
GR249990	Side Seal, Polycarb. (pkg 2)
GR277298	Side Seal, Polycarb. (pkg 50)

FUSION AP SERVICE/MAINTENANCE

SKU NUMBER	DESCRIPTION
DYNACU61G	Gun Cleaner/Solvent, Low VOC (1 gal)
DYNACU65G	Gun Cleaner/Solvent, Low VOC (5 gal)
GR117642	Nut Driver, 5/16
GR117661	Pin Vise
GR117792	Grease Gun
GR119386	AP/PC Drill Bit Kit
GR15D546	Fusion Gun Cleaning Kit
GR24W849	AP Gun Parts Kit
GR248139	Solvent Flush Kit, 1qt
GR248279	Lubricant (4oz Tube X 10)
GR248280	Grease (3oz Cartridge X 10)
GR248969	AP Handle Cleanout Drill Kit

FUSION AP EXTENSION TIP KITS

SKU NUMBER	RECOMMENDED MIX CHAMBER	SPRAY DIST (FT)	PATTERN DIA. (IN.)
GR248020	(Required for ALL Kits below)		
GR248010	AR2020/AF2929	15	10
GR248011	AR2929/AF2929	12	10
GR248012	AR4242/AF4242	12	12
GR248013	AR5252/AF5252	8	20
GR248014	AR2020/AF2929	15	10
GR248015	AR2929/AF2929	12	8
GR248016	AR5252/AF5252	12	8
GR248017	PC52RD	8	6
GR248018	Extension Tip Seal Kit—Flat		
GR248019	Extension Tip Seal Kit—Round		

FUSION AP MIX CHAMBER CLEANOUT DRILLS

MIX CHAMBER	NOZZLE DRILL (PKG 6)	ORIFICE DRILL (PKG 6)
GRAR4242 (-01)	GR246627	GR246629
GRAR4747	GR248893	GR246814
GRAR4242 (-02)	GR246626	GR246628
GRAR6060 (-03)	GR246625 (pkg 3)	GR246627
GRAW4646	GR248639	GR246814
STUD WALL EXTENSION		
GR12F854	GR246624	

FUSION AP MIX CHAMBER TABLE

ROUND PATTERN	SIZE
GRAR2020	-000
GRAR2929	-00
GRAR3737	None
GRAR4242	-01
GRAR4747	None
GRAR5252	-02
GRAR6060	-03
GRAR7070	-04
GGRAR8686	-05
WIDE RD PATTERN	SIZE
GRAW3939	-01
GRAW4646	-02
STUD WALL	SIZE
GR249421 KIT (Requires Mix Chamber below)	
GRAF2929	-00
GRAF4242	-01
GRAF5252	-02
POUR NOZZLE KIT	
GGR248528	

FUSION AP/PC HANDLE SCHEMATIC

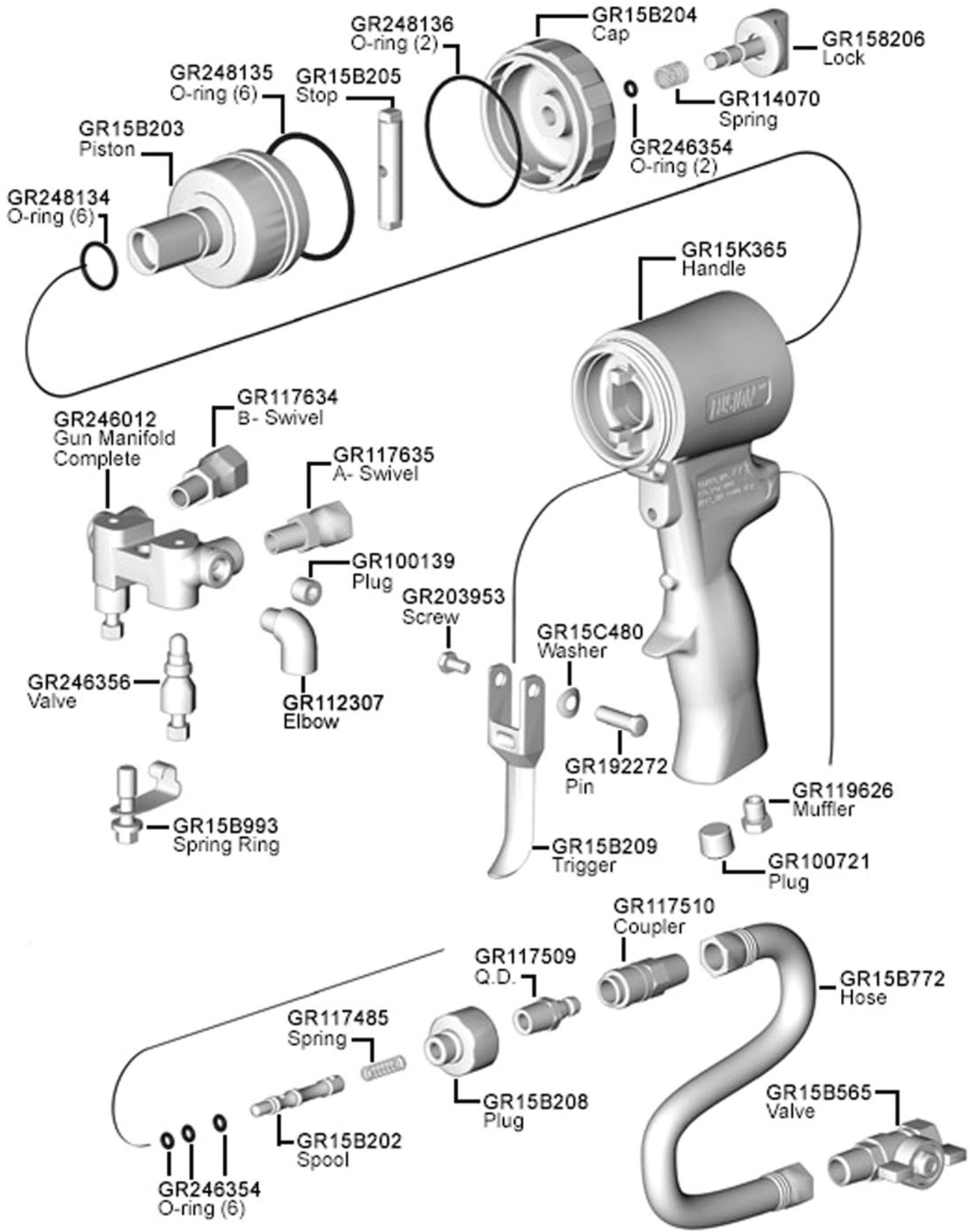

FUSION PC FLUID HOUSING SPRAYER SCHEMATICS

CHECK VALVE FILTER SCREEN KITS (PKG 10)	
Part	Size
GR246357	40 mesh
GR246358	60 mesh
GR246359	80 mesh

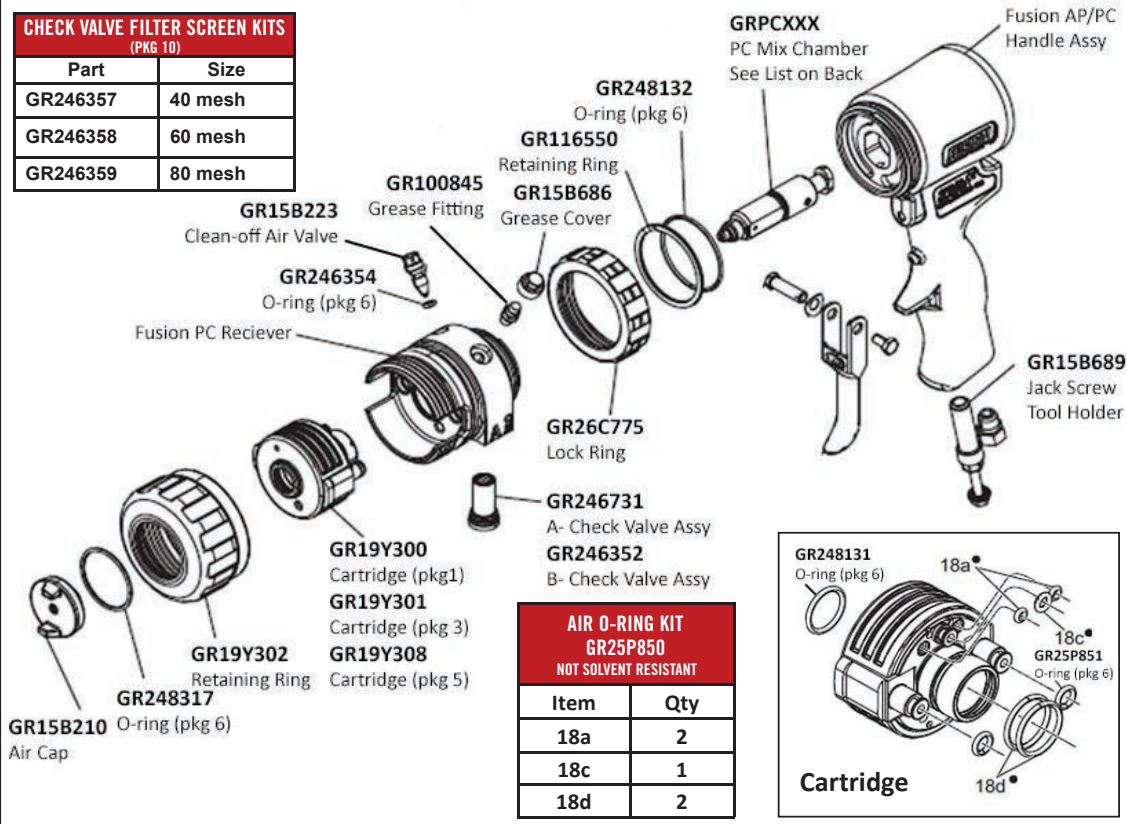

GRPCXXX
PC Mix Chamber
See List on Back

Fusion AP/PC
Handle Assy

GR248132
O-ring (pkg 6)

GR116550
Retaining Ring

GR15B686
Grease Cover

GR100845
Grease Fitting

GR15B223
Clean-off Air Valve

GR246354
O-ring (pkg 6)

Fusion PC Receiver

GR26C775
Lock Ring

GR15B689
Jack Screw
Tool Holder

GR246731
A- Check Valve Assy
GR246352
B- Check Valve Assy

GR19Y300
Cartridge (pkg 1)

GR19Y301
Cartridge (pkg 3)

GR19Y302
Retaining Ring

GR19Y308
Cartridge (pkg 5)

GR248317

GR15B210 O-ring (pkg 6)
Air Cap

AIR O-RING KIT GR25P850 NOT SOLVENT RESISTANT	
Item	Qty
18a	2
18c	1
18d	2

Cartridge

GR248131
O-ring (pkg 6)

18a*

18c*

GR25P851
O-ring (pkg 6)

18d*

CHECK VALVE DETAIL	
	GR25B214 Screw
	GR117490 Spring
	GR257420 Ball (10)
	SCREEN See Table
	GR248129 O-ring (6)
	GR246731 A- Check Assy GR246352 B- Check Assy
	GR248133 O-ring (6)

FUSION PC SPRAY GUN BULK PACKAGES

SKU NUMBER	DESCRIPTION
GR246354	O-ring Bulk, Air Valve (pkg 6)
GR246357	Filter Screen, 40 Mesh (pkg 10)
GR246358	Filter Screen, 60 Mesh (pkg 10)
GR246359	Filter Screen, 80 Mesh (pkg 10)
GR248129	O-ring Bulk, Check Valve (pkg 6)
GR25M247	O-ring Bulk, Check Valve (pkg 50)
GR248132	O-ring Bulk, Ring (pkg 6)
GR248133	O-ring Bulk, Check Valve (pkg 6)
GR248137	O-ring Bulk, Fluid Housing (pkg 6)
GR248135	O-ring Bulk, Piston (pkg 6)
GR25M245	O-ring Bulk, Piston (pkg 50)

FUSION PC MIX CHAMBERS

ROUND	SIZE
GRPC20RD	-000
GRPC29RD	-00
GRPC37RD	-00 - 01
GRPC42RD	-01
GRPC47RD	-01 - 02
GRPC52RD	-02
GRPC60RD	-03
GRPC70RD	-04
GRPC86RD	-05
FLAT	SIZE
GRPC20FL	-000
GRPC29FL	-00
GRPC42FL	-01
GRPC52FL	-02
WIDE	SIZE
GRPC22WD	-2222

FUSION PC RETROFIT KITS

SKU NUMBER	DESCRIPTION
GR25P700	Fusion PC Retrofit, -00 Mix Chamber—Round
GR25R087	Fusion PC Retrofit, -00 -01 Mix Chamber—Round
GR25P701	Fusion PC Retrofit, -01 Mix Chamber—Round
GR25P703	Fusion PC Retrofit, -01 -02 Mix Chamber—Round
GR25P702	Fusion PC Retrofit, -02 Mix Chamber—Round
GR25R088	Fusion PC Retrofit, -03 Mix Chamber—Round
GR25R089	Fusion PC Retrofit, -00 Mix Chamber—Flat

FUSION PC SERVICE/MAINTENANCE

SKU NUMBER	DESCRIPTION
DYNACU61G	Gun Cleaner/Solvent, Low VOC (1 gal)
DYNACU65G	Gun Cleaner/Solvent, Low VOC (5 gal)
GR117642	Nut Driver, 5/16
GR117661	Pin Vise
GR117792	Grease Gun
GR119386	AP/PC Drill Bit Kit
GR15D546	Fusion Gun Cleaning Kit
GR24W849	AP Gun Parts Kit
GR248139	Solvent Flush Kit, 1qt
GR248279	Lubricant (4oz Tube X 10)
GR248280	Grease (3oz Cartridge X 10)
GR248969	AP Handle Cleanout Drill Kit
GR25P660	PC Cartridge Tools

FUSION PC EXTENSION TIP KITS

SKU NUMBER	RECOMMENDED MIX CHAMBER	SPRAY DIST (FT)	PATTERN DIA. (IN.)
(Required for ALL Kits below)			
GR248020	PC20RD/PC20FL	15	10
GR248010	PC29RD/PC29FL	12	10
GR248011	PC29RD/PC29FL	12	10
GR248012	PC42RD/PC42FL	12	12
GR248013	PC52RD	8	20
GR248014	PC20RD/PC20FL	15	10
GR248015	PC29RD/PC29FL	12	8
GR248016	PC42RD/PC42FL	12	8
GR248017	PC52RD	8	6
GR248018	Extension Tip Seal Kit—Flat		
GR248019	Extension Tip Seal Kit—Round		

FUSION PC MIX CHAMBER CLEANOUT DRILLS

MIX CHAMBER	NOZZLE DRILL (PKG 6)	ORIFICE DRILL (PKG 6)
GRPC20RD (-000)	GR246629	GR246631
GRPC29RD (-00)	GR246628	GR246630
GRPC37RD (-00,01)	GR246628	GR246618
GRPC42RD (-01)	GR246627	GR246629
GRPC47RD (-01,02)	GR248893	GR246814
GRPC52RD (-02)	GR246626	GR246628
GRPC60RD (-03)	GR246625 (pkg 3)	GR246627
GRPC70RD (-04)	GR246624	GR246626

FUSION CS FLUID HOUSING SPRAYER SCHEMATICS

GRACO SCHEMATICS

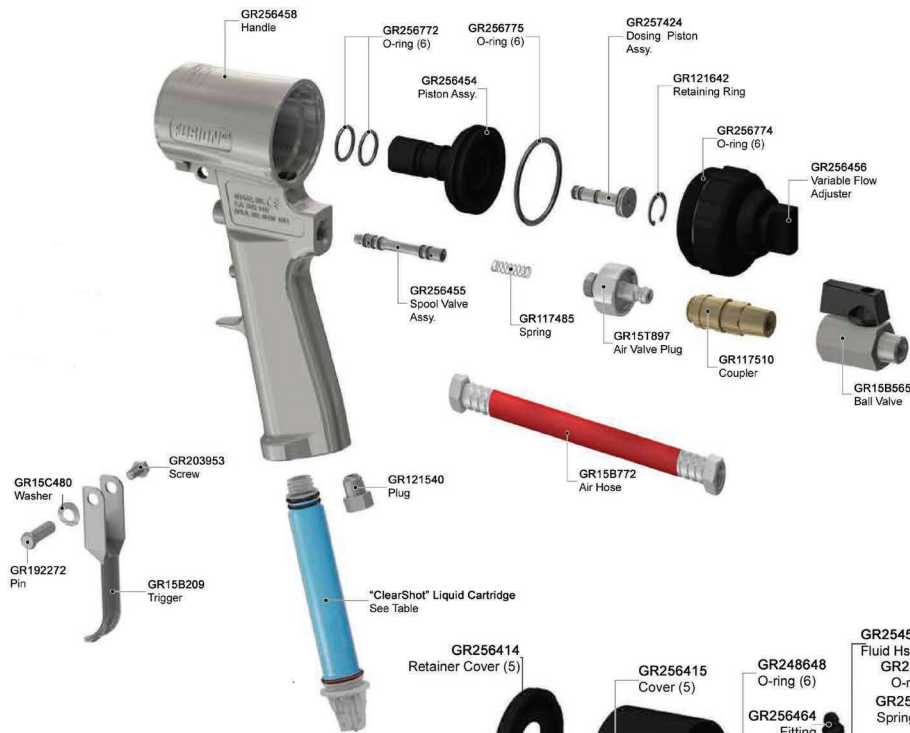

FUSION CS MIX CHAMBER TABLE

ROUND PATTERN	SIZE
GRRD2020	-000
GRRD0000	-00
GRRD0101	-01
GRRD0202	-02
GRRD0303	-03
WIDE ROUND PATTERN	SIZE
GRWD2222	N/A
GRWD0000	-00
GRWD0101	-01
GRWD0202	-02
GRWD0303	-03
FLAT PATTERN	SIZE
GRFL2020	-000
GRFL0000	-00
GRFL0101	-01
GRFL0202	-02
FLAT PATTERN WALL STUD KIT	
GR256569	
GR256570	

FUSION CS SPRAY GUN BULK PACKAGES

SKU NUMBER	DESCRIPTION
GR256387	ClearShot Liquid Cartridges (pkg 100)
GR256385	ClearShot Liquid Cartridges (pkg 25)
GR256386	ClearShot Liquid Cartridges (pkg 50)
GR256772	O-ring Bulk, Air Piston (pkg 6)
GR256775	O-ring Bulk, Air Piston (pkg 6)
GR248648	O-ring Bulk, Fluid Head (pkg 6)
GR25M241	O-ring Bulk, Fluid Head (pkg 50)
GR256773	O-ring Bulk, Fluid Head (pkg 6)
GR248132	O-ring Bulk, Ring (pkg 6)
GR256469	O-ring Bulk, Fluid Manifold Check (pkg 6)
GR256774	O-ring Bulk, Variable-Flow Adjuster (pkg 6)
GR246354	O-ring Kit, Fluid Head Check Valves (pkg 6)
GR25M239	O-ring Kit, Fluid Head Check Valves (pkg 50)
GR256771	O-ring Kit, Fluid Head Check Valves (pkg 6)
GR25M249	O-ring Kit, Fluid Head Check Valves (pkg 50)
GR256640	O-ring Kit, Fluid Head Check Valves (pkg 6)
GR256468	O-ring Kit, Side Seal Housing (pkg 6)
GR25M241	O-ring Kit, Side Seal Housing (pkg 50)
GR246357	Filter Screen, 40 mesh (pkg 10)
GR246358	Filter Screen, 60 mesh (pkg 10)
GR246359	Filter Screen, 80 mesh (pkg 10)
GR256465	Side Seal Kit, Polycarb., incl. O-ring (pkg 2)
GR256489	Side Seal Kit, Polycarb., incl. O-ring (pkg 2)
GR256464	Side Seal Kit, SST, incl. O-rings (pkg 2)
GR256467	Side Seal O-ring Kit, incl. O-rings, Springs, Installation Tools (pkg 6)

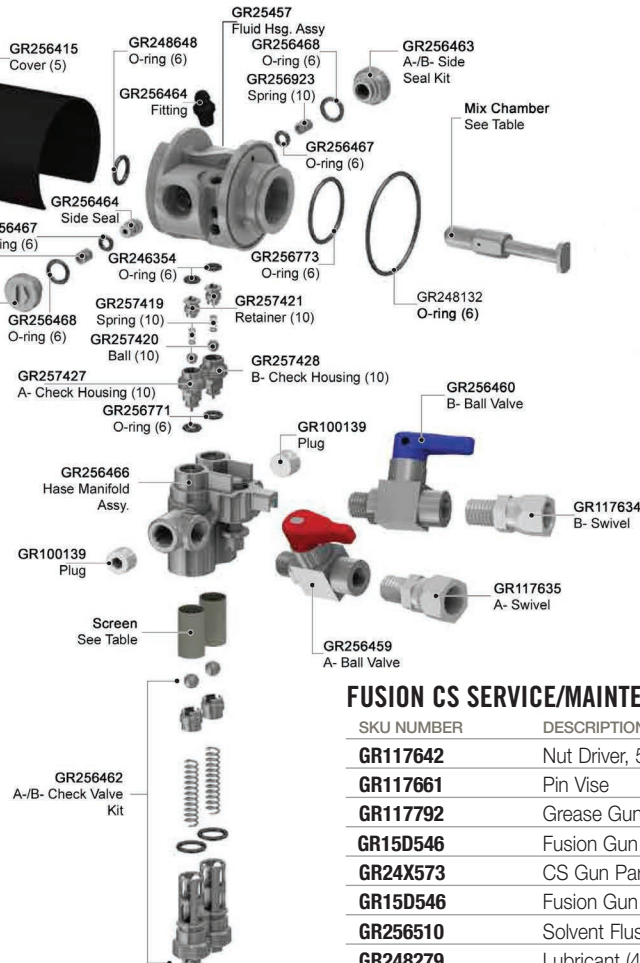

FUSION CS SERVICE/MAINTENANCE

SKU NUMBER	DESCRIPTION
GR117642	Nut Driver, 5/16
GR117661	Pin Vise
GR117792	Grease Gun
GR15D546	Fusion Gun Cleaning Kit
GR24X573	CS Gun Parts Kit
GR15D546	Fusion Gun Cleaning Kit
GR256510	Solvent Flush Kit, 1qt
GR248279	Lubricant (4oz Tube X 10)
GR248280	Grease (3oz Cartridge X 10)
GR256526	CS Handle Cleanout Drill Kit
GR15D234	Tip Clean-out Tool
GR258996	Fusion CS/AP Manifold Adapter
GR256490	CS Complete O-ring Kit
GR256471	CS Fluid Head O-ring Kit
GR256470	CS Air Piston O-ring Kit
GR256472	CS Back Cap O-ring

3M HALF-FACE RESPIRATOR, 6000 SERIES

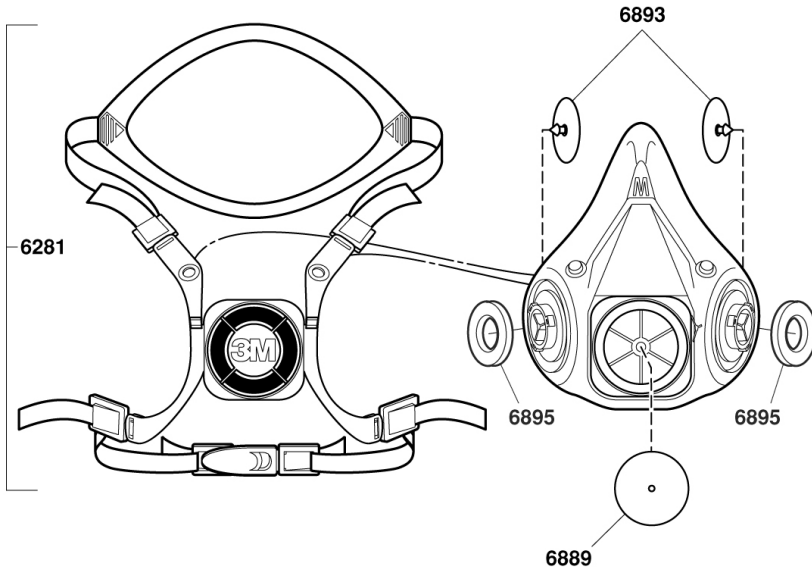

3M HALF-FACE RESPIRATOR, 6000 SERIES

PART NUMBER	DESCRIPTION
6281	Head Harness Assembly
6893	Inhalation Valve
6895	Inhalation Port Gasket
6889	Exhalation Valve

3M FULL-FACE RESPIRATOR, 6000 SERIES

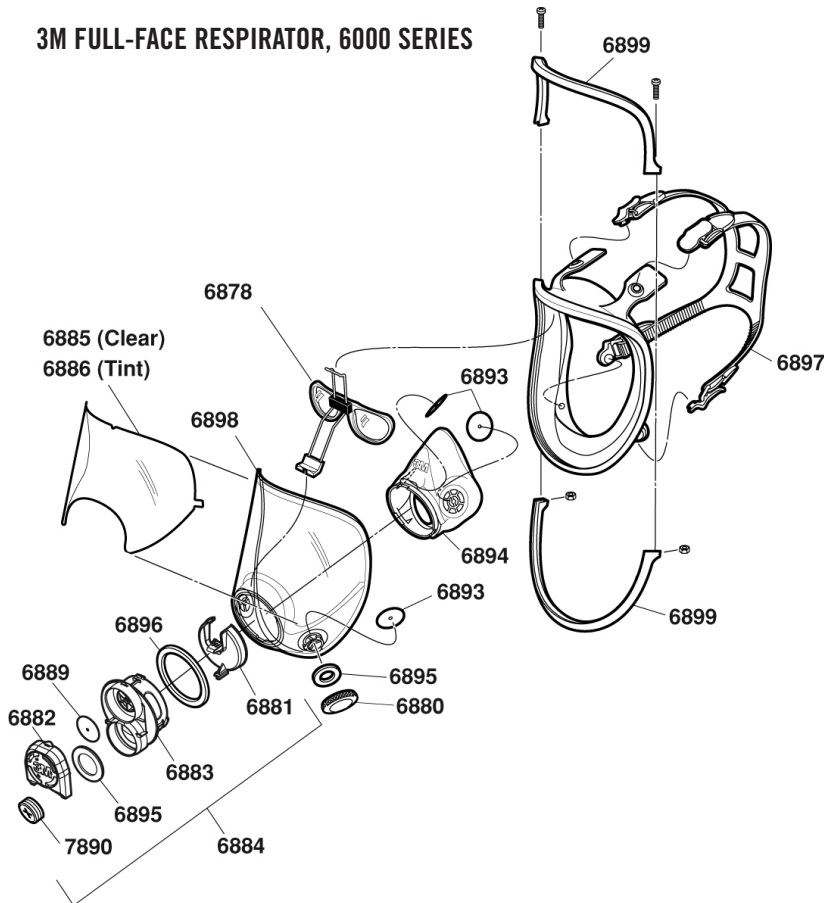

3M FULL-FACE RESPIRATOR, 6000 SERIES

PART NUMBER	DESCRIPTION
6878	Spectacle Kit
6880	Bayonet Cap
6881	Air Director
6882	Cover
6883	Port Base
6884	Center Port Adapter
6885 (Clear)	Faceshield Cover
6886 (Tint)	Tinted Lens Cover
6889	Exhalation Valve
6893	Inhalation Valve
6894	Nose Cup Assembly
6895	Inhalation Port Gasket
6896	Inhalation Gasket
6897	Center Adapter Gasket
6897	Head Harness
6898	Lens Assembly
6899	Frame Kit
7890	Plug

A·D·O[®]

More than just a distributor, ADO is the only prime manufacturer of attic ventilation channels offered to the insulation contractor. **Products You Need. Service We Deliver.**

DUROVENT[®] →

The **Number ONE** selling vent in the industry!



← **DUROVENT[®]** **BAFFLE** →

Offers full joist coverage with an adjustable heel. Its design allows for easy positioning and installation.

proVent[®] **BAFFLE**

New spray foam baffle
for the insulation professional.



PRODUCTS YOU NEED. SERVICE WE DELIVER.



A·D·O[®]

PRODUCTS YOU NEED. SERVICE WE DELIVER.

800-666-8191

sales@adoproducts.com

www.adoproducts.com

PROUD MEMBER OF
INSULATION CONTRACTORS
ICAA
ASSOCIATION OF AMERICA