



# Rich Passage Clam Bay Net Pens Review - DNR

October 10, 2017



Mott MacDonald  
110 James Street  
Suite 101  
Edmonds WA 98020  
United States of America

T +1 (425) 778 6243  
F +1 (425) 778 6883  
mottmac.com

State of Washington  
Department of Natural  
Resources  
1111 Washington Street SE  
Olympia Washington 98504

# **Rich Passage Clam Bay Net Pens Review - DNR**

October 10, 2017



# Issue and revision record

| Revision | Date       | Originator | Checker | Approver | Description |
|----------|------------|------------|---------|----------|-------------|
| 2A       | 10/3/2017  | NS         | JJ      | SP       | Draft       |
| 2B       | 10/9/2017  | NS         | JJ      | SP       | Final       |
| 2C       | 10/10/2017 | NS         | JJ      | SP       | Final       |
|          |            |            |         |          |             |
|          |            |            |         |          |             |
|          |            |            |         |          |             |

**Document reference:** 385629 | 2 | C

**Information class:** Standard

This document is issued for the party which commissioned it and for specific purposes connected with the above-captioned project only. It should not be relied upon by any other party or used for any other purpose.

We accept no responsibility for the consequences of this document being relied upon by any other party, or being used for any other purpose, or containing any error or omission which is due to an error or omission in data supplied to us by other parties.

This document contains confidential information and proprietary intellectual property. It should not be shown to other parties without consent from us and from the party which commissioned it.

# Contents

|   |           |
|---|-----------|
| Acronyms and Abbreviations                            | viii      |
| Certifications  | ix        |
| <b>1 Introduction</b>                                 | <b>1</b>  |
| 1.1 Purpose and Methods                               | 1         |
| 1.2 Inspection Scope and Standards                    | 2         |
| 1.3 Deficiency Classification and Priority Classes    | 2         |
| <b>2 Document Review</b>                              | <b>4</b>  |
| 2.1 Document Review                                   | 5         |
| <b>3 Metocean Review</b>                              | <b>8</b>  |
| 3.1 Winds   | 8         |
| 3.2 Waves   | 8         |
| 3.3 Water Levels                                      | 8         |
| 3.4 Currents  | 8         |
| <b>4 Net Pen Structure</b>                            | <b>9</b>  |
| 4.1 Anchors   | 9         |
| 4.2 Mooring Line & Hardware                           | 9         |
| 4.3 Mooring Line to Float Connection                  | 9         |
| 4.4 Predator Net                                      | 9         |
| 4.5 Fish Pen Net                                      | 9         |
| 4.6 Walkway Frame                                     | 9         |
| 4.7 Pontoon   | 9         |
| <b>5 Inspection, Maintenance &amp; Repair History</b> | <b>10</b> |
| 5.1 Background  | 10        |
| 5.2 Inspection  | 10        |
| 5.3 Maintenance & Repair History                      | 11        |
| 5.4 Ultrasonic Thickness Measurements                 | 11        |
| 5.5 Assessment  | 11        |
| <b>6 Site Visit and Existing Conditions</b>           | <b>12</b> |
| 6.1 Anchors   | 14        |
| 6.2 Mooring Lines                                     | 14        |
| 6.3 Pontoon Floats                                    | 15        |
| 6.4 Steel Framing Superstructure                      | 16        |

|     |  |    |
|-----|--|----|
| 6.5 | Walkways and Railings  | 16 |
| 6.6 | Predator Nets and Connections  | 16 |
| 6.7 | Containment Nets and Connections   | 17 |
| 6.8 | Floating Shed  | 17 |
| 6.9 | Records and Documents On-Site  | 17 |
| 7   | Conclusions  | 18 |
| 8   | References   | 19 |
|     | Appendix A – Drawings  | A  |
|     | Appendix B – Dive Inspection Report  | B  |
|     | Appendix C – Photographs   | C  |
|     | <b>Figures</b>   |    |
|     | Figure 1: Rich Passage Clam Bay Net Pens – Oblique Aerial Photo 7/24/2016                        | 1  |
|     | Figure 2: Damage Rating for Steel Elements   | 3  |
|     | Figure 3: Area Map   | 4  |
|     | Figure 4: Clam Bay Bathymetry  | 5  |
|     | Figure 5: Clam Bay Net Pens – View from Southeast  | 12 |
|     | <b>Tables</b>  |    |
|     | Table 1: Document Review – Summary   | 5  |
|     | Table 2: Predicted Tide: Daily Highs and Lows – Clam Bay (Pacific Daylight Time)                 | 12 |
|     | Table 3: Predicted Currents near Clam Bay: Daily Maximum Floods and Ebbs (Pacific Daylight Time) | 13 |
|     | Table 4: Clam Bay Net Pens – Existing Conditions Summary   | 13 |

# Acronyms and Abbreviations

|      |   |
|------|---|
| ASCE | American Society of Civil Engineers                   |
| ASTM | American Society for Testing and Materials            |
| BAP  | Best Aquaculture Practices                            |
| ECY  | Washington State Department of Ecology                |
| FRP  | Fiberglass Reinforced Plastic Grating                 |
| MLLW | Mean Lower Low Water                                  |
| NOAA | National Oceanographic and Atmospheric Administration |
| OHW  | Ordinary High Water                                   |
| WDFW | Washington State Department of Fish and Wildlife      |
| WDNR | Washington State Department of Natural Resources      |



# Certifications

This report has been prepared by Mott MacDonald under the supervision of a Professional Engineer, including all findings and recommendations.

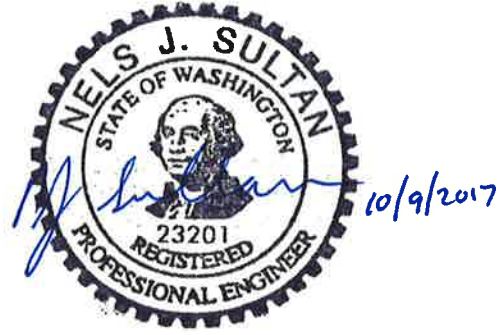

Name: Shane Phillips, PE

Nels J. Sultan, PE

Signature: 



Date: OCT 9 2017

OCT 9, 2017

# 1 Introduction

This report presents the results of a document review, site visit and assessment of the net pen facilities in Clam Bay owned by Cooke Aquaculture. Figure 1 is an aerial photo of the facility. This work has been performed by Mott MacDonald for the State of Washington Department of Natural Resources (WDNR). The dive inspection portion of the work has been performed by Collins Engineers, Inc. as a sub-consultant to Mott MacDonald.

**Figure 1: Rich Passage Clam Bay Net Pens – Oblique Aerial Photo 7/24/2016**



Source: Washington State Department of Ecology

## 1.1 Purpose and Methods

The purpose of the work is to conduct a site visit and review available documents to provide an engineering assessment of the Rich Passage Clam Bay net pen facility. This report is for use by WDNR and state agencies in processing a permit application for use of the facility.

The document review and site visit includes review of the following general elements:

- WDNR permit requirements.
- Best Aquaculture Practices (BAP)
- Permit applicant documentation (inspection reports, design conditions, etc..).
- Inspection type and frequency.
- Maintenance and repair history.
- Facility design documentation and lease requirements.
- Industry standards for design, operations, maintenance, and best management practices.

- Site visit observations and dive inspection with respect to the above listed documents and standards.

This work is limited in scope. Detailed inspection and physical material sampling were not performed. A load rating or structural analysis has not been performed. Repair or maintenance recommendations are not included in this report.

The site visit and inspection only included those elements above water at the time of the site visit. Not included in this review are mechanical systems and utilities, such as lighting, power and water lines and pumps.

This assessment is focused on the structural elements of the net pens. The floating shed and barge between the north and south net pens is included for completeness, but was not inspected in detail. Mott MacDonald did not access closed spaces or access the roof of the barge shed.

## 1.2 Inspection Scope and Standards

Mott MacDonald and Collins Engineers have followed the recommended standards and practices in ASCE Manual No. 130 - *Waterfront Facilities Inspection and Assessment* published by the American Society of Civil Engineers (ASCE, 2015).

The above water inspection by Mott MacDonald staff is consistent with a Level I visual and tactile inspection of all surfaces that were visible without removing coatings or opening hatches. The methods were consistent with a "Routine" type of inspection. The Collins Engineers dive inspection is consistent with a Level I inspection with a Level II inspection at selected areas. The Level I and II methods and Routine inspection type are defined in ASCE No. 130.

## 1.3 Deficiency Classification and Priority Classes

The damage/condition rating system in ASCE Manual No. 130 is applied in this report. It includes the following condition ratings "Minor, Moderate, Major, and Severe," which are defined for different material types. The damage rating definitions for Steel elements are shown below in Figure 2 for ease of reference. Similar figures from ASCE Manual No. 130 exist for mooring hardware, timber and other materials and have been applied for this project.

The following definitions from ASTM standard E2018-15 are applied in this report, copied below for ease of reference. These are assigned to the major components.

"good condition" – in working condition, and does not require immediate or short-term repairs above an agreed threshold\*.

"fair condition" - in working condition, but may require immediate or short-term repairs above an agreed threshold\*.

"poor condition" – not in working condition or requires immediate or short-term repairs substantially above an agreed threshold\*.

The "agreed threshold" is presumed to be the *de minimis* reporting threshold unless otherwise specified.

**Figure 2: Damage Rating for Steel Elements**

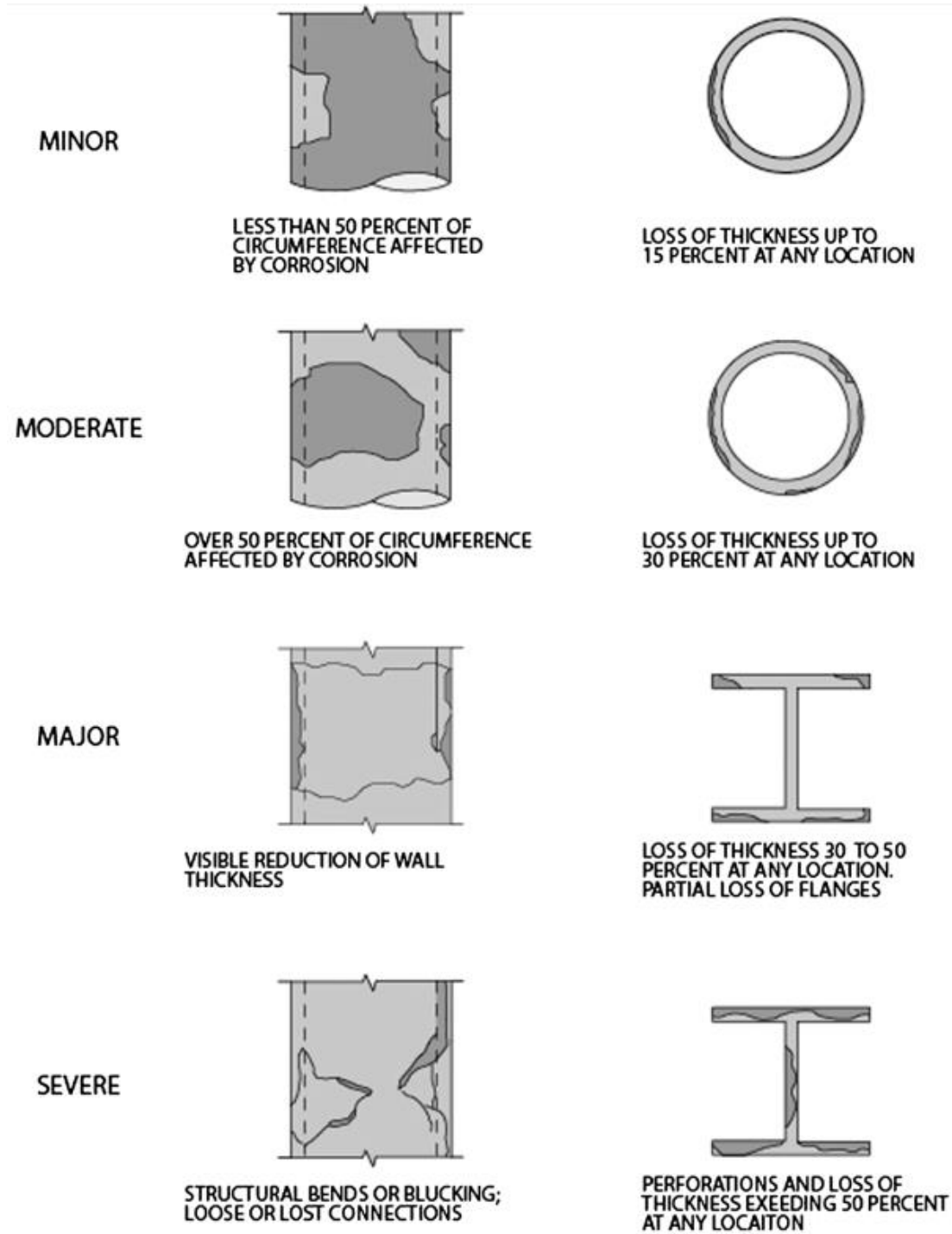

Source: ASCE Standard of Practice No. 130 "Waterfront Facilities Inspection and Assessment"

## 2 Document Review

Clam Bay is near the east end of Rich Passage, between Bainbridge Island and the Kitsap Peninsula. The net pen facilities owned by Cooke Aquaculture are located east of a pier and net pens at the Manchester Naval Supply Center. Figure 3 is an area map. Figure 4 shows the bathymetry in more detail. The depths appear to be between 60 feet and 100 feet (MLLW) along the length of the Clam Bay net pens. Drawings in Appendix A show a general plan and photos of the existing facilities. Additional site photos are in Appendix C.

**Figure 3: Area Map**

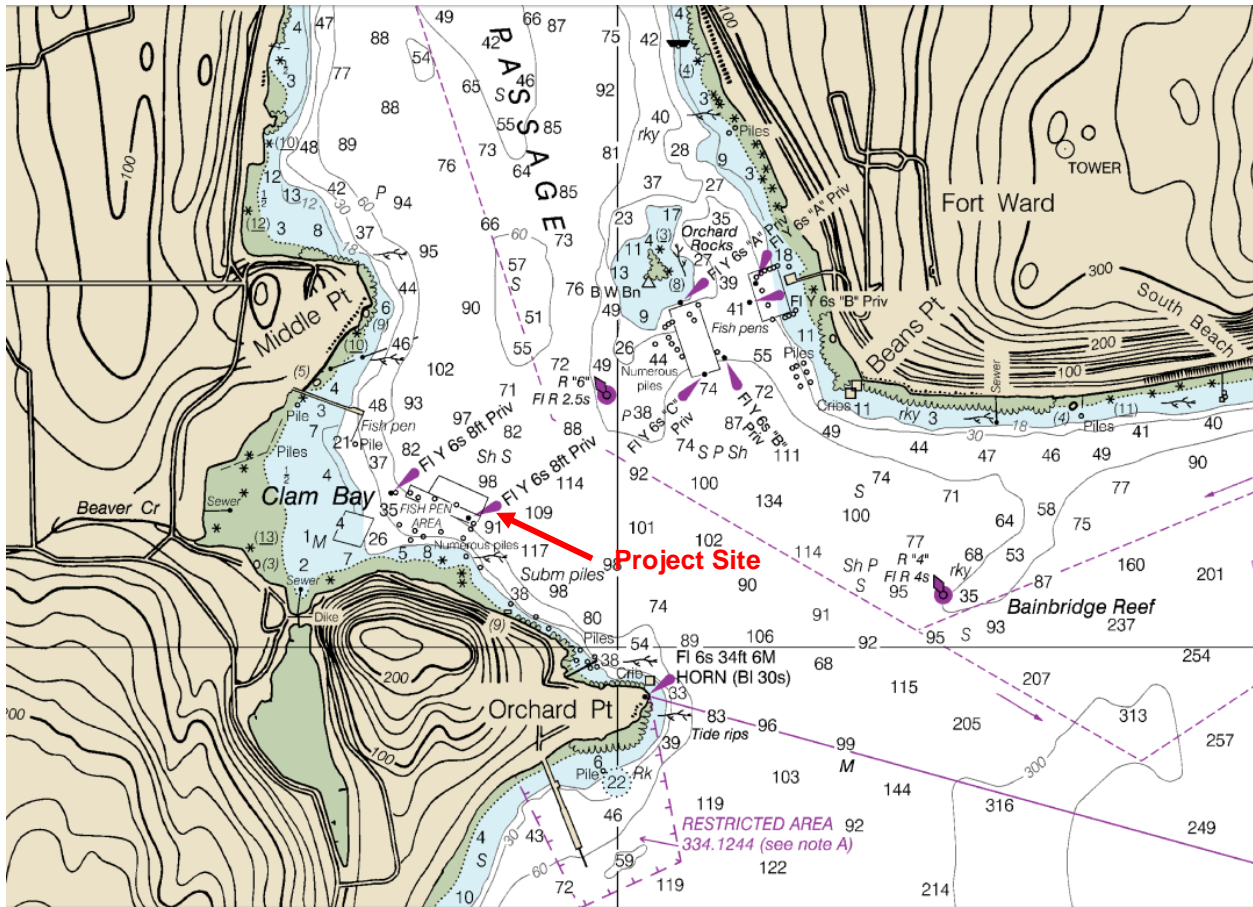

Source: NOAA Chart 18449



**Figure 4: Clam Bay Bathymetry**

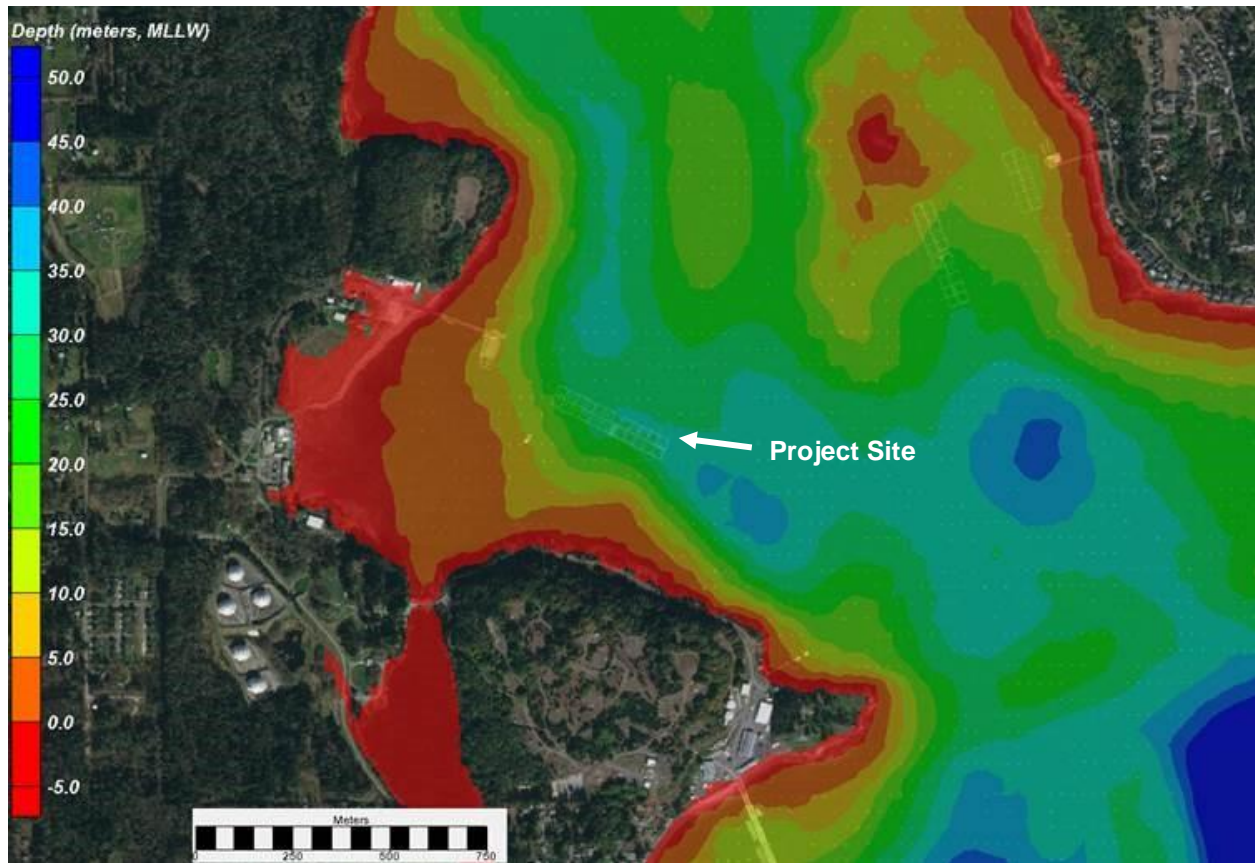

Source: NOAA Digital Elevation Model (DEM) of Puget Sound Bathymetry

## 2.1 Document Review

Documents reviewed by Mott MacDonald are described in Table 1. Document interpretations are included elsewhere in this report.

**Table 1: Document Review – Summary**

| No.   | Description   | Comments  |
|---|---|---|
| <b>Documents received from Miller Nash on 9/27/2017</b> |   |   |
| 1   | Ocean Catamaran Brochure and Design Drawings, 22 pages  | The brochure and drawings contain general information from the manufacturer on the steel pontoon and superstructure, but not the nets or mooring system.                              |
| 2   | Net log records, 18 documents (one Excel spreadsheet and 17 pdf files)  | The net log records include onsite service records for net cleaning and repairs, and an inventory of the nets at the site as of Sept. 2017  |
| 3   | Phase 1 Environmental Site Assessment & Limited Compliance Review prepared by Environmental Resources Management (ERM), 183 pages | Phase 1 Environmental Site Assessment completed by ERM in 2008 of the American Gold Seafoods LLC facility including the Clam Bay net pen.   |
| 4   | Risk Management Survey completed by Aquaculture Risk (Management) Ltd in 2011, 3 pages  | Risk management survey evaluating the water supply, equipment, nets, diving, backup facilities, water supply issues, site security, fish health, predation, and blooms and jellyfish. |

| No.  | Description  | Comments   |
|--|--|--|
| 5  | Risk Management Survey completed by Aquaculture Risk (Management) Ltd in 2016, 8 pages   | Risk management survey evaluating the water qualities issues, equipment, nets, mooring and grid, feeding, diving, stock, backup and staff, site security, fish health, predation, and blooms and jellyfish.  |
| 6  | Ultrasonic Gauging Survey completed by International Inspection on September 15 <sup>th</sup> , 2017, 26 pages   | Ultrasonic thickness measurements of the north pontoons No.1-7 and walkways and south pontoons No. 8-13 and walkways. Schematic drawings of pontoons and walkways.   |
| 7  | Image of North Pontoon drawing with field notes from Ultrasonic Gauging Survey, 1 jpg  | Image with ultrasonic thickness measurements and hand-written field notes  |
| 8  | Mill Test Certificate/Certificate of Inspection, 1 page  | ISO 2307 load test results for the mooring line rope by DSR Corp.  |
| 9  | Clam Bay Mooring Diagram, Excel spreadsheet  | Mooring diagram of existing conditions, includes piles, anchors, chains, roads, and information on inspection and replacement  |
| 10   | Concrete Floats Tow or Anchor Points, email  | Email between American Gold Seafoods and Bruce Colegrave about concrete float anchors. How this applies to the Clam Bay facility is not clear.   |
| <b>Documents received from WDFW and WDNR</b> |  |  |
| 11   | 2017 Cooke Aquaculture Pacific, LLC Fish Escape Prevention Plan Updated January 2017, 9 pages  | Plan includes new technologies and materials being implemented, routine procedures and best management practices to minimize stock escape and fish escape reporting and response plan.   |
| 12   | Water Compliance Inspection Report, 9/14/2015 by ECY   | Inspection report documenting operations, feed, solid waste handling, and permits and paperwork. Photo addendum includes photos of the Clam Bay site, feed storage, and permits/procedures bulletin board.   |
| 13   | DNR Rich Passage Lease, executed 2008  | Includes facility description in Exhibit B.  |
| 14   | Land Survey of Rich Passage net pens in 2008   | Survey of the net pen locations and dimensions with legal descriptions.  |
| 15   | Letter to DFW re issuance of permits to Cooke Aquaculture, 9/20/2017, with 2015 Inspection report attached   | Letter includes Exhibit A: previous ultrasonic gauging reports and Exhibit B: mooring map.   |
| 16   | WDFW Fish Transport Applications/Permit (Bainbridge and Hope), 8/5/2016  | Applications includes permit and email chain between WDFW and Cooke Aquaculture on required pathogen testing.  |
| <b>Standards, Guidelines, Studies, Plans</b> |  |  |
| 17   | Norwegian Standard NS 9415.E:2009 -- Marine fish farms Requirements for site survey, risk analyses, design, dimensioning, production, installation and operation | The standard includes site survey requirements, load and load combinations, general requirements for the main components of a marine fish farm, requirements regarding net pens, floating collars, rafts, and mooring.   |
| 18   | Aquaculture Facility Certification Salmon Farms Best Aquaculture Practices (BAPs) Certification Standards, Guidelines, - by the Global Aquaculture Alliance      | BAPs are practices adopted and self-enforced by the industry. A number of references are available from different states and countries. In Washington state, the BAPs are assumed to include the 1986 interim guidelines (described below).  |
| 19   | Recommended Interim Guidelines for the Management of Salmon Net-Pen Culture in Puget Sound – Dec. 1986   | These interim guidelines prepared for the Washington Department of Ecology are intended to provide a coordinated agency approach to management of salmon net-pens in the Puget Sound. The guidelines are for interim use until a programmatic EIS can be completed and focus on environmental protection. Guidelines include water quality, site selection, and environmental surveys. |
| <b>Miscellaneous</b>                         |  |  |
| 20   | 2014 Fin Fish Aquaculture Plan of Operation – updated June 2014 by American Gold Seafoods  | Obtained by Mott MacDonald. The 2014 plan includes an overview of existing farming sites, stock species,   |

| No. | Description | Comments   |
|-----|-------------|--|
|     |             | and health certifications and screenings. Attachment A lists the facility locations and permits, 2014 Fish Escape Prevention Plan, Employee and guidance for routine handling procedures to minimize the potential for escape. |

Source: *Mott MacDonald*



## 3 Metocean Review

A metocean review was conducted for the net pen located in Clam Bay, Rich Passage, WA as part of this study. General metocean conditions are described in Exhibit B to the DNR lease agreement recorded with the Kitsap County Auditor. This section reviews the wind, wave, water level, and tidal currents condition statements by the net pen owner included in Exhibit B.

### 3.1 Winds

The Owner reported the following:

- Wind speed is “in excess of 50 knots during major storm events”.
- Estimate was based on “personal observation of farm staff”.

Mott MacDonald takes no exception to this statement.

### 3.2 Waves

The Owner has reported the following:

- Southeast winds create largest waves in the area, typically maximum wave is less than 4 feet.
- Clam Bay is protected from the South/Southeast winds by land.
- Clam Bay nets are exposed to northerly waves, maximum wave heights around 4 feet or higher.

Mott MacDonald has compared these reported wave conditions with its internal Puget Sound Computer Wave Model, based on extreme wind analysis from West Point wind station. Mott MacDonald takes no exceptions to this description.

Vessel wakes are not discussed in the documents provided for review by Cooke Aquaculture. Vessel wakes are an important design criterion for this site, considering the frequent nearby ferry traffic.

### 3.3 Water Levels

The owner has reported the following:

- Extreme tide range is 14.5 feet.

This corresponds to the maximum predicted tide range at the nearest tide gage station in Seattle.

### 3.4 Currents

The owner has reported the following:

- Average is 110 cm/sec (2.1 knots) at midway in water column.

The maximum daily predicted current speed at a nearby NOAA current station was reviewed. Mott MacDonald takes not exception to this statement.

## 4 Net Pen Structure

The Clam Bay fish farm facility is an Ocean Catamaran Platform system manufactured by Procean. The fabricated steel structure includes mooring and net pen system and hardware attached to walkway structures which are supported by steel pontoons for flotation. The net pen system is a catenary moored floating structure relying upon forces imposed on the flotation pontoons and net systems to be resisted by a series of mooring chain and anchors. The following is a summary of the key components of the system which we reviewed as a part of our site assessment work. The basis of the information includes the documents provided for review and our observations during the site visit. Drawings of the net pen structure are in Appendix A.

### 4.1 Anchors

The mooring line is shackled to the anchor at the seabed. The anchor types include Danforth and Navy type drag anchors, and fixed mooring points on the seabed called “cans” by Cooke personnel and labeled “steel pile” on the mooring plan provided by Cooke (Appendix A).

### 4.2 Mooring Line & Hardware

The mooring line is composed of a combination of stud link and navy chain, rode line, shackles and other mooring hardware. The mooring line is connected to the float frame at the top and the anchor at the seabed.

### 4.3 Mooring Line to Float Connection

The mooring lines connect to steel plate mooring brackets. The mooring brackets are attached to the walkway structure frame near the walking surface.

### 4.4 Predator Net

The net system connects to steel pipe along outboard edge of the walkway frame.

### 4.5 Fish Pen Net

The net system connects to steel pipe along inboard edge of the walkway frame.

### 4.6 Walkway Frame

The fabricated steel structure provides support for the walkways, main bridge, mooring lines, predator nets and fish pen applied loads. The frame spans between the flotation pontoons and is the primary fixed structure that supports applied loads to the mooring system and flotation pontoons. The center walkway transverse to the pontoons is called the main bridge on the drawings by Procean. Forklifts only travel on the main bridge.

### 4.7 Pontoon

The steel fabricated float pontoons are an octagon cross-section which support the walkway structure frame.

## 5 Inspection, Maintenance & Repair History

A review of the inspection, maintenance and repair history was conducted based on the information provided and as described by Cooke personnel during our site visit.

### 5.1 Background

The following documents and standards apply to the net pen system inspection and maintenance activities.

- WDNR Aquatic Lease #20-B10237 (February 7, 2008). Minor maintenance to the cage structures, anchor lines and netting occurs throughout the year and on a continual basis. Major maintenance of cage structures is typically replacement. Average service life expectancy is approximately 15 years. Metal fatigue can be a factor based on constant wave action and corrosive environment. Inspection of submerged mooring systems are to be made periodically by divers and surface connections checked daily.
- Cooke Aquaculture Fish Escape Prevention Plan (January 2017). Document outlines requirements for moorage system damage inspections. It also outlines requirements for frequency of inspection and post-storm inspection requirements.
- Procean - Ocean Catamaran Net Pen System Product Documentation. The manufacturer outlines recommendations for adjustment and tightening of anchor lines (1000 kg per line and even distribution to all lines), maximum level of net fouling (50% of net and thickness not greater than 50 mm), weekly inspections, monthly inspections, annual, and extreme weather event special inspections. Details of each of these types of inspections are outlined for each component of the net pen system.
- Industry Standards. Various industry standards and other governmental standards for marine fish farming facility inspection and maintenance exist. These include requirements in other U.S. States, Canada and Norway. These other governments and industry practice have a summary of recommended inspection and maintenance activities for net pen systems.

### 5.2 Inspection

- Net Inspections. 2015 to 2017 detailed net cleaning and inspection log by independent company. Routine visual inspections are done by Cooke staff on a weekly basis.
- Dive Inspections. Documentation of detailed independent dive inspection work was limited to reports in July 2015 and September 2017. The inspection reports provided results of the review of mooring system walkway and pontoon elements; no other facility elements were inspected. Risk Management surveys describe facility staff visual dive inspections occur 3 times per week but documentation thereof is not available.
- Environmental & Risk Management Surveys. These were conducted in 2008, 2011 and 2016. The focus of these surveys was water supply, equipment, nets, dives, security, fish health, and other operational aspects.
- Visual Inspections. Conducted by Cooke staff, but no written documentation or reporting was seen. Video is available.

### 5.3 Maintenance & Repair History

Documentation of historical maintenance and repair work is sparse based on the information provided at the time of this assessment. A verbal description of maintenance and repair was provided during the site visit, as well as observation of recent repairs completed and repair work in progress by welders. The September 20, 2017 letter from Miller Nash-Graham Dunn outlined maintenance and repair work being conducted by Cooke in September 2017 for those items outlined in the July 2015 and September 2017 inspection report requiring attention prior to restocking. Documentation of those improvements being completed were not provided at the time of this assessment, other than the “Clam Bay Mooring Diagram” provided in an Excel spreadsheet.

### 5.4 Ultrasonic Thickness Measurements

Mott MacDonald reviewed documents by International Inspection; the July 2, 2015, Sept. 15, 2017 and Sept. 27, 2017 reports titled “Ultrasonic Gauging Surveys”. The documents indicate corroded areas, and include drawings that indicate suggested repairs. The documents do not include an explanation of the figures or provide recommendations for repairs.

Our interpretation of these documents is that the Sept. 15 report is a reconnaissance survey, with more focused inspection of some areas on Sept. 27. The documents do not provide a complete survey. If we are interpreting it correctly it appears the gauging was done at selected areas, called “bands” in the document. The bands circle the pontoons, measuring areas both above and below water, and are spaced approximately 22 feet along the pontoons. The width of the sampling bands is not indicated. It appears parts of the pontoons and structure were not gauged. It is possible weak areas with corrosion exist in the areas between the bands that were not measured. The thickness measurements of the pontoons are also discussed in Section 6.3.

### 5.5 Assessment

The following is our assessment of the inspection, maintenance and repairs being conducted at the facility.

- Inspections appear to be occurring as required by the lease agreement between DNR and the net pen owners.
- Nets, pontoons, walkways and mooring line systems are inspected on a regular basis and prior to stocking with repairs and component replacement conducted prior to restocking.
- Inspection of other key float frame and net support systems such as the predator net support frame and fish net support pipe system are not occurring. Consideration for inspection of these elements should be made on a go forward basis as they are integral elements of the overall net pen structural support system.
- Inspections as outlined in the supplier documentation and industry standards typically require a greater level of inspection and documentation thereof than what appears to be conducted and as outlined in the information provided for this assessment.
- Although not required in the lease and fish escapement plan, documentation of repairs conducted to implement deficiencies identified in the inspection reports should be provided.

## 6 Site Visit and Existing Conditions

Mott MacDonald visited the net pen facility between 8:30 am and 5 pm on September 28, 2017. Collins Engineers performed a dive inspection on both September 28 and 29, 2017. The personnel present included Nels Sultan and James LaFave with Mott MacDonald, Cooke Aquaculture employees, and Washington State Agency staff and officials. Figure 5 shows the net pens. Photographs are included in Appendices A and C. The dive inspection report by Collins is in Appendix B.

**Figure 5: Clam Bay Net Pens – View from Southeast**



Source: Mott MacDonald photograph September 28, 2017

During the site visit observations were made and photos were taken. On September 28 at noon the weather was warm, 70°F, clear sky, with winds light and variable, and the sea calm. Wake waves from ferries up to 1 feet high were observed passing through the structure with no observable motion of the net pen while the waves propagated through the facility. The predicted tide elevations are below in Table 2. Mean Higher High Water (MHHW) is elevation +11.5 feet, MLLW. The mean tide range is 6.7 feet. The predicted currents are in Table 3. The maximum predicted current speed during the site visit was approximately 0.7 knots.

**Table 2: Predicted Tide: Daily Highs and Lows – Clam Bay (Pacific Daylight Time)**

| Tide | Time<br>(Pacific<br>Daylight) | Elevation       |
|------|-------------------------------|-----------------|
| Low  | 9/25/2017 5:29 am             | +1.7 feet, MLLW |
| High | 9/25/2017 1:11 pm             | +9.9 feet       |
| Low  | 9/25/2017 6:44 pm             | +6.6 feet       |
| High | 9/25/2017 11:23 pm            | +8.3 feet       |

Source: Tides&Currents Software

**Table 3: Predicted Currents near Clam Bay: Daily Maximum Floods and Ebbs (Pacific Daylight Time)**

| Time<br>(Pacific Daylight) | Speed     | Direction   |
|----------------------------|-----------|-------------|
| 9/25/2017 3:25 am          | 0.9 knots | 143°, Ebb   |
| 9/25/2017 7:30 am          | 0         | slack       |
| 9/25/2017 10:12 am         | 0.7       | 321°, Flood |
| 9/25/2017 1:30 pm          | 0         | slack       |
| 9/25/2017 5:02 pm          | 0.6 knots | 143°, Ebb   |
| 9/25/2017 9:30 pm          | 0         | slack       |

Source: *Tides&Currents Software*

The components and observed deficiencies are discussed below, and summarized in Table 4. The assessment is based on the conditions observed on September 28, 2017, our document review and our professional judgment and experience. See the drawings in Appendix A for the numbering system.

The year built is estimated based on available documents, discussions with Cooke Aquaculture employees on site, and our experience with marine facilities in the region.

**Table 4: Clam Bay Net Pens – Existing Conditions Summary**

| Component                     | Year Built<br>(estimate) | Description  | Deficiencies  | Overall Assessment |
|-------------------------------|--------------------------|--|---|--------------------|
| Anchors                       | varies                   | See diagram provided by Cooke Aquaculture. Most underwater anchors appeared in good condition  | none observed by divers, although there may be design deficiencies  | good               |
| Mooring Lines                 | varies                   | See diagram provided by Cooke Aquaculture. Most underwater mooring lines and hardware appeared in good condition, although some are covered in marine growth | none observed by divers, although there may be design deficiencies<br>documented dive inspection results and confirmation of corrective actions not available | good               |
| Pontoon Floats                | 2000                     | steel octagon cross-section pontoons (hollow)  | surface rust  | fair               |
| Superstructure above pontoons | 2000                     | spans and structures that support walkway, support nets and attach to anchor chain   | surface rust with localized moderate damage<br>some parts not inspected<br>the north net pens have more corrosion damage than the south net pens              | fair               |

| Component                     | Year Built (estimate) | Description  | Deficiencies  | Overall Assessment |
|-------------------------------|-----------------------|--|---|--------------------|
| Walkways and Railings         | 2000                  | steel fabrication with metal grate walking surface and hinge connections | surface rust, localized severe corrosion, guard rails not secure, grating not secured and damaged,                                    | fair               |
| Predator Nets                 | N/A                   | bird nets and marine mammal nets   | none observed   | good               |
| Containment Nets              | N/A                   | new net observed being installed, seems like a strong net system         | none observed   | good               |
| Floating Shed                 | 1990's                | concrete barge with wood frame shed and metal roof and siding            | concrete float has damage that seems to be caused by vessel impact. Fenders not observed in use when tender vessel is alongside barge | fair               |
| Records and Documents at site | N/A                   | The operations plan notes that records are kept on site                  | not inspected   | --                 |

Source: Mott MacDonald

## 6.1 Anchors

- The International Inspection report in 2015 identifies corrective actions for the anchors and mooring system. A dive inspection by Collins Engineers observed that the anchors appear to be in generally newer condition, with a number of anchors that appeared to be recently installed. The divers were able to inspect 23 of 35 mooring lines. 16 of these mooring lines included inspection to the seabed and the anchors. Drag anchor No. 6 is not buried, the others were buried as expected.
- The anchors are a mix of old and new. The age and condition of some of the anchors has not been determined.
- The anchors are different types, including Navy Stockless, Danforth, and steel piles. Cooke Aquaculture staff noted some are what they call “cans” that may be steel pipe piles or helical screw anchors. The extent and capacity of these anchor systems are not known. Manufacturer’s documentation indicated drag type anchors and no mention of gravity or helical type anchors.

## 6.2 Mooring Lines

- Above water the anchor mooring lines consist of steel chains and shackles ranging from 1.5-inch to 2-inch diameter. Several mooring lines are taut and at a relatively shallow angle of the chain to the water where it connects to the net pen. See for example the mooring chain on the net pen southeast corner, right side of the photo in Figure 5. A mooring line with too much tension when there is minimal wind, wave and current load may become overloaded during an extreme storm event. The Procean manual, section 3.11 notes that “A mooring plan and associated engineering study and report should be



conducted...”. We have not reviewed an engineering study or mooring plan for this facility.

- Above water mooring brackets were observed during our site visit to be in fair condition. Minor to moderate corrosion was observed at connecting elements to the steel frame.
- The thickness of the steel was measured with a gauge at selected areas by International Inspection (2017a and 2017b). The documents indicate the measurements were made September 15 and 27, 2017.
- In general, the anchors and mooring lines observed were in good condition.

### 6.3 Pontoon Floats

- There are two net pen assemblies, one north of the floating barge, and one south. The pontoons are transverse to the overall facility. The pontoons are connected by steel beams perpendicular to the pontoon floats. The pontoon system was inspected by International Inspection in September 2017 with condition and corrective actions noted.
- The pontoons are hollow steel tubes that provide flotation for the entire structure. The metal thickness is 5/16-inch. The pontoons are coated but there is no description of the system used. The Procean drawings call out both paint and primer, but not specifically the pontoons. The Procean drawings say the primer is “WB-14a Zinc”.
- Above water portions of pontoons were visually reviewed by Mott MacDonald and appeared to be in fair condition with surface corrosion and areas of localized minor damage. Steel struts extend from the top of the pontoons to support the net pen superstructure.
- Freeboard was measured and varied by up to 7-inches at different points along the structure. The freeboard variability observed was relatively small, and is not likely caused by flooding into the pontoons.
- Below water conditions are described in the dive inspection report (Appendix B) which includes “the floating pontoons of the net pen system ... overall in good to satisfactory condition with no notable deterioration, damage or any other reasons for concern identified. ... the submerged surfaces had the majority of their protective coatings intact and well-adhered”.
- Thickness measurements of the steel by International Inspection (2017a, 2017b) indicate areas of corrosion that exceed 25% of the thickness of the steel in places, most of the corrosion identified in the ultra-sound thickness survey was located at or above the waterline. The underwater faces of the pontoons were found to be in better condition, which is consistent with the diver observations of minimal corrosion.
- Note that under visual inspection, it is difficult to tell the difference between 5/16-inch thick steel (pontoon design thickness) and 1/4-inch thick. This is especially true underwater. The ultrasound survey denotes this change (20% section loss) as “substantial wastage”. 1/16-inch of surface corrosion would look minimal, but is significant when considering the wall thickness of the pontoons.
- Corrosion protection includes coating (paint) and sacrificial anodes.



## 6.4 Steel Framing Superstructure

- The primary structural framing consists of large, steel members. Along the exterior, the frame is approximately 30 inches wide and 30 inches deep. The framing running down the center of the pen, the main bridge, is smaller and there are two main frames. The framing has surface corrosion and is in fair condition.
- The framing runs north to south and acts as a bridge, spanning between the pontoons. Steel barrel hinges connect the steel frame segments.
- The cross-sectional shape of the framing was not able to be visually verified. The cross sections are assumed to be the same as those shown in the Procean drawings. Minor surface rust was observed across most of the frame, with moderate rust damage in localized areas. The International Inspection 2017 report shows areas of section loss of the north pen. This was visually confirmed during the site visit.

## 6.5 Walkways and Railings

- The walkways include steel grating panels with diamond surfacing. The main walkway grating runs down the center of the pens and is 78 inches wide, 5 inches deep. It is a heavy duty grating capable of supporting net pen equipment and forklifts, as observed on site. The grating was loose and damaged in places.
- The exterior and pontoon walkways are narrower and use 3-inch deep steel grating. Several panels were observed to be either missing bolts and/or damaged by heavy objects. Instead of replacing grating panels, localized repairs have been made by welding steel plate on top of the grating.
- The railings are galvanized 1.5" diameter pipe and border all sides of the walkways. They are removable as needed, slotted into brackets connected to the steel framing. Most of these brackets were moderately covered in rust, with localized cases of major corrosion. The deterioration of the brackets caused the railing to become loose and rotate when pressure was applied.
- Primary structure elements and hinges were exhibiting severe corrosion in places and should be repaired.

## 6.6 Predator Nets and Connections

- Predator nets include both in-water nets to prevent seals and other marine mammals from entering the pens, and above water nets to prevent bird predation of the salmon.
- The in-water nets are supported by 4-inch diameter pipe rails that are attached to the steel framing are in fair condition with surface rust. The nets are taut, extending straight down into the water and held in place by weighted pipes. The nets appear in good condition.
- The nets appeared to be in good condition. To remove marine growth fouling they are pulled up and dried. Full replacement is done about every 4 years.

## 6.7 Containment Nets and Connections

- The containment nets confine the salmon inside each individual pen. The nets are supported by 2.5" diameter pipe rails that surround the perimeter of each pen. Surface corrosion was observed on the pipe connections to the frame. The nets observed were in new condition.
- Mott MacDonald observed a net during installation. The nets being installed were new and appeared to be of strong construction. The containment nets are used for about three crop cycles before they are replaced.

## 6.8 Floating Shed

- The floating shed is a one-story structure, consisting of timber framing built on top of a concrete barge.
- An assessment of the floating shed condition is outside of our scope. However, damage to the concrete barge was observed that seems to have been caused by vessel impact.
- Fenders were not observed to be in use when the tender vessel is alongside the barge.

## 6.9 Records and Documents On-Site

The documents note that records are stored on site but we did not ask to see them.

## 7 Conclusions

In general, the facility is in fair condition, with some repairs needed as noted in this report. No major concerns or critical areas exhibiting severe condition were observed for the components that were reviewed. The structure system is a robust, heavy steel frame design, relative to the sheltered conditions in Clam Bay. However, the mooring system design documentation is not available. Mooring anchor modifications have been made and there is no information to verify adequacy for site conditions.

### Key findings

Based on a review of the documents and the site visit the following is noted:

1. No site specific stamped engineering drawings were provided. Drawings of the system attached to the Procean brochure appear to be generic shop drawings, and are not a custom drawing of the system installed in Clam Bay.
2. The design of the mooring system is not documented. A schematic mooring diagram and notes describing the existing components are available.
3. Underwater portions of the mooring system and pontoons appear to be in good condition with recent and ongoing maintenance and replacement occurring. One drag anchor, No. 6, is completely on the surface, not buried. The underwater inspection did not reveal any significant deterioration or deficiencies for the components or their connections that would suggest any appreciable reduction in their originally designed integrity or stability
4. Surface rust and minor to moderate corrosion damage is widespread on the above water portion of the structure. Severe corrosion damage was observed in localized areas
5. The north pens were observed to have a higher level of corrosion than the south pens. The north pens require a higher level of attention for repairs and future maintenance.
6. The design of the corrosion protection system is not documented. Sacrificial anodes were observed hanging from copper wires and attached to the bottom of the pontoons. The corrosion protection (both paint and anodes) appears more effective for the in-water portion of the pontoons. The above water portion of the structure has less effective corrosion protection.
7. Documentation of the corrective actions identified in the 2015 and 2017 inspection reports being performed is not complete.
8. Inspection by the Owner of other key components of float frame and mooring points by ultrasonic gauge methods should be conducted and documented with corrective actions noted.
9. Inspections conducted by the Owner do not appear in accordance with manufacturer's recommendations or industry standards, as discussed in Section 5.1 of this report. Inspections of additional critical structure elements should be conducted considering their age and condition.

The findings and results of this assessment work by Mott MacDonald do not constitute a certification of the facility structural integrity but rather an overall review of the condition as represented by the applicant and verified in the field during a site visit and dive inspection.

## 8 References

Aquaculture Risk (Management) Ltd. (2011). "Fish Farm Survey Report".

Aquaculture Risk (Management) Ltd. (2016). "Fish Farm Survey Report".

ASCE (2015). "Waterfront Facilities Inspection and Assessment", ASCE Manuals and Reports on Engineering Practice No. 130.

ASCE (2012). "Planning and Design Guidelines for Small Craft Harbors", ASCE Manual of Practice No. 50, 3rd Edition.

ASTM (2018). "Standard Guide for Property Condition Assessments: Baseline Property Condition Assessment Process", American Society for Testing and Materials, ASTM Standard E2018-15.

Badinotti (2015). "Net Washing, Disinfecting, Repair and Dipping", 12 reports, GW01 to GW31. Customer Onsite Service Records.

Badinotti (2015). "Net Washing, Disinfecting, Repair and Dipping", 4 reports, GW02 to GW30. Customer Onsite Service Records.

Bruce Colegrave (2014). "Concrete Floats Tow or Anchor Points". Email.

Cooke Aquaculture (2017). "Clam Bay Net Inventory - September 2017". Microsoft Excel Spreadsheet.

Cooke Aquaculture (2017). "Clam Bay Mooring Map September 2017 with Mooring Numbers, 4816-5605-3585 v.1.xls". Microsoft Excel Spreadsheet.

Cooke Aquaculture (2017). "Fish Escape Prevention Plan, Updated January 2017".

DOD (2001). "Maintenance and Operation: Maintenance of Waterfront Facilities", Department of Defense, UFC 4-150-07, June 19, 2001, pp. 219.

DSR Corp. (2017). "Mill Test Certificate/Certificate of Inspection".

Environmental Resources Management. (2008). "Phase 1 Environmental Site Assessment & Limited Compliance Review".

Global Aquaculture Alliance (2016). "Aquaculture Facility Certification-Salmon Farms-Best Aquaculture Practices-Certification Standards, Guidelines" v. 10/16, <[www.gaalliance.org](http://www.gaalliance.org)>.

FDACS. (2016). "Aquaculture Best Management Practices Manual". Florida Department of Agriculture and Consumer Services, Division of Aquaculture.

Icicle Acquisition Subsidiary, LLC (2014). “2014 Fin Fish Aquaculture plan of Operation”.

International Inspection, Inc. (2017). “IMG\_0008” JPEG image.

International Inspection, Inc. (2017a). “Clam Bay Pontoon North & South: Ultrasonic Gauging Survey” on September 27, 2017.

International Inspection, Inc. (2017b). “Clam Bay Pontoon North & South: Ultrasonic Gauging Survey” on September 15, 2017.

International Inspection, Inc. (2015). “Clam Bay Pontoon North & South: Ultrasonic Gauging Survey” on July 2, 2015.

MacLearnsberry, Inc. (2008). “American Gold Seafoods, LLC. Aquatic Lease No. 20-B10237 Land Survey”.

Malison, J., Hartleb, C. (2005). “Best Management Practices for Aquaculture in Wisconsin and the Great Lakes Region”. University of Wisconsin Sea Grant Institute.

Miller Nash. (2017). “Cooke Aquaculture Pacific LLC transfer and import permits”. Letter Via Email.

NAVFAC (1993). “Inspection of Shore Facilities”, Naval Facilities Engineering Command, NAVFAC MO-322, Volume II, January 1993, pp. 198.

Procean. “Industrial Fish farming and Water purification: Ocean Catamaran”, Brochure, Drawings and Operating Manual.

Washington Dept. of Ecology (1986). “Recommended Interim Guidelines for the Management of Salmon Net-Pen Culture in Puget Sound”.

Standards Norway. (2010). “Marine fish farms Requirements for site survey, risk analysis, design, dimensioning, production, installation, and operation”. NS 9415.E:2009.

WDFW. (2016). “Fish Transport Application/Permit, Permit No. 7398-08-05-16”.

WDNR. (2005). Aquatic Lands Aquaculture Lease No. 20-B10237”.

Washington Dept. of Ecology. (2015). “Water Compliance Inspection Report”. State of Washington Department of Ecology Northwest Regional Office.

# Appendix A – Drawings

# Appendix B – Dive Inspection Report

# Appendix C – Photographs



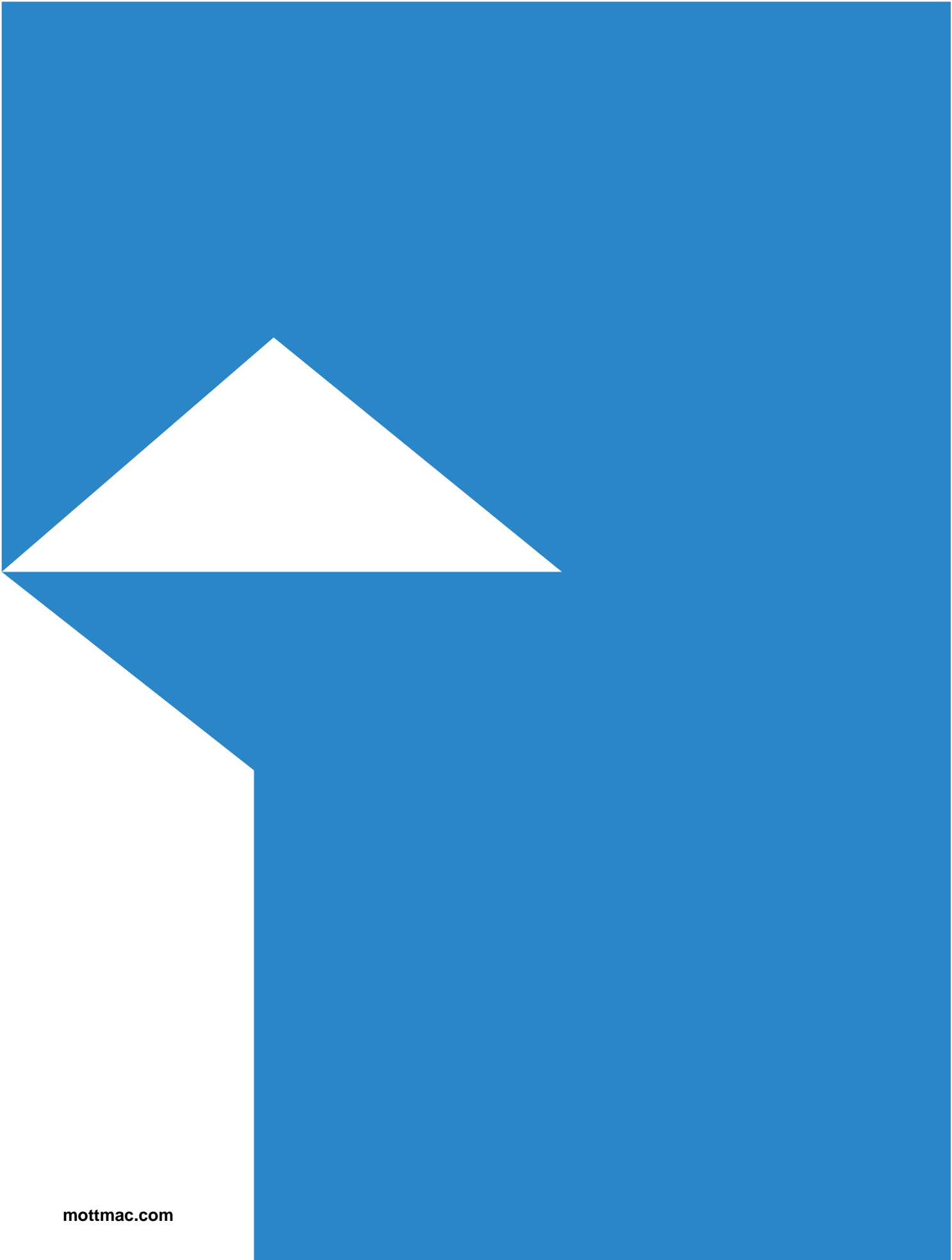

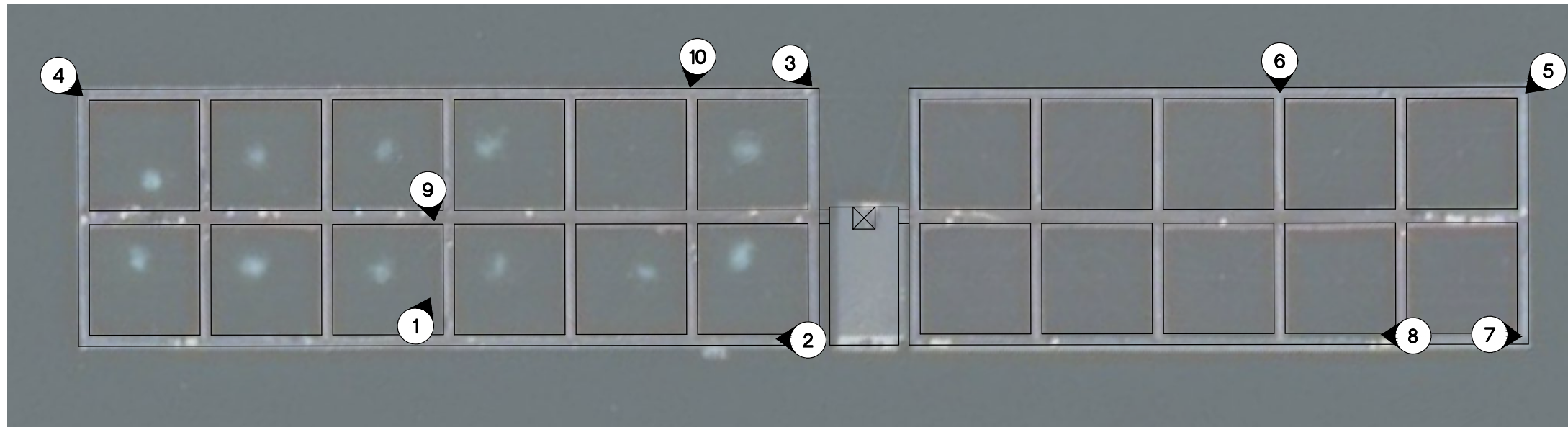

**LEGEND**

1 PHOTO LOCATION AND ORIENTATION

**NOTES**

MOORING SYSTEM NOT SHOWN, SEE SHEET 2

**CLAM BAY NET PEN**

PHOTOS-PLAN

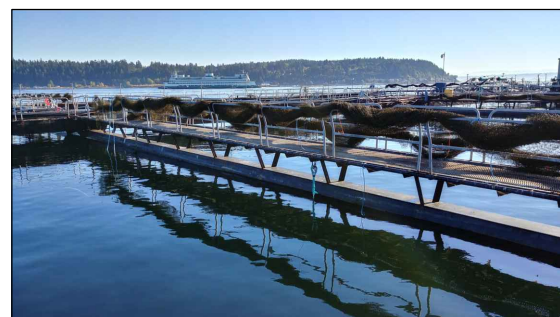
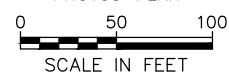

**PHOTO 1**  
PONTON WALKWAY

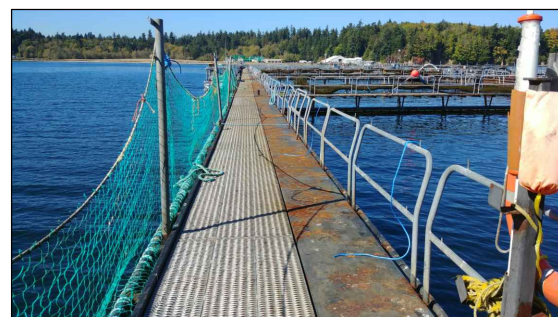

**PHOTO 2**  
EXTERIOR WALKWAY / PREDATOR NET

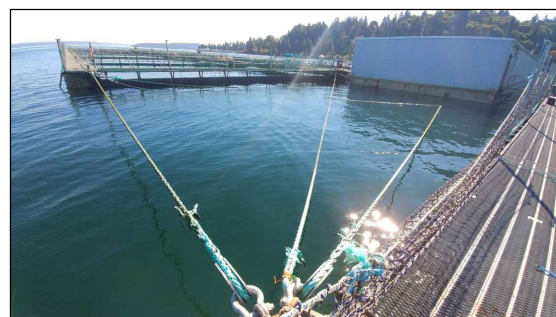

**PHOTO 3**  
LINES AND SHACKLES BETWEEN NORTH AND SOUTH NET PENS



**PHOTO 4**  
NET PEN DURING NET INSTALLATION



**PHOTO 5**  
SOUTH FISH PENS



**PHOTO 6**  
PONTON WALKWAY SURFACE

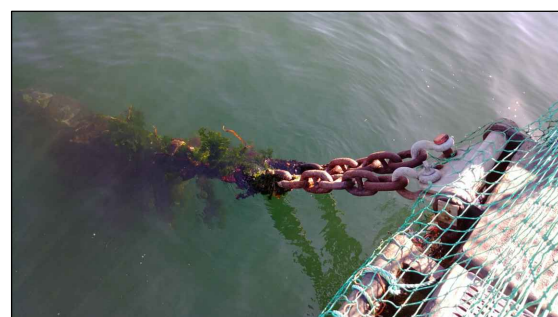

**PHOTO 7**  
MOORING CHAINS

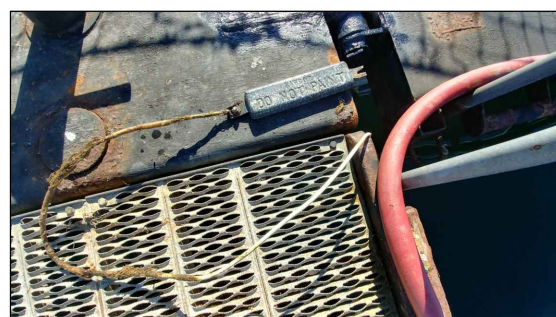

**PHOTO 8**  
ZINC ANODE SUSPENDED FROM COPPER WIRE



**PHOTO 9**  
EXTERIOR WALKWAY HINGE CONNECTION



**PHOTO 10**  
GRATING AND PREDATOR NET RAIL SUPPORTS



110 James Street  
Suite 101  
Edmonds, Washington 98020  
  
T +1 (425) 778 6243  
F +1 (425) 778 6883  
W www.mottmacamericas.com

Client



WASHINGTON DEPARTMENT OF FISH AND WILDLIFE

| Rev | Date    | Drawn | Description     | Ch'k'd | App'd |
|-----|---------|-------|-----------------|--------|-------|
| 1   | 9/29/17 | CT    | PLAN AND PHOTOS | JL     | NS    |

|                |     |       |
|----------------|-----|-------|
| Project Number | B/O | Total |
| 385629         | 1   | 4     |

|                 |           |              |             |
|-----------------|-----------|--------------|-------------|
| Designed        | J. LaFave | Eng check    | S. Phillips |
| Drawn           | C. Taylor | Coordination |             |
| Dwg check       | N. Sultan | Approved     |             |
| Scale at ANSI D | Status    | Rev          | Security    |
| As Shown        |           |              |             |
| Drawing Number  |           |              |             |

Washington State  
Department of Fish and Wildlife  
Rich Passage Clam Bay Net Pen  
Site Assessment Plan



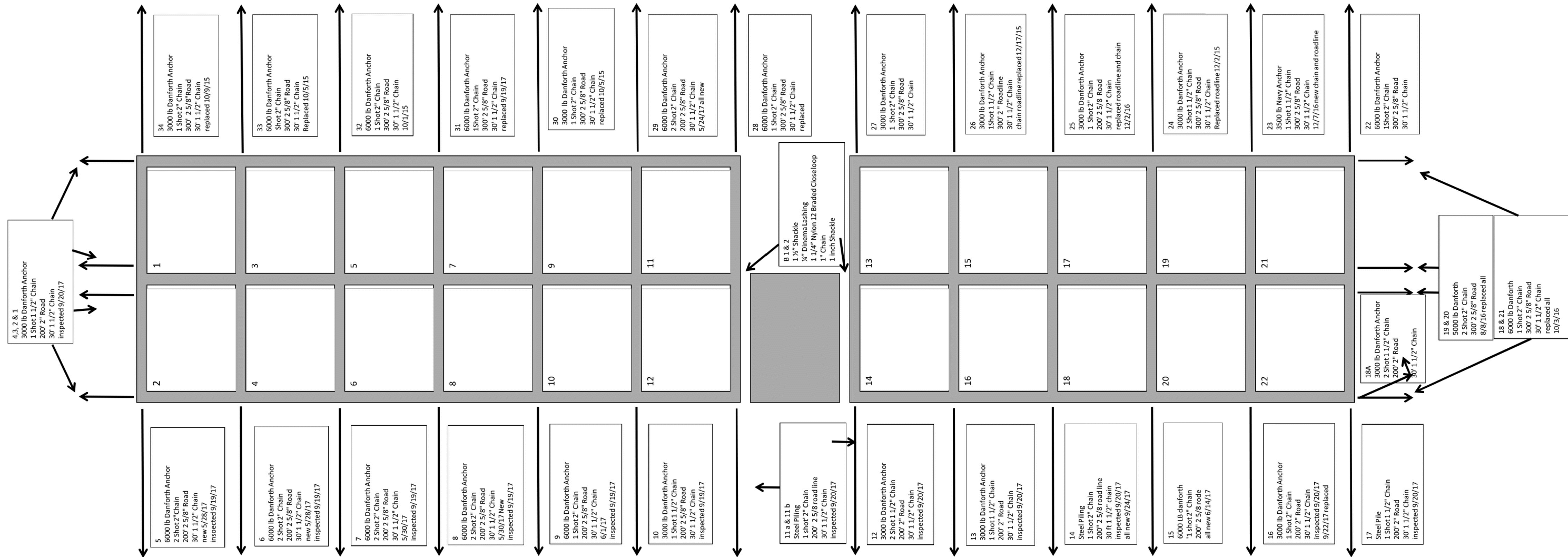

**CLAM BAY NET PEN**  
MOORING PLAN  
NOT TO SCALE

**NOTES**  
MOORING SYSTEM SCHEMATIC PLAN  
PROVIDED BY COOKE AQUACULTURE.

**M M**  
**MOTT MACDONALD**

110 James Street  
Suite 101  
Edmonds, Washington 98020

T +1 (425) 778 6243  
F +1 (425) 778 6883  
W www.mottmacamericas.com

Client



**WASHINGTON DEPARTMENT OF FISH AND WILDLIFE**

| Rev | Date    | Drawn | Description     | Ch'k'd | App'd |
|-----|---------|-------|-----------------|--------|-------|
| 1   | 9/29/17 | CT    | PLAN AND PHOTOS | JL     | NS    |

|                |        |     |   |       |   |
|----------------|--------|-----|---|-------|---|
| Project Number | 385629 | B/O | 2 | Total | 4 |
|----------------|--------|-----|---|-------|---|

|                 |           |              |             |
|-----------------|-----------|--------------|-------------|
| Designed        | J. LaFave | Eng check    | S. Phillips |
| Drawn           | C. Taylor | Coordination |             |
| Dwg check       | N. Sultan | Approved     |             |
| Scale at ANSI D | Status    | Rev          | Security    |
| As Shown        |           |              |             |
| Drawing Number  |           |              |             |

Title

Washington State  
Department of Fish and Wildlife  
Rich Passage Clam Bay Net Pen  
Mooring Schematic

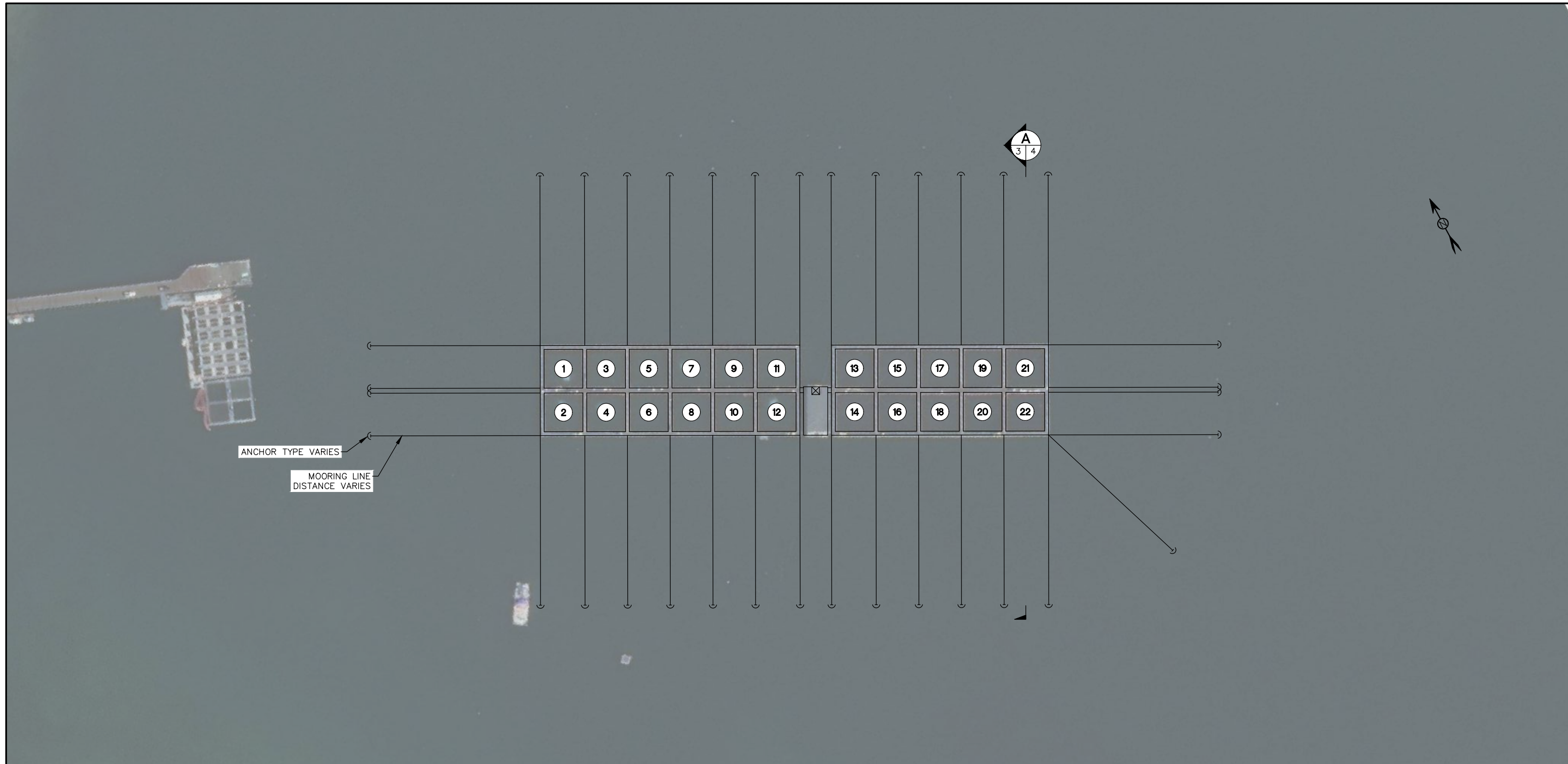

**CLAM BAY NET PEN**

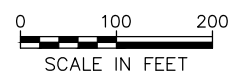

**M M**  
**MOTT MACDONALD**

110 James Street  
Suite 101  
Edmonds, Washington 98020

T +1 (425) 778 6243  
F +1 (425) 778 6883  
W www.mottmacamericas.com

Client

**WASHINGTON DEPARTMENT OF FISH AND WILDLIFE**

| Rev | Date    | Drawn | Description     | Ch'k'd | App'd |
|-----|---------|-------|-----------------|--------|-------|
| 1   | 9/29/17 | CT    | PLAN AND PHOTOS | JL     | NS    |

|                |     |       |
|----------------|-----|-------|
| Project Number | B/O | Total |
| 385629         | 3   | 4     |

|                 |           |              |             |
|-----------------|-----------|--------------|-------------|
| Designed        | J. LaFave | Eng check    | S. Phillips |
| Drawn           | C. Taylor | Coordination |             |
| Dwg check       | N. Sultan | Approved     |             |
| Scale at ANSI D | Status    | Rev          | Security    |
| As Shown        |           |              |             |
| Drawing Number  |           |              |             |

Title

Washington State  
Department of Fish and Wildlife  
Rich Passage Clam Bay Net Pen  
Existing Site - Moorings

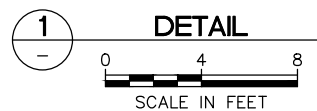
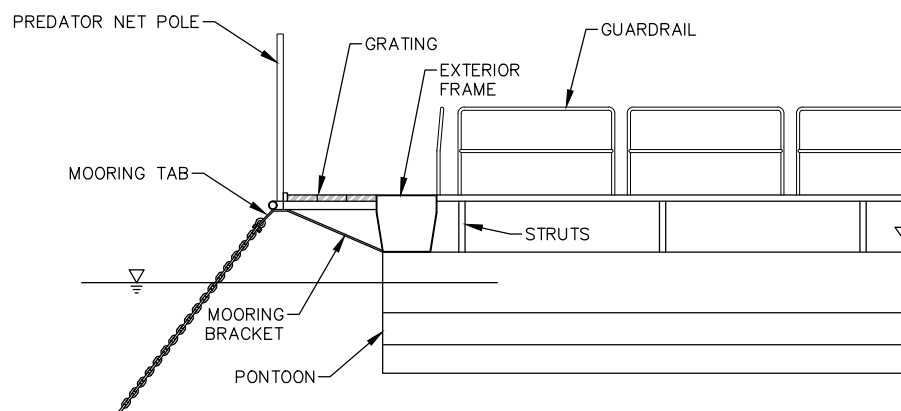
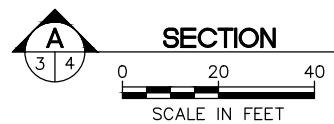
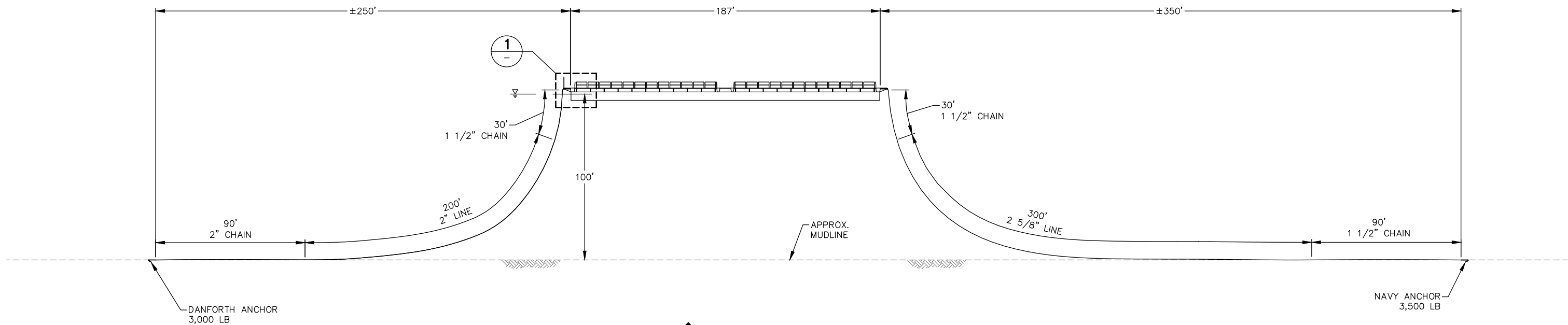

110 James Street  
Suite 101  
Edmonds, Washington 98020  
  
T +1 (425) 778 6243  
F +1 (425) 778 6883  
W www.mottmacamericas.com

Client



WASHINGTON DEPARTMENT  
OF FISH AND WILDLIFE

| Rev | Date    | Drawn | Description     | Ch'k'd | App'd |
|-----|---------|-------|-----------------|--------|-------|
| 1   | 9/29/17 | CT    | PLAN AND PHOTOS | JL     | NS    |

|                |     |       |
|----------------|-----|-------|
| Project Number | B/O | Total |
| 385629         | 4   | 4     |

|                 |           |              |             |
|-----------------|-----------|--------------|-------------|
| Designed        | J. LaFave | Eng check    | S. Phillips |
| Drawn           | C. Taylor | Coordination |             |
| Dwg check       | N. Sultan | Approved     |             |
| Scale at ANSI D | Status    | Rev          | Security    |
| As Shown        |           |              |             |
| Drawing Number  |           |              |             |

Washington State  
Department of Fish and Wildlife  
Rich Passage Clam Bay Net Pen  
  
Section - Mooring



October 09, 2017  
Collins Job No. 45-10702

Underwater Inspection of Clam Bay Fish Net Pen System within  
Rich Passage in the Puget Sound near Manchester, WA.

Mr. Nels Sultan, Ph.D, PE  
Principle Engineer  
North America Ports, Coastal and Offshore  
Mott MacDonald  
110 James Street, Suite 101  
Edmonds, WA 98020

Dear Mr. Sultan:

On September 28 and 29, 2017, Collins Engineers, Inc. conducted an underwater inspection of various submerged components of the Clam Bay Fish Net Pen System located within Rich Passage in the Puget Sound near Manchester, WA. The intent of the inspection was to inspect as much submerged net pen system construction as possible, given the constraints of the two-day inspection window and standard in-water, at-depth limitations, as established by the U.S. Navy Dive Tables and regulated by OSHA for No-Deco diving operations, and then based on the below water inspection findings, comment on the current integrity and stability of the net pen system.

The net pen system components inspected included primarily all or a representative sample of the floating pontoons that support the overall system, their attachments to the various anchor lines, and the anchor line assemblies. The inspection effort, as was deemed necessary, placed more time and concentration on any aspects of the net pen system construction that could be more susceptible to individual deficiency and/or failure, which in turn could lead to more far-reaching deficiency or failure of the overall net pen system, with such aspects consisting mostly of the various connections between the different submerged components of the system. The inspection intensity consisted primarily of a Level I inspection effort (visual and tactile techniques), with very limited cleaning of existing marine growth, and the overall inspection process followed the guidelines established by the ASCE Manual of Practice 130 – Waterfront Facilities Inspection and Assessment Standard Practice Manual. The inspection also did not include the taking of any remaining member thickness measurements with non-destructive testing equipment.

Ultimately, based on the available inspection time, the underwater inspection effort was able to include the submerged portion of all of the net pen system pontoons, aside for the two pontoons on either side of Pens 1 and 2, with those pontoons inaccessible due to ongoing fish net placement operation being conducted by workers at the net pen facility. Regarding the attachment of the pontoons to their corresponding anchor lines, all of those connections,



including those at the pontoons on either side of Pens 1 and 2, were inspected. As for the various anchor lines extending from around the perimeter of the net pen system, based on the time available and prevailing water depths at many of the anchors, all or some of the critical portions of approximately 23 anchor lines could be inspected, with the chains and/or anchors inspected at the seabed at some 16 of those anchor lines. In particular, the net pen system anchors that received some extent of inspection included: the center two anchor lines on the northerly side of the system; twelve of the anchor lines along the westerly (inboard) side of the system; and nine of the anchor lines along the easterly (outboard side). Regarding the anchor lines along the easterly side of the net pen system, it should be noted that due to prevailing water depths at anchor locations along that side of the system, which mostly ranged between 105 fsw and 120 fsw, most of those inspections only included the upper chain and rope portions, with just the southernmost two anchor lines along the easterly side inspected to the anchor at the seabed, since water depths were less than 100 fsw, which is the OSHA limitation for commercial dive operations not requiring a recompression chamber to be onsite.

It should also be noted that in the process of inspecting the above-indicated net pen system components, the nets of the system in the general area of those components were given a cursory inspection, although the nets in place were only the predator nets, with inner-lying the fish nets mostly not in place at the time of inspection (only being deployed in Pens 1 and 2 as previously indicated). Overall, the predator net inspection did not reveal any concerns, aside for one 12 inch by 12 inch hole that was observed on the easterly side of Pen 5 just below the water surface.

Overall, the underwater inspection of the floating pontoons, the pontoon connections to the anchor lines, and the anchor line assemblies revealed the following key findings:

- The inspected floating pontoons were typically found to be generally in good condition, with only minor corrosion damage in random locations and their protective coatings primarily intact, and with their system of cathodic protection anodes appearing to be adequately protecting the pontoon steel.
- The inspected connections between the anchor lines and the floating pontoons were typically found to be generally in good condition, with minimal deterioration (minor damage), and with all connection elements sound and secure.
- The inspected anchor lines and anchors were typically found to be generally in good condition, with minimal deterioration (minor damage), and with a majority of the inspected items appearing to be relatively new based on the lack of corrosion and marine growth.
- The inspected anchors and anchor chain legs were typically found to be adequately embedded in the seabed, suggesting that they were well-seated and affording the expected anchorage. The only exception to this was found at Anchor 6, which was

resting on top of the seabed, although with no indication that the anchor has been moving since placement.

As for the floating pontoons of the net pen system, the inspection of those components always revealed them overall to generally be in good condition with no notable deterioration, damage or any other reasons for concern identified. For the most, the submerged surfaces had the majority of their protective coatings intact and well-adhered, with approximately 90% to 100% of the coated pontoon surfaces exhibiting a mostly light layer of marine growth that consisted primarily of small barnacle and soft, grass-like marine growth. In general, the pontoons typically only exhibited protective coating breakdown and failure across an estimated 5% or less of their submerged surface area, with the coating loss being very random and spotty (generally groupings of 1 inch diameter and smaller areas of coating loss). Where coating loss was evident on the below water surfaces of the pontoons, there was always just minor surface corrosion and a light dusting of rust scale, which could be easily brushed away with a gloved hand, observed, with no notable loss of steel section related to the corrosion detected. The pontoon inspections also included the inspection of the various cathodic protection anodes attached to the pontoons, with the sacrificial anodes on the southerly half of the net pen system hanging down (on a cable) from the pontoons and on the northerly half of the system being attached directly (bolted to a bracket) to the pontoons. In most instances, the anodes were found to have minimal consumption, with just a general rounding of their edges that would suggest no more than an estimated 10% of loss of original anode section. There were, however, a few instances of anodes with heavier consumption, with section losses estimated at being between 80% and 100%, although this condition was only observed a well under 5% of the anodes. Even with these random and very isolated heavier anode consumptions, there still appeared to be more than sufficient anode population to afford proper cathodic protection of the pontoons, which seemed to be evidenced by the very minimal and light corrosion on the areas of exposed pontoon steel below water.

Regarding the attachment of the anchor lines to the various pontoons around the entire perimeter of the net pen system, they were always found to be fully intact and secure in what could always be deemed as generally good condition. Typically, the item of the pontoon-to-anchor line connections that exhibited the greatest deterioration was observed to be the steel plate that serves as a means of connecting the anchor line shackle to the steel bracket assembly that connects to the pontoon and pen system perimeter walkway. As for these connection plates, which lie in the splash zone, they typically exhibited moderated corrosion that had some associated rust delaminations; however, there still appeared to be very minimal loss of original steel plate thickness related to the corrosion. Attached to these connection plates, the anchor line shackles typically exhibited little, if any, deterioration, and in many instances appeared to be relatively new hardware. Also regarding the upper anchor line shackles, they were always found to be properly aligned and secure, with the restraining wires for the shackle pins typically in place and properly installed. Likewise, an inspection of all accessible portions of the steel framing that provides the connection between the aforementioned shackle plates and the pen system pontoons and perimeter walkway



construction typically revealed those assemblies to be sound and secure with no concerns for instability.

As previously indicated, the anchor line inspections included, to various extents, all or portions of the upper (surface) lengths of chain, the anchor leg portions of chain, the large diameter rope (rode line) running between the two runs of chain, and the anchors themselves, when exposed above the seabed. As for the runs of chain, they were typically found to have varying degrees of marine growth, ranging from 100% coverage of up to 2 inch thick, soft anemone and grass-like growth, most often on upper chain runs, to a sparse coverage of small barnacle and grass-like growth that could be found on both the upper and anchor leg runs. Regarding the extent of marine growth on the chains, it was never observed to be what would be considered excessive, and the extent was definitely related to the apparent age of the chain, with the majority of the chain appearing to be newer and therefore having just sparse marine growth. In all instances, the lengths of chain inspected exhibited only very minor deterioration, with just light surface corrosion being present that had no notable loss of original chain section associated with it. With respect to the rope running between the surface and seabed chain runs, it was always found to be in good, full section condition, with no evidence of fraying or abrasion related damage ever encountered. Similarly, the thimble assemblies and their related rope eye splices, which were used to connect the rode line of the anchor lines to the upper and lower chain shackles, were also always found to be sound and secure, with no evidence of any conditions that would compromise the connection detail in any way. As for the amount of marine growth on the various rode lines inspected, the growth tended to either be the previously described 100% coverage of 2 inch thick softer marine growth or essentially no growth at all. Again, the lack of any marine growth on the anchor line ropes corresponded to readily apparent newer rope material, which was more often the case for the rode lines inspected.

Regarding the anchor leg portions of chain and the anchors inspected, in all instances, the anchor legs of chain were always found to be generally in good condition, with the chain resting on and/or embedded in the seabed to some extent, suggesting an appropriate anchor location and length of overall anchor line to promote the proper setting and subsequent grip of the Danforth type anchors used for the net pen system. In this regard, most often the anchor leg chains were generally embedded half way into the seabed, and there was no evidence of any rutting of the seabed, which would suggest that an anchor leg was being lifted up from or being moved side-to-side in the seabed. In addition, the studs were always in place within the links of the anchor leg chains, which is a good indication that there has been any undue thrashing or unintended movement of the anchor leg chains once they have been placed. As for the anchors, the majority of the anchors inspected were found to either be completely buried or buried to the extent that only 1 foot (vertical) or less of the anchor at the fluke/shaft interface was exposed above the seabed, which in either case suggests that the anchor was well-seated and gripping into the seabed. The only exception to this typical embedment condition was observed for one of the anchors on the northerly end of the westerly side of the net pen system (denoted as Anchor 6), where the anchor was still mostly

# COLLINS ENGINEERS INC.

just resting on the seabed. At this location, however, the corresponding anchor leg chain exhibited the typical amount of embedment into the seabed, suggesting that there has been no appreciable movement of the anchor since it was placed. It should also be noted that for the two anchors which could be inspected on the southerly end of the easterly side of the net pen system, the majority of the anchor leg chain was also fully embedded into the seabed along with the corresponding anchor.

Refer to Photographs 1 through 20 for views for the typical conditions observed for the various components of the net pen system that were inspected underwater.

In conclusion, it can be stated that the underwater inspection conducted for the various components of the Clam Bay Fish Net Pen System, as outlined and discussed above, did not reveal any significant deterioration, as well as any other deficiencies for the components themselves or their related connections that would suggest any appreciable reduction in their originally designed integrity or stability. In that regard, the components inspected below water were typically found to be in sound condition with no indication that a reduction in the originally intended capacity of a component or connection could be expected. If you have any questions or require any additional information with respect to the underwater inspection findings, please don't hesitate to contact me.

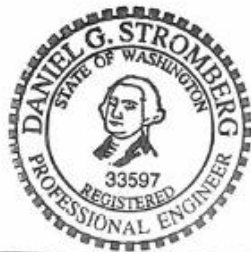

Respectfully submitted,  
Collins Engineers, Inc.

A handwritten signature in black ink, appearing to read "Daniel G. Stromberg".

Daniel G. Stromberg, P.E.  
Chief Structural Engineer/Diver



Photograph 1 : Overall View of the Clam Bay Pen, Looking Southwest.



Photograph 2 : Overall View of the Clam Bay Pen, Looking Northwest.





Photograph 3 : Underwater View of the Typical Marine Growth and Coating on the Pontoons.

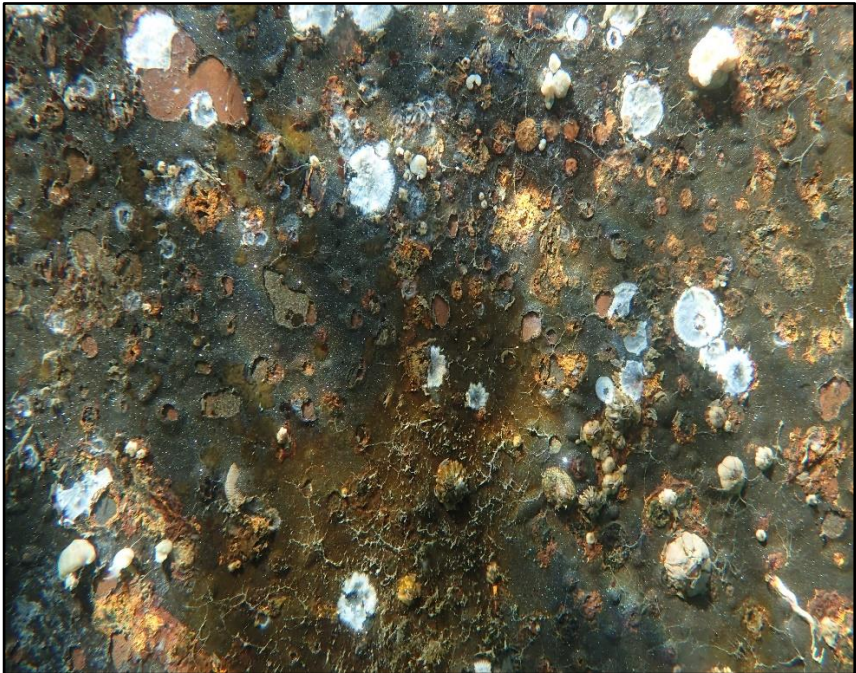

Photograph 4 : Underwater View of the Coating Loss and Surface Corrosion on the Pontoons.



Photograph 5 : Underwater View of the Hanging Style Anode on the pontoons.

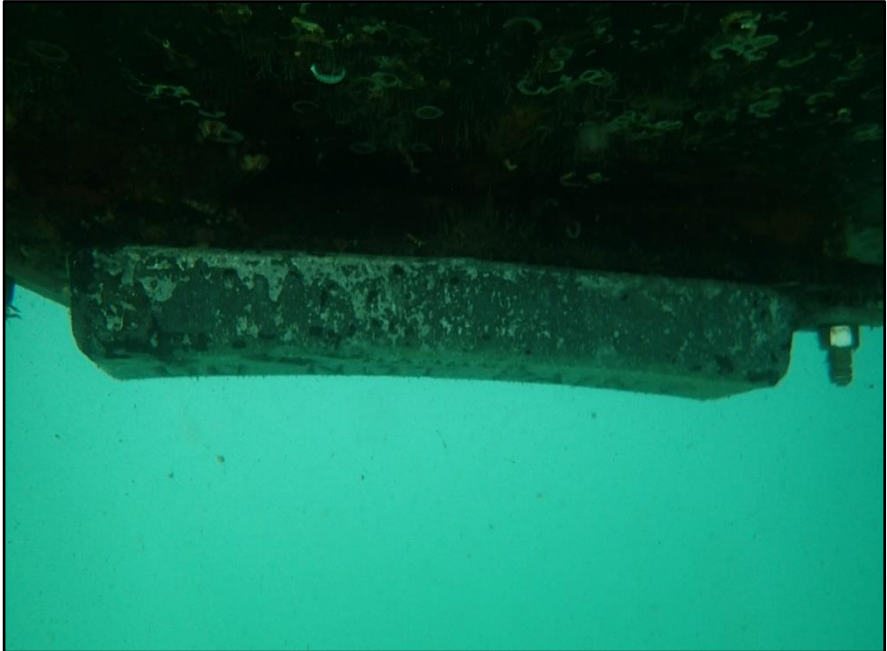

Photograph 6 : Underwater View of the Bolted Style Anode on the pontoons.



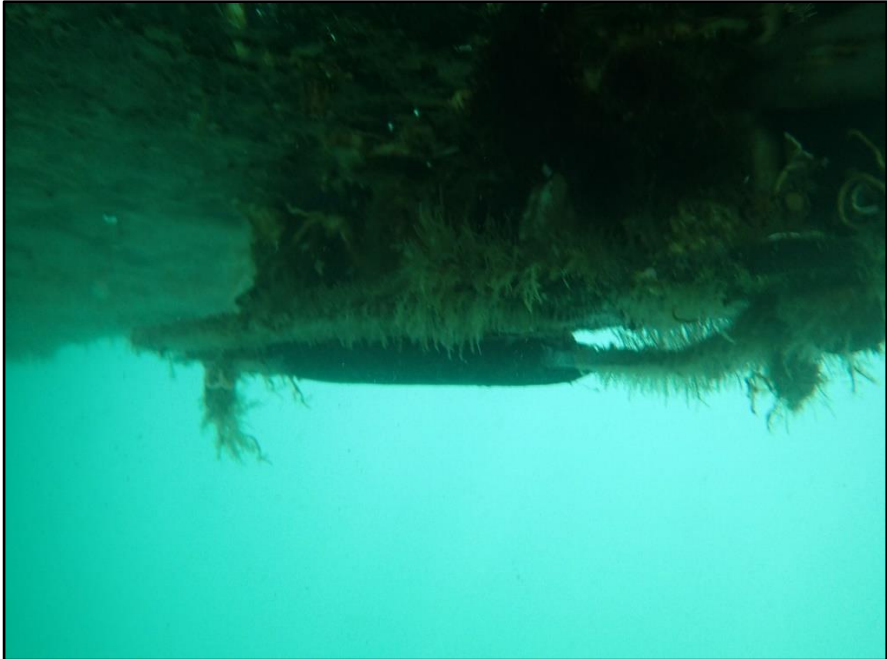

Photograph 7 : Underwater View of the Consumed Bolted Style Anode.



Photograph 8 : View of the Typical Steel Plate Condition.



Photograph 9 : View of the Typical Corrosion of the Steel Plate and Shackle.



Photograph 10 : Underwater View of the Typical Marine Growth on the Anchor Chain.





Photograph 11 :  
Underwater View of the  
Typical Clean Anchor Chain.



Photograph 12 :  
Underwater View of the  
Typical Surface Corrosion  
on the Anchor Chain.





Photograph 13 :  
Underwater View of the  
Typical Rode Line  
Condition.



Photograph 14 :  
Underwater View of the  
Typical Condition of the  
Anchor Chain at the  
Channel Bottom.



Photograph 15 :  
Underwater View of the  
Typical Buried Conditon of  
the Anchor Chain at the  
Channel Bottom.



Photograph 16 :  
Underwater View of the  
Typical Condition of the  
Anchor Chain at the  
Channel Bottom.



Photograph 17 :  
Underwater View of the  
Typical Rode Line and  
Thimble to Shackle  
Condition.

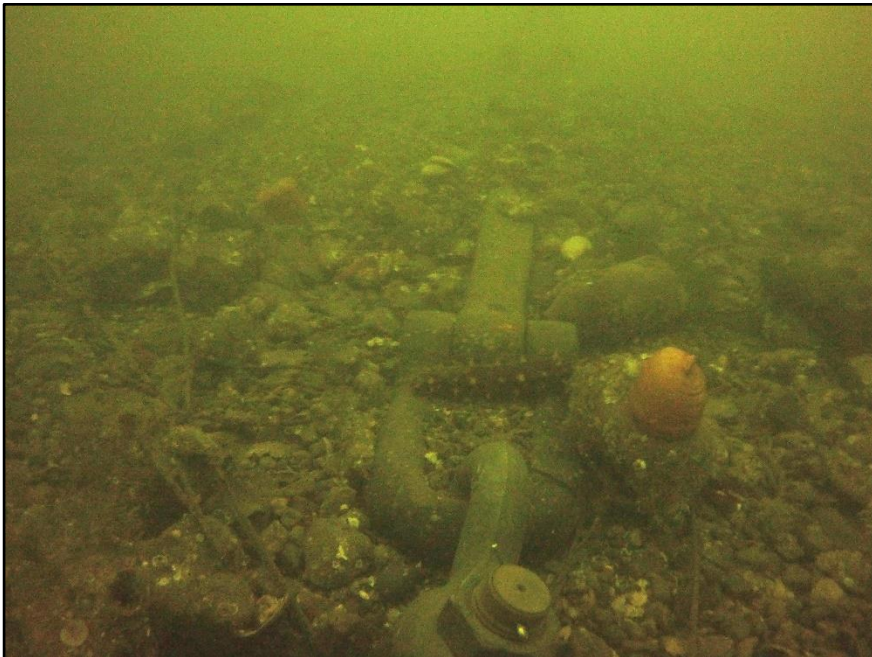

Photograph 18 :  
Underwater View of the  
Typical Buried Anchor  
Exposure.





Photograph 19 :  
Underwater View of the  
Typical Buried Anchor  
Exposure.



Photograph 20 :  
Underwater View of the  
Unburied Anchor (Anchor 6  
Shown).



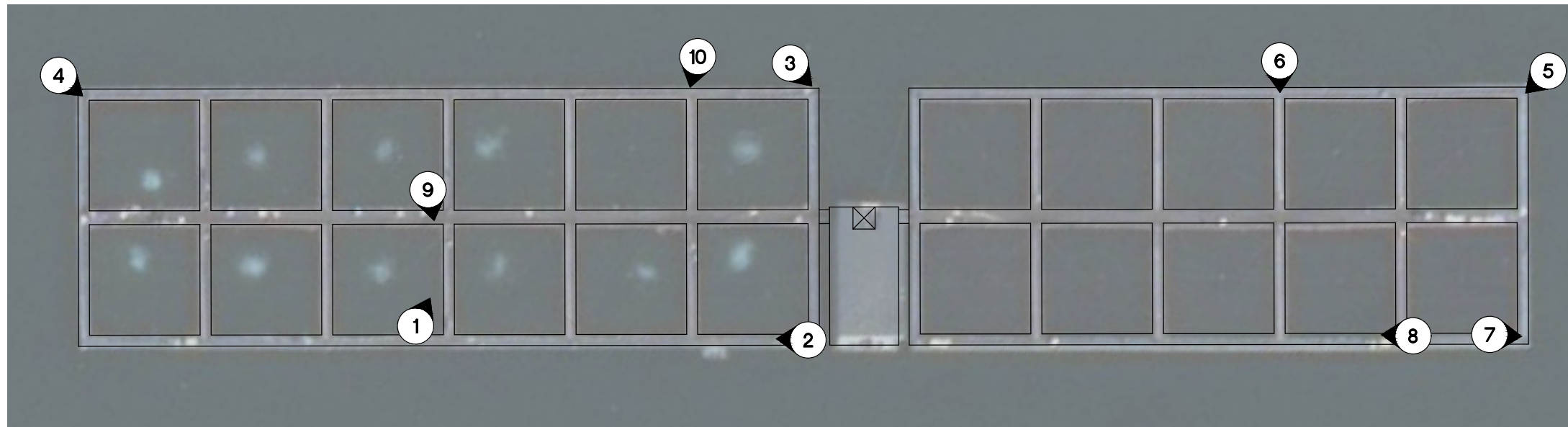

**LEGEND**

1 PHOTO LOCATION AND ORIENTATION

**NOTES**

MOORING SYSTEM NOT SHOWN, SEE SHEET 2

**CLAM BAY NET PEN**

PHOTOS-PLAN

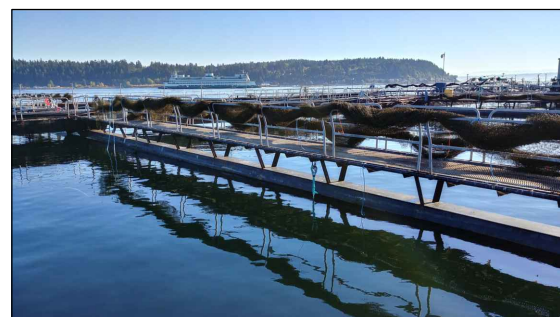
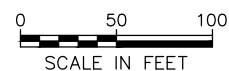

**PHOTO 1**  
PONTON WALKWAY

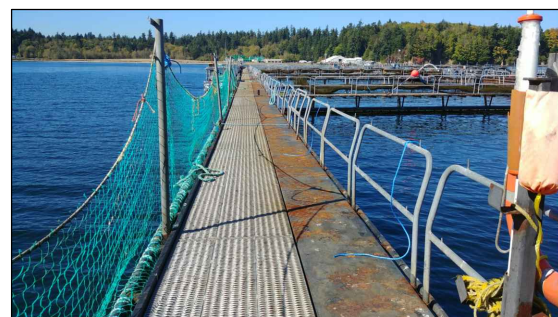

**PHOTO 2**  
EXTERIOR WALKWAY / PREDATOR NET

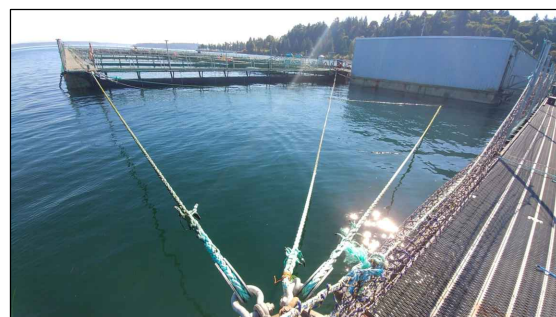

**PHOTO 3**  
LINES AND SHACKLES BETWEEN NORTH AND SOUTH NET PENS



**PHOTO 4**  
NET PEN DURING NET INSTALLATION



**PHOTO 5**  
SOUTH FISH PENS



**PHOTO 6**  
PONTON WALKWAY SURFACE

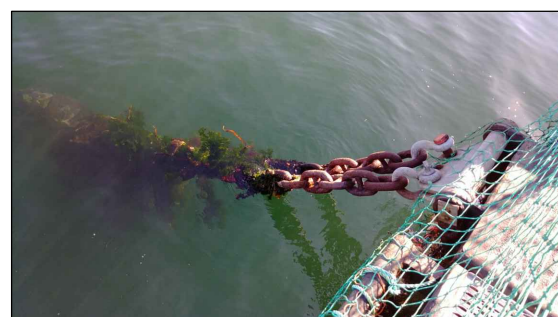

**PHOTO 7**  
MOORING CHAINS

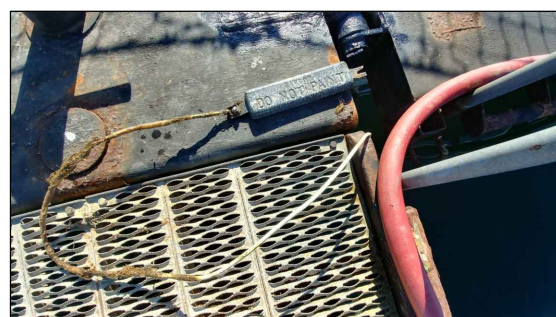

**PHOTO 8**  
ZINC ANODE SUSPENDED FROM COPPER WIRE



**PHOTO 9**  
EXTERIOR WALKWAY HINGE CONNECTION



**PHOTO 10**  
GRATING AND PREDATOR NET RAIL SUPPORTS



110 James Street  
Suite 101  
Edmonds, Washington 98020  
  
T +1 (425) 778 6243  
F +1 (425) 778 6883  
W www.mottmacamericas.com

Client



WASHINGTON DEPARTMENT OF FISH AND WILDLIFE

| Rev | Date    | Drawn | Description     | Ch'k'd | App'd |
|-----|---------|-------|-----------------|--------|-------|
| 1   | 9/29/17 | CT    | PLAN AND PHOTOS | JL     | NS    |

|                |     |       |
|----------------|-----|-------|
| Project Number | B/O | Total |
| 385629         | 1   | 4     |

|                 |           |              |             |
|-----------------|-----------|--------------|-------------|
| Designed        | J. LaFave | Eng check    | S. Phillips |
| Drawn           | C. Taylor | Coordination |             |
| Dwg check       | N. Sultan | Approved     |             |
| Scale at ANSI D | Status    | Rev          | Security    |
| As Shown        |           |              |             |
| Drawing Number  |           |              |             |

Washington State  
Department of Fish and Wildlife  
Rich Passage Clam Bay Net Pen  
Site Assessment Plan



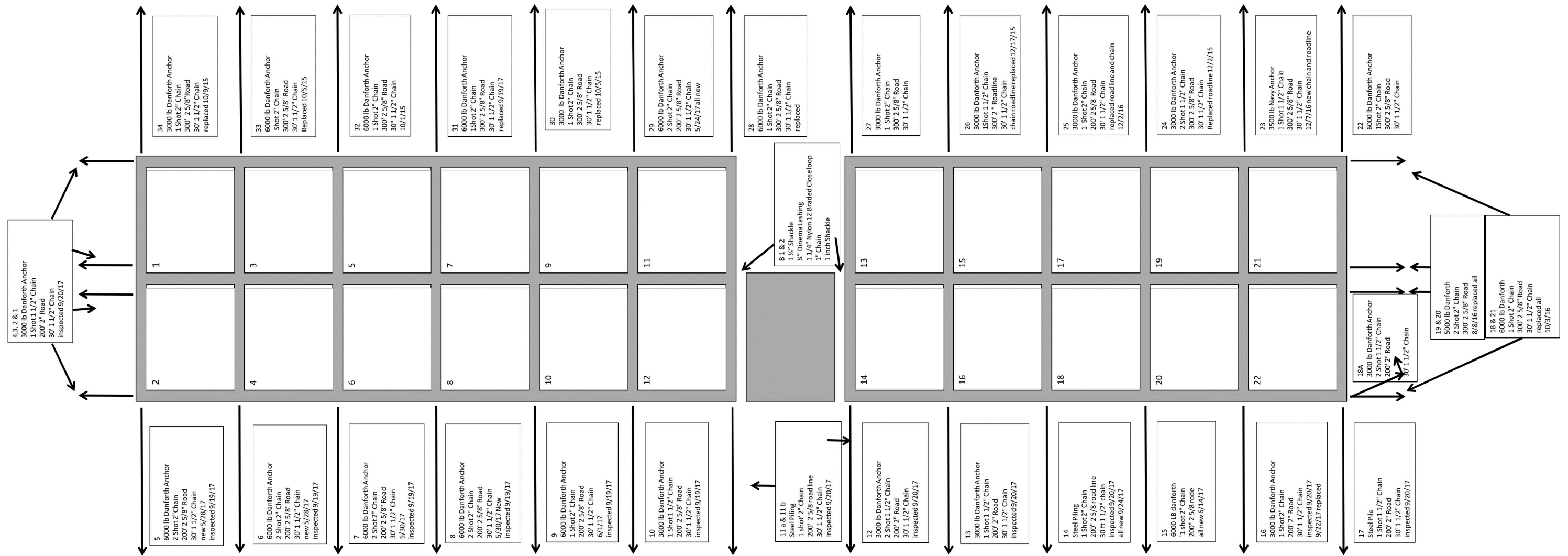

**CLAM BAY NET PEN**  
MOORING PLAN  
NOT TO SCALE

**NOTES**  
MOORING SYSTEM SCHEMATIC PLAN  
PROVIDED BY COOKE AQUACULTURE.

**M M**  
**MOTT MACDONALD**

110 James Street  
Suite 101  
Edmonds, Washington 98020

T +1 (425) 778 6243  
F +1 (425) 778 6883  
W www.mottmacamericas.com

Client



**WASHINGTON DEPARTMENT OF FISH AND WILDLIFE**

| Rev | Date    | Drawn | Description     | Ch'k'd | App'd |
|-----|---------|-------|-----------------|--------|-------|
| 1   | 9/29/17 | CT    | PLAN AND PHOTOS | JL     | NS    |

|                |        |     |   |       |   |
|----------------|--------|-----|---|-------|---|
| Project Number | 385629 | B/O | 2 | Total | 4 |
|----------------|--------|-----|---|-------|---|

|                 |           |              |             |
|-----------------|-----------|--------------|-------------|
| Designed        | J. LaFave | Eng check    | S. Phillips |
| Drawn           | C. Taylor | Coordination |             |
| Dwg check       | N. Sultan | Approved     |             |
| Scale at ANSI D | Status    | Rev          | Security    |
| As Shown        |           |              |             |
| Drawing Number  |           |              |             |

Title

Washington State  
Department of Fish and Wildlife  
Rich Passage Clam Bay Net Pen

Mooring Schematic

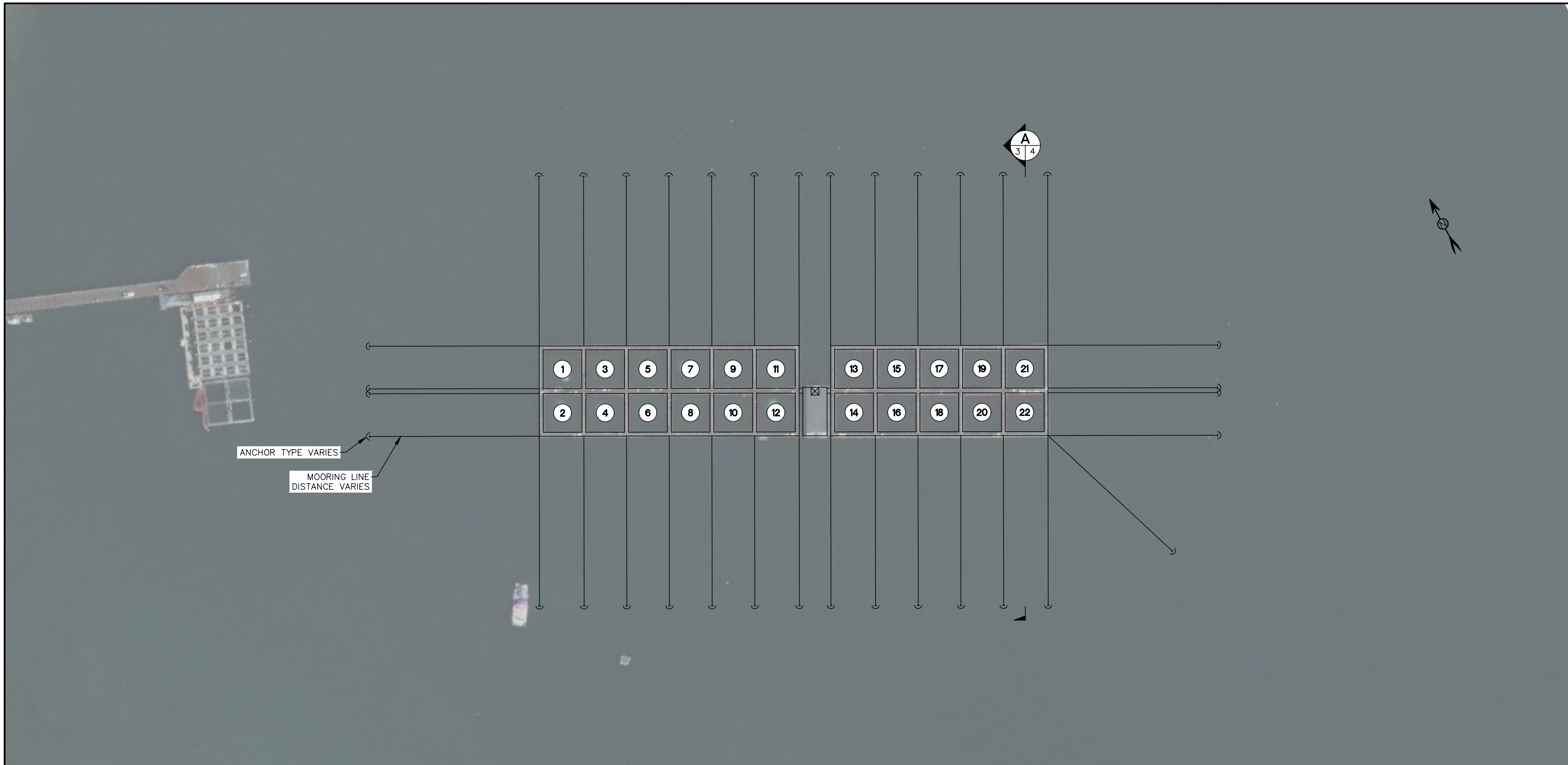

**CLAM BAY NET PEN**

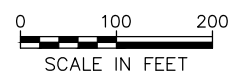

**M M**  
**MOTT MACDONALD**

110 James Street  
Suite 101  
Edmonds, Washington 98020

T +1 (425) 778 6243  
F +1 (425) 778 6883  
W www.mottmacamericas.com

Client

**WASHINGTON DEPARTMENT OF FISH AND WILDLIFE**

| Rev | Date    | Drawn | Description     | Ch'k'd | App'd |
|-----|---------|-------|-----------------|--------|-------|
| 1   | 9/29/17 | CT    | PLAN AND PHOTOS | JL     | NS    |

|                |     |       |
|----------------|-----|-------|
| Project Number | B/O | Total |
| 385629         | 3   | 4     |

|                 |           |              |             |
|-----------------|-----------|--------------|-------------|
| Designed        | J. LaFave | Eng check    | S. Phillips |
| Drawn           | C. Taylor | Coordination |             |
| Dwg check       | N. Sultan | Approved     |             |
| Scale at ANSI D | Status    | Rev          | Security    |
| As Shown        |           |              |             |
| Drawing Number  |           |              |             |

Title

Washington State  
Department of Fish and Wildlife  
Rich Passage Clam Bay Net Pen  
Existing Site - Moorings

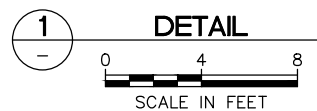
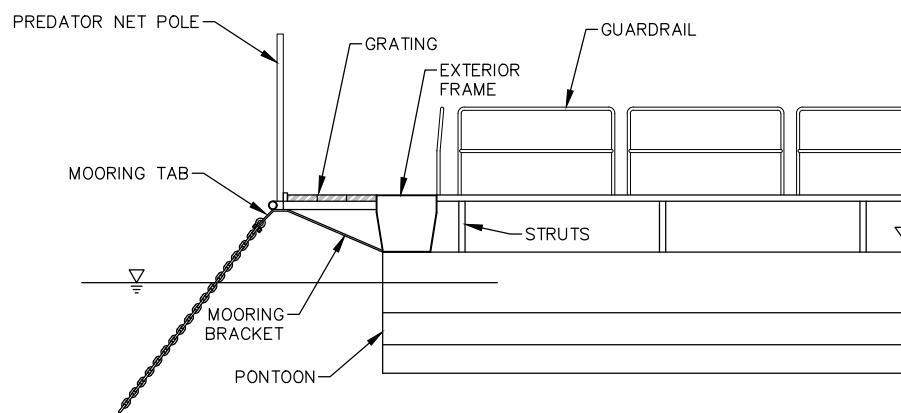
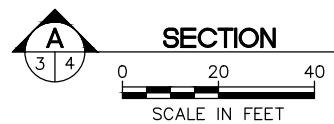
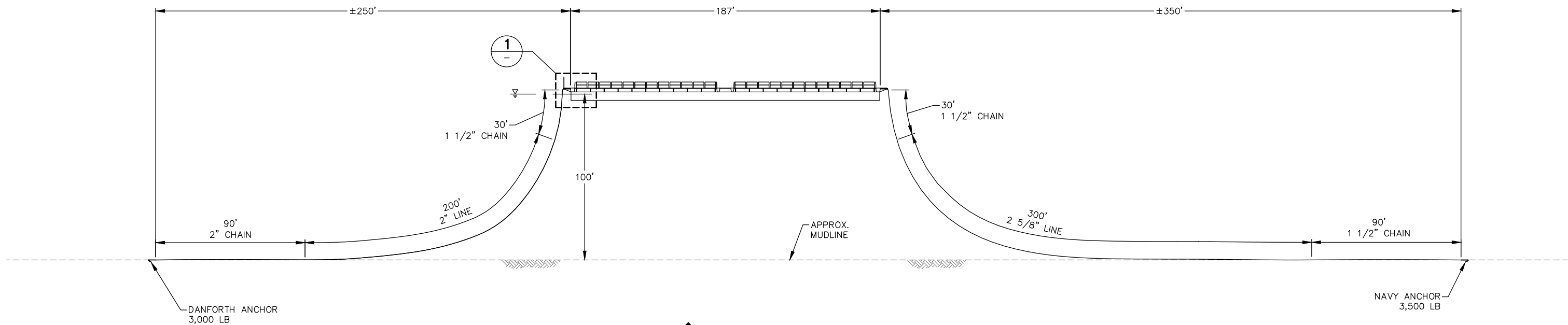

110 James Street  
Suite 101  
Edmonds, Washington 98020  
  
T +1 (425) 778 6243  
F +1 (425) 778 6883  
W www.mottmacamericas.com

Client



WASHINGTON DEPARTMENT  
OF FISH AND WILDLIFE

| Rev | Date    | Drawn | Description     | Ch'k'd | App'd |
|-----|---------|-------|-----------------|--------|-------|
| 1   | 9/29/17 | CT    | PLAN AND PHOTOS | JL     | NS    |

|                |     |       |
|----------------|-----|-------|
| Project Number | B/O | Total |
| 385629         | 4   | 4     |

|                 |           |              |             |
|-----------------|-----------|--------------|-------------|
| Designed        | J. LaFave | Eng check    | S. Phillips |
| Drawn           | C. Taylor | Coordination |             |
| Dwg check       | N. Sultan | Approved     |             |
| Scale at ANSI D | Status    | Rev          | Security    |
| As Shown        |           |              |             |
| Drawing Number  |           |              |             |

Washington State  
Department of Fish and Wildlife  
Rich Passage Clam Bay Net Pen  
  
Section - Mooring