



United States Government Accountability Office

Report to the Chairman, Committee on
Natural Resources, House of
Representatives

November 2021

BUREAU OF LAND MANAGEMENT

Better Workforce Planning and Data Would Help Mitigate the Effects of Recent Staff Vacancies

GAO@100

A Century of Non-Partisan Fact-Based Work

GAO@100 Highlights

Highlights of [GAO-22-104247](#), a report to the Chairman, Committee on Natural Resources, House of Representatives

Why GAO Did This Study

BLM's workforce of about 8,800 permanent staff is responsible for a portfolio of public lands, which, according to BLM, encompasses more than 245 million surface acres, primarily in western states. BLM's mission includes managing these lands for a variety of uses while maintaining natural and cultural resources. BLM headquarters provides national policy direction to the rest of BLM, while state offices generally administer programs in the states. Since 2016, BLM's workforce has experienced hiring restrictions and a reorganization.

GAO was asked to review recent changes to BLM's workforce and the agency's workforce planning efforts. This report examines, for the period since 2016, (1) changes in BLM's organizational structure, (2) changes in BLM's workforce composition, and (3) the extent to which BLM has had a strategic workforce plan that supports its mission and goals.

GAO analyzed BLM workforce data, information on organizational changes, and workforce planning documents from 2016 to 2021, and interviewed 13 BLM staff members from offices affected by organizational and workforce changes.

What GAO Recommends

GAO recommends that BLM (1) track data on vacancies and details for all offices, and (2) develop an agency-wide strategic workforce plan that aligns its human capital program with emerging mission goals and includes long-term staffing strategies. Interior agreed with GAO's recommendations.

View [GAO-22-104247](#). For more information, contact Frank Rusco at (202) 512-3841 or ruscof@gao.gov.

November 2021

BUREAU OF LAND MANAGEMENT

Better Workforce Planning and Data Would Help Mitigate the Effects of Recent Staff Vacancies

What GAO Found

Since 2016, the Department of the Interior's Bureau of Land Management (BLM) changed its organizational structure by merging or transferring several of its headquarters functions. BLM also moved its headquarters from Washington, D.C., to Grand Junction, CO, and relocated most of its headquarters positions to its new headquarters and other offices in 11 western states. In September 2021, the Secretary announced plans to return the headquarters to Washington, D.C.

Since 2016, BLM's workforce composition changed in several ways, including through increases in headquarters vacancies and in temporary reassignments—known as details—to fill the duties of those vacant positions. BLM senior officials told GAO they do not have consistent and reliable data on vacancies agency-wide or the use of details. However, BLM provided some vacancy data for headquarters positions from July 2019 to May 2021. According to these data, the number of vacant headquarters positions increased after BLM announced the relocation of its headquarters in July 2019, as shown in the figure below.

BLM Headquarters Vacancies from July 2019 to May 2021

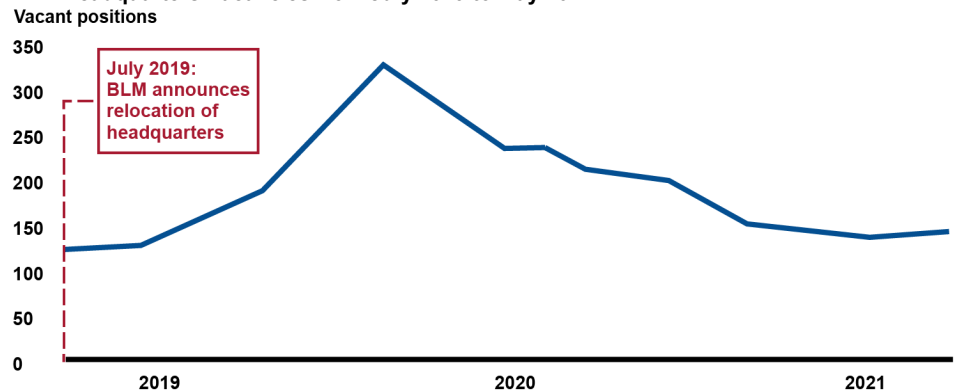

Source: GAO analysis of Bureau of Land Management (BLM) data. | GAO-22-104247

Most BLM staff GAO spoke with said vacancies in key headquarters positions caused delays in creating or clarifying guidance or policy. Further, some said an increased reliance on details negatively affected their office's performance—for example, because state office staff detailed to headquarters reduced capacity in state offices. Without complete and reliable data on vacancies and details across the agency, BLM officials cannot make informed decisions about filling vacancies and initiating details to help the agency achieve its mission and goals.

GAO also found that BLM does not have an agency-wide strategic workforce plan that supports its mission and programmatic goals. BLM officials told GAO their mechanism for strategic workforce planning is a 2019 memorandum, but this memorandum generally does not address the two critical needs that define strategic workforce planning: (1) aligning the human capital program with emerging mission goals and (2) developing long-term strategies for acquiring, developing, and retaining staff to achieve programmatic goals. Without a strategic workforce plan that addresses these needs, BLM lacks reasonable assurance the agency will have the workforce necessary to achieve its goals in managing millions of acres of public lands.

Contents

Letter		1
	Background	5
	BLM Changed Its Organizational Structure by Reorganizing Its Headquarters Functions and Relocating Headquarters Positions to Western States	10
	BLM Experienced Changes to Its Workforce Composition but Does Not Have Complete Information on Vacancies and Details	14
	BLM Does Not Have a Strategic Workforce Plan that Aligns Its Workforce with Its Mission and Programmatic Goals	23
	Conclusions	25
	Recommendations for Executive Action	26
	Agency Comments	26
Appendix I	Organizational Changes to the Bureau of Land Management's Headquarters Divisions	28
Appendix II	Comments from the Department of the Interior	36
Appendix III	GAO Contact and Staff Acknowledgments	38
Table		
	Table 1: Bureau of Land Management Workforce Changes, by Race or Ethnicity, January 2016–January 2021	22
Figures		
	Figure 1: Location of BLM Headquarters and the Locations and Administrative Boundaries of the 12 State Offices	6
	Figure 2: BLM National Office and State Offices	8
	Figure 3: Comparison of BLM Headquarters Offices, 2016 and 2021	11
	Figure 4: Number of BLM Vacant Headquarters Positions, July 2019–May 2021	17
	Figure 5: Percentage of BLM Workforce, by Years of Federal Service in the Department of the Interior, January 2016–January 2021	19

Figure 6: Number of Staff with at Least 25 Years of Service within the Department of the Interior, by BLM Office, January 2016 and January 2021	20
Figure 7: Racial and Ethnic Groups as a Percentage of BLM's Workforce, January 2016 and January 2021	21
Figure 8: Comparison of BLM Headquarters Offices, 2016 and 2021	29
Figure 9: Changes in Organization of BLM's Office of the Director, 2016 and 2021	30
Figure 10: Changes in Organization of BLM's Directorate of Resources and Planning, 2016 and 2021	31
Figure 11: Changes in Organization of BLM's Directorate of Energy, Minerals, and Realty, 2016 and 2021	32
Figure 12: Changes in Organization of BLM's Directorate of National Conservation Lands and Community Partnerships, 2016 and 2021	33
Figure 13: Changes in Organization of BLM's Directorate of Communications, 2016 and 2021	34
Figure 14: Reorganization of BLM's Directorate of Human Capital Management and Directorate of Business, Fiscal and Information Resources Management into the Directorate of Business Management and Administration, 2016 and 2021	35

Abbreviations

BLM	Bureau of Land Management
GS	General Schedule

This is a work of the U.S. government and is not subject to copyright protection in the United States. The published product may be reproduced and distributed in its entirety without further permission from GAO. However, because this work may contain copyrighted images or other material, permission from the copyright holder may be necessary if you wish to reproduce this material separately.

November 16, 2021

The Honorable Raúl Grijalva
Chairman
Committee on Natural Resources
House of Representatives

Dear Mr. Chairman:

The workforce of the Department of the Interior's Bureau of Land Management (BLM) is responsible for managing a portfolio of public lands and resources. According to BLM, this encompasses more than 245 million surface acres,¹ primarily located in 12 western states. Its mission includes managing public lands for uses—such as energy and mineral development, livestock grazing, recreation, and timber harvesting—while ensuring that natural, cultural, and historic resources are maintained for present and future generations. Since January 2017, BLM's workforce has experienced hiring restrictions and the relocation of the agency's Washington, D.C., headquarters offices to Grand Junction, Colorado.² According to a July 2019 letter from Interior, the goals of this relocation included delegating more responsibility to the field, maximizing services to the American people, and increasing BLM's presence closest to the resources it manages.³ The letter also cited expected cost savings and travel reductions, particularly for staff in the new headquarters office. The relocation was completed in August 2020. In September 2021, the Secretary of the Interior announced a plan to return BLM's national

¹According to BLM, in addition to the 245 million surface acres it manages, it also administers 700 million acres of subsurface mineral estate.

²Interior notified Congress on May 8, 2019, of its intent to proceed with the effort to relocate BLM headquarters positions to western states and establish a new headquarters location in Grand Junction, Colorado. According to Interior's 2018-2022 strategic plan, the agency had developed a reform plan—which aimed to better enable managers and the workforce in the field to make decisions, in part by shifting the workforce closer to field locations—in response to a March 2017 Executive Order on reorganizing the executive branch.

³Department of the Interior, *Assistant Secretary for Land and Minerals Management letter to Senator Murkowski* (July 16, 2019).

headquarters to Washington, D.C., and make the current Grand Junction headquarters the agency's Western headquarters.⁴

In March 2020, we assessed the agency's relocation efforts and found BLM had not substantially followed key practices for effective reforms to ensure that it achieved its goals and could continue to deliver valuable services to the taxpayer.⁵ In addition, we have reported on human capital challenges at the agency.⁶ We also included Interior's management of federal oil and gas resources on our 2021 High-Risk List of programs and operations that are vulnerable to waste, fraud, abuse, or mismanagement, or in need of transformation.⁷

You asked us to review changes to BLM's workforce in recent years and the agency's workforce planning efforts. This report examines, since 2016, (1) changes in BLM's organizational structure, (2) any changes in BLM's workforce composition, and (3) the extent to which BLM has had a strategic workforce plan that supports its mission and programmatic goals.

⁴On September 17, 2021, Interior announced plans to relocate BLM's national headquarters from Grand Junction, Colorado, to Washington, D.C. According to Interior, the Secretary intends to locate the Director and other key leadership in the national headquarters where they can ensure coordination with Congress, other federal agencies, and stakeholders that visit Washington, D.C. Additionally, the Secretary announced plans to maintain BLM's Grand Junction office as its Western headquarters to reinforce western perspectives in decision-making and to play a role in BLM's clean energy, outdoor recreation, conservation, and scientific mission, among other work. Department of the Interior, "Secretary Haaland Outlines Next Steps to Rebuild Bureau of Land Management" (Washington, D.C.: Sept. 17, 2021), accessed September 20, 2021, <https://www.doi.gov/pressreleases/secretary-haaland-outlines-next-steps-rebuild-bureau-land-management>.

⁵GAO, *Bureau of Land Management: Agency's Reorganization Efforts Did Not Substantially Address Key Practices for Effective Reforms*, [GAO-20-397R](#) (Washington, D.C.: Mar. 6, 2020).

⁶GAO, *Oil and Gas Oversight: Interior Has Taken Steps to Address Staff Hiring, Retention, and Training but Needs a More Evaluative and Collaborative Approach*, [GAO-16-742](#) (Washington, D.C.: Sept. 29, 2016).

⁷GAO, *High-Risk Series: Dedicated Leadership Needed to Address Limited Progress in Most High-Risk Areas*, [GAO-21-119SP](#) (Washington, D.C.: Mar. 2, 2021). Interior's rating regressed for managing its human capital challenges related to the management of federal oil and gas resources. Specifically, its rating in the criteria for removal from the list in the areas of leadership commitment, capacity, and action plan changed from "partially met" to "not met." Interior's management of federal oil and gas resources was first added to our high risk series in 2011.

To describe how BLM's organizational structure has changed since 2016, we analyzed documentation from BLM, including detailed organizational charts called tables of organization and other documents that describe changes to BLM's organizational structure between January 2016 and February 2021, and spoke to agency officials.⁸ Specifically, we reviewed available tables of organization for headquarters and state offices from January 2016 through February 2021. In addition, we reviewed all available decision documents since 2016, which document proposed organizational changes—such as office mergers or other realignments—and their subsequent approval. We also interviewed senior agency officials, including the Deputy Director of Operations, to clarify the timing and purpose of any organizational changes.

To examine how, if at all, BLM's workforce composition has changed since 2016, we analyzed workforce data from BLM's Federal Personnel and Payroll System. Our analysis included a review of workforce data for all BLM staff at twice-yearly intervals from January 2016 through January 2021 to identify changes in staffing by sub-bureau, division, grade, location, permanent or temporary status, and race and ethnicity for all staff over this period. We also analyzed annual workforce data on retirement and years of service for all permanent staff. To assess the reliability of these data, we (1) conducted electronic testing for outliers and missing data, (2) reviewed related documentation, and (3) interviewed knowledgeable agency officials. We found the data to be sufficiently reliable for understanding changes to BLM's workforce such as the number of staff employed, their years of experience with Interior, and the representation of racial and ethnic groups over our timeframe. We also analyzed information provided by senior BLM officials about the staff asked to relocate as part of the agency's headquarters relocation, including the number of staff that left BLM after being informed of their required relocation, from July 2019 through May 2021. We found this information sufficiently sound and accurate for our reporting purposes based on interviews with knowledgeable BLM staff, review by knowledgeable BLM staff of the information provided, and corroboration of the information with other sources.

To gather information about any effects of changes to BLM's organizational structure and workforce composition, we interviewed 13 knowledgeable staff members who worked at BLM from 2016 through

⁸Tables of organization show all the positions in an office and the organizational relationships between the positions.

2021. We selected staff members who had been employed with BLM since at least 2016 and who were in management positions as of January 2021 in BLM offices that were (1) directly affected by an organizational change such as an office merger or a change in office functions, and (2) experienced the largest changes in the number of staff between 2016 and January 2021. We selected these staff members so they could provide their perspectives about any changes and potential effects over this period. We included nine staff members in headquarters offices and four staff members in state offices. We asked these staff members whether and how changes to BLM's workforce composition and organizational structure have affected its ability to carry out core functions and its mission. We conducted an analysis of the content of these interviews to identify common themes and areas of agreement, and we describe the number of staff members who agreed with various statements as follows: a few is three or four, some is five to seven, most is eight to 10, almost all is 11 or 12, and all is 13. The information gathered from these interviews is not generalizable to all staff members but provides examples of staff views on the topics we discussed.

To identify the extent of BLM's strategic workforce planning to support its mission and programmatic goals since 2016, we reviewed agency workforce planning documents and interviewed senior BLM officials. We assessed BLM's primary workforce planning mechanism, as identified by senior BLM officials, against a definition of strategic workforce planning we identified in our December 2003 report to determine the extent to which it aligns with this definition.⁹ Specifically, two analysts reviewed BLM's seven criteria for reviewing operations in BLM Instruction Memorandum 2019-042.¹⁰ The analysts independently assessed the extent to which each of the seven criteria addressed (1) aligning the agency's human capital program with emerging mission goals, and (2) developing long-term strategies for acquiring, developing, and retaining staff to achieve programmatic goals. The analysts reached agreement on their assessments. To further understand BLM's workforce planning strategy, we interviewed senior BLM officials. In addition, to understand the effect of BLM's workforce planning strategy, we interviewed 13

⁹GAO, *Human Capital: Key Principles for Effective Strategic Workforce Planning*, [GAO-04-39](#) (Washington, D.C.: Dec. 11, 2003).

¹⁰Bureau of Land Management, Deputy Director of Operations, *Updating and Standardizing BLM Tables of Organization*, Instruction Memorandum No. 2019-042 (Aug. 20, 2019).

selected BLM staff from headquarters and state offices, as described above.

We conducted this performance audit from April 2020 to November 2021 in accordance with generally accepted government auditing standards. Those standards require that we plan and perform the audit to obtain sufficient, appropriate evidence to provide a reasonable basis for our findings and conclusions based on our audit objectives. We believe that the evidence obtained provides a reasonable basis for our findings and conclusions based on our audit objectives.

Background

BLM administers its programs through a workforce of roughly 8,800 permanent staff supplemented by about 500 to 2,000 temporary staff over the course of each year.¹¹ Duties of these staff vary depending on whether BLM assigns them to the national office—which includes its Grand Junction, Colorado, headquarters¹²—or one of the 12 state offices, as shown in figure 1 below.¹³

¹¹The estimate of 8,800 permanent staff was calculated using workforce data from the Department of the Interior's Federal Personnel and Payroll System. It is an estimate of the calculated average number of permanent staff, twice yearly, in January 2016 through January 2021.

¹²As noted above, in September 2021, the Secretary of the Interior announced plans to return the BLM national headquarters to Washington, D.C., and to create a Western headquarters in Grand Junction, Colorado.

¹³The 12 state offices are Alaska, Arizona, California, Colorado, Eastern States, Idaho, Montana/Dakotas, Nevada, New Mexico, Oregon/Washington, Utah, and Wyoming offices. The Eastern States office manages public lands and their resources in the 31 states east of and bordering the Mississippi River. BLM also has 50 district offices and 121 field offices, and the heads of these offices are directly responsible to the state office director.

Figure 1: Location of BLM Headquarters and the Locations and Administrative Boundaries of the 12 State Offices

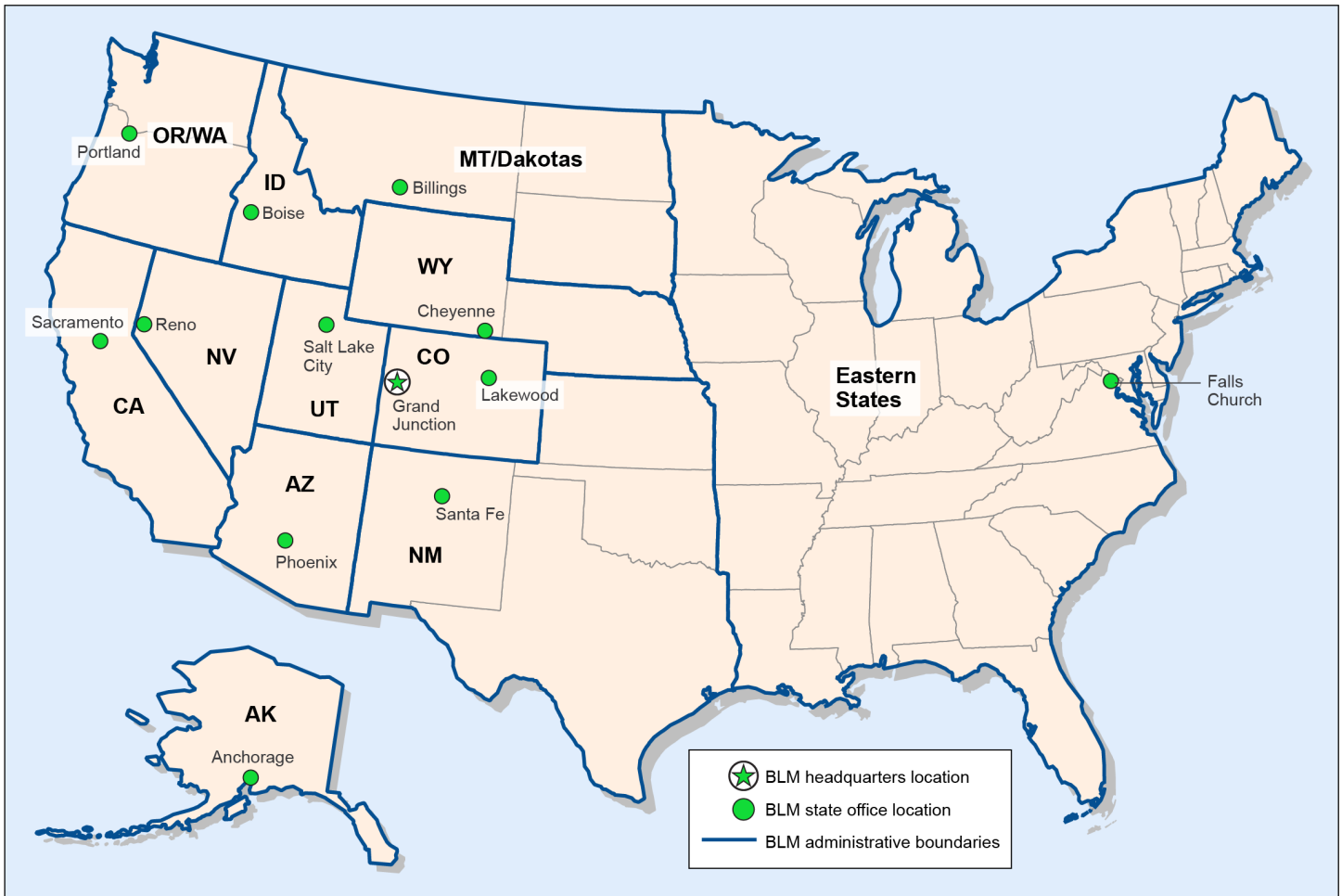

Sources: GAO analysis of Bureau of Land Management (BLM) data; Map Resources (map). | GAO-22-104247

BLM’s national office includes its Headquarters Office, which provides national-level decision-making, policy, and program direction to the rest of BLM.¹⁴ BLM conducts its Headquarters Office functions through the Office of the Director and five subordinate offices, known as directorates, which in turn include smaller divisions responsible for carrying out BLM’s

¹⁴Prior to April 2020, BLM’s headquarters was known as the Washington Office. The agency reclassified it as the Headquarters Office as part of the agency’s relocation of its headquarters from Washington, D.C., to Grand Junction, Colorado. For the purposes of this report, we will refer to it as headquarters in all time periods.

programs.¹⁵ For example, BLM's Directorate of Energy, Minerals, and Realty Management includes the Fluid Minerals division, which oversees BLM's oil and natural gas permitting programs. These headquarters offices provide policy guidance, oversight, and technical support to agency-wide programs, among other things. Other national office functions include the National Operations Center—which provides operational and technical program support to BLM employees and stakeholders—and the Office of Fire and Aviation—which is responsible for developing policies and standards for firefighting safety, training, prevention, and mitigation, among other things.¹⁶ Both before and after BLM's relocation, some headquarters staff worked out of state offices or other offices in the west.

BLM's 12 state offices are responsible for administering BLM programs in the states and supporting the implementation of programs by their constituent district and field offices. Field offices direct customer services and conduct on-the-ground management of BLM programs, and district offices guide and assist field offices under them in accomplishing mission activities.¹⁷

See figure 2 for an organizational chart of BLM's national and state offices. Appendix I provides more information on the Headquarters Office functions.

¹⁵The Office of the Director also includes the Office of Law Enforcement and Security—which develops policy, guidance, and standards and maintains oversight for law enforcement—and the Office of Civil Rights—which administers the agency's civil rights and equal opportunity employment programs.

¹⁶The National Operations Center and the Office of Fire and Aviation report to the Office of the Director through the Deputy Director for Operations. The Office of Fire and Aviation operates as a directorate under its own organization code.

¹⁷BLM state offices currently include 50 district offices and 121 field offices. For the purposes of this report, state office refers to the state, district, and field office staff and functions.

Figure 2: BLM National Office and State Offices

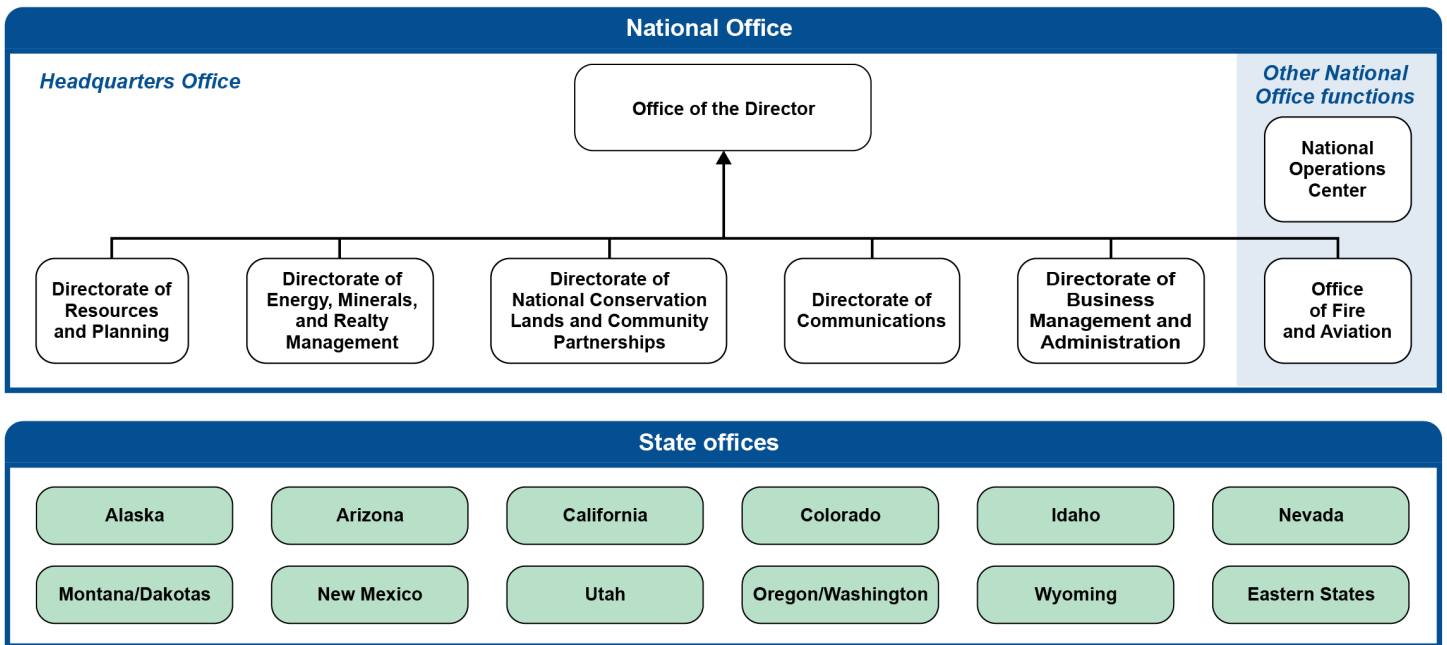

Source: Bureau of Land Management (BLM) documents. | GAO-22-104247

Note: The headquarters office is located in Grand Junction, Colorado and is a separate entity from the Colorado state office. The Office of the Director includes the Office of the Law Enforcement and Security, which reports to the Director through the Deputy Director for Operations.

From January 2017 through May 2021, BLM’s workforce experienced some kind of hiring restriction. Specifically, in January 2017, the president issued a memorandum calling for an across-the-board hiring freeze for federal civilian staff, including BLM. In April 2017, the across-the-board hiring freeze was lifted, but a memo from the Associate Deputy Secretary of the Interior, acting with the delegated authority of the Assistant Secretary, announced other hiring restrictions on some senior positions and positions in the Washington, D.C., and Denver metropolitan areas. Some of these restrictions were removed over time, but restrictions on hiring at the General Schedule 15 pay grade at BLM remained in place

through at least May 2021.¹⁸ According to BLM officials, these restrictions remained because they wanted to ensure senior positions are needed before filling them. In addition, on January 20, 2021, Interior Secretarial Order 3395 put limits on hiring for 60 days for most positions at the General Schedule 13 pay grade or above.¹⁹ According to the order, the purpose was to implement a targeted and time-limited elevation of relevant decisions at Interior for the purposes of reviewing the questions of fact, law, and policy they raise. Although the secretarial order expired, as of May 2021, according to senior BLM officials, hiring restrictions remained in place for some headquarters positions. According to these officials, the headquarters hiring restrictions were intended to allow the recently confirmed Secretary of the Interior time to review the organization, including the location of some headquarters positions. These officials said they do not want to fill open positions until they know the positions' ultimate locations.

¹⁸The General Schedule (GS) pay system covers the majority of civilian white-collar federal employees in professional, technical, administrative, and clerical positions. The General Schedule has 15 grades—GS-1 (lowest) to GS-15 (highest). Agencies establish the grade of each job based on the level of difficulty, responsibility, and qualifications required. Individuals with a high school diploma and no additional experience typically qualify for GS-2 positions, those with a bachelor's degree for GS-5 positions, and those with a master's degree for GS-9 positions.

¹⁹Secretarial Order 3395 suspended the delegation of authority to Interior bureaus and offices to appoint, hire, or promote personnel; or approve the appointment of any personnel assigned to a position at or above the level of General Schedule 13 pay grade, without the approval of the Secretary of the Interior, the Deputy Secretary of the Interior, the Solicitor, or listed Assistant Secretaries of the Interior.

BLM Changed Its Organizational Structure by Reorganizing Its Headquarters Functions and Relocating Headquarters Positions to Western States

BLM changed its organizational structure by merging or transferring several headquarters functions and relocating most of its headquarters positions to offices in 11 western states, including its new headquarters office in Grand Junction, Colorado. BLM also reassigned many headquarters positions from headquarters duties to state office duties, reallocating them as state positions.

Changes in Functions within Headquarters

After 2016, BLM changed its organizational structure by merging or transferring divisions within its headquarters offices; the structure of BLM's state offices and other national office functions remained relatively unchanged. More specifically, BLM reduced the number of headquarters directorates from six to five and the number of divisions from 25 to 20. See figure 3 for a comparison of BLM's headquarters structure in 2016 and 2021. Appendix I provides a more detailed explanation of changes to BLM's headquarters divisions and functions.

Figure 3: Comparison of BLM Headquarters Offices, 2016 and 2021

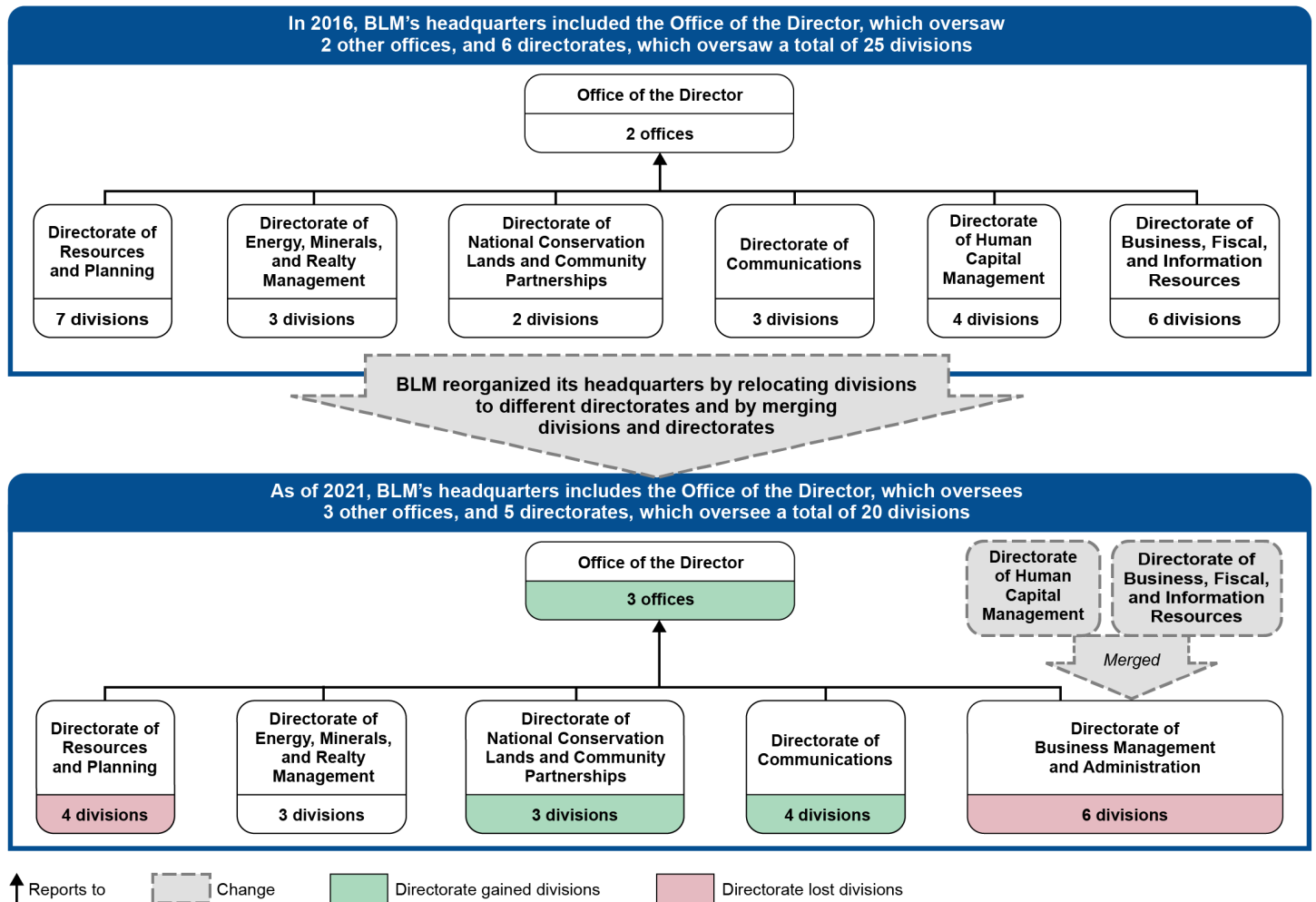

Source: GAO analysis of Bureau of Land Management (BLM) data. | GAO-22-104247

Note: All relocated or merged divisions occurred within BLM's Headquarters Office with the exception of the relocation of three Information Technology divisions from the Directorate of Business, Fiscal, and Information Resources to the National Operations Center.

According to BLM documents, the changes were for purposes such as reducing administrative redundancies and correcting workload imbalances. Major changes include

- In 2019, BLM merged most the functions of its Environmental Quality and Protection division into other divisions within its Directorate of Resources and Planning, removing the division from its organizational structure. It merged most of the division's functions with the former

Fish and Wildlife Conservation division, creating a new Wildlife Conservation, Aquatics, and Environmental Protection division. BLM also incorporated some limited functions into the Forest, Range, and Vegetation Resources division. BLM did not provide information on the reason and timing of this change, including any realignment or decision memorandums.

- In September 2019, BLM reorganized two divisions—its Recreation and Visitor Services division and the Cultural, Paleontological Resources, and Tribal Consultation division—from its Directorate of Resources and Planning to its Directorate of National Conservation Lands and Community Partnerships. According to a BLM realignment memo, BLM transferred these divisions as part of its goal to reduce the size of the headquarters workforce and to increase efficiency by combining related functions. The memo noted the changes were expected to correct a long-standing imbalance in priority workload between the two directorates, to provide cost savings by reducing the number of headquarters staff, and to increase coordination of merged programs.
- In September 2019, BLM approved the transfer its Office of Civil Rights from its former Directorate of Human Capital Management to the Office of the Director. According to a BLM memo, the agency transferred these functions to comply with a recommendation from the U.S. Equal Employment Opportunity Commission that the Equal Opportunity Director should report directly to the agency head in order ensure the Equal Opportunity Director can act with the greatest degree of independence.
- In October 2020, BLM merged its Directorate of Human Capital Management and its Directorate of Business, Fiscal, and Information Resources into a new Directorate of Business Management and Administration, reducing the total number of headquarters directorates to five. According to a BLM memorandum, this change was made to reduce administrative redundancies and improve efficiency by streamlining senior staff positions under the oversight of a single assistant director.

The 13 BLM staff members we interviewed cited benefits and challenges of these organizational changes. Two staff members we interviewed said that certain mergers were working well. For example, one staff member said some of the changes helped balance workload and clarified roles. However, a few other staff cited concerns with the new alignment of the directorates. For example, one staff member told us one of the mergers combined programs that had different functions, dealt with different laws,

and required different expertise. Another staff member said that some of the changes broke up natural working groups by realigning division functions and increased the workload of merged divisions.

Relocation of Headquarters Positions to Western States

The majority of changes in headquarters functions coincided with BLM's relocation of most of its headquarters positions from Washington, D.C., to offices in 11 western states between July 2019 and August 2020.²⁰ While most of these relocated positions are still assigned to perform headquarters duties, BLM also reallocated many of its headquarters positions to state offices where the positions are now responsible for state office duties, reclassifying them as state positions.

According to BLM documentation, out of the 556 total headquarters positions in July 2019, when BLM announced the relocation, the agency relocated 252 headquarters positions to western offices and reallocated 76 positions as state positions. Of the remaining 228 headquarters positions, 60 remained in Washington, D.C., and the other 168 were already located outside of Washington, D.C.²¹

Some of the staff members we interviewed said that the lack of information sharing with staff about the move west was a challenge. For example, one staff member said that BLM leadership made relocation decisions "behind closed doors" and without manager or employee input, and another staff member described an atmosphere where staff were discouraged from asking questions about the move. In March 2020, we found that BLM had minimally or not at all addressed key reform practices for involving and communicating with employees and other key stakeholders regarding the relocation.²² For example, BLM did not provide information on any communication with staff outside of the executive leadership team before announcing its plan.²³ According to BLM officials in response to our March 2020 report, BLM managers in

²⁰In March 2020, we reported that BLM's reorganization efforts had not substantially addressed key practices for effective reforms, including involving employees and key stakeholders in the decision process, addressing key questions on strategic workforce planning, and others. See [GAO-20-397R](#). Since the release of that report, BLM completed its reorganization.

²¹These positions were located in state, district, and field offices as well as in the national operations center. BLM officials told us that the agency has dispersed its headquarters staff outside of Washington, D.C., since the 1990s.

²²[GAO-20-397R](#).

²³BLM's executive leadership team consists of the BLM Director, deputy directors, assistant directors, center directors, and state directors.

headquarters offices provided input into whether headquarters positions were intrinsically tied to the Washington, D.C., geographic area, among other things.

Additionally, a few staff members told us they were concerned about the relocation of BLM senior executives to Grand Junction, Colorado. For example, one staff member told us that interagency coordination could suffer if BLM does not have a significant presence in Washington, D.C. The staff member also said that the quality of internal coordination could decline with BLM senior management in different locations. Another staff member said that the move to Grand Junction was wasteful and inefficient, noting that Grand Junction does not have direct flights to Washington, D.C., which could be available from a state capital in the west. In a July 2019 letter to Congress, Interior stated the goals of this relocation included delegating more responsibility to the field, maximizing services to the American people, and increasing BLM's presence closest to the resources it manages.²⁴ As noted above, in September 2021, the Secretary of the Interior announced plans to restore the national headquarters in Washington, D.C., and make the current Grand Junction headquarters the agency's Western headquarters.

BLM Experienced Changes to Its Workforce Composition but Does Not Have Complete Information on Vacancies and Details

From January 2016 through January 2021, BLM's workforce composition changed in several ways.²⁵ In particular, headquarters staff left the agency, which resulted in an increase in vacant positions, and BLM increased its use of temporary reassignments—known as details—to fill the duties of these vacant positions. Experienced staff also left offices across the agency, and BLM saw shifts in the representation of certain races or ethnicities. We also found BLM does not track data on vacant positions and details across the agency, and, therefore, does not have complete information with which to make staffing decisions to help achieve its mission and goals.

²⁴Department of the Interior, *Assistant Secretary for Land and Minerals Management letter to Senator Murkowski*.

²⁵BLM's workforce is primarily permanent staff, but the agency also hires temporary staff, particularly during the summer months. According to BLM data, from January 2016 to January 2021, BLM hired an average of 483 temporary staff in January of each year and 2,027 temporary staff in the summer in excess of its average of 8,808 permanent staff.

A Large Number of Headquarters Staff Left BLM, But BLM Does Not Have Complete Vacancy Data

The total number of permanent headquarters staff remained relatively steady at about 560 from January 2016 until the July 2019 announcement of the relocation of most headquarters positions from Washington, D.C., to western states—after which a large number of staff in these positions left the agency. According to BLM documentation, of the 328 headquarters positions that BLM reassigned to western states or reallocated as state positions, 134 were vacant before the relocation, the agency reallocated 17 that were already located in state offices to state positions, and one position was pending administrative action as of May 2021. This resulted in 176 staff who needed to relocate. Of these 176 staff, 41—or about 23 percent—accepted their reassignments.²⁶ The remaining 135 staff separated from their positions, either by declining their reassignments or by separating from their positions prior to receiving a reassignment, which created additional vacancies.²⁷

After the relocation, BLM filled some of the vacancies created by the separations, but the number of staff in its headquarters office remained lower than before the relocation. According to data provided by BLM, as of January 2021, the total permanent headquarters workforce was 18 percent smaller than in July 2019 (reduced from 537 to 441).²⁸ This decrease in the number of headquarters staff reflects (1) employees that separated from the agency, resulting in vacancies, and (2) decreases in the total number of headquarters positions due to reallocation to states or elimination.

We asked senior BLM officials for data on the total number of positions and vacancies in headquarters and agency wide since 2016, but they said they do not maintain a list of vacancies for state offices and

²⁶Three of the staff that accepted their relocations held positions in the senior executive service, and their relocations were handled under a different process.

²⁷On November 12, 2019, BLM notified affected staff in writing that they had 30 days to accept or decline their reassignments. If responses were not received within 30 days (by December 12, 2019), it was assumed the staff were declining the reassignments. Those accepting reassignments had an additional 90 calendar days to report to their new duty station. According to documentation provided by BLM in May 2021, out of the 135 staff that either declined their reassignments or separated from their positions, 18 staff separated prior to being issued a management-directed relocation letter, and 117 separated after being issued a letter.

²⁸These numbers are snapshots based on data from the Federal Personnel and Payroll System data. BLM provided these data in twice-yearly intervals. As a result, we can report only on the data at these intervals and cannot report on any fluctuations between those time periods.

headquarters vacancy data are not available for all time periods.²⁹ As a result, it is not possible to determine the proportion of positions that were vacant at any given time or the specific positions that were vacant. Although BLM could not provide complete data on all vacancies since 2016, it provided some data on headquarters vacancies since July 2019.³⁰ According to these data, the number of vacant headquarters positions increased after BLM announced the relocation of its headquarters offices to Grand Junction, Colorado, in July 2019. Specifically, headquarters vacancies increased from 121 in July 2019 to 326 in March 2020, an increase of about 169 percent. BLM gradually reduced these vacancies; however, the number of vacant positions remained at 142 as of May 2021, or about 17 percent higher than when the agency announced the relocation. Figure 4 shows the number of vacant headquarters positions from July 2019 to May 2021.

²⁹BLM provided twice-yearly workforce data on the number of staff from the Federal Personnel and Payroll System. BLM officials told us that these data track employees and cannot provide information on the number of positions or vacancies.

³⁰We requested vacancy data starting in January 2016 to align with the workforce data that we used to analyze the number of staff. BLM told us that vacancy data were available for headquarters positions starting in July 2019. BLM provided this vacancy data in non-standard intervals from about 1 and 3 months (i.e. July 2019, September 2019, December 2019, March 2020, June 2020, July 2020, August 2020, October 2020, December 2020, March 2021, and May 2021).

Figure 4: Number of BLM Vacant Headquarters Positions, July 2019–May 2021

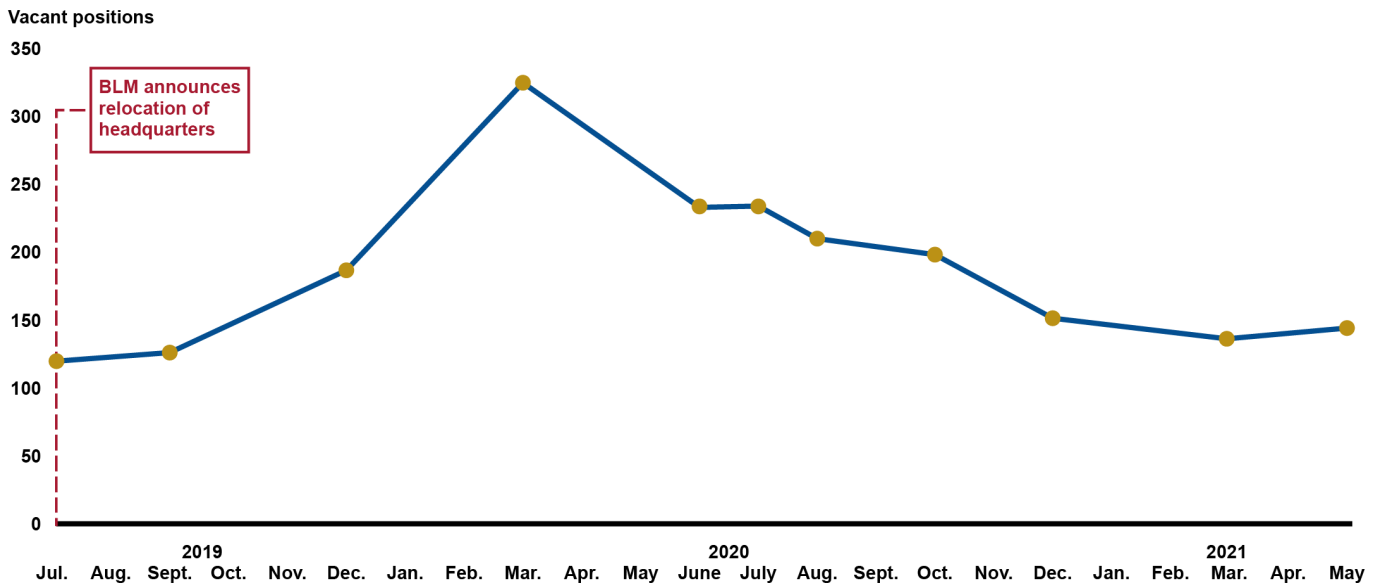

Source: GAO analysis of Bureau of Land Management (BLM) data. | GAO-22-104247

Note: BLM provided vacancy data since July 2019 in non-standard intervals from about one and three months. BLM provided data for the following months and years: July 2019, September 2019, December 2019, March 2020, June 2020, July 2020, August 2020, October 2020, December 2020, March 2021, and May 2021.

All of the BLM staff we interviewed told us about challenges in completing their duties because of headquarters vacancies after 2016. For example, most staff told us that vacancies in key headquarters positions caused delays in creating or clarifying guidance or policy. One staff member told us that, in some cases, the staff member’s office relied on outdated policy guidance in order to make decisions. We recently reported on weaknesses in the way BLM was implementing upgrades to its information technology systems,³¹ and one staff member told us that staff losses delayed implementation of an upgrade to one of these systems.

As noted earlier, all BLM offices experienced hiring restrictions of some kind from January 2017 through June 2021. These restrictions on hiring limited BLM’s ability to fill vacancies created during the relocation as well as vacancies from normal attrition. Most BLM staff we interviewed told us that hiring restrictions affected their offices at some point during this

³¹GAO, *Oil and Gas: Interior Should Strengthen Management of Key Data Systems Used to Oversee Development on Federal Lands*, GAO-21-209 (Washington, D.C.: May 27, 2021).

period, either directly or indirectly because BLM prioritized filling key vacant positions in other offices. For example, one staff member we interviewed told us that the agency promoted a number of state office staff to fill vacant headquarters positions after the relocation, and hiring restrictions prevented state offices from filling empty positions. BLM headquarters does not track vacant state office positions; vacancy information is tracked at the state office level using different methodologies. As a result, the extent to which state offices experienced vacancies cannot be determined.

BLM staff we interviewed also told us that the agency increased its use of temporary reassignments, known as details, to fill the duties of vacant headquarters positions. Almost all said that the number of details increased after 2016 because of the greater number of vacancies in headquarters. Some staff we interviewed said that the use of details helped address gaps in staffing. For example, one staff member said that details helped meet timelines for specific projects, and another said that details helped address staffing shortages until the agency could fill vacancies. However, almost all staff we interviewed said that the increased reliance on details negatively affected their office's performance. For example, one staff member said that BLM detailed too many staff at a given time, which led to some confusion and inefficiency. Another staff member described a ripple effect where details of state office staff to headquarters led to reduced capacity in state and field offices. One staff member said that they expected the reliance on details to decrease once BLM fills headquarters vacancies.

BLM officials told us that they do not have reliable data on details. Further, as stated above, BLM could not provide complete data on headquarters and state office vacancies since 2016. Under federal standards for internal control, managers should identify and obtain quality information to achieve the entity's objectives. Maintaining data on vacancies and details across the agency would give management a better picture of its staffing and allow for the prioritization of the agency's greatest needs. Without complete and reliable data on vacancies and details across the agency, BLM officials do not have complete information to make decisions about filling vacancies and initiating details to help the agency achieve its mission and goals.

The Number of Experienced Staff across BLM Decreased

While the total number of BLM staff did not change substantially between January 2016 and January 2021, there was a decrease in the proportion and number of experienced staff across the agency as a whole and in every office. Specifically, the percentage of BLM staff with at least 25

years of federal service within Interior declined from 24 percent to 17 percent (from 2,071 to 1,486) during this time period.³² See figure 5.

Figure 5: Percentage of BLM Workforce, by Years of Federal Service in the Department of the Interior, January 2016–January 2021

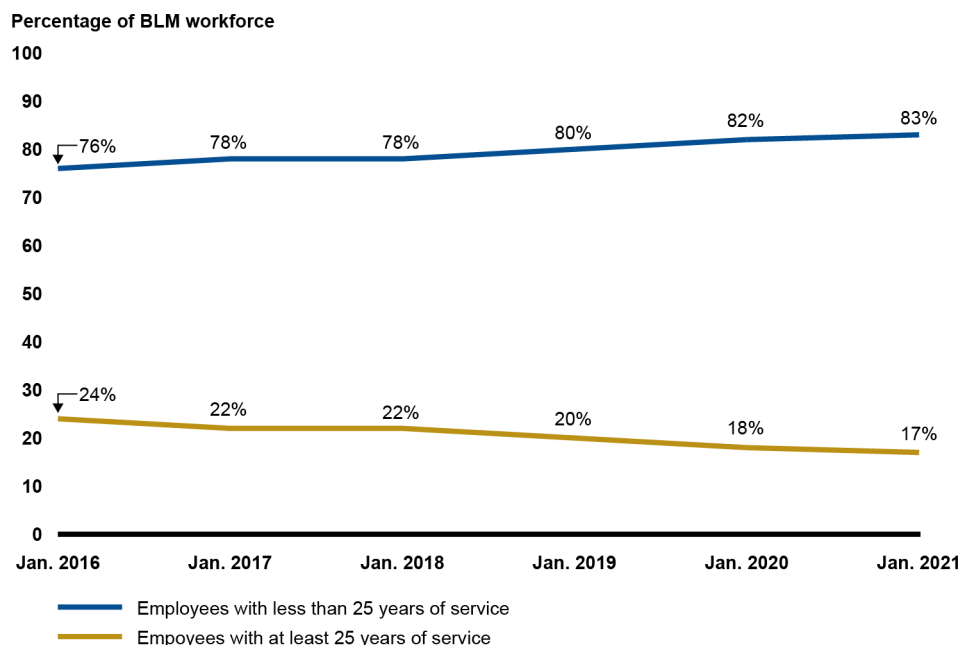

Source: GAO analysis of Bureau of Land Management (BLM) data. | GAO-22-104247

Note: Data are not available for years of service within BLM specifically, only for years of service with the Department of the Interior.

This loss of experienced staff occurred in all BLM offices. For example, from January 2016 to January 2021, the number of headquarters staff with at least 25 years of service within Interior declined by nearly 34 percent (from 171 to 113). In state offices, experienced staff declined by more than 29 percent (from 1,666 to 1,181) over the same period, ranging from nearly 12 percent in the Idaho state office (from 127 to 112) to more than 41 percent in the Arizona state office (from 107 to 63), even though overall permanent staffing in state offices remained relatively steady. (See fig. 6.)

³²The retirement eligibility data on which we based our analysis do not include temporary employees that are not eligible for retirement.

Figure 6: Number of Staff with at Least 25 Years of Service within the Department of the Interior, by BLM Office, January 2016 and January 2021

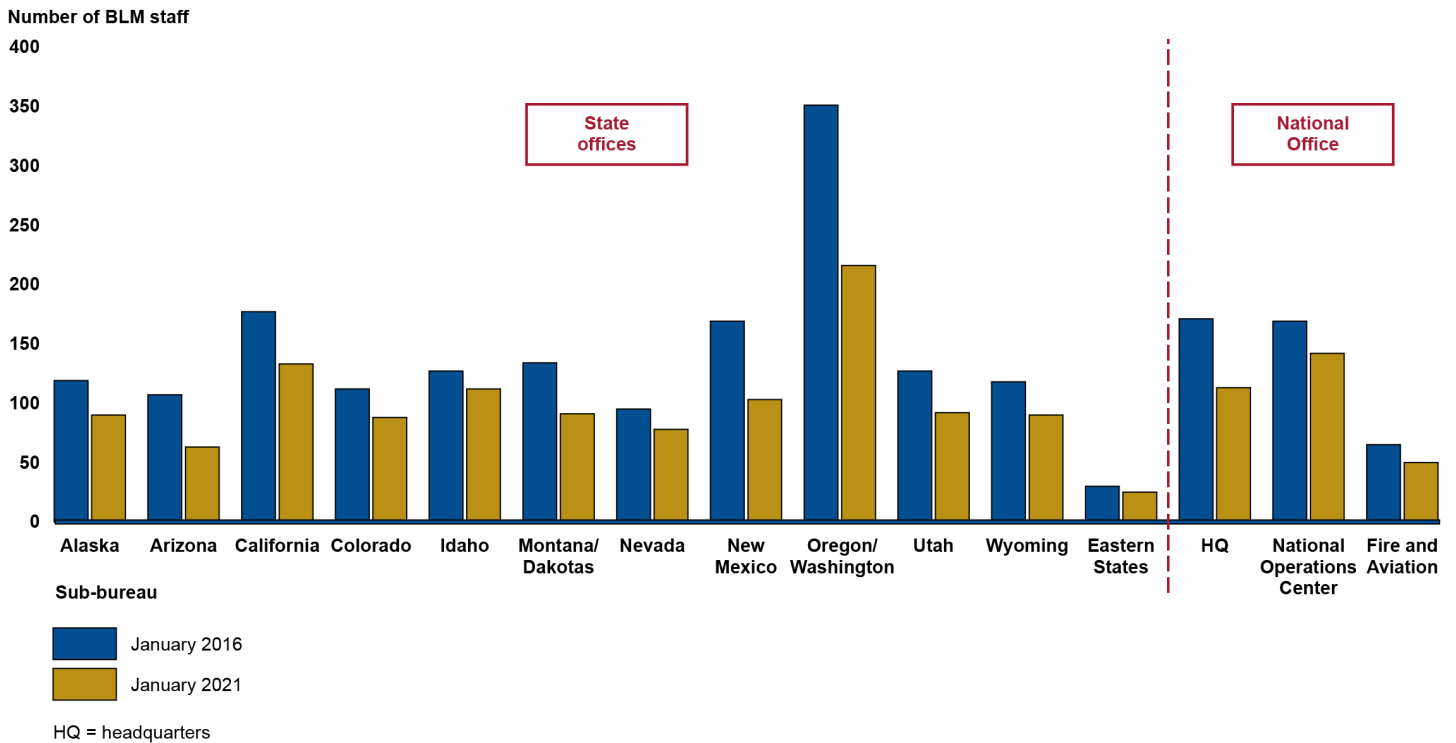

Source: GAO analysis of Bureau of Land Management (BLM) data. | GAO-22-104247

Note: Data are not available for years of service within BLM specifically, only for years of service with the Department of the Interior.

In our interviews with 13 BLM staff members, almost all told us that the loss of experienced staff negatively affected their offices' ability to conduct its duties. For example, one staff member said that the loss of institutional knowledge about laws and regulations meant that BLM was not able to provide knowledgeable input on proposed rules and legislation. Additionally, some staff members said that the rapid loss of experienced staff during the relocation hindered knowledge transfer. For example, one staff member said that in some cases employees left without providing a playbook or guidelines for how to do their jobs. However, another staff member told us that the staff member's office was successful in overcoming the knowledge loss through record keeping, succession-planning activities such as training events, and asking state offices for assistance during the relocation.

Representation of Certain Racial and Ethnic Groups as a Percentage of BLM's Workforce Changed from 2016 to 2021

Since January 2016, BLM's workforce saw shifts in the overall representation of certain racial and ethnic groups. Throughout this period, White staff consistently constituted the majority of BLM's workforce, while other racial and ethnic groups each constituted between less than 1 percent and about 9 percent.³³ See figure 7 for a comparison of the percentage of BLM's workforce by race or ethnicity in 2016 and 2021.

Figure 7: Racial and Ethnic Groups as a Percentage of BLM's Workforce, January 2016 and January 2021

January 2016

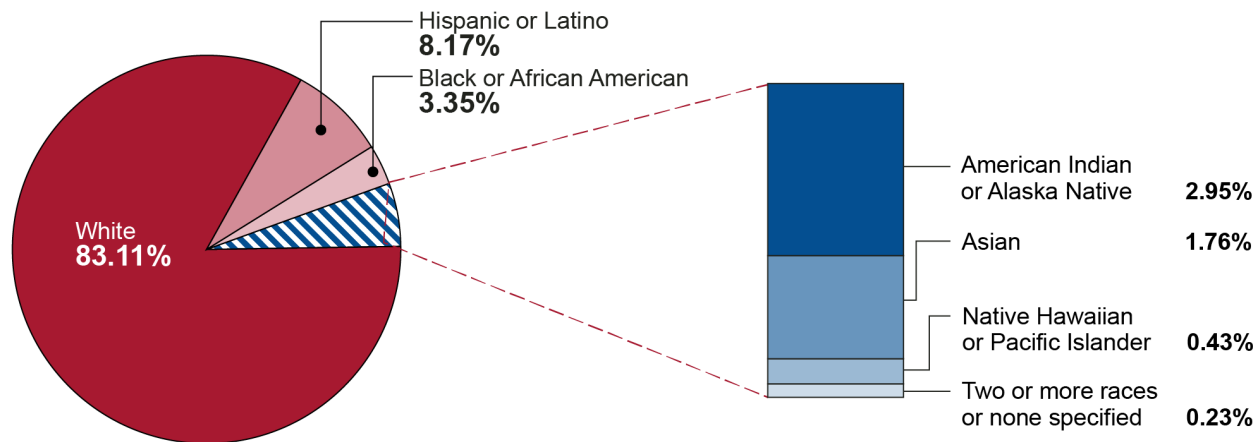

January 2021

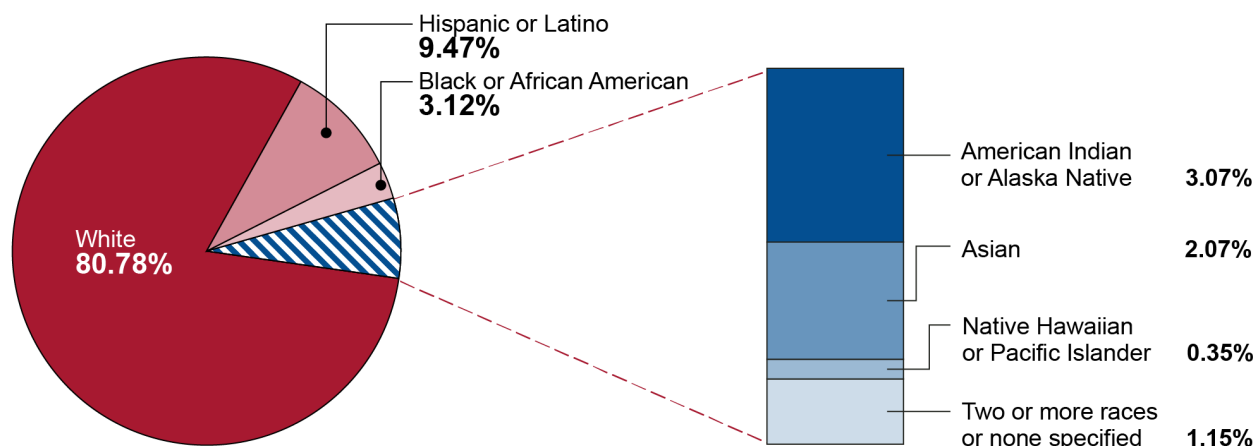

Source: GAO analysis of Bureau of Land Management (BLM) data. | GAO-22-104247

Note: Race and ethnicity data reflect self-identification by BLM staff. Percentages may not add to 100 due to rounding.

³³Data on race and ethnicity are based on self-identification by BLM staff and include permanent and temporary positions.

By January 2021, total representation for certain races and ethnicities increased, while others decreased since January 2016. For example, the representation of Hispanics or Latinos increased by about 17 percent, Asians by about 18 percent, and American Indians or Alaska Natives by about 5 percent. In contrast, representation of Blacks or African Americans decreased by about 6 percent, Native Hawaiians or Pacific Islanders by about 18 percent, and Whites by about 2 percent. See table 1 for changes in BLM’s workforce by race or ethnicity.

Table 1: Bureau of Land Management Workforce Changes, by Race or Ethnicity, January 2016–January 2021

Racial or ethnic group	Jan. 2016	Jan. 2017	Jan. 2018	Jan. 2019	Jan. 2020	Jan. 2021	Change, Jan. 2016–Jan. 2021	
							Number	Percentage
Asian	161	178	192	199	195	190	+29	+18.01
Hispanic or Latino	746	760	778	814	832	871	+125	+16.76
American Indian or Alaska Native	269	272	278	288	284	282	+13	+4.83
White	7,589	7,650	7,609	7,633	7,459	7,429	-160	-2.11
Black or African American	306	336	332	332	302	287	-19	-6.21
Native Hawaiian or Pacific Islander	39	39	34	30	32	32	-7	-17.95
Total workforce^a	9,131	9,273	9,279	9,376	9,201	9,197		

Source: Bureau of Land Management (BLM) | GAO-22-104247

Note: Data on race and ethnicity are based on self-identification by BLM staff.

^aTotal workforce also includes staff that identified as “two or more races” or as “none specified.” Each of these categories accounted for less than 1 percent of BLM’s total workforce.

BLM’s state offices saw an overall increase in the representation of non-White racial or ethnic groups since 2016, while some of the largest decreases occurred in its headquarters office during the relocation of the agency’s headquarters from Washington, D.C., to western state offices.

- In July 2019, when the relocation was announced, Black or African American headquarters staff made up 21 percent of total headquarters staff (116 of 541) and 35 percent of the agency’s total Black or African American workforce (116 of 329). By January 2021, after the relocation was completed, the number of Black or African American headquarters staff decreased by more than half, making up 12 percent of total headquarters staff (55 of 443) and 19 percent of the total Black or African American workforce (55 of 287).
- The number and representation of Asian headquarters staff saw a similar decline. From July 2019 to January 2021, the number of Asian staff in headquarters positions decreased by more than half, from 3

percent of total headquarters staff (17 of 541) to less than 2 percent (8 of 443).

- Comparatively, while the numbers of White headquarters staff decreased since the relocation, their representation among total headquarters staff increased. From July 2016 to January 2021, the percentage of White staff in headquarters positions increased from about 67 percent (361 of 541) to 74 percent (328 of 443).

BLM Does Not Have a Strategic Workforce Plan that Aligns Its Workforce with Its Mission and Programmatic Goals

We found that BLM does not have a strategic workforce plan that supports its mission and programmatic goals, even as it experienced the significant workforce changes described above—a loss of headquarters staff, increased numbers of headquarters vacancies, a loss of experienced staff, and decreased representation of employees of some races and ethnicities. BLM officials told us in December 2020 that their mechanism for strategic workforce planning is Instruction Memorandum 2019-042.³⁴ However, this memorandum, described in further detail below, does not constitute a strategic workforce plan because it generally does not address either of the two critical needs that define strategic workforce planning: (1) aligning the agency’s human capital program with emerging mission goals, and (2) developing long-term strategies for acquiring, developing, and retaining staff to achieve programmatic goals.³⁵

BLM issued Instruction Memorandum 2019-042 in August 2019, shortly after it announced its headquarters relocation. The memorandum directs BLM’s state and headquarters offices to review their operations and organizational structure according to certain criteria, such as

- seeking opportunities to reduce administrative redundancies,
- devoting a greater share of their budgets to the field, and
- sharing resources more effectively.

³⁴Bureau of Land Management, Deputy Director of Operations, *Updating and Standardizing BLM Tables of Organization*.

³⁵[GAO-04-39](#). The definition of strategic workforce planning is planning that addresses (1) aligning an organization’s human capital program with its current and emerging mission and programmatic goals, and (2) developing long-term strategies for acquiring, developing, and retaining staff to achieve programmatic goals.

According to the memorandum, state offices are also to compare the pay grades of their staff with a “functional chart of a typical BLM state organization” and justify any variance from the pay grades in the typical structure.³⁶ After the offices complete their reviews, they are to submit detailed organizational charts known as tables of organization for approval by the Deputy Director of Operations. According to agency officials, as of May 2021, all offices had completed these reviews and received approval for their tables of organization. The memorandum also directs that there will be at least annual updates to ensure the offices’ tables of organization remain current.

We found the memorandum does not constitute a strategic workforce plan because it does not address aligning the agency’s human capital program with emerging mission goals or include strategies for acquiring, developing, or retaining staff. We have also previously reported that, as part of strategic workforce planning, information on attrition rates, projected retirement rates, and demographic trends can be useful,³⁷ and the memorandum does not address these topics.³⁸ One BLM staff member we interviewed told us that, in their view, reviews called for in the memorandum were not about workforce planning, but they were rather about ensuring tables of organization accurately reflected position relocations as part of the bureau’s move west.

Other agencies have used strategic workforce planning to ensure that their human capital program capitalizes on their workforce’s strengths and addresses challenges in a manner that is clearly linked to achieving the agency’s mission and goals. For example, in December 2003 we reported on strategic workforce planning by a research institute in the National Institutes of Health.³⁹ We found that, as the institute developed new

³⁶Offices are also to reduce organizational barriers to citizen service, return decision-making to line officers, and ensure their tables of organization reflect the positions that were reallocated from headquarters to state offices as a part of the agency’s 2019 changes in organizational structure.

³⁷In addition, under Executive Order 14035, issued on June 25, 2021, agencies are to, (1) assess the current state of diversity, equity, inclusion, and accessibility in their workforces within 100 days after the issuance of the order; and (2) develop and submit strategic plans to remove any potential barriers to diversity, equity, inclusion, and accessibility in the workforce. Exec. Order No. 14035, *Diversity, Equity, Inclusion, and Accessibility in the Federal Workforce*, 86 Fed. Reg. 34593 (June 30, 2021) (issued June 25, 2021).

³⁸[GAO-04-39](#).

³⁹[GAO-04-39](#).

strategic goals, it identified the scientific and research capability it needed to fulfill these goals, and scientists discussed what skills were needed and how to acquire or develop these skills to achieve the institute's goals.

In May 2021, Interior announced it was reviewing the relocation of the BLM headquarters and the associated relocations of headquarters staff across the west.⁴⁰ According to the announcement, the review was focused on understanding the impacts of the relocations on BLM operations and employees, assessing the impact of the significant loss of experience, and identifying needed actions to improve bureau capacity. This review could provide valuable insights into the effects of the relocation and help inform agency plans for the restoration of its national headquarters in Washington, D.C. However, without a strategic workforce plan that addresses the significant workforce changes the agency has experienced in recent years, BLM lacks reasonable assurance that it will have the workforce necessary to achieve its mission and goals in managing millions of acres of public lands and associated natural, cultural, and historic resources.

Conclusions

BLM depends on a workforce of about 8,800 permanent staff to help achieve mission and programmatic goals such as managing energy development on public lands. After 2016, BLM made substantial changes to its organizational structure, which also affected its workforce composition, including through loss of headquarters staff, increased numbers of headquarters vacancies, loss of experienced staff, and decreased representation of employees of some races and ethnicities. Increased vacancies, and the details used to temporarily fill those vacancies, sometimes led to confusion and inefficiency, according to staff members we interviewed. Further, the Secretary of the Interior has announced plans for additional organizational changes that would restore the national headquarters in Washington, D.C., and make the Grand Junction headquarters a Western headquarters. However, BLM does not have complete and reliable data on vacancies and details, and, therefore, does not have a complete picture of its staffing needs. Without such data on vacancies and details across the agency, BLM officials do not have complete information to make decisions about filling vacancies and initiating details to help the agency achieve its mission and goals. BLM also made these significant changes to its organizational structure without a strategic workforce plan addressing the two critical needs that define

⁴⁰Bureau of Land Management, *Bureau Highlights*. Accessed July 15, 2021. <https://www.doi.gov/sites/doi.gov/files/fy2022-bib-bh007.pdf>.

strategic workforce planning: (1) aligning the agency's human capital program with emerging mission goals, and (2) developing long-term strategies for acquiring, developing, and retaining staff to achieve programmatic goals. Without developing a strategic workforce plan that addresses these needs, BLM lacks reasonable assurance that it will have the workforce necessary to achieve its mission and goals.

Recommendations for Executive Action

We are making the following two recommendations to BLM:

The Director of BLM should track data on vacancies and the use of details for all offices. (Recommendation 1)

The Director of BLM should develop an agency-wide strategic workforce plan that aligns the agency's human capital program with emerging mission goals and includes long-term strategies for acquiring, developing, and retaining staff to achieve programmatic goals. (Recommendation 2)

Agency Comments

We provided a draft of this report to the Department of the Interior for review and comment. In its comments, reproduced in appendix II, Interior concurred with our recommendations. According to their letter, BLM intends to establish a more standardized process to track vacancies and details bureau-wide, and the agency is currently developing a process for bureau-wide strategic workforce planning. The target date for these actions is June 30, 2022. Interior also provided technical comments, which we incorporated as appropriate.

As agreed with your office, unless you publicly announce the contents of this report earlier, we plan no further distribution until 30 days from the report date. At that time, we will send copies to the appropriate congressional committees, the Secretary of the Interior, and other interested parties. In addition, the report will be available at no charge on the GAO website at <https://www.gao.gov>.

If you or your staff have any questions about this report, please contact me at (202) 512-3841 or ruscof@gao.gov. Contact points for our Offices of Congressional Relations and Public Affairs may be found on the last page of this report. GAO staff who made key contributions to this report are listed in appendix III.

Sincerely yours,

A handwritten signature in black ink that reads "Frank Rusco". The signature is written in a cursive style and extends to the right with a long, thin horizontal stroke.

Frank Rusco
Director
Natural Resources and Environment

Appendix I: Organizational Changes to the Bureau of Land Management's Headquarters Divisions

After 2016, the Bureau of Land Management (BLM) headquarters offices experienced the largest structural changes of any of the bureau's offices. BLM's headquarters offices are currently organized into the Office of the Director and five directorates, each of which contains multiple divisions that carry out specific functions.¹ The functions of BLM's Office of the Director and its headquarters directorates, including the major changes to the divisions within each directorate since 2016, are summarized below. (See fig. 8 for a comparison of BLM's headquarters structure in 2016 and in 2021.)

¹BLM's national office also includes the Office of Fire and Aviation and the National Operations Center, which report to the Office of the Director through the Deputy Director for Operations. The National Operations Center provides a suite of professional services to support BLM and it provides expertise in financial management, human resources, information management and technology, and land and natural resources management. The Office of Fire and Aviation is responsible for developing policies and standards for firefighting safety, training, prevention and mitigation, among other things. It operates as a directorate under its own organization code.

Appendix I: Organizational Changes to the Bureau of Land Management's Headquarters Divisions

Figure 8: Comparison of BLM Headquarters Offices, 2016 and 2021

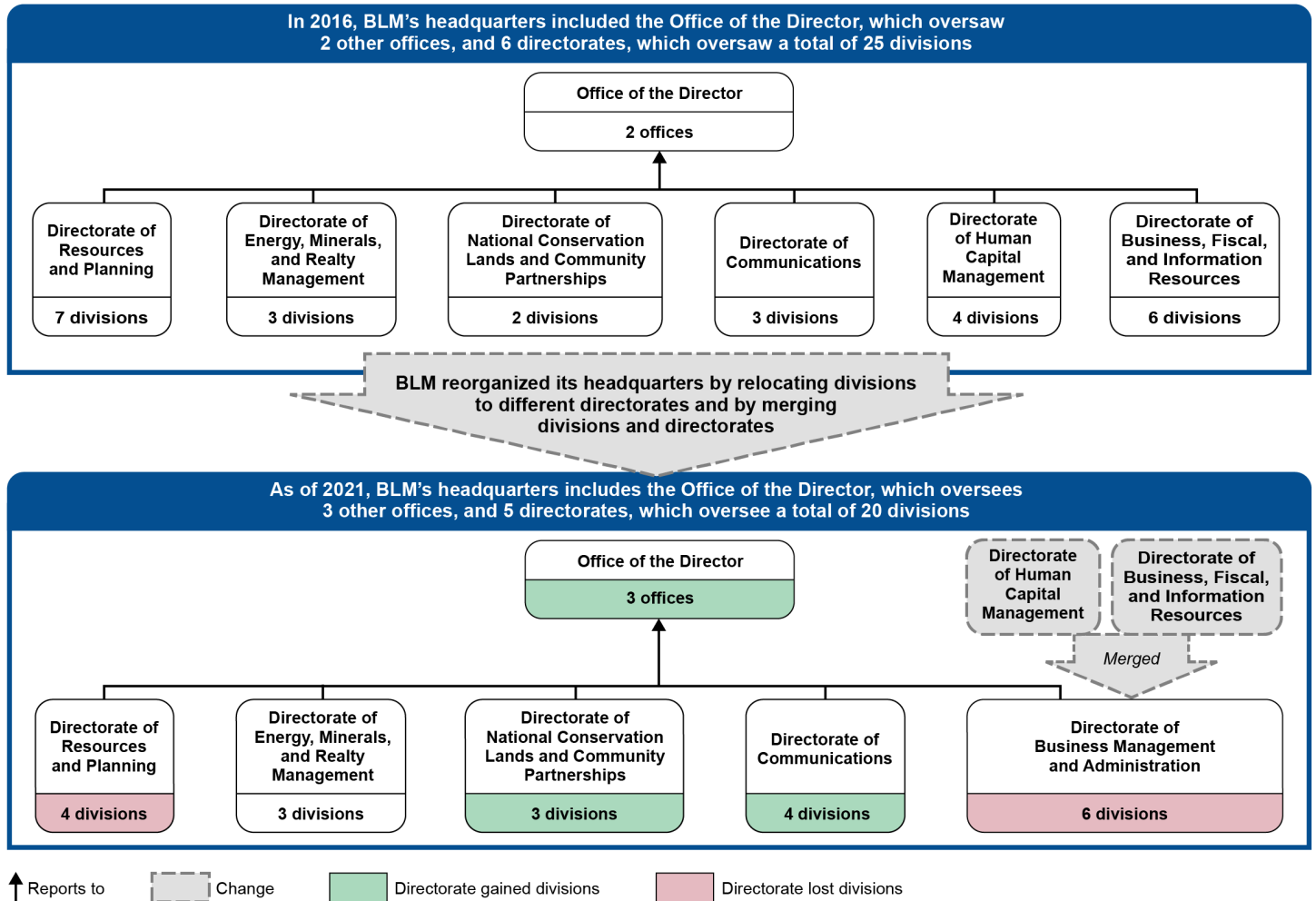

Source: GAO analysis of Bureau of Land Management (BLM) data. | GAO-22-104247

Note: All relocated or merged divisions occurred within BLM's Headquarters Office with the exception of the relocation of three Information Technology divisions from the Directorate of Business, Fiscal, and Information Resources to the National Operations Center.

The Office of the Director

The Office of the Director currently consists of the Director's Staff, the Office of Law Enforcement and Security, and the Office of Civil Rights. The Director's Staff provides overall national direction and leadership for BLM. The Office of Law Enforcement and Security supports the agency's mission through the enforcement of federal laws and regulations related to the use, management, and development of public lands and resources. The Office of Civil Rights is responsible for the administration of BLM's

Appendix I: Organizational Changes to the Bureau of Land Management's Headquarters Divisions

civil rights program, and it provides policy and guidance on implementation of civil rights requirements, including equal employment opportunity programs.

In September 2019, BLM relocated the Office of Civil Rights from the Human Capital Management Directorate to the Office of the Director. See figure 9 for a comparison of the Office of the Director's functions in January 2016 and January 2021.

Figure 9: Changes in Organization of BLM's Office of the Director, 2016 and 2021

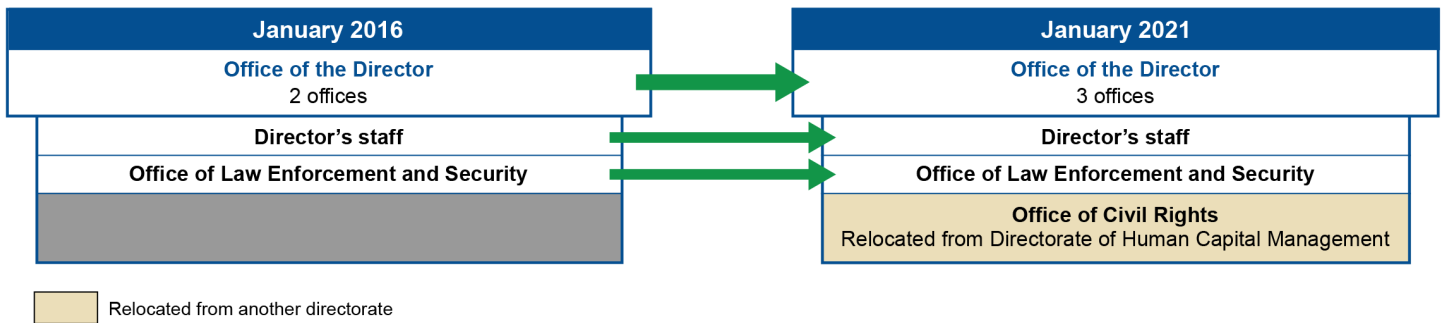

Source: GAO analysis of Bureau of Land Management (BLM) documents. | GAO-22-104247

Directorate of Resources and Planning

The Directorate of Resources and Planning develops regulation and policy and provides technical guidance related to natural resource laws such as the National Environmental Policy Act, the Endangered Species Act, and the Taylor Grazing Act. The directorate also provides budget formulation and program oversight for many of BLM's natural resource programs, including programs related to land use planning, livestock grazing, forestry and timber, wildlife and aquatic habitat, hazardous and abandoned mine lands, and wild horses and burros.

In 2019, BLM merged most the functions of its Environmental Quality and Protection division into other divisions within its Directorate of Resources and Planning, removing the division from its organizational structure. Most of the functions were merged with the former of Fish and Wildlife Conservation division, creating a new Wildlife Conservation, Aquatics, and Environmental Protection division, while some limited functions were incorporated into the Forest, Range, and Vegetation Resources division. Additionally, BLM reorganized its riparian program from the former Forest, Rangeland, Riparian, and Plant Conservation division to this new division. In September 2019, BLM relocated the directorate's Cultural, Paleontological Resources, and Tribal Consultation division and its

Appendix I: Organizational Changes to the Bureau of Land Management's Headquarters Divisions

Recreation and Visitor Services division to the Directorate of National Conservation Lands and Community Partnerships. See figure 10 for a comparison of the directorate's divisions in January 2016 and January 2021.

Figure 10: Changes in Organization of BLM's Directorate of Resources and Planning, 2016 and 2021

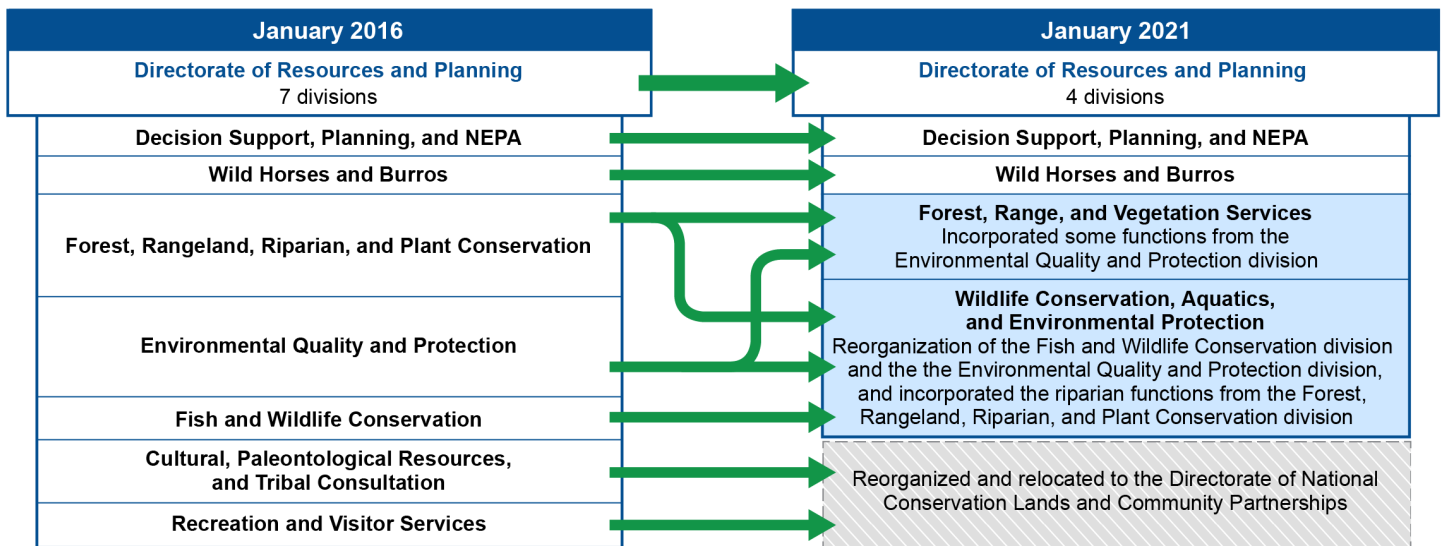

Merged or added functions
 Relocated to another directorate

NEPA = National Environmental Policy Act

Source: GAO analysis of Bureau of Land Management (BLM) documents. | GAO-22-104247

Directorate of Energy, Minerals, and Realty Management

The Directorate of Energy, Minerals, and Realty Management is responsible for the development, implementation, and monitoring of legislation, regulations, policies, and technical guidance related to energy and minerals on BLM-managed lands. Its three divisions primarily consist of subject matter experts and support staff.

The Fluid Minerals division provides oversight and guidance for the oil and gas program. The Solid Minerals division provides oversight and guidance for the Coal, Mining Law, Non-Energy Leasable, and Salable Minerals programs. The Lands, Resources, and Cadastral Survey division provides oversight and guidance on actions connected to the processing of land exchanges, withdrawals, rights of way (including those for solar and wind projects), transmission and pipelines, and communications sites.

Appendix I: Organizational Changes to the Bureau of Land Management's Headquarters Divisions

The structure of this directorate has remained unchanged since 2016. See figure 11 for a comparison of the directorate's divisions in January 2016 and January 2021.

Figure 11: Changes in Organization of BLM's Directorate of Energy, Minerals, and Realty, 2016 and 2021

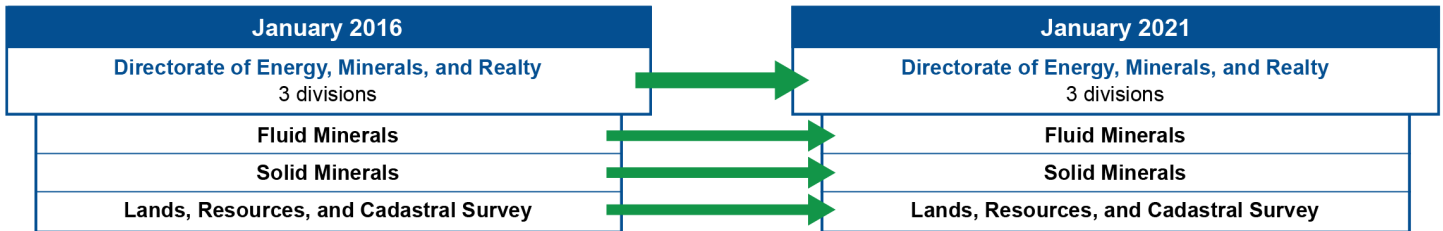

Source: GAO analysis of Bureau of Land Management (BLM) documents. | GAO-22-104247

Directorate of National Conservation Lands and Community Partnerships

The Directorate of National Conservation Lands and Community Partnerships supports the management of about 35 million acres of public lands. It establishes policy and guidance, formulates budgets, and tracks performance for BLM-wide programs on issues such as recreation, environmental and heritage education, and cultural and paleontological resources.

The National Conservation Lands division oversees lands such as national monuments, national conservation areas, national wild and scenic rivers, and national scenic and historic trails. The Education, Cultural and Paleontological Resources division supports education, youth, and paleontological resources and manages more than 28,000 volunteers. The Recreation and Visitor Services division provides guidance and budget formulation for local offices that see about 70 million recreational visitors each year.

In 2020, BLM reorganized its Cultural, Paleontological Resources and Tribal Consultation division and its Recreation and Visitor Services division to this directorate from its Directorate of Resources and Planning. As part of this reorganization, BLM merged the functions of the Cultural, Paleontological Resources, and Tribal Consultation division with its former Education, Interpretation, and Partnerships division to create the current Education, Cultural, and Paleontological Resources division. See figure 12 for a comparison of the directorate's divisions between January 2016 and January 2021.

Figure 12: Changes in Organization of BLM's Directorate of National Conservation Lands and Community Partnerships, 2016 and 2021

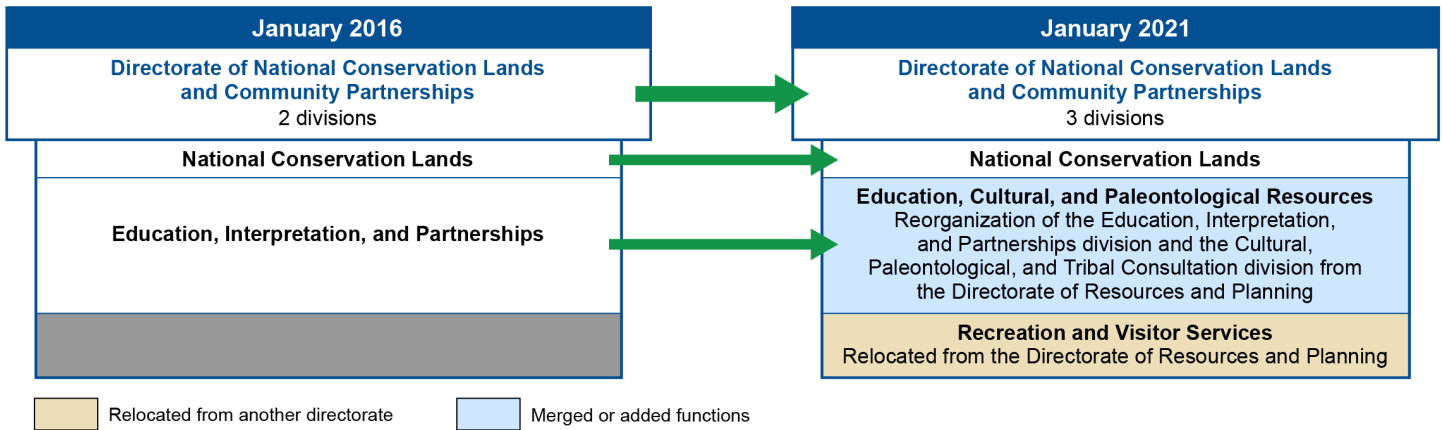

Source: GAO analysis of Bureau of Land Management (BLM) documents. | GAO-22-104247

Directorate of Communications

The Directorate of Communications works to ensure BLM's strategic goals, directions, and communications support and enhance the public's understanding of BLM programs. It also oversees correspondence, responses to Freedom of Information Act requests, and BLM's online and social media functions.

The Public Affairs division manages BLM's public relations by conveying policy to internal and external audiences. The Legislative Affairs Division is responsible for all BLM legislative and congressional matters, including developing and clearing formal written testimony, tracking and analyzing legislation, and responding to inquiries from Congress. The Regulatory Affairs division assists programs with drafting final rules and Federal Register notices, manages BLM's information collection and clearance process, and conducts regulatory analyses of proposed regulations of interest to BLM. The External Affairs division oversees responses to Freedom of Information Act requests, coordinates with state and local officials, handles priority correspondence, and coordinates Federal Advisory Committees and international issues.

In 2016, BLM created the External Affairs division. See figure 13 for a comparison of the directorate's divisions in January 2016 and January 2021.

Figure 13: Changes in Organization of BLM's Directorate of Communications, 2016 and 2021

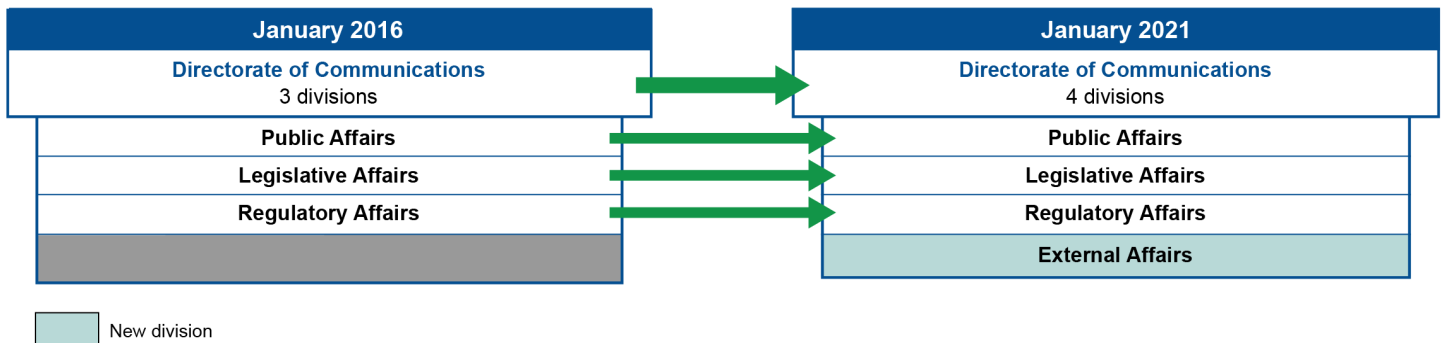

Source: GAO analysis of Bureau of Land Management (BLM) documents. | GAO-22-104247

Directorate of Business Management and Administration

The Directorate of Business Management and Administration oversees BLM's human capital management. It also provides policy guidance, expertise, and assistance on business, audits and evaluations, and fiscal programs throughout the agency. Such programs address issues, including workforce and strategic planning and analysis, diversity and inclusion, employee engagement, human resources policies and programs, recruitment and retention, employee development and training, safety, occupational health, and emergency management.

BLM created the directorate in October 2020 as a merger of its Directorate of Human Capital Management and Directorate of Business, Fiscal, and Information Resources. Between 2016 and the formation of the current Business Management and Administration directorate, BLM made several changes to these two former directorates. In April 2019, BLM reorganized two divisions within its former Directorate of Business, Fiscal, and Information Resources—the Business Resources division and the Evaluations and Management Services division—into two new divisions—the Business Engineering and Evaluations division and the Acquisitions and Financial Assistance division. In September 2019, BLM relocated its Office of Civil Rights from the Directorate of Human Capital Management to the Office of the Director. In March 2019, BLM reorganized three information technology divisions from the Directorate of Business, Fiscal, and Information resources to the National Operations Center. See figure 14 for a comparison of the directorate's divisions in January 2016 and January 2021.

**Appendix I: Organizational Changes to the
Bureau of Land Management's Headquarters
Divisions**

Figure 14: Reorganization of BLM's Directorate of Human Capital Management and Directorate of Business, Fiscal and Information Resources Management into the Directorate of Business Management and Administration, 2016 and 2021

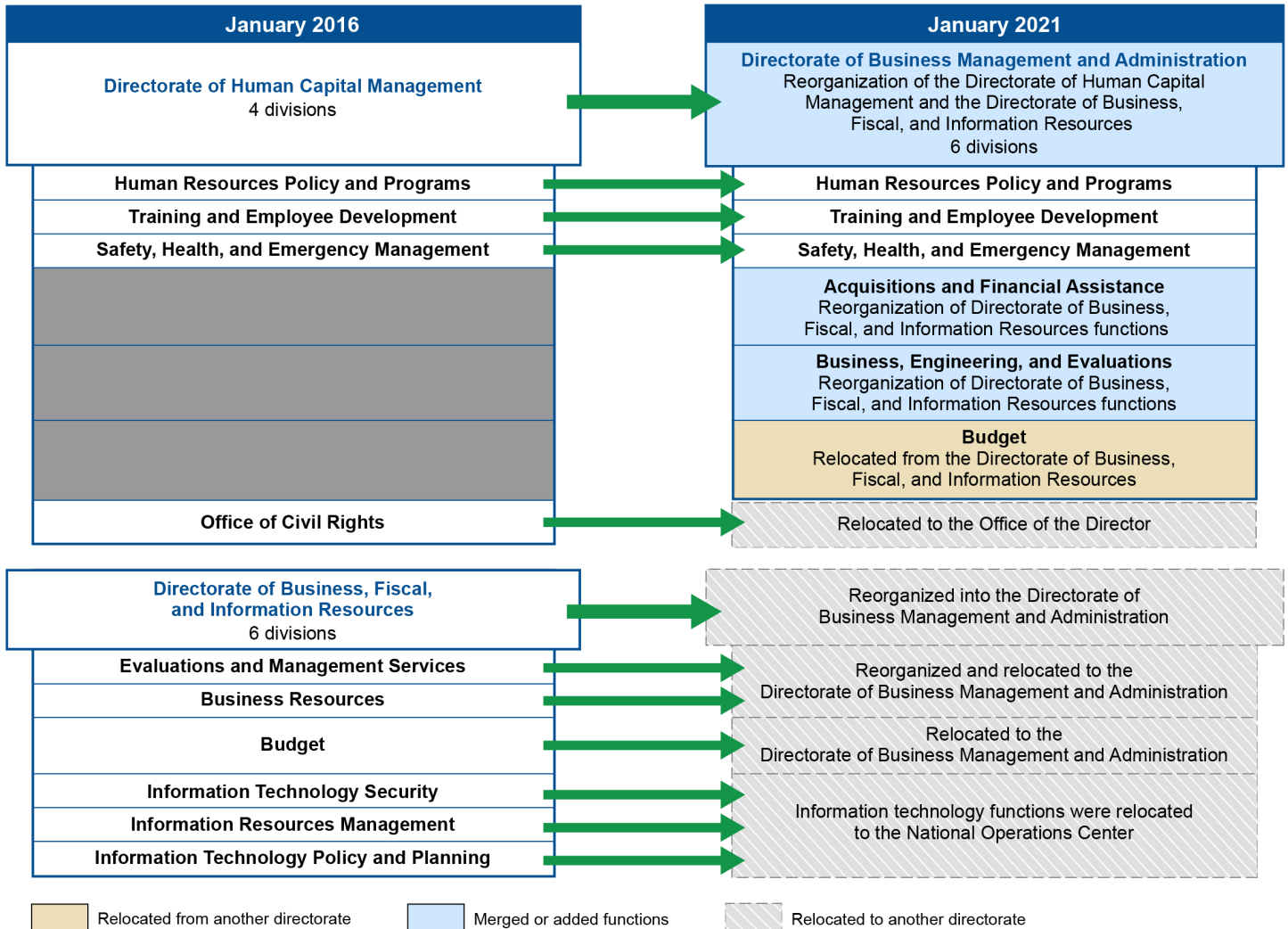

Source: GAO analysis of Bureau of Land Management (BLM) documents. | GAO-22-104247

Appendix II: Comments from the Department of the Interior



United States Department of the Interior

OFFICE OF THE SECRETARY
Washington, DC 20240

Frank Rusco
Director, Natural Resources and Environment
U.S. Government Accountability Office
441 G Street, NW
Washington, DC 20548

Dear Mr. Rusco,

Thank you for providing the Department of the Interior (Department) an opportunity to review and comment on the draft Government Accountability Office (GAO) report titled, *Bureau of Land Management: Better Workforce Planning and Data Would Help Mitigate the Effects of Recent Staff Vacancies* (GAO-22-104247). The Bureau of Land Management (BLM) takes seriously its commitment to all aspects of workforce excellence and looks forward to issuance of the final report.

The GAO issued two recommendations to the Department as part of its overall findings. The report contains two recommendations to the BLM. Below is a summary of actions taken or planned to implement the recommendations.

Recommendation 1: The Director of BLM should track data on vacancies and the use of details for all offices.

Response: Concur. The BLM currently tracks vacancies and detailees at the individual state office level. Moving forward, the BLM intends to establish a more standardized process to track vacancies and detailees bureau-wide, incorporating state/center and directorate information.

Responsible Official: Assistant Director, Business Management and Administration

Target Date: June 30, 2022

Recommendation 2: The Director of BLM should develop an agency-wide strategic workforce plan that aligns the agency's human capital program with emerging mission goals and includes long-term strategies for acquiring, developing, and retaining staff to achieve programmatic goals.

Response: Concur. The BLM is currently in the process of developing a process for bureau-wide strategic workforce planning.

**Appendix II: Comments from the Department
of the Interior**

Responsible Official: Assistant Director, Business Management and Administration

Target Date: June 30, 2022

If you should have any questions or need additional information, please contact Barbara Eggers, Assistant Director of Business Management and Administration at egggers@blm.gov or (970) 256-4912.

Sincerely,

Laura Daniel-Davis
Digitally signed by Laura Daniel-Davis
Date: 2021.10.26 14:08:25 -04'00'

Laura Daniel-Davis
Principal Deputy Assistant Secretary,
Land and Minerals Management

Appendix III: GAO Contact and Staff Acknowledgments

GAO Contact

Frank Rusco at (202) 512-3841 or ruscof@gao.gov

Staff Acknowledgments

In addition to the contact named above, Janice Ceperich and Elizabeth Erdmann (Assistant Directors), Marietta Mayfield Revesz (Analyst in Charge), Travis Cady, William Gerard, Cindy Gilbert, Ying Long, Steven Lozano, Cynthia Norris, and Dan Royer made key contributions to this report.

GAO's Mission

The Government Accountability Office, the audit, evaluation, and investigative arm of Congress, exists to support Congress in meeting its constitutional responsibilities and to help improve the performance and accountability of the federal government for the American people. GAO examines the use of public funds; evaluates federal programs and policies; and provides analyses, recommendations, and other assistance to help Congress make informed oversight, policy, and funding decisions. GAO's commitment to good government is reflected in its core values of accountability, integrity, and reliability.

Obtaining Copies of GAO Reports and Testimony

The fastest and easiest way to obtain copies of GAO documents at no cost is through our website. Each weekday afternoon, GAO posts on its [website](#) newly released reports, testimony, and correspondence. You can also [subscribe](#) to GAO's email updates to receive notification of newly posted products.

Order by Phone

The price of each GAO publication reflects GAO's actual cost of production and distribution and depends on the number of pages in the publication and whether the publication is printed in color or black and white. Pricing and ordering information is posted on GAO's website, <https://www.gao.gov/ordering.htm>.

Place orders by calling (202) 512-6000, toll free (866) 801-7077, or TDD (202) 512-2537.

Orders may be paid for using American Express, Discover Card, MasterCard, Visa, check, or money order. Call for additional information.

Connect with GAO

Connect with GAO on [Facebook](#), [Flickr](#), [Twitter](#), and [YouTube](#).
Subscribe to our [RSS Feeds](#) or [Email Updates](#). Listen to our [Podcasts](#).
Visit GAO on the web at <https://www.gao.gov>.

To Report Fraud, Waste, and Abuse in Federal Programs

Contact FraudNet:

Website: <https://www.gao.gov/about/what-gao-does/fraudnet>

Automated answering system: (800) 424-5454 or (202) 512-7700

Congressional Relations

A. Nicole Clowers, Managing Director, ClowersA@gao.gov, (202) 512-4400, U.S. Government Accountability Office, 441 G Street NW, Room 7125, Washington, DC 20548

Public Affairs

Chuck Young, Managing Director, youngc1@gao.gov, (202) 512-4800
U.S. Government Accountability Office, 441 G Street NW, Room 7149
Washington, DC 20548

Strategic Planning and External Liaison

Stephen J. Sanford, Managing Director, spel@gao.gov, (202) 512-4707
U.S. Government Accountability Office, 441 G Street NW, Room 7814,
Washington, DC 20548



Please Print on Recycled Paper.