

# TRANSCRIPT

Edward Tom reflects on retirement and 30 years helping Admissions.

PAGE 28

Legalizing marijuana creates a whole new field of opportunity.

PAGE 36

Erwin Chemerinsky joins Berkeley Law as new dean.

PAGE 44



# Fortune Teller

DAVID ESTRADA '93 FUELS THE TECH REVOLUTION WITH HARD WORK, KEEN INSIGHT, AND A BIT OF CLAIRVOYANCE.

PAGE 20

# TRANSC

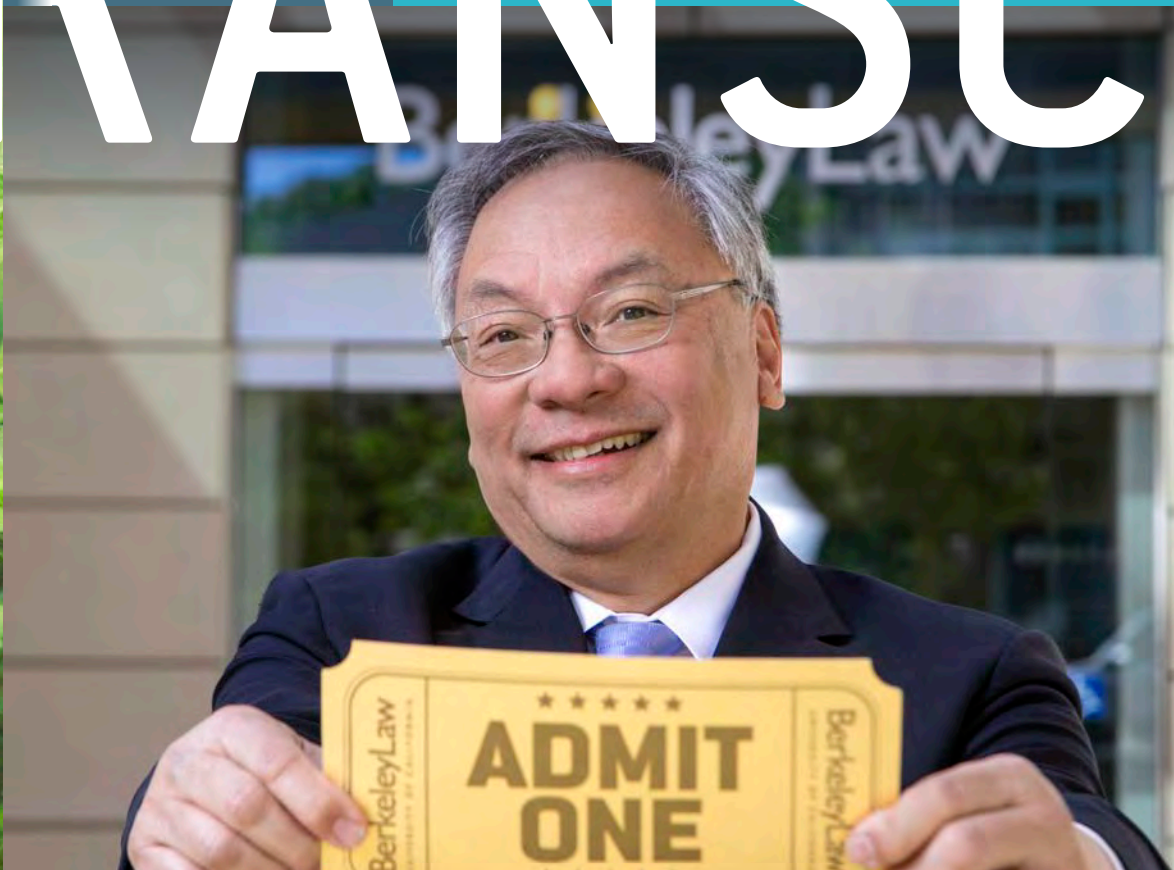

## FEATURES

### 20 Tomorrow Man

#### COVER STORY

Visionary lawyer David Estrada '93 has shown an uncanny knack for helping shape the world's tech revolution.

*By Andrew Faught*

### 28 Dream Weaver

#### Q&A

Retiring in December, Edward Tom reflects on a joyful 30-year ride as Berkeley Law's Dean of Admissions.

*By Andrew Cohen*

### 36 Fields of Opportunity

#### LEGAL PIONEERS

Alumni, faculty, and clinics light the way for a burgeoning area of legal work related to marijuana in California and beyond.

*By Rachel DeLetto*

### 28 Ready To Lead

#### NEW DEAN

Erwin Chemerinsky brings vast experience and abundant energy to his new job as Berkeley Law's dean.

*By Andrew Cohen*

## COLUMNS

### 2 From the Interim Dean

### 62 Insight

Sacramento's Challenge of Redefining Federalism. *By Senator Henry Stern '09*

# RIPT

# Contents

Spring 2017

Vol. 49



## SECTIONS

### 3 In Brief

Big Hitters Ignite Business Boom  
Students Buoy Central Valley Startups  
A New Approach for Lethal Words  
Stirred up for Justice Sotomayor  
Making Mental Health Matter  
Passi '13 on Forbes' 30 Under 30 List  
Improv(ed) Legal Skills  
Highest Degree Reaches New Peak  
From Classmates to SCOTUS Clerks  
Lavalais Among *National Jurist's* 25 Law Students of the Year  
Forging the Future of Reproductive Rights  
Educator Extraordinaire  
Plum DOJ Positions Taste Sweet

### 12 Forefront

Where Innovation Fuels Investigation  
Leading the Fight for Fairness  
Empowering Local Youth  
Deal Camp Yields High Returns  
A Decade of Healing  
Magnet School

### 46 Creative Works

Artistic Contributions from Our Community

### 48 Fast Forward

Three Student Action Figures

### 51 Study Hall

Selected Faculty Scholarship

### 55 Advancement

News and Notes from the Alumni Center

### 63 Class Notes

All in the Alumni Family



“THE FEELING OF UNITY AND PURPOSE INSIDE THE BERKELEY LAW COMMUNITY IS PALPABLE AND POWERFUL.”

—MELISSA MURRAY

# From the Interim Dean

Serving as Berkeley Law’s interim dean has been challenging, humbling, and thoroughly exhilarating. It has been such a privilege to serve the Boalt community in this way.

The circumstances that led to my appointment were deeply unsettling, as were some of the issues we’ve faced since then. Budget anxieties from campus, increased competition for top applicants, far-reaching concerns for our foreign students and those from immigrant families—the list goes on. These are restless times.

When I became interim dean in March 2016, I, like so many in our community, wanted to “get back to normal.” But even as we sought a sense of normalcy, we also wanted to craft a “new normal” grounded in a renewed commitment to our core values and mission.

And this is what we have done, reimagining our community and taking concrete steps to make it more inclusive and engaged. From our staff-faculty climate committee, to our expanding slate of alumni events, and our inspired clinical partnerships, the feeling of unity and purpose inside the Berkeley Law community is palpable and powerful.

Our faculty are thought leaders in a wide range of fields, informing policy and practice at all levels. Our staff members, many of whom have been part of the law school for a generation or more, bring their A-game to work every day. And our students continue to inspire us by tackling some of the most intractable problems facing our society.

Our alumni are a vital component of this renewed vigor and purpose. In my short term as interim dean, I’ve seen firsthand their profound commitment to making Berkeley Law exceptional—and accessible—for students from all backgrounds. Our international graduates are enthusiastically forming Boaltie hubs overseas. Young alumni have started to flock to our new B-Link platform to share professional and personal news and reconnect with classmates and friends. And in this challenging year, alumni have stepped up to support the law school and its traditions of excellence and accessibility in myriad ways. I am profoundly grateful for your friendship and generosity.

This year has given me an even deeper appreciation for the law school and our amazing community. But I know our best days are yet to come, and I’m excited for what lies ahead.

New Dean Erwin Chemerinsky is an extraordinary person of abundant integrity, energy, and humaneness. As one of the world’s most influential legal scholars and the founding dean of UC Irvine’s law school, he has a proven record of visionary ideas that advance progress, justice, and diversity. Erwin is ideally suited to lead our school forward.

As interim dean, I saw Berkeley Law’s unique culture thriving all over the world—global warming of the best kind—and gained inspiration from so many of you. Thank you for enriching our community, and for making my time as interim dean so rewarding.

**Melissa Murray,**  
*Interim Dean, Alexander F. and May T. Morrison Professor of Law*

## Transcript

**EDITOR & DIRECTOR, COMMUNICATIONS**  
Michael Bazeley

**MANAGING EDITOR & SENIOR WRITER, COMMUNICATIONS**  
Andrew Cohen

**CONTRIBUTING EDITOR**  
Craig Lancaster

**DESIGN & CREATIVE DIRECTION**  
Arno Ghelfi, l’atelier starno

**CONTRIBUTING PHOTOGRAPHERS**  
Jim Block  
Rachel DeLetto

**CONTRIBUTING WRITERS**  
Rachel DeLetto  
Andrew Faught  
Andrea Lampros  
Senator Henry Stern ’09  
Wendy Witherspoon

**CONTRIBUTING ARTISTS**  
Krystal Lauk  
Richard Mia  
Eva Vázquez

**UPDATE YOUR ADDRESS**  
Email: [updates@law.berkeley.edu](mailto:updates@law.berkeley.edu)  
Phone: 510.642.1832  
U.S. Mail:  
Alumni Center  
University of California, Berkeley  
School of Law  
224 Boalt Hall #7200  
Berkeley, CA 94720-7200

**VISIT [WWW.LAW.BERKELEY.EDU](http://WWW.LAW.BERKELEY.EDU)**

*Transcript* is published by the University of California, Berkeley, School of Law, Communications Department.

© 2017 Regents of the University of California. All rights reserved

# In

News from the  
School Community

# Brief

**TEAMING UP:**

Gibson, Dunn & Crutcher partners Rachel Brass and Joel Sanders '82, who co-teach International Antitrust Law, are part of a formidable roster teaching business law courses.



**“TO GIVE OUR STUDENTS THE OPPORTUNITY TO INTERACT WITH NOT JUST THE WORLD’S TOP ACADEMICS, BUT ALSO THE WORLD’S TOP PRACTITIONERS”**

JIM BLOCK

## BIG HITTERS IGNITE BUSINESS BOOM

**Susan Mac Cormac was named North America’s Most Innovative Lawyer** by the *Financial Times* in 2015. Randall Baron has recovered more than \$1 billion for shareholders challenging mergers and acquisitions. Scott Kupor heads one of Silicon Valley’s premier venture capital firms.

Just a sampling of the standouts enriching Berkeley Law’s business portfolio. Adam Sterling ’13, executive director of the

school’s Berkeley Center for Law, Business and the Economy, has put the pedal down to “give our students the opportunity to interact with not just the world’s top academics, but also the world’s top practitioners.”

Mac Cormac (Social Enterprise Law), Baron (Anatomy of Deal Litigation), and Kupor (Governance in Venture Capital) are among those who taught many first-time offerings. The list included Executive

Compensation, in which Doreen Lilienfield—who surveys compensation-related governance practices of the largest 100 domestic issuers each year—illuminated a specialty that affects almost every corporate deal.

Schedule flexibility also paid dividends. Greg Genske '98, who has negotiated some of baseball's richest contracts, taught Representing Professional Athletes on seven consecutive Wednesdays. Over three packed

days, deal-making dynamo Linda Lichter '76 brought entertainment agreements to life in Negotiating Hollywood Contracts.

Condensing the schedule of certain courses “lets us bring in top experts who otherwise couldn't come to Berkeley for an entire semester,” says Susan Whitman, assistant dean of academic planning and coordination. “There's great value in that.”  
—*Andrew Cohen*



**HANDS ON:** UC Merced Associate Vice Chancellor Peter Schuerman and Berkeley Law Interim Dean Melissa Murray forge a promising partnership.

Valley Ventures. Working with business accelerators at UC Merced and Fresno State, Xu, Practicum Director William Kell, and senior law students provide comprehensive legal services to Valley entrepreneurs of limited means.

They conduct monthly workshops in Merced on entity formation, intellectual property protection, and other common startup law issues, hold biweekly office hours by Skype, and will soon launch an online self-help resource library.

The Practicum began aiding Central Valley businesses in 2011. In October 2016, Berkeley Law and UC Merced pledged to co-develop a legal assistance program.

Two months later, the Practicum raised over \$275,000, enough to expand the workshops and office hours to all of Merced and Fresno counties by 2018, and add two additional Valley counties each year thereafter.

Early success stories include Sweep Energy, a student-led venture at UC Merced that creates devices for monitoring energy usage in industrial machines.

“We helped the company navigate its entity formation, stock issuance, and IP protection,” Xu says. “Now, Sweep Energy is attracting considerable interest, winning pitch competitions, and gaining customers. The Practicum hopes to create many more successful Valley startup stories like this in the coming years.”  
—*Andrew Cohen*

## Students Buoy Central Valley Startups

**It's a two-hour drive from Silicon Valley** to the Central Valley. When it comes to supporting entrepreneurs, however, Kevin Xu '15 knows the two areas are light years apart.

“The Bay Area has many business incubators, co-working spaces, and transactional attorneys to help fledgling ventures,” says Xu, deputy attorney at

Berkeley Law's New Business Practicum. “In the Central Valley, that infrastructure doesn't exist. Entrepreneurs are left to wing it without legal assistance, with potentially catastrophic fallout for themselves and their families.”

The Practicum is bridging that urban-rural divide through a newly funded *Startup@BerkeleyLaw* initiative: Central





# A NEW APPROACH FOR LETHAL WORDS



**WORD WATCHER:** Gregory Gordon '90 tackles the legal implications of hate speech.

**Through his work as a** Department of Justice and United Nations prosecutor and adviser in relation to atrocities in Nazi-occupied Europe, Rwanda, Sierra Leone, Cambodia, and Bosnia, Gregory Gordon '90 became increasingly convinced that words can kill.

"There's a relationship between incendiary rhetoric and mass crimes," says Gordon, an associate dean and law professor at The Chinese University of Hong Kong. "Dehumanization, cultivated through hate speech, permits neighbors to kill neighbors."

His new book from Oxford University Press, *Atrocity Speech Law*, examines the history of and jurisprudence governing the relationship between hate speech and international crimes. Gordon

finds troubling incoherence within this area of the law but proposes an innovative solution: a "Unified Liability Theory" that would link all qualifying speech offenses to all atrocity crimes. Currently, for example, "incitement" is limited to genocide, but he would have it cover war crimes and crimes against humanity.

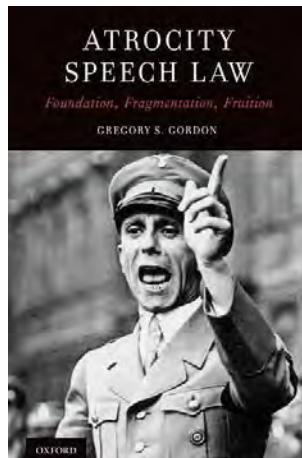

An expert on international criminal prosecution, Gordon has appeared on major media outlets worldwide, including CNN and the BBC, and lectured in such venues as the United Nations and the International Criminal Court. He has also trained prosecutors in Ethiopia, Cambodia, and Bosnia.

"My research was most disturbing at the individual level," Gordon says. "The German housewife, poisoned by Nazi propaganda, who took home a group of terrified Jewish children escaping a death transport, cared for them, then murdered them."

Despite such harrowing accounts, Gordon laments that "the relevant law has been formulated myopically and applied inconsistently."  
—Andrew Cohen

## Stirred Up For Justice Sotomayor

### U.S. Supreme Court

Associate Justice Sonia Sotomayor visited campus on March 9, meeting with Berkeley Law students and faculty before joining Interim Dean Melissa Murray for a conversation at Zellerbach Hall. After the capacity crowd gave Sotomayor a thunderous standing ovation, she said, "You have no idea how overwhelming this is."

The court's first Hispanic and third female justice, she discussed her rise from growing up in a Bronx housing project and shared her thoughts about the judiciary's role in society.

Between sessions with Murray, who clerked for Sotomayor on the U.S. 2nd Circuit Court of Appeals, the justice walked through the crowd and answered questions while shaking hands—and sometimes exchanging hugs.



**STRESS RELIEVER:** Psychologist Linda Zaruba helps students traverse the law school terrain.

## Making Mental Health Matter

**When it comes to mental health issues—** anxiety, depression, stress, grief—law students are hardly exempt. At Berkeley Law, staff psychologist Linda Zaruba provides valuable help in easing those burdens.

For the past five years, Zaruba has held a half-time appointment in a Boalt Hall office as part of University Health Services' outreach efforts.

"Students sometimes think they're only welcome in my office if there's a law school issue, but that's not the case," she says. "I'm here to help them navigate any personal issue that may be interfering in their lives."

Zaruba has spent more than three decades working for UC Berkeley's Counseling and Psychological Services (CPS). A recurring theme among first-year law students? "The 'imposter syndrome,'" she says. "That feeling of 'I don't belong here. It must be a mistake I got in.'"

Zaruba also weighs in on time management challenges. "Too often students believe that in order to be successful, they should focus entirely on studying and shut down other parts of their lives," she says. "But that just increases the dark moods."

Available to meet with faculty and staff members about student concerns, Zaruba also provides referrals for long-term therapy and psychiatry.

Her space is one of 10 CPS satellite offices on campus. "They're highly effective," says CPS Assistant Director Susan Bell, "because they're more accessible and we can tailor services to the population being served."

—Wendy Witherspoon



**CUTTING LOOSE:** Students in the fledgling Boalt Improv Group ramp up the comedic mayhem every Wednesday during the school year.



JIM BLOCK

**FORBES  
NAMES  
SONYA  
PASSI '13  
TO ITS  
ANNUAL 30  
UNDER 30  
LIST IN LAW  
& POLICY**





# Improv(ed) Legal Skills

**“You’re in a hot-air balloon,” someone shouts. “She just rejected his marriage proposal,” another voice suggests. “The genre is sci-fi!”** So begins a silly round of “Oscar Winning Moment,” starring members of the Boalt Improv Group.

Every Wednesday, law students with comedic flair turn a lecture hall into a stage. After a warmup exercise involving ninja screams and moves, the weight of studying law dissolves into a relaxed rhythm of laughter and movement.

Seeking an outlet for 1L pressures, Steven Chizen '19 and Charles Miller '19 launched the group as a space for not taking it all so seriously.

Alexis Payne '19 joined “because laughter

is the best medicine for stressed-out law students. The games also help me think on my feet, which is a big part of law school and ultimately being a lawyer.”

Because improv builds on what others say and do, it also sharpens listening and collaboration skills. Payne and Miller note that the teamwork aspect helped them in Berkeley Law’s annual Bales Mock Trial Competition.

“Embarrassing yourself in here makes it easier to stand before people and respond to something you may not be totally prepared for,” Payne says.

Indeed, breaking down fear may be the group’s greatest benefit.

Seeing classmates let loose helped Man Chi Wong '19 build confidence. “I think when I work in a law firm, this experience will help me to know my colleagues probably have a fun side, too.” —Rachel DeLetto

JIM BLOCK (IMPROV GROUP)

**Passi founded FreeFrom**, a national nonprofit that works to combat economic barriers to justice for survivors of domestic violence. In law school, she co-founded the Family Violence Appellate Project, which mobilizes pro bono representation for California survivors.

“If victims can leave their situation without facing poverty and homelessness, a life free from violence becomes attainable,” Passi says.



**20 per minute**

People physically abused by an intimate partner in the U.S.

**20,000**

Daily phone calls placed to domestic violence hotlines nationwide

**\$8.3 billion**

Annual cost of intimate partner violence

Data from the National Coalition Against Domestic Violence



# Highest Degree Reaches New Peak

**“New and improved”** may be a stretch. After all, Berkeley Law’s three-year Doctor of Juridical Science (J.S.D.) has long been a mark of distinction for international legal scholars. Nevertheless, recent updates are invigorating the school’s most advanced degree program.

“We’ve tightened up our admissions process to ensure that the people we admit truly fit Berkeley Law,” says Evelyn Borchert,

**GLOBAL APPEAL:** J.S.D. students Daniel Castaño and Aylin Akturk Sahin with Evelyn Borchert, associate director of Berkeley Law’s International & Advanced Degree Programs

## FROM CLASSMATES TO SCOTUS CLERKS

**Greg Miller '12 and Karim Kentfield '12** will begin coveted U.S. Supreme Court clerkships in July—Miller for Justice Clarence Thomas, Kentfield for Justice Ruth Bader Ginsburg.

Miller experienced exhilaration and heartache en route to the high court. He was set to clerk for Justice Antonin Scalia last year, until the jurist died unexpectedly. “That was the toughest news I’d received in a long time,” says Miller, who read Scalia’s book *A Matter*

*of Interpretation* in high school. “Being hired as his law clerk was a dream come true. Losing out on that dream was difficult.”

His wish to clerk on the Supreme Court was delayed, but not derailed. An appellate associate at Vinson & Elkins’ Houston office, Miller—who had two federal clerkships under his belt—applied to clerk for Thomas months after Scalia’s death.

“Eric Stern [of Berkeley Law’s

Career Development Office] did a great job making sure my recommendation letters and other materials were ready in time,” Miller recalls. “Professors Amanda Tyler, Jesse Choper, and John Yoo were also tremendously helpful.”

Kentfield, a tax associate at Skadden Arps in New York City, has also clerked for two federal judges. The former Google software engineer calls Justice Ginsburg “one of my legal

associate director of the J.S.D. and LL.M. programs. “We’ve also reshaped J.S.D. coursework and candidacy requirements to provide students more structure and support.”

Previously based mainly on a single faculty member’s recommendation, admission is now determined by a committee, and applicant screening includes an invitation to interview.

Designed to foster global scholarly training, the J.S.D. now requires a dissertation committee of three members, including one from an outside department. Each committee member must belong to the UC Berkeley Academic Senate. As a rule, only tenure-track faculty may chair such committees and serve as faculty advisers.

The program also now

makes second- and third-year students eligible for in-state tuition and recently developed a yearlong J.S.D. Legal Scholarship seminar.

Berkeley Law’s 23 current J.S.D. students hail from 14 countries. This year’s graduates include a law professor from Colombia’s Externado University, a commercial law lecturer from Egypt’s Alexandria University, and a legal advisor to Turkey’s Grand National Assembly.

“We train students in legal theory and innovative research methodologies in law and other disciplines, including public policy, political science, economics, and information management,” Borchert says. “Through our graduates’ contributions, this program influences legal systems in jurisdictions around the world.”

—Wendy Witherspoon



**HIGH-COURT HELPERS:** Classmates Greg Miller '12 and Karim Kentfield '12 start Supreme Court clerkships in July.

heroes for her work on sex discrimination and women’s equality. It’s an enormous honor to clerk for such an inspiring person.”

In the same section as 1Ls, Kentfield and Miller later both worked on the *California Law Review*. “I feel very proud and lucky that we’ll represent Berkeley Law at the Supreme Court,” Kentfield says. —Andrew Cohen

J. MICHAEL TUCKER (LAVALLAIS)



**FOR THE SECOND CONSECUTIVE TIME, NATIONAL JURIST NAMED A BERKELEY LAW STUDENT AMONG ITS 25 LAW STUDENTS OF THE YEAR. THIS YEAR’S HONOREE: AHMED LAVALAIS '17. AMONG HIS MANY ACHIEVEMENTS, LAVALAIS HELPED A SCHOOL CLINIC END REGRESSIVE JUVENILE JUSTICE FEES IN FIVE CALIFORNIA COUNTIES, SPARKING A PUSH TO REPEAL THEM NATIONWIDE (SEE PAGE 13).**



ILLUSTRATION BY EVA VALZQUEZ

## Forging the Future of Reproductive Rights

**As anti-abortion sentiment** gains political momentum, Berkeley Law's Center on Reproductive Rights and Justice (CRRJ) is redoubling its commitment to protect a

woman's right to end her pregnancy.

The center heads the Self-Induced Abortion Legal Team, a consortium of organizations that use law and policy tools

to ensure that women can legally end their pregnancies outside the formal health system. Created two years ago, it is the nation's only advocacy group of its kind, says CRRJ Executive Director Jill E. Adams '06.

"We turned our attention to this after seeing arrests and prosecutions throughout the states for alleged self-induced abortion," Adams explains. "The political climate has people concerned about the inaccessibility of clinic-based abortion care, and the criminalization of self-directed abortion care. No one should fear arrest or jail for ending their own pregnancy."

A 2015 study by academic researchers reported that between 100,000 and 240,000 women in Texas have tried to end their pregnancies, mostly by self-administering herbs or abortion pills purchased online. The most common reason women cite for needing an abortion, Adams notes, is poverty and inadequate resources to care for a child.

"Our vision is that all pregnant people have access to a range of safe, legal, affordable abortion methods," she says. —*Andrew Faught*



**A 2015 STUDY BY ACADEMIC RESEARCHERS REPORTED THAT BETWEEN 100,000 AND 240,000 WOMEN IN TEXAS HAVE TRIED TO END THEIR PREGNANCIES, MOSTLY BY SELF-ADMINISTERING HERBS OR ABORTION PILLS PURCHASED ONLINE.**





# EDUCATOR EXTRAORDINAIRE

**Kristen Holmquist teaches** three courses during the school year, directs the Academic Support Program (ASP), serves as Associate Director of Experiential Education, and coordinates equity and inclusion projects.

“I honestly have no idea how she does it,” says Eileen Sherman ’18, one of her students and ASP tutors, about this year’s winner of the

**MULTI-TASKER:** The versatile Kristen Holmquist won this year’s Rutter Award for Teaching Distinction.

Rutter Award for Teaching Distinction. “She teaches complex issues in the clearest way, really cares about her students, and gives each of them an equal chance to succeed.”

Established by the late William Rutter—a philanthropist, lawyer, educator, and author—the annual award honors a Berkeley Law instructor who inspires students and demonstrates a deep commitment to teaching.

“The people who have received this award are among my teaching heroes,” says Holmquist, who teaches Estates and Trusts, Constitutional Law, and Lawyering as Problem Solving. “To share this honor with them feels pretty great.”

As the ASP director, Holmquist helps student tutors create exercises for 1Ls to read cases and perform legal analysis more effectively. She also launched a pre-orientation program that offers incoming students—many of whom are budding first-generation professionals—a valuable weeklong introduction to law school life.

Holmquist says she is “incredibly proud that students and faculty alike now think of academic support as integral to our curriculum.”

—Andrew Cohen

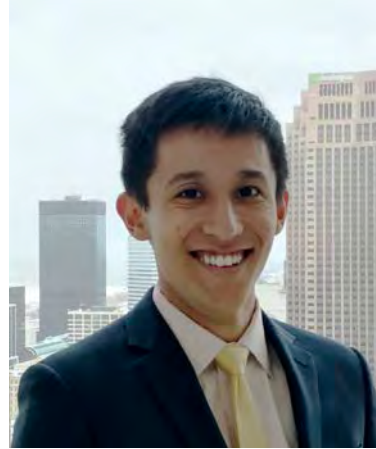

Ben Takemoto '15



Monsura Sirajee '17

## Plum DOJ Positions Taste Sweet

**For seven Boalties chosen to join the prestigious U.S. Department of Justice (DOJ) Honors Program, exhilaration turned into uncertainty after January’s executive order of a governmental hiring freeze.**

Several weeks of limbo later, the good news arrived for Hayley Carpenter ’16, Andy Coghlan ’15, Katherine DeMocker ’15, Lisa Nash ’14, Monsura Sirajee ’17, Ben Takemoto ’15, and a graduate who wants to remain anonymous: their offers would go forward.

A school-record nine people from Berkeley Law received DOJ offers. Of the seven who accepted, two each will join the Civil Rights Division and the Environment & Natural Resources Division. Those divisions typically hire only 10 to 12 attorneys per year and receive the most applications among participating sectors.

“After working very closely with all of our applicants, it was so thrilling to see their unprecedented success in landing spots with one of the nation’s most competitive programs,” says Eric Stern, director of operations in Berkeley Law’s Career Development Office.

Selection criteria includes a demonstrated commitment to government service; academic achievement; leadership; journal, clinical, moot court, and mock trial experience; past employment; and extracurricular activities. Eligible candidates are 3Ls and recent law school alumni who entered judicial clerkships, graduate law programs, or qualifying legal fellowships within nine months of graduating.

Takemoto will work for the DOJ’s Federal Programs Branch, which he learned about from Professor Anne Joseph O’Connell.

“She worked there and mentioned it in Advanced Administrative Law,” Takemoto explains. “It was one of my favorite courses, and working at Federal Programs is essentially like getting paid to take that class. I couldn’t be luckier.” —Andrew Cohen



JIM BECK / HOLMQUIST

At the Leading Edge  
Of Research and Service

# Forefront

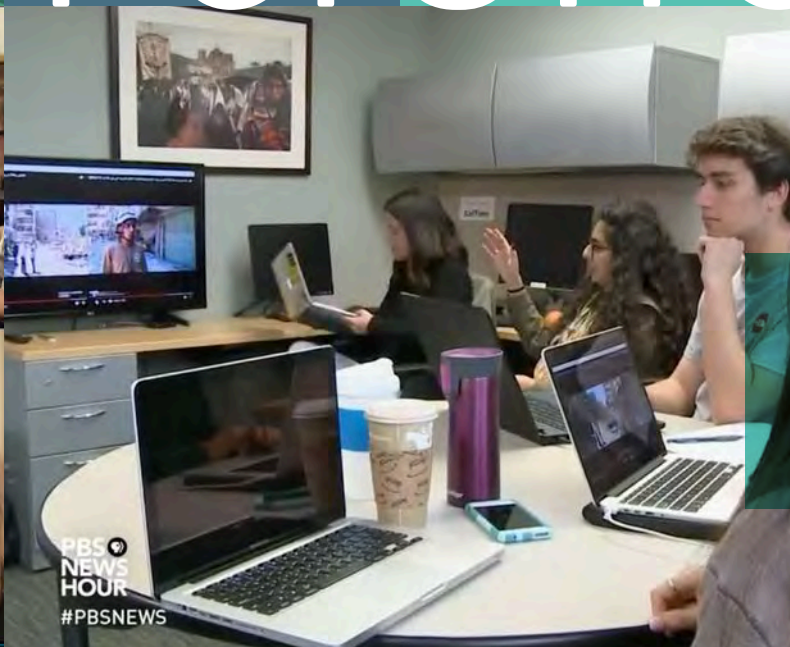

**WATCHING CLOSELY:**  
A new initiative at the Human Rights Center, led by Alexa Koenig (lower left), tracks atrocities worldwide.

## Where Innovation Fuels Investigation

### GROUNDBREAKING LAB TRAINS STUDENTS TO GATHER EVIDENCE OF HUMAN RIGHTS ABUSES

**Walking through Cairo's Tahrir Square following an Arab Spring protest in 2011, Andrea Trewinnard '19** picked up one of the many tear gas canisters that littered the ground and saw the jarring words: Made in the United States.

"That hit me hard," recalls Trewinnard, who participated in the massive, peaceful protests. Her disap-

pointment in the U.S. military industrial complex "supporting oppressive state authorities" fueled her path to Berkeley Law—and to its Human Rights Investigations Lab.

Run by the school's Human Rights Center (HRC), the first university-based lab of its kind launched in January. It has trained over 60 graduate and undergraduate students—who collectively speak 18 languages—to conduct "open source investigations."

Using publicly available data and cutting-edge techniques, the students verify videos and photos from war zones for use in human rights reports and

news stories. Their methods document evidence of genocide, crimes against humanity, and war crimes to preserve for criminal courts worldwide.

The lab collaborates with university students in Essex, Toronto, and Pretoria, South Africa. It was developed with Amnesty International, whose experts trained Berkeley students in verifying photos and videos and using geo-location tools.

Those students have logged more than 6,000 hours analyzing and authenticating videos of atrocities in countries such as Syria, Yemen, Egypt, Bahrain, Democratic Republic of Congo, and Myanmar. They also use social media to document the rise in hate speech and hate crimes after the U.S. presidential election, and feed that information to investigative journalists at ProPublica.

Trewinnard recently spent more than 20 hours verifying a series of videos related to a bombing in western Aleppo. Her work confirmed the use of cluster bombs, a war crime.

“Manipulating facts and spreading untruths is a weapon of warfare all over the world,” she says. “That’s why verification is so important.”

Collaborating with an area law firm, Jurisprudence and Social Policy Program student Mayra Feddersen—a human rights lawyer in Chile before coming to Berkeley—is leading open-source work on a legal case in Latin America.

Because accessing evidence can be challenging in human rights cases, where government assistance is often lacking, Feddersen sees open-source techniques as invaluable for gathering evidence.

“It’s a great first step before interviewing people,” she says. “With background from these investigations you can save economic and human resources, make questions more precise, and avoid double victimization.”

In June, Feddersen, Trewinnard, and other lab students will participate in an HRC-hosted international student summit on open-source investigations.

Participants will evaluate the lab’s first year and the potential for replicating the model globally, says HRC Executive Director Alexa Koenig.

“Students contribute critical tech, language, and disciplinary skills,” she explains. “They are dedicated to conducting complicated and often painstaking open-source work for human rights—with the potential to make a significant impact.”

—Andrea Lampros



## Leading the Fight For Fairness

### CLINIC STUDENTS POWER MOVEMENT TO ELIMINATE REGRESSIVE JUVENILE JUSTICE FEES NATIONWIDE

**Berkeley Law students are at the forefront of a** national effort to help families overwhelmed by draconian juvenile justice fees. Students and lawyers at the East Bay Community Law Center first identified the problem among their clients. Then research by the Policy Advocacy Clinic (PAC) revealed that such fees are often charged illegally, devastate families, and provide California counties little or no financial gain.

The fees fall hardest on low-income families of color, whose children are disproportionately punished in the juvenile system, resulting in large bills they cannot pay. Studies show that juvenile debt also correlates with higher recidivism.

“The system isn’t designed to punish kids, it’s meant to rehabilitate them and help them get their lives together,” says recent PAC student Tim Kline ’17. “Charging these fees is anathema to that purpose.”

The clinic’s findings spurred Alameda County to become the first in the nation to ban such fees.

Four other state counties followed suit, and *The New York Times* and U.S. Department of Justice cited PAC's work in recommending reform.

With momentum for new legislation, clinic students drafted Senate Bill 190 to repeal juvenile fees throughout California. The bill cleared its first hurdles at two spring hearings and may reach the governor's desk this summer. PAC students wrote supporting documents, provided research and technical support, organized advocacy groups, handled public and media outreach, and will testify at State Senate and Assembly committee hearings.

"State law says these fees are supposed to help counties recoup costs," notes PAC Director and Clinical Professor of Law Jeff Selbin. "They're not supposed to hurt vulnerable families."

Now—thanks to a major, multiyear grant from the Laura and John Arnold Foundation—the clinic will lead a national endeavor to eliminate such fees.

"This includes analyzing other states' systems ... speaking with key stakeholders on the ground, and gauging interest among potential partner organizations in those states," says Katherine Buckley '17. The clinic will also co-develop a web-based policy

hub with the Juvenile Law Center for advocates and policymakers.

A new PAC report shows that some counties charge fees not authorized by state law, authorized only in the adult setting, and to youth found not guilty. Many counties violate federal law by charging to feed their children in detention while also seeking reimbursement from national programs.

As *Transcript* went to press, 53 of California's 58 counties charged families at least one of the administrative fees, including for detention, legal counsel, electronic monitoring, probation supervision, drug testing, and investigation reports.

A telling example: Orange County billed Maria Rivera \$16,372 for her son's detention and lawyer. She sold her home to pay more than \$9,500 and filed for bankruptcy when the county continued to pursue the debt's balance. The county relented only after a federal appeals court declared the debt dischargeable in bankruptcy.

"We have yet to find a fee regime in California that is both fair and cost effective," says PAC teaching fellow Stephanie Campos-Bui '14.

—Andrew Cohen



**CROSS EXAMINER:**  
Kai Morrison grills a witness during a fifth-grade mock trial held at Berkeley Law.

## Empowering Local Youth

### STUDENTS, FACULTY, AND ALUMNI EXPAND THEIR OUTREACH TO AREA SCHOOLS

Berkeley Law helps young local students in myriad ways. Here are three inspiring examples:

#### CENTER FOR YOUTH DEVELOPMENT THROUGH LAW

About 35 local high school students from disadvantaged circumstances are chosen for this annual summer program. Four days a week, they work as paid interns for law offices, nonprofits, government



departments, and elected officials. On Thursdays, they attend classes at Berkeley Law that integrate a legal curriculum with life skills and leadership development activities.

Law school instructors, students, and alums play key teaching roles, and participants take part in two mock trials.

“They make the lesson plans so interesting and encourage us to actively join in the discussions,” says El Cerrito High School senior Cali Luke. “When you see a teacher working hard to engage you, that’s motivating.”

Program Executive Director Nancy Schiff seeks to forge a mentorship community that will support the students into college and beyond. “We aim to instill a belief that they can be successful in college, law school, and a professional workplace regardless of their background.”

Since 1999, more than 92 percent of participants have enrolled in higher education. “This opportunity builds skills and confidence on many levels,” Luke says. “I’m so grateful for it.”

### **AN ELEMENTARY APPROACH**

In 2013, Clinical Professor Ty Alper helped launch a fifth-grade mock trial program at Rosa Parks Elementary School in Berkeley. For 15 weeks, participants practice each Thursday before school, learning public-speaking basics before developing trial skills.

The program culminates with two mock trials at Berkeley Law, overseen last year by Alameda County Superior Court Judge Jeffrey Brand ’69 and retired Judge Demetrios Agretelis ’64.

Brand praised the students for deftly avoiding argumentative points in their opening statements and leading questions in their direct examinations. “This was truly marvelous,” he told them.

Alper helped coach the fifth-graders with James Stevens ’12 and Joy Haviland ’08, among others. “This program normalizes the concept of being a lawyer for kids who hadn’t envisioned themselves in that role,” Alper says. “That’s empowering.”

### **PROVIDING INSIGHT AND HOPE**

In October, a group of Berkeley Law students shared legal knowledge and personal insights with

**“FOR KIDS WHO ARE THE FIRST IN THEIR FAMILIES TO FINISH HIGH SCHOOL OR PURSUE HIGHER EDUCATION, IT’S IMPORTANT TO PROVIDE INFORMATION, GUIDANCE, AND CONFIDENCE.”**

— JESSICA HOLLIS ’18

33 students from Oakland Fremont High School’s Mandela Law & Public Service Academy.

After meeting with the students over lunch, Alexis Payton ’17, Travis Mitchell ’19, and Cheyenne Overall ’19 taught a Fourth Amendment “Know your Rights” session while Jessica Hollis ’18, Alice Chi ’18, David Giron ’19, and Drew Washington ’19 led a discussion on immigration law.

“For kids who are the first in their families to finish high school or pursue higher education, it’s important to provide information, guidance, and confidence that will help them take the next step,” Hollis says.

Academy Director Patricia Arabia saw how talking with law students from similar backgrounds gave her students “a huge lift ... and a sense that college could be in their future.” —*Andrew Cohen*

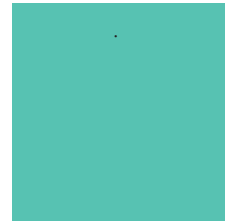



**VENTURE ADVENTURE:** Participants in the biannual four-day executive education program learn how to navigate the often tricky waters of early-stage investments.



500 Startups Preview Day, and hands-on workshops about the nuts and bolts of investment decision-making.

“This is the most cutting-edge executive education program for the investment community,” says organizer Adam Sterling ’13, executive director of the Berkeley Center for Law, Business and the Economy.

February’s event featured more than 30 investor participants who hailed from 14 countries and represented diverse sources of capital, including corporate, family, and VC funds.

“I was looking for a platform where I could take what I’ve learned through my experience in

VC and apply a more academic approach,” says Zosia Ulatowski, principal at Cornerstone Venture Partners and a February Deal Camp participant. “A highlight for me was hearing the perspectives from the guest investors. I also loved the practical components of the course.”

The program starts at 500 Startups Preview Day in Mountain View, where attendees hear pitches from the accelerators’ current batch of company founders.

The remaining agenda is held primarily at Boalt Hall. February’s “campers” heard timely lectures that included Berkeley Law Professors Robert Bartlett on the art of valuation and Steven Davidoff Solomon on exit strategies and mergers and acquisitions.

Presenters also included UC Berkeley alum Christine Tsai, who co-founded 500 Startups, and

## Deal Camp Yields High Returns

### NEW VENTURE CAPITAL PROGRAM EMPOWERS INVESTORS AND TRAINS STUDENTS

**There’s a new go-to forum for investors looking to sharpen their skills in early-stage negotiations:** Berkeley Law’s Venture Capital (VC) Deal Camp. The recurring four-day program raises the bar for VC executive education.

Deal Camp is a collaboration between *Startup@BerkeleyLaw*, a fast-expanding initiative that supports students interested in the law surrounding entrepreneurship, and 500 Startups, a leading global VC fund and startup accelerator. Launched in October 2016 and planned for each October and February, Deal Camp helps investors improve their ability to define, negotiate, and execute early-stage investments.

The gatherings feature full-service insight: timely lectures from Berkeley faculty, a front-row view of

Ellen Pao, a partner at Kapor Capital.

Interactive workshops foster eager participation on topics such as term sheets and capitalization tables. While many seasoned venture capitalists might not be able to reverse-engineer a cap table, Sterling says, “Our goal is to make our campers ‘cap table wizards.’”

After taking part in the pilot event last October, Blacktop Capital General Partner Ben Brasher sees his newly acquired skill set becoming invaluable.

“The sense of confidence I got from participating

really reinforced the feeling that this is something I can take on and be successful at,” Brasher says.

For Berkeley Law, Deal Camp constitutes just one highlight of the school’s multifaceted commitment to supporting entrepreneurs.

“We see ourselves not just as leaders in business law, but in business generally,” Sterling explains. “The idea that these faculty members are at the forefront of educating and training the business community illustrates how, as I like to say, ‘Berkeley means business.’” —*Wendy Witherspoon*

# A Decade of Healing

## MEDICAL-LEGAL PARTNERSHIP HELPS PATIENTS SECURE BASIC NEEDS FOR THEIR FAMILIES

**Their work is often more vexing than vindicating,** more trying than triumphant. But for Berkeley Law students who provide help—and hope—for clients of the East Bay Community Law Center’s Medical-Legal Partnership project, the experience is intensely satisfying.

The project, which liaises with three area hospitals to help patients secure basic needs to stabilize their families’ lives, recently celebrated a decade of collaboration with Oakland Children’s Hospital. “We confront the many economic and social determinants of health and their connections to poverty,” student David Nahmias ’18 says. “This project doesn’t look at law in a vacuum.”

Fluent in Spanish, Nahmias helped a mother of



**HEALTH CARERS:** EBCLC Health & Welfare Practice supervisor Erin Le and Oakland Children’s Hospital pediatrician Gena Lewis.

three—who speaks almost no English—secure overdue repairs to her rental home and reverse cuts in her food stamps allocation. “The complete trust she placed in me, and the knowledge that I’ve helped provide a more stable situation ... extremely gratifying,” he says.

Doctors and social workers identify legal issues faced by patients and their families, including denial of public benefits. Although patients are often referred with a single concern, attorney Erin Le

and her team of law students dig for broader solutions to their life circumstances, resulting in both direct assistance and referrals to other legal resources.

“Many of our client families have children and adults who have experienced traumatic events or the lifelong trauma of growing up poor,” Le says. “These stressors have real health impacts.”

Le’s group appeals and negotiates settlements for denied, terminated, or reduced public benefits; advocates on post-entitlement benefits issues;

helps prepare simple wills and advance health care directives; and supports clients in pre-litigation housing matters. Students also work with medical teams to write letters of support, gather evidence, and represent clients at federal disability hearings.

“We get comprehensive training on how to handle different kinds of cases, and we have constant access to supervising attorneys who are always willing to talk through the issues,” says Emma Connolly ’18. “A common theme we see is that families feel they’re being

treated like criminals and liars when really these processes are just so opaque and difficult to understand.”

Many clients are not native English speakers, making it hard for them to wade through the complex, paperwork-laden world of public benefits. Le conducts regular onsite trainings that educate patients and medical practitioners.

“This partnership has improved the health of patients we see through direct service, and educated more than 500 doctors about the special nature of legal services and how to use lawyers as consultants,” says Gena Lewis, a Children’s Hospital staff pediatrician.

Lewis’ colleague, neo-natal social worker Chela Rios-Muñoz, notes that the families involved “often operate on misinformation or fear without knowing their rights.”

“They’ve had to live in circumstances that aren’t fair, and this partnership helps to change that,” she says. —*Andrew Cohen*

**“WE CONFRONT THE MANY ECONOMIC AND SOCIAL DETERMINANTS OF HEALTH AND THEIR CONNECTIONS TO POVERTY. THIS PROJECT DOESN’T LOOK AT LAW IN A VACUUM.”**

—DAVID NAHMIAS ’18



## Magnet School

### FACULTY PROWESS HELPS ATTRACT NEW PROFESSORS TO BERKELEY

For **Abbye Atkinson**, **Adam Badawi ’03**, and **Joy Milligan**, joining Berkeley Law’s faculty is as humbling as it is thrilling.

Atkinson calls her new cohort “unmatched in its intellectual depth and range.” Badawi notes that “the faculty was a huge part of what drew me back to Berkeley.” Milligan, a fellow at the school, says “there’s no law school faculty I admire more.”

They start July 1 and will later be joined by corporate law expert Frank Portnoy (hired at press time).

### VERSATILITY PERSONIFIED

Atkinson’s new gig represents a homecoming of sorts. A Stanford Law School fellow and lecturer, she earned her undergraduate degree in Dramatic Arts at UC Berkeley—where she was a Regent’s Scholar and received the Mark Goodson Prize for distinction in the performance arts.

At Harvard Law School, she served as a research and teaching assistant to Professor Elizabeth Warren, now a U.S. senator, on a consumer bankruptcy project and Bankruptcy Law course.

“She was a master teacher who always encouraged me to think about the law’s real-life implications,” Atkinson says. “That’s been a huge influence in how I’ve approached my scholarship.”

**OFFER ACCEPTED:** Abbye Atkinson will teach Contracts and consumer law courses such as Secured Transactions.

Atkinson has enjoyed a rewarding and varied career, working as a special-education teacher, a clerk for two federal judges, and an associate with Gibson Dunn & Crutcher in San Francisco. At Stanford, her research probed bankruptcy law's impact on the economically vulnerable.

"Bankruptcy Law concerns itself with helping people who are in a precarious financial position rebuild themselves," she says. "We often think about that in a middle- or upper-class context. But if bankruptcy is an important mechanism to let people reboot financially, why does it exclude people on the lower end of the socio-economic spectrum—people whose financial troubles are often borne of bigger social issues?"

Another strong pull for Atkinson: the recent explosion of consumer justice work at Berkeley Law. "It'll be great to get involved in that community," she says.

### HOMeward BOUND

While he enjoyed his two years as a University of Chicago law fellow and lecturer and seven years as a professor at Washington University of St. Louis, Badawi—who earned three degrees from UC Berkeley—relished a chance to come back.

"There's nowhere like it," he says. The prospect of joining the business law program, which he says is "influential, energetic, and thinks about research and teaching in innovative ways," made returning to Boalt "an easy decision."

Badawi clerked on the U.S. Tenth Circuit Court of Appeals and practiced at Munger, Tolles & Olson for before entering academia. His research focuses on shareholder litigation, how boards operate, and how debt contracts and corporate governance interact. A current project explores the influence lawyers and

law firms have on the public disclosures they help draft for clients.

"What draws me to business-related research is the importance that effective corporate governance has for producing growth and employment in our economy," he says. "It helps that there are massive amounts of data available on how firms and corporate governance interact."

Currently co-writing a Business Associations casebook, Badawi wants his students "to think about how lawyers can improve deals rather than just win the liti-

**WRANGLING RIGHTS:** Joy Milligan will teach Civil Procedure and a survey course in anti-discrimination law.



gation that results when those deals turn problematic ... I know the Berkeley student body's love of intellectual engagement and commitment to its ideals will never go away. That makes for a dynamic classroom and I can't wait to be a part of it."

### FAMILIARITY BREEDS RESPECT

The more Milligan interacted with Berkeley Law's faculty, the more she wanted to join it. "The depth and diversity of their work is truly world-class," she says.

Her research considers the impact of American law and political institutions on entrenched inequality, specifically how the civil rights movement links with the administrative state's institutional design. One recent project compared the trajectories of racial and religious discrimination in the Supreme Court's constitutional jurisprudence.

"The fundamental question in civil rights law is why do we still see so much entrenched inequality—particularly racial inequality after the 'Civil Rights Revolution?'" Milligan says. "Why has law not been more effective in bridging this gap? That issue underlies my research."

Currently finishing her Ph.D. in Berkeley Law's Jurisprudence and Social Policy Program, Milligan has earned degrees from Harvard (undergraduate), New York University (JD), and Princeton (MPA).

After law school, she worked for the NAACP's Legal Defense & Educational Fund and clerked on the U.S. Ninth Circuit Court of Appeals. Looking ahead to teaching at Berkeley Law, she values a pragmatic approach.

"In Civil Procedure, I want students to learn the key practical tools and know how to use them, because I've seen firsthand how procedure impacts the fate of cases," Milligan says. "In Antidiscrimination Law, I want students to understand where the stumbling blocks are for civil rights plaintiffs." —Andrew Cohen

**NEW DEAL:** Adam Badawi '03 will teach Contracts and business law courses such as Business Associations.



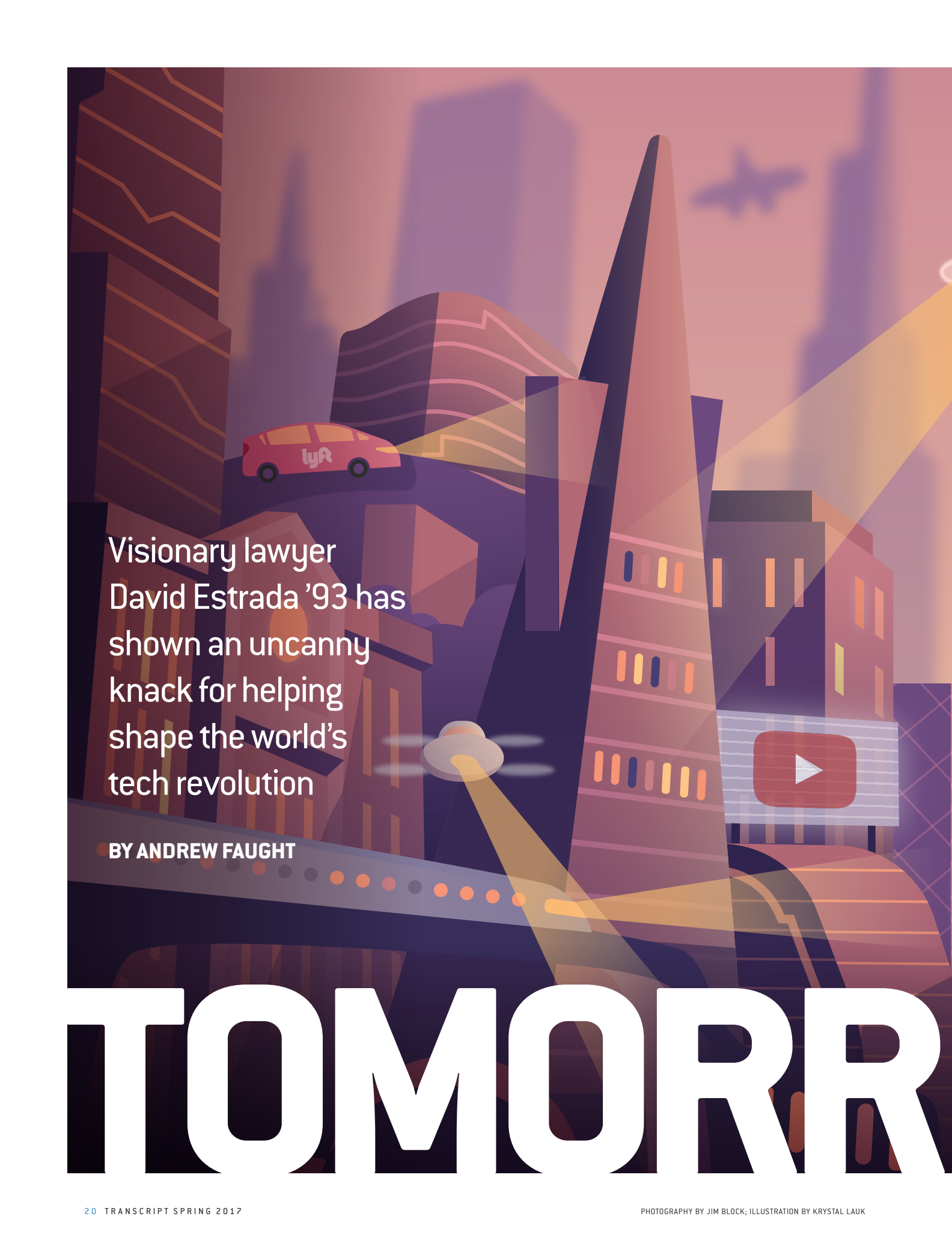

Visionary lawyer  
David Estrada '93 has  
shown an uncanny  
knack for helping  
shape the world's  
tech revolution

BY ANDREW FAUGHT

# TOMORRR



HOW MAN

The two-story, white concrete building stands in a Mountain View industrial park overlooking the Bay wetlands. The structure bears no identification, its black windows made of privacy glass to deter prying eyes.

For more than a year after its stealth beginning, the company's one-page website displayed only its logo and a jobs link, betraying nothing that happened behind its walls. A LinkedIn description hinted tersely: "Kitty Hawk is a Silicon Valley technology company dedicated to building a new era of flight."

On April 24, however, the company made an eyebrow-raising announcement that got prominent coverage in *The New York Times*: Kitty Hawk will release its first personal electric aircraft to the public—the Kitty Hawk Flyer—before the end of this year.

While the name honors the first flying machine built and flown by the Wright brothers, this modern version is small enough to fit in a home garage—where you can also charge it. And no pilot's license is required because the Flyer falls within the Ultralight category of Federal Aviation Administration regulations, which are classified as vehicles, not aircraft.

Those conducting this work, including David Estrada '93, might be accused of folly. But over the past decade, Estrada has shown an uncanny ability to help shape the world's unfolding, and at times seemingly improbable, tech revolution—paving the way for Google self-driving cars, legalizing the once questionable ride-sharing service Lyft, and turning YouTube into an unlikely content juggernaut. In his latest venture, things are looking up.

As Kitty Hawk's chief legal officer and head of public policy, Estrada hopes to, literally, get the world's next great thing off the ground. Counting him out could be the bigger folly: "Shorter distance flight in various kinds of small electric aircraft, like commuting to work or going out for

a spin, is going to become a normal part of life sooner than people think," he asserts.

While perfecting the technology for this to become reality is extremely complex, Estrada says the much larger and more challenging hurdle is building a regulatory framework in which a new generation of small electric aircraft outside the Ultralight category could navigate the friendly skies.

That's why Kitty Hawk CEO Sebastian Thrun, the force behind Google X—the Internet giant's self-driving-car project, among other bold endeavors—in November 2015 lured Estrada from Lyft.

## FROM ONLINE VIDEO TO SELF-DRIVING CARS

Thrun and Estrada have a history of working on once inconceivable challenges together. While serving as legal director at Google X, Estrada collaborated with Nevada officials to make it the first state to authorize the operation of Thrun's self-driving cars.

He then helped pass similar legislation in California and Florida. Ten or so other states have since passed legislation related to such cars, and now governments around the world are working to create national legal frameworks



around autonomous vehicles.

Bruce Breslow, former director of Nevada's Department of Motor Vehicles, worked with Estrada to craft the Nevada regulations and calls the lawyer a "dynamic guy" and a "straight shooter."

"David reduced the volume of regulations from a Manhattan-sized phone book down to a very few strategic regulations, and it worked," says Breslow, who now directs Nevada's Department of Business and Industry. "We accepted almost all of his recommendations and changes. My goal was to reduce regulations and allow for the technology to come forward without putting any unnecessary burdens on it."

Estrada joined Google in 2007 through its acquisition of YouTube, where he was the fledgling online video company's second attorney and associate general counsel under Berkeley Law grad Zahavah Levine '96. The search engine already was headlong into developing online advertising technology and cloud computing services. And, ultimately, self-driving cars.

"These guys were inventing the future," Estrada says of Google. "Law and policy were going to be at the heart of that. What started to crystallize for me, which I never planned for, was that my love of law and my love of politics would somehow start to merge with my love of computers. That's what happened at Google X."

## FINDING HIS PASSION

Growing up in Vallejo, the son of a house painter father and nurse mother, Estrada didn't see the payoff in education. He got good grades without working very hard, and his parents never pressed the issue. "They were very *laissez faire*," he says. "I didn't have a lot of rules. My parents treated me well and loved me, but I was never pushed."

An uncle, however, helped to stretch his boundaries of inquiry. At age 5, Estrada started riding dirt bikes at his uncle's home in Clear Lake. The pair took apart and reassembled motorcycles. In the early 1980s, the dawn of personal computer era, Estrada's uncle bought him a Commodore 64—an eight-bit job that, while a Ford Model A by today's standards, for the first time made computing possible for middle-class Americans.

Estrada was 15 when he got the keyboard; the Commodore 64 lacked a monitor and had to be connected to a TV. He was immediately hooked on the nascent technology. In a primordial exercise, he'd write sample Spanish tests, and he started to learn basic programming. "Then as I got into high school, I also got fascinated with politics, and the two things competed for my attention," Estrada says.

The first in his family to attend college, he enrolled at UC Santa Barbara and majored in political science. A tech geek and a gearhead, Estrada saw fax machines and



# SOARING OUT OF STEALTH MODE

On April 24, Kitty Hawk zoomed down the runway and took off. Destination: The public's imagination. The company rolled out its new product (the Kitty Hawk Flyer), launched a new website (<https://kittyhawk.aero>), and got front-and-center treatment on *The New York Times* homepage and throughout the tech blogosphere.

The *Times* story described how a Kitty Hawk aerospace engineer maneuvered the vehicle about 15 feet above a lake, circling 20 to 30 yards from shore before stopping on a landing pad at the end of a dock.

The Flyer is one of several prototypes that Kitty Hawk is designing. The company also says the final commercial product will look different from and be notably quieter than the test model.

Some other nuggets of note about the Flyer prototype:



**220**  
Weight,  
in pounds



**2**  
Joystick-like controls  
for steering

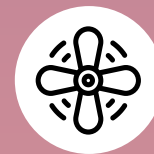

**8**  
Number of  
battery-operated  
propellers for power



**12+**  
Competition startups  
that are working to  
develop flying cars

videorecorders sweeping the land. He long figured that he'd go to law school because "my parents said that I would argue about anything."

"Whatever they told me, if it didn't make sense, I'd argue," he says. "The idea was implanted by my parents, even though I didn't know what lawyers did."

Estrada enrolled at Berkeley Law, where he wrote for the *High Technology Law Journal* (now the *Berkeley Technology Law Journal*.) High tech in those days was spartan, to be sure. "Windows 3.1, that was it, man," Estrada says. His plan was to work for a firm that litigated intellectual property, which at the time centered on biotech, not computer technology.

One of his classmates was Lee Van Pelt '93, a Cupertino patent lawyer and lecturer at Berkeley Law for the past decade. Van Pelt met Estrada when they were 1Ls in 1990, and the pair blew off steam playing basketball at the Recreational Sports Facility.

"David was very competitive, and trying to guard him probably took a couple years off my career," says Van Pelt, who still exercises with his buddy, mountain biking along the San Francisco Peninsula's Skyline Ridge. "He was tough and hard to guard."

That tenacity bleeds into Estrada's tech work.

"For tech executives who are trying to do these new, very hard things, Dave epitomizes being a general counsel," Van Pelt says. "For advice on entering new territory, Dave's the guy."

## MOMENTS OF TRUTH ... AND FLIGHT

Seeking a break from work, Estrada took a year off to travel Europe in 2000. "During that time I realized I wanted to start spending my time building something, instead of writing court papers and letters to opposing counsel," he says.

# A GOLDEN TOUCH IN THE SILVER STATE

The secret missions commenced in 2011. Then the legal director for Google X—the company's clandestine facility known for its "moon-shot" projects—David Estrada made routine drives from company headquarters in Mountain View to Carson City, Nevada, to build the future of transportation.

In the Silver State capital, legislators were less regulatory-minded than their California counterparts. Self-driving cars had found their first, and likely most propitious, proving ground.

The legislature approved the idea—testing the cars in the state, not making them available to motorists—with resounding support and no shortage of wonder. That was just the beginning. Nevada's Department of Motor Vehicles (DMV) then had to write the rules that actually implemented the law.

Enter Estrada.

"I didn't know anything about this

stuff," he says. "I wasn't an expert in self-driving cars; nobody was. But I was the team's new legal director, and order No. 1 was to meet with the head of the DMV and start figuring out new regulations for self-driving cars, knowing that nobody's ever done this before.

"We were creating the world's first policies and regulations for software driving an automobile," Estrada adds. "That became what I do for a living, without any planning on it."

Estrada found an ally in Bruce Breslow, then Nevada's DMV director. More than four decades earlier, Breslow had marveled at a driverless-car exhibit at the 1964 New York World's Fair. The future, suddenly, was upon them—and other states were watching.

"We were starting at ground zero," Breslow says.

DMV staffers were asked to come up with questions related to how to register and license self-driving cars.

Their inquiries ran to 400 pages. The DMV solicited advice from various university officials as well as the National Highway Traffic Safety Administration.

"It was David who walked us through every step," Breslow says. "He was a visionary in seeing through legislative clutter."

In the end, the DMV required companies testing autonomous vehicles in Nevada to submit a description of their technology, a detailed safety plan, and a plan for hiring and training test drivers. Companies also needed to prove that such vehicles had been driven 10,000 miles on a test track, a stipulation now lifted. Ten other states have since adopted similar legislation.

"We had to deliver a sleek, perfect set of regs, because we knew that once we did it, the rest of the country would follow," Breslow says. "We wanted to make sure we got it right." —Andrew Faught



**TRAIL BLAZERS:**  
Longtime friends and Berkeley Law classmates David Estrada '93 and Lee Van Pelt '93 on San Francisco Peninsula's Skyline Ridge

That hiatus also coincided with the start of the dot-com implosion, during which his tech-heavy investment portfolio lost 80 percent of its value. Returning to California, he joined the original Internet powerhouse Yahoo! as senior counsel in December 2000. He stayed there until 2006, negotiating license agreements and other commercial matters while sharpening his skills in the copyright field.

One day in early 2006, a former Yahoo! colleague asked him to “take a look at this new little video site called YouTube” that he had just joined. After clicking on a few grainy videos, Estrada thought the site would never go anywhere. Six months later, YouTube’s popularity was soaring and Estrada persuaded Levine, the company’s general counsel, to bring him aboard as associate general counsel.

When he joined YouTube it was known for two things: cat videos and TV show clips uploaded by users. “People were comparing it to Napster,” Estrada says. In 2007, the media conglomerate Viacom sued YouTube for \$1 billion, charging copyright infringement. Estrada quickly set out to change YouTube’s “outlaw” reputation for airing copyrighted content without the permission of rights holders, and he brought content owners to the table.

“We said to them, ‘We can run your content on our service, but how about this? Instead of taking it down, we’ll put an ad on it and share 50 percent of the revenue with you,’” he says. “Providers started adopting this en masse. It has become a huge, critical piece of revenue for the music industry, in particular. It was exciting to be part of it.”

Estrada stayed with YouTube for four years after Google acquired it. He worked with company founders Chad Hurley and Steve Chen to negotiate a pivotal deal with Apple to include the YouTube app on the first version of the iPhone. At the time there was no App Store, and YouTube was the only third-party app featured on the iPhone.

When Estrada completes a challenge, he has been known to get bored and start sniffing out more vexing opportunities. After helping YouTube secure hundreds of content deals and distribution on all mobile platforms, he began considering his next move—but he never anticipated what it turned out to be.

Estrada’s boss, after summoning a handful of Google lawyers, let them in on a new initiative percolating in 2011: self-driving cars. “My jaw dropped,” Estrada recalls.

“At the time, I was still a fairly risk-averse lawyer,” he says. “The other lawyers and I thought, ‘Let’s see, Google was a search engine. Now we’re streaming all the world’s video and building a smartphone platform (Android), and next we’re a self-driving car company?’ It didn’t feel like a fit.”

But the more he got immersed, the less fantastical the possibilities seemed. “I realized that figuring out the legal and regulatory space for new technologies without a clear legal framework could be my sweet spot,” Estrada says.

“It’s like I finally realized after all these years what I really loved doing.” After helping establish the world’s first self-driving-car regulations at Google X, he again felt the itch for something new.

## REACHING NEW HEIGHTS

In 2014, Estrada moved to Lyft. As vice president of government relations, he wrestled with his next big challenge: preventing cities and states from shutting down the fledgling “ride-sharing” service and helping them pass new regulations creating a new category of transportation.

His work led to the passage of around 30 state laws and 30 more city regulations to make ride-sharing legal. That included bringing Lyft through a defining moment in the summer of 2014, when the state of New York filed suit

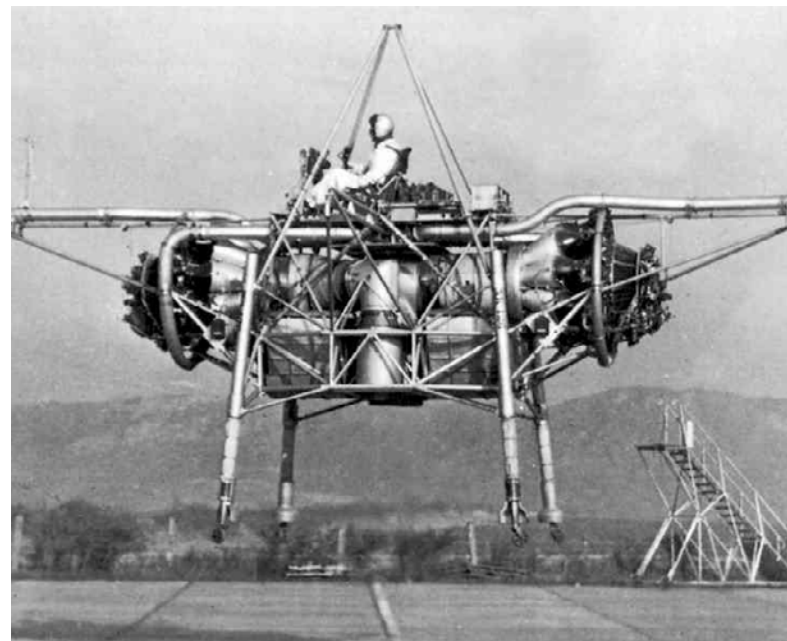

# THE SKY'S THE LIMIT

**Kitty Hawk isn't the only outfit with designs to change the way we get around.**

Corporate giants Airbus, Boeing, and Uber are reportedly developing flying-car prototypes and platforms for air taxi services, according to a March report by *Business Insider* and subsequent announcements by the companies. Uber published a detailed white paper called *Uber Elevate* aimed at proving the viability of an air taxi busi-

against Lyft to stop it from launching the service in New York City, America's largest market.

The stressful moment is captured in *The Upstarts*, a new book by business writer Brad Stone. It describes Estrada and Lyft founder John Zimmer huddled in the offices of the New York Taxi and Limousine Commission, negotiating a way of working within the city's existing rules for Lyft to begin operations.

"It's not work to him," attests his wife of 15 years, Gina Estrada. "Ever since I've known him he's been involved in technology and learning. I admire his ability to jump into things that not everyone would. His risk-taking has really paid off for him, and it's been a fulfilling way to live."

The couple, who have three children and live in Los Altos, met at the Palo Alto law firm then known as Cooley Godward. It was David's first job out of Berkeley Law, and

Gina worked in the trial services department. They took up jogging together, then started dating. They've traveled extensively, including to Seville, Spain, where the pair learned to flamenco dance.

As for where technology steps next, Estrada sees virtual reality as the next frontier.

"But it doesn't interest me," he concedes. "It worries me because humans are happiest when we're out in nature being active, interacting with others to solve problems, applying our creativity, and building things. Virtual reality seems instead poised to create ultimate human passivity. I hope I can continue hiking with my kids and get them to start mountain biking with me instead of strapping on a pair of goggles."

In that way, at least, Estrada has his feet firmly on the ground. ■

**AIMING HIGH:** Famed engineer Nikola Tesla (1928 renderings, right) and Rolls-Royce (1953 photo, left) are among those who envisioned the future.

ness that uses electric vertical takeoff and landing (VTOL) aircraft, much like today's system of hailing a car with a smartphone app.

"When I tell family and friends what I'm working on—small VTOL aircraft that can be used for everyday flight—their eyes light up," Estrada says. "They think it's pretty amazing."

Estrada works to change public perception so people are not stuck on the fairly fantastical notion of flying cars.

"I think 'flying car' is used as a headline-grabbing term in press reports now," he adds. "Some of the earliest companies in this space were actually doing just that. They wanted to take your car and put wings on it, allowing you to drive down the road and take off. But where we're going, you won't need roads," he says with a grin.

Such dreams are not new. Engineer and futurist Nikola Tesla conceptualized vertical takeoff and landing vehicles as long ago as 1928; Rolls-Royce in 1953 developed its own "thrust measuring rig" [dubbed the flying bedstead, because of its bedframe appearance, complete with castor wheels.]

But the times have changed, and concerns aren't limited to vehicle engineering.

"Currently, we have an archaic system of air traffic management," Estrada says. "If I'm flying a Boeing 737 into SFO, I radio the tower and we're having a cryptic conversation on a party line with lots of other pilots. In the future, the vehi-

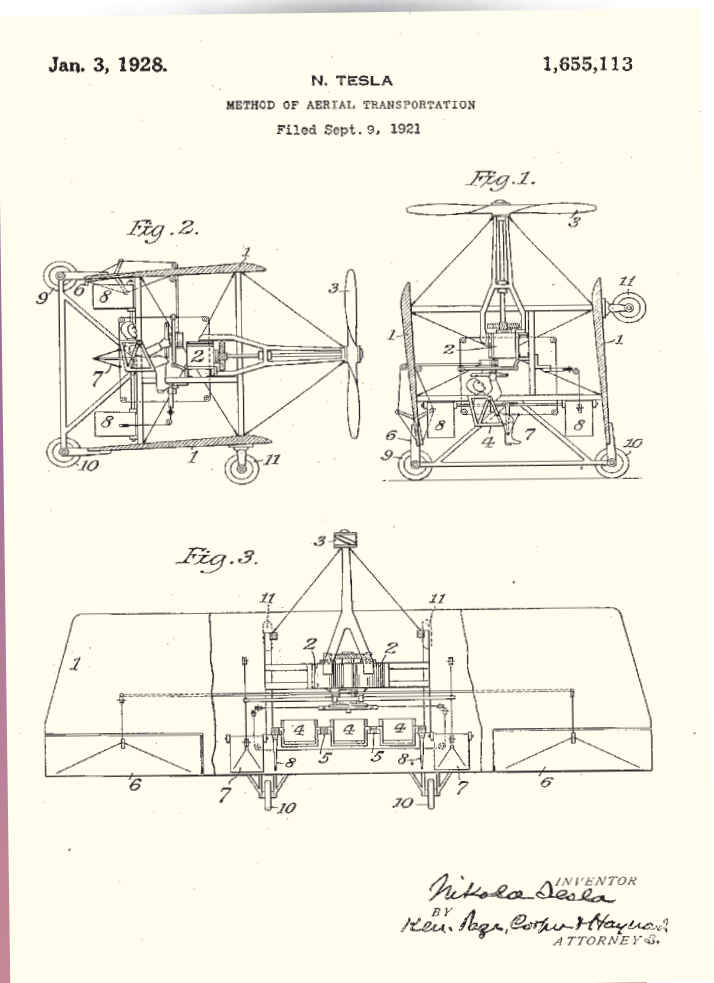

cles will all talk to each other electronically and allow for many more aircraft to be in the sky in closer proximity, all while improving safety." —Andrew Faught



# DREAM WEAVER



Retiring in December,  
Edward Tom reflects on  
a joyful 30-year ride as  
Dean of Admissions

**INTERVIEWED BY ANDREW COHEN**

**QUITE A LEGACY:** Known throughout Berkeley Law for his work ethic and warmth, Tom has overseen the enrollment of more than 9,000 JD students at the school.



# BerkeleyLaw

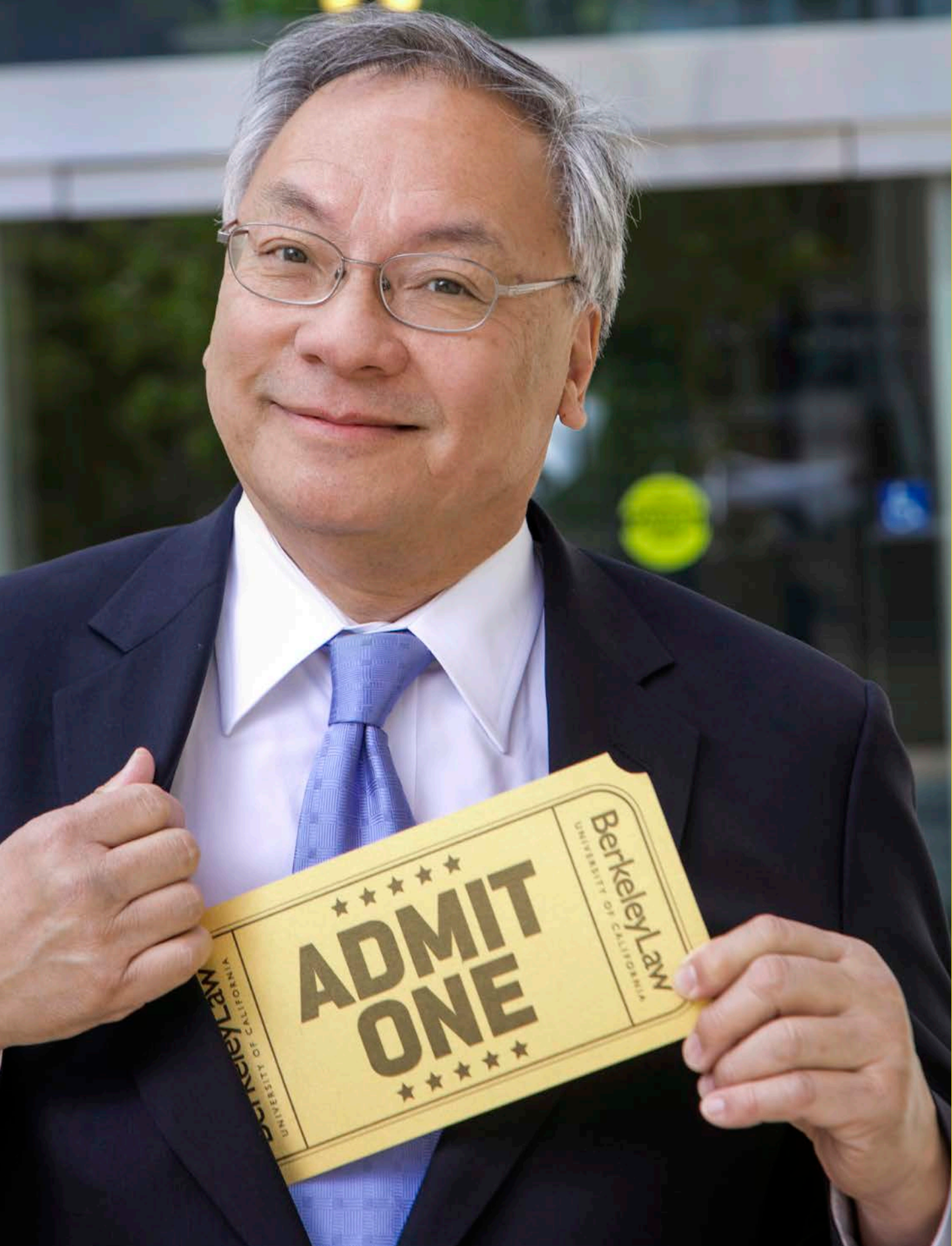

**E**dward Tom has seen it all at Berkeley Law. Parachute pants and mullets. Scrunchies and overalls. Man buns and skinny jeans.

While the styles parading through Boalt Hall over the past 30 years have changed, one thing has remained constant: Tom's position as Dean of Admissions.

Hundreds of faculty members have come and gone, and Melissa Murray is Tom's eighth dean. Legal education has experienced huge changes, and state support of the school plummeted from about 80 percent of its operating budget to just 13 percent last fiscal year. Two decades ago, California's Proposition 209 eliminated affirmative action in admissions decisions.

At every step, Tom's diligence and attention to detail ensured that Berkeley shined as one of the nation's extraordinary law schools. What's more, his team has deftly nourished a welcoming atmosphere by admitting a diverse mix of students who value collaboration and collegiality.

After creating indelible memories for thousands of admits (see page 32), Tom recently announced—to a resounding chorus of “Nooooo!”—that he will retire at the end of 2017. He recently took some time to reflect on his three-decade tenure with senior communications writer and *Transcript* managing editor Andrew Cohen.

**Andrew Cohen: What sparked your interest in admissions, and what about the work kept you so enthusiastically engaged?**

**Ed Tom:** My first job after college was as a crisis interventionist for high school youth in Monterey County. After five years, I was drained and decided to return to Berkeley to look into another degree. I also needed a job. Serendipity intervened and the Boalt Hall Admissions Office hired me, mainly based on my counseling experience. My first title was Administrative Assistant II, and my first task was to staple small envelopes inside each of 4,000 application folders. Of course, I was hooked and never looked back.

My work has been extremely rewarding since then. I encounter interesting people every day. I get to work at my alma mater, and I live in a beautiful area of the country. Most of all, few jobs provide the chance to recognize potential in people and then to watch them turn that potential into their own reality.

**Given all that, why retire?**

After 30 years, I think it's time for someone else to be given the chance to do what I do. Serving as Berkeley Law's Admissions Dean truly has been the joy of my life. I've been very fortunate for the responsibility and for having worked with such great deans and faculty. But now I'm ready to do other things.

**What's on your list?**

I hope to have more time to play and collect guitars and to learn how to play jazz. I want to learn tai chi. My wife and I may do some traveling, and maybe down the road I'll do some consulting. But most of all, I want to be able to read for fun again. Often, my eyes are just too weary from reading applications. I have a big library at home of books that are awaiting my attention.

**Speaking of your guitar prowess, Interim Dean Melissa Murray rapped on a recent school video and Human Resources Director Sheri Showalter sings in a Pink Floyd cover band.**





### **Any collaboration on the horizon?**

Unlikely, but one never knows. Most days, I'm content to just crank my amp up when I get home and play the blues on my own.

### **What's the biggest misconception about law school admissions?**

That our admission process is only about numbers. Yes, LSAT and GPA are substantial factors in our review, but they certainly don't measure all the many traits and strengths that are important both for pedagogic reasons and in the profession.

### **You've said putting together an entering class is a bit like organizing a choir. How so?**

One of the important factors that contributes to a Berkeley Law education is the caliber of the conversations that comprise our classroom experiences. Those conversations depend on a variety and diversity of voices to occupy the seats. I often suggest to prospective applicants that they try not to view me as the Dean of Admissions, but as a choir director whose goal is to rebuild a choir every year with each member who can offer a different, unique voice.

### **Berkeley Law is widely praised for its welcoming culture compared with other top schools. How does your team help cultivate that?**

I believe many people choose to study at Berkeley Law because of our reputation for offering a challenging curriculum within a nurturing environment. Our reputation, which has grown over the years and is now known and acclaimed within the prelaw community, begins with how we treat our applicants and new admits. Even though we're the most selective public law school in the country, it's important for us not to be arrogant about it. In fact, because we have to say "no" so many more times than we can say "yes," I believe we have to try even harder to be fair, compassionate, and transparent.

### **It seems GPA, LSAT score, and personal statement/letters of recommendations are considered the holy trinity of law school admissions. Do you value them equally?**

Yes, I view them as equal tools within a holistic review process. Each tool has a use, but no one tool is necessarily more valuable than another for building a class. Is there a correlation between "high numbers" and the traits that contribute to good law students and lawyers? Perhaps, but I have qualms about consistent reliability. A well-written personal statement, interesting résumé, and strong recommendations provide insight into an applicant's potential, too. We don't admit just numbers. We try to admit human beings.

"I HAVE NO IDEA AS TO HOW MANY APPOINTMENTS I MADE DURING MY 10 YEARS AS DEAN. BUT I DO KNOW, CLEAR AS A BELL, THAT THERE IS NO APPOINTMENT THAT I MADE THAT WAS MORE BENEFICIAL TO BOALT HALL DURING THE TIME I WAS IN THAT OFFICE."

—FORMER DEAN AND PROFESSOR  
EMERITUS JESSE CHOPER



### **What percentage of accepted applicants typically enroll at Berkeley?**

This number has varied from year to year, but over the past two decades it's been about one-third.

### **How large is the waitlist every year, and how many of those wait-listed do you usually admit?**

The waitlist size and number of people admitted from the waitlist varies a lot from year to year. On average, we waitlist about 300 to 350 people. In most years, the number admitted from the list is zero to fewer than 10. It depends on our yield rate and what's happening at other schools.

### **Do you remember the first student you ever admitted?**

Unfortunately, I don't. However, I'm still in touch with the first person I admitted from the waitlist.

### **How has the student body changed over the years?**

They all look so much younger now.

### **Law school tuition has risen sharply since 2008, and the legal marketplace has become less stable. How do you address concerns about student loans or the current value of a law degree?**

We used to get the bulk of our operating funds from the state. Relatively speaking, that resource has disappeared and tuition and fees have increased. Students are more aware of the cost-benefit analysis than when I started. And of course they want to attend a school where they will receive a high-quality education and have great employment and clerkship opportunities afterward.

I know we're competitive with the other top schools on most levels except one, which is scholarship availability.



# CARTWHEELS, TEARS, AND SCREAMS

**Mirella Nieto '14** started doing cartwheels outside her office. Ksenia Maiorova '07 burst into tears in a library computer lab. Maysa Eissa Nichter '06 jumped and screamed with joy—prompting the young girl she was babysitting to jump and scream with her.

Edward Tom has made the phone call thousands of times. But the reactions are wonderfully unique from those who get the good news: “You’ve been admitted to Berkeley Law.”

Some flat-out lose their minds. Some, perhaps trying to project a poised lawyer-in-training, respond

more calmly. And some are literally too overwhelmed for words.

Walking to class at Cal when her phone rang, Sara Dorosti '11 was promptly reduced to three letters.

“Ed: ‘Hi, Sara, this is Ed Tom.’ Me: ‘OMG, OMG.’ Ed: ‘Do you know why I’m calling?’ Me: ‘OMG, OMG.’ Ed: ‘You got

**GRATEFUL TRIO:** Natasha Arora '15 (top), David Abella '10, and Sara Dorosti '11 happily remember the gleeful moment when Dean Tom called to say they had been admitted.

into Berkeley Law.' Me: 'OMG, OMG.' Ed: 'Now go celebrate.' Me: 'OMG ... thank you.'"

"That was the entire conversation," Dorosti says. "I remember it as if it was yesterday. One of the best days of my life."

Sometimes, the ensuing conversation is even more monumental. After all, many admits are also weighing offers from other top schools.

"I was undecided," David Abella '10 says. "Dean Tom told me to come to Admit Day and that it would help me make up my mind. After visiting the campus and meeting with students, faculty, and staff, there was no doubt in my heart where I needed to go to law school."

Natasha Arora '15 still has a phone screenshot of Tom's 2012 email confirming her acceptance. "I wanted to remember the day," she says. "I thought the call might have been a dream, but then this email solidified it. ... I'm so thankful to Dean Tom for everything he did for me and so many other young adults wanting to make even the smallest difference in our legal community."

While reactions vary, everyone seems to remember where the call from Tom happened. "On my way to a dining hall ... Helping with an immigration workshop ... With my grandmother at a doctor's appointment ... Jogging on the UVA campus ... At a Caribou Coffee."

Hamada Zahawi '08 had just returned from Carnival in Brazil "having lost all hope of getting into a great law school."

"Then I landed at LAX, listened to my messages, and heard Dean Tom's voice saying I got in," Zahawi says. "That call made me happier than anything I felt on that epic trip to Brazil. And that's a tall order!" —*Andrew Cohen*



“ED SOUGHT OUT STUDENTS WHO WERE NOT ONLY GREAT ON PAPER, BUT WHO ALSO HAD UNIQUE LIFE AND WORK EXPERIENCES THAT WOULD ALLOW THEM TO CONTRIBUTE TO OUR COMMUNITY IN AND OUTSIDE OF THE CLASSROOM.”

—INTERIM DEAN AND PROFESSOR MELISSA MURRAY



We simply don't have the deep pockets that the top privates have. What we do have are the intangibles: location, a supportive learning ambience, great faculty, numerous clinics and centers, a worldwide network, and so on. Nevertheless, in the end, money talks and it's disheartening to lose a wonderful admit for lack of a competitive scholarship offer.

**How did the recent national decline in law school applications affect the quality of Berkeley Law applicants?**

Fortunately, the decline didn't seem to impact our applicant pool quality as much as feared. We still receive many more great applications than we can accommodate. That gives me the luxury to focus more on recruiting our admits to choose us over another school rather than on generating applications. Of course, that's important as well.

**What's the biggest change you've seen in the admissions process during your 30 years here?**

The biggest changes are the result of technological advancement. Email, websites, online applications and review, electronic fund transfers, to name a few, have made a huge impact on streamlining our work. We no longer have little envelopes stapled into manila files. In fact, we no longer have manila files!

**What's easier about your job now than when you started, and what has become harder?**

Creating an application file is much easier now than when I started. We no longer have to file hundreds of hard-copy documents manually. The application process is entirely electronic now, so no more paper cuts.

What has become harder is wooing top candidates to choose us over another top school. Our relative cost advantage has disappeared. Every year there are so many admit-

# ADMISSIONS BY THE NUMBERS



**192,489**

JD applications reviewed since 1987



**9,104**

JD students enrolled since 1987



**11**

Current Berkeley Law faculty members Dean Tom has admitted as students



**80 to 90**

Annual recruiting events attended by the Admissions team



**20 to 25**

States visited by Dean Tom and his staff each year



**200+**

Students who have served on the Admissions Committee since 1987



**40+**

Faculty who have served on the Admissions Committee since 1987



**350 to 400**

Prospective Boalties who attend Admitted Students Weekend each year



“ED IS A PERSON OF INCREDIBLE LEADERSHIP, COLLABORATION, AND INTEGRITY WHO HAS NEVER FAILED TO INSPIRE ALL THOSE WITH WHOM HE HAS WORKED OVER THE YEARS.”

—PROFESSOR CALVIN MORRILL, ASSOCIATE DEAN OF THE JURISPRUDENCE AND SOCIAL POLICY PROGRAM



ted students who tell me they would attend Berkeley but for another school’s more attractive financial aid offer.

### When was the most exciting time to be at Berkeley?

The most exciting time for me is every opening day of orientation when I greet the new entering class. To meet in person the people you’ve only known on a computer screen for so many months is such an extraordinary experience. And because I’ve been delivering the same welcome speech for many years, I also get a charge whenever I encounter alumni who remind me of their first day at the school or when I phoned to let them know that they had been admitted.

### What was the most difficult time?

Definitely around the passage of Prop. 209 and its immediate aftermath. It seemed like my office was in the spotlight all the time and everything we did was the subject of a news article or broadcast. The aftermath required us to transform our admission process and messaging, too.

### How diverse are your entering classes now compared with before Prop. 209, and how challenging is it to maintain that diversity?

Diversity in the class has slowly climbed back, and we work hard to ensure that our classes are filled with as many different voices as possible. We continue to work on our outreach and recruitment campaigns. We adopted a holistic review process that seeks to identify a wide range of potentials. I think the process is sound, but its effect is slow, unpredictable, and subtle. Diversity, in all of its shapes and forms, is a fragile thing and always changes from class to class.

### When you first started, it must have been difficult choosing one student over another. Is that hard now?

Yes, it’s still hard and more labor-intensive. When I first

began many years ago, the average applicant pool size was around 3,500. Today, it's around 5,500. However, our class size has remained the same at 270 to 290.

### Have you ever regretted not admitting a particular applicant?

I deal with heartache almost every day because there are so many worthy applicants but not enough room to admit them all. But my biggest heartaches happen when someone I've admitted decides to enroll elsewhere. It's similar to making a love connection, but then getting jilted.

### What's the best advice you can offer someone applying to Berkeley Law?

Going to law school can never be a default decision because there's nothing better to do. If you're not sure, I advise taking care of any unfinished business in your life. Have you ever dreamed of learning the tango in Argentina? Working on a ranch? Hiking through Cambodia? Whatever it is, go do that first before coming to law school because once you come to us, there won't be time for quite a while. ■



**OPEN ARMS:** Every year in March, Admitted Students Weekend welcomes hundreds of potential Boalties to the law school, where they attend presentations and mock classes and meet with faculty, students, and staff.

JIM BLOCK

# A REAL EYE-OPENING EXPERIENCE

While educators by trade, the faculty who serve on Berkeley Law's Admissions Committee spend a lot of time learning.

"I already knew we had an amazing group of students, but I hadn't appreciated how talented nearly the entire applicant pool is," says Professor David Oppenheimer, the committee's faculty chair. "Many of the personal essays are deeply moving, hilariously funny, or keenly insightful. The diversity of life experiences and professional accomplishments is stunning."

Seven committee teams—each with a faculty member and two students—review and select part of the incoming class. Their work peaks in a six-week period during which every team reviews about 150 applications that have made the initial cut. Admissions Dean Edward Tom oversees the intricate process.

"Ed is an exquisite facilitator with absolute command of his field, but he values the participation of faculty and students in admissions," says Professor Elisabeth Semel, an Admissions Committee member for two years. "He and his staff ensure that we understand that process and how it coheres with the law school's public teaching, service, and research missions."

Oppenheimer notes that nearly every application he reads from that group "is from someone I'd be happy to have in my classes."

"But we can only say 'yes' to approximately one in three," he adds.

Passed in 1996, California's Proposition 209 bars affirmative action in admissions decisions, but the committee does consider race-neutral factors that enrich experiential, class, and intellectual diversity. Oppenheimer says those factors include whether applicants are the first in their families to attend college or graduate school, come from low-income families, or have surmounted significant disadvantages.

"Ed is committed to diversity as an educational value, which helps us maximize opportunities for candidates," Semel says. "However, he believes that the committee's job is only half-finished when we admit students—in no small part because we are competing with other top schools that may have more financial carrots to offer." —*Andrew Cohen*



# Fields of Opportunity

Berkeley Law alumni, faculty, and clinics light the way for a burgeoning area of legal work related to marijuana

**BY RACHEL DELETTO**

**F**rom progressive political movements to technological innovations to environmental benchmarks, California has long been a bellwether for national trends. In 1996, it became the first state to permit marijuana for medical use. Since then, 28 other states have adopted medical marijuana, and seven other states and the District of Columbia have legalized recreational use.

No, California was not the first state to legalize recreational use. But when voters passed Proposition 64, the Adult Use of Marijuana Act (AUMA) in November, the state

again went beyond what its counterparts have done.

The act lays out a framework for a robust new area of business with the potential to create hundreds of thousands of jobs—including high demand for cannabis lawyers—and billions in revenue. Uniquely, it also includes provisions to remedy past harms of the war on drugs and those worst affected by its impact.

As an institution dedicated to public service and legal innovation, Berkeley Law has many graduates, faculty members, and clinics at the forefront of navigating the legal thicket of this new state law—one whose effects could ripple through other states and perhaps federal law.

In 2015, California took in nearly \$58 million in sales tax revenue from medical marijuana dispensaries across the state. Under AUMA, starting in January 2018, recreational

marijuana sales will be taxed 15 percent and growers will pay a harvesting tax. The California Legislative Analyst's Office estimates net state and local tax revenues could eventually exceed \$1 billion annually.

Building a new avenue of industry where none existed is difficult, especially when the federal government still classifies the product as a Schedule I drug not recognized to have any medical use under the Controlled Substance Act (CSA) (see *Can Sessions Squash Legalization?*, right, on the federalism issues involved).

"There are so many legal areas that cannabis touches on: criminal law, regulatory issues, business law, trademark and other IP work, labor issues, bankruptcy, tax," says Ryan Shaening Pokrasso '13, who co-founded SPZ Legal with classmate Hash Zahed '13.

With so many challenges to maneuver, specialized cannabis lawyers are in high demand. And for lawyers trained to rely on precedent, it presents an unusual and exciting opportunity.

Noting the absence of any treatise or casebook to consult, Shaening Pokrasso—who represents a range of cannabis businesses, including cultivators—relies on the cannabis law community in California and other states where it is legal for guidance.

"You have to be bold in doing this type of work," Shaening Pokrasso says. "You have to just read the law and interpret it the best you can for your client's situation. It's fascinating work, especially with the personalities involved."

That challenge of a relatively blank slate is what drives Jay Purcell '11. "With marijuana law, this is the ground floor," he says. "The rules are not written. We can become the most expert people in the country in this practice area, and help shape policy in a way that's responsible and serves the community well."

Purcell sees how "this industry is growing by leaps and bounds. It's huge, totally bananas." An associate attorney at Rogoway Law Group and a member of the Boalt Hall Alumni Association board, Purcell had no experience with cannabis clients while a corporate and small-business lawyer. But as cannabis entrepreneurs began seeking advice relating to legalization, he joined Rogoway to help build a new practice.

"We have clients that have a long history of operating in the unregulated cannabis space in various ways," Purcell says. "Suddenly, we have to figure out how to move these undocumented businesses into an elaborate new regime quickly."

## CULTIVATING LAW AND POLICY

AUMA establishes 19 types of state licenses, which all cannabis businesses will have to acquire. These cover culti-

# CAN SESSIONS SQUASH LEGALIZATION?

**Under the Obama administration, the** Department of Justice (DOJ) issued a memorandum advising federal prosecutors to focus enforcement priorities relating to marijuana on "the most significant threats." Those include preventing distribution to minors; sales revenue from going to criminal enterprises, gangs, and cartels; violence and use of firearms; and drugged driving.

But the confirmation of U.S. Attorney General Jeff Sessions, a noted critic of marijuana, sparked concerns about a federal crackdown in California and other states that have legalized some form of the drug.

Jolene Forman '12, an attorney at Drug Policy Alliance (DPA), says states are well within their rights to legalize marijuana activities such as possession, use, sharing, transport, and cultivation. Under the Tenth Amendment's anti-commandeering doctrine, the federal government cannot order states to criminalize marijuana or compel state police to enforce federal law. Therefore, in California, Proposition 64's legalization provisions appear safe from federal challenge.

Forman, who co-authored the article "Cooperative Federalism and Marijuana Regulation" with renowned constitutional scholar and new Berkeley Law Dean Erwin Chemerinsky and others, says Sessions may try to ramp up enforcement of federal marijuana laws. However, she believes doing so would counter federal interests.

"The federal government can enforce federal law against individual marijuana businesses, which may have a chilling effect," says Forman. "But it



has neither the political support nor the financial or personnel resources to stamp out every marijuana business operating in compliance with state law.”

According to recent Gallup polls, more than 60 percent of national voters support states’ rights to legally regulate and control marijuana. Moreover, reports conducted by the DPA, Cato Institute, and Brookings have found legalization policies to be effective so far.

“By shifting away from counterproductive marijuana arrests and focusing instead on public health, states that have legalized marijuana are diminishing many of the worst harms of the war on drugs while managing to raise substantial tax revenues,” Forman says.

Legally regulating and controlling marijuana “enables the state to set product safety standards and restrict youth access,” she adds, noting how such states are seeing a sharp decrease in marijuana arrests and convictions. During the same period, these states have not experienced increases in youth use or traffic fatality rates. “It’s too soon to draw definitive conclusions, but the evidence so far clearly shows that the worst fears of legalization opponents have not come to pass,” Forman says.

Joy Haviland ’08, Forman’s DPA colleague, believes the federal government’s limited resources would be better allocated for more pressing issues.

“Every dollar spent by the Sessions DOJ going after marijuana businesses is money and resources that could be used on other important DOJ programs and priorities,” she says.

—Rachel DeLetto

**STATE SUPPORTERS:** Drug Policy Alliance lawyers Jolene Forman ’12 and Joy Haviland ’08 say states that have legalized marijuana are reducing harms caused by the “war on drugs.”



vation, manufacturing, testing, distribution, and retail. Additionally, localities are empowered to license and regulate commercial marijuana businesses, and they have the latitude to ban recreational businesses entirely. In addition to advising clients on the many issues that arise in licensing, cannabis attorneys do a big part of their work in local advocacy.

Ariel Clark '05, a founding partner at Clark Neubert LLP (aka, Lawyers for the Green Frontier) in Los Angeles and San Francisco, has practiced in the marijuana space for more than a decade and co-founded the Los Angeles Cannabis Task Force. The organization works with the city to develop a transparent process that allows cannabis businesses, neighborhood groups, scientists, and other community members to participate in creating rules and permits.

“Advocacy goes hand-in-hand with practicing cannabis law. This industry can’t thrive without market clarity, so a big part of my work is taking clients’ needs to regulators and speaking up on their behalf,” Clark says. “I’m here to make sure my clients follow the law—but also to ensure the laws themselves are fair.”

It all depends on the regulations adopted by individual municipalities. That’s why Clark spends significant time meeting with cannabis stakeholders and regulators, to ensure that the laws relating to marijuana businesses ultimately adopted by Los Angeles fairly represent the interests of her clients, especially in the area of diversity.

To create racial, gender, and socioeconomic diversity within the industry, Clark cites Oakland as a template. The city council is considering an “equity permit” program, which would reserve some of Oakland’s cannabis business licenses for people with past marijuana-related convictions and residents in areas with high numbers of marijuana arrests.

Like Clark, Purcell and Shaening Pokrasso say policy work makes up a fundamental part of their practice. They agree that community participation and advocacy will play a huge role in shaping the future of California’s cannabis industry.

“Different counties are approaching recreational marijuana businesses in very different ways,” says Purcell. “That’s because someone went to a town council meeting, stood up, made a fuss, and participated in the rulemaking process.” Purcell and Clark encourage those who care about this issue, on either side, to make their voices heard.

“It’s not often that we get to be part of an emerging industry,” says Clark, noting that California citizens can help establish a value system for an important cash crop for the state. To ensure that the new regulations benefit

everyone, she says, “it’s incredibly important for people to be engaged and for cannabis businesses to get organized.”

## LEARNING FROM THE WAR ON DRUGS

Beyond the major business opportunities created by recreational legalization, AUMA seeks to remedy decades of often discriminatory enforcement of criminal laws relating to marijuana.

“Prop. 64 goes much further than any other state in terms of social justice reform,” says Joy Haviland '08, a staff attorney on the Marijuana Law and Policy team at Drug Policy Alliance (DPA). Haviland and her DPA colleague Jolene Forman '12 were among the advocates representing interest groups at the Prop. 64 drafting table.

“The way we see the war on drugs, and specifically marijuana prohibition, it’s really a war on people of color,” Haviland says. “Blacks and Latinos are arrested at significantly higher rates than white people for possessing or selling drugs, even though studies show they use and sell drugs at the same rate.”

Before joining DPA, Haviland worked at the Bronx Public Defenders’ office in New York City and saw how the long-term consequences of marijuana convictions can be severe for young people and non-citizens.

She and Forman pushed for reform within Prop. 64 to address these issues—and succeeded. The version adopted by voters includes what Forman calls “gold-standard provisions,” such as:

- Record-clearing and retroactive sentencing reductions for people previously convicted of offenses that would not be a crime, or would be a lesser offense, under AUMA’s revised penalty structure.
- Ensuring that youth offenders are no longer liable for criminal punishment for marijuana-related offenses; instead, they are subject to drug education and community service.
- Prohibiting the denial of business licenses based solely on previous marijuana convictions.
- Lowering financial barriers to enter the business, including micro-licenses, so people without significant wealth and resources can join the market.

In addition, \$10 million of marijuana sales taxes will go to California public universities to study and help implement AUMA, and \$10 million per year will go to community reinvestment programs starting in 2018 (increasing by \$10 million annually to a cap of \$50 million). These encompass grants to nonprofits, re-entry services, job placement, mental health and substance abuse treatment, legal services,

# MARIJUANA AND YOU

What does California's Adult Use of Marijuana Act (AUMA) mean for state residents?



## USE

### BEFORE

UNDER THE CALIFORNIA COMPASSIONATE USE ACT (CCUA) OF 1996

Patients may obtain a recommendation from a California-licensed physician for certain medical conditions and use marijuana for that purpose except in the following circumstances: (a) In any place where smoking is prohibited by law; (b) In or within 1,000 feet of the grounds of a school, recreation center, or youth center, unless the medical use occurs within a residence; (c) On a school bus; (d) While in a motor vehicle that's being operated; (e) While operating a boat.

### AFTER AUMA

EFFECTIVE IMMEDIATELY

Adults 21+ may use marijuana, but consumption is forbidden in any public place except for licensed dispensaries when authorized by local governments. Violations are a \$100 infraction. Recreational users may not purchase marijuana in stores without a doctor's recommendation until 2018.



## CULTIVATION

Patients are allowed up to 100 square feet of growing space per person, with collective gardens limited to five patients unless they obtain a state license.

Adults 21+ may cultivate up to six plants and possess the marijuana from them at their residence for personal use. Cultivation of over six plants, transport of over an ounce, illegal sale or distribution for compensation, and possession with intent to sell are downgraded from felonies to misdemeanors, except in certain aggravating circumstances.



## POSSESSION

Patients may possess whatever amount of marijuana is necessary for their personal medical use. However, they can be arrested for exceeding reasonable amounts and they can be cited or fined for exceeding limits in local laws.

Adults 21+ may possess, process, transport, obtain, or give to other adults no more than one ounce of marijuana. Violations are a \$100 infraction.

Possession of more than one ounce remains a misdemeanor. Other offenses (including cultivation of over six plants, transport of over an ounce, illegal sale or distribution for compensation, and possession with intent to sell) are downgraded from felonies to misdemeanors except in certain aggravating circumstances.

AUMA does not alter allowances for medical patients under CCUA.



## DUI

Consumption or possession of an "open container" of marijuana or marijuana products is prohibited while driving or riding as a passenger in a motor vehicle, aircraft, vessel, or other transportation vehicle.

Current laws remain unchanged.



## EMPLOYMENT

The California Supreme Court has ruled that employers have a right to drug-test and fire employees who test positive for marijuana, regardless of their medical use (*Ross v. RagingWire*, 2008).

Current laws remain unchanged.

and other services to communities disproportionately affected by the war on drugs.

## CLEANING THE SLATE

While the new licensing structure for recreational sale of marijuana does not take effect until January, the decriminalization of use and possession (see *Marijuana And You* graphic, page 41) and criminal penalty restructuring provisions are effective immediately. The East Bay Community Law Center's Clean Slate Clinic is one of the organizations helping to clear and reclassify marijuana convictions from the records of thousands of Californians.

"Low-level drug offenses can prevent people from getting jobs and occupational licenses and increase the risk of future incarceration," says Sarah Crowley, the clinic's director. She believes AUMA's sentence reduction and record-sealing provisions can be game-changers for her team's clients, many of whom have served time and are now trying to reintegrate into society.

"One of the great things about AUMA is that it puts the burden on the prosecutor to show why a petitioner isn't eligible for relief under the redesignation provisions," Crowley says. She hopes this will make Prop. 64 relief much easier to adjudicate, even if a petitioner cannot afford representation.

In addition to assisting clients with petitions, Berkeley Law students in the clinic will host educational sessions in the community. They will also conduct other outreach to publicize the remedies available under AUMA and make sure people know their rights and how to file petitions for relief.

## SHIFT IN PUBLIC OPINION

Berkeley Law Professor Franklin Zimring is a leading scholar on criminal justice reform and co-author of *Criminal Law and the Regulation of Vice*, one of the first legal textbooks to analyze alternative drug policies and their impact. To his eye, AUMA's unprecedented and progressive penalty structure comes from a drastic change in public opinion.

"Medical marijuana was a fascinating struggle. But once it was in place, people started realizing marijuana isn't terrible," Zimring says. "It's not hairy beasts with loud guitars smoking dope, it's little old ladies with cancer and gay men with AIDS trying to reduce pain."

Opponents of AUMA worry that legalizing marijuana will increase crime. Zimring says this is an unfounded concern. "We're in a period of adjustment to decriminalization," he notes. "So far, nothing bad has happened. And based on recent reports looking at long-term trends there don't appear to be extreme effects either way."

Despite significant science to the contrary, the federal

government continues to classify marijuana as Schedule I—which covers drugs, substances, or chemicals with no currently accepted medical use and a high potential for abuse. Included in that category: heroin, LSD, ecstasy, methaqualone, and peyote.

The fact that marijuana remains a Schedule I drug "probably meets the legal definition of obscenity," Zimring said during a March event at Berkeley Law on marijuana policy. Many lawmakers agree. In March, Democratic members of Congress introduced legislation to remove cannabis from the CSA, which would enable each state to tax and regulate it like alcohol or tobacco.

Zimring suggests that regulating marijuana in a similar way to alcohol makes sense in many respects. However, a key concern—the expected increase of accidents, arrests, and convictions related to driving under the influence of marijuana following legalization—may not be so simply solved. According to Professor Andrea Roth, states face a challenging task in setting standards for regulating such driving (see *The Trouble with DUI Marijuana*, page 43).

## RIPE FOR INNOVATION

Unless and until marijuana is removed from Schedule I designation, assisting in the sale of cannabis products is illegal under dozens of federal laws, and efforts to build legitimate cannabis businesses face many legal obstacles.

The Obama Department of Justice memorandum (see *Sessions*, page 38) lessened the risk of federal raids for distributors and cultivators. But the federal illegality of marijuana also creates complications for entrepreneurs and their attorneys with regard to banking, insurance, taxes, intellectual property, brand protection, and even legal ethics.

Under the CSA, it is illegal to aid and abet the manufacture, distribution, or dispensing of marijuana. Therefore, banks would violate various federal laws by accepting deposits from the sale of marijuana, processing credit card payments for purchasing it, or providing a loan for a cannabis business.

This creates a serious conundrum. "Federally chartered banks will shut down your account if they find out the business is cannabis-related," Purcell says. State-chartered banks are slightly more lenient but still subject to many of the same federal rules. Unable to deposit revenue into secured accounts, many marijuana business owners are forced to deal entirely in cash.

"Completely legitimate businesses have to take bags full of cash to pay their taxes," says Shaening Pokrasso. "It's a huge security risk to have that much cash on premises."

Many of Purcell's clients rely on management companies as intermediaries to handle finances, taxes, and payroll. But this is also risky as management companies—like lawyers—

**STEERING SENSE:**  
Professor Andrea Roth  
drives home a  
science-based  
argument.

# THE TROUBLE WITH DUI MARIJUANA

**In every state, DUI alcohol can be proven two ways:**

by showing the driver had a blood-alcohol concentration of .08 percent or higher (“per se” DUI), or by proving that the driver was “impaired” by alcohol. As part of marijuana legalization, some states have tried to analogize to alcohol, criminalizing driving with a certain THC blood level, such as 5 ng/mL.

Under California’s Adult Use of Marijuana Act (AUMA), however, DUI marijuana can only be proven by showing impairment. Berkeley Law Professor Andrea Roth says California should resist the temptation to follow other states and create a “per se” DUI marijuana law.

Roth notes in a recent paper that unlike with alcohol, there is no predictable relationship between the level of THC in the blood and the level of intoxication in the brain.

Different cannabis strains have different potencies, and the mode of ingestion and user’s history impact THC’s effect, Roth explains in *The Uneasy Case for Marijuana as Chemical Impairment Under a Science-Based Jurisprudence of Dangerousness*. Unlike alcohol, THC stays in one’s system for hours or days after ingestion, and is not water and fat soluble like alcohol. In short, “just because a person has THC in her blood does not mean that she’s impaired,” Roth says.

The .08 blood-alcohol standard is “based on decades of



careful scientific research showing how specific blood-alcohol concentration increases relative crash risk,” she explains. Roth notes that morally blameworthy dangerousness—in this case increased crash risk—has always been what the law looks to in deciding how to criminalize impairment from a legal drug.

So far, she notes, relevant studies have not found increased relative crash risk from THC blood levels alone. “By criminalizing DUI marijuana based on THC blood levels absent any relationship to increased relative crash risk, we label and punish as criminals people who have not been demonstrated to be at a morally blameworthy level of chemical impairment,” she says.

Roth believes officer training, body cameras, and further scientific crash-risk studies can combat drugged driving without relying on incoherent numerical standards in criminal laws. AUMA allocates a portion of the tax revenue from recreational sales to the California Highway Patrol for training law enforcement officers in techniques to detect impaired driving—and to establish statewide protocols and standards for identifying impaired drivers. —Rachel DeLetto

could be subject to the CSA’s aiding-and-abetting provisions.

“There are literally billions of dollars that need a home. It’s an area ripe for innovation,” says Shaening Pokrasso.

According to Shaening Pokrasso, who represents a few marijuana tech companies, the startup community is taking notice of this opportunity. Companies such as Kind Financial provide record-keeping services to ease the complex task of closely monitoring marijuana businesses’ cash-only transactions. Another young startup, Tokken, aims to offer an electronic payment system that will not rely on credit card companies or bank debit networks, but instead the Bitcoin blockchain, similar to Venmo.

But solutions are still a ways off, and with the uncertainty

of a new administration, cannabis lawyers must make sure their clients understand how to strictly follow California’s laws. Berkeley Law is also taking steps to prepare future attorneys in the field by offering the course Marijuana Law & Policy this fall. Tamar Todd, senior director of DPA’s Office of Legal Affairs, will teach it.

Prop. 64 opened an enormous window of opportunity for cannabis-industry jobs and businesses. Nevertheless, Purcell advises enthusiastic clients to be cautious.

“Don’t be the gazelle that runs ahead,” he says. “The next few years, just focus on coloring in the lines and being totally compliant with state law. It’s probably going to become safer every day, but right now, we don’t know what this administration will do.” ■

# READY TO LEAD

Colleagues hail new dean Erwin Chemerinsky as multitalented, visionary, and “a perfect match”

BY ANDREW COHEN



Those who have worked closely with Erwin Chemerinsky say Berkeley Law struck gold in its search for a new dean. His mid-May appointment triggered a laudatory torrent from coast to coast.

“Erwin will bring an enormous range of qualities and talents to the deanship,” says Professor Katharine Bartlett ’75, Duke University’s law school dean for three years that Chemerinsky taught there. “These include a prodigious energy, a passion for the law and for legal education, an ability to communicate with a wide range of audiences, an encyclopedic knowledge of constitutional law, and a warmth and profound compassion toward others. He is perfect for Berkeley, and I’ll be proud to claim him as the dean of my alma mater.”

Chemerinsky left Duke in 2008 to become the founding dean of UC Irvine School of Law, where he has spent the past nine years. He starts July 1 at Berkeley after an open, national search that considered internal and external candidates. Chemerinsky says he is “thrilled and humbled” by what he calls “this amazing opportunity.”

Earlier this year, *National Jurist* magazine named Chemerinsky the most influential person in legal education in the United States. A renowned authority on constitutional law, federal practice, and civil rights, he has taught

courses on constitutional analysis, appellate litigation, and free-speech rights, among others, and plans to continue teaching at Berkeley.

Chemerinsky has written 10 books—another will be published this summer—and nearly 200 law review articles. The first member of his family to attend college, he is a prolific op-ed writer and media commentator who has argued cases before the U.S. Supreme Court and various federal appellate courts.

Berkeley Law Professor and dean search committee member Sonia Katyal calls Chemerinsky a “living legend ... who exemplifies the very best that the field of law has to offer: brilliant, warm-hearted, thoughtful, open-minded, and deeply engaged in the culture of public service.”

## LEADING AND LISTENING

Chemerinsky’s first order of business inside Boalt Hall: paying close attention to those who inhabit it.

“The most important thing for me to do at the start is listen and learn,” he says. “Berkeley is a well-established school with its own culture and procedures. I want to meet with each faculty member in the first couple months, have regular coffees with students, hold town halls, have monthly meetings with staff, and get to know each department.”



# THE CHEMERINSKY FILE

**Most recent position:** Founding Dean and Distinguished Professor, UC Irvine School of Law, with a joint appointment in Political Science

**Past Professorships:** Duke (Law, Political Science), 2004-2008; Southern California (Public Interest Law, Legal Ethics, Political Science), 1983-2004; DePaul (associate professor, law), 1980-1983

**Areas of expertise:** Constitutional law, federal practice, civil rights and civil liberties, appellate litigation

**Scholarship:** Author of 10 books, with another to be published this summer by Yale University Press, and nearly 200 law review articles

**Other Writing:** Pens a weekly column for the *Orange County Register*, monthly columns for the *ABA Journal* and the *Daily Journal*, and op-eds in newspapers nationwide

**Education:** Harvard (JD, 1978); Northwestern (BA, 1975)

**Advocacy:** Often argues appellate cases, including in the U.S. Supreme Court

**Trainer:** BAR/BRI lecturer in Constitutional Law and Professional Responsibility since 1986

**Family:** Married to UC Irvine law professor and Berkeley Law graduate Catherine Fisk '86; has four children and two grandchildren; first member of his family to attend college

Ohio State University President Michael Drake was UC Irvine's chancellor for the first six years of Chemerinsky's tenure there. They worked closely together, co-teaching a freshman undergraduate seminar that Drake calls one of the highlights of his academic career.

"In addition to being the perfect founding dean, he is a master teacher, and certainly among a handful of the most sought-after legal minds in the world," Drake says.

When Chemerinsky launched Irvine Law, he persuaded the school's leadership to approve free tuition for all three years to the first entering class. That helped vault the school from unaccredited to a top 30 ranking. "It succeeded beyond what I could have ever imagined," he says.

Chemerinsky brings similar resolve to Berkeley Law, which he believes "should aspire to be truly one of the top five law schools in the country, by any and every measure."

Fundraising is his first priority in the face of declining state support of higher education. He sees that as pivotal to retaining and recruiting top faculty, keeping the school accessible to qualified applicants from all backgrounds, and upholding Berkeley Law's public mission.

While Chemerinsky faces some formidable challenges, Bartlett cautions against underestimating him. "When I asked something of Erwin, he never said no," she recalls. "His ability to multitask exceeds anyone I have ever known."

University of Southern California law professor Scott Bice, Chemerinsky's dean for 17 years there, concurs. Bice marvels at his "legendary energy that inspires awe and affection ... Berkeley has made a superb choice. It is a rare combination of achievements to excel as scholar, teacher, advocate, and administrator. Erwin is really one of a kind."

## FOSTERING INCLUSION

Chemerinsky is plenty familiar with his new employer as his wife, Irvine law professor Catherine Fisk '86, and father-in-law are Boalt graduates.

"I think it's so important that Berkeley Law be an inclusive community," he says. "That involves many things, including diversity of faculty, staff, and students. It also involves being a community where all members feel welcome and can thrive within it. I think Melissa Murray has done an outstanding job in the most difficult circumstances as interim dean. I need to build on that."

Bartlett says Chemerinsky's track record in that area should comfort those who care about the school.

"I've always been impressed by his ability to relate to others 'across the aisle,'" she explains. "While his own political commitments are clear and firmly held, he respects those with contrary points of view and supports their right to advance them. At Duke, he was adored equally by the Federalist Society and the American Constitution Society."

Given that the legal marketplace demands "graduates who are ever-more practice ready," Chemerinsky appreci-

ates that "Berkeley has a wonderful clinical program and pro bono program. I want to maintain those, and I want to enhance them."

He is also eager to engage with alumni. Bice anticipates a warm reception, calling Chemerinsky "a great teacher, a prolific scholar, a gifted appellate advocate, a highly successful founding dean of a first-rate law school, a much-published public intellectual, and an engaging colleague."

Drake, his former chancellor, agrees. "Erwin Chemerinsky is a wonderful choice," he says. "One of the nation's outstanding legal scholars leading one of the nation's premier law schools—a perfect match." —*Andrew Cohen*

# Creative Works

Artistic Contributions From Our Community

**DANCER: NATALIE GOLDEN**

## DANCING QUEEN REIGNS SUPREME

Studying abroad often leads to life-changing experiences. Rarely, however, does it lead to a world championship.

The summer after her junior year at Berkeley High School, Natalie Golden spent a month in Oaxaca, Mexico, for a

Spanish immersion program. With ballet in her blood—she started at age 3, performing in “The Nutcracker” and other shows for the San Francisco Ballet Company and later the Berkeley Ballet Theater—she needed a dancing fix.

“I took some salsa lessons and just loved the experience,” says Golden, a Berkeley Law staff member. “It was challenging, exciting, different, and really fun. I had realized I didn’t want to be a professional ballet dancer, and salsa was a great new outlet.”

As a student at UC Davis, Golden danced at the school’s salsa club. After graduating in 2013, she returned home to Berkeley and joined the law school’s Advanced Degree Programs office,

where she was recently promoted to Associate Director for Admissions and Student Services.

She also joined Salsamania in Oakland, an elite dance company.

“Certain aspects of ballet training translate well to salsa dancing—turning, flexibility, learning choreography,” Golden explains. “Other aspects, not so much. You’re more grounded in salsa, and certain body movements are a big adjustment because ballet is more upright.”

Another big adjustment: trading ballet slippers for high heels.

Golden quickly climbed the ranks in Salsamania’s amateur program. In December 2016, she and seven others represented the company in the World

Latin Dance Cup. Her team practiced its complicated two-minute routine for nearly a year before spending a week in Miami for the finals.

Dancing against teams from Argentina, Canada, Mexico, Peru, Sweden, and the U.S., Golden’s group emerged victorious.

“There was so much focus on every micro-detail,” she says. “To see that work pay off definitely inspired me and pushed me to go farther with salsa competitions.”

Golden trains at Salsamania two or three days during the week, and for a couple hours every Saturday and Sunday. “And this is the down time,” she says with a laugh. “But I love it. The company is like a family to me.”

—Andrew Cohen



**GOLDEN STYLE:** Berkeley Law staff member and world amateur champion salsa dancer Natalie Golden





SCREENWRITER: JUSTIN MALEN '01

# Big Laughs for The Big Screen

**Forget holiday cheer. Justin Malen '01 dumps eggnog all over** an annual workplace rite in the 2016 comedy “Office Christmas Party,” which he co-wrote. You’ll never think of an ice-carved Saint Nick in quite the same way.

Starring Jennifer Aniston and Jason Bateman, the film is “naughty, inappropriate fun,” wrote *The New York Times*.

An aspiring screenwriter since the fifth grade, Malen gleaned inspiration from his time as a corporate lawyer for Kaye Scholer in New York and Los Angeles. He found the workplace—and, more to the point, alcohol-drenched and inhibition-compromised workplace social gatherings—to be natural comedic fodder.

“It’s just an uncomfortable, potentially problematic setting given how much is on the line professionally,” Malen says. “Those types of conflicts create comedy.”

Humans behaving badly is another potent allure.

“It’s a nice escape to create characters who get to say and do whatever they want,” he says. “I think a lot of lawyers can relate to that, not necessarily getting to say and do everything they’d like to during the workday.”

These are heady times for the Los Angeles-based Malen. Warner Brothers is producing his comedy “Bastards,” starring Owen Wilson and Ed Helms, which is scheduled to hit the big screen December 22. In December 2016, ABC purchased “Lawyer Up,” a legal comedy series that Malen is penning.

He grew up watching Christopher Guest movies, but he also



**COMIC RELIEF:** Justin Malen with his wife, Melinda Chan, at the premiere of “Office Christmas Party”

draws inspiration from writers Judd Apatow, Todd Phillips, and the late Harold Ramis. Law school lent another guiding hand.

“A lot of what I learned at Boalt I now use in screenwriting,” Malen says. “Issue spotting, critical thinking, skills like that help me deal with studios, producers, and actors to develop a project. It was almost better than going to film school.”

Drawing a laugh, it turns out, is no exact science.

“Things as written aren’t necessarily the funniest things on screen,” he says. “It’s a big trick, and no one knows for sure what’s going to make people laugh.”

Christmas parties notwithstanding. —Andrew Faught

POET: SOJOURNER KINCAID ROLLE '81

## TAKING A POETIC PATH

**When Sojourner Kincaid Rolle '81 was attending Berkeley Law,** someone told her, “You have to decide whether you’re going to be a lawyer or a crusader.”

In becoming a poet, Rolle believes she chose the latter.

“I sort of hold up the sky where I am,” she says.

Santa Barbara’s poet laureate for the past two years, Rolle has enjoyed a prolific career. Her poems appear in six chapbooks and in various anthologies and literary journals. She has written several plays, including a theatrical dance performance (“Ayo’s Journey”) about the transatlantic slave trade, based on an original 12-poem cycle. And as a television producer and journalist, Rolle has conducted numerous interviews for broadcast and print.

She considers herself a “public poet” and a professional classroom guest. For the past three decades, she has com-

posed poems for community celebrations, hosted poetry events, and led poetry workshops for all ages.

“People resonate to poetry,” says Rolle, whose multimedia work is established at UC Santa Barbara’s California Ethnic and Multicultural Archives. “People see their own world reflected in a poem, gain insight, and feel that they are not alone.”

At Berkeley Law, Rolle became an activist, serving in the Graduate Assembly and the Coalition for a Diversified Faculty, and started writing more poetry. She also began formulating her post-law-school aspiration to be a “legally trained person in service to the community.”

“And that’s exactly who I am,” she says. —Wendy Witherspoon

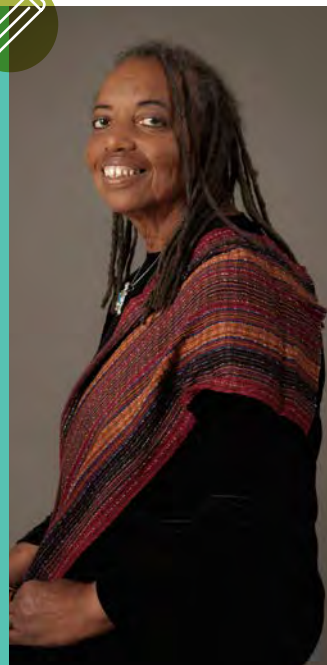

# Fast Forward

Three Student Action Figures



KEVIN WALKER '17

## A CALLING TO PROTECT AND SERVE

**He sees the furrowed brows, the blank stares, the befuddled expressions.** Why, Kevin Walker '17 is often asked, would someone with such a promising future risk his life, repeatedly, for free?

Walker, who became a reserve police officer while an undergrad at UCLA, recalls vividly the moment his life underwent a seismic shift.

"When I was in college, I tutored middle school kids in Los Angeles," he says. "One lived in a high-crime neighborhood. I'd sometimes hear gunfire during our sessions, and one day his mom described how a gang had beaten her up—and how the cops who responded to the 9-1-1 call essentially saved her life. That sparked something in me."

Walker went through police training and joined the LA County Sheriff's Department. While reserve officers are unpaid, their duties mirror those of full-time cops—same hiring standards, equipment, and responsibilities.

"Reserve officers are doctors, teachers, people from all walks of life," Walker says. "I worked alongside a Hollywood movie producer for a while."

Just 21, Walker was assigned to some notorious areas of South Central LA.

"I was concerned," says Kevin's father, Richard Walker '84. "The public's trust in law enforcement was eroding. But Kevin did it for the right reasons—to help find common ground to divisions in our communities."

Indeed, the chance to heal rifts and debunk stereotypes proved alluring.

"My co-workers were very attuned to the area's history of tensions between officers and civilians," Walker says. "Every car I pulled over, every person I talked to on the beat provided an opportunity to help reduce that tension and create better connections."

While juggling school, Walker worked 800 hours during his first year of police work. When driving to LA became unsustainable in law school, he joined Moraga's force.

Yes, he is fully aware of his passion's peril. Last fall, he

found himself in a harrowing, high-speed pursuit of an AK-47-wielding suspect.

“Everyone involved was fortunate not to get hurt,” he says. “The suspect ended up in custody and no shots were fired. Several hours later, I was in class learning how rules of evidence apply to criminal justice proceedings.”

Last year, Walker connected a Berkeley Law clinic and research center with his old LA department. They studied local

law enforcement’s response to human trafficking in California, and a detailed report is scheduled for release this summer.

Walker worked at a Hong Kong arbitration center during the spring semester, and will practice corporate law at a San Francisco firm starting this fall. And, yes, his police work will continue.

“I call it community service on steroids,” he says. “For me, it’s a meaningful way to give back.” —*Andrew Cohen*

## JASLEEN SINGH '17

# Bringing Sikh Stories Front and Center

**Jasleen Singh '17 believes in the power of stories.**

So much so that in the summer of 2013, after earning her bachelor’s degree from UC Berkeley, she requested a deferment for her planned first year at Berkeley Law and embarked on a journey to interview more than 150 Sikh people in communities across the United States.

Singh, who grew up in a Sikh household in Southern California, spun the interviews into a stage play called “Sikh Monologues.” The show has been mounted five times in the past three years—in California, New York, and Washington, D.C.

Through 10 first-person stories, the play explores identity, judgment, discrimination, immigration, and domestic violence in Sikh-American communities.

“The concept of people talking for themselves is beautiful to me, and I was tired of media dictating everything my Sikh community stands for, believes in, and looks like,” Singh says. “The media’s pre-packaged ‘Sikh story’ is devoid of nuance and lived experience, so I created a platform to tell our own stories.”

Singh’s parents immigrated to the United States from India in the 1980s

and settled in Santa Clarita, California.

As a child, Singh attended Punjabi school on Sundays and felt connected to her identity as a Sikh, a faith founded in the 15th century in South Asia.

As an undergrad, Singh explored her interests in law, Sikh-American identity, and theater. She also interned for the Sikh American Legal Defense and Education Fund and participated in a campus production of “The Vagina Monologues.” After her admission to Berkeley Law, she sought to explore these passions and began drafting a plan for her “Sikh Monologues” project.

Although that project kept her busy, Singh nevertheless produced a distinguished law school career. She served as a law clerk for both the Equal



Justice Society and the U.S. Department of Justice's Civil Rights Division last year, and she also became involved with Berkeley Law's Women of Color Collective and the Coalition for Diversity.

Eyeing life after law school, Singh

continues to explore ways to merge her interests. "I've started thinking about how I can incorporate artistic expression or theater as part of my social justice advocacy," she says.

After earning her JD, Singh will join the California Attorney General's Office

as an Honors Program attorney.

"I'm glad that I chose law as my path," she says, "because I think a lot of lawyering is enabling people who are oppressed or marginalized in some way to make sure that their story is heard." —*Wendy Witherspoon*

## ZACHARIAH OQUENDA '19

# INFORMED VOICE ON RURAL HOMELESSNESS

**It's an under-told story: 14 percent of America's homeless population can be found in rural areas, according to the Annual Homeless Assessment Report.**

For a time that included Zachariah Oquenda '19, who lived in a campground in Marseilles, Illinois, with his parents and six siblings.

"Rural homelessness looks different than urban homelessness," he says. "People usually don't sleep on the streets. For my family, it was living in a tent. Or you move in with another family because there's no shelter in rural areas."

Oquenda hopes to galvanize awareness of the problem and provide hope for rural communities, where the homeless often lack access to health care and social services. He plans to practice housing law. "Given my socioeconomic background, I want to change laws across the board to give more access and equity to families who otherwise wouldn't have it," Oquenda says.

At Berkeley Law, he has drawn on personal experiences while helping low-income employees recover unpaid wages through the Wage Claims Clinic and helping low-income area residents secure housing and other necessities through the Tenants' Rights Workshop. During the school year, he logged about 140 pro bono hours.

Oquenda says his family was unjustly evicted from one home and moved into substandard housing in Illinois ("it didn't have proper insulation, the kitchen floor was bowed, the central heating didn't work, and we often didn't have electricity or running water"), forcing the campground move.

After brushes with the law growing up, he figured his future "was either a hard-labor job, the military, or prison." He has since found a softer side: Oquenda is a salsa ballroom danc-



ing enthusiast who is learning East and West Coast swing with his fiancée, April. He also started a lock-picking club in college after he locked himself out of his dorm room and campus police charged \$25 to open the door. More than 60 students joined the group—for lawful purposes.

Oquenda left Illinois at 17, moving to California to live with grandparents he didn't know. The arrangement didn't work out, but his high school rallied behind him, finding him a room with a retiree.

He gained admission to Claremont McKenna College, where he won a \$30,000 Truman Scholarship (payable toward his legal education) for his work to secure more financial, academic, and institutional support on behalf of first-generation, low-income students.

"I always felt like I had something that I needed to prove, to compensate for, because we weren't as well off as other families," Oquenda says. "School has been a haven for me." —*Andrew Faught*

# Study Hall

## Selected Faculty Scholarship

Capturing the breadth and impact of Berkeley Law's faculty research could fill countless pages. Here is just a sampling of professors' wide-ranging scholarship over the past year.



## WHEN POLICE KILL



F. Zimring

**Franklin Zimring's book *When Police Kill*** reveals that U.S. law enforcement officers shoot and kill about 1,000 people each year—almost double the official estimates. Providing the first

legal empirical analysis of police shootings, Zimring studies a swath of government records and mass media reports, examines data from other developed countries, and finds that the U.S. compares poorly.

Suggesting a series of reforms to save lives without jeopardizing officer safety, Zimring argues that any changes to policing must start within local law enforcement agencies. As for why the FBI fails to more carefully audit and collect data

on lethal encounters with police, he says lax rules on the use of deadly force have made those who represent police interests terrified of quality empirical research.



## SURVEYING SURVEILLANCE



C. Crump

**Major American cities have acquired** high-tech surveillance tools without the knowledge of elected officials and the public. An example: After a city council review that lasted literally

two minutes, Oakland created a data integration center that networked together all of its existing surveillance infrastructure. How is this possible? Research by Catherine Crump demonstrates that the answer is federal procurement.

Her article is the first to comprehensively explore the intersection of procurement and local surveillance policymaking. It shows how the federal government funnels billions of dollars to local law enforcement agencies that can be used to buy surveillance equipment. Crump proposes politically feasible steps to bolster local accountability, transparency, and input regarding what technology should be adopted and when it should be used.



BUSINESS  
LAW

## STOCK MARKET SCENE



R. Bartlett

**Robert Bartlett and Justin McCrary** counter a common theory of stock market abuse that high-speed traders are gouging investors—one that was touted in Michael Lewis' best-selling book *Flash Boys*. Their detailed study refutes the idea that such traders fail to offer the best price available



J. McCrary

to offer the best price available to customers and exploit those using slower public data feeds.

Using timestamp data from the two Securities Information Processors (SIPs), Bartlett and McCrary conducted the first market-wide analysis of the latency with which SIPs process quote and trade data. Despite latencies averaging 1.13 milliseconds for quotes and 22.84 milliseconds for trades, surrounding data shows little evidence that “fast” traders initiate such orders to capitalize on stale stock quotes for profit.

## BANKRUPTCY ON THE SIDE



K. Ayotte

**Kenneth Ayotte** tackles the controversial issue of side agreements in corporate bankruptcy, in which one party stays silent at certain points of

the reorganization. His research paper, written with two co-authors, identifies how to maintain the benefits of these agreements, limit their negative impacts, and clarify when to resolve disputes in or out of bankruptcy court.

Ayotte's paper proposes that if a side agreement is unlikely to cause externalities, a court should enforce it according to its terms. But if there is real potential for value-destroying externalities, the court should limit a non-breaching party's remedy to its expectation damages. This contrasts sharply with the case law's current approach, which focuses on tougher contract interpretation standards instead of remedy limitations.



CIVIL &  
SOCIAL RIGHTS

## WORKPLACE DISCRIMINATION

**Lauren Edelman '86** received the first copy of her new book on November 7, election eve. “It's not often the world changes the day after your book comes out,” she says. Her colleagues believe the award-winning *Working Law: Courts, Corporations, and Symbolic Civil Rights* could help change the world of workplace race and gender discrimination, which persists even though almost all companies have anti-discrimination policies in place.

While unearthing a system of increasingly feckless policies and procedures that sustain longstanding discrimination patterns, Edelman finds that symbolic civil rights have replaced substantive civil rights. Her theory of “legal endogeneity” describes how institutionalized organizational structures and practices strongly influence judicial notions of legality and compliance.

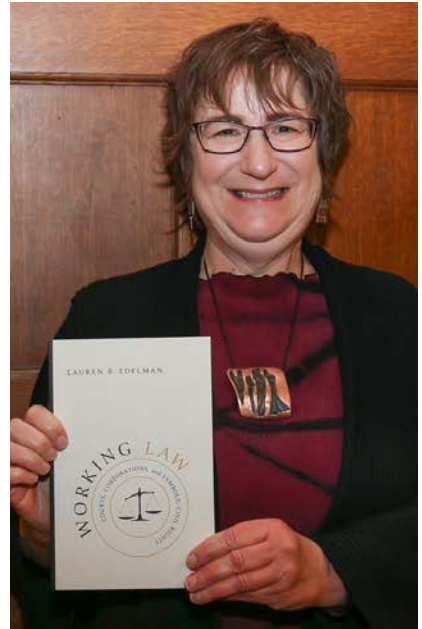

L. Edelman

## FAIR EDUCATIONAL OPPORTUNITY



T. Syed

**A new paper by Talha Syed** asks: what does fair educational opportunity mean for students who, on account of disability, have differential needs and capacities from others? For more than 30 years, that question has stymied courts and commentators alike in their efforts to ascertain the appropriate scope and guiding principles of the Individuals with Disabilities Education Act.

While the law entitles eligible students to individualized education programs that provide “adequate” educational benefit, what counts as adequate remains a source of contention. Syed offers a comprehensive answer by advancing a new principle of distributive justice that reframes the issue of adequate benefits as one of distributive equity, rather than nondiscrimination or equality of opportunity.



# THE HABEAS PRIVILEGE



A. Tyler

**The English Habeas Corpus Act of 1679 was a response to** perceived failings by the royal courts and the common law writ to check executive excess at the expense of individual rights. Amanda Tyler’s recent article explains the Act’s huge impact on the development of habeas jurisprudence in English law—greater than most jurists and scholars recognize—and its influence on early American habeas law.

Much of that law did not surface through judicial innovation, Tyler notes, but from efforts to incorporate the Act’s key protections. She says the Act also formed the model that the founding generation imported into the U.S. Constitution’s Suspension Clause. Her research tackles the statutory origins of the habeas privilege, which famed English Judge William Blackstone called “a second magna carta.”

# DEPENDENT STATES



K. Tani

**A scholar of American legal history and social welfare law,** Karen Tani explores the evolution of welfare in the United States in her book, *States of Dependency: Welfare, Rights, and American Governance, 1935-1972*. Spanning the New Deal to the modern era, Tani provides a unique understanding of how the social-services program emerged and how it redefined the meaning of citizenship.

The book elucidates how the welfare system implicates federalism, including the division of powers and responsibilities between different levels of government. It posits that disagreements about welfare are often, at heart, conflicts about who should have access to the benefit of citizenship and which level of government ought to decide. With more than 45 million Americans living below the official poverty line, it is a timely topic.



# TRACKING THE IMPACT OF RAPID GROWTH

**As human actions create more** changes to the planet, Eric Biber says rapid growth in technology and population will expand government involvement in many areas of society. His paper *Law in the Anthropocene Epoch* predicts continual updating of regulations and laws in response to these challenges, pressuring American legal doctrines and norms.



E. Biber

Because the effects of human activity now substantially influence the whole planet, earth scientists are considering identifying a new geologic time period, the Anthropocene. As humans adapt to major changes in oceans, climate, and other vital functions society relies on, Biber foresees greater government involvement in many human activities—and constant updating of government laws and regulations.

# A TROUBLING IMPLEMENTATION GAP

**The gap between legislative** expectations and actual outcomes is especially cavernous in environmental law. Daniel Farber explains how the work of lawyers in the field largely involves compliance or enforcement efforts rather than rulemaking. One of his recent articles describes how best to counter weak government enforcement, including citizen suits and the use of “big data” to help identify potential violators.



D. Farber

Farber also demonstrates how agencies can devise new methods of achieving statutory goals not initially anticipated by the legislature—so long as “creative implementation” does not stray far from the statutes. He notes that while mismatches between implementation and statutes can produce useful results, they also risk damaging our concept of the rule of law.



## CALIFORNIA'S HIGH COURT



H. Scheiber

With his latest book, *Constitutional Governance and Judicial Power: The History of the California Supreme Court*, Harry Scheiber charts a compelling journey from humble beginnings to one of the nation's most respected state courts. He also explores the court's hefty impact on

California's cultural, socio-economic, and political landscape over its first 165 years.

Scheiber writes about the court's jurisprudence from 1964 to 1987, when it tackled such crises as the Los Angeles riots, school busing, gay rights, and farm strikes. He also edits chapters by fellow scholars, including longtime Jurisprudence and Social Policy Program administrator and instructor Charles McClain. The book has been called the most complete, authoritative study of any state supreme court.

## MULTIDISTRICT FAIRNESS



A. Bradt

Nearly all mass-tort multidistrict litigation (MDL) settles, but judges cannot reject a settlement they deem unfair.

Probing the judiciary's proper role in handling MDL cases, Andrew Bradt says judges should be able to issue non-binding opinions about a settlement's fairness, which would enable parties to make informed decisions about whether to accept it.

With the Supreme Court's hostility to class actions, MDL cases make up nearly half of the federal civil caseload. But unlike in class actions, MDL judges have no authority to reject a settlement agreement as unfair to the potentially thousands of parties involved. Bradt and his co-author argue that letting a judge act as an "information-forcing intermediary" would mitigate many agency problems inherent to MDL.



## PRIVACY ON THE GROUND

Privacy scandals now form a regular part of the news cycle—rocking industries, harming relations between countries, and sparking citizen mistrust of government. While the public favors stronger regulation, Kenneth Bamberger and Deirdre Mulligan saw little evidence of whether it



K. Bamberger

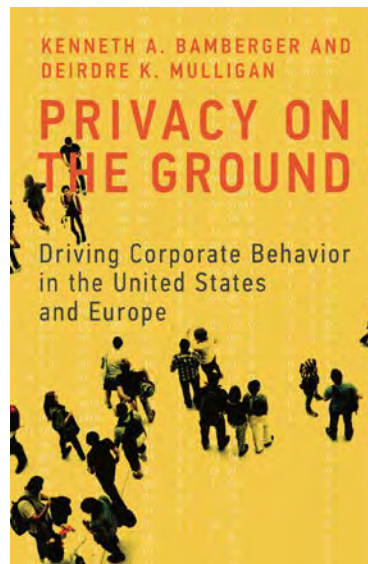

worked, and sought to change that in *Privacy on the Ground: Driving Corporate Behavior in the United States and Europe*.



D. Mulligan

Given the 2016 International Association of Privacy Professionals' Privacy Leadership Award, the book presents a five-nation study on how those charged with protecting privacy do their work and what types of regulation shape their behavior. The authors discuss corporations' best practices, offer guidance to policymakers, and share key lessons for anyone concerned with privacy.

## NOTICE AND TAKEDOWN



J. Urban



B. Schofield

More often than not, decisions on whether to remove online content based on alleged copyright infringement are made by a computer algorithm. A report co-written by Samuelson Clinic for Law, Technology & Public Policy

Director Jennifer Urban '00 and fellow Brianna Schofield '12 shows how this impersonal approach often leads to misguided takedown actions that would benefit from human review.

Drawing on three main studies, they suggest that whether notice and takedown "works" depends largely on the user and the actual use, and that no viable one-size-fits-all model exists. With the scale of online infringement leading to automated systems that leave little room for human review or discretion, Urban and Schofield suggest various reforms to both law and practice.





## BERKELEY SEED FLOWERS BACK HOME IN INDONESIA

**A powerful seed of Indonesia's human rights** movement was planted more than 8,000 miles away, in a Berkeley Law classroom. While studying for his LL.M. degree, Todung Mulya Lubis '78 took an International Human Rights Law class with Professor Frank Newman. The course changed the direction of his career—and his country.

"I began to spend more time studying human rights, interacting with activists, and attending rallies and demonstrations," Lubis says. "I realized I had a lot to do to help improve the human rights situation in Indonesia."

On May 13, Lubis—called "Jakarta's voice for the rule of law"—received UC Berkeley's prestigious Elise and Walter A. Haas International Award. The honor brought back some life-changing memories.

"Professor Newman told his students that when you became a human rights activist, what matters is human beings, not nationality," Lubis recalls. "I agree that fighting for human rights should not be stopped by national boundaries."

Lubis spent two years in Berkeley, to further his career and to escape danger. As a

**RELENTLESS:** Haas International Award winner Todung Mulya Lubis '78 remains a powerful voice for human rights.

young lawyer, some of his pro bono work defended media outlets that exposed corruption among Indonesia's ruling elite. He received death threats and had case documents stolen from his office during the authoritarian regime of Suharto, whose three-decade dictatorship was one of the most brutal of the 20th century.

After Lubis earned his LL.M., Berkeley Law Professor Richard Buxbaum asked him to write a joint textbook on economic law in developing nations and encouraged him to help his country. Upon returning home, Lubis galvanized support for reform, led his nation's Legal Aid Foundation, and published the first Indonesian Human Rights Report.

"It seemed ironic to have such reports published by Amnesty International and the U.S. State Department," he says. "Indonesia needs human rights reports prepared and published by Indonesians. I just filled the void, having been inspired by people like Professor Newman and Professor Buxbaum."

Lubis is the co-founder of Lubis, Santosa & Maramis, a top Jakarta firm specializing in corporate and commercial matters, intellectual property, and dispute resolution. But his country's fate remains intertwined with his work.

Thanks partly to his efforts, Indonesia has made important legal reforms in recent years. It separated the judiciary from the executive, and established the Constitutional Court and the Judicial Commission to strengthen checks and balances. Many courts now publish decisions on their websites, and judicial selections are more transparent.

"These are notable achievements," Lubis says. "But problems remain—corruption, collusion, nepotism. Corruption in Indonesia is among the worst in the world, including within the judiciary. This is our challenge."

After decades of pushing for change, Lubis shows no sign of slowing down. He holds leadership roles with several Indonesian NGOs that focus on legal reform, governmental transparency, and human rights.

"I still have a lot to do," says Lubis, 67. "I still owe a lot to my people."

—Andrew Cohen

# PARTNERS IN LEADERSHIP CAMPAIGN SPREADS ITS WINGS

**One word to best describe** the Partners in Leadership (PiL) campaign? Connection.

Yes, the annual fundraising drive—during which organizations with multiple Berkeley Law grads seek to attain 100 percent alumni giving—supports vital school programs. But participants also relish the rewarding byproduct of connecting with fellow alums.

Given that Silicon Valley is the tech hub connecting our world, it makes sense that PiL has veered into the area.

“As more people leave firms and move in-house, it’s important to continue to foster a spirit of community among those alums,” says Monique Liburd ’08, Google’s trademark counsel.

In the tech world, Liburd sees Berkeley Law graduates “on the front lines in so many areas. Who better to serve as mentors and advocates for fellow alums and current students looking to enter the industry than those

of us working directly in that space?”

Liburd recently signed on as a PiL captain. Each participating organization has at least one captain who brings graduates together, encourages them to donate, and shares updates about the school and its challenges.

“It seemed like a great way to leverage my natural interest in keeping in touch with my classmates and colleagues to do something with meaningful impact for the school,” Liburd says.

Campaign co-chair David Zapolsky ’88, general counsel of Amazon.com, is thrilled to see PiL grow deeper roots in Silicon Valley. Over the past two years, Google, Eventbrite, Netflix, Dropbox, Lyft, Salesforce, and Uber have all joined the campaign.

“Many of our most accomplished alumni have gone in-house to join some of the coolest and most innovative companies in the world,” Zapolsky says. “Yet some of



**NUMBER ONE:** Howard Clowes '82, whose law firm (DLA Piper) won the “Mod A” giving competition, with PiL co-chair Tyler Gerking '02

our alumni programs tended to overlook this important community of lawyers in the past. We’re changing that. Adding these companies to the campaign shows how enlisting these alumni can move the needle in improving alumni engagement with Berkeley Law.”

Law firms still form PiL’s backbone, of course. During last year’s six-week campaign, participating “Mod A” organizations—those with 30 or more Berkeley Law graduates—engaged in a rousing competition for highest giving percentage.

Following dramatic shifts atop the leaderboard, DLA Piper (captained by Howard

Clowes '82 and George Gigounas '00) surged ahead in the final week to claim first place with an 89 percent giving rate. Fenwick & West, led by Jennifer Bretan '04, and Morrison & Foerster, led by Sara Terheggen '07 and Allison Lauterbach Dale '14, placed second and third.

Liburd is happy to follow their lead.

“It’s really great getting to know people within your organization who have the shared experience of attending Boalt,” she says. “I had no idea some of the colleagues I interacted with were also alums until the campaign started. Because of PiL, many of us have become more energized around supporting the law school—and each other.”  
—Andrew Cohen

**TECH TITANS:** Monique Liburd '08 (Google) and Gregory Davidson '88 (Gibson Dunn) at a PiL event



Welcome to Berkeley Law Link

JOIN NOW

Connect with

LinkedIn

Facebook

Email

Why is it safe to register with LinkedIn / Facebook?



**Connect**

Find and reminisce with fellow graduates; see what they have been up to, and stay in touch.



**Network**

Seek and/or offer mentorship, employment, advice from fellow alumni.



**Engage**

Keep up with Berkeley Law news and find alumni events in your region.



**Advance**

Advance your career through alumni connections across the globe.

Recently joined



# BERKELEY IN A BLINK

**Moving to a new city or country?** Looking to change practice areas or find an expert in a specialized field? Now Boalties can easily connect with trustworthy contacts through B-LINK, a new online portal exclusively for alumni.

Just launched, B-LINK ([law.berkeley.edu/blink](http://law.berkeley.edu/blink)) is a social hub and networking destination for graduates across generations and geography.

“Our alumni are leaders in every area of the legal profession, working at firms and organizations across the world,” says Amy Ambrose, Berkeley Law’s Assistant Dean of Advancement. “One of our priorities in the Alumni Center is to enable our com-

munity to remain engaged with the law school and tap into the vast benefits of the Boalt family.”

As well as an alumni directory that can be searched by practice area, firm, city/region, interests, and affinity groups, B-LINK is a one-stop destination for law school news and events. The platform also lets users share their own professional

updates, photos, and events.

With Reunion Weekend approaching (see page 59), alums can use B-LINK to find classmates they have lost touch with and start planning their return to the old haunts. Or for those who would rather attend something in their own region, the platform allows users to easily find fellow Boalties, form a local chapter, or organize a

“BEING ABLE TO EASILY CONNECT WITH ONE ANOTHER THROUGH B-LINK ... HELPS US AMPLIFY OUR EFFORTS AND BUILD A MORE CONNECTED COMMUNITY OF ADVOCATES.”  
—CAMILLE PANNU ’11

**PRIME PORTAL:** B-LINK is a new social hub and networking site for Berkeley Law alums.

social or networking event.

“Boalt alumni do amazing work across the country and throughout the world,” says Camille Pannu ’11, director of the Aoki Water Clinic at UC Davis School of Law. “Being able to easily connect with one another through B-LINK to share information, resources, and friendship helps us amplify our efforts and build a more connected community of advocates.”

The platform also provides a space to share and look for jobs, offer or seek professional mentoring or advice, and find important information related to the alumni community.

Monitored by the school’s Alumni Center, B-LINK is a closed network accessible only to Berkeley Law graduates. Alums can log on to B-LINK using their LinkedIn or Facebook credentials, or via email. Even for those who rarely use social networks, registration takes only a few minutes, and the benefits are vast and varied.

The Alumni Center encourages graduates to join B-LINK and start connecting with fellow Boalties. This is a new platform, and Berkeley Law staff members are continually working with the developer to make improvements. Feedback is greatly valued. If you have any suggestions, troubles, or questions, please email [blink@law.berkeley.edu](mailto:blink@law.berkeley.edu).  
—Rachel DeLetto



# OUTPOURING OF CALIFORNIA LOVE FOR BIG GIVE

**HEARTFELT:** Berkeley Law's DeCarol Davis '17, Hamza Jaka '18, and Matt Kempf '17 pump up the giving spirit.

**Just as the butterfly effect** suggests that small actions can cause large, resonating effects, small actions that support Berkeley Law make a big impact on the school and the world around us.

This concept stood at the heart of “The Berkeley Effect,” the theme of UC Berkeley’s annual Big Give—a one-day, campus-wide fundraising campaign held November 17, 2016. And the law school’s alumni mobilized en masse to support future generations of Boalties.

“We are humbled and incredibly grateful for the outpouring of generosity from our alumni during Big Give,” says Interim Dean Melissa Murray. She notes that the majority of gifts

were allocated to the Boalt Hall Fund, which finances student scholarships, programming, public interest fellowships, and Berkeley Law’s Loan Repayment Assistance Program.

From the jovial “carpool karaoke” video featuring Dean Murray and current students to a stream of photos, good wishes, and support via social media channels, Boalt pride overflowed throughout the 24-hour fundraising blitz.

During the campaign, Berkeley Law raised a total of \$803,866 for its students, with more than 1,000 gifts from alumni, faculty, staff members, students, and friends. Thanks to its community’s robust participation, Berkeley Law

received an additional \$12,880 from the university through incentive-based funding based on various benchmarks.

A special shout-out to graduates of classes 2006-2016: Thanks to you, Berkeley Law tied for the most young alumni donors of all units on campus. What’s more, those gifts were matched 2-to-1 by the alumni-supported Boalt Young Alumni Matching Gift Program.

The law school also received great support from seed gift donors, who pledged \$5,000 or more in advance of Big Give.

International alumni also stepped up, sending gifts to their alma mater from Brazil, Canada, China,

Finland, France, Germany, Great Britain, Hong Kong, Japan, the Netherlands, Taiwan, and the Virgin Islands.

“For over 100 years, Berkeley Law has empowered its graduates to influence change across the country and the world,” says Assistant Dean of Advancement Amy Ambrose. “Now, through Big Give and other fundraising initiatives, our alumni are helping the students of today have access to the same opportunity. We’re so thankful for their ongoing support and pride in this outstanding institution.”

Mark your calendars for this year’s Big Give on Thursday, November 16. —Rachel DeLetto

# REVVING UP FOR REUNION

**Rekindled friendships,** educational panels deep with insight, impressive moves on the dance floor—all are among the fond memories from last year’s Alumni Reunion Weekend.

But for many attendees, the emotional outpouring during a ceremony celebrating the life and legacy of Joyce Hall, Boalt’s longtime bookstore manager, truly exemplified the spirit of Berkeley Law. Hall, who retired in 2008, passed away in December 2015.

With summer fast approaching, it’s time to start planning a return to Berkeley

for Boalt Hall’s Alumni Reunion Weekend 2017, scheduled for Friday and Saturday, October 6-7. All graduates are encouraged to come celebrate our beloved institution and its incredible community.

This year, Reunion begins Friday evening with a family-friendly barbecue on the law school’s rooftop terrace. Catch up with friends and faculty, learn about the impressive work of current students, and meet new Berkeley Law Dean Erwin Chemerinsky as the sun goes down over the Bay.

On Saturday, start the

morning with networking and brunch before heading into a perennial Reunion favorite, the *Supreme Court Update*. Professor Emeritus and former Dean Jesse Choper, Professor Melissa Murray, and other constitutional law experts will discuss key developments and decisions from the highest court.

The most anticipated Reunion event features a Town Hall with Dean Chemerinsky. He will discuss the state of the law school, outline his vision for maximizing its potential, and take questions. This event

will be livestreamed for those who are unable to attend; stay tuned to Berkeley Law’s social media channels for details.

After lunch, faculty and alumni on the front lines of fighting proposed rollbacks of state rights will present an MCLE panel on *The California Resistance*.

Later, choose between two interactive workshops: experience how Berkeley Law provides innovative, real-world training to students, alumni, and practitioners from around the globe at *Startup Deal Camp Workshop*, or learn about student pro-bono projects in environmental law, immigration, and criminal justice—then work with students to expand these and other initiatives at *Pro Bono in Practice*.

Members of graduating classes ending in ‘2’ and ‘7’ are invited to individual Reunion Class Cocktail Parties + Dinners, where they’ll have time to reminisce about law school days and find out where life has taken their fellow classmates. Finally, all will gather for drinks and dancing under the stars on Berkeley Law’s rooftop garden.

Act fast: Register by June 30, and get an early-Bear special discount of 20 percent off the full program price. Visit [law.berkeley.edu/reunion2017](http://law.berkeley.edu/reunion2017) for more details. We can’t wait to see you at Reunion!

—Rachel DeLetto



# A TRULY GLOBAL COMMUNITY

**International business,** economic, and political relationships are increasingly crucial to many areas of law. With graduates living and working in 103 countries, and faculty and students contributing to high-profile international scholarship and service, Berkeley Law is making a big imprint on the global legal profession.

The school houses many projects with far-reaching impact. The Korea Law Center works with overseas partners to examine and improve the legal, constitutional, and political systems in South Korea. The International Refugee Assistance Project—recently honored with a UC Berkeley Chancellor’s Award for Public Service—provides

legal assistance for clients in life-or-death situations, including Iraqis and Afghans at risk for their work as interpreters with the U.S. military. Nare Aleksanyan ’17 and Carla Gharibian ’17 organized Irava-Tech, the first law and technology conference in Armenia. And that’s just a sampling.

Beyond Berkeley lies a vast network of alumni who are leading judges, attorneys, and legal professionals in their countries. For more than 60 years, Berkeley Law has trained lawyers from across the world in its Master of Laws (LL.M.) program. With the launch of the Professional Track LL.M. program in 2009, students from abroad now surpass U.S. stu-

dents in graduate numbers each year.

It can be difficult for alumni, especially those far away from the school, to remain connected to their alma mater. That’s why the Alumni Center has redoubled efforts to engage with Boalt’s international community.

In December, Interim Dean Melissa Murray attended the Boalt Hall Alumni Association of Japan’s annual meeting, spent an afternoon with alums at Latham & Watkins in Hong Kong, and delivered the keynote at the Berkeley Club’s alumni gala in Seoul.

Then in January, the International Association of Boalt Alumni celebrated its 50th anniversary in Berlin. And in April, Berkeley Law

faculty hosted an alumni and admitted-student reception in Mexico City.

But this covers just a tiny fraction of the school’s international community, which is why the Alumni Center hopes graduates far and wide will join Berkeley Law’s new alumni portal, B-LINK [see page 57 for details].

“B-LINK is an amazing asset for our international alumni,” says Assistant Dean of Advancement Amy Ambrose. “Not only will they be able to connect with fellow alumni in their country, but they can also organize regional events for networking and socializing with other Boalties and remain up to date on all of the wonderful things happening at the law school.” —Rachel DeLetto

“WITH GRADUATES LIVING AND WORKING IN 103 COUNTRIES ... BERKELEY LAW IS MAKING A BIG IMPRINT ON THE GLOBAL LEGAL PROFESSION.”



**SEOUL FULL GATHERING:** On December 5, 2016, the Berkeley Club of Korea enjoyed a great turnout for its annual gala in Seoul.

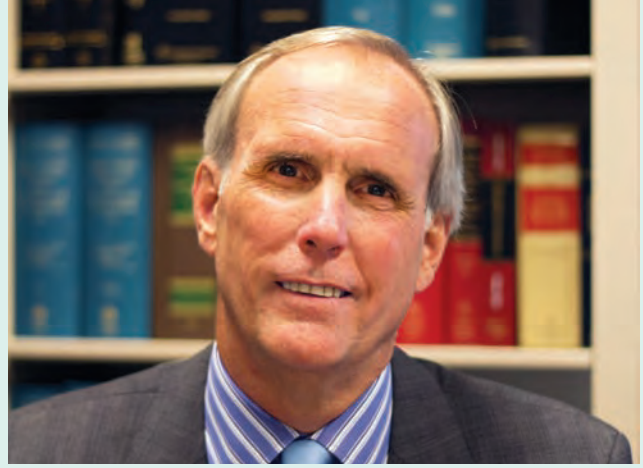

**BOARD GAME:** Karen Boyd '96 and Paul Clark '80 eagerly joined the Boalt Hall Alumni Association board of directors.

## BOALT HALL ALUMNI ASSOCIATION BOARD OF DIRECTORS

### Executive Committee

John Kuo '88  
*President*

Nancy Fineman '86  
*Past president*

Melissa Murray  
*Interim dean*

### Directors

Karen Boyd '96  
Gregory Call '85  
David Carrillo '95  
Paul Clark '80  
Benson Cohen '04  
Evan Cox '87  
Andrew Davis '99  
Tyler Gerking '02  
Sonia Gonzales '07  
Yury Kapgan '01  
Kevin Kennedy '91  
Jennifer Kobayashi '01  
Mark Lubin '77  
Michael Martinez '78  
James McManis '67  
Kim Natividad '09  
Carly O'Halloran Alameda '06  
Lynn Pasahow '72  
Jeffrey Purcell '11  
Cara Sandberg '12  
Sean SeLegue '91  
Jay Shafran '63  
Arthur Shartsis '71  
Mary Jo Shartsis '72  
Sara Terheggen '07  
Duane Valz '96  
Lenard Weiss '62  
Sarah Weiss '10  
Jeffrey Wolfstone '77  
David Zapolsky '88

### Faculty Representatives

Stephen Bundy '78 (Emeritus)  
Jesse Choper (Emeritus)

# NEWCOMERS ADD FRESH INGREDIENTS

**They bring to the table myriad** backgrounds and vantage points, but new members of the Boalt Hall Alumni Association board of directors share a common goal: helping the law school deftly navigate the terrain ahead.

For Paul Clark '80, geography can't deter his desire to contribute. A partner in the Washington, D.C. office of Seward & Kissel, he wants to increase alumni engagement.

"Lack of engagement with a school breeds apathy and disinterest in the state of that school," Clark says. "Some of this can certainly be addressed by greater engagement among alumni themselves, but Boalt must help facilitate this interaction through faculty and staff visits."

Clark joined the advisory board of the Berkeley Center for Law, Business and the Economy (BCLBE) in 2010. That generated renewed contact with faculty and alumni—and the school itself.

Impressed with how Professors Robert Bartlett

and Steven Davidoff Solomon and BCLBE Executive Director Adam Sterling '13 have created "a very exciting environment for learning business law," Clark wants to fuel the business of sustaining Boalt's overall excellence.

"The main challenge, and the challenge our board can best address, is the utterly abysmal giving rate of alumni," Clark says. "We've consistently been below 20 percent, well below our peer public law schools like UCLA, Virginia, and Michigan."

For Karen Boyd '96, returning to Boalt as an adjunct lecturer from 2002 to 2009 "reminded me just how important the school has been to my professional life. When I was asked to join the board, it seemed like a great opportunity to engage with the school in another important way."

A founding partner at Turner Boyd in Redwood City, she knows a thing or two about successful transitions. Boyd launched her own practice in 2008 after 10 years at a large firm

(Fish & Richardson).

"Boalt is shifting from being primarily supported by the state to having to rely on other sources," she says. "This is where the alumni board comes in. Most of our peer law schools have decades or even century-long traditions of substantial alumni giving. Traditionally, Boalt hasn't needed that. But times change, and our alumni engagement—including financial support—needs to change with it."

While the board's diversity reflects that of the school's 17,000-plus graduates, its members share a common determination.

"The resilience of the school amazes me," Boyd says. "Many great professors and staff I knew as a student, I couldn't imagine Boalt going on without them. And yet, as they've retired or passed away, the school continues to churn out great lawyers and great research year after year. Maybe that shouldn't be surprising. Maybe that's just the nature of great institutions." —*Andrew Cohen*



INSIGHT: SENATOR HENRY STERN '09

# Sacramento's Challenge of Redefining Federalism

**Henry Stern, 35, is the first millennial elected to the California State Senate and represents nearly a million residents in the 27th District. Stern chairs the Senate Committee on Elections and Constitutional Amendments, and also serves on four other committees.**

“CALIFORNIA LAWMAKERS WILL WORK DILIGENTLY TO PRESERVE THE ENVIRONMENTAL QUALITY OF LIFE OUR RESIDENTS EXPECT.”

Sitting in Con Law in 2007, listening to then-Professor Goodwin Liu impart the tricky tensions of federalism, I had no idea these lessons would become so valuable to preserving progress a decade later.

After the divisive 2016 national election, California finds itself girding for battle with Washington. At risk are rollbacks of billions of dollars in federal funding, as well as rules, regulations, and laws that protect our health, environment, civil rights, and safety.

The Constitution provides many tools—the anti-commandeering doctrine, dormant Commerce Clause, preemption limits under the Supremacy Clause—to help states chart their paths forward, undisturbed. Nevertheless, the often porous boundaries between state and federal authority will be tested on many fronts in the coming years, with California likely at the tip of the spear.

As the Senate's resident environmental lawyer, I'm working with Senator (and former Boalt classmate) Ben Allen, and Senate President pro Tempore Kevin de León, to make federal environmental and worker safety regulation enforceable as a matter of state law. Senate Bill 49 would erect a “green wall” of sorts.

By requiring state environmental, public health, and worker safety agencies to take all actions within their authorities to ensure that federal standards enacted during the Obama Administration remain enforceable in California, SB 49 would prevent the Trump Administration from administratively undermining them by mere federal fiat, without an expressly preemptive act of Congress.

While California has some of the nation's strongest environmental policies, it relies on an overlapping network of state and federal rules.

For example, the Clean Air Act enables California to regulate air pollution caused by vehicles more strictly than the federal government. Yet comments from the new Administrator of the Environmental Protection Agency convey a desire to deny California its “waiver authority.”

Just as California continues to resist federal interventions in its approach to health care and immigration, California lawmakers will work diligently to preserve the environmental quality of life our residents expect regardless of the change of perspective in Washington.

As Justice Louis Brandeis memorably observed in his landmark dissent in *New State Ice Co. v. Liebmann*, “a single courageous State may, if its citizens choose, serve as a laboratory; and try novel social and economic experiments without risk to the rest of the country.”

California has the courage, but whether the federal government—administratively or congressionally—decides to turn federalism on its head and preempt states' rights to be as progressive as they choose remains the critical open question.



# Class

# Notes

All in the  
Alumni Family

Your  
Classmates  
Want to Hear  
From You!

## CONTACT US

### BY EMAIL

classnotes@law.berkeley.edu

### BY MAIL

Alumni Center  
UC Berkeley School of Law  
224 Boalt Hall #7200  
Berkeley, CA 94720-7200



## 1962

**Kathryn Mickle Werdegar**, a California Supreme Court justice, will retire on August 31. She wrote some groundbreaking decisions in her 23 years on the court, including a 1996 ruling that required business owners to abide by civil rights laws despite their religious beliefs. The first woman elected editor-in-chief of the *California Law Review*, Kathryn previously worked at the U.S. Department of Justice, taught at the University of San Francisco's law school, and directed the California Continuing Education of the Bar's criminal law division.

## 1965

**Roy Doolan** was born in Manila, Philippines, and spent his formative years there. In his book, *My Life in a Japanese Prison Camp During World War II*, Roy and his father describe first-hand experiences of what happened in the Philippines during the war.

**Michael Halloran** joined two longtime friends and colleagues to open Halloran Farkas + Kittila, a national corporate and litigation boutique with offices in Palo Alto; Washington, D.C.; Wilmington, Delaware; and Jackson Hole, Wyoming. Michael formerly headed Pillsbury's Corporate Securities and Financial Practice and was counselor to the Securities and Exchange Commission (SEC) chairman and deputy chief of staff.

## 1967

**Timothy Laddish** was named to the Calaveras County Planning

Commission in January. A former senior assistant attorney general for the California Attorney General's Office, Timothy is also a volunteer water tender driver for the Central Calaveras Fire and Rescue Protection District.

## 1968

**Philip Anisman** has joined the Ontario Securities Commission as a part-time member.

**Bob Rhodes** was honored by Leadership Florida with the Governor Le Roy Collins Lifetime Achievement Award.





CARL ANDERSON '62

## A ROCK SOLID DECISION

**As a Berkeley undergrad, Carl Anderson couldn't see a law career for the trees. Or, rather, the rocks.**

"I had never met a lawyer before," he says. "But my Boy Scouts summer camp was up in the Sierra and I just loved geology. That's what I wanted to study when I went to Cal."

But university coursework required Saturday hikes, which often conflicted with another abiding passion: Golden Bear football games. Anderson played trumpet in the marching band. Meanwhile, other challenges weren't limited to climbing the Berkeley hills to map synclines and anticlines. He suffered bouts of poison oak, and "I was losing my eyesight in the mineralogy lab, trying to look through little binoculars and magnifiers at all these facets on all these stones."

A career assessment test, quizzically, suggested that he become a farmer. He went back two years later, this time better prepared to appraise his interests and talents.

"Law came out way on top," Anderson says.

And so marked the origins of a fruitful career. After law school, he spent a year in Germany on a Boalt fellowship before joining the Alameda County District Attorney's

Office. He served as a judge on the Alameda County Superior Court from 1975 to 1984, then was appointed to the state's First District Court of Appeal in San Francisco—a post Anderson held until he retired in 1997.

These days he's arbitrating and mediating business disputes, putting in 20 to 60 hours per week.

"I sort of flunked retirement," says Anderson, who lives in Piedmont with Margo, his wife of 52 years.

Never one to waste time, while on the Court of Appeal he wrote "Time on Appeal" (published by the American Bar Association and based on the experiences of five state intermediate appellate courts), posing suggestions to speed up judicial proceedings. When he joined the court, judges were laboring through a three-year case backlog.

"As far as the judges were concerned, we just had to work more," Anderson says. "We decided that by doing 10 opinions per judge, per month, we'd be able to clear the backlog in a couple years. And we did."

But the plan depended on superior court reporters filing transcripts more expeditiously—at the risk of being held in contempt of court.

"We didn't want to be heavy-handed and force fines on court reporters, but we wanted some cooperation," Anderson recalls. "Ultimately, we were able to get it."

Long before that, Boalt imparted some important lessons.

"You learn to ask a lot of questions and to be inquisitive," he says. "And you learn that maybe your first impression isn't always the right impression."

Even if it takes poison oak to drive home the point. —*Andrew Faught*

**Robert Freedman** retired as a judge of the Alameda County Superior Court on March 31.

## 1969

**Frank Orton** received an Honorary Doctor of Law degree from the Széchenyi István University in Hungary, where he has been a visiting professor since 2007. Frank is a former Swedish judge who has served as the Discrimination Ombudsman of Sweden and the Human Rights Ombudsman of Bosnia and Herzegovina.

## 1971

**William Bedsworth**, an appellate judge and award-winning columnist, published his third book, *Lawyers, Gubs and Monkeys: Laughing at the Law*.



**Robert Lutz**, a professor at Southwestern Law School, won the American Bar Association (ABA) Section of International Law's 2016 Lifetime Achievement

Award. Robert, who co-founded Berkeley Law's pioneering student journal *Ecology Law Quarterly*, received his award at the ABA's Annual Meeting in San Francisco.

## 1972

**Ray Bourhis** published his third book, *Billionaires and Bagmen: What Happens When a Small Town Takes Them On*. He describes his latest effort as "a not very fictional fiction."

## 1974

**Eric Danoff**, a partner in the San Francisco office of Sedgwick LLP, was recognized as a Northern California Super Lawyer for Transportation/Maritime on the annual list published by Thomas Reuters. Only up to 5 percent of attorneys in each state are named Super Lawyers.



**Albert Maldonado** retired from the Monterey County Superior Court in March after 22 years on the bench. The county's first Latino judge, he says he

## LOUISE ING '78 & COLBERT MATSUMOTO '78

# MAKING WAVES IN HAWAII

**Listening to classmates Louise Ing and Colbert Matsumoto provides a hint of why**

Hawaii has the highest life expectancy among all 50 states.

"Lawyers are much more congenial to each other here than you see elsewhere, partly because it's a small community and partly because it's ingrained in our culture," Matsumoto says. "There's a high level of sensitivity and courtesy, which makes for a pleasant work environment."

That ethos extends to giving back. Among their many philanthropic endeavors, Ing and Matsumoto support the Judge Martin Pence '31 Fellowship Fund—which honors the late Hawaii federal judge by helping talented Berkeley Law students who are from Hawaii or interested in practicing there.

"He enjoyed putting young lawyers through their paces, but he was very supportive of them and very fair," says Ing, who had a 10-year Ponzi scheme bankruptcy case before Pence, who died in 2000. "He made us become better lawyers."

Exhibit A: Ing, a founding shareholder and director of Alston Hunt Floyd & Ing, recently served as president of both the Hawaii Bar Association and Hawaii State Bar Foundation. She has received numerous honors for her legal work, community efforts, and legislative advocacy on women's reproductive health issues.

Exhibit B: After 20 years in private practice, Matsumoto became CEO of Island Insurance Company. A trustee of Hawaii's \$15 billion Employees Retirement System, he has led fundraising efforts for several nonprofits and raised \$9 million in nine months to save the Japanese Cultural Center of Hawaii from foreclosure.

"Living in an island community, we're sensitive to having limited resources and needing to work together," Matsumoto says. "I grew up on a pineapple plantation and could only attend Boalt because of a scholarship. The concept of giving back to organizations that fueled your success is inbred in most Hawaiians."

A tight-knit group, Honolulu's contingent of late-1970s Boalt alums gathers for an annual holiday party. Last October Ing, Matsumoto, Lily Nakagawa '78, Leigh-Ann Miyasato '79, and others took a European cruise together with stops in Prague and Copenhagen.

A fitting trip for friends from a school "that put me in the habit of pushing boundaries," Ing says. "Boalt challenged me and made me stronger in so many ways. I also made lifelong friends. I think that's why many of us here support the Pence Fund, to make sure new generations get that same opportunity."

While financial aid brought Matsumoto to Berkeley, institutional support helped him stay. After he bombed a first-semester quiz, Professor Herma Hill Kay called to express concern.

"She and so many others at Boalt supported me and helped me make it through," Matsumoto says. "I'm very thankful for those kindnesses. They made possible a life-changing and life-defining experience." —*Andrew Cohen*



# Class Notes

looks forward to returning to private practice, “where I will initially work as a volunteer attorney with Legal Services for Seniors in Seaside. I also will practice in Palm Springs and Los Angeles.”

---

## 1976

**Harold Brown** was named the Beverly Hills Bar Association’s 2017 Entertainment Lawyer of the Year. Brown, a partner at Gang, Tyre, Ramer & Brown, has a roster of clients that includes Steven Spielberg, Stephen King, Robert Zemeckis, Heidi Klum, Dwayne Johnson, and Gwyneth Paltrow, among many others.

---

**Bill Sokol** has been serving as an appointee of Governor Jerry Brown on the new California Secure Choice Retirement Investment Board.

---

## 1977

**Arlene Mayerson** won this year’s ABA Paul G. Hearne Award. A lecturer at Berkeley Law, Arlene is the directing attorney at the Disability Rights Education & Defense Fund.

---

## 1978

**Constance de la Vega** was given the Warren G. Christopher International Lawyer of the Year award by the California State Bar’s International Section in October 2016.

**Jon Michaelson** is the new managing partner of Kilpatrick Townsend & Stockton’s Silicon Valley office in Menlo Park. He acts as trial counsel in cases spanning many disciplines, including intellectual property, employment law, class actions, competition issues, and complex commercial controversies. Jon is also active in various area civic organizations.



---

## 1979

**Patricia Lucas** took office as presiding judge of Santa Clara County Superior Court on January 1, 2017.



---

## 1980

**Doug Straus** was named managing partner of Archer Norris, which has offices in

Los Angeles, San Francisco, and Walnut Creek. A partner there since joining the firm in 2000, Doug has been a member of the firm’s Management Committee for the past two years. He represents private and public sector clients in such areas as financial services, real estate development and lending, solid waste management, and health care.



---

## 1981

**Monica Dell’Osso** joined Wendel, Rosen, Black & Dean as a partner in its trusts and estates practice group. She has more than 35 years of experience in trust and estate law and is a certified specialist in the field.

---

**David Hercher** in January became a judge of the U.S. Bankruptcy Court for the District of Oregon in Portland.

---

## 1983

**Keith Hiraoka** was appointed to Hawaii’s First Circuit Court by Governor David Ige. Keith had been an attorney at Roeca Luria

Hiraoka (now Roeca Luria Shin) in Honolulu, and served as the governor’s campaign manager.



---

## 1984

**Gregory Brittain** was the guest speaker at the San Bernardino County Republican Women Federated’s monthly meeting in February. He is a civil attorney, host of the Unite IE radio show, and a founding organizer of the annual Unite IE Conservative Conference.

---

**Margaret “Maggie” Hughes** earned a Master’s in Counseling Psychology at Sonoma State. In 2009, she founded an educational consulting and tutoring business and now serves middle and high school students and their families in Marin County and San Francisco. Margaret specializes in helping students with learning differences succeed in rigorous academic environments.

---

## 1985

**Ruth Greenberg** had a case heard by the U.S. Supreme

CARLA DEWBERRY '80

# GIVING HEALTH CARE CLIENTS A VALUED VOICE

**The daughter of an Air Force officer, Carla DewBerry had a clear view of her career runway.**

"I always liked the idea of helping people solve problems," she recalls. "Becoming a lawyer seemed like a satisfying way to do that."

DewBerry's peers clearly applaud her decision, naming her to *The Best Lawyers in America* list in health care for each of the past seven years. A partner at K&L Gates in Seattle, she also focuses on mergers and acquisitions and tax matters.

After graduating from Berkeley Law, DewBerry worked in Arthur Andersen's tax department and helped design various hospital reorganizations. That led to more health care work upon joining a law firm in Seattle.

"The field has certainly changed," she says. "When I started, there wasn't much high-profile litigation. It was a small, close-knit group that knew each other and worked well together. Then Wall Street took an interest."

From DewBerry's perspective, more people investing in health care for financial reasons has produced both helpful and harmful results.

"It brings resources to the market that otherwise wouldn't be there, which benefits many nonprofits," she says. "But it also creates 'winners and losers' and extends the divide about how health care should be paid for and delivered."

Amid the chaotic landscape from President Obama's Affordable Care Act to President Trump's proposed American Health Care Act, DewBerry acknowledges stress and uncertainty in the industry. What repels some lawyers, however, attracts others.

"Some of us enjoy working in a space where there's no clear answer," she says. "And helping clients who truly want to give their patients better health care is incredibly enriching."

From owning a private law practice to serving as tax manager of a large multinational accounting firm, DewBerry relishes giving clients a voice.

"I represented a nonprofit client that wanted to partner with a more sophisticated nonprofit," she recalls. "At a



meeting of the executive teams, someone from the other side said something and I interjected. When I finished, an elderly woman on our board slapped her hand on the table and said, 'Yes!' I knew I'd given the other side an important look at her worldview."

DewBerry's own perspective was indelibly shaped at Berkeley. "I can't imagine having a better law school experience anywhere else," she says.

Grateful for how affordable the school was in the late 1970s—especially compared with today—DewBerry serves as her office captain for Berkeley Law's Partners in Leadership campaign (see page 56).

"When I went to Berkeley, it was cheap enough that I could work and pay for tuition myself," she says. "That's no longer remotely possible. All of us who benefited from that system should want to help the school's current students."  
—Andrew Cohen

ANGEL GARGANTA '92

## KEEPING IT ALL IN PERSPECTIVE

**Hard to believe, given his status as a leading consumer class action defense litigator, but Angel Garganta has pulled only one all-nighter as a lawyer.** While his commitment to work-life balance permeates Venable LLP's San Francisco office, where he is a hiring partner and co-chairs the firm-wide Class Action Defense Group, its roots extend to Boalt Hall.

Garganta left Princeton in 1984 to pursue a history Ph.D.



at UC Berkeley. His now-husband, fellow Princeton historian Michael Schwarz '93, soon followed and the couple settled in San Francisco. After realizing professional academia was not the right fit, both found their way to Boalt—and vowed not to let it consume their lives.

“We treated it like our job,” says Garganta, a Cuban immigrant who decided to apply his talent for turning facts into compelling storytelling to a law career while working as a paralegal. “Nine to five, then we went home and had dinner together.”

They even brought their domestic life to school, hanging out in the *California Law Review* lounge with their black lab Amelia.

Twenty years later, Garganta and Schwarz, now in-house counsel at Oracle, were married by retired federal Judge Marilyn Hall Patel, for whom Garganta had clerked.

Garganta cut his teeth representing big banks with “the old lions of the San Francisco bar,” at McCutchen, Doyle, Brown & Enersen (now Morgan Lewis). But after representing Dannon in various consumer class action suits, his focus shifted toward the food and beverage industry.

“There has been exponential growth in this area because of FDA information becoming available on the internet and consumers becoming more interested in healthy, natural, organic products,” Garganta says. This fueled his practice, as the Northern District of California is commonly called the “food court” because so many consumer class actions are filed there.

As a partner at Arnold & Porter, Garganta’s class action prowess earned the respect of both clients and opposing counsel. In 2014, Venable, which boasts one of the country’s top-ranked advertising practices, invited him to join the firm’s new San Francisco office as its fourth partner. In just over three years, Garganta has helped grow the office to more than 30 attorneys.

“We take pride in bringing in talented lawyers, but also people that will fit into our firm,” Garganta says. “It’s actually a lot like Boalt. That spirit of collaboration and helping each other you see among Boalt students, I like to think we have that at Venable.”

To help maintain his firm’s talent and diversity, Garganta has begun to develop a relationship with Berkeley Law’s La Raza student organization.

“People from different backgrounds bring a totally different perspective to the table,” he says. “And it’s an added benefit if they’re from Boalt.” —Rachel DeLetto

Court on April 19. A criminal defense lawyer, Ruth has represented Kentel Weaver, who in 2003 was a child accused of murder, since his conviction. She says the case's grapples with "the interplay between the right to public trial and the right to the effective assistance of counsel," and whether relief will be granted where "the trial lawyer did not know enough about public trial to object to courtroom closure."



## 1986

**Trina Thompson** was appointed to the board of directors for the National Council on Crime & Delinquency. She is a California Superior Court judge in Alameda County.

## 1987

**Uttam Dhillon** was appointed by President Trump to join a White House team that will address ethics and compliance matters. Named Special Assistant and Associate Counsel to the President, Uttam previously served as

Chief Oversight Counsel for the U.S. House of Representatives Financial Services Committee and as chief of the Department of Homeland Security's Office of Counternarcotics Enforcement.

## 1988

**John Adkins** was named the San Diego County Public Law Library system's director of libraries after nearly 20 years of academic law librarianship. He is also president of the Council of California County Law Librarians and sits on the American Association of Law Libraries' board of directors. John writes, "I owe my entire career ... to former Boalt Hall Law Library Director and Professor Bob Berring. He hired me as his secretary/clerk in 1983 and by his example inspired, challenged, and encouraged me to go to library school and law school."

## 1989

**Beverly Ortega Babers** was asked to serve as the U.S. Department of the Treasury's Agency Transition Director. In that role, she was the senior career Treasury official responsible for ensuring a fluid transition from the Obama Administration to the Trump Administration. Beverly works as the Department's Deputy Assistant Secretary for Management and Budget.

**Jeffrey Bleich** was elected chair of the J. William Fulbright Foreign Scholarship Board for 2017. Appointed by the President, the 12-member board oversees the worldwide Fulbright Program. A former U.S. Ambassador to Australia (2009 to 2013), Jeffrey is a partner in the San Francisco office of the global law firm Dentons. He previously served in the White House as special counsel to President Obama and chaired the California State University Board of Trustees.

## 1990

**Juliet Browne**, who chairs Verrill Dana's Environmental Law Group, authored a chapter of the MCLE book, *A Practical Guide to Land Use in Maine*. The guide covers topics ranging from licensing and permitting to wind energy and shoreland zoning. Juliet authored the chapter on the Maine Wind Energy Act.



**Juliet Davison** has been appointed by the Boston Bar Association to serve as

co-chair of its Solo & Small Firm Section until August 2018. Juliet, who founded Davison Law in 2008, advises employers and employees on their legal rights and obligations and often represents clients in the drafting and negotiation of employment, termination, and severance agreements.

### **Debra Green Garfinkel**

returned to full-time work as a writing specialist at Atkinson, Andelson, Loya, Ruud & Romo in Cerritos, California, after raising three children with her husband. Debra has published 27 children's books and young adult novels.

**Patricia Reilly** has been named a "Lawyer of the Year" in Litigation – Labor and Employment in the 2017 edition of *The Best Lawyers in America*. A shareholder in Littler's New Haven, Connecticut office, Patricia counsels and represents clients in multiple areas of employment law.

**Jonathan Shapiro** published the legal thriller *Deadly Force*, and presented "Pop Culture and the Perception of Justice" with David E. Kelley to a full house at the ABA's annual meeting in August 2016. An Emmy and Peabody Award winner, Jonathan has written and produced iconic television shows such as *The Blacklist*, *The Practice*, and *Boston Legal*.

MILES COOLEY '99

## FROM FOSTER CHILD TO A-LIST ADVOCATE

While millions pay to hear megastars Jay-Z, Rihanna, and 50 Cent on their iPhones, Miles Cooley receives a handsome hourly rate to hear them in person. Representing A-list celebrities across music and sports—litigating their cases and negotiating their deals—Cooley's star status in the entertainment law galaxy is light years removed from a harrowing childhood.

"I didn't get a good shake as a kid," he says. "Being a lawyer flows from my constant pursuit of justice back then."

Born to teenage parents, Cooley lived in several unhealthy settings as a child. His mother left for a year when he was 1, and Cooley was just 5 when he found her dead from a drug overdose. Put up for adoption, he spent seven rocky years with a Davis family who eventually put him in foster care.

Life turned at 16 when he moved in with Leslie Cooley, a school psychologist with whom he had bonded over the years. He excelled at Sacramento City College, then transferred to UC Berkeley.

A Peace Corps assignment followed in Ecuador, where Cooley became fluent in Spanish—and frustration. "I went in with enormous drive but had a miserable first year," he says. "We couldn't get anything done, and it was very difficult. It was a blessing, though. I had to dig deep in many ways, and we ended up doing some amazing projects for women and children."

Cooley flourished at Berkeley Law, winning the McBaine Honors Moot Court Competition award for both best brief and best oral argument. He went on to practice corporate law in Los Angeles, where one day a partner sought help with a new client. "Next thing I know," Cooley recalls, "I'm a third-year associate handling litigation for 50 Cent."

Word of Cooley's acumen spread quickly, leading to a four-year stint as general counsel for Rihanna and coveted legal work for Jay-Z and other celebrities. Now a partner at Kelley Drye & Warren, Cooley stays nimble in a fast-moving field.

The biggest misconception about representing celebrities? "That it's more glamorous than other work," he says. "It really isn't. While the profile might be a bit higher, you're still dealing with the same legal principles. Celebrities expect quality work and excellent results just like any other client."



A regular at Berkeley Law's annual sports law conference, Cooley is developing an educational boot camp program to prepare Cal student-athletes for life after sports. His extensive pro bono work also includes helping nonprofits that advocate for foster children.

"I know what that life can be," says Cooley, 47, who became a father in 2015. "I want to make sure other kids don't have it like I did." —*Andrew Cohen*



## 1992

**Karen Baynes-Dunning**, a former juvenile court judge, was honored by the State Bar of Georgia with its Justice Robert Benham Award for Community Service. The award hails lawyers and judges in Georgia who have made major contributions to their communities and demonstrated positive contributions beyond their legal or official work.

**Daralyn Durie** was featured in *Northern California Super Lawyers Magazine* as one of San Francisco's top intellectual property attorneys. She practices at Durie Tangri, which she co-founded, and worked with Google on its very first patent case.

**Howard Shelanski**, a former Berkeley Law professor, joined Davis Polk as a partner in the firm's Washington, D.C., office. A leading antitrust expert with high-level experience at the Federal Trade Commission and the Federal Communications Commission, where he served as chief economist [1999 to 2000], Howard is a law professor at Georgetown University. He was counsel at Davis Polk from 2011 to 2012 and returns from the White House Office of Management and Budget, where he was Administrator of the Office of Information and Regulatory Affairs since 2013.



## 1993

**Cynthia Taub** was elected partner at Steptoe & Johnson in the firm's Washington, D.C., office. Her practice focuses on myriad environmental regulatory and litigation matters, including biocides regulation, the Clean Water Act, and the National Environmental Policy Act.



## 1994

**Ethan Boyer** co-founded the law firm Noonan Lance Boyer & Banach, headquartered in San Diego.

**Amul Thapar** was nominated by President Trump to the U.S. Sixth Circuit Court of Appeals. The first South Asian Article III judge, Amul had served in the Eastern District of Kentucky.

## 1995

**Valerie (Horwitz) Alexander** was the 2016 commencement speaker at her undergraduate alma mater, Trinity University [Texas]. She has been a venture capital consultant, investment banker, executive at two media startups, and screenwriter. Valerie has also written multiple books about happiness as a second language.

## 1997

**Jahna (McGranahan) Lindemuth** was named Attorney General of Alaska, becoming only the second woman to hold the position. She took over the state's 550-employee Department of Law in August. Jahna had been a longtime partner at Dorsey and Whitney in Anchorage.



**Jennifer Madden**, elected as a judge of California's Alameda County Superior Court, was sworn in for the position in January.

**Ana Penteadó** (LL.M.) and her husband, Haas School of Business graduate Paulo Penteadó, co-authored an

article for *Australian Corporate Lawyer* (winter edition 2016) titled "Alternative Fee Arrangements—a Short Why, When and How." The article is available at <http://acla.acc.com/resources/the-journal>.



## 1999

**Khue Hoang** joined Hughes Hubbard & Reed as a partner in the firm's New York City office in January. Khue is an intellectual property and technology lawyer who advises clients on a broad range of patent litigation and licensing matters. She previously practiced law at Ropes & Gray, and was a process and product engineer for Rockwell Semiconductor Systems.

## 2000

**Carrie LeRoy** has joined White & Case's intellectual property practice as a partner in the firm's Silicon Valley office. She was previously counsel at Skadden, Arps, Slate, Meagher & Flom. Named one of *The Recorder's* 2016 Women Leaders in Tech Law, Carrie

JENNIFER BRETAN '04

## A ROUNDABOUT ROUTE TO THE FAMILY BUSINESS

**For Jennifer Bretan, family lore held that you were destined to become a lawyer, judge, cop, or criminal.** (A career court clerk, her grandfather helped establish New York City's court systems; another forebear was famed trial attorney Sidney Sparrow).

As a child, Bretan seemed predisposed to follow the legal path.

"I was a bit of an extrovert and a competitor," she says. "Combine those qualities, and it's not far-fetched to imagine

ending up as a lawyer."

At first, her career took a different tack. After graduating from Cornell, Bretan jumped into the entertainment industry, ultimately landing as a vice president of public relations at a boutique firm that later became Untitled Entertainment.

"It was so much fun, and you were really in the thick of it," she says of her time representing such clients as Martin Short, Molly Ringwald, Tim Burton, and Michelle Williams. "But I felt it incumbent on me to fulfill my family destiny."

Bretan quickly took Berkeley Law by storm, winning the McBaine Honors Moot Court Competition's best respondent brief award and advancing to its oral argument finals as a 2L.

"I could have been described as a little intense during law school," she says. "I put a lot of pressure on myself to make the most of it."

After accepting an associate position with Fenwick & West in San Francisco, Bretan took a class as a 3L in securities litigation and found her calling. Serendipitously, Fenwick was expanding that practice area at the time.

"There was a new team of securities litigators needing help," Bretan says. "On Day One I walked in and said, 'What can I do?' I've been doing it ever since."

And doing it well.

At the end of 2013, she was elected to Fenwick's partnership.

In 2014, on a matter of first impression, Bretan persuaded the Ninth Circuit to affirm the dismissal of a securities class action. The ruling established that a company's announcement of an internal investigation does not itself establish loss causation.

The following year, Bretan's team successfully argued to dismiss derivative claims against a company's directors. That decision, upheld by the Delaware Supreme Court, affirmed that directors are presumed independent even when their venture capital firms have historical ties to a company's founder.

Bretan also enjoys consulting with companies on litigation concerns. "It's equal parts law, crisis management, public relations, and counseling," she says. "It's a nice intersection that makes great use of the skills I developed earlier in my career."

Giving back to Berkeley Law is another priority for Bretan, who served as a captain in last year's Partners in Leadership campaign.

"I'm so grateful for everything the school gave me," she says.

For one, her ticket to the family business.

—Wendy Witherspoon



advises tech companies on IP strategy and mergers and acquisitions. She served as the lead IP attorney for Broadcom Corp. in its \$37 billion purchase of Avago Technologies Ltd. in 2015, and for SanDisk Corp. in its \$19 billion sale to Western Digital Corp. in 2016.

---

## 2001

**James Oleson** published a book based on his Ph.D. research 10 days before the birth of his first child, Jameson. *Criminal Genius: A Portrait of High-IQ Offenders*, provides some of the first empirical information about the self-reported crimes of people with genius-level IQ scores. James teaches sociology at the University of Auckland.

---

## 2002

**Cassie Springer Ayeni** has founded Springer Ayeni, where she will continue representing individuals in plaintiff-side ERISA claims, litigation, and appeals. Cassie was recognized this year by *Super Lawyers* as a Top 100 Attorney and Top 50 Woman Attorney in Northern California. She is also a past recipient of the *Daily Journal's* Top 20 under 40 award.

---

**Seth Shelden** recently completed a Fulbright Specialist grant, sponsored by the U.S. Department of State, teaching intellectual property law at Toyo University in Tokyo.

## 2004

**Meredith (Stow) Markwell** was named an attorney Of Counsel at the Las Vegas law firm Maupin · Naylor · Braster. A complex commercial litigation lawyer, Meredith focuses on appellate work and complex business disputes. She has also won multiple awards for her pro bono work.

---

**Hannah Sholl** was honored for her pro bono work by the *New York Law Journal*, which featured her accomplishments in its 2016 *Lawyers Who Lead by Example* publication. The article highlights key pro bono endeavors Hannah has taken on, and offers her perspective on opportunities she has created for others and her own development as a lawyer.

---



## 2005

**Shannon Armstrong** was honored in the 2016 issue of *Oregon Super Lawyers* as a Rising Star. The publication identifies the top 5 percent of attorneys in the state, as chosen by their peers and through the inde-

pendent research of *Super Lawyers* magazine.

Shannon is a trial lawyer with Markowitz Herbold in Portland. Her cases involve a wide range of business issues that include contract disputes, partnership dissolutions, breach of fiduciary duty, and class actions.

---

**Mark Massoud** was named to the 2016 class of Andrew Carnegie Fellows. An associate professor in the Politics Department and Legal Studies Program at UC Santa Cruz, Mark has won the American Political Science Association's Corwin Award for best dissertation in public law. His research focuses on law and society in conflict settings and authoritarian states, and on Islamic law and society.

---



**Ann O'Leary**, a former lecturer at Berkeley Law, joined Boies Schiller Flexner's Palo Alto office as a partner in the firm's Crisis Management and Government Response practice. She will provide legal counsel to leaders and organizations in the

corporate, nonprofit, and philanthropic sectors. Ann previously served as senior policy advisor to Hillary Clinton in her Presidential campaign and as senior fellow at the Center for American Progress' economic policy team.

---

**Daniel Tristan** joined Baker Botts as a partner in the firm's Houston office. His clients include lenders and borrowers involved with international and domestic financing, including asset-based financings, working capital credit, commercial paper programs, project finance, and acquisition financings.

---

**Robert Vartabedian**, a partner at Thompson & Knight, has been selected for inclusion in *Benchmark Litigation's* Under 40 Hot List for 2016. *Benchmark Litigation* identifies the leading U.S. trial attorneys and firms at the local and national levels, and recognizes exceptional partners 40 or younger.

---

## 2006

**Ed Fierro**, a former official of the SEC's Office of Municipal Securities, has joined Bracewell LLP as senior counsel in the firm's Houston office. He serves as bond counsel, disclosure counsel, and underwriter's counsel as part of Bracewell's public finance practice, advising clients on legal, regulatory, and policy issues.

## In Memoriam

Morton Bloom '41	Donald Hubbard '61	Jill White '72	Teresa Panepinto '07	Roslyn Grossman Morris
James Werson '42	Roscoe Keagy '61	Timothy Winchester '72	Ramy Elmeligy '15	Richard Mosk
Louise Gelber '44	Alex McDonald '61	Stephen Zamora '72	Nathan Berry '17	Barbara Mumby
Frederic Jacobus '47	Kenneth Conn '62	Eni Faleomavaega, Jr. '73	—	Donald Neudeck
Charles Gray, Jr. '49	Dennis Kavanagh '62	Russell Kelley '73	Mathilde Albers	Carol Newman
Paul Larsen '50	Thomas Frey '63	James Askew '74	Nancy Witter Bates	John Noonan
Robert Desky '51	Doris Anderson '64	Thomas	Daniel Bernstine	Serge Novovich
Edward Merrill '51	Timothy Hansen '64	Williamson, Jr. '74	Nathan Berry	John O'Donnell
Paul Asperger '52	Donald Newell '64	James Gilliland, Jr. '79	Norman Coliver	Shirley Plant
Betty Barry Deal '52	Donald Satterlee '64	George Platt '79	Jane Johnson Cross	T. Gary Rogers
William Edlund '53	David Bow Woo '64	John	Jeanne England	William Rohwer, Jr.
William McDermott '53	Ronald Gill '65	Gonzales-Madrid '81	Janet Erickson	Arthur Rosenfeld
Gilbert Pavlovsky '53	David Leaverton '65	Natalie Gubb '81	Annette Faria	Robert Rosson, Jr.
Richard Haugner '54	D. Keith Bilter '66	Martina Knee '83	Gilda Feller	Maxine Rosston
Charles Williams '55	Paul Cahill '66	Jay Fujitani '84	Mary Hagar Hafner	Rob Ruby
A.N. Yiannopoulos '55	Howard Franklin '66	R. Michael	John Hetland	William Schwarzer
George Ebling '56	Michael Antoncich '67	Scarano, Jr. '84	Charles Holloway	Irene Shephard
Albert Salera '56	Thomas Bleauvelt '68	Malcolm Smith '84	Carla Johnson	Tracy Innes Stephenson
Adolph Capurro '58	Lawrence Curtice '68	Mark Dykes '87	Phyllis Levy	John Tishman
Allen Fields '59	Stephen Lieberman '68	Camille Hill '87	June Lilienthal	Donald Treadwell
Justin Jacobs, Jr. '59	Marjorie Madonne '68	Douglas Drayton '89	Shirley Loube	Warren Unna
Richard Wilson '59	Alfred Oats '72	Mark Olson '90	William Lyon	John Vlahos
James Dilworth '60	Howard Pilch '72	Gregory Walther '91	Maryanne Stephenson	Ian Wishart
Raymond Saint '60	Roger Ritter '72	Raul Cadena '93	McMahon	

### Professor John Hetland: 1930-2017

**John Hetland**, a Berkeley Law professor for more than 30 years and a leading expert on secured transactions, died in February at age 86. Hetland joined the faculty in 1959 and became one of the youngest professors in school history.

First in his class at the University of Minnesota Law School, he was editor of its *Law Review*. Hetland took a hiatus to join the Navy, continued with the Navy Reserves, and retired in 1965 as a Lt. Commander. He clerked for two Minnesota Supreme Court justices and practiced in Minneapolis before coming to Berkeley.

A prolific author on real property security and litigation, Hetland wrote the seminal article on California secured transactions in 1963—still cited by courts as persuasive authority. Known for his classroom humor and high expectations, he also taught continuing legal education courses and had a successful consulting practice.

Former California Governor Pete Wilson '62, a student of Hetland's, wrote that "his goals were unselfish—always extending to what others could achieve."

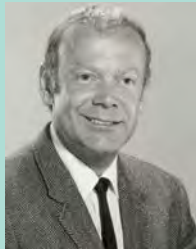

### Judge John Noonan, Jr.: 1926-2017

**John Noonan, Jr.**, who taught at Berkeley Law from 1966-1985 before becoming a U.S. Ninth Circuit Court of Appeals judge, died in April at age 90. He wrote an astounding 1,080 decisions on the Ninth Circuit bench.

While a conservative, Noonan built a reputation for independent decisions untethered to political ideology. An active judge for 11 years before assuming senior status in 1996, he wrote 13 books on myriad subjects and was a historical consultant for Pope Paul VI's commission on studying birth control.

Noonan earned his undergraduate and law degrees from Harvard, and a Philosophy Master's and Ph.D. from Catholic University in Washington, D.C. He worked for President Eisenhower's national security adviser, joined a Boston firm, and then taught law at Notre Dame for five years before moving to Berkeley. His courses focused on professional responsibility, jurisprudence, and legal history.

Berkeley Law Lecturer in Residence Patricia Plunkett Hurley, a former Ninth Circuit staff attorney, says Noonan was "brilliant, wise, and thoughtful" as well as "unfailingly gracious and full of deep integrity and kindness."

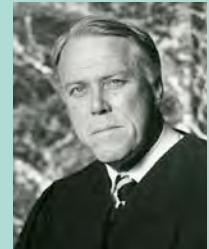

## 2007

**Jacqueline Beaumont** was named to *Super Lawyers'* list of Southern California Rising Stars for the fifth straight year. A shareholder at Call & Jensen in Newport Beach, Jackie defends and advises employers in wage-and-hour class actions and other employee litigation. She and her husband, Sean McLean, are proud of their two-year-old son and are expecting to grow their family in the fall.



**Annisah Um'rani** was named a partner at Akin Gump in Washington, D.C. As part of the firm's health practice, Annisah represents medical device manufacturers, pharmaceutical companies, hospital systems, and other health care entities in governmental investigations, internal investigations, and lawsuits. She also represents hospitals in Medicare and Medicaid reimbursement and enrollment litigation.

## 2008

**Michael Lii** has joined Schiff Hardin as counsel in

the firm's Dallas office, working in the Finance Group with a focus on energy and financial institutions. He previously worked at Thompson & Knight in Dallas, where he represented banks and borrowers in commercial finance transactions that mainly dealt with the oil and gas industry.



## 2009

**Jean-Paul Cart** has been promoted to partner at Schiff Hardin in the firm's San Francisco office. He focuses on commercial litigation spanning business torts and commercial disputes, including consumer class actions, trademark infringement, securities fraud, derivative class actions, licensing and con-

tract actions, insurance disputes, and privacy litigation.

**Keith Hiatt** joined the Silicon Valley nonprofit software company Benetech as Vice President of Human Rights. He had served as director of the Human Rights and Technology Program at Berkeley Law's Human Rights Center, and will continue as a research fellow there. Keith also works as administrator of the Technology Advisory Board for the International Criminal Court's Office of the Prosecutor.

## 2010

**Jonas Lerman** recently moved back to San Francisco after five years on the East Coast. He is an Assistant United States Attorney in the U.S. Attorney's Office for the Northern District of California. Previously, Jonas worked as an international lawyer at the U.S. Department of State.



**Aurelio Pérez** has been elevated by Littler from asso-

ciate to shareholder. Working in the firm's San Francisco office, Aurelio is a management-side attorney who advises and represents employers, handling labor disputes and employment litigation or helping employers avoid such disputes.

## 2011

**Fatima Abbas** became the first Native woman and the youngest-ever general counsel for the Karuk Tribe, which is California's largest federally-recognized tribe. She previously served as deputy attorney general for the Colorado River Indian Tribes. Fatima is also an executive member of the ABA Young Lawyers Division Women in Practice Committee.

**Joshua Johnson** recently celebrated his second jury trial win defending tenants from eviction. In both trials, he obtained a 100 percent reduction in rent for his clients due to their landlords' failure to provide livable conditions. Joshua is a trial attorney at Legal Aid Foundation of Los Angeles, a nonprofit, direct services law firm for poor and low-income people in the city.

## 2012

**Donnie Morgan** is Chief Litigation Counsel for the City of Indianapolis. He previously spent the first three-plus years of his career as a litigator at

# Class Notes

Faegre Baker Daniels. In his new role, Donnie oversees all litigation for the nation's 14th largest city while focusing his own docket on appellate advocacy.



## 2014

**Shepard O'Connell** joined Brooks Pierce in its Raleigh,

North Carolina office. Fluent in Spanish, she works in the firm's international law practice group and focuses on commercial litigation and international arbitration. She previously worked at Arnold & Porter representing multinational corporations and foreign governments in disputes arising under bilateral investment treaties.

**Michel Sancovski** (LL.M.) was made partner at Baker McKenzie Brazil (Trench Rossi e Watanabe Advogados). Michel focuses on anti-corruption law, corporate cross-border investigations, M&A due diligence, and the imple-

mentation of compliance programs.



## 2015

**Zehra Betul Ayranci** (LL.M.) received the International Bar Association (IBA) 2016 global scholarship from its IP, Communications &

Technology Law section for her article "Digital Death: What Happens to Your Digital Assets When You Die?" IBA is the world's largest international organization of law societies, bar associations, and individual lawyers. Zehra will speak at its annual conference this fall in Sydney.

**Mindy Phillips** was featured in an *Emerson Collective* article about her immigration work in Oakland public schools. An Equal Justice Works fellow at the East Bay Community Law Center, Mindy offers free legal counsel on immigration matters to students and their families.



## INTRODUCING PROFESSIONAL LEGAL EDUCATION AT BERKELEY LAW

A void exists between the education young lawyers get in a law school course and what they can acquire from continuing education programs later in their careers. Berkeley Law's new Professional Legal Education (PLE) courses aim to change that by offering in-depth training for practicing attorneys and non-legal professionals in relevant fields.

Unlike brief, narrowly-focused MCLE sessions, PLE offers lawyers from the U.S. and abroad, and non-attorneys with relevant experience, an opportunity to participate in comprehensive, interactive courses on a non-credit basis.

Taught by Berkeley Law's expert faculty, PLE courses are offered in 1- to 3-week summer sessions so as to minimally disrupt work obligations. More than 50 courses are available to help attorneys revisit basics, develop professional skills, or dive into a new practice area. You can also earn a certificate in Business, Technology, Energy & Environmental, or Public Law.

[LAW.BERKELEY.EDU/PLE](http://LAW.BERKELEY.EDU/PLE)

# POSTSCRIPT



**Bob Berring isn't the kind of retiree to excitedly look forward to his last day in the office.**

"I'm a teaching junkie," says Berring, 67, who earned a JD from Boalt in 1974 and then returned in 1982 to teach for 35 years. "I love first-year students. They come in with such drive and energy."

But time flies like an arrow, and Berring has decided that retirement beckons.

"I'd like to go out having done a good job and not be one of those people where you have to tell them, 'It's time.'"

Berring is wrapping up a distinguished career as a beloved professor, library director, interim dean, China scholar, and alter ego "Uncle Zeb."

On a recent weekday, while getting ready to grade his last batch of finals in his expansive corner office, he regaled visitors with stories about the law school. Faculty strife, student protests about diversity, talent shows, the post-Proposition 209 era, graduation hijinks.

"There was a very bad stretch for a while. Student speakers would lecture the faculty at graduations, and faculty just stopped going," Berring recalled.

Interim dean from January 2003 to June 2004, Berring said the arrival of Dean Chris Edley heralded a new era. "He was an outsider, and an incredible breath of fresh air....The school has totally changed. Now the students are happy warriors."

Having taught 7,000 to 8,000 students (including legal-studies students) is a remarkable legacy in itself. But to some, Berring may best be remembered as Uncle Zeb, the anonymous Dear Abby-esque sage who doled out advice (some serious, but often not) to law students in a large book kept at the library's reference desk. While Uncle Zeb himself moves into retirement, Cafe Zeb lives on, named after what Berring calls his "ectoplasmic entity."

As the semester wound down, Berring's students bought him a portable record player (he's a huge music fan) and two albums: *The Best of the Mills Brothers* and *The Best of the Ink Spots*.

"Bob's contributions to our community are enormous," Interim Dean Melissa Murray said in announcing his retirement, "and I doubt that anyone, however well-intentioned, could do justice to his record of service and collegueship." —*Michael Bazeley*





— BOALT HALL —

# ALUMNI REUNION WEEKEND

— [law.berkeley.edu/reunion2017](http://law.berkeley.edu/reunion2017) —

OCTOBER 6-7, 2017

Come back to Berkeley this fall for a memorable celebration of our beloved institution and its incredible community. The weekend begins with a welcome barbecue on Friday evening, where you'll catch up with friends and faculty and get to know current students. On Saturday, join us for a slate of MCLE sessions and a Town Hall with new Berkeley Law Dean Erwin Chemerinsky, followed by cocktails, dinner, and dancing with fellow Boalties!