

# THE MAGAZINE

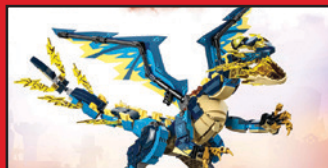

COOL CREATIONS



ACTIVITIES



COMICS



NEW LEGO MODELS



# WELCOME TO ISSUE 4!

HI, IT'S MAX!  
THE FESTIVE SEASON  
IS HERE! JOIN US  
IN BUILDING HEARTS  
AND SHARING THE  
SUPERPOWER OF PLAY!

WHAT KIND OF  
HEART WILL YOU  
BUILD?

IT'S HOT  
HERE... I  
BETTER  
MOVE!

MY HEART CAN  
BRIGHTEN THE  
NIGHT!





## THE ADVENTURES OF MAX



### ARE YOU PUZZLED?

Look for these bricks on activity pages. They will tell you if the activity is easy, hard, or somewhere in-between. Try them all and see how you do! **If you get stuck, all the answers can be found on page 27.**

-  **LEVEL 1**  
Easy
-  **LEVEL 2**  
In-between
-  **LEVEL 3**  
Hard

### FIND THE PET FRIENDS!

The puppies or the dogs will direct you to the activities and stories that have been created especially for you!





Rebuild  
the  
world™

**TELL MAX WHAT  
YOU THINK OF THIS  
MAGAZINE!**

Ask a parent or guardian to scan this code or visit [LEGO.com/LIFESURVEY](https://LEGO.com/LIFESURVEY) to take the survey right away!

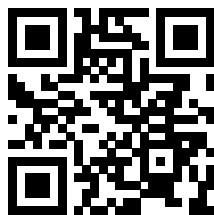

**Check out this cool  
stuff inside!**

**New  
comic**  
Pages 4-5



**Amazing  
challenges**  
Pages 12, 17, 23



**Get inspired**  
Pages 6, 22, 26-27



**And much,  
much more!**



**LEGO® Life Magazine**

For information about LEGO® Life visit [LEGO.com/life](https://LEGO.com/life)

For questions about your membership visit [LEGO.com/service](https://LEGO.com/service)

 **LEGO Life Magazine**  
PO Box 3384  
Slough SL1 0BJ  
00800 5346 5555

 **LEGO Life Australia**  
PO Box 856  
North Ryde BC, NSW, 1670  
Freecall 1800 823757

 **LEGO Life  
New Zealand**  
B:Hive, Smales Farm  
Level 4  
72 Taharoto Rd  
Takapuna  
Auckland 0622  
New Zealand

(UK/AU/NZ)

LEGO, the LEGO logo, DREAMzz, the FRIENDS logo, NINJAGO, the Minifigure and the Brick and Knob Configurations are trademarks of the LEGO Group. ©2023 The LEGO Group.





# THE FRIENDSHIP PARTY

CAN'T WAIT TO SEE WHAT MY FRIENDS CREATE!



TEE HEE

WHY HAS NO ONE SHOWN UP YET? HAVE I DONE SOMETHING WRONG?

SHHHH

SHHHH! HEHEHE



THANKS, BUDDY. YOUR PINATA HAS INSPIRED ME TO MAKE ANOTHER ONE!

WAAAAIT...



I FEEL A BIT DISAPPOINTED, BUT I AM GLAD THAT WE ARE BOTH HERE. LET'S OPEN UP YOUR PINATA!

WOOF!

WOOF! WOOF!

GOOOO!



SURPRISE!

HAHA, MAX'S FACE!





WOW, YOU WERE HERE ALL ALONG! THIS IS THE BEST SURPRISE EVER!

WHO TURNED OFF THE LIGHTS?



KNOCK! KNOCK!

I'LL GET IT!



SORRY WE'RE LATE, MAX!

WE WANTED TO MAKE A PIÑATA THAT YOU'D REALLY LOVE. GUESS WE LOST TRACK OF TIME!

AND WE MADE COOKIES!

I'M SO GLAD YOU'RE HERE! I CAN'T WAIT TO SEE WHAT'S IN YOUR PIÑATA!



THANKS FOR LETTING US BRING OUR KIND OF FUN.

TOTALLY! I WANTED TO CELEBRATE EVERYONE'S COOL IDEAS. AND I LOVE ALL OF YOUR PIÑATA SURPRISES!

DANDELIONS?! SOME RABBIT SWEETS. NICE!

WHAT DID I MISS?

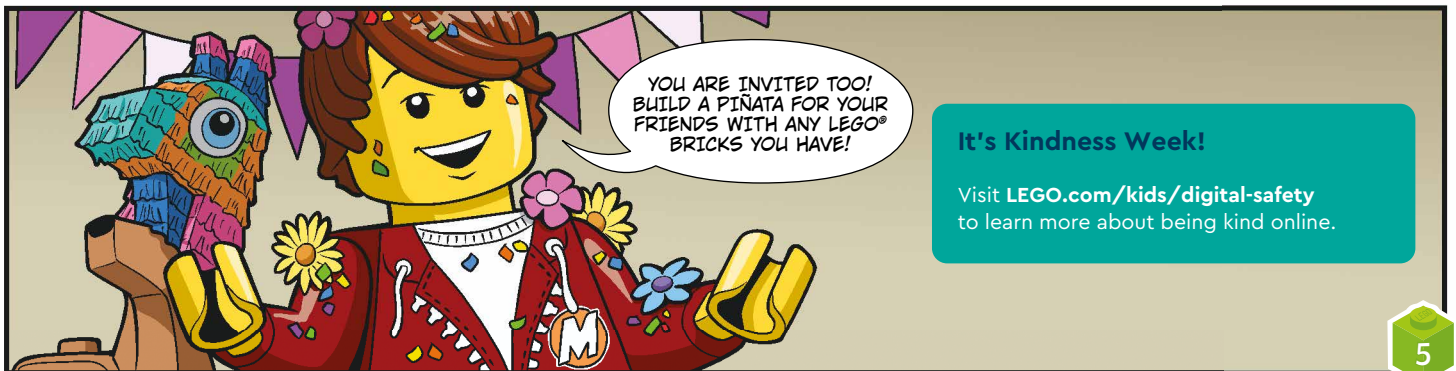

YOU ARE INVITED TOO! BUILD A PIÑATA FOR YOUR FRIENDS WITH ANY LEGO® BRICKS YOU HAVE!

**It's Kindness Week!**  
Visit [LEGO.com/kids/digital-safety](https://www.lego.com/kids/digital-safety) to learn more about being kind online.



# COOL CREATIONS

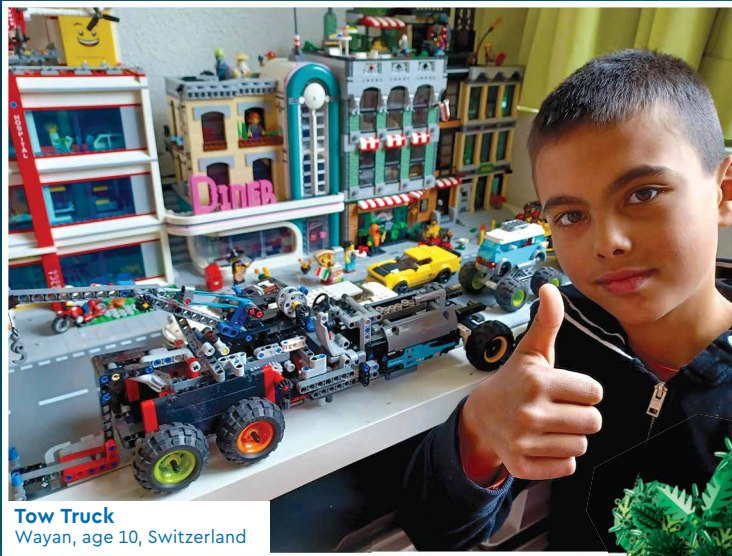

**Tow Truck**  
Wayan, age 10, Switzerland



**"Be Happy" Cat DOT Art**  
Madison and Taylor,  
age 8 and 6, Canada

Do you have an **AWESOME BUILD** you would like to share with other builders?

## SEND US YOUR PHOTO!

- 1 Have a **photo taken of you with your build**. You might see it on this page in a future issue.
- 2 Ask a parent or guardian to go to [LEGO.com/cool-creations](https://www.lego.com/cool-creations).
- 3 There they can **download and complete the Submission Form**, then email it along with your photo. See the Submission Form for the email address.
- 4 Remember that you can send us a story about your model too. Tell us how you built it, what's going on in the scene, or whatever you like. Max also loves getting your letters!



**Dream Beach House**  
Ludwig and Pia,  
age 6 and 8, Germany

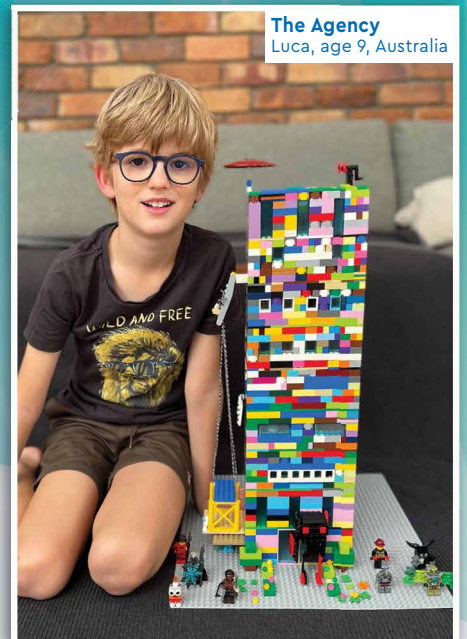

**The Agency**  
Luca, age 9, Australia



THANKS TO EVERYONE WHO SENT IN THEIR CREATIONS, INCLUDING ISABELLA, THOMAS, OLIVER, NORMA, AIDEN AND SHARDUL. YOU ROCK!



**The Ultra Mech**  
Peter, age 11, USA



**Dinosaur Attack on LEGO City**  
Ava and Shay, age 10 and 8, Ireland



**Police Station**  
Emily and Andrew,  
age 6 and 4, USA



**Barn & Fun Shop**  
Joseph, Rosalie and Xavier,  
age 7, 9 and 4, UK



**Clothing Store**  
Alessandro, age 6, Italy



**My Stylish Glasses**  
Raphaël, age 7, France



**Dear Grown-Ups!**

You can submit a photo by filling out the form on [LEGO.com/cool-creations](http://LEGO.com/cool-creations).



**Rebuild  
the  
world™**



# BECOME A DREAM CRAFTER



Join Mrs. Castillo, Mateo and Zoey in creating your own LEGO® DREAMZZZ™ dream creature.

**Dear Grown-Up!**  
 What would a unicorn plane look like? Help your child build their own dream creature!

IF WE CAN HAVE A TURTLE FOOD TRUCK, WHY NOT A CHICKEN BOAT?



## CREATE YOUR OWN DREAM CREATURE

Mix a vehicle with an animal or make something entirely new! Draw your creature below or build it with LEGO® bricks.



MONSTER TRUCK



PLANE



BOAT



UNICORN



CHICKEN



HAMMERHEAD SHARK

YOUR CREATURE'S NAME: .....



# DONKEY KONG'S TREE HOUSE FUN!



 The Donkey Kong™ crew have a lot of laughs in the LEGO® Super Mario™ Donkey Kong's Tree House set. So much so that things are flying around now! Can you put them where they belong? Write the number of each missing piece in the empty space.



x 9



## BANANA QUEST

Donkey Kong needs your help finding all of the yummy bananas. Let's get searching!



# THE NINJA MEMORY CHALLENGE

**Dear Grown-Ups!**  
This game is also for you. You can help prepare the board, explain the rules and even join in the fun!

When Sora repaired Destiny's Bounty, the ninja were able to take a flight across the United Realms. On their journey, they conquered villains, met other ninja and practised important skills, such as their memory.

Are you ready to join them?







## HOW TO PLAY

Test your ninja memory and challenge your friend to a game.

- 1 Cover up all the squares with pieces of paper or LEGO® bricks. You might need to cut the paper into small squares.
- 2 The youngest player starts. Pick up two pieces of paper or bricks and look at the pictures underneath. If the pictures match, collect the pieces. If they don't, put the pieces back.
- 3 Take turns until all the pictures are uncovered.
- 4 Count the pieces of paper or bricks each of you collected to check who won the memory challenge.





# POWER UP YOUR DRAGON!

Sora is facing Beatrix's mech in an epic battle, but she's not alone! She has her skills, loyal friends and a mighty dragon by her side. How about making it even stronger?



## CREATE AN UNDEFEATABLE DRAGON

Select new skills for your dragon! Using your favourite coloured pens or pencils, draw the upgrades and create your own awesome creature!



Extra spikes



Fire



Mace tail



Thunder roar



Light beam



Energy shield









STAR WARS  
THE

# MANDALORIAN







Disney

# Give Wonder

Disney  
100









# A MIX-UP AT WEASLEYS' WIZARD WHEEZES™!



Harry Potter



Oops! Someone has slipped and spilled the Peruvian Instant Darkness Powder all around Diagon Alley™. In the chaos, many magical items got lost.



**HELP THE WEASLEYS**

Try to find all the missing things.



-  **OWL POST™ X2**
-  **LOVE POTION**
-  **FANGED FRISBEE**
-  **PYGMY PUFF™**
-  **WEASLEYS' WILDFIRE WHIZ-BANGS**

Do you need some help?  
Check page 27 for answers.



## PYGMY PUFF™ CHALLENGE

They are cute, adorable creatures. Now you can make your own! Get your crayons ready and decorate it just the way you like. You can also add some cool accessories.



WIZARDING WORLD and all related trademarks, characters, names, and indicia are © & ™ Warner Bros. Entertainment Inc. Publishing Rights © JKR. (S23)



# TROUBLE IN THE MULTIVERSE



MARVEL STUDIOS  
SPIDER-MAN  
*No Way Home*



Swing into action with the Spider-Men! The portal opened the way to two new multiverses. Only the top one is original. Can you spot six differences between the two copies below?

Need help? Answers can be found on page 27.



ORIGINAL



MULTIVERSE 1



MULTIVERSE 2

SPIDER-MAN, YOU NEED TO UNTANGLE THIS RIDDLE!



WHICH ONE DO YOU MEAN?



I THINK HE MEANS ALL OF US!





# THE POWER OF WISHES



Asha is wishing upon a star. What would you ask for if you looked up at the sky and saw a wishing star?

## CREATE YOUR WISHES!

Use your imagination and draw or write your biggest wishes. You can then get all your LEGO® bricks and build it!

**A WISH FOR ME**

**A WISH FOR MY FAMILY AND FRIENDS**



## FIND THE WISHING STAR!

Do you need some help?  
Check page 27 for answers.

WHAT IS YOUR WISH FOR THE NEW YEAR?

EVERYONE BELIEVING THEY CAN MAKE A DIFFERENCE.



©Disney

Disney  
**WISH**



# GIFT SWAP



Batman™ and The Joker™ have called a truce. And they decided to exchange gifts! What did they get for each other? Connect the dots to find out.



**Need Help?** Answers can be found on page 27.

BATMAN and all related characters and elements © & ™ DC (s23).



# DINO ON THE RUN



A Velociraptor is on the loose! Dr Ellie Sattler and the park ranger Robert Muldoon are using the computer to track it.

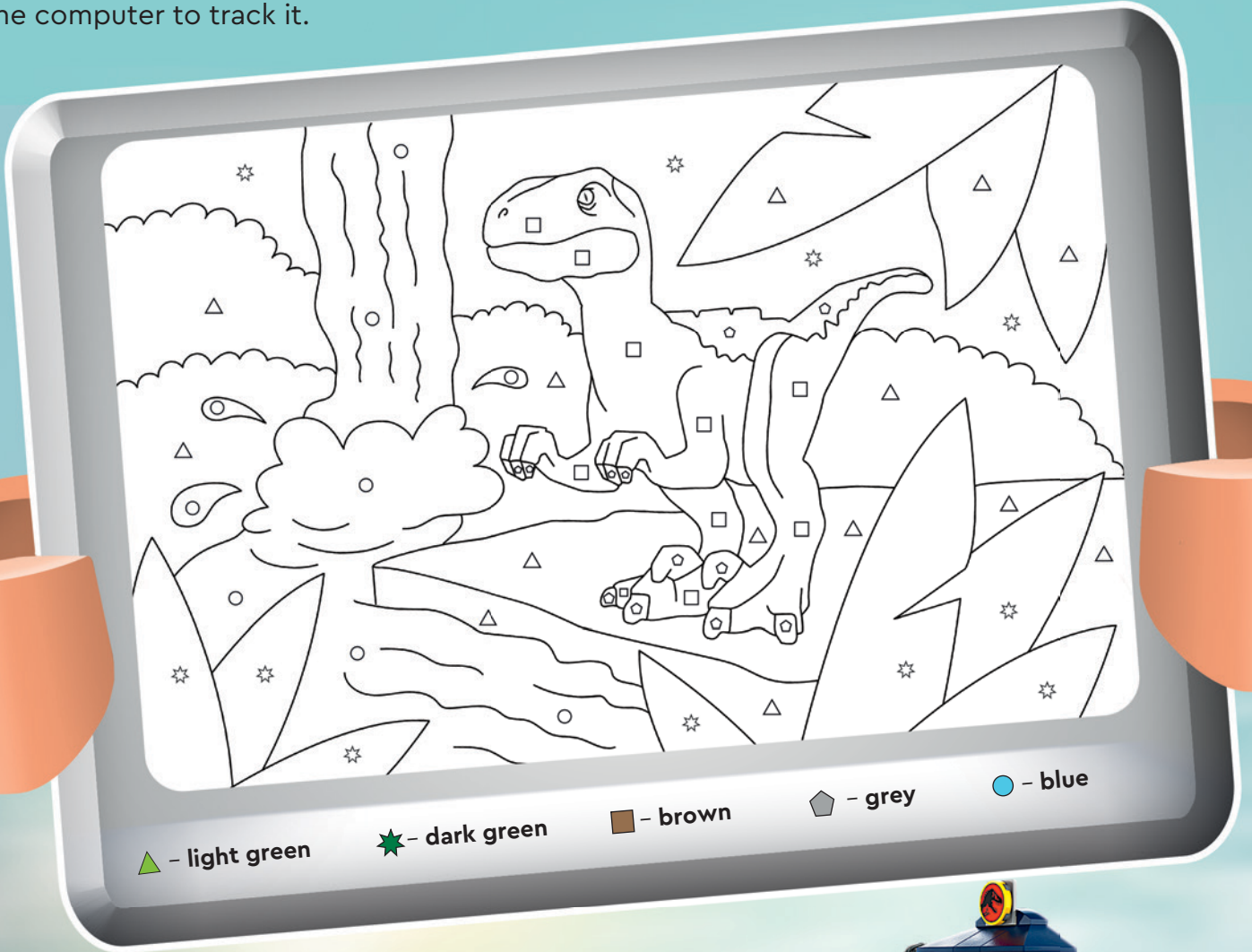

## SPOT THE VELOCIRAPTOR

The dino is hiding somewhere in the picture. Colour it to reveal the Velociraptor! Use the colours shown by the computer.



Still looking for the dino? Check page 27.

© Universal City Studios LLC and Amblin Entertainment, Inc. All Rights Reserved.



# SPACE FUN

What would you do in a space amusement park?  
You decide! Read about the attractions and put the rides in the order you would like to visit them.



- SATELLITE
- SATURN
- METEOR



## RIDE ONE

Hop on a Space Roller Coaster and zoom between planets, rockets and stars. Can you spot the three items shown on the page?



INPUT

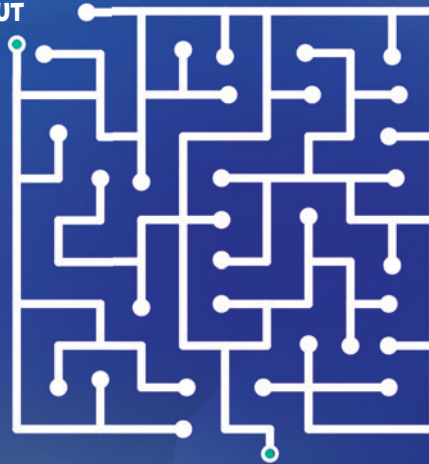

OUTPUT



## RIDE TWO

Feel the thrill of the space rocket launch! It won't start due to a computer glitch. Trace the circuit lines from the **INPUT** to the **OUTPUT** to fix it.



## RIDE THREE

The space merry-go-round is so fast, that the world can become blurry! What's that shape? Connect the dots to find out.

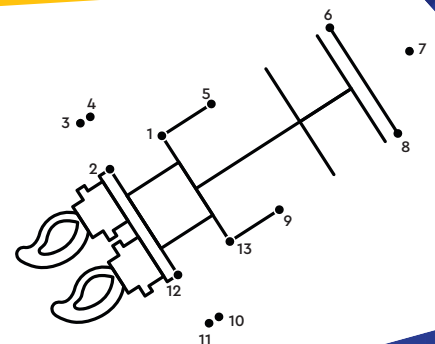



# SONIC'S AMAZING LOOP RACE



Help Sonic the Hedgehog™ find the path through the grass maze and outsmart Dr. Eggman. Pick up speed and fly through the loop-de-loop before freeing Amy and the animals at the finish line.



Play the new LEGO® Sonic the Hedgehog™ game on [LEGO.com/kids](http://LEGO.com/kids).



**START**



Do you need some help? Check page 27 for the answers.

©SEGA. All rights reserved. SEGA is registered in the U.S. Patent and Trademark Office. SEGA and SONIC THE HEDGEHOG are either registered trademarks or trademarks of SEGA CORPORATION.

**FINISH**



# WINTER HOTEL ADVENTURE

Aliya, Nova and Olly arrived at the winter hotel. They are having fun playing in the snow and taking care of the dogs. Are you ready to join them?

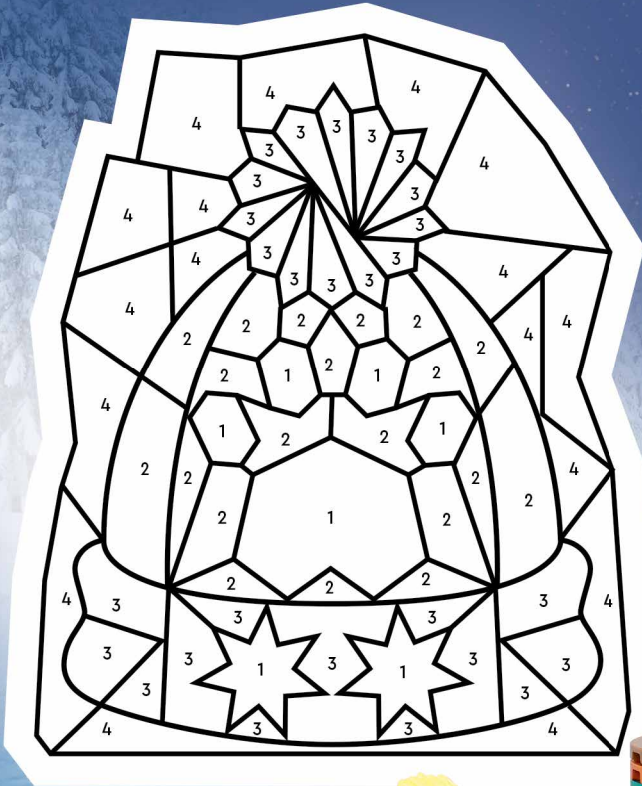

## CARVE AN ICE OUTFIT

Olly found a block of ice. What has he turned it into? Colour it in using the numbers to find out!



-  Pink = 1
-  Purple = 2
-  Green = 3
-  Blue = 4



LET'S MAKE THE SCULPTURE TOGETHER!



## DOG SLEIGH CHASE

Test your outdoor skills! Help Nova and the dogs find their way through the maze to some delicious treats.



**START**



**Dear Grown-Ups!**  
 In this game you can use any bricks you like, and even try putting them sideways.



**ICE TOWER CHALLENGE**

Build the tallest LEGO® tower ever! You'll need some LEGO bricks to build with and one brick to use as a dice.

**HOW TO PLAY:**

- Players take turns throwing the LEGO® brick. The youngest player goes first.
- Depending on what you throw, add or remove bricks from your tower:
  - Studs up: add one brick.
  - Studs down: add two bricks.
  - Side: remove one brick.
- The game ends when all the LEGO bricks have been used. The winner is the player who has the tallest tower at the end of the game.





# CREATE AS IF IN A DREAM

Have you ever wanted to dream craft like Mateo, Izzie and Cooper? Now you can! Follow their guide on how to create dream creatures, grab any LEGO® bricks you have, and bring your dreams to life.

A SNAKE  
SLITHERING IN  
THE SKIES... OR  
WEARING RUNNING  
SHOES.



I HAVE ALWAYS  
DREAMT OF A  
MOBILE HOME.  
NOW,  
THAT'S THE WAY TO  
TRAVEL!







THERE'S NO LIMIT TO YOUR DREAMS! YOU CAN GIVE THEM WHEELS, WINGS... OR MAKE THEM SUPER CUDDLY!



Look for more inspiring building instructions in the free LEGO® Builder app!

- Save your sets
- Zoom in and rotate your model while you build
- Track your building completion!



Don't forget to ask a grown-up's permission before downloading apps.

# ANSWERS:

LEGO® Super Mario™, p. 6:



LEGO Harry Potter™, p. 17:



LEGO Marvel, p. 18:



LEGO | Disney, p. 19:



LEGO DC Batman™, p. 20:



LEGO Jurassic World, p. 21:



LEGO Friends, p. 24-25:



LEGO Sonic the Hedgehog™, p. 23: LEGO Creator, p. 22:

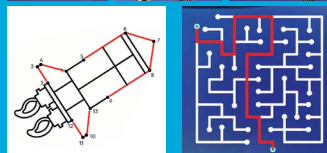
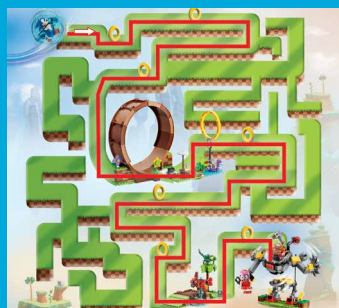



Next issue of the LEGO® Life Magazine out in January!



## BUILD A HEART, SHARE THE JOY

Build a heart and share it in the Build to Give group in the LEGO® Life app to help bring the superpower of play to children in need.



**STAY  
TUNED FOR  
THE NEXT  
ISSUE**

See you in  
2024!

