

## Chapter 3

# BSL Operations

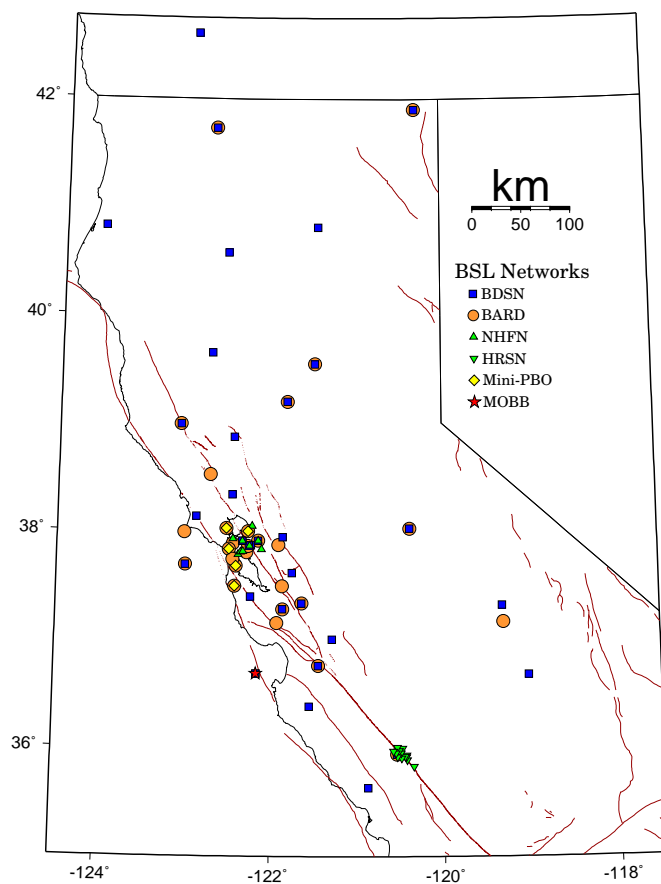

Figure 3.1: Map illustrating the distribution of BSL networks in Northern and Central California.

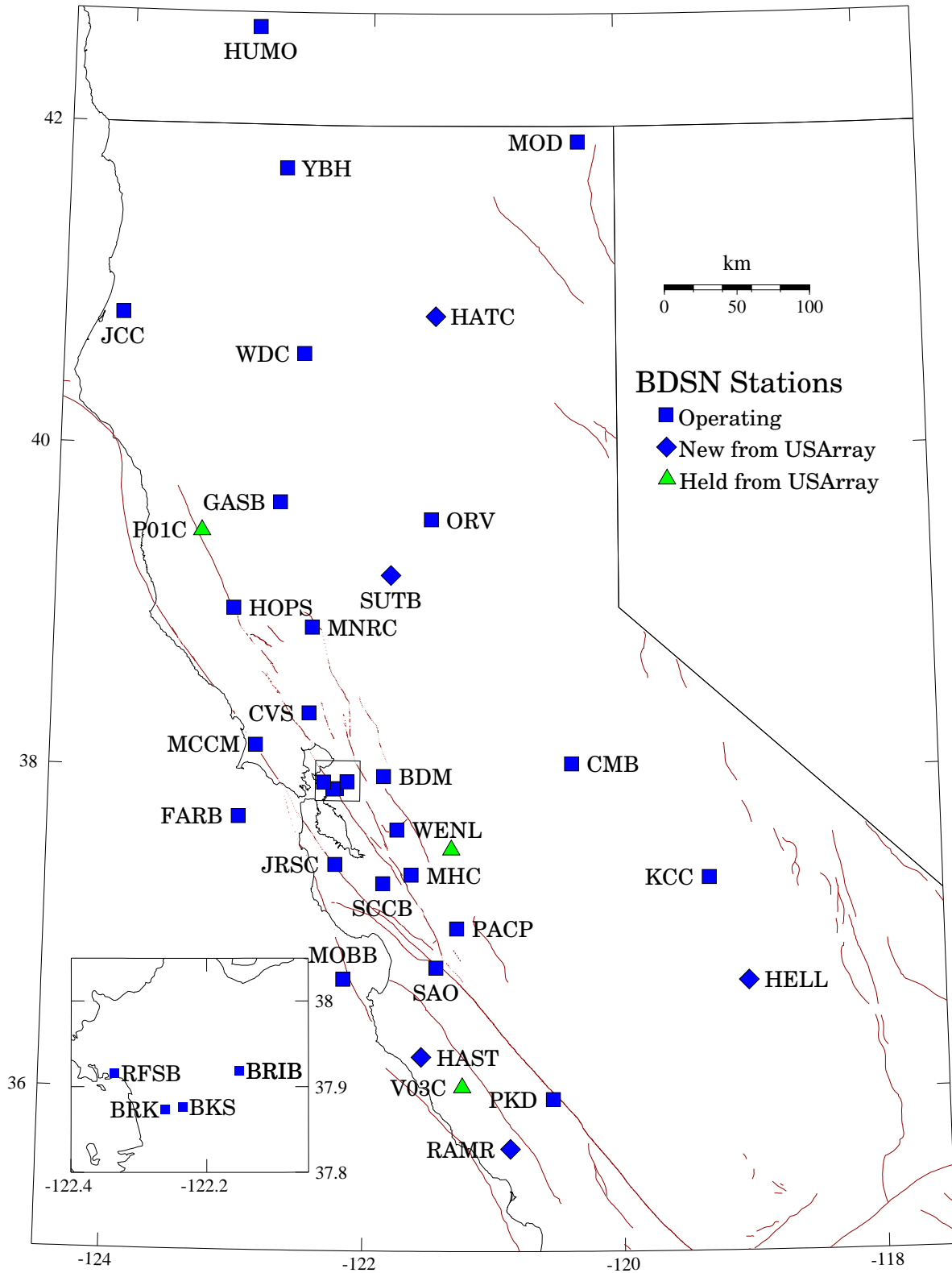

Figure 3.2: Map illustrating the distribution of BDSN stations in Northern and Central California.

# 1. Berkeley Digital Seismic Network

## 1.1 Introduction

The Berkeley Digital Seismic Network (BDSN) is a regional network of very broadband and strong motion seismic stations spanning Northern California and linked to UC Berkeley through continuous telemetry (Figure 3.2 and Table 3.1). The network is designed to monitor regional seismic activity at the magnitude 3+ level as well as to provide high quality data for research in regional and global broadband seismology.

Since 1991, the BDSN has grown from the original 3 broadband stations installed in 1986-87 (BKS, SAO, MHC) to 32 stations, including an autonomous ocean-bottom seismometer in Monterey Bay (MOBB). We take particular pride in high quality installations, which often involve lengthy searches for appropriate sites away from sources of low-frequency noise as well as continuous improvements in installation procedures and careful monitoring of noise conditions and problems. While maintenance and repair were an important focus of this year's efforts, we were also able to add five new stations as the USArray deployment left California. Considerable engineering and research activities were also involved in several projects to develop and test new instrumentation (see Section 7., Section 9., and Chapter 1, Section 34.). The project involving new electronics for the STS-1 seismometers, the E300, was completed, and we have deployed the beta version of the electronics for testing at several stations. It is currently at KCC. We also made progress in testing a new, low-cost sensor for pressure and temperature to be installed at seismic and GPS sites. Finally, the BSL is part of a team to develop and test a new version of the STS-1 seismometer.

As always, the expansion of our network to increase the density of state-of-the-art strong motion/broadband seismic stations and improve the joint earthquake notification system in this seismically hazardous region, one of BSL's long term goals, must be coordinated with other institutions and is contingent on the availability of funding.

Equally important to network growth, data quality and the integrity of the established network must be preserved. The first generation of broadband seismometers installed by BSL have been operating for almost 25 years. At the same time, the first generation of broadband data loggers are entering their 17th year of service. This requires continued vigilance and the commitment of time and resources to both repairs and upgrades.

## 1.2 BDSN Overview

Twenty-nine of the BDSN sites are equipped with three component broadband seismometers and strong-

motion accelerometers, and a 24-bit digital data acquisition system or data logger. Two additional sites (RFSB and SCCB) consist of a strong-motion accelerometer and a 24-bit digital data logger. The ocean-bottom station MOBB is equipped with a three component broadband seismometer. Data from all BDSN stations, except MOBB, are transmitted to UC Berkeley using continuous telemetry. In order to avoid data loss during utility disruptions, each site has a three-day supply of battery power; many are accessible via a dialup phone line. The combination of high-dynamic range sensors and digital data loggers ensures that the BDSN has the capability to record the full range of earthquake motion required for source and structure studies. Table 3.2 lists the instrumentation at each site.

Most BDSN stations have Streckeisen STS-1 or STS-2 three-component broadband sensors (*Wielandt and Streckeisen, 1982; Wielandt and Steim, 1986*). A Guralp CMG-3T downhole broadband sensor contributed by LLNL is deployed in a post-hole installation at BRIB. A Guralp CMG1-T is deployed at MOBB. The strong-motion instruments are Kinometrics FBA-23, FBA-ES-T or MetroZet accelerometers with  $\pm 2$  g dynamic range. The recording systems at all sites are either Q330, Q680, Q730, or Q4120 Quanterra data loggers, with 3, 6, 8, or 9 channel systems. The Quanterra data loggers employ FIR filters to extract data streams at a variety of sampling rates. In general, the BDSN stations record continuous data at .01, 0.1, 1.0, 20.0 or 40.0, and 80 or 100 samples per second. However, at some sites, data at the highest sampling rate are sent in triggered mode using the Murdock, Hutt, and Halbert event detection algorithm (*Murdock and Hutt, 1983*) (Table 3.3). In addition to the 6 channels of seismic data, signals from thermometers and barometers are recorded at many locations (Figure 3.3).

As the broadband network was upgraded during the 1990s, a grant from the CalREN Foundation (California Research and Education Network) in 1994 enabled the BSL to convert data telemetry from analog leased lines to digital frame-relay. The frame-relay network uses digital phone circuits which support 56 Kbit/s to 1.5 Mbit/s throughput. Since frame-relay is a packet-switched network, a site may use a single physical circuit to communicate with multiple remote sites through the use of "permanent virtual circuits". Frame Relay Access Devices (FRADs), which replace modems in a frame-relay network, can simultaneously support a variety of interfaces such as RS-232 async ports, synchronous V.35 ports, and ethernet connections. In practical terms, frame relay communication provides faster data telemetry between

Code	Net	Latitude	Longitude	Elev (m)	Over (m)	Date	Location
BDM	BK	37.9540	-121.8655	219.8	34.7	1998/11 -	Black Diamond Mines, Antioch
BKS	BK	37.8762	-122.2356	243.9	25.6	1988/01 -	Byerly Vault, Berkeley
BRIB	BK	37.9189	-122.1518	219.7	2.5	1995/06 -	Briones Reservation, Orinda
BRK	BK	37.8735	-122.2610	49.4	2.7	1994/03 -	Haviland Hall, Berkeley
CMB	BK	38.0346	-120.3865	697.0	2	1986/10 -	Columbia College, Columbia
CVS	BK	38.3453	-122.4584	295.1	23.2	1997/10 -	Carmenet Vineyard, Sonoma
FARB	BK	37.6978	-123.0011	-18.5	0	1997/03 -	Farallon Island
GASB	BK	39.6547	-122.716	1354.8	2	2005/09 -	Alder Springs
HAST	BK	36.3887	-121.5514	542.0	3	2006/02 -	Carmel Valley
HATC	BK	40.8161	-121.4612	1009.3	3	2005/05 -	Hat Creek
HELL	BK	36.6801	-119.0228	1140.0	3	2005/04 -	Miramonte
HOPS	BK	38.9935	-123.0723	299.1	3	1994/10 -	Hopland Field Stat., Hopland
HUMO	BK	42.6071	-122.9567	554.9	50	2002/06 -	Hull Mountain, Oregon
JCC	BK	40.8175	-124.0296	27.2	0	2001/04 -	Jacoby Creek
JRSC	BK	37.4037	-122.2387	70.5	0	1994/07 -	Jasper Ridge, Stanford
KCC	BK	37.3236	-119.3187	888.1	87.3	1995/11 -	Kaiser Creek
MCCM	BK	38.1448	-122.8802	-7.7	2	2006/02 -	Marconi Conference Center, Marshall
MHC	BK	37.3416	-121.6426	1250.4	0	1987/10 -	Lick Obs., Mt. Hamilton
MNRC	BK	38.8787	-122.4428	704.8	3	2003/06 -	McLaughlin Mine, Lower Lake
MOBB	BK	36.6907	-122.1660	-1036.5	1	2002/04 -	Monterey Bay
MOD	BK	41.9025	-120.3029	1554.5	5	1999/10 -	Modoc Plateau
ORV	BK	39.5545	-121.5004	334.7	0	1992/07 -	Oroville
PACP	BK	37.0080	-121.2870	844	0	2003/06 -	Pacheco Peak
PKD	BK	35.9452	-120.5416	583.0	3	1996/08 -	Bear Valley Ranch, Parkfield
RAMR	BK	37.9161	-122.3361	416.8	3	2004/11 -	Ramage Ranch
RFSB	BK	37.9161	-122.3361	-26.7	0	2001/02 -	RFS, Richmond
SAO	BK	36.7640	-121.4472	317.2	3	1988/01 -	San Andreas Obs., Hollister
SCCB	BK	37.2874	-121.8642	98	0	2000/04 -	SCC Comm., Santa Clara
SUTB	BK	39.2291	-121.7861	252.0	3	2005/10 -	Sutter Buttes
WDC	BK	40.5799	-122.5411	268.3	75	1992/07 -	Whiskeytown
WENL	BK	37.6221	-121.7570	138.9	30.3	1997/06 -	Wente Vineyards, Livermore
YBH	BK	41.7320	-122.7104	1059.7	60.4	1993/07 -	Yreka Blue Horn Mine, Yreka

Table 3.1: Stations of the Berkeley Digital Seismic Network currently operating. Each BDSN station is listed with its station code, network id, location, operational dates, and site description. The latitude and longitude (in degrees) are given in the WGS84 reference frame, and the elevation (in meters) is relative to the WGS84 reference ellipsoid. The elevation is either the elevation of the pier (for stations sited on the surface or in mining drifts) or the elevation of the well head (for stations sited in boreholes). The overburden is given in meters. The date indicates either the upgrade or installation time.

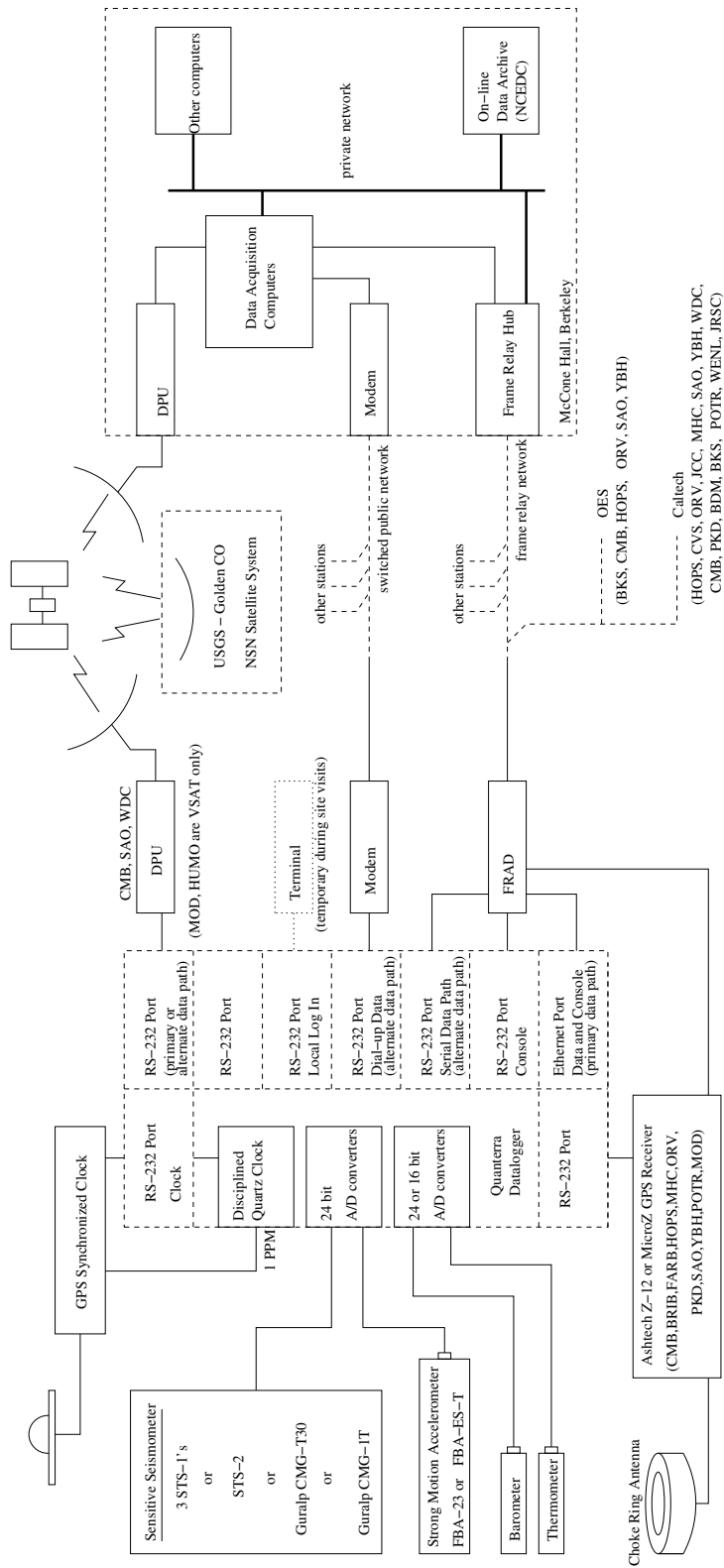

Figure 3.3: Schematic diagram showing the flow of data from the sensors through the data loggers to the central acquisition facilities of the BSL.

Code	Broadband	Strong-motion	data logger	T/B	GPS	Other	Telemetry	Dial-up
BDM	STS-2	FBA-23	Q4120	X			FR	
BKS	STS-1	FBA-23	Q980	X		Baseplates	FR	X
BRIB	CMG-3T	FBA-23	Q980		X	Vol. Strain	FR	X
BRK	STS-2	FBA-23	Q680				LAN	
CMB	STS-1	FBA-23	Q980	X	X	Baseplates	FR	X
CVS	STS-2	FBA-23	Q4120	X			FR	
FARB	CMG-3T	FBA-23	Q4120	X	X		R-FR/R	
GASB	STS-2	FBA-ES-T	Q4120	X			R-FR	
HAST	STS-2	FBA-ES-T	Q330				R-Sat	
HATC	STS-2	FBA-ES-T	Q330				T-1	
HELL	STS-2	FBA-ES-T	Q330				R-Sat	
HOPS	STS-1	FBA-23	Q980	X	X	Baseplates	FR	X
HUMO	STS-2	FBA-ES-T	Q4120	X			VSAT	X
JCC	STS-2	FBA-23	Q980	X			FR	X
JRSC	STS-2	FBA-23	Q680				FR	X
KCC	STS-1	FBA-23	Q980	X		Baseplates	R-Mi-FR	X
MCCM	STS-2	FBA-ES-T	Q4120				VSAT	
MHC	STS-1	FBA-23	Q980	X	X		FR	X
MNRC	STS-2	FBA-ES-T	Q4120	X			None	X
MOBB	CMG-1T		GEOSense			Current meter, DPG	None	
MOD	STS-1*	FBA-ES-T	Q980	X	X	Baseplates	VSAT	X
ORV	STS-1	FBA-23	Q980	X	X	Baseplates	FR	X
PACP	STS-2	FBA-ES-T	Q4120	X			Mi/FR	
PKD	STS-2	FBA-23	Q980	X	X	EM	R-FR	X
RAMR	STS-2	FBA-ES-T	Q330				R-FR	X
RFSB		FBA-ES-T	Q730				FR	
SAO	STS-1	FBA-23	Q980	X	X	Baseplates, EM	FR	X
SCCB		MetroZet	Q730		X		FR	
SUTB	STS-2	FBA-EW-T	Q330				R-FR	
WDC	STS-2	FBA-23	Q980	X			FR	X
WENL	STS-2	FBA-23	Q4120	X			FR	
YBH	STS-1 & STS-2	FBA-23	Q980	X	X	Baseplates	FR	X

Table 3.2: Instrumentation of the BDSN as of 06/30/2007. Except for PKD1, RFSB, SCCB and MOBB, each BDSN station consists of collocated broadband and strong-motion sensors, with a 24-bit Quanterra data logger and GPS timing. The stations RFSB and SCCB are strong-motion only, while MOBB has only a broadband sensor. Additional columns indicate the installation of a thermometer/barometer package (T/B), collocated GPS receiver as part of the BARD network (GPS), and additional equipment (Other), such as warplless baseplates or electromagnetic sensors (EM). The obs station MOBB also has a current meter and differential pressure gauge (DPG). The main and alternate telemetry paths are summarized for each station. FR - frame relay circuit, LAN - ethernet, Mi - microwave, POTS - plain old telephone line, R - radio, Sat - Commercial Satellite, VSAT - USGS ANSS satellite link, None - no telemetry at this time. An entry like R-Mi-FR indicates telemetry over several links, in this case, radio to microwave to frame relay. (\*) During 2007-2008 the STS-1 at this station was replaced by an STS-2.

the remote sites and the BSL, remote console control of the data loggers, services such as FTP and telnet to the data loggers, data transmission to multiple sites, and the capability of transmitting data from several instruments at a single site, such as GPS receivers and/or multiple data loggers. Today, 25 of the BDSN sites use frame-relay telemetry for all or part of their communications system.

As described in Section 7., data from the BDSN are

acquired centrally at the BSL. These data are used for rapid earthquake reporting as well as for routine earthquake analysis (Section 2. and 8.). As part of routine quality control (Section 7.), power spectral density (PSD) analyses are performed continuously and are available on the internet.

The occurrence of a significant teleseism also provides the opportunity to review station health and calibration. Figure 3.4 displays BDSN waveforms for a  $M_w$  7.7 deep

focus earthquake in the Sea of Okhotsk region on July 5, 2008.

BDSN data are archived at the Northern California Earthquake Data Center. This is described in detail in Section 6.

Sensor	Channel	Rate (sps)	Mode	FIR
Broadband	UH?	0.01	C	Ac
Broadband	VH?	0.1	C	Ac
Broadband	LH?	1	C	Ac
Broadband	BH?	20/40	C	Ac
Broadband	HH?	80/100	C	Ac/Ca
SM	LL?	1	C	Ac
SM	BL?	20/40	C	Ac
SM	HL?	80/100	C	Ac/Ca
Thermometer	LKS	1	C	Ac
Barometer	LDS	1	C	Ac

Table 3.3: Typical data streams acquired at BDSN stations, with channel name, sampling rate, sampling mode, and the FIR filter type. SM indicates strong-motion; C continuous; T triggered; Ac acausal; Ca causal. The LL and BL strong-motion channels are not transmitted over the continuous telemetry but are available on the Quanterra disk system if needed. The HH channels are recorded at two different rates, depending on the data logger. Q4120s and Q330s provide 100 sps and causal filtering; Q680/980s provide 80 sps and acausal filtering.

### Electromagnetic Observatories

In 1995, in collaboration with Dr. Frank Morrison, the BSL installed two well-characterized electric and magnetic field measuring systems at two sites along the San Andreas Fault which are part of the Berkeley Digital Seismic Network. Since then, magnetotelluric (MT) data have been continuously recorded at 40 Hz and 1 Hz and archived at the NCEDC (Table 3.4). At least one set of orthogonal electric dipoles measures the vector horizontal electric field, E, and three orthogonal magnetic

Sensor	Channel	Rate (sps)	Mode	FIR
Magnetic	VT?	0.1	C	Ac
Magnetic	LT?	1	C	Ac
Magnetic	BT?	40	C	Ac
Electric	VQ?	0.1	C	Ac
Electric	LQ?	1	C	Ac
Electric	BQ?	40	C	Ac

Table 3.4: Typical MT data streams acquired at SAO, PKD, BRIB and JRSC with channel name, sampling rate, sampling mode, and FIR filter type. C indicates continuous; T triggered; Ac acausal.

sensors measure the vector magnetic field, B. These reference sites, now referred to as electromagnetic (EM) observatories, are collocated with seismometer sites so that the field data share the same time base, data acquisition, telemetry, and archiving system as the seismometer outputs.

The MT observatories are located at Parkfield (PKD1, PKD) 300 km south of the San Francisco Bay Area, and Hollister (SAO), halfway between San Francisco and Parkfield (Figure 3.2). In 1995, initial sites were established at PKD1 and SAO, separated by a distance of 150 km, and equipped with three induction coils and two 100 m electric dipoles. PKD1 was established as a temporary seismic site, and when a permanent site (PKD) was found, a third MT observatory was installed in 1999 with three induction coils, two 100 m electric dipoles, and two 200 m electric dipoles. PKD and PKD1 ran in parallel for one month in 1999, and then the MT observatory at PKD1 was closed.

Data at the MT sites are fed to Quanterra data loggers, shared with the collocated BDSN stations, synchronized in time by GPS and sent to the BSL via dedicated communication links.

Since 2004, new electromagnetic instrumentation has been installed at various Bay Area stations in conjunction with Simon Klemperer at Stanford University. Sensors are installed at JRSC, MHDL and BRIB.

### 1.3 2007-2008 Activities

#### USArray

When the USArray deployment began in Northern California, the BSL contracted with IRIS to contribute data from 19 BDSN stations. The stations were CMB, CVS, FARB, GASB, HOPS, HUMO, JCC, JRSC, KCC, MCCM, MNRC, MOD, ORV, PACP, PKD, POTR, WDC, WENL, and YBH. In the fall of 2007, the USArray pulled out equipment from its temporary sites. No data from the BDSN was sent to USArray after November 2007. For the USArray, the BSL modified the data loggers to change the BH sampling rate from 20 Hz to 40 Hz, a sampling rate which we continue to use.

During the station installation phase in Northern and Central California, the BSL collaborated with USArray to identify and permit sites that might be suitable as BDSN stations. Several were located at UC reserves and field stations. Data from these sites (Figure 3.2) were sent directly to the BSL as well as to the Array Network Facility and used in routine analysis to assess their performance. As the USArray left, we retained eight of the temporary sites (HAST, HATC, HELL, P01C, RAMR, S04C, SUTB and V03C). BSL engineers contacted the landowners prior to IRIS's departure. They received permission and made arrangements to continue operating stations at these sites. Because the overall objectives of the USArray deployment differ from the BSL's, their

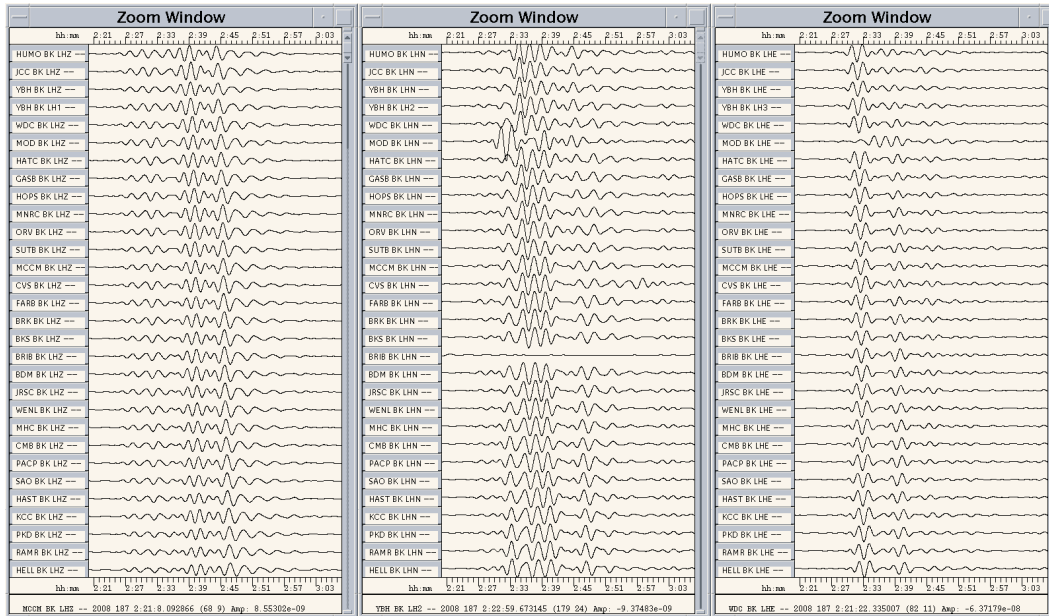

Figure 3.4: Long period waveforms recorded across BDSN from the deep  $M_w$  7.7 teleseism which occurred on July 5, 2008, in the Sea of Okhotsk at  $53.888^\circ$  N,  $152.869^\circ$  E. The traces are deconvolved to ground velocity, scaled absolutely, and ordered from top to bottom by distance from the epicenter. The highly similar waveforms recorded across the BDSN provide evidence that the broadband sensors other than the N component at BRIB are operating within their nominal specifications. The sensor at MOD is currently an STS-2, which is rotated by  $90^\circ$ , so the N and E components are exchanged.

sites' construction and infrastructure are also different. As each station was reinstrumented, BSL engineers made a special effort to minimize or eliminate water that accumulated in the vaults/pits from condensation. Five of the sites have now been reinstrumented (see below). All of these sites operate using solar power, and are equipped with Q330 data loggers and STS-2 seismometers. The strong motion sensor is either a Kinemetrics EPISensor or Metrozet TSA 100 accelerometer. Continuous data telemetry to Berkeley has been achieved from all sites using a variety of methods.

### Station Installation, Upgrades, Maintenance and Repairs

Given the remoteness of the off-campus stations, BDSN data acquisition equipment and systems are designed, configured, and installed so that they are both cost effective and reliable. As a result, the need for regular station visits has been reduced. Nonetheless, the broadband seismometers installed by BSL are of the first generation and are now approaching 25 years in age. Concurrently, the first generation of broadband data loggers are now 17 years old. Computer systems are retired long before this age, yet the electronics that form these data acquisition systems are expected to perform without interruption.

In 2007-2008 one focus of BSL's technical efforts went toward maintaining and repairing existing instrumentation, stations and infrastructure. In addition, equipment was installed at five former USArray stations. While expanding the data acquisition network continues to be a long term goal of BSL, it is equally important to assure integrity of the established network and preserve data quality.

*RAMR: Ramage Ranch, San Luis Obispo County, CA*  
This former USArray site is on private property at the Ramage Ranch west of Paso Robles, California. Seismic equipment was reinstalled in September, 2007. The site required a number of visits, however, to develop engineering solutions to improve the USArray vaults. At RAMR the vault is a 1.5 meter corrugated plastic culvert with a plastic lid set vertically into the native limestone. The lid is covered with soil and must be shoveled free each time entry is desired. Both the STS-2 and the strong motion sensor sit on the bottom of the vault along with a pump to remove accumulating water. The data logger, telemetry radio, batteries, and solar charge controller sit on a shelf of foam insulation above the seismometers. The telemetry antenna, external clock antenna and solar panel are mounted on a mast 10 meters from the vault. The cables pass through a buried conduit.

As it is built, condensation forming in the conduit and



filling it eventually drains into the vault and settles at the bottom. Within the vault, moisture also condensed and dripped from the underside of the lid. This water vapor was present year round - even during the rain free summer months. The USArray seismometers were continuously wet and often standing in about 50 mm of water. The sump pump could not remove water below this level.

Fearing long-term damage from corrosion, BSL engineers did not reinstall seismometers until the accumulated water vapor had been removed from the vault and provisions made to prevent condensation from forming. In the original construction, the sole connection of the vault to the outside air was the cable conduit containing cables. BSL engineers emptied more than twenty liters of water from the conduits and pulled a 4 mm tube from inside the vault to the top of the mast. Next a "tee" section was added to the mast and the cables routed out one leg of the tee together with the newly installed tube. The area around the cables and tube was carefully plugged with expanding foam. A solar vent was added to the remaining section of the tee.

In the newly configured "tube within a conduit", a restricted and controlled amount of outside air is continuously pulled through the tubing into the vault by the suction created by the solar vent. The air is exhausted during daylight hours by the solar vent. Water vapor does not condense on the underside of the lid. The air exchange is at a rate beyond the nominal bandwidth of the seismometers.

BSL engineers returned to the site several times after the instruments were installed in order to optimize the solar panel, trim newly grown brush from the solar panel and telemetry antenna, and monitor the success of the vent system. Engineers also replaced the power system for the receiving radio at the frame relay drop.

*SUTB: Sutter Buttes, Butte County, CA* BSL engineers reinstalled instrumentation at the former USArray site at SUTB in April and May 2008. The site is located on private land north of the BARD-GPS site at Sutter Buttes. Continuous telemetry is achieved via digital radio telemetry relay to the GPS site atop Sutter Buttes, and onward to the frame relay circuit at station ORV.

As described at RAMR, BSL engineers installed a solar powered ventilation system to eliminate condensation within the vault. Engineers also relocated the mast supporting the solar panel and radio antennas from beneath the canopy of an oak tree. The radio link remains problematic with remote troubleshooting required regularly.

*HATC: Hat Creek Observatory, Lassen County, CA* Instrumentation was reinstalled at the former USArray site at Hat Creek in April of 2008. The site is located on property owned by the University of California within the boundaries of the radio telescope array. Data are telemetered continuously from the site via the Observatory's

T-1 line back to Berkeley. The support and cooperation of the UCB Astronomy department merits special mention.

*HAST: Hastings Reserve, Monterey County, CA* BSL engineers reinstalled instrumentation in the USArray vault at the Hastings Reserve in March of 2008. The site is located on property owned by the University of California system and operated as a biological field station (<http://www.hastingsreserve.org>). As at RAMR, BSL engineers installed solar ventilation at HAST to eliminate condensation within the vault. Telemetry from the site is accomplished via digital radio link to the University operated satellite link.

*HELL: Hellweg Property, Fresno County, CA* BSL reinstalled instrumentation in the USArray vault on property owned by Peggy Hellweg of the BSL in March of 2008. Telemetry from the site is accomplished via digital radio link and leased commercial satellite internet.

As at RAMR, BSL engineers installed solar ventilation at HELL to eliminate condensation within the vault.

*V03C: Fort Hunter-Liggett, Monterey County, CA* The USArray site V03C of interest to the BSL is located on federal property at Fort Hunter-Liggett in Monterey County. This military base is administered by the US Army Corp of Engineers. USArray initially paid a substantial permitting fee to receive permission to occupy the site.

BSL has indicated to the Corp of Engineers that we would be taking over operation of the site, and as a member of the IRIS consortium, have already paid the necessary permit fee. Our proposal appears to have been well received, and the permit transfer is currently being processed. We expect that the site will be reinstrumented with the 2008 calendar year.

*WENL: The BSL station WENL began operating in 1997. The equipment is installed in a high humidity adit used for storing and aging wine. BSL engineers replaced cables and the STS-2 seismometer this year after a reduction in the instrument's sensitivity (signal levels) was observed. Since WENL was installed, growth and development at the winery caused increases in the background noise levels over the past several years. A search for a suitable replacement site has begun.*

*HOPS: The BDSN station at Hopland, California, has been operating since October, 1994. The station is located approximately 100 miles northwest of Berkeley. In the summer of 2007, BSL engineers temporarily removed the control electronics for the STS-1 seismometers at HOPS. The external connectors on the electronics were found to have corroded sufficiently that currents leaked from pin-to-pin. Under magnification, the electronics were also found to have white "fuzz" growing on individual components. The resultant electrical leakage can reduce the seismometer's response to ground movement or even completely stop it. The electronics were*

thoroughly cleaned in an alcohol solution, and all connectors were replaced.

When the cleaned electronics were replaced at HOPS, a calibration pulse was initiated using the factory electronics. The data were used to calculate the responses of the instruments. Then, the newly developed E300 electronics were substituted. The seismometers were run with the E300 control electronics for six weeks, after which the original electronics were reinstalled.

The development and testing of MetroZet E300 electronics are described more fully in Section 9.

*KCC:* At station KCC (Kaiser Creek California) BSL engineers removed the STS-1 seismometers during 2006-2007 and installed an STS-2, an instrument consistent with the specifications of the TA. This provided the opportunity to use the three STS-1 components at Berkeley's Byerly Vault in the STS-1 electronics upgrade program. In November 2007, the STS-1 seismometers were reinstalled at KCC.

When the STS-1 seismometers were reinstalled at KCC, normal leveling and orientation procedures were followed. The prototype E300 electronics were also installed and the calibration features of the new electronics were exercised while the BSL engineers were on site. The calibration features could not be remotely activated once the engineers returned to Berkeley. Some grounding issue affecting the network connection is thought to be the reason. The network connection to the seismometer control E300 prototype has not been resolved at this time. It is, however, convenient to have the E300 electronics for the STS-1 seismometers installed at this site, as it allows remotely operated recentering.

*MCCM:* Continuous data telemetry from the station MCCM is achieved using VSAT equipment supplied by ANSS. During 2007, engineers from BSL installed additional hardware so that the VSAT system could be rebooted remotely if it should hang up or some other failure should occur.

BSL also received permission from the California State Park system and the California Department of Forestry and Fire (CDF) to install two digital radio repeaters so that data from MCCM can be relayed to Berkeley by means other than the VSAT. We are currently awaiting specific siting instructions from the CDF on the radio tower at St Helena.

*JRSC:* The equipment at station JRSC is operated and maintained by BSL on behalf of Stanford University. In April of 2008, the strong motion FBA-23 was replaced with a MetroZet model TSA-100S sensor. The replacement sensor is plug compatible with the other strong motion sensors within the BDSN network. Additionally, the removed sensor did not provide the differential output that the Quanterra data logger expects. This incompatibility manifests itself in the form of ground loops and high instrument noise. The replacement TSA-100A sen-

sor was purchased and provided by Stanford.

*MHC:* In late 2007, the strong motion Episensor at station MHC began to exhibit an offset on the east component. This is usually consistent with a sensor problem. Although the engineers from BSL installed a replacement sensor, the same symptoms continued during the next month. A second trip to the site revealed that the cable between the data logger and the sensor had become so stressed that an individual wire had disconnected at the back of the connector shell. The connector was repaired onsite.

Additionally, BSL engineers proactively replaced the BARD GPS receiver which had been operating continuously since 1996. These receivers have been known to lose their software when their internal battery dies. Repair and upgrade of these receivers is described elsewhere in this publication.

*MHDL and OXMT:* The BSL equipment at MHDL and OXMT is co-located with USGS instruments as part of the miniPBO network. BSL engineers developed a scheme to isolate power to all instruments. The scheme involves separate AC-DC power supplies for each of the six instrument sets at the site. BSL engineers replaced several of the power supplies at each of the sites during 2007-2008 that had been damaged by mice infestation.

*OHLN:* The BSL equipment at OHLN is co-located with USGS instruments as part of the miniPBO array. Power to the site is provided by the local school district. Several times during the year, maintenance workers at the school inadvertently cut power to the seismic site. Power was always restored after BSL personnel contacted the school authority.

*FARB:* BSL has operated instrumentation on SE Farallon Island continuously since 1994. Beginning initially with a GPS receiver, broadband seismic instruments were added in 1996. Because of the highly corrosive marine environment, the radio telemetry antennas have been replaced every two years.

Continuous seismic and GPS telemetry from the island is achieved using redundant 900 MHz and 2.4 GHz digital radio transceivers. The 900 MHz link operates from the island, through the Golden Gate, to the hills above the Berkeley campus. The 2.4 GHz link operates from the island to the University of California Medical Science building in San Francisco. From San Francisco, a frame relay circuit completes the data link to Berkeley.

In the fall of 2007, BSL engineers made several trips to the island to replace and realign the antennas. During the same trips, the BSL engineers enabled digital radios for the use and benefit of the USFWS and the biologist stationed there. This link provides both data and VOIP services to the inhabitants of the island. BSL engineers also replaced all of the receiving antennas on the San Francisco end of links.

## The Monterey Bay Ocean Bottom Seismic Observatory (MOBB)

The Monterey Ocean Bottom Broadband observatory (MOBB) is a collaborative project between the Monterey Bay Aquarium Research Institute (MBARI) and the BSL. Supported by funds from the Packard Foundation to MBARI, NSF/OCE funds and UC Berkeley funds to BSL, its goal has been to install and operate a long-term seafloor broadband station as a first step towards extending the on-shore broadband seismic network in Northern California to the seaside of the North-America/Pacific plate boundary, providing better azimuthal coverage for regional earthquake and structure studies. It also serves the important goal of evaluating background noise in near-shore buried ocean floor seismic systems, such as may be installed as part of temporary deployments of “leap-frogging” arrays (e.g. Ocean Mantle Dynamics Workshop, September 2002).

BSL staff put significant effort in the development of procedures to minimize instrumental noise caused by air circulation inside the seismometer package casing (see 2001-2002 and 2002-2003 BSL Annual Reports). These procedures were later applied to the preparation of 3 similar packages destined for installation on the Juan de Fuca plate in the framework of University of Washington’s Keck project.

This project follows the 1997 MOISE experiment, in which a three component broadband system was deployed for a period of 3 months, 40 km offshore in Monterey Bay, with the help of MBARI’s “Point Lobos” ship and ROV “Ventana” (Figure 3.5). MOISE was a cooperative program sponsored by MBARI, UC Berkeley, and the INSU, Paris, France (*Stakes et al.*, 1998; *Romanowicz et al.*, 1999; *Stutzmann et al.*, 2001). During the MOISE experiment, valuable experience was gained on the technological aspects of such deployments, which contributed to the success of the present MOBB installation.

The successful MOBB deployment took place April 9-11, 2002, and the station has been recording data autonomously ever since (e.g. *Romanowicz et al.*, 2003). It comprises a three component very broadband CMG-1T seismometer system, a differential pressure gauge, (DPG, *Cox et al.*, 1984) and a current meter. Data from the DPG are acquired with a sampling rate of 1 sps and are crucial for the development and implementation of a posteriori noise deconvolution procedures to help counteract the large contribution of infragravity wave noise in the period range 20-200 sec. Procedures for removal of infragravity wave noise as well as signal generated noise have been developed.

Twenty-three “dives” involving the MBARI ship “Point Lobos” and ROV “Ventana” have so far taken place to exchange data loggers and battery packages during the time period 04/10/02 to 06/30/08. In February 2004, the N/S component seismometer failed. It was tem-

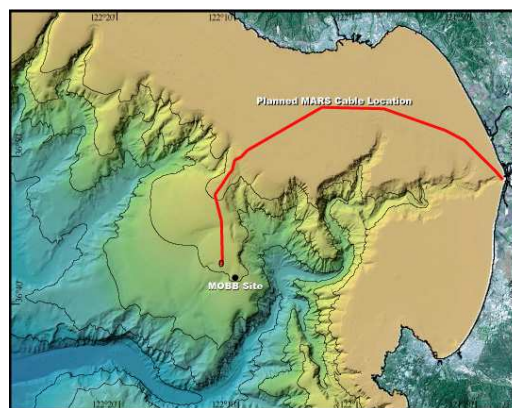

Figure 3.5: Location of the MOBB station in Monterey Bay, California, against seafloor and land topography. The path of the MARS cable is indicated by the solid line.

porarily replaced, from 05/19/04 to 07/09/04, by one of the Keck seismometer packages which was conveniently available at that time. The original seismometer was sent back to Guralp Systems Ltd. for repair and successfully reinstalled on 07/09/04.

The data collection from the broadband seismic system is fairly complete. However, there have been recurring DPG sensor as well as DPG data storage problems in the first two years of the MOBB operation. Well recorded DPG data are available since 03/18/2004.

The MOBB station is located close to the path of the MARS cable (Figure 3.5) which was deployed in the spring of 2007. The connection of MOBB to the MARS cable will allow continuous, real-time data acquisition from this site. Developing the interface for the connection to MARS is the object of a recently funded NSF project. Work on this project commenced in the summer of 2007. Installation is planned in spring 2009.

## 1.4 Acknowledgements

Under Barbara Romanowicz’s general supervision, Peggy Hellweg and Doug Neuhauser oversee the BDSN data acquisition operations, and Bill Karavas heads the engineering team. John Friday, Jarrett Gardner, Rick Lellinger and Bob Uhrhammer contribute to the operation of the BDSN. Karl Kappler has been responsible for the operation of the EM observatories. Bill Karavas, Bob Uhrhammer, and Peggy Hellweg contributed to the preparation of this section.

The California Governor’s Office of Emergency Services and the Federal Emergency Management Agency provided funds for the instrumentation installed at the new stations HAST, HATC, HELL, RAMR and SUTB.

MOBB is a collaboration between the BSL and MBARI, involving Barbara Romanowicz, Bob Uhrham-

mer and Doug Neuhauser from the BSL, and Paul McGill from MBARI. The MBARI team also has included Steve Etchemendy (Director of Marine Operations), Jon Erickson, John Ferreira, Tony Ramirez and Craig Dawe. The MOBB effort at the BSL is supported by UC Berkeley funds. MBARI supports the dives and data recovery. The MOBB seismometer package was funded by NSF/OCE grant #9911392. The development of the interface for connection to the MARS cable is funded by NSF/OCE grant #0648302.

## 1.5 References

Cox, C., T. Deaton and S. Webb, A deep-sea differential pressure gauge, *J. Atm. Ocean. Tech.*, 1, 237-245, 1984.

Crawford W. C., and S. C. Webb, Identifying and removing tilt noise from low-frequency (<0.1 Hz) seafloor vertical seismic data, *Bull. Seis. Soc. Am.*, 90, 952-963, 2000.

Murdock, J., and C. Hutt, A new event detector designed for the Seismic Research Observatories, *USGS Open-File-Report 83-0785*, 39 pp., 1983.

Romanowicz, B., D. Stakes, J. P. Montagner, P. Tarits, R. Uhrhammer, M. Begnaud, E. Stutzmann, M. Pasyanos, J.F. Karczewski, and S. Etchemendy, MOISE: A pilot experiment towards long term sea-floor geophysical observatories, *Earth Planets Space*, 50, 927-937, 1999.

Romanowicz, B., D. Stakes, R. Uhrhammer, P. McGill, D. Neuhauser, T. Ramirez, and D. Dolenc, The MOBB experiment: a prototype permanent off-shore ocean bottom broadband station, *EOS Trans. AGU*, Aug 28 issue, 2003.

Stakes, D., B. Romanowicz, J.P. Montagner, P. Tarits, J.F. Karczewski, S. Etchemendy, D. Neuhauser, P. McGill, J-C. Koenig, J.Savary, M. Begnaud, and M. Pasyanos, MOISE: Monterey Bay Ocean Bottom International Seismic Experiment, *EOS Trans. AGU*, 79, 301-309, 1998.

Stutzmann, E., J.P. Montagner et al., MOISE: a prototype multiparameter ocean-bottom station, *Bull. Seism. Soc. Am.*, 81, 885-902, 2001.

Wielandt, E., and J. Steim, A digital very broadband seismograph, *Ann. Geophys.*, 4, 227-232, 1986.

Wielandt, E., and G. Streckeisen, The leaf spring seismometer: design and performance, *Bull. Seis. Soc. Am.*, 72, 2349-2367, 1982.

Zürn, W., and R. Widmer, On noise reduction in vertical seismic records below 2 mHz using local barometric pressure, *Geophys. Res. Lett.*, 22, 3537-3540, 1995.

## 2. California Integrated Seismic Network

### 2.1 Introduction

Advances in technology have made it possible to integrate separate earthquake monitoring networks into a single seismic system as well as to unify earthquake monitoring instrumentation. In California, this effort began in the south with the TriNet Project. There Caltech, the California Geological Survey (CGS), and the USGS combined efforts to create a unified seismic system for southern California. With major funding provided by the Federal Emergency Management Agency (FEMA), the California Governor's Office of Emergency Services (OES), and the USGS, the TriNet project provided the opportunity to upgrade and expand the monitoring infrastructure, combining resources in a federal, state and university partnership. In 2000, the integration effort expanded to the entire State with the formation of the California Integrated Seismic Network (CISN, see 2000-2001 Annual Report). To this end, UC Berkeley and the USGS Menlo Park and Pasadena offices joined forces with Caltech and the CGS. The CISN is now in the eighth year of collaboration and its seventh year of funding from the OES.

### 2.2 CISN Background

#### Organization

The organizational goals, products, management, and responsibilities of the CISN member organizations are described in the founding MOU and in the strategic and implementation plans. To facilitate activities among institutions, the CISN has formed three management centers:

- Southern California Earthquake Management Center: Caltech/USGS Pasadena
- Northern California Earthquake Management Center: UC Berkeley/USGS Menlo Park
- Engineering Strong Motion Data Center: California Geological Survey/USGS National Strong Motion Program

The Northern and Southern California Earthquake Management Centers are operating as twin statewide earthquake processing centers serving information on current earthquake activities, while the Engineering Strong Motion Data Center has the responsibility for producing engineering data products and distributing them to the engineering community.

The Steering Committee, made up of two representatives from each core institution and a representative from

OES, oversees CISN projects. The position of chair rotates among the institutions; Rob Clayton took over as chair of the Steering Committee in June 2008 from Jeroen Tromp to complete Caltech's tenure.

An external Advisory Committee represents the interests of structural engineers, seismologists, emergency managers, industry, government, and utilities, and provides review and oversight. The Advisory Committee is chaired by Stu Nishenko of Pacific Gas and Electric Company. It last met in October 2007. Agendas from the meetings and the resulting reports may be accessed through the CISN Web site (<http://www.cisn.org/advisory>).

The Steering Committee has formed other committees, including a Program Management Group to address planning and coordination and a Standards Committee to resolve technical design and implementation issues.

In addition to the core members, other organizations contribute data that enhances the capabilities of the CISN. Contributing members include: University of California, Santa Barbara; University of California, San Diego; University of Nevada, Reno; University of Washington; California Department of Water Resources; Lawrence Livermore National Lab; and Pacific Gas and Electric.

#### CISN and ANSS

The USGS Advanced National Seismic System (ANSS) is being developed along a regionalized model. Eight regions have been organized, with the CISN representing California. David Oppenheimer of the USGS represents the CISN on the ANSS National Implementation Committee (NIC).

Over the past 9 years, ANSS funding in California has been directed primarily to the USGS Menlo Park to expand the strong-motion instrumentation in the San Francisco Bay Area. As a result, more than 100 sites have been installed or upgraded, significantly improving the data available for ShakeMaps.

As the ANSS moves forward, committees and working groups are being established to address issues of interest. BSL faculty and staff have been involved in several working groups of the Technical Integration Committee, including Doug Dreger, Pete Lombard, Doug Neuhauser, Bob Uhrhammer, and Stephane Zuzlewski.

#### CISN and OES

The California Governor's Office of Emergency Services has had a long-term interest in coordinated earthquake monitoring. The historical separation between

Northern and Southern California and between strong-motion and weak-motion networks resulted in a complicated situation for earthquake response. Thus, OES has been an advocate of increased coordination and collaboration in California earthquake monitoring and encouraged the development of the CISON. In FY01-02, Governor Gray Davis requested support for the CISON, to be administered through OES. Funding for California Geological Survey, Caltech and UC Berkeley was made available in spring 2002, officially launching the statewide coordination efforts. Following the first year of funding, OES support led to the establishment of 3-year contracts to the UC Berkeley, Caltech, and the California Geological Survey for CISON activities. The first multi-year award covered activities in 2002-2005. The three-year contract for 2006-2008 has just been completed. Past CISON-related activities are described in previous annual reports.

### 2.3 2007-2008 Activities

The CISON funding from OES has supported a number of activities at the BSL during the past year.

#### Adopting USArray Stations

In late 2003, the CISON concluded a memorandum of agreement with the Incorporated Research Institutions in Seismology (IRIS) covering the duration of the US-Array project in California. As a result, data from 19 stations operated by the BSL and 41 stations operated by Caltech were contributed to USArray’s travelling array (TA) during its California deployment. The BSL also provided accelerometers for use at TA sites which might be of interest as future BDSN stations. We monitored the data from these stations in real time and included the data in ShakeMaps and moment tensors. In addition, data from these TA stations were included in our development of new parameters that are valid statewide for determining  $M_L$  (see Research Study 34.). The TA moved out of California during the fall of 2007, and the BSL adopted eight of the sites. Instrumentation has been installed at RAMR, HAST, HATC, HELL, and SUTB (see Section 1.). Support for the equipment has come from FEMA Hazard Grant Mitigation Program Funds and from CISON funding. Vaults have been left open at P01C, S04C, and V03C, which the BSL will instrument when funding becomes available.

#### Northern California Earthquake Management Center

As part of their effort within the CISON, the BSL and the USGS Menlo Park are implementing the new generation of the Northern California joint notification system. Section 8. describes the operations of the existing Management Center and reports on the design and implementation progress.

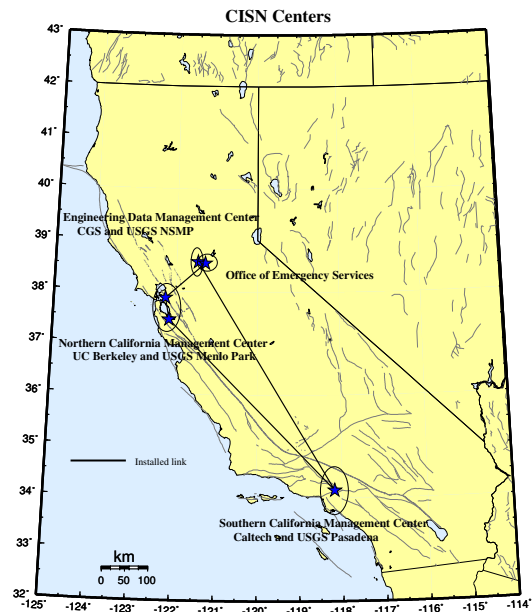

Figure 3.6: Map showing the geographical distribution of the CISON partners and centers. The communications “ring” is shown schematically with installed links (solid lines).

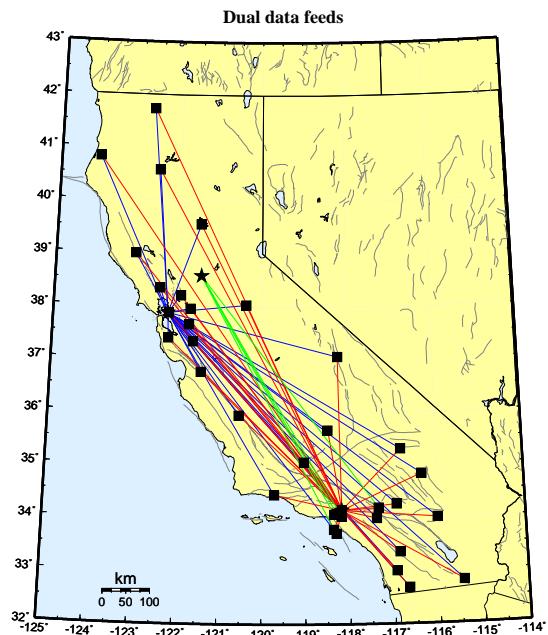

Figure 3.7: Map showing the 30 stations selected to send data directly to the Northern and Southern California processing centers, and the 5 stations that send data directly to the Engineering Data Center and the Southern California processing center.

In order to move ahead with plans for restructuring the Northern California earthquake monitoring system, the USGS Menlo Park and BSL have been improving their communications infrastructure. At present, the BSL and the USGS Menlo Park are connected by two dedicated T1 circuits. One circuit is a component of the CISON ring, while the second circuit was installed in 2004-2005 (Figure 3.8) to support dedicated traffic between Berkeley and Menlo Park above and beyond that associated with the CISON.

The installation of the second dedicated T1 between Berkeley and Menlo Park freed up a frame-relay connection deployed by the BSL as part of the CalREN project in mid-1990s. The BSL has reconfigured this frame-relay circuit to serve as a second data acquisition link. BDSN data acquisition is now distributed between two frame-relay T1 circuits, eliminating what had been a single point of failure. An additional Permanent Virtual Circuit (PVC) has also been implemented at each BDSN site so that each station has connections to both T1s. This has improved the robustness of data acquisition at the BSL by providing redundancy in the incoming circuit.

In the long term, the BSL and USGS Menlo Park hope to be connected by high-bandwidth microwave or satellite service. Unfortunately, we have not yet been able to obtain funding for such an additional communication link.

## 2.4 Statewide Integration

BSL staff are involved in many elements of the statewide integration effort. The Standards Committee, chaired by Doug Neuhauser, continues to define and prioritize projects important to the development and implementation of the statewide earthquake processing system and to establish working groups to address them (see minutes from meetings and conference calls at <http://www.cisn.org/standards/meetings.html>).

*Dual Station Feeds:* Early in the existence of CISON, “dual station feeds” were established for 30 stations (15 in Northern California and 15 in Southern California) (Figure 3.7). The Northern California Earthquake Management Center (NCEMC) is using data from the Southern California stations to estimate magnitudes on a routine basis. A subset of these stations are being used for the moment tensor inversions, a computation that is sensitive to the background noise level.

*Data Exchange:* Pick exchange was initiated between the NCEMC and its Southern California counterpart in 2001-2002. The software CISON has developed to produce and exchange the reduced amplitude timeseries has also been completed. Currently, these timeseries are being exchanged at the NCEMC, but not yet statewide. Using a common format, the CISON partners continue to exchange observations of peak ground motion with one another following an event or a trigger. This step increases the ro-

bustness of generating products such as ShakeMap, since all CISON partners now exchange data directly with one another. This also improves the quality of ShakeMaps for events on the boundary between Northern and Southern California, such as the San Simeon earthquake, by allowing all data to be combined in a single map. Finally, this is a necessary step toward the goal of generating statewide ShakeMaps.

*The Software Calibration & Standardization:* CISON partners are working to standardize the software used for automatic earthquake processing and earthquake review, as well as to calibrate it. Currently, the software implemented at the NCEMC and at the Southern California Earthquake Management Center is very different. During the past year in the NCEMC, we have worked on preparing a version of the Southern California TriNet software for implementation as CISON software in the NCEMC.

- **Magnitude:** Calibrating magnitude estimates has proven to be more difficult than originally anticipated. As described in 2003-2004, evidence indicates that there is a bias between the Northern and Southern California estimates of local magnitude  $M_L$ . Efforts to understand this issue have been hampered by the lack of a good statewide dataset. Bob Uhrhammer has selected data from 180 earthquakes distributed throughout the state and comprising recordings from 976 horizontal components from the AZ, BK, CI and NC networks (see Research Study 34.). In January 2007, we agreed on a  $\log A_o$  function suitable for statewide use. Station-specific corrections for  $M_L$  have now been defined for most broadband/strong motion stations. We are working to develop station-specific corrections for strong motion only stations, and to tie the new system in with historical stations. A final component of the magnitude efforts is the determination of a magnitude reporting hierarchy. For the near future, each region will continue to use its own preferences for magnitude reporting.
- **ShakeMap:** At present, ShakeMaps are generated on 5 systems within the CISON. Two systems in Pasadena generate “SoCal” Shakemaps; 2 systems in the Bay area generate “NoCal” Shakemaps; and 1 system in Sacramento generates ShakeMaps for all of California. The Sacramento system uses QDDS to provide the authoritative event information for Northern and Southern California.

The dearth of stations in the near source region of the 2003 San Simeon earthquake raised the issues of how to measure the quality of a ShakeMap and how to quantify the uncertainty. A subset of the Working Group worked on this issue, based on the work of *Hok and Wald* (2003). *Lin et al* (2006) pre-

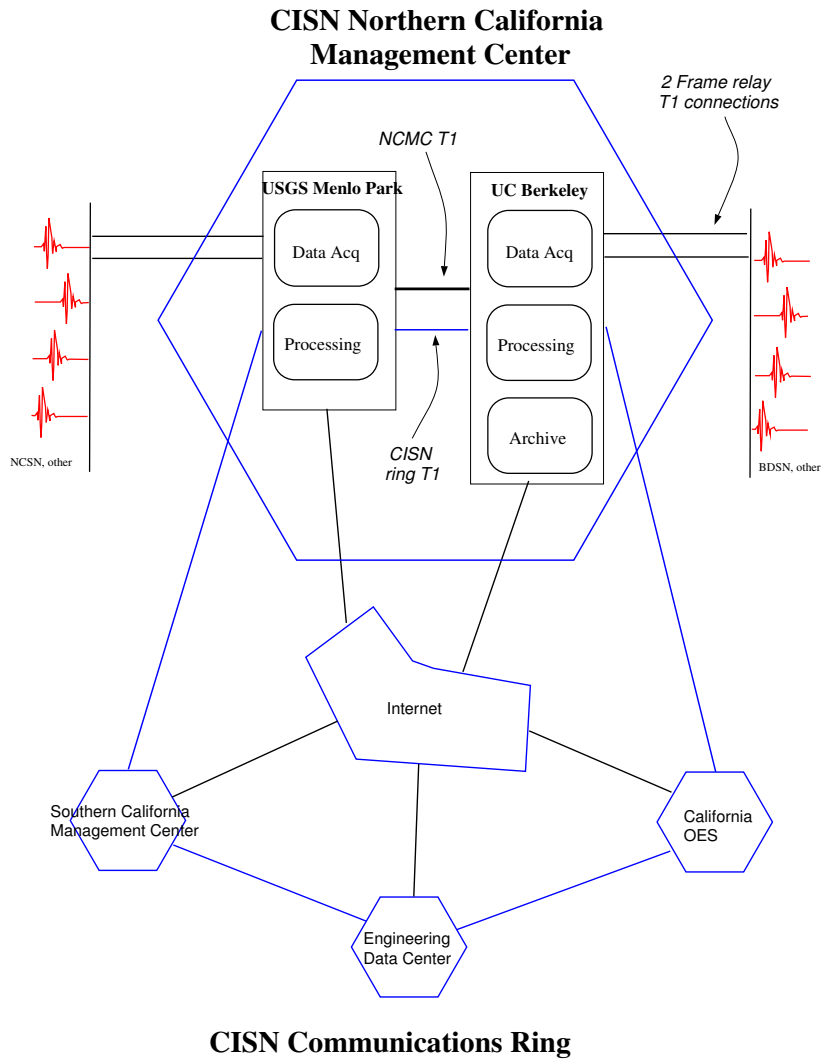

Figure 3.8: Schematic diagram illustrating the connectivity between the real-time processing systems at the USGS Menlo Park and UC Berkeley, forming the Northern California Management Center, and with other elements of the CISN.

sented progress toward quantifying ShakeMap uncertainty, and ShakeMaps are now published with a grade.

A second goal of this effort was to improve the robustness of ShakeMap generation and delivery by taking advantage of the fact that ShakeMaps are generated in the Bay Area, Pasadena, and Sacramento. Ongoing efforts in this direction will likely be based on the new USGS ShakeMap webpages at the National Earthquake Information Center.

- **Location Codes:** The CISN adopted a standard for the use of “location” codes (part of the Standard for the Exchange of Earthquake Data (SEED) nomenclature to describe a timeseries based on network-station-channel-location) in the late fall of 2003. USGS and UC Berkeley developers modified the Earthworm software to support their use. After the transition at USGS Menlo Park away from the CUSP analysis system to **Jiggle** in late November, 2006, all networks in the CISN implemented location codes in their systems.



- **Metadata Exchange:** Correct metadata are vital to CISN activities, as they are necessary to ensure valid interpretation of data. CISN is working on issues related to their reliable and timely exchange. The CISN Metadata Working Group compiled a list of metadata necessary for data processing and developed a model for their exchange. In this model, each CISN member is responsible for the metadata for its stations and for other stations that enter into CISN processing through it. For example, Menlo Park is responsible for the NSMP, Tremor, and PG&E stations, while Caltech is responsible for the Anza data. At the present time, dataless SEED volumes are used to exchange metadata between the NCEMC and the SCEMC. The Metadata Working Group is developing a Station XML format for metadata exchange. This vehicle is expandable, and will probably allow exchange of a more comprehensive set of metadata than dataless SEED volumes, some of which may be necessary for other systems, for example in V0 formatted data.
- **Leap second compatibility:** Northern and Southern California databases handled leap seconds differently. A major software programming effort in the past year has been directed toward taking this into account. The data processing and analysis software now treats leap seconds consistently. All packages can be configured to pass the time information to the database in nominal or true time, as necessary.
- **Standardization:** The CISN's focus on standardization of software continues. For example, the BSL and the USGS Menlo Park are adapting the software running at the SCEMC for use at the NCEMC and are currently testing its various elements. The adoption of *Jiggle* in northern California in late November 2007 was the first step in the implementation of the new software. Current efforts are directed toward the implementation and testing of the complete system (see Section 8.). This software will be offered to other regional networks of the ANSS in the near future.

### CISN Display

CISN Display is an integrated Web-enabled earthquake notification system designed to provide earthquake information for emergency response at 24/7 operations centers. First responders, organizations with critical lifelines and infrastructure, and emergency responders are invited to register for an account at <http://www.cisn.org/software/cisndisplay.htm>.

The application provides users with maps of real-time seismicity and automatically provides access to Web-related earthquake products such as ShakeMaps. CISN

Display also offers an open source GIS mapping tool that allows users to plot freely available layers of public highways, roads and bridges, as well as private layers of organizational-specific infrastructure and facilities information. The current version of CISN Display is 1.4. Its primary enhancement over the previous version is the development of a kiosk-mode for public display purposes.

### Earthquake Information Distribution

The USGS hosted a workshop in October 2004 to develop plans for the installation and use of the EIDS software. Doug Neuhauser and Pete Lombard participated in this workshop, which resulted in a document outlining the steps necessary for the installation and migration of the earthquake notification system from the current Quake Data Distribution Services (QDDS) to EIDS.

### Outreach

Since FY05-06, the CISCN Web site ([www.cisn.org](http://www.cisn.org)) has been supported by two servers located at Berkeley and Caltech. The Web servers are set up so that the load can be distributed between them, providing improved access during times of high demand. With the increased robustness provided by the new servers, the CISCN provides access to certain earthquake products directly from [www.cisn.org](http://www.cisn.org). For example, ShakeMaps are now served directly from the CISCN Web site, in addition to being available from several USGS Web servers and the CGS. The design and content of <http://www.cisn.org> continues to evolve. The Web site is an important tool for CISCN outreach as well as for communication and documentation among the CISCN partners.

The CISCN continues to support the dedicated Web site for emergency managers. Following a suggestion from the Advisory Committee, we have designed a Web site to provide personalized access to earthquake information. Known as "myCISCN," the Web site is available at [eoc.cisn.org](http://eoc.cisn.org). Access to the Web site is limited to registered users in order to provide highly reliable access. At present, "myCISCN" is a single Web server located at UC Berkeley. However, modifications to the database are underway to allow for multiple servers in the future. A second computer, already purchased, will either be installed in Sacramento or in Southern California.

As part of the CISCN, the BSL is contributing to efforts to raise awareness of earthquakes and preparedness as the 140 anniversary of the 1868 Hayward Fault earthquake approaches on October 21, 2008. In particular, we will be co-hosting the *Third Conference on Earthquake Hazards in the Eastern Bay Area* as well as organizing and participating in other related activities.

## 2.5 Acknowledgements

CISN activities at the BSL are supported by funding from the Governor's Office of Emergency Services.

Barbara Romanowicz and Peggy Hellweg are members of the CISN Steering Committee. Peggy Hellweg is a member of the CISN Program Management Group, and she leads the CISN project at the BSL with support from Doug Neuhauser. Doug Neuhauser is chair of the CISN Standards Committee, which includes Peggy Hellweg, Pete Lombard, and Stephane Zuzulevski as members.

Because of the breadth of the CISN project, many BSL staff members have been involved, including: John Friday, Jarrett Gardner, Peggy Hellweg, Bill Karavas, Alexei Kireev, Rick Lelling, Pete Lombard, Doug Neuhauser, Charley Paffenbarger, Bob Uhrhammer and Stephane Zuzlewski. Peggy Hellweg contributed to this section. Additional information about the CISN is available through reports from the Program Management Group.

## 2.6 References

Hok, S., and D. J. Wald, Spatial Variability of Peak Strong Ground Motions: Implications for ShakeMap Interpolations, *EOS. Trans. AGU*, 84(46), F1121, 2003.

Lin, K-W., D. Wald, B. Worden and A.F. Shakal, Progress toward quantifying CISN ShakeMap uncertainty, *Eighth National Conference on Earthquake Engineering, San Francisco, California, April 18-21, 2006*.

## 3. Northern Hayward Fault Network

### 3.1 Introduction

Complementary to the regional broadband network, the Hayward Fault Network (HFN) (Figure 3.9 and Table 3.5) is a deployment of borehole-installed, wide-dynamic range seismographic stations along the Hayward Fault and throughout the San Francisco Bay toll bridges network. Development of the HFN initiated through a cooperative effort between the BSL and the USGS, with support from the USGS, Caltrans, EPRI, the University of California Campus/Laboratory Collaboration (CLC) program, LLNL, and LBNL. The project's objectives included an initial characterization period followed by longer-term monitoring effort using a backbone of stations from among the initial characterization set. Subsequent funding from Caltrans, however, has allowed for continued expansion of the backbone station set for additional coverage in critical locations.

The HFN consists of two components. The Northern Hayward Fault Network (NHFN), operated by the BSL, consists of 29 stations with various operational statuses. These include stations located on Bay Area bridges and now at borehole sites of the Mini-PBO (MPBO) project, which were installed with support from NSF and the member institutions of the MPBO project. The NHFN is considered part of the BDSN and uses the network code BK. The Southern Hayward Fault Network (SHFN) is operated by the USGS and currently consists of 5 stations. This network is considered part of the NCSN and uses the network code NC. The purpose of the HFN is threefold: 1) to increase substantially the sensitivity of seismic data to low amplitude seismic signals, 2) to increase the recorded bandwidth for seismic events along the Hayward fault, and 3) to obtain bedrock ground motion signals at the bridges from more frequent, smaller earthquakes.

Data with these attributes contribute significantly to a variety of scientific objectives including: a) investigating bridge responses to stronger ground motions from real earthquakes, b) obtaining a significantly lower detection threshold for microearthquakes and possible nonvolcanic tremor signals, c) increasing the resolution of the fault-zone seismic structure (e.g., in the vicinity of the Rodgers Creek/Hayward Fault step over), d) improving monitoring of spatial and temporal evolution of seismicity (to magnitudes approaching  $M \sim -1.0$ ) that may signal behavior indicative of the nucleation of large damaging earthquakes, e) the investigation of earthquake scaling, physics, and related fault processes, f) improving working models for the Hayward fault, and g) using these models to make source-specific response calculations for estimating strong ground shaking throughout the Bay

Area.

This section is primarily focused on the NHFN and activities associated with the BSL operations.

### 3.2 NHFN Overview

The initial characterization period of HFN development ended in 1997. During that period, the NHFN sensors provided signals to on-site, stand-alone Quanterra Q730 and RefTek 72A-07 data loggers, and manual retrieval and download of data tapes was required. Also in that year, the long-term monitoring phase of the project began, involving the installation of 24-bit data acquisition and communication platforms and data telemetry to the BSL archives for a backbone of the initial NHFN stations.

Over the years, Caltrans has provided additional support for the upgrade of two non-backbone sites to backbone operational status and for the addition of several new sites to the monitoring backbone. These expansion efforts are ongoing. Also since the transition to the long-term monitoring phase, the 5 stations of the MPBO project have been folded into the NHFN.

Of the 29 stations considered part of the NHFN history, 13 of the stations are currently operational, with telemetered data streams flowing continuously into the BSL's BDSN processing stream with subsequent archival in the Northern California Earthquake Data Center (NCEDC) archive. These include the 5 MPBO sites. Nine of the 29 stations are non-backbone stations that have not been upgraded to continuous telemetry. Though collection of data from these sites has been discontinued, their borehole sensor packages are still in place (having been grouted in), and efforts to find funding for upgrade of these sites with Quanterra Q4120, Q730, or Q330 data loggers and continuous telemetry continue. One of the upgraded backbone sites (BBEB) now operates only as a telemetry repeater site because access to the borehole was cut off during seismic retrofit work on the eastern span of the Bay Bridge in August of 2007. One original backbone site (SMCB) was also upgraded from a post-hole to a deep borehole installation in 2007 and was renamed SM2B.

The remaining 5 sites are in the process of being added to the NHFN backbone. Four of the sites have been drilled and instrumented and are awaiting installation of their electronics and infrastructures. Equipment has been purchased for the 1 remaining site (PINB), which is awaiting final land-use agreement from the Regional Parks district and drilling by Caltrans. We have also begun negotiating a land-use agreement with Cal Maritime for permission to install a new borehole at that site,

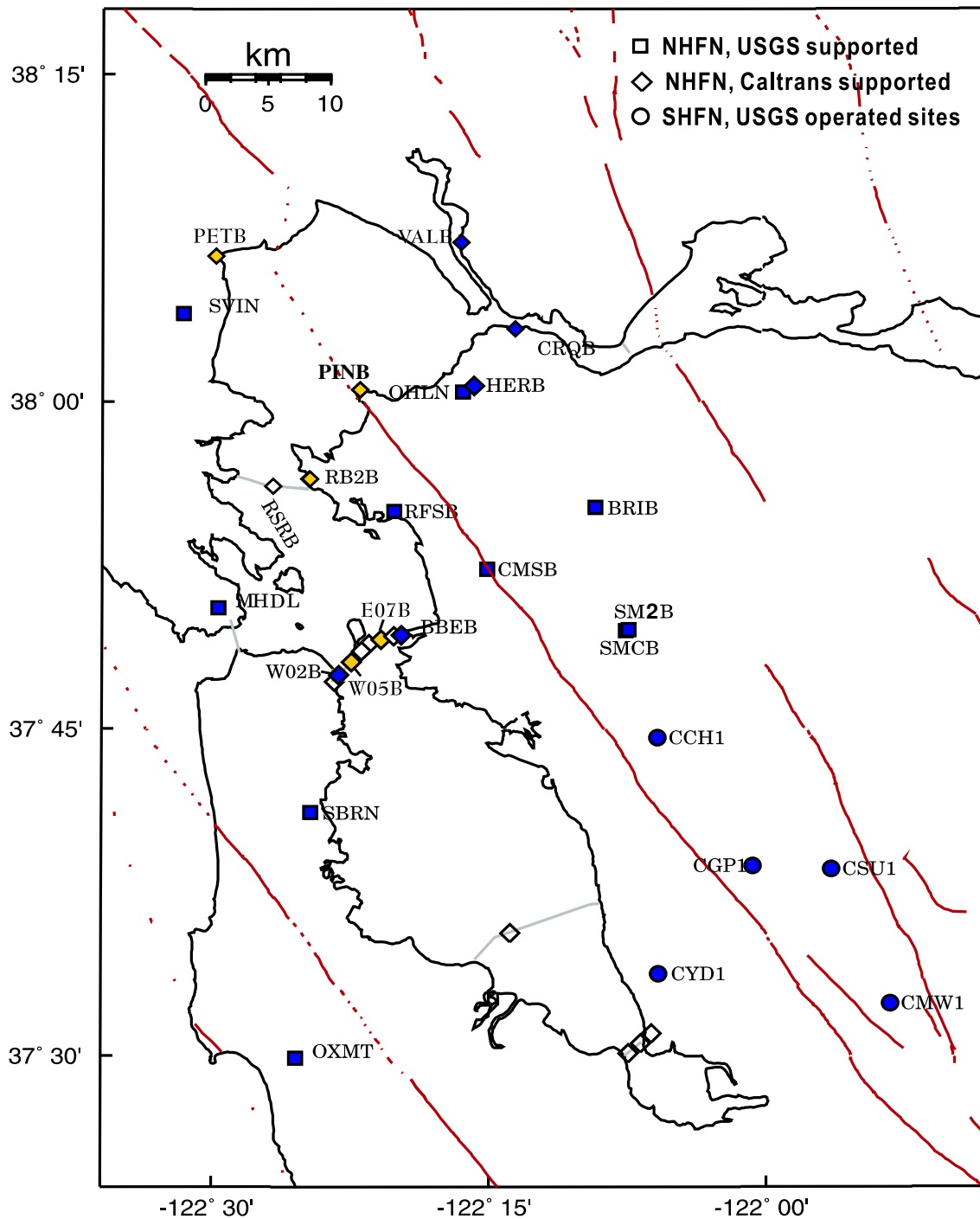

Figure 3.9: Map showing the locations of the HFN stations operated by the BSL (NHFN - squares and diamonds) and the USGS (SHFN - circles). Operational sites are filled blue/black, while sites in progress are yellow/grey. Other instrumented but currently non-operational boreholes are indicated as open symbols. Now, station BBEB operates only as a telemetry repeater site because access to the borehole was cut off during seismic retrofit work on the eastern span of the Bay Bridge.

Code	Net	Latitude	Longitude	Elev (m)	Over (m)	Date	Location
VALB	BK	38.1215	-122.2753	-24	155.8	2005/11 - current	Napa River Bridge
PETB	BK	38.1189	-122.5011	-30	113	in progress	Petaluma River Bridge
CRQB	BK	38.05578	-122.22487	-25	38.4	1996/07 - current	CB
HERB	BK	38.01250	-122.26222	-25	217.9	2000/05 - current	Hercules
PINB*	BK	38.0113	-122.3653	tbd	tbd	in progress	Point Pinole
BRIB	BK	37.91886	-122.15179	219.7	108.8	1995/06 - current	BR, Orinda
RFSB	BK	37.91608	-122.33610	-27.3	91.4	1996/01 - current	RFS, Richmond
CMSB	BK	37.87195	-122.25168	94.7	167.6	1994/12 - current	CMS, Berkeley
SMCB	BK	37.83881	-122.11159	180.9	3.4	1997/12 - 2007/06	SMC, Moraga
SM2B	BK	37.8387	-122.1102	200	150.9	2007/06 - current	SMC, Moraga
SVIN	BK	38.03325	-122.52638	-21	158.7	2003/08 - current	MPBO, St. Vincent's school
OHLN	BK	38.00742	-122.27371	-0	196.7	2001/07 - current	MPBO, Ohlone Park
MHDL	BK	37.84227	-122.49374	94	160.6	2006/05 - current	MPBO, Marin Headlands
SBRN	BK	37.68562	-122.41127	4	157.5	2001/08 - current	MPBO, San Bruno Mtn.
OXMT	BK	37.4994	-122.4243	209	194.2	2003/12 - current	MPBO, Ox Mtn.
BBEB	BK	37.82167	-122.32867	-31	150.0	2002/05 - 2007/08	BB, Pier E23
E17B	BK	37.82086	-122.33534		160.0	1995/08 - current *	BB, Pier E17
E07B	BK	37.81847	-122.34688	tbd	134.0	1996/02 - current *	BB, Pier E7
YBIB	BK	37.81420	-122.35923	-27.0	61.0	1997/12 - current *	BB, Pier E2
YBAB	BK	37.80940	-122.36450		3.0	1998/06 - current *	BB, YB Anchorage
W05B	BK	37.80100	-122.37370	tbd	36.3	1997/10 - current *	BB, Pier W5
W02B	BK	37.79120	-122.38525	-45	57.6	2003/06 - current	BB, Pier W2
SFAB	BK	37.78610	-122.3893		0.0	1998/06 - current *	BB, SF Anchorage
RSRB	BK	37.93575	-122.44648	-48.0	109.0	1997/06 - current *	RSRB, Pier 34
RB2B	BK	37.93	-122.41	tbd	133.8	2003/07 - current *	RSRB, Pier 58
SM1B	BK	37.59403	-122.23242		298.0	not recorded	SMB, Pier 343
DB3B	BK	37.51295	-122.10857		1.5	1994/09 - 1994/11	DB, Pier 44
					62.5	1994/09 - 1994/09	
					157.9	1994/07 - current *	
DB2B	BK	37.50687	-122.11566			1994/07 - current *	DB, Pier 27
					189.2	1992/07 - 1992/11	
DB1B	BK	37.49947	-122.12755		0.0	1994/07 - 1994/09	DB, Pier 1
					1.5	1994/09 - 1994/09	
					71.6	1994/09 - 1994/09	
					228.0	1993/08 - current *	
CCH1	NC	37.7432	-122.0967	226		1995/05 - current	Chabot
CGP1	NC	37.6454	-122.0114	340		1995/03 - current	Garin Park
CSU1	NC	37.6430	-121.9402	499		1995/10 - current	Sunol
CYD1	NC	37.5629	-122.0967	-23		2002/09 - current	Coyote
CMW1	NC	37.5403	-121.8876	343		1995/06 - current	Mill Creek

Table 3.5: Stations of the Hayward Fault Network. Each HFN station is listed with its station code, network id, location, operational dates, and site description. The latitude and longitude (in degrees) are given in the WGS84 reference frame. The elevation of the well head (in meters) is relative to the WGS84 reference ellipsoid. The overburden is given in meters. The start dates indicate either the upgrade or installation time. The abbreviations are: BB - Bay Bridge; BR - Briones Reserve; CMS - Cal Memorial Stadium; CB - Carquinez Bridge; DB - Dumbarton Bridge; MPBO - mini-Plate Boundary Observatory; RFS - Richmond Field Station; RSRB - Richmond-San Rafael Bridge; SF - San Francisco; SMB - San Mateo Bridge; SMC - St. Mary's College; and, YB - Yerba Buena. The \* for station PINB indicates that this station name has been requested but has not yet been approved and may change. The \* in the Date column indicates the stations that have recorded data from an earlier period of manually retrieved tapes, but that are currently off-line. Note that station BBEB now operates only as a telemetry relay station and no longer records seismic activity.

Site	Geophone	Accelerometer	Z	H1	h2	data logger	Notes	Telem.
VALB	Oyo HS-1	Wilcoxon 731A	TBD	TBD	TBD	Q330		FR
PETB	Oyo HS-1	Wilcoxon 731A	TBD	TBD	TBD	TBD		TBD
CRQB	Oyo HS-1	Wilcoxon 731A	-90	251	341	Q4120		FR
HERB	Oyo HS-1	Wilcoxon 731A	-90	TBD	TBD	Q4120		FR
PINB	Oyo HS-1	Wilcoxon 731A	TBD	TBD	TBD	TBD		TBD
BRIB	Oyo HS-1	Wilcoxon 731A	-90	79	349	Q4120	Acc. failed, Dilat.	FR
RFSB	Oyo HS-1	Wilcoxon 731A	-90	256	346	Q4120		FR
CMSB	Oyo HS-1	Wilcoxon 731A	-90	19	109	Q4120		FR
SMCB	Oyo HS-1	Wilcoxon 731A	-90	76	166	None at present	Posthole	FR
SM2B	Oyo HS-1	Wilcoxon 731A	TBD	TBD	TBD	Q4120		FR
SVIN	Mark L-22		-90	298	28	Q4120	Tensor.	FR/Rad.
OHLN	Mark L-22		-90	313	43	Q4120	Tensor.	FR
MHDL	Mark L-22		-90	TBD	TBD	Q4120	Tensor.	FR
SBRN	Mark L-22		-90	347	77	Q4120	Tensor.	FR
OXMT	Mark L-22		-90	163	253	Q4120	Tensor.	FR
BBEB	Oyo HS-1	Wilcoxon 731A	-90	TBD	TBD	None at present	Acc. failed	Radio
E17B	Oyo HS-1	Wilcoxon 731A	-90	TBD	TBD	None at present		
E07B	Oyo HS-1	Wilcoxon 731A	-90	TBD	TBD	None at present		
YBIB	Oyo HS-1	Wilcoxon 731A	-90	257	347	None at present	Z geop. failed	FR/Rad.
YBAB	Oyo HS-1	Wilcoxon 731A	-90	TBD	TBD	None at present		
W05B	Oyo HS-1	Wilcoxon 731A	-90	TBD	TBD	None at present		
W02B	Oyo HS-1	Wilcoxon 731A	-90	TBD	TBD	Q4120		Radio
SFAB	None	LLNL S-6000	TBD	TBD	TBD	None at present	Posthole	
RSRB	Oyo HS-1	Wilcoxon 731A	-90	50	140	None at present	2 acc. failed	FR
RB2B	Oyo HS-1	Wilcoxon 731A	-90	TBD	TBD	None at present	1 acc. failed	
SM1B	Oyo HS-1	Wilcoxon 731A	-90	TBD	TBD	None at present		
DB3B	Oyo HS-1	Wilcoxon 731A	-90	TBD	TBD	None at present	Acc. failed	
DB2B	Oyo HS-1	Wilcoxon 731A	-90	TBD	TBD	None at present		
DB1B	Oyo HS-1	Wilcoxon 731A	-90	TBD	TBD	None at present	Acc. failed	
CCH1	Oyo HS-1	Wilcoxon 731A	-90	TBD	TBD	Nanometrics HRD24	Dilat.	Radio
CGP1	Oyo HS-1	Wilcoxon 731A	-90	TBD	TBD	Nanometrics HRD24	Dilat.	Radio
CSU1	Oyo HS-1	Wilcoxon 731A	-90	TBD	TBD	Nanometrics HRD24	Dilat.	Radio
CYD1	Oyo HS-1	Wilcoxon 731A	-90	TBD	TBD	Nanometrics HRD24	Dilat.	Radio
CMW1	Oyo HS-1	Wilcoxon 731A	-90	TBD	TBD	Nanometrics HRD24	Dilat.	Radio

Table 3.6: Instrumentation of the HFN as of 06/30/2008. Every HFN downhole package consists of collocated 3-component geophones and accelerometers, with the exception of MPBO sites which have only 3-component geophones and are also collecting tensor strainmeter data. Six HFN sites (5 of the SHFN and 1 of the NHFN) also have dilatometers (Dilat.). Currently, 13 NHFN sites have Quanterra data loggers with continuous telemetry to the BSL. The remaining backbone sites are either still being developed with support from Caltrans or are being upgraded to Quanterra data loggers. The 5 SHFN sites have Nanometrics data loggers with radio telemetry to the USGS. The orientation of the sensors (vertical - Z, horizontals - H1 and H2) are indicated where known or identified as "to be determined" (TBD).

which is eventually to replace a particularly noisy backbone station at the south end of the Carquinez bridge (CRQB). With support for drilling and the purchase of a sensor package from Caltrans, the plan is to transfer the surface infrastructure and recording equipment at CRQB to the Cal Maritime site after Caltrans drill time becomes available and package installation is complete.

*Installation/Instrumentation:* The NHFN Sensor

packages are generally installed at depths ranging between 100 and 200 m, the non-backbone non-operational Dumbarton bridge sites being exceptions with sensors at multiple depths (Table 3.5).

The five former MPBO sites that are now part of the NHFN have 3-component borehole geophone packages. Velocity measurements for the MPBO sites are provided by Mark Products L-22 2 Hz geophones (Ta-

Sensor	Channel	Rate (sps)	Mode	FIR
Accelerometer	CL?	500.0	T	Ca
Accelerometer	HL?	200.0	C	Ca
Accelerometer	BL?	20.0	C	Ac
Accelerometer	LL?	1.0	C	Ac
Geophone	DP?	500.0	T,C	Ca
Geophone	EP?	200.0	C	Ca
Geophone	EP?	100.0	C	Ca
Geophone	BP?	20.0	C	Ac
Geophone	LP?	1.0	C	Ac

Table 3.7: Typical data streams acquired at NHFN sites, with channel name, sampling rate, sampling mode, and FIR filter type. C indicates continuous, T triggered, Ca causal, and Ac acausal. Typically, the DP1 continuous channel is archived and the remaining high sample rate data (i.e., CL and DP channels) are archived as triggered snippets. Prior to Sept. 2004, however, only triggered data was archived for all high sample rate channels. Currently operational stations CRQB, HERB, BRIB, RFSB, CMSB, SM2B, and W02B record at maximum sample rates of 500 Hz; VALB at maximum 200 Hz and MPBO sites (SVIN, OHLN, MHDL, SBRN, OXMT) at maximum 100 Hz.

ble 3.6). All the remaining backbone and non-backbone NHFN sites have six-component borehole sensor packages. The six-component packages were designed and fabricated at LBNL’s Geophysical Measurement Facility and have three channels of acceleration, provided by Wilcoxon 731A piezoelectric accelerometers, and three channels of velocity, provided by Oyo HS-1 4.5 Hz geophones.

The 0.1-400 Hz Wilcoxon accelerometers have lower self-noise than the geophones above about 25-30 Hz, and remain on scale and linear to 0.5 g. In tests performed in the Byerly vault at UC Berkeley, the Wilcoxon is considerably quieter than the FBA-23 at all periods, and is almost as quiet as the STS-2 between 1 and 50 Hz.

All 13 operational NHFN backbone sites have Quanterra data loggers with continuous telemetry to the BSL. Signals from these stations are digitized at a variety of data rates up to 500 Hz at 24-bit resolution (Table 3.7). The data loggers employ causal FIR filters at high data rates and acausal FIR filters at lower data rates.

*Data Rates and Channels:* Because of limitations in telemetry bandwidth and disk storage, 8 of the 9 (excluding VALB) six-component NHFN stations transmit one channel of geophone data continuously (i.e., their vertical geophone channels) and an additional 3 channels of triggered data in 90 sec. snippets. A Murdock, Hutt, and Halbert (MHH) event detection algorithm (*Murdock and Hutt, 1983*) is operated independently at each station on 500 sps data for trigger determinations. Because

the accelerometer data is generally quieter, the 3 triggered channels are taken from the Wilcoxon accelerometers when possible. However, there is a tendency for these powered sensors to fail, and, in such cases, geophone channels are substituted for the failed accelerometers. Station VALB also transmits data from only 4 channels; however, all channels are transmitted continuously. Continuous data for all channels at reduced rates (20 and 1 sps) are also transmitted to and archived at the BSL. The five MPBO originated sites transmit their 3-component continuous geophone data streams at 100, 20 and 1 sps, which are also archived at BSL.

### Station Maintenance

Ongoing network maintenance involves regular inspection of the collected seismic waveform data and spectra of nearby seismic events, and also of noise samples. Other common problems include changes to background noise levels due to ground loops and failing preamps, as well as power and telemetry issues. Troubleshooting and remediation of problems often require a coordinated effort, with a technician at the BSL to examine seismic waveforms and spectra while the field technicians are still on site. BSL technicians and researchers regularly review data and assist in troubleshooting.

The NHFN station hardware has proven to be relatively reliable. Nonetheless, numerous maintenance and performance enhancement measures are still carried out. In particular, when a new station is added to the backbone, extensive testing and correction for sources of instrumental noise (e.g., grounding related issues) and telemetry through-put are carried out to optimize the sensitivity of the station. Examples of maintenance and enhancement measures that are typically performed include: 1) testing of radio links to ascertain reasons for unusually large numbers of dropped packets, 2) troubleshooting sporadic problems with numerous frame relay telemetry dropouts, 3) manual power recycle and testing of hung Quanterra data loggers, 4) replacement of blown fuses or other problems relating to dead channels identified through remote monitoring at the BSL, 5) repair of frame relay and power supply problems when they arise, and 6) correcting problems that arise due to various causes, such as weather or cultural activity.

### Quality Control

- Power Spectral Density Analyses: One commonly used quality check on the performance of the borehole installed network includes assessment of the power spectral density (PSD) distributions of background noise. Shown in Figure 3.10 are power spectral density (PSD) plots of background noise for vertical component geophone channels of the 13 operating NHFN stations for a 30 minute period beginning

NHFN 2008.213.1000 Background Noise PSD

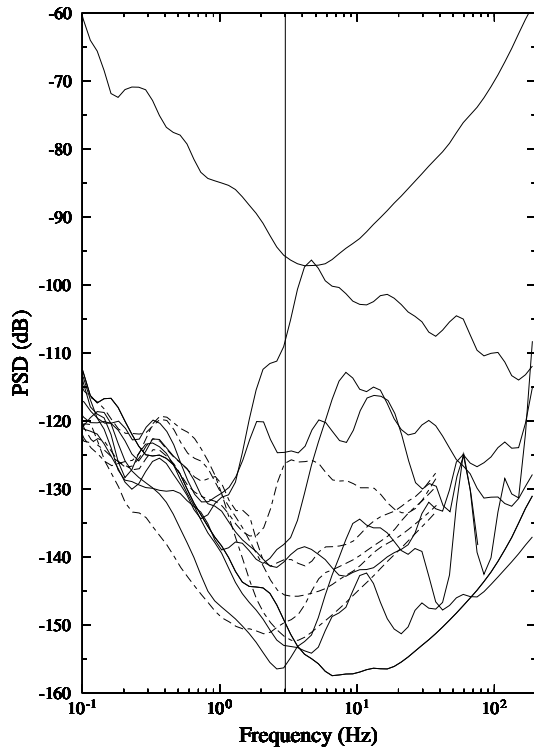

Figure 3.10: Plot showing typically observed background noise PSD for the NHFN borehole stations (including the MPBO in dashed lines) as a function of frequency. The data are from 2 am local time on a Sunday morning. Note that there is considerable variation in the general level and structure of the individual station background noise PSD estimates. The signals from three of the stations (RFSB, SM2B, and VALB) have 60 Hz noise (sometimes accompanied by 120 and 180 Hz harmonics), which is indicative of the presence of ground loops that need to be addressed. The PSD ranking of the stations at 3 Hz (near minimum PSD for most NHFN stations) is:

- CMSB.BK.DP1 -156.28314
- SM2B.BK.DP1 -152.98677
- OXMT.BK.EP1 -151.68407
- SVIN.BK.EP1 -149.62009
- BRIB.BK.DP1 -149.20291
- MHDL.BK.EP1 -145.56151
- RFSB.BK.DP1 -140.75999
- SBRN.BK.EP1 -140.37402
- W02B.BK.DP1 -138.14912
- OHLN.BK.EP1 -126.25831
- VALB.BK.EP1 -124.60077
- CRQB.BK.DP1 -109.07751
- HERB.BK.DP1 -95.616780

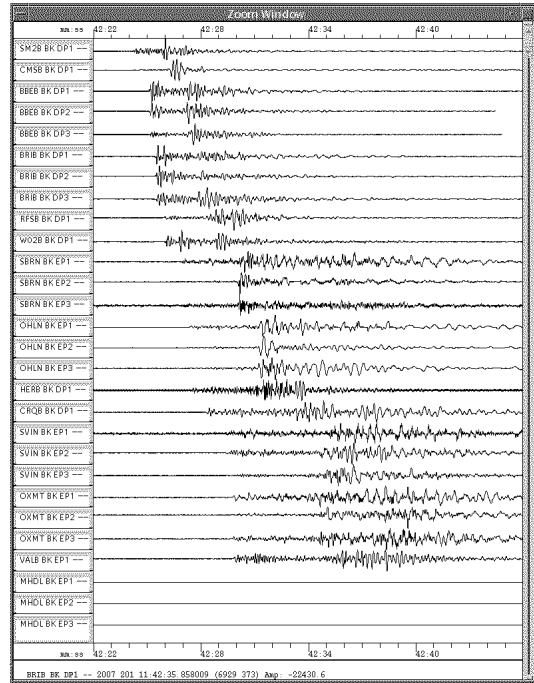

Figure 3.11: Plot of unfiltered P-wave seismograms, recorded on the geophones of the 14 NHFN borehole stations operational at the time of the event (i.e., before station BBEB was terminated due to Bay Bridge retrofit work), for a recent Bay Area earthquake (20 July 2007, M4.2 Piedmont, CA). The stations have been ordered by increasing distance from the event (top to bottom). It is immediately apparent from this simple display that station MHDL was dead and needed immediate attention.

at 2 AM local time on 7/31/2008 (Thursday morning). By periodically generating such plots, we can rapidly evaluate the network's recording of seismic signals across the wide high-frequency spectrum of the borehole NHFN sensors. Changes in the responses often indicate problems with the power, telemetry, or acquisition systems or with changing conditions in the vicinity of station installations that are adversely affecting the quality of the recorded seismograms. In general, background noise levels of the borehole NHFN stations are more variable and generally higher than those of the Parkfield HRSN borehole stations (see Parkfield Borehole Network section). This is due in large part to the significantly greater cultural noise in the Bay Area. For example the noisiest station (i.e., HERB) is located within a Caltrans maintenance yard which often has maintenance vehicle traffic during evening hours. The second noisiest station (CRQB) is located near the southern bridge abutment of the Carquinez Bridge for Freeway 80, which has heavy traffic most hours of the day.



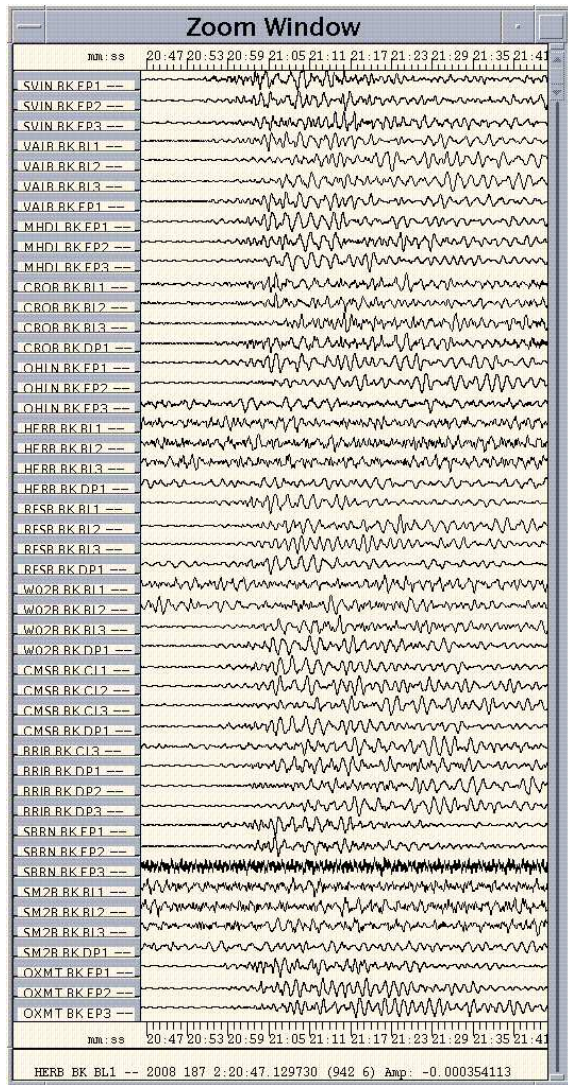

Figure 3.12: Plot of inferred relative ground velocity P-wave seismograms of the deep focus  $M_w$  7.7 earthquake in the Sea of Okhotsk (Lat.: 53.8920; Lon.: 152.8840; 6688 km from Parkfield, CA; depth 636 km) occurring on July 5, 2008 at 02:12:04 (UTC) recorded by all channels of the borehole NHFN in operation at the time. All station waveforms in the plots are ordered by distance from the earthquake. Data has been 0.5-4 Hz bandpass filtered, and the highest available sampling rate for a given component is plotted.

On average the MPBO component of the NHFN sites is more consistent and somewhat quieter. This is due in large part to the greater average depth of the MPBO sensors, the locations of MPBO stations in regions with generally less industrial and other cultural noise sources, and possibly to the absence of powered sensors (i.e. accelerometers) in their borehole sensor packages.

One of the most pervasive problems at NHFN stations equipped with the Q4120 data loggers is power line noise (60 Hz and its harmonics at 120 and 180 Hz). This noise reduces the sensitivity of the MHH detectors and can corrupt research based on full waveform analyses. When NHFN stations are visited, the engineer at the site and a seismologist at the BSL frequently work together to identify and correct ground-loop problems, which often generate 60, 120, and 180 Hz contamination from inductively coupled power line signals.

- Real Event Displays: Another method for rapid assessment of network performance is to generate and evaluate the seismograms from moderate local and large teleseismic earthquakes recorded by the NHFN stations.

Shown in Figure 3.11 is an example display of NHFN geophone channels for a local M4.2 event occurring on 20 July 2007 near Piedmont, CA. It is immediately apparent from this simple display that station MHDL was dead and needed immediate attention. It is also apparent from the 60 Hz buzz underlying the earthquake signal for stations SBRN and HERB that the grounding schemes for these channels may be in need of modification. At any given station, 60 Hz related noise sources can change over periods of weeks to months, requiring continued vigilance and adaptability of the grounding scheme in order to maintain the desired high sensitivity to low amplitude seismic signals.

Figure 3.12 shows inferred relative ground velocity P-wave seismograms of the deep focus  $M_w$  7.7 earthquake in the Sea of Okhotsk (Lat.: 53.8920; Lon.: 152.8840) occurring on July 5, 2008 at 02:12:04 (UTC) (~ 6000 km from the Bay Area, CA; depth 636 km) recorded on all operational channels (geophones and accelerometers) of the NHFN borehole stations. The seismic data from the quake was telemetered directly to the BSL and was available for analysis by the Northern California Seismic System (NCSS) real-time/automated processing stream within a few seconds of being recorded by the NHFN. Waveforms in the plots are ordered by distance from the epicenter.

This is a good signal source for examining the relative responses of the BK borehole network station/components to seismic ground motion, and these indicate that the following stations were not responding normally to teleseismic ground motions at the time of this event:

CRQB.BK.BL1, CRQB.BK.BL2, CRQB.BK.BL3, CRQB.BK.DP1 - high background noise level in all four components with a hint of the teleseismic signal visible

OHLN.BK.EP3 - digitizer bit noise, no seismic signal present

HERB.BK.BL1, HERB.BK.BL2, HERB.BK.BL3, HERB.BK.DP1 - digitizer bit noise on all four components

RFSB.BK.DP1 - asymmetric waveform and high frequency burst noise present which masks the teleseismic signal

SBRN.BK.EP3 - coherent noise with a narrow 30+ dB peak at  $\sim 1.4$  Hz and a 40+ dB narrow peak at  $\sim 3.4$  Hz

SM2B.BK.BL1, SM2B.BK.BL2, SM2B.BK.BL3, SM2B.BK.DP1 - digitizer bit noise on all four components

By rapidly generating such plots following large teleseismic events, quick assessment of the HRSN seismometer responses to real events are easily done and corrective measures implemented with relatively little delay.

- **Geophone Calibration Tests:** Comparisons of the inferred ground accelerations generated by local earthquakes from co-sited NHFN geophone and accelerometer pairs show that the waveforms generally are quite coherent in frequency and phase response, but that their inferred ground accelerations differ significantly. At times, the amplitudes differ by up to a factor of 2 while the times of the peak amplitudes are identical. This implies that the free period, and damping of the geophones are well characterized. However, it also indicates that the generator constant is not accurate (assuming that the corresponding ground accelerations inferred from the accelerometers are accurate).

Generally speaking, the accelerometers, being an active device, are more accurate and also more stable than the geophones, so it is reasonable to assume that the most likely reason for the difference is that the assumed generator constants for the geophones are inaccurate. *Rodgers et al.* (1995) describe a way to absolutely calibrate the geophones in situ and to determine their generator constant, free period and fraction of critical damping. The only external parameter that is required is the value of the geophone's inertial mass.

We have built a calibration test box which allows us to routinely perform the testing described by *Rodgers et al.* whenever site visits are made. The box drives the signal coil with a known current step and rapidly switches the signal coil between the current source and the data logger input. From this information, expected and actual sensor response characteristics can be compared and corrections applied. Also, changes in the sensor response over time can be evaluated so that adjustments can be

made, and pathologies arising in the sensors due to age can be identified. Once a geophone is absolutely calibrated, we also check the response of the corresponding accelerometer.

### 3.3 2007-2008 Activities

Over the past year, in addition to routine maintenance, operations, quality control, and data collection, NHFN project activities have included: a) integration of NHFN data into the Northern California Seismic System (NCSS) real-time/automated processing stream, online SeisNet-Watch state-of-health monitoring tool, and online SeisQuery metadata access, b) efforts to obtain additional funds for future upgrade and expansion of the network, c) leveraging NHFN activities through partnerships with various institutions outside of BSL, d) network adaptations to compensate for changing conditions associated with retrofit work on Bay Area bridges, and e) new station additions and network expansion efforts.

#### Integration into the NCSS, SeisNetWatch, and SeisQuery

The NHFN is primarily a research network that complements regional surface networks by providing down-hole recordings of very low amplitude seismic signals (e.g., from micro-earthquakes or non-volcanic tremor) at high gain and low noise. Nonetheless we have now also completed the integration of data flow from all operating NHFN stations into the Northern California Seismic System (NCSS) real-time/automated processing stream for response applications and collection of basic data for long-term hazards mitigation. The NCSS is a joint USGS (Menlo Park) and Berkeley Seismological Laboratory (BSL) entity with earthquake reporting responsibility for Northern California, and data from networks operated by both institutions are processed jointly to fulfill this responsibility.

Through this integration, the NHFN picks, waveforms, and NCSS event locations and magnitudes are automatically entered into a database where they are immediately available to the public through the NCEDC and its DART (Data Available in Real Time) buffer. The capability for monitoring state of health information for all NHFN stations using SeisNetWatch has also now been added, and up-to-date dataless SEED formatted metadata is now made available by the NCEDC with the SeisQuery software tool.

#### Additional Funding

Operation of this Bay Area borehole network is funded by the ANSS and through a partnership with the California Department of Transportation (Caltrans). ANSS provides operations and maintenance (O&M) support for a fixed subset of 9 stations that were initiated as part

of previous projects in which the USGS was a participant. Caltrans provides O&M support for an additional 10 stations that have been or are in the process of being added to the network with Caltrans partnership grants. Caltrans also continues to provide additional support for upgrade and expansion when possible.

This year, we also submitted a competitive proposal to Caltrans to expand the NHFN with 3 additional borehole installations and to upgrade several NHFN sites with strong-motion surface sensors to provide up-hole down-hole data for fundamental research on amplification effects in the upper  $\sim 1$ -200 meters. Unfortunately, in spite of high hopes on the part of both Caltrans and ourselves, the proposal was not funded in this year's round. Nonetheless, we are continuing our discussions with our partners at Caltrans for a possible resubmittal of the proposal this coming year.

### Partnerships

The NHFN is heavily leveraged through partnerships with various institutions, and we have continued to nurture and expand these relationships. Over the past year we have actively collaborated through partnerships with Caltrans and St. Mary's College. We have also been working with Cal Maritime Academy, the East Bay Parks District, UNAVCO, Lawrence Berkeley National Laboratory, and non-ANSS components of the USGS, to either resurrect previously funded partnership activities or to establish entirely new partnerships focused on continued NHFN expansion.

### Network Adaptation

In August of 2007, recording of seismic signals from one of the NHFN backbone sites (BBEB) was necessarily terminated due to seismic retrofit work on the east span of the Bay Bridge. The borehole site containing the permanently emplaced seismic package is being effectively destroyed by the project, so reactivation of recording from the site will not be possible. The BBEB installation also served as a relay site for data telemetry from other borehole stations on the east and west spans of the bridge. Fortunately the portions of the BBEB installation critical for telemetry relay were recoverable, and we have now revitalized its role as the principal relay site for NHFN stations located along the Bay Bridge.

### New Installations

We have now fully upgraded our only post-hole (3.4 meter deep) site (SMCB) with a deep borehole (150.9 meter) installation (SM2B) at St. Mary's College. An overlap period of  $\sim 60$  days of coincident data from both stations was also collected and analyzed in July of 2007 for calibration purposes, and the new site is on-line and contributing real-time data to the NCSS. Over the past

year, considerable field effort has been placed into hardening the site and knocking down spurious noise sources so that the data currently being recorded by SM2B is now on par with the quality of borehole data from other NHFN sites and of significantly better signal to noise than was available from the 3.4 meter post-hole installation.

Also through our partnership with Caltrans, significant progress on infrastructure installation has been made at 4 additional sites where deep boreholes have been drilled and instrumented (PETB, E07B, W05B, and RB2B). These sites are expected to come on-line in the next year as contributed efforts from our Caltrans partner are completed and as retrofit projects on the Bay Bridge are completed.

With Caltrans funding, we have also purchased sensors and instrumentation for 2 additional sites, and Caltrans will provide drilling for these sites as spare drilling crew time becomes available (i.e., holes of opportunity). Permit negotiations for these two sites (PINB, shown in Figure 3.9; and a site at Cal Maritime Academy, north of the Carquinez bridge) are in their final stages. Once permits have been granted, drilling and sensor installation at these two sites will take place as Caltrans drill crews become available.

## 3.4 Acknowledgments

Thomas V. McEvelly, who passed away in February 2002, was instrumental in developing the Hayward Fault Network, and, without his dedication and hard work, the creation and continued operation of the NHFN would not have been possible.

Under Bob Nadeau's and Doug Dreger's general supervision, Rich Clymer, Doug Neuhauser, Bob Uhrhammer, Bill Karavas, John Friday, and Rick Lellingner all contribute to the operation of the NHFN. Bob Nadeau prepared this section.

Support for the NHFN is provided by the USGS through the NEHRP grant program (grant no. 07HQAG0014) and by Caltrans through grant no. 59A0578. Pat Hipley of Caltrans has been instrumental in the effort to continue to upgrade and expand the network. Larry Hutchings and William Foxall of LLNL have also been important collaborators on the project in years past.

## 3.5 References

Rodgers, P.W., A.J. Martin, M.C. Robertson, M.M. Hsu, and D.B. Harris, Signal-Coil Calibration of Electromagnetic Seismometers, *Bull. Seism. Soc. Am.*, 85(3), 845-850, 1995.

Murdock, J. and C. Hutt, A new event detector designed for the Seismic Research Observatories, *USGS Open-File-Report 83-0785*, 39 pp., 1983.

## 4. Parkfield Borehole Network (HRSN)

### 4.1 Introduction

The operation of the High Resolution Seismic Network (HRSN) at Parkfield, California began in 1987, as part of the United States Geological Survey (USGS) initiative known as the Parkfield Prediction Experiment (PPE) (*Bakun and Lindh, 1985*).

Figure 3.13 shows the location of the network, its relationship to the San Andreas fault, sites of significance from previous and ongoing research using the HRSN, double-difference relocated earthquake locations from 1987-1998, routine locations of seismicity from August 2002 to July 2003, nonvolcanic tremor locations from January 2006 through December 2007, and the epicenter of the 1966 and 2004 M6 earthquakes that motivated much of the research. The HRSN records exceptionally high-quality data, owing to its 13 closely-spaced three-component borehole sensors (generally emplaced in the extremely low attenuation and background noise environment at 200 to 300 m depth (Table 3.8), its high-frequency wide bandwidth recordings (0-100 Hz; 250 sps), and its sensitivity to very low amplitude seismic signals (e.g., recording signals of micro-earthquakes with magnitudes below magnitude 0.0 Ml).

Several aspects of the Parkfield region make it ideal for the study of small earthquakes and nonvolcanic tremors and their relationship to tectonic processes and large earthquakes. These include the fact that the network spans the SAFOD (San Andreas Fault Observatory at Depth) experimental zone, the nucleation region of earlier repeating magnitude 6 events and a significant portion of the transition from locked to creeping behavior on the San Andreas fault, the availability of three-dimensional P and S velocity models (*Michelini and McEvilly, 1991*), a long-term HRSN seismicity catalogue (complete to very low magnitudes and that includes at least half of the M6 seismic cycle), a well-defined and simple fault segment, the existence of deep nonvolcanic tremor (NVT) activity, and a relatively homogeneous mode of seismic energy release as indicated by the earthquake source mechanisms (over 90% right-lateral strike-slip).

In a series of journal articles and Ph.D. theses, the cumulative, often unexpected, results of UC Berkeley's HRSN research efforts (see: [http://www.seismo.berkeley.edu/seismo/faq/parkfield\\_bib.html](http://www.seismo.berkeley.edu/seismo/faq/parkfield_bib.html)) trace the evolution of a new and exciting picture of the San Andreas fault zone responding to its plate-boundary loading, and they are forcing new thinking on the dynamic processes and conditions within the fault zone at the sites of recurring small earthquakes and deep nonvolcanic tremors (*Nadeau and Dolenc, 2005*).

The Parkfield area has also become an area

of focus of the EarthScope Project (<http://www.earthscope.org>) through the SAFOD experiment (<http://www.icdp-online.de/sites/sanandreas/news/news1.html>), and the HRSN is playing a vital role in this endeavor. SAFOD is a comprehensive project to drill into the hypocentral zone of repeating  $M \sim 2$  earthquakes on the San Andreas Fault at a depth of about 3 km. The goals of SAFOD are to establish a multi-stage geophysical observatory in close proximity to these repeating earthquakes, to carry out a comprehensive suite of down-hole measurements in order to study the physical and chemical conditions under which earthquakes occur, and to monitor and exhume rock, fluid, and gas samples for extensive laboratory studies (*Hickman et al., 2004*).

### 4.2 HRSN Overview

Installation of the HRSN deep (200-300m) borehole sensors initiated in late 1986, and recording of triggered 500 sps earthquake data began in 1987. The HRSN sensors are 3-component geophones in a mutually orthogonal gimbaled package. This ensures that the sensor corresponding to channel DP1 is aligned vertically and that the others are aligned horizontally. Originally a 10 station network, completed in 1988, the HRSN was expanded to 13 borehole stations in late July 2001, and the original recording systems (see previous Berkeley Seismological Laboratory (BSL) Annual Reports) were upgraded to 24 bit acquisition (Quanterra 730s) and 56K frame relay telemetry to UCB. Properties of the sensors are summarized in Table 3.9.

The 3 newest borehole stations were added, with NSF support, at the NW end of the network as part of the SAFOD project to improve resolution of the structure, kinematics, and monitoring capabilities in the SAFOD drill-path and target zones. Figure 3.13 illustrates the location of the drill site, the new borehole sites, and locations of earthquakes recorded by the initial and upgraded/expanded HRSN.

These 3 newest SAFOD stations have a similar configuration to the original upgraded 10 station network and include an additional channel for electrical signals. Station descriptions and instrument properties are summarized in Tables 3.8 and 3.9. All the HRSN data loggers employ FIR filters to extract data at 250 and 20 Hz (Table 3.10).

The remoteness of the drill site and new stations required an installation of an intermediate data collection point at Gastro Peak, with a microwave link to our facility on the California Department of Forestry's (CDF) property in Parkfield. The HRSN stations use SLIP to

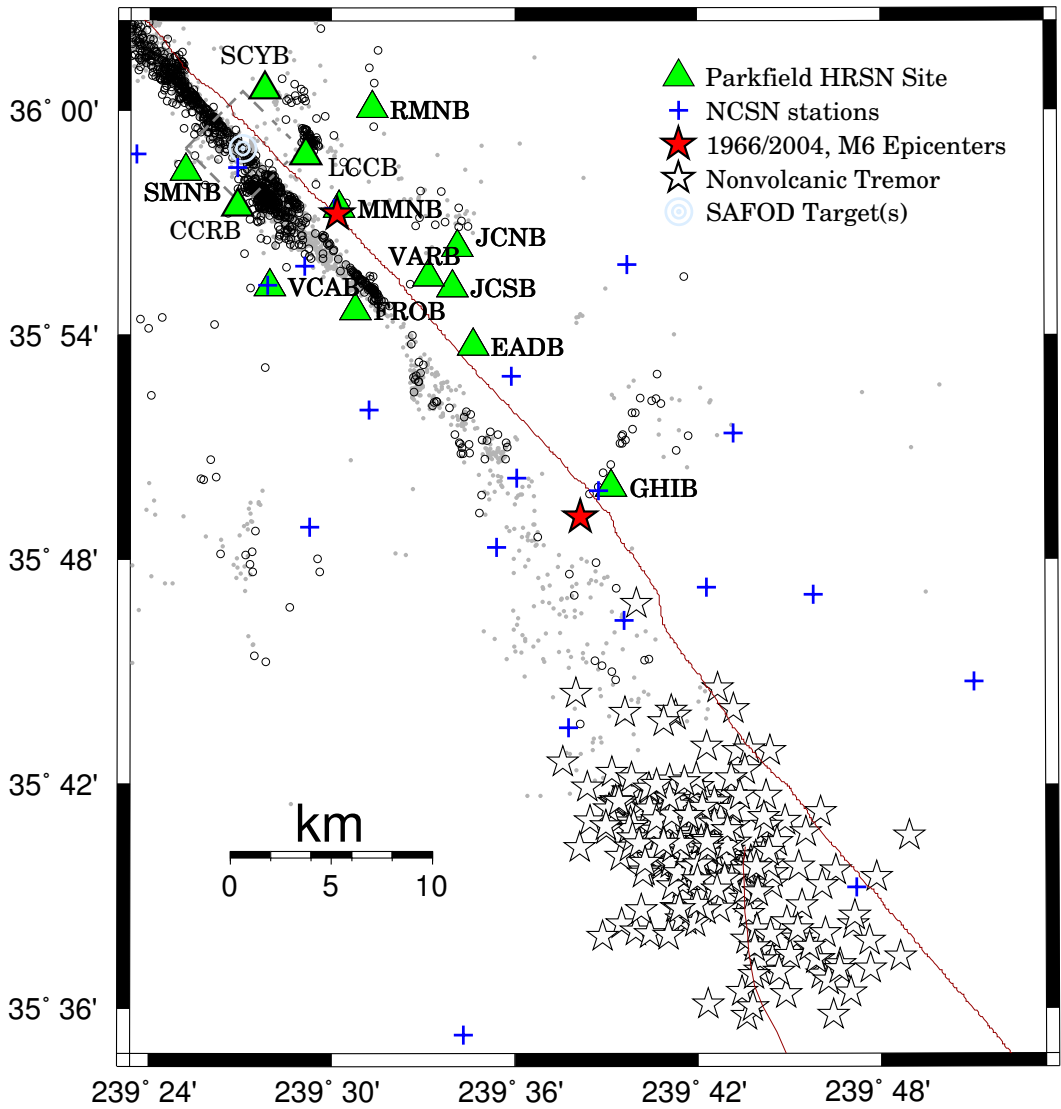

Figure 3.13: Map showing the San Andreas Fault trace and locations of the 13 Parkfield HRSN stations, the repeating M2 SAFOD targets (a 4 km by 4 km dashed box surrounds the SAFOD zone), and the epicenters of the 1966 and 2004 M6 Parkfield main shocks. Also shown are double-difference relocations of nonvolcanic tremors in the Cholame, CA area (January 2006 through December 2007), routine locations of earthquakes recorded by the expanded and upgraded 13 station HRSN (small open circles) and locations of events recorded by the earlier vintage 10 station HRSN relocated using an advanced 3-D double-differencing algorithm (gray points) applied to a cubic splines interpolated 3-D velocity model (*Michelini and McEvilly, 1991*).

Site	Net	Latitude	Longitude	Surf. (m)	Depth (m)	Date	Location
EADB	BP	35.89525	-120.42286	466	245	01/1988 -	Eade Ranch
FROB	BP	35.91078	-120.48722	509	284	01/1988 -	Froelich Ranch
GHIB	BP	35.83236	-120.34774	400	63	01/1988 -	Gold Hill
JCNB	BP	35.93911	-120.43083	527	224	01/1988 -	Joaquin Canyon North
JCSB	BP	35.92120	-120.43408	455	155	01/1988 -	Joaquin Canyon South
MMNB	BP	35.95654	-120.49586	698	221	01/1988 -	Middle Mountain
RMNB	BP	36.00086	-120.47772	1165	73	01/1988 -	Gastro Peak
SMNB	BP	35.97292	-120.58009	699	282	01/1988 -	Stockdale Mountain
VARB	BP	35.92614	-120.44707	478	572	01/1988 - 08/19/2003	Varian Well
VARB	BP	35.92614	-120.44707	478	298	08/25/2003 -	Varian Well
VCAB	BP	35.92177	-120.53424	758	200	01/1988 -	Vineyard Canyon
CCRB	BP	35.95718	-120.55158	595	251	05/2001 -	Cholame Creek
LCCB	BP	35.98005	-120.51424	640	252	08/2001 -	Little Cholame Creek
SCYB	BP	36.00938	-120.53660	945	252	08/2001 -	Stone Canyon

Table 3.8: Stations of the Parkfield HRSN. Each HRSN station is listed with its station code, network id, location, date of initial operation, and site description. The latitude and longitude (in degrees) are given in the WGS84 reference frame. The surface elevation (in meters) is relative to mean sea level, and the depth to the sensor (in meters) below the surface is also given. Coordinates and station names for the 3 new SAFOD sites are given at the bottom.

Site	Sensor	Z	H1	H2	RefTek 24	RefTek 72-06	Quanterra 730
EADB	Mark Products L22	-90	170	260	01/1988 - 12/1998	12/1998 - 07/1999	03/2001 -
FROB	Mark Products L22	-90	338	248	01/1988 - 12/1998	12/1998 - 07/1999	03/2001 -
GHIB	Mark Products L22	90	failed	unk	01/1988 - 12/1998	12/1998 - 07/1999	03/2001 -
JCNB	Mark Products L22	-90	0	270	01/1988 - 12/1998	12/1998 - 06/2001	03/2001 -
JCSB	Geospace HS1	90	300	210	01/1988 - 12/1998	12/1998 - 07/1999	03/2001 -
MMNB	Mark Products L22	-90	175	265	01/1988 - 12/1998	12/1998 - 06/2001	03/2001 -
RMNB	Mark Products L22	-90	310	40	01/1988 - 12/1998	12/1998 - 07/1999	03/2001 -
SMNB	Mark Products L22	-90	120	210	01/1988 - 12/1998	12/1998 - 06/2001	03/2001 -
VARB	Litton 1023	90	15	285	01/1988 - 12/1998	12/1998 - 07/1999	03/2001 -
VCAB	Mark Products L22	-90	200	290	01/1988 - 12/1998	12/1998 - 06/2001	03/2001 -
CCRB	Mark Products L22	-90	N45W	N45E	-	-	05/2001 -
LCCB	Mark Products L22	-90	N45W	N45E	-	-	08/2001 -
SCYB	Mark Products L22	-90	N45W	N45E	-	-	08/2001 -

Table 3.9: Instrumentation of the Parkfield HRSN. Most HRSN sites have L22 sensors and were originally digitized with a RefTek 24 system. After the failure of the WESCOMP recording system, PASSCAL RefTek recorders were installed. In July of 1999, 6 of the PASSCAL systems were returned to IRIS and 4 were left at critical sites. Since July 25, 2001, the upgraded network uses a Quanterra 730 4-channel system. For the three new stations (bottom) horizontal orientations are approximate (N45W and N45E) and will be determined more accurately as available field time permits.

Sensor	Channel	Rate (sps)	Mode	FIR
Geophone	DP?	250.0	T and C	Ca
Geophone	BP?	20.0	C	Ac

Table 3.10: Data streams currently being acquired at operational HRSN sites. Sensor type, channel name, sampling rate, sampling mode, and type of FIR filter are given. C indicates continuous; T triggered; Ac acausal; Ca causal. “?” indicates orthogonal, vertical, and 2 horizontal components.

transmit TCP and UDP data packets over bidirectional spread-spectrum radio links between the on-site data acquisition systems and the central recording system at the CDF. Prior to June, 2008, six of the sites transmitted directly to a router at the central recording site. The other seven sites transmitted to a router at Gastro Peak, where the data are aggregated and transmitted to the central site over a 4 MBit/second digital 5.4 GHz microwave link. All HRSN data are recorded to disk at the CDF site. Due to disproportionately increasing landowner fees for access to the Gastro Peak site, we have been in the process of reducing our dependence on that site, and, as of this report, data from three of the stations previously telemetering through Gastro Peak have been routed through an alternative site and Hogs Canyon (HOGS) (See “2007-2008 Activities,” this section).

The upgraded and expanded system is compatible with the data flow and archiving common to all the elements of the BDSN/NHFN and the NCEDC (Northern California Earthquake Data Center), and is providing remote access and control of the system. It has also provided event triggers with better timing accuracy and is also now recording continuous 20 and 250 sps data for all channels of the HRSN, which flow seamlessly into both the USGS automated earthquake detection system and into Berkeley’s NCEDC for archiving and online access to the community. The new system also helps minimize the problems of timing resolution, dynamic range, and missed detections, in addition to providing the added advantage of conventional data flow (the old system (1987-2001) recorded SEG Y format).

Another feature of the new system that has been particularly useful both for routine maintenance and for pathology identification has been the Internet connectivity of the central site processing computer and the station data loggers with the computer network at BSL. Through this connection, select data channels and on-site warning messages from the central site processor are sent directly to BSL for evaluation by project personnel. If, upon these evaluations, more detailed information on the HRSN’s performance is required, additional information can also be remotely accessed from the central site processing computer at Parkfield. Analysis of this remotely

acquired information has been extremely useful for trouble shooting by allowing field personnel to schedule and plan the details of maintenance visits to Parkfield. The connectivity also allows certain data acquisition parameters to be modified remotely when needed, and commands can be sent to the central site computer and data loggers to modify or restart processes when necessary.

The network connectivity and seamless data flow to the NCEDC also provides near-real-time monitoring capabilities that are useful for rapid evaluation of significant events as well as the network’s overall performance level. For example, shown in Figure 3.14 are P-wave seismograms of the deep focus  $M_w$  7.7 earthquake in the Sea of Okhotsk (Lat.: 53.8920; Lon.: 152.8840) occurring on July 5, 2008 02:12:04 (UTC) (6688 km from Parkfield, CA; depth 636 km) recorded on the DP1 (vertical) channels of the 12 HRSN borehole stations in operation at the time. No casualties were reported from this event. The seismic data from the quake was telemetered to Berkeley and available for analysis by the Northern California Seismic System (NCSS) real-time/automated processing stream within a few seconds of being recorded by the HRSN. All station waveforms in the plots are ordered by distance.

This is a good signal source for examining the relative responses of the BP borehole network station/components to seismic ground motion, and these and corresponding waveform plots for the horizontal (DP2 and DP3 channels) indicate that the following stations were not responding normally to seismic ground motions at the time of this event:

- JCSB.BP.DP2 - spiking - no seismic response
- JCSB.BP.DP3 - digitizer bit noise - no seismic response
- GHIB.BP.DP1 - digitizer bit noise - no seismic response
- LCCB.BP.DP1 - poor response
- LCCB.BP.DP1 - poor response
- MMNB.BP.DP1 - low frequency drift - no response
- MMNB.BP.DP2 - low frequency drift - no response

In addition, the ground velocities inferred from the two horizontal components at RMNB and the DP2 horizontal at VCAB are significantly higher than the corresponding ground velocities inferred from the other operating BP network horizontal components. By rapidly generating such plots following large teleseismic events, quick assessment of the HRSN seismometer responses to real events is easily done and corrective measures implemented with relatively little delay.

## Data Flow

*Initial Processing Scheme.* Continuous data streams on all HRSN components are recorded at 20 and 250 sps on disk on the local HRSN computer at the CDF facility. These continuous data are transmitted in near-real-time to the Berkeley Seismological Laboratory (BSL) over a T1 link and then archived at the NCEDC. In addition,

the near-real-time data are being transmitted over the T1 circuit to the USGS at Menlo Park, CA where they are integrated into the Northern California Seismic System (NCSN) real-time/automated processing stream. This integration has also significantly increased the sensitivity of the NCSN catalog at lower magnitudes, effectively doubling the number of small earthquake detections in the critical SAFOD zone.

Shortly after being recorded to disk on the central site HRSN computer, event triggers for the individual station data are also determined, and a multi-station trigger association routine then processes the station triggers and generates a list of potential earthquakes. For each potential earthquake that is detected, a unique event identification number (compatible with the NCEDC classification scheme) is also assigned. Prior to the San Simeon earthquake of December 22, 2003, 30 second waveform segments were then collected for all stations and components and saved to local disk as an event gather, and event gathers were then periodically telemetered to BSL and included directly into the NCEDC earthquake database (dbms) for analysis and processing.

Because of its mandate to detect and record very low magnitude events in the Parkfield area, the HRSN is extremely sensitive to changes in very low amplitude seismic signals. As a consequence, in addition to detecting very small local earthquakes at Parkfield, the HRSN also detects numerous regional events and relatively distant and small amplitude nonvolcanic tremor events. For example, spot checks of aftershocks following the M6.5 San Simeon earthquake of December 22, 2003 using continuous data and HRSN event detection listings have revealed that the overwhelming majority of HRSN detections following San Simeon resulted from seismic signals generated by San Simeon's aftershocks, despite the HRSN's ~50 km distance from the events. Data from the California Integrated Seismic Network (CISN) show that there were ~1,150 San Simeon aftershocks with magnitudes > 1.8 in the week following San Simeon, and during this same period, the number of HRSN event detections was ~10,500 (compared to an average weekly rate before San Simeon of 115 detections). This suggests that, despite the ~50 km distance, the HRSN is detecting San Simeon aftershocks well below magnitude 1.

*Current Processing.* Since the beginning of the network's data collection in 1987, and up until recently, the local and regional events were discriminated based on analyst assessment of S-P times, and only local events with S-P times less than ~2.5 sec at the first arriving station were picked and located as part of the HRSN routine catalog. However, because of the network's extreme sensitivity to the large swarm of aftershocks from the San Simeon and M6 Parkfield earthquakes of September 2004 (e.g., in the first 5 months following the San Simeon mainshock, over 70,000 event detections were made by the HRSN sys-

tem, compared to an average 5 month detection rate of 2500 prior to San Simeon) and because of ever declining funding levels, this approach has had to be abandoned.

The dramatic increase in event detections vastly exceeded the HRSN's capacity to process both the continuous and triggered event waveform data. To prevent the loss of seismic waveform coverage, processing of the triggered waveform data has been suspended to allow the telemetry and archiving of the 20 and 250 sps continuous data to continue uninterrupted. Cataloging of the event detection times from the modified REDI real-time system algorithm is also continuing, and the continuous waveform data is currently being telemetered directly to the BSL and USGS over the T1 link for near-real-time processing and archiving at the NCEDC, for access to the research community.

Funding to generate catalogs of local events from the 10s of thousands of aftershock detections has not been forthcoming, and, as a consequence, major changes in our approach to cataloging events have been implemented. The HRSN data is now integrated into NCSN automated event detection, picking, and catalog processing (with no analyst review). In addition, a high resolution procedure is now being developed to automatically detect, pick, locate, double-difference relocate, and determine magnitudes for similar and repeating events down to very low magnitudes (i.e., below magnitude -1.0Ml). These new schemes are discussed in more detail in the activities section below.

### 4.3 2007-2008 Activities

In addition to the routine operations and maintenance of the HRSN (California's first and longest operating borehole seismic network), research into: a) how to process ongoing similar and repeating seismicity to very low magnitudes, b) ongoing non-volcanic tremors in the Parkfield-Cholame area, c) SAFOD related activities, and d) various approaches to lowering operational (primarily landowner fee) costs have been the primary driving forces behind most of the HRSN project's activities this year.

### Operations and Maintenance

Routine maintenance tasks required this year to keep the HRSN in operation include cleaning and replacement of corroded electrical connections; grounding adjustments; cleaning of solar panels; re-seating, resoldering, and replacement of faulty pre-amp circuit cards; testing and replacement of failing batteries; and insulation and painting of battery and data logger housings to address problems with low power during cold weather. Remote monitoring of the network's health using the Berkeley Seismological Laboratory's SeisNetWatch software is also performed to identify both problems that can be



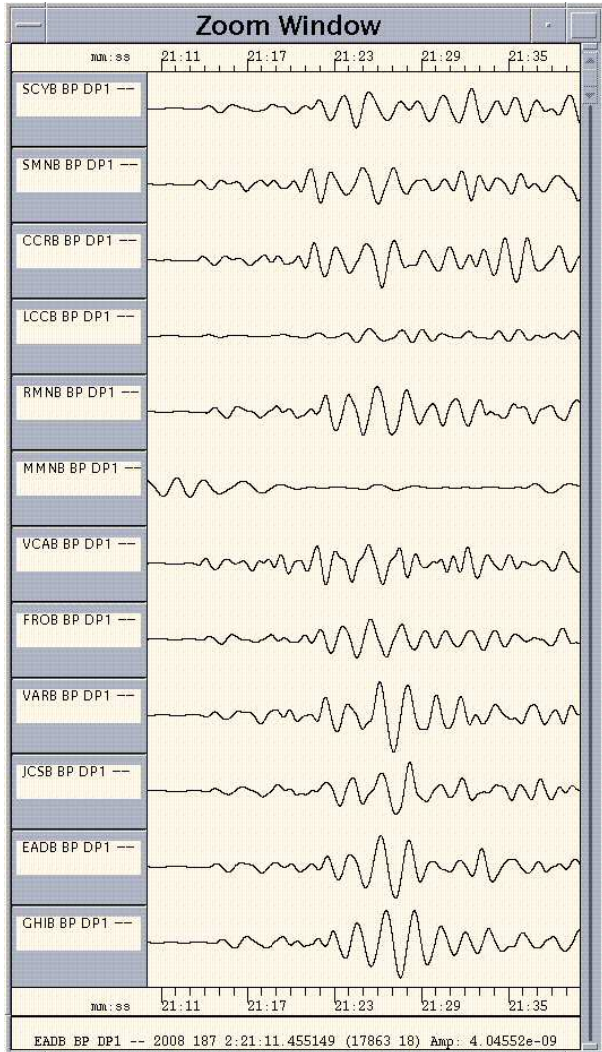

Figure 3.14: Plot of P-wave seismograms of the deep focus  $M_w$  7.7 earthquake in the Sea of Okhotsk (Lat.: 53.8920; Lon.: 152.8840; 6688 km from Parkfield, CA; depth 636 km) occurring on July 5, 2008 02:12:04 (UTC) recorded on the DP1 (vertical) channels of the 12 HRSN borehole stations in operation at the time. All station waveforms in the plots are ordered by distance from the earthquake. Here, vertical component geophone (velocity) data have been 0.1-0.5 Hz bandpass filtered.

resolved over the Internet (e.g. rebooting of data acquisition systems due to clock lockups) and more serious problems requiring field visits. Over the years, such efforts have paid off handsomely by providing exceptionally low noise recordings of very low amplitude seismic signals produced by microearthquakes (below magnitude 0.0Ml) and nonvolcanic tremors.

Also in the spring of this year, the central site processing computer at our CDF site failed. We had previously obtained funds to purchase a back-up computer at the site, and these funds were used to purchase a new computer which is now installed and operating properly. During the failure, data was telemetered directly over the T1 line, resulting in relatively little data loss. Now, with the computer processing reestablished, backup support in case of telemetry failures is once again in place.

In the Spring of 2008, signals from HRSN station JCNB began showing signs of deterioration. Shortly thereafter, data flow from this station stopped completely. Field investigation showed that the borehole sensor and cable had been grouted to within  $\sim 100$  feet of the surface and that a rodent had found itself trapped in the upper 100 foot void space and chewed through the cable, thus severing the connection to the deep borehole package. At this time, costs for reestablishing connection to the cable at depth have been prohibitive, and it is also likely that the grouted-in sensor has been compromised by fluids running down the exposed cable. Hence, plans are being made to substitute either a surface seismometer or a borehole sensor package within the open 100 foot section of the borehole to provide continued seismic coverage at the JCNB site.

The network connectivity over the T1 circuit also allows remote monitoring of various measures of the state of health of the network in near-real-time, such as background noise levels. Shown in Figure 3.15 are power spectral density (PSD) plots of background noise for vertical components of the HRSN for a 30 minute period beginning at 2 AM local time on day 7/31/2008 (Thursday morning). By periodically generating such plots, we can rapidly evaluate the network's recording of seismic signals across the wide high-frequency spectrum of the borehole HRSN sensors. Changes in the responses often indicate problems with the power, telemetry, or acquisition systems, or with changing conditions in the vicinity of station installations that are adversely effecting the quality of the recorded seismograms.

Notable in Figure 3.15 are the relatively low PSD levels and overall consistency for most of the HRSN stations. One exception is the relatively high PSD for station LCCB's DP1 channel, which at the time of the PSD analysis was experiencing serious spiking and elevated noise levels across the entire spectrum. Also notable on the DP1 channels for stations GHIB and SCYB are 60 Hz noise peaks, which are indicative of ground loop prob-

lems. Noise peaks for station RMNB can also be seen at 15 Hz and 30 and 60 Hz harmonics. These spectral peaks are not always present but occur for about 4 hours at night every other day or so when the Southern California Gas company's generator kicks in to supplement the charging of batteries for their otherwise solar powered installation located about 30 m from the RMNB site.

Once state of health issues are identified with the PSD analyses, further remote tests can be made to more specifically determine possible causes for the problem, and corrective measures can then be planned in advance of field deployment within a relatively short period of time.

### Reducing Operational costs

The increased scientific activity in the rural Parkfield area due to SAFOD has led to an increased demand for site access and development on privately owned property and a corresponding increase in access fees charged by private land owners. As a result, land use fees paid by the HRSN project have increased dramatically from less than \$1000 annually prior to the SAFOD effort to over \$14,000. This represents over 15% of the entire HRSN budget with no corresponding increase in support from the project's funding agency. To compensate for the increased landowner costs, maintenance efforts have had to be cut back, and network performance has suffered.

To help alleviate the problem, this year we have begun implementing plans to minimize our dependence on access to private lands. This has primarily involved establishing alternative telemetry paths for HRSN sites with a minimum of additional effort and equipment. Central to this effort has been reaching cooperative agreements with other agencies involved in research in the area (i.e., the USGS and UNAVCO).

To date, telemetry paths for three HRSN sites (SCYB, CCRB, and SMNB) have been redirected from the Gastro Peak relay site to an alternative relay site at Hogs Canyon (HOGS) through an agreement with the USGS. Plans to redirect telemetry of an additional 4 sites from Gastro Peak (MMNB, VARB, LCCB, and GHIB) through Mine Mountain are now being field tested, and, if proven sound, negotiations with UNAVCO and the Mine Mountain landowner will be undertaken and infrastructure for the alternative paths will be installed.

### Tremor Monitoring

The HRSN data played an essential role in the discovery of nonvolcanic tremors along the San Andreas Fault (SAF) below Cholame, CA (*Nadeau and Dolenc, 2005*). The Cholame tremors occupy a critical location between the smaller Parkfield ( $\sim$ M6) and much larger Ft. Tejon ( $\sim$ M8) rupture zones of the SAF (Figure 3.13). Because the time-varying nature of tremor activity is believed to reflect time-varying deep deformation and presumably

episodes of accelerated stressing of faults, and because an anomalous increase in the rate of Cholame tremor activity preceded the 2004 Parkfield M6 by  $\sim$ 21 days, we are continuing to monitor the tremor activity observable by the HRSN to look for anomalous rate changes that may signal an increased likelihood for another large SAF event to the SE. Some recent results of the monitoring effort are described further in the "Research" section of this report.

### Similar Event Catalog

The increased microseismicity rates resulting from the San Simeon M6.5 and Parkfield M6 events and the increased interest in even smaller events in the SAFOD target zone have required new thinking on how to detect and catalog microearthquakes recorded by the HRSN. One action taken to help address this problem has been to integrate HRSN data streams into the NCSN event detection and automated cataloging process. This approach has been successful at discriminating small events in the local Parkfield area from other types of event detections and for providing automated locations of a significantly increased number of small events in the local area (approximately double that of the NCSN network alone). However, the HRSN sensitized NCSN catalog is still only catching about 1/2 the number of local events previously cataloged by the HRSN, and waveforms for the small events are not typically made available. In addition, unlike the previous HRSN catalog, the additional events added by the NCSN-HRSN integration are not reviewed by an analyst, nor do they generally have magnitude determinations associated with them. In some cases, the selection rules used for the integrated catalog also result in exclusion of events that are otherwise included by the NCSN.

These limitations severely hamper ongoing efforts relying on similar and characteristically repeating microearthquakes. They also reduce the effectiveness of research relying on numerous very small magnitude events in the SAFOD zone (e.g. for monitoring seismicity in the SAFOD target region).

To help overcome these limitations, we are continuing our efforts to develop and implement our automated similar event cataloging scheme based on cross-correlation and pattern scanning of the continuous HRSN data now being archived. The method uses a small number of reference events whose waveforms, picks, locations, and magnitudes have been accurately determined, and it automatically detects, picks, locates, and determines magnitudes for events similar to the reference event to the level of accuracy and precision that only relative event analysis can bring.

The similar event detection is also remarkably insensitive to the magnitude of the reference event used, allowing similar events ranging over several magnitude units to

**HRSN 2008.213.1000 Background Noise PSD**

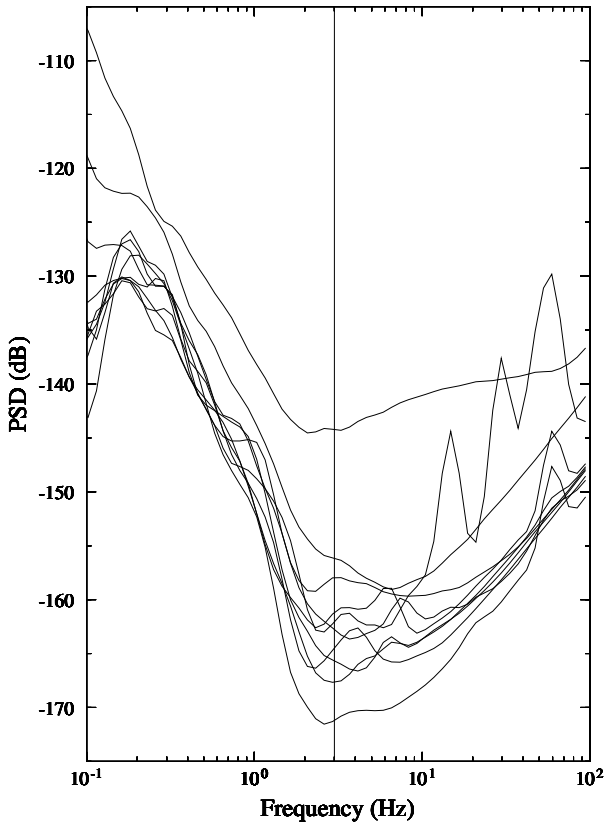

Figure 3.15: Background noise Power Spectral Density (PSD) levels for the 250 sps vertical component channels (DP1) of the HRSN borehole stations as a function of frequency. The data are from 2 AM Local time on 7/31/2008 (Thursday morning). The vertical (DP1) channels for stations CCRB and MMNB were out during this period. The 2 Hz minimum for the sensors occurs because of the 2 Hz sensors used at these sites. Below 2 Hz, noise levels rise rapidly and the peak at 5 to 3 sec (.2 to .3 Hz) is characteristic of teleseismic noise observed throughout California. The PSD (dB) ranking at 3 Hz (intersection with vertical line) for the vertical channels in operation at the time of the analysis was:

SCYB.BP.DP1 -171.30859  
 FROB.BP.DP1 -167.66554  
 SMNB.BP.DP1 -165.58936  
 EADB.BP.DP1 -164.69122  
 JCSB.BP.DP1 -162.62303  
 RMNB.BP.DP1 -162.25391  
 GHIB.BP.DP1 -161.32861  
 VCAB.BP.DP1 -157.98297  
 VARB.BP.DP1 -156.12631  
 LCCB.BP.DP1 -144.19135

be fully cataloged using a single reference event. It also does a remarkably good job even when seismic energy from multiple events is superposed. Once a cluster of similar events has been cataloged, it is a relatively straightforward process to identify characteristically repeating microearthquake sequences within the cluster (frequently a single similar event “cluster” will contain several sequences of repeating events).

This high level of precision and low magnitude completeness has already proven useful to SAFOD for helping to delineate and constrain the active fault structure in the target zone (see, “Efforts in Support of SAFOD”, below). It has also proven vital this year for helping to resolve a long-standing debate in the seismologic community regarding the stress-drop scaling issues by providing pairs of nearly collocated events with similar waveforms but significantly differing magnitudes for use in kinematic slip inversions using an eGf approach (*Dreger et al., 2007*).

This year, the automated cataloging procedure for similar events is continuing to be refined to capture even smaller events and events over a larger area, as well as for increased processing speed. Eventually, a composite catalog of similar event groups from throughout the HRSN coverage zone is planned.

Further development of the similar event processing approach also holds promise in other applications where automated and precise monitoring of bursts of seismic activity to very low magnitudes is desirable (e.g. in aftershock zones or in volcanic regions) or where automated updates of preexisting repeating sequences and their associated deep slip estimates are desired.

### Efforts in Support of SAFOD

An intensive and ongoing effort by the EarthScope component called SAFOD (San Andreas Fault Observatory at Depth) is underway to drill through, sample, and monitor the active San Andreas Fault at seismogenic depths and in very close proximity (within a few 10s of km or less) of a repeating magnitude 2 earthquake site. The HRSN data plays a key role in these efforts by providing low noise and high sensitivity seismic waveforms from active and passive sources, and by providing a backbone of very small earthquake detections and continuous waveform data.

As of early September, 2007, SAFOD drilling had penetrated the fault near the HI repeating target sequence and collected core samples in the fault region that presumably creeps and surrounds the repeatedly rupturing HI patch. Unfortunately, due to complications during drilling, penetration and sampling of the fault patch involved in repeating rupture was not possible. Future efforts will be focused on long-term monitoring of the ongoing chemical, physical, seismological, and deformational properties in the zone (particularly any signals that might be associated with the next repeat of the SAFOD

repeating sequences).

HRSN activities this year have contributed in three principal ways to these and longer-term SAFOD monitoring efforts:

1) Integration and processing of the HRSN data streams with those from the NCSN in the Parkfield area continues, effectively doubling the number of small events available for monitoring seismicity in the target zone and for constraining relative locations of the ongoing seismic activity.

2) Telemetry of all HRSN channels (both 20 and 250 sps data streams) continues to flow directly from Parkfield, through the USGS Parkfield T1 and the NCEMC T1, to the USGS and the BSL for near-real-time processing, catalog processing, and data archiving on the web-based NCEDC. This also provides near immediate access of the HRSN data to the SAFOD community without the week- or month-long delay associated with the previous procedure of having to transport DLT tapes to Berkeley to upload and quality check the data.

3) We have also continued to apply our prototype similar event automated catalog approach to the primary, secondary, and tertiary SAFOD target zones as a continued effort to monitor the SAFOD target zone activity at very high relative location precision.

During the final push to penetrate the repeating SAFOD target last Fall, our SAFOD similar event detections and catalogs were also used by the working group to extract data from the corresponding PASO array, Pilot Hole, NCSN, and mainhole data sets for integration with the HRSN data in order to provide the detailed information that was needed by drill crews for the final targeting of the HI target penetration and coring.

## 4.4 Acknowledgments

Thomas V. McEvelly, who passed away in February 2002, was the PI on the HRSN project for many years. Without his dedication, continued operation of the HRSN would not have been possible. Under Bob Nadeau's and Doug Dreger's general supervision, Rick Lellingner, Rich Clymer, Bob Uhrhammer, Doug Neuhauser, Peter Lombard, Bill Karavas, John Friday and Don Lippert all contribute to the operation of the HRSN. Bob Nadeau prepared this section. During this reporting period, operation, maintenance, and data processing for the HRSN project was supported by the USGS, through grant 07HQAG0014.

## 4.5 References

Bakun, W. H., and A. G. Lindh, The Parkfield, California, prediction experiment, *Earthq. Predict. Res.*, *3*, 285-304, 1985.

Dreger, D., R.M. Nadeau, and A. Morrish, Repeating Earthquake Finite-Source Models: Strong Asperities Re-

vealed on the San Andreas Fault, *Geophys. Res. Lett.*, revised version submitted, 2007.

Hickman, S., M.D. Zoback and W. Ellsworth, Introduction to special section: Preparing for the San Andreas Fault Observatory at Depth, *Geophys. Res. Lett.*, *31*, L12S01, doi:10.1029/2004GL020688, 2004.

Michelini, A. and T.V. McEvelly, Seismological studies at Parkfield: I. Simultaneous inversion for velocity structure and hypocenters using B-splines parameterization, *Bull. Seismol. Soc. Am.*, *81*, 524-552, 1991.

Nadeau, R.M. and D. Dolenc, Nonvolcanic Tremors Deep Beneath the San Andreas Fault, *SCIENCE*, *307*, 389, 2005.

## 5. Bay Area Regional Deformation Network

### 5.1 Introduction

This year was the second of the funded BARD project for the period 2007-2010. In consequence, this year, we have continued to push forward the efforts initiated in the previous year. One new site was installed (UCSF). According to our specifications, this site is collecting 1Hz data and buffering 5Hz data. The scientific efforts have focused on the processing of the high-rate GPS data in order to include the GPS solutions (static offsets and dynamic waveforms) in the existing monitoring system for the seismic activity in Northern California (magnitude determination, moment tensors, and the Elarms system). With Doug Dreger, we are about to release a slip distribution model for the 2004 seismic event based on high rate GPS waveforms only.

### 5.2 BARD overview

#### Description of the network

The BSL currently maintains and operates 30 BARD stations (twenty-six bi-frequency sites and four L1 sites). The sampling rate varies from 1 to 30 seconds, and the data are transmitted continuously over a serial connection. Most stations use frame relay technology, either alone or in combination with radio telemetry.

Of the 30 sites, ten (BRIB, CMBB, FARB, HOPB, MHCB, ORVB, PKDB, SAOB, SUTB, and YBHB) are collocated with broadband seismic stations of the BDSN with which they share continuous frame-relay telemetry to UC Berkeley. These sites use the Quanterra data loggers to store and retrieve the GPS data converted to MiniSEED format (*Perin et al.*, 1998). The MiniSEED approach provides more robust data recovery from on-site backup on the Quanterra disks following telemetry outages.

Another five stations (SVIN, MHDL, OHLN, OXMT, and SBRN) have been installed in the last 3 years in the SFBA and along the Hayward Fault as the Berkeley part of a multi-institutional effort funded by the NSF/MRI program to improve strain monitoring in the SFBA using an integrated approach, with significant participation of the USGS/MP (*Murray et al.*, 2002a). These stations include borehole tensor strainmeters, three-component borehole seismic velocity sensors, downhole pore pressure and tilt sensors, and GPS receivers. This project served as a prototype for the strainmeter installations planned for PBO, which faces many of the same station installation, configuration, and data retrieval issues we have addressed. Consequently, these 5 stations have received the nickname *mini-PBO*. From July 2001 to August 2002, five boreholes were drilled to about 200-m depth and

equipped with tensor strainmeters recently developed by CIW and 3-component L22 (velocity) seismometers. For this project, we developed a self-centering GPS antenna mount for the top of the borehole casings, which are mechanically isolated from the upper few meters of the ground, to provide a stable, compact monument that allows access to the top of the borehole casing for downhole maintenance. The 5 GPS receivers were progressively installed and connected to Quanterra 4120 data loggers, which provide backup and telemetry capabilities. The completion of the last station (MHDL), located in the Marin Headlands, took longer because it required AC power, which PG&E installed in December 2005. The site is operational since September 1, 2006. In addition, 10-minute interval data, which are retrieved from all the sites by the USGS via a backup GOES satellite system, show that all the sites are successfully measuring strains due to tidal effects and to local and teleseismic earthquakes (*Murray et al.*, 2002b).

The remaining BSL/BARD stations only record C-GPS data.

Each BSL/BARD station uses a low-multipath choking antenna, most of which (except the “mini-PBO” ones discussed above) are mounted to a reinforced concrete pillar approximately 0.5-1.0 meter above the ground level. The reinforcing steel bars of the pillar are drilled and cemented into a rock outcrop to improve long-term monument stability. A low-loss antenna cable is used to minimize signal degradation on the longer cable setups that normally would require signal amplification. Low-voltage cutoff devices are installed to improve receiver performance following power outages. Most stations are equipped with aging Z-12 receivers, which were originally programmed to record data once every 30 s and observe up to 12 satellites simultaneously at elevations down to the horizon. The antennas are equipped with SCIGN antenna adapters and hemispherical domes, designed to provide security and protection from weather and other natural phenomena and to minimize differential radio propagation delays. The BSL acquired 7 Ashtech MicroZ-CGRS (uZ) receivers with NSF funding for the Mini-PBO project. These have been installed at the “mini-PBO” stations, and two have been used to replace failing Z12s at other stations (CMBB and MODB). At these sites, the data are collected using only direct serial connections and are susceptible to data loss during telemetry outages.

There is growing interest in collecting higher rate data for a variety of applications. For example, GPS measurements can accurately track the propagation of earthquake dynamic motions both on the ground (*e.g.*, *Lar-*

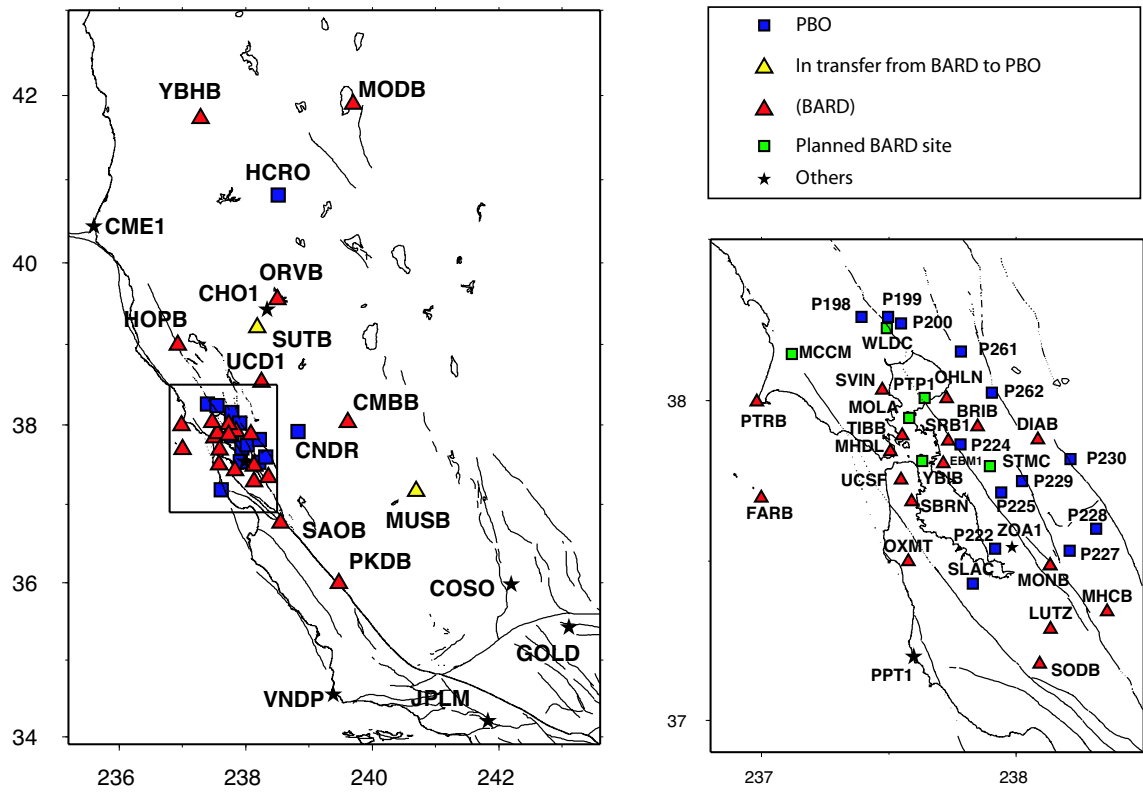

Figure 3.16: Operational BARD stations (red triangles) in northern California (left) and in the San Francisco Bay area (zoom on the right). PBO C-GPS sites are indicated by blue squares and planned BARD sites for period 2007-2010 are symbolized by green ones.

son *et al.*, 2003) and in the atmosphere (*e.g.*, *Artru et al.*, 2001, *Ducic et al.*, 2003), providing complementary information to seismic observations (calibration of integrated acceleration and velocity sensor data) and estimates of earth structure (direct observation of surface wave propagation over the oceans). We started collecting 1 Hz observations at 2 stations (DIAB and MONB) in 2003. In the last year, we have progressively upgraded the telemetry to continuous 1 Hz telemetry at 3 additional stations (BRIB, HOPB, and PTRB), where the bandwidth of the existing telemetry system allowed it. At stations collocated with broadband seismic sensors, the seismic data has priority for telemetry, because it is used in the Northern California real-time earthquake notification system (see <http://www.cisn.org/ncmc/>) making this upgrade more difficult and in general not feasible with the current Z12 receivers because of insufficient data compression. All data collected from BARD/BSL are publicly available at the Northern California Earthquake Data Center (NCEDC; <http://www.ncedc.org/bard/>).

Between 1993 and 2001, the BSL acquired 29 Ashtech Z-12 and Micro-Z receivers from a variety of funding sources, including from federal (NSF and USGS), state (CLC), and private (EPRI) agencies. The network enhances continuous strain measurements in the Bay Area and includes several profiles between the Farallon Islands and the Sierra Nevada in order to better characterize the larger scale deformation field in Northern California (Figure 3.16). During the last two years 10 NETRS have been purchased via the UNAVCO purchase program. These receivers will help to upgrade the network to full high-rate capabilities. Three receivers are operating today (BRIB, MHDL and DIAB).

The number of continuous GPS stations in Northern California is significantly increasing with over 250 new site installations planned by 2008 as part of the Plate Boundary Observatory (PBO) component of the NSF-funded Earthscope project. UNAVCO and researchers from BARD and the other regional networks, such as SCIGN, BARGEN, and PANGA, are funded by NSF to fold operation and maintenance of about 200 existing stations, which constitute the PBO Nucleus network, into the PBO array by 2008. Two BSL-maintained stations (SUTB and MUSB) are included in the PBO Nucleus network. The other BSL stations are either collocated with seismic instrumentation or are located near the San Andreas Fault where real-time processing of the GPS data for earthquake notification is a high priority. Another 23 Northern California stations, including most of the Parkfield network, will be included in the PBO Nucleus, and we are working with UNAVCO to facilitate their transition to UNAVCO control.

## BARD Stations

The majority of the BSL BARD stations use a low-multipath choke-ring antenna, most of which are mounted to a reinforced concrete pillar approximately 0.5–1.0 meter above local ground level. The reinforcing steel bars of the pillar are drilled and cemented into a rock outcrop to improve long-term monument stability. A low-loss antenna cable is used to minimize signal degradation on the longer cable setups that normally would require signal amplification. Low-voltage cutoff devices are installed to improve receiver performance following power outages. Most use Ashtech Z-12 receivers that are programmed to record data once every 30 seconds and observe up to 12 satellites simultaneously at elevations down to the horizon. The antennas are equipped with SCIGN antenna adapters and hemispherical domes, designed to provide security and protection from weather and other natural phenomena, and to minimize differential radio propagation delays.

Data from most BSL-maintained stations are collected at 15 or 30-second intervals and transmitted continuously over serial connections (Table 5.2). Station TIBB uses a direct radio link to Berkeley, and MODB uses VSAT satellite telemetry. Most stations use frame relay technology, either alone or in combination with radio telemetry. Fourteen GPS stations are collocated with broadband seismometers and Quanterra data loggers (Table 3.2). With the support of IRIS, we developed software that converts continuous GPS data to MiniSEED opaque blockettes that are stored and retrieved from the Quanterra data loggers (*Perin et al.*, 1998), providing more robust data recovery from onsite disks following telemetry outages.

Data from BRIB, CMBB, DIAB, HOPB, MHCB, MHDL, MONB, OHLN, OXMT, PTRB, SBRN, SRB1, SVIN, TIBB, and UCD1 in the Bay Area, and 13 stations in the Parkfield region (all but PKDB), are now being collected at 1-second intervals. All high-rate observations collected by these stations are currently available from the NCEDC. Collecting at such high-frequency (for GPS) allows dynamic displacements due to large earthquakes to be better measured; however, this 30-fold increase in data can pose telemetry bandwidth limitations. We are planning to convert additional stations to 1-second sampling where possible during the next year. The acquisition of the 5 NETRS bundles will help to complete this project (see Subsection 5.3). In the Bay Area, we have converted stations that have sufficient bandwidth and are currently assessing bandwidth issues at other stations. Prior to the September 28, 2004 M6 Parkfield earthquake, data from the Parkfield stations were collected on an on-site computer, written to removable disk once per month, and sent to SOPAC for long-term archiving (decimated 30-sec data is acquired daily via the BSL frame relay circuit). In response to the earthquake, we modified the procedures

	Sites	Lat. (deg.)	Lon. (deg)	Receiver	Telem.	Sampling rate	Collocated Network	Location
1	BRIB	37.91	237.84	<b>NETRS</b>	T1	<b>1Hz</b>	BDSN	Briones Reservation, Orinda
2	CMBB	38.03	239.61	A-UZ12	FR	1Hz	BDSN	Columbia College, Columbia
3	DIAB	37.87	238.08	A-Z12	FR	1Hz		Mt. Diablo
4	FARB	37.69	236.99	A-Z12	R-FR/R	15 s	BDSN	Farallon Island
5	EBMD	37.81	237.71	T-SSI	R	1Hz		East Bay Mud Headquarters
6	HOPB	38.99	236.92	<b>TR 4000</b>	FR	<b>1Hz</b>	BDSN	Hopland Field Stat., Hopland
7	LUTZ	37.28	238.13	A-Z12	FR	30 s		SCC Comm., Santa Clara
8	MHCB	37.34	238.35	A-Z12	FR	1Hz	BDSN	Lick Obs., Mt. Hamilton
9	MHDL	37.84	237.50	T-NETRS	FR	1Hz	mini-PBO	Marin Headlands
10	MODB	41.90	239.69	A-UZ12	NSN	15 s		Modoc Plateau
11	MONB	37.48	238.13	A-Z12	FR	1Hz		Monument Peak, Milpitas
12	MUSB	37.16	240.69	A-Z12	R-Mi-FR	30 s		Musick Mt.
13	OHLN	38.00	237.72	A-UZ12	FR	1Hz	mini-PBO	Ohlone Park, Hercules
14	ORVB	39.55	238.49	A-Z12	FR	15 s	BDSN	Oroville
15	OXMT	37.49	237.57	A-UZ12	FR	1Hz	mini-PBO	Ox Mountain
16	PKDB	35.94	239.45	A-Z12	FR	30 s	BDSN	Bear Valley Ranch, Parkfield
17	PTRB	37.99	236.98	A-Z12	R-FR	<b>1Hz</b>		Point Reyes Lighthouse
18	SAOB	36.76	238.55	A-Z12	FR	30 s	BDSN	San Andreas Obs., Hollister
19	SBRN	37.68	237.58	A-Z12	FR	1Hz	mini-PBO	San Bruno
20	SODB	37.16	238.07	A-Z12	R-FR	30 s		Soda Springs, Los Gatos
21	SRB1	37.87	237.73	T-SSE	FR	1Hz		SRB building, Berkeley
22	SUTB	39.20	238.17	A-Z12	R-FR	30 s	BDSN	Sutter Buttes
23	SVIN	38.03	237.47	A-UZ12	R-FR	1Hz	mini-PBO	St Vincents
24	TIBB	37.89	237.55	A-UZ12	R	1Hz		Tiburon
25	UCD1	38.53	238.24	<b>NETRS</b>	WEB	1Hz		UC - Davis
26	YBHB	41.73	237.28	A-Z12	FR	15 s	BDSN	Yreka Blue Horn Mine, Yreka
27	UCSF	37.75	237.55	NETRS	FR	1Hz		UC-San Francisco, San Francisco
28	BDM	37.95	238.13	NETRS			BDSN	Black Diamond Mines Park, Antioch
29	MCCM	38.14	237.12	NETRS			BDSN	Marconi Conference Center, Marshall
30	PTP1	38.00	237.64	NETRS			NHFN	Point Pinole Regional Park

Table 3.11: List of the BARD sites maintained by the BSL. Five models of receiver are operating now: Trimble 4000 SSE (T-SSE), Trimble 4000 SSI (T-SSI), Trimble NETRS, (T-NETRS), Ashtech Z12, and Ashtech Micro Z (A-UZ12). The replacement of the Ashtech Z12 by Trimble NETRS will make the receiver park more homogeneous. The telemetry types are listed in column 6. FR = Frame Relay, R = Radio, Mi= Microwave, WEB = DSL line. Some sites are transmitting data over several legs with different telemetry. Changes from the last year's network table are highlighted in bold typography. The sites 28 to 30 are in progress. For these 3 sites, the instrumentation is available, and permit request procedures have been started.



to download 1-second data converted to compact RINEX format at hourly intervals, which does not significantly impact the telemetry bandwidth.

### Data archival

The Northern California Earthquake Data Center (NCEDC), operated jointly by the BSL and USGS, archives all permanent-site GPS data currently being collected in Northern California. In the past months, due to the transition to PBO, some sites are not present in the NCEDC archive (PPT1, for instance). All the sites available will be archived as in the past. We archive the Federal Aviation Administration (FAA) sites all over the west Pacific coast (the closest one is ZOA1). Data importation and quality assurance are automated, although some manual correction of unusual data problems is still required.

As part of the activities funded by the USGS through the BARD network, the NCEDC has established an archive of the 7000+ survey-mode occupations collected by the USGS since 1992. The NCEDC continues to archive non-continuous survey GPS data. The initial dataset archived is the survey GPS data collected by the USGS Menlo Park for northern California and other locations. The NCEDC is the principal archive for this dataset. Significant quality control efforts were implemented by the NCEDC (*Romanowicz et al., 1994*) to ensure that the raw data, scanned site log sheets, and RINEX data are archived for each survey. All of the USGS MP GPS data has been transferred to the NCEDC, and virtually all of the data from 1992 to the present has been archived and is available for distribution. We are also archiving additional high-precision GPS data sets from Northern California (mainly Park-field measurements). Together with graduate students in the department, who are now using the GAMIT software to process survey-mode data in the San Francisco Bay area, we are working to combine the survey-mode and C-GPS solutions into a self-consistent velocity field for Northern California. The campaign velocity field computed from campaign measurements by UCB and USGS groups has been published by *d'Alessio et al., (2005)*.

Data from five of our sites (HOPB, MHCB, CMBB, OHLN, and YBHB) are sent to the National Geodetic Survey (NGS) in the framework of the CORS (Continuous Operating Reference Stations) project (<http://www.ngs.noaa.gov/CORS/>). The data from these five sites are also distributed to the public through the CORS ftp site.

## 5.3 2007-2008 Activities

### New stations and upgrades

**Permit requests:** The permit releases of the sites PTP1 and BDM have encountered administrative de-

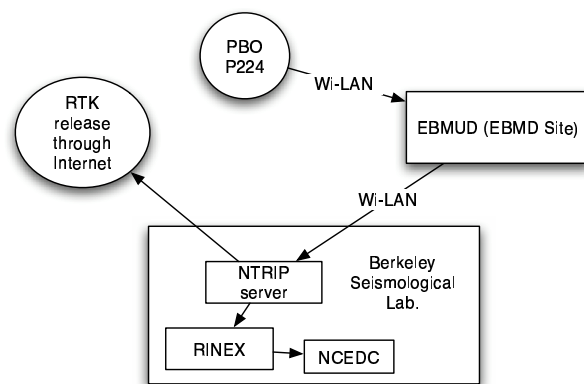

Figure 3.17: Present BSL operations at EBMUD site and planned operations between the PBO site P224 and BSL. Since its installation in 2003, the EBMD site was sending data to BSL using an internet DSL connection. The data collected (Trimble 5700 receiver) are now sent to BSL using a WI-LAN radio connection. The connection represents an upgrade of the quality of the radio link. The data collected here are thus more safely sent to BSL in case of a large seismic event.

lays during the year. However, an agreement has been reached, and the permits are currently at UC Berkeley to be signed by the Real Estate office. The installation of these sites should be completed during the next year. A new site has been installed on the roof top of a UCSF building. This site, as well as the other NETRS site is transmitting real-time 1Hz data and is recording on-site 5Hz data available in case of emergency.

**Real-Time Kinematic (RTK) service:** In the framework of the collaboration with EBPARK, BSL is distributing RTK corrections for some sites. This experimental project aims at developing collaborations with private users or local institutions in Northern California. We hope to densify the network and reduce monumentation and telemetry costs associated with the installation and operation of new sites. This year we have been encountering issues related to the Trimble user of our RTK network. After a series of tests, we requested assistance from the local reseller to complete a reliable connection between one of our NETRS and the Trimble remote device.

**Meteorological Sensors and troposphere:** In February 2008, we received funding to install three meteorological sensors at GPS sites, in collaboration with UC Riverside. Two of these sensors will be installed at the site SBRN.

**SBRN move:** The site SBRN has been damaged 3 times this year. The staff decided to move this site to a safer location near the existing one. For a period of time, two receivers will be operated simultaneously in order to

check the stability of the current site. It is likely the new site will not keep the code SBRN.

**Replacement of CHAB site:** We are looking for a new site to replace the existing site CHAB. This 1992 installation is of foremost importance due to its proximity to the Hayward Fault; however, it might be difficult to restore if service is discontinued.

## 5.4 Data Analysis and Results

### CALREF, a stable reference frame for Northern California

The BARD dataset has been processed in the ITRF2000 (Altamimi *et al.*, 2002). The solutions (Houlié and Romanowicz, in prep) are in good agreement with campaign solutions (BAVU and USGS) previously released (d’Alessio *et al.*, 2005). The new coordinates release for the BARD network includes currently operating sites and velocities for the sites transferred from BSL to PBO during the last two years.

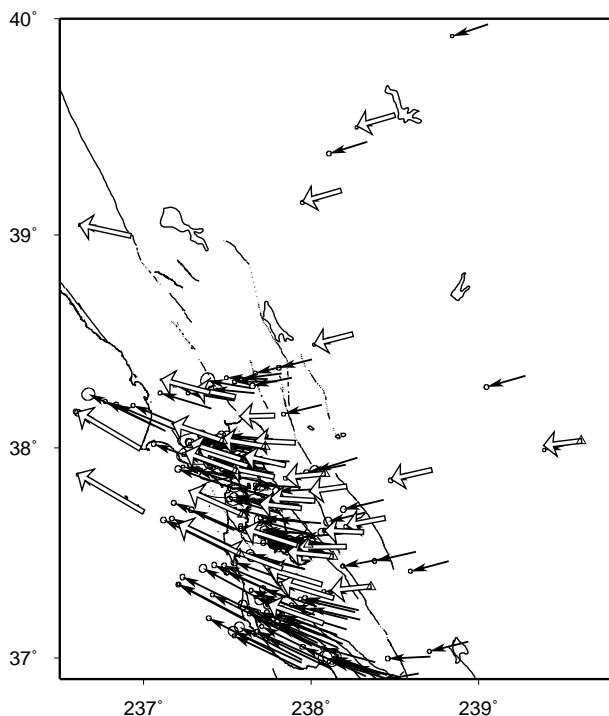

Figure 3.18: Comparison of the BARD solutions (white arrows) with the Bay Area Velocity Unification (BAVU) solutions (black arrows). All the data available at the BSL between 1994 and 2006 have been reprocessed (From Houlié and Romanowicz, in prep). BAVU website: <http://seismo.berkeley.edu/~burgmann/RESEARCH/BAVU/>

All the BARD sites have been processed jointly with IGS sites in California. No *a priori* constraints have been assumed during the processing. All the velocities included in the first release of California Reference Frame

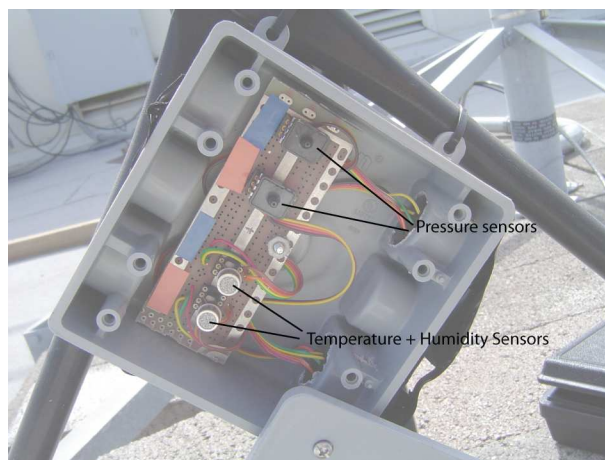

Figure 3.20: Meteorological pair of sensors designed by John Friday.

(CALREF) are given in Table 3.12. The CALREF will provide velocities and coordinates of sites located in the Bay Area at specific epochs. Each solution will be associated with error estimations (formal and real). Every surveyor will be able to control the reference site coordinates for a given survey.

The CALREF processing is being reprocessed to integrate the meteorological data collected at some sites during the last decade.

### Quick processing of a selection of sites

In addition to the daily and long-term processing, we developed an additional channel of processing dedicated to the quick solutions. This processing focuses on locating 4 sites in order to provide quick solution offsets in less than 10 minutes. These offsets will thus be available for use in the local moment tensor inversions.

### BARD products released on the web

A series of products are released on the new BARD website (<http://www.ncedc.org/bard/>). The list of products released covers various domains (from time-series to daily troposphere maps) that can potentially benefit from GPS data and will encourage collaboration with BSL researchers and others. All products are updated daily.

### Troposphere study in Southern California and in SFBA

Preliminary work completed during the previous year led to a project funded by the Southern California Earthquake Center (SCEC). We are processing years 2006, 2007, and 2008 of the GPS data for the San Gabriel Valley and extending this study to the east. This year,

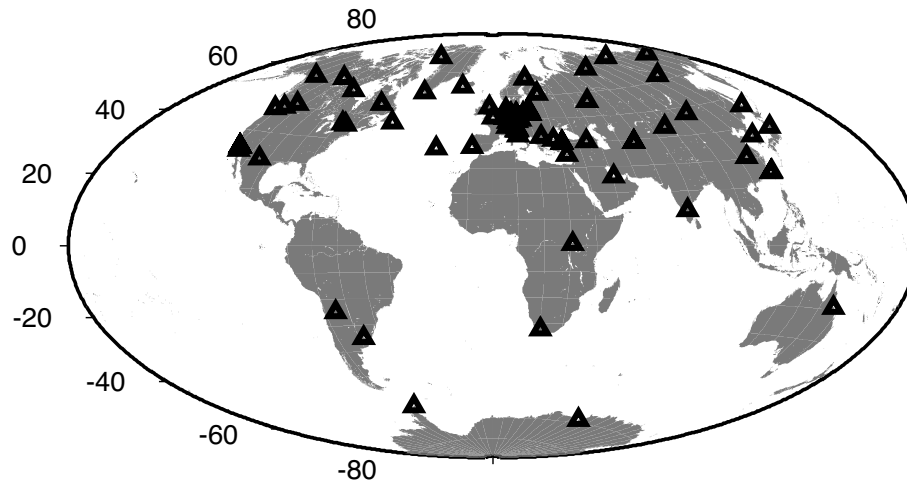

Figure 3.19: Map of the 74 GPS sites, available at SOPAC, collecting meteorological parameters. Only two of these sites are in California (JPLM and SIO3). The sensors we propose to install along BARD instruments will benefit the GPS community.

we will apply similar processing to the BARD network. Two meteorological packages will be operated at SBRN during August 2008 and likely at BRIB during the year 2008/2009. These sensors (Figure 3.20) were designed by John Friday. We hope to minimize the effect of the troposphere on BARD solutions and improve their repeatability.

#### 2004 Parkfield slip distribution update

This year, we have focused our efforts on the high-rate data and their application to seismological products. We have produced high-rate GPS time-series. In collaboration with Doug Dreger, a slip distribution model based on GPS waveforms only has been computed. This slip model was presented at the AGU Fall Meeting 2007. We confirm that the GPS waveforms can be used to constrain fault slip model for large seismic events ( $M_w > 6$ ).

### 5.5 Acknowledgements

Barbara Romanowicz oversees the BARD program. Nicolas Houlié, Rich Clymer, Bill Karavas, Rick Lellinger, John Friday, and Doug Neuhauser contributed to the operation of the BARD network. The operation of the BARD network is partially supported by funding from the USGS/NEHRP program (grant number 07HQAG0031) and funding from the NSF/UNAVCO PBO nucleus grant (number 0453975-09).

### 5.6 References

Altamimi, Z., P. Sillard, and C. Boucher, ITRF2000: A new release of the International Terrestrial Reference

Frame for earth science applications, *J. Geophys. Res.*, 107(B10), 2214, doi:10.1029/2001JB000561, 2002

Artru, J., P. Lognonné and E. Blanc, Normal modes modeling of post-seismic ionospheric oscillations, *Geophys. Res. Lett.*, 28, 697-700, 2001

d'Alessio, M. A., I. A. Johanson, R. Bürgmann, D. A. Schmidt, and M. H. Murray, Slicing up the San Francisco Bay Area: Block kinematics from GPS-derived surface velocities, *J. Geophys. Res.*, 110, B06403, doi:10.1029/2004JB003496, 2005.

Ducic, V., J. Artru and P. Lognonné, Ionospheric remote sensing of the Denali Earthquake Rayleigh surface waves, *Geophys. Res. Lett.*, 30, 18, 2003

Houlié, N. and Romanowicz, B., CALREF, a stable reference frame for the Northern California, submitted.

Larson, Using 1-Hz GPS Data to Measure Deformations Caused by the Denali Fault Earthquake, *Science*, 300, 1421-1424, 2003

Murray, M., Neuhauser D., Gee, L., Dreger, D., Basset, A., and Romanowicz, B., Combining real-time seismic and geodetic data to improve rapid earthquake information, *EOS. Trans. AGU*, 83(47), G52A-0957, 2002.

Perin, B. J., C. M. Meertens, D. S. Neuhauser, D. R. Baxter, M. H. Murray, and R. Butler, Institutional collaborations for joint seismic and GPS measurements, *Seismol. Res. Lett.*, 69, 159, 1998.

Romanowicz, B., B. Bogaert, D. Neuhauser, and D. Oppenheimer, Accessing northern California earthquake data via Internet, *EOS Trans. AGU*, 75, 257-260, 1994.

Site	Lon.	Lat	Ve (mm/y)	Vn (mm/y)	$\sigma_e$ (mm/y)	$\sigma_n$ (mm/y)	Start
BAY1*	197.29	55.19	-6.3	-25.5	0.0000	0.0000	1996.08
BAY2	197.29	55.19	-5.6	-25.2	0.0400	0.0300	1996.08
BRIB	237.85	37.92	-24.8	5.6	0.0100	0.0100	1993.58
CMBB	239.61	38.03	-22.9	-2.8	0.0100	0.0100	1993.92
CNDR	238.72	37.90	-24.4	-5.5	0.0200	0.0200	1999.27
DIAB	238.08	37.88	-23.7	-2.2	0.0100	0.0100	1998.33
FARB	237.00	37.70	-39.8	23.3	0.0100	0.0100	1994.00
GOLD*	243.11	35.43	-18.2	-5.4	0.0000	0.0000	1989.95
HCRO	238.53	40.82	-18.0	-8.7	0.1400	0.1500	2003.50
HOPB	236.93	39.00	-31.1	6.8	0.0100	0.0100	1995.58
JPLM*	241.83	34.21	-36.6	11.8	0.0000	0.0000	1989.44
LUTZ	238.14	37.29	-31.7	9.5	0.0100	0.0100	1996.33
MHCB	238.36	37.34	-24.2	-2.4	0.0100	0.0100	1996.33
MODB	239.70	41.90	-16.9	-9.1	0.0200	0.0200	1999.83
MOLA	237.58	37.95	-30.5	9.7	0.0100	0.0100	1993.75-2002.22
MONB	238.13	37.49	-27.5	2.7	0.0100	0.0100	1998.50
MUSB	240.69	37.17	-22.3	-4.0	0.0100	0.0100	1997.83
OHLN	237.73	38.01	-26.4	4.4	0.0200	0.0200	2001.83
ORVB	238.50	39.56	-22.7	-6.6	0.0100	0.0100	1996.83
OXMT	237.58	37.50	-36.9	18.0	0.0600	0.0600	2004.12
P181(PBO)	237.62	37.92	-29.0	9.6	0.3800	0.4000	2005.09
P198 (PBO)	237.39	38.26	-29.2	7.9	0.0900	0.1000	2004.77
P200 (PBO)	237.55	38.24	-24.3	4.7	0.2000	0.2200	2005.73
P222 (PBO)	237.92	37.54	-31.5	10.0	0.1100	0.1200	2005.26
P224 (PBO)	237.78	37.86	-26.9	5.5	0.1000	0.1100	2005.25
P225 (PBO)	237.94	37.71	-25.2	2.7	0.0900	0.1000	2005.14
P227 (PBO)	238.21	37.53	-28.6	-0.4	0.5800	0.6300	2006.20
P228 (PBO)	238.31	37.60	-23.5	1.0	0.4300	0.4700	2005.93
P229 (PBO)	238.02	37.75	-26.8	1.6	0.1100	0.1200	2005.29
P230 (PBO)	238.21	37.82	-22.5	-3.1	0.1100	0.1200	2005.15
P261 (PBO)	237.78	38.15	-21.0	-0.5	0.0900	0.1000	2004.50
P262 (PBO)	237.90	38.03	-24.2	1.2	0.1100	0.1200	2005.32
PKDB	239.46	35.95	-43.0	18.7	0.0100	0.0100	1996.67
PPT1*	237.61	37.19	-40.7	22.1	0.0000	0.0000	1996.14
PTRB	236.98	38.00	-37.7	22.2	0.0100	0.0100	1998.58
S300	238.44	37.67	-22.9	-4.4	0.0200	0.0200	1998.48
SAOB	238.55	36.77	-41.4	22.0	0.0100	0.0100	1997.58
SBRN	237.59	37.69	-32.0	14.2	0.0300	0.0300	2003.18
SODA	26.39	67.42	18.7	34.1	0.1400	0.1600	1994.70
SODB	238.07	37.17	-33.1	11.7	0.0100	0.0100	1996.33
SUAA	237.83	37.43	-33.7	12.4	0.0100	0.0100	1994.30
SUTB	238.18	39.21	-23.1	-6.7	0.0100	0.0100	1997.33
SVIN	237.47	38.03	-30.5	10.3	0.0400	0.0400	2003.89
THAL	238.07	37.35	-32.0	9.5	0.2000	0.2200	2003.00
TIBB	237.55	37.89	-30.8	11.2	0.0100	0.0100	1994.42
UCD1	238.25	38.54	-23.1	-6.0	0.0100	0.0100	1996.38
VNDP*	239.38	34.56	-42.2	20.9	0.0000	0.0000	1992.48
YBHB	237.29	41.73	-15.8	-6.7	0.0100	0.0100	1996.75

Table 3.12: CALREF 2006 official velocities. All velocities and estimated errors ( $\sigma$ ) are indicated in mm per year. For each site, the relevant time-span and the network are specified. The sites with a star are the sites for which the velocities have been used during the combination of the daily solutions.

## 6. Northern California Earthquake Data Center

### 6.1 Introduction

The Northern California Earthquake Data Center, a joint project of the Berkeley Seismological Laboratory (BSL) and the U.S. Geological Survey at Menlo Park, serves as an online archive for various types of digital data relating to earthquakes in Central and Northern California. The NCEDC is located at the Berkeley Seismological Laboratory, and has been accessible to users via the Internet since mid-1992.

The primary goal of the NCEDC is to provide a stable and permanent archival and distribution center of digital geophysical data for networks in Northern and Central California. These data include seismic waveforms, electromagnetic data, GPS data, strain, creep, and earthquake parameters. The seismic data comes principally from the Berkeley Digital Seismic Network (BDSN) operated by the Seismological Laboratory, the Northern California Seismic Network (NCSN) operated by the USGS, the Berkeley High Resolution Seismic Network (HRSN) at Parkfield, the EarthScope USArray Transportable Array stations in Northern California, the various Geysers networks, and selected stations from adjacent networks such as the University of Reno, Nevada network and the Southern California Seismic Network (SCSN). GPS data are primarily from the Bay Area Regional Deformation (BARD) GPS network and the USGS/Menlo Park GPS surveys. The collection of NCSN digital waveforms dates from 1984 to the present, the BDSN digital waveforms date from 1987 to the present, and the BARD GPS data date from 1993 to the present. The BDSN includes stations that form the specialized Northern Hayward Fault Network (NHFN) and the MiniPBO (MPBO) borehole seismic and strain stations in the SF Bay Region. Additional seismic and strain data from the EarthScope Plate Boundary Observatory (PBO) and the San Andreas Fault Observatory at Depth (SAFOD) are also archived at the NCEDC.

The NCEDC also provides support for earthquake processing and archiving activities of the Northern California Earthquake Management Center (NCEMC), a component of the California Integrated Seismic Network (CISN). The CISN is the California regional organization of the Advanced National Seismic System (ANSS).

### 6.2 2007-2008 Activities

By its nature, data archiving is an ongoing activity. In 2007-2008, the NCEDC continued to expand its data holdings and enhance access to the data. Projects and activities of particular note include:

- In collaboration with the USGS Menlo Park, im-

ported the entire NCSN earthquake catalog with phase and amplitude readings into the CISN database schema, performed quality-control tests on the catalog, and updated Web data distribution tools to use the NCSN catalog from the database.

- Developed procedures for replacing waveforms rapidly collected in real-time for earthquake event analysis with QC-ed waveforms from the BK and BP networks.
- Supported the NCEMC earthquake analysis by providing real-time access to earthquake parameters and waveforms from the NCEDC for the CISN *Jiggle* earthquake review software.
- Made significant progress on reading and archiving continuous NCSN seismograms from tapes for 2001-2005.
- In collaboration with USGS Menlo Park, provided QC procedures to evaluate the intermediate conversion of older 1990's NCSN waveform tapes into a format that could be processed and archived at the NCEDC.

### 6.3 BDSN/NHFN/MPBO Seismic Data

Archiving current BDSN (Section 1.), NHFN (Section 3.), and Mini-PBO (Section 3.) (all stations using the network code BK) seismic data is an ongoing task. These data are telemetered from 47 seismic data loggers in real-time to the BSL, where they are written to disk files, used for CISN real-time earthquake processing, and delivered in real-time to the DART (Data Available in Real Time) system on the NCEDC, where they are immediately available to anyone on the Internet. In September 2004, the NCEDC began to archive continuous high frequency data (80 Hz and 100 Hz) from all of the BDSN broadband, strong motion, and strainmeter sensors. Previously, 20 Hz and lower rate data channels were archived continuously, and high frequency data was archived only for events. In early 2006, the NCEDC started to receive all of the BK stations in real-time and make them available to users through the DART. All timeseries data from the Berkeley networks continue to be processed and archived by an NCEDC analyst using *calqc* in order to provide the highest quality and most complete data stream to the NCEDC.

#### NCSN Seismic Data

NCSN continuous waveform data are sent in real-time to the NCEDC via the internet, and are made available

to users in real-time through the NCEDC DART. NCSN event waveform data, as well as data from all other real-time BSL and collaborating networks, are automatically collected by the NCEMC waveform archiver and stored at the NCEDC for event review and analysis and for distribution to users. All NCSN and NCEMC data are archived in MiniSEED format.

The NCEDC also maintains a list of historic teleseismic events recorded by the NCSN, since these events do not appear in the NCSN catalog.

A description of the successive improvements in the acquisition of NCSN data, leading to the acquisition of complete NCSN waveform data in early 2006, can be found in the 2005-06 BSL Annual Report. We have made significant progress this year in the NCSN continuous waveform archiving project by reading, converting and archiving NCSN seismograms from all NCSN tapes for 2003 through early 2006. Figure 3.23 shows the total data volume by year.

### **Parkfield High Resolution Seismic Network Data**

The history of upgrades to the acquisition and archival of HRSN data can be found in the 2005-06 BSL Annual Report.

In early 2006, the NCEDC started to receive the HRSN 20 Hz data and a subset of the 250 Hz data in real-time for distribution through the DART. The NCEDC continued to archive continuous 250 Hz and 20 Hz data streams from the HRSN tapes written in Parkfield and processed at the NCEDC. In early 2007, the BSL established a radio telemetry link from the HRSN recording center at the California Department of Forestry (CDF) in Parkfield to Carr Hill, and started to telemeter all HRSN continuously to UCB. These data are fed into the NCSN backup Earthworm system at Carr Hill, and are also routed through the USGS Parkfield T1 circuit to USGS/MP and through the NCEMC T1 circuit to the BSL for real-time processing by the NCEMC earthquake processing system. The data are also made available to users through the NCEDC DART and are continuously archived at the NCEDC.

### **EarthScope USArray Transportable Array**

EarthScope began installing broadband stations for the Transportable Array component of USArray in California in 2005. The NCEDC started acquiring telemetered continuous data from the Northern California and surrounding stations as they were installed, and is archiving these data to support users working with Northern California seismic data. These data are made available to users using the same data request methods as all other continuous data waveform data at the NCEDC. The Transportable Array stations have a limited operational timespan of 18 to 24 months, after which they will be relocated to new sites across the country. Data from

these stations were delivered to the NCEDC as they were received by the BSL for distribution through the DART. The USArray station feed to the BSL was discontinued in late November 2007 when the stations were relocated to new sites outside of California.

### **EarthScope Plate Boundary Observatory (PBO) strain data**

The NCEDC is one of two funded archives for PBO EarthScope borehole and laser strain data. Strain data are collected from all of the PBO strain sites and are processed by UNAVCO. MiniSEED data are delivered to the NCEDC using SeedLink, and raw and XML processed data are delivered to the NCEDC using Unidata's Local Data Manager (LDM). The MiniSEED data are inserted into the NCEDC DART and are subsequently archived from the DART. UNAVCO provides EarthScope funding to the NCEDC to help cover the processing, archiving, and distribution costs for these data.

### **EarthScope SAFOD**

The NCEDC is an archive center for the SAFOD event data and will also process the continuous SAFOD data. Starting in July 2002, scientists from Duke University successfully installed a three component 32 level downhole-seismic array in the pilot hole at the EarthScope SAFOD site in collaboration with Steve Hickman (USGS), Mark Zoback (Stanford University), and the Oyo Geospace Engineering Resources International (GERI) Corporation. High frequency event recordings from this array have been provided by Duke University for archiving at the NCEDC. We converted data from the original SEG-2 format data files to MiniSEED, and have developed the SEED instrument responses for this data set. Continuous 4 KHz data from SAFOD are written to tape at SAFOD and are periodically sent to the BSL to be converted, archived, and forwarded to the IRIS DMC. SAFOD EarthScope funding to the NCEDC is to cover the processing, archiving, and distribution costs for these data. A small subset of the continuous SAFOD data channels are also incorporated into the NCSN, are available in real-time from the NCEDC DART, are archived at the NCEDC, and are forwarded to the IRIS DMC. In March 2008, SAFOD installed a Guralp broadband and accelerometer package in the Pilot Hole, which sends continuous data at 200 samples-per-second to the NCEDC.

### **UNR Broadband data**

The University of Reno in Nevada (UNR) operates several broadband stations in western Nevada and eastern California that are important for Northern California earthquake processing and analysis. Starting in August 2000, the NCEDC has been receiving and archiving continuous broadband data from four UNR stations. The

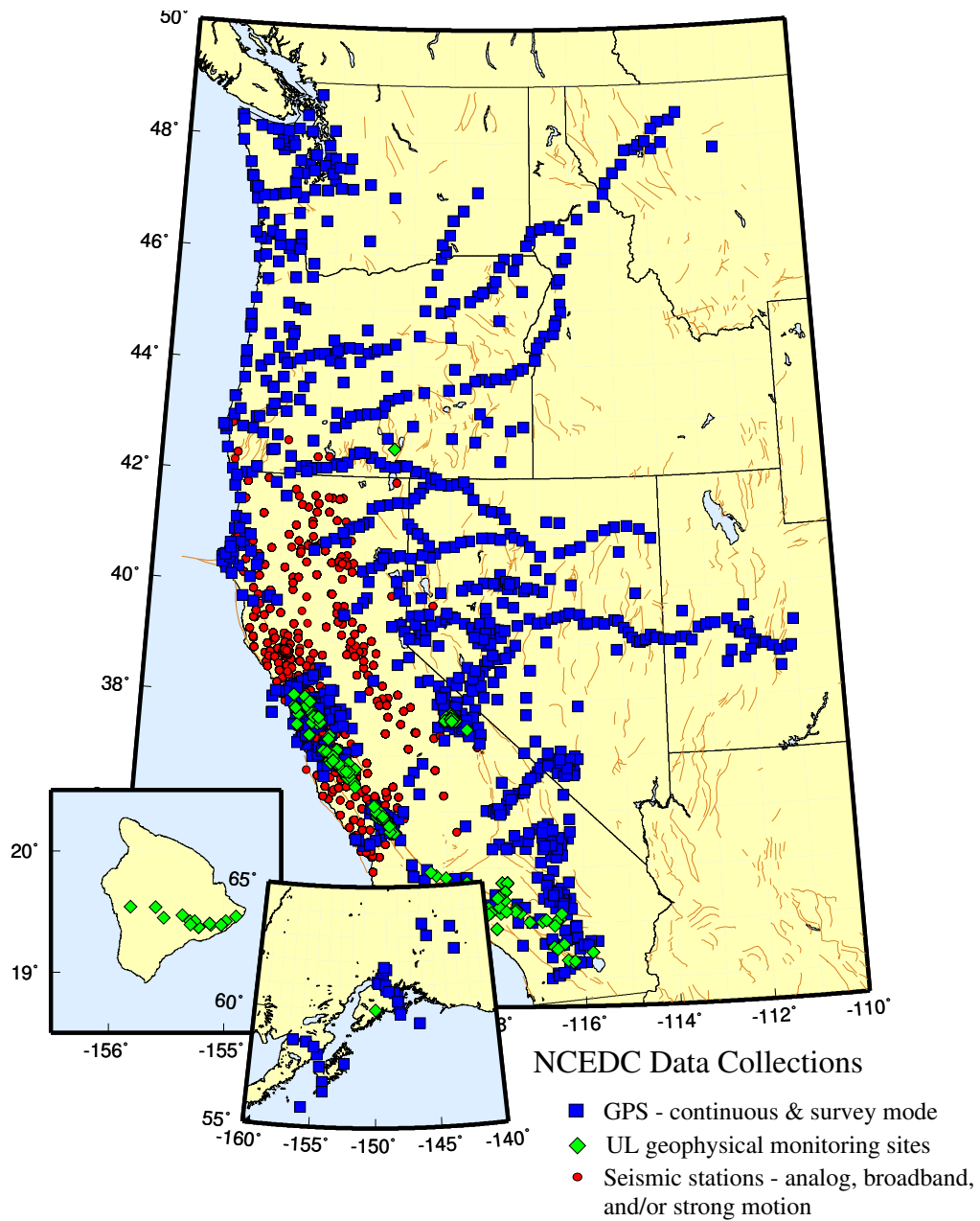

Figure 3.21: Map showing the location of stations whose data are archived at the NCEDC. Circles are seismic sites, squares are GPS sites, and diamonds are the locations of USGS low-frequency experiments.

### Volume of Data Archived at the NCEDC

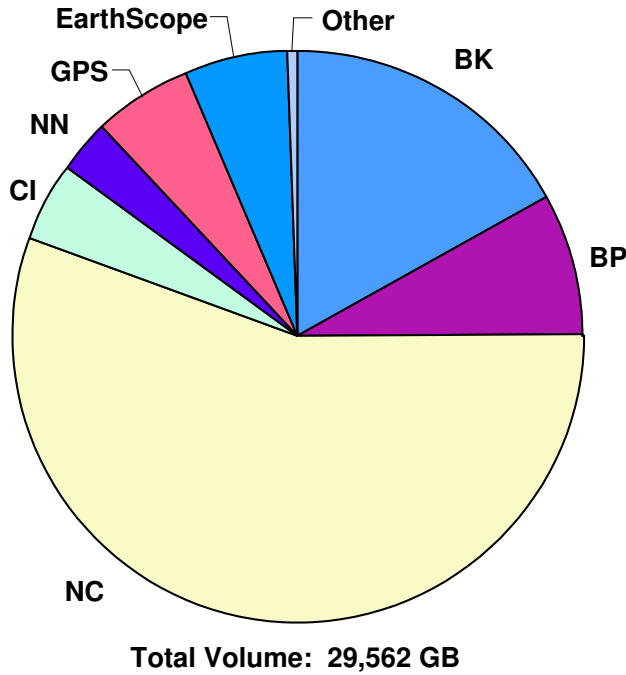

Figure 3.22: Chart showing the relative proportion of each data set at the NCEDC. (BK - Berkeley Digital Seismic Network; BP - Berkeley High-resolution Seismic Network in Parkfield; NC - Northern California Seismic Network and collaborators; CI - Southern California Seismic Network; NN - University of Nevada, Reno Seismic Network; GPS - various GPS datasets, including BARD; EarthScope - data from various EarthScope activities; Other - various small data sets)

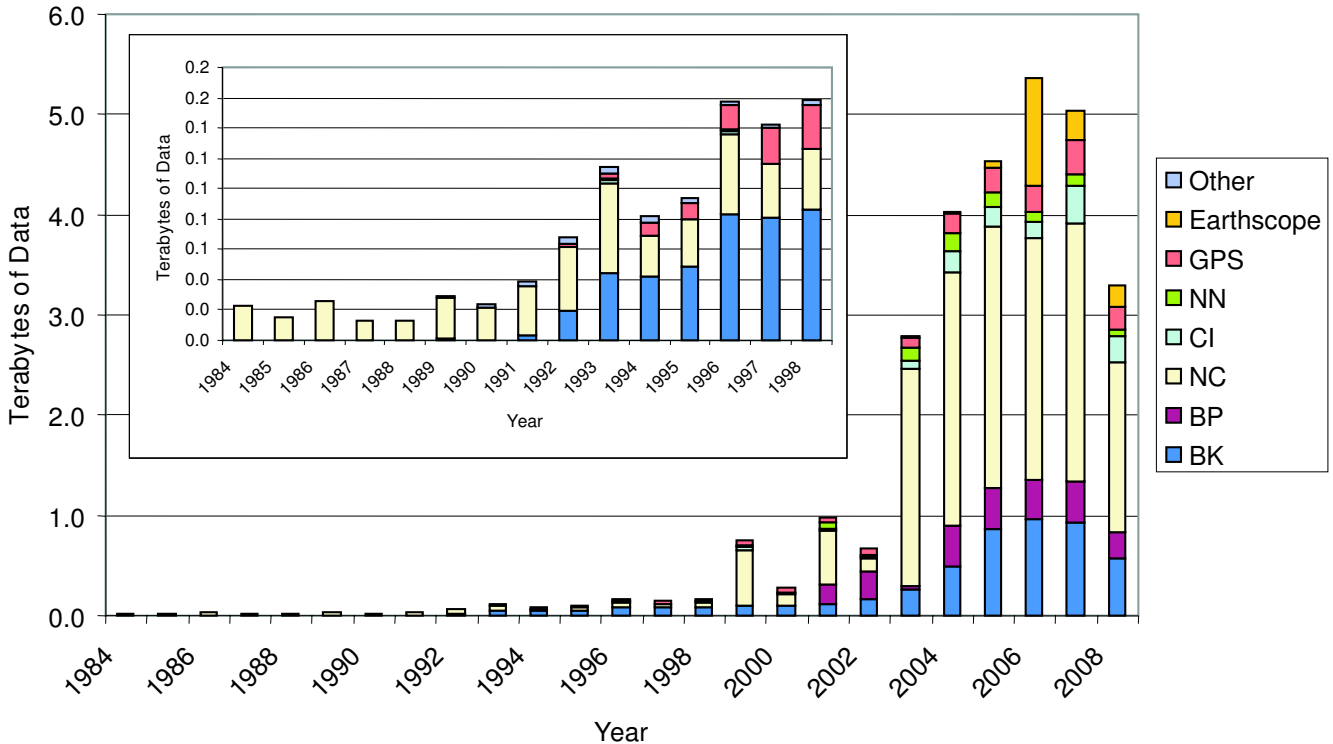

Figure 3.23: Figure showing the total volume of data archived at the NCEDC, broken down by data year.



Data Type	GBytes
BDSN/NHFN/MPBO (broadband, electric and magnetic field, strain) waveforms	5,026
NCSN seismograms	16,365
Parkfield HRSN seismograms	2,387
BARD GPS (RINEX and raw data)	1,704
UNR Nevada seismograms	880
SCSN seismograms	1,348
Calpine/Unocal Geysers region seismograms	38
EarthScope SAFOD seismograms	972
EarthScope USArray seismograms	271
EarthScope PBO strain waveforms	455
USGS low frequency geophysical waveforms	2
Misc data	114
Total size of archived data	29,562

Table 3.13: Volume of Data Archived at the NCEDC by network

data are transmitted in real-time from UNR to UC Berkeley, where they are made available for CISN real-time earthquake processing and for archiving. Initially, some of the stations were sampled at 20 Hz, but all stations are now sampled and archived continuously at 100 Hz.

The NCEDC installed Simple Wave Server (SWS) software at UNR, which provides an interface to UNR's recent collection of waveforms. The SWS is used by the NCEDC to retrieve waveforms from UNR that were missing at the NCEDC due to real-time telemetry outages between UNR and UC Berkeley.

In early 2006, the NCEDC started to archive continuous data from the UNR short-period stations that are contributed to the NCSN. Both the broadband and short-period UNR stations contributed to the CISN are available in real-time through the NCEDC DART.

### Electro-Magnetic Data

The NCEDC continues to archive and process electric and magnetic field data acquired at several UC Berkeley sites. The BSL operates both magnetic and electric field sensors at PKD and SAO. Through a collaboration with Dr. Simon Klemperer at Stanford University, we acquire magnetic and electric field channels at BSL sites JRSC and BRIB, and magnetic field channels at site MHDL. The three magnetic field channels and either two or four electric field channels are digitized at 40 Hz, 1 Hz, and 0.1 Hz, and are telemetered in real-time along with seismic data to the Berkeley Seismological Laboratory, where they are processed and archived at the NCEDC in a similar fashion to the seismic data.

Using programs developed by Dr. Martin Fullerkrug at the Stanford University STAR Laboratory (now at the University of Bath), the NCEDC has computed and archived magnetic activity and Schumann resonance analysis using the 40 Hz data from this dataset. The

magnetic activity and Schumann resonance data can be accessed from the Web. This processing was halted in mid 2005 due to problems with the code and will be resumed when the problems have been identified and corrected.

The NCEDC also archives data from a low-frequency, long-baseline electric field project operated by Dr. Steve Park of UC Riverside at site PKD2. These data are acquired and archived in an identical manner to the other electric field data at the NCEDC.

### GPS Data

The NCEDC continues to archive GPS data through the BARD (Bay Area Regional Deformation) network of continuously monitored GPS receivers in Northern California (Section 5.). The NCEDC GPS archive now includes 67 continuous sites in Northern California. There are approximately 50 core BARD sites owned and operated by UC Berkeley, USGS (Menlo Park and Cascade Volcano Observatory), LLNL, UC Davis, UC Santa Cruz, Trimble Navigation, and Stanford. Data are also archived from sites operated by other agencies including East Bay Municipal Utilities District, the City of Modesto, the National Geodetic Survey, and the Jet Propulsion Laboratory.

In addition to the standard 15 second or 30 second continuous GPS datastream, the NCEDC is now privately archiving high-rate 1 Hz continuous GPS data from the 14 stations in Parkfield and from 10 BARD stations. The high-rate Parkfield data are collected by UN-AVCO as part of the PBO Nucleus. The Parkfield data are available via anonymous FTP from the NCEDC but are currently not included in the GPS Seamless Archive (GSAC), since the GSAC does not currently handle both high-rate and low-rate data from the same site and day.

The NCEDC continues to archive non-continuous sur-

vey GPS data. The initial dataset archived is the survey GPS data collected by the USGS Menlo Park for Northern California and other locations. The NCEDC is the principal archive for this dataset. Significant quality control efforts were implemented by the NCEDC to ensure that the raw data, scanned site log sheets, and RINEX data are archived for each survey. All of the USGS MP GPS data have been transferred to the NCEDC, and virtually all of the data from 1992 to the present has been archived and is available for distribution.

### **Geysers Seismic Data**

The Calpine Corporation operated a micro-seismic monitoring network in the Geysers region of Northern California. Prior to 1999 this network was operated by Unocal. Through various agreements, both Unocal and Calpine have released triggered event waveform data from 1989 through 2000 along with preliminary event catalogs for the same time period for archiving and distribution through the NCEDC. This dataset represents over 296,000 events that were recorded by Calpine/Unocal Geysers network and are available via research accounts at the NCEDC.

The Lawrence Berkeley Laboratory (LBL), with funding from the California Energy Commission, currently operates a 22 station network in the Geysers region with an emphasis on monitoring seismicity related to well water injection. The earthquake locations and waveforms from this network are sent to the NCEDC, and the locations are forwarded to the NCSN so that they can be merged into the NCSN earthquake catalog. In August 2007, the NCSN installed an Earthworm system at the Geysers to receive continuous LBL Geysers data, and this system provides event waveforms in real-time for the NCEMC earthquake processing and the NCEDC event archives. The event data from LBL Geysers event waveforms collected from April 2004 to August 2007 will be associated with events from the NCSN catalog and will be included with the existing waveforms for these events.

### **USGS Low Frequency Data**

Over the last 30 years, the USGS at Menlo Park, in collaboration with other principal investigators, has collected an extensive low-frequency geophysical data set that contains over 1300 channels of tilt, tensor strain, dilatational strain, creep, magnetic field, and water level as well as auxiliary channels such as temperature, pore pressure, rain and snow accumulation, and wind speed. In collaboration with the USGS, we assembled the requisite information for the hardware representation of the stations and the instrument responses for many channels of this diverse dataset, and developed the required programs to populate and update the hardware database and generate the instrument responses. We developed the programs and procedures to automate the process of

importing the raw waveform data and converting it to MiniSEED format. Since these data are delivered to the NCEDC on a daily basis and immediately archived, these data are not inserted into the NCEDC DART.

We have currently archived timeseries data from 887 data channels from 167 sites, and have instrument response information for 542 channels at 139 sites. The waveform archive is updated on a daily basis with data from 350 currently operating data channels. We will augment the raw data archive as additional instrument response information is assembled by the USGS for the channels and will work with the USGS to clearly define the attributes of the “processed” data channels.

### **SCSN/Statewide seismic data**

In 2004, the NCEDC started to archive broadband and strong motion data from 15 SCSN (network CI) stations that are telemetered to the Northern California Management Center (NCEMC) of the California Integrated Seismic Network (CISN). These data are used in the prototype real-time state-wide earthquake processing system and also provide increased coverage for Northern California events. Since the data are telemetered directly from the stations in real-time to both the SCSN and to the NCEMC, the NCEDC archives the NCEMC’s copy of the data to ensure that at least one copy of the data will be preserved.

In early 2006, the NCEDC started to continuously archive all of the selected SCSN short-period stations that are contributed to the NCSN. All of these data are available in real-time from the NCEDC DART.

### **Earthquake Catalogs**

*Northern California:* The NCEDC provides searchable access to both the USGS and BSL earthquake catalogs for Northern and Central California. The “official” UC Berkeley earthquake catalog begins in 1910 and runs through 2003, and the “official” USGS catalog begins in 1966. Both of these catalogs are archived and available through the NCEDC, but the existence of 2 catalogs has caused confusion among both researchers and the public.

In late 2006, the NCEMC began to archive and distribute a single unified Northern California earthquake catalog in real-time to the NCEDC through database replication from the NCEMC’s real-time systems. The NCEDC developed and tested the required programs used to enter all previous NCSN catalog data into the NCEDC database. In 2008, we migrated all of the historic NCSN catalog, phase, and amplitude data from 1967 - 2006 into the NCEMC catalog. In addition, we spent considerable effort addressing the mapping of phase data in the BSL catalog to SEED channel names. We plan to merge the BSL catalog with the NCEMC catalog to form a single unified Northern California catalog from 1910 to the present. The BSL and the USGS have spent

considerable effort over the past years to define procedures for merging the data from the two catalogs into a single Northern and Central California earthquake catalog in order to present a unified view of Northern California seismicity. The differences in time period, variations in data availability, and mismatches in regions of coverage all complicate the task.

*Worldwide:* The NCEDC, in conjunction with the Council of the National Seismic System (CNSS), produced and distributed a world-wide composite catalog of earthquakes based on the catalogs of the national and various U.S. regional networks for several years. Each network updates their earthquake catalog on a daily basis at the NCEDC, and the NCEDC constructs a composite world-wide earthquake catalog by combining the data, removing duplicate entries that may occur from multiple networks recording an event, and giving priority to the data from each network's *authoritative region*. The catalog, which includes data from 14 regional and national networks, is searchable using a Web interface at the NCEDC. The catalog is also freely available to anyone via ftp over the Internet.

With the demise of the CNSS and the development of the Advanced National Seismic System (ANSS), the NCEDC was asked to update its Web pages to present the composite catalog as a product of the ANSS. This conversion was completed in the fall of 2002. We continue to create, house, distribute, and provide a searchable web interface to the ANSS composite catalog, and to aid the regional networks in submitting data to the catalog.

## 6.4 NCEDC Operations

In 2005, the NCEDC relocated its archive and distribution system from McCone Hall to a new state-of-the-art computer facility in a new seismically braced building on the Berkeley campus. The facility provides seismically braced equipment racks, gigabit ethernet network, air conditioning, and power conditioning. The entire facility is powered by a UPS with generator backup.

The currently installed NCEDC facilities consist of a mass storage environment hosted by a Sun V240 host computer, a 100 slot LTO-2 tape library with two tape drives and a 20 TByte capacity, and 50 TBytes of RAID storage, all managed with the SAM-FS hierarchical storage management (HSM) software. A Sun system provides Web services and research account access to the NCEDC, a dual Sun 280R processor provides data import and export services, and a Sun V20Z computer is used for quality control procedures. Two AIT tape libraries are used to read NCSN continuous data tapes. A 64-bit Linux system hosts a database dedicated to providing data to external users. Two Sun Opteron processors provide additional data processing support for the NCEDC.

The hardware and software system is configured to automatically create multiple copies of each timeseries file.

The NCEDC creates one copy of each file on an online RAID, a second copy on LTO2 tape which is stored online in the tape library, and a third copy on LTO2 tape which is stored offline and offsite. All NCEDC data are online and rapidly accessible by users.

The NCEDC operates two instances of its Oracle database, one for internal operations and one for external use for user data queries and data distribution programs. The databases are synchronized using multi-master replication.

## Data Quality Control

The NCEDC developed a GUI-based state-driven system *calqc* to facilitate the quality control processing that is applied to the continuously archived data sets at the NCEDC.

The quality control procedures for these datasets include the following tasks:

- data extraction of a full day of data,
- quickcheck program to summarize the quality and stability of the stations' clocks,
- determination if there is missing data for any data channel,
- provided procedures to retrieve missing data from the stations and incorporate it into the day's data,
- optional creation of multi-day timeseries plots for state-of-health data channels,
- optional timing corrections for data,
- optional extraction of event-based waveforms from continuous data channels,
- optional repacking of MiniSEED data,
- creating waveform inventory entries in the NCEDC database,
- publishing the data for remote access on the NCEDC.

*Calqc* uses previously developed programs to perform each function, but it provides a graphical point-and-click interface to automate these procedures, and to provide the analyst with a record of when each process was started, whether it executed correctly, and whether the analyst has indicated that a step has been completed. *Calqc* is used to process all data from the BDSN network, and all continuous broadband data from the NCSN, UNR, SCSN, and HRSN networks that are archived by the NCEDC. The remainder of the continuously archived

data are automatically archived without any analyst interaction.

The NCEDC is developing programs and procedures to replace waveforms collected for event analysis in near real-time with QC-ed waveforms from the UCB QC-ed waveform archive. This procedure will also be used to augment the NCSN event-based waveform collection from 1991 - 2006 with the appropriate waveforms from the UCB seismic networks.

## 6.5 Database Development

The NCEDC parametric database schema for storing earthquake event information was adopted by the CISN for use within the Northern and Southern California earthquake processing centers as well as the NCEDC and SCEDC. Through the efforts of the CISN Standards Group, this schema continues to be enhanced to address new requirements of the CISN.

The most significant database development this year has been the migration of the entire NCSN earthquake catalog, phase data, and amplitude readings into the NCEDC database. In collaboration with the NCSN, we developed the programs and procedures necessary to migrate the 1967-2006 NCSN catalog into the CISN parametric schema and have been performing quality control procedures on the data prior to entering the catalog into the database. In support of this project, the NCEDC developed the *dbselect* program which can search the database, retrieve earthquake information, and optionally recreate full Hypoinverse files. The *dbselect* program is now used in the NCEDC web-based catalog search interface.

The NCEDC continues to support the Northern California Earthquake Management Center (NCEMC) by providing information and resources vital to the NCEMC's role of rapid earthquake analysis and data dissemination. The NCEDC receives earthquake parametric data in real-time from the NCEMC real-time systems and provides real-time access to the NCEDC database for *jiggle*, the CISN event analysis tool. The NCEMC continues to support the maintenance and distribution of the hardware configurations and instrument responses of the UCB, USGS/MP NCSN, and other seismic stations used by the NCEMC. During 2002-2004, the NCEDC and NCSN jointly developed a system consisting of an extensive spreadsheet containing per-channel information that describes the hardware of each NCSN data channel and provides each channel with a SEED-compliant channel name. This spreadsheet, combined with a limited number of files that describe the central-site analog digitizer, FIR decimation filters, and general characteristics of digital acquisition systems, allows the NCSN to assemble its station history in a format that the NCEDC can use to populate the hardware tracking and instrument response database tables for the NCSN.

The NCEDC instrument response schema represents full multi-stage instrument responses (including filter coefficients) for the broadband data loggers. The hardware tracking schema represents the interconnection of instruments, amplifiers, filters, and data loggers over time, and is used to describe all of the UC Berkeley and USGS stations and channels archived at the NCEDC.

The NCEDC has developed XML import and export procedures to provide better maintenance of the hardware tracking information and resulting instrument responses for stations in our database. When changes are made to either existing hardware or to station configurations, we export the current view in XML format, use a GUI-based XML editor to easily update the information, and import the changes back into the database. When adding new stations or hardware, we can easily use information from existing hardware or stations as templates for the new information. This allows us to treat the database as the authoritative source of information, and to use off-the-shelf tools such as the XML editor and XML differencing programs as part of our database maintenance procedures.

All NCSN event waveforms originally collected with the USGS CUSP processing system have been converted to MiniSEED, and are available along with the UC Berkeley data and data from the other networks archived at the NCEDC in full SEED format.

Additional details on the joint catalog effort and database schema development may be found at <http://www.ncedc.org/db>

## 6.6 Data Distribution

The NCEDC continues to use the World Wide Web as a principal interface for users to request, search for, and receive data from the NCEDC. In fall 2005, the NCEDC acquired the domain name *ncedc.org*. The NCEDC's Web address is now <http://www.ncedc.org/>

### Earthquake Catalogs

The NCEDC provides users with searchable access to Northern California earthquake catalogs and to the ANSS world-wide catalog via the web. Users can search the catalogs by time, magnitude, and geographic region, and can retrieve either hypocenter and magnitude information or a full set of earthquake parameters including phase readings, amplitudes, and codas. Moment tensor results are now being added to the NCEMC California earthquake catalog.

### Station Metadata

In addition to the metadata returned through the various data request methods, the NCEDC provides dataless SEED volumes and SEED RESP files for all data channels archived at the NCEDC. The NCEDC currently has

full SEED instrument responses for 12,989 data channels from 1,909 stations in 20 networks. This includes stations from the California Geological Survey (CGS) strong motion network that will contribute seismic waveform data for significant earthquakes to the NCEDC and SCEDC.

### SeismiQuery

We have ported and installed the IRIS *SeismiQuery* program at the NCEDC, which provides a common interface to query network, station, and channel attributes and query the availability of archived timeseries data. We have provided both IRIS and the SCEC Data Center with our modified version of *SeismiQuery*.

### DART (Data Available in Real Time)

The DART (Data Available in Real Time) represents the first step in NCEDC's effort to make current and recent timeseries data from all networks, stations, and channels available to users in real-time. The NCEDC developed DART in December 2005 to provide a mechanism for users to obtain access to real-time data from the NCEDC. All real-time timeseries data streams delivered to the NCEDC are placed in MiniSEED files in a Web-accessible directory structure. The DART waveforms can be accessed by Web browsers or http command-line programs such as *wget*, a *FISSURES* waveform server, and a Berkeley-developed Simple Wave Server (SWS) which provides programmatic access to the DART data by specified SEED channel and time interval. We will be providing users with a client program to retrieve data from the SWS in the near future. The DART currently provide access to the most recent 30 days of data.

We are using the Freeorb software, an enhanced version of the open-source orb software developed by the IRIS-funded Joint Seismic Project (JSP), as the primary method for delivering real-time data to the NCEDC and into the DART. The freeorb package implements an object ring buffer (ORB) and orbserver, which provides a reliable storage ring buffer and an interface for orb client programs to read, write, and query the orbserver. Orbserver clients running at the NCEDC computer connect to remote orbserver at the BSL and USGS/Menlo Park, retrieve the MiniSEED timeseries data records, and write them to daily channel files in the NCEDC DART. Strain data from the EarthScope PBO network are delivered to the NCEDC using SeedLink and are inserted into the DART using a similar SeedLink client program.

The NCEDC developed an automated data archiving system to archive data from the DART on a daily basis. It allows us to specify which stations should be automatically archived, and which stations should be handled by the NCEDC's Quality Control program *calqc*, which allows an analyst to review the waveforms, retrieve missing data from stations or waveservers that may have

late-arriving, out-of-order data, and perform timing corrections on the waveform data. The majority of data channels are currently archived automatically from the DART.

### NetDC

In a collaborative project with the IRIS DMC and other worldwide datacenters, the NCEDC helped develop and implement *NetDC*, a protocol which will provide a seamless user interface to multiple datacenters for geophysical network and station inventory, instrument responses, and data retrieval requests. The *NetDC* builds upon the foundation and concepts of the IRIS *BREQ\_FAST* data request system. The *NetDC* system was put into production in January 2000 and is currently operational at several datacenters worldwide, including NCEDC, IRIS DMC, ORFEUS, Geoscope, and SCEDC. The *NetDC* system receives user requests via email, automatically routes the appropriate portion of the requests to the appropriate datacenter, optionally aggregates the responses from the various datacenters, and delivers the data (or ftp pointers to the data) to the users via email.

### STP

In 2002, the NCEDC wrote a collaborative proposal with the SCEDC to the Southern California Earthquake Center, with the goal of unifying data access between the two data centers. As part of this project, the NCEDC and SCEDC are working to support a common set of 3 tools for accessing waveform and parametric data: *SeismiQuery*, *NetDC*, and *STP*.

The *Seismogram Transfer Program* or *STP* is a simple client-server program, developed at the SCEDC. Access to *STP* is either through a simple direct interface that is available for Sun or Linux platforms, or through a GUI Web interface. With the direct interface, the data are placed directly on a user's computer in several possible formats, with the byte-swap conversion performed automatically. With the Web interface, the selected and converted data are retrieved with a single ftp command. The *STP* interface also allows rapid access to parametric data such as hypocenters and phases.

The NCEDC has continued work on *STP*, working with the SCEDC on extensions and needed additions. We added support for the full SEED channel name (Station, Network, Channel, and Location), and are now able to return event-associated waveforms from the NCSN waveform archive.

### EVT\_FAST

In order to provide Web access to the NCSN waveform before the SEED conversion and instrument response for the NCSN has been completed, the NCEDC implemented *EVT\_FAST*, an interim email-based waveform request

system similar to the *BREQ\_FAST* email request system. Users email *EVT\_FAST* requests to the NCEDC and request NCSN waveform data based on the NCSN event ID. Initially, the NCSN waveform data was converted to either SAC ASCII, SAC binary, or AH format, and placed in the anonymous ftp directory for retrieval by the users. *EVT\_FAST* event waveforms can now also be provided in MiniSEED format and are now named with their SEED channel names.

## FISSURES

The *FISSURES* project developed from an initiative by IRIS to improve earth scientists' efficiency by developing a unified environment that can provide interactive or programmatic access to waveform data and the corresponding metadata for instrument response, as well as station and channel inventory information. *FISSURES* was developed using CORBA (Common Object Request Broker Architecture) as the architecture to implement a system-independent method for the exchange of this binary data. The IRIS DMC developed a series of services, referred to as the *Data Handling Interface (DHI)*, using the *FISSURES* architecture to provide waveform and metadata from the IRIS DMC.

The NCEDC has implemented the *FISSURES Data Handling Interface (DHI)* services at the NCEDC, which involves interfacing the DHI servers with the NCEDC database schema. These services interact with the NCEDC database and data storage system and can deliver NCEDC channel metadata as well as waveforms using the *FISSURES* interfaces. We have separate *FISSURES DHI* waveform servers to serve archived and DART data streams. Our *FISSURES* servers are registered with the IRIS *FISSURES naming services*, which ensures that all *FISSURES* users have transparent access to data from the NCEDC.

## GSAC

Since 1997, the NCEDC has collaborated with UNAVCO and other members of the GPS community on the development of the *GPS Seamless Archive Centers (GSAC)* project. This project allows a user to access the most current version of GPS data and metadata from distributed archive locations. The NCEDC is participating at several levels in the *GSAC* project: as a primary provider of data collected from core BARD stations and USGS MP surveys, and as a wholesale collection point for other data collected in Northern California. We helped to define database schema and file formats for the *GSAC* project and have produced complete and incremental monumentation and data holdings files describing the data sets that are produced by the BARD project or archived at the NCEDC so that other members of the *GSAC* community can provide up-to-date information about our holdings. Currently, the NCEDC is the

primary provider for over 138,000 data files from over 1400 continuous and survey-mode monuments. The data holdings records for these data have been incorporated into the *GSAC* retailer system, which became publicly available in late 2002.

In addition, the NCEDC is archiving and distributing high-rate 1 Hz GPS data from 10 BARD stations in addition to the normally sampled 15 second or 30 second data. These high-rate data are now publicly available to the entire community.

## 6.7 Acknowledgements

The NCEDC is a joint project of the BSL and the USGS Menlo Park and is funded primarily by the BSL and the USGS Cooperative Agreement 07HQAG0013. Additional funding for the processing and archiving of the EarthScope PBO and SAFOD data were provided by EarthScope subawards EAR0350025-06 through UNAVCO and 18036080-28436-F through Stanford University.

Doug Neuhauser is the manager of the NCEDC. Stephane Zuzlewski, Rick McKenzie, Mario Aranha, Nicolas Houlie, Bob Uhrhammer, Jennifer Taggart, and Peggy Hellweg of the BSL and David Oppenheimer, Hal Macbeth, Lynn Dietz, and Fred Klein of the USGS Menlo Park contribute to the operation of the NCEDC. Doug Neuhauser and Peggy Hellweg contributed to the preparation of this section.

## 7. Data Acquisition and Quality Control

### 7.1 Introduction

Stations from the networks operated by the BSL transmit data continuously to the BSL facilities on the UC Berkeley campus for analysis and archival. In this section, we describe activities and facilities which pertain to the individual networks described in Sections 1., 3., and 4., including procedures for data acquisition and quality control, and sensor testing capabilities and procedures. Some of these activities are continuous from year to year and have been described in prior BSL annual reports. In this section, we describe changes or activities which are specific to 2007-2008.

### 7.2 Data Acquisition Facilities

Before 2005-2006, both the BSL staff monitoring routine data acquisition and the computers and facilities to acquire, process, and archive the data were located in McCone Hall. Since 2006, the computers and telemetry equipment associated with data acquisition reside in the new campus computer facility at 2195 Hearst Avenue. This building was constructed to current “emergency grade” seismic codes, and is expected to be operational even after a  $M$  7 earthquake on the nearby Hayward Fault. The hardened campus computer facility within was designed with special attention for post-earthquake operations. The computer center contains state-of-the-art seismic bracing, UPS power and air conditioning with generator backup, and extensive security and equipment monitoring.

With the move of many BSL and NCEDC operations servers to the campus computer center, the generator power and air conditioning resources in the BSL server room in 237 McCone better match our needs for the infrastructure remaining in McCone Hall. The BSL generator is maintained by Physical Plant Capital Services and is run without load twice monthly. During the past year, we noted problems with the UPS and replaced defunct batteries. In addition, during a spell of hot weather the cooling system failed, requiring repairs.

### 7.3 Data Acquisition

Central-site data acquisition for data from the BDSN/NHFN/MPBO networks is performed by two computer systems in the 2195 Hearst Avenue data center (Figure 3.24). These acquisition systems also collect data from the Parkfield-Hollister electromagnetic array and the BARD network. A third system is used primarily for data exchange with the USNSN and transmits data to the USNSN from HOPS, CMB, SAO, WDC, HUMO, MOD, MCCM, and YBH. Data acquisition for the HRSN

was upgraded during the past year, to use the USGS T1 from Parkfield to Menlo Park. This is described in Section 4.. We also collected data from local USArray travelling array stations from the orb-server of the Anza Network Facility at the University of California San Diego until the array moved out of California in the late fall of 2007.

The BSL uses the program `comserv` developed by Quanterra for central data acquisition. This program receives data from a remote Quanterra data logger and redistributes the data to one or more `comserv` client programs. The `comserv` clients used by REDI include `dataLog`, which writes the data to disk files for archival purposes, `cdafill`, which writes the data to the shared memory region for REDI analysis, and other programs such as the seismic alarm process, the DAC480 system, and the feed for the Memento Mori Web page (Figure 3.25).

The two computers performing data acquisition also serve as REDI processing systems and hold the databases now used by these systems for storing earthquake information. In order to facilitate REDI processing, each system maintains a shared memory region that contains the most recent 30 minutes of data for each channel used by the REDI analysis system. All REDI analysis routines first attempt to use data in the shared memory region and will only revert to retrieving data from disk files if the requested data is unavailable in the shared memory region.

Each BDSN data logger that uses frame relay telemetry is configured to enable data transmission simultaneously to two different computers over two different frame relay T1 circuits to UCB. However, the BSL normally actively enables and uses only one of these data streams from each station at any given time. The `comserv` client program `cs2m` receives data from a `comserv` and multicasts the data over a private ethernet. The program `mcast`, a modified version of Quanterra’s `comserv` program, receives the multicast data from `cs2m`, and provides a `comserv`-like interface to local `comserv` clients. This allows each REDI system to have a `comserv` server for every station, and each of the two systems has a complete copy of all waveform data.

We have extended the multicasting approach to handle data received from other networks such as the NCSN and UNR. These data are received by Earthworm data exchange programs and are then converted to MiniSEED and multicast in the same manner as the BSL data. We use `mserv` on both REDI computers to receive the multicast data and handle it in an identical fashion to the BSL MiniSEED data.

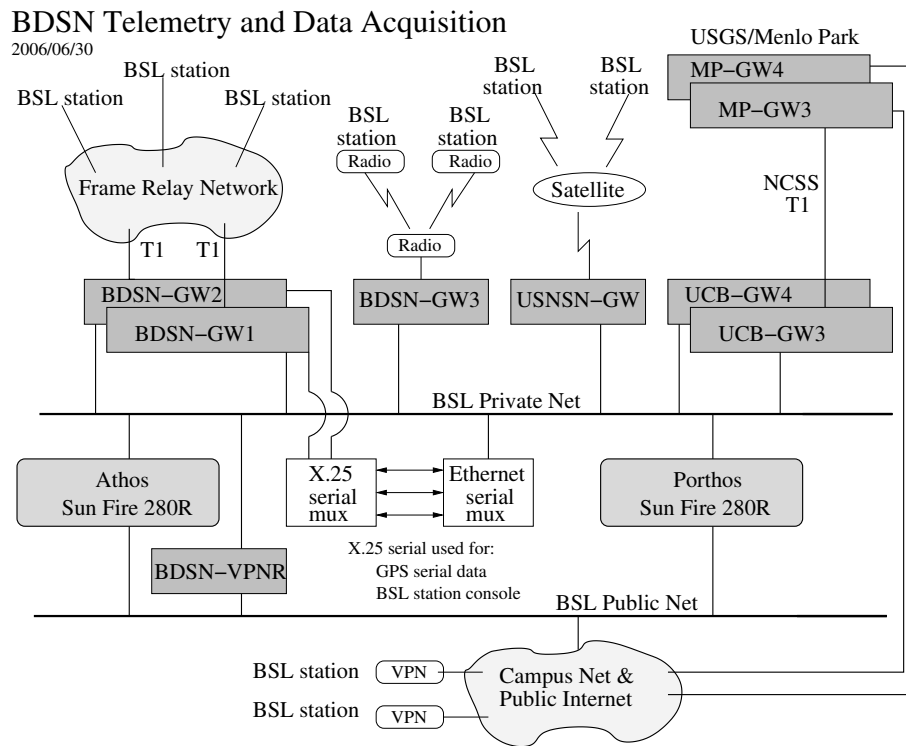

Figure 3.24: Data flow from the BDSN, NHFN, MPBO, HRSN, and BARD network into the BSL central processing facility.

In 2006, the BSL established a real-time data feed of all BSL waveforms between the BSL acquisition systems and the NCEDC computers using the open source Freeorb software. This allows the NCEDC to provide near-real-time access to all BSL waveform data through the NCEDC DART (Data Available in Real Time) system.

For several years now, we have been monitoring the seismic stations and telemetry using the program `seisnetwatch`. This program extracts current information such as time quality, mass positions, and battery voltage and allows it to be displayed. If the parameter departs from the nominal range, the station is marked with yellow or red to indicate a possible problem.

## 7.4 Seismic Noise Analysis

BSL seismic data are routinely monitored for state-of-health. An automated analysis is computed regularly to characterize the seismic noise level recorded by each broadband seismometer.

### PSD Noise Analysis

The estimation of the Power Spectral Density (PSD) of the ground motion recorded at a seismic station, as documented in the 2000-2001 BSL annual report ([http://seismo.berkeley.edu/annual\\_report/ar00\\_01/](http://seismo.berkeley.edu/annual_report/ar00_01/)), provides an objective measure of background

seismic noise characteristics over a wide range of frequencies. When used routinely, the PSD algorithm also provides an objective measure of seasonal and secular variation in the noise characteristics and aids in the early diagnoses of instrumental problems. A PSD estimation algorithm was developed in the early 1990's at the BSL for characterizing the background seismic noise and as a tool for quality control. As presently implemented, the algorithm sends the results via email to the engineering and some research staff members and generates a bar graph output which compares all the BDSN broadband stations by components. We also use the weekly PSD results to monitor trends in the noise level at each station. Figures showing the analysis for the current year are produced. These cumulative PSD plots are generated for each station and show the noise level in 5 frequency bands for the broadband channels. These plots make it easier to spot certain problems, such as failure of a sensor. In addition to the station-based plots, a summary plot for each channel is produced, comparing all stations. These figures are presented as part of a noise analysis of the BDSN on the WWW at <http://www.seismo.berkeley.edu/seismo/bdsn/psd/>.





sensors to the data logger with shielded signal lines. A GPS rebroadcaster has also been installed, so that all data loggers in the Byerly vault operate on the same time base. Upon acquisition of data at up to 200 samples-per-second (sps) from the instruments under test, PSD analysis, coherence analysis, and additional ad hoc analysis algorithms are used to characterize and compare the performance of each sensor. Tilt tests and seismic signals with a sufficient signal level above the background seismic noise are also used to verify the absolute calibration of the sensors. A simple vertical shake table is used to assess the linearity of a seismic sensor. The sensor testing facility of the BSL is described in detail in the BSL 2001-2002 Annual Report (available on-line at <http://www.seismo.berkeley.edu/>).

Several projects made use of the sensor testing facility in 2007-2008. Initial tests of the new STS-1 electronics (E300) took place in Byerly Vault (see Section 9.). In addition, the new pressure/temperature sensors were installed and data collected for calibration and assessment (see Section 9.). Finally, the facility will house initial tests of new STS-1-type sensors being developed jointly by Metrozet and the BSL.

## 7.6 Acknowledgements

Doug Neuhauser, Bob Uhrhammer, Peggy Hellweg, Pete Lombard, Rick McKenzie and Jennifer Taggart are involved in the data acquisition and quality control of BDSN/NHFN/MBPO data. Development of the sensor test facility and analysis system was a collaborative effort of Bob Uhrhammer, Tom McEvelly, John Friday, and Bill Karavas. IRIS and DTRA provided, in part, funding for and/or incentive to set up and operate the facility, and we thank them for their support. Bob Uhrhammer, Peggy Hellweg, Pete Lombard, Doug Neuhauser, and Barbara Romanowicz contributed to the preparation of this section. The STS-1 project is funded by the NSF through the IRIS/GSN program (IRIS Subaward Agreement number 388). This is a collaborative project with Tom VanZandt of Metrozet, LLC (Redondo Beach, CA).

## 7.7 References

Ekström, G. and M. Nettles, <http://www.seismology.harvard.edu/~ekstrom/Projects/WQC.html>, 2005.

Gardner, W. A., A unifying view of coherence in signal processing, *Signal Processing*, 29, p. 113-140, 1992.

Ingate, S. et al, Workshop Report from Broadband Seismometer Workshop, Lake Tahoe, CA, <http://www.iris.edu/stations/seisWorkshop04/report.htm>, 2004.

McNamara, D. and R. Buland, Ambient Noise Levels in the Continental United States *Bull. Seism. Soc. Am.*, 94, 4, 2004.

Scherbaum, Frank. Of Poles and Zeros: Fundamentals in Digital Seismology, Volume 15 of Modern Approaches in Geophysics, G. Nolet, Managing Editor, Kluwer Academic Press, Dordrecht, xi + 257 pp., 1996.

Tapley, W. C. and J. E. Tull, SAC - Seismic Analysis Code: Users Manual, *Lawrence Livermore National Laboratory*, Revision 4, 388 pp., March 20, 1992.

Wielandt, E. and G. Streckeisen, The leaf spring seismometer: design and performance, *Bull. Seis. Soc. Am.*, 72, 2349-2367, 1982.

Wielandt, E. and Steim, J. M., A digital very broad band seismograph, *Annales Geophysicae*, 4 B(3), 227-232, 1986.

## 8. Northern California Earthquake Monitoring

### 8.1 Introduction

Routine analysis of the data produced by BSL networks begins as the waveforms are acquired by computers at UC Berkeley, and ranges from automatic processing for earthquake response to analyst review for earthquake catalogs and quality control.

Starting in the mid 1990s, the BSL invested in the development of the hardware and software necessary for an automated earthquake notification system (*Gee et al.*, 1996; 2003a) called the Rapid Earthquake Data Integration (REDI) project. This system provides rapid determination of earthquake parameters: near real-time locations and magnitudes of Northern and Central California earthquakes, estimates of the rupture characteristics and the distribution of ground shaking following significant earthquakes, and tools for the rapid assessment of damage and estimation of loss. In 1996, the BSL and the USGS began collaborating on a joint notification system for Northern and Central California earthquakes. This system merges the programs in Menlo Park and Berkeley into a single earthquake notification system, combining data from the NCSN and the BDSN. Today, the joint BSL and USGS system forms the Northern California Earthquake Management Center (NCEMC) of the California Integrated Seismic Network (Section 2.), and development is proceeding on the next generation of earthquake reporting software based on Southern California's Trinet system.

With partial support from the USGS, the BSL has also embarked on the development and assessment of a system to warn of imminent ground shaking in the seconds after an earthquake has initiated but before strong motion begins at sites that may be damaged (Research Study 26.).

### 8.2 Northern California Earthquake Management Center

Details of the Northern California processing system and the REDI project have been described in previous annual reports. In this section, we describe how the Northern California Earthquake Management Center fits within the CISN system.

Figure 3.8 in Section 2. illustrates the NCEMC as part of the the CISN communications ring. The NCEMC is a distributed center, with elements in Berkeley and in Menlo Park. The 35 mile separation between these two centers is in sharp contrast to the Southern California Earthquake Management Center, where the USGS Pasadena is located across the street from the Caltech Seismological Laboratory. As described in Section 2., the CISN partners are connected by a dedicated T1 commu-

nications link, with the capability of falling back to the Internet. In addition to the CISN ring, the BSL and the USGS Menlo Park have a second dedicated communications link to provide bandwidth for shipping waveform data and other information between their processing systems.

Figure 3.26 provides more detail on the current system at the NCEMC. At present, two Earthworm-Earlybird systems in Menlo Park feed two "standard" REDI processing systems at UC Berkeley. One of these systems is the production or paging system; the other is set up as a hot backup. The second system is frequently used to test new software developments before migrating them to the production environment. The Earthworm-Earlybird-REDI systems perform standard detection and location and estimate  $M_d$ ,  $M_L$ , and  $M_w$  as well as processing ground motion data. The computation of ShakeMaps is also performed on two systems, one in Menlo Park and one in Berkeley. An additional system at the BSL performs finite-fault processing and computes higher level ShakeMaps.

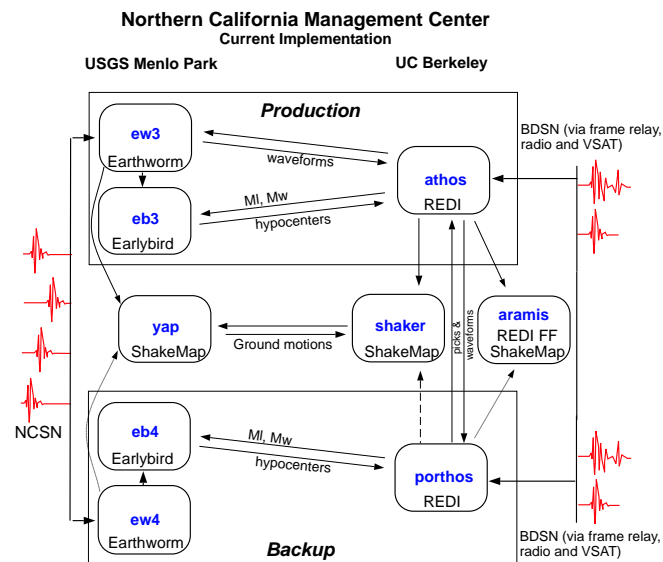

Figure 3.26: Detailed view of the current Northern California processing system, showing the two Earthworm-Earlybird-REDI systems, the two ShakeMap systems, and the finite-fault system.

The dense network and Earthworm-Earlybird processing environment of the NCSN provides rapid and accurate earthquake locations, low magnitude detec-

tion thresholds, and first-motion mechanisms for small quakes. The high dynamic range data loggers, digital telemetry, and broadband and strong-motion sensors of the BDSN along with the REDI analysis software provide reliable magnitude determination, moment tensor estimation, peak ground motions, and source rupture characteristics. Robust preliminary hypocenters are available about 25 seconds after the origin time, while preliminary coda magnitudes follow within 2-4 minutes. Estimates of local magnitude are generally available 30-120 seconds later, and other parameters, such as the peak ground acceleration and moment magnitude, follow within 1-4 minutes (Figure 3.27).

Earthquake information from the joint notification system is distributed by pager/cellphone, e-mail, and the WWW. The first two mechanisms “push” the information to recipients, while the current Web interface requires interested parties to actively seek the information. Consequently, paging and, to a lesser extent, e-mail are the preferred methods for emergency response notification. The *recenteqs* site has enjoyed enormous popularity since its introduction and provides a valuable resource for information whose bandwidth exceeds the limits of wireless systems and for access to information which is useful not only in the seconds immediately after an earthquake, but in the following hours and days as well.

### 8.3 2007-2008 Activities

#### System Development

As part of ongoing efforts to improve the monitoring systems in Northern California and to unify the processing systems within the CISN, the BSL and the USGS Menlo Park made progress in the development of the next generation of the Northern California joint notification system for the Northern California Seismic System (NCSS). Figure 3.26 illustrates the current organization of the system. Although this approach functions reasonably well, there are potential problems associated with the separation of critical system elements by ~35 miles of San Francisco Bay.

Since FY01-02, we have been working to design and implement software for Northern California operations so that identical, complete systems operate independently at the USGS and UC Berkeley. When CISN started, independently developed systems for monitoring earthquakes operated in Southern and Northern California, TriNet and Earthworm/REDI, respectively. Each of these systems has its strengths and weaknesses, and choices had to be made. The current design for the new Northern California system draws strongly on the development of TriNet in Southern California (Figure 3.28), with modifications to allow for local differences (such as very different forms of data acquisition and variability in network distribution). In addition, the BSL and the USGS want to minimize use of proprietary software in the system.

One exception is the database program. As part of the development of the Northern California Earthquake Data Center, the USGS and BSL have worked extensively with Oracle databases, and extending this to the real-time system is not viewed as a major issue.

During the last few years, BSL staff members, particularly Pete Lombard, have become extremely familiar with portions of the TriNet software. We have continued to adapt the software for Northern California, making adjustments and modifications along the way. For example, Pete Lombard has adapted the TriNet magnitude module to Northern California, where it is now running on a test system. Pete made a number of suggestions on how to improve the performance of the magnitude module and has worked closely with Caltech and the USGS/Pasadena on modifications. One of the biggest programming efforts in the past year has been to make the package leap second compliant.

The BSL and the USGS Menlo Park have implemented a system to exchange “reduced amplitude timeseries.” One of the important innovations of the TriNet software development is the concept of continuous processing (*Kanamori et al.*, 1999). Waveform data are constantly processed to produce Wood Anderson synthetic amplitudes and peak ground motions. A program called *rad* produces a reduced timeseries, sampled every 5 secs, and stores it in a memory area called an “Amplitude Data Area” or ADA. Other modules can access the ADA to retrieve amplitudes to calculate magnitude and ShakeMaps as needed. The BSL and the USGS Menlo Park have collaborated to establish the tools for ADA-based exchange. As part of the software development in Northern California, a number of modules have been developed.

#### Event Review with Jiggle

CUSP was finally retired as the event review system in the NCEMC in late November, 2006. This program was initially developed in Southern California during the late 1970s - early 1980s and has been used to time earthquakes for a number of years in Northern California. However, the CUSP system became increasingly outdated, as it relied on obsolete hardware. The primary responsibility for the programming and development necessary to make the transition has rested on BSL staff. They implemented the *RequestCardGenerator* (a module that decides which channels to archive, given a particular earthquake), a waveform archiving module, and *Jiggle* (the earthquake timing interface) within the Northern California system. The entry of all parameteric earthquake data from real-time processing into the Oracle database and the preparation of station and instrument metadata for insertion into the database were important prerequisites for the transition. The NCEMC and SCEMC collaborated on modifications to *Jiggle* for use in Northern California, such as the computation of  $M_d$ .

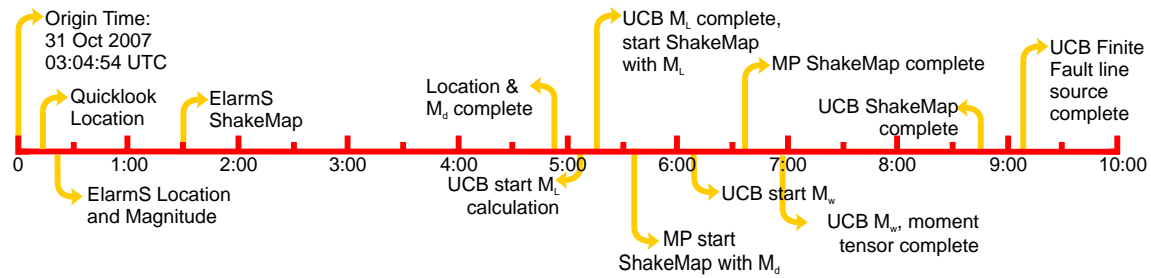

Figure 3.27: Illustration of the earthquake products timeline for the  $M_w$  5.4 Alum Rock earthquake of October 30, 2007. Note that all processing was complete within 10 minutes of the origin time.

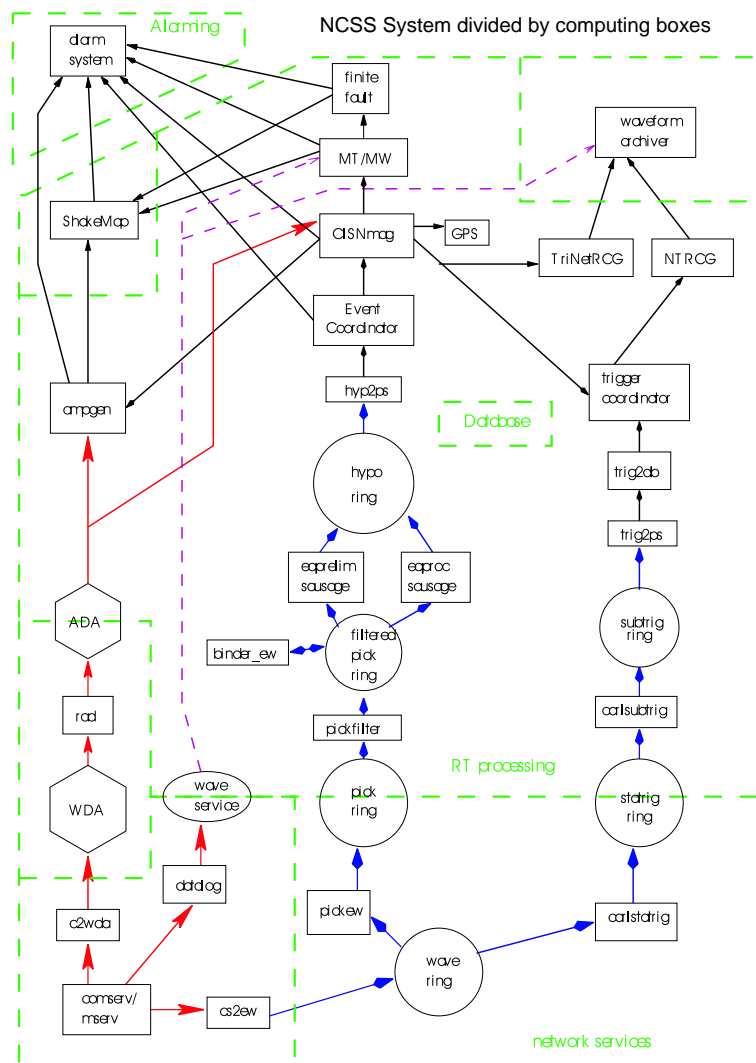

Figure 3.28: Schematic diagram of the planned NCSS system. The design combines elements of the Earthworm, TriNet, and REDI systems

### $M_L$ and $M_w$

The REDI system has routinely produced automatic estimates of moment magnitude ( $M_w$ ) for many years.

However, wary of complications caused by the publication of multiple magnitudes, these estimates were not routinely used as the “official” magnitude until after the

05/14/2002 Gilroy earthquake ( $M_w$  4.9,  $M_L$  5.1). Since then, solutions that meet a minimum quality criterion are automatically reported (a variance reduction of 40% or higher). This criterion appears to work very well and screens out events contaminated by teleseisms. Over the last few years, nearly all events over 4.5 have met this criterion, as have a number of events in the M3.5-4.5 range. As part of the effort to establish a statewide magnitude reporting hierarchy, we have looked more closely at the estimates of  $M_w$  (Gee *et al.*, 2003b; 2004) and the comparison between  $M_w$  and  $M_L$ .

Two methods of determining regional moment tensor (RMT) solutions were originally part of the REDI system - the complete waveform modeling technique (CW) of Dreger and Romanowicz (1994) and the surface wave inversion (SW) of Romanowicz *et al.* (1993). In FY05-06, processing for the SW algorithm was discontinued; however, CW moment tensors continue to be calculated, reviewed, and reported. Comparison between the results of the CW method and other regional moment tensor studies in Northern California and the western United States show excellent agreement in the estimate of seismic moment and  $M_w$ .

As we transition toward statewide reporting of earthquake information, a comparison of magnitudes calculated for Southern and Northern California becomes important. We have collected a set of events recorded well by digital broadband and and strong motion stations of the Northern California (NC), Berkeley, (BK) and Southern California (CI) networks. Research Study 34. reports on these activities. A new  $\log A_o$  function has been developed that is valid throughout the state, and a corresponding set of corrections calculated for the collocated broadband and strong motion stations. Research Study 34. reports on the validation of these parameters for Northern and Southern California.

## 8.4 Routine Earthquake Analysis

In fiscal year 2007-2008, more than 26,000 earthquakes were detected and located by the automatic systems in Northern California. This compares with over 23,000 in 2006-2007, 30,000 in 2005-2006 and 38,800 in 2004-2005. Many of the large number of events in 2004-2005 are aftershocks of the 2004 Parkfield earthquake. The number of events continues to remain high, because we now receive and process data from a network of seismometers in the Geysers, a region with a high level of small magnitude seismicity. Of the more than 26,000 events, over 200 had preliminary magnitudes of three or greater. Thirty-two events had  $M_L$  greater than 4. The largest event recorded by the system was the Alum Rock earthquake which occurred on 31 October 2007 with  $M_w$  5.4. Other earthquakes with magnitudes greater than 5 occurred off the coast of northernmost California.

As described in the 2003-2004 Annual Report, the BSL

staff are no longer reading BDSN records for local and regional earthquakes (as of March 2004). This decision was in part intended to reduce duplication of effort between Berkeley and Menlo Park.

## 8.5 Moment Tensor and Finite Fault Analysis

The BSL continues to focus on the unique contributions that can be made from the broadband network. From July 2007 through June 2008, BSL analysts reviewed many earthquakes in Northern California and adjoining areas of magnitude 3.2 and higher. Reviewed moment tensor solutions were obtained for 39 of these events (through 6/30/2008). Figure 3.29 and Table 3.14 display the locations of earthquakes in the BSL moment tensor catalog and their mechanisms.

In the past, moment tensor information has been stored in a flat file, with only the fault planes and the moment recorded. The database associated with the CISN software system allows all the information to be stored that is necessary to recalculate the moment tensor. It includes the moment tensor components as well. During this year, we made an effort to enter information for past Northern California events into the database (see Research Study 36.). This project is nearly completed, thanks to the hard work of Angie Chung, Rick McKenzie, and Jennifer Taggart.

During this year, two earthquakes were large enough to allow finite fault inversions to be performed: the Alum Rock earthquake (October 31, 2007) (see Research Study 22.) and the Wells, NV earthquake of February 7, 2008 (see Research Study 24.).

## 8.6 Acknowledgements

Peggy Hellweg oversees the REDI system and directs the routine analysis. Peter Lombard and Doug Neuhauser contribute to the development of software. Rick McKenzie, Doug Dreger, Aimin Cao, Sean Ford, Aurelie Guilhem, Ayhi Kim, Ved Lekic, Angie Chung, and Jennifer Taggart contribute to the routine analysis of moment tensors. Peggy Hellweg, Doug Neuhauser, and Bob Uhrhammer contributed to the writing of this section. Partial support for the development and maintenance of the REDI system is provided by the USGS.

## 8.7 References

Dreger, D., and B. Romanowicz, Source characteristics of events in the San Francisco Bay region, *USGS Open File Report 94-176*, 301-309, 1994.

Gee, L., J. Polet, R. Uhrhammer, and K. Hutton, Earthquake Magnitudes in California, *Seism. Res. Lett.*, 75(2), 272, 2004.

Gee, L., D. Neuhauser, D. Dreger, M. Pasyanos, R. Uhrhammer, and B. Romanowicz, The Rapid Earth-

UCB MT Catalog - 01/01/1992-06/30/2008

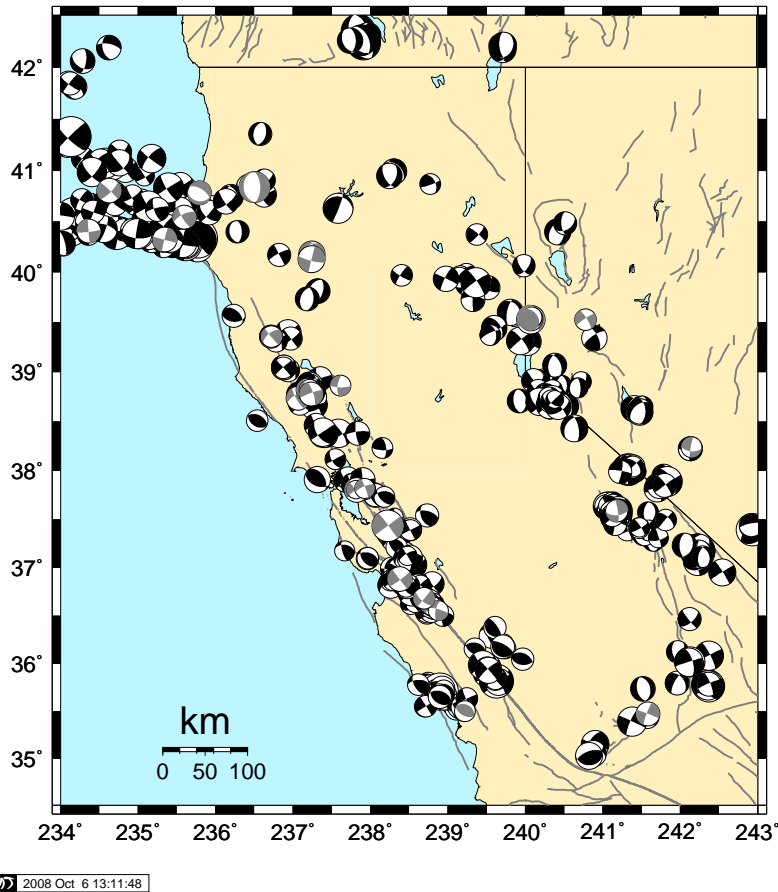

Figure 3.29: Map comparing reviewed moment tensor solutions determined by the BSL from past years (black) with those from the fiscal year 2007-2008 (grey).

quake Data Integration Project, *Handbook of Earthquake and Engineering Seismology*, IASPEI, 1261-1273, 2003a.

Gee, L., D. Dreger, G. Wurman, Y. Gung, B. Uhrhammer, and B. Romanowicz, A Decade of Regional Moment Tensor Analysis at UC Berkeley, *Eos Trans. AGU*, 84(46), Fall Meet. Suppl., Abstract S52C-0148, 2003b.

Gee, L., D. Neuhauser, D. Dreger, M. Pasyanos, B. Romanowicz, and R. Uhrhammer, The Rapid Earthquake Data Integration System, *Bull. Seis. Soc. Am.*, 86, 936-945, 1996.

Pasyanos, M., D. Dreger, and B. Romanowicz, Toward real-time estimation of regional moment tensors, *Bull. Seis. Soc. Am.*, 86, 1255-1269, 1996.

Romanowicz, B., D. Dreger, M. Pasyanos, and R. Uhrhammer, Monitoring of strain release in central and northern California using broadband data, *Geophys. Res. Lett.*, 20, 1643-1646, 1993.

Location	Date	UTC Time	Lat.	Lon.	MT Depth	$M_l$	$M_w$	Mo	Str.	Dip	Rake
Aromas	7/2/2007	19:58:53	36.882	-121.622	8	4.5	4.3	3.06E+22	143	88	-174
Oakland	7/20/2007	11:42:22	37.8	-122.18	5	4.1	4.2	2.52E+22	321	89	168
Geysers	7/20/2007	17:50:20	38.81	-122.8	11	3.7	3.9	9.09E+21	61	75	-41
Chatsworth	8/9/2007	07:58:48	34.258	-118.635	8	4.4	4.4	5.86E+22	298	60	111
Oakland	8/15/2007	07:13:10	37.8052	-122.189	5	3.2	3.2	8.54E+20	140	88	-178
Petrolia	9/8/2007	08:16:28	40.3193	-124.654	14	4.3	4.3	3.30E+22	105	88	177
Clear Lake	9/17/2007	14:43:21	38.86	-122.388	8	3.6	3.6	2.73E+21	91	77	-23
Cuca	10/16/2007	08:53:44	34.356	-117.629	11	4	4	1.31E+22	295	58	114
Alum Rock	10/31/2007	03:04:54	37.4323	-121.776	11	5.6	5.4	1.85E+24	323	87	180
Ferndale	11/9/2007	03:37:11	40.5398	-124.404	21	4.1	4.1	1.80E+22	149	77	157
Pinnacles	11/28/2007	02:30:12	36.5998	-121.208	8	5.1	3.4	1.40E+21	49	78	-15
Geysers	12/1/2007	20:50:12	38.7333	-122.933	4	3.9	3.9	1.97E+22	149	77	152
Pinnacles	12/11/2007	08:04:45	36.554	-121.122	5	3.4	3.5	2.44E+21	287	80	23
Offshore of Mendocino	12/11/2007	19:17:20	40.415	-126.384	8	4.8	4.8	1.98E+23	271	88	-134
Redbluff	1/19/2008	17:18:46	40.175	-122.755	11	4.4	4.5	6.49E+22	352	68	-112
Redbluff	1/19/2008	23:13:05	40.125	-122.759	11	4.9	4.7	1.26E+23	14	90	-10
Nevada	2/7/2008	12:53:09	38.236	-117.855	5	3.28	3.6	2.79E+21	190	83	-148
Geysers	2/24/2008	05:32:10	38.817	-122.809	5	4.01	4	1.30E+22	50	63	-44
Willits	3/10/2008	05:14:27	39.355	-123.277	8	3.44	3.7	4.35E+21	140	86	151
Offshore of Oregon	3/15/2008	14:44:38	42.487	-126.663	18	5.6	5.6	3.48E+24	25	73	-91
Geysers	3/27/2008	21:04:36	38.817	-122.786	8	3.6	3.6	3.04E+21	244	84	23
Offshore of Mendocino	4/10/2008	14:17:35	40.404	-125.639	30	3.89	4.2	2.46E+22	175	89	-174
Eureka	4/21/2008	22:00:54	40.78	-124.208	21	4.2	4.2	2.38E+22	301	61	-79
Reno, NV	4/24/2008	22:47:04	39.525	-119.223	5	3.8	3.7	5.10E+21	236	81	-11
Reno, NV	4/24/2008	22:55:49	39.527	-119.929	5	4.2	4.3	3.81E+22	153	74	-166
Reno, NV	4/26/2008	06:40:11	39.524	-119.932	5	5.13	4.9	3.35E+23	60	85	25
Reno, NV	4/28/2008	11:33:18	39.533	-119.931	5	4.2	4.1	1.77E+22	315	87	-170
Templeton	4/29/2008	17:45:17	35.499	-120.783	8	3.6	3.6	2.95E+21	119	55	93
Willow Creek	4/30/2008	03:03:07	40.836	-123.497	30	5.4	5.4	1.46E+24	359	60	-88
Lake Isabella	5/1/2008	08:11:43	35.471	-118.42	8	4.1	4.1	1.96E+22	291	89	-172
Offshore of Mendocino	5/6/2008	17:18:32	43.171	-126.447	14	4.5	4.5	6.70E+22	123	83	165
Reno, NV	5/8/2008	05:55:01	39.542	-119.92	5	3.5	3.6	3.40E+21	118	82	-167
Ferndale	5/13/2008	04:07:39	40.801	-125.374	11	4.2	4.3	3.29E22	314	86	167
Geysers	5/30/2008	04:48:36	38.776	-122.764	5	3.9	4.1	2.01E+22	250	82	-14
Green Valley	6/4/2008	02:29:04	38.242	-122.184	8	3.9	3.9	8.27E+21	63	87	-12
Oakland	6/6/2008	09:02:54	37.816	-122.075	8	3.5	3.5	2.00E+21	339	84	-162
Reno, NV	6/8/2008	17:53:41	39.546	-119.918	5	3.6	3.7	3.66E+21	195	-54	56
Tres Pinos	6/19/2008	23:57:51	36.681	-121.308	8	3.76	3.8	5.45E+21	40	88	-24
Tom's Place	6/28/2008	14:44:10	37.586	-118.819	11	4.3	3.9	9.89E+21	351	83	-32

Table 3.14: Moment tensor solutions for significant events from July 1, 2007 through June 30, 2008 using a complete waveform fitting inversion. Epicentral information is from the UC Berkeley/USGS Northern California Earthquake Management Center. Moment is in dyne-cm and depth is in km.



## 9. Instrumentation Testing

### 9.1 Introduction

The BSL Instrumentation Testing Facility located in the Byerly Vault (BKS) has been busy this past year with the testing of several sensors. In July 2007, the sensitivity and noise performance of the 8-channel Quanterra Q4120 data logger was checked to verify that is operating within the factory specifications. The BSL staff has also been involved in projects to test new STS-1 electronics developed by Metrozet LLC and to test a new temperature, hygrometer, and pressure sensor package that is being developed in-house. We have also tested new and repaired broadband and strong motion sensors on an *ad hoc* basis prior to deployment in the field.

A new advanced electronics package, the Metrozet STS-1-E300, has been developed and tested as a modern replacement for the original Streckeisen STS-1 very-broadband seismometer “Feedback Electronics” boxes. The development and testing is a collaborative effort between Metrozet LLC and the BSL. The new electronics package matches the outstanding analog performance of the original Streckeisen circuitry while providing a number of enhancements to facilitate installation and operation of the STS-1 sensors. The enhancements include: digital control of all sensor parameters; digital control of centering motor operations; monitoring of all major state-of-health parameters, and a complete calibration capability. All control and diagnostic functions can be controlled either locally (via RS-232, USB or Ethernet) or remotely (via Ethernet).

A new temperature, humidity, and pressure (THP) sensor package is being developed in-house at BSL as a replacement for the existing and aging temperature and pressure sensors at the BDSN stations. Measurement of the temperature and pressure at a BDSN station is useful for reducing the components of the seismic background noise that are correlated with temperature and pressure. A hygrometer has also been added to the sensor package to enable measurement of the local atmospheric relative humidity, a parameter which is potentially useful for estimating and correcting for geodetic GPS tropospheric propagation delays.

### 9.2 Instrumentation Test Facility

The BSL sensor testing facility is described in detail in the BSL 2001-2002 Annual Report (available on-line at <http://www.seismo.berkeley.edu>).

#### Data Logger Calibration

In July 2007, the sensitivity and self-noise PSD for each data channel and inter-channel crosstalk of the 8 chan-

nel Quanterra Q4120 data logger was checked using a reference signal applied first simultaneously and then sequentially to all channels, with the non-driven channels resistively terminated. The relative sensitivities of the data logger channels were checked by applying a high-level ( $\sim 19.8$  V peak-to-peak (P-P)) 1 Hz square wave signal simultaneously to all channels. The signal level on each channel was measured and the relative signal levels were compared to the sensitivities on the factory calibration sheet. The sensitivities of four of the channels have not changed by more than 0.01% from the factory calibration values. Of the remaining four channels, three changed by less than  $\pm 0.3\%$ , and the fourth changed by  $-0.8\%$ . Modulo 0.25% sensitivity changes are inherent in Q4120 at boot time because it steps the sensitivity in 0.25% increments and selects the sensitivity that has the lowest internal noise level. Sensitivity changes that are not near modulo 0.25% are likely due to a combination of modulo 0.25% increments and degradation of the components.

The self-noise of the Q4120 channels (with 1 k $\Omega$  resistance termination) was determined via Power Spectral Density (PSD) analysis. A composite plot of the Q4120 self-noise over the 20 microHz to 0.5 Hz band is shown in Figure 3.30, and a more detailed plot of the high-frequency (0.2-80 Hz self-noise PSD is shown in Figure 3.31. The minimum observed self-noise PSD is approximately 6 dB below the factory specification for a thermally stable environment in the 2-20 Hz band.

The inter-channel cross-talk of the data logger was checked by connecting each of the channels in sequence with the high amplitude (20 V P-P) 1 Hz square-wave signal while terminating the other seven channels with 1 k $\Omega$  resistors at the data logger input connectors. The Q4120 data logger contains two 4-channel digitizer modules (HH1-HH4 and HH5-HH8). The observed cross-talk signal level on all 8 channels is below the 2.34  $\mu$ V quantization (least significant bit or LSB) level of the Q4120 data logger. The cross-talk signal level is thus more than 138.5 dB below the drive signal level. A check of the coherence between the channels was performed by driving each channel sequentially with a one minute duration 20V P-P 1 Hz square wave while terminating the remaining seven channels with 1 k $\Omega$  resistors across the signal input connectors of the data logger. Spectral phase coherence analysis of the signal between the inter-channel pair combinations did not detect any significant coherence.

#### Instrumentation Test Bed

The data logger is connected to the seismometer test bed breakout box via a  $\sim 6$  meter shielded signal ca-

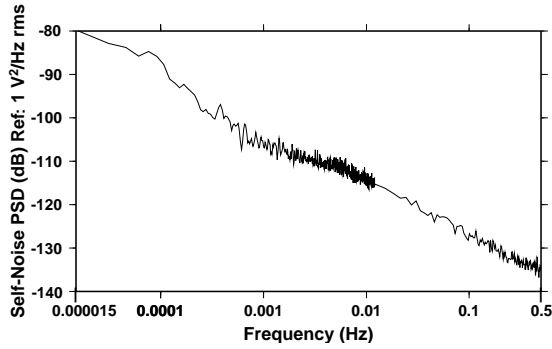

Figure 3.30: Self-Noise PSD of Q4120 data logger used in testing. A 1 k $\Omega$  resistance termination was placed across the data logger input. The plot is composite, derived from 1 sps noise data for frequencies below  $\sim$  0.01 Hz and 200 sps noise data at higher frequencies.

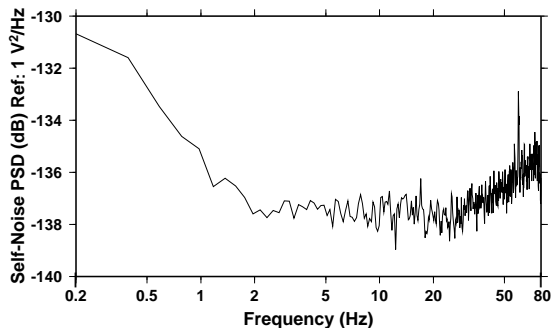

Figure 3.31: High-frequency self-noise PSD of Q4120 data logger used in testing. The data logger input was terminated with a 1 k $\Omega$  resistor. The median value of 32 noise sample PSD data are plotted, and the lowest self-noise PSD of  $\sim$ -137 dB is observed in the 2-30 Hz band. For comparison, the factory noise specification is that the terminated input noise level is typically -134.5 dB and it may exceed -137.5 dB at constant temperature.

ble. The above coherence test was repeated with the drive signal and terminating resistances connected at the breakout box, and some inter-channel pairs exhibited detectable phase coherence at 1 Hz and its odd harmonics and also at the 60 Hz power mains frequency, between adjacent signal pairs in the cable, which is consistent with capacitive coupling in the signal cable and with proximity of the signal cable to 60 Hz power wires in the vault. The largest observed cross-talk signal levels on the terminated channels were  $\sim$ 120 dB below the 20V P-P 1 Hz square wave drive signal level which is sufficiently low that the cross-talk does not interfere with subsequent data analysis.

### 9.3 BDSN *Ad Hoc* Sensor Testing

During the past year, the following sensors were tested to verify that they were performing within the factory specifications prior to re-deployment in the field:

- 1) The 3 STS-1's from KCC (STS-1Z s/n 109112, STS-1H s/n 29212, and STS-1H s/n 29201) with Metrozet STS-1-E300-005 electronics,
- 2) The 3 STS-1's from SAO with their corresponding factory electronics boxes (STS-1Z s/n 109119, STS-1H s/n 48528, and STS-1H s/n 48529).

### 9.4 STS-1 Sensor Electronics Testing

From the perspective of the BSL, the critical task in developing new electronics for the STS-1 seismometers, the E300, is the evaluation of performance and the comparison between new and old systems. Several iterations of the E300 were evaluated during the design and development phase. Objective evaluation of the new electronic subsystem required a stable and repeatable test platform of seismometers, base plates, cables, connectors, and digitizer channels. Only when the system was stable, as evidenced by repeated calibration results, was the platform suitable for evaluation of the new electronics.

#### Seismometer Acquisition and Alignment

Having characterized and calibrated the data logger (as discussed above), it was necessary to establish a stable seismometer subsystem test bed. Nine different STS-1 instruments (six horizontal, and three vertical instruments) were set up and leveled, and the outputs to the Q4120 data logger were compared quantitatively.

The horizontal instruments were aligned along a single axis allowing comparisons and evaluations of their coherence. Misalignment of less than one degree across the six horizontal instruments caused unacceptable variances in signal coherence, and took a week to resolve by rotating individual instruments. Alignment of the vertical instruments was much easier. Only after all alignment incoherences were resolved, were the new electronics evaluated against the original factory electronics.

Each cable, connector, and base plates combination were marked, color coded, and assigned, as new and original electronics were mated with seismometers. The color coding endeavored to eliminate ambiguities and variables beyond the actual electronics. Each combination of seismometers and electronics was recorded for a minimum of 24 hours. In the end, over 100 combinations of original and new electronics and seismometers were evaluated under conditions that were documented.

When individually labeled and identified combinations of base plates, cables, seismometers, and electronics were characterized and deemed repeatable, the new Metrozet electronics were substituted. Initially, the prototype

Metrozet electronics were operated on only one seismometer, with three, four or five other seismometers simultaneously operating on Streckeisen’s factory electronics. After verifying correct input and output signal levels, the single Metrozet electronics were rotated and verified amongst six seismometers. A second prototype Metrozet electronics package was likewise rotated through the seismometers, but this time powering two seismometers concurrently.

### Sensor/Electronics Testing

Testing of the STS-1 sensor and electronics systems involved several components. STS-1 vertical- and horizontal-component sensors for testing were gathered from among the available BDSN sensors, from surplus sensors on loan from the Gräfenberg Array, and from UC San Diego. The sensors were systematically inspected and checked to ensure that they were operating correctly. The ones that performed best were selected for the testing procedures and installed in the test bed. In total, 16 broadband STS-1 sensors (7 vertical and 9 horizontal components) were utilized during the testing process. Nine of them are owned by the BSL; 5 were on loan from Gräfenberg and 2 from IGPP/UCSD. The horizontal-component sensors were aligned east.

### Coherence and Power Spectral Density

An algorithm (*scn\_psd*) to calculate the signal Power Spectral Density (PSD), the noise PSD, and the coherence between sensors has been developed, in-house at BSL, as a tool for quantifying the performance differences between the seismic sensors under test. Three continuous hours of 200 Hz data are used by the *scn\_psd* algorithm. *scn\_psd* parses the data into 32 non-overlapping segments, applies and corrects for the effects of a Hanning window, scales the data to ground motion, calculates the Fast Fourier Transform (FFT) and stores the resulting complex spectral values for each segment. At each frequency, the RMS signal PSD is calculated from the average of the complex spectral values, coherence is calculated from the averaged complex spectral cross product, and the RMS noise PSD is then determined from the product of the signal PSD and (1 - coherence). The method is described in detail in *Barzilai et al.* (1992). In all tests, the BKS STS-1’s are used as the reference signals in the analysis. Two sample results of the algorithm are shown. Figure 3.32 shows the results for four seismometers in the case of a large seismic event, and Figure 3.33 shows the results for four seismometers in the case of background noise. In the presence of large seismic signals, the coherence is typically close to unity at all frequencies below the 5 Hz high-frequency corner of the BKS reference STS-1’s. Note the relatively high noise PSD level on the horizontal components in the vicinity of

0.1 Hz. This is due to a slight misalignment of the sensitive axes of the horizontal components. Several time-consuming trial and error iterations in aligning the horizontal components are required to lower the horizontal component noise PSD.

### Response Calibration

A pair of algorithms were developed in-house to determine the seismometer frequency response as characterized by the seismometer free period ( $T_s$ ) and fraction of critical damping ( $h_s$ ) and the high-frequency (“galvanometer”) corner frequency ( $f_g$ ) and fraction of critical damping ( $h_g$ ). These algorithms were developed to take advantage of the step function and low-frequency swept sine and high-frequency stepped sine calibration stimuli generated by the E300 electronics boxes, applied to the STS-1 calibration coils, and also recorded on one channel of the data logger. Thus, we can compare the observed and calculated responses to a known calibration stimulus to precisely determine the frequency response of the seismometer. Note that these algorithms determine only the shape of the frequency response and not the sensitivity of the seismometer. The corresponding flat pass-band sensitivity of the seismometer is determined using the Metrozet-supplied STS-1 Scale Factor Calculator V1.0 Java software applet (available via <http://www.metrozet.com/TSA-100S.html>), which, when given the values of all the feedback components from the factory calibration sheet for a specific STS-1 with factory electronics, determines the corresponding sensitivity with the E300 electronics connected. This method, of course, assumes that the original factory determination of the STS-1 response parameters is accurate. An alternative method to determine the absolute sensitivity is to determine the response of the STS-1 to known micro-tilts, a procedure which is very tedious and not easily done with sufficient accuracy. We prefer to check the accuracy of the STS-1 sensitivity by comparison of large seismic ground motions inferred from the STS-1s, with the corresponding ground motions from co-sited broadband or strong motion sensors. An added advantage of comparison with the signals from the accelerometers is that their responses are flat to DC, and their calibration is easily checked by tilting them  $\pm 90$  degrees along the horizontal sensitive axes to induce a  $\pm 1$  g acceleration step.

The first algorithm, *td\_tfp*, determines the transfer function parameters using an adaptive migrating grid search methodology to minimize the difference between the observed and calculated time series response to a known stimulus function. This routine determines the calculated response via direct integration of the seismometer equation of motion response to a known stimulus input using a fourth-order Runge-Kutta integration scheme. Also, the *td\_tfp* algorithm was specifically developed to determine the seismometer  $T_s$  and  $h_s$  using,

preferably, the low-frequency calibration stimulus or, alternatively, the step-function stimulus data.

The free period  $T_s$  and fraction of critical damping were determined via a grid search for the maximum variance reduction between the observed response and the theoretical response to stimulus signal input to the calibration coils. Sample outputs of the  $td\_tfp$  are shown in Figures 3.34 and 3.35 and the calibration results for the BKS reference STS-1 sensors are listed in Table 4.

The second algorithm,  $pd\_tfp$ , determines the transfer function parameters using a grid search methodology to minimize the difference between the observed and calculated phase response to a known stimulus function.  $pd\_tfp$  determines the parameters from the frequency and slope of the phase response curve when the measured phase delay between the calculated and observed responses is  $\pi/2$ . Also,  $pd\_tfp$  algorithm was specifically developed to determine  $f_g$  and  $h_g$  using high sampling rate data (e.g.  $\geq 80$  sps) and the stepped sine (0.5-40Hz) stimulus input to the calibration coils. A sample of the algorithm output is shown in Figure 3.36.

Both algorithms,  $td\_tfp$  and  $pd\_tfp$ , are capable of determining the transfer function parameters ( $T_s$ ,  $h_s$ ,  $f_g$  and  $h_g$ ) to approximately one part per thousand or better when the response to the stimulus signal is 20+ dB above the seismic background noise level.

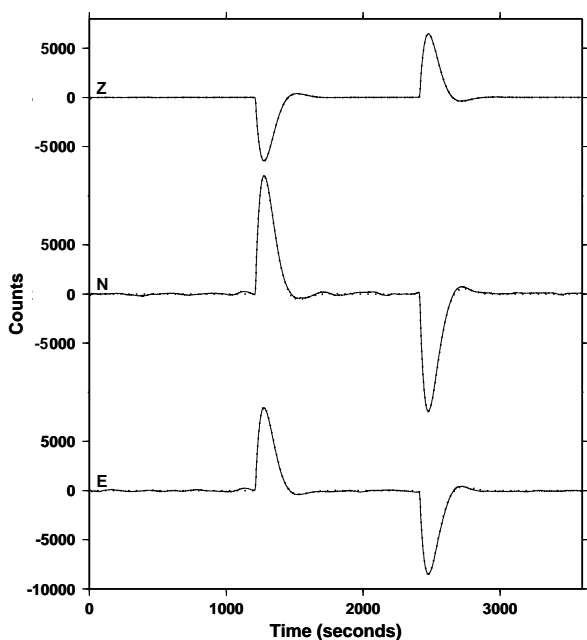

Figure 3.34: Calibration of BKS STS-1 seismometer low-frequency responses by time domain analysis of response of the seismometer to a step function calibration stimulus. Shown are the observed (solid lines) and calculated responses (dashed lines) to a 1200 second duration current step (equivalent to an acceleration step) input to the seismometer calibration coils.

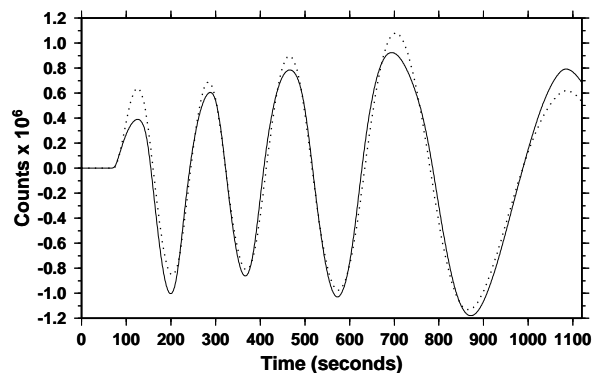

Figure 3.35: Calibration of HOPS STS-1 Z-component seismometer low-frequency response by time domain analysis of response of seismometer to a swept sine function calibration stimulus. Shown are the observed (solid line) and calculated (dashed line) responses to a 40-1100 second swept sine current (equivalent to a swept acceleration) input to the seismometer calibration coil.

## 9.5 Temperature, Humidity, Pressure Sensor Testing

During the past year, BSL staff have tested several generations of a new temperature, humidity, pressure (THP) sensor at the Instrumentation Test Facility and on the roof of McCone Hall. The new THP sensor package is being developed and upgraded to replace the temperature and pressure sensors currently installed at bdsn stations, which are aging and failing.

The pressure sensing element is a Honeywell SDX15A2-A which is temperature compensated. The specification sheet says that the sensor range of 0-15 psi in absolute pressure results in a 90mv ( $\pm 1\%$ ) differential change on the outputs when the bridge is excited with 12V. The sensor is operated in a bridge circuit configuration and its sensitivity is:

$$P(\text{psi}) = (V + 134.3)/9.995$$

where: V is the bridge output in Volts and psi is pounds per square inch (1 psi = 6894.8 Pa).

The resistance thermal detector (RTD) is a Honeywell HEL-700 with a resistance of 1k $\Omega$  at 0 $^\circ$  C. The RTD is operated in a circuit with offset and gain and its sensitivity is:

$$T(^{\circ}\text{C}) = (V + 9.09)/.3463$$

where: V is the output in Volts.

The humidity sensing element is a Honeywell HIH-4602C which is sensitive to the relative humidity. The sensor is operated in a circuit which results in an overall calibrated sensitivity of:

$$\%RH = ((V + 9.29)/3.168 - Z)/S$$

where: %RH is the percent relative humidity and V is the voltage output. S and Z are given in the factory calibration sheet as Z  $\sim$  0.826 mV and S  $\sim$  31.5 mv/%RH. Thus:

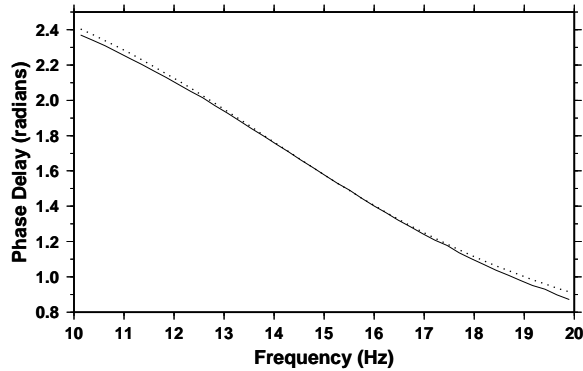

Figure 3.36: Calibration of HOPS STS-1 Z-component seismometer high-frequency response by phase domain analysis of response of seismometer to a stepped sine function calibration stimulus. Shown are the observed (solid line) and calculated (dashed line) responses to a 0.5-40 Hz stepped sine current (equivalent to a stepped acceleration) input to the seismometer calibration coil.

$$\%RH = (V + 6.673)/0.09979.$$

The factory specification sheet indicates that the response time is  $\sim 50$  seconds and the accuracy is  $\pm 3.5\%RH$ . The absolute humidity (AH) is a function of temperature, and, given the temperature, AH can be derived from relative humidity (RH) via:

$$AH(g/m^3) = (0.000002T^4 + 0.0002T^3 + 0.0095T^2 + 0.337T + 4.9034) * RH$$

where: T is the temperature in  $^{\circ}C$ .

## 9.6 Acknowledgements

Development of the sensor test facility and analysis system was a collaborative effort of Bob Uhrhammer, Tom McEvelly, John Friday, and Bill Karavas. IRIS and DTRA provided, in part, funding for and/or incentive to set up and operate the facility, and we thank them for their support. Robert Uhrhammer, John, Friday, Jarrett Gardner, Bill Karavas and Barbara Romanowicz (all from BSL), Tom VanZandt (Metrozet LLC), Charles R. Hutt (Albuquerque Seismological Laboratory) and Erhard Wielandt (Institute of Geophysics, University of Stuttgart) contributed to this chapter. The STS-1 electronics upgrade project was funded by the NSF through the IRIS/GSN program, with complementary support from University funds to the BSL. We thank Jennifer Taggart and Aimin Cao for their help in preparing the figures.

## 9.7 References

Barzilai, A., T. VanZandt, and T. Kenny, Technique for measurement of the noise of a sensor in the presence of large background signals, *Rev. Sci., Instrum.*, 69, 2767-2772, 1998.

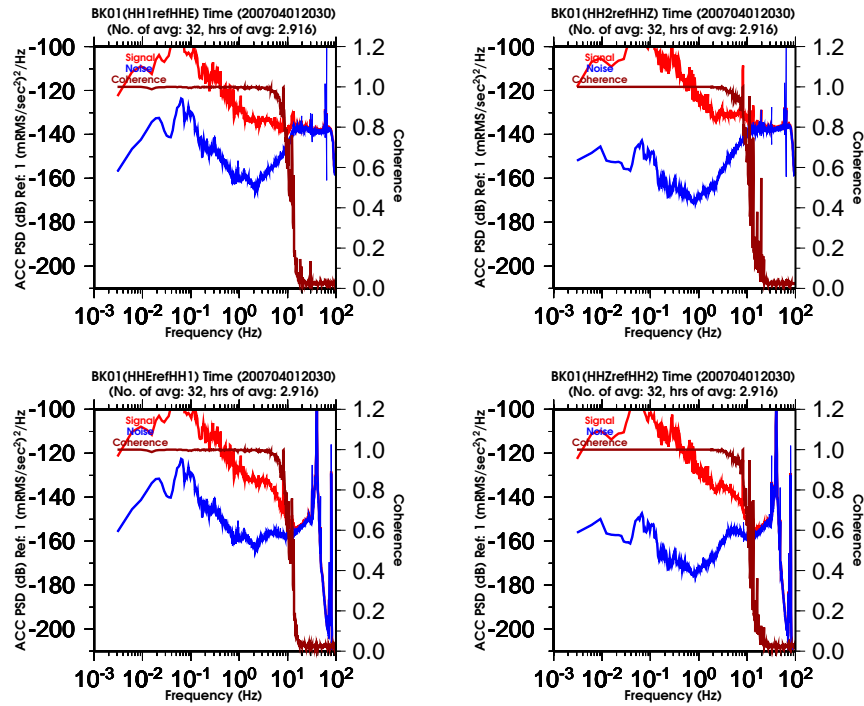

Figure 3.32: Results for two vertical component STS-1's (HHZ and HH2) and two horizontal component STS-1's (HHE and HH1) in the presence of a large seismic signal. The event is a  $M_w$  8.1 earthquake which occurred 87.9 degrees WSW of Berkeley on 2007/04/01 at 20:39 UT. Shown are the signal PSD (red), the noise PSD (blue), and the coherence (brown) for each sensor.

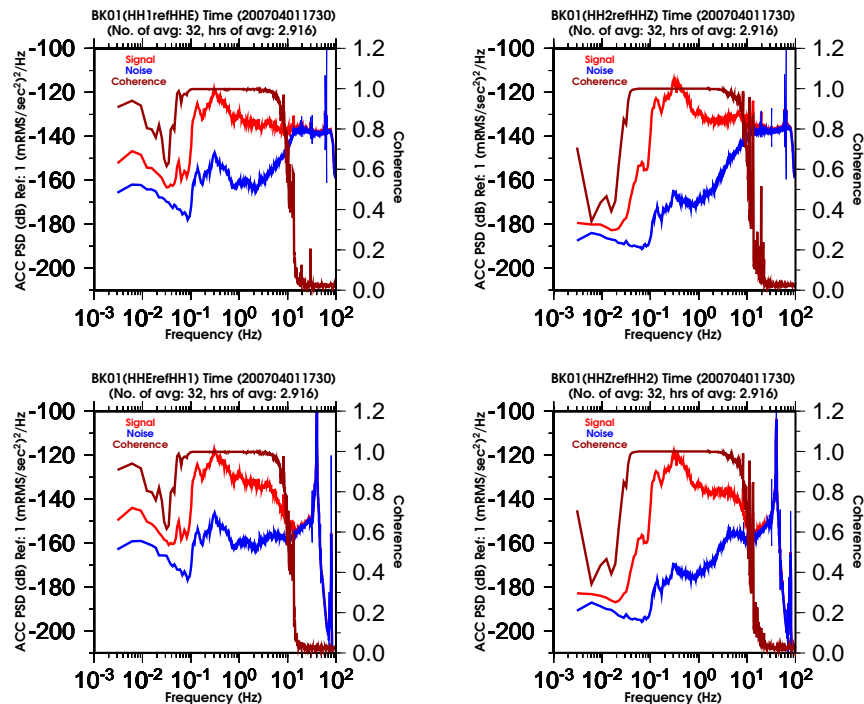

Figure 3.33: Results for four vertical component STS-1's (HHZ, HH4, HH5, and HH7) in the presence of background noise. The traces are the same as in Figure 3.32. The lower and upper frequencies at which the coherence degrades from near unity varies among the sensors. Coherence bandwidth is a measure of the performance of the sensors, and HH5 has the best performance of the four sensors.

## 10. Outreach and Educational Activities

### 10.1 Introduction

The BSL is involved in a variety of outreach activities ranging from lectures to lab tours and educational displays. Recorded information on current earthquake activity is updated regularly on our information tape (510-642-2160). Additional basic information on earthquakes and seismic hazards for northern and central California, as well as other information about seismology and our research, can be found on our extensive set of web pages at <http://seismo.berkeley.edu/>.

### 10.2 Highlights of 2007-2008

The Hayward Fault runs through the UCB campus. It last ruptured on October 21, 1868. Since then, new scientific insights put the average interval between large earthquakes on the Hayward Fault at 140 years; 2008 represents an important anniversary.

This year's Lawson Lecture highlighted local concerns. Dr. Roland Bürgmann of U.C. Berkeley presented "A tectonic time bomb in our backyard: Earthquake Potential of the Hayward Fault." He described the many advances, such as GPS monitoring and paleoseismological investigations, that allow us new insight into the forces that cause large movements along the fault. The Lawson Lectures are webcast at <http://seismo.berkeley.edu/news/lawsonlecture>.

The 1868 Earthquake Alliance is using the 140th anniversary as a unique opportunity to increase public awareness of seismic hazard posed by the Hayward Fault and other East Bay Faults, promote earthquake preparedness and mitigation, and to explore the ways in which the 1868 Hayward earthquake affected the personal lives, culture, economy and development of the greater San Francisco Bay Area (<http://1868alliance.org>). The BSL is contributing to the commemoration activities and participates in organization.

The 140th anniversary of the Hayward Earthquake is also the impetus for organizing the "Third Conference on Earthquake Hazards in the Eastern San Francisco Bay Region", which will take place October 22-26, 2008, at Cal State University East Bay (Hayward). The previous two conferences were held in 1982 and 1992. The BSL is a co-organizer of this conference, with Roland Bürgmann and Peggy Hellweg serving on the organizing committee. The meeting will include three days of technical sessions, a public forum, field trips and teacher education programs (<http://www.consrv.ca.gov/cgs/News/Pages/eastbayconference.aspx>).

### 10.3 On-Going Activities

#### Tours and Presentations

As in every year, tours and presentations formed an important part of BSL's public relations activities. Each month, several groups, ranging from middle-school students to scientists and engineers, tour our laboratory under the guidance of a graduate student or a member of the staff.

During 2007-2008 the BSL conducted several tours, both for local schools and groups from around the world. Peggy Hellweg led a group of Germans along the California Faults for the *Bild der Wissenschaft* magazine, starting in Los Angeles and ending in the San Francisco Bay Area. Several school classes at different grade levels received tours. BSL graduate students also visited local elementary, middle and high schools to talk about earthquakes and how we measure them. In addition to the tours, Drs. Allen, Dreger, Hellweg, Mayeda and Uhrhammer presented talks on earthquakes and related phenomena to public groups and the media.

#### Open House

The BSL again participated in *CalDay*. The attendance for the open house was exceptionally good this year. The visitors learned about UC Berkeley's role in earthquake monitoring, watched a streaming feed of earthquake data, jumped up and down to "make a quake," played with the earthquake machine, made P and S-waves with springs, learned about earthquake preparedness, and were given sample seismograms. The BSL repeated Roland Bürgmann's Lawson Lecture and also co-sponsored a lecture with the Earth and Planetary Science department on "Field Geology and Digital Mapping."

#### Educational Displays

The BSL continues to make REDI earthquake data available to certain schools, universities, colleges, and museums for educational displays. Participating organizations receive a REDI pager and the Qpager software to display the earthquake information. The Qpager program maps the previous seven days of seismicity, with each earthquake shown as a dot. The size of the dot indicates the magnitude of the event, while the color of the dot indicates its age. These educational displays have been installed at UC Berkeley (McCone Hall, Earthquake Engineering Research Center), California Academy of Sciences, CSU Fresno, CSU Northridge, CSU Sacramento, Caltech, College of the Redwoods, Fresno City College, Humboldt State University, San Diego State University, Sonoma State University, Stanford University

(Blume Engineering Center, Department of Geophysics), UC Davis, UC Santa Cruz, UC San Diego, and USC. For the past four years, middle schools of the San Francisco Unified School District have participated in the program.

In addition to the seismicity displays, the BSL provides local waveform feeds for helicorders at visitor centers associated with BDSN stations (CMB and MHC). Organizations such as LHS, KRON, and KPIX receive feeds from BKS via dedicated phone lines for display, while the USGS Menlo Park uses data from CMB for display in the lobby of the seismology building. The BSL has also loaned a seismometer and helicorder display to the San Leandro Unified School District for their use in science classes.

### **BSL Web Pages**

We continue to maintain and update our presence on the Internet. The Web pages are intended to provide a source of earthquake information for the public. They also present information about the networks we operate, including station profiles. This benefits the research community as well. The BSL Web pages publicize seminar schedules, advertise courses, and describe our research, as well as our operations. They offer updates on recent earthquake activity, details on Bay Area seismicity and hazards, and links to other earthquake and earth science servers. We also use the web server to distribute information internally among BSL personnel, with such details as the computing and operational resources, rosters, and schedules for various purposes.

### **Earthquake Research Affiliates Program**

The UC Berkeley Earthquake Research Affiliates (ERA) Program is an outreach project of the BSL, the Department of Earth and Planetary Science, and the Earthquake Engineering Research Center. The purpose is to promote the support of earthquake research while involving corporations and governmental agencies in academic investigation and education activities such as conferences and field trips. The ERA program provides an interface between the academic investigation and practical application of earthquake studies.

## **10.4 Acknowledgements**

Peggy Hellweg oversees the outreach activities at the BSL. Barbara Romanowicz, Bob Uhrhammer, Rick McKenzie, Jennifer Taggart and many other faculty, staff, and students at the BSL contribute to the outreach activities. Rick McKenzie and Peggy Hellweg contributed to the preparation of this section.



# Glossary of Common Acronyms

Table 3.15: Standard abbreviations used in this report.

Acronym	Definition
AMR	Accelerating Moment Release
ANSS	Advanced National Seismic System
BARD	Bay Area Regional Deformation
BAVU	Bay Area Velocity Unification
BDSN	Berkeley Digital Seismic Network
BSL	Berkeley Seismological Laboratory
CALREF	California Reference Frame
CDF	California Department of Forestry
CFS	Coulomb Failure Stress
CGS	California Geological Survey
CISN	California Integrated Seismic Network
CLVD	Compensated Linear Vector Dipole
CSMIP	California Strong Motion Instrumentation Program
CW	Complete Waveform
DART	Data Available in Real Time
DC	Double Couple
DNA07	Dynamic North America model of 2007
EM	Electromagnetic
ElarmS	Earthquake Alarm Systems
FA	Flexible Array
FACES	FlexArray along Cascadia Experiment for Segmentation
FAME	Flexible Array Mendocino Experiment
FFT	Fast Fourier Transform
FRAD	Frame Relay Access Device
GVF	Green Valley Fault
HF	Hayward Fault
HRSN	High Resolution Seismic Network
ICB	Inner Core Boundary
IG	Infragravity
IMS	International Monitoring System
InSAR	Interferometric Synthetic Aperture Radar
IRIS	Incorporated Research Institutions in Seismology
K-NET	Kyoshin Net, Japan
LBL	Lawrence Berkeley National Laboratory
LFES	Low-frequency Earthquakes
LLNL	Lawrence Livermore National Laboratory
LP	Long Period
MBARI	Monterey Bay Aquarium Research Institute
MMI	Modified Mercalli Intensity
MORB	Mid Ocean Ridge Basalts

*continued on next page*

Table 3.15: *continued*

Acronym	Definition
MPBO	Mini-Plate Boundary Observatory
MT	Magnetotelluric
NCEDC	Northern California Earthquake Data Center
NCEMC	Northern California Earthquake Management Center
NCF	Noise Correlation Functions
NCSN	Northern California Seismic Network
NCSS	Northern California Seismic System
NHFN	Northern Hayward Fault Network
NSMP	National Strong Motion Program
NTS	Nevada Test Site
NVT	Non-volcanic Tremor
OES	California Governor's Office of Emergency Services
PBO	Plate Boundary Observatory
PDF	Probability Density Function
PGV	Peak Ground Velocity
PSD	Power Spectral Density
PVC	Permanent Virtual Circuit
QDDS/EIDS	Quake Data Distribution System/Earthquake Information Distribution System
RCF	Rodgers Creek Fault
REDI	Rapid Earthquake Data Integration
RES	Repeating Earthquake Sequence
RGF	Reference Green Function
RMS	Root Mean Squared
RMT	Regional Moment Tensor
S/N	Signal to Noise
SAF	San Andreas Fault
SAFOD	San Andreas Fault Observatory at Depth
SCEC	Southern California Earthquake Center
SCEMC	Southern California Earthquake Management Center
SCSN	Southern California Seismic Network
SFBA	San Francisco Bay Area
SMIP	Strong Motion Instrumentation Program
STA/LTA	Short Time Average/ Long Time Average
SW	Surface Wave Inversion
SWD	Spectral Wave Density
THP	Temperature, Humidity, Pressure
UNAVCO	University NAVSTAR Consortium
USGS/MP	United States Geological Survey/ Menlo Park
USNSN	United States National Seismic Network
UUSS	University of Utah Seismic Stations
VLP	Very Long Period

# Appendix I Publications, Presentations, and Panels 2008-2008

## Publications

- Aagaard, B. T., T. M. Brocher, D. Dolenc, D. Dreger, R. W. Graves, S. Harmsen, S. Hartzell, S. Larsen, and M. L. Zoback, Ground-motion modeling of the 1906 San Francisco Earthquake, Part I: Validation using the 1989 Loma Prieta Earthquake, *Bull. Seism. Soc. Am.*, *98*, 989-1011, 2008.
- Aagaard, B. T., T. M. Brocher, D. Dolenc, D. Dreger, R. W. Graves, S. Harmsen, S. Hartzell, S. Larsen, K. McCandless, S. Nilsson, N. A. Petersson, A. Rodgers, B. Sjoegreen, and M. L. Zoback, Ground-motion modeling of the 1906 San Francisco Earthquake, Part II: Ground-motion estimates for the 1906 Earthquake and scenario events, *Bull. Seism. Soc. Am.*, *98*, 1012-1046, 2008.
- Allen, R.M., Earthquake hazard mitigation: New directions and opportunities, *Treatise on Geophysics*, G. Schubert (ed.), Vol 4 (H. Kanamori ed.), p607-648, Elsevier, 2007.
- Benetatos, C., D. Dreger, and A. Kiratzi, Complex and segmented rupture associated with the 14 August 2003 Mw 6.2 Lefkada, Ionian Islands, Earthquake, *Bull. Seism. Soc. Am.*, *97*, 35-51, 2007.
- Biggs, J., R. Bürgmann, J. Freymueller, Z. Lu, B. Parsons, I. Ryder, G. Schmalzle and T. Wright, The postseismic response to the 2002 M7.9 Denali Fault Earthquake: Constraints from InSAR, *Geophys. J. Int.* (in press).
- Bolt, B.A., and D. S. Dreger, Nature of Earthquakes and Seismic Hazards, *Designing for Earthquakes*, FEMA Publication 454, 392p., 2008.
- Brocher, T. M., K. Knudsen, M.L. Zoback, J. Perkins, M. Hellweg, W. Savage, and K. Bailey, The Hayward fault: Is it America's most dangerous?, *Catastrophe Risk Magazine*, April 2008.
- Brudzinski, M.R. and R.M. Allen, Segmentation in episodic tremor and slip all along Cascadia, *Geology*, *35* (10), 907-910, doi: 10.1130/G23740A.1, 2007.
- Bürgmann, R., and G. Dresen, Rheology of the lower crust and upper mantle: Evidence from rock mechanics, geodesy and field observations, *Ann. Rev. Earth Plan. Sci.*, *36*, 531-567, doi:10.1146/annurev.earth.36.031207.124326, 2008
- Cammarano F. and Romanowicz B., Radial profiles of seismic attenuation in the upper mantle based on physical models. *Geophys. J. Int.*, (in press).
- Cannon, E. C., R. Bürgmann, A. J. Crone, M. N. Machette, and R. L. Dart, Map and data for Quaternary faults and fault systems on the Island of Hawaii, U .S. Geological Survey Open-File Report, 2007-1284 (<http://pubs.usgs.gov/of/2007/1284/>), 1-81, 2007.
- Cao, A. and B. Romanowicz, Test of the Innermost Inner Core Models Using Broadband PKIKP travel time residuals, *Geophys. Res. Lett.*, *34*, L08303, doi:10.1029/2007GL029384, 2007.
- Chen, K.H., S. Toda, and R.J. Rau, A leaping, triggered sequence along a segmented fault: the 1951 Hualien - Taitung earthquake sequence in eastern Taiwan, *J. Geophys. Res.*, *113*, doi:10.1029/2007JB005048, 2008.

- Cobden L., Goes S., Cammarano F., and Connolly J.D., Thermo-chemical interpretation of one dimensional seismic reference models for the upper mantle: evidence for bias due to heterogeneity, *Geophys. J. Int.*, (in press).
- Dolenc, D., B. Romanowicz, P. McGill, and W. Wilcock, Observations of infragravity waves at the ocean-bottom broadband seismic stations Endeavour (KEBB) and Explorer (KXBB), *Geochem. Geophys. Geosys.*, *9(Q05007)*, doi:10.1029/2008GC001942, 2008.
- Dreger, D., R. Nadeau, and A. Chung, Repeating Earthquake Finite-Source Models: Strong Asperities Revealed on the San Andreas Fault, *Geophys. Res. Lett.*, *34(L23302)*, doi:10.1029/2007GL031353, 2007.
- Dziewonski, A. M. and B. Romanowicz, Overview of Volume I: Seismology and structure of the earth, *Treatise on Geophysics* G. Schubert (ed.), Vol. 1 (B. Romanowicz and A. Dziewonski, ed.), Elsevier, ISBN: 0-444-51928-9, 2007.
- Ellsworth, W.L., P.E. Malin, K. Imanishi, S.W. Roecker, R. Nadeau, V. Oye, C.H. Thurber, F. Waldhauser, N.L. Boness, S.H. Hickman, and M.D. Zoback, Seismology Inside the Fault Zone: Applications to Fault-Zone Properties and Rupture Dynamics, *Scientific Drilling*, Special Issue No. 1, Part 4: The Physics of Earthquake Rupture, p. 84, doi:10.2204/iodp.sd.s01.04-2007, 2007.
- Ford, S.R., D.S. Dreger, K. Mayeda, W.R. Walter, L. Malagnini, W.S. Phillips, Regional attenuation in northern California: A comparison of five 1-D methods, *Bull. Seismol. Soc. Am.*, August, 2008.
- Freed, A.M., R. Bürgmann, and T.A. Herring, Far-reaching transient motions after Mojave earthquakes require broad mantle flow beneath a strong crust, *Geophys. Res. Lett.*, *34*, doi:10.1029/2007GL030959, 2007.
- Funning, G., R. Bürgmann, A. Ferretti, F. Novali, and A. Fumagalli, Creep on the Rodgers Creek fault from PS-InSAR measurements, *Geophys. Res. Lett.*, *34*, doi:10.1029/2007GL030836, 2007.
- Gasperikova, E., J.T. Smith, H.F. Morrison, A. Becker, and K. Kappler, UXO detection and identification based on intrinsic target polarizabilities - a case history, *Geophysics*, (in press).
- Goldfinger, C., K. Grijalva, R. Bürgmann, A.E. Morey, J.E. Johnson, C.H. Nelson, J. Gutierrez-Pastor, A. Ericsson, E. Karabanov, J.D. Chaytor, J. Patton, and E. Gràcia, Late Holocene rupture of the Northern San Andreas fault and possible stress linkage to the Cascadia subduction zone, *Bull. Seism. Soc. Am.*, *98*, 861-889, 2008.
- Kim, A. and D. Dreger, Rupture Process of the 2004 Parkfield Earthquake from Near-Fault Seismic Waveform and Geodetic Records, *J. Geophys. Res.*, *113(B07308)*, doi:10.1029/2007JB005115, 2008.
- Malagnini, L. and K. Mayeda, High-stress strike-slip faults in the Apennines: An example from the 2002 San Giuliano earthquakes (Southern Italy), *Geophys. Res. Lett.*, *35*, doi:10.1029/2008GL034024, 2008.
- Malagnini, L., L. Scognamiglio, A. Mercuri, A. Akinci, K. Mayeda, Source scaling for ground motion prediction in central Italy: Evidence for strong non-self-similar behavior, *Geophys. Res. Lett.*, (accepted).
- Minson, S. and D. Dreger, Stable Inversions for Complete Moment Tensors, *Geophys. J. Int.*, 2007 (in press).
- Minson, S. E., D. S. Dreger, R. Bürgmann, H. Kanamori, and K. M. Larson, Seismically and geodetically determined nondouble-couple source mechanisms from the 2000 Miyakejima volcanic earthquake swarm, *J. Geophys. Res.*, *112*, doi:10.1029/2006JB004847, 2007.
- Morasca, P., K. Mayeda, R. Gök, W.S. Phillips, and L. Malagnini, 2-D coda and direct wave tomography in northern Italy, *Bull. Seism. Soc. Am.*, *98*, doi: 10.1785/0120070089, 2008.
- Murphy, K.R., K. Mayeda, and W.R. Walter, Coda spectral peaking for Nevada nuclear test site explosions, *Seism. Res. Lett.*, in press, 2008.
- Phillips, W.S., R.J. Stead, G.E. Randall, H.E. Hartse, and K. Mayeda, Source effects from broad area network calibration of regional distance coda waves, *Scattering of Short Period Waves in the Heterogeneous Earth*, H. Sato and M.C. Fehler, Editors, 2008 (in press).

- Pollitz, F., P. Banerjee, K. Grijalva, B. Nagarajan, and R. Bürgmann, Effect of 3D viscoelastic structure on postseismic relaxation from the 2004 M = 9.2 Sumatra earthquake, *Geophys. J. Int.*, *172*, 189-204, 2008.
- Olivieri, M., R.M. Allen, and G. Wurman, The potential for Earthquake Early Warning in Italy using ElarmS, *Bull. Seism. Soc. Am.*, *98*, 495-503, doi: 10.1785/0120070054, 2008.
- Romanowicz, B. and B. Mitchell, Q in the Earth from crust to core, *Treatise of Geophysics, Vol. 1*, Elsevier, ISBN: 0-444-51928-9, 2007.
- Romanowicz, B. Using seismic waves to image Earth's internal structure, *Nature*, *451*, 266-268, 2008.
- Ryder, I. and R. Burgmann, Spatial variations in creep rate on the central San Andreas Fault, *Geophys. J. Int.* (in press).
- Rau, R.J. and K.H. Chen, Repeating earthquakes and seismic potential along the northern Longitudinal Valley fault of eastern Taiwan, *Geophys. Res. Lett.*, *34*(L24301), doi:10.1029/2007GL031622, 2007.
- Schutt, D. L., K. Dueker, and H. Yuan, Crust and upper mantle velocity structure of the Yellowstone hot spot and surroundings, *J. Geophys. Res.*, *113*(B03310), doi:10.1029/2007JB005109, 2008.
- Stachnik, J. C., K. Dueker, D. Schutt, and H. Y. Yuan, Imaging Yellowstone plume-lithosphere interactions from inversion of ballistic and diffusive Rayleigh wave dispersion and crustal thickness data, *Geochem. Geophys. Geosyst.*, doi:10.1029/2007GC001901(9), doi:10.1029/2008GC001992, 2008.
- Taira, T., P.G. Silver, F. Niu, and R.M. Nadeau, Detecting seismogenic stress evolution and constraining fault-zone rheology in the San Andreas Fault following the 2004 Parkfield Earthquake, *J. Geophys. Res.*, *113*(B03303), doi:10.1029/2007JB005151, 2008.
- Templeton, D., R.M. Nadeau R., and Bürgmann, Behavior of Repeating Earthquake Sequences in Central California and the Implications for Subsurface Fault Creep, *Bull. Seism. Soc. Am.*, *98*, 52-65, 2008.
- Tsang, L., R.M. Allen, and G. Wurman, Magnitude scaling relations from P-waves in southern California, *Geophys. Res. Lett.*, *34*(L19304), doi:10.1029/2007GL031077, 2007.
- Xue, M. and R.M. Allen, The Fate of the Juan de Fuca Plate: Implications for a Yellowstone plume head, *Earth Planet. Sci. Lett.*, *264*, 266-276, doi:10.1016/j.epsl.2007.09.047, 2007.
- Yuan, H. Y., K. Dueker, and D. L. Schutt, Testing five of the simplest upper mantle anisotropic velocity parameterizations using teleseismic S and SKS data from the Billings, Montana PASSCAL array, *J. Geophys. Res.*, *113*(B03304), doi:10.1029/2007JB005092, 2008.
- Zollezi, F., P. Morasca, K. Mayeda, W.S. Phillips, and C. Eva, Attenuation tomography of the southern Apennines (Italy), *J. of Seism.*, *12*, doi10.1007/s10950-007-9079-6, 2007.

## Presentations

### **Southern California Earthquake Center 2007 Meeting, Palm Springs, CA, September 9-12, 2007**

- Guilhem, A., R. Bürgmann, A. Freed, and T. Ali, Accelerating Moment Release in the Areas of High Stress?
- Houlié, N. and B. Romanowicz, Asymmetric motion along the San Francisco Bay Area faults. Implication on the magnitude of future seismic events.
- Ryder, I. and R. Bürgmann, A Decade of InSAR Observations on the Creeping Segment of the San Andreas Fault.

### **Annual Workshop of the Working Group "Seismic phenomena associated with volcanic activity" of the European Seismological Commission, Nesjavellir, Iceland, September 10-15, 2007**

- Hellweg, M., S. Ford, D. Templeton, S. J. Ohlendorf, S. Minson, and D. Dreger, Volcanoes and Geysers: Full Moment Tensors for these (and Other) Unusual Sources.

## **Wilhelm and Else Heraeus Seminar: Density, Temperature and Elastic Constants of Earth's Mantle II, Linderhof, Germany, September 11-16, 2007**

Romanowicz, B., Elastic, anisotropic and anelastic structure of the upper mantle at the global and continental scale, (keynote speaker).

## **Monitoring Research Review, Denver, CO, September 26-28, 2007**

Ford, S.R., D.S. Dreger, and W.R. Walter, Identifying isotropic events using an improved regional moment tensor inversion technique.

Ford, S.R., D.S. Dreger, K. Mayeda, W.R. Walter, L. Malagnini, and W.S. Phillips, Regional analysis of Lg attenuation: Comparison of 1D methods in Northern California and application to the Yellow Sea/Korean Peninsula.

Romanowicz, B., A. Cao, A. Kim, M. Panning, M. Pasyanos, and D. Dreger, Calibration of 3D upper mantle structure in Eurasia using regional and teleseismic full waveform data.

## **American Geophysical Union Fall Meeting, San Francisco, CA, December 10-14, 2007**

Acevedo-Cabrera, A.L., M. Xue, and R.M. Allen, Seismic Tomography of western North America, *Eos Trans. AGU*, 88(52), Fall Meet. Suppl., Abstract S23B-1391, 2007.

Allen, R.M., G. Wurman, P. Hellweg, A. Kireev, and D. Neuhauser, Earthquake early warning across California: Performance of ElarmS on the existing seismic networks, *Eos Trans. AGU*, 88(52), Fall Meet. Suppl., Abstract S23E-01, 2007.

Brown, H. and R.M. Allen, Application of ElarmS to earthquakes in Japan, *Eos Trans. AGU*, 88(52), Fall Meet. Suppl., Abstract S13C-1443, 2007.

Bürgmann, R., G. Funning, I. Johanson, K. Johnson, and R.M. Nadeau, Imaging Rupture Asperities and Earthquake Potential of Partly Creeping Faults, *EOS Trans. AGU*, 88, Fall Meet. Suppl., Abstract S34C-03, 2007 (invited).

Cammarano, F. and B. Romanowicz, Constraints on Upper Mantle Temperature from Seismic Attenuation, *EOS Trans. AGU*, 88, Fall Meet. Suppl., Abstract U21A-0003, 2007.

Cammarano, F., B. Romanowicz, A. Deuss, and S. Goes, Insights on Compositional and Thermal Structure of the Earth's Upper Mantle Using Mineral Physics and Seismic Data. *EOS Trans. AGU*, 88, Fall Meet. Suppl., Abstract DI51B-01, 2007 (invited).

Cannata, A., M. Hellweg, R.M. Nadeau, and S. Gresta, Detection Method of Low-Frequency Earthquakes in the Non-Volcanic Tremor Beneath the San Andreas Fault, *Eos Trans. AGU*, 88(52), Fall Meet. Suppl., Abstract T21A-0356, 2007.

Cao, A., M. Panning, A. Kim, and B. Romanowicz, Non-linear 3D Born Shear Wave Tomography in Southeastern Asia, *EOS Trans. AGU*, 88, Fall Meet. Suppl., Abstract S31E-02, 2007.

Chen, K.H., R. Bürgmann, and R.M. Nadeau, Do repeating earthquakes talk to each other?, *EOS Trans. AGU*, 88(52), Fall Meet. Suppl., Abstract S33C-1469, 2007.

Chang, S., S. Van der Lee, M. P. Flanagan, H. Bedle, F. Marone, E. Matzel, M. Pasyanos, A. Rodgers, B. Romanowicz, and C. Schmid, Joint inversion for 3-dimensional S-velocity mantle structure along the Tethyan margin, *Eos Trans. AGU*, 88(52), Fall Meet. Suppl., Abstract T23A-1202, 2007.

Cheng, X., F. Niu, P.G. Silver, and R.M. Nadeau, Seismic imaging of scatterer migration using waveform data of repeating earthquakes, *EOS Trans. AGU*, 88(52), Fall Meet. Suppl., Abstract T51C-0683, 2007.

Dreger, D., A. Morrish, and R.M. Nadeau, Finite-Source Modeling of Micro-earthquakes on the Parkfield Segment of the San Andreas Fault, *EOS Trans. AGU*, 88(52), Fall Meet. Suppl., Abstract S54A-08, 2007.

Dolenc, D., B. Romanowicz, P. McGill, and D. Neuhauser, Five Years of Data at the Monterey Ocean Bottom Broadband Seismic Station (MOBB), *Eos Trans. AGU*, 88(52), Fall Meet. Suppl., Abstract S11D-06, 2007 (invited).

- Dolenc, D., B. Romanowicz, P. McGill, and W. Wilcock, Observations of Infragravity Waves at the Ocean-Bottom Broadband Seismic Stations Endeavour (KEBB) and Explorer (KXBB), *Eos Trans. AGU*, 88(52), Fall Meet. Suppl., Abstract S23A-1106, 2007.
- Dziewonski, A.M., B. Kustowski, V. Lekic, and B. Romanowicz, Seismic Tomography and Structure of the Transition Zone, *EOS Trans. AGU*, 88(52), Fall Meet. Suppl., Abstract V44B-01, 2007.
- Evans, E., R. Bürgmann, and R.M. Nadeau, Linking Faults: Subsurface Creep on a Contiguous Fault Structure Connecting the Hayward and Calaveras Faults, *EOS Trans. AGU*, 88(52), Fall Meet. Suppl., Abstract S21A-0240, 2007.
- Grijalva, K., E. Apel, and R. Bürgmann, Modeling stress changes following the 2004-2005 Sumatra earthquake sequence: Exploring triggering of the 2007 rupture and its relationship to the 1797 and 1833 events, *Eos Trans., AGU*, 88 (52), Fall Meet. Suppl., Abstract U51A-0011, 2007.
- Grijalva, K., R. Bürgmann, and C. Goldfinger, Stress interaction between the Cascadia subduction zone and the northern San Andreas fault, *Eos Trans., AGU*, 88 (52), Fall Meet. Suppl., Abstract G13A-0911, 2007.
- Guilhem, A., D.S. Dreger, and R.M. Nadeau, Scanning for Unusual Seismicity in the Mendocino Triple Junction Region, *EOS Trans. AGU*, 88(52), Fall Meet. Suppl., Abstract S43A-1047, 2007.
- Hellweg, M., R. Uhrhammer, K. Hutton, A. Walter, P. Lombard, and E. Hauksson, Recalibrating ML for the California Integrated Seismic Network, *Eos Trans. AGU*, 88(52), Fall Meet. Suppl., Abstract S43A-1057, 2007.
- Houlié, N., D. Dreger, A. Kim, and B. Romanowicz, The 28th September 2004 Parkfield earthquake revisited through high-rate GPS data inversion, *Eos Trans. AGU*, 88(52), Fall Meet. Suppl., Abstract G24A-02, 2007 (invited).
- Houlié, N. and B. Romanowicz, Asymmetric motion along the San Francisco Bay Area faults. Implication on the magnitude of future seismic events, *Eos Trans. AGU*, 88(52), Fall Meet. Suppl., Abstract G21C-0678, 2007.
- Kim, A., D. Dreger, and S. Larsen, 3D structure effects on local and near-regional seismic wave propagation in the San Francisco Bay Area *EOS Trans. AGU*, 88, Fall Meet. Suppl., S21A-0235
- Komorowski, J-C.K., N. Houlié, J.P. Montagner, J. Dufek, Hidden Dykes detected on Ultra Long Period seismic signals at Piton de la Fournaise volcano - Constraints on the upper reservoir pressure state since 1992, *Eos Trans. AGU*, 88(52), Fall Meet. Suppl., Abstract V52B-07, 2007 (convener).
- Lekic, V. and B. Romanowicz, Finite Frequency Upper Mantle Tomography Using the Spectral Element Method, *EOS Trans. AGU*, 88(52), Fall Meet. Suppl., Abstract S32A-05, 2007.
- Lippman, J., A. Cao, and B. Romanowicz, Global Observations of Short Wavelength Topography on the Inner Core Boundary, *EOS Trans. AGU*, 88(52), Fall Meet. Suppl., Abstract DI31A-0251, 2007.
- Nadeau, R.M. and A. Guilhem, Multi-scale Quasi-periodic Rate Changes of Nonvolcanic Tremor at Cholame, CA Following the 2004 Parkfield Mainschock, *EOS Trans. AGU*, 88(52), Fall Meet. Suppl., Abstract T12C-04, 2007.
- Neuhauser, D.S., A. Kireev, G. Wurman, M. Hellweg, and R. Allen, A Real-Time CISM Test Bed for the ElarmS Early Warning Algorithm, *Eos Trans. AGU*, 88(52), Fall Meet. Suppl., Abstract S13C-144, 2007.
- Olivieri, M., R. Basili, and R.M. Allen. ElarmS and the next large earthquake in Italy *Eos Trans. AGU*, 88(52), Fall Meet. Suppl., Abstract S13C-1441, 2007.
- Porritt, R. and R.M. Allen. Observations of tremor using newly available seismic datasets in Cascadia, *Eos Trans. AGU*, 88(52), Fall Meet. Suppl., Abstract T21A-0348, 2007.
- Ryder, I. and R. Burgmann, Variations in Creep Rate along the Central San Andreas Fault from InSAR and GPS Observations, *Eos Trans. AGU*, 88(52), Fall Meet. Suppl., Abstract G53A-01, 2007.
- Romanowicz, B., F. Cammarano, L. Stixrude, C. Lithgow-Bertelloni, W. Xu, Constraints on Lateral Variations in Temperature and Composition in the Upper Mantle From Inversion of Long Period Seismic Waveforms, *Eos Trans. AGU*, 88(52), Fall Meet. Suppl., Abstract MR52A-02, 2007 (invited).

- Romanowicz, B. and A. Cao, Illuminating Slab Remnants in the Lower Mantle Using PKP Precursors, *Eos Trans. AGU*, 88(52), Fall Meet. Suppl., Abstract U21A-0006, 2007.
- Silver, P.G., T. Taira, F. Niu, and R.M. Nadeau, Dynamic Weakening of the San Andreas Fault by the 2004 Sumatra-Andaman Earthquake, *Eos Trans. AGU*, 88, Fall Meet. Suppl., Abstract T53C-05, 2007.
- Tsang, L.L.H., R.M. Allen, and G. Wurman, Calibration of ElarmS using earthquakes in southern California, *Eos Trans. AGU*, 88(52), Fall Meet. Suppl., Abstract S13C-1442, 2007.
- Tran, A. and R.M. Allen. Patches of tremor around the Mendocino Triple Junction, *Eos Trans. AGU*, 88(52), Fall Meet. Suppl., Abstract T21A-0347, 2007.
- Uhrhammer, R., W. Karavas, J. Friday, T. van Zandt, R. Hutt, E. Wielandt, and B. Romanowicz, New STS-1 Electronics: Development and Test Results, *Eos Trans. AGU*, 88(52), Fall Meet. Suppl., Abstract S41A-0248, 2007.
- Wurman, G., D.D. Oglesby, and R.M. Allen. Exploring the Relationship Between Early Rupture History and Final Earthquake Size, *Eos Trans. AGU*, 88(52), Fall Meet. Suppl., Abstract S14B-07, 2007.
- Xue, M. and R.M. Allen. Imaging Mantle Convection Processes Beneath the Western USA Using the EarthScope Transportable Array, *Eos Trans. AGU*, 88(52), Fall Meet. Suppl., Abstract S43D-01, 2007.
- Yuan, H. Y., F. Marone, K. Liu, S. Gao, and B. Romanowicz, 3D Radial and Azimuthal Anisotropic Structure in North America, *Eos Trans. AGU*, 88(52), Fall Meet. Suppl., Abstract T23A-1204, 2007.
- Zeleznik, M., P.J. Maechling, G. Wurman, A. Kireev, K. Solanki, R. Allen, D. Neuhauser, E. Hauksson, P. Hellweg, G. Cua, T. Heaton, and T.H. Jordan, Development of the CISN Earthquake Early Warning Web Site: Establishing a Basis for Comparison of Algorithms, *Eos Trans. AGU*, 88(52), Fall Meet. Suppl., Abstract S13C-1446, 2007.

### **Joint BSL/IPG Workshop: “Seismology and Seismotectonics: BSL and IPGP research perspectives”, Berkeley Seismological Laboratory, December 16-17, 2007**

- Cao, A., N Born and SEM based regional tomography.
- Dreger, D., Repeating Earthquake Finite-Source Models: Strong Asperities Revealed on the San Andreas Fault.
- Dreger, D., R Allen, G. Wurman - The M5.4 Alum Rock earthquake.
- Houlié, N., Chasing EQ in Northern California using RT GPS.
- Mayeda, K., A New Approach to Constrain Earthquake Source Scaling.
- Nadeau, R.M., Change in Nonvolcanic Tremor Evolution in Central California Associated with the San Simeon M6.5 and Parkfield M6.0 Earthquakes.
- Neuhauser, D., Real time data acquisition and processing at BSL.

### **USGS/NEHRP Northern California Earthquake Hazards Workshop, USGS Menlo Park, January 23-24, 2008**

- Allen, R.M., H. Brown, P. Hellweg, A. Kireev, and D. Neuhauser, CISN earthquake early warning: Testing of seismological algorithms.
- Grijalva, K., R. Bürgmann, C. Goldfinger, Stress interaction between the Cascadia subduction zone and the northern San Andreas fault.
- Hellweg, M., The Orinda Events: Complexity in Small Earthquakes.
- Mayeda, K., Stable source estimates derived from local and regional coda envelopes.
- Romanowicz, B., M. Hellweg, and D. Neuhauser, Operation of the Northern California Earthquake Management Center (NCEMC): Collaboration between UC Berkeley and the USGS Menlo Park, CA.
- Uhrhammer, R., M. Hellweg, P. Lombard, K. Hutton, E. Hauksson, A. Walter, and D. Oppenheimer, Recalibrating  $M_L$  for CISN.



**EarthScope Workshop on Aseismic Slip, Non-Volcanic Tremor, and Earthquakes, Sidney, British Columbia, February 25-28, 2008**

Nadeau, R.M. and A. Guilhem, Evidence for Laterally Distributed Tremor Activity Across the San Andreas Fault Zone at Cholame, CA.

**Workshop on Deformation Process and Earthquake Scaling, Hiroshima University, Hiroshima, Japan, March 3-4, 2008**

Hellweg, M., Scaling and Complexity in small earthquakes.

**International Workshop on Ocean floor observations, JAMSTEC, Tokyo, Japan, March 10-11, 2008**

Romanowicz, B., Scientific Motivations for Seafloor Observatories, International Workshop on Ocean floor observations, (keynote lecture).

**UNAVCO Science Workshop, Boulder, CO, March 11-13, 2008**

Ryder, I., R. Bürgmann, Z. Shen, and A. Thomas, Postseismic motion following two recent major earthquakes in Tibet.

**European Geophysical Union Meeting, April 2008**

Cua, G., P. Maechling, R.M. Allen, E. Hauksson, T. Heaton, P. Hellweg, A. Kireev, D. Neuhauser, K. Solanki, S. Wiemer, J. Woessner, and M. Zeleznik, Comparison and testing of earthquake early warning algorithm performance.

**Environmental and Engineering Geophysical Society Annual Meeting (SAGEEP), April 6-10, 2008**

Kappler, K.N., An approach to UXO discrimination via polarizability curvematching and feature extraction applied to polarizability curves.

**Annual Meeting of the Seismological Society of America, Santa Fe, NM, April 16-18, 2008**

Allen, R.M., M. Xue, and S.H. Hung, Convective interactions beneath North America: An improved view using finite frequency kernels, *Seism. Res. Lett.*, 79, 308, 2008 (invited).

Chung, A.I., D.S. Dreger, and R.M. Nadeau, Kinematic Source Parameters and Scaling of Micro-Repeating Earthquakes at Parkfield, *Seism. Res. Lett.*, 79, 357, 2008.

Dolenc, D., R. Uhrhammer, and B. Romanowicz, Analysis of long-period noise at the Farallon Islands broadband seismic station FARB, *Seism. Res. Lett.*, 79, 293, 2008.

Hellweg, M., A. Cannata, S. Gresta, S. Ford, and G. Di Grazia, Moment tensors for very long period signals at Etna Volcano, Italy, *Seism. Res. Lett.*, 79, 320, 2008.

Hellweg, M., A. Chung, D. Dreger, A. Kim, and J. Boatwright, Mapping the rupture of the MW 5.4 Alum Rock earthquake. *Seism. Res. Lett.* 79, 353, 2008.

Hellweg, M., R.A. Uhrhammer, S. Ford, and J. Friday, Nonvolcanic tremor in Denali surface waves at broadband stations in Northern California: Instrumental causes? *Seism. Res. Lett.*, 79, 327, 2008.

Malagnini, L. and K. Mayeda, Strong Coupling of Strike-Slip Faults: An Example from the San Giuliano Mainshocks (Southern Italy), *Seism. Res. Lett.*, 79, 336, 2008.

Mayeda, K., L. Malagnini, and W.R. Walter, Earthquake Scaling for the Chi-Chi, Taiwan Sequence, *Seism. Res. Lett.*, 79, 337, 2008.

Nadeau, R.M. and A. Guilhem, Evidence for Laterally distributed Tremor Activity across the San Andreas Fault Zone at Cholame CA, *Seism. Res. Lett.*, 79, 291, 2008.

Oppenheimer, D., W. Bakun, R. Uhrhammer, J. Boatwright, and R. Simpson, Seismicity on the central and southern Calaveras fault and earthquake forecasts; Part 1 1910-present, *Seism. Res. Lett.*, 79, 342-343, 2008.

Shelly, D.R., R.M. Nadeau, R. Burgmann, W.L. Ellsworth, J.M. Murray, T.F. Ryberg and C. Haberland, Repeating Nature and Relative Location of San Andreas Fault Tremors near Cholame, CA, *Seism. Res. Lett.*, 79, 291, 2008.

### **American Geophysical Union Joint Meeting, Fort Lauderdale, FL, May 27-30, 2008**

Allen, R., M. Bose, H. Brown, G. Cua, D. Given, E. Hauksson, T. Heaton, M. Hellweg, T. Jordan, A. Kireev, P. Maechling, D. Neuhauser, D. Oppenheimer, K. Solanki, and M. Zeleznik, Rapid telemetry and earthquake early warning, *Eos Trans. AGU*, 89(23), Jt. Assem. Suppl., Abstract G21A-01, 2008.

Houlié, N. and R.M. Allen. The Instantaneous Displacement (ID) Method: Application of rapid displacement estimates to earthquake early warning alerts, *Eos Trans. AGU*, 89(23), Jt. Assem. Suppl., Abstract G21A-02, 2008.

### **IRIS Annual Workshop, Stevenson, WA, June 4-6, 2008**

Allen, R.M., M. Xue, and S.H. Hung, The fate of the Juan de Fuca plate.

Guilhem, A. and R.M. Nadeau, Influence of large earthquakes on the nonvolcanic tremor activity in the Parkfield-Cholame region, CA.

Taira, T., P.G. Silver, F. Niu, and R.M. Nadeau, Dynamically-induced weakening of the San Andreas Fault by the 2004 Sumatra-Andaman earthquake.

Shelly, D.R., R.M. Nadeau, R. Bürgmann, W.L. Ellsworth, J. Murphy, T.F. Ryberg, C. Haberland, and G. Fuis, Repeating Nature and Relative Location of San Andreas Fault Tremors Near Cholame, CA.

Yuan, H. Y., F. Marone, K. Liu, S. Gao, and B. Romanowicz, 3D Radial and Azimuthal Anisotropic Structure in North America.

### **ORFEUS Workshop, Utrecht University, Utrecht, Netherlands, June 19-20, 2008**

Romanowicz, B., Elastic, anisotropic and anelastic tomography of the Earth's mantle: inferences on global dynamics.

### **Speaking Engagements**

Allen, R.M., Toward earthquake early warning for California. SAFER (Seismic Early Warning for Europe) Meeting, Athens, Greece, June 2007.

Allen, R.M., Subduction, upwelling, earthquakes and tremor, all in the Pacific Northwest, UC Davis Geology and Geophysics Seminar, January 2008.

Allen, R.M., Earthquake early warning: Adding societal value to regional networks and station clusters, IRIS "Out of Africa" Workshop, Boston, MA, February 2008.

Allen, R.M., Detecting large earthquakes (and warning before ground shaking), Georgia Tech Department Seminar, March 2008.

Allen, R.M., Tremor across Cascadia: A view of megathrust processes? Georgia Tech Geophysics Seminar, March 2008.

Allen, R.M., Subduction, upwelling, earthquakes and tremor, all in the Pacific Northwest. Earthquake Hazards and Volcano Hazards joint seminar, USGS, Menlo Park, CA, May 2008.

Allen, R.M., First Jolt: New Science Behind Understanding Earthquakes. Presentation at the Annual Donors Dinner for the College of Letters and Sciences, UC Berkeley, May 2008.

Allen, R.M. and M. Hellweg, Berkeley Seismological Laboratory: A research Laboratory for active earthquake monitoring. Briefing to Floyd Kvamme, Co-Chair of President Bush's Council of Advisors on Science and Technology, USGS, Menlo Park, CA, May 2008.

- Apel, E., Shells on a Sphere: Insights from Indian Plate motion, USGS Earthquake Seminar Series, Menlo Park, CA, August 22, 2007.
- Bürgmann, R., Earthquakes in the San Francisco Bay Area, Deutsche Studienstiftung in North America, Meeting, Berkeley, CA, September 29, 2007.
- Bürgmann, R., Active Tectonics and Non-Tectonics in the San Francisco Bay Area, Stanford University, Stanford, CA, November 11, 2007.
- Bürgmann, R., A tectonic time bomb in our backyard: Earthquake potential of the Hayward fault, Lawson Lecture, UC Berkeley, Berkeley, CA, April 9, 2008.
- Bürgmann, R., A tectonic time bomb in our backyard: Earthquake potential of the Hayward fault, CalDay, UC Berkeley, Berkeley, CA, April 12, 2008.
- Bürgmann, R., Active Tectonics and Non-Tectonics of the San Francisco Bay Area (from “Aseismology”), Univ. Washington, Seattle, WA, May 29, 2008.
- Bürgmann, R., What gives in the lower crust? Evidence from post-loading deformation and exhumed fault zones, CIG Workshop, Golden, CO, June 24, 2008.
- Cammarano F., Insights on the compositional and thermal structure of the upper mantle from seismic data, Macquarie University, Sydney, Australia, February, 2008 (invited).
- Chen, K.H., How do the repeating earthquakes at Parkfield talk to each other?, Institute of Earth Sciences, Academia Sinica, Taiwan, May 29, 2008 (invited).
- Hellweg, M., Characteristics of tremor and other unusual seismic signals, presented at Hiroshima University, Hiroshima, Japan, February 19 - March 14, 2008.
- Hellweg, M., Moment tensors of local and regional events, including isotropic components, presented at Hiroshima University, Hiroshima, Japan, February 19 - March 14, 2008.
- Hellweg, M., Realtime Earthquake Monitoring at UCB and Waveform Analysis: Filtering and Polarization, presented at Hiroshima University, Hiroshima, Japan, February 19 - March 14, 2008.
- Hellweg, M., Erdbeben im Garten: Einführung in die Seismotektonik und Seismizität von Kalifornien, presented as part of the Bild der Wissenschaft Leserreise “Bewegte Erde”, June 07-25, 2008.
- Hellweg, M., Introduction to the Berkeley Seismological Laboratory, presented as part of the Bild der Wissenschaft Leserreise “Bewegte Erde”, June 07-25, 2008.
- Hellweg, M., Schornsteine der Subduktion: Der Mount St. Helens und die Vulkane des Kaskadengebirges, presented as part of the Bild der Wissenschaft Leserreise “Bewegte Erde”, June 07-25, 2008.
- Hellweg, M., Below Zero: Scaling and Complexity in Small Earthquakes, Seminar at the School of the Earth and Environment, University of Leeds, Leeds, UK, September 17, 2008.
- Houlié, N., Deformation transitoire longue periode de la croute terrestre. Application au Piton de la Fournaise et au seisme de Parkfield, Observatoire Midi-Pyrenees, Toulouse, France, April 29, 2008.
- Houlié, N., GPS Double Difference. Application to Volcanology and Seismology. A new hope for GPS seismology? , Departamento de Geofisica, Facultad de Ciencias Fisicas y Matematicas, Universidad de Chile, Chile, July 18th, 2008.
- Houlié, N., GPS: past and future investigations., Departamento de Geofisica, Facultad de Ciencias Fisicas y Matematicas, Universidad de Chile, Chile, July 16th 2008.
- Mayeda, K. and J. Bonner, Regional P-coda for stable estimates of body wave magnitude and yield: Extending the Ms:mb discriminant to smaller events, Air Force Research Laboratory, Hanscom Air Force Base, MA, September 24, 2007.
- Mayeda, K., Earthquakes and Seismic Hazard in our Backyard, Head-Royce Middle School 6th grade class, Oakland, CA, also filmed by French TV travel show Echappées Belles, March 10, 2008.
- Mayeda, K., Stable source estimates derived from local and regional coda envelopes, UC Santa Cruz, Santa Cruz, CA, March 14th, 2008.

- Mayeda, K., A new approach to constrain earthquake source scaling: On the path to improving MDAC, Air Force Technical Applications Center, Patrick Air Force Base, Satellite Beach, Florida, April 2, 2008.
- Nadeau, R.M., Nonvolcanic Tremor and the M6.5 San Simeon and M6.0 Parkfield Earthquakes in Central California, Institut de Physique du Globe de Paris Departement de Sismologie seminar, Paris, France, June 24, 2008.
- Romanowicz, B., The Earth's hum: bridging the gap between seismology and oceanography, US Geological Survey, Menlo Park, CA, October 2007.
- Romanowicz, B., Seismological Constraints on the deep structure of continents, Smith Lecture, University of Michigan, Ann Arbor, MI, October 2007.
- Romanowicz, B., Global and regional mantle tomography by inversion of time domain seismic waveforms, Institute of Geophysics, Chinese Academy of Sciences, Beijing, China, February 2008.
- Romanowicz, B., Global and regional mantle tomography by inversion of time domain seismic waveforms, Chinese Earthquake Administration, Beijing, China, February 2008.
- Romanowicz, B., The Earth's hum: bridging the gap between seismology and oceanography, Peking University, Department of Geophysics, Beijing, China, February 2008.
- Romanowicz, B., Elastic and anelastic tomography of the Earth's mantle: Inferences on global dynamics, Earthquake Research Institute, University of Tokyo, Tokyo, Japan, March 2008.
- Romanowicz, B., Elastic and anelastic tomography of the Earth's mantle: Inferences on global dynamics, IFREE, Yokohama, Japan (Institute for Research on the Earth and Environment), March 2008.
- Romanowicz, B., The Earth's hum: bridging the gap between seismology and oceanography, Kyoto University, Kyoto, Japan, March 2008.
- Romanowicz, B., Elastic and anelastic tomography of the Earth's mantle: Inferences on global dynamics, Rice University, Houston, Texas, March 26, 2008.
- Romanowicz, B., Global Earth Structure in the context of global broadband seismic networks, Science Advisory Committee meeting for Geoscope, Paris, France, April 2008.
- Ryder, I., Probing the deep rheology of Tibet using satellite imagery, Rosenstiel School of Marine and Atmospheric Science, University of Miami, May 7, 2008.
- Uhrhammer, R., Earthquakes, Albany Rotary Club, Albany, CA, July 15, 2007.
- Uhrhammer, R., Seismology, Berkeley Rotary Club, Berkeley, CA, September 15, 2007.
- Uhrhammer, R., California Earthquakes, Redwood Empire DX Association, Petaluma, CA, April 9, 2008.

## Panels and Professional Service

### Richard M. Allen

Member, IRIS PASSCAL Standing Committee, December 2007-present  
 Organizer of the "ElarmS Users Workshop" May 5-16 2008, attendees from  
 Korea, Germany, Switzerland, Puerto, Rico, and the Pacific Tsunami Warning Center  
 U.S. participant in the European Commission project "Seismic Early Warning Across Europe,"  
 June 2006 to June 2009

### Roland Bürgmann

Associate Editor, Bulletin of the Seismological Society of America  
 Editorial Advisory Board, Eos  
 Editorial Board, Earth and Planetary Science Letters  
 Elected member, SSA Board Of Directors  
 Chair, EarthScope PBO Standing Committee  
 Member, UC Berkeley Graduate Fellowship Committee  
 Organizing Committee of Third Conference on Earthquake Hazards in the Eastern San Francisco Bay Area

## **Douglas S. Dreger**

Member, COSMOS Board of Directors  
Member, Golden Gate Bridge Instrumentation Committee  
Reviewer of manuscripts for BSSA, GRL, JGR, and PRL.  
Reviewer of proposals submitted to NSF and NNSA.  
Associate Director, BSL, 2002-  
Acting Director, BSL, Jan-July, 2008

## **Margaret Hellweg**

Member, CISN Program Management Committee  
Member, CISN Standards Committee  
Member, CISN Steering Committee  
Member, CISN Outreach Committee  
Member, 1868 Commemoration Committee  
Member, 1868 Commemoration Executive Committee  
Member, Organizing Committee, Third Conference on East Bay Earthquake Hazards (October 21-25, 2008)  
Member, Editorial Board of Journal of Volcanology and Geothermal Research  
Chair, 1868 Committee for Developing Education and Outreach Materials and Programs  
Contributed earthquake sounds to Bates, M., "Music from Underground Spaces (World Premier)"  
orchestra and electronica, California Symphony, May 4 and 6, 2008, Leshner Center for the  
Arts, Walnut Creek, CA

## **Douglas S. Neuhauser**

Chair, Standards Group, California Integrated Seismic Network (CISN)  
Acting Member, CISN Program Management Committee

## **Barbara Romanowicz**

Reviewing Editor for Science  
Seismology Coordinator, International Scientific Review of the IMS  
Member, AGU Fellows Committee  
Member, Advisory Committee for College de France, Paris, France  
Member, Conseil d'Administration, Institut de Physique du Globe, Paris, France  
Member, Conseil scientifique, Institut pour la Recherche et le Développement, France  
Member, Advisory Committee, Geophysical Institute, University of Alaska, Fairbanks  
Member, Scientific Review committee for the Geoforschungs Zentrum (GFZ), Potsdam, Germany (Spring 2008)  
Member, National Earthquake Prediction Evaluation Council  
Member, CISN Steering Committee  
Member, NRC's Board on Earth Sciences and Resources (BESR)  
Lead organizer, CIDER 2008 summer program in Santa Barbara  
Co-organizer, Workshop on Ocean floor observatories, JAMSTEC, Tokyo, Japan, March 2008

## **Robert A. Uhrhammer**

Member, International Association of Seismology and Physics of the Earths Interior, Working Group on Magnitudes  
Member, California Integrated Seismic Network, Magnitude Working Group  
Member, American National Seismic System, Technical Integration Committee, Working Group D, Seismic  
Instrumentation

## Appendix II Seminar Speakers 2007-2008

HUAIYU YUAN

Berkeley Seismological Laboratory  
UC Berkeley

*"Yellowstone hotspot system: plume interaction with old cratonic continent"*

Tuesday, August 28, 2007

BERNARD CHOUET

USGS Menlo Park

*"Shallow magma transport pathway under Kilauea Caldera imaged from waveform inversions of very-long-period seismic data"*

Tuesday, September 4, 2007

NATHAN SIMMONS

Lawrence Livermore National Laboratory

*"Mantle Heterogeneity and Flow from Seismic and Geodynamic Constraints"*

Tuesday September 11, 2007

SHUO MA

Stanford

*"Dynamic Modeling of the 2004 Mw 6.0 Parkfield Earthquake"*

Tuesday, September 18, 2007

DAVID SHELLY

UC Berkeley

Department of Earth and Planetary Science

*"A new look at episodic transient slip through precise tremor locations in Japan: "fast" sub-events and tidal triggering"*

Tuesday, September 25, 2007

THORNE LAY

UC Santa Cruz

*"Seismic Migrations For Imaging "Rough" Upper and Lower Mantle Structure"*

Tuesday, October 2, 2007

BILL ELLSWORTH

USGS Menlo Park

*"Earthquake Science in the Source: Fault Rocks and Earthquakes in the Near Field in the San Andreas Fault Observatory at Depth"*

Tuesday, October 9, 2007

DAVID SCHWARTZ

USGS Menlo Park

*"A Tale of Two Earthquake Cycles: the San Francisco Bay Area, AD 1600-2007; the Denali Fault System, Alaska, AD 800-2007"*

Tuesday, October 16

JOE DUFEK

UC Berkeley

Department of Earth and Planetary Science

*"The growth and eruption of large silicic magma bodies"*

Tuesday, October 23, 2007

JENNIFER JACKSON

Caltech

*"Wave velocities of minerals at high-pressure and temperature: Geophysical implications"*

Tuesday, October 30, 2007

LARRY HUTCHINGS

Lawrence Berkeley National Laboratory

*"A Physically-based Strong Ground Motion Prediction Methodology Applied to the SFO Bay Bridge"*

Tuesday, November 6, 2007

DAVID BOWMAN

CSU at Fullerton

*"Getting Ready for a Big One: Accelerating Seismicity and Earthquake Predictability"*

Tuesday, November 13, 2007

KEN CREAGER

University of Washington

*"Episodic Tremor and Slip"*

Tuesday, November 20, 2007

MEI XUE

Berkeley Seismological Laboratory

UC Berkeley

*"High resolution imaging of the western USA: Interaction between the Yellowstone plume and Cascadia subduction?"*

Tuesday, December 4, 2007

TAKA'AKI TIARA

University of Utah

*"Stress-induced temporal changes in the seismogenic crust at the San Andreas Fault zone"*

Tuesday, January 22, 2008

MEGHAN MILLER

Rice University

*"The Caribbean: from the crust to the core"*

Tuesday, January 29, 2008

KAREN FISCHER

Brown University

*“Subduction zone structure, dynamics and melting processes: Lessons from Central America”*

Tuesday, February 5, 2008

MARIE LUCE-CHEVALIER

Stanford University

*“Determination, by  $^{10}\text{Be}$  cosmogenic dating, of slip-rates on the Karakorum Fault (Tibet) and paleoclimatic evolution since 200ka”*

Tuesday, February 12, 2008

JESSE LAWRENCE

Stanford University

*“The Quake Catcher Network & Distributed Computing Seismology”*

Tuesday, February 19, 2008

LAURENT STEHLY

Berkeley Seismological Laboratory

UC Berkeley

*“Surface waves tomography from observations of seismic ambient noise”*

Tuesday, February 26, 2008

MARCO BOHNHOFF

Stanford University

*“Seismotectonic Setting of the Aegean-Anatolian region”*

Tuesday, March 4, 2008

JAY MELOSH

University of Arizona

*“Landslides, Impact Craters and Earthquakes: The Paradoxical Behavior of Sliding Rock en Masse”*

Tuesday, March 18, 2008

Lawson Lecture

ROLAND BÜRGMANN

Berkeley Seismological Laboratory

UC Berkeley

*“A tectonic time bomb in our backyard: Earthquake potential of the Hayward fault”*

Wednesday, April 9, 2008

WU-CHENG CHI

Academia Sinica, Taiwan

*“Seismological, Oceanic, and Metrological Phenomena Observed by Ocean Bottom Seismographs: An Example from Taiwan”*

Tuesday, April 22, 2008

THOMAS L. HOLZER

USGS Menlo Park

*“Probabilistic mapping of liquefaction hazard in the San Francisco Bay Area”*

Tuesday, April 29, 2008

REBECCA HARRINGTON

UCLA

*“Volcanic hybrids that are brittle failure events”*

Tuesday, May 6, 2008

BRIAN STUMP

Southern Methodist University

*“Combining high frequency seismic and infrasound signals for characterizing propagation paths in both the atmosphere and the solid earth”*

Tuesday, May 13, 2008

DAYANTHIE WEERARATNE

CSU Northridge

*“Seismic and Rheological Behavior of the Asthenosphere Beneath Intraplate Seamount Chains in the South Pacific”*

Tuesday, May 20, 2008

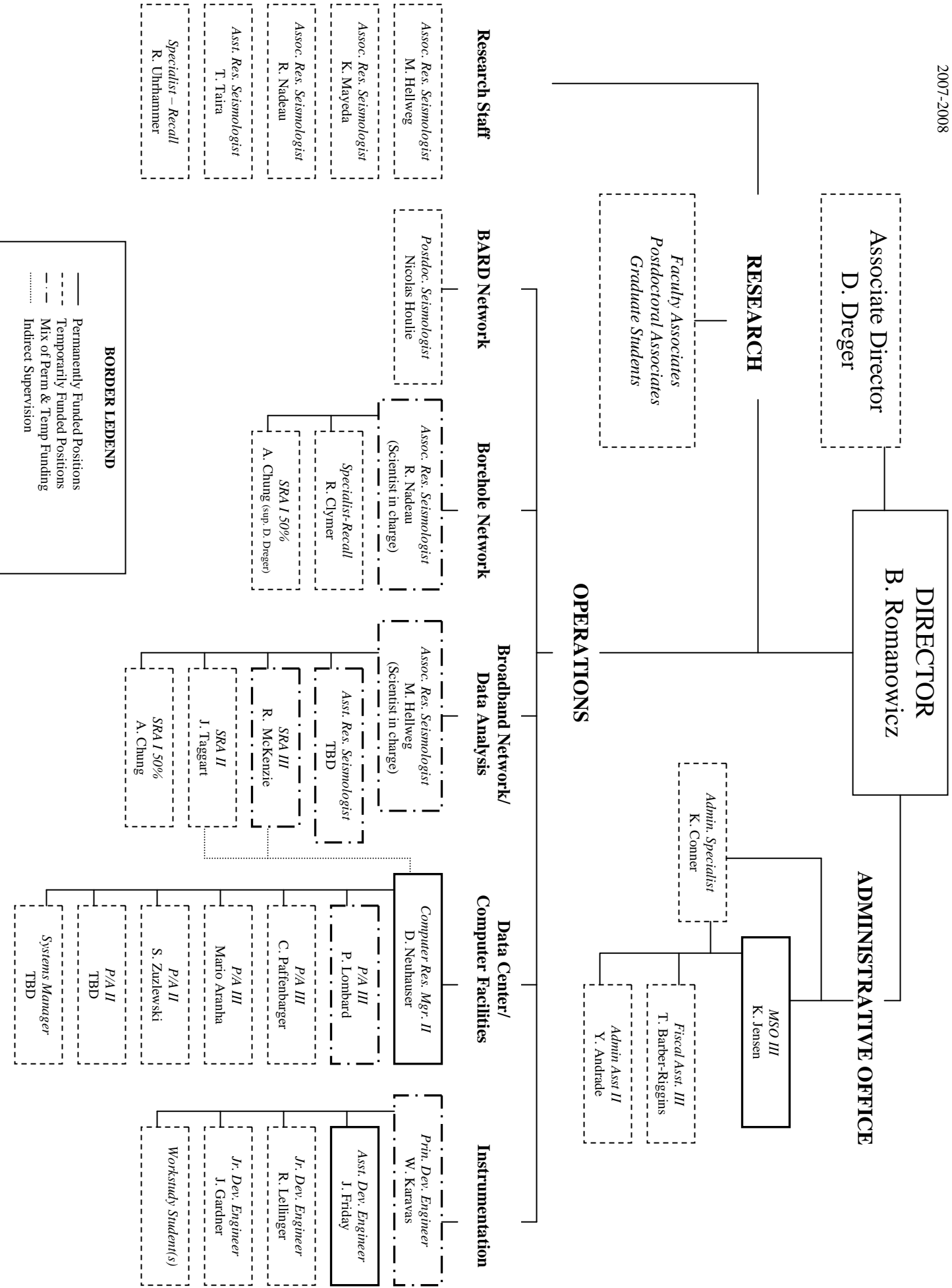

**BORDER LEGEND**

- Permanently Funded Positions
- - - - - Temporarily Funded Positions
- · - · - Mix of Perm & Temp Funding
- ..... Indirect Supervision