

# DESIGN AND EARLY OBSERVATIONS FROM THE DSCOVR SOLAR WIND FARADAY CUP

Justin Kasper (University of Michigan)

Tony Case, Mike Stevens (SAO)

Adam Szabo, Andriy Koval (GSFC)

With gratitude to the incredible commissioning and  
operations teams at NASA and NOAA

# SUMMARY

- DSCOVR/PlasMag Faraday Cup records stable and radiation tolerant measurements of solar wind velocity, density, and temperature
  - 200 – 1,200 km/s proton velocity distribution @ 3s
  - Low calibration drift ~ 0.1%/decade
  - Insensitive to ionizing radiation
- Status
  - Completed: HV ramp up, software patches, performance optimization
  - Entered optimized performance configuration in April
  - Monitoring performance, calibration, working on improvement to tracking software
- Examples here
  - Raw data, shocks, Wind-comparison, magnetic reconnection, science result: solar wind is colder than we thought!

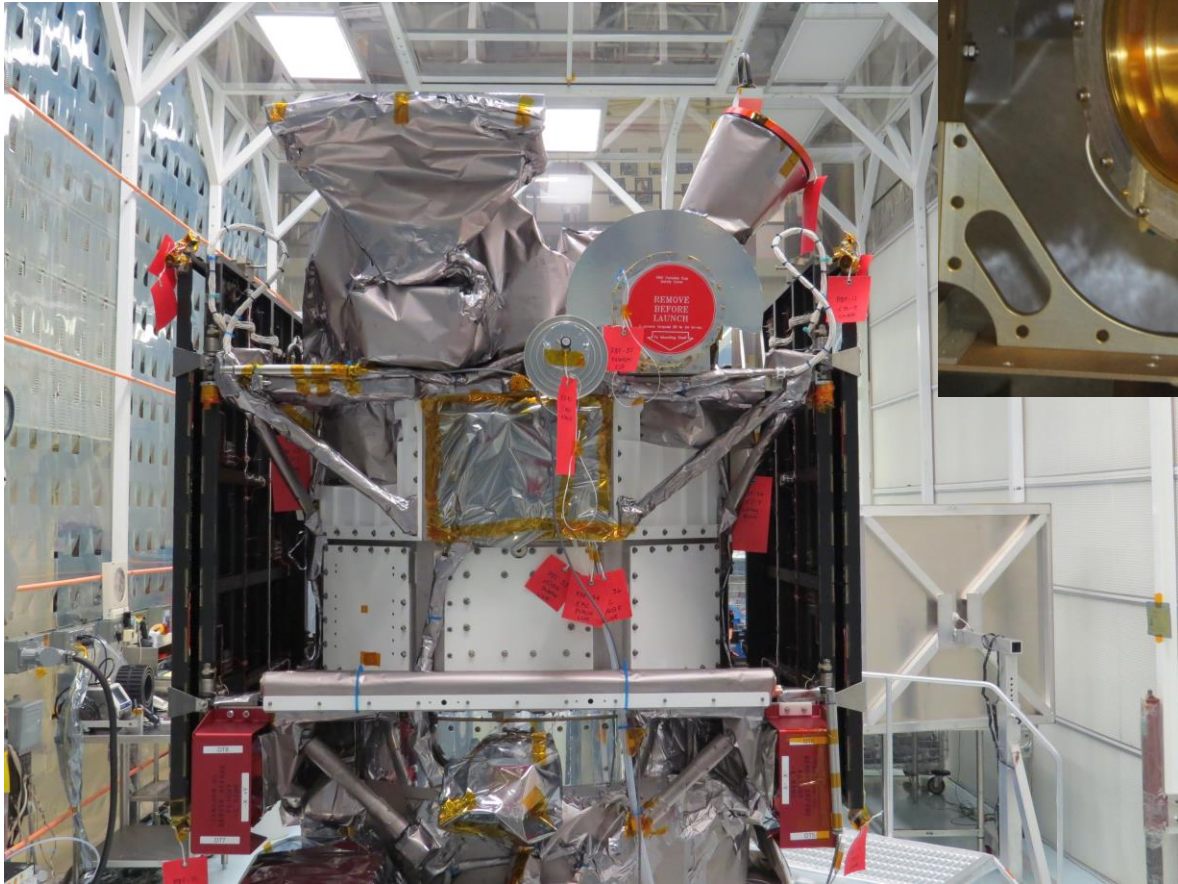
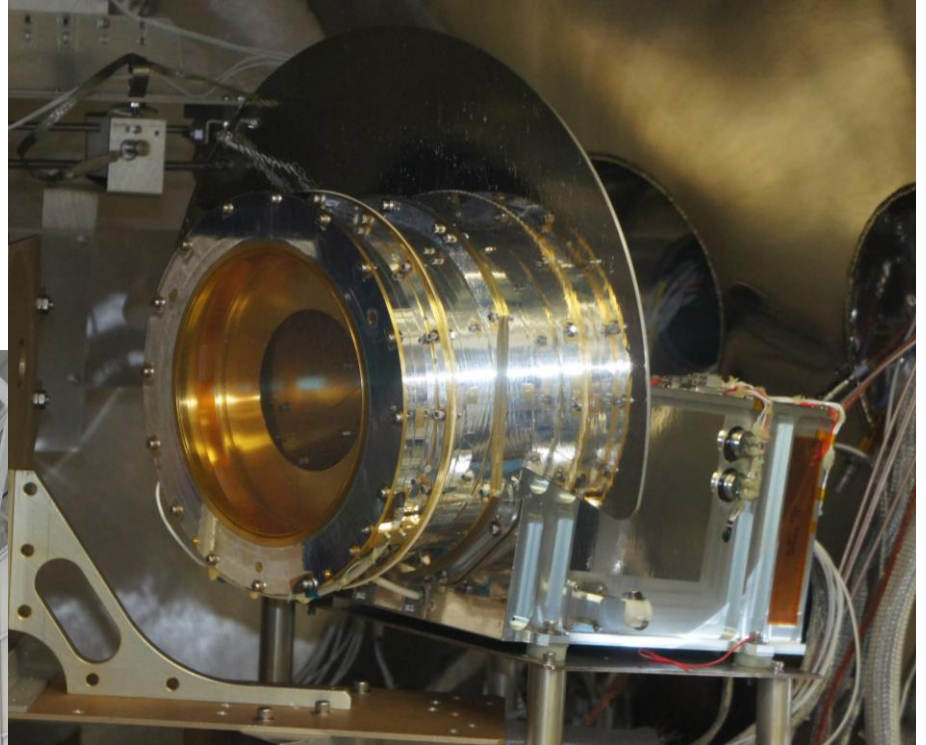
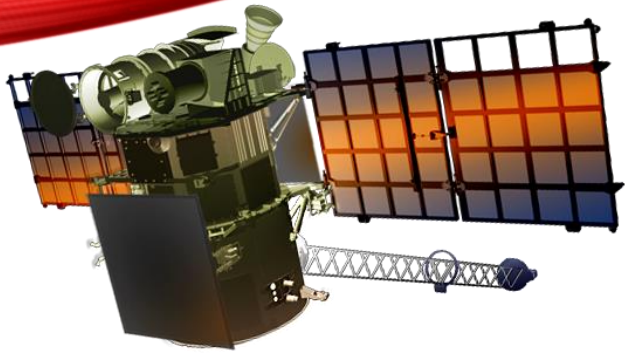

# FARADAY CUP TEAM

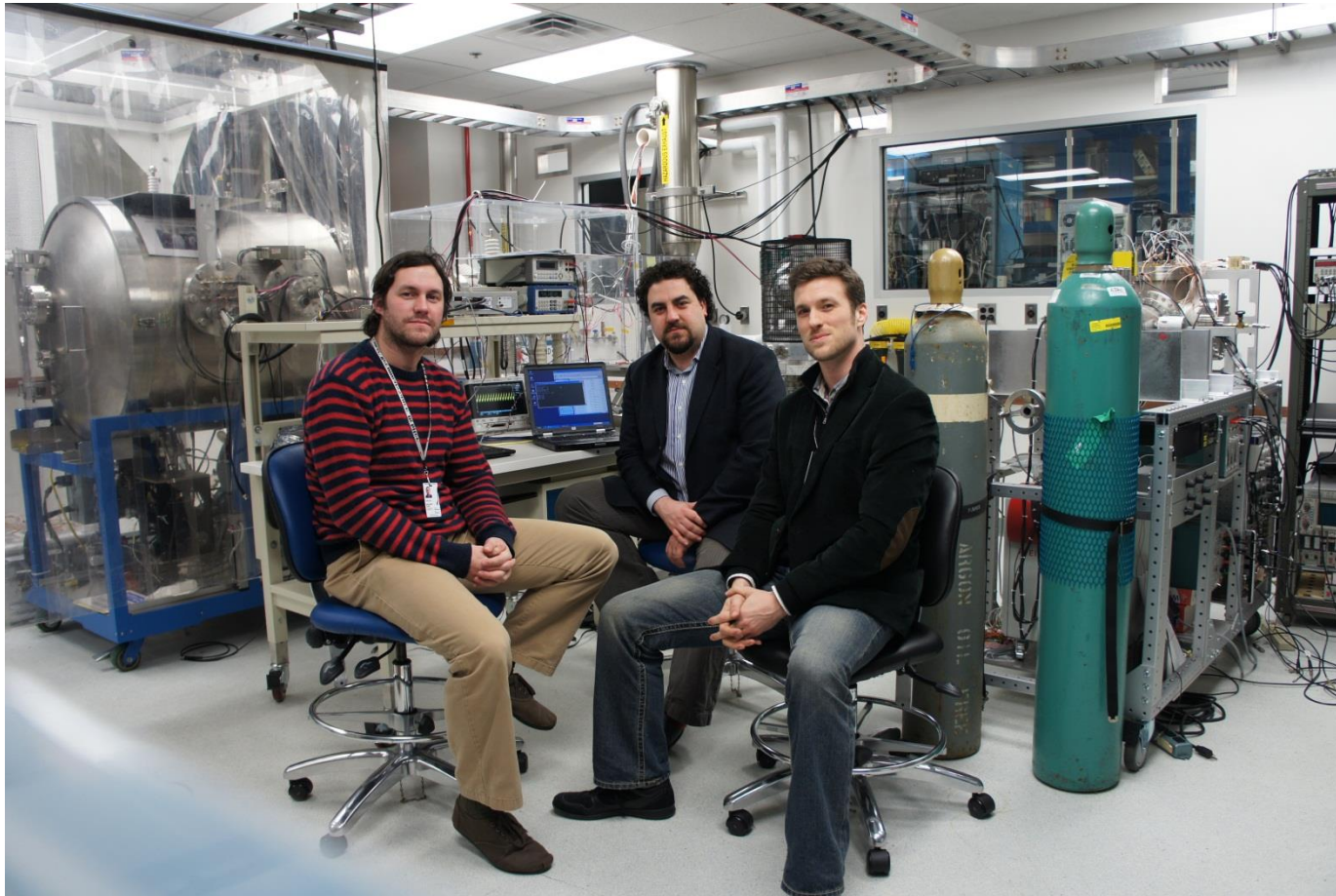

- Left: Tony Case (SAO), hardware lead
- Middle: Justin Kasper (Michigan), instrument lead
- Right: Michael Stevens (SAO): software lead

# ITS BEEN A WHILE!

2000



2013

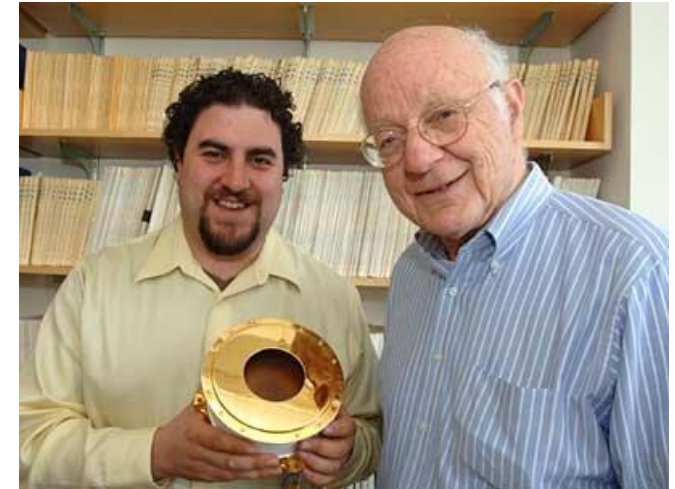

DSCOVN/FC conceived and led by Dr. Alan Lazarus

Fabricated from spare parts procured in 1988 for Wind/FC

Intended in part as technology demonstrator for Solar Probe

# CONCEPT OF OPERATIONS

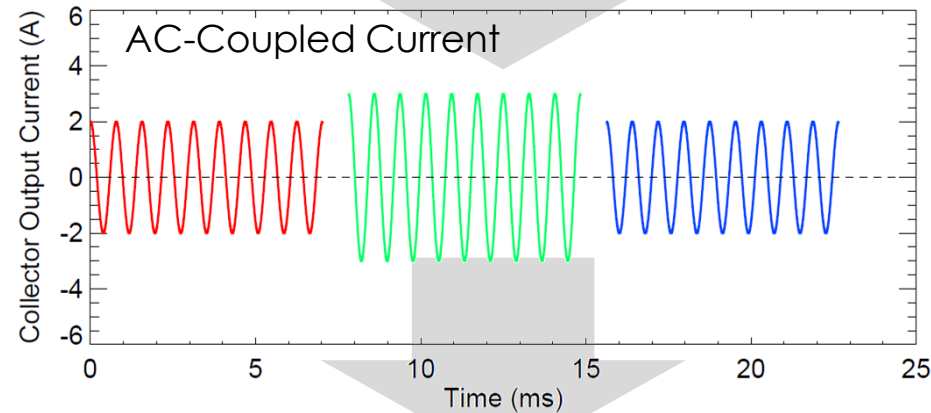
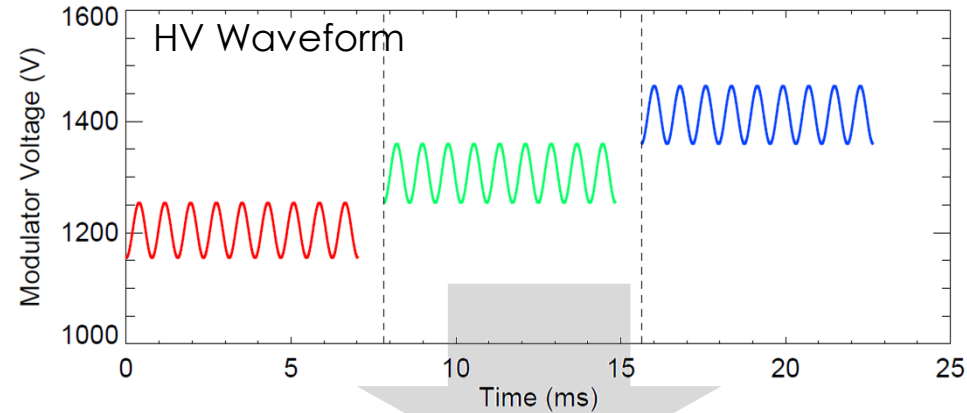
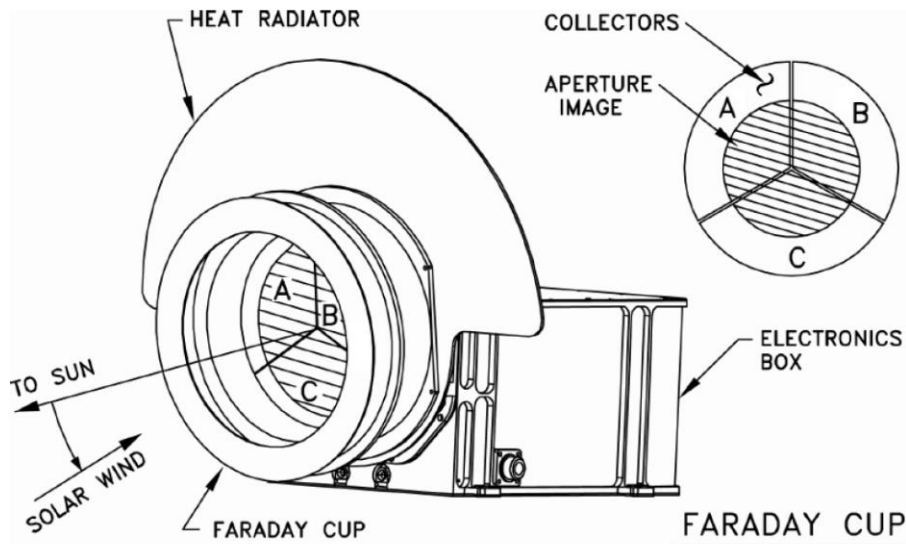
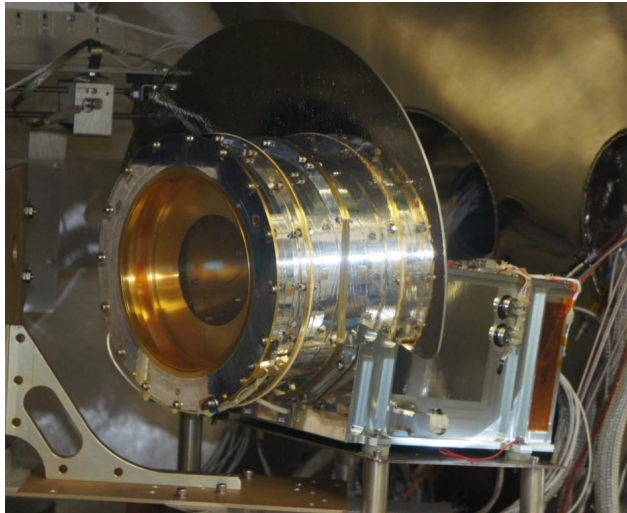

Convert current to voltage, AC couple,  
invert half the signal and integrate  
Digitize log of integrated current  
Move on to next energy window

# BLOCK DIAGRAM

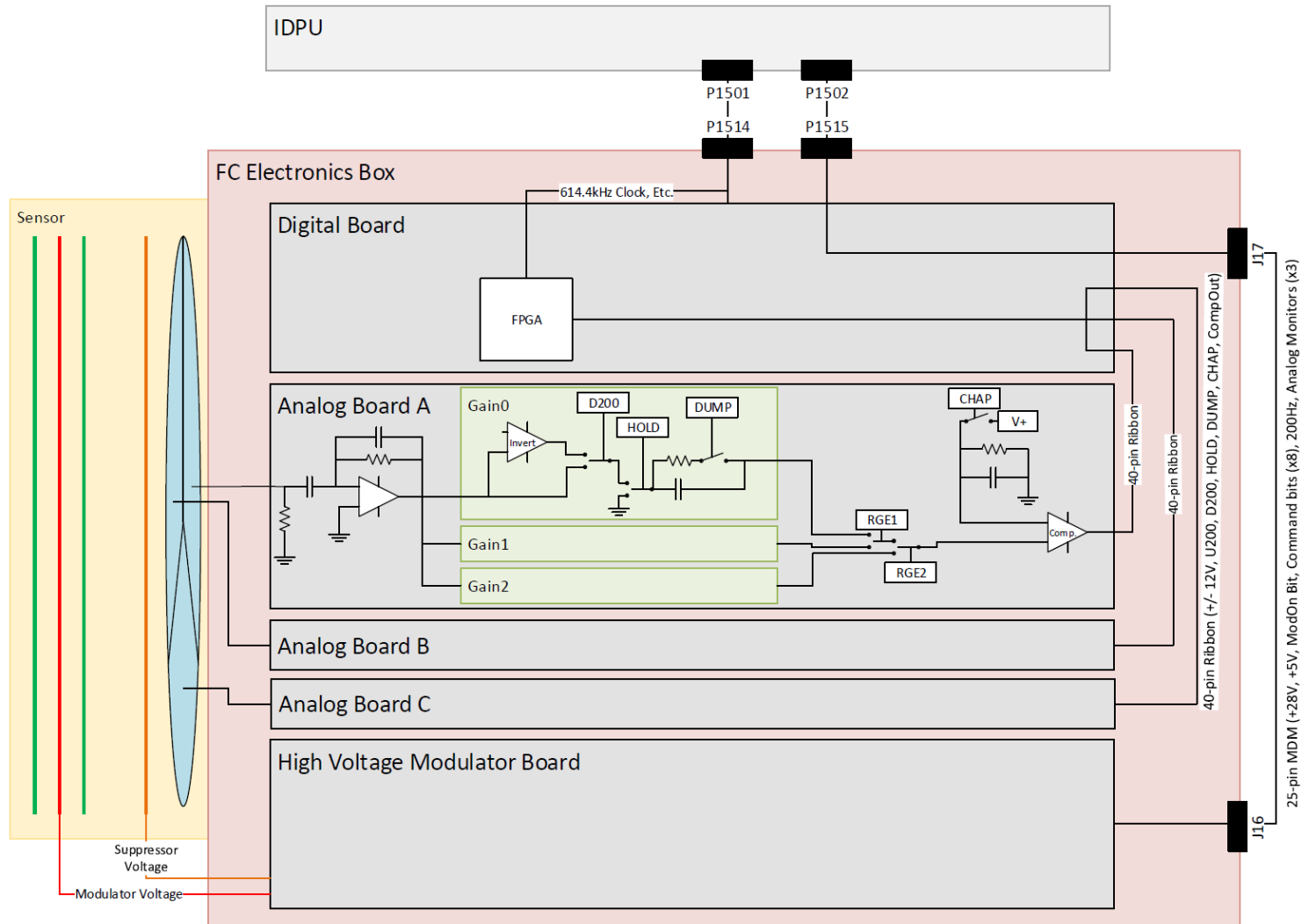

# THE FARADAY CUP IS FAST!

- DSCOVR/FC can generally resolve plasma and field structure smaller than a single convected proton gyro-radius in the solar wind
- This high cadence permits robust solar wind determination with filtering for space weather, but it also permits unique new science
  - Shocks
  - Waves
  - Magnetic reconnection

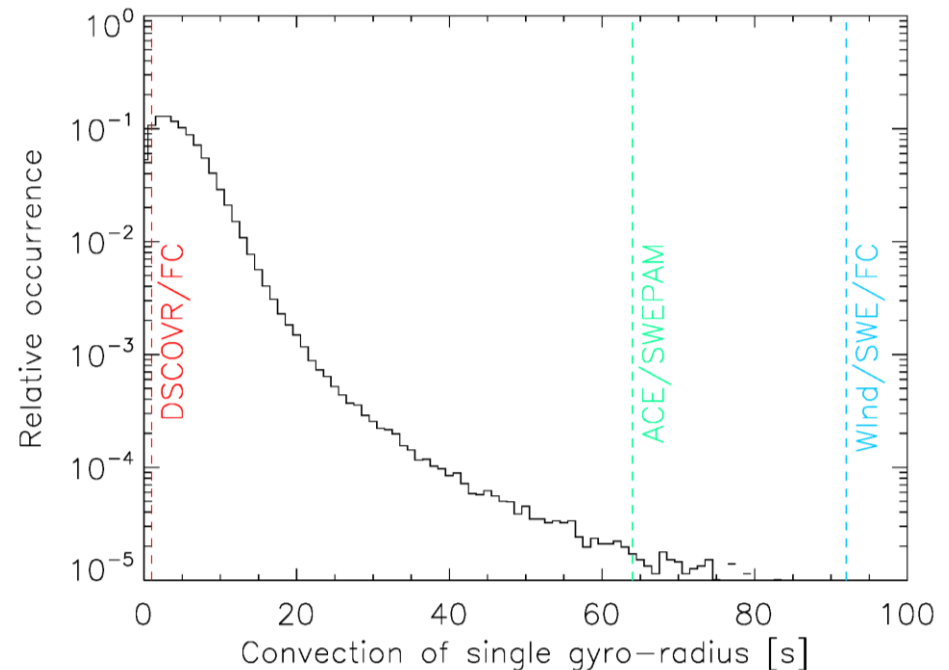



# RADIATION TOLERANT

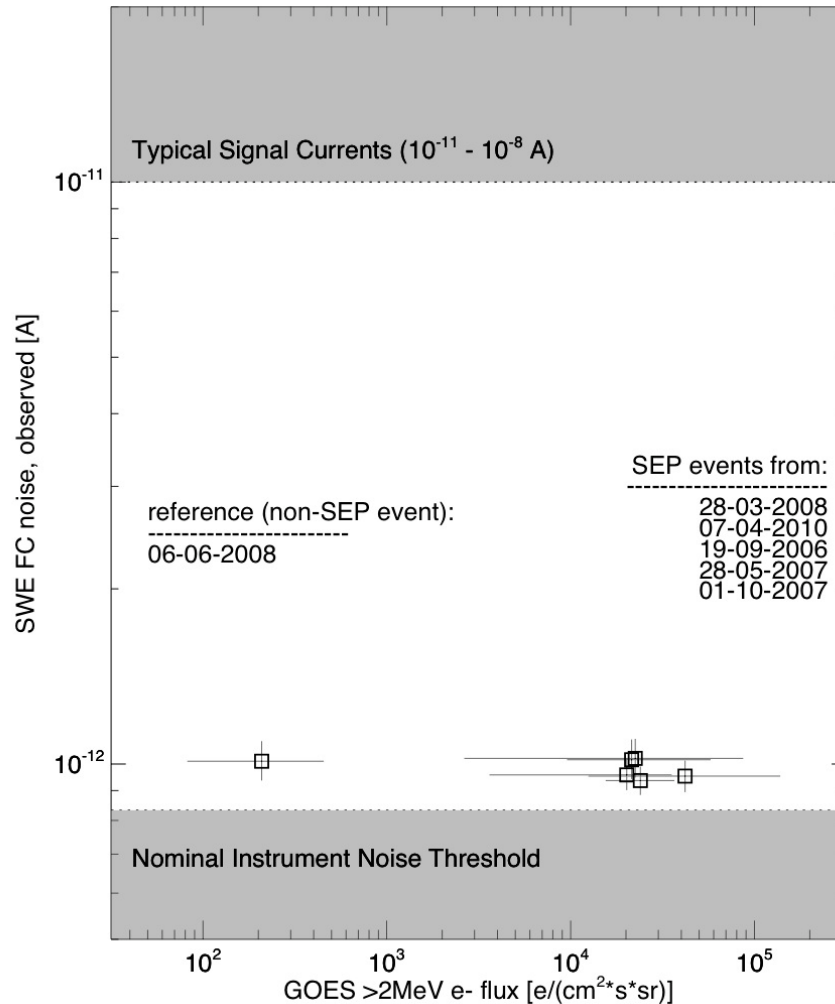

- Faraday Cup detectors are just metal plates – no radiation damage
- Synchronous detection means ionizing radiation doesn't generate detectable signal
- Surveys with Wind Faraday Cup instrument background show no trend with SEP flux (yes, understand GOES wasn't a good choice for this graphic)

# RESPONSE IS VERY STABLE

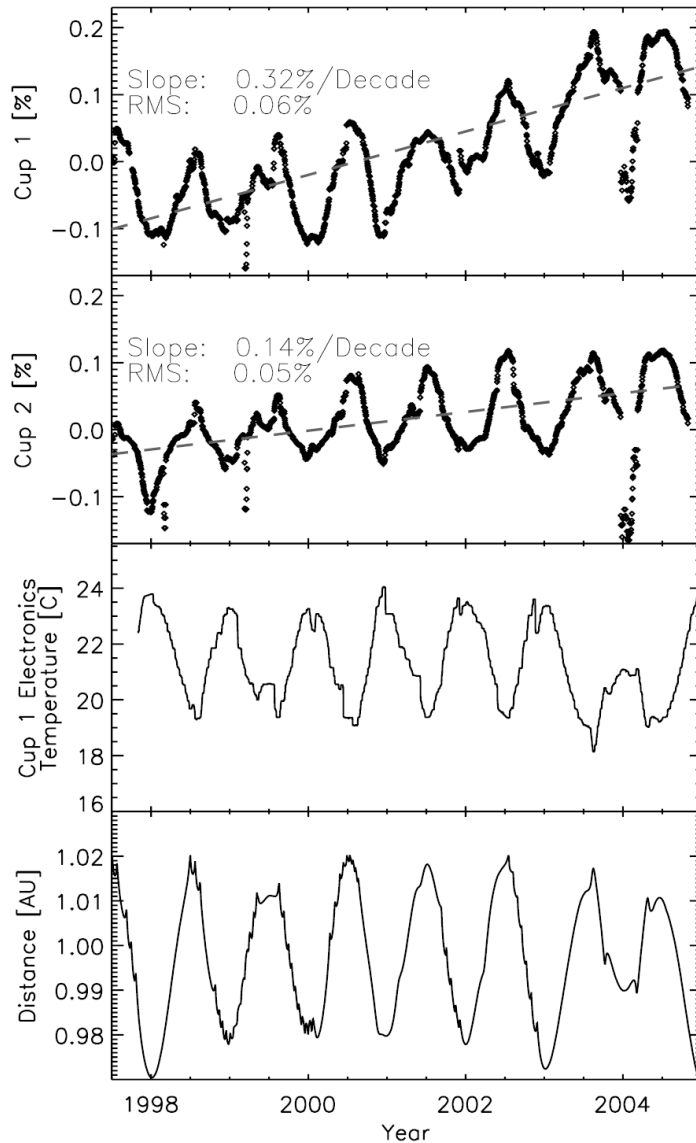

DSCOV/FC < 0.1% drift in calibration between 2001 and 2015 (Below)

Consistent with Wind/FC in flight stability (Left; Kasper et al, 2005)

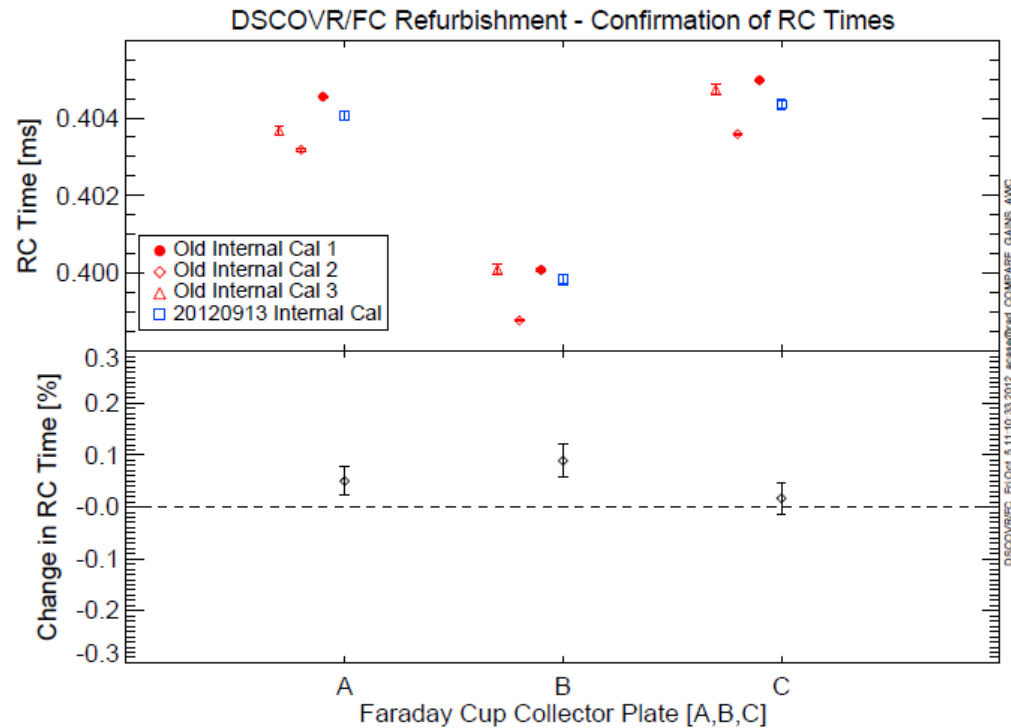

# INITIAL OBSERVATIONS



# RAW DATA – VELOCITY SPECTRA

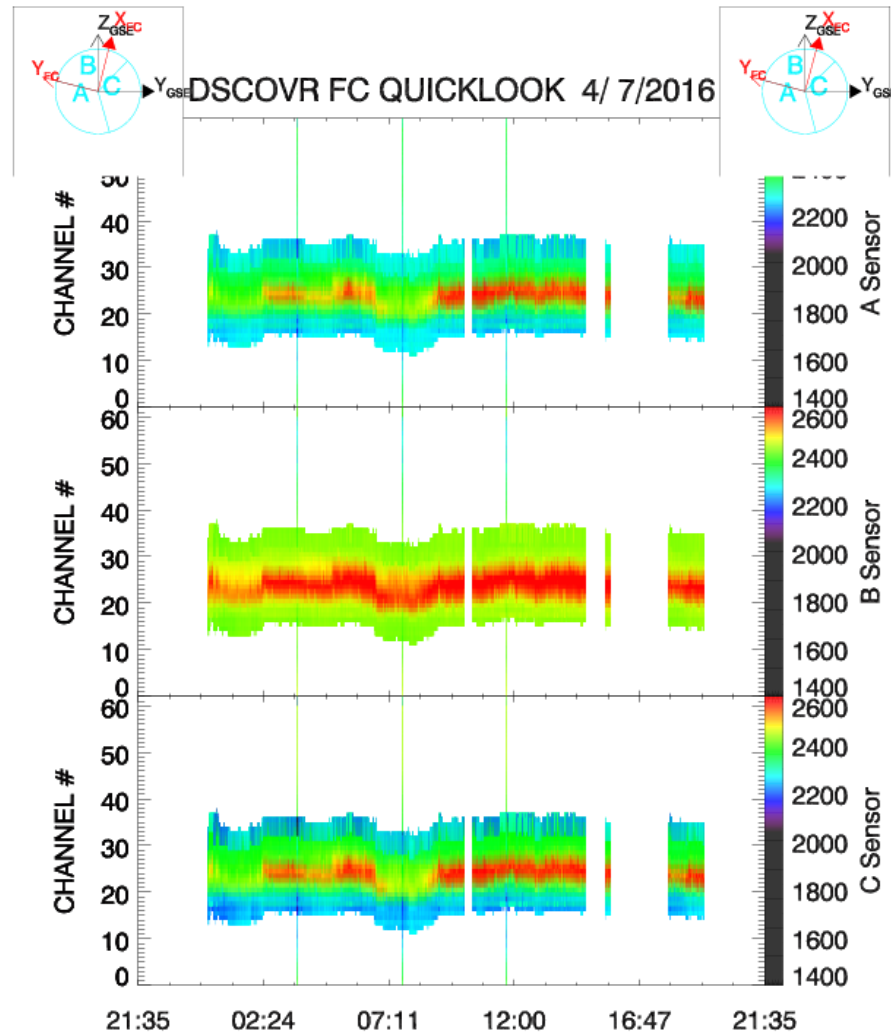

# OUR FIRST SHOCK

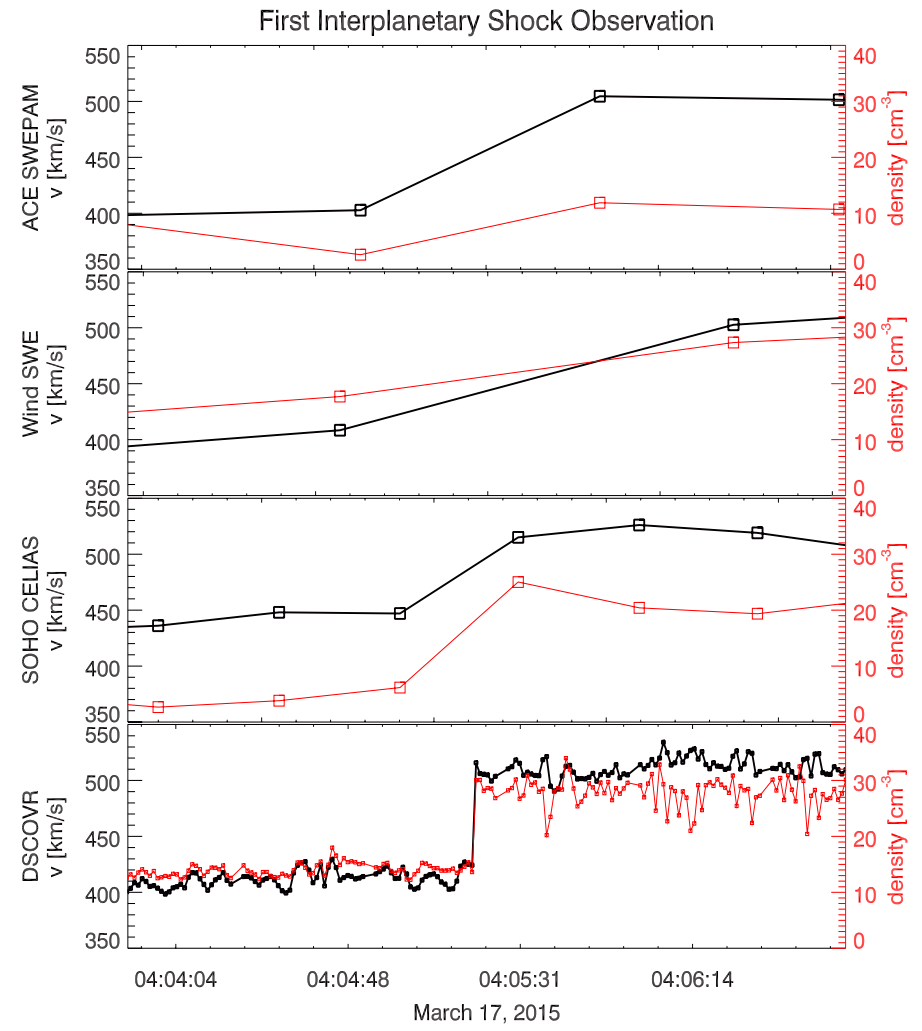
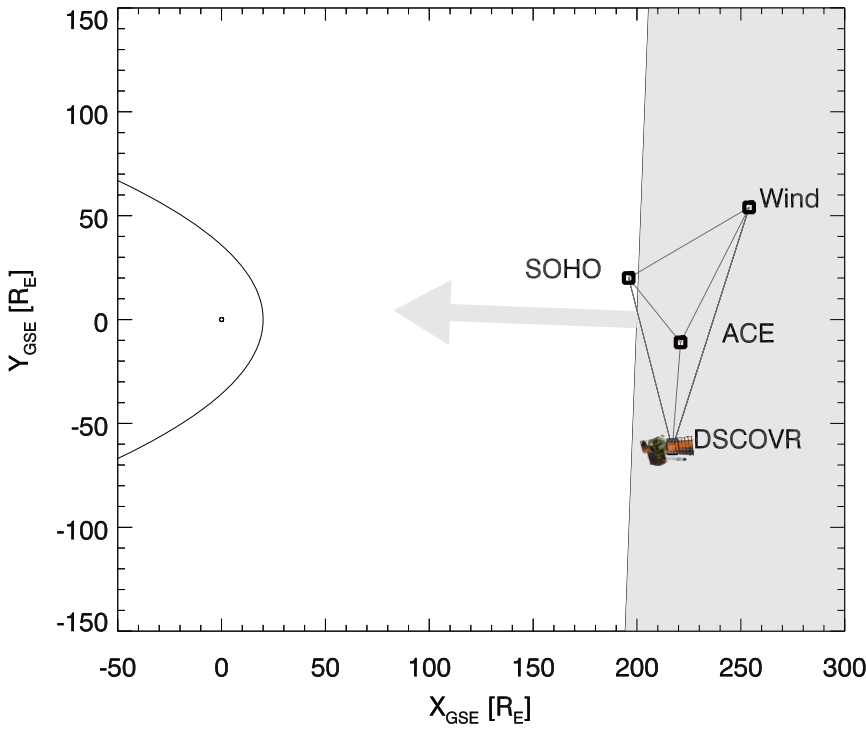

# LAST 30 DAYS WIND AND DSCOVER

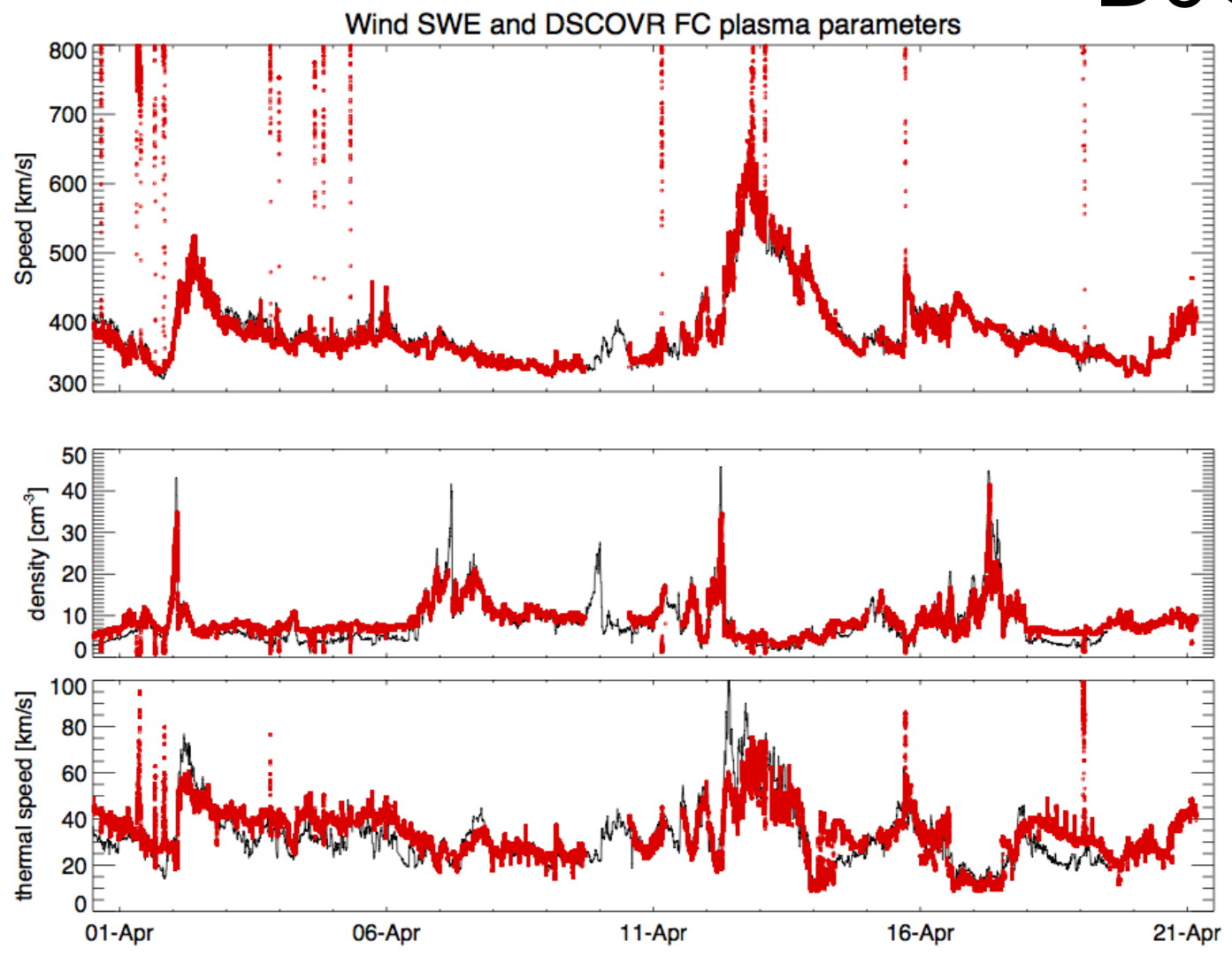

# SPEED COMPARISON

April 2016, 5-minute averages  
column-normalized histogram

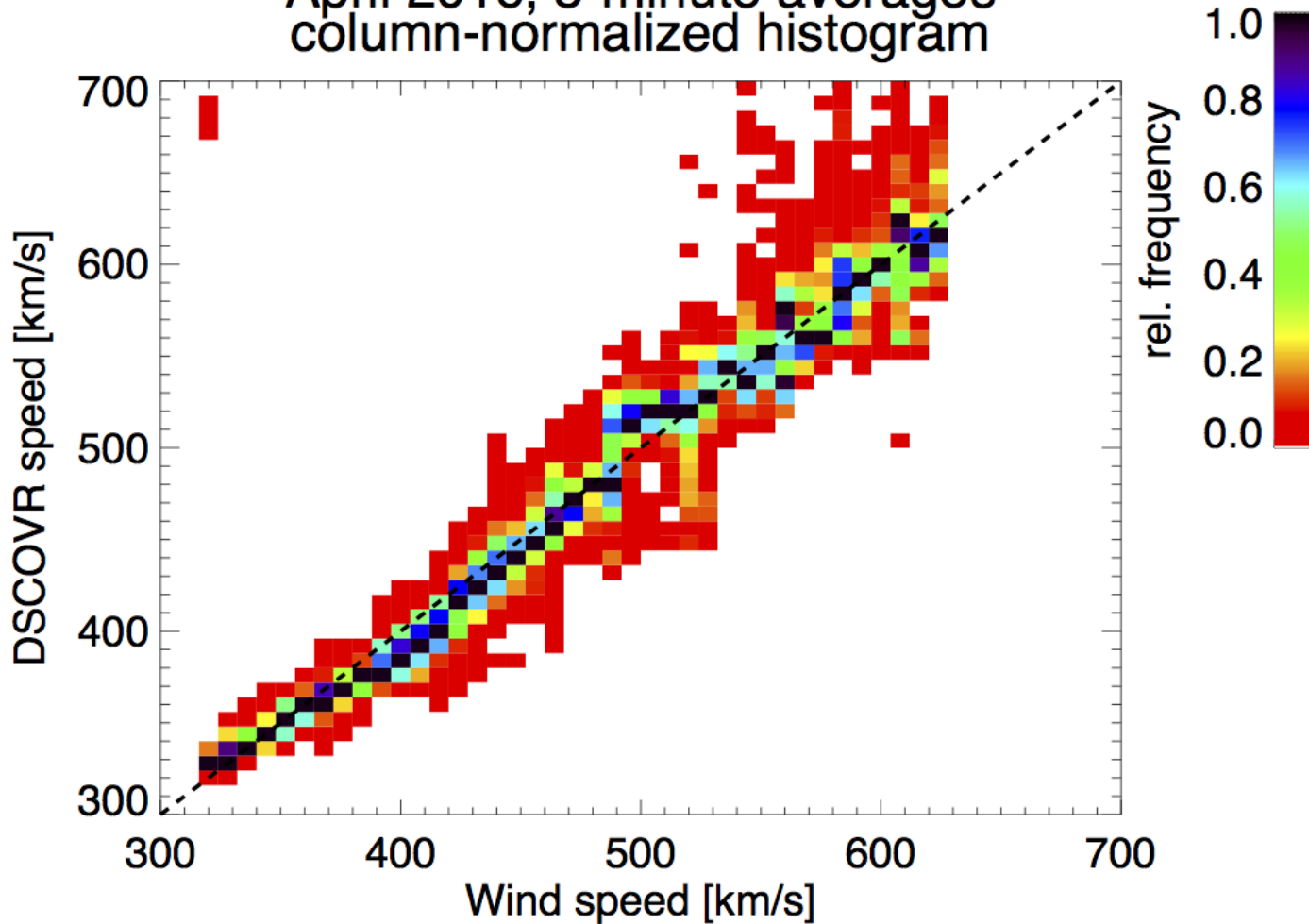

# DENSITY COMPARISON

April 2016, 5-minute averages  
column-normalized histogram

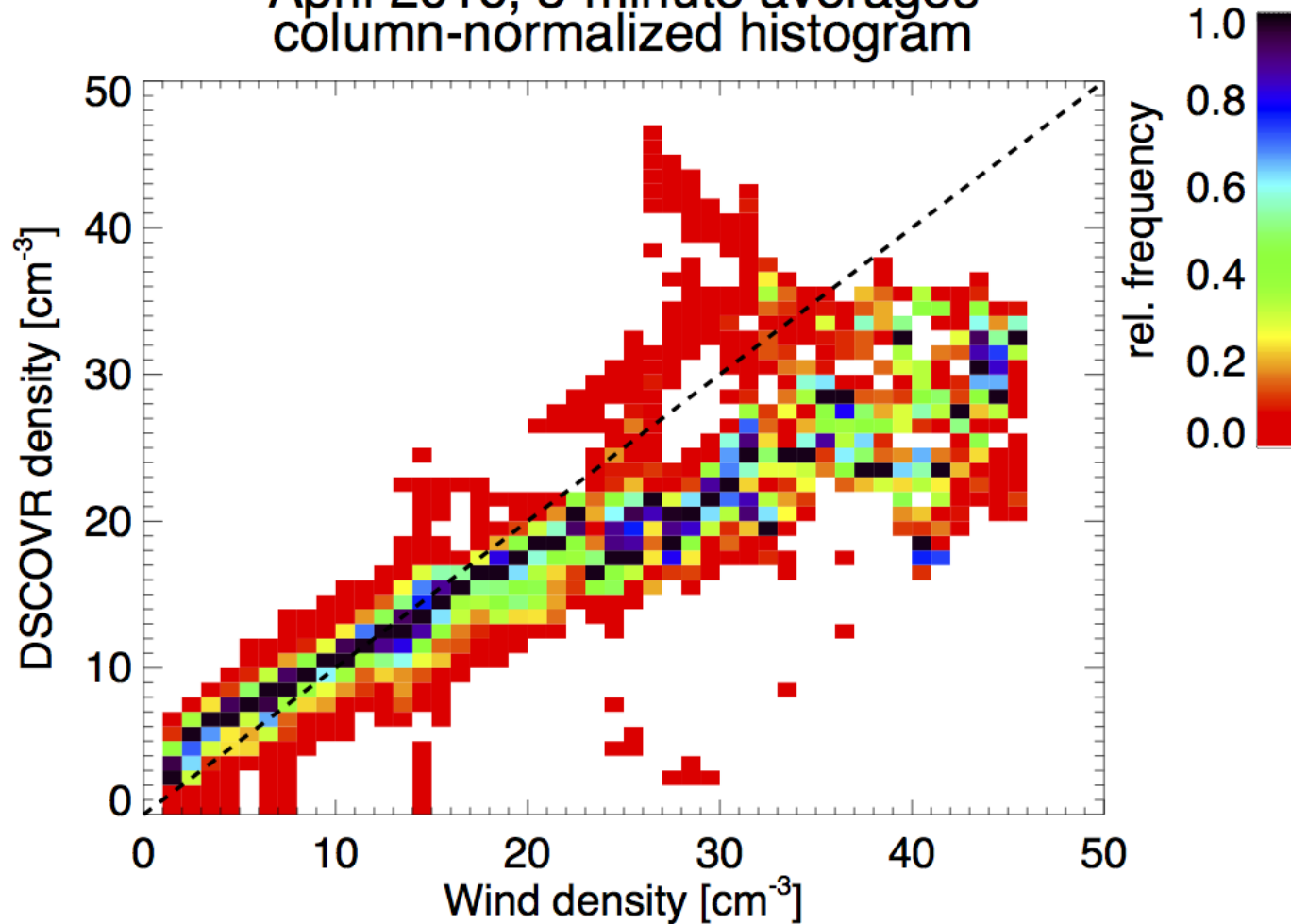



# TEMPERATURE COMPARISON

April 2016, 5-minute averages  
column-normalized histogram

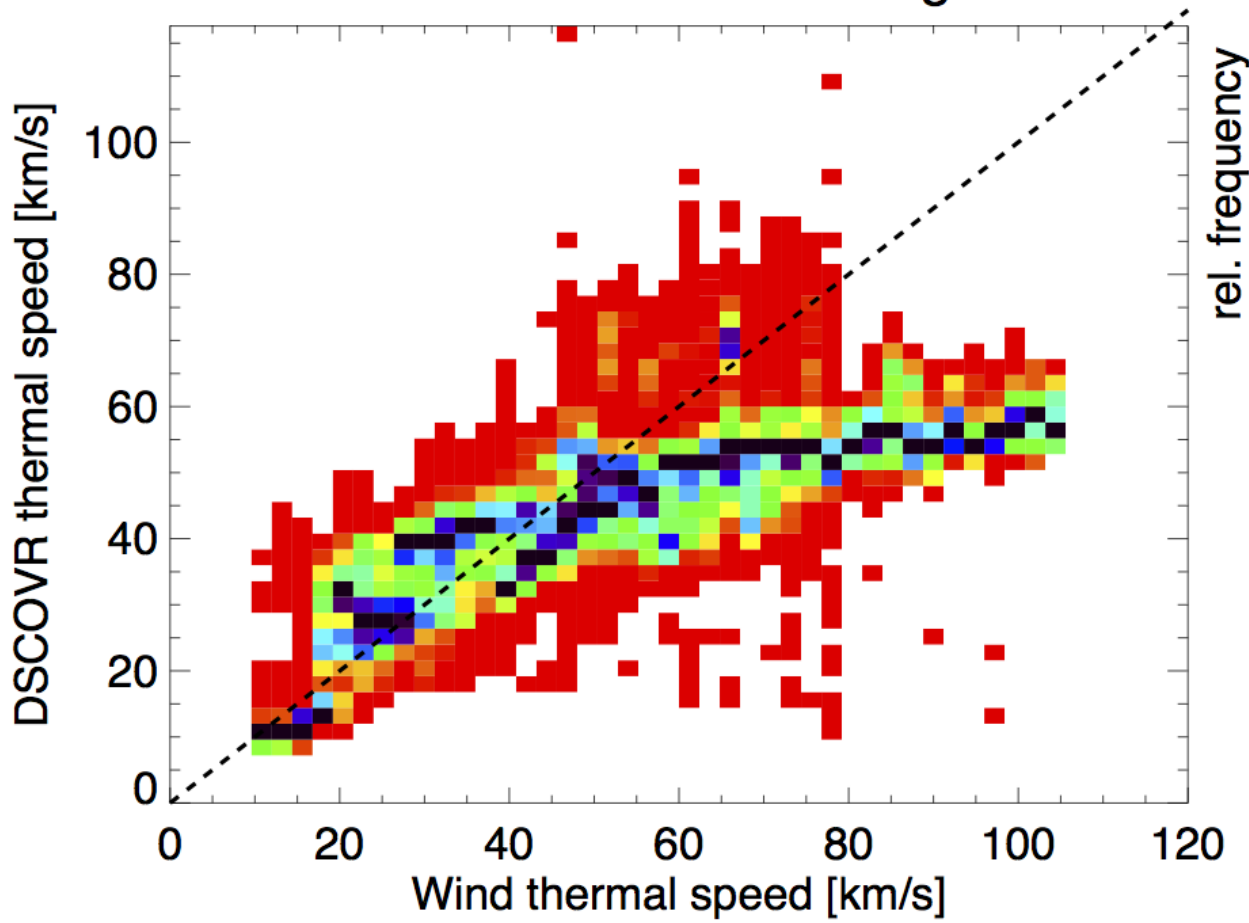

Investigating sources of differences. So far: moment vs fitting and faster resolution of DSCOVR are factors (see next slides)

# SIMILAR TREND SEEN IN WIND DATA

Temperature determined through robust moment calculation

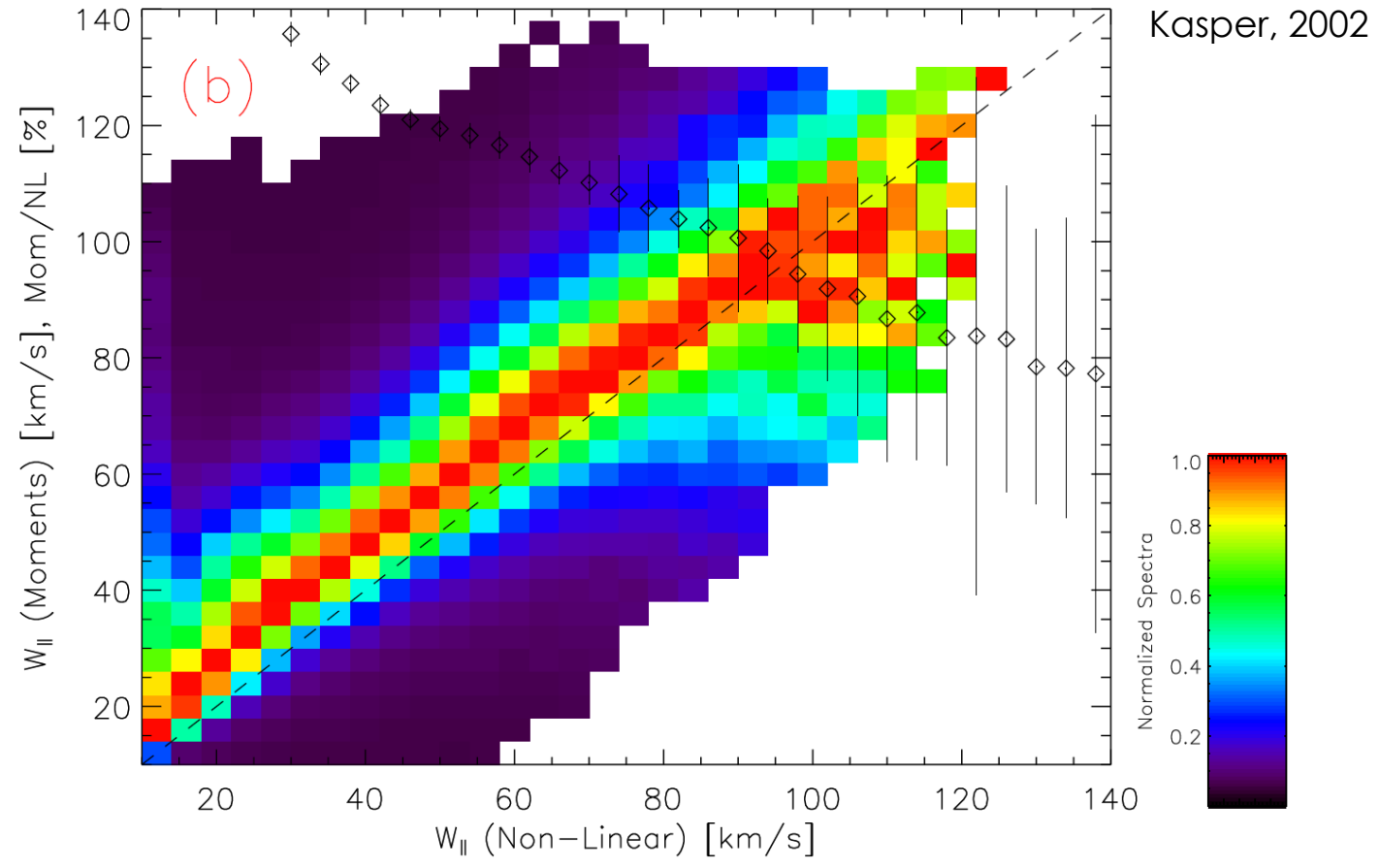

Temperature determined through non-linear fitting of model to data

ANOTHER FACTOR:  
DSCOVR/FC SHOWS US SOLAR  
WIND IS COLDER THAN WE  
THOUGHT!



# SOLAR WIND IS FULL OF TURBULENCE

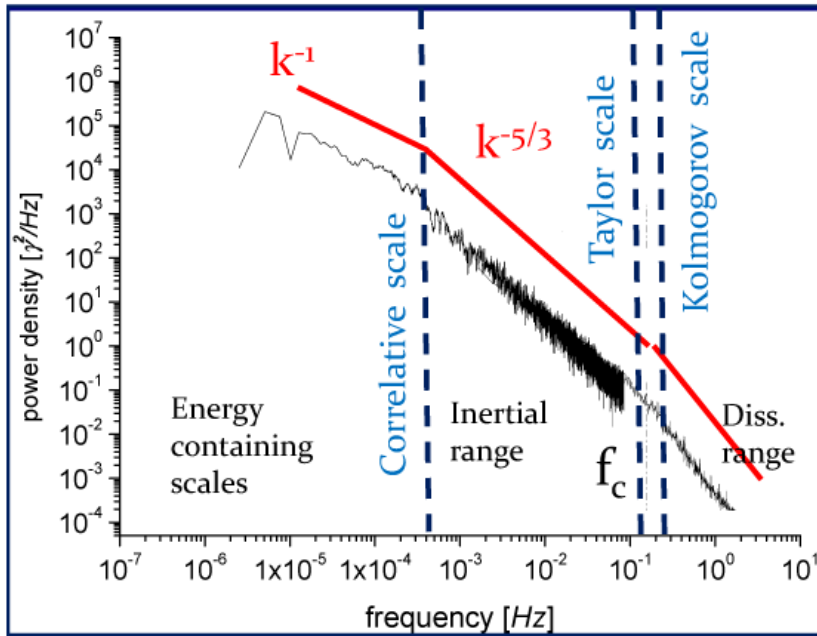

Bruno et al, 2015 (ad. Bruno et al 2009, Leamon et. Al 1998)

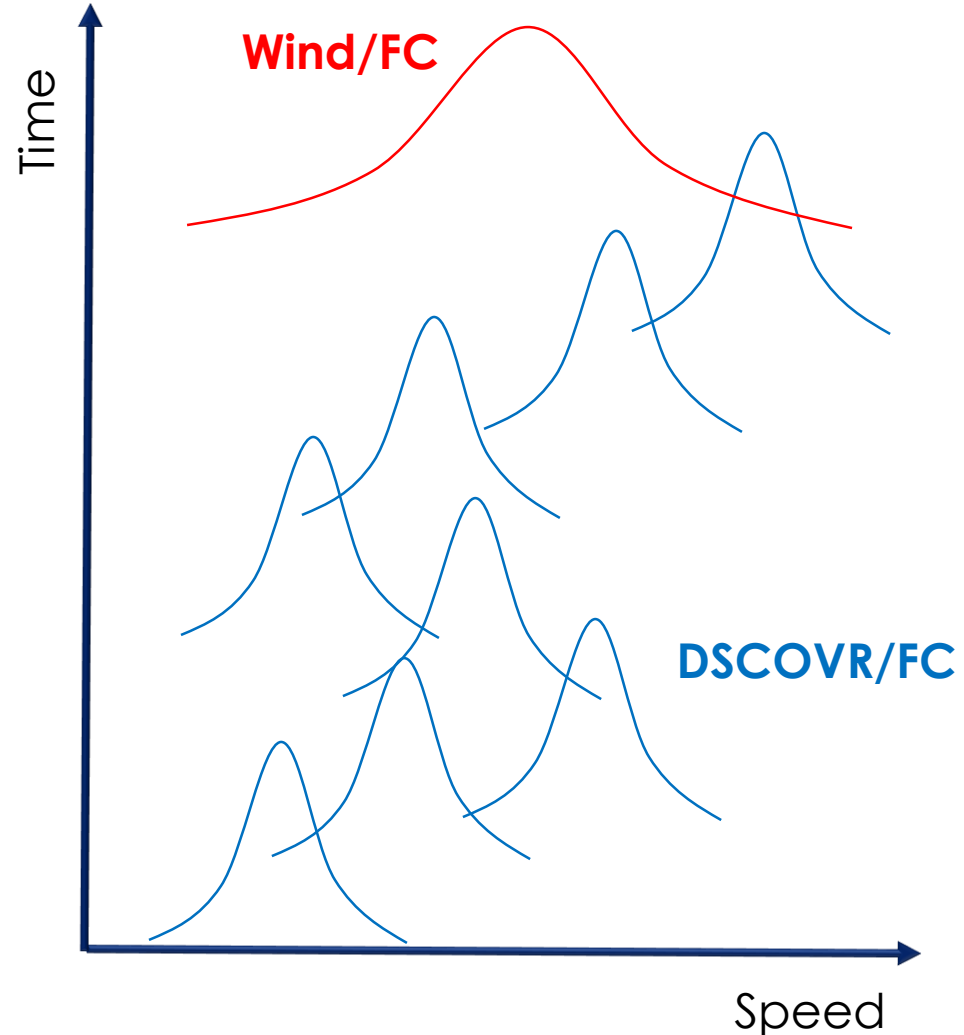

# CONJUNCTION COMPARISON

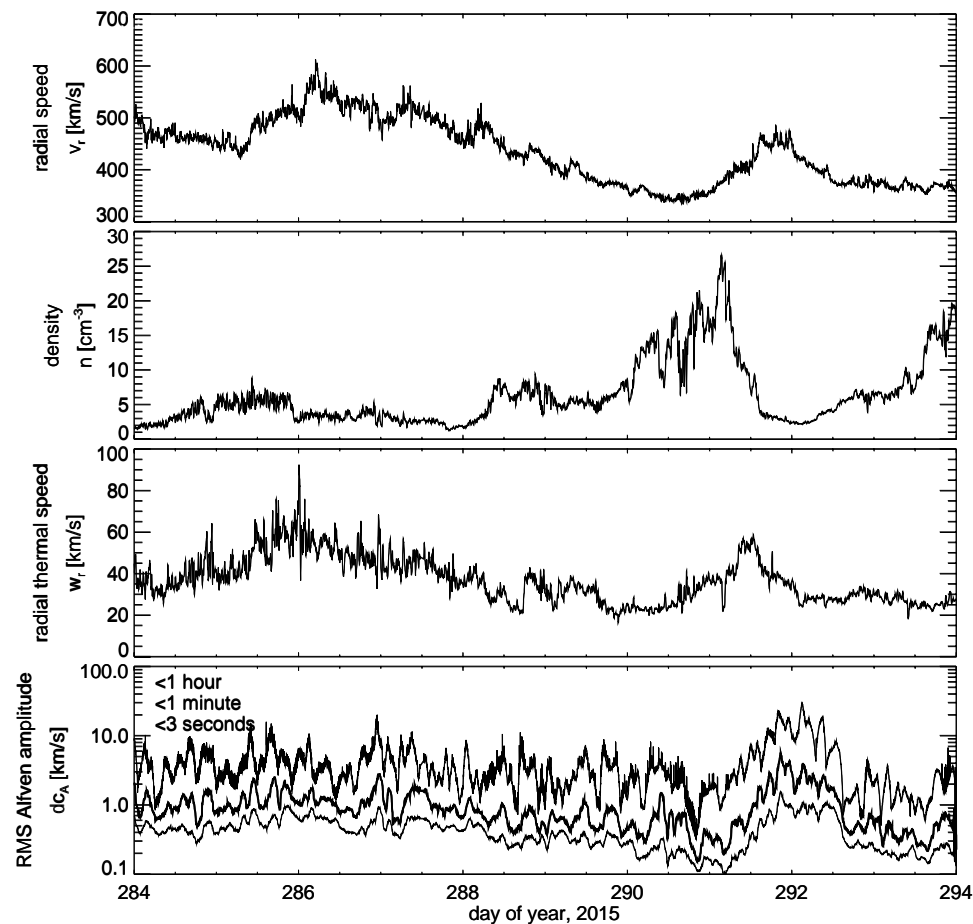
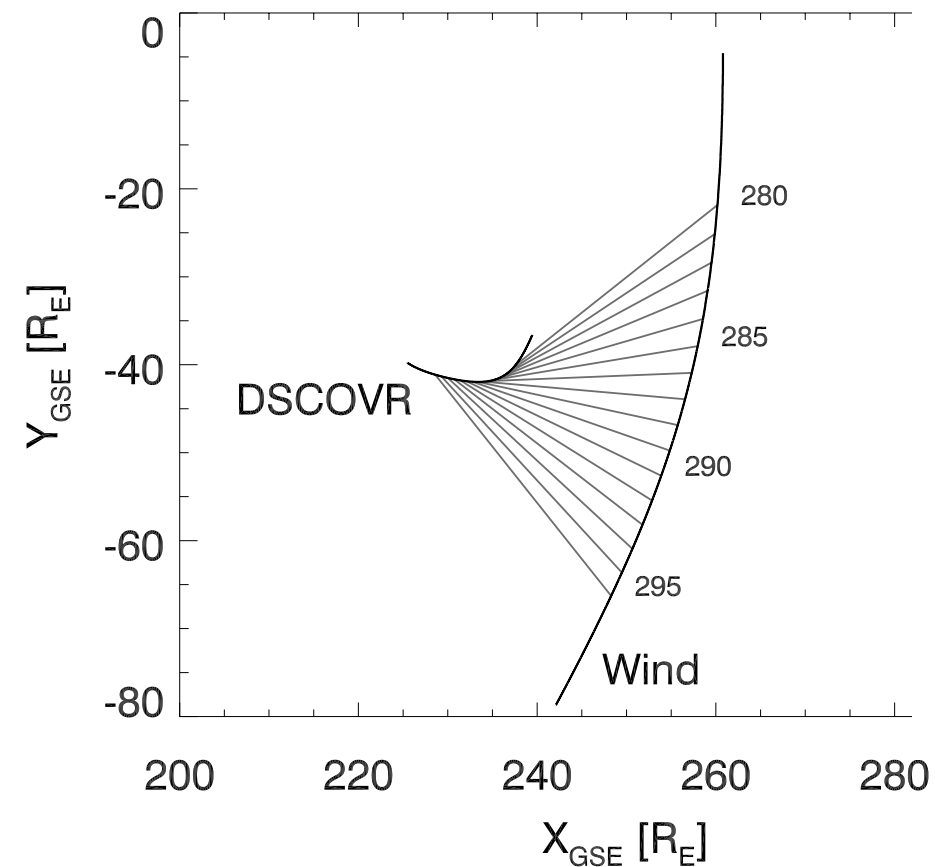

300

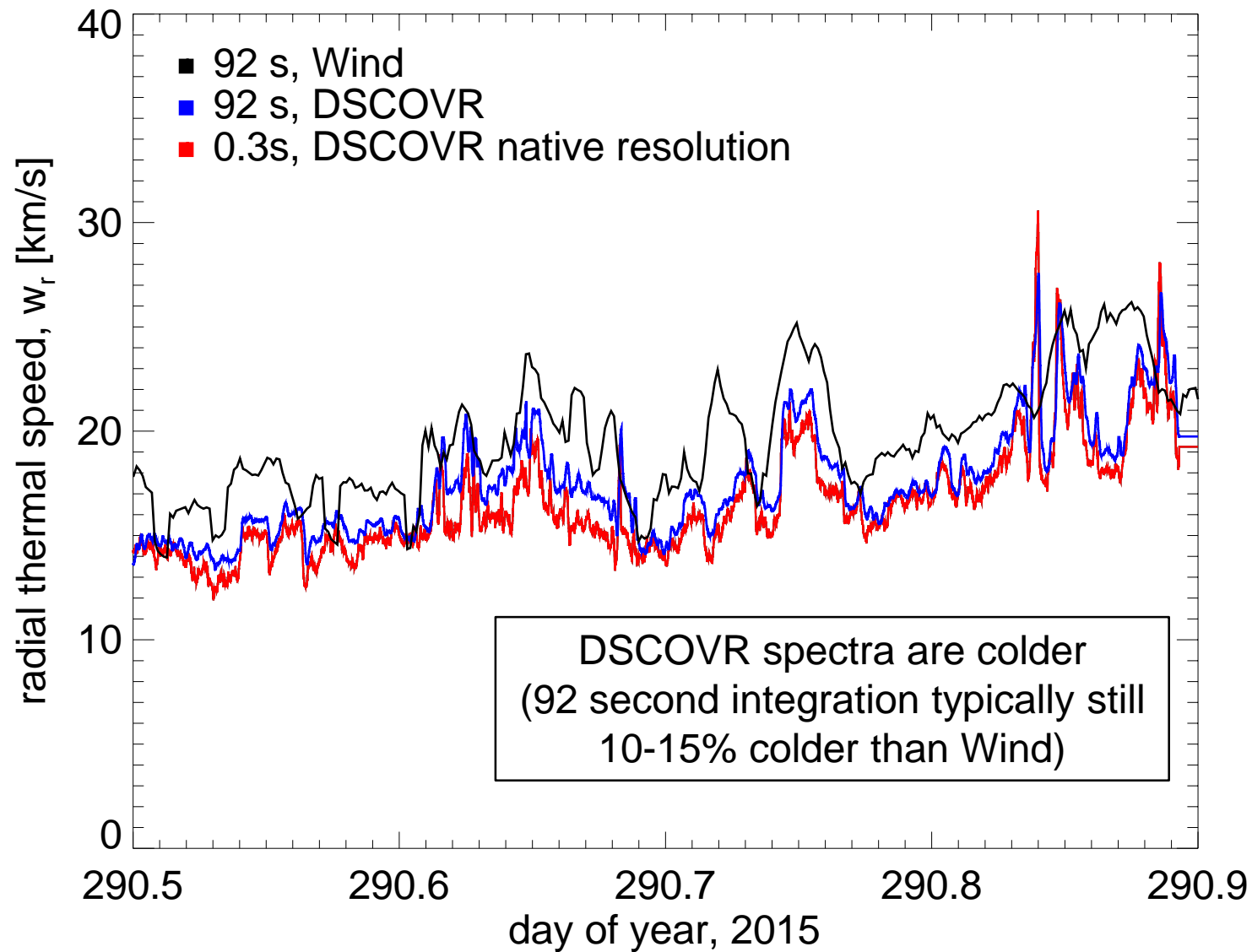

# WAVE BROADENING OF THERMAL SPEED

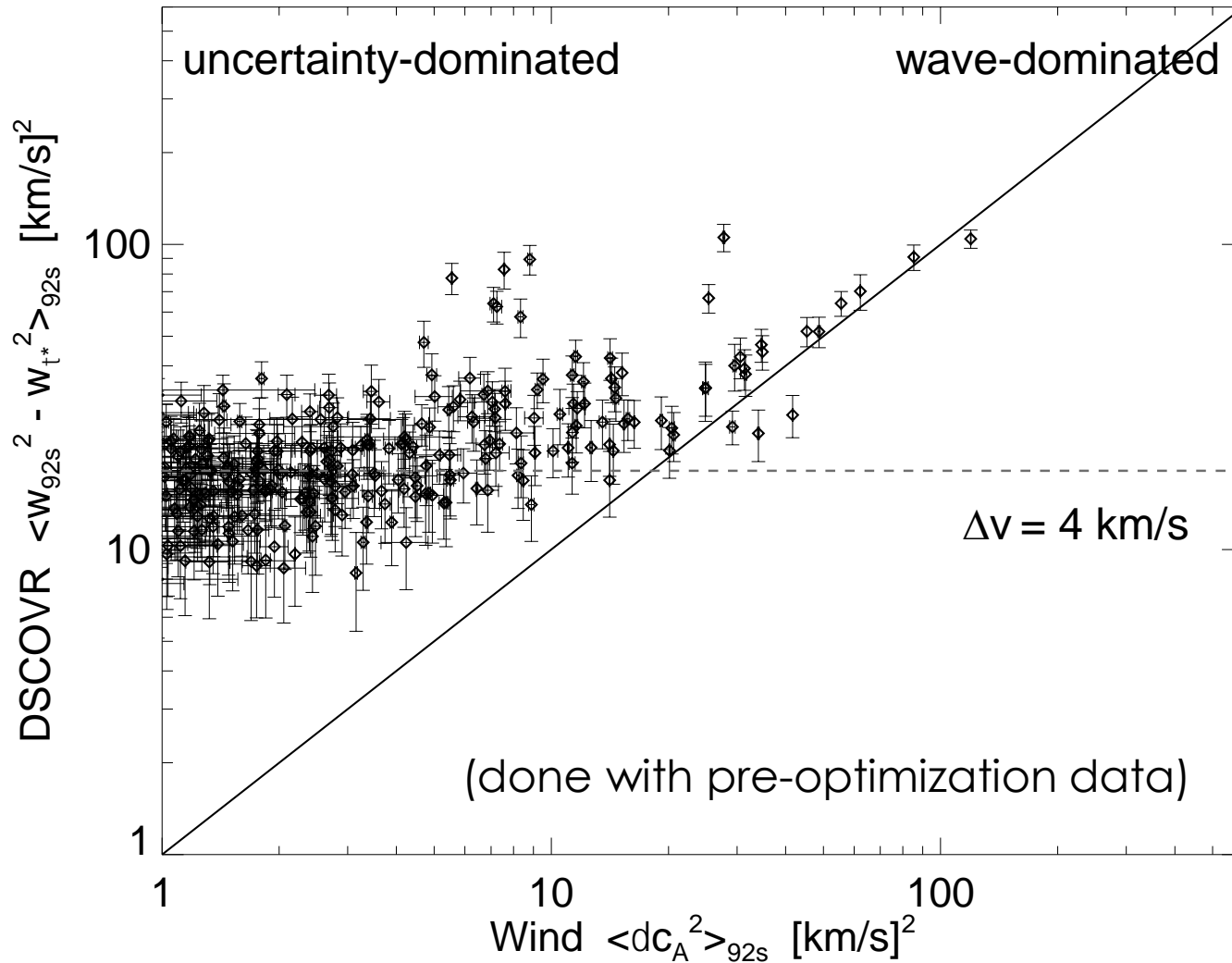

# RECONNECTION JETS

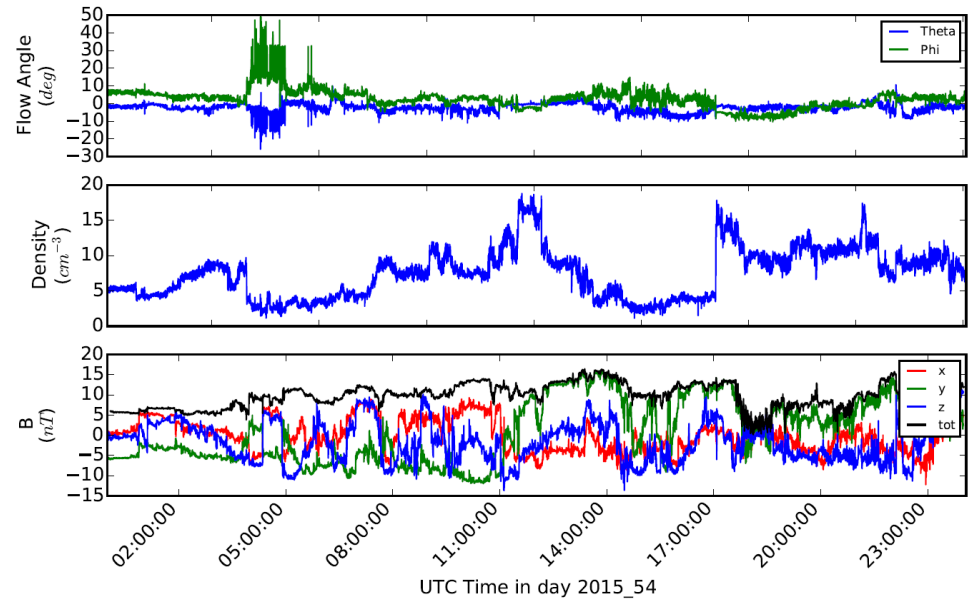
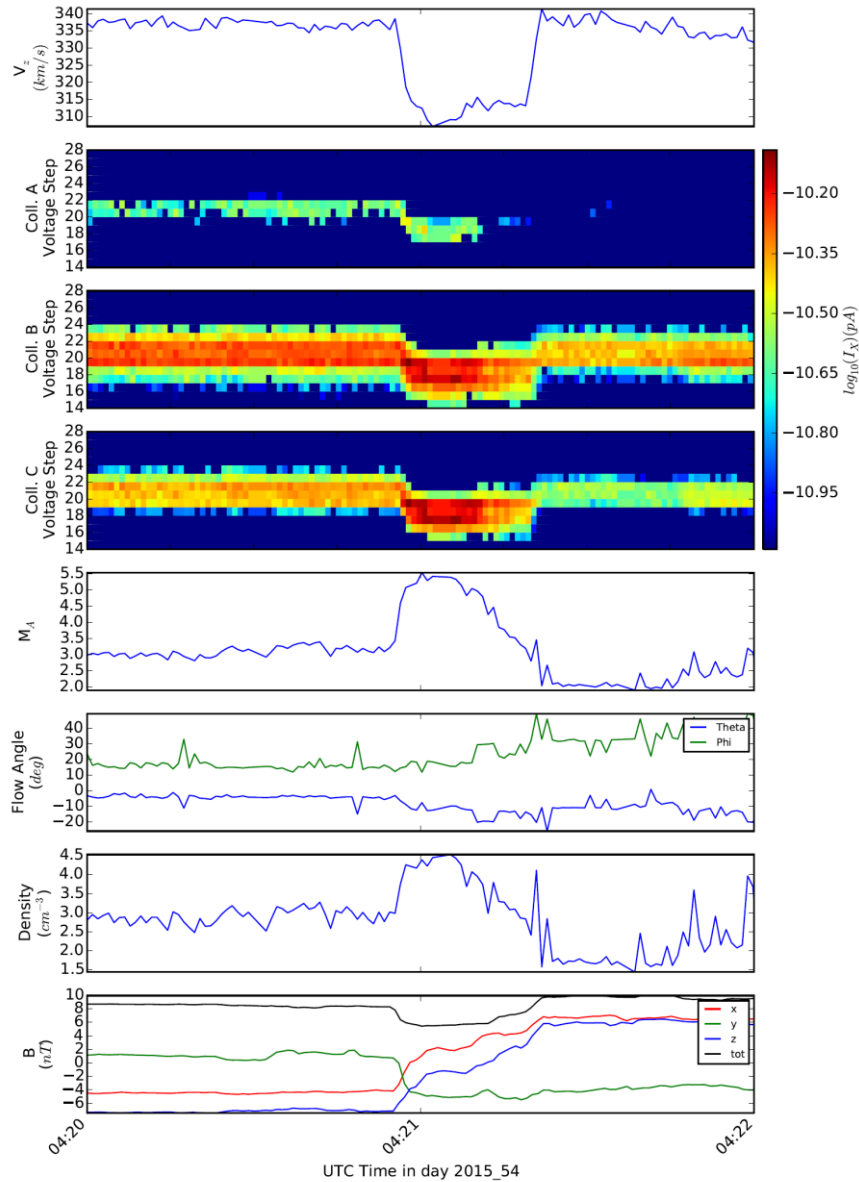



# SUMMARY

- DSCOVR/PlasMag 25Faraday Cup records stable and radiation tolerant measurements of solar wind velocity, density, and temperature
  - 200 – 1,200 km/s proton velocity distribution @ 3s
  - Low calibration drift ~ 0.1%/decade
  - Insensitive to ionizing radiation
- Status
  - Entered optimized performance configuration in April
  - Monitoring performance, calibration, working on improvement to tracking software
- Examples here
  - Raw data, shocks, Wind-comparison, magnetic reconnection, science result: solar wind is colder than we thought!

