

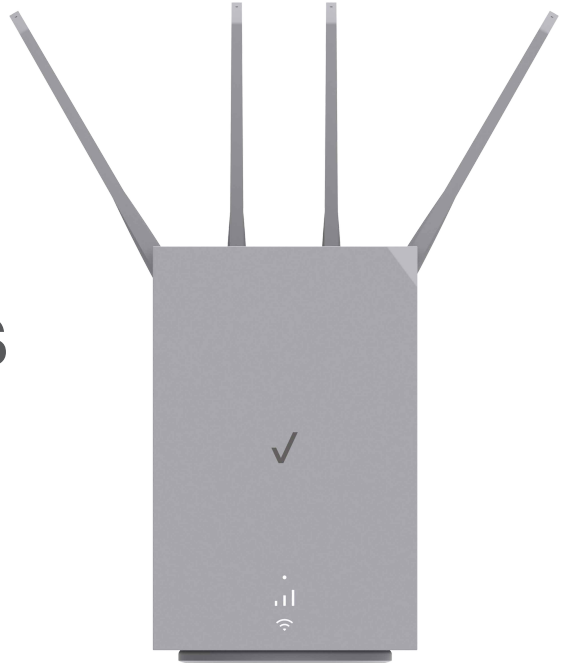

Verizon  
Internet  
Gateway  
for Business

**USER  
GUIDE**



# CONTENTS

---

## 01/

### INTRODUCTION

- 1.0 Inside the box 5
- 1.1 Getting to Know Your Verizon Internet Gateway for Business 5
- 1.2 Setting Up Verizon Internet Gateway for Business 10

## 02/

### CONFIGURING YOUR VERIZON INTERNET GATEWAY FOR BUSINESS

- 2.0 Configure Your Verizon Internet Gateway for Business 17
- 2.1 Computer Network Configuration 21
- 2.2 Main Screen 27

## 03/

### WI-FI SETTINGS

- 3.0 Overview 34
- 3.1 Basic Settings 35
- 3.2 Advanced Settings 43

## 04/

### CONNECTED DEVICES

- 4.0 Device Settings 52
- 4.1 Setting Content Controls 56
- 4.2 Universal Plug & Play 60

---

## 05 /

### CONFIGURING ADVANCED SETTINGS

- 5.0 Security & Firewall 66
- 5.1 Network Settings 82
- 5.2 Diagnostics & Monitoring 118
- 5.3 System 123

## 06 /

### TROUBLESHOOTING

- 6.0 Troubleshooting Tips 140
- 6.1 Frequently Asked Questions 146

## 07 /

### SPECIFICATIONS

- 7.0 General Specifications 152
- 7.1 Connections 152

## 08 /

### NOTICES

- 8.0 Regulatory Compliance Notices 155

# 01 /

## INTRODUCTION

- 1.0** Inside the box
- 1.1** Getting to Know Your Verizon Internet Gateway for Business
- 1.2** Setting Up Verizon Internet Gateway for Business



# INSIDE THE BOX

---

## 1.0/ INSIDE THE BOX

Inside the product package you should find the following items. Contact Verizon if any item is missing or damaged.

- Verizon Internet Gateway for Business
- Setup guide
- Power adapter
- Ethernet cable
- Paddle antenna x 4

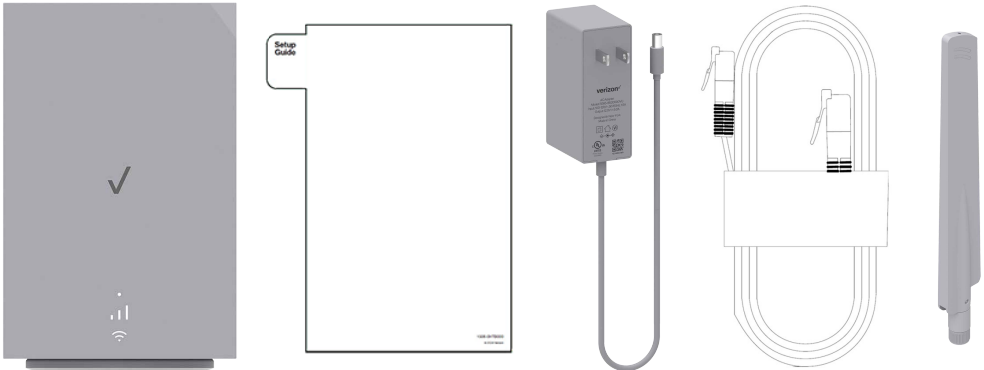

## 1.1/ GETTING TO KNOW YOUR VERIZON INTERNET GATEWAY FOR BUSINESS

Your Verizon Internet Gateway for Business (Gateway) provides fast triband Wi-Fi (with channel steering) for all your devices, and features built-in network security as well as content controls, guest Wi-Fi and automatic software updates.

*Take a moment to familiarize with your product:*

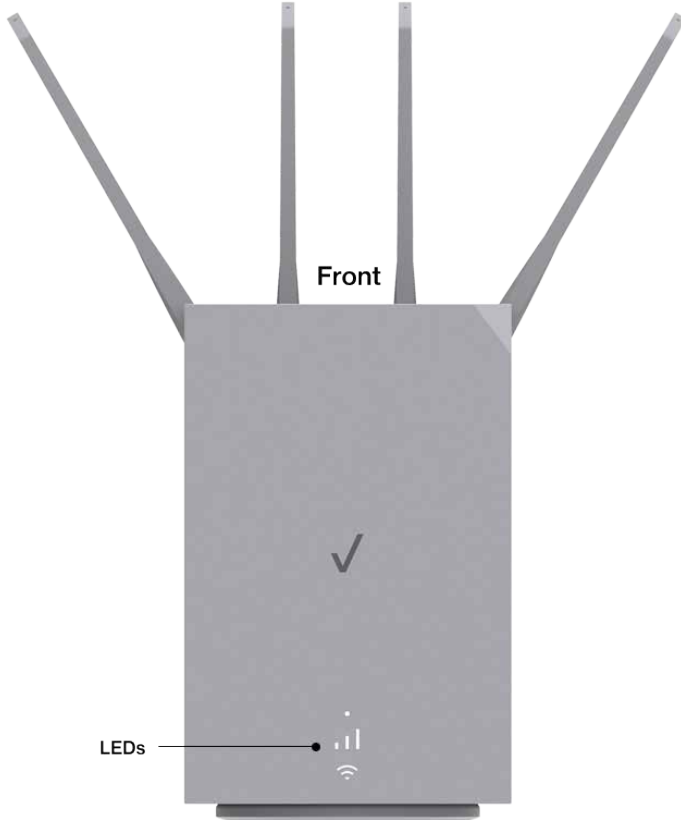

# GETTING TO KNOW YOUR VERIZON INTERNET GATEWAY FOR BUSINESS

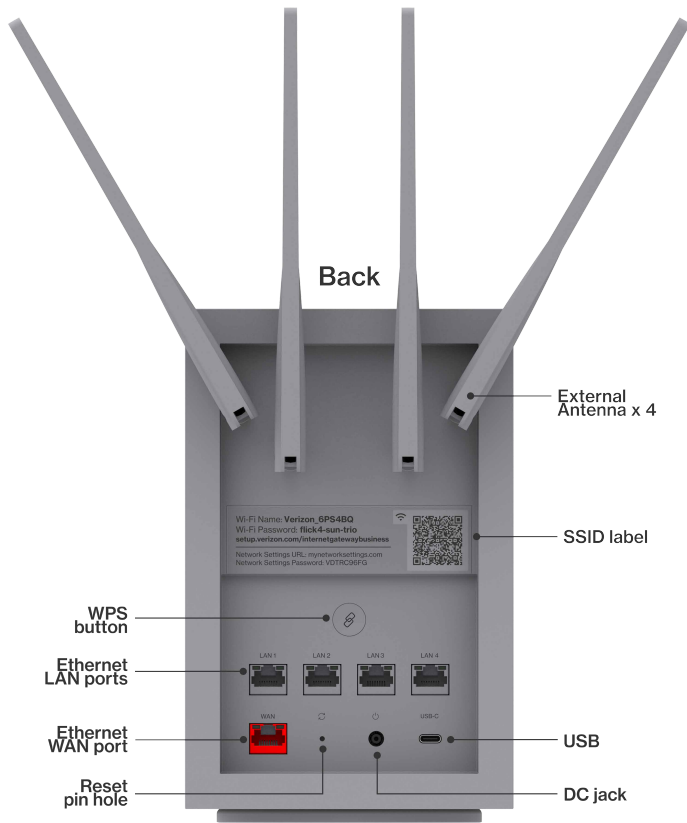

## 1.1a/ RESET PIN HOLE

The reset PIN hole allows you to reset the gateway back to its factory default state. Using the reset function will revert all settings and changes made during the setup process. To perform a factory reset and return the Verizon Internet Gateway for Business to default settings, press and hold the reset PIN hole for 3+ seconds. The System LED will flash yellow to indicate a reset has been triggered, followed by fading in/out (white) while the gateway restarts.

## 1.1b/ WPS

WPS is an easy way to add supported Wi-Fi devices to your network. Press the WPS button on the back of the Gateway to activate WPS. You will need to activate WPS on your Wi-Fi device too. Refer to “3.1d/ Wi-Fi Protected Setup (WPS)” on page 40.

## 1.1c/ LEDS

The LEDs indicate the system and connection status, and WPS activity.

### System LED



Front LED Mode	Status	LED Pattern
<b>System Status (O)</b>		
Bootup	System booting	Soft blink white
	Firmware update	Fast blink white
Regular usage mode	Rest mode	Solid white
Wired WAN connectivity	In service	Solid blue
IP Passthrough mode	IPPT ( IP Passthrough) enabled	Solid green
Other	Factory reset	Fast blink yellow
	Hardware error	Soft blink red
	No SIM card	Hard blink red
	No signal	Solid red

# SETTING UP YOUR VERIZON INTERNET GATEWAY FOR BUSINESS

## Wi-Fi LED

Front LED Mode	Status	LED Pattern
		
Regular usage mode	Passing signal	Solid white
	Setup complete	Solid white
	Not connected to Internet	Solid red
	Rest mode	Solid dim white
Pairing	Pairing WPS (in progress)	Hard blink blue
	WPS connection success	Fast blink blue
	WPS connection unsuccessful (time out)	Fast blink red
	WPS connection failure (interrupted)	Hard blink red
Other	Hardware error	Soft blink red

## Signal Strength LEDs

Front LED Mode	Status	LED Pattern
Regular usage mode	Rest mode	50% dim white
3 bars (  )	Excellent 5G or 4G coverage	Solid white
2 bars (  )	Good 5G or 4G coverage	Solid white
1 bar (  )	Weak 5G or 4G coverage	Solid white

## Ethernet Port LEDs

Ethernet Port LED Mode	Status	Left LED	Right LED
Wired LAN connection	Ethernet > 100M* Link	Off	Solid white
* Threshold level can be decided based on port capability.	Ethernet > 100M* Activity	Off	Blinking white
	Ethernet < 100M* Link	Solid yellow	Off
	Ethernet < 100M* Activity	Blinking yellow	Off
	No Ethernet connection	Off	Off

## 1.2/ SETTING UP VERIZON INTERNET GATEWAY FOR BUSINESS

### 1.2a/ POSITIONING YOUR GATEWAY

For the best wireless signal transmission from the Gateway to your network devices:

- Place the Gateway on an elevated surface near a window or perimeter wall and plug it in.
- Avoid keeping the device in the basement to get better signal.
- Avoid having obstacles near the device, clear any objects near the window that could interfere with getting a signal.
- Keep the Gateway away from metal obstructions and away from direct sunlight.

# SETTING UP YOUR VERIZON INTERNET GATEWAY FOR BUSINESS

---

- Keep the Gateway away from 802.11g or 20MHz only Wi-Fi devices, 2.4GHz computer peripherals, Bluetooth devices, cordless phones, transformers, heavy-duty motors, fluorescent lights, microwave ovens, refrigerators, and other industrial equipment to prevent signal interference or loss.

## 1.2b/ CONNECTING EXTERNAL ANTENNAS

The Verizon Internet Gateway for Business comes with four detachable antennas. To connect the external antennas:

1. Ensure the Gateway is in vertical position.
2. From rear side of the Gateway, align then screw each antenna into the antenna ports as shown below. Ensure the connection is tight and secure.

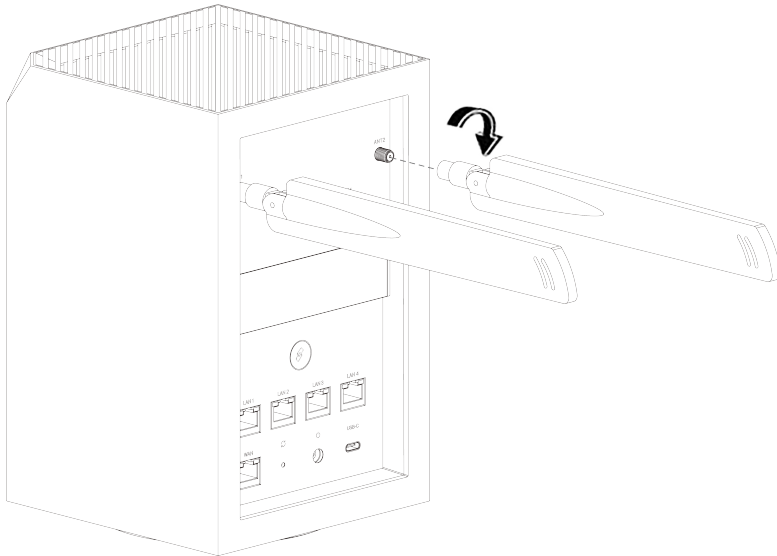

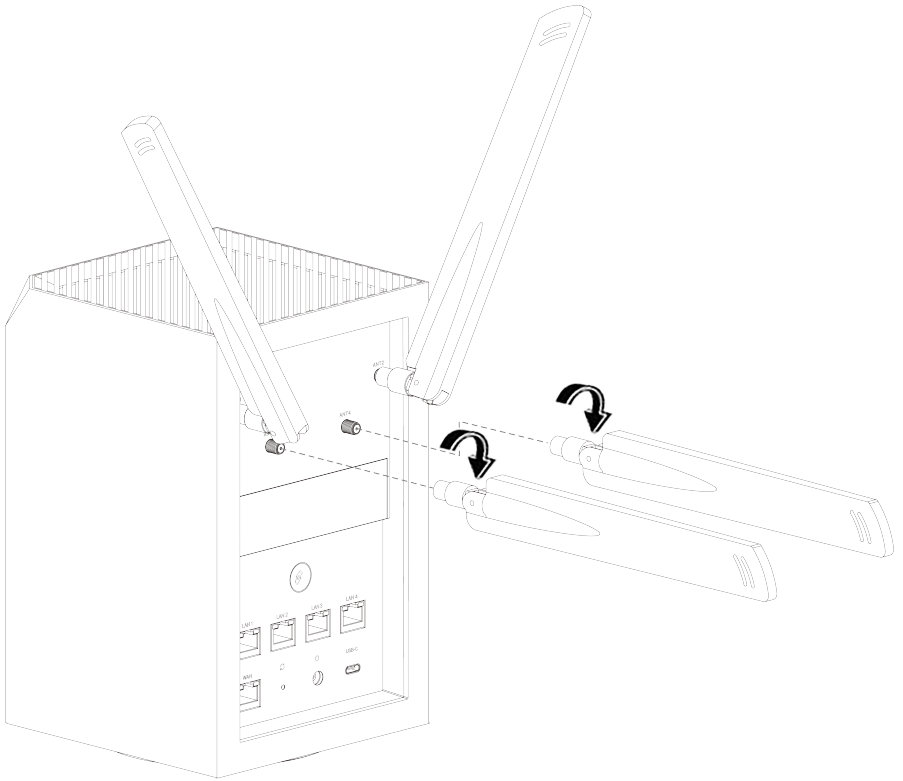



# SETTING UP YOUR VERIZON INTERNET GATEWAY FOR BUSINESS

---

3. For the best reception, position the antennas so that they are at right angles to one another.

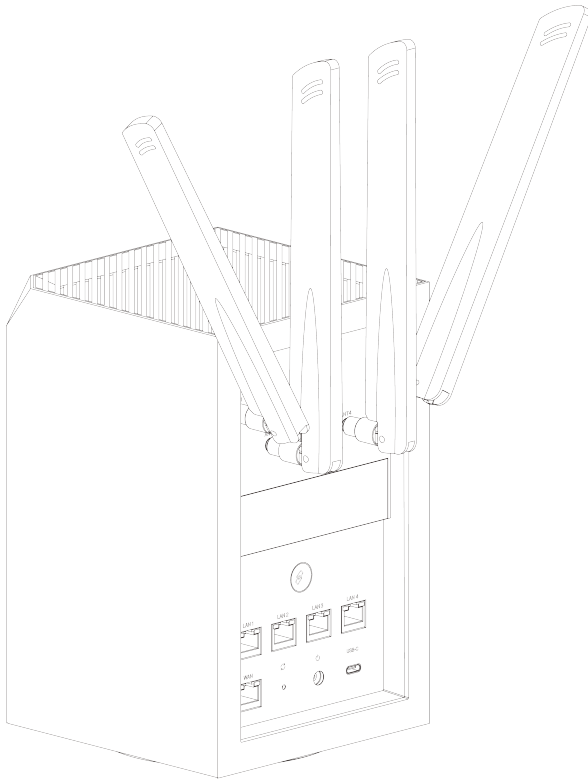

## 1.2c/ SETTING UP

Before you begin, if you are replacing an existing gateway, disconnect it. Remove all old gateway components, including the power supply. They will not work with the new Verizon Internet Gateway for Business.

1. Plug in the Gateway. Stand it vertically on an elevated surface near a window.
2. Wait up to 15 minutes for the system light to turn off.

The light will blink white while the Gateway is powering on and updating software. Don't unplug.

If it turns solid red: No signal in this location. Move the Gateway to another location.

If it blinks red: Activation error. Unplug the Gateway and plug it back in.

3. Check the signal strength. One signal bar is all you need, but you can try to find an even stronger signal by checking different areas.
4. Wait up to 15 minutes for the Wi-Fi light to turn on.

Once it lights up solid white, you're ready to connect your devices. If it blinks red: Activation error. Unplug the Gateway and plug it back in.

5. Connect your network devices.

Connect to your new network using the Wi-Fi name and password printed on the rear panel of the Gateway, or scan the QR code there to connect automatically.

---

02 /

# CONFIGURING YOUR VERIZON INTERNET GATEWAY FOR BUSINESS

- 2.0** Configure Your Verizon Internet Gateway for Business
- 2.1** Computer Network Configuration
- 2.2** Main Screen

---

Connecting your Verizon Internet Gateway for Business and accessing its web-based User Interface (UI) are both simple procedures.

Accessing the UI may vary slightly, depending on your device's operating system and web browser.

# CONFIGURE YOUR VERIZON INTERNET GATEWAY FOR BUSINESS

## 2.0/ CONFIGURE YOUR VERIZON INTERNET GATEWAY FOR BUSINESS

1. Open a web browser on the device connected to your Verizon Internet Gateway for Business network.
2. In the browser address field (URL), enter: <https://192.168.0.1>, then press the **Enter** key on your keyboard.

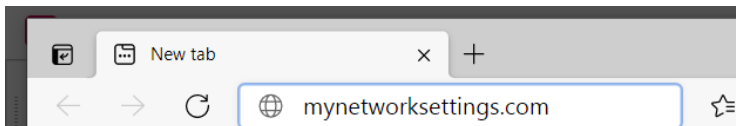

3. You may see a security message warning that **Your connection is not private** when you visit <https://192.168.0.1> for GUI management. To get to the login screen, click the **ADVANCED** button, then on **Proceed to 192.168.0.1 (unsafe)** link.



### Your connection is not private

Attackers might be trying to steal your information from **192.168.0.1** (for example, passwords, messages, or credit cards). [Learn more](#)

NET:ERR\_CERT\_AUTHORITY\_INVALID

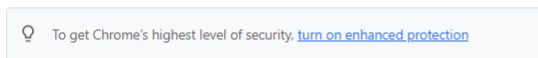

Hide advanced



Back to safety

This server could not prove that it is **192.168.0.1**; its security certificate is not trusted by your computer's operating system. This may be caused by a misconfiguration or an attacker intercepting your connection.

[Proceed to 192.168.0.1 \(unsafe\)](#)

4. The login screen will appear.

The first time you access your Gateway, an Easy Setup Wizard displays to help step you through the setup process.

5. On the **Log in to Verizon Internet Gateway** screen, enter the password that is printed next to the Password on the label on the back of your Gateway.

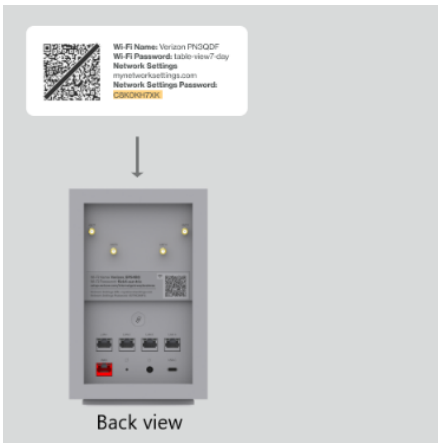

## Log in to Verizon Internet Gateway

Enter the Network Settings Password located on the information sticker on your router.

Network Settings Password

Keep Me Signed In ⓘ

**Log In**



# CONFIGURE YOUR VERIZON INTERNET GATEWAY FOR BUSINESS

- Click **Log In**. The **Change Wi-Fi name** screen displays. Move the selector to **on** for setting up your **Guest Wi-Fi** to personalize your Guest Wi-Fi Name and Password.

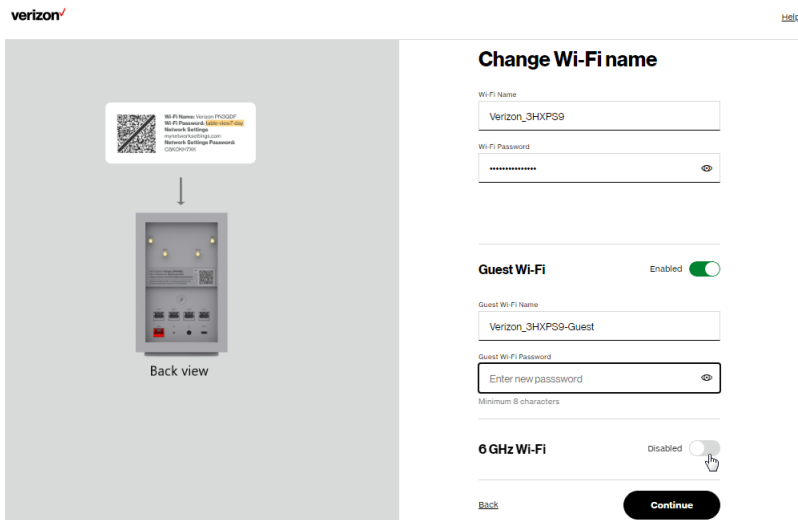

For your protection, your Gateway is pre-set at the factory to use WPA2 (Wi-Fi Protected Access II) encryption for your Wi-Fi network. This is the best setting for most users and provides security.

- Click **Continue**. The **Apply Wi-Fi changes** screen appears. You have an option of saving the Wi-Fi settings as an image on your device by clicking the **Save as image** button. After you click **Save as image** to save your Wi-Fi settings as an image, click **Apply** to save the Wi-Fi changes to Gateway.

*Note: If you select **Save as image**, the image file is saved to your web browser's download folder.*

**Important:** If you are on a Wi-Fi device when setting up your Gateway, you will be disconnected from the Wi-Fi network when you change the Wi-Fi name or Wi-Fi password. When this occurs, your Gateway will detect this situation and prompt you to reconnect using the new settings.

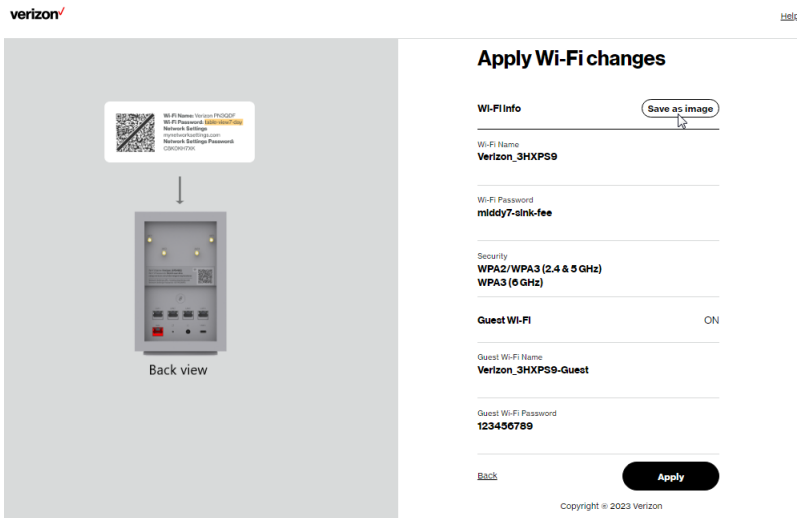

The **You're all set up!** screen displays once your Gateway verifies the final settings and has successfully connected to the internet and is ready for use. You can click on **Go to Network Settings** to access the main screen of the Gateway.



# CONFIGURE YOUR VERIZON INTERNET GATEWAY FOR BUSINESS

---

verizon✓

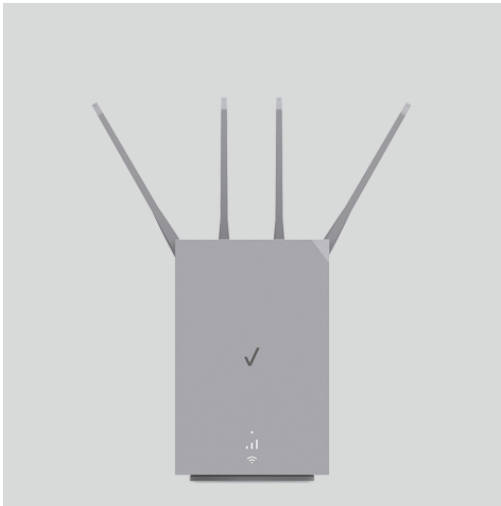

**You're all set up!**

[Go to Network Settings](#)

If your Gateway is subsequently reset to the factory default settings, the settings printed on the label will again be in effect.

If your Gateway fails to connect, follow the troubleshooting steps in the Troubleshooting section of this guide.

## **2.1/** COMPUTER NETWORK CONFIGURATION

Each network interface on your computer should either automatically obtain an IP address from the upstream Network DHCP server (default configuration) or be manually configured with a statically defined IP address and DNS address. We recommend leaving this setting as it is.

## 2.1a/ CONFIGURING DYNAMIC IP ADDRESSING

*To configure a computer to use dynamic IP addressing:*

### WINDOWS 7/8

1. In the Control Panel, locate **Network and Internet**, then select **View Network Status and Tasks**.
2. In the **View your active networks – Connect or disconnect** section, click **Local Area Connection** in the **Connections** field. The Local Area Connection Status window displays.
3. Click **Properties**. The Local Area Connection Properties window displays.
4. Select **Internet Protocol Version 4 (TCP/IPv4)**, then click **Properties**. The Internet Protocol Version 4 (TCP/IPv4) Properties window displays.
5. Click the **Obtain an IP address automatically** radio button.
6. Click the **Obtain DNS server address automatically** radio button, then click **OK**.
7. In the Local Area Connection Properties window, click **OK** to save the settings.
8. To configure Internet Protocol Version 6 (TCP/IPv6) to use dynamic IP addressing, repeat steps 1 to 7. However for step 4, select **Internet Protocol Version 6 (TCP/IPv6)** in the **Properties** option (refer to IPv6 section for Gateway configuration).

# COMPUTER NETWORK CONFIGURATION

---

## WINDOWS 10

1. On the Windows desktop, click on the **Start** icon. Select **Settings** and click **Network & Internet**.
2. In the Network & Internet, click **Ethernet**.
3. Select **Network and Sharing Center**. The **View your basic network information and set up connections** window displays.
4. In the **View your active networks**, click **Ethernet** in the **Connections** field. The **Ethernet Status** window displays.
5. Click **Properties**. The **Ethernet Properties** window displays.
6. Select **Internet Protocol Version 4 (TCP/IPv4)**, then click **Properties**. The **Internet Protocol Version 4 (TCP/IPv4) Properties** window displays.
7. Click the **Obtain an IP address automatically** radio button.
8. Click the **Obtain DNS server address automatically** radio button, then click **OK**.
9. In the **Local Area Connection Properties** window, click **OK** to save the settings.
10. To configure Internet Protocol Version 6 (TCP/IPv6) to use dynamic IP addressing, repeat steps 1 to 9. However for step 6, select **Internet Protocol Version 6 (TCP/IPv6)** in the **Properties** option (refer to IPv6 section for Gateway configuration).

## MACINTOSH OS X

1. Click the **Apple** icon in the top left corner of the desktop. A menu displays.
2. Select **System Preferences**. The System Preferences window displays.
3. Click **Network**.

4. Verify that **Ethernet**, located in the list on the left, is highlighted and displays **Connected**.
5. Click **Assist Me**.
6. Follow the instructions in the Network Diagnostics Assistant.

## **2.1b/ CONNECTING OTHER COMPUTERS AND NETWORK DEVICES**

You can connect your Gateway to other computers or set top boxes using an Ethernet cable or Wi-Fi connection.

### **ETHERNET**

1. Plug one end of an Ethernet cable into one of the Ethernet ports on the back of your Gateway.
2. Plug the other end of the Ethernet cable into an Ethernet port on the computer.
3. Repeat these steps for each computer to be connected to your Gateway using Ethernet.

### **CONNECTING A WI-FI DEVICE USING WPS**

Wi-Fi Protected Setup (WPS) is an easier way for many devices to set up a secure Wi-Fi network connection. Instead of manually entering passwords or multiple keys on each Wi-Fi client, such as a laptop, printer, or external hard drive, your Gateway creates a secure Wi-Fi network connection.

In most cases, this only requires the pressing of two buttons – one on your Gateway and one on the Wi-Fi client. This could be either a built-in button or one on a compatible Wi-Fi adapter/card, or a virtual button in software. Once completed, this allows Wi-Fi clients to join your Wi-Fi network.

# COMPUTER NETWORK CONFIGURATION

To initialize the WPS process, you can either press and hold the WPS button located on the rear of your Gateway for more than two seconds or use the UI and press the on-screen button.

You can easily add Wi-Fi devices to your Wi-Fi network using the WPS option if your Wi-Fi device supports the WPS feature.

*To access WPS using the user interface:*

1. From the **Basic** menu, select **Wi-Fi** settings, then click **Wi-Fi Protected Setup**.

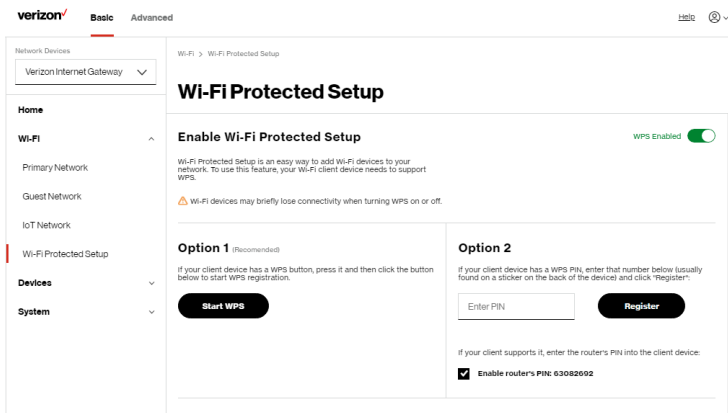

2. Enable the protected setup by moving the selector to **on**.
3. Use one of the following methods:
  - If your Wi-Fi client device has a WPS button, press the WPS button on your Gateway for more than two seconds, then click the **Start WPS** button in **Option 1** to start the WPS registration process.
  - If your client device has a WPS PIN, locate the PIN printed on the client's label or in the client documentation. Enter the PIN number in **Option 2** on the user interface.

- Click **Register**.
  - Alternatively, you can enter the Gateway's PIN shown on this screen into the WPS user interface of your device, if this PIN mode is supported by your Wi-Fi device.
4. After pressing the WPS button on your Gateway, you have two minutes to press the WPS button on the client device before the WPS session times out.

When the WPS button on your Gateway is pressed, the Status LED on the front of your Gateway begins flashing blue. The flashing continues until WPS pairing to the client device completes successfully. At this time, the Status LED turns solid blue.

If WPS fails to establish a connection to a Wi-Fi client device within two minutes, the Status LED on your Gateway flashes red for two minutes to indicate the WPS pairing process was unsuccessful. After flashing red, the light returns to solid white to indicate that Wi-Fi is on.

*Note: Wi-Fi Protected Setup (WPS) cannot be used if WPA3 security is enabled or SSID broadcast is disabled or if MAC address authentication is enabled with an empty white list.*

## CONNECTING A WI-FI DEVICE USING A PASSWORD

1. Verify each device that you are connecting with Wi-Fi has built-in Wi-Fi or an external Wi-Fi adapter.
2. Open the device's Wi-Fi settings application.
3. Select the Wi-Fi network name (SSID) of your Gateway from the device's list of discovered Wi-Fi networks.
4. When prompted, enter your Gateway's Wi-Fi password (WPA2 or WPA3 key) into the device's Wi-Fi settings. Your Gateway's default Wi-Fi network name and password are located on the sticker on the back of your Gateway.

# MAIN SCREEN

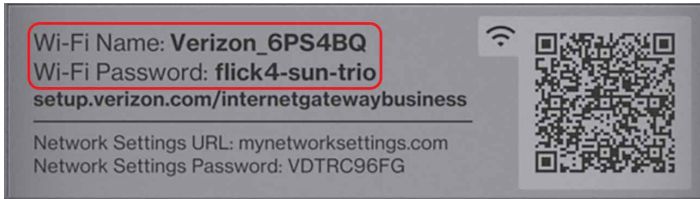

5. Verify the changes were implemented by using the device's web browser to access a site on the internet.
6. Repeat these steps for every device that you are connecting with Wi-Fi to your Gateway.

## 2.2/ MAIN SCREEN

When you log into your Gateway, the dashboard main page displays the navigation menus of Basic and Advanced settings, Wi-Fi settings, Devices, Content Controls, and connection status, and Basic quick links.

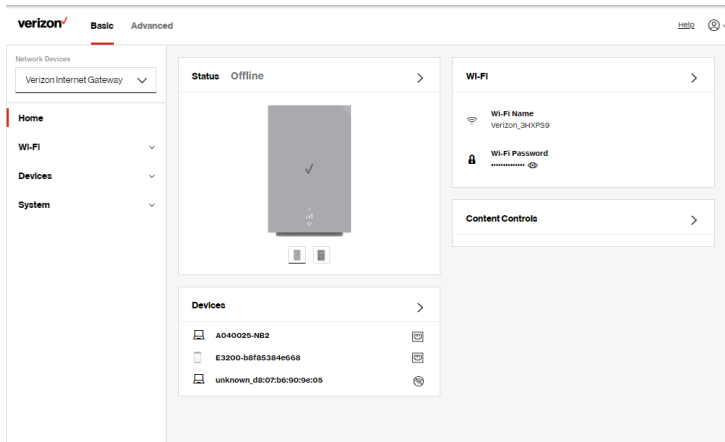

---

The configuration options available via the left-hand main menu are described in the following chapters:

- Basic Settings
  - System - this chapter
  - Wi-Fi - Chapter 3
  - Devices - Chapter 4
- Advanced Settings - Chapter 5

## 2.2a/ SYSTEM

### SYSTEM STATUS

*To view the status:*

1. Access the dashboard **Home** page.
2. You can quickly view your Gateway's status by clicking **System\ System Status** on the screen. This section displays the status of your Gateway's local network (LAN) and internet connection (WAN), firmware and hardware version numbers, MAC Address, IP settings of Verizon Internet Gateway for Business and Wi-Fi extender(s) (if connected).



# MAIN SCREEN

verizon **Basic** Advanced [Help](#)

Network Devices  
Verizon Internet Gateway

Home  
Wi-Fi  
Devices  
System  
System Status  
Open Source Software

System > System Status

## System Status

Auto-refresh  **Refresh**

Broadband IPv4	Broadband IPv6
Status Disconnected	Status Disconnected
IPv4 address is from: Cellular Modem	IPv6 address is from: Cellular Modem
IPv4 address	Assigned Prefix
Subnet Mask	IPv6 Address
IPv4 Default Gateway	Link-Local Address
IPv4 DNS Address 1	IPv6 Default Gateway
IPv4 DNS Address 2	IPv6 DNS Address 1
NATs Supported (used / max) 0 / 30000	IPv6 DNS Address 2

verizon **Basic** Advanced [Help](#)

Network Devices  
Verizon Internet Gateway

Home  
Wi-Fi  
Devices  
System  
System Status  
Open Source Software

System > System Status

## System Status

Auto-refresh  **Refresh**

Modem
Firmware Version 81137.7000.00.06.0115
Mobile Number •
IMEI 358664490003580
ICCID •
Sim Status Absent
Roaming Status •
4G LTE Signal Strength •
5G Signal Strength •

verizon Basic Advanced Help ⊙ ✓

Network Devices  
Verizon Internet Gateway

Home  
Wi-Fi  
Devices  
System  
System Status  
Open Source Software

System > System Status

### System Status

Auto-refresh  Refresh

**Router**

Firmware Version 3.3.0.4 Check for updates

Hardware Version 4

Model Name ASK-NCM100E

Serial Number ACC33200098

LAN IP v4 Address 192.168.1.1

Broadband Physical Connection Disconnected

Router has been active for 0 days(s) 6 hours 16 minutes 34 seconds

LED Status Undefined

verizon Basic Advanced Help ⊙ ✓

Network Devices  
Verizon Internet Gateway

Home  
Wi-Fi  
Devices  
System  
System Status  
Open Source Software

System > System Status

### System Status

Auto-refresh  Refresh

**Extender**

Device Name E3200-bbf85384e668

Model Name E3200

Firmware Version 3.11.15

Hardware Version 1102

Serial Number E30120071800005

MAC Address BbF85384E668

System Up Time 0 days(s) 6 hours 16 minutes 4 seconds

LED Status Normal operation

Backhaul Type Ethernet

# MAIN SCREEN

The screenshot shows the Verizon Internet Gateway interface. At the top, there is a navigation bar with the Verizon logo, tabs for 'Basic' (selected) and 'Advanced', and a 'Help' icon. Below the navigation bar, the page is divided into a left sidebar and a main content area. The sidebar contains a dropdown menu for 'Network Devices' (set to 'Verizon Internet Gateway') and a list of menu items: 'Home', 'Wi-Fi', 'Devices', 'System', 'System Status', and 'Open Source Software'. The 'System' menu item is expanded, showing 'System Status' and 'Open Source Software'. The main content area is titled 'System Status' and includes an 'Auto-refresh' toggle (currently off) and a 'Refresh' button. The status information is as follows:

Backhaul Type	Ethernet
Bit Rate	100 Mbps
IPv4 Address	192.168.1.100
IPv6 Address	
Subnet Mask	255.255.255.0
Default Gateway	192.168.1.1

Copyright © 2023 Verizon

## OPEN SOURCE SOFTWARE

The screenshot shows the Verizon Internet Gateway interface for the 'Open Source Software' page. The navigation bar is the same as in the previous screenshot. The left sidebar shows the 'Open Source Software' menu item selected. The main content area is titled 'Open Source Software' and contains the following text:

This product includes software made available under open source licenses. Additional information about that software, applicable licenses, and downloadable copies of source code, is available at: <https://verizon.com/opensource/>

All open source software contained in this product is distributed WITHOUT ANY WARRANTY. All such software is subject to the copyrights of the authors and to the terms of the applicable licenses included in the download.

This information is provided for those who wish to edit or otherwise change such programs. You do not need a copy of any of such open source software source code to install or operate the device.

*To view:* From the **Basic** menu, select **System** from the left pane and then click **Open Source Software**.

---

03 /

# WI-FI SETTINGS

- 3.0** Overview
- 3.1** Basic Settings
- 3.2** Advanced Settings

---

Wi-Fi networking can enable you to free yourself from wires, which can make your devices more accessible and easier to use.

You can create a Wi-Fi network, including accessing and configuring Wi-Fi security options.

# OVERVIEW

---

## 3.0/ OVERVIEW

The Verizon Internet Gateway for Business provides you with Wi-Fi connectivity using the 802.11a, b, g, n, ac or ax standards. These are the most common Wi-Fi standards.

The Gateway supports 2.4 GHz, 5 GHz and 6 GHz Wi-Fi bands, and the operation modes and speeds are listed as follows:

- 2.4 GHz
  - Legacy operation mode: supports IEEE 802.11b/g/n with maximum theoretical rate of 600 Mbps
  - Compatibility mode: supports IEEE 802.11ax
    - backward compatible with IEEE 802.11b/g/n/ac
    - maximum theoretical rate up to 1.1 Gbps
- 5 GHz
  - Legacy operation mode: supports IEEE 802.11a/n/ac with maximum theoretical rate of 2.2 Gbps
  - Compatibility mode: supports IEEE 802.11ax
    - backward compatible with IEEE 802.11a/n/ac
    - maximum theoretical rate up to 2.4 Gbps
- 6 GHz
  - Operation mode: supports IEEE 802.11ax
  - Maximum rate up to 4.8 Gbps

The Wi-Fi service and Wi-Fi security are activated by default. The level of security is preset to WPA2 encryption using a unique default WPA2 key (also referred to as a passphrase or password) pre-configured at the factory. This information is displayed on a sticker located on the rear of your Gateway.

Your Gateway integrates multiple layers of security. These include Wi-Fi Protected Access, and firewall.

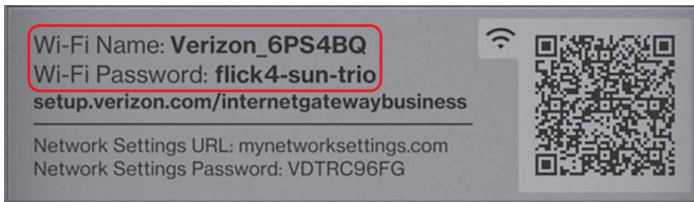

## 3.1/ BASIC SETTINGS

### 3.1a/ PRIMARY NETWORK

You can configure the basic security settings for 2.4 GHz, 5 GHz or 6 GHz of your Wi-Fi network.

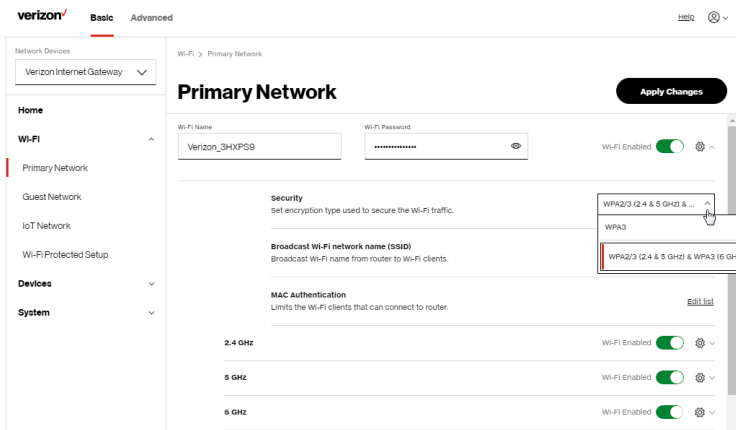

To configure the basic security radio, SSID and security settings:

1. From the **Basic** menu, select **Wi-Fi** from the left pane and then click **Primary Network**.

# BASIC SETTINGS

---

2. To activate the Wi-Fi radio, move the selector to **on**. If the radio is not enabled, no Wi-Fi devices will be able to connect to the office network.
3. If desired, enter a new name and password for the Wi-Fi network or leave the default name and password that displays automatically.

*Note: The SSID is the network name. All devices must use the same SSID.*

4. To configure the Wi-Fi **Security**, click the setup  button and select **WPA2** or **WPA3**.

You can optionally enable the 6 Ghz Wi-Fi band by toggling the selection to **On**. Enabling 6 GHz will modify the existing 2.4 & 5 GHz security from WPA2 to WPA2/WPA3 and 6 GHz will be enabled using WPA3.

*Caution: These settings should only be configured by experienced network technicians. Changing the settings could adversely affect the operation of your Gateway and your local network.*

- **Broadcast Wi-Fi network name (SSID)**

You can configure the Gateway's SSID broadcast capabilities to allow or disallow Wi-Fi devices from automatically using a broadcast SSID name to detect your gateway Wi-Fi network.

- To enable SSID broadcasting, move the selector to **on**. SSID broadcast is enabled by default. The SSID of the Wi-Fi network will be broadcast to all Wi-Fi devices.
- To disable SSID broadcasting, move the selector to **off**. The public SSID broadcast will be hidden from all Wi-Fi devices. You will need to manually configure additional Wi-Fi devices to join the Wi-Fi network.

- **MAC Authentication**

You can configure your Gateway to limit access to your Wi-Fi network to only those devices with specific MAC addresses.



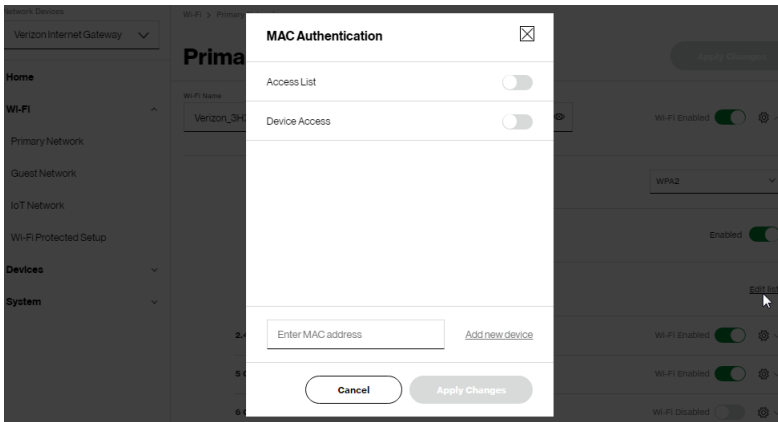

To set Wi-Fi MAC authentication:

1. To setup access control, click on the **Edit List**.
2. Select either:
  - **Access List** – allows the listed devices to access the Wi-Fi network.

***Warning:** This will block Wi-Fi network access for all devices not in the list. Only devices in the list will be able to connect to the Wi-Fi network.*

- **Device Access** – Wi-Fi devices will be able to access the Wi-Fi network if they use the correct Wi-Fi password.
3. Enter the MAC address of a device and click **Add new device**.
4. Repeat step 2 and step 3 to add additional devices, as needed.
5. When all changes are complete, click **Apply Changes** to save the changes.

# BASIC SETTINGS

## 3.1b/ GUEST NETWORK

The **Guest Network** is designed to provide internet connectivity to your guests while restricting access to your primary network and shared files. The primary network and the guest network are separated from each other through firewalls. You create one Guest Wi-Fi SSID and one password, and use it for all guests. The guest network SSID does not change when you make a change to your primary network SSID.

The Verizon Internet Gateway for Business is shipped from the factory with Guest Wi-Fi turned off. The default SSID for Guest Wi-Fi is preconfigured at the factory to the default Wi-Fi network name (SSID) which is displayed on a sticker located on the back of the Gateway followed by hyphen guest (-Guest). For example, if the Gateway is shipped with a default SSID of “Verizon-ABCDE” then the default SSID for Guest Wi-Fi is “Verizon-ABCDE-Guest”.

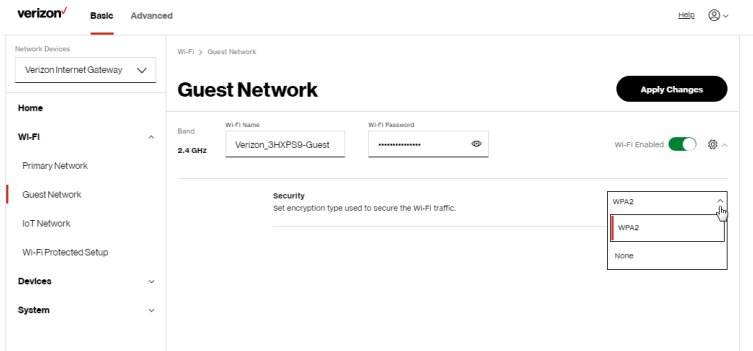

*To configure the security settings for your guest network:*

1. From the **Basic** menu, select **Wi-Fi** and then click **Guest Network**.
2. Move the selector to **on**.
3. If desired, enter a new name and password for the Wi-Fi network or leave the default name and password that displays automatically.

4. Press **Apply Changes** to save the changes.

*Important: It is not recommended to create a guest network without a password.*

### 3.1c/ IOT NETWORK

The Gateway supports connection of multiple IoT devices on a separate Wi-Fi SSID. The IoT Network is designed to provide an easier setup experience for your Internet of Things (IoT) devices which benefit from connecting to the 2.4 GHz band while keeping your Primary Network settings unchanged. IoT devices and Primary devices can communicate with no firewall restrictions separating them.

The Gateway is shipped from the factory with IoT Wi-Fi turned off. The default SSID for IoT Wi-Fi is preconfigured at the factory to the default Wi-Fi network name (SSID) which is displayed on a sticker located on the back of the Gateway followed by hyphen IoT (-IoT). For example, if the Gateway is shipped with a default SSID of “Verizon-ABCDE” then the default SSID for IoT Wi-Fi is “Verizon-ABCDE-IoT”.

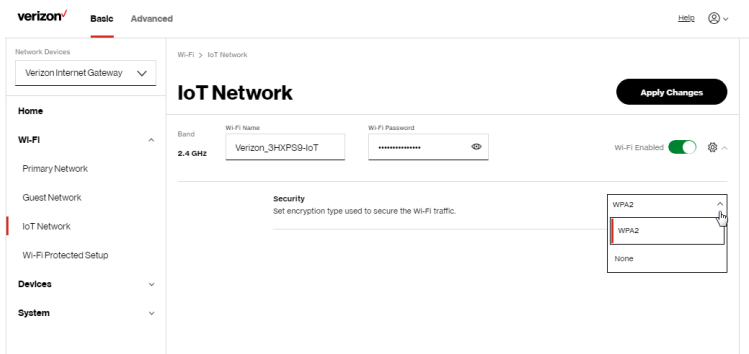

# BASIC SETTINGS

---

*To enable IoT Wi-Fi link:*

1. From the **Basic** menu, select **Wi-Fi** and then click **IoT Network**.
2. Move the selector to **on**.
3. If desired, enter a new name and password for the Wi-Fi network or leave the default name and password that displays automatically.
4. Press **Apply Changes** to save the changes.

## **3.1d/ WI-FI PROTECTED SETUP (WPS)**

Wi-Fi Protected Setup (WPS) is an easier way for many devices to set up a secure Wi-Fi network connection. Instead of manually entering passwords or multiple keys on each Wi-Fi client, such as a laptop, printer, or external hard drive, your Gateway creates a secure Wi-Fi network connection.

In most cases, this only requires the pressing of two buttons – one on your Gateway and one on the Wi-Fi client. This could be either a built-in button or one on a compatible Wi-Fi adapter/card, or a virtual button in software. Once completed, this allows Wi-Fi clients to join your Wi-Fi network.

To initialize the WPS process, you can either press and hold the WPS button located on the rear of your Gateway for more than two seconds or use the UI and press the on-screen button.

You can easily add Wi-Fi devices to your Wi-Fi network using the WPS option if your Wi-Fi device supports the WPS feature.

*To access WPS using the user interface:*

1. From the **Basic** menu, select **Wi-Fi** and then click **Wi-Fi Protected Setup (WPS)**.

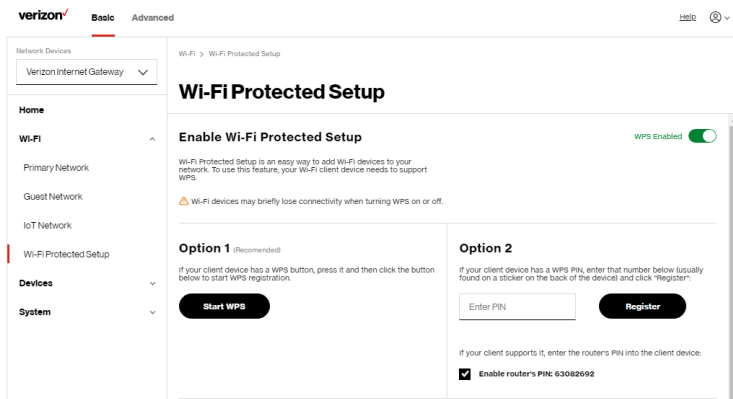

2. Enable the protected setup by moving the selector to **on**.
3. Use one of the following methods:
  - If your Wi-Fi client device has a WPS button, press the WPS button on your Gateway for more than two seconds, then click the **Start WPS** button in **Option 1** to start the WPS registration process.
  - If your client device has a WPS PIN, locate the PIN printed on the client's label or in the client documentation. Enter the PIN number in **Option 2** on the user interface.
  - Click **Register**.
  - Alternatively, you can enter the Gateway's PIN shown on this screen into the WPS user interface of your device, if this PIN mode is supported by your Wi-Fi device.

# BASIC SETTINGS

---

4. After pressing the WPS button on your Gateway, you have two minutes to press the WPS button on the client device before the WPS session times out.

When the WPS button on your Gateway is pressed, the Status LED on the front of your Gateway begins flashing blue. The flashing continues until WPS pairing to the client device completes successfully. At this time, the Status LED turns solid white.

If WPS fails to establish a connection to a Wi-Fi client device within two minutes, the Status LED on your Gateway flashes red for two minutes to indicate the WPS pairing process was unsuccessful. After flashing red, the light returns to solid white to indicate that Wi-Fi is on.

*Note: Wi-Fi Protected Setup (WPS) cannot be used if WPA3 security is enabled or SSID broadcast is disabled or if MAC address authentication is enabled with an empty white list.*

## 3.2/ ADVANCED SETTINGS

### 3.2a/ PRIMARY NETWORK

#### Self-Organizing Network (SON)

The Verizon Internet Gateway for Business supports 2.4 GHz, 5 GHz and 6 GHz signals. The Self-Organizing Network (SON) feature lets your devices move between these signals automatically for an optimized Wi-Fi connection.

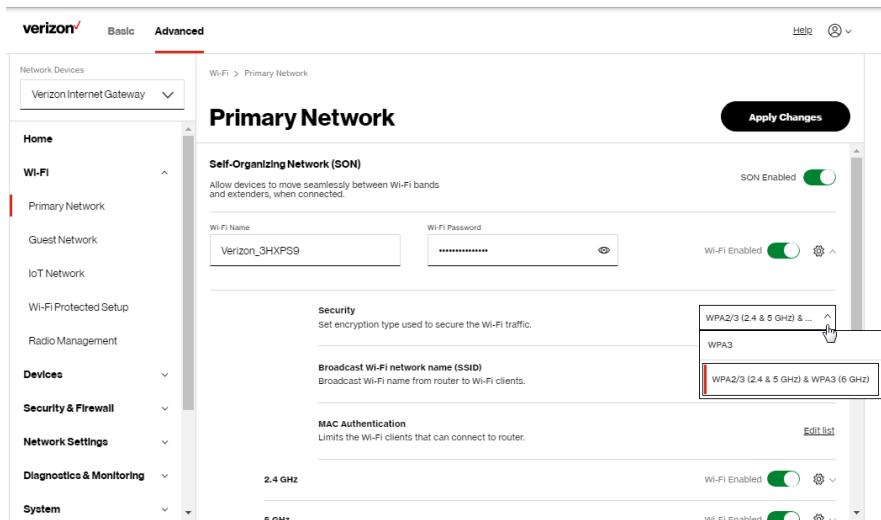

To configure SON, Wi-Fi radio, SSID and security settings:

1. From the **Advanced** menu, select **Wi-Fi** from the left pane and then click **Primary Network**.
2. To enable SON, move the selector to **on**.
3. To activate the Wi-Fi radio, move the selector to **on**. If the radio is not enabled, no Wi-Fi devices will be able to connect to the primary network.

# ADVANCED SETTINGS

- If desired, enter a new name and password for the Wi-Fi network or leave the default name and password that displays automatically.

*Note: The SSID is the network name. All devices must use the same SSID.*

- To configure the Wi-Fi security, click the setup  button.

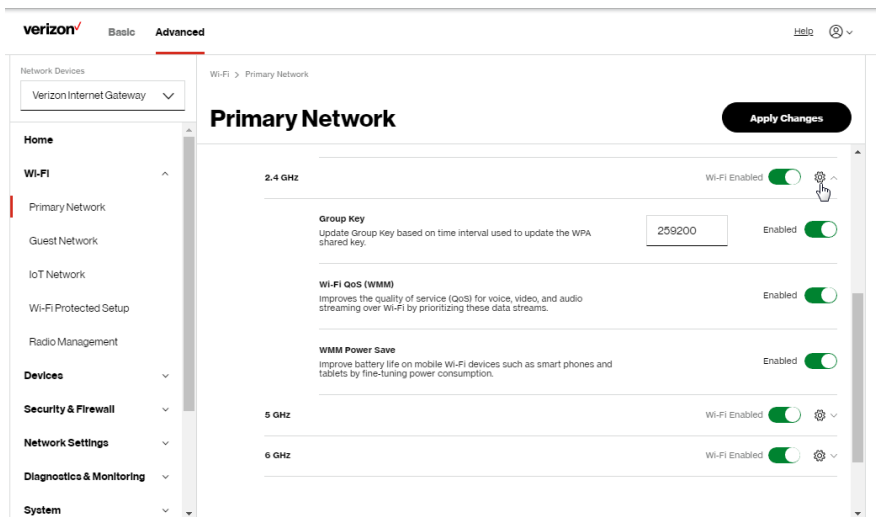

*Caution: These settings should only be configured by experienced network technicians. Changing the settings could adversely affect the operation of your Gateway and your local network.*

- Group key** - to update the WPA shared key, move the selector to **on**.
- Wi-Fi QoS (WMM)** - improves the quality of service (QoS) for voice, video, and audio streaming over Wi-Fi by prioritizing these data streams.
- WMM Power Save** - improves battery life on mobile Wi-Fi devices such as smart phones and tablets by fine-tuning power consumption.



## 3.2b/ RADIO MANAGEMENT

You can configure the channel settings for the 2.4 GHz, 5 GHz and 6 GHz band(s) of your Wi-Fi network.

The screenshot displays the Verizon Business Internet Gateway interface for Radio Management. The left sidebar shows a navigation menu with categories: Home, Wi-Fi, Devices, Security & Firewall, Network Settings, Diagnostics & Monitoring, and System. The 'Radio Management' option is highlighted. The main content area is titled 'Radio Management' and includes a 'Channel Analysis' section. This section contains two graphs: a bar chart showing scores for channels 1-11 and a line graph showing signal strength across channels 1-14. Below the graphs is a 'Channel Settings' section with dropdowns for Band (2.4 GHz), Channel (Ch. 11 (Auto)), Width (20/40MHz), and Health (3.42). A 'Radio Enabled' toggle is also present.

# ADVANCED SETTINGS

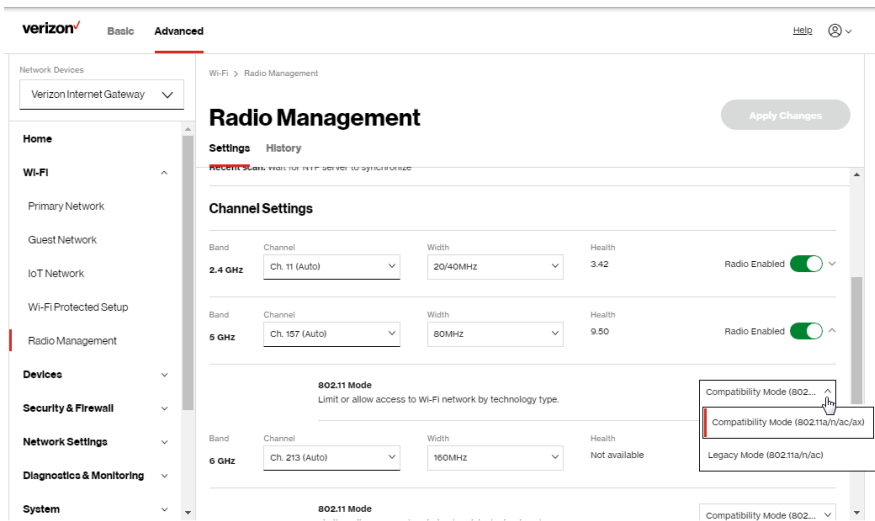

To view and configure the channel settings:

1. From the **Advanced** menu, select **Wi-Fi** and then click **Radio Management**.
2. Click on **Settings** on the top right-hand side of the **Radio Management** page to configure the channel scan settings:

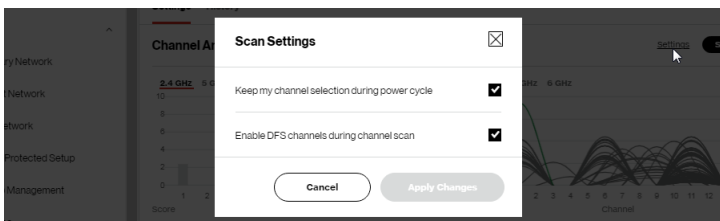

- Select the **Keep my channel selection during power cycle** check box to save your channel selection when your Gateway is rebooted.
- **Enable DFS channels during channel scan:** DFS channels are enabled by default during channel scans.

*Note: DFS channels are a subset of the 5 GHz network that is shared with radar systems. Some consumer devices do not support these channels and cannot connect to gateways using them. Examples include some media streaming devices. Disabling this feature will allow the Gateway to select the best available channel to broadcast on and allow these devices to connect.*

- Press **Apply Changes** to save the changes.
3. Click **Scan** to perform a channel availability scan for the Gateway to identify the radio channels providing the best Wi-Fi performance.
  4. On the **Radio Management** page for 2.4 GHz, 5 GHz or 6 GHz, the following information displays and can be configured:
    - **Channel Analysis** - scans and displays channel bandwidth and signal strength of available APs. **Channel Score** displays a network congestion score of zero to ten in each Wi-Fi channel. It can be used to determine which channels to use or to avoid. Higher score indicates less congestion in a channel.
    - **Channel Settings** - this is the radio channel used by the Wi-Fi Gateway and its clients to communicate with each other. The channel must be the same on the Gateway and all of its Wi-Fi clients. Select the channel you want the Wi-Fi radio to use to communicate, or accept the default (**Auto**) channel selection. Then the Gateway will automatically assign itself a radio channel.

# ADVANCED SETTINGS

---

- **Width** - displays the bandwidth available to the Wi-Fi channel currently in use on each band. Users can select from available channels.
- **802.11 Mode**

You can limit the Wi-Fi access to your network by selecting the 2.4 GHz and 5 GHz Wi-Fi communication standard best suited for the devices you allow to access your Wi-Fi network.

Select the Wi-Fi mode as follows:

- **Compatibility** – This is the default mode setting on 5 GHz, providing a good balance of performance and interoperability with existing Wi-Fi devices. 802.11a,n,ac and ax devices can connect.
- **Legacy** – This is the default mode setting on 2.4 GHz, providing broad connection support for old and new Wi-Fi devices. 802.11a,b,g,n and ac devices can connect.

**Notes:**

*802.11n is available on both 2.4 GHz and 5 GHz frequencies.*

*Connecting 802.11a, b or g devices will cause your Wi-Fi network to slow on that radio and is not recommended.*

To view the channel settings history:

1. From the **Advanced** menu, select **Wi-Fi** and then click **Radio Management**.
2. Click on **History** to display the channel settings history.

The screenshot shows the Verizon Business Internet Gateway interface. The top navigation bar includes the Verizon logo, 'Basic', and 'Advanced' (which is selected). There are links for 'Help' and a user profile icon. The main content area is titled 'Radio Management' and has two tabs: 'Settings' and 'History' (which is selected). A table displays the channel settings history with columns for Band, Channel, Time, and Date. The table contains 10 rows of data.

Band	Channel	Time	Date
2.4 GHz	Ch. 11	N/A	N/A
2.4 GHz	Ch. 6	N/A	N/A
2.4 GHz	Ch. 11	N/A	N/A
2.4 GHz	Ch. 1	N/A	N/A
2.4 GHz	Ch. 11	N/A	N/A
5 GHz	Ch. 157	N/A	N/A
5 GHz	Ch. 112	N/A	N/A
5 GHz	Ch. 157	N/A	N/A

---

04 /

# CONNECTED DEVICES

- 4.0** Device Settings
- 4.1** Setting Content Controls
- 4.2** Universal Plug & Play

---

You can view the settings of the network devices connected to the network of your Verizon Internet Gateway for Business.

The abundance of harmful information on the internet poses a serious challenge for employers and parents alike as they ask “How can I regulate what my employee or child does on the internet?”

With that question in mind, the Content Controls of your Gateway were designed to allow control of internet access on all locally networked devices.

# DEVICE SETTINGS

## 4.0/ DEVICE SETTINGS

To view and manage the connected devices on your network:

1. From the **Basic** menu, select **Devices** from the left pane.
2. The screen displays information about connected devices including **Device Name** and identifiers, **Content Controls**, the type of network connection, and settings that you can view and configure.

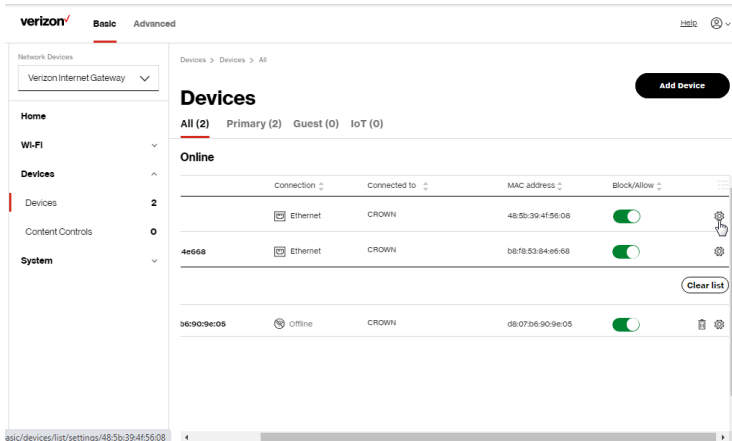
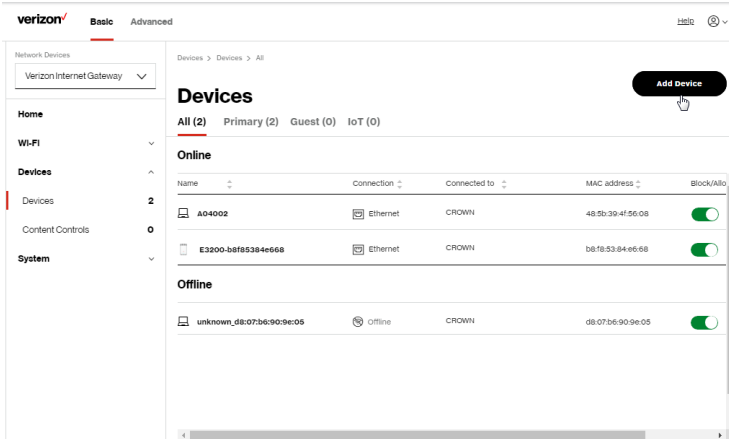



3. To easily add a new device to the network:
  - A. Click **Add Device** button on the screen.
  - B. Select the preferred **Network Type** from the dropdown list (**Primary**, **Guest** or **IoT**).
  - C. Scan the provided QR code with the new device's camera.
  - D. Tap the push notification to connect the device to your network.

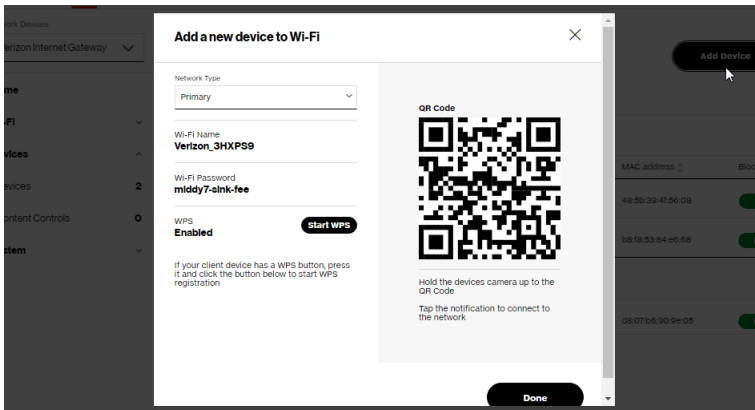

- E. You can add the new device to your Wi-Fi network by clicking the **Start WPS** button if your Wi-Fi device supports the WPS feature. Refer to “3.1d/ Wi-Fi Protected Setup (WPS)” on page 40 for detailed information.
  - F. Click **Done** to save the changes.
4. Click and drag the horizontal scrolling bar to the right on the screen for device configuration.
  5. Click the **Block/Allow** option to quickly disable/enable a device from having internet access.

For additional information about blocking websites, refer to “Setting Content Controls” on page 56.

# DEVICE SETTINGS

- Click the Settings icon to access the **Device Settings** page for that device:

The screenshot shows the Verizon Device Settings page for a device named "Extender". The page is divided into several sections:

- Device Information:** Includes fields for Name (2F4), Host Name (E3200-08F53844668), Location (Bedroom1), and Mobility (Portable).
- Device Add-Ons:** Includes Port Forwarding (N/A), Access Control (N/A), DMZ host (N/A), and DNS Server (N/A).
- Device Connection:** This section is currently empty.

The left sidebar shows the navigation menu with "Devices" selected, indicating 2 devices are connected. The top navigation bar shows "Basic" and "Advanced" tabs, with "Basic" selected.

This screenshot shows the "Device Connection" section of the Verizon Device Settings page. The page is divided into two main columns:

- Connection Info:** Shows Connection (Ethernet) and Phy Rate / Modulation Rate (1000 Mbps).
- Network Info:** Shows MAC Address (D8-9B-53-84-66-08), Connected to (CROWN), IPv4 Address (192.168.1.100), Subnet Mask (255.255.255.0), IPv4 DNS (192.168.1.1), IPv4 Address Allocation (Dynamic), Lease Type (DHCP), DHCP lease time remaining (1127 minutes 56 seconds), and IPv6 LAN Prefix (0/0).

The left sidebar and top navigation bar are identical to the previous screenshot, showing the "Basic" tab selected.

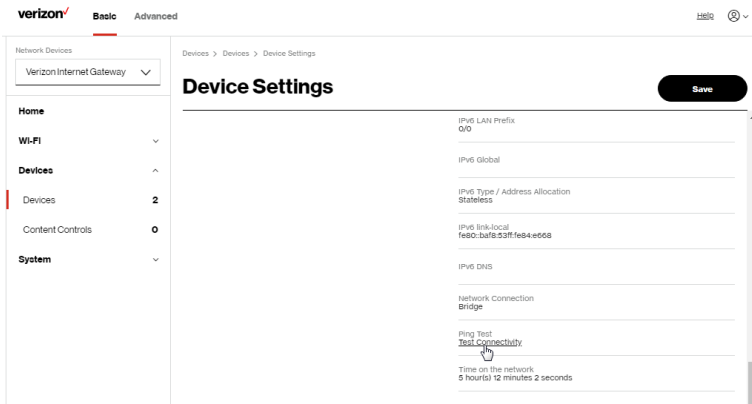

- **Device Information:**

**Device Type, Name/Host Name, Location, and Mobility** - Displays the current known information of the device. These can be updated or corrected as needed. Click **Edit** and **Save** to apply any changes.

- **Device Add-Ons**

**Port Forwarding** - Port Forwarding allows your network to be exposed to the internet in specific limited and controlled ways. For example, you could allow specific applications, such as video conferencing, voice, and chat, to access servers in the local network. To access the Port Forwarding page, click the setup button.

For additional information, refer to the Port Forwarding section in Chapter 5 Configuring Advanced Settings.

**Access Control** - Access Control restricts access from the local network to the internet. To access the Access Control page, click the setup button.

For additional information, refer to the Access Control section in Chapter 5 Configuring Advanced Settings.

# SETTING CONTENT CONTROLS

---

**DMZ host** - DMZ host allows a single device on your primary network to be fully exposed to the internet for special purposes such as an email server. To access the DMZ host page, click the setup button.

For additional information, refer to the section in Chapter 5 Configuring Advanced Settings.

**DNS Server** - DNS Server manages the DNS server host name and IP address. To access the DNS Server page, click the setup button.

For additional information, refer to the section in Chapter 5 Configuring Advanced Settings.

## – Device Connection

- This section provides the device MAC Address, Access Point information the device is connected to as well as the IPv4 Address of the device.
- This section displays Connection information of how and how well the device is connected to the Access Point. It also displays the Network related information, including IPv6 addresses and a **Ping Test** option.

## **4.1/ SETTING CONTENT CONTROLS**

### **4.1a/ ACTIVATING CONTENT CONTROLS**

You can create a basic access policy by using the provided **Rule Templates** for any computer or device on your Gateway network. Content Controls limit internet access to specific websites based on a schedule that you create.

Access can be limited on specific websites or keywords embedded in a website. For example, you can block access to the 'www.anysite.com' as well as block any website that has the word 'any' in its site name.

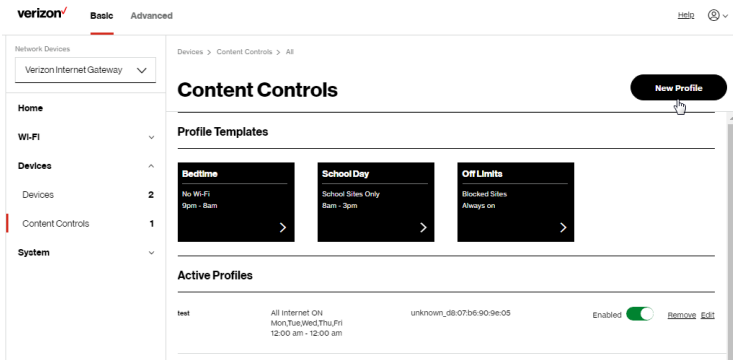

To limit device access:

1. From the **Basic** menu, select **Devices** from the left pane and then click **Content Controls**.
2. To use the default **Rule Templates**, select one of the pre-defined rules as shown on screen to quickly setup access policy for devices on your network.
3. To create a new access policy, click on the **New Rule** and the configuration page displays.

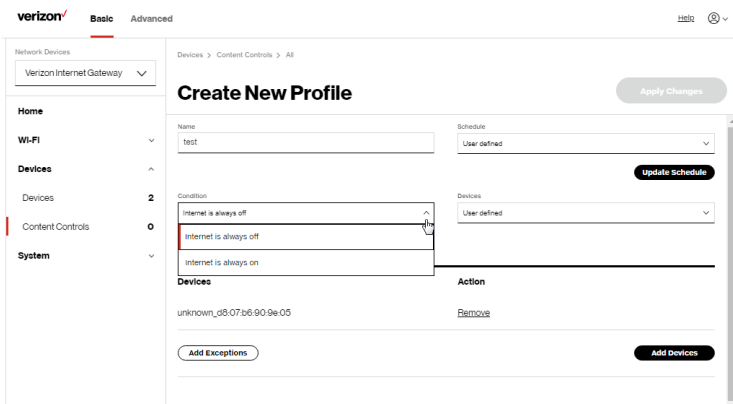

# SETTING CONTENT CONTROLS

---

4. Create a rule name.
5. Create a **Schedule** by selecting **User defined** from the dropdown list.

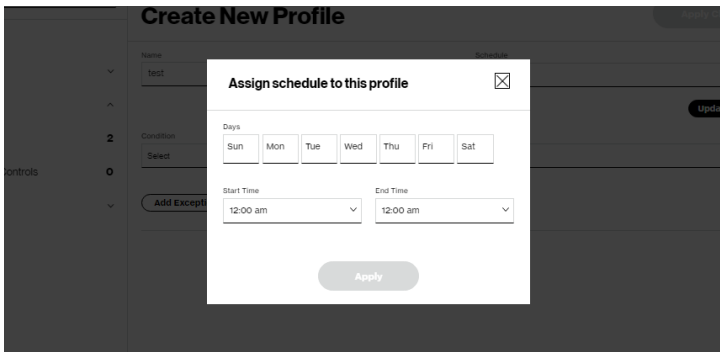

6. Select the days of the week when the rule will be active or inactive.
7. Set the time when the rule will be active or inactive, then specify the start time and end time.
8. Click **Apply** to save changes.
9. Select the **Condition** rule of **Internet is always off/Internet is always on** to block/allow the access to all internet websites.
10. Create the **Devices** rule by selecting **User defined** from the dropdown list and select the computers or clicking **Add Devices** to add a device where you are limiting access.

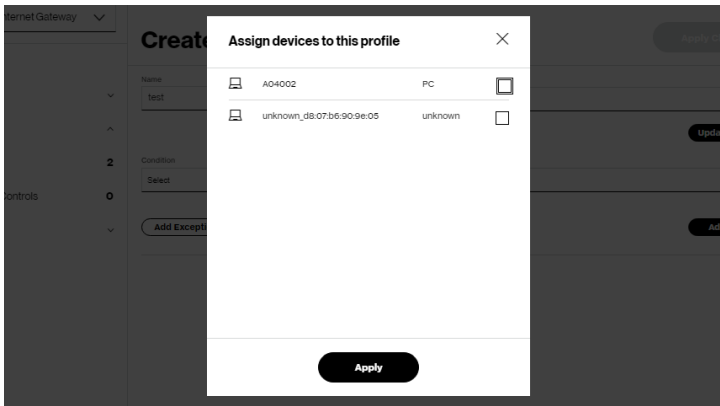

11. Click **Apply** to save changes.
12. To remove a device from the list, click **Remove** for the assigned device.
13. Click **Add Exceptions** for the following exception options:
  - Enter the name of the website or keywords within a URL to block/allow the specified websites and websites with names containing the specified keyword.

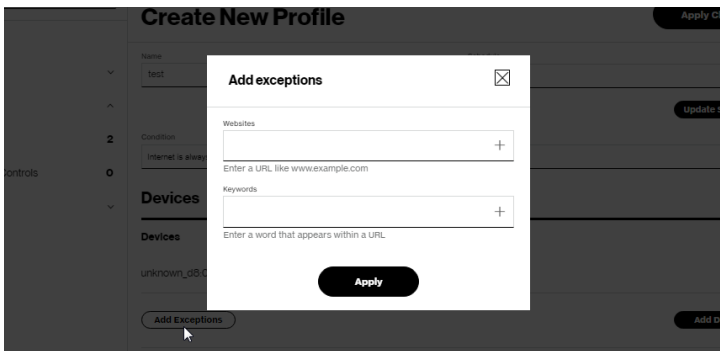

14. Click **Apply** to save changes.

# UNIVERSAL PLUG & PLAY

## 4.1b/ ACTIVE RULES

You can view the rules created for your Gateway shown on the **Content Controls** page.

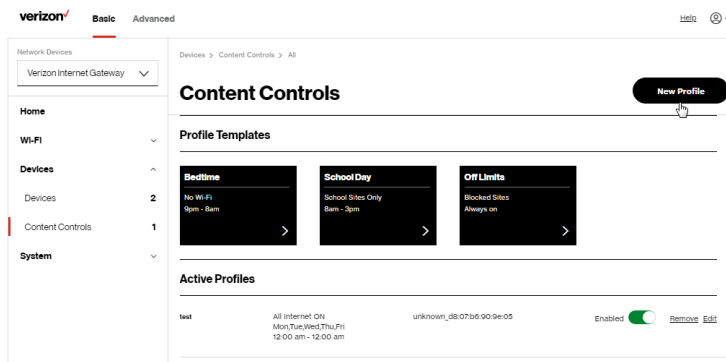

## 4.2/ UNIVERSAL PLUG & PLAY

You can use Universal Plug and Play (UPnP) to support new devices without configuring or rebooting your Gateway.

In addition, you can enable the automatic cleanup of invalid rules. When enabled, this functionality verifies the validity of all UPnP services and rules every five minutes. Old and unused UPnP defined services are removed, unless a user-defined rule depends on it.

UPnP services are not deleted when disconnecting a computer without proper shutdown of the UPnP applications, such as messenger. Services may often not be deleted and eventually this leads to the exhaustion of rules and services. No new services can be defined. The cleanup feature locates the invalid services and removes them, preventing services exhaustion.



To access this setting:

1. From the **Advanced** menu, select **Devices** from the left pane and then click **Universal Plug & Play**.

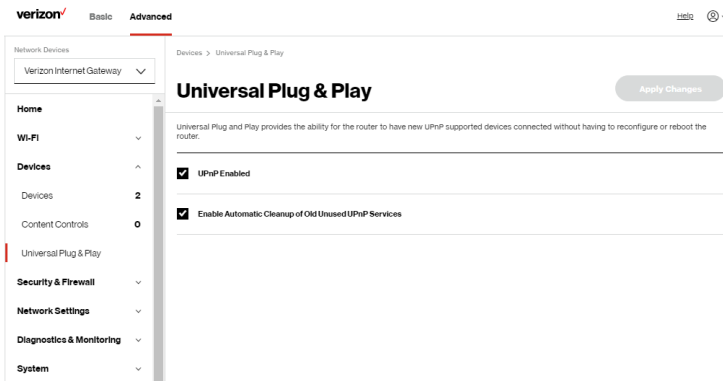

2. To enable UPnP and allow UPnP services to be defined on any network hosts, select the **UPnP Enabled** check box.
3. To enable automatic cleanup of invalid rules, select **Enable Automatic Cleanup of Old Unused UPnP Services** check box.
4. Click **Apply Changes** to save changes.

---

05 /

# CONFIGURING ADVANCED SETTINGS

- 5.0** Security & Firewall
- 5.1** Network Settings
- 5.2** Diagnostics & Monitoring
- 5.3** System

Advanced settings cover a wide range of sophisticated configurations for your Verizon Internet Gateway for Business' firmware, security setup and network.

The security suite of your Gateway includes comprehensive and robust security services, such as stateful packet inspection, firewall security, user authentication protocols, and password protection mechanisms.

These and other features help protect your computers from security threats on the internet.

---

*This chapter covers the following advanced features:*

## **Security & Firewall**

- General Firewall – manages the security level for the firewall.
- Access Control – restricts access from the local network to the internet.
- DMZ Host – allows a single device on your primary network to be fully exposed to the internet for special purposes such as video conferencing.
- IPv6 Pinholes – provides access tunnel to a service on a host for a particular application.
- Port Forwarding – enables access from the internet to specified services provided by computers on the local network.
- Port Forwarding Rules – displays port forwarding rules.
- Port Triggering – defines port triggering entries to dynamically open the firewall for some protocols or ports.
- Scheduler Rules Settings – limits the activation of firewall rules to specific time periods.
- SIP ALG – supports the Application Layer Gateway for Session Initiation Protocol.

## **Network Settings**

- ARP Table – displays active devices with their IP and MAC addresses.
- DNS Server – manages the DNS server host name and IP address.
- Dynamic DNS – allows a static domain name to be mapped to the dynamic IP address.
- IPv4/IPv6 Address Distribution – adds computers configured as DHCP clients to the network.
- IPv6 – enables IPv6 support.

- 
- NDP (Neighbor Discovery Protocol) Table – displays active devices with their IPv6 and MAC addresses of DHCP connection.
  - Network Connections – displays and manages the details of a specific network connection.
  - Network Objects – defines a group, such as a group of computers.
  - Port Configuration – sets up the Ethernet ports as either full- or half-duplex ports, at either 10 Mbps, 100 Mbps, or 1000 Mbps.
  - Routing – manages the routing and IP address distribution rules.

**Diagnostics & Monitoring** – performs diagnostic tests and displays the details and status of:

- Bandwidth Monitoring
- System Logging
- Full Status/System wide Monitoring of Connections/Traffic Monitoring
- Backhaul Logging

### **Advanced System Settings**

- Date & Time Settings – sets the time zone and enables automatic time updates.
- Factory Reset – resets your Gateway to its default settings.
- LED Brightness – controls the Status LED light to either dim or brighten.
- Reboot Router – restarts your Gateway.
- Remote Administration - enables remote configuration of your Gateway from any internet-accessible computer.
- System Settings – sets up various system and management parameters.

# SECURITY & FIREWALL

---

## **5.0/ SECURITY & FIREWALL**

The firewall is the cornerstone of the security suite for your Gateway. It has been exclusively tailored to the needs of the residential or office user and is pre-configured to provide optimum security.

The firewall provides both the security and flexibility that office users seek. It provides a managed, professional level of network security while enabling the safe use of interactive applications, such as video conferencing.

Additional features, including surfing restrictions and access control, can also be configured locally through the user interface or remotely by a service provider.

The firewall regulates the flow of data between the local network and the internet. Both incoming and outgoing data are inspected, then either accepted and allowed to pass through your Gateway or rejected and barred from passing through your Gateway, according to a flexible and configurable set of rules. These rules are designed to prevent unwanted intrusions from the outside, while allowing local network users access to internet services.

The firewall rules specify the type of services on the internet that are accessible from the local network and types of services in the local network that are accessible from the internet.

Each request for a service that the firewall receives is checked against the firewall rules to determine whether the request should be allowed to pass through the firewall. If the request is permitted to pass, all subsequent data associated with this request or session is also allowed to pass, regardless of its direction.

For example, when accessing a website on the internet, a request is sent to the internet for this site. When the request reaches your Gateway, the firewall identifies the request type and origin, such as HTTP and a specific computer in

the local network. Unless your Gateway is configured to block requests of this type from this computer, the firewall allows this type of request to pass to the internet.

When the website is returned from the web server, the firewall associates the website with this session and allows it to pass; regardless HTTP access from the internet to the local network is blocked or permitted. It is the origin of the request, not subsequent responses to this request, which determines whether a session can be established.

## 5.0a/ SETTING FIREWALL CONFIGURATION

You can select a normal, high, or low security level to limit, block, or permit all traffic. The following table shows request access for each security level.

Security Level	Internet Requests Incoming Traffic	Local Network Requests Outgoing Traffic
High	Blocked	Limited
Normal	Blocked	Unrestricted
Low	Unrestricted	Unrestricted

*The request access is defined as:*

- Blocked traffic – no access allowed, except as configured in Port Forwarding and Remote Access
- Limited – permits only commonly used services, such as email and web browsing
- Unrestricted – permits full access of incoming traffic from the internet and allows all outgoing traffic, except as configured in Access Control

# SECURITY & FIREWALL

## SPECIFYING GENERAL SETTINGS FOR IPV4 OR IPV6

To set your firewall configuration:

1. From the **Security & Firewall General** settings page, click on desired **IPv4 settings/IPv6 settings** option to configure IPv4/IPv6 security.

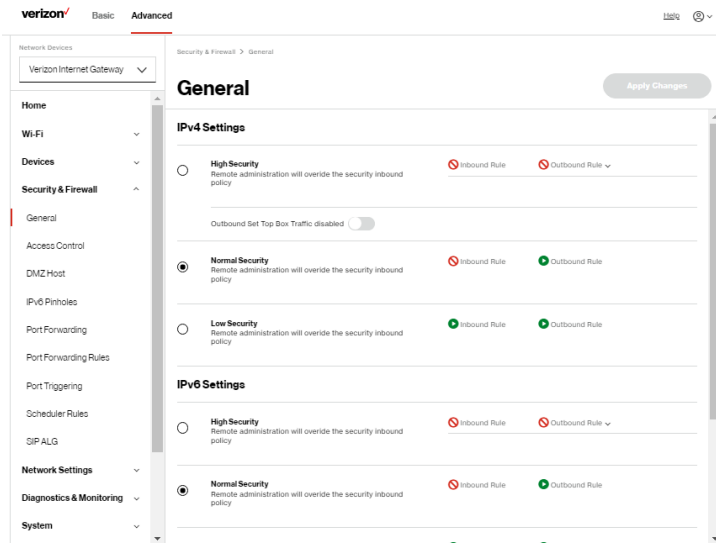

2. Select a security level by clicking one of the radio buttons. Using the **Low Security** setting may expose the local network to significant security risks, and should only be used for short periods of time to allow temporary network access.
3. Click **Apply Changes** to save changes.



## 5.0b/ ACCESS CONTROL

You can block individual computers on your local network from accessing specific services on the internet. For example, you could block one computer from accessing the internet, then block a second computer from transferring files using FTP as well as prohibit the computer from receiving incoming email.

Access control incorporates a list of preset services, such as applications and common port settings.

## ALLOW OR RESTRICT SERVICES

*To allow or restrict services:*

1. From the **Advanced** menu, select **Security & Firewall** from the left pane and then click **Access Control**. The **Access Control** page opens with the allowed and blocked status displayed. The allowed section only displays when the firewall is set to maximum security.

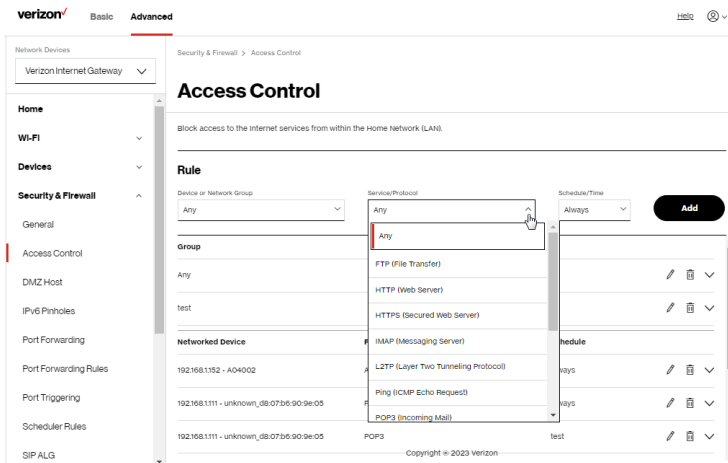

# SECURITY & FIREWALL

- To apply the rule to:
  - Networked Device or Network Group - select **Any**.
  - Specific devices only – select networked device or **User Defined**.
- Select the networked device to be allowed or blocked in the list.
- In the **Add devices**, enter the group name, then click **Add**. The new network group is automatically added to the **Access Control** section.

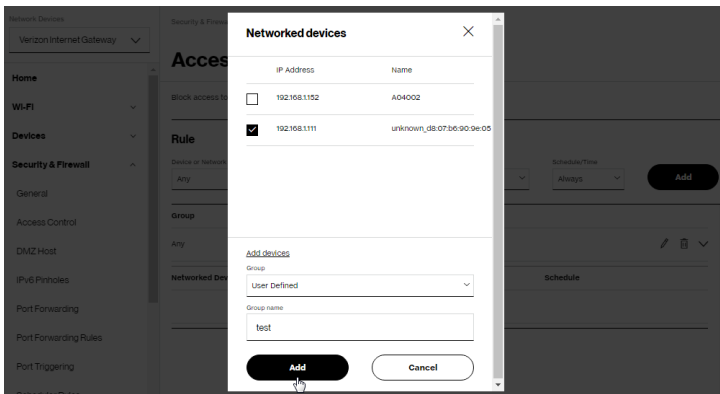

- To block a service, select the internet protocol to be blocked in the **Protocol** field.
- If the service is not included in the list, select **User Defined**, define the service, then click **Add another entry**.
- Click **Add**. The service is automatically added to the **Access Control** section.

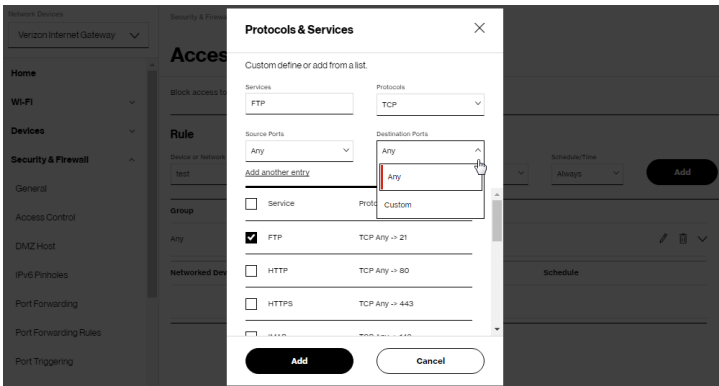

- Specify when the rule is active as **Always** or **User Defined**.
- Specify days of the week, and set the start time and end time when the rule will be active or inactive.

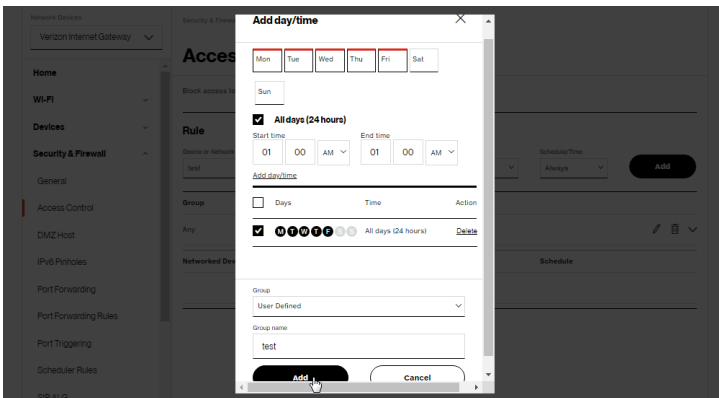

- Click **Add day/time** to create the schedule time and choose the schedule rule by clicking on the check box on the screen.
- Click **Add** to apply the changes.

# SECURITY & FIREWALL

---

12. The **Access Control** page displays a summary of the new access control rule.
13. To modify the current settings, click the edit icon in the action column and then the **Apply** button.
14. To remove an access restriction, click the trash icon. The rule is removed from the Access Control table.

## 5.0c/ DMZ HOST

DMZ Host allows a single device on your primary network to be fully exposed to the internet for special purposes like video conferencing.

***Warning:** Enabling DMZ Host is a security risk. When a device on your network is a DMZ Host, it is directly exposed to the internet and loses much of the protection of the firewall. If it is compromised, it can also be used to attack other devices on your primary network.*

Follow these steps to designate a device on your primary network as a DMZ Host:

1. From the **Advanced** menu, select **Security & Firewall** and then click **DMZ Host**.
2. Select **Enable** for the DMZ Host.
3. Enter the IP address or select the MAC address of the device you want to designate as the DMZ Host.

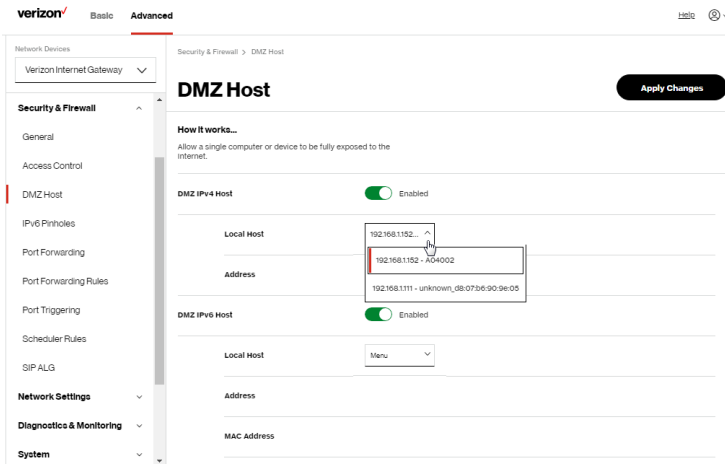

4. Click **Apply Changes** to save changes.

## 5.0d/ IPV6 PINHOLES

The IPv6 Pinhole feature of the Gateway allows an application to send incoming packets for a certain port number to the destination computer by setting up the rule of authorization.

*To configure the rules:*

1. From the **Advanced** menu, select **Security & Firewall** and then click **IPv6 Pinhole**.

# SECURITY & FIREWALL

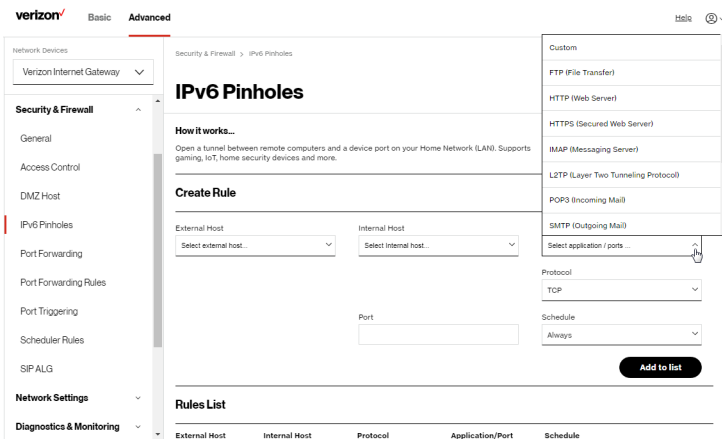

2. Select external and internal host, protocol and the application port type.
3. To schedule the rule, select either **Always** or **User Defined** in the **Schedule** list box.
4. Click **Add to list**. The screen displays opened pinhole port and its status. It shows the IP addresses of remote device and connected device on your network.
5. Click **Apply Changes** to save changes.

## 5.0e/ PORT FORWARDING

You can activate port forwarding to expose the network to the internet in a limited and controlled manner. For example, enabling applications, such as video conferencing and voice, to work from the local network as well as allowing internet access to servers within the local network.

To create port forwarding rules:

1. From the **Advanced** menu, select **Security & Firewall** from the left pane and then click **Port Forwarding**. The **Port Forwarding** page opens with the current rules displayed.

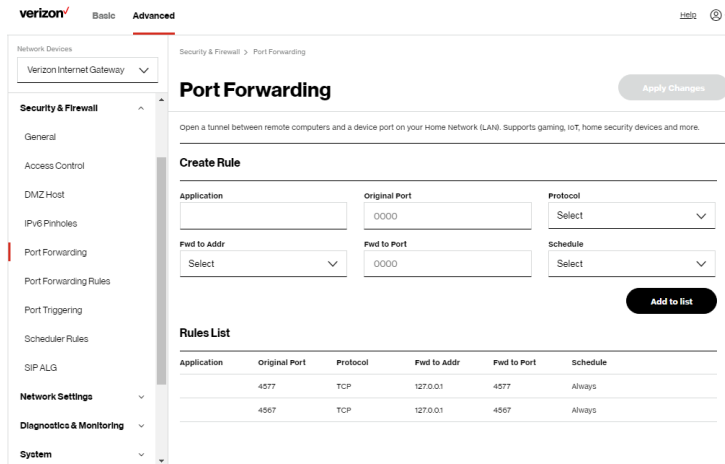

verizon Basic Advanced

Network Devices  
Verizon Internet Gateway

Security & Firewall

General

Access Control

DMZ Host

IPv6 Pinholes

Port Forwarding

Port Forwarding Rules

Port Triggering

Scheduler Rules

SIP ALG

Network Settings

Diagnostics & Monitoring

System

### Port Forwarding

Apply Changes

Open a tunnel between remote computers and a device port on your Home Network (LAN). Supports gaming, IoT, home security devices and more.

#### Create Rule

Application

Original Port

Protocol

Fwd to Addr

Fwd to Port

Schedule

Add to list

#### Rules List

Application	Original Port	Protocol	Fwd to Addr	Fwd to Port	Schedule
	4577	TCP	127.0.0.1	4577	Always
	4567	TCP	127.0.0.1	4567	Always

2. To create a new rule, enter the application name, configure its inbound and outbound port numbers, forwarding destination address, then select the protocol.
3. To schedule the rule, select either **Always** or **User Defined** in the **Schedule** list box.
4. Click **Add to list**. The rule displays in the **Rules List** section.
5. Click **Apply Changes** to save changes.

# SECURITY & FIREWALL

## 5.0f/ PORT FORWARDING RULES

You can view, modify, and delete port forwarding rules.

To access the rules:

1. Select **Port Forwarding Rules** in the **Security & Firewall** section.

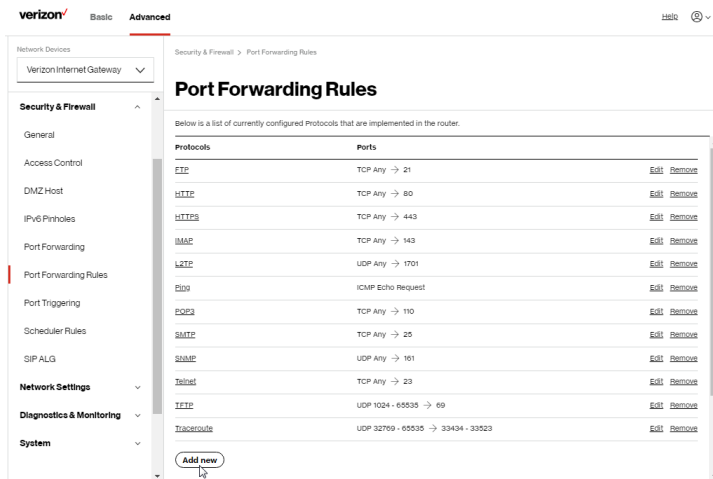

2. To create or edit a protocol rule, click the **Add new** or **Edit** icon in the action column. The **Edit Service** page displays.



Network Devices  
Verizon Internet Gateway

Security & Firewall

General

Access Control

DMZ Host

IPv6 Pinholes

Port Forwarding

Port Forwarding Rules

Port Triggering

Scheduler Rules

SIP ALG

Network Settings

### Edit Service

**Edit Service**

Service Name

Service Description

**Service Ports**

Protocols	Ports
<input type="button" value="Add"/>	

3. Modify the **Service Name** and **Service Description**, as needed.
4. To add server ports, click **Add**.
5. To modify the current protocol, click the **Edit** icon in the action column. The **Edit Service Server Ports** page displays.

Network Devices  
Verizon Internet Gateway

Security & Firewall

General

Access Control

DMZ Host

IPv6 Pinholes

Port Forwarding

Port Forwarding Rules

Port Triggering

### Edit Service

**Edit Service Server Ports**

Protocol

Source Ports

Destination Ports

6. Enter the **Protocol**, **Source Ports** and **Destination Ports**, as needed.
7. Click **Apply** to save changes.

# SECURITY & FIREWALL

---

## 5.0g/ PORT TRIGGERING

Port triggering can be described as dynamic port forwarding. By setting port triggering rules, inbound traffic arrives at a specific network host using ports that are different than those used for outbound traffic. The outbound traffic triggers the ports where the inbound traffic is directed.

For example, a web server is accessed using UDP protocol on port 2222. The web server then responds by connecting the user using UDP on port 3333, when a web session is initiated.

In this case, port triggering must be used since it conflicts with the following default firewall settings:

- Firewall blocks inbound traffic by default.
- Server replies to your Gateway IP, and the connection is not sent back to the host since it is not part of a session.

To resolve the conflict, a port triggering entry must be defined, which allows inbound traffic on UDP port 3333 only after a network host generated traffic to UDP port 2222. This results in your Gateway accepting the inbound traffic from the web server and sending it back to the network host which originated the outgoing traffic to UDP port 2222.

*To configure port triggering:*

1. From the **Advanced** menu, select **Security & Firewall** and then click **Port Triggering**.

The screenshot shows the Verizon Business Internet Gateway configuration interface. The left sidebar is expanded to 'Security & Firewall' > 'Port Triggering'. The main content area is titled 'Port Triggering' and includes an 'Apply Changes' button. Below the title, there is a section for 'Create Rule' with the following fields: Application (PT-test), Trig Port Range (Start: 11, End: 22), Protocol (TCP), Fwd Port Range (Start: 33, End: 44), and Schedule (test). An 'Add to list' button is located below the 'Create Rule' section. Below that is a 'Rules List' table with the following data:

Application	Trig port range	Protocol	Fwd port range	Schedule	
PT	11 - 22	TCP	33 - 44	test	<input checked="" type="checkbox"/>

2. To add a service as an active protocol, enter the application name, configure its inbound and outbound (triggered/forwarded) port range, then select the protocol.
3. To schedule the rule, select either **Always** or **User Defined** in the **Schedule** list box.
4. Click **Add to list**. The rule displays in the **Rules List** section.
5. Click **Apply Changes** to save changes.

## 5.0h/ SCHEDULER RULES

**Scheduler Rules** are used for limiting the activation of firewall rules to specific time periods. The time periods are either for days of the week or for hours of each day based on activity or inactivity.

# SECURITY & FIREWALL

To define a rule:

1. Verify that the date and time of your Gateway is correct.
2. Select **Scheduler Rules** in the **Security & Firewall** section.

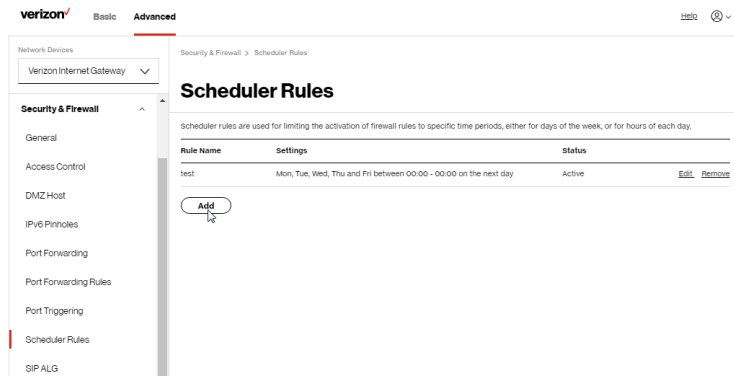

3. Click Add. The **Rule Scheduler** page displays.

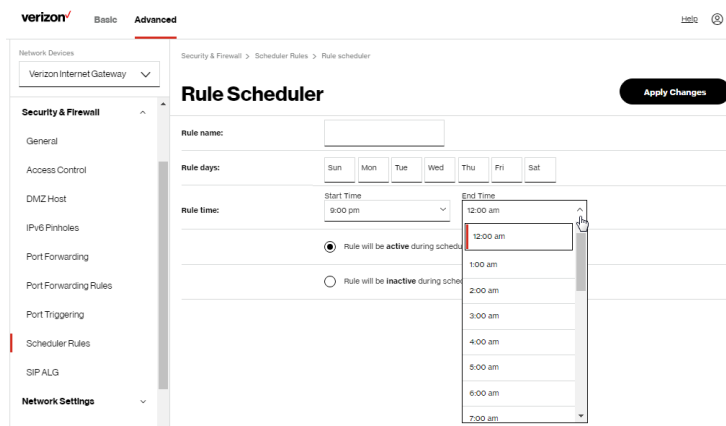

4. Enter the name of the rule, select the active or inactive days of the week and the start and end time range.

5. Specify if the rule is **active** or **inactive** at the scheduled time.
6. Click **Apply Changes** to save changes.

## 5.0i/ SIP ALG

SIP ALG (Application Level Gateway) - supports various multiple application protocols by allowing dynamic ephemeral TCP/ UDP ports to communicate with the known ports which a particular client application (such as FTP, VoIP service, net meeting or streaming media) requires.

*To enable the SIP ALG settings:*

1. From the **Advanced** menu, select **Security & Firewall** and then click **SIP ALG**.
2. Select **Enabled** for the SIP ALG.

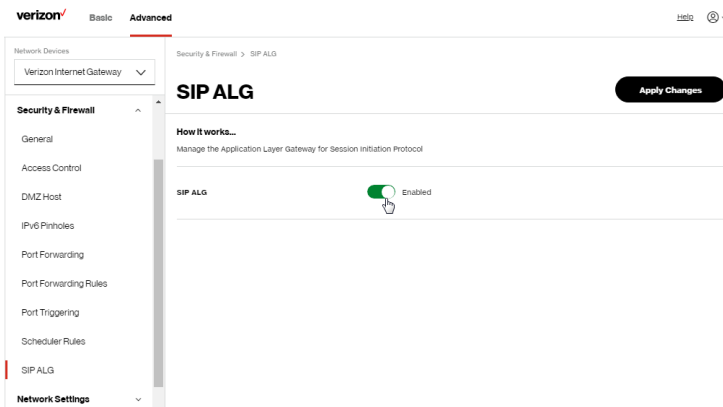

3. Click **Apply Changes** to save changes.

# NETWORK SETTINGS

## 5.1/ NETWORK SETTINGS

### 5.1a/ ARP TABLE

You can view the IPv4 and MAC addresses of each DHCP connection.

*To view the IPv4 and MAC addresses for each device:* From the **Advanced** menu, select **Network Settings** and then click **ARP Table**.

The screenshot shows the Verizon Network Settings interface. At the top, there is a Verizon logo and navigation tabs for 'Basic' and 'Advanced'. Below this, a sidebar on the left lists various network settings, with 'Network Settings' expanded to show 'ARP Table' selected. The main content area is titled 'ARP Table' and includes a 'Refresh' button. A table below displays DHCP connection details.

IPv4 Address	MAC Address	State	Device
192.168.1.151	-	FAILED	Network (Home/Office)
192.168.1.152	48:5b:39:4f:56:08	REACHABLE	Network (Home/Office)
192.168.1.100	b8:fb:53:84:e6:68	REACHABLE	Network (Home/Office)

### 5.1b/ DNS SERVER

You can edit the host name and/or IP address, if the host was manually added to the DNS table. If not, you can only modify the host name.

*To access the DNS server:*

1. From the **Advanced** menu, select **Network Settings** and then click **DNS Server**.

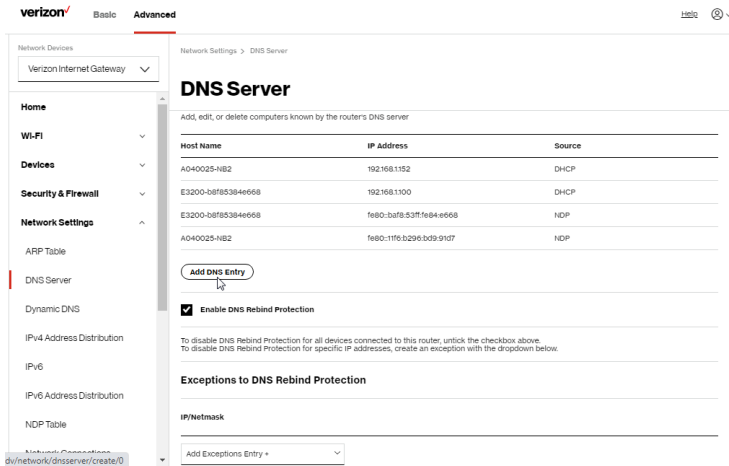

2. To disable DNS rebind protection for all devices connected to the Gateway, untick the check box of **Enable DNS Rebind Protection**.

*Warning: Disabling this protection may create a risk of cyber security attack to devices connected to this Gateway.*

3. To add a computer stored in the **DNS** table, click **Add DNS Entry**. The **DNS Entry** page displays.

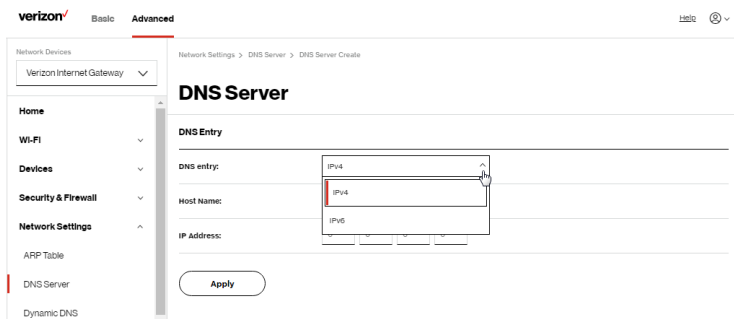

# NETWORK SETTINGS

---

4. In the **Host Name** field, enter the name of the computer, then enter the **IP address** and click **Apply** to save changes.
5. Then the **DNS Server** page displays.
6. To add a new IP address entry, select the **Add Exceptions Entry** in the **Exceptions to DNS Rebind Protection** section. Edit the IP address.
7. To remove a host from the DNS table, click the **Remove** icon on the screen.
8. Click **Apply Changes** to save changes.

## 5.1c/ DYNAMIC DNS

Typically, when connecting to the internet, your Gateway is assigned an unused public IP address from a pool, and this address changes periodically.

Dynamic DNS allows a static domain name to be mapped to the dynamic IP address, allowing a computer within your network to be more easily accessible from the internet.

When using Dynamic DNS, each time the public IP address changes, the DNS database is automatically updated with the new IP address. In this way, even though the IP address changes often, the domain name remains constant and accessible.

*To set up dynamic DNS:*

1. Select **Dynamic DNS** in the **Network Settings** section.



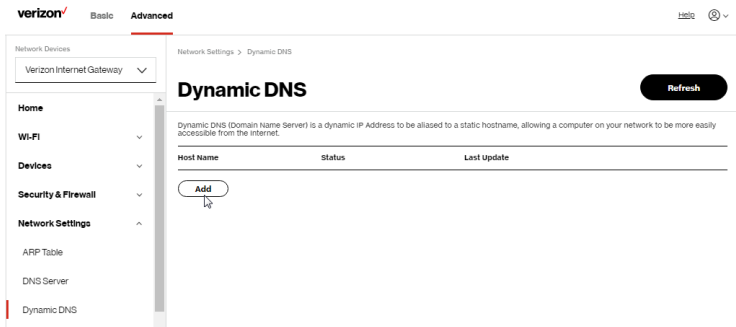

2. To set up a new entry, click the **Add** button.

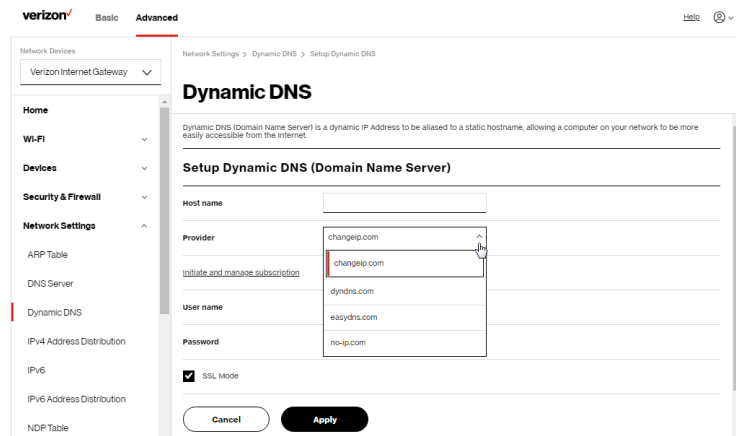

3. Configure the following parameters:

- **Host Name** – enter the full domain name for your Dynamic DNS domain.
- **Provider** – select the Dynamic DNS account provider from the menu.
- **User Name** – enter your user name for your Dynamic DNS account.

# NETWORK SETTINGS

---

- **Password** – enter the password for your Dynamic DNS account.
  - **SSL Mode** – select if your Dynamic DNS service supports SSL.
4. Click **Apply** to save your changes.

## 5.1d/ IPV4 ADDRESS DISTRIBUTION

You can easily add computers configured as DHCP clients to the network. The DHCP server provides a mechanism for allocating IP addresses to these hosts and for delivering network configuration parameters to the hosts.

For example, a client (host) sends a broadcast message on the network requesting an IP address for itself. The DHCP server then checks its list of available addresses and leases a local IP address to the host for a specific period of time and simultaneously designates this IP address as taken. At this point, the host is configured with an IP address for the duration of the lease.

The host can renew an expiring lease or let it expire. If it renews a lease, the host receives current information about network services, as it did during the original lease, allowing it to update its network configurations to reflect any changes that occurred since the first connection to the network.

If the host wishes to terminate a lease before its expiration, it sends a release message to the DHCP server. This makes the IP address available for use by other hosts.

*The DHCP server performs the following functions:*

- Displays a list of all DHCP host devices connected to your Gateway
- Defines the range of IP addresses that can be allocated in the network
- Defines the length of time the dynamic IP addresses are allocated

- Provides the above configurations for each network device and can be configured and enabled or disabled separately for each network device
- Assigns a static lease to a network computer to receive the same IP address each time it connects to the network, even if this IP address is within the range of addresses that the DHCP server may assign to other computer
- Provides the DNS server with the host name and IP address of each computer connected to the network

To view a summary of the services provided by the DHCP server:

1. Select **IPv4 Address Distribution** in the **Network Settings** section.

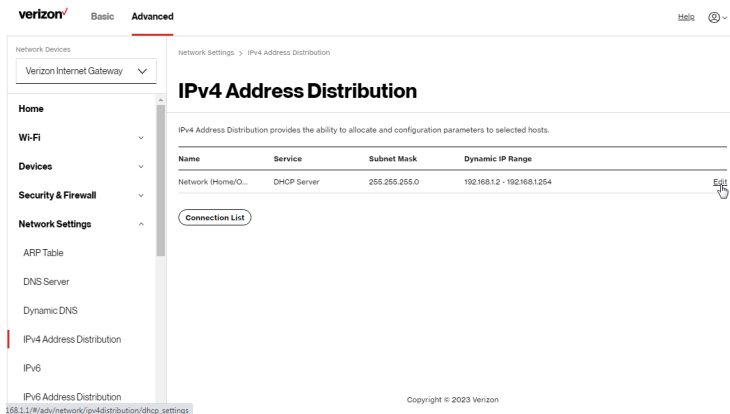

2. You can edit the DHCP server settings for a device. On the **IPv4 Address Distribution** page, click the **Edit** icon on the screen. The DHCP Settings page opens with the device information displayed.
3. To enable the DHCP server, select **DHCP Server** in the **IPv4 Address Distribution** field.
4. Once enabled, the DHCP server provides automatic IP assignments (IP leases) based on the preset IP range defined below.

# NETWORK SETTINGS

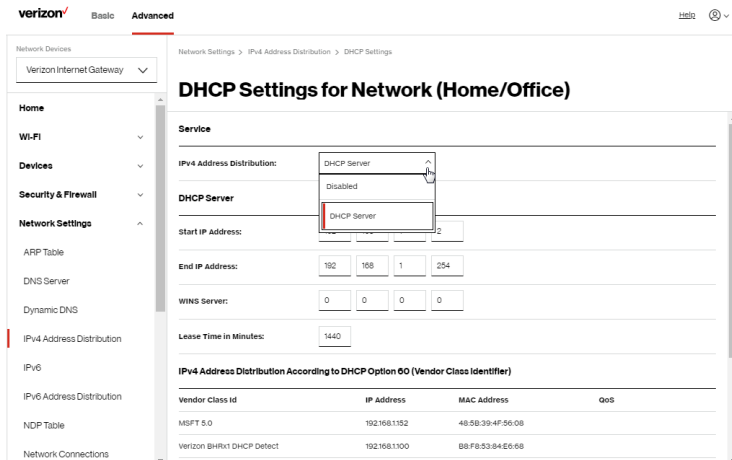

5. To configure the DHCP server, complete the following fields:
- **Start IP Address** – enter the first IP address that your Gateway will automatically begin assigning IP addresses from. Since your Gateway’s default IP address is 192.168.0.1, the default start IP address should be 192.168.0.2.
  - **End IP Address** – enter the last IP address that your Gateway will stop at for the IP address allocation. The maximum end IP address range that can be entered is 192.168.0.254.
  - **WINS Server** – determines the IP address associated with a network device.
  - **Lease Time in Minutes** – assigns the amount of time in minutes that each device is assigned an IP address by the DHCP server when it connects to the network.

When the lease expires, the server determines if the computer has disconnected from the network. If it has, the server may reassign this IP address to a newly connected computer.

## IPv4 Address Distribution According to DHCP option 60 (Vendor Class Identifier)

DHCP vendor class is related to DHCP option 60 configuration within the Gateway. User can add option 60 configurations such that particular vendor can get lease from a specified pool of address. The existing vendor class ID, IP address, MAC address and QoS are shown on the screen above.

1. Click **Apply** to save changes.

## DHCP Connection List

You can view a list of the connections currently assigned and recognized by the DHCP server.

*To view a list of computers:*

1. On the **IPv4 Address Distribution** page, click **Connection List**.

The screenshot shows the Verizon Business Gateway Advanced Settings page. The left sidebar contains a navigation menu with categories: Home, Wi-Fi, Devices, Security & Firewall, Network Settings, ARP Table, DNS Server, Dynamic DNS, IPv4 Address Distribution (highlighted), IPv6, and IPv6 Address Distribution. The main content area is titled "DHCP Connections" and includes a sub-header "Network Settings > IPv4 Address Distribution > DHCP Connections". Below the title is a description: "IPv4 Address Distribution provides the ability to allocate and configuration parameters to selected hosts." A table lists two active DHCP connections with columns for Host Name, IP Address, Physical Address, Lease Type, Connection Name, Status, and Expired in. Below the table is a button labeled "Add static connection" with a mouse cursor pointing to it.

Host Name	IP Address	Physical Address	Lease Type	Connection Name	Status	Expired in
E3200-88f95384e...	192.168.1.100	88:F8:53:84:E6:68	Dynamic	Network (Home/O...	Active	995 <a href="#">Search</a> <a href="#">Edit</a>
A040025-NE2	192.168.1.152	48:5B:30:4F:56:08	Dynamic	Network (Home/O...	Active	094 <a href="#">Search</a> <a href="#">Edit</a>

# NETWORK SETTINGS

2. To define a new static connection with a fixed IP address, click **Add static connection**.

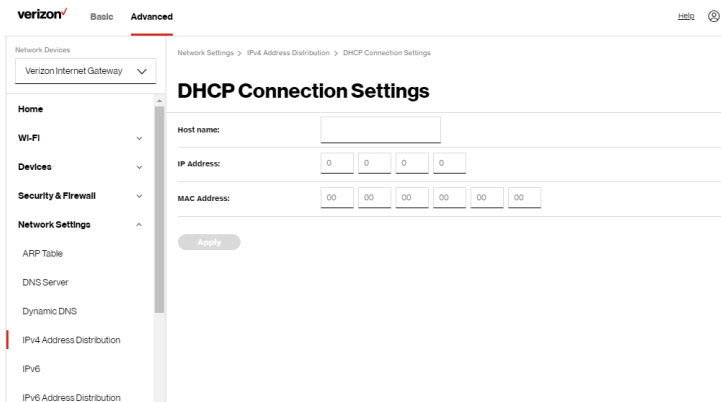

3. Enter the host name.
4. Enter the fixed IP address to be assigned.
5. Enter the MAC address of the network interface of the computer used with this DHCP static connection.
6. Click **Apply** to save changes.

## 5.1e/ IPV6

Use the IPv6 feature settings to enable, disable, or configure an IPv6 Internet connection and IPv6 LAN settings.

1. To configure your network to use the IPv6 Internet connection type, select **IPv6** in the **Network Settings** section to display the IPv6 service options:

Network Devices  
Verizon Internet Gateway

Basic Advanced

IPv6 Configuration Controls

Apply Changes

1. Enable IPv6 Support Enabled

2. Specify the method to be used to obtain your WAN IPv6 Address

IPv6 WAN Configuration: [Dropdown]

Assigned Prefix: [Input]

IPv6 WAN Address: [Input] / [Input]

Default Gateway: [Input]

WAN Link-Local Address: fe80:7693:daff:fe0:93f9

IPv6 DNS Address 1: [Input]

IPv6 DNS Address 2: [Input]

2. Select **Enabled** in the **Enable IPv6 Support** field.
3. Click **Apply Changes** to have changes take effect.

*Note: The Internet IPv6 service is required for this feature to work over the internet.*

4. To disable the IPv6 service, move the selector to **off** in the **Enable IPv6 Support** field.
5. Click **Apply Changes** to have changes take effect.

Once configured using valid IPv6 WAN and LAN configurations, you should not see any errors when you click on the **Apply Changes** button and the **Basic/System/System Status** page will reflect the Gateway's new IPv6 address.

You should also see the IPv6 address for all IPv6 supported devices on your local network displayed on the **Basic/Devices/Devices** page by selecting the Settings icon to access the **Device Settings** page for that device.

# NETWORK SETTINGS

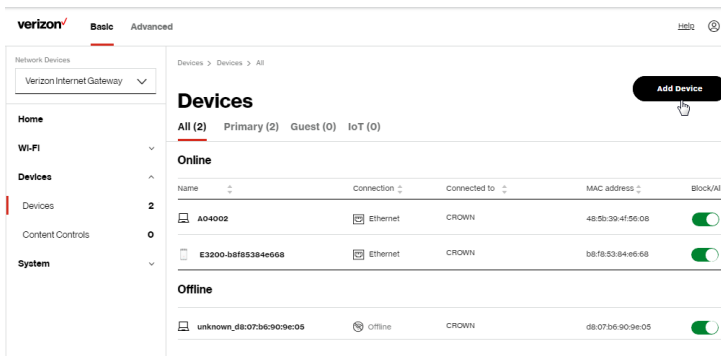

## WAN IPv6 with LAN IPv6 Stateful (DHCPv6) Settings

1. To configure IPv6 WAN Stateful (DHCPv6) mode, select the **Stateful (DHCPv6)** option on the **IPv6 Configuration Controls** page as shown below:

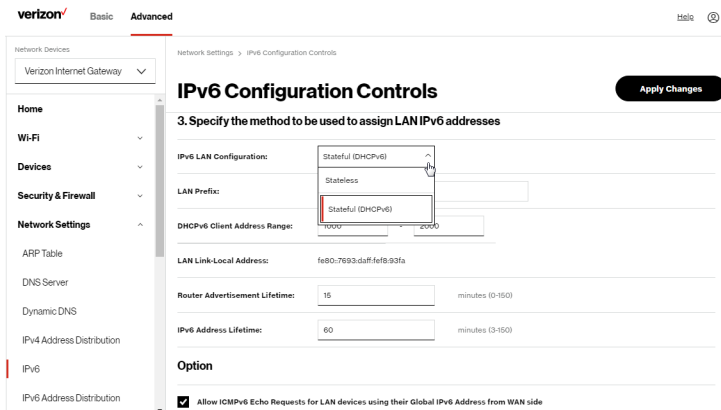

2. Specify the **Stateful (DHCPv6)** settings to be used to assign LAN IPv6 addresses by entering the following details:



- **IPv6 LAN Configuration** (select **Stateful** from the dropdown list)
  - **LAN Prefix** (automatically populated)
  - **DHCPv6 Client Address Range** (start and end)
  - **LAN Link Local Address** (automatically populated)
  - **Router Advertisement Lifetime** (minutes between 0-150)
  - **IPv6 Address Lifetime** (minutes between 3-150)
  - **Option: Allow ICMPv6 Echo Request for LAN devices using their Global IPv6 Address from WAN side** - requesting an IPv6 address from any available DHCPv6 servers available on the ISP
3. After entering all appropriate IPv6 settings, click **Apply changes** to have changes take effect.

## WAN IPv6 with LAN IPv6 Stateless Settings

1. To configure IPv6 LAN Stateless mode with DHCPv6 WAN, select the **Stateless** option on the **IPv6 Configuration Controls** page as shown below:

The screenshot shows the Verizon network settings interface for IPv6 Configuration Controls. The page is titled "IPv6 Configuration Controls" and includes a "3. Specify the method to be used to assign LAN IPv6 addresses" section. A dropdown menu is open, showing three options: "Stateless" (highlighted with a red box), "Stateful", and "Stateful (DHCPv6)". The "LAN Prefix" field is empty. The "LAN Link-Local Address" field contains the value "fe80::e3a:1234:5678:9012". The "Router Advertisement Lifetime" is set to 15 minutes. The "Option" section has a checked box for "Allow ICMPv6 Echo Requests for LAN devices using their Global IPv6 Address from WAN side".

verizon Basic Advanced title @

Network Devices  
Verizon Internet Gateway

Home  
Wi-Fi  
Devices  
Security & Firewall  
Network Settings  
ARP Table  
DNS Server  
Dynamic DNS  
IPv4 Address Distribution  
IPv6  
IPv6 Address Distribution

Network Settings > IPv6 Configuration Controls

### IPv6 Configuration Controls

Apply Changes

3. Specify the method to be used to assign LAN IPv6 addresses

IPv6 LAN Configuration: Stateless

LAN Prefix:

LAN Link-Local Address: fe80::e3a:1234:5678:9012

Router Advertisement Lifetime: 15 minutes (0-150)

Option

Allow ICMPv6 Echo Requests for LAN devices using their Global IPv6 Address from WAN side

# NETWORK SETTINGS

- Specify the settings to be used to assign LAN IPv6 addresses by entering the following details:
  - IPv6 LAN Configuration** (select **Stateless** from the dropdown list)
  - LAN Prefix** (automatically populated)
  - LAN Link Local Address** (automatically populated)
  - Router Advertisement Lifetime** (minutes between 0-150)
  - Option: Allow ICMPv6 Echo Request for LAN devices using their Global IPv6 Address from WAN side** - requesting an IPv6 address from any available DHCPv6 servers available on the ISP
- After entering all appropriate IPv6 settings, click **Apply changes** to have changes take effect.

## 5.1f/ IPV6 ADDRESS DISTRIBUTION

To view a summary of the services provided by the DHCP server:

- Select **IPv6 Address Distribution** in the **Network Settings** section.

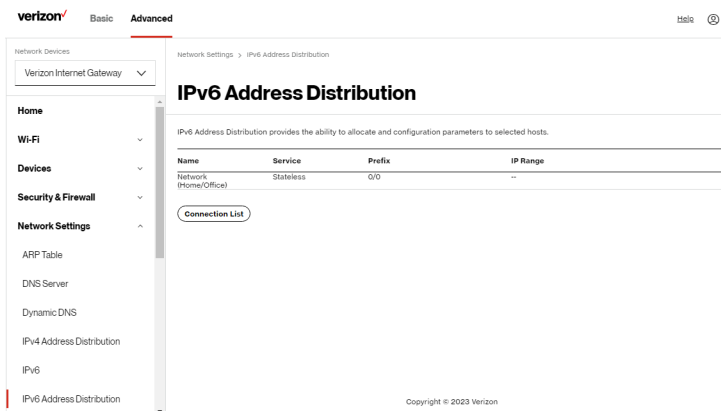

The screenshot shows the Verizon Network Settings interface. The top navigation bar includes the Verizon logo, 'Basic', and 'Advanced' tabs. The main content area is titled 'IPv6 Address Distribution' and includes a description: 'IPv6 Address Distribution provides the ability to allocate and configuration parameters to selected hosts.' Below this is a table with columns for Name, Service, Prefix, and IP Range. The table contains one entry: 'Network (Home/Office)' with Service 'Stateless', Prefix '0/0', and IP Range '--'. A 'Connection List' button is located below the table. The left sidebar shows a navigation menu with 'Network Settings' expanded to show 'IPv6 Address Distribution' selected. The footer contains the copyright notice 'Copyright © 2023 Verizon'.

Name	Service	Prefix	IP Range
Network (Home/Office)	Stateless	0/0	--

2. You can edit the DHCP server settings for a device. On the **IPv6 Address Distribution** page, click the **Edit** icon on the screen column. The DHCP Settings page opens with the device information displayed.
3. To configure the DHCP server complete the following fields:
  - **Start IPv6 Address** – the starting IPv6 address in the consecutive list of addresses that makes up this LAN pool for the DHCPv6 server.
  - **End IPv6 Address** – the ending IPv6 address in the consecutive list of addresses that makes up this LAN pool for the DHCPv6 server.
  - **Lease Time in Minutes** – assigns the amount of time in minutes that each device is assigned an IP address by the DHCP server when it connects to the network.

When the lease expires, the server determines if the computer has disconnected from the network. If it has, the server may reassign this IP address to a newly connected computer.
4. Click **Apply** to save changes.

## DHCP Connection List

You can view a list of the connections currently assigned and recognized by the DHCP server.

*To view a list of computers:*

1. On the **IPv6 Address Distribution** page, click **Connection List**.
2. To define a new static connection with a fixed IP address, click **Add static connection**.
3. Enter the host name.
4. Enter the fixed IP address to be assigned.

# NETWORK SETTINGS

5. Enter the MAC address of the network interface of the computer used with this DHCP static connection.
6. Click **Apply** to save changes.

## 5.1g/ NDP TABLE

You can view the IPv6 and MAC addresses of each DHCP connection.

To view the IPv6 and MAC addresses for each device: select **NDP** (Neighbor Discovery Protocol ) **Table** in the **Network Settings** section.

The screenshot shows the Verizon Network Settings interface. The top navigation bar includes the Verizon logo, 'Basic', and 'Advanced' tabs. The left sidebar lists various settings: Network Settings, ARP Table, DNS Server, Dynamic DNS, IPv4 Address Distribution, IPv6, IPv6 Address Distribution, NDP Table (highlighted), Network Connections, Network Objects, and Port Configuration. The main content area is titled 'NDP Table' and contains a table with the following data:

IPv6 Address	MAC Address	State	Rtr	Device
fe80::ba18:531f:fe44:e059	-	FAILED	No	Network (Home/Office)
fe80::7923:da1f:fe18:93fa	-	FAILED	Yes	Network (Home/Office)
fe80::116:5266:ba05:91c7	48:5b:39:41:56:08	REACHABLE	No	Network (Home/Office)
fe80::ba18:531f:fe44:e058	b8:18:53:84:e6:68	REACHABLE	Yes	Network (Home/Office)

## 5.1h/ NETWORK CONNECTIONS

**Caution:** The settings described in this chapter should only be configured by experienced network technicians. Changes could adversely affect the operation of your Gateway and your local network.

To view the network connections:

1. From the **Advanced** menu, select **Network Settings** from the left pane and then click **Network Connections**.

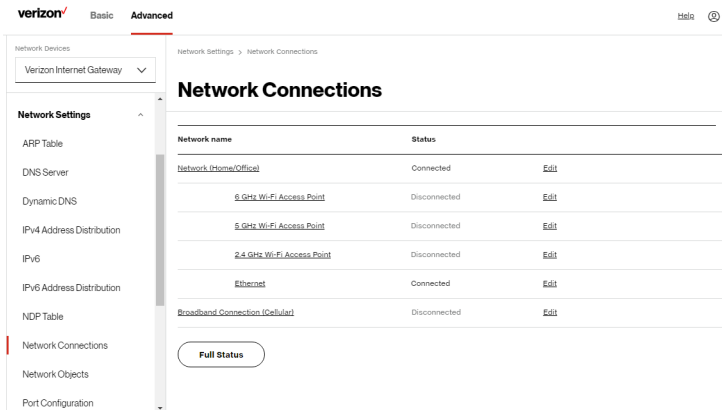

2. To view and edit the details of a specific network connection, click the hyperlinked name or the action icon. The following sections detail the types of network connections that you can view.

## NETWORK (HOME/OFFICE) CONNECTION

You can view the properties of your local network. This connection is used to combine several network interfaces under one virtual network. For example, you can create a home/office network connection for Ethernet and other network devices.

**Note:** When a network connection is disabled, the underlying devices formerly connected to it will not be able to obtain a new DHCP address from that Gateway network interface.

To view the connection:

1. On the **Network Connections** page, click the **Network (Home/Office)** connection link. The **Network (Home/ Office) Properties** page displays.

# NETWORK SETTINGS

The screenshot shows the Verizon network settings interface. At the top, there are tabs for 'Basic' and 'Advanced', with 'Advanced' selected. The breadcrumb trail reads 'Network Settings > Network Connections > Network (Home/Office)'. The main heading is 'Network (Home/Office)'. Below the heading, there is a 'Settings' button and a 'Save' button. The main content area displays the following configuration details:

- Name:** Network (Home/Office)
- Status:** Connected
- Network:** Network (Home/Office)
- Underlying Device:** 5 GHz Wi-Fi Access Point, 6 GHz Wi-Fi Access Point, 2.4 GHz Wi-Fi Access Point, Ethernet
- Connection Type:** Bridge
- MAC Address:** 74:93:DA:FB:93:FA
- IPv4 Address:** 192.168.1.1

A URL bar at the bottom left shows `h/network/networkconnections/networksettings`.

This screenshot shows the same Verizon network settings page, but with the 'Advanced' tab selected. The breadcrumb trail and main heading remain the same. The 'Settings' and 'Save' buttons are still present. The main content area displays the following advanced configuration details:

- IPv4 Address:** 192.168.1.1
- Subnet Mask:** 255.255.255.0
- IP Address Distribution:** DHCP Server
- IPv6 LAN Prefix:**
- IPv6 Address:**
- Link Local Address:** fe80::7693:daff:fef9:93fa
- IPv6 Address Distribution:** Stateless
- Received Packets:** 28090
- Sent Packets:** 39465
- Time Span:** 1:08:32

The 'Diagnostics & Monitoring' section is visible at the bottom of the left sidebar.

2. To rename a network connection, enter the new network name in the **Name** field.
3. Click **Save** to save the changes.

## CONFIGURING THE HOME/OFFICE NETWORK

To configure the network connection:

1. In the **Network (Home/Office)** properties page, click **Settings**. The configuration page displays.

The screenshot shows the Verizon Business Internet Gateway configuration interface. The page is titled "Network (Home/Office)" and is part of the "Advanced" settings. The left sidebar lists various network settings, with "Network Connections" selected. The main content area displays the configuration for the selected network connection. The status is "Connected". The connection type is "Network (Home/Office)". The physical address is "74-93-DA-F8-93-FA". The MTU is set to "Automatic" with a value of "1500". The IP address is "192.168.1.1" and the subnet mask is "255.255.255.0". The "Bridge" section is currently empty.

Network Devices  
Verizon Internet Gateway

Basic **Advanced**

Network Settings

- ARP Table
- DNS Server
- Dynamic DNS
- IPv4 Address Distribution
- IPv6
- IPv6 Address Distribution
- NDP Table
- Network Connections**
- Network Objects
- Port Configuration
- Routing
- Diagnostics & Monitoring

Network Settings > Network Connections > Network (Home/Office)

### Network (Home/Office)

Save Changes

Important: Only advanced technical users should use this feature.

#### General

Status: Connected

Connection Type: Network (Home/Office)

Physical Address: 74-93-DA-F8-93-FA

MTU: Automatic 1500

IP Address: 192 168 1 1

Subnet Mask: 255 255 255 0

#### Bridge

Name	VLAN	Status
------	------	--------

# NETWORK SETTINGS

The image displays two screenshots of the Verizon network settings interface, specifically the 'Network (Home/Office)' configuration page. The top screenshot shows the 'Bridge' section, and the bottom screenshot shows the 'Routing Table' section.

**Bridge Section:**

Name	VLAN	Status	
<input type="checkbox"/> IP Passthrough	Disable	Disconnected	<a href="#">Edit</a>
<input checked="" type="checkbox"/> 5 GHz Wi-Fi Access Point	Disable	Disconnected	<a href="#">Edit</a>
<input checked="" type="checkbox"/> 6 GHz Wi-Fi Access Point	Disable	Disconnected	<a href="#">Edit</a>
<input checked="" type="checkbox"/> 5.4 GHz Wi-Fi Access Point	Disable	Disconnected	<a href="#">Edit</a>
<input checked="" type="checkbox"/> Ethernet	Disable	Connected	<a href="#">Edit</a>

IP Address Distribution: DHCP Server

Start IP Address: 192.168.1.2

End IP Address: 192.168.1.254

WINS Server: 0.0.0.0

Lease time in minutes: 1440

**Routing Table Section:**

Vendor Class ID	IP Address	MAC Address	QoS
MSFT 5.0	192.168.1.152	48:5B:39:4F:56:08	
Verizon BHRx1 DHCP Defect	192.168.1.100	88:F8:53:84:E6:68	

**Routing Table**

Name	Destination	Gateway	Netmask	Metric	Status	Action
<a href="#">Add new route</a>						

Copyright © 2023 Verizon

2. Configure the following sections, as needed.



## General

In the **General** section, verify the following information:

- **Status** – displays the connection status of the network.
- **Connection Type** – displays the type of connection interface.
- **Physical Address** – displays the physical address of the network card used for the network.
- **MTU** – displays the Maximum Transmission Unit (MTU) indicating the largest packet size permitted for internet transmissions:
  - **Automatic**: sets the MTU (Maximum Transmission Unit) at 1500.
  - **Automatic by DHCP**: sets the MTU according to the DHCP connection.
  - **Manual**: allows you to manually set the MTU.
- **IP address** and **Subnet Mask**: the network connection uses a permanent or static **IP address** and **Subnet Mask** address, provided by Verizon or experienced network technician.
- **Bridge**

In the **Bridge** section of the **Network (Home/Office)** properties, you can configure the various LAN interfaces.

***Caution:** Do not change these settings unless specifically instructed to by Verizon. Changes could adversely affect the operation of your Gateway and your local network.*

Verify the following information:

- **IP Passthrough** – select to disable Wi-Fi and routing capabilities of the Gateway. May be necessary if connecting 3rd party routers to the Gateway and disabling the IP Passthrough mode into the device.

# NETWORK SETTINGS

---

- **Status** – displays the connection status of a specific network connection.
  - **Action** – contains an **Edit** hyperlink that, when clicked, generates the next level configuration page for the specific network connection or network device.
- **IP Address Distribution**

The **IP Address Distribution** section is used to configure the Dynamic Host Configuration Protocol (DHCP) server parameters of your Gateway.

Once enabled and configured, the DHCP server automatically assigns IP addresses to any network devices which are set to obtain their IP address dynamically.

If DHCP Server is enabled on your Gateway, configure the network devices as DHCP Clients. There are 2 basic options in this section: **Disabled** and **DHCP Server**.

To set up the Gateway's network bridge to function as a DHCP server:

1. In the **IP Address Distribution** section, select the **DHCP server**. Once enabled, the DHCP server provides automatic IP assignments (also referred to as IP leases) based on the preset IP range defined below.
  - **Start IP Address** – Enter the first IP address in the IP range that the Gateway will automatically begin assigning IP addresses from. Since your Gateway's IP address is 192.168.0.1, the default Start IP Address is 192.168.0.2.
  - **End IP Address** – Enter the last IP address in the IP range that the Gateway will automatically stop the IP address allocation at. The maximum end IP address range that can be entered is 192.168.0.254.

2. If Windows Internet Naming Service (WINS) is being used, enter the **WINS Server** address.
  3. In the **Lease time in minutes** field, enter the amount of time a network device is allowed to connect to the Gateway with its currently issued dynamic IP address.
- **IP Address Distribution According to DHCP option 60 (vendor class Identifier)**

DHCP vendor class is related to DHCP option 60 configuration within the Gateway. Adding option 60 configurations allows a particular vendor to get a lease from a specified pool of addresses.

## Routing Table

You can configure your Gateway to use static or dynamic routing.

- **Static routing** – specifies a fixed routing path to neighboring destinations based on predetermined metrics.
- **Dynamic routing** – automatically adjusts how packets travel on the network. The path determination is based on network/device reachability and the status of the network being traveled.

*To configure routing:*

1. In the **Routing Table** section, click the **Add new route** button to display and modify the new route configuration page.

# NETWORK SETTINGS

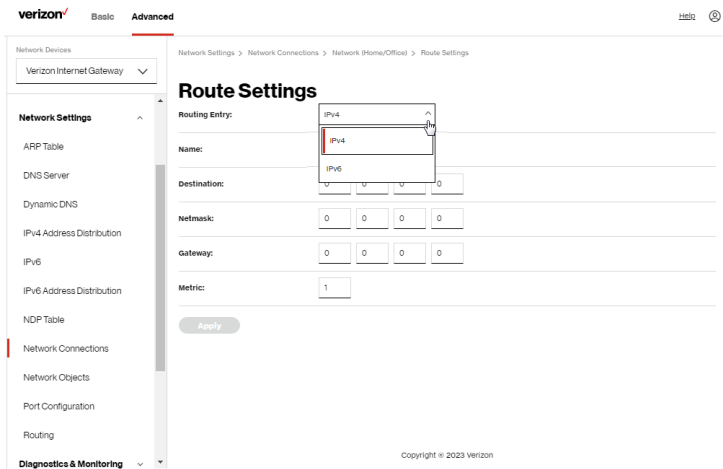

2. To save your changes click **Apply**.

## Wi-Fi ACCESS POINT CONNECTION

A Wi-Fi Access Point network connection allows Wi-Fi devices to connect to the local area network (LAN) using the 2.4 GHz, 5 GHz or 6 GHz Wi-Fi network.

**Note:** Once disabled, all Wi-Fi devices connected to that Wi-Fi network will be disconnected from the LAN network and internet.

To view the connection settings:

1. From the **Advanced** menu, select **Network Settings** from the left pane and then click **Network Connections**.
2. To access the connection settings pages, click on the link of the Wi-Fi Access Point connections listed under **Network name** on the **Network Connections** page.

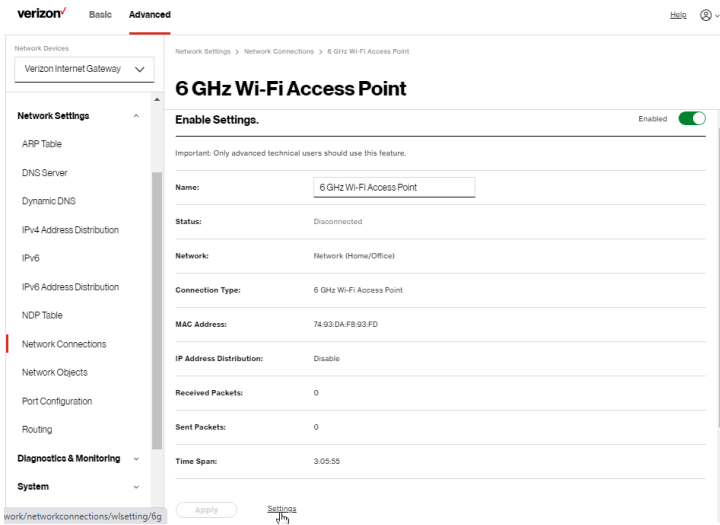

3. From the connection's **Enable Settings** page, to enable or disable the connection, move the selector to **on** or **off**.
4. To rename the connection, enter a name in the **Name** field.
5. Click **Apply** to save the changes.
6. Reboot your Gateway.

## CONFIGURING WI-FI ACCESS POINT PROPERTIES

To configure the connection:

1. On the bottom of the Access Point's specific **Enable Settings** page, click **Settings**. The configuration page displays.

# NETWORK SETTINGS

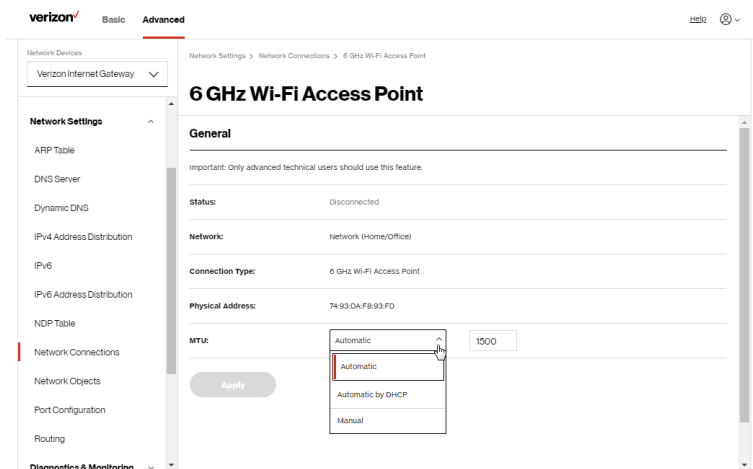

2. Verify the following information:

## General

- **Status** - displays the connection status of the network.
- **Network** – displays the type of network connection.
- **Connection Type** – displays the type of connection interface.
- **Physical Address** – displays the physical address of the network card used for the network.
- **MTU** - specifies the largest packet size permitted for internet transmissions:
  - **Automatic**: set the MTU (Maximum Transmission Unit) at 1500.
  - **Automatic by DHCP**: sets the MTU according to the DHCP connection.
  - **Manual**: allows you to manually set the MTU.

3. Click **Apply** to save changes.

## ETHERNET CONNECTION

You can view the properties of your Ethernet LAN connection using an Ethernet cable inserted into one of your Gateway's Ethernet LAN ports.

*To view the connection settings:*

1. To access the **Ethernet** properties page, click the **Ethernet** link listed under **Network name** on the **Network Connections** page.

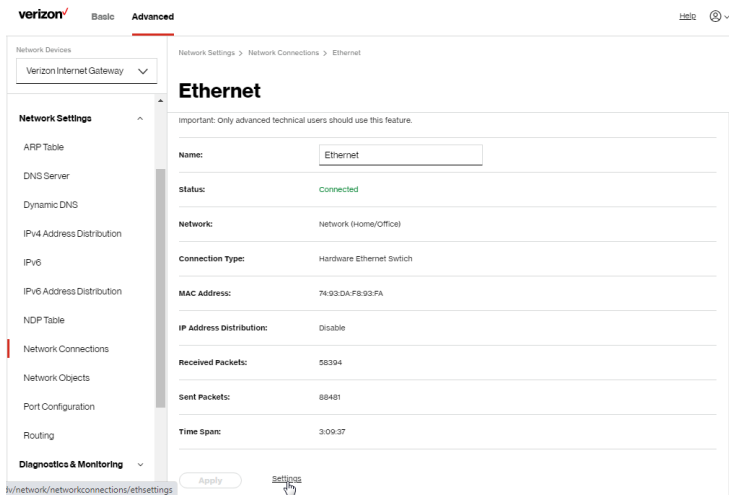

2. To rename the network connection, enter the new name in the **Name** field.
3. Click **Apply** to save changes.

# NETWORK SETTINGS

## CONFIGURING ETHERNET PROPERTIES

To configure the connection:

1. In the **Ethernet** page, click **Settings**. The configuration page displays.

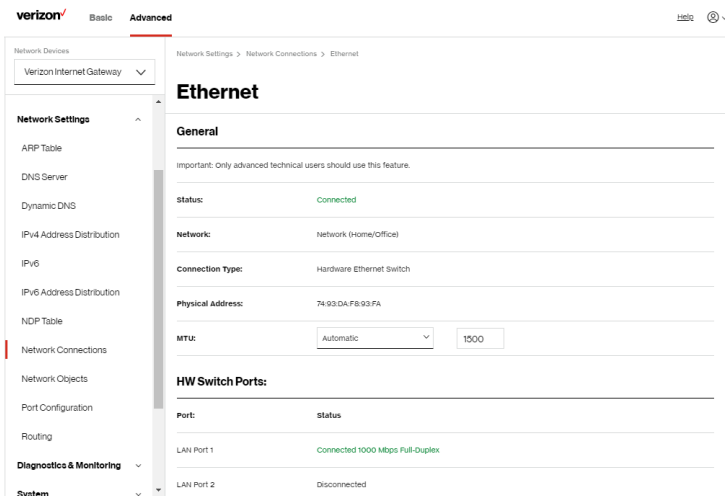

2. Verify the following information:

### General

- **Status** – displays the connection status of the network.
- **Network** – displays the type name of network connection.
- **Connection Type** – displays as **Hardware Ethernet Switch**.
- **Physical Address** – displays the physical address of the network card used for the network.
- **MTU** - specifies the largest packet size permitted for transmissions:
  - **Automatic**: sets the MTU (Maximum Transmission Unit at 1500).



- **Automatic by DHCP:** sets the MTU according to the DHCP connection.
  - **Manual:** allows you to manually set the MTU.
- **HW Switch Ports** – displays the status of each LAN port.
3. Click **Apply** to save the changes.

## BROADBAND CONNECTION (CELLULAR)

You can view the properties of your broadband connection (your connection to the internet).

*To view the connection settings:*

1. In the **Network Connections** page, click the **Broadband Connection (Cellular)**.

The screenshot shows the Verizon Business Internet Gateway interface. The top navigation bar includes the Verizon logo, 'Basic', and 'Advanced' tabs. The breadcrumb trail reads 'Network Settings > Network Connections > Broadband Connection (Cellular)'. The main heading is 'Broadband Connection (Cellular)'. Below the heading is a toggle switch for 'Enable Settings', which is currently turned on. A warning message states: 'Important: Only advanced technical users should use this feature.' The settings are organized into several sections: 'Name' (Broadband Connection (Cellular)), 'Status' (Disconnected), 'Network' (Broadband Connection), 'Connection Type' (Disconnected), 'IPv4 WAN Address', 'Subnet Mask', and 'Default Gateway'. At the bottom, there are fields for 'IPv4 DNS Address 1' and 'IPv4 DNS Address 2'. The left sidebar contains a list of navigation options: Network Devices, Network Settings (expanded), Network Connections, Network Objects, Port Configuration, Routing, Diagnostics & Monitoring, and System.

# NETWORK SETTINGS

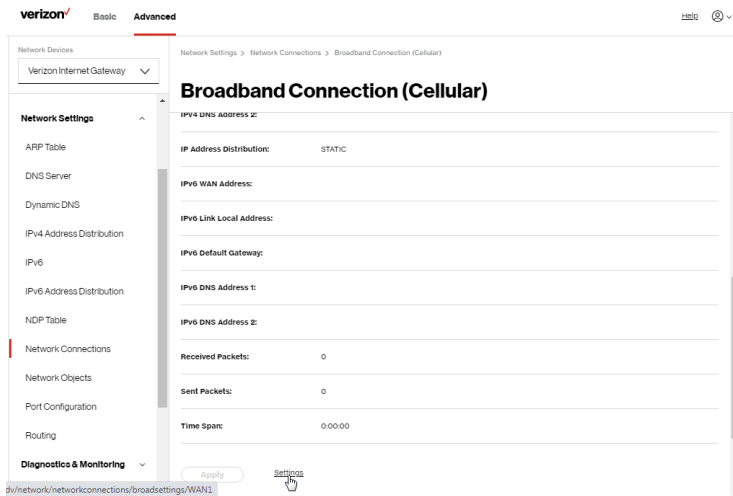

2. From the connection's **Enable Settings** page, to enable or disable the connection, move the selector to **on** or **off**.
3. To rename the network connection, enter the new name in the **Name** field.
4. Click **Apply** to save changes.

## CONFIGURING THE BROADBAND CONNECTION

*To configure the connection:*

1. On the bottom of the **Broadband Connection (Cellular)** page, click **Settings**. The configuration page displays.

The image displays two screenshots of the Verizon Business Internet Gateway configuration interface, specifically the 'Broadband Connection (Cellular) Settings' page. The interface is divided into a left sidebar with navigation options and a main content area.

**Top Screenshot:** Shows the 'General' section of the settings. The status is 'Disconnected'. The network is 'Broadband Connection (Cellular)'. The connection type is 'Disconnected'. The MTU is set to 'Automatic' with a value of '1500'. The Internet APN is 'V5G001INTERNET'. The WAN IP Address section shows 'Internet Protocol' set to 'Obtain IPv4 Address Automatically' and 'Override Subnet Mask' set to '0 0 0 0'.

**Bottom Screenshot:** Shows the 'WAN IP Address' section. The 'Internet Protocol' is 'Obtain IPv4 Address Automatically'. The 'Override Subnet Mask' is '0 0 0 0'. The 'DHCP Lease' section has 'Release' and 'Renew' buttons. The 'Expires In' section is empty. The 'IPv4 DNS' is 'Obtain IPv4 DNS Address Automatically'. The 'Internet Connection Firewall' is checked and 'Enable', with a note: 'This feature provides the ability to change the default firewall setting on this interface. We highly recommend that you do not change the default setting.' An 'Apply' button is at the bottom.

2. Configure the following settings, as needed.

# NETWORK SETTINGS

---

## General

Verify the following information:

- **Status** – displays the connection status of the network.
- **Network** – displays the type of network connection.
- **Connection Type** – displays the type of connection interface.
- **MTU** – specifies the largest packet size permitted for internet transmissions:
  - **Automatic:** sets the MTU (Maximum Transmission Unit at 1500).
  - **Automatic by DHCP:** sets the MTU according to the DHCP connection.
  - **Manual:** allows you to manually set the MTU.
- **Internet APN** (Access Point Name) – you may input APN information for your private network.

## WAN IP Address

- In the **Internet Protocol** section of **WAN IP Address**, specify one of the following:
  - **No IPv4 Address:** the connection has no IP address. This is useful if the connection operates under a bridge.
  - **Obtain an IPv4 Address Automatically:** the network connection is required by your service provider to obtain an IP address automatically. The server assigning the IP address also assigns a subnet mask address, which can be overridden by entering another subnet mask address.
  - **Use the Following IP Address:** the network connection uses a permanent or static **IP address** and **Subnet Mask** address, provided by your service provider or experienced network technician.

- To override the subnet mask, select the **Override Subnet Mask** check box, then enter the new subnet mask.
  - Click **Release/Renew** in the **DHCP Lease** field to drop/get an IP address from the DHCP server.
  - In the **Expires In** field, enter the amount of time a network device is allowed to connect to the Verizon Internet Gateway for Business with its currently issued dynamic IP address.
  - **IPv4 DNS** - selects **Obtain IPv4 DNS Address Dynamically** for using Dynamic DNS. Each time the public IP address changes, the DNS database is automatically updated with the new IPv4 address. In this way, even though the IP address changes often, the domain name remains constant and accessible.
  - **Internet Connection Firewall** - allows you to enable or disable the firewall configuration on this interface.
3. Click **Apply** to save changes.

## 5.1i/ NETWORK OBJECTS

Network objects define a group, such as a group of computers, on your Gateway network by MAC address, IP address, and/or host name. The defined group becomes a network object. You can apply settings, such as configuring system rules, to all devices defined in the network object.

For example, instead of setting the same website filtering configuration individually to five computers one at a time, you can define the computers as a network object. Website filtering can then be simultaneously applied to all the computers.

# NETWORK SETTINGS

You can use network objects to apply security rules based on host names, instead of IP addresses. This is useful since IP addresses change from time to time. In addition, you can define network objects according to MAC address to make the rule application more persistent against network configuration settings.

*To define a network object:*

1. From the **Advanced** menu, select **Network Settings**.
2. Select **Network Objects** in the **Network Settings** section.

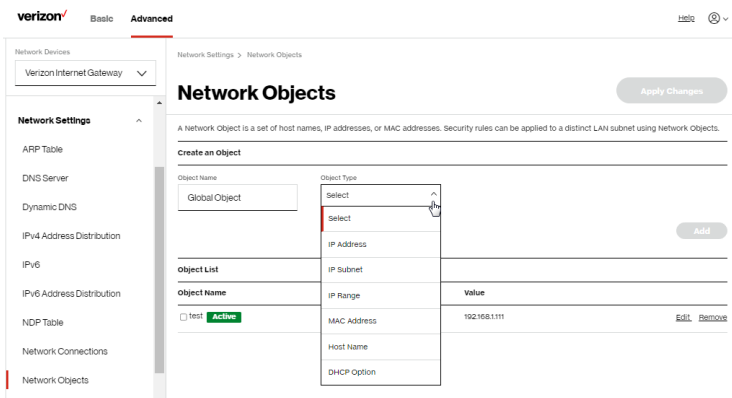

3. To define a network object, enter a name for the network object in the **Objects Name** field.
4. Select and configure the type of network object as IP address, IP subnet, IP range, MAC address, host name, or DHCP option, and click **Add**.
5. The network object displays in the **Objects List** section.
6. Repeat the above steps to create additional network objects.
7. When complete, click **Apply Changes** to save changes.

## 5.1j/ PORT CONFIGURATION

Ethernet port configuration allows you to set up the Ethernet ports as either full- or half-duplex ports, at either 10 Mbps, 100 Mbps, or 1000 Mbps.

To configure the ports:

1. Select **Port Configuration** in the **Network Settings** section.

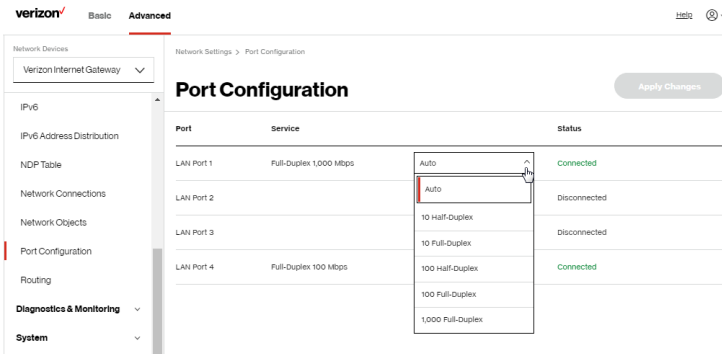

2. To emulate the speed and duplex configuration of the port with which it's communicating, select **Auto** or select the port speed and duplicity.
3. Click **Apply Changes** to save changes.

# NETWORK SETTINGS

## 5.1k/ ROUTING

You can view the routing and IP address distribution rules as well as add, edit, or delete the rules.

### Routing Table

To view the rules:

1. Select **Routing** in the **Network Settings** section.

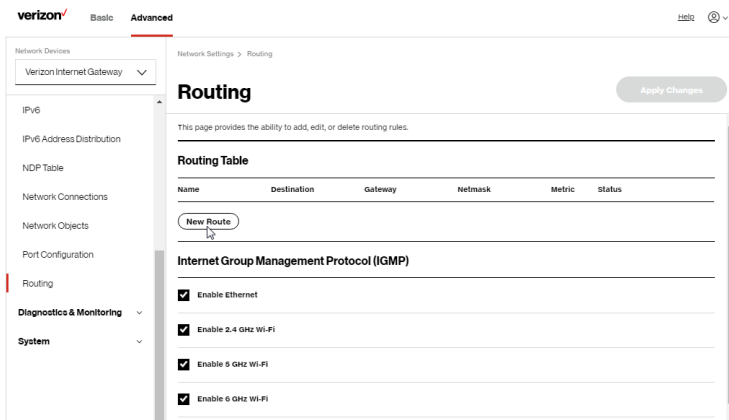

2. To add a new Route, click **New Route**.

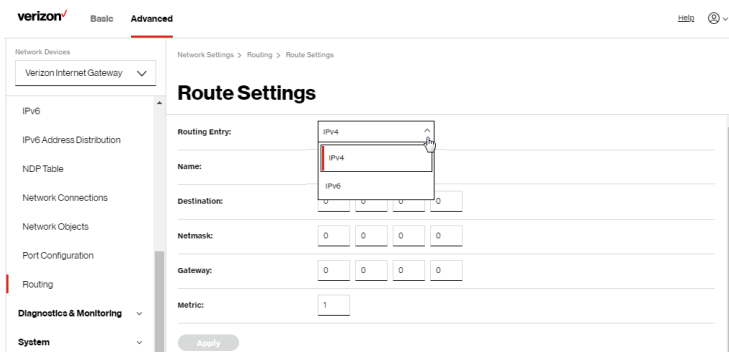



3. Specify the following parameters:
  - **Routing Entry** – select the IP address type.
  - **Name** – the network connection type.
  - **Destination** – enter the destination IP of the destination host, subnet address, network address, or default route. The destination for a default route is 0.0.0.0.
  - **Netmask** – enter the network mask. This is used in conjunction with the destination to determine when a route is used.
  - **Gateway** – enter the IP address of your Gateway.
  - **Metric** – enter a measurement preference of the route. Typically, the lowest metric is the most preferred route. If multiple routes exist to a specific destination network, the route with the lowest metric is used.
4. Click **Apply** and **Apply Changes** to save changes.

## Internet Group Management Protocol (IGMP)

IGMP allows for managing a single upstream interface and multiple downstream interfaces of the IGMP/MLD (Multicast Listener Discovery)-based forwarding. This function enables the system to send IGMP host messages on behalf of hosts that the system discovers through standard IGMP interfaces. Also, IGMP snooping allows an Ethernet switch to “listen in” on the IGMP conversation between hosts and routers, while IGMP querier will send out periodic IGMP queries.

*To enable this function:*

1. Choose the IGMP interfaces by clicking on the check boxes on the screen.
2. Click **Apply Changes** to save changes.

# DIAGNOSTICS & MONITORING

## 5.2/ DIAGNOSTICS & MONITORING

### 5.2a/ BANDWIDTH MONITORING

You can view and monitor the recorded bandwidth usage measured in bytes.

*To view the bandwidth:*

1. From the **Advanced** menu, select **Diagnostics & Monitoring**.
2. In the **Diagnostics & Monitoring** section, select **Bandwidth Monitoring**.

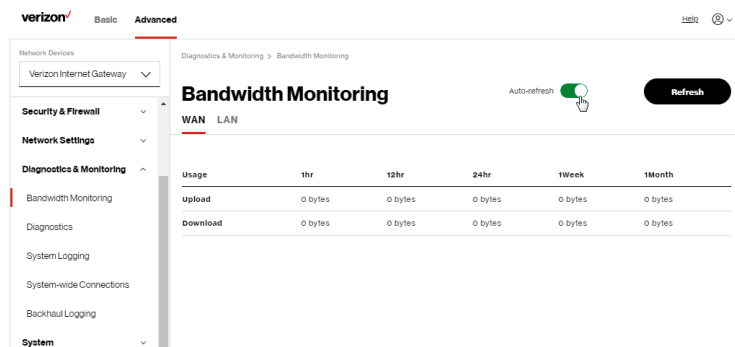

3. To refresh the page, click **Refresh**.
4. To continuously refresh the page, click **Auto-refresh on**.

### 5.2b/ DIAGNOSTICS

You can use diagnostics to test network connectivity.

*To diagnose network connectivity:*

1. Select **Diagnostics** in the **Diagnostics & Monitoring** section.
2. To ping an IP address, enter the IP address or domain name in the **Destination** field and click **Go**.

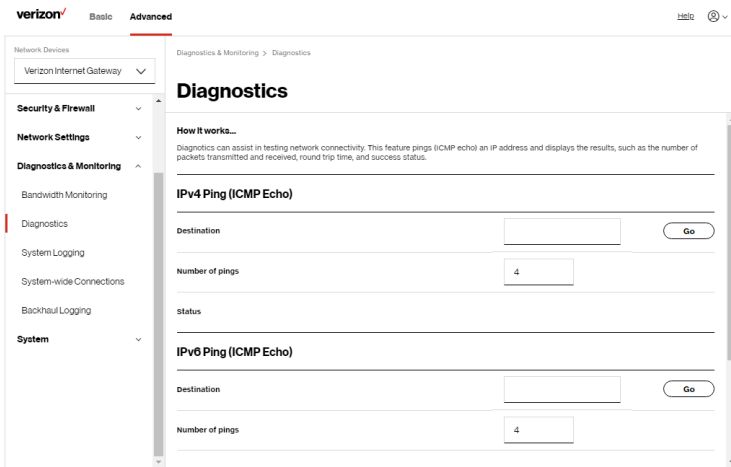

The diagnostics will display the number of pings, status, packets sent, and round trip time.

If no diagnostic status displays, click refresh in your web browser.

## 5.2c/ SYSTEM LOGGING

System logging provides a view of the most recent activity of your Gateway. In addition, you can view additional logs, such as the security, advanced, firewall, WAN link and LAN DHCP.

*To view the system log:*

1. Select **System Logging** in the **Diagnostics & Monitoring** section.

# DIAGNOSTICS & MONITORING

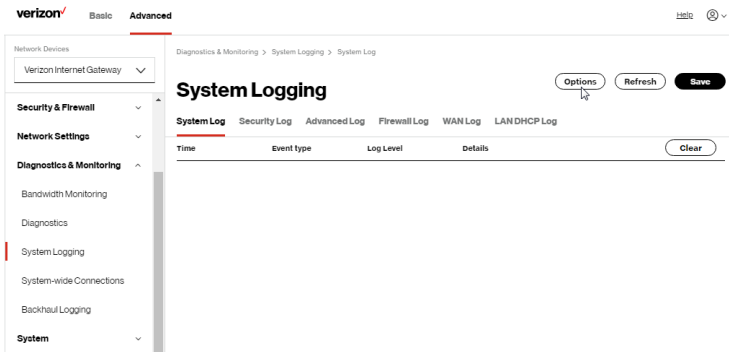

2. To view a specific time of log event, click on the **Options** button.

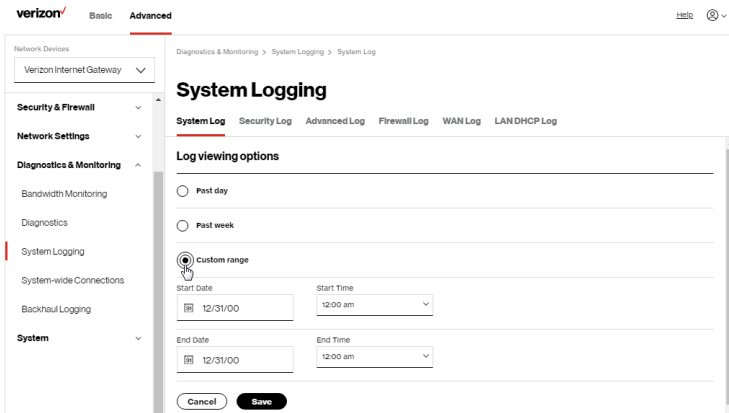

3. Select your preferred logging time.
4. Click **Save** to save changes.
5. To view a specific type of log event such as Security Log, WAN Log, etc., click the appropriate link in the menu on the top.
6. To update the data, click **Refresh**.

## 5.2d/ SYSTEM-WIDE CONNECTIONS

You can view a summary of the monitored data collected for your Gateway.

To view your Gateway's full system status and traffic monitoring data:

1. Select **System-wide Connections** in the **Diagnostics & Monitoring** section.

The screenshot displays the 'System-wide Connections' page in the Verizon Gateway interface. The page is titled 'System-wide Connections' and includes an 'Auto-refresh' toggle switch. A table lists the following connections:

Name	Network (Home/Office)	Broadband Connection (Cellular)	5 GHz Wi-Fi Access Point	5 GHz Wi-Fi Access Point	2.4 GHz Wi-Fi Access Point
Status	Connected	Disconnected	Disconnected	Disconnected	Disconnected
Underlying Device	Network (Home/Office)	Broadband Connection (Cellular)	Network (Home/Office)	Network (Home/Office)	Network (Home/Office)
Connection Type	5 GHz Wi-Fi Access Point 5 GHz Wi-Fi Access Point 2.4 GHz Wi-Fi Access Point Ethernet	Cellular	5 GHz Wi-Fi Access Point	5 GHz Wi-Fi Access Point	2.4 GHz Wi-Fi Access Point
MAC Address	74:93:DA:F8:93:FA	--	74:93:DA:F8:93:FD	74:93:DA:F8:93:FC	74:93:DA:F8:93:FB
IPv4 Address	192.168.11	--	--	--	--
Subnet Mask	255.255.255.0	--	--	--	--

# DIAGNOSTICS & MONITORING

The screenshot shows the Verizon Network Manager interface for a Verizon Internet Gateway. The left sidebar is expanded to 'Diagnostics & Monitoring', with 'System-wide Connections' selected. The main content area displays the 'System-wide Connections' configuration page. At the top right, there is an 'Auto-refresh' toggle switch that is turned on. Below the title, there is a table of connections. The first row is for the IPv4 Default Gateway (192.168.1.1). The second row is for IPv4 DNS Address 1. The third row is for IPv4 DNS Address 2. The fourth row is for IPv4 Address Distribution, showing DHCP Server and various status options (Disable, Disable, Disable, Disable). The fifth row is for IPv6 Prefix. The sixth row is for IPv6 Address. The seventh row is for IPv6 Link-Local Address (fe80::7693:daff:fe:802f). The eighth row is for IPv6 Default Gateway (fe80::7693:daff:fe:802f). The ninth row is for IPv6 DNS Address 1. The tenth row is for IPv6 DNS Address 2.

Connection Name	IP Address	Subnet	Gateway	DHCP Server	Status 1	Status 2	Status 3	Status 4
IPv4 Default Gateway	192.168.1.1							
IPv4 DNS Address 1	--	--	--	--	--	--	--	--
IPv4 DNS Address 2	--	--	--	--	--	--	--	--
IPv4 Address Distribution	DHCP Server	Disable	Disable	Disable	Disable			
IPv6 Prefix	--	--	--	--	--	--	--	--
IPv6 Address	--	--	--	--	--	--	--	--
IPv6 Link-Local Address	fe80::7693:daff:fe:802f							
IPv6 Default Gateway	fe80::7693:daff:fe:802f							
IPv6 DNS Address 1	--	--	--	--	--	--	--	--
IPv6 DNS Address 2	--	--	--	--	--	--	--	--

The screenshot shows the Verizon Network Manager interface for a Verizon Internet Gateway. The left sidebar is expanded to 'Diagnostics & Monitoring', with 'System-wide Connections' selected. The main content area displays the 'System-wide Connections' configuration page. At the top right, there is an 'Auto-refresh' toggle switch that is turned on. Below the title, there is a table of connections. The first row is for IPv6 DNS Address 2. The second row is for IPv6 Address Distribution, showing Stateless and various status options (Disable, Disable, Disable, Disable). The third row is for Received Packets (73862). The fourth row is for Sent Packets (113483). The fifth row is for Received Bytes (13918105). The sixth row is for Sent Bytes (19808108). The seventh row is for Received Errors (0). The eighth row is for Received Drops (0). The ninth row is for Time Span (4:07:19).

Connection Name	IP Address	Subnet	Gateway	DHCP Server	Status 1	Status 2	Status 3	Status 4
IPv6 DNS Address 2	--	--	--	--	--	--	--	--
IPv6 Address Distribution	Stateless	Disable	Disable	Disable	Disable			
Rec'd Packets	73862	0	0	0	0			
Sent Packets	113483	0	0	0	0			
Rec'd Bytes	13918105	0	0	0	0			
Sent Bytes	19808108	0	0	0	0			
Rec'd Errors	0	0	0	0	0			
Rec'd Drops	0	0	0	0	0			
Time Span	4:07:19	0:00:00	4:07:19	4:07:19	4:07:19			

2. To modify the connection properties, click the individual connection links.
3. To continuously refresh the page, click **Auto-refresh on**.

## 5.2e/ BACKHAUL LOGGING

You can view a summary of the BHM (backhaul modes: Ethernet and Wi-Fi) status of your network.

To view the backhaul modes log:

1. Select **Backhaul Logging** in the **Diagnostics & Monitoring** section.

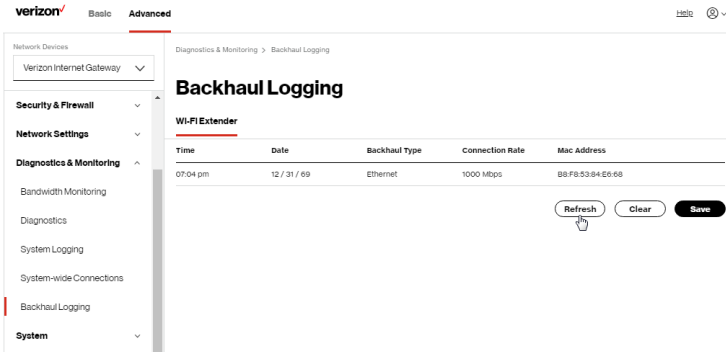

2. To refresh the page, click **Refresh**.
3. To delete the log information, click **Clear**.
4. To save the log information, click **Save**.

## 5.3/ SYSTEM

### 5.3a/ SYSTEM STATUS

To view the status:

1. From the **Advanced** menu, select **System**.
2. You can quickly view your Gateway's status by selecting **System Status** in the **System** section.
3. To refresh the page, click **Refresh**.

# SYSTEM

4. To continuously refresh the page, click **Auto-refresh on**.
5. To check for the latest firmware version of your Gateway, click **Check for updates**.

This section displays the status of your Gateway's local network (LAN) and internet connection (WAN), firmware and hardware version numbers, MAC Address, IP settings of Verizon Internet Gateway for Business and extender(s) (if connected).

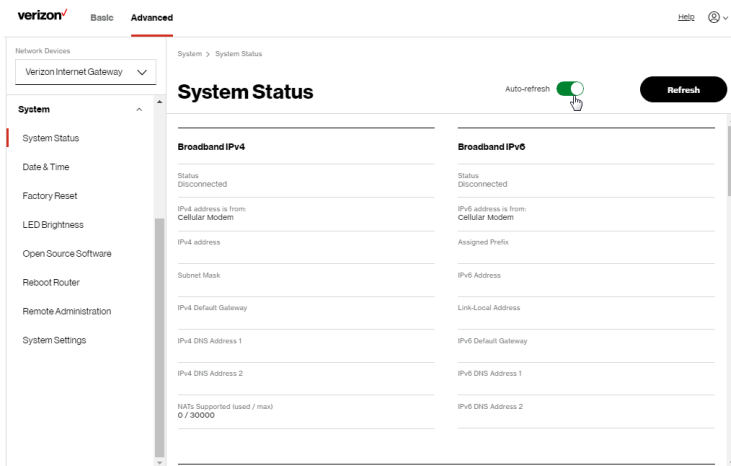



The screenshot shows the 'System Status' page for a Verizon Internet Gateway. The interface includes a top navigation bar with the Verizon logo, 'Basic', and 'Advanced' tabs. A left sidebar lists system settings such as 'System Status', 'Date & Time', 'Factory Reset', 'LED Brightness', 'Open Source Software', 'Reboot Router', 'Remote Administration', and 'System Settings'. The main content area displays the following information:

- System > System Status**
- System Status** (Title)
- Auto-refresh:
- Refresh** (Button)
- Modem** (Section Header)
- Firmware Version: 81137.7000.00.06.01.15
- Mobile Number
- IMEI: 356954490003560
- ICCID
- Sim Status: Absent
- Roaming Status
- 4G LTE Signal Strength
- 5G Signal Strength

The screenshot shows the 'System Status' page for a Router. The interface is identical to the previous screenshot, including the navigation and sidebar. The main content area displays the following information:

- System > System Status**
- System Status** (Title)
- Auto-refresh:
- Refresh** (Button)
- Router** (Section Header)
- Firmware Version: 3.3.0.4 (with **Check for updates** button)
- Hardware Version: 4
- Model Name: ASKNCM1100E
- Serial Number: ACC3200098
- LAN IP-v4 Address: 192.168.1.1
- Broadband Physical Connection: Disconnected
- Router has been active for: 0 day(s) 5 hours 19 minutes 43 seconds
- LED Status: Undefined

# SYSTEM

verizon Basic Advanced Help

Network Devices  
Verizon Internet Gateway

System > System Status

## System Status

Auto-refresh  Refresh

**System**

- System Status
- Date & Time
- Factory Reset
- LED Brightness
- Open Source Software
- Reboot Router
- Remote Administration
- System Settings

**Extender**

Device Name  
E3200-26f85384e668

Model Name  
E3200

Firmware Version  
3.1135

Hardware Version  
1102

Serial Number  
E301900718000005

MAC Address  
88f8f5384e66e8

System Up Time  
0 days 0 hours 10 minutes 5 seconds

LED Status  
Normal operation

Backhaul Type  
Ethernet

Bit Rate  
10 Gbps

verizon Basic Advanced Help

Network Devices  
Verizon Internet Gateway

System > System Status

## System Status

Auto-refresh  Refresh

**System**

- System Status
- Date & Time
- Factory Reset
- LED Brightness
- Open Source Software
- Reboot Router
- Remote Administration
- System Settings

Backhaul Type  
Ethernet

Bit Rate  
10 Gbps

IPv4 Address  
192.168.1.100

IPv6 Address

Subnet Mask  
255.255.255.0

Default Gateway  
192.168.1.1

Copyright © 2023 Verizon

## 5.3b/ DATE & TIME SETTINGS

You can set the time zone and enable automatic time updates.

*To configure the settings:*

1. From the **Advanced** menu, select **System**.
2. Select **Date & Time** in the **System** section.

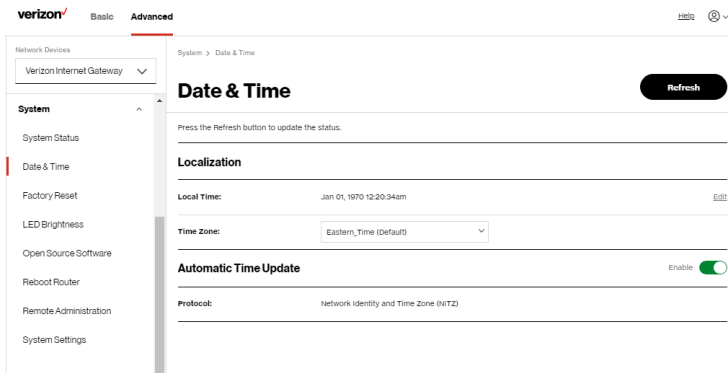

3. Select the local time zone. Your Gateway automatically detects daylight saving times for selected time zone.
4. In the **Automatic Time Update** section, click **Enable on** to perform an automatic time update.
5. Define the time server addresses.
6. Enter the IP address or domain name of the time server, then click **Apply** to save changes.
7. To refresh the page, click **Refresh**.

# SYSTEM

---

## 5.3c/ FACTORY RESET

You can use this functionality to save and load configuration files. These files are used to backup and restore the current configuration of your Gateway.

Only configuration files saved on a specific Verizon Internet Gateway for Business can be applied to that Verizon Internet Gateway for Business. You cannot transfer configuration files between Gateways.

*Warning: Manually editing a configuration file can cause your Gateway to malfunction or become completely inoperable.*

### Restore Options

You can restore your configuration settings to your Gateway factory default settings. Restoring the default settings erases the current configuration, including user defined settings and network connections. All connected DHCP clients must request new IP addresses. Your Gateway must restart.

Prior to restoring the factory defaults, you may want to save your current configuration to a file. This allows you to reapply your current settings and parameters to the default settings, as needed.

*Note: When restoring defaults, the setting and parameters of your Gateway are restored to their default values. This includes the administrator password. A user-specified password will no longer be valid.*

To restore your Gateway's factory default settings:

1. Click **Factory Reset** in the **System** section.
2. Select **Default Settings or Default Settings except current user settings**.
  - **Default Settings** – will erase all router settings including user settings for SSID and Passwords.
  - **Default Settings except current user settings** – will erase all router settings but will retain the user settings for SSID and passwords.

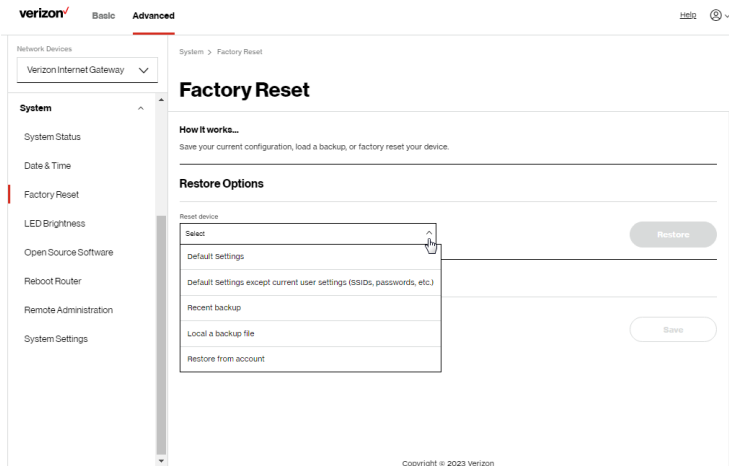

3. Click the **Restore** button. The factory default settings are applied and your Gateway restarts. Once complete, the Login page for the First Time Easy Setup Wizard displays.

*To load the configuration file:*

1. Select **Factory Reset** in the **System** section.
2. To load a previously saved configuration file, select **Recent backup** or **Load a backup file** then click **choose file**.
3. Browse to the location of the file, and click the **Restore** button to begin the configuration uploading process.
4. Accessing the **My Verizon** account also allows you to restore the previously saved settings. Select **Restore from account** and use **My Verizon** account to restore the saved settings to the Gateway.
5. Click the **Restore** button. Your Gateway will automatically restart with that configuration.

# SYSTEM

## Save Options

To save the configuration file:

1. From the **Advanced** menu, select **System**.
2. Select **Factory Reset** in the **System** section.

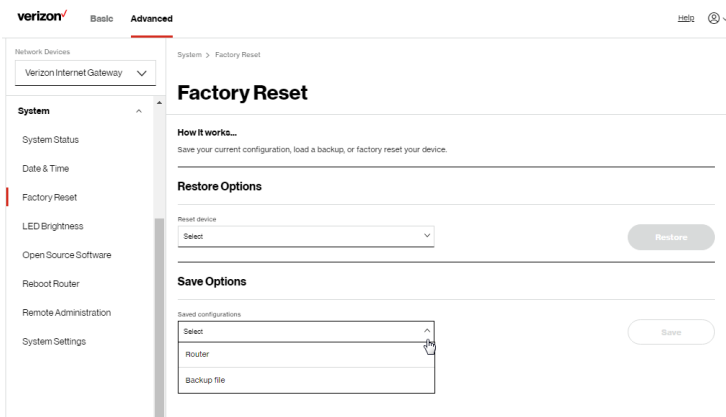

3. Select **Router** or **Backup file** to save the current configuration, then click **Save** button.
4. If you select **Backup file**, the configuration file is saved to you web browser's download folder.
5. Click **Save** button to begin the configuration backup process.

## 5.3d/ LED BRIGHTNESS

The Verizon Internet Gateway for Business allows you to set the LED brightness to turn Off (0%) or stay bright (50% or 100%) using the user interface.

To control the LED brightness:

1. Select **LED Brightness** in the **System** section.

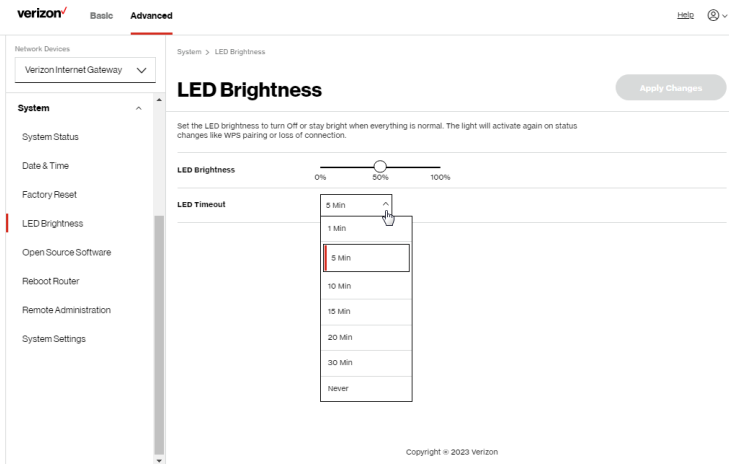

2. Slide the bar to adjust the brightness of the LED.
3. Select your preferred timeout period (in minutes) from the dropdown list for the LED dimming setting. The Status LED will automatically turn off after the timeout period.
4. Click **Apply Changes** to save changes.

**Note:** The light will activate again on status changes like WPS pairing or loss of connection.

# SYSTEM

## 5.3e/ REBOOT VERIZON INTERNET GATEWAY FOR BUSINESS

*Warning: Only select Reboot Router if instructed to do so by Verizon support.*

You can reboot your Gateway using the Reboot Router feature. Refer to 1.1a/ Reset PIN Hole for factory reset function.

*To reboot your Gateway using the user interface:*

1. Select **Reboot Router** in the **System** section.

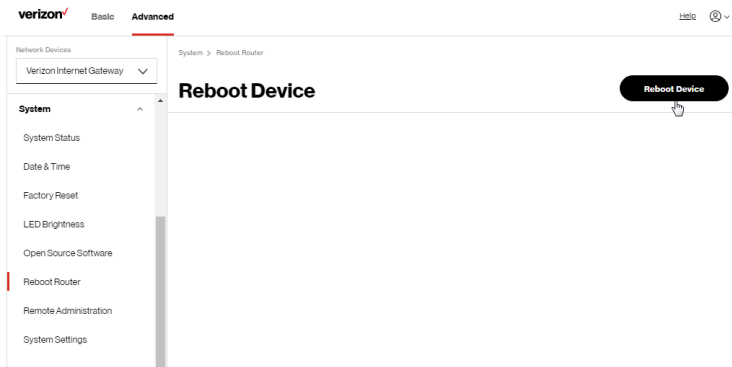

2. To reboot, click **Reboot Device**. Your Gateway will reboot. This may take up to a minute.
3. To access your Gateway user interface, refresh your web browser.
4. After the Status LED on the front panel turns solid white, you will automatically be sent to the web browser login page.



## 5.3f/ REMOTE ADMINISTRATION

**Caution:** Enabling Remote Administration places your Gateway network at risk from outside attacks.

You can access and control your Gateway not only from within the local network, but also from the internet using **Remote Administration**.

You can allow incoming access to the following:

- **Allow Incoming WAN Access to Web-Management** - used to obtain access to your Gateway's UI and gain access to all settings and parameters through a web browser.
- **Diagnostic Tools** - used for troubleshooting and remote system management by a user or Verizon.

Remote administration access of Web Management may be used to modify or disable firewall settings. Web Management services should be activated only when absolutely necessary.

To enable remote administration:

1. Select **Remote Administration** in the **System** section.

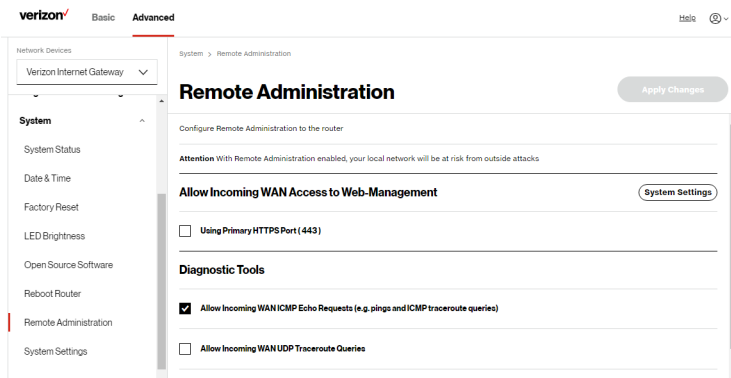

# SYSTEM

2. To enable access, select the check box.
3. To remove access, clear the check box.
4. Click **Apply Changes** to save changes.

## 5.3g/ SYSTEM SETTINGS

You can configure various system and management parameters.

*To configure system settings:*

1. Select **System Settings** in the **System** section.

The screenshot displays the Verizon System Settings interface. At the top, there are tabs for 'Basic' and 'Advanced', with 'Advanced' selected. The breadcrumb path is 'System > System Settings'. On the left, a sidebar menu lists various system settings, with 'System Settings' highlighted. The main content area is titled 'System Settings' and features an 'Apply Changes' button. The settings are organized into sections: 'Router Status' and 'User Settings'. The 'Router Status' section includes fields for 'Router's Hostname' (set to 'CROWN'), 'Local Domain' (set to 'mynetworksettings.com'), and 'Location' (set to 'Other'). The 'User Settings' section includes a 'User name' field (set to 'Admin'), a 'Set new password' field (with a 'minimum 8 characters' note), a 'Retype new password' field, and an 'Unsuccessful Login Attempts' dropdown menu (set to '10' with a 'maximum attempts' note). A 'Router' section is partially visible at the bottom.

The image displays two screenshots of the Verizon System Settings page. The top screenshot shows the 'Router' section with the following settings:

- Automatic Refresh of System Monitoring Web Pages
- Prompt for Password When Accessing via LAN
- Warn User Before Configuration Changes
- Session lifetime: 600 seconds
- Number of concurrent sessions that can be logged into the router: 10

The bottom screenshot shows the 'Remote Administration' section with the following settings:

- Primary HTTPS Management Port: 443
- System Logging:  Disable
- Remote System Notify Level: None
- Remote Security Notify Level: None

Both screenshots show a sidebar with 'System Settings' selected and an 'Apply Changes' button in the top right corner. The bottom screenshot also includes a copyright notice: 'Copyright © 2023 Verizon'.

- In the **Router Status** section, configure the following:

  - Router's Hostname** – enter the host name of your Verizon Internet Gateway for Business.

# SYSTEM

---

- **Local Domain** – view the local domain of the network.
  - **Location** – select your current location of the Gateway from the dropdown list.
3. In the **User Settings** section, you can view the administration user that can currently access your Wi-Fi network. In addition, you can modify the login password and manage the number of unsuccessful login attempts the administration user can enter before your Gateway temporarily denies all further login attempts by the user.
4. In the **Router** section, configure the following by selecting the check box:
- **Automatic Refresh of System Monitoring Web Pages** – activates the automatic refresh of system monitoring web pages.
  - **Prompt for Password when Accessing via LAN** – causes your Gateway to ask for a password when trying to connect to the network.
  - **Warn User Before Configuration Changes** – activates user warnings before network configuration changes take effect.
  - In the **Session Lifetime** field, specify the length of time required before re-entering the login password after your Gateway has been inactive.
  - In the **Number of concurrent sessions that can be logged into the router** field, select the number of users that can access your Gateway at the same time.
5. In the **Remote Administration** section, configure the following:
- Enter the **Primary HTTP Management Port**.  
Refer to 5.3f Remote Administration for using this feature.
  - In the **System Logging** section move the selector to **on** to activate system logging.

- **Remote System Notify Level** – specify the type of information, such as none, error, warning, and information, received for remote system logging.
  - **Remote Security Notify Level** – specify the type of information, such as none, error, warning, and information, received for remote network security logging.
6. Click **Apply Changes** to save changes.

---

06 /

# TROUBLE SHOOTING

**6.0** Troubleshooting Tips

**6.1** Frequently Asked Questions

---

This chapter lists solutions for issues that may be encountered while using your Verizon Internet Gateway for Business as well as frequently asked questions.

Although the majority of internet connectivity is automatic and transparent, if an issue does occur accessing the internet (e.g. complete loss of connectivity, inability to access services, etc.), you may need to take additional steps to resolve the problem.

# TROUBLESHOOTING TIPS

---

*Note: The advanced settings should only be configured by experienced network technicians to avoid adversely affecting the operation of your Gateway and your local network.*

## **6.0/ TROUBLESHOOTING TIPS**

### **6.0a/ IF YOU ARE UNABLE TO CONNECT TO THE INTERNET:**

- The first thing to check is whether your Gateway is powered on and is connected to the internet. Check the Status LED on the front of the Gateway. Be sure to refer to the “1.1c/ LEDs” on page 8 to determine status of the Gateway.
- If the prior tips do not resolve your connection issue, try power cycling the Gateway by unplugging the power cord from the power supply and wait 2 minutes. During the 2 min. wait period, also power cycle the network device (e.g. the computer, tablet, etc.) and then plug the power cable back into the Gateway. After 3-5 minutes, recheck the Status LED and try again to access the internet.
- If rebooting your Gateway does not resolve your connection issue, try resetting the Gateway back to its factory default state by manually pressing the reset PIN hole on the rear panel of the Gateway for 3+ seconds (the Status LED should go off) to begin resetting your Gateway. Your Gateway will perform a factory reset and return the Gateway to default settings. The Gateway will return to service in 3-5 minutes depending on your network connection. Check Status LED and if it is solid white, try again to access the internet.

### **6.0b/ IF YOU ARE UNABLE TO CONNECT TO YOUR VERIZON INTERNET GATEWAY FOR BUSINESS USING WI-FI:**

- Be sure your Wi-Fi device is within range of your Gateway; move it closer to see if your connection improves.



- Check your network device's Wi-Fi settings to be sure your device's Wi-Fi is on (enabled) and that you have the correct Wi-Fi network and password (if using a Wi-Fi password) as configured on your Gateway.
- Be sure you are connecting to the correct Wi-Fi network; check to be sure you are using your Gateway's SSID. In some cases, if using a Wi-Fi password, you may need to enter the Wi-Fi password into your network device again to be sure your device accepts the password.
- Check to be sure you are running the latest software for your network device.
- Try turning your network device's Wi-Fi off and on, and try to connect.
- If you have made any changes in your network settings and turning your network device's Wi-Fi off and on does not help, try to restart your network device.
- You may need to turn the Wi-Fi settings from on to off, and back to on again and apply the changes.
- If you are still unable to access your Gateway, you may need to try connecting to the Gateway using another network device. If the issue goes away with another network device, the issue is likely with that individual network device's configuration.

## **6.0c/ ACCESSING YOUR VERIZON INTERNET GATEWAY FOR BUSINESS IF YOU ARE LOCKED OUT**

- If your Gateway connection is lost while making configuration changes, a setting that locks access to Gateway's UI may have inadvertently been activated.

*The common ways to lock access to your Gateway are:*

- Scheduler - If a schedule has been created that applies to the computer over the connection being used, your Gateway will not be accessible during the times set in the schedule.

# TROUBLESHOOTING TIPS

---

- Access Control - If the access control setting for the computer is set to block the computer, access to your Gateway is denied.

To gain access, restore the default settings to your Gateway.

## **6.0d/ RESTORING YOUR VERIZON INTERNET GATEWAY FOR BUSINESS' DEFAULT SETTINGS**

There are two ways to restore the default settings of your Gateway. It is important to note that after performing either procedure, all previously save settings on your Gateway will be lost.

For additional information regarding the Restore Defaults feature, refer to section 5.3c/ Factory Reset/Restore Options.

- Using the tip of a paperclip or similar object, press and hold the reset PIN hole on the rear of your Gateway for over three seconds.
- Access the UI and navigate to the Advanced Settings page. Select the 5.3c/ Factory Reset option. After saving your configuration, if desired, click the Factory Default radio button. For additional details, refer to the 5.3c/ Factory Reset/Restore Options section of this guide.

*Note: If you reset or reboot your Gateway, you may also need to disconnect your Gateway's power supply for a few minutes (3 or more) and then reconnect the power cable.*

## **6.0e/ LAN CONNECTION FAILURE**

*To troubleshoot a LAN connection failure:*

- Verify your Gateway is properly installed, LAN connections are correct, and that the Gateway and communicating network devices are all powered on.
- Confirm that the computer and your Gateway are both on the same network segment.

If unsure, let the computer get the IP address automatically by initiating the DHCP function, then verify the computer is using an IP address within the default range of 192.168.0.2 through 192.168.0.254. If the computer is not using an IP address within the correct IP range, it will not connect to your Gateway.

- Verify the subnet mask address is set to 255.255.255.0.

## **6.0f/ TIMEOUT ERROR OCCURS WHEN ENTERING THE URL OR IP ADDRESS**

*Verify the following:*

- All computers are working properly.
- IP settings are correct.
- Your Gateway is on and connected properly.
- The Gateway settings are the same as the computer.

*For connections experiencing lag or a slow response:*

- Check for other devices on the network utilizing large portions of the bandwidth and if possible temporarily stop their current utilization and recheck the connection.
- If lag still exists, clear the cache on the computer and if still needed, unplug the Ethernet cable or disable the Wi-Fi connection to the computer experiencing the slow connection and then reconnect or enable the Wi-Fi connection and try the connection again.

*In rare cases you may also need to:*

- Unplug the Ethernet cable to your Gateway and restart the Gateway, wait 1-2 mins. and insert the Ethernet cable again.
- Under limited circumstances you may use a port forwarding configuration on the Gateway, based on the application you are using (refer to the 5.0e/ Port Forwarding section or Verizon's support online help for more details).

# TROUBLESHOOTING TIPS

## 6.0g/ FRONT LEDS AND WPS BUTTON

### System LED

Front LED Mode	Status	LED Pattern
<b>System Status (O)</b>		
Bootup	System booting	Soft blink white
	Firmware update	Fast blink white
Regular usage mode	Rest mode	Solid white
Wired WAN connectivity	In service	Solid blue
IP Passthrough mode	IPPT ( IP Passthrough) enabled	Solid green
Other	Factory reset	Fast blink yellow
	Hardware error	Soft blink red
	No SIM card	Hard blink red
	No signal	Solid red

### Wi-Fi LED

Front LED Mode	Status	LED Pattern
		
Regular usage mode	Passing signal	Solid white
	Setup complete	Solid white
	Not connected to Internet	Solid red
	Rest mode	Solid dim white

Front LED Mode	Status	LED Pattern
Pairing	Pairing WPS (in progress)	Hard blink blue
	WPS connection success	Fast blink blue
	WPS connection unsuccessful (time out)	Fast blink red
	WPS connection failure (interrupted)	Hard blink red
Other	Hardware error	Soft blink red

### Signal Strength LEDs

Front LED Mode	Status	LED Pattern
Regular usage mode	Rest mode	50% dim white
3 bars (■ ■ ■)	Excellent 5G or 4G coverage	Solid white
2 bars (■ ■)	Good 5G or 4G coverage	Solid white
1 bar (■)	Weak 5G or 4G coverage	Solid white

The rear panel's WPS Button allows quick access to the Wi-Fi Protected Setup (WPS) feature and handset paging/paring mode.

# FREQUENTLY ASKED QUESTIONS

## 6.0h/ REAR LIGHTED INDICATORS

Ethernet Port LED Mode	Status	Left LED	Right LED
Wired LAN connection  * Threshold level can be decided based on port capability	Ethernet > 100M* Link	Solid white	Off
	Ethernet > 100M* Activity	Blinking white	Off
	Ethernet < 100M* Link	Off	Solid yellow
	Ethernet < 100M* Activity	Off	Blinking yellow
	No Ethernet connection	Off	Off

## 6.1/ FREQUENTLY ASKED QUESTIONS

### 6.1a/ I'VE RUN OUT OF ETHERNET PORTS ON MY VERIZON INTERNET GATEWAY FOR BUSINESS. HOW DO I ADD MORE COMPUTERS OR DEVICES?

Plugging in an Ethernet hub or switch expands the number of ports on your Gateway.

- Run a straight-through Ethernet cable from the Uplink port of the new hub to the Gateway.

Use a crossover cable if there is no Uplink port/switch on your hub, to connect to the Gateway.

- Remove an existing device from the Ethernet port on your Gateway and use that port.

## **6.1b/ HOW DO I CHANGE THE PASSWORD ON MY GATEWAY UI?**

*To change the password:*

1. On the main screen, select **Advanced**, then select **System Settings** in the **System** section.
2. In the **User Settings** section, set a new password.

## **6.1c/ IS THE WI-FI OPTION ON BY DEFAULT ON MY GATEWAY?**

Yes, your Gateway's Wi-Fi option is activated out of the box.

## **6.1d/ IS THE WI-FI SECURITY ON BY DEFAULT WHEN THE WI-FI OPTION IS ACTIVATED?**

Yes, with the unique WPA2 (Wi-Fi Protected Access II) key, also called the Wi-Fi Password, that is printed on the sticker on the back of your Gateway.

## **6.1e/ ARE THE GATEWAY'S ETHERNET PORTS AUTO-SENSING?**

Yes. Either a straight-through or crossover Ethernet cable can be used.

## **6.1f/ CAN I USE AN OLDER WI-FI DEVICE TO CONNECT TO MY GATEWAY?**

Yes, your Gateway can interface with 802.11b, g, n, ac or ax devices. The Gateway also can be setup to handle only n Wi-Fi cards, g Wi-Fi cards, b Wi-Fi cards, or any combination of the three.

# FREQUENTLY ASKED QUESTIONS

---

## **6.1g/ CAN MY WI-FI SIGNAL PASS THROUGH FLOORS, WALLS, AND GLASS?**

The physical environment surrounding your Gateway can have a varying effect on signal strength and quality. The denser the object, such as a concrete wall compared to a plaster wall, the greater the interference. Concrete or metal reinforced structures experience a higher degree of signal loss than those made of wood, plaster, or glass.

## **6.1h/ HOW DO I LOCATE THE IP ADDRESS THAT MY COMPUTER IS USING?**

In Windows 8 or Windows 10, click the Windows button and select **Settings**, then click **Network & Internet** and **Status**. Click the **Properties** button for details of IP address.

On Mac OS X, open System Preferences and click the Network icon. The IP address displays near the top of the screen.

To find the IP address from the router GUI:

1. From the **Basic** menu, select **Devices** from the left pane.
2. Click the Settings icon to access the **Device Settings** page for that device to view detailed IP address information for the device.

## **6.1i/ I USED DHCP TO CONFIGURE MY NETWORK. DO I NEED TO RESTART MY COMPUTER TO REFRESH MY IP ADDRESS?**

No. In Windows 8, Windows 10 and Mac OSX, unplug the Ethernet cable or Wi-Fi card, then plug it back in.



---

**6.1j/ I CANNOT ACCESS MY GATEWAY UI. WHAT SHOULD I DO?**

If you cannot access the UI, verify the computer connected to your Gateway is set up to dynamically receive an IP address.

**6.1k/ I HAVE A FTP OR WEB SERVER ON MY NETWORK. HOW CAN I MAKE IT AVAILABLE TO USERS ON THE INTERNET?**

For a web server, enable port forwarding for port 80 to the IP address of the server. Also, set up the web server to receive that port. Configuring the server to use a static IP address is recommended.

For a FTP server, enable port forwarding for port 21 to the IP address of the server. Also, set up the web server to receive that port. Configuring the server to use a static IP address is recommended.

**6.1l/ HOW MANY COMPUTERS CAN BE CONNECTED THROUGH MY GATEWAY?**

Your Gateway is capable of 254 connections, but we recommend having no more than 132 connections. As the number of connections increases, the available speed for each computer decreases.

---

*07 /*

# **SPECIFICATIONS**

**7.0** General Specifications

**7.1** Connections

---

The specifications for your Verizon Internet Gateway for Business are as follows.

This includes standards, cabling types and environmental parameters.

# GENERAL SPECIFICATIONS

---

*Note: The specifications listed in this chapter are subject to change without notice.*

## 7.0/ GENERAL SPECIFICATIONS

Model Number:	NCM1100E
Technical Standard:	3GPP Release 16 (DL CAT 19, UL CAT 18)
Frequency band:	LTE Band: B2,B5,B13,B48,B66, DL 4x4 MIMO, UL 1x1 SISO 5G Band: n2, n5, n48, n66, n77, DL 4x4 MIMO, UL 2x2 MIMO
Wi-Fi Standard:	802.11 a/b/g/n/ac/ax
Dimensions:	140 mm x 140 mm x 220.5 mm (L x W x H)
Weight:	1.63 Kg
Certifications:	FCC, UL
Operating Temperature:	5° C to 40° C (41° F to 104° F)
Storage Temperature:	-45° C to 70° C (-49° F to 158° F)
Operating Humidity:	5% to 90%
Storage Humidity:	5% to 95% (non-condensing)

## 7.1/ CONNECTIONS

DC Input:	source adapter: 12V/5A
Ethernet:	RJ-45 Gigabit LAN Ports 3 x 1G; 1 x 2.5G*; *Coming soon (Post Launch)

---

08 /

# NOTICES

**8.0** Regulatory Compliance Notices

---

This chapter lists various compliance and modification notices, as well as the NEBS requirements and GPL.

# REGULATORY COMPLIANCE NOTICES

---

## **8.0/ REGULATORY COMPLIANCE NOTICES**

### **8.0a/ Class B Equipment**

This equipment has been tested and found to comply with the limits for a Class B digital device, pursuant to Part 15 of the FCC Rules. These limits are designed to provide reasonable protection against harmful interference in a residential installation. This equipment generates, uses and can radiate radio frequency energy and, if not installed and used in accordance with the instructions, may cause harmful interference to radio communications. However, there is no guarantee that interference will not occur in a particular installation. If this equipment does cause harmful interference to radio or television reception, which can be determined by turning the equipment off and on, the user is encouraged to try to correct the interference by one of the following measures:

- Reorient or relocate the receiving antenna.
- Increase the separation between the equipment and receiver.
- Connect the equipment into an outlet on a circuit different from that to which the receiver is connected.
- Consult the dealer or an experienced radio/ TV technician for help.

FCC Caution: Any changes or modifications not expressly approved by the party responsible for compliance could void the user's authority to operate this equipment.

### **RF Exposure Information (MPE)**

This device has been tested and meets applicable limits for Radio Frequency (RF) exposure.

This transmitter must not be co-located or operating in conjunction with any other antenna or transmitter.

This equipment should be installed and operated with minimum distance 36 cm between the radiator & your body.

## Operation restrictions

FCC regulations restrict operation of this device to indoor use only.

The operation of this device is prohibited on oil platforms, cars, trains, boats, and aircraft, except that operation of this device is permitted in large aircraft while flying above 10,000 feet in the 5.925-6.425 GHz band.

Operation of transmitters in the 5.925-7.125 GHz band is prohibited for control of or communications with unmanned aircraft systems.

This device complies with Part 15 of the FCC Rules. Operation is subject to the following two conditions: (1) this device may not cause harmful interference, and (2) this device must accept any interference received, including interference that may cause undesired operation.

## 8.0b/ NEBS (Network Equipment Building System) Statement

An external SPD is intended to be used with NCM1100E.

**WARNING:** The intra-building ports of the equipment or subassembly is suitable for connection to intra-building or unexposed wiring or cabling only. The intra-building port(s) of the equipment or subassembly **MUST NOT** be metallically connected to interfaces that connect to the OSP or its wiring. These interfaces are designed for use as intra-building interfaces only (Type 4 ports as described in GR-1089) and require isolation from the exposed OSP cabling. The addition of Primary Protectors is not sufficient protection in order to connect these interfaces metallically to OSP wiring.



# REGULATORY COMPLIANCE NOTICES

---

## **8.0c/ UL Statement**

This product is intended to be supplied by an UL certified Class II power supply or Class II DC source suitable for use at minimum Tma 40 degree C whose output meets ES1, PS2 and is rated 12VDC, 5A. If need further assistance, please visit <http://support.verizon.com/router> to find your nearest Verizon store or for 24/7 help with live chat and device-specific support.

*Caution: The Verizon Internet Gateway for Business must be installed inside the home or office. The Gateway is not designed for exterior installation.*

## **8.0d/ GENERAL PUBLIC LICENSE**

This product includes software made available under open source licenses. Additional information about that software, applicable licenses, and downloadable copies of source code, is available at:

<https://verizon.com/opensource/>

All open source software contained in this product is distributed WITHOUT ANY WARRANTY. All such software is subject to the copyrights of the authors and to the terms of the applicable licenses included in the download.

This information is provided for those who wish to edit or otherwise change such programs. You do not need a copy of any of such open source software source code to install or operate the device.